

The Poole Iron Age Logboat

edited by

Jessica Berry

David Parham

Catrina Appleby

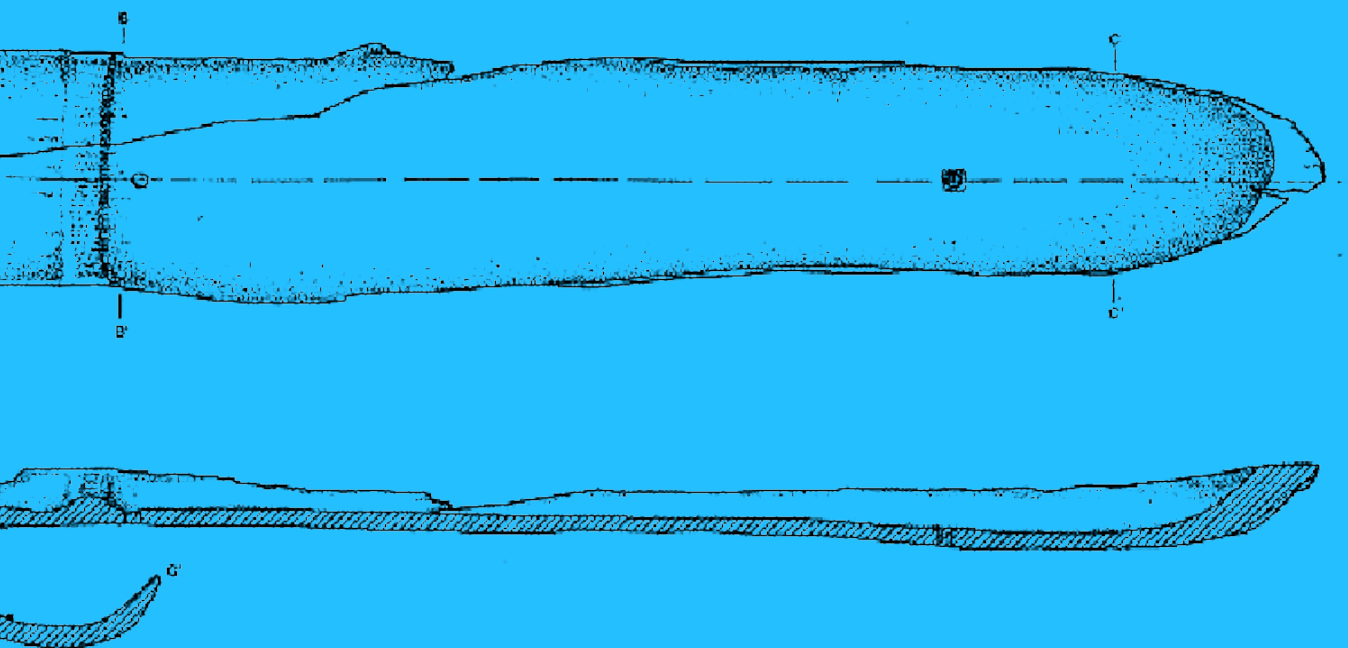

with contributions by

Damian Goodburn, Jeremy Hutchings, Keith Jarvist, Seán McGrail, Katie Morton,
James A Spriggs, Pat Tanner, David Watkins, Eileen Wilkes

The Poole Iron Age Logboat

edited by

Jessica Berry, David Parham
and Catrina Appleby

with contributions by

Damian Goodburn, Jeremy Hutchings, Keith Jarvist, Seán McGrail, Katie Morton,
James A Spriggs, Pat Tanner, David Watkins and Eileen Wilkes



ARCHAEOPRESS ARCHAEOLOGY



ARCHAEOPRESS PUBLISHING LTD
Summertown Pavilion
18-24 Middle Way
Summertown
Oxford OX2 7LG

www.archaeopress.com

ISBN 978-1-78969-144-3
ISBN 978-1-78969-145-0 (e-Pdf)

© the individual authors and Archaeopress 2019

Cover: 3D laser scan of the physical remains of the Poole logboat

All rights reserved. No part of this book may be reproduced, or transmitted, in any form or by any means, electronic, mechanical, photocopying or otherwise, without the prior written permission of the copyright owners.

This book is available direct from Archaeopress or from our website www.archaeopress.com

Contents

Contents	i
List of figures	iii
List of tables	v
List of contributors	vi
Acknowledgements	vii
Foreword	ix
<i>Professor Seán McGrail</i>	
Chapter 1 Introduction	1
<i>Keith Jarvis†</i>	
Chapter 2 Environmental and archaeological background to prehistoric Poole Harbour	5
<i>Eileen Wilkes</i>	
Physical character	5
Geology and environment	5
Relative sea-level change	7
Archaeological background	8
Known archaeology	8
Chapter 3 Evidence for the building of the Poole logboat	11
<i>Damian Goodburn</i>	
Introduction	11
Investigations into ancient British logboats	12
Methodology used for recording features of the Poole logboat	13
Towards a hypothetical reconstruction of the original form and size of the Poole logboat	14
Hull distortion and shrinkage since discovery	16
Reconstructing the parent tree used for the Poole logboat	17
The early stages in building the Poole logboat	20
Final shaping and smoothing of the hull	26
Reconstructing the tool kit	29
Weight and movement of the hull	31
Discussion of design features	33
Notes on performance	33
Acknowledgements	34
Chapter 4 The Poole logboat: digital comparisons	35
<i>Pat Tanner</i>	
Introduction	35
Recording method	35
Analysis of the 1974 reconstruction	39
Hypothetical reconstruction	51
Reconstructing the parent log	65
Analysis of the 2013 reconstruction	66
Concluding remarks	83
Acknowledgements	85
Glossary and abbreviations	85

Chapter 5 The conservation of the Poole logboat	87
<i>Jeremy Hutchings and James A Spriggs</i>	
Introduction.....	87
Treatment prior to sucrose immersion	87
Selection of sucrose method.....	88
Pre-treatment documentation and investigation	89
Impregnation treatment	90
Analysis of the wood.....	92
Selection of drying regime.....	93
Preparation for display.....	102
Conclusions	102
Acknowledgements.....	103
Chapter 6 The display and interpretation of the Poole logboat.....	105
<i>Katie Morton and David Watkins</i>	
Introduction.....	105
Initial display	106
Initial conservation	106
1990s Museum redisplay	106
Sucrose conservation.....	106
Reconstruction projects	107
The present display	108
The future interpretation of the logboat	111
Bibliography	113
Index	119

List of figures

Figure 2.1	Poole Harbour, Dorset: location of sites mentioned in the text (drawn by Tom Cousins).....	6
Figure 3.1	The location of key features of the Poole logboat recognised and recorded in 1994 and July 2013.	14
Figure 3.2	Approximate outline reconstruction of the shape and dimensions of the freshly built Poole logboat	17
Figure 3.3	a: reconstruction of the great prehistoric oak used to build the Poole logboat; b: a typical large, modern woodland oak from traditionally managed woodland in southern England..	19
Figure 3.4	Drawings showing the likely key stages in the building of the Poole logboat	22
Figure 3.5	Further stages in building the Poole logboat.....	25
Figure 3.6	Sketches showing the character of all the best-preserved surviving toolmarks (TMs) seen in photographs taken in 1964, and records made 1994 and 2013	28
Figure 3.7	Sketch to show a possible form of the finished Poole logboat being hauled to its launch site .	32
Figure 4.1	3D laser scan of physical remains	36-37
Figure 4.2	1974 survey drawing (after McGrail 1977, fig. 10.4).....	38
Figure 4.3	2013 scan outline overlaid on 1974 survey drawing.....	40-41
Figure 4.4	2013 survey drawing	42-43
Figure 4.5	1974 McGrail reconstruction (after McGrail 1977, fig. 10.5).....	44
Figure 4.6	2013 digital version of 1974 reconstruction.....	46-47
Figure 4.7	State A.....	48
Figure 4.8	State B.....	48
Figure 4.9	State C.....	49
Figure 4.10	State D	49
Figure 4.11	Hogging at stern area.....	51
Figure 4.12	Hogging at bow area	52
Figure 4.13	Cross-sections taken at 10 stations.....	53
Figure 4.14	Section at station 0.....	53
Figure 4.15	Section at station 0 showing possible parent log diameter.....	53
Figure 4.16	Preferred stern profile shape	54
Figure 4.17	Andrew Hawke’s photo (1964) with reconstruction superimposed.....	54
Figure 4.18	Projecting hull cross-section profiles at each station	55
Figure 4.19	Section at station 9 showing possible parent log diameter.....	55
Figure 4.20	Solid hull model created from repaired cross-sections	56
Figure 4.21	Unusual step feature at the bow (image courtesy of Poole Museum)	56
Figure 4.22	3D scan of bow area showing false stem and step feature.....	57
Figure 4.23	Bow section showing remodelled false stem and hull step	57
Figure 4.24	Reconstruction showing recorded material	58-59
Figure 4.25	Forward transverse ridge.....	60
Figure 4.26	Aft transverse ridge	60
Figure 4.27	Internal space division	61
Figure 4.28	Aft space division	61
Figure 4.29	Stern transom slot.....	62
Figure 4.30	Central hole.....	62
Figure 4.31	Forward hole	63

Figure 4.32 Aft hole.....	63
Figure 4.33 Possible thwart and stanchion.....	64
Figure 4.34 Hypothetical reconstruction (including thwarts)	65
Figure 4.35 Hypothetical reconstruction fully loaded.....	65
Figure 4.36 The parent log.....	66
Figure 4.37 The parent log halved.....	66
Figure 4.38 The half log roughly hollowed.....	66
Figure 4.39 The exterior shape formed.....	66
Figure 4.40 The interior shape finished and transom board fitted.....	66
Figure 4.41 Reconstruction drawing.....	68-69
Figure 4.42 Weight report using green oak.....	71
Figure 4.43 Weight report State A: restricted draft at 60 kg per person.....	74
Figure 4.44 Reconstructed logboat with restricted draft at 60 kg per person.....	74
Figure 4.45 Weight report State A: restricted draft at 80 kg per person.....	75
Figure 4.46 Reconstructed logboat with restricted draft at 80 kg per person.....	76
Figure 4.47 Weight report State B: standard freeboard 150 mm.....	76
Figure 4.48 Reconstructed logboat with standard draft (150 mm)	77
Figure 4.49 Weight report State C: minimum freeboard.....	78
Figure 4.50 Reconstructed logboat with minimum draft (130 mm).....	78
Figure 4.51 Weight report State D: maximum crew at 60 kg per person.....	79
Figure 4.52 Reconstructed logboat with maximum crew at 60 kg per person.....	79
Figure 4.53 Weight report State D: maximum crew at 80 kg per person.....	80
Figure 4.54 Reconstructed logboat with maximum crew at 80 kg per person.....	81
Figure 5.1 Key dates in the treatment of the Poole logboat.....	87
Figure 5.2 Boat in the tank in 1976 at Scaplin’s Court, Poole Museum	88
Figure 5.3 Photogrammetric record of boat.....	89
Figure 5.4 Boat being lifted into treatment tank in 1995.....	90
Figure 5.5 Wood core sample analysis, December 2003.....	93
Figure 5.6 Wood core sample analysis, May 2005.....	93
Figure 5.7 Power-hosing sucrose crust from boat in May 2005.....	95
Figure 5.8 Sucrose crystals in open grain and the transom slot in May 2005 (photo courtesy of Jeremy Hutchings).....	96
Figure 5.9 Keith Jarvis, Curator of Archaeology at Poole Museum, in the drying chamber.....	97
Figure 5.10 Graph showing reduction in weight of the boat versus set RH on humidistat and actual RH within the chamber, over time.....	99
Figure 5.11 External weather conditions in Poole compared to actual conditions within the chamber.....	99
Figure 5.12 Diagrams showing weight loss versus condensate removed during drying.....	99
Figure 5.13 Diagrams showing dimensional changes during drying process.....	100-101
Figure 5.14 Localised cleaning using water and absorbent paper.....	102
Figure 5.15 Plugging core sample holes with coloured Liberon™ wax filler.....	102
Figure 6.1 The Poole logboat when it was first raised in 1964.....	105
Figure 6.2 Diorama of the Poole logboat at Poole Waterfront Museum, late 1990s.....	107
Figure 6.3 The logboat as it is displayed today.....	108
Figure 6.4 Digitally recording the logboat in 2013.....	109
Figure 6.5 Text panel from the current display at Poole Museum.....	110

List of tables

Table 4.1 Comparison of surveyed dimensions.....	35
Table 4.2 Comparison of 1974 reconstruction data to 2013 digitally version of 1974 data.....	39
Table 4.3 Comparison of 1974 test result data to 2013 digital version of 1974 reconstruction.....	50
Table 4.4 Log conversion details.....	67
Table 4.5 Comparison of empty logboat.....	70
Table 4.6 Overall characteristics and Holtrop analysis results for the various flotation conditions.....	82
Table 5.1 Analyses of sucrose syrup samples from 1996 to 2003 (British Sugar)	91
Table 5.2 Wood core sample analysis, October 1997 (% sucrose content)	92
Table 5.3. Wood core sample analysis, November 1998 (% sucrose content).....	92
Table 6.1 Styles of interpretation in the ground-floor logboat gallery.....	110

List of contributors

Catrina Appleby: Freelance Editor

Jessica Berry: CEO, Maritime Archaeology Sea Trust

Damian Goodburn: Archaeological Woodwork Specialist

Jeremy Hutchings: Head of Collections and Documentation, The Norwegian Armed Forces Museum

Keith Jarvis[†]: former Archives Collections Officer at Poole Museum

Seán McGrail: Professor of Maritime Archaeology (retired)

Katie Morton: former Poole Museum Curator (Collections and Community)

David Parham: Professor of Archaeology, Bournemouth University

James A Spriggs: Archaeological conservator (retired). Formerly Head of Conservation at York Archaeological Trust, UK

Pat Tanner: Boatbuilder, sailor and maritime archaeologist specialising in ship reconstructions

David Watkins: Local History Manager at Poole Museum

Eileen Wilkes: Principal Academic in Archaeology at Bournemouth University

Acknowledgements

This volume is the brainchild of Professor David Parham of Bournemouth University and Jessica Berry, CEO of the Maritime Archaeology Sea Trust, who came up with the idea of gathering the combined knowledge of all the specialists in this field and acted as academic editors. Until now the vessel has existed in a kind of vacuum, stunning to behold but with little information available all in one place.

This project could not have been carried out without the generous funding from, in no particular order, the Headley Trust, the Gosling Foundation, the Autumn Trust, the Valentine Charitable Trust and the Marsh Christian Trust.

Thanks are due to Poole Waterfront Museum for facilitating access to the logboat and providing details and information from their archive, and to the team at Archaeopress for their patience, energy and enthusiasm.

Particular thanks are owed to all the authors for all their hard work and patience, and to Professor Seán McGrail for providing the Foreword.

The volume was edited and prepared for publication by Catrina Appleby.

Foreword

On 20 August 1964, a dredger working in Poole Harbour, east of Brownsea Island, recovered a large fragment of a logboat. Two weeks later, divers from Bournemouth British Sub Aqua Club (BSAC) located and retrieved a further element of this boat. When the two timbers were laid alongside one another, they formed the near-complete bottom of an oak logboat (see Figure 4.17), i.e. a boat hewn out of a single log. It was subsequently radiocarbon dated to c. 300 BC.

In 1972 I began to document the logboats held in English and Welsh museums. In August 1974, using a measuring tape, a plumb bob, a pencil and a drawing board, I compiled a measured drawing of the Poole logboat remains (see Figure 4.2) as they lay in a tank on display in Poole Museum's Old Town House (now known as Scaplen's Court). The sides of that tank were used as axes for taking the boat's measurements.

Of the 179 logboats I documented in that survey, only 26 had sufficient remains to warrant compiling a hypothetical reconstruction drawing by 'filling-in' those parts of the boat now missing from the remains, so that the original size, shape and features of the ancient boat could be depicted. The Poole boat was one of this small group, with its full length and part of its top edge (sheerline) surviving. Thus its original, overall dimensions were known and a hypothetical reconstruction of the original boat was drawn (see Figure 4.5). From this drawing, a set of hydrostatic curves was calculated and from them, estimates were made of the loads that such a boat could have carried and the speeds it could have achieved under paddle or pole (McGrail 1978, 254–7).

Conservation having been completed, this important boat has been on display in Poole Museum since July 2007. During the last two years, Jessica Berry, CEO of the Maritime Archaeology Sea Trust (MAST) and Professor Dave Parham of Bournemouth University have coordinated and funded the long-awaited research programme undertaken by a multidisciplinary team whose findings are published in this volume. In Chapter 2 the environmental and archaeological contexts of this Iron Age find are evaluated by Dr Eileen Wilkes of Bournemouth University. With full access to the boat now available, the remains have been examined by Dr Damian Goodburn, a specialist in ancient woodworking, who establishes in Chapter 3 the size, shape and special features of the oak tree from which this boat was hewn. Pat Tanner, drawing on his 25 years experience as a builder of wooden boats and ships, recorded the boat using 3-dimensional laser scanning: the data from this recording has been processed by computer, leading to an improved 'as found' drawing and a better understanding of the boat's original size, shape and capabilities (Chapter 4). In Chapter 5 the boat's conservation is documented by conservators Dr Jeremy Hutchings and James Spriggs. Finally, in Chapter 6 Katie Morton and David Watkins of Poole Museum describe the presentation and display of this important prehistoric boat.

The laser scanning of this logboat and the use of computers to investigate and develop that data have resulted in a more accurate 'as-found' drawing of the boat than could be gained from my 'primitive' 1974 attempt; thus a better understanding has been attained of this boat's original size, shape and capabilities. Moreover, much is now known about the great oak tree from which this logboat was created and we have a deeper understanding of its Iron Age environmental and archaeological context. The documentation of the problems encountered during the conservation of the Poole logboat provides useful information for future similar projects.

Professor Seán McGrail
November 2018

Chapter 1

Introduction

Keith Jarvis†

(formerly Archaeological Officer, Poole Museums Archaeological Unit)

The discovery of the Poole logboat in 1964 started a 40-year project which has involved many volunteers, sponsors, and staff over the years. In retrospect, the vessel was found at a difficult time, when conservation was in its infancy and had not yet become almost routine. Corporate funding was also scarce until the 1990s and Lottery funding was not available until later still. In 1964, Poole Museums was run by volunteers and Dorchester Museum assisted with the discovery (Peers 1965). Divers helped to recover the vessel, which was found after dredging near the main channel at 6–7 m depth. However, Poole Harbour Commissioners have since confirmed that the dredging would have been to a depth of 2 m; consequently, it is likely that the vessel had slipped into the main channel. This would be consistent with being abandoned in a muddy Iron Age creek, as is often seen with old hulks on mudflats today.

Since the discovery, we now know that Green Island was an international Iron Age trading port in the centuries before the Romans arrived, and had two large stone and timber moles, emphasising its status (Markey, Wilkes and Darvill 2002). Our vessel can now be seen as transporting goods from this trade.

After the discovery, the logboat entered the most dangerous period of its existence. Photographs show it standing in quayside yards, but fortunately there was enough interest and voluntary help to ensure that it survived this stage and did not dry out and disintegrate. By the early 1970s the vessel was safely in a concrete tank of water in the Scaplen's Court Museum. Credit must be due to those unknown persons who constructed this to secure the boat's safety.

From the late 1970s onward, the museum's conservator, Annette Downing, worked on the logboat whilst the curator, Graham Smith, acquired some PEG (Polyethylene Glycol) for conservation. Conservation advice and sampling was provided by the National Maritime Museum. However, when the majority of the PEG was lost through a spillage accident, the project failed to maintain momentum.

In 1995, responsibility for the logboat moved to the Poole Museums Archaeological Unit and the author asked David Watkins to review the project, assess low-cost solutions relying on sponsorship, and formulate a project design. Three options became apparent: the first was to soak the logboat in a tank of PEG but this presented financial difficulties. A second option was soaking in PEG followed by freeze drying, but this would have required the logboat to be cut to fit into the largest available freeze dryer; it was rejected for this reason.

A new, pioneering option was soaking the vessel in sugar before drying slowly; this was attractive due to the lower costs, and support from British Sugar (see Chapter 5). Jeremy Hutchings had completed a PhD thesis on the process but it had not been undertaken on a large object in the UK and would require solving the various problems presented. For museum staff, it involved managing chemistry, conservation and engineering skills. The museum commissioned Jim Spriggs of York Archaeological Trust to advise on the project and work began by removing the top of an old British Sugar road tanker to provide a suitable tank which could be kept in a council depot. Poole Rowing Club helped to move the logboat to the depot where it was immersed in the tank of sugar solution supplied by British Sugar, who also provided laboratory sample analyses. The author continued this work initiated by Watkins and took it through to completion. During this time there were several sugar changes, and many samples were taken, while lack of finance caused delays and setbacks. Jeremy Hutchings, now a lecturer in Norway, continued to advise

and Health and Safety procedures for the tank, aimed at preventing spillage from sugar and biocide, were put in place.

After the soaking, drying needed to be addressed and a Heritage Lottery bid in 2004 to alter the Waterfront Museum gave a target date for display. The next challenge was to construct a heated drying chamber in suitable premises. Expensive hired units and empty council properties were rejected and eventually part of the Scaplen's Court Museum was used as this did not involve any additional costs. At the time there were concerns about large heating bills and damp but these proved groundless.

The construction of the drying chamber required careful design and was based on timber seasoning units. It consisted of a plywood box roughly 12 m by 4 m by 2 m, insulated externally with polystyrene foam slabs and an interior lined with black polythene to protect against damp and rot. Fans and monitoring equipment were set up inside.

In 2004, the day of the move to the chamber came, and with much press attention the sections of the logboat were lifted by crane out of the tank and then cleaned with a pressure hose before being loaded on to a lorry. They were later moved to Scaplen's Court, where the Rowing Club again helped to move the vessel into its drying chamber. The next day required a return to the tank to deal with swarms of wasps attracted by the sugar.

During 2005, some months of slowly adjusting the temperature and humidity controls followed, using technical advice from Jim Spriggs, until the surplus water was removed. At this time, the BBC presenter John Craven visited the logboat chamber for *Countryfile*.

It was now time to move the logboat to its display area and once more the Rowing Club assisted in moving it from Scaplen's Court into the main museum. Here, the cleaning operation started in 2006 with a team of volunteers who removed the sugar from cracks with small wooden picks and water.

Finally the case was completed for the museum opening in 2007. Many of the volunteers, sponsors and staff that had contributed over the years attended and were thanked for their contributions. In retrospect it all looked easy, but there had been many concerns along the way. One concern was for wasps and ants: during the soaking process there had been occasional problems with wasps and at times long poles were used to move sugar-coated debris away from the wasps (thus avoiding stings). With the boat now on display, some had suggested that ants might also become a problem but fortunately this has not happened.

Logboats have, for some time, been recognised as an important prehistoric boat-building tradition of Northern Europe, along with skin-covered boats and plank-built vessels. The studies in this volume will play a significant part in understanding this tradition in more detail and form part of a new era of more detailed analysis of logboats. This will, in turn, lead to more discoveries in prehistoric ship science as further analyses are carried out.

McGrail's monographs containing summaries and drawings of most of the logboats found in the UK have for long been a major source of information on logboats.¹ However, since this corpus was published, other complete logboats have also been discovered and the occasional new discovery will add to the data available.

The studies here will allow the building of a corpus of new, more accurate, information. For example, the laser recording will bring a level of accuracy of just a few millimetres in the drawings of the lines of the vessel after adjustment is made for post-deposition and conservation changes. This more precise recording gives the potential for greater analysis to determine chronological changes in hull shapes.

¹ Now available on the Archaeology Data Service website (accessed 11 October 2018): <http://archaeologydataservice.ac.uk/library/browse/personDetails.xhtml?personId=6926>

Poole Harbour, for example, is at present calm which would lead to a wide design, whilst it also has a strong double tide making a narrow design desirable.

In conclusion, the detailed recording of the Poole logboat presented here will be a valuable contribution to work in this field and will have implications for studies of logboats both nationally and in the European setting.

Chapter 2

Environmental and archaeological background to prehistoric Poole Harbour

Eileen Wilkes

Physical character

Poole Harbour covers almost 4000 hectares; it is the largest natural harbour in the UK and the second-largest natural harbour in the world (Wilkes and Hewitt 2000, 3; Figure 2.1). It offers the advantages of safe and sheltered moorings and beaching points and is fed by the rivers Sherford, Frome, Piddle (Trent), and Corfe that together drain over 77,500 hectares (c. 300 square miles) through Dorset and adjacent areas (May 1969, 143). These provide access routes west and north to Purbeck and the Dorset heaths. It has two northern ‘lobes’ – Lytchett and Holes Bays – and four main islands: Brownsea, Furzey, Green, and Round and Long Islands, which are still joined at low water. Prior to a rise in sea-level at the end of the Iron Age (see below), two of the current islands in the south of the harbour, Furzey Island and Green Island, were one landmass (named ‘South Island’ in the study by Wilkes (2004)) which was separated from the mainland by the South Deep channel (Cox and Hearne 1991, figure 91). Within the harbour today, two deep water channels (Middle Ship Channel and South Deep) reach a maximum depth of c. 6 m and provide corridors for water flow. The main channels in the harbour are now regularly dredged and the mud, silt and sand deposits are therefore highly mobile. Dredging regimes through the modern era mean that the northern channel, the Middle Ship Channel, is now the preferred, more dominant, route from the harbour entrance to the main port facilities of Poole. However, in antiquity, prior to dredging and the use of mechanically powered craft, the more sheltered South Deep channel leading directly to the Corfe River, Upper Wych, Wareham Channel and rivers Frome and Piddle, was probably the favoured route (Wilkes 2004, 171).

The current entrance to Poole Harbour is narrow, less than 300 m between North Haven and South Haven (Sandbanks and Studland), creating a constricted run of water at spring tides. Surface currents run through the harbour mouth at up to five knots (BP Exploration 1991, 2). The approach from Poole Bay requires navigation around Hook Sand, but is generally clear of obstacles and sheltered by land from winds in all directions other than east. Offshore surface currents rarely exceed one knot (*ibid*). The harbour experiences a double tide in each 24 hours with a current range of just 1.3 m between low and high springs (c. 0.5 m OD and 1.8 m OD respectively) – one of the lowest ranges on the English Channel coast. However, the physical nature of the harbour is such that even at the lowest spring tide, the level of the water in the channels remains above mean sea level for most of the day. Recent research (Cook 2007) has suggested that the harbour entrance may have been c. 1.5 km to the north in antiquity (see also Ward 1922, 97; Green 1940; Robinson 1955), but the approach through Poole Bay would have followed the same route past Hook Sand, and within the harbour the entrance channel fed directly into the southern channel leading to South Deep.

Geology and environment

In common with most sites along the south coast, Poole Harbour has a complex history of sea-level change, erosion, and deposition. Over 80% of its area is intertidal mud flat and salt marsh of considerable ecological interest (May 1969; Syrratt 1984, 9). The geology comprises Tertiary and Quaternary sediments, predominantly sands and gravels that do not withstand erosion by wind and water. The pre-Quaternary surface geology is made up of Bracklesham Group Tertiary sediments (Plint 1983) which Bristow *et al.* (1991) divided into two stratigraphic components. The upper is the Branksome Sand Formation; the lower

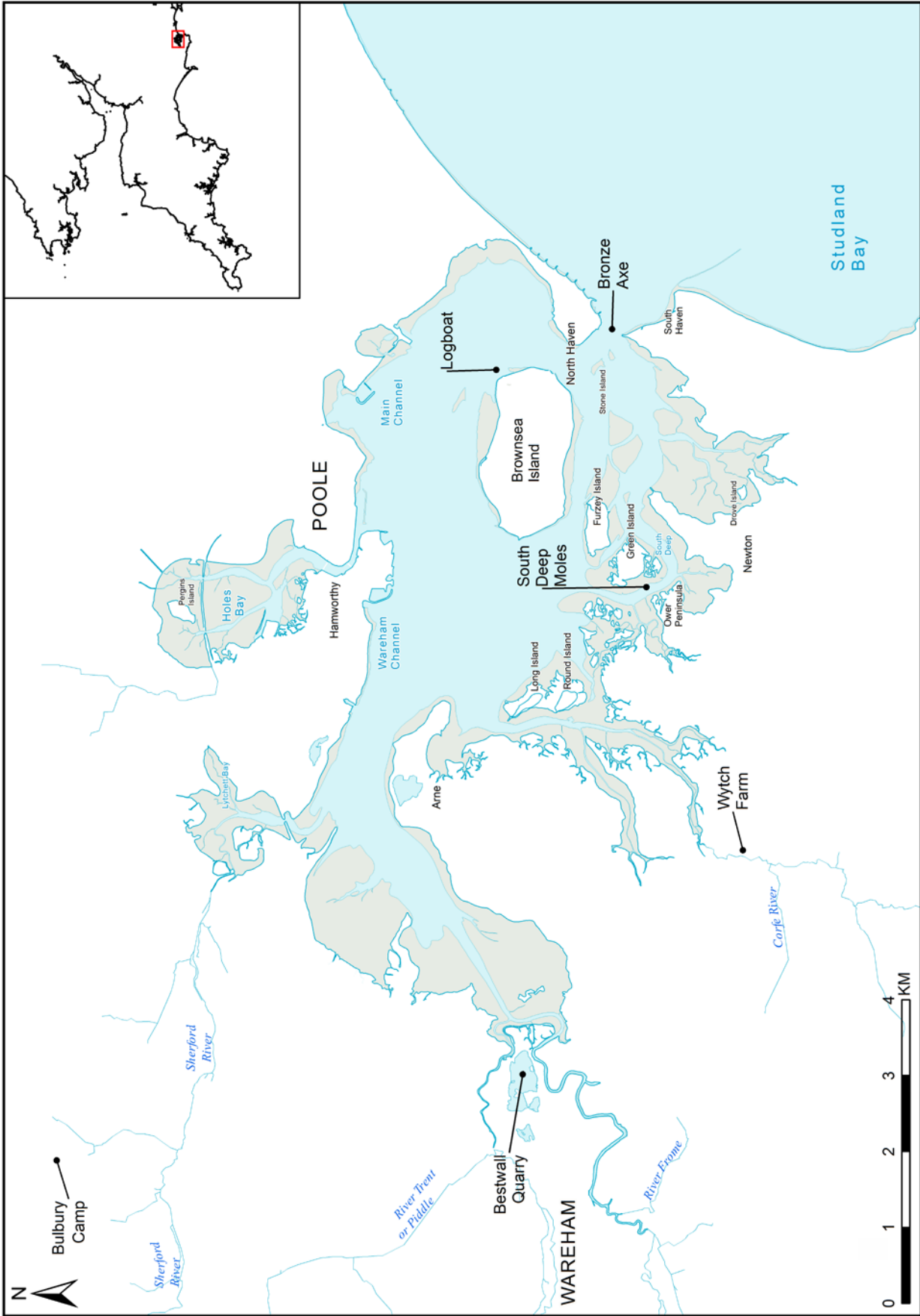

Figure 2.1 Poole Harbour, Dorset: location of sites mentioned in the text (drawn by Tom Cousins)

is the Poole Formation. Both contain alternating sequences of sands and clays. The harbour contains important Quaternary sediments and post-glacial deposits of fluvial gravels which are part of the larger complex of Hampshire Basin gravels. Gravel terraces within the Harbour have been recorded by Bristow *et al.* (1991).

The improving climate at the start of the Holocene led to changes in vegetation, soils and sea level, with further moderation to the environment by human activity. The littoral area today is characterised by sand beaches or reeds and *spartina* giving out to a mainly heathland landscape. This developed following extensive deforestation and soil degradation in the Holocene, particularly from the late Bronze Age, such that by the Iron Age there was only limited tree cover (Scaife 1991). The soils, now as then, are typically podzols, poor and acidic, so not capable of supporting much agricultural activity (*ibid.*). The heaths have historically been used for rough grazing and supplying fuel. Areas of enclosure and reclamation from the heath are known around the harbour (see e.g. Wilkes and Hewitt 2000) and a detailed pollen assessment was conducted as part of the Bestwall Quarry investigations (Scaife 2009).

Relative sea-level change

Sea-level change along the English Channel coast has been highly varied and is best approached on a local, site-specific basis. Despite various programmes of boring associated with water services and oil extraction (undertaken by Wessex Water and BP), Poole Harbour has not provided many datable levels. However, using foraminiferal data from multiple cores, Edwards (2001) constructed a relative sea-level record for the harbour over the past 5000 years. The cores were extracted from the areas of salt marsh at Arne and Newton. Four phases of relative sea-level (RSL) change were identified, with phases i and ii relating to the prehistoric period. During phase i (c. 4700 cal BP – c. 2400 cal BP) RSL rose. In phase ii (c. 2400 cal BP – c. 1200 cal BP) RSL was stable or possibly falling slightly. The mean tide level (MTL) for phase ii was calculated to be c. -1.0 m OD (*ibid.*, 230).

More specifically for later prehistory, late Iron Age / early Roman HAT (Highest Astronomical Tide) has been calculated as -1.01 m OD based on archaeological data from a site in the intertidal zone of Brownsea Island (Bowen 1974; Jarvis 1992). Current HAT in Poole Harbour is 1.66 m OD so a rise in sea level of c. 2.67 m over the past 2000 years can be inferred. This accords with the c. 2.6 m rise proposed by Cunliffe (1987, 6–13) based on the level of the gravel hard excavated at Hengistbury Head, just 15 km to the east. The archaeological data produced the same c. -1.0 m OD level as Edwards' (2001) calculation from faunal dating. Although Jarvis suggested that level as the HAT, and Edwards proposed it was the MTL (Mean Tide Level), the correlation between the two, supported by conclusions from subsequent excavations and calculated levels, should not be ignored, particularly as the tidal range in Poole, as noted above, is remarkably small.

The current area of Poole Harbour was mainly composed of saltmarsh prior to the Roman marine transgression, with a network of creeks and rivers through the wetland which extended to approximately one quarter of the current size of the harbour (Hawkins 1971; Farrar 1977; Jarvis 1992). Patches of peat on the current harbour bed are probably the remains of former dry or intertidal land surfaces; as yet these have not been studied or mapped in detail. Prehistoric period water flow and sediment rates were different from those known today so in order to assess past land / water boundaries it is not sufficient or appropriate to use the current -1.0 m contour as the line of the ancient shore. As cautioned by various authors, (including Bournemouth University 2001), modern bathymetry cannot be used to identify past contours. The situation in Poole Harbour is exacerbated by the intensive dredging regime which releases much sediment from the channels to be deposited elsewhere. The nature of vegetation has also changed and the colonization of Poole Harbour by *spartina* since 1890 has impacted on the retention and release of sediments on the harbour fringes (May 1969).

Archaeological background

The amount of archaeological investigation in and around Poole Harbour has been largely determined by the level of development and agricultural activity. Modern development in the town of Poole has resulted in isolated archaeological investigations around the north of the harbour but elsewhere relatively few rescue excavations have been undertaken. There has been little opportunity anywhere around the harbour for field walking or aerial reconnaissance. However, the antiquarian observations of John Hutchins were recorded (1803; 1862–73), and more recent surveys have been published by the RCHME (1970) during the final stage of their county inventory survey. Specific observations and limited excavations were conducted through the early and mid-20th century. The most extensive studies have been occasioned by the development of the Wytch Farm Oil Field by BP from the late 1970s to the 1990s, with archaeological investigations on Furzey Island (Cox 1988) and at Ower Peninsula (Woodward 1987; Cox and Hearne 1991), and also at the aggregates quarry site of Bestwall, near Wareham (Ladle and Woodward 2009). Poole Harbour is recognised as a key element of the along- and across-Channel exchange network of later prehistory, with extensive Iron Age evidence from the Wytch Farm and Bestwall excavations and smaller-scale investigations on Green Island (Wilkes 2004; 2010a).

Prehistoric inhabitants of the area exploited the marine and terrestrial resources, including salt, good-quality clays, shale and stone, with opportunities for manufacture and trade, which were sufficiently advantageous to provide a viable subsistence base.

Poole Harbour is well known for its pottery output, particularly of Black Burnished Ware (BBW) in the late Iron Age and Romano-British periods (see Williams 1977). The suitability of the clays for pottery production is reflected in their use throughout subsequent centuries. A number of BBW production sites have been identified around the harbour, and distribution of the material extended throughout southern Britain and beyond (Farrar 1977; 1982; Hearne and Smith 1991; Allen and Fulford 1996). The Poole Harbour clays and prehistoric pottery industry are currently the subject of ongoing research at Bournemouth University (Jones 2017; Trim 2018).

The pottery output from Poole was distributed via the coastal and riverine networks (Allen and Fulford 1996). The same distribution network was used for another main product of Poole – Purbeck stone. This is a form of limestone ‘marble’ that was quarried throughout the Purbeck area and transported by track, river and coast to Poole Harbour for onward shipping along the south coast. A summary of find locations was compiled by John Palmer (2001).

Known archaeology

Ower Peninsula: extensive later prehistoric planned coastal settlement with evidence of late Iron Age pottery and salt production, shale and metal-working. It has a good ceramic assemblage with imports from the south-west of Britain and from the continent. Kiln and pottery material still erodes from the low cliffs of the peninsula and evidence of *in situ* remains have been recorded in geophysical survey and excavated evidence including a late Iron Age inhumation burial (Monteith and Craig-Atkins 2012). The extent of the settlement has not yet been defined although there have been complex results from geophysical surveys (Cox and Hearne 1991; Wilkes 2004). The site was an important component in the late Iron Age international trade network; its establishment has been dated to c. 20 BC, operating until the 2nd century AD (Woodward 1987; Cox and Hearne 1991; Wilkes 2004).

Poole Harbour logboat: The subject of this volume, the logboat was recovered from the edge of the main ship channel c. 75 m off the current eastern shore of Brownsea Island during dredging works in 1964 (Peers 1965). It was of a sophisticated type within the logboat class, having a slot-fitted transom and well-shaped bow. The organic caulking around the transom survived well enough to provide a radiocarbon determination of 2245+/-50 BP (Q-821), calibrated to 397–176 BC (see also McGrail and Switsur 1975, 191–200). The presence of the logboat attests to inland waterborne traffic in the Iron Age. The area of

the find has not been investigated further so it is not known if the vessel was associated with a shoreline, beaching point, or waterside facility as at Barland's Farm (Nayling *et al.* 1994) or Caldicot (Parry and McGrail 1991). The logboat is displayed at Poole Museum.

Brownsea Island: This may originally have formed a larger land mass with neighbouring Furzey and Green Islands but had become isolated and distinct at least by the Iron Age. There is little recorded prehistoric archaeology on the island, but current research into clay sources and salt production suggests the island may have been used as a source of raw materials and possibly production during prehistory (Hathaway 2005; 2013; Jones 2017).

Furzey Island: Prehistoric settlement and production sites on the island are known from an extensive system of enclosures, some surviving in earthwork form, others identified from geophysical survey; these may be a continuation of the system of enclosures identified on Ower Peninsula and Green Island. The sites date to the 1st millennium BC and are associated with mixed agriculture and were involved in the maritime exchange function of the harbour in later prehistory, with links to the south-west of Britain and the continent (Cox 1985; Cox and Hearne 1991; Wilkes 2004). Two phasing schemes were developed for activity on the island, one based on the ceramic finds (Cox 1988, 52), the other from the excavated stratigraphy (Cox and Hearne 1991, 47, 48). The island may have formed part of a larger landmass with Green Island throughout prehistory; it is estimated that the south-east shore has eroded by 25–100 m since the Roman period (Jarvis 1985, 154); Cox (1988) suggests a minimum erosion of 70 m.

Green Island: Unlike Furzey Island, Green Island has been subject to only sporadic and opportunistic archaeological investigation. Archaeological deposits including Iron Age pottery and evidence of shale-working and iron-smelting have been recorded (Calkin 1955, 53–4; Farrar 1963; 1964; 1967; Bromby 1969; Wilkes 2004). Shale-working is particularly significant as evidence suggests Green Island is one of only a handful of known sites where pre-Roman lathe-turned production was carried out (Calkin 1955). In addition, pottery finds include early, middle, and late Iron Age wares; Romano-British material including samian sherds; and non-local pieces including Hengistbury (class C) ware and early imported amphorae (Farrar 1964; 1967). This links Green Island directly with the Iron Age trading emporium of Hengistbury Head c. 15 km to the east; Green Island was another component of the harbour's later prehistoric maritime trade complex (Peacock 1977; Williams 1977; 1988; Cunliffe 1987; Wilkes 2004).

South Deep Moles: Two moles or jetty structures extend into South Deep, one running from the mainland at Ower Peninsula (Cleavel Point), the other from Green Island. These are substantial and internationally significant structures, currently unique in the archaeological record of Britain and with no close parallels known from Europe. Traditionally known as the 'Green Island causeway', survey and excavation have determined the structures are two distinct features, but radiocarbon dates from oak piles within both structures confirm their contemporaneity. The dates suggest the moles were constructed in the mid- to late Iron Age (Bugler 1967; Markey *et al.* 2002; Wilkes 2004; 2013; Markey forthcoming).

The structures now lie under a metre of mud and silt in the intertidal zone, and where they project into South Deep the top surfaces are below the low-water mark. However, in exceptional circumstances (the lowest spring tide combined with high atmospheric pressure), the water level falls sufficiently to reveal the moles. They are of a complex construction, with a timber framework embedded in the harbour bottom supporting a matrix of brushwood, clay, flint, sand and gravel. The moles were capped with Purbeck Marble slabs (a local limestone variant) which would have given them a monumental appearance (Wilkes 2007; 2013).

The southern mole is at least 160 m long, and 8 m wide across its top surface. The northern mole (on the Green Island side of South Deep) is at least 55 m long, and again, 8 m wide. The northern edge of the mole terminates c. 170 m from the current shore of Green Island. It is likely that the gap represents the amount of erosion from Green Island since the mole was in use: it would originally have terminated at the contemporary shore. The gap between the two moles is c. 70 m. The function of the moles has been

generally associated with that of quays, allowing vessels to tie up both at the ends of the structures, and along the sides as far as water level permitted. They also acted as a 'gateway' point, providing a formal entrance from which to monitor access into and out of the inner harbour (Wilkes 2004; 2007; 2013).

Bronze Age axe: A Bronze Age axe of end-winged type and interlocked ferrule fragment were found in the narrow entrance to Poole Harbour in 2005. Such axes are a familiar type in the Ewart-stage hoards of south-east Britain in particular, and more scattered examples occur in the south-west peninsula. Comparable axes are also found in northern French hoards, with a concentration in Armorica. In general, they have often been considered to be a key type within the 'Carp's Tongue complex'. Equivalent axes in the Urnfield zone of central Europe are stylistically distinct.

The form of ferrule is consistent with the tubular ferrules well known in late Bronze Age contexts and interpreted as spear-butt fittings. Those in Wilburton assemblage hoards are very long, but even the shorter ones of the Ewart stage are significantly longer than this, presumably fragmentary, example. While one cannot rule out this being a fragment of a long Wilburton ferrule, its inextricable association with the end-winged axe strongly favours a Ewart-stage type.

Although finds of end-winged axes are less numerous in Britain than on the opposite side of the Channel, the number is greater than is obviously accounted for by direct imports; it is more likely that they were part of a shared tradition initially stemming from the near Continent. The find dates to c. 1000–775 BC (Needham, Parham and Frieman 2013).

Hinterland sites: Areas around the harbour have been investigated and evidence gathered from later periods (e.g. medieval Poole (Horsey 1992) and the Foundry site (Watkins 1994)) and the 16th-century AD Studland Bay wreck (Ladle 1993) discovered immediately outside the harbour entrance. Further afield, late prehistoric sites at Worgret (Maynard 1988; Hearne and Smith 1991), east of Corfe River (Cox and Hearne 1991, 27–46), and Bulbury hillfort (Cunnington 1884; Cunliffe 1972) are likely to have been associated with later prehistoric activities in and around the harbour (Wilkes 2010b). Bronze Age funerary and ritual sites are known from the individual and clustered round barrows on the heaths and gravels around the harbour (see Calkin 1951) and earlier, likely Neolithic, activity is suggested by such features as the stone row at Studland (SZ 026 853). Within the harbour, occasional finds continue to provide evidence related to prehistoric water-borne and terrestrial activities, such as the wooden implement, probably a paddle, recovered from the River Piddle upstream of Swineham Point and close to a platform of logs that may have been a landing stage (Bryant and Horner 1990, 38, 47).

In general, Poole Harbour has been the site of high levels of human activity throughout prehistory and history and offers conditions conducive to excellent preservation of archaeological remains. The potential for significant archaeological remains within both the harbour and the littoral area is very high. Extensive use of the harbour area for settlement, ritual, manufacturing and trade has been demonstrated. Further evidence related to these activities may be recovered from all harbour and littoral zones and it is therefore important that opportunities for the fullest recording of these archaeologically important deposits should be taken whenever possible.

Chapter 3

Evidence for the building of the Poole logboat

Damian Goodburn

Introduction

This chapter considers the evidence that can be derived from the Poole logboat regarding its construction, including the nature of the parent tree, the tools and techniques needed to build it, and the logistics of actually building it. Earlier descriptions and records of the boat are revisited, and new evidence obtained after conservation is described.

Aims of this part of the reinvestigation of the Poole logboat

This section is focused on a practical description of evidence which shows us how the Poole logboat was built. The new multi-disciplinary re-investigation is intended to extend, deepen, and in some cases correct, the earlier recording and analysis of the boat find made in the mid-1970s by Seán McGrail (1978). There has been much progress in the field of boat archaeology and related disciplines and new recording technologies have also become available in just the last few years, as illustrated by the re-scanning of the vessel.

The aim here is to reconstruct the details of the great prehistoric oak that was used for its hull, and the tools and techniques used in its construction. The scale of the work in terms of the size of the workforce needed and other logistical questions are also discussed, which should help to place the boat better in its social and environmental setting.

Sources of evidence and related information used

The starting point is the remains of the vessel itself, together with recent and earlier records made of it. Where evidence is thin or non-existent, inferences are drawn from studies of broadly similar logboats and recent accounts of logboat building in other parts of the world (ethnographic sources). The interpretation of the evidence and inferences drawn are also tempered by this author's practical experience of involvement in building 13 logboats, 10 of which were of oak. One of these reconstruction projects was a full-scale interpretation of the Poole logboat, done in 1989–90 at the Cranborne Centre for Ancient Technology, Dorset. This project was led by Jake Keen, a leading specialist in early technology teaching and experimental investigation who established the Cranborne Centre. The author provided advice and practical assistance based on his experience of other oak logboat reconstructions. The Cranborne reconstruction was fairly closely based on the limited record of the boat then available, which we now know was not entirely accurate. The reconstruction was, however, roughly the right size and form (although of insufficient length) and was built with simple hand tools. The vessel had some informal use in Poole Harbour, but was mainly based at the similar, but smaller, tidal Christchurch Harbour just to the east. There it was used by Dorset County Council for Outward Bound activities and archaeological education projects. The author was lucky enough to take part in a short voyage in the vessel in 1991 around Christchurch Harbour and the adjacent tidal rivers, and to repair and reuse the boat in 2004. Qualified use of insights gained from the construction, use and life history of this reconstruction and others, have informed several aspects of the following discussion.

Notes on the history of the Poole logboat since its discovery

The fields of maritime archaeology, specifically boat and foreshore archaeology, were very poorly developed around the British coast at the time when this boat was found in 1964. While many finds and structures were discovered, they often went unrecorded and remains such as this vessel were rarely kept. Indeed, the importance and value of logboat (or dugout) finds was generally greatly underestimated, even by archaeologists and the museum world. Methods of preserving ancient waterlogged wood were also little developed (see Chapter 5). The recording carried out shortly after the boat's discovery was limited to some detailed black and white and colour photography, with some images including a scale in Imperial feet.

Given the circumstances, we must be grateful that this find was retained at all and kept in good enough condition for both public display and reinvestigation and detailed recording nearly 50 years after it was found. However, it is noteworthy that substantial amounts of evidence for the building, original size, use and form of the vessel were not recorded when the timber of the vessel was in prime, freshly exposed condition. Inevitably abrasion, decay, distortion and shrinkage of the degraded timber has taken place. Even when the boat was examined in some detail for the first time in 1974 by Seán McGrail, although with limited access, these factors had reduced the quality and quantity of information that could then be recorded. Unfortunately, the more degraded surface zones of ancient waterlogged timber, where most evidence of features such as toolmarks and wear is located, are most prone to loss in handling and storage. A forensic approach was therefore adopted in order to extract as much information as possible from the limited surviving evidence.

Investigations into ancient British logboats: myths, guesswork and developing a more practical approach

The earliest researchers

While the serious study of logboat finds in Britain was something of a Cinderella subject within archaeology as a whole, a small number of archaeologists in the 20th century did recognise their potential and drove knowledge forward. Space does not allow a full survey of this work but a brief outline is warranted. The first amongst the early British archaeologists to investigate logboat finds seriously was Cyril Fox who was sparked into action by the find of a small oak logboat at Llangorse in south Wales in 1925 (Fox 1926). He examined the boat and published detailed drawings and photographs. He also attempted to set the find in context and to create a sequence of over 30 comparable finds, set out in a gazetteer. However, dating evidence was limited at the time and although we might be critical of some of his conclusions today, the detail of his practical-minded observations on topics such as the section of the log used, size and form of parent tree, and the surviving toolmarks were remarkable and not surpassed until the late 1980s in Britain (Goodburn 1989; 2002). Fox was even able to suggest that although there was no dating evidence associated with the boat, the toolmarks showed evidence of use of an iron axe (Fox 1926, 125). He also proposed that British dugout boat finds were not all 'from the Stone Age', as is often assumed even today, but were in use for a long period up to the 18th century in remote corners of Britain. Despite his very detailed, standard-setting analysis, the evidence for the building of the Llangorse boat and its date and setting have also been reappraised recently as a result of extensive fieldwork at the find spot and the building of a reconstruction of the vessel (Redknap and Goodburn, forthcoming). Fox was a pioneer figure in the archaeology of logboats in Britain, who drove the subject forward in leaps and bounds, but his approach was not widely adopted and it was not until the mid-1970s that there was another systematic campaign of enquiry into these craft.

Developing the systematic study of logboat finds – Seán McGrail's work in the 1970s

By the mid-1970s there had been a resurgence of interest in boat and ship archaeology following the discovery of several new planked vessel finds of prehistoric to recent date. This archaeological trend also included, to some extent, logboat finds. Seán McGrail, then of the National Maritime Museum, took up

the challenge to create an updated gazetteer of logboat finds in England and Wales and recorded many finds, including the Poole logboat, for the first time (McGrail 1978).¹ His extensive study was influenced by the trends in archaeology at that time, and he also attempted a new formal classification scheme. Suggestions as to developments through time were made, as well as attempts to reconstruct the probable performance of a selection of craft using naval architectural formulae. Other aspects of his survey covered the reconstruction of the diameters of the parent trees used and occasionally brief records of toolmark evidence. A selection of ethnographic sources were drawn on to provide comparative evidence, although, as he acknowledged, this did not include records of building logboats of oak. Despite difficulties in accessing the remains of the Poole logboat, McGrail's recording and analysis of the boat stood for many years as the definitive academic account of the boat find. By the mid-1990s it was clear that more information about the boat and some aspects of the recording and analysis of the find could be developed further, enabling a reinterpretation of the boat (Goodburn 1994).

Methodology used for recording features of the Poole logboat

Brief examination in 1994

Following some work on the detailed recording and analysis of other logboat finds and the building of archaeology-led reconstructions of several early oak vessels (Goodburn 1989; Goodburn and Redknap 1988), in 1994 the author was asked to examine the Poole logboat. At that time it lay in a conservation tank in the town. The aim of that examination was threefold:

- to see if there were any further details of the vessel not covered in McGrail's recording;
- to ascertain the condition of the remains;
- to assess the overall importance of the find to inform future conservation.

Although the lighting and access conditions were difficult, some new information on the survival of occasional original toolmarks, tree anatomical features, and detailed aspects of the original form of the boat were recorded in notes and sketches with measured dimensions. The main findings made during the brief visit were summarised in a short document for Poole Museum (Goodburn 1994).

Further recording July 2013

In July 2013, a further inspection was made to attempt to answer specific questions raised by a re-evaluation of McGrail's notes and those made during the 1994 visit. By this time the boat had been conserved and was on permanent display in Poole Waterfront Museum, allowing a much more detailed examination than had been possible previously. Poole Museum staff opened the case to allow close access and with the aid of additional raking light, the surfaces of the boat were closely examined, with the exception of the centre-most external parts of the bottom which were inaccessible. The location of toolmarks and tree anatomical details noted in the 1994 visit were checked and re-measured. Some additional toolmarks and a mysterious scribed oval mark located near the bow were found and recorded with measured sketches and notes (see Figures 3.1 and 3.6). These additional features were marked on a 1:25 copy of the McGrail plans, with additional direct measurements from key fixed points, such as the extreme bow or false frame ridges. The best-preserved and most diagnostic of these details were then numbered (TM for toolmarks and TA for tree anatomical features, principally knots), measured-off and added to 1:25 scale printouts of the accurate images of the boat derived from the scanning survey (see Chapter 4), when these became available in late September 2013 (Figure 3.1). The location of these key features is shown in composite plan Figure 3.1 and the TM and TA feature numbers will be referred to below.

The new information gained in 2013 was integrated with observations made in 1994 and considered alongside evidence visible in photographs taken shortly after the hull was lifted, to produce the following

¹ Robert Mowatt later created a gazetteer of the Scottish finds – see Mowatt 1996.

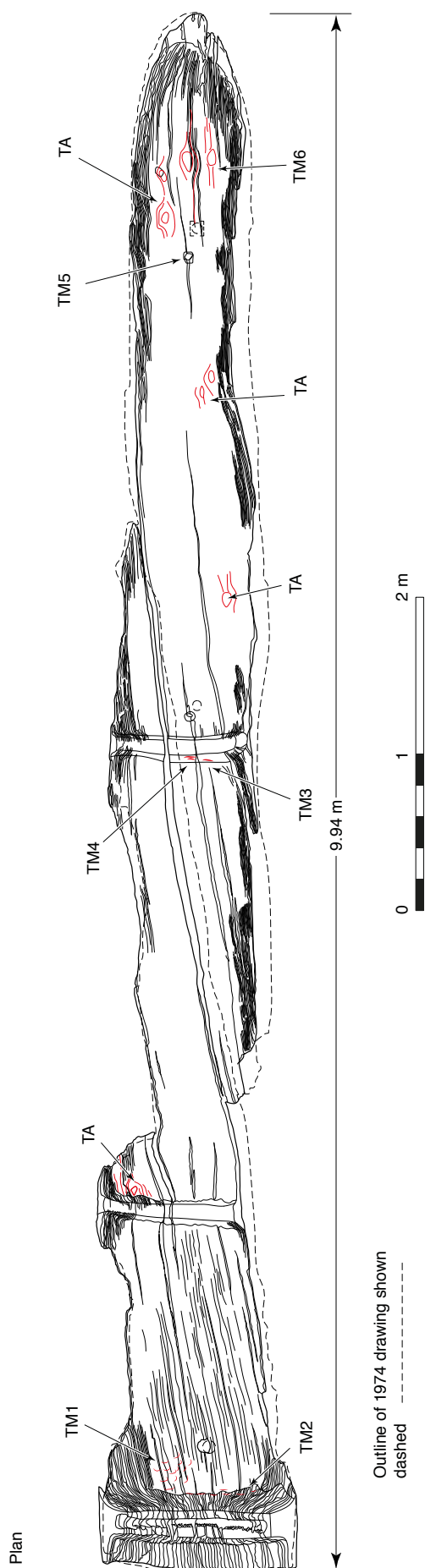

Figure 3.1 The location of key features of the Poole logboat recognised and recorded in 1994 and July 2013

description and discussion. Where appropriate the newer evidence and the inferences drawn from it have been set against relevant parts of the discussion of the Poole logboat presented by McGrail in 1978 (McGrail 1978, 254–7; 1987, 20–1). Here, the approach to this type of forensic analysis of prehistoric boat remains follows a similar course to that taken for aspects of the study of the middle Bronze Age Dover Boat, a vessel of lashed carved planks, and the much more similar late Bronze Age Carpow logboat (Darrah 2004a; 2004b; Goodburn 2004; 2010, 97–113). However, both the degree of survival of the evidence and the resources available for this project have required a briefer, more closely focused study.

Towards a hypothetical reconstruction of the original form and size of the Poole logboat

The effect of the original drying out of the timber

The original dimensions of the vessel such as width (beam) and depth are crucial factors not only for reconstructing the appearance of the vessel but also its likely performance, where relatively small changes in dimensions would have had considerable effects. Whilst the surviving remains have now been scanned, resulting in an accurate 3D digital image and a new set of plan, elevation and cross-sectional views of the boat as it now (see Chapter 4), the dimensions and form of the original vessel would have been markedly different. Ancient waterlogged oak timber is well understood to shrink and distort, to varying degrees, depending on the section of log used, degree of decay and speed of drying. What is less well-known, except to a small number of very traditional woodworkers, archaeological experimenters and wood scientists, is that freshly cut, or green oak will also shrink and distort markedly as it dries out, or ‘seasons’. This is particularly true when in large sections. This shrinkage can often be as much as 1/12th (7.5%) of the width of a freshly cut oak timber measured parallel to the annual rings (i.e. tangentially). Thus in fine joinery and cabinet-making, oak was always used fairly or totally dried out, but in heavy timber framing and some surviving traditional boatbuilding (rather than fine yacht building), larger section timbers are still often worked green or only partially dried. The reasons for this today are:

- green oak timber is much cheaper than seasoned oak;
- oak timber is much softer and easier to cut when fresh.

Using the traditional ‘rule of thumb’ for air-drying times of ‘one year for every inch [25 mm] of thickness’, large timbers will take decades to season fully and by that time will probably have developed large drying splits due to the uneven drying of the core as opposed to the surfaces. This latter issue would have been a key factor for logboat builders.

Finally, green or, better still, partially seasoned oak is more flexible and easier to bend, and although this is not a relevant feature when building a logboat, it is often useful in planked boatbuilding.

While there are practical advantages to using green oak timber there are also considerable disadvantages, such as a serious tendency to split and distort during drying out, particularly if that is rapid. Green oak is also much heavier than fully seasoned oak timber, an issue revisited below.

Observations of distortion in reconstructed oak logboats

McGrail was the first boat archaeologist to try to reconstruct systematically the shrinkage of ancient waterlogged boat timbers. His approach was based on measuring the ratio between the width of holes across the grain of a timber versus the dimension along the grain (McGrail 1978, 23; 1987, 41). Here, the typical behaviour of timber to shrink relatively slightly along the grain as opposed to across it was the key consideration. In practice, many other factors also cause hole distortion such as the shape of any fastenings or other elements in holes, localised grain distortion, and the practice of driving wedges into fastenings to lock them (Goodburn 2002, 123). In general, logboats might reasonably be expected to shrink in beam and depth from building to abandonment but observations of several oak logboat reconstructions actually shows a surprising counter-trend, with the hulls losing no width due to flexing outward during seasoning. In the case of the reconstruction of the Saxon Clapton logboat, for example, it actually became 25 mm wider over four years after construction, with a slight decline in depth. The vessel had been stored either in the shade, on a dampened surface or afloat in fresh water (Goodburn 2002, 25). Interestingly, the reconstruction of the Poole logboat built in 1990–91 was patched-up for use with another logboat reconstruction for a filmed archaeological experiment in 2004. In the 14 years since construction it had become wider by as much as 100 mm at the stern end, so a new stern filling plank (transom) had to be made to fit. However, that boat had suffered a period of neglect and exposure to wind and sun that the original Poole logboat was unlikely to have been subjected to.

Direct observations of the remains of the Dark Age Loch Doon 1 logboat (Mowat 1996, 55) show a clear case of splitting and growing wider at the bow by at least 120 mm after exposure. As most of these observations were of smaller oak logboats made from whole rather than halved logs, as was used in the Poole logboat (and observations of the neglected Poole logboat reconstruction), their applicability to the case of the Poole vessel is perhaps a little uncertain.

Possible design weaknesses

As early as the 1920s, Fox recognised the potential weakness of the open transom stern form of logboat hulls, as used in the Poole example (Fox 1926, 131). The fact that many large oaks have star-shaped splits (shakes) in the centre at the root end, even in the standing tree, explains why transom planks were often fitted. Although such broad, square sterns were always closed with a cross-wise transom plank, that alone would not have held them together strongly. Most later prehistoric oak boats with this form of stern, with well-preserved upper sides, have traces of cross-beam fittings that would have resisted this spreading tendency (e.g. Strachan 2010, 69; Millett and McGrail 1987, 114). There is no surviving trace of this type of fitting in the Poole craft and there are two possible explanations for this apparent lack. Firstly, the upper sides at the stern may have eroded away; secondly, the builders may have tried to obviate this weakness by making the grooved seating area for the transom plank particularly deep and massive in the hope that this would resist splitting and spreading tendencies. The latter approach worked for a while in the Cranborne reconstruction of the Poole logboat but after

a few years the spreading was so extreme that the boat became unusable. There does appear to have been some loss of timber depth at the stern of the Poole logboat, with splitting-off along the radial planes of weakness in the oak timber, but it appears unlikely that this was more than c. 100 mm. Taking account of a degree of spiral grain and flattening of the bottom of the boat, the half log could not have accommodated much more than 100 mm of greater depth in the finished hull. It is therefore possible that some form of tie beam was fitted across the stern originally although it would have had rather shallow joints or fastenings at each end. Clearly this important structural question will have to remain unanswered but this author favours the probable original existence of such a light tie beam. As timber is very strong in tension this element would not have needed to be a large timber.

Distortion of the logboat hull prior to exposure in 1964

The degree of distortion, shrinkage and erosion which the hull of the Poole logboat underwent after abandonment is very difficult to assess now, over 50 years after its exposure. We can note, however, that some depth of side over most of the hull had clearly eroded or split off. This implies that the boat had been sitting upright in the silt which must have partially protected it, as the bottom was the best preserved. As the loss of depth is roughly similar at the bow and stern it is likely that the boat had lain approximately horizontal over its long axis.

Hull distortion and shrinkage since discovery

There are two key sources of evidence for assessing the hull's distortion and shrinkage since its discovery in 1964: the photographs taken at the time (with Imperial (feet) scales) and McGrail's drawings of the mid-1970s. These can now be compared with the drawings derived from the recent scanning (see Chapter 4, Figures 4.4, 4.11, 4.12 & 4.17). We are fortunate to have a photograph in the boat archive taken by Andrew Hawke shortly after the remains were lifted from the harbour in 1964 showing the view forward though the stern, which was missing its original transom board (see Figure 4.17).

We are even luckier that the scale of the print is by chance at almost exactly at 1:10, so that the one foot (1') scale bars are 305 mm long. This allows reasonably close key dimensions for the size of the stern of the boat just after it had been lifted from the harbour silts to be scaled-off. Small drying splits, indicating a minor amount of distortion had taken place, are visible in the photograph but it would appear that the shrinkage or expansion of the stern would have been minimal at this time. The extreme width or beam of the vessel was just forward of the extreme stern end and a little below the upper surviving edge. The stern had the shape of a capital letter 'D' with a flattened bottom and had clearly not been shaped entirely symmetrically, providing a slight sense of the irregular shape of the spreading buttress of the parent oak. The photograph shows that the logboat's maximum beam at that time was c. 1.5 m. This was very close to the stern, which also had the maximum surviving depth of c. 0.58 m. This is over 100 mm more than it has now and c. 80 mm more than shown in McGrail's record drawing. As it is argued that the boat has lost some of its upper timber at this point, an approximate original maximum depth of c. 0.65 m is proposed. This depth allows for the trimming of irregularities off the split-out heartwood of the log.

Interestingly, when the 1970s recording plan and central longitudinal section drawings are overlain on the new drawings made in 2013 (See Chapter 4, Figure 4.3) there appears to have been considerable loss of the upper sides from c. 2.20 m from the stern. This is presumably the result of losses from decay, handling and conservation work. In 1994, it was clear that there had been irregular and patchy flaking from the surfaces of the logboat in many areas, with a loss of up to 30 mm of thickness apparent. This kind of flakey surface loss is typical of more-degraded areas of ancient waterlogged oak.

The 1970s outline reconstruction drawings

It is clear from the 1970s reconstruction drawings of the Poole craft (McGrail 1978, figure 71) that the beam of the vessel at the stern was thought to have been c. 1.50 m and the plan view seems to be

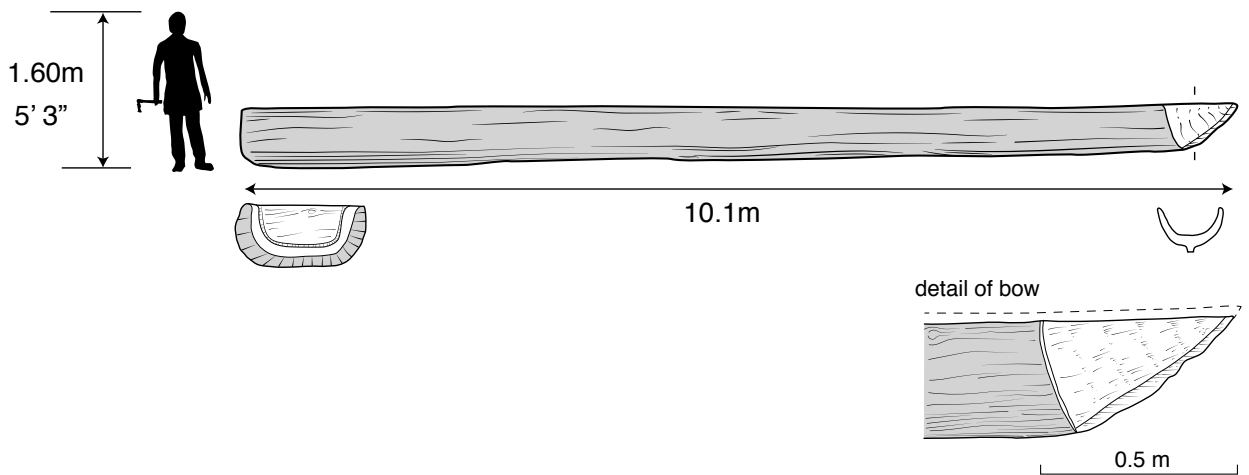

Figure 3.2 Approximate outline reconstruction of the shape and dimensions of the freshly built Poole logboat

broadly in line with the new shape of hull suggested here. The cross-sections, however, appear to show the vessel as having an almost completely rounded bottom which is also far too thin. It is also very likely that the original vessel was a little deeper of side. These drawings were used for earlier calculations of the capabilities of the logboat and have been widely used as an example of such work (McGrail 1978, 256; 1987, 20–1), but it is clear that these earlier findings must now be revised considerably (see Chapter 4, Figures 4.16, 4.17, and 4.18). The fact that the bottom of the vessel was substantially flatter than previously believed would mean the boat would have been more stable and would have needed a little less water to float it. Counter to that would have been the vessel's much greater actual original weight (see below). Figure 3.2 attempts an approximate outline form for the original vessel with cross-sections near the stern and bow. While such a drawn reconstruction can never be more than very approximate, it is suggested that this new outline reconstruction is much closer to the original appearance of the boat than that previously published. Attempting to reconstruct the original dimensions of the vessel is very important to enable us to visualise the original boat better, and also for any attempts at calculating the possible performance of the vessel.

Reconstructing the parent tree used for the Poole logboat

The size and form of the parent tree: a glimpse of the prehistoric wildwood of southern England

It is often thought in Britain that boat and shipbuilders were major users of the best oak timber growing at any particular period. Since the earliest investigations of prehistoric sites in Britain there has been much interest in the changing nature of woodland cover at particular times in different regions. The general non-specialist view was that in prehistoric times there were larger areas of woodland of various types than today in most areas. In many cases our two native oak species and their hybrids formed a substantial part of the tree cover. The non-specialist view was based almost exclusively on poetic imagination, while that of the early environmental archaeologists came from examining sequences of pollen found in deep sediments and peat. While pollen cores can provide some information about the presence and rough proportions of tree cover as against more open ground, and also shed some light on the species present, it cannot provide a tangible reconstruction of any particular prehistoric woodland in three dimensions.

By the early 1970s, practical woodland botanist and historian Oliver Rackham had begun to examine surviving early historic, and occasionally prehistoric, timbers for what they could tell us about the types and sizes of trees, and the wooded land they grew in and how that changed (Rackham 1976). By measuring the sizes of the timbers, noting the section of the tree used, and the presence of major knots and the natural rounded edges of the tree (wane) left on some timbers and smaller roundwood, he was able to reconstruct the varied types of 'treeland' they had grown in. (Many trees do not now grow in 'woodland' but rather hedges, pasture land, orchards and plantations, hence 'treeland'. This

variation also occurred to different degrees in the past.) Space does not allow an extended discussion of all the strands of evidence than can now be used in this important work, nor the ongoing debates on the level and character of woodland cover in southern England in later prehistory, but it is hoped that at least one of the great oaks that grew in the Poole Harbour region or its hinterland can be visualised following the discussion below (see Figure 3.3).

McGrail was one of the first boat archaeologists to recognise the particular potential of logboat finds to help provide a solidly based tangible view of Britain's woodland past. Clearly various forms of treeland were essential until very recently for any form of boat or ship building. McGrail calculated the approximate dimensions of the parent log used to build the Poole logboat but did not describe how it might have looked (McGrail 1978, 256). It was suggested that the great oak log would have been 1.72 m in diameter at the butt end, tapering to c. 1.20 m some 9 m from that end. Given the new information gathered together in this study for the width of the stern and loss of original timber it would seem likely that these basic parameters must be broadly correct, although a slightly smaller upper diameter to the outside of the bark might be argued for. The boat's builders would have been fully aware of the rather perishable nature of oak sapwood and had cut most, if not all, of it away leaving the rot-resistant heartwood to form the bulk of the hull.

We can now consider what the actual great oak used for the Poole logboat looked like. The probable original size of the boat which provides the basic information needed to reconstruct the original outline of the whole parent tree has been double checked. A plausible c. 0.60 m has been allowed for the space needed to make the axe-cut V-shaped felling cuts, and three types of tree anatomical features have also been recorded (see Figure 3.1). These features include:

- the presence of substantial knots reflecting branch locations existing just before the felling of the parent tree;
- the presence of marked spiral grain;
- the fact that the annual growth rings in the hull are fairly narrow at c. 2 mm width.

Consideration of these features of the parent tree, still visible in the remains of the boat, serve to create a much fuller view of how the tree would have looked. The parent tree was a very tall oak combining a rather large diameter at the base with straightness and a height of c. 9.50 m to the first really substantial branches. These features, together with the narrow annual rings, are characteristic of a particularly large old oak growing in tall dense woodland little affected by human activity. This type of woodland is commonly referred to by woodland researchers as 'lowland temperate wildwood' (e.g. Peterken 1996). But even by the standards of the large wildwood type trees reconstructed from timbers found on other logboats, the Poole logboat oak was exceptionally large and is only slightly surpassed by the parent log used to build the giant Iron Age Brigg logboat found in south Humberside (McGrail 1978, 309).

The presence of a few moderately sized branches as low as c. 6 m from the ground and the spiral grain may suggest that the parent tree grew near the edge of a grove of particularly large trees where some light percolated beneath the canopy. In order to appreciate fully the vast size of the Poole logboat tree, a comparative element must be included: a fairly typical largish oak from a traditionally managed, modern southern English woodland is shown in Figure 3.3b for comparison. Whilst great oaks of the size used to build the Poole logboat can still be found in small numbers in southern England, they are typically trees growing in small clusters in old, planned parkland settings. However, these oaks are quite different as they are heavily branched much lower down and have wider annual rings. Oaks of much greater diameter can also be found today, but these are normally old hedgerow or pasture-land trees of modest height with heavy low branches.

As to the probable age of the parent tree when it was used for the boat, it is only possible to provide an extremely rough estimate as the annual rings from the outside of very large oaks are almost always

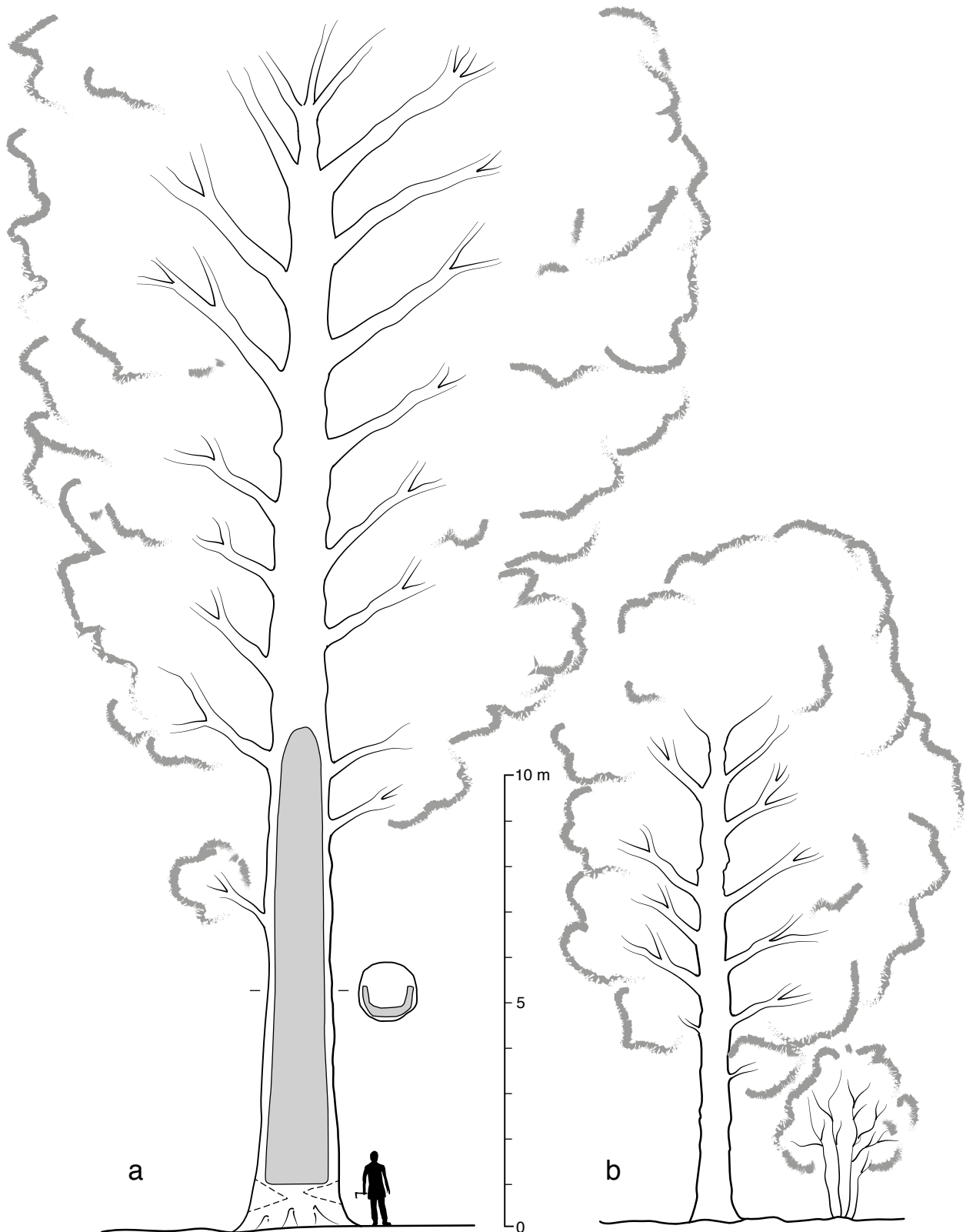

Figure 3.3 a: reconstruction of the great prehistoric oak used to build the Poole logboat;
b: a typical large, modern woodland oak from traditionally managed woodland in southern England

narrower than those nearer the heart. However, taking an average ring width overall of perhaps 3 mm, and allowing for missing sapwood, the great oak would have been at least 280 to 350 years old, quite probably rather more. For comparison, the apparently rather slower-grown log of a similar size used for the large Hasholme Iron Age logboat was estimated to have been as much as 600 years old (Millett and McGrail 1987, 84).

The overall importance of this information is that the patches of lowland deciduous wildwood which the Poole logboat builders could exploit is now extinct in Europe, although a mixed conifer and deciduous forest version can still be found in protected forest reserves in eastern Poland. While this great tree must have come from at least a grove, if not a wider area of wildwood, we also now know, from studies made in other regions where late prehistoric wood survives (e.g. Brunning *et al.* 2000, 187; Goodburn 2003, 103), that other forms of ‘treeland’ existed in southern Britain during the period. This included forms of intensively managed woodland, with much smaller, regularly cut trees alongside areas of high wildwood and more open farmed land which included some hedgerows. Interestingly, the very large Dorset oak used to build the Cranborne reconstruction of the Poole logboat was growing in a small grove of very large oak on the edge of a managed ancient wood, but it was next to a dense, dark, spruce plantation which appears to have encouraged very straight branch-free growth. Unfortunately the number of annual rings, and thus the age of the tree, was not recorded.

Weight of the parent log

Wood science research shows that English-grown oak with narrow annual rings is lighter, softer and less strong than the medium- or wide-ringed oak typically felled today (with rings c. 3–8 mm wide), but it is possible to make a rough estimate of the weight of the parent oak. Typically, modern freshly cut oak heartwood weighs c. 1.073 tonnes per cubic metre (Millett and McGrail 1987, 106), which makes it heavier than fresh water. Indeed, it can sometimes sink in salt water even when still covered in more buoyant bark. Thus, the weight of the felled log with the branches removed, at just over 10 m long, would have been about 12 tonnes (Tanner calculated 10.5 m length weighs 16,560 kg [c. 16.5 tonnes]), allowing a little for the narrow-ringed character of the timber. It has been suggested that logboat logs could have been moved by rolling, but this is extremely unlikely due to the large weight involved and the need to fell and clear a large area of land. It would also have been necessary to build some form of roadway of logs, in this case up to c. 12 m wide! The ethnography of logboat building in recent times shows that for all but the smallest craft, the vessels were roughly carved-out before being moved to a launch or workshop area, thereby greatly reducing the labour needed to move them (e.g. Best 1976, 112). The moving of a large, partially carved or even finished logboat was a serious communal undertaking; this is explored below.

The early stages in building the Poole logboat

Selection of a suitable tree

There would have been a plethora of issues affecting the best choice of log for a new boat. This decision would have been made by the most-experienced senior woodworker in the community, and as the building of a large logboat was a huge investment in time and effort, this person may have had a ritual as well as a practical role; master logboat builders also functioned as priests in some parts of the world (McGrail 1987, 64). It is known that groves of trees had religious significance for the native Celtic population of Britain, at least at the end of the Iron Age. Even today, many notice the emotive atmosphere created by a stand of very large trees. There are also risks attached to such work as the nature of the inside of a large tree could not be viewed prior to felling and during felling the tree could be damaged or hurt those below. A large falling tree can sometimes bring down branches off other trees nearby which can kill bystanders or those involved in the felling, even when they are some distance from the stump.

It is clear from the Poole logboat remains that the parent tree was selected not only for its great size but also for being straight and largely branch free (based on the branches seen as knots in the finished hull) for approximately 9.5 m. The straightness of the grain, partially shown by the fissures in the bark, would also have been a sought-after feature (Figure 3.4a). However, in this respect the builders had limited choice as the tree had some spiral to the grain which would have made it impossible to split it neatly in half. Finally, such large oaks, even in a section of high wildwood, may have been owned or reserved for special purposes and their use may have had to have been negotiated with the local elite. Other considerations would have been the proximity of the tree to a launch site and the location of obstacles such as other trees or natural features.

Some evidence for the general location of the boatbuilding site

The great size and weight of this boat, combined with its low sides in relation to its length, indicate that any exposed sea voyaging would have been impossible. Thus the building site must have been somewhere in the hinterland of Poole Harbour, as it was then. The boat's general lack of suitability for open-sea travel was demonstrated by the severe trouble experienced in gently towing the Cranborne reconstruction to nearby Christchurch Harbour in the early 1990s (Jake Keen, pers comm.).

Felling and bucking the 'parent tree' to make a parent log

Whilst it is assumed that to build a half-log boat the parent tree would have to be felled, in the north-west coast of North America at least, half logs were split out of great standing trees (Lincoln 1991, 25). Some of these trees even survived and have been surveyed by archaeologists. However, there is no clear evidence of this approach being used with large oaks in British prehistory. The spiral grain of the parent tree for the Poole logboat would also have prevented that procedure from being employed. Further, recently wind-felled trees can be used to build logboats, as this author did following the hurricane which hit southern England in 1987 and felled many large oaks (Goodburn and Redknap 1988). Very large trees can be damaged in such conditions and there is no evidence to indicate that this might have been the case for the Poole logboat tree.

In a few cases, parts of the felling cuts were apparently left on the butt ends of square-sterned logboats. In the case of the Hasholme boat, for example, asymmetry shown in the drawings of the stern end might be a relic of the felling operations. In the case of the Poole craft, there appears to be no direct surviving evidence for this but it must be considered briefly based on evidence from other sites. It is worth noting the great labour such a job entailed using the relatively small socketed iron axes that are known from the British Iron Age. With large trees, wide V-shaped felling cuts were axe-cut. In the case of exceptional trees like that under consideration here, it is very likely that one cut was made at the top edge of the felling cut or gob, and one at the lower edge (see Figure 3.4b). Gradually the two cuts were probably worked together with the intervening wood being split out – far easier than chipping out every piece when using comparatively small axes. It is likely that two main cuts were made opposite each other, with the one on the side to which the workers intended that the tree should fall being slightly lower. A crude estimate might be that this felling operation could have taken between one and two days using at least two axes, depending on the labour force, which probably worked in relays. The work would have produced around one tonne of chips and split-out wood, or waste (see below). Lopping the relatively few branches on the parent log that were not crushed during the felling would have probably happened alongside the next stage of work, the bucking.

During the process of cutting off the upper part of the parent tree, or 'bucking it', to provide the main lower end to use for the logboat, a wide V-shaped cut would have had to be made as axes cannot cut straight across a tree like a saw.² In practice, cross-wise cutting of oak with axes is particularly hard labour and tough on the tool hafts. Thus in experimental logboat building with oak, it is useful to do much of the shaping of the bow ends at this stage, thereby saving labour later.

² Large saws were only introduced during the Roman period.

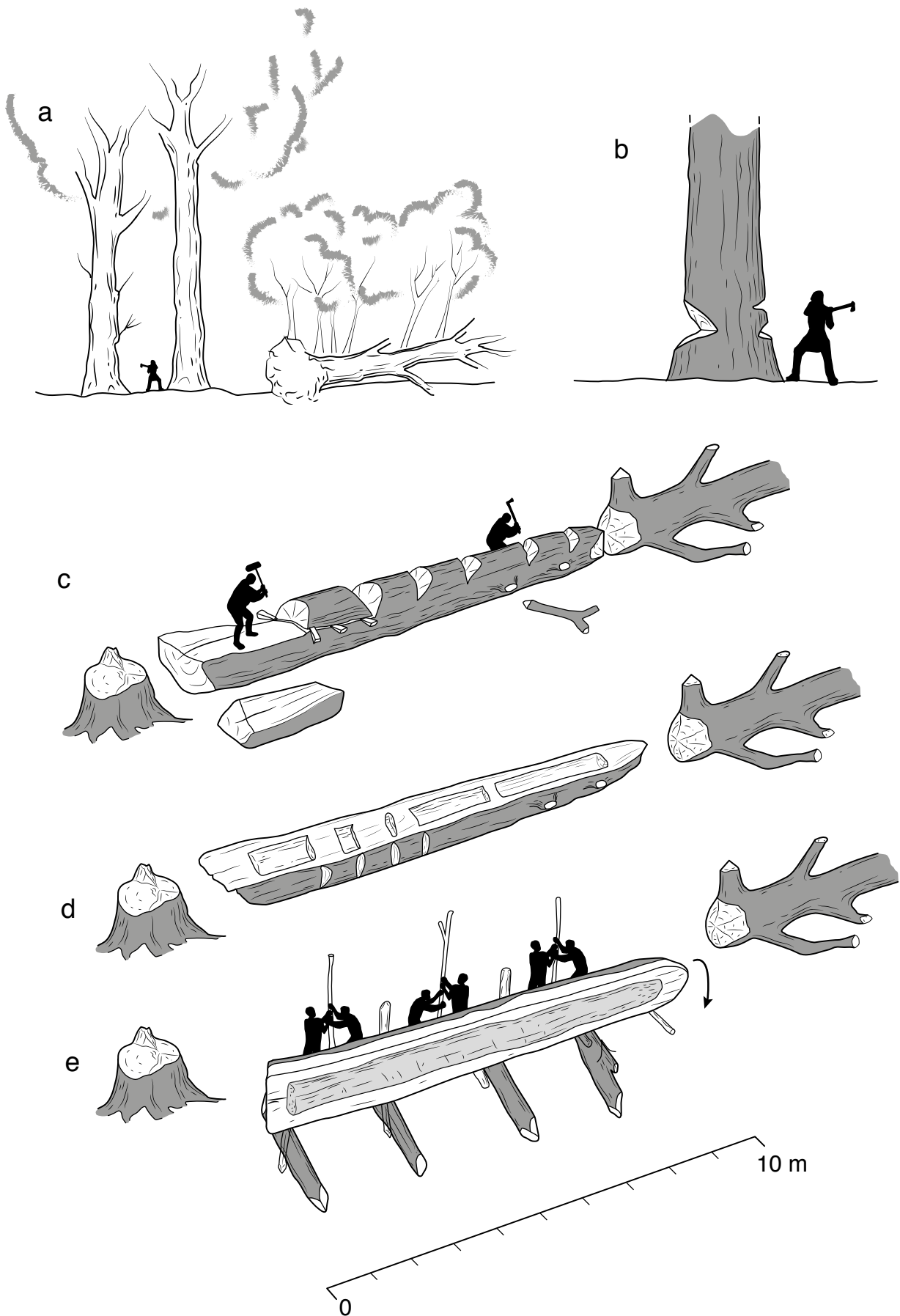

Figure 3.4 Drawings showing the likely key stages in the building of the Poole logboat

Splitting or cleaving out the half log

When the butt log to be used from the great oak had been lopped and bucked, the next step would have been to cleave it in half. However, the existence of spiral grain, which can be seen in the plan view of the boat as a series of splits along the curving grain, would have presented the builders with considerable problems. It would have been impossible to split the log neatly in half from one end to the other in one go as the plane of cleaving in a large log can only be steered a little by the positioning of the wooden wedges that must have been used to split it. Thus the builders would have made a series of V-shaped cuts roughly half way through the log and split off sections of only a few metres at a time (Figure 3.4c). Simple wooden tools such as various sizes of wooden wedges and pole levers, driven by large wooden mallets or mauls, would have been essential for this work. Such tools would have been available from at least the Neolithic period, but our oldest surviving examples in Britain are of Bronze Age date. (For more on cleaving large oak logs with prehistoric tool kits, see Darrah 2004, 168 and Goodburn 2004, 134.) Some of these short sections of half log could have weighed up to two tonnes and would have been removed from the main half log with wedges and poles. At least five, or more likely ten, people would have been involved.

'Waste timber' – a valuable community resource

In practice, c. 1 tonne of fuel could have been produced from felling a tree of this size, a similar amount from the bucking, and over 4 tonnes from the interior of the boat, even if the best, largest cleft sections were reserved for other projects. Indeed, what is often seen as waste timber today would not have been treated as such for the local Iron Age community. In any pre-late 20th-century society the smaller material would have been treated as essentially free kindling and fuel. It was commonly the work of children and women to gather this material in baskets for use (or sale or exchange), even though the larger fragments would have required some period of drying before burning because oak is a useless fuel when green. This fuel would have been in addition to all the fuel wood due from the surrounding trees which were felled in order to gain access to the chosen tree, or were knocked over during the felling, along with the upper parts of the logboat tree. This substantial tonnage must have fulfilled the fuel needs of several households for a year. Perhaps we can picture the boatbuilding site with a stream of men, women and children visiting with food and water and leaving loaded with fuel to stockpile at the settlement. If the parent tree was at a distance from the settlement, temporary shelter would probably also have been erected at the boatbuilding site.

Today, wooden paddles and oars in Britain are usually of conifer timbers such as spruce although some are of native ash. British archaeological paddle finds, however, are made almost exclusively from sections of cleft and carved oak (e.g. the large late Bronze Age Canewdon paddle – McGrail 1987, 206). Thus, it is very likely that the lower, straighter sections of waste were used to make paddles and possibly other fittings for the Poole logboat. This was done during the making of a reconstruction of the late Bronze Age/Iron Age Short Ferry Boat at Christchurch Harbour in 2004, a vessel that was of broadly similar shape to the Poole example, but a little smaller.

Rough hollowing and shaping (Figure 3.4d)

The key focus of interest in how logboats were constructed is the 'hollowing of the log' and many myths surround how this was done. The method is generally assumed to have been a combination of burning and chopping with adzes, but when ancient British logboat finds are closely examined this is found not to have been the case. The key practical consideration, in a British context, is that freshly cut oak burns particularly poorly and as soon as metal tools became available, it was far easier to cut grooves into the timber and split out the bulk of the waste between the grooves (Goodburn and Redknap 1988; Goodburn 2002, chapter 5). Unfortunately, the surfaces of decayed, waterlogged, oak heartwood generally turn black under most burial conditions in Britain, since soil and muds almost always contain iron compounds that react with the acids in the oak timber to give a blue-black colour. When these surfaces dry out, they crack along and across the grain in a similar way to that seen in

charred wood. However, the surface is a shade lighter in colour and does not have the crystalline, brittle nature of carbonised oak. Whilst the distinction is clear to the experienced touch and eye (a trowel rings when dragged over charred oak but not waterlogged oak), it is easy to see why this form of surface can be mistakenly identified as charred.

This ‘groove and split’ approach was probably also used for rough-shaping the external faces of logboats; it is well documented in ethnographic sources, later logboat finds, and in the hollowing of the dugout elements of the earlier planked boat found in Dover (Goodburn 2002, chapter 5; 2004, 132). Interestingly, Fox had already realised that this was the main method of hollowing used in oak logboat building as early as 1925 (Fox 1926, 125). When the grain is knot-free and straight, large volumes can be removed quickly, but with spiral grain and any knots the process is slowed down by the need to cut more deep grooves across the grain.

Whilst cutting the grooves for hollowing large wood chips fly out with great force so workers have to space themselves out along the log being hollowed. As this vessel was just over 10 m (c. 32 feet) long, up to five people a side could have been working simultaneously, though it was probably a smaller number working in relays if circumstances required it. This work was the most demanding physically and was the first to be replaced by power tools in recent logboat building projects. It seems likely that frequent rest days would have been taken during this stage of the work, if not throughout. Wrist and shoulder joints can only take so much of the jarring and strain that constantly cross-cutting large sections of oak creates: it is the equivalent of felling a considerable number of large oaks. A guesstimate of at least a week’s working time (probably rather more) for this phase is likely, unless the workforce was very large and had little else to do.

Rolling the part-shaped hull over

The slightly trimmed half log must have weighed at least 5 tonnes, probably nearer 6, before any hollowing. Following some rough hollowing, whilst still leaving the sides thick enough to resist damage during the rolling process, the part-shaped boat of green oak would have weighed perhaps 2.5–3 tonnes. Whilst still a substantial weight, this would have greatly eased the rolling process. To ease the work further, and to allow for easier adjustments to the position of the heavy boat, it is very likely that it would have been rolled onto bearer logs (Figure 3.4e). This simple building platform would have allowed easier access to all areas of the boat, reduced backache for the builders, and eased any further movement. Elevating the boat off the forest floor would also help to keep it clean and grit free, thereby prolonging the life of the tool edges.

Rough shaping the lower parts of the outside of the hull in the inverted position

This stage of shaping the hull was probably done next for several reasons, although the exact order of the early stages of hull-shaping from the rough half log can never be reconstructed with absolute certainty. The range of ethnographic evidence also provides no set model for the order of the work. It is quite possible that the rational order of work proposed here may well diverge from what the Iron Age community in Dorset viewed as the ‘way we have always done it’. Boats were just as much formed by local traditions as pottery or burial practices; the power of local tradition over rational procedure in boatbuilding can be seen in Britain and elsewhere during the 19th and early 20th century. Variation in the details of building practices and hull forms in prehistoric dugout boats must reflect not only local customs but also local resources and social and practical needs.

Marking out the shape of the bottom of the boat must have been done at this stage and timber removed along the central part of the bottom and lower part of the sides of the vessel. The new examination and recording of the Poole logboat shows that it had a rather flatter bottom than the recording of the 1970s suggested, which could only have been created by removing some heartwood along the centre of the bottom whilst the hull was inverted (Figure 3.5a). This would have been essential at the butt end of the

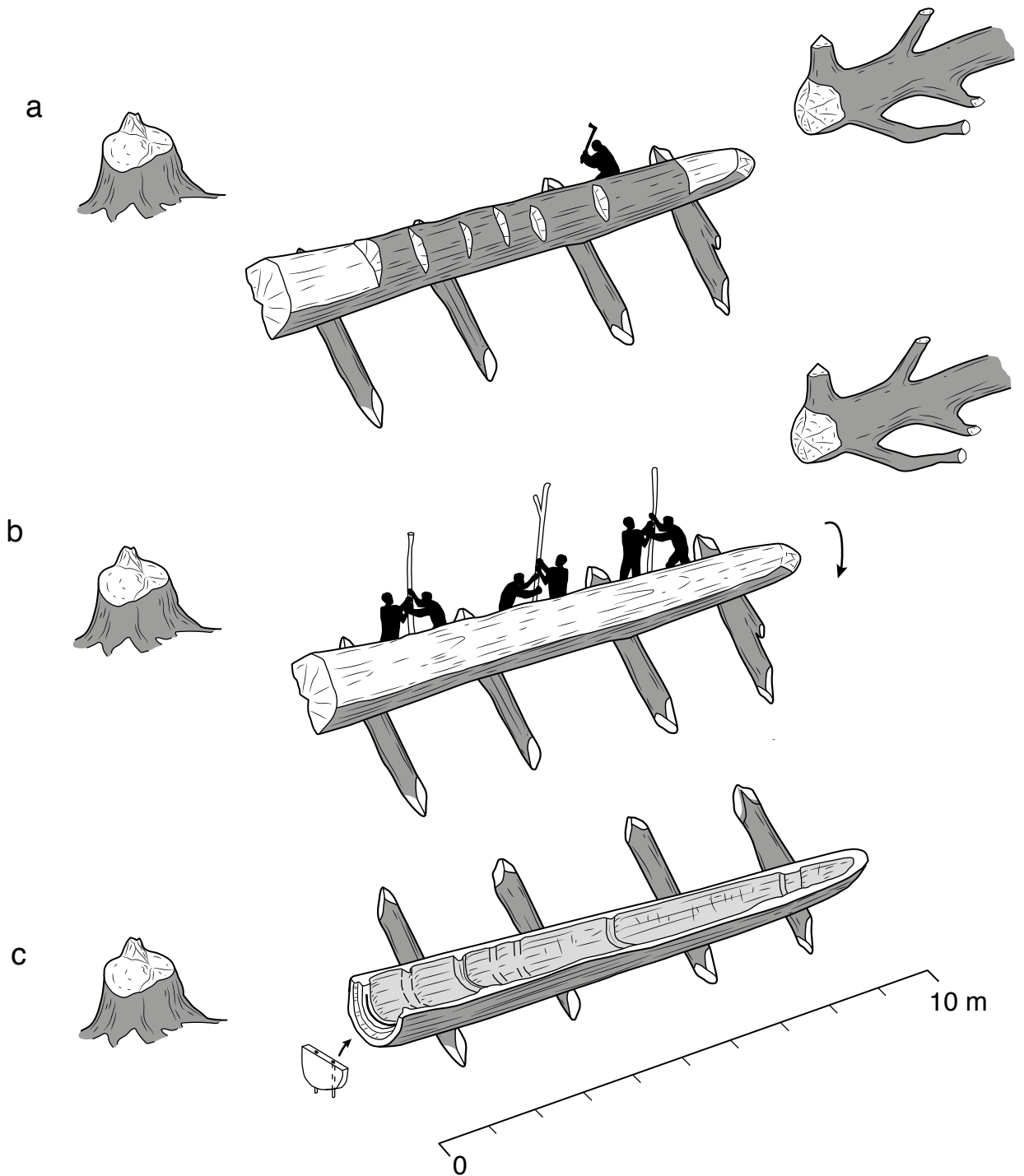

Figure 3.5 Further stages in building the Poole logboat

log, where the swelling out towards the buttress at the base of the tree would otherwise have caused the bottom of the boat to droop down excessively. This would not only have made it very difficult to drag to the launch site, but also slower and more cumbersome afloat. It is clear that a small amount of upward turn (rocker) was carved in at both the bow and stern at this point (see Figure 4.4). The builders were clearly well aware of the advantages of lifting the ends of the carved bottom a little, probably mainly to ease beaching and riding over obstacles.

The bulk of the waste timber would probably have been removed by cutting grooves and splitting off the excess timber with wedges, but where there was only sapwood and bark to remove, it is likely that shallow grooves were cut with axes and the waste just chopped or hewn off with axes and adzes. The

toolmark evidence does not survive on the outside of the Poole logboat hull but it is likely that edged tools hafted as adzes were used to smooth and regularise, or fair off, the bottom. Adzes allow the worker to stand, or sit, at right-angles to the work, which in practice is far more convenient for finishing the inverted bottom and lower sides than standing in line with the timber whilst using an axe.

Due to the sloping shape of the Poole logboat bow, it would have been impossible to hew it out unless the hull was in the inverted position. It is likely that the surfaces of the bow, the bottom, and lower part of the sides were given their final shape and finish at this point, since rolling the heavy vessel back over again would have been difficult and would probably have damaged the thinner upper edges of the boat. In addition, the finished external surfaces would have provided a surface to cut back to from the inside during its final shaping. Whole-log logboats only require rolling over once, but logistical considerations suggest that this boat must have been rolled over and then back again, with all the labour and difficulty that involved. (This was, from necessity, the procedure used for the Cranborne reconstruction.) Shaping the bow indentation and false stem timber would have been relatively easy for anyone moderately skilled with axe and adze work; no smaller tools would have been needed. Unfortunately, no clear toolmarks could be seen in this area, which was probably much abraded in use in any case.

Before the boat, with its nearly finished external surface, was rolled back over to finish the inside and upper sides, it is almost certain that the three central holes were cut at this time. It seems probable that they were used as points where the bottom thickness could be easily gauged. The fact that they do not line up clearly in a straight line may indicate that a central marked line of symmetry was not considered very important by the builders. Other recesses associated with them on the finished inside surface of the boat indicate they also probably had other functions (see below).

Rolling the externally shaped boat back over to an upright position

The boat's hull would now have been somewhat lighter and thinner, but probably still at least half to one tonne heavier than its final weight; perhaps 2.0–2.5 tonnes (Figure 3.5b). Thus to roll the vessel back over would have been an extended communal effort. A group of at least 10 people using pole levers, wedges, and chocks of waste timber would be required: some to lever in pairs and others to move the wedges and chocks. Once the tipping point was reached, a dangerous movement of the heavy log would have to be averted, perhaps with a cushion of branches to slow the motion. The boat would then have been wedged evenly upright on the log platform whilst sitting on its new, fairly flat bottom. As much of the surface of the hull would now have been close to its finished state, it is certain that the builders would have applied fats or oils to slow the drying out of the sap and reduce splitting (see below).

Final shaping and smoothing of the hull

Finishing the upper sides

Trimming the upper sides internally and externally would have been more easily achieved using axes with the boat in the upright position (Figure 3.5c). Any guidelines marked with charcoal or chalk could have been seen whilst directing the blows. While marks left by axe-type tools used for this work have been recorded on many other logboat finds (Goodburn 2002, chapter 5), they were not found in the Poole logboat due to abrasion, decay and the loss of the upper parts of the hull. Tools hafted as adzes could also have been used for this work, although for a neatly finished 'gunwhale' line the woodworker would have to keep stopping to look along the long axis of the side of the boat. When oak dries, small chips and areas of rough grain often become sharp and projecting, so it is likely the final top edge of the boat was carefully trimmed and bevelled or rounded at this stage and again later.

Shaping the transom groove

Surprisingly, no clear toolmarks were observed in this otherwise protected area. It is possible that the groove which once held the transom plank had suffered rough cleaning out at some point after

discovery. With practice such grooves could be cut, largely or entirely, with a small axe and adze, particularly if V-shaped in profile. Although by the 1970s the groove was roughly flat bottomed, photographs taken in 1964 (Poole Museum archive no. F 4f -0017.hf) show that the original transom groove was once far more V-shaped; perhaps this change is proof of damage created by cleaning out. This means the sides and base of the transom plank had been hewn to a fairly sharp, bevelled edge resembling that of a barrel end piece.

Shaping the internal bottom of the boat and the false frame ridges

Here there is more solid evidence to interpret as some reasonably clear toolmarks have now been recognised and recorded in these areas. No details of surviving toolmarks on the boat were recorded in the 1970s study, presumably due to poor lighting conditions, although McGrail did note ‘possible toolmarks on the inside near the starboard beam’, a location which is uncertain (McGrail 1978, 255).

During the author’s first visit to the boat in 1994, several surviving toolmarks were found and recorded, with more being seen at the second visit in 2013 under better lighting conditions. Further marks were then recognised on some of the photographs taken in 1964. All this evidence is used here and in more detail in the tool kit discussion below. The locations of the best-preserved toolmarks are indicated in Figure 3.1. The early photos have shown that the inside of the boat was smoothly finished, in the lower parts at least, using a small adze-type tool that was swung diagonally at about 45° to the grain of the timber. This left a smooth, but slightly dimpled, surface which survived near the transom at the time of discovery (Toolmarks 1 and 2 on Figure 3.1. See also Figure 3.6a).

It is also clear from the toolmarks on both the forward face of the ridge left of the transom groove, and in several places on the lower parts of the edges of the false frame ridges, that their final shaping was carried out with a small edge tool(s), probably hafted as an adze, the hafting being indicated by the direction of the blow (TMs 3 and 4 in Figure 3.1). The marks are of two forms: one an ‘incut’ created when the tool was swung at a steep angle to the surface, as in cutting grooves or nicks to split out waste, the other slightly dished facets, sometimes ending in clear ‘stop marks’, where the tool was used at a shallower angle with a paring blow. The second form of mark was created during the final finishing work.

The bottom holes

The three roughly central bottom holes were clearly cut with a narrow-bladed gouge (rounded chisel-type tool) rather than bored out with some type of drilling tool. The marks of the gouge were particularly clear around the edges of the hole near the bow (Figure 3.6c). This vertical through hole is now oval and c. 50 mm across and 40 mm in the long axis, with an irregular rounded recess c. 20 mm deep surrounding its upper end. The presence of the additional recess may imply a vertical timber with a roughly circular peg-like end was fitted into the hole rather than just a wooden bung. As McGrail noted, these three holes are much larger than is typical for those that clearly functioned simply as thickness gauge holes. When examined in the 1970s, the middle hole, which was approximately of the same form and size as the bow hole, was also noted as having a shallow recess surrounding it (McGrail 1978, 255). At that time it also still had fragments of some form of wooden bung or peg end *in situ*. The stern hole was rather larger than the other two and survives as an oval hole c. 90 mm in the long axis by 80 mm wide and it has clearly suffered some damage. In 1994, fragments of vertical-grain oak were noted as still adhering in this hole, implying that it had once held a large oak bung or perhaps the tapered end of an upright timber.

Notes on the probable nature of the missing transom plank

Although no remains of the transom plank were apparently found in 1964, judging by the fresh dimensions of the transom groove it would have been D-shaped, about 1 m wide, at least 350 mm deep and at least 55 mm thick. The edge would have been hewn to a ‘V’ shape to match the groove in the logboat bottom. The transom plank groove apparently had slivers of animal hide in it when found. It is likely that this

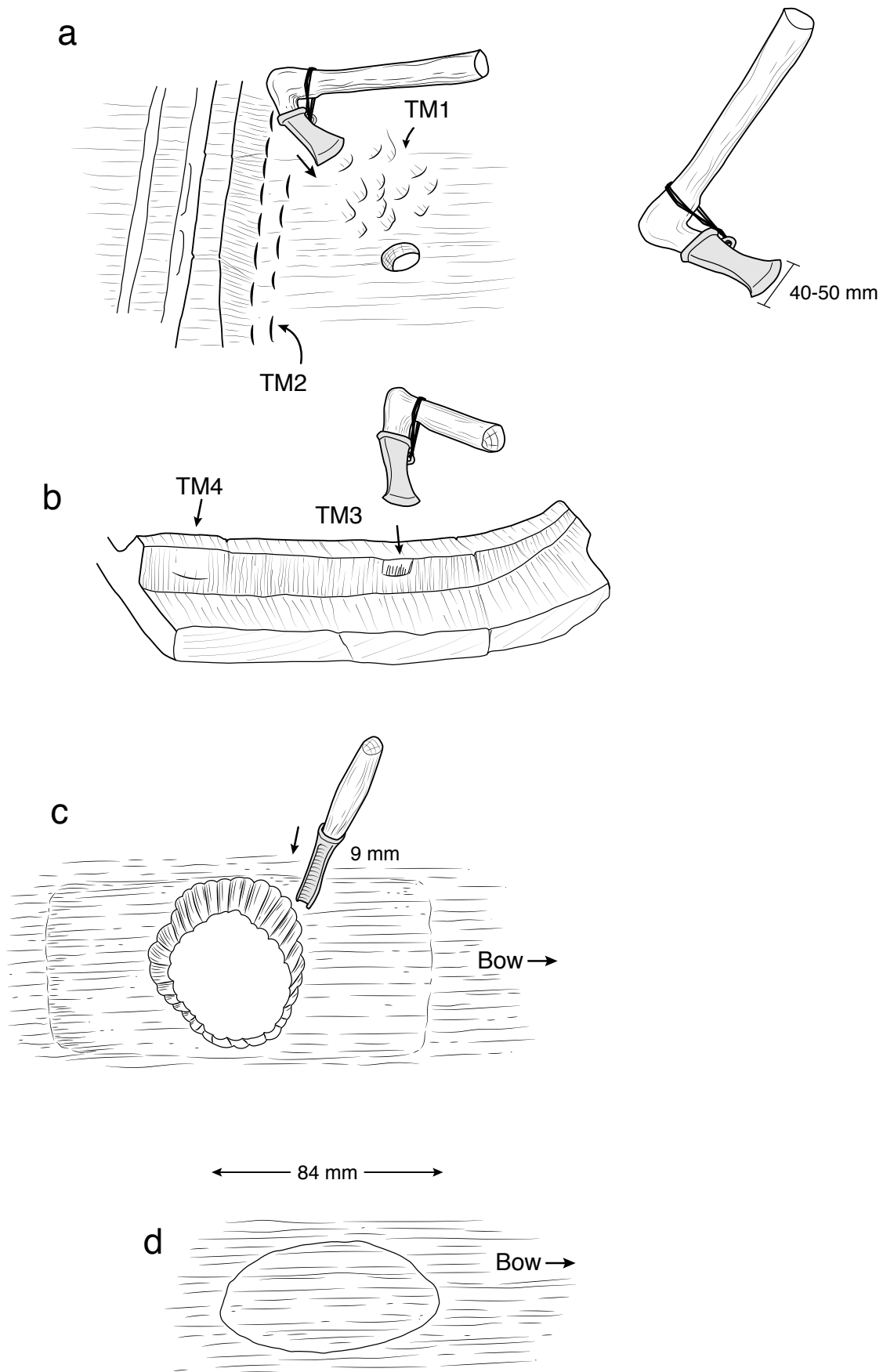

Figure 3.6 Sketches showing the character of all the best-preserved surviving toolmarks (TMs) seen in photographs taken in 1964, and records made 1994 and 2013

fairly shallow transom was made from timber cleft out of the boat and may have resembled the plain, fairly roughly made example found *in situ* in the Carpow boat (Strachan 2010). However, it is also possible that this timber had additional carved features like that found in the Hasholme boat (Millett and McGrail 1987).

Oval mark cut in the bottom near the bow

In 2013, in the much better lighting conditions that the boat was viewed in, a previously unseen, faint subtle mark was visible. This was a finely scratched (scribed) oval mark c. 84 mm in the long axis of the boat by c. 50 mm wide. It lay c. 100 mm to starboard of the centre line and c. 1 m from the extreme bow (Figure 3.6d). The mark appeared to be ancient and not related to post-discovery handling or conservation. It was probably cut with a fine knife tip or the corner of an axe or adze blade. Its purpose is uncertain, but should there have been two such marks it might tentatively have been suggested that they were symbolic eyes, or oculi. These have occasionally been found at the bow ends of other logboats, such as the very large Iron Age Brigg craft (McGrail 1987, 84). If this was intended as one of a pair of such marks, its faint character may imply a secretive magic rather than something to be publicly displayed.

Reconstructing the tool kit

Edge tools implied by surviving toolmarks (see Figure 3.6b)

Although no details of surviving toolmarks were clearly recognised, recorded or discussed before 1994, several categories of original marks have now been identified, measured and located on plans of the vessel. The author's experience of making a number of oak logboat reconstructions has been a great aid to the recognition of these details which take us closer to the actual work of the logboat builders. In some ways toolmarks on early woodwork are akin to the fingerprints studied in police forensic work, where only the best-preserved examples of each print are of prime importance. Specialists are often able to identify the general size and form of toolmarks and when the wood surfaces are extremely well preserved, traces of individual tools can sometimes be identified by patterns of striations mimicking small nicks on the blade edge. These distinctive striations are usually termed signature marks and can be used to identify the number of tools used and phases of work. Very detailed work has been done on some late Bronze Age and early Iron Age tool signatures on well-preserved woodwork from Scotland, including a freshly abandoned logboat transom plank (Sands 1997; 2010, 75). Unfortunately, none of the toolmarks found on the surfaces of the Poole logboat from 1994 onward had these very fine features preserved, although it is still possible to reconstruct the size and general form of some of the tools and surmise how they were employed.

Archaeologists have studied the development, form and dating of prehistoric axe- and adze-type tool heads for at least 200 years but until very recently, only rarely was consideration given as to how they were hafted and actually used. There are a few key sources of comparative evidence for later prehistoric toolmarks and attempts to reconstruct tool kits used by early woodworkers. One of the earliest archaeologists to examine this subject in detail was Stuart Piggott in his study of prehistoric wheeled vehicles (Piggott 1983). He was the first to realise that some of the axe heads must have been hafted as adzes (the tool is put on a handle or 'haft' at 90° to the long axis of the handle, like a hoe). Axe-type blades hafted as adzes were, of course, crucial tools in the finishing stages of making logboats and the Poole vessel is no exception. This is because the deep, concave, internal form prevents the free swinging of an axe handle for the trimming on the lower inside areas (see Figure 3.6a and b). At the same time, extensive investigations of late prehistoric wooden trackways, well linings, and other structures gradually produced a large amount of comparative evidence from Britain and Ireland (e.g. Coles and Orme 1985). Later specialists, who were informed by archaeology-led experiments in prehistoric woodworking and improved dating methods, were able to provide more detailed studies and date the development of specific types of later prehistoric woodworking tools more reliably (O'Sullivan 1997; Sands 1997; Brunning *et al.* 2000; Goodburn 2003; 2004).

One central problem has been in the use of C14 dating for the period of the late Bronze Age to middle Iron Age when more accurate tree-ring dating has not been possible. However, scientists are now able to suggest that the width of axe and adze marks on timbers produced by large-scale work are broadly datable. During the Bronze Age, the axe heads found typically declined in blade width with only rare exceptions, so that from the late Bronze Age (c. 1200 BC – c. 800 BC) typical axe marks found are only c. 35–50 mm wide, although a few slightly wider axes are known (Goodburn 2003, 104). While there are fewer well-dated Iron Age toolmarks and far fewer axe heads, there is a clear increase in blade width and weight of larger axe-type tools when iron tools are adopted c. 800–700 BC (Sands 1997, 81; Brunning *et al.* 2000, 195). The axe-head form used until Roman influence takes effect at the very end of the Iron Age appears to be the socketed form, resembling scaled-up versions of late Bronze Age tools (see Figure 3.6a and b). Typical blade widths of the larger range of tools, presumably used for heavy work, were now c. 65–80 mm wide (Sands 1997, 80), although some smaller, and a very few wider, blades are also known. Very strangely, there is no surviving trace of the use of axes or adzes of this, typically larger, Iron Age size range on the Poole logboat. In most early logboats, and indeed even prehistoric planked vessels, traces of the larger tools used for the heavy-duty roughing-out stages can be found here and there where they bit in a little deep (Goodburn 2002, chapter 5; 2004, 131). The lack of toolmarks from the suggested early phases of work may be a testament to the careful work of the builders who did not allow their tools to bite-in too much.

None of the toolmarks surviving on the the Poole logboat is well preserved but a few are fairly clear. Perhaps the best-preserved, when the boat was found, were the smooth, dished facets left from using an adze-type tool to finish the bottom of the boat on the inside near the stern (Toolmarks TM1 on Figures 3.1 and 3.6a). The facets show the tool was used diagonally to the grain and the blade was rounded or, less likely, slightly dished at the end, with a width of c. 40 mm or slightly less. A rounded end to the blade creates the concave dimples when used at a shallow angle to the timber surface for smoothing. In the same photograph, clear, straight, in-cut marks can be seen at the front edge of the flange left for fitting the transom plank (Toolmarks TM2, Figures 3.1 and 3.6a). These marks were also c. 40 mm wide and may have been made with the same adze, or perhaps a small axe, used at a steep angle to the timber surface. Some of these marks were still visible in 2013.

On the forward and aft edges of the false frame ridges several toolmarks could be seen in 1994 and 2013. For example, on the aft face of the forward frame ridge, faint facets c. 38 mm wide and an incut 40 mm wide were recorded (Toolmarks TM 3 and 4 on Figures 3.1 and 3.6b). In this case it appears most likely, from their location, that they were left by a tool hafted as an adze. These are clearly toolmarks left from the use of a small form of adze, and possibly an axe, at the finishing stages only.

Finally, the clear concave marks of a small gouge (rounded chisel) were found, with the clearest marks having a width of only 9 mm surviving inside the forward bottom hole (Figure 3.1, Toolmark TM 5; Figure 3.6c). The gouge was clearly wider than this but cutting a considerable depth of oak end grain is demanding work so the full width of the tool would not have bitten in. The woodworkers also appear to have wanted to create a relatively smooth-sided, rounded hole, presumably because this could be made watertight more easily. It seems that large woodworking drills (augers) were not widely available in Britain until the Roman period and prior to that gouges were used to carve holes laboriously through large timbers. This tool would have been of a socketed form and probably at least 20 mm wide in total. It was also clearly used with a mallet of some type.

To summarise, there is only direct evidence for the use of a small adze or adzes and possibly a small axe, both with blades c. 40 mm wide, and a small gouge and mallet. However, a range of other tools is clearly implied by the form and size of the hull.

Implied tools that left no direct trace

Among the tools which have left no direct trace on the logboat must be the larger axes used for felling and bucking the huge parent tree, and cutting the many deep, V-shaped scores needed to cleave out the bulk of the ‘waste’ timber. A large set of wooden wedges and a heavy wooden mallet, or maul, to drive

them, would also have been needed for the controlled splitting work. Several pole levers were probably used to help open splits, move heavy waste timber sections, and move and roll the logboat's heavy hull. Some rope and many skid logs for the proposed building platform and the 'skid row' for hauling the finished, or near-finished, boat to its launch site must also have been prepared.

It is very likely that pigment in the form of charcoal or chalk was used to mark out key areas, although scribing with edge tools could also have been used. Pots or tubs for containing the fatty material (and possibly beeswax) needed to control seasoning and assist with waterproofing would have been required, and finally a small wooden wedge or caulking tool would have been needed to push organic matter into the transom groove and probably the drying splits developing around larger knots at the bow end.

The need to control seasoning and other materials used in construction

Even in the winter, wind can dry and harden the surfaces of an oak logboat under construction, although the problem is worse in the summer. To counter this, large quantities of fatty or oily materials would have been needed – probably animal fats and fish oils. It is likely that wind breaks or sunshades of wattle work or vegetation were used as well to control over-rapid drying. The drawback of using animal- or fish-based products is that they would inevitably attract wild animals. Foxes, badgers, rats and many birds are regular visitors to experimental logboat building sites when in woodland settings. In the middle Iron Age of Dorset, such animals could have included wolves and wild boar which may have posed a risk to the building team after dark.

McGrail (quoting Poole Museum data) notes that the transom groove was apparently caulked with animal hide, but no reference to the identification of this material is given. As the transom groove would not have been waterlogged, such a material would have decayed very quickly and it appears an odd choice for such a purpose. Perhaps the material was actually thin slivers of a soft, flexible wood or even bark, both of which would have resembled leather when found; either of the above would have been far more practical. These natural materials have been found widely used, with others, such as moss and beeswax, in later prehistoric vessels (e.g. Marsden 2004, 67). This author would suggest that the original sealing of the transom joint would probably have been based on vegetable material backed up with beeswax, but the post-abandonment erosion and decay has removed much of the evidence.

Weight and movement of the hull

Reconstructing the weight of the hull

It is accepted here that the newly completed vessel would have been nearly totally green with only minimal drying of the surfaces, particularly the upper parts. By the end of the first year's use the weight of the upper sides would have been reduced, but if kept afloat or on a tidal shore the bottom of the vessel would have never fully seasoned. A typical fresh modern oak heartwood density has been given as 1.073 tonnes per cubic metre (Millett and McGrail 1987, 106), just a little over that of fresh water. This means that much freshly cut modern English-grown oak timber will not float in fresh water or even, sometimes, in salt water. However, this author's experience confirms the findings of others which highlight the considerable range in density found in north-west European oak, principally due to variation in annual ring width. Narrow-ringed oak timber (c. 2 mm or less annual ring width) tends to be considerably lighter, softer and weaker than medium- to fast-grown oak with rings 3–8 mm wide.

Having established an approximate reconstruction of the original proportions and dimensions of the Poole logboat (see Figure 3.2), a rough figure for the weight of the boat's hull just after completion can be calculated. This has been done by turning the half cylinder of the boat's hull into a nominal plank using average dimensions of the hull and average thickness and multiplying by its length (c. 1.8 m wide by c. 85 mm thick by c. 10.1 m long). This process provides a figure, using average modern green oak heartwood density, in the order of 1.64 tonnes. Allowing additional weight for the transom and thicker ends but countering that with the lower weight of the narrow-ringed timber and the slight drying of the

upper sides, the figure can be approximated at c. 1.5 tonnes (but see also Tanner, Chapter 4). This figure is far in excess of that given by McGrail of c. 862 kg (0.862 tonnes) in his original analysis of the boat (1978, 256). However, in checking through his figures it can be seen that McGrail greatly underestimated the average thickness of the bottom of the hull as being only 65 mm; this would account for the low figure for hull weight given. This substantial change to the hull weight calculation, together with the revision of the previous interpretation of the original hull cross-sections, have a considerable effect on our understanding of the Poole logboat's capabilities as a vessel (see below and Tanner, Chapter 4).

Probable size of hauling party

Given a freshly built weight of c. 1.5 tonnes, it must be imagined that a large party of people would be needed to move the finished vessel, and even more if it had to be moved unfinished or uphill. As few as four adults, with pole levers, chocks and wedges could have moved the boat a few metres, if it was on log skids, but many more would have been needed in a long haul. Based on experience of hauling logboat replicas on level ground on damp skid logs, a group of perhaps 25 to 30 people would be required for the direct hauling of this boat, with perhaps 10 to keep moving the skid logs and keep the boat on track using poles. Once a heavy logboat has been urged in to motion it is very much easier to continue at a fast walking speed for some distance than to stop and start every metre or so (Figure 3.7).

The haulers would have needed a way of attaching a hauling rope – this might possibly have been a feature of timber left in the solid hull till launch date, or possibly some form of strong post fastened into one of the large bottom holes and braced at the upper lever by a cross beam.

Timescale

It is impossible to have any precision in this estimate but it is likely that the building of the Poole logboat was the work of at least an extended family or, more likely, a substantial part of a village community from the autumn to spring. Summer would have been the busiest time in the community and the heavy work involved in building the boat would have been far harder in hot weather. Even more important is the fact that the green oak timber would have been prone to much more rapid drying in summer, with more distortion and splitting as a result.

The early stages of work would have been physically very demanding and rest periods and other important work would no doubt have broken-up the labour. It is easy to imagine the core team being perhaps some five to ten adults led by one or two experienced older men, with periodic assistance at certain moments in the work, such as the essential rolling over and hauling out, from a much larger group of at least ten more people.

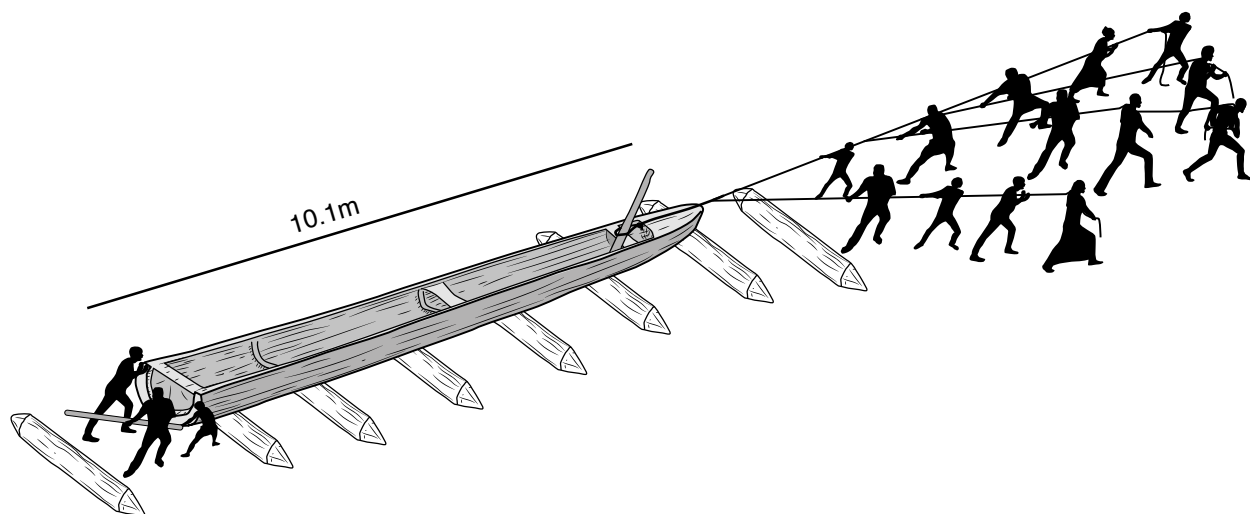

Figure 3.7 Sketch to show a possible form of the finished Poole logboat being hauled to its launch site

Signs of ancient wear and damage to the hull

Observations on the patterns of wear seen in some oak logboat reconstructions which have been regularly used can provide some general parallels for assessing ancient wear. The lack of any surviving toolmarks on the outboard face is partly due to the loss of decayed surfaces but is also likely to be a result of wear to some extent. Dents in the solid carved false stem projection at the bow end may well reflect impacts while in use. This suggests several years of use, with abrasion resulting from grounding on beaches, banks and possibly rubbing against other boats and waterfront structures such as the South Deep moles. However, what appears to be an early set of photos taken in 1964, soon after the stern section of the hull was lifted, shows a smooth, adze-finished internal surface near the stern. The smooth faceted surface has clearly only been very slightly abraded. If this surface was typical of the freshness of the little-decayed surfaces of the boat's interior originally, then it might suggest only a short period of use, perhaps less than three years. In practice, sand grains adhering to feet or shoes quickly start to abrade the surfaces of oak logboats in regular use.

Discussion of design features

The large recesses cut around the forward and middle centre-line holes

The unusually large oval holes gouged through the bottom of the Poole logboat are distinctive and while they may have acted as thickness testing holes during the hollowing, they are unnecessarily large. The forward and central examples also had shallow recesses up to 20 mm deep cut around them on their upper faces. It is likely that these features actually represent the locating socket for upright timbers of some kind that also functioned as bungs. The aft and central holes may have held uprights that supported cross planks or thwart that would both reinforce the hull and act as benches for the crew (see Figure 4.35). The same may have been true of the forward hole but that location would also have been in a suitable position for a short mast. Sailing craft are known by the end of the Iron Age in the English Channel area so a mast might not be incongruous. It is evident from the existence of the functionally unnecessary solid stem at the bow that the builders were simulating features of more elaborate craft which would almost certainly have been made of planks. If this feature was a mast socket, the upright timber must have been braced by a beam or thwart at the level of the eroded top edge or sheerline of the boat (see Figures 4.34 and 4.35). Such a mast would have been very short and would probably have been used to carry a towing or hauling-out line, as seen in narrow canal barges in England until the 1950s. In the shallow and probably narrow tidal channels this boat would have operated by in-line towing from the bank. A short towing mast helps keep the line above vegetation such as reeds.

Some surprisingly narrow, simple logboats have been equipped to sail in recent times in many parts of the world. Small sails or even a bush or crewman's cape have been documented as being used for downwind sailing in such small craft (Roberts and Shackleton 1983, 87) and simple drift sailing can be surprisingly effective in sheltered waters.³ However, the suggestion that a small sailing mast might have been fitted for downwind sailing is highly tentative.

Notes on performance

Some general observations

Despite demand for serious measured trials of reconstructions of later prehistoric logboats, none has been carried out to date. However, more informally gathered information is available and is arguably still of some value, since there are no ethnographic records of the use of broad-sterned oak logboats.

³ This author once sailed about three miles downwind in a dinghy in Chichester harbour, simply by standing up whilst wearing an old-fashioned cycling cape and using a small oar to steer.

Informal practical experience of travelling in several reconstructions of British logboat finds has highlighted some factors that desktop calculations have not made clear. Firstly, logboats vary greatly in size, hull form and weight but the vast majority share the characteristic of being far heavier than modern small wooden boats, and in particular canoes and kayaks in synthetic materials. This means most logboats, and particularly a vessel like the Poole example, were much heavier than the crew and had great momentum. Most hull forms of British logboat finds are also relatively narrow and shallow-sided in relation to their length and are therefore only suitable for use in sheltered water. This is particularly true of boats made from half logs, like the Poole example, where the bow and stern normally ended up only as high as a little less than half the diameter of the parent tree.

First-hand experience in the Cranborne reconstruction, which was based on the earlier McGrail paper reconstruction of the Poole logboat, showed that it was only just able to cope with waves generated by Force 4 winds (on the Beaufort Scale) in the inner reaches of Christchurch Harbour with a moderate load of five adults. Although smaller than Poole Harbour now, Christchurch Harbour may have been quite similar to Poole during the lower sea levels of the Iron Age. During that outing a pole was used extensively wherever the water was shallow enough, and was shown to be far more efficient than paddles in such conditions. One person punting with a pole could easily move the vessel as fast as four paddling, and faster still when the boat could be quanted. In quanting, a long fork-ended pole is used whilst the crew member leans backward against the pole top and walks the boat along. In all but very windy conditions, one experienced, strong adult could easily have propelled the Poole logboat using a pole in shallow water; in deeper water at least three paddlers would probably have been needed.

One advantage of punting standing up is that the view is much clearer in reedy channels with obstacles. Possibly the most appropriate comparative example of a paddle model for the Poole logboat is the large late Bronze Age example from Canewdon in Essex (McGrail 1987, 206). This paddle is large enough to be used standing up and could also have been used as a steering oar or even a short rowing oar (Strachan and Goodburn 2010, 115–23). The effects of tidal flows would also have been used to advantage.

During trials in 1991 (when the boat would not have been fully dried out) in gentle winds in Poole Harbour, the Cranborne reconstruction carried up to nine crew with small waves not more than c. 0.25 m high. However, as several of the crew were teenagers, this might equate to seven or eight adults. In still water, more people or an equivalent cargo weight could have been carried.

Acknowledgements

Thanks are due to Jessica Berry of MAST for organising this project and securing funding and to Dave Parham of Bournemouth University. Thanks are also due to Poole Waterfront Museum for facilitating the author's visits to the logboat and making the archive available; to Pat Tanner for discussions on developing an updated record of the boat and a new, more faithful, graphic reconstruction of its original form; and to Lesley Collett for redrawing the author's draft figures. Lastly, thanks are due to Jake Keen, then of the Cranborne Ancient Technology Centre, for inviting the author to take part in the first reconstruction experiment based on the vessel as it was understood in 1990–91.

Chapter 4

The Poole logboat: digital comparisons

Pat Tanner

Introduction

The aim of this section is to re-examine the characteristics and suggested reconstruction of the Poole Iron Age logboat discovered in Poole Harbour, Dorset in 1964. The logboat was first examined in detail by Professor Seán McGrail in 1974, when a series of hull form characteristics and reconstruction drawings was published (McGrail 1978). A series of measurements and photographs were recorded shortly after discovery in 1964 (Peers, quoted in McGrail 1978, 255). Subsequent measurements are given on a Poole Museum leaflet published in 1973 in addition to the recording carried out by McGrail in August 1974 (McGrail 1978).

Since the initial publication, advances in recording techniques such as 3D laser scanning (Tully and Tanner 2012), advanced 3D digital modelling (Jones *et al.* 2013), combined with new archaeological evidence and historical research and this author's 25+ years of traditional shipbuilding and sailing knowledge, allows the creation of a more definitive reconstruction model. This model, together with computer-aided digital analysis of varying hypothetical reconstructions and the ability to test previous results, allows, through an iterative process, a more definitive, synthetic reconstruction to be proposed (Tanner 2013). Archaeologists are thus able to characterise accurately the capabilities, capacity and seaworthiness of the original vessel. The new data, together with original recorded measurements, are set out in Table 4.1.

A glossary and list of abbreviations is provided at the end of the chapter.

The remaining timber has a volume of 0.635 m³; using 800 kg/m³ as being a typical density for oak at 27% moisture content, the hull would have a weight of 508 kg.

Recording method

Three-dimensional (3D) laser scanning was carried out by 1st Horizon Surveying & Engineering Ltd. As the logboat could not easily be removed from the display cabinet, and laser scanning does not accurately record the target object through glass walls, a total of 29 individual scans were carried out inside the logboat display cabinet at Poole Museum. Each individual scan records millions of point measurements,

Table 4.1 Comparison of surveyed dimensions

Measurement	Peers 1964	Museum 1973	McGrail 1974	Tanner 2013
Length	10.08 m	10.06 m	10.01 m	9.94 m
Beam max.	1.24 m	1.22 m	1.22 m	1.23 m
Height Stern	0.38 m*	0.51 m	0.50 m	0.50 m**
Height Bow		0.33 m		0.33 m**
Volume ¹				0.635 m ³
Weight ²				508 kg

* Interpreted as being maximum internal height

** Measured vertically from the baseline

¹ Volume of remaining timber

² Weight of remaining timber calculated at 800 kg/m³ being a typical density for oak at 27% moisture content

"Poole Iron Age Logboat"



NOTES

This drawing is based on the 3D laser scanning of the logboat remains.

Figure 4.1 3D laser scan of physical remains



 **3D Scanning Ireland**
32, Rowan Court, Ballee Woods, Carrigaline, Co. Cork, Ireland.
Tel: +353 (0)87 2811458 Email: pat@3dscanning.ie
www.3dscanning.ie 

DRAWN **P. Tanner**
DRAWING NUMBER **1**
MODEL UNITS **Metres**

DATE **17/09/2013**
SHEET **A3**
SCALE **N/A**

each point recorded having a three-dimensional coordinate in the form of x, y, z, and the data are saved in what is known as a point cloud.

Processing the scan data

Each individual point cloud was then cropped to remove extraneous information before being registered using a ‘best fit’ algorithm in Geomagic Studio software; these were then combined into a single point cloud containing a total of 101.34 million points, registered to a tolerance of 3 mm. A polygon mesh model was created based on the registered point cloud. This polygon mesh represents a 3D digital model of the logboat remains and was exported to Rhinoceros 3D, a CAD modelling software (Figure 4.1). The original 1974 survey drawings (Figure 4.2) were imported and aligned. An outline of the 3D polygon mesh was then generated and compared to the 1974 survey drawings (Figure 4.3).

A survey drawing was also produced (Figure 4.4) showing overall shape and significant features such as grain direction, splits, and the three ‘thickness gauge’ holes, as well as an outline of the 1974 recorded drawing.

Initial assessment

A baseline was established to coincide with the predominantly straight central section of the logboat and the bow and stern were then measured to this baseline in order to establish the amount of hogging, where both ends of a vessel tend to sag over time during the vessel’s use life. From the original survey drawings the vessel appears to be hogged by c. 45 mm at the bow and 105 mm near the stern; however, McGrail states there may be slight inaccuracies in the original survey drawing due to the difficulty of aligning the two fragments (McGrail 1978, 255). The 2013 3D laser scan shows the logboat is currently hogged by 85 mm at the bow and 144 mm near the stern (Figure 4.3). This increase in hogging is possibly the result of the supporting structure used in the display cabinet; it was ‘repaired’ using the bend command in the CAD software. This was similar to the methodology used on the Newport Medieval Ship reconstruction (Jones *et al.* 2013, 127) and is dealt with in more detail in the hypothetical reconstruction section.

Shrinkage

In the 1978 report McGrail gives the recorded dimensions taken by Peers in 1964 as 10.08 m length, 1.24 m maximum beam, and 0.38 m height of the stern.

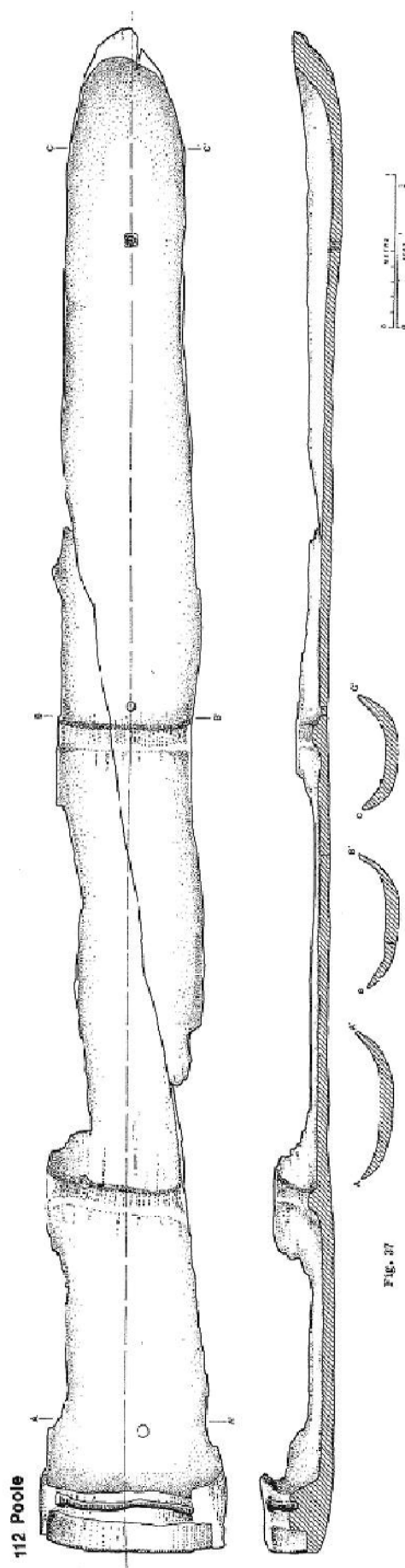

Figure 4.2 1974 survey drawing (after McGrail 1977, fig. 10.4)

McGrail interprets this 0.38 m height as being the maximum *internal* depth near the stern. McGrail's measurements from 1973 give 10.01 m length, 1.28 m beam, 0.50 m external height, and a thickness of c. 30 mm and c. 65 mm for the sides and bottom respectively. He further states that there has been no significant shrinkage since the boat was measured in 1964 (McGrail 1978, 255–6).

From the 1974 recording, McGrail gives measurements of the three centre-line holes as 93 mm diameter for the aft hole and c. 51 mm for the other two (McGrail 1978, 256), with shrinkage indices of 1.24 and 1.29 giving a mean shrinkage index of 1.25. This figure was then used to calculate the original scantlings, or thickness of each timber, from the 1974 survey drawings. The 2013 laser scan shows an overall length of 9.94 m, giving a longitudinal shrinkage index of 1.007 and a transverse shrinkage index of 1.008 near the stern. Thus, there has been no further significant longitudinal shrinkage.

Analysis of the 1974 reconstruction

McGrail states that the full original length of c. 10 m and part of the sheerline have survived, that the boat was made from half an oak log, with the stern coming from the butt end, and that the shape conforms closely to that of the log, being of rounded transverse section throughout (Figure 4.5), with the body tapering in plan and elevation (McGrail 1978, 255).

An accurate 3D digital model of McGrail's 1974 reconstruction (Figure 4.5) was created using the Rhinoceros 3D software, and this was used to compare with the 1974 data (Table 4.2) and the 2013 laser scan recording (Figure 4.6), as well as re-examining the original test result data by analysing the hydrostatic and form coefficients using computer software.

Discrepancies between the original 1974 data and the 2013 digital data could possibly be explained as follows:

- Volume of wood calculated in 1974 was from the scantlings in the reconstructed drawing (McGrail 1978, 134), while the 2013 version was calculated directly by the computer software.
- Weight was calculated in 1974 by breaking the drawing down into regular geometric solids and multiplying the volume of timber by the specific density of oak at 27% moisture content (McGrail 1978, 134). The 2013 figure was calculated directly by assigning the same density to the 3D model and letting the computer software calculate the weight.
- Volume of hollow was calculated in 1974 by obtaining the displacement volume from the manually calculated hydrostatic curves at a draft corresponding to that with the top edge awash (McGrail 1978, 134). The 2013 figure was calculated by modelling a complete half log or solid boat and using the Boolean subtract feature to remove the logboat material, thereby leaving a solid 3D model

Table 4.2 Comparison of 1974 reconstruction data to 2013 digitally version of 1974 data

Measurement	1974 data (McGrail 1978:256)	Digital version of 1974 data
Length	10.01 m	10.01 m
Beam	1.52 m	1.52 m
Height	0.50 m	0.50 m
Side thickness	30 mm	30 mm
Bottom thickness	65 mm	65 mm
Volume of Wood	1.077 m ³	1.103 m ³
Weight*	862 kg	882 kg
Volume of Hollow	3.298 m ³	2.281 m ³
V.C.G.	0.17 m (being 1/3 external height)	0.18 m
L.C.G.		4.24 m for'd of stern

* Weight of timber calculated at 800 kg/m³ being a typical density for oak at 27% moisture content

"Poole Iron Age Logboat"

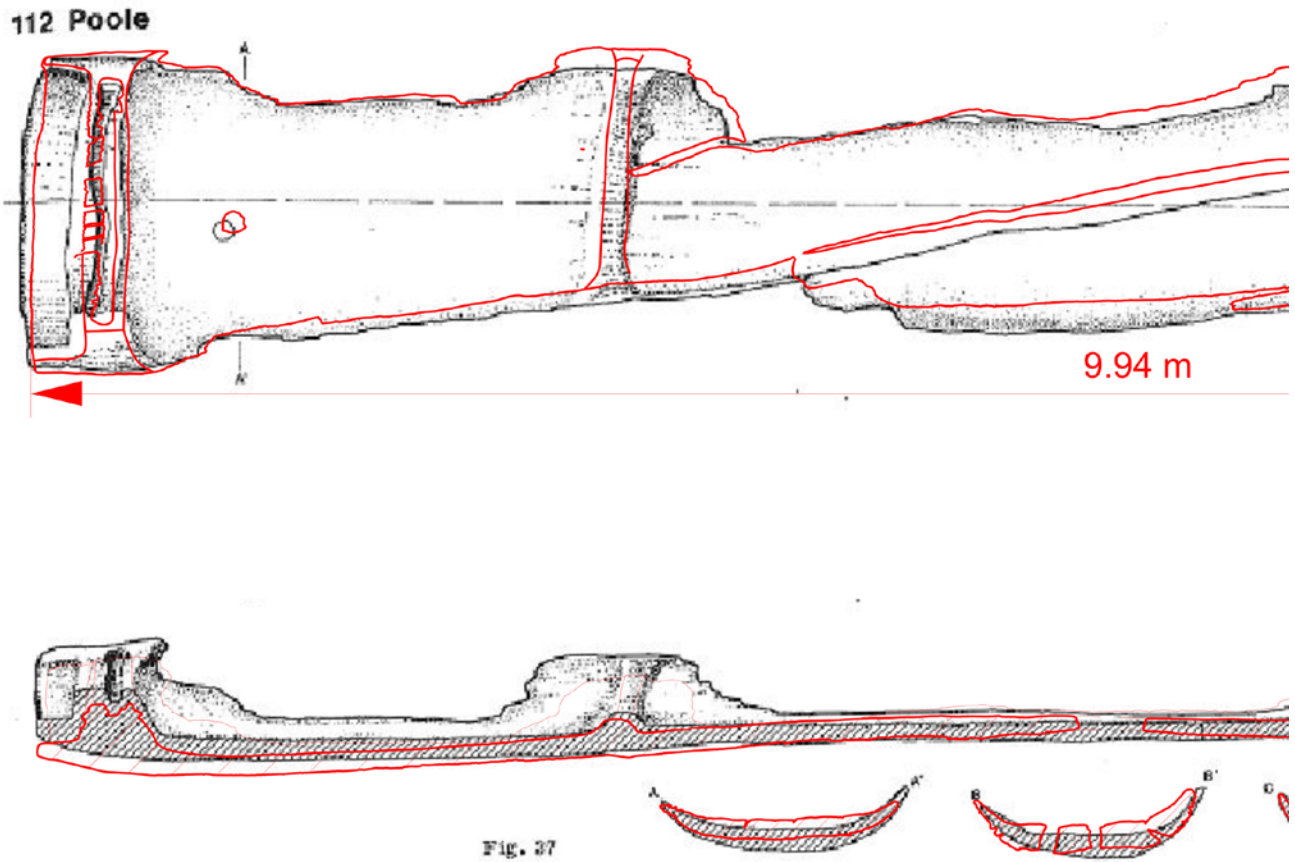

2013 3D Laser Scan outline shown in red

NOTES

This drawing is based on the 3D laser scanning of the logboat remains.

Figure 4.3 2013 scan outline overlaid on 1974 survey drawing

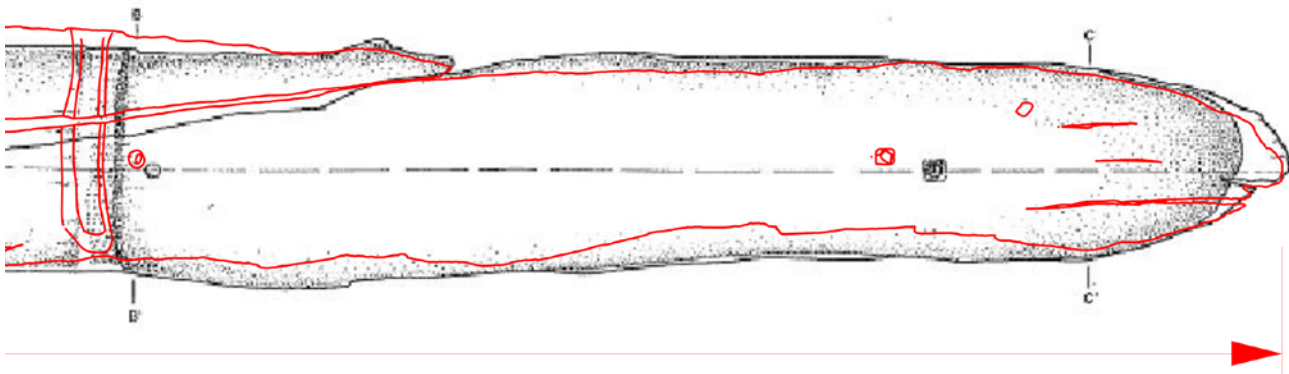

3D Scanning Ireland
32, Rowan Court, Ballee Woods, Carrigaline, Co. Cork, Ireland.
Tel: +353 (0)87 2811458 Email: pat@3dscanning.ie
www.3dscanning.ie



DRAWN P. Tanner
DRAWING NUMBER 2
MODEL UNITS Metres

DATE 17/09/2013
SHEET A3
SCALE 1 : 25

"Poole Iron Age Logboat"

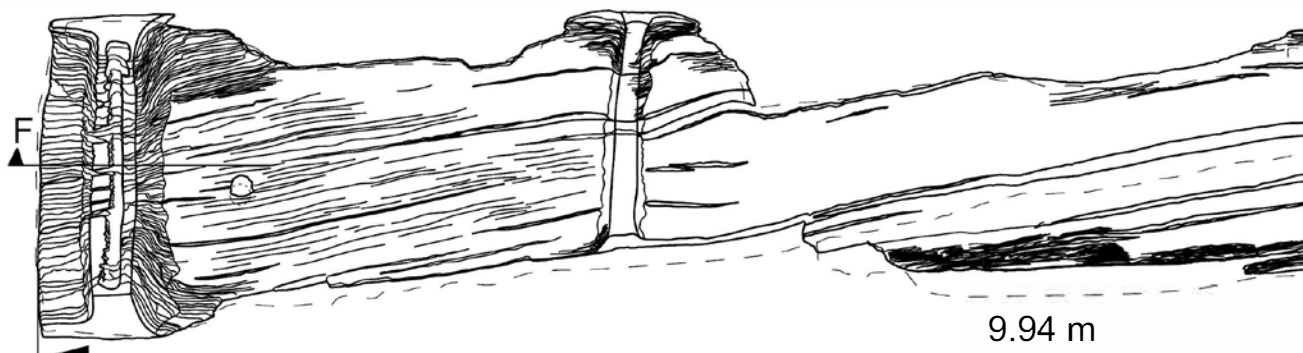

Plan

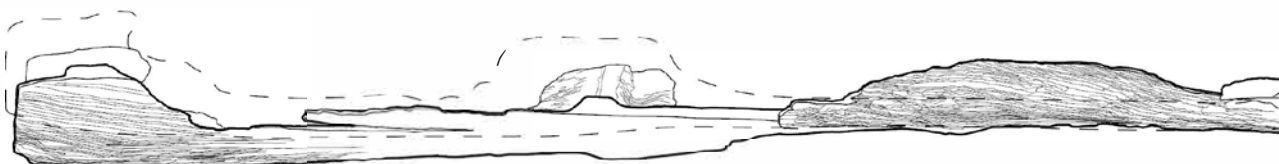

Starboard Elevation

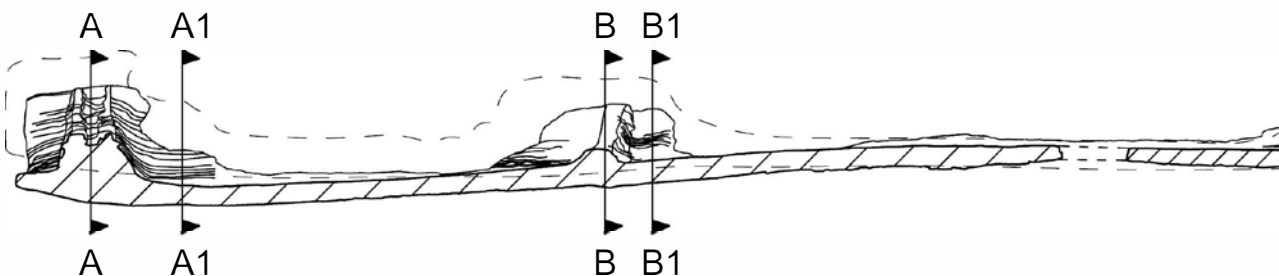

Longitudinal Section F-F

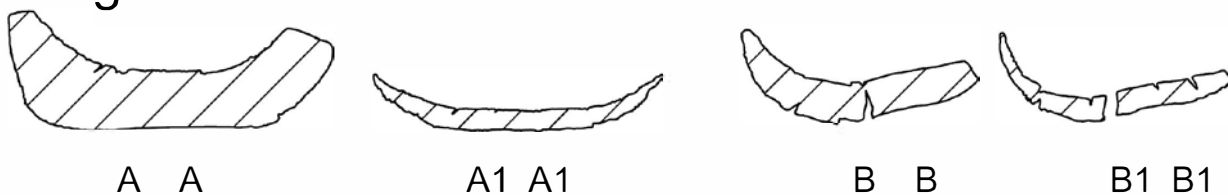

Survey Drawing

NOTES

This drawing is based on the 3D laser scanning of the logboat remains.

Volume of remaining log 0.635 m³
 Weight of remaining log 508 kg
 (based on Oak @ 27% moisture content being 800 kg/m³)

Figure 4.4 2013 survey drawing

Outline of 1974 drawing shown dashed

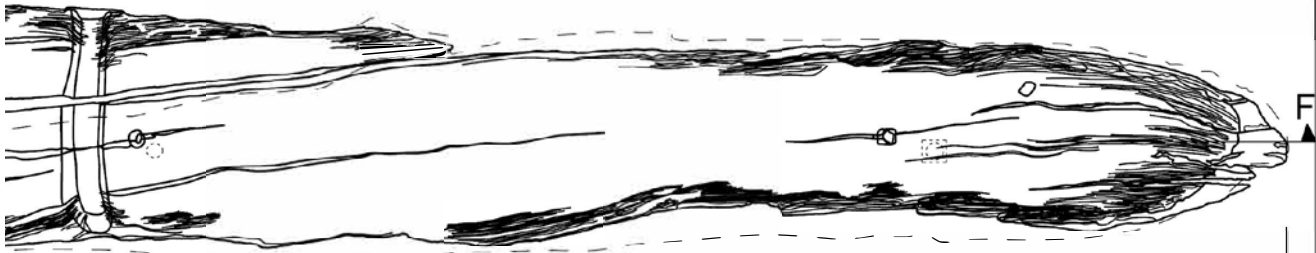

G H I J K L M N

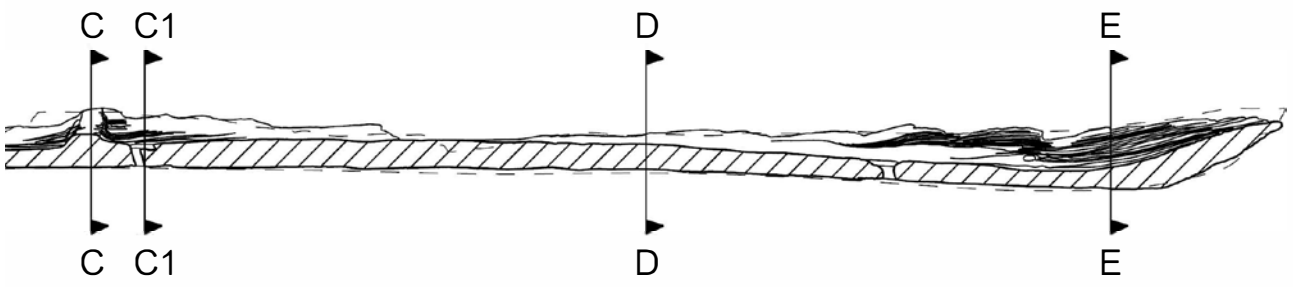

3D Scanning Ireland
 32, Rowan Court, Ballea Woods, Carrigaline, Co. Cork, Ireland.
 Tel: +353 (0)87 2811458 Email: patt@3dscanning.ie
 www.3dscanning.ie

DRAWN P. Tanner DATE 09/10/2013
 DRAWING NUMBER 3 SHEET A3
 MODEL UNITS Metres SCALE 1 : 25

of the internal volume, for which the computer software easily calculated a volume.

- The vertical centre of gravity (V.C.G.) for the 1974 model was manually calculated for several logboats as being close to one-third of the maximum external height; this factor of 1/3 was then used for the Poole boat. The 2013 figure was accurately calculated by the Orca 3D marine software by assigning a material density to the logboat hull, as well as any external influences such as crew or cargo, thereby allowing the software to combine all weights to generate both vertical (V.C.G.) and longitudinal centres of gravity (L.C.G.) (Tanner 2013, 141).

Test criteria used

The 1974 report examined the reconstruction in four loading states, and was deemed to pass the test criteria if the minimum freeboard was not exceeded, and the vessel had a positive metacentric height (GM_t).

The minimum freeboard criteria was set by McGrail at 0.13 m when the vessel would have the upper edge awash at 10° heel (McGrail 1998, 20). With regard to crew spacing within the logboat, McGrail states a minimum of 0.85 m breadth is required to allow two men to paddle side by side, and a minimum of 1.00 m is required longitudinally between adjacent pairs of paddlers (ibid, 132). For crew figures, McGrail used a human model of 1.65 m height, weighing 60 kg, having a centre of gravity 1.10 m above the feet when standing, 0.45 m above the knees when kneeling, and 0.40 m above the seat when sitting. The crew complement consisted of two men standing and the remainder kneeling. McGrail describes his hypothetical individual as a short, lean, wiry person (ibid, 131).

The standard freeboard, based on examination of several photographs of logboats in use, is set at 0.15 m for all logboats (ibid, 133). For loading purposes, a typical cargo of turf was used, having a density of 435 kg/m³ and was assumed to occupy 80% of the internal volume of the logboat.

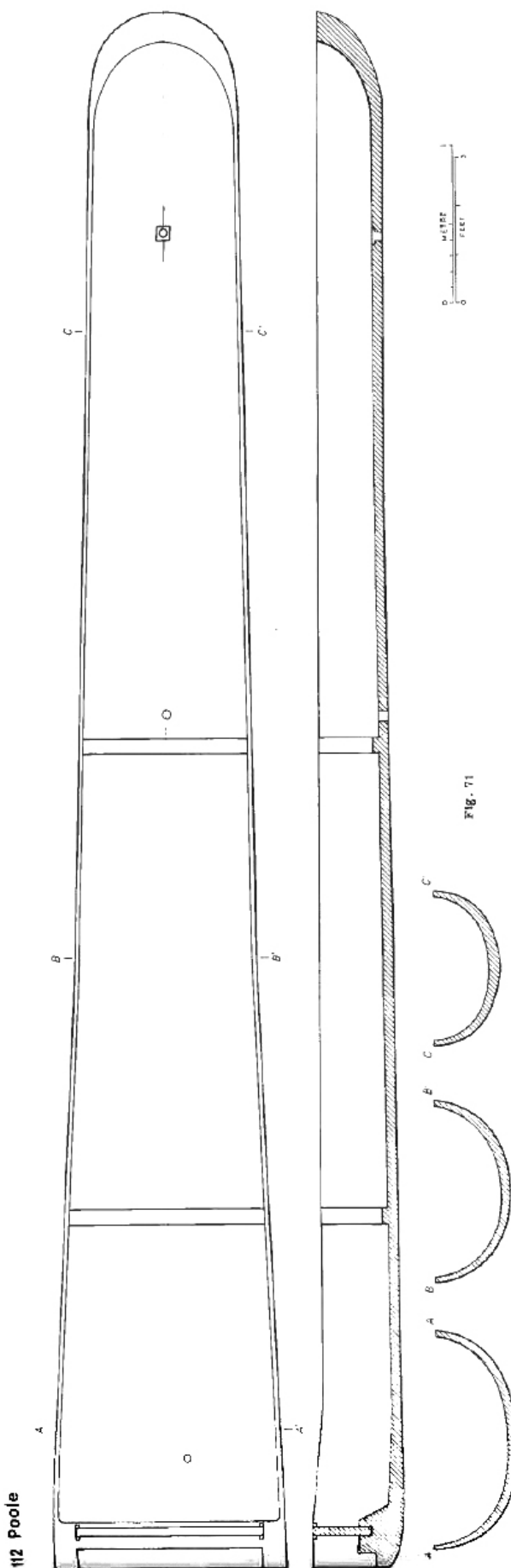

Figure 4.5 1974 McGrail reconstruction (after McGrail 1977, fig. 10.5)

1974 test results

The results of the 1974 reconstruction (McGrail 1978, 134–40) in the four loading states are:

A – Maximum men The theoretical maximum number of paddlers which can be physically fitted into the boat.

2 men standing and 16 kneeling.

This resulted in: draft of 0.295 m;

Freeboard of 0.205 m;

GM_t of 0.385 m.

B – Restricted draft The theoretical maximum number of paddlers, kneeling and standing as A above, plus the equipment or ballast/cargo which can be carried at a draft of 0.30 m.

2 men standing and 16 kneeling,

plus 58 kg equipment positioned in aft area of the logboat.

This resulted in: draft of 0.300 m;

Freeboard of 0.200 m;

GM_t of 0.372 m.

C – Standard freeboard With a minimum crew and the maximum cargo which could be carried in 80% of the hollowed-out volume of the boat at a draft equivalent to a standard freeboard of 0.15 m.

4 men standing,

plus 1448 kg turf cargo extending to 0.11 m above the sheer.

This resulted in: draft of 0.350 m;

Freeboard of 0.150 m;

GM_t of 0.370 m.

D – Minimum freeboard With a minimum crew as in C above and the maximum cargo which could be carried at a draft equivalent to the calculated minimum freeboard (0.13 m).

4 men standing,

plus 1723 kg turf cargo extending to 0.11 m above the sheer.

This resulted in: draft of 0.370 m;

Freeboard of 0.130 m;

GM_t of 0.331 m.

"Poole Iron Age Logboat"

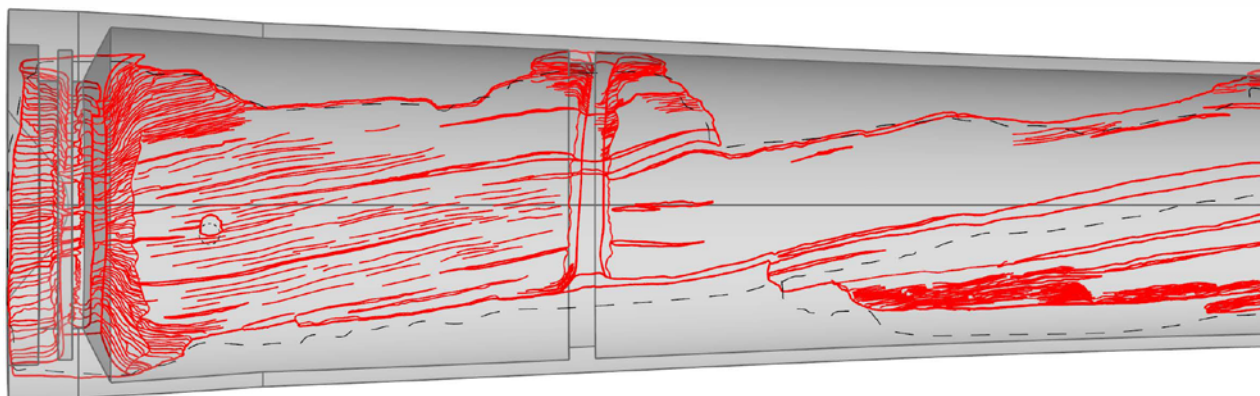

Plan

2013 3D Laser Scan outline shown in red

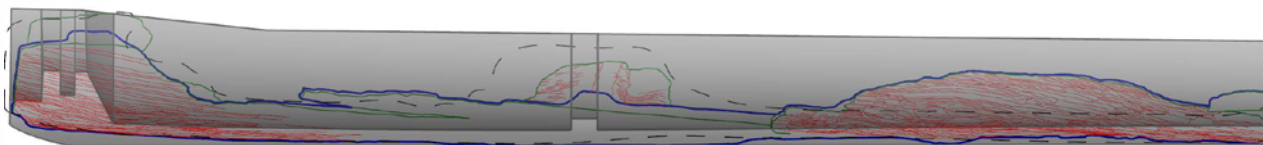

Starboard Elevation (with hogging repaired)

Laser Scan overlain on Digital Version of 1974 Reconstruction

NOTES

This drawing is based on the 3D laser scanning of the logboat remains.

Figure 4.6 2013 digital version of 1974 reconstruction

Outline of 1974 drawing shown dashed - - - - -

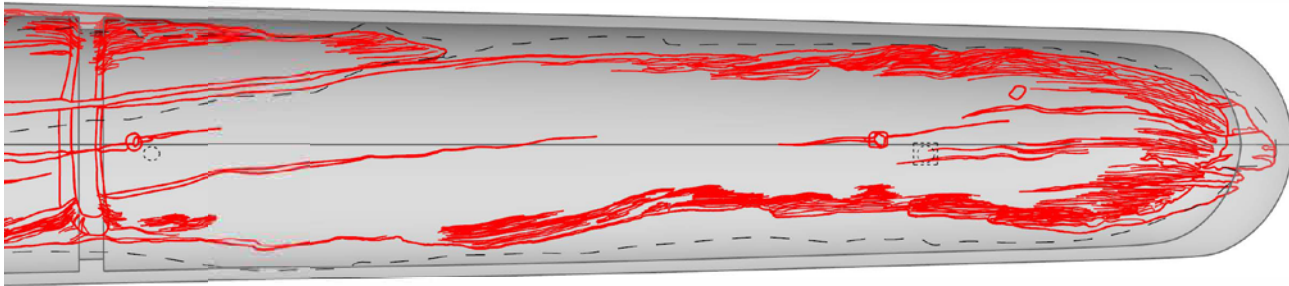

3D Scanning Ireland
32, Rowan Court, Ballee Woods, Carrigaline, Co. Cork, Ireland.
Tel: +353 (0)87 2811458 Email: pat@3dscanning.ie
www.3dscanning.ie

DRAWN P. Tanner
DRAWING NUMBER 4
MODEL UNITS Metres

DATE 16/12/2013
SHEET A3
SCALE 1 : 25

2013 digital test results of 1974 model

The 2013 digital version of this reconstruction was then re-examined using the Orca 3D marine software to compare the results.

The original 1974 results were manually calculated and considered the flotation condition of the logboat based on the combined weight of the vessel, crew and any cargo added, with the freeboard calculated from the resulting vessel displacement. A figure of 0.13 m was set as a minimum freeboard, being the height required when the vessel was heeled to 10° with the upper edge awash.

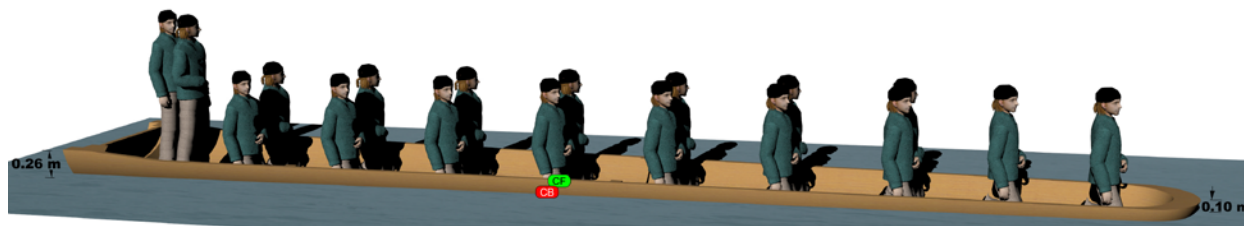

Figure 4.7 State A

2013 results: State A – Maximum men (Figure 4.7)

2 men standing and 16 men kneeling.

Draft 0.280 m,

Fb Aft 0.257 m,

Fb For'd 0.104 m,

GM_t of 0.236 m.

This should be classed as failing as the freeboard forward is less than 0.13 m.

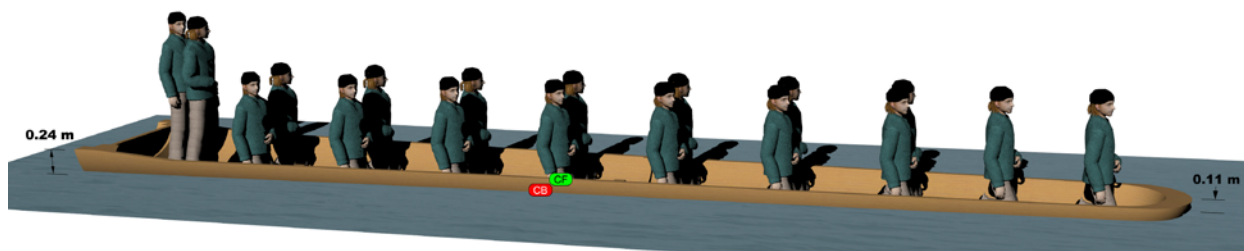

Figure 4.8 State B

2013 results: State B – Restricted draft (Figure 4.8)

2 men standing and 16 kneeling,

plus 58 kg equipment positioned in aft area of the logboat.

Draft 0.297 m,

Fb Aft 0.239 m,

Fb For'd 0.112 m,

GM_t of 0.241 m.

This should be classed as failing as the freeboard forward is less than 0.13 m.

However, as the vessel is heeled (rotated through the longitudinal axis) towards 10° , the underwater profile of the vessel changes, thereby affecting the centres of buoyancy (CB) and flotation (CF), which results in a change of trim (rotation about the transverse axis). Consequently, the displacement and resulting sinkage of the vessel will continually change as the vessel is heeled. These calculations are too onerous for manual calculation techniques but are simply and rapidly calculated, and continuously updated, by computer software.

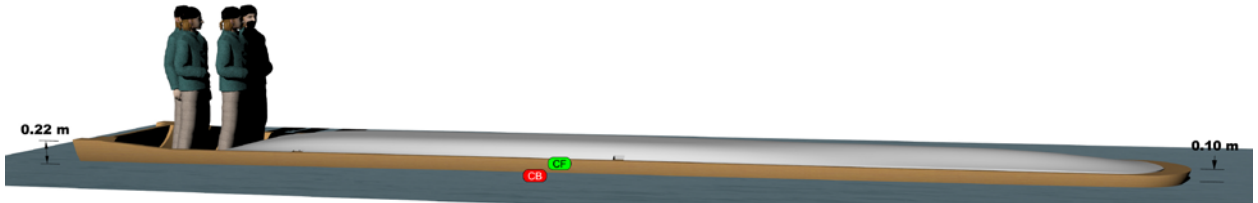

Figure 4.9 State C

2013 results: State C – Standard freeboard (Figure 4.9)

Internal volume = 2.281 m^3 , therefore 80% = 1.825 m^3 ;

when loaded to 0.110 m above the sheerline has a volume of 2.450 m^3 .

Using turf @ 435 kg/m^3 this cargo weighs 1063 kg, not 1448 kg as per original test criteria.

Draft 0.319 m,

Fb Aft 0.216 m,

Fb For'd 0.104 m,

GM_t of 0.292 m.

This should be classed as failing as the freeboard forward is less than 0.13 m, although at 10° heel the forward freeboard is still 0.030 m.

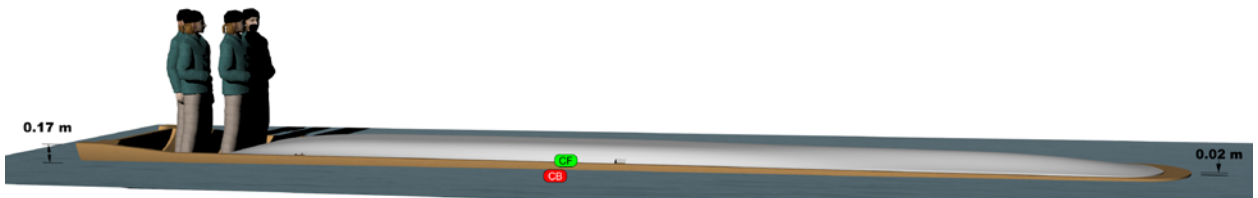

Figure 4.10 State D

2013 results: State D – Minimum freeboard (Figure 4.10)

The total cargo volume when loaded to 0.11 m above sheerline has a volume of 2.45 m^3 @ 435 kg/m^3 , thus this cargo only weighs 1063 kg. Therefore a heavier cargo of 704 kg/m^2 was used to simulate the 1723 kg originally tested.

Draft 0.362 m,

Fb Aft 0.174 m,

Fb For'd 0.024 m,

GM_t of 0.279 m.

This should be classed as failing as the freeboard forward is less than 0.13 m, and when heeled to 10° the upper edge would be 0.112 m *under water!*

Table 4.3 Comparison of 1974 test result data to 2013 digital version of 1974 reconstruction

Measurement	Empty State		State A		State B		State C		State D	
	1974 data	2013 data	1974 data	2013 data	1974 data	2013 data	1974 data	2013 data	1974 data	2013 data
Displacement	862 kg	882 kg	1942 kg	1963 kg	2000 kg	2020 kg	2550 kg	2185 kg ^{note 1}	2825 kg	2845 kg ^{note 2}
L.C.G. for'd of stern		4.24 m		4.515 m		4.410 m		4.37 m		4.551 m
V.C.G. above baseline	0.17 m	0.18 m		0.416 m		0.414 m	0.34 m	0.36 m	0.39 m	0.352 m
Draft		0.175 m	0.295 m	0.280 m	0.30 m	0.297 m	0.35 m	0.319 m	0.37 m	0.362 m
Fb aft		0.361 m	0.205 m	0.257 m	0.20 m	0.239 m	0.15 m	0.217 m	0.13 m	0.174 m
Fb for'd		0.228 m		0.104 m		0.112 m		0.104 m		0.024 m
Fb aft at 10° heel		0.232 m		0.127 m		0.109 m		0.087 m		0.036 m
Fb for'd at 10° heel		0.155 m		0.030 m		0.038 m		0.030 m		-0.112 m
GM _t		0.523 m	0.385 m	0.236 m	0.372 m	0.241 m	0.370 m	0.292 m	0.331 m	0.279 m
Cb		0.473		0.541		0.513		0.503		0.551
Cp		0.709		0.784		0.747		0.732		0.786
Waterplane area		8.272 m ²		10.091 m ²		10.142 m ²		10.289 m ²		10.823 m ²
Wetted surface		9.064 m ²		12.314 m ²		12.456 m ²		12.875 m ²		14.369 m ²
Righting moment at 10° heel angle		79.3 kgf-m		79.7 kgf-m		83.6 kgf-m		109.8 kgf-m		56.0 kgf-m

State A: 2 men standing and 16 kneeling

State B: 2 men standing and 16 kneeling and 58 kg equipment

State C: 4 men standing and 1448 kg turf extending to 0.11 m above the sheer

State D: 4 men standing and 1723 kg cargo extending to 0.11 m above the sheer

Note 1 The internal volume is 2.281 m³, cargo area of 80% = 1.825 m³, when loaded to 0.11 m above sheer has a volume of 2.45 m³ @ 435 kg/m³ weighs 1063 kg + 882 kg boat weight + 240 kg crew weight = 2185 kg.

Note 2 The internal volume is 2.281 m³, cargo area of 80% = 1.825 m³, when loaded to 0.11 m above sheer has a volume of 2.45 m³ @ 704 kg/m³ weighs 1723 kg + 882 kg boat weight + 240 kg crew weight = 2845 kg.

Table 4.3 shows a comparison of the 1974 test result with the 2013 results. The 1974 report was deemed to pass the test criteria if the minimum freeboard (0.15 m) was not exceeded, and the vessel had a positive metacentric height (GM_t). From Table 4.3, the logboat has a positive metacentric height (GM_t) for all four loading states, but has less than the minimum freeboard of 0.15 m (shown red) for all four loading states. As a result, the logboat as tested has too many crew for loading states A and B, and is carrying too much cargo for loading states C and D. This is dealt with in the following hypothetical reconstruction.

Hypothetical reconstruction

Recreating the original shape

Repairing distortion

The first stage in attempting to recreate the original shape was to repair the hogging in the longitudinal plane. As already mentioned, and as is clearly visible in Figures 4.3 and 4.4, the logboat has hogged or sagged at both the forward and aft ends. A straight baseline was introduced to coincide with the predominantly straight bottom edge of the boat in the amidships area, and the distances measured. From the original 1974 drawings this was measured as 45 mm at the forward end and 105 mm at the aft end. The 2013 survey drawing shows that this sagging or hogging has increased to 85 mm at the forward end and 144 mm at the aft end. The powerful transform tools in the Rhinoceros 3D software such as rotate and move are well understood and frequently used. However, two other transform commands, which are part of the daily language of every shipwright – twist and bend – have not been widely used. To assess and quantify the effects of these powerful transformation tools, a methodology was developed by the author during the digital reconstruction of the Newport medieval ship (Jones *et al.* 2013, 127), whereby a number of typical planks were first measured in their original recorded shape state using the Analyze/Mass Properties/Volume feature in Rhinoceros 3D. The digital solid was then twisted to conform to the emerging hull shape, as a shipbuilder would the actual plank when building the vessel, and the resulting ‘repaired’ plank was again measured with the Analyze/Mass Properties/Volume command. Results showed changes in the repaired component’s volume of less than 0.02% when compared to the original volume.

The bend command in the Rhinoceros 3D modelling software was used to repair the longitudinal shape in order to remove the hogging. As the recorded material potentially included the full overall length and parts of the sheerline, a ‘minimum reconstruction’ as defined by Crumlin-Pedersen and McGrail was considered feasible (Crumlin-Pedersen and McGrail 2006, 57).

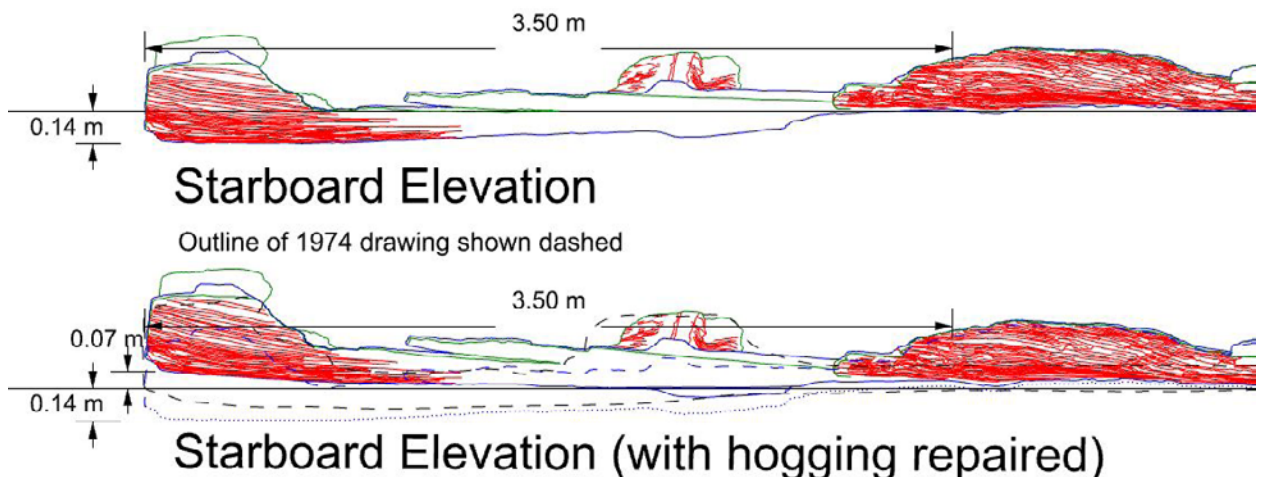

Figure 4.11 Hogging at stern area

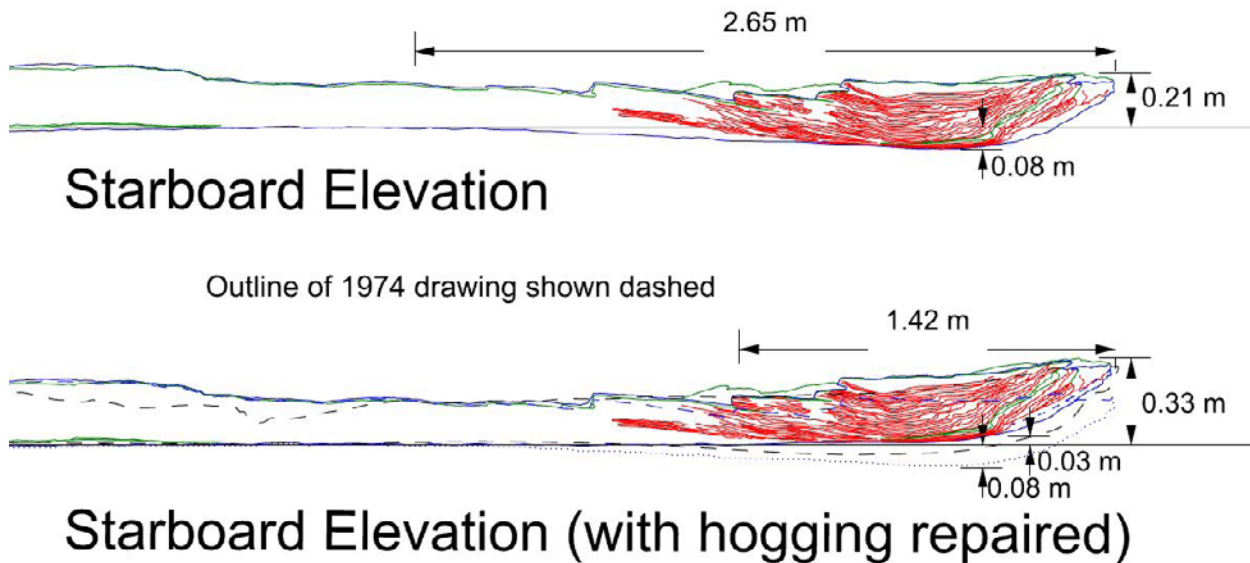

Figure 4.12 Hogging at bow area

When the hogged shape was corrected to the baseline it showed that the logboat had, in fact, some rocker to the bottom profile: in the stern area the hogging which measured 144 mm was repaired and the resulting rocker commences c. 2 m forward of the stern and rises 72 mm (Figure 4.11). In the bow area, the hogging which measured 85 mm was repaired and the resulting rocker commences c. 1.4 m aft of the bow and rises 10 mm (Figure 4.12).

Determining widths

The next stage involved taking a series of cross-sections (Figure 4.13), at 10 stations through the remaining logboat shape and examining each cross-section in order to recreate the complete hull shape at each station.

The cross-section at station 0 near the stern (Figure 4.14) shows the recorded hull shape after correcting hogging which matches the original recorded dimensions from Table 4.1.

The radial planes of the oak were then extended to find an approximate position of the pith or centre of the parent log, giving a log girth of c. 5.43 m, with a diameter of c. 1.73 m including the bark, and c. 1.53 m diameter for the usable heartwood (Figure 4.15).

In the original 1974 measurements, McGrail gives a hypo-reconstruction max. width of 1.52 m near the stern. As already discussed in the earlier section on shrinkage, McGrail determined from the three thickness gauge holes that the logboat had a mean shrinkage index of 1.25 (McGrail 1978, 256). It would appear to this author that McGrail then took the measured width of 1.22 m and applied this shrinkage factor ($1.22 \times 1.25 = 1.525$) to obtain a 'corrected' width of 1.52 m (S. McGrail, pers. comm., 21 March 2018) (Figures 4.16 and 4.17 dotted line semi-circular profile). If the same shrinkage index was applied to the recorded shape, a larger parent tree in the region of c. 1.90 m diameter would be required. Keeping in mind Goodburn's comments in Chapter 3 regarding the tendency of a logboat to widen by as much as 100 mm rather than becoming narrower due to shrinkage, this author believes that a maximum width of c. 1.2 m is a closer approximation of the original width (see blue lines on Figures 4.16 & 4.17).

It can be clearly seen from the recorded material (Figures 4.14–4.16) that the cross-section profile of the logboat has a flattened bottom, and not the semi-circular or 'rounded transverse section throughout' (Figure 4.17) that McGrail describes and uses in the 1974 reconstruction (McGrail 1978, 255).

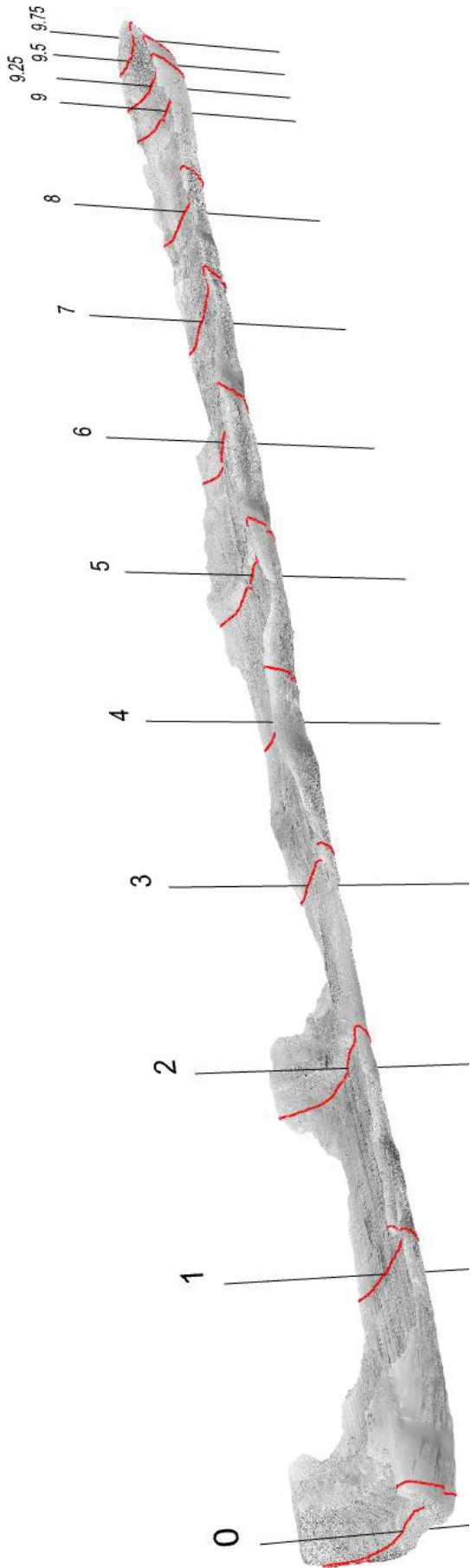

Figure 4.13 Cross-sections taken at 10 stations

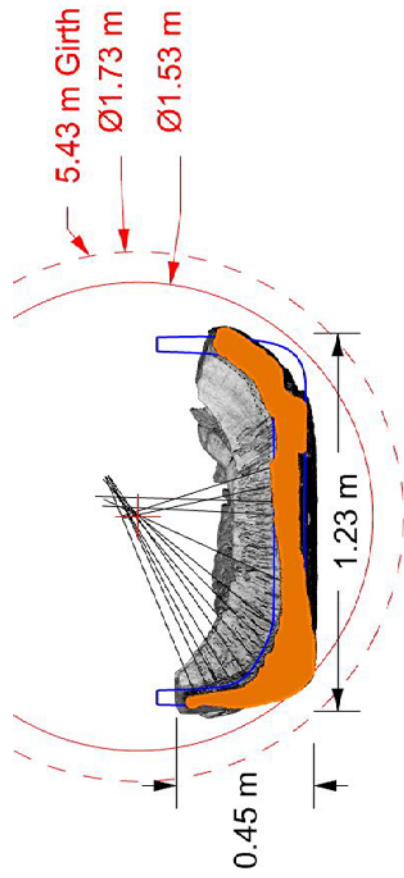

Figure 4.15 Section at station 0 showing possible parent log diameter

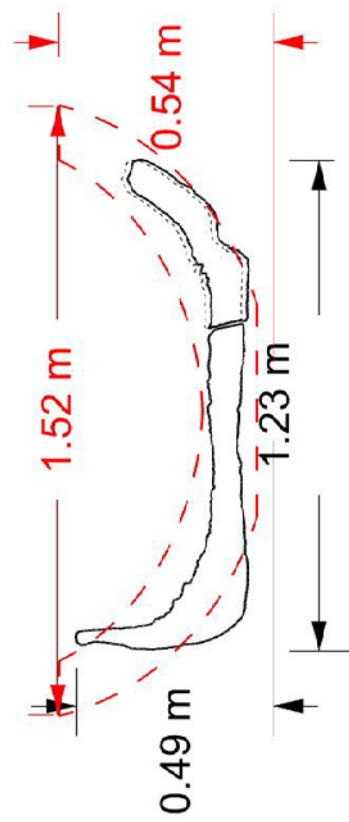

Figure 4.14 Section at station 0

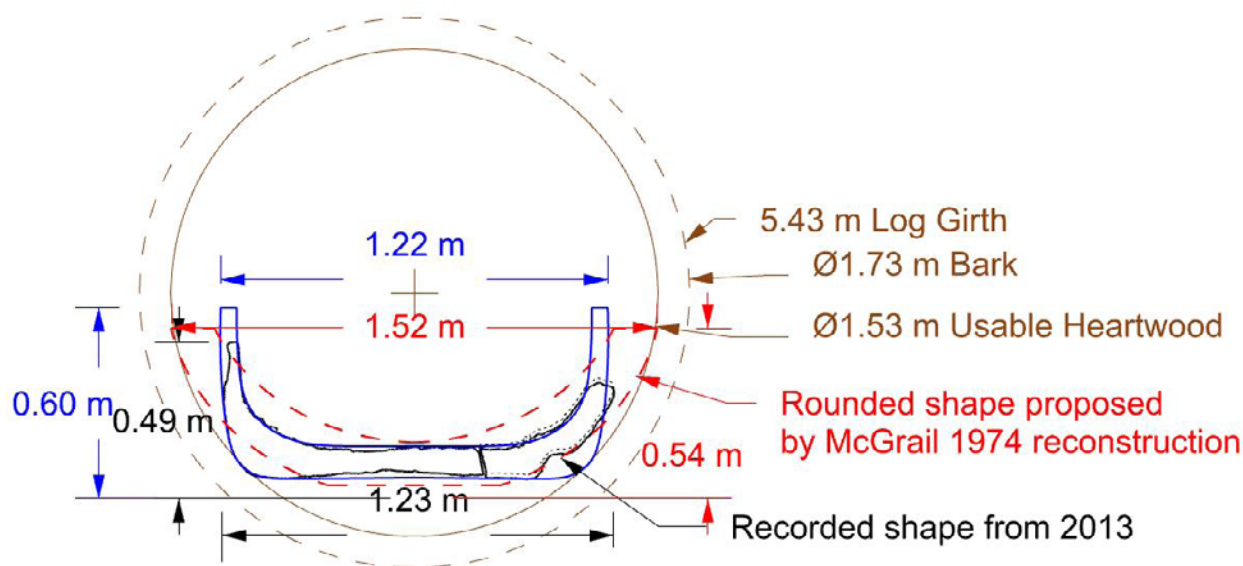

Figure 4.16 Preferred stern profile shape

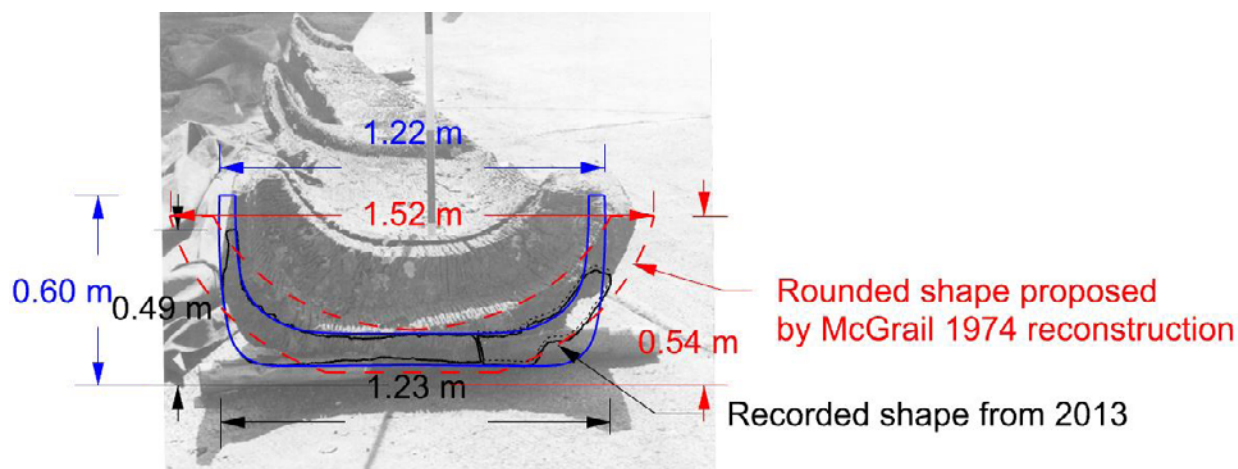

Figure 4.17 Andrew Hawke's photo (1964) with reconstruction superimposed

Determining the height or sheerline

In attempting to recreate the original cross-sections of the logboat, a series of faired curves were created to coincide with the recorded shape and subsequently extended to determine a potential location for the sheerline.

McGrail states that part of the sheerline has survived, and the boat was made from half an oak log (McGrail 1978, 255). As Goodburn notes in Chapter 3, there appears to have been some loss of timber at the sheerline, possibly due to erosion, wear or splitting-off along the radial planes of weakness in the oak timber. The potential height of the sheerline could, therefore, be greater than that indicated by the surviving material.

With a heartwood diameter of c. 1.5 m, the log when halved would have a usable height of c. 0.75 m. A baseline was established to coincide with the underside of the logboat, at a height where the surviving material would fit within the usable width of heartwood of the parent log.

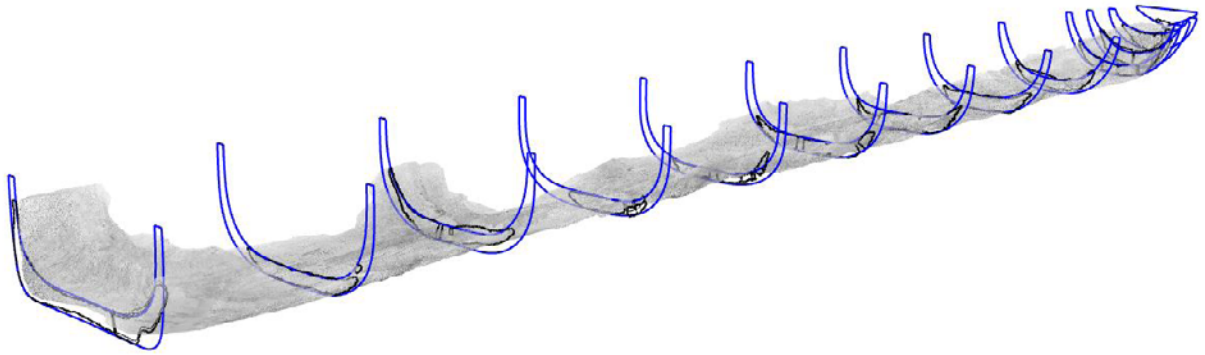

Figure 4.18 Projecting hull cross-section profiles at each station

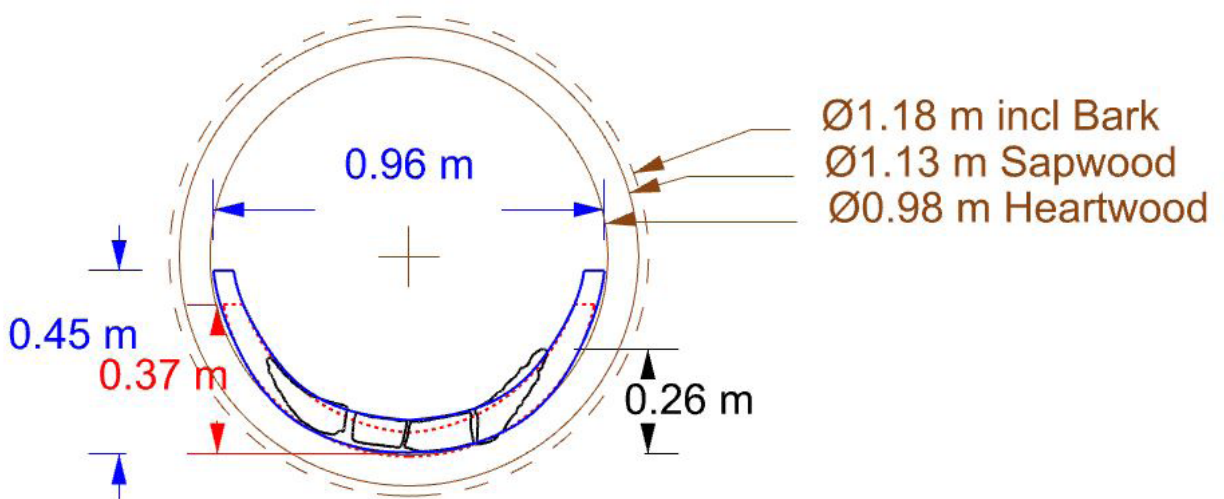

Figure 4.19 Section at station 9 showing possible parent log diameter

Material to a height of *c.* 0.14 m was removed from the lower portion of the heartwood to create the flattened bottom profile (Figure 4.16), leaving a potential height from the baseline to the pith of *c.* 0.61 m. Allowing between 5 and 10 mm for some trimming or straightening of the split half log would result in a potential sheer height of *c.* 0.60 m as opposed to the 0.50 m depth used in the original reconstruction.

This process was repeated for each station at 1 m intervals along the length of the logboat (Figure 4.18).

The cross-section profile at station 9 (*c.* 9.0 m from the stern) has a recorded (2013) surviving height of 0.26 m, and the original reconstruction has a sheer height of 0.37 m. However, the reconstruction of the parent log, having a diameter of *c.* 0.98 m of heartwood, gives a usable available height of *c.* 0.49 m after splitting. Allowing for some trimming or straightening of the split half log there would be sufficient timber remaining to have a sheer height in the region of *c.* 0.45 m (Figure 4.19). As the logboat was hewn from the half log, it can be reasonably expected that the upper edge was hewn close to the limit of both width and height, as any decrease in this area would prove detrimental to seafaring characteristics.

Once each station had been repaired using a series of fair curves to recreate the complete cross-section profile up to the sheer height, these curves were then used to generate a solid model of the reconstructed shape (Figure 4.20).

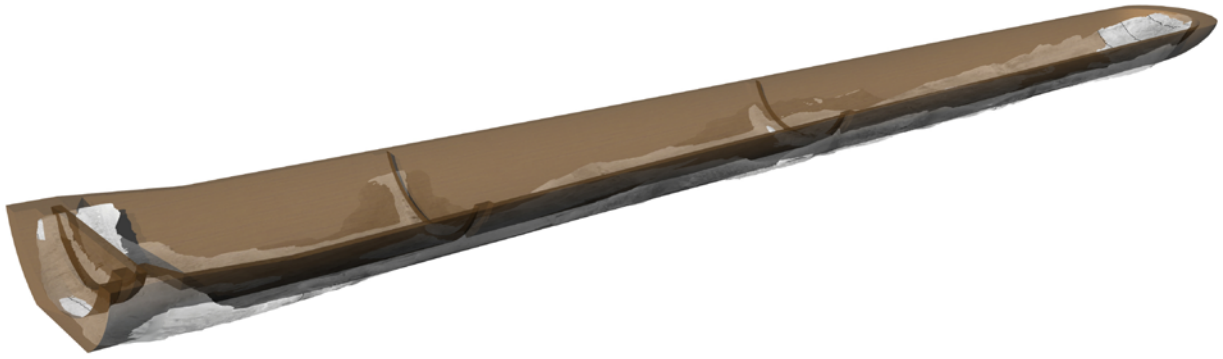

Figure 4.20 Solid hull model created from repaired cross-sections

Additional features

Additional features and details were then checked from the recorded 3D scan data and the original photographs (Figures 4.21 & 4.22) and the final hull shape modified to suit (Figure 4.23). Examples of such details include the solid carved stem feature (Figure 4.21 blue arrow) and the unusual step in the hull near the forward end (Figure 4.21 red arrow). These additional features were then added to the digital reconstruction model (Figures 4.23 and 4.24).

Transverse ridges

It was tentatively suggested by McGrail (1978, 315) that the transverse ridges divided logboats into functional spaces such as areas for propulsion, cargo, command and steering.

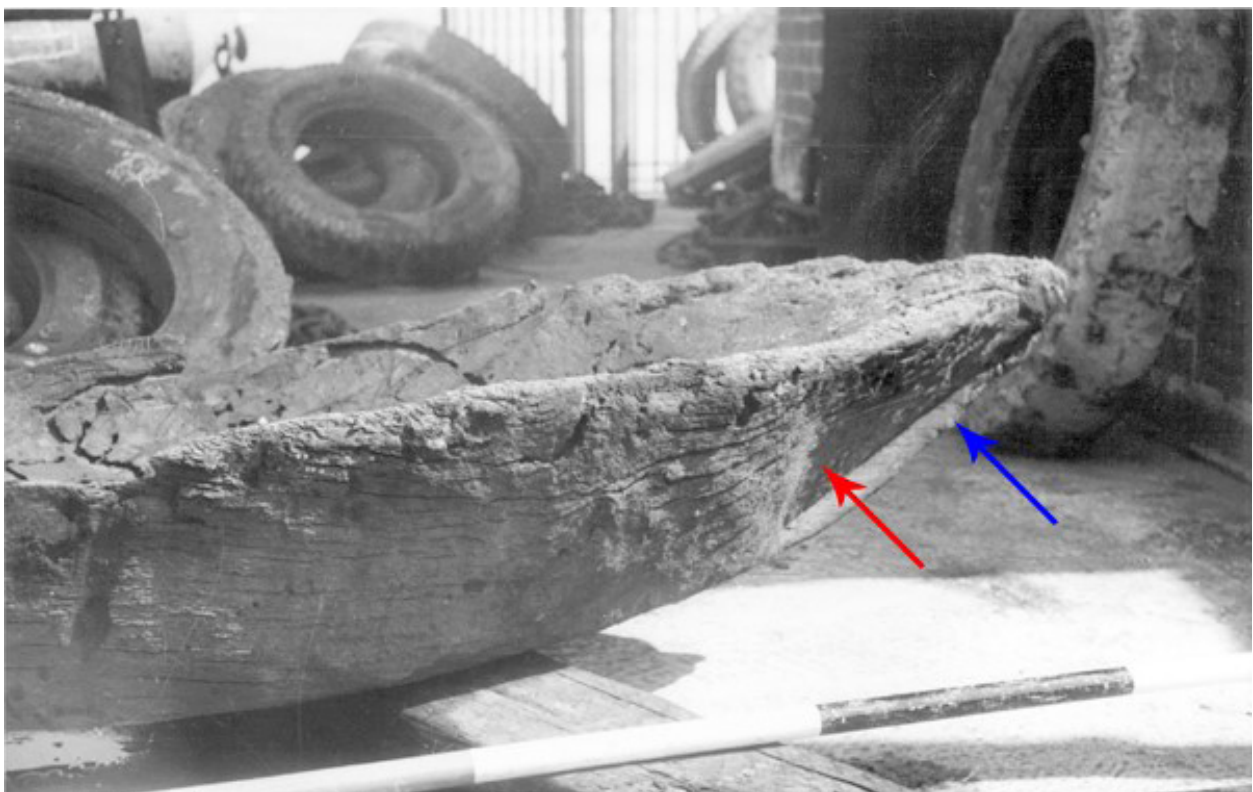

Figure 4.21 Unusual step feature at the bow (image courtesy of Poole Museum)

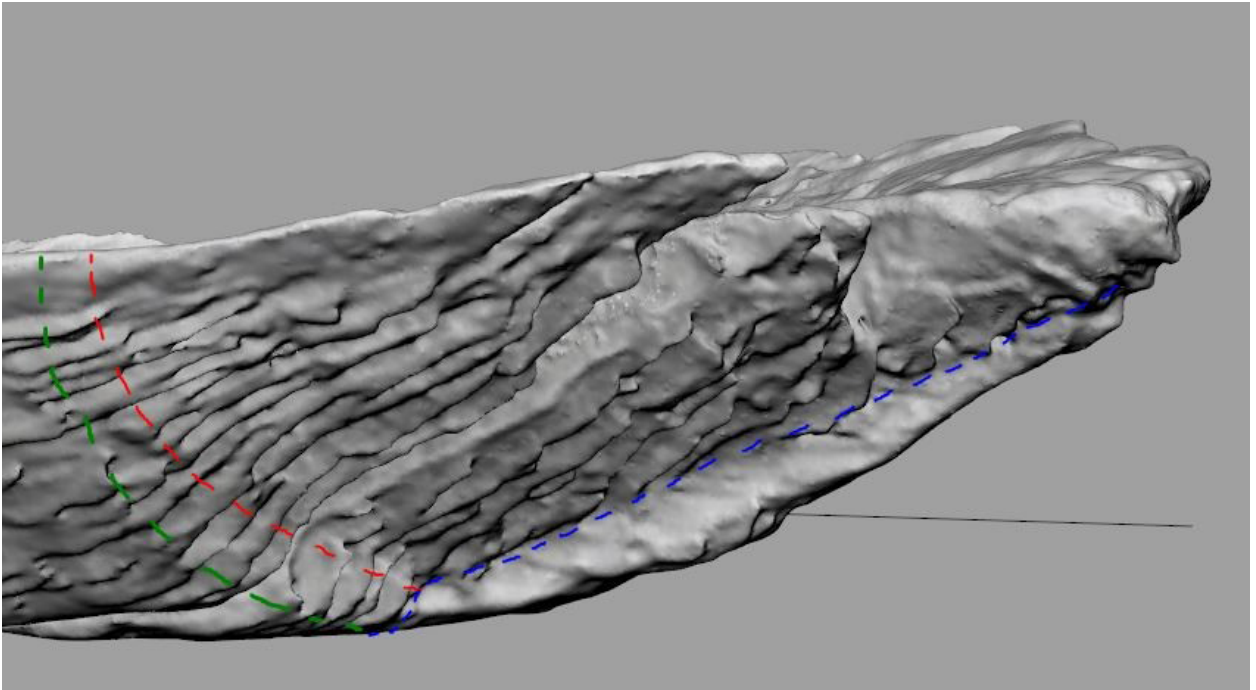

Figure 4.22 3D scan of bow area showing false stem and step feature

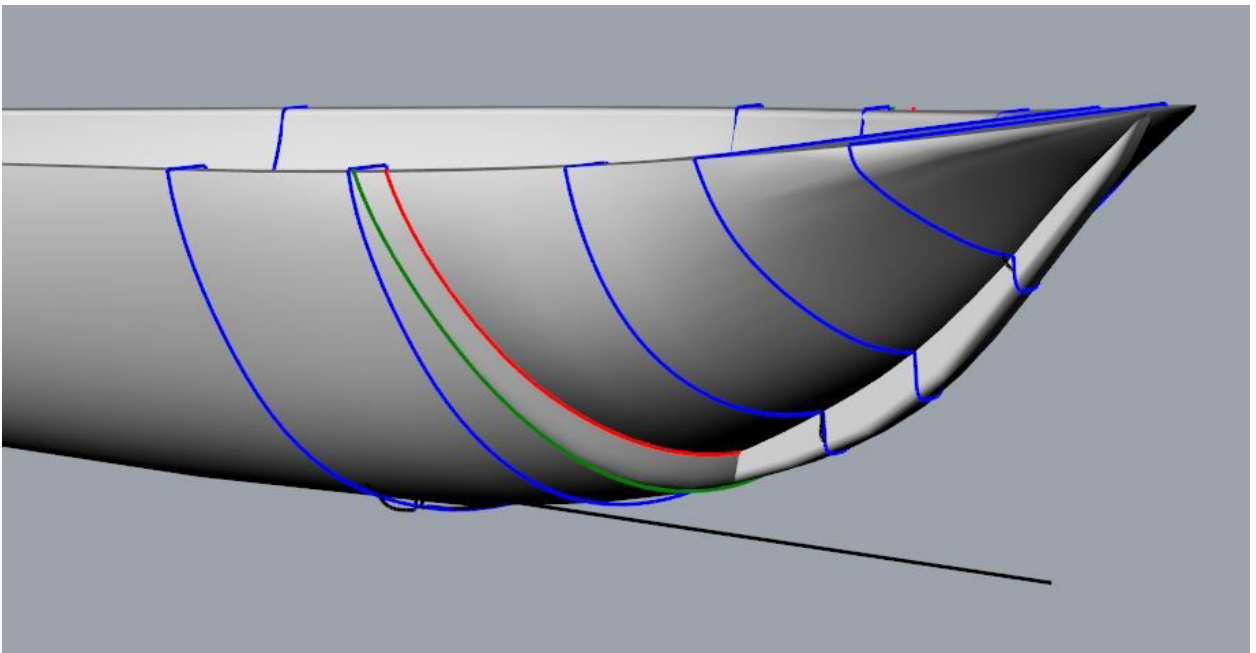
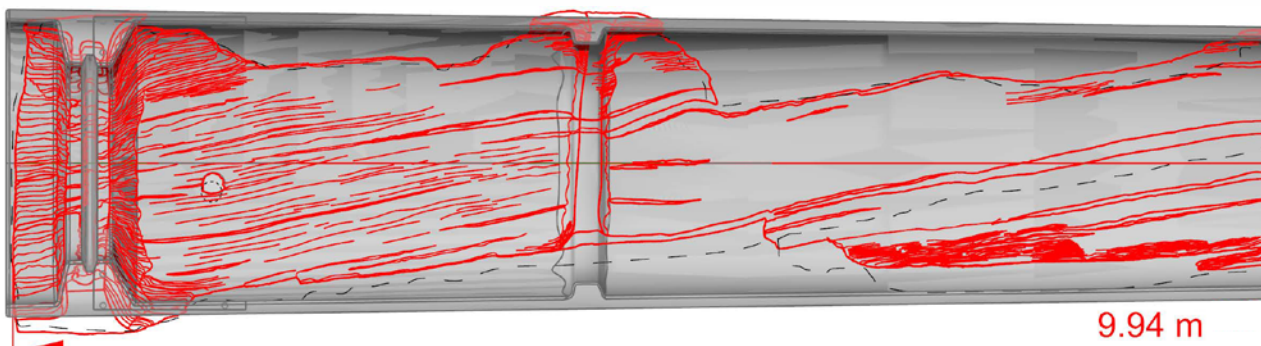

Figure 4.23 Bow section showing remodelled false stem and hull step

With the Poole logboat having two transverse ridges, the first located at 4.8 m from the bow (Figure 4.25) and the second 7.8m from the bow (Figure 4.26), being 47% and 77% respectively from the bow, or alternatively 2.3 m from the stern and the second at 5.3 m from the stern, being 23% and 53 % respectively. McGrail postulated that the Poole logboat was divided into propulsion (forward 47%), cargo (central 30%), passengers and steering (after 23%) (Figure 4.27).

However, taking the aft area, delineated by the transverse ridge, would allow a space for not more than four men standing, and fewer if kneeling. This would be unlikely to be classified as a passenger and steering space, as there is only sufficient room for four people standing. Standing in a logboat is a very skilled operation requiring great balance and experience, and not a likely position for inexperienced passengers. (Figure 4.28).

"Poole Iron Age Logboat"



Plan

2013 3D Laser Scan outline shown in red

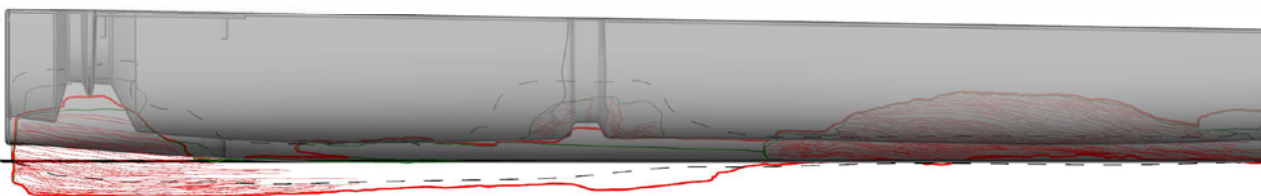

Starboard Elevation

Reconstruction showing recorded material

NOTES

This drawing is based on the 3D laser scanning of the logboat remains.

Figure 4.24 Reconstruction showing recorded material

Outline of 1974 drawing shown dashed - - - - -

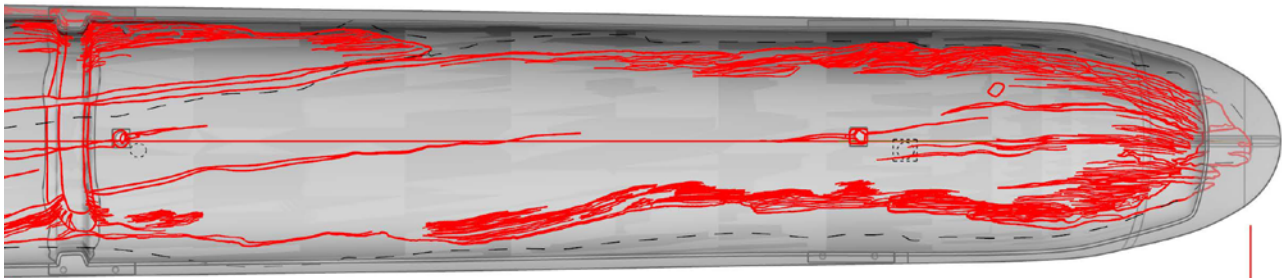

Outline of 1974 drawing shown dashed - - - - -

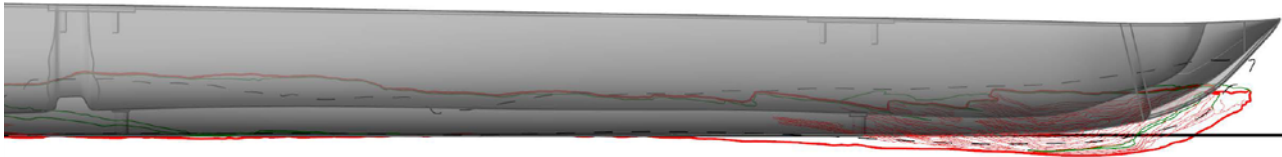

	3D Scanning Ireland 32, Rowan Court, Ballea Woods, Carrigaline, Co. Cork, Ireland. Tel: +353 (0)87 2811458 Email: pat@3dscanning.ie www.3dscanning.ie	
-------------------------------------------------------------------------------------	-----------------------------------------------------------------------------------------------------------------------------------------------------------------------	---------------------------------------------------------------------------------------

DRAWN P. Tanner
DRAWING NUMBER 5
MODEL UNITS Metres

DATE 25/10/2013
SHEET A3
SCALE 1 : 25



Figure 4.25 Forward transverse ridge

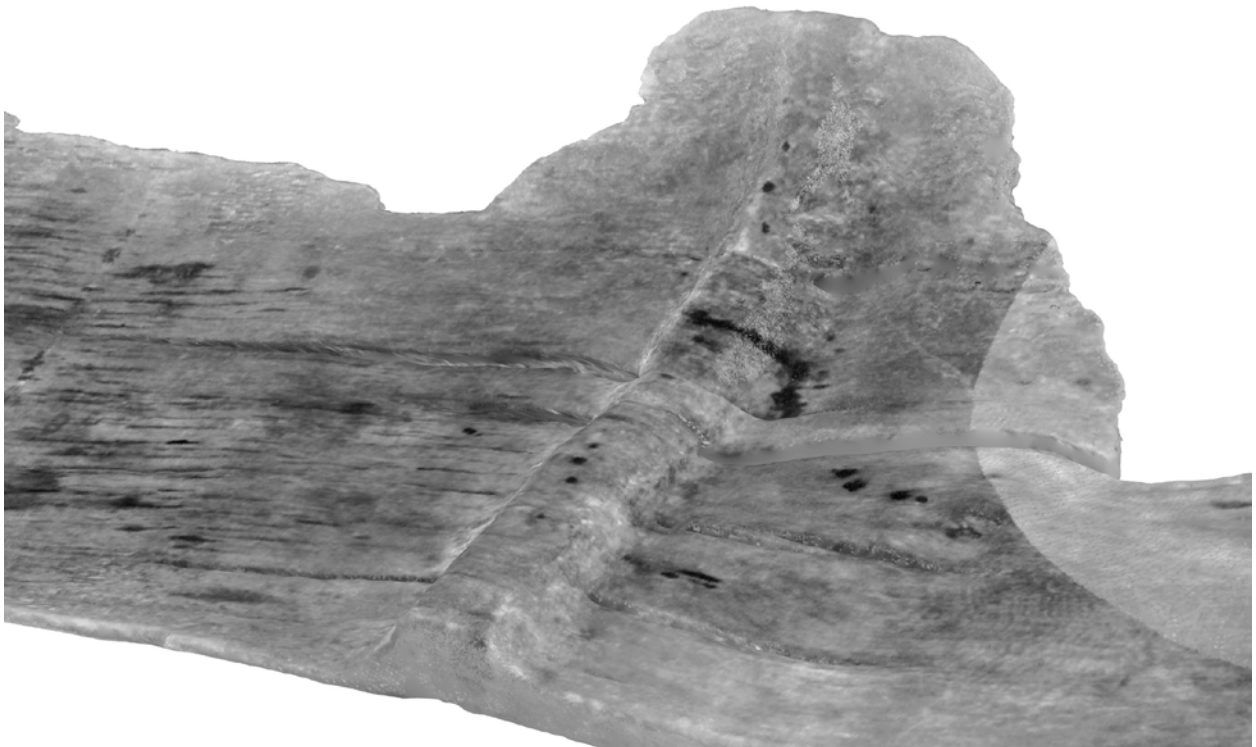

Figure 4.26 Aft transverse ridge

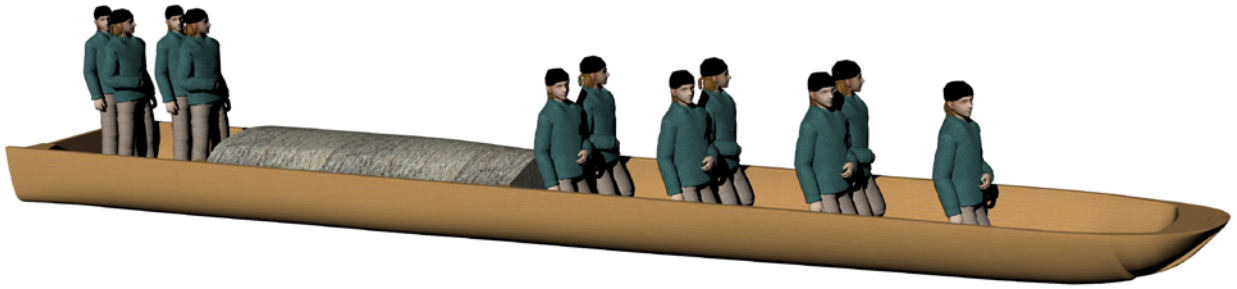

Figure 4.27 Internal space division

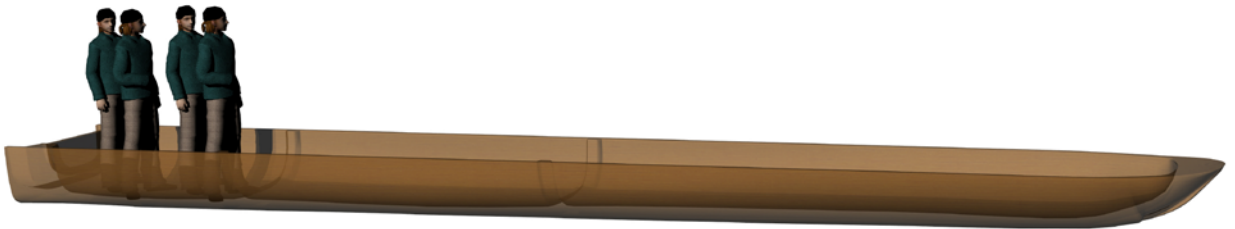

Figure 4.28 Aft space division

The aft ridge could be interpreted as a sub-division in the stern area to delineate a command or propulsion area, capable of accommodating four men standing, but sub-dividing the remainder of the logboat between cargo and propulsion on almost an equal basis would appear unlikely, especially as it has been shown (see Table 4.6) that the logboat could potentially be propelled by as few as two crew while carrying a cargo of 1880 kg at speeds in the region of 4 knots. Additionally, if the forward section was solely for propulsion, leaving only the central 30% for cargo, this area of cargo would have a volume of 1.464 m³. The remaining forward section of 47% for propulsion would accommodate seven crew, three pairs kneeling side by side, and a single man forward (see Figure 4.27). This configuration is limited by the flotation characteristics. In this configuration, a total of 11 men occupy the vessel, four aft and seven forward, with the remaining central space for cargo. If this central cargo space was filled with a turf cargo it would weigh only 636.8 kg, and if a cargo of wheat grain was used it would weigh only 995.5 kg, both of which, when combined with the weight of 11 men, are well below the actual 1880 kg cargo capacity of the logboat. Hence the propulsion, cargo, steering and passenger division of internal space would appear to be an unlikely best use of the logboat's potential.

This author is of the opinion that these transverse ridges were retained during the hollowing process in an attempt to stiffen the relatively thin-walled logboat, or alternatively in an attempt to resist the splitting tendency of the oak during the drying process. From a boatbuilding viewpoint, the almost midway (53%) location of the central transverse ridge would seem to be a logical location for hull strengthening or stiffening.

Fitted transom

The stern area was closed by means of a separate transom board, no evidence of which was recovered, fitted into a transom slot (Figure 4.29); this was recorded during the 1974 survey as being 46 mm deep and c. 43 mm wide, increasing in width towards the sheer.

Material identified at the time as animal hide caulking was also recovered. This area has degraded to an extent such as to make accurate dimensional analysis unreliable at the time of 3D scanning. Consequently a transom board and slot were modelled based on the 1974 recorded dimensions.

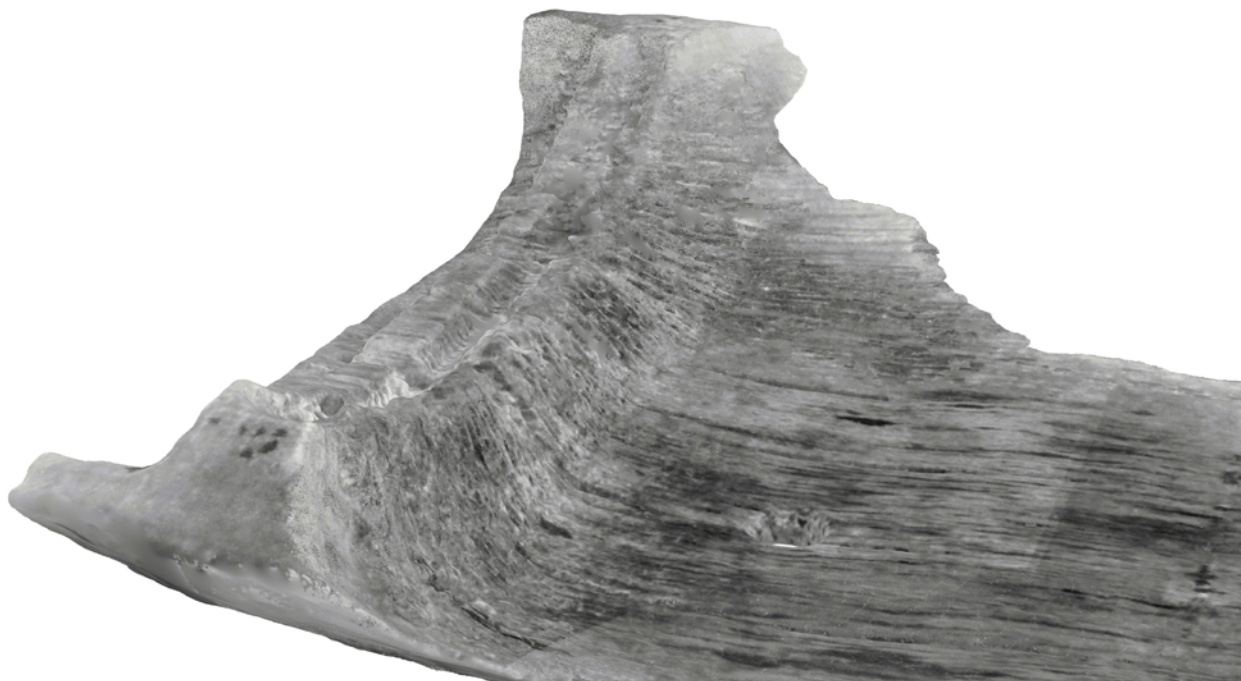

Figure 4.29 Stern transom slot

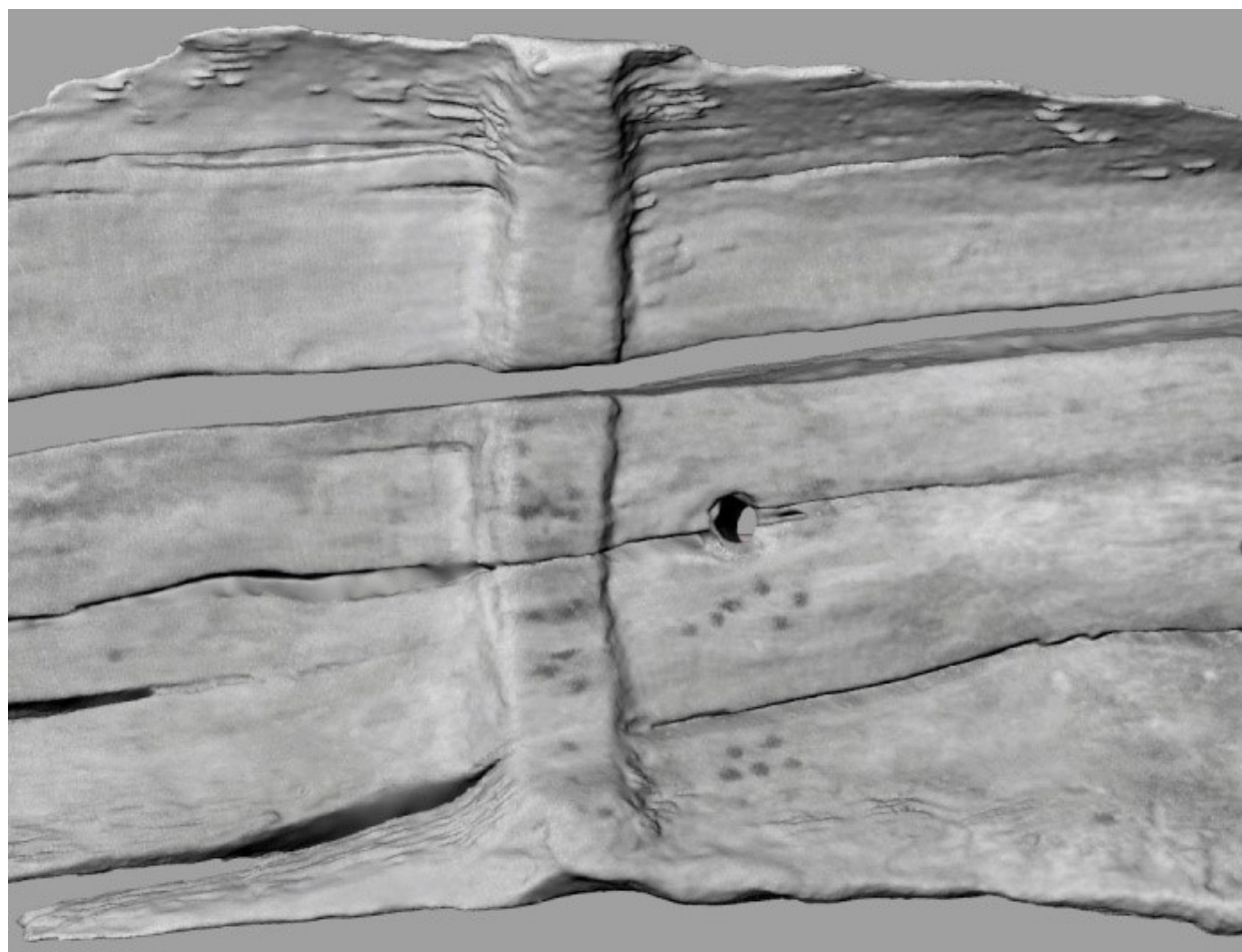

Figure 4.30 Central hole

Hull piercings

Three vertical holes pierced the bottom of the Poole logboat roughly on the centre line. The central hole (with a diameter of c. 51 mm) had what is described as a shadow of a rectangular depression around it (Figure 4.30) but this was no longer visible in the 2013 3D scan, and had vertical-grained oak fragments which McGrail described as a treenail (McGrail 1978, 256).

The forward hole (Figure 4.31), also with a diameter of c. 51 mm, was set inside a shallow rectangular recess c. 10 mm deep (still clearly visible in the 3D scan). The aft hole (Figure 4.32) had a diameter of c. 93 mm. McGrail describes these three holes as being close to the centre line and spaced so that they could be thickness gauges. In considering shrinkage, he speculates that the forward recess was probably square. He also states that the position of the forward hole would be a suitable towing point and it is possible that the forward thickness gauge hole was subsequently adapted to take a towing bollard or post, for which further support at the sheerline level would be required. McGrail notes (1978, 255–6) that the aft hole, having a diameter of almost twice the other two, is difficult to explain as a simple thickness gauge.

Twenty of the logboats recorded as part of the *Logboats of England and Wales*

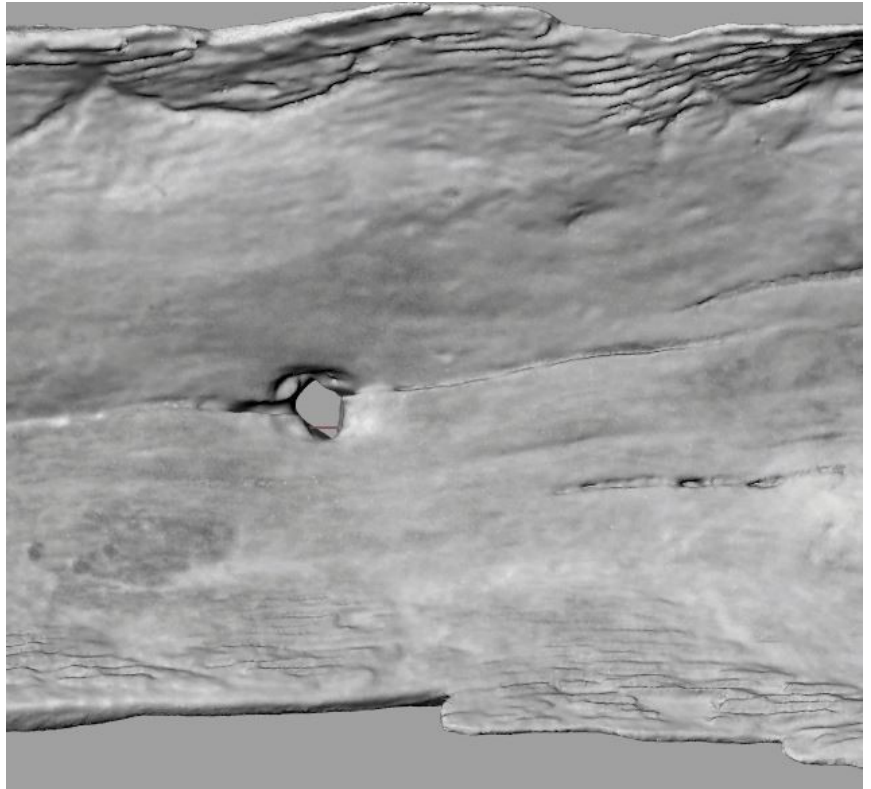

Figure 4.31 Forward hole

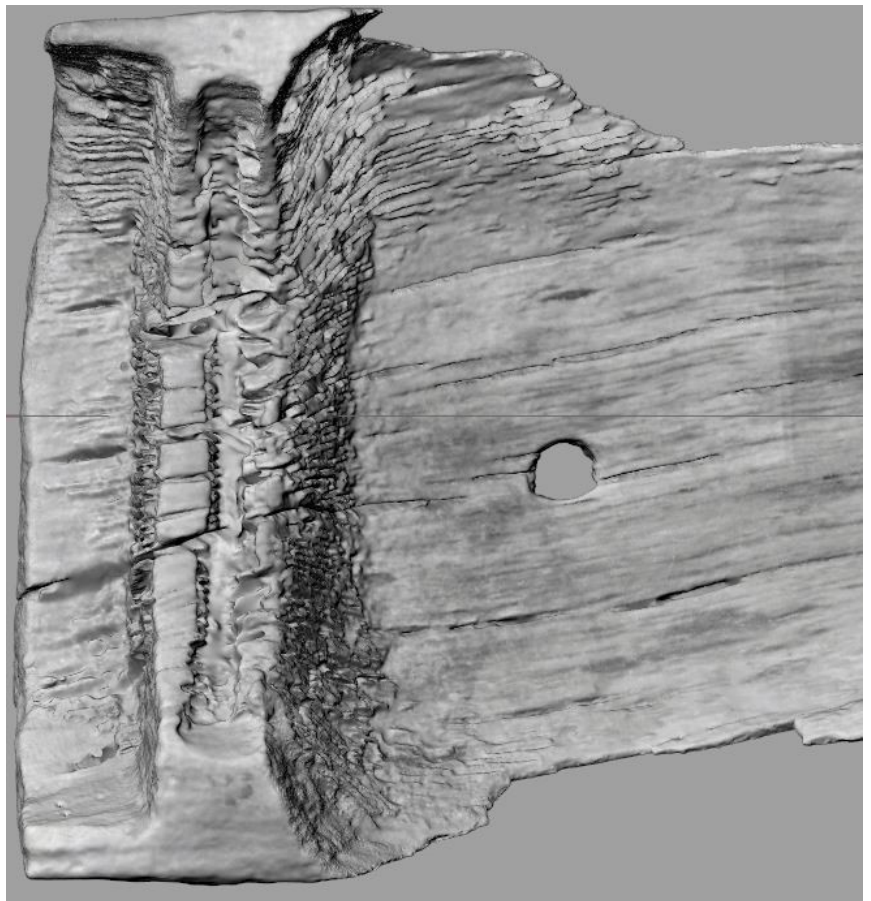

Figure 4.32 Aft hole

publication had holes interpreted as thickness gauges (McGrail 1978). Some 52 measurable holes had diameters in the range of 12–28 mm. Larger holes were also recorded, ‘Short Ferry’ having three holes of c. 38 mm diameter and ‘Holme Pierrepont 1’ had a square hole of c. 40 mm sides (ibid, 320).

The two smaller holes of the Poole logboat at 51 mm diameter and the aft hole of 93 mm diameter would appear to be excessively large when compared with existing records of holes attributed to thickness gauges.

Additional elements - thwarts

At least five logboats from the collections surveyed as part of the *Logboats of England and Wales* publication (McGrail 1978) had timbers of such a size and in positions that have been interpreted as thwarts. Two oak planks shaped to fit across each end and into notches cut into both sides of the top edge were recorded as part of the ‘Kentmere 1’ logboat, as well as a thwart reported to fit across one end on the ‘Warrington 2’ example. This latter measures 20 mm thick and 180 mm in breadth, which fits into notches in the sheer, and was fastened with treenails 24 mm in diameter (ibid, 316–17).

The central hole could potentially have been used as a thwart support, if the rectangular shadow recorded around the central hole was interpreted as a compression mark caused by a rectangular support post under a central thwart (Figure 4.33). The larger aft hole could, potentially, be a support for a more substantial thwart or a raised platform for use when punting the logboat in shallow waters. This could also exhibit a certain level of advance planning when positioning the thickness gauge to coincide with thwart or platform locations.

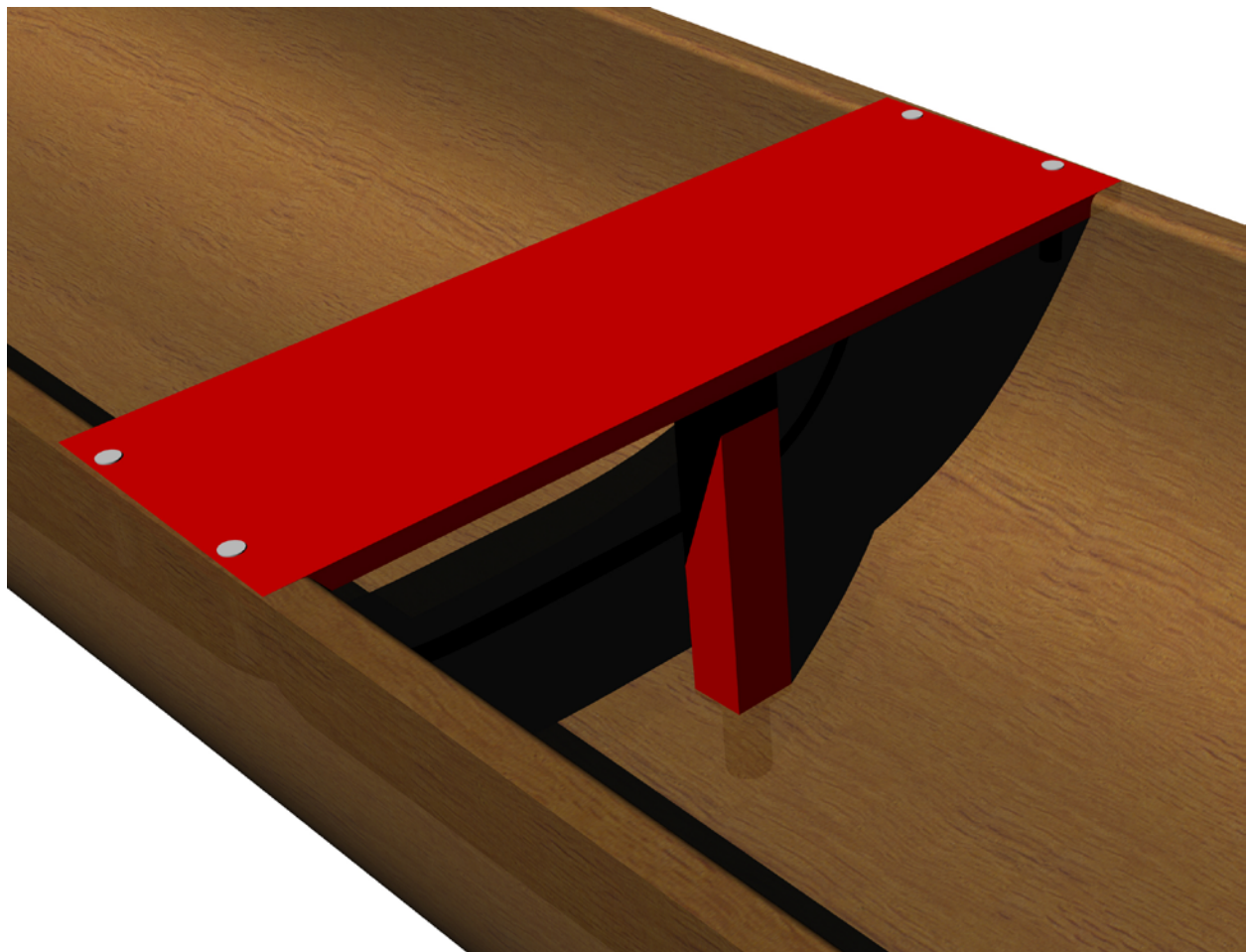

Figure 4.33 Possible thwart and stanchion

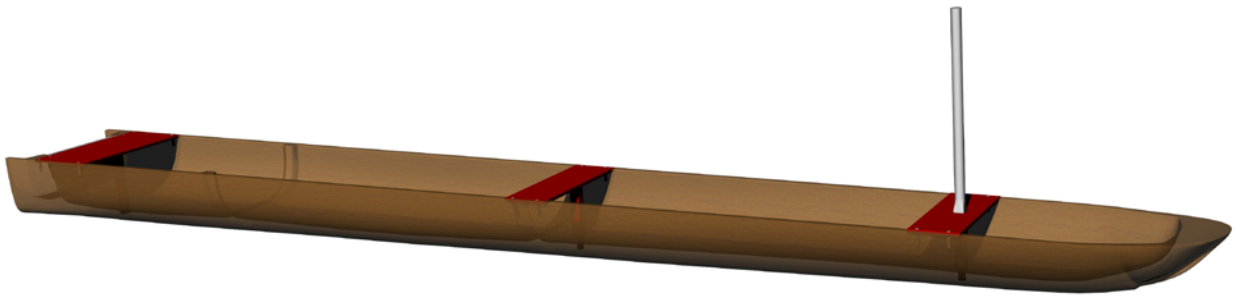

Figure 4.34 Hypothetical reconstruction (including thwarts)

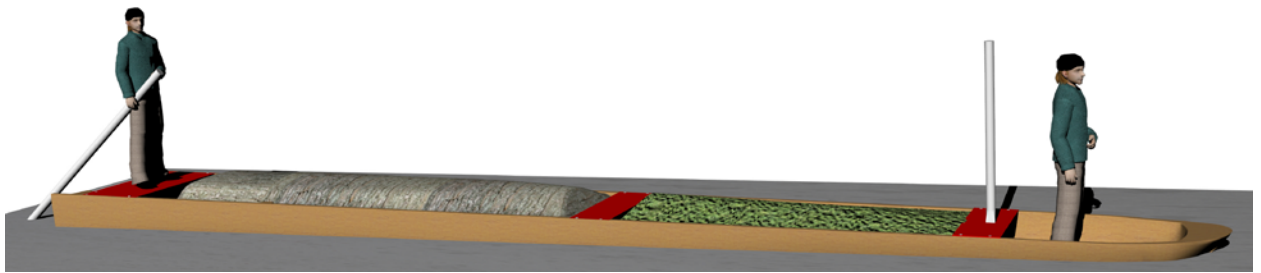

Figure 4.35 Hypothetical reconstruction fully loaded

The inclusion of thwarts similar to those recorded on the ‘Kentmere 1’ logboat which fit into notches at sheer level and are fastened with treenails would also aid in resisting the logboat’s tendency to spread or widen during use. Although no evidence for thwarts was recovered, such fittings and notches, if present at the sheerline level on the original vessel, would represent ‘water traps’ in areas of exposed end grain, leading to an accelerated rate of decay. They would thus be one of the earliest features to disappear from the remains, frequently rotting during the use life of the vessel and requiring maintenance or repair. A hypothetical reconstruction with the inclusion of these thwarts is shown in Figures 4.34 and 4.35.

Additional elements - towing or sailing mast

As McGrail pointed out (1978, 321), the use of masts and sails may leave very little evidence in a logboat, but its recorded use in the Hasselo boat (Rasmussen 1953 in McGrail 1978, 321) means the possible use of a mast and sail in a logboat from England or Wales cannot be ruled out. It is therefore possible that the ‘large by comparison’ holes in the Poole logboat may have originally been thickness gauges but were subsequently put to another use such as support sockets for a towing post or even a rudimentary sailing mast in the forward hole (Figures 4.34 & 4.35). The Poole logboat, fully loaded with a mixed cargo weighing c. 1870 kg and two crew, would require 1.2 kW to achieve a speed of 5 knots. A simple sailing mast supporting, for example, a 4 m² sail area, could potentially generate 0.6 kW in a 15 knot wind. From Table 4.6 this would be adequate to propel the logboat at c. 4 knots.

Reconstructing the parent log

A series of cross-sections were taken through the reconstructed logboat, including the original 3D scanned data, to determine the diameter of the smallest circumscribing circle in order to remodel the parent log (see Figures 4.16 and 4.19). This gave a parent log with a diameter of c. 1.70 m near the stern and c. 1.20 m at 9 m length. The centre line of the parent log and a base line were then aligned to examine the potential construction of the reconstructed logboat form.

The parent log was digitally modelled with a diameter of 1.72m at the butt end tapering to 1.20 m at 9 m height and an overall length of 10.52 m which represents the felled tree with branches removed and

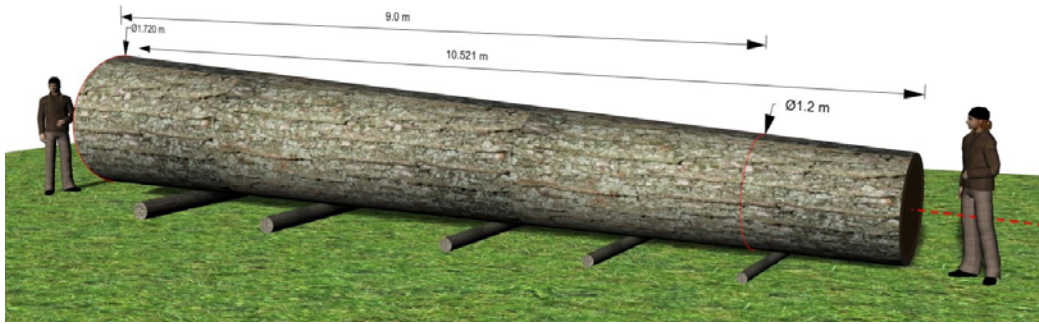

Figure 4.36 The parent log

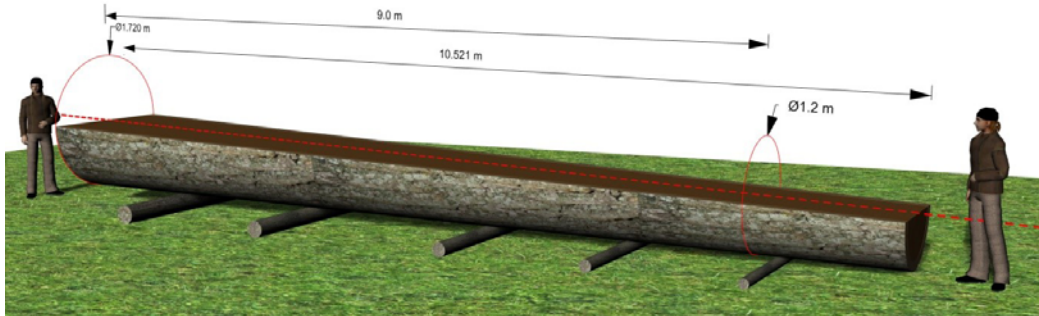

Figure 4.37 The parent log halved

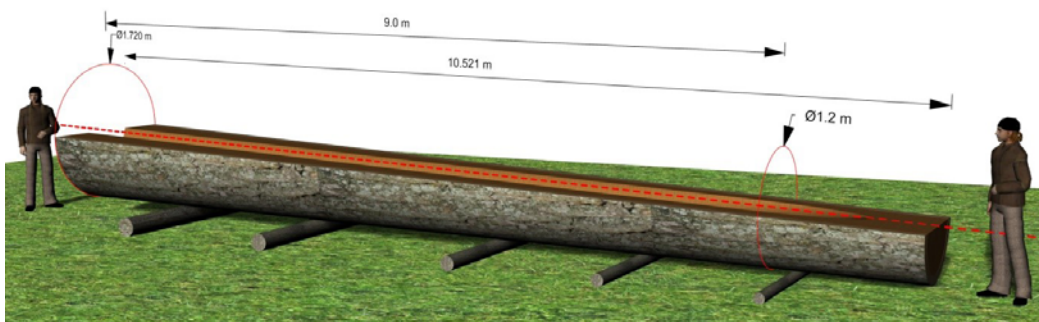

Figure 4.38 The half log roughly hollowed

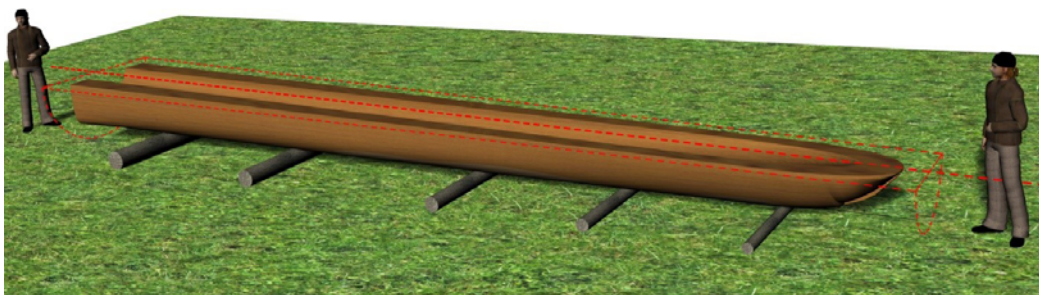

Figure 4.39 The exterior shape formed

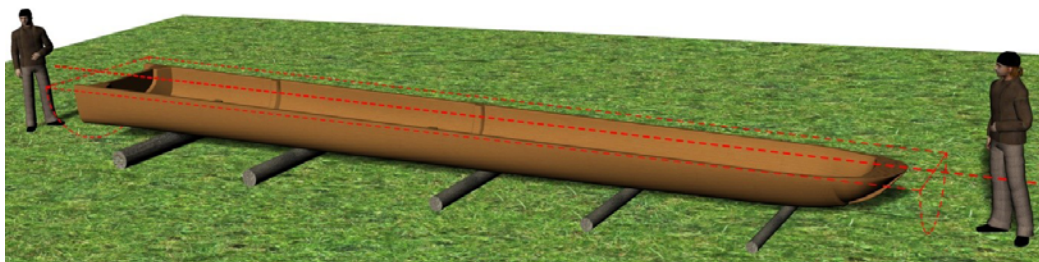

Figure 4.40 The interior shape finished and transom board fitted

Table 4.4 Log conversion details

Measurement	1974 Survey (McGrail 1978)	2013 Reconstruction
Parent log:		
Diameter	1.72 m tapering to 1.2 m @ 9 m	1.72 m tapering to 1.2 m @ 9 m
Girth	5.4 m at butt end	5.35 m at butt end
Volume	16.76 m ³	16.82 m ³
Weight		16,560 kg
Volume of logboat	1.077 m ³	1.313 m ³
% worked away	93.6 % of the whole log	92.1 % of the whole log
Log conversion Coefficient	0.064	0.079
% worked away	87.15 % of 1/2 log	84.15 % of 1/2 log

roughly cut to length (Figure 4.36). The log was recreated with an allowance of 100 mm for sapwood and bark (McGrail 1978, 121), which was subdivided on the basis of 75 mm sapwood and 25 mm bark. The CAD software was then used to analyse the volumes of the resulting log, which has a volume of 12.47 m³ of heartwood, 4.20 m³ of sapwood and 1.15 m³ of bark.

With freshly cut oak heartwood weighing c. 1073 kg/m³ (McGrail 1978, 133), and slightly lower weights of 800 kg/m³ and 400 kg/m³ for the sapwood and bark respectively, when these densities are applied to the digital model, the parent log at 10.5 m long would weigh 459.6 kg for the bark, 2718.8 kg for the sapwood, and 13,381.4 kg for the heartwood, giving a total combined weight of c. 16,560 kg (16.56 tonnes).

The parent log roughly split or cleaved in half would weigh c. 8280 kg (Figure 4.37).

The half log with c. 2.20 m³ removed during the rough hollowing weighs c. 5920 kg (Figure 4.38).

With the exterior hull shape formed (Figure 4.39) the remaining log consisting of only heartwood has a volume of 4.89 m³ and weighs c. 4175 kg.

Following final hollowing of the interior and overall fairing or smoothing, the finished logboat has a volume of 1.30 m³ and a weight of 1396 kg (1.39 tonnes) (Figure 4.40).

This has resulted in a volume reduction of the parent log from 16.80 m³ to 1.30 m³ and a reduction in weight from 16,560 kg to 1396 kg (Table 4.4).

Based on the results generated in Table 4.5, the 2013 reconstruction (Figure 4.41) using green oak was then used for further analysis.

Analysis of the 2013 reconstruction

Establishing flotation condition

In order to establish a flotation condition for the vessel, three key facts are required:

1. Vessel hull shape in order to establish the centre of buoyancy (CB);
2. Vessel weight in order to establish displacement;
3. Vessel centre of gravity (CoG) to establish flotation trim.

Hull shape

The vessel hull shape (Figure 4.41) has been established based on the reconstruction methods already outlined in the preceding sections. Once this shape has been digitally remodelled, the Orca 3D marine

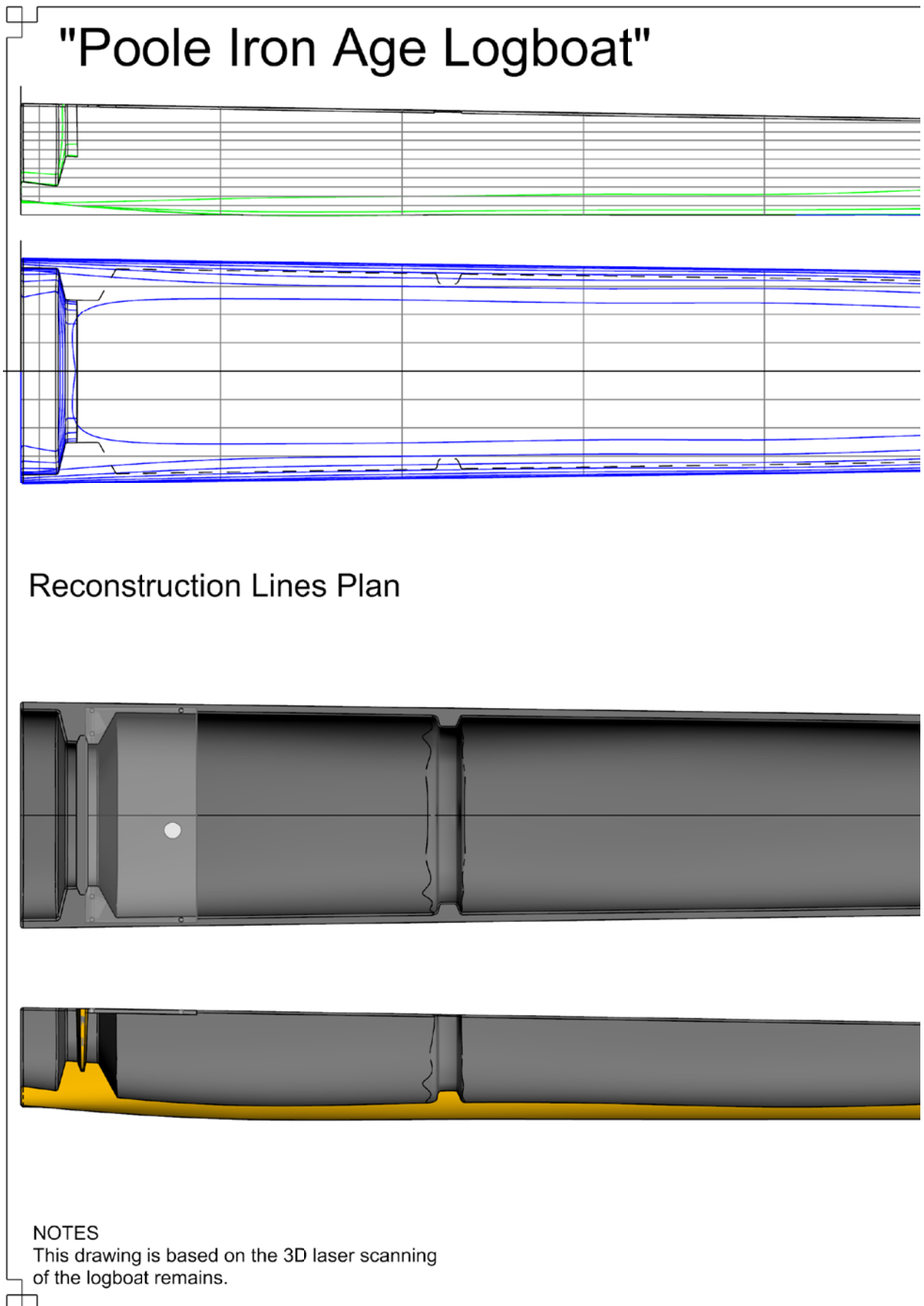
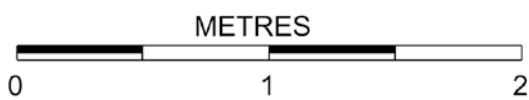
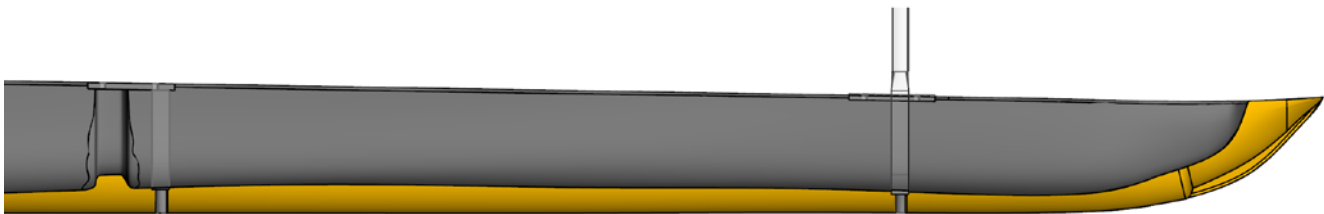
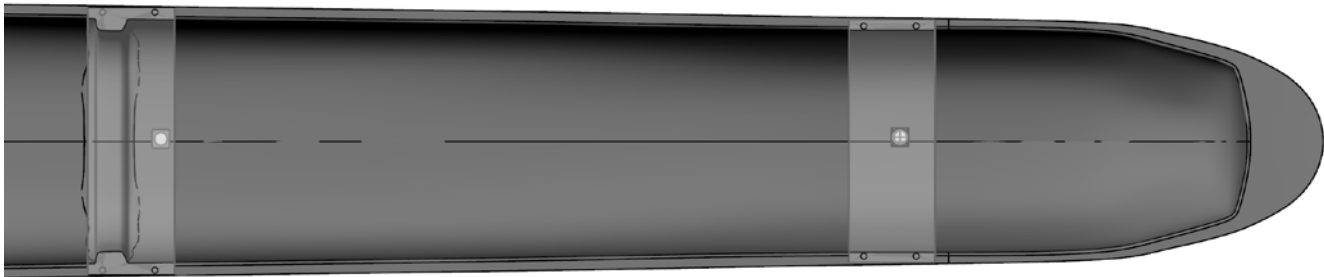
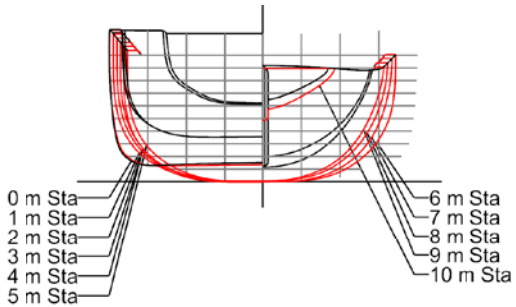
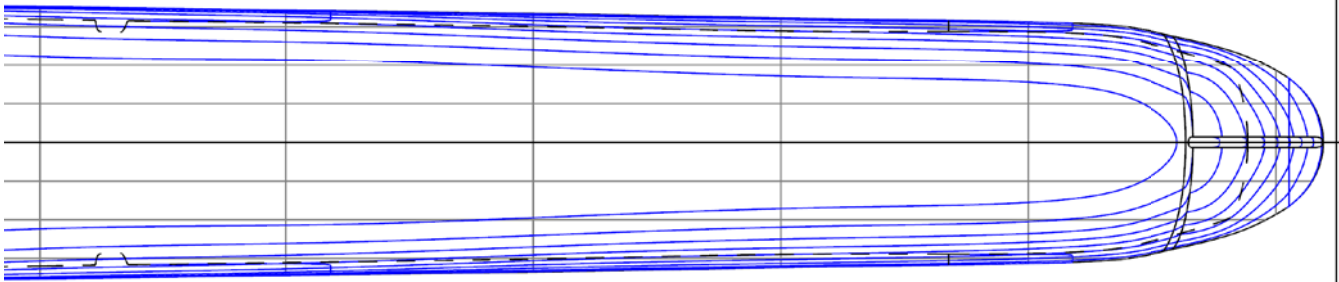
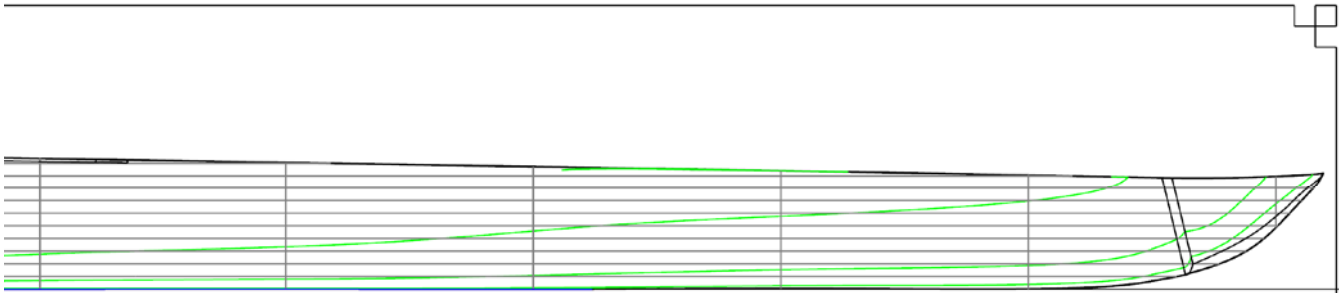

Figure 4.41 Reconstruction drawing



3D Scanning Ireland
 32, Rowan Court, Ballee Woods, Carrigaline, Co. Cork, Ireland.
 Tel: +353 (0)87 2811458 Email: pat@3dscanning.ie
 www.3dscanning.ie

DRAWN P. Tanner

DATE 25/10/2013

DRAWING NUMBER 6

SHEET A3

MODEL UNITS Metres

SCALE 1 : 25

Table 4.5 Comparison of empty logboat

Measurement	1974 Digital Reconstruction	2013 Reconstruction	2013 Reconstruction
The Boat Data (empty)	Based on oak @ 27% moisture content weighing 800 kg/m ³	Based on oak @ 27% moisture content weighing 800 kg/m ³	Based on green oak weighing 1073 kg/m ³
Length Overall	10.01 m	10.09 m	10.09 m
Maximum Beam	1.52 m	1.22 m	1.22 m
External Height	0.50 m aft – 0.36 m for'd	0.60 m aft – 0.46 m for'd	0.60 m aft – 0.46 m for'd
Hull Weight	862 kg	1051 kg	1409 kg
Thickness Bottom	c. 65 mm	c. 81 mm	c. 81 mm
Thickness Sides	c. 30 mm	c. 50 mm	c. 50 mm
Volume of Wood	1.077 m ³	1.313 m ³	1.313 m ³
Volume of Hollow	3.298 m ³	3.251 m ³	3.251 m ³
Displacement	882 kgf	1051 kgf	1409 kgf
L.C.G.	4.24 m from stern	4.343 m from stern	4.343 m from stern
T.C.G. assumes symmetrical hull	0 mm	0 mm	0 mm
V.C.G. above baseline	0.180 m	0.184 m	0.184 m
Draft	0.175 m	0.160 m	0.202 m
Fb aft	0.361 m	0.444 m	0.402 m
Fb for'd	0.228 m	0.293 m	0.260 m
Fb aft at 10° heel	0.232 m	0.336 m	0.293 m
Fb for'd at 10° heel	0.155 m	0.229 m	0.202 m
GM _t	0.523 m	0.543 m	0.469 m
Cb	0.473	0.565	0.589
Cp	0.709	0.802	0.794
Waterplane area	8.272 m ²	8.807 m ²	9.136 m ²
Wetted surface	9.064 m ²	9.829 m ²	10.966 m ²
Righting moment at 10°	79.3 kgf-m	96.3 kgf-m	113.3 kgf-m

plug-in for the Rhinoceros 3D software, which is a naval architecture suite, is used to determine accurately the centre of buoyancy (CB).

Vessel weight

The most accurate method of determining the weight of a vessel is to weigh it in air. In order to weigh the vessel a complete, rebuilt vessel would be required. As this is not practical at this stage, and the fact that various hypothetical reconstructions are still being examined, an alternative approach was used.

The logboat was accurately modelled using Rhinoceros 3D solid modelling techniques as described above and, using the Orca 3D marine plug-in for Rhinoceros 3D, a material is assigned to each part. Orca 3D then uses each constituent part's dimensions and assigned material to calculate the weight (Figure 4.42).

With regard to the materials assigned for each element, the logboat was constructed of oak. Oak heartwood can vary between 600 and 1073 kg per m³ depending on moisture content. Oven- or kiln-dried oak heartwood will typically have a density of c. 606 kg/m³, while green or freshly felled oak heartwood will have a density of c. 1073 kg/m³. In the original 1974 analysis an average of 800 kg per m³ was used in the calculations, being a typical value for oak heartwood at 27% moisture content, which is the density of oak at fibre saturation point (McGrail 1978, 131).

Poole Iron Age Logboat						
Orca3D Weight and Cost Report						
3D Scanning Ireland						
Report Time: 02 November 2013, 16:54:31						
Model Name: D:\Dropbox\3D Scanning\Scans\Poole Logboat\Poole_2_3dm						
Weight Items						
Object Name	Material	Weight (kgf)	LCG (m)	TCG (m)	VCG (m)	Weight Basis
☐ All Items						
Transom	Oak Heartwood Green	13.214	0.331	0.000	0.461	0.012 m ³
Reconstructed Hull	Oak Heartwood Green	1396.229	4.381	0.000	0.181	1.301 m ³
SubTotal		1409.444	4.343	0.000	0.184	
Totals		1409.444	4.343	0.000	0.184	
* Values with an asterisk are assigned directly and not computed from the corresponding material and geometry.						
** These items are associated with Rhino block instances. See "Block Item Details" section for breakdown of these weight items.						

Figure 4.42 Weight report using green oak

This author feels that the weight of 800 kg per m³ used during the original 1974 analysis is an underestimate. McGrail states ‘oak is easier to work whilst it is green i.e. of a high moisture content, before the log has seasoned ... and what little ethnographic evidence there is indicates that logboats were similarly fashioned from “green” logs’ (ibid, 117). This is a well-known fact to all wooden boat builders, and many dislike, or will indeed refuse to work with, oak which has become over-seasoned or ‘hard’, on account of the need to re-sharpen tools constantly.

The logboat was, in all probability, carved from a freshly felled oak tree, on the basis that freshly felled or green oak is much easier to cut and work than seasoned oak, and by the traditional ‘rule of thumb’ of 1 year per inch (25 mm) for air drying, a log of sufficient size to accommodate the Poole logboat could take upwards of 30 years to season. During this air-drying process the log would develop considerable splits and distortion, which would probably render the log useless as a potential logboat.

Typical modern freshly cut oak heartwood weighs *c.* 1073 kg/m³ (Millett *et al.* 1987, 106). If the logboat was, in fact, constructed using green oak, the characteristics as shown in Table 4.5 and Figure 4.42 show a considerable increase in the bare hull weight, from the estimated 862 kg used in the 1974 analysis to the 2013 figure of 1409 kg.

The net result of this additional weight is an increased righting arm moment, while maintaining a freeboard aft of 0.402 m and freeboard forward of 0.260 m. This increased righting arm moment results in a logboat with increased initial stability, or what sailors generally refer to as ‘stiffness’. A practical example of this ‘stiffness’ is when a crew member steps on the gunnel or deck edge when entering the boat. Using McGrail’s typical human weighing 60 kg, the 1974 reconstruction would heel to 12.4°, the 2013 reconstruction if built of seasoned oak at 27% moisture content would heel to 10.2° while the 2013 reconstruction if built of green oak would heel to only 8.7°.

Centre of mass

The most accurate method of determining a vessel’s centre of mass¹ is to weigh it in air and then carry out an inclining test to establish the position of the centre of mass (McKee 1974, 11–13). In order to weigh the vessel and perform an inclining test, a complete, rebuilt vessel would be required. As this is not practical, for the reasons outlined above, an alternative approach was used.

¹ While ‘centre of mass’ is the correct engineering term, ‘centre of gravity’ is widely used in naval architecture.

The centre of gravity of the logboat and separate transom board is individually calculated by the Orca 3D software. When these constituent parts are combined, an overall weight, centre of gravity, and centre of buoyancy for the entire vessel (Figure 4.42) is produced and the software will then automatically orient the vessel in order to generate an equilibrium floating condition calculated on the basis of the hull shape.

Cargo

The initial study (McGrail 1978, 132) uses three standard cargoes:

1. Stone with a stowage rate of 2500 kg/m³;
2. Wheat-grain with a stowage rate of 680 kg/m³;
3. Turf with a stowage rate of 435 kg/m³.

The cargo was assumed to occupy 80% of the internal volume of the logboat.

Crew

A representative person of 1.65 m (5ft 5in) height and weighing 60 kg, which McGrail describes as a short, lean, wiry person, having a centre of gravity of 1.10 m above the feet when standing, 0.45 m above the knees when kneeling, and 0.40 m above the seat when sitting was used in the initial study (McGrail 1978, 131). McGrail gives a minimum space requirement of 0.85 m width for two paddlers seated side by side, and a space of 1.00 m longitudinally between adjacent pairs of paddlers, with individual paddlers working over opposing sides requiring 0.66 m longitudinal space.

This author feels that the short, lean, wiry person used by McGrail in the initial study is an underestimate of the typical crew. A crew member continually involved in physical exertion while poling or paddling the boat, as well as loading and unloading cargoes, would tend to develop a more physical and muscular stature for which a weight of 80 kg would be more appropriate. Steckel noted that male height decreased from an average of 1.74 m during the early middle ages to a low of 1.67 m during the 17th and 18th centuries (Steckel 2004). Therefore it is also proposed to test the hypothetical reconstruction with a human model of 1.70 m height, weighing 80 kg, having a centre of gravity 1.20 m above the feet when standing, 0.55 m above the knees when kneeling, and 0.50 m above the seat when sitting, with two men standing and the remainder kneeling.

Seaworthiness

The term seaworthiness is a very broad one, as it includes not only the physical state of the vessel but also extends to other aspects and factors. Consequently, it is not easy to define seaworthiness in rigorous terms. A 13th-century law defined a ship as seaworthy if she did not need to be bailed (emptied of water) more than three times in 24 hours (Christensen 1968, 138–9). The *Marine Insurance Act* (1906) states ‘A ship is deemed to be seaworthy when she is reasonably fit in all respects to encounter the ordinary perils of the seas of the adventure insured’ (Chalmers and Ivamy 1976). Consequently, seaworthiness can be defined as the following: the fitness of the vessel in all respects to encounter the ordinary perils of the sea that could be expected on her voyage, and to deliver the cargo safely to its destination.

Evaluating whether a vessel would have been seagoing is an art as well as a science since a number of interacting factors have to be considered, including the strength, durability and integrity of the hull, the freeboard at operational drafts, the stability, and reserves of buoyancy (McGrail 2001, 6). McGrail also states that an open boat below a certain size is unlikely to have been seagoing, while a boat-shaped underwater hull and a sheerline rising towards the ends suggest a seagoing vessel (*ibid*).

In order to determine seaworthiness, the vessel must be examined in varying flotation conditions. These conditions are suggested as being influenced by the following four main factors (McGrail 1998,13):

1. Weight and centre of gravity of the vessel;
2. Number and normal station of crew;
3. Bulk density of cargo;
4. Freeboard, the distance between the gunwale or top edge, and the operational waterplane, will need to be examined.
 1. The weight and centre of gravity of the vessel has been calculated as being 1409 kg, with the centre of gravity located 4.340 m forward of the stern and 0.184 m above the baseline (bottom exterior), with a draft aft of 0.202 m in the empty state.
 2. The number of crew was notionally set at 18 by McGrail in the 1974 analysis, the total number there is space for.
 3. The bulk density of the cargo will be dealt with in the loaded flotation conditions.
 4. Ethnographic evidence suggests that for inland waters, small boats were loaded to very little freeboard (McGrail 1978, 91). Seagoing data is not readily available, but a medieval Icelandic Law in the Grâgâs Codex states the minimum freeboard (F) of a cargo ship should be $F=2D/5$, where D=depth of hull amidships (Morken 1980,178).

The use of four 'standard freeboards' is suggested (McGrail 1998, 199):

- a. draft restricted to 300 mm (minimum depth of water);
- b. at a standard freeboard of 150 mm (safety consideration);
- c. minimum freeboard as a function of transverse stability (upper edge of sides awash at 10° heel);
- d. the maximum number of crew there is space for.

The 1974 report examined the reconstruction in four loading states and was deemed to pass the test criteria if the minimum freeboard was not exceeded, and the vessel had a positive metacentric height (GM_t). The minimum freeboard criteria was set by McGrail at 0.13 m when the vessel would have the upper edge awash at 10° heel (McGrail 1998, 20). A standard freeboard, based on examination of several photographs of logboats in use, was set at 0.15 m for all logboats (McGrail 1978, 133).

It was therefore decided to re-examine the current reconstruction using the same test criteria, which would enable this reconstruction to be compared on an equal basis with the other logboats as recorded in the original study (McGrail 1978). The test results, such as number of crew or cargo capacity, were then calculated and modified as required in order to comply with the original test criteria, such as maximum crew, minimum freeboard, cargoes to achieve both standard and restricted drafts.

Flotation conditions

State A (60 kg person) restricted draft

The theoretical maximum number of paddlers, kneeling and standing, plus the equipment or ballast/cargo which can be carried at a draft of 0.30 m.

2 men standing and 16 kneeling and 58 kg equipment positioned in aft area was the quantity from the original 1974 analysis.

As the draft already exceeds 0.30 m with the maximum crew, the crew was reduced to 1 man standing and 15 kneeling with no extra equipment (Figures 4.43 & 4.44).

Poole Iron Age Logboat

Orca3D Weight and Cost Report

3D Scanning Ireland

Report Time: 02 November 2013, 20:52:33

Model Name: D:\Dropbox\3D Scanning\Scans\Poole Logboat\Poole_2_3dm



Weight Items						
Object Name	Material	Weight (kgf)	LCG (m)	TCG (m)	VCG (m)	Weight Basis
☐ All Items						
Standing Crew	Person 60 kg	60.000	1.156	-0.114	1.200	0.000 N/A
Kneeling Crew	Person 60 kg	60.000	8.524	0.000	0.540	0.000 N/A
Kneeling Crew	Person 60 kg	60.000	2.690	0.271	0.540	0.000 N/A
Kneeling Crew	Person 60 kg	60.000	2.690	-0.271	0.540	0.000 N/A
Kneeling Crew	Person 60 kg	60.000	3.690	0.256	0.540	0.000 N/A
Kneeling Crew	Person 60 kg	60.000	4.690	0.241	0.540	0.000 N/A
Kneeling Crew	Person 60 kg	60.000	5.690	0.226	0.540	0.000 N/A
Kneeling Crew	Person 60 kg	60.000	6.690	0.215	0.540	0.000 N/A
Kneeling Crew	Person 60 kg	60.000	7.690	0.189	0.540	0.000 N/A
Kneeling Crew	Person 60 kg	60.000	1.690	-0.271	0.540	0.000 N/A
Kneeling Crew	Person 60 kg	60.000	1.690	0.271	0.540	0.000 N/A
Kneeling Crew	Person 60 kg	60.000	7.690	-0.189	0.540	0.000 N/A
Kneeling Crew	Person 60 kg	60.000	6.690	-0.215	0.540	0.000 N/A
Kneeling Crew	Person 60 kg	60.000	5.690	-0.226	0.540	0.000 N/A
Kneeling Crew	Person 60 kg	60.000	4.690	-0.241	0.540	0.000 N/A
Kneeling Crew	Person 60 kg	60.000	3.690	-0.256	0.540	0.000 N/A
Transom	Oak Heartwood Green	13.214	0.331	0.000	0.461	0.012 m³
Reconstructed Hull	Oak Heartwood Green	1396.229	4.381	0.000	0.181	1.301 m³
SubTotal		2369.444	4.491	-0.003	0.345	
Totals		2369.444	4.491	-0.003	0.345	

Figure 4.43 Weight report State A: restricted draft at 60 kg per person

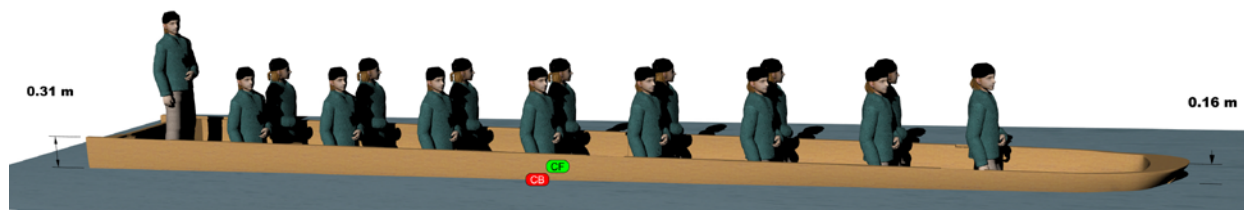

Figure 4.44 Reconstructed logboat with restricted draft at 60 kg per person

This resulted in: a draft of 0.296 m,
 Freeboard Aft of 0.308 m,
 Freeboard For'd of 0.157 m,
 GM_t of 0.212 m.

The logboat can heel to 22.5° with a righting moment of 190 kgf-m and reserve freeboard of 0.026m @ 22.5° of heel.

At 25° heel the top edge forward would be 15 mm underwater.

In this restricted draft state the logboat could carry 16 men weighing 60 kg.

Test criteria: Draft less than 0.30 m, minimum freeboard greater than 0.13 m, and the vessel has a positive metacentric height (GM_t).

The original 1974 analysis used 18 men and 58 kg of equipment located in the aft area. This would fail the test criteria as the draft exceeded 0.30 m with 18 men and 58 kg of equipment.

In order to reduce the draft to 0.30 m the crew had to be reduced from 18 to 16 men.

In this configuration the hypothetical reconstruction is deemed to pass, but does not include any additional equipment.

State A (80 kg person) restricted draft

The theoretical maximum number of paddlers, kneeling and standing as A above, plus the equipment or ballast/cargo which can be carried at a draft of 0.30 m.

2 men standing and 16 kneeling and 58 kg equipment positioned in aft area was the quantity from the original reconstruction.

With the increased crew weight compared to State A (60 kg person above), the crew was further reduced to 1 man standing and 12 kneeling with no extra equipment (Figures 4.45 & 4.6).

Poole Iron Age Logboat
 Orca3D Weight and Cost Report
 3D Scanning Ireland
 Report Time: 03 November 2013, 14:20:07
 Model Name: D:\Dropbox\3D Scanning\Scans\Poole Logboat\Poole_2.3dm



Weight Items						
Object Name	Material	Weight (kgf)	LCG (m)	TCG (m)	VCG (m)	Weight Basis
☐ All Items						
Transom	Oak Heartwood Green	13.214	0.331	0.000	0.461	0.012 m^3
Reconstructed Hull	Oak Heartwood Green	1396.229	4.381	0.000	0.181	1.301 m^3
Kneeling Crew	Person 80 kg	80.000	2.690	0.271	0.640	0.000 N/A
Kneeling Crew	Person 80 kg	80.000	2.690	-0.271	0.640	0.000 N/A
Kneeling Crew	Person 80 kg	80.000	3.690	0.256	0.640	0.000 N/A
Kneeling Crew	Person 80 kg	80.000	4.690	0.241	0.640	0.000 N/A
Kneeling Crew	Person 80 kg	80.000	5.690	0.226	0.640	0.000 N/A
Kneeling Crew	Person 80 kg	80.000	6.690	0.215	0.640	0.000 N/A
Kneeling Crew	Person 80 kg	80.000	7.690	0.189	0.640	0.000 N/A
Kneeling Crew	Person 80 kg	80.000	7.690	-0.189	0.640	0.000 N/A
Kneeling Crew	Person 80 kg	80.000	6.690	-0.215	0.640	0.000 N/A
Kneeling Crew	Person 80 kg	80.000	5.690	-0.226	0.640	0.000 N/A
Kneeling Crew	Person 80 kg	80.000	4.690	-0.241	0.640	0.000 N/A
Kneeling Crew	Person 80 kg	80.000	3.690	-0.256	0.640	0.000 N/A
Standing Crew	Person 80 kg	80.000	0.699	0.000	1.200	0.000 N/A
SubTotal		2449.444	4.556	0.000	0.396	
Totals		2449.444	4.556	0.000	0.396	

Figure 4.45 Weight report State A: restricted draft at 80 kg per person

THE POOLE IRON AGE LOGBOAT

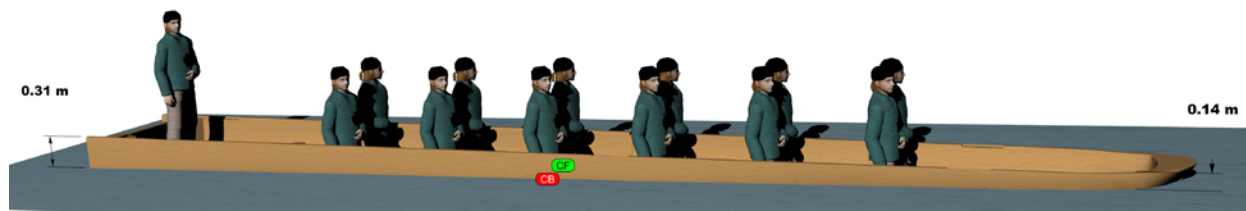

Figure 4.46 Reconstructed logboat with restricted draft at 80 kg per person

This resulted in: a draft of 0.300 m,
 Freeboard Aft of 0.309 m,
 Freeboard For'd of 0.139 m,
 GM_t of 0.157 m.

The logboat can heel to 20° with a righting moment of 130 kgf-m and reserve freeboard of 0.023m @ 20° of heel.

At 22.5° heel the top edge forward would be 8 mm underwater.

In this restricted draft state the logboat could carry 13 men weighing 80 kg.

Test criteria: Draft less than 0.30 m, minimum freeboard greater than 0.13 m, and the vessel has a positive metacentric height (GM_t).

The original 1974 analysis used 18 men and 58 kg of equipment located in the aft area. This would fail the test criteria as the draft exceeded 0.30 m with 18 men and 58 kg of equipment.

In order to reduce the draft to 0.30 m with a heavier 80 kg the crew, the number had to be reduced from 18 to 13 men.

In this configuration the hypothetical reconstruction is deemed to pass, but does not include any additional equipment.

State B standard freeboard

With a minimum crew and the maximum cargo which could be carried in 80% of the hollowed-out volume of the boat at a draft equivalent to a standard freeboard of 0.15 m.

4 men standing and 1448 kg of turf cargo extending to 0.11 m above the sheer was the quantity from the original 1974 analysis.

Poole Iron Age Logboat						
Orca3D Weight and Cost Report						
3D Scanning Ireland						
Report Time: 03 November 2013, 12:18:44						
Model Name: D:\Dropbox\3D Scanning\Scans\Poole Logboat\Poole_2.3dm						
Weight Items						
Object Name	Material	Weight (kgf)	LCG (m)	TCG (m)	VCG (m)	Weight Basis
☐ All Items						
Transom	Oak Heartwood Green	13.214	0.331	0.000	0.461	0.012 m³
Reconstructed Hull	Oak Heartwood Green	1396.229	4.381	0.000	0.181	1.301 m³
Standing Crew	Person 80 kg	80.000	8.787	0.000	1.177	0.000 N/A
Standing Crew	Person 80 kg	80.000	0.699	0.000	1.200	0.000 N/A
Cargo Turf	Turf @ 435 kg/m³	1561.186	4.044	0.000	0.391	3.589 m³
SubTotal		3130.630	4.215	0.000	0.338	
Totals		3130.630	4.215	0.000	0.338	

Figure 4.47 Weight report State B: standard freeboard 150 mm

As shown in the later section dealing with propulsion, two crew men could comfortably propel the logboat at speeds approaching 4 knots while either paddling or poling in shallower waters. As a result, the minimum number of crew required was reduced to two in favour of more cargo-carrying capacity.

In order to create this trim state of 0.15m freeboard, a cargo of turf was loaded into the logboat and its height above the sheer adjusted until the 150 mm freeboard was achieved (Figure 4.47). This resulted in a cargo volume of 4.6 m³ of turf with a stowage rate of 435 kg/m³, having a weight of 1561 kg, and a crew of two men (Figure 4.48).

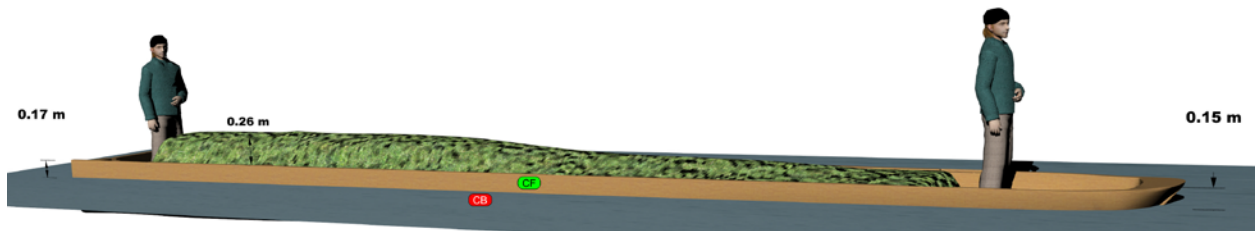

Figure 4.48 Reconstructed logboat with standard draft (150 mm)

This resulted in: a draft of 0.400 m,
Freeboard Aft of 0.169 m,
Freeboard For'd of 0.152 m,
GM_t of 0.181 m.

The logboat can heel to 15° with a righting moment of 150 kgf-m and reserve freeboard of 0.004m @ 15° of heel.

At 17.5° heel the top edge aft would be 43 mm underwater.

In this standard freeboard state the logboat could carry 2 men and 1561 kg of turf cargo extending to 0.25 m above the sheer in the aft area and tapering to sheer level towards the bow.

Test criteria: Standard freeboard of 0.15 m, and the vessel has a positive metacentric height (GM_t).

The original 1974 analysis used 4 men standing and a cargo of 1448 kg.

In this configuration the hypothetical reconstruction is deemed to pass, with a crew of two men and carrying a cargo of 1561 kg.

State C minimum freeboard

With a minimum crew as in B above and the maximum cargo which could be carried at a draft equivalent to the calculated minimum freeboard (0.13 m).

4 men standing and 1723 kg turf extending to 0.11 m above the sheer was the quantity from the original 1974 analysis.

A series of differing cargoes was tested in order to trim the logboat to a minimum freeboard condition of 0.13 m. In order to create this trim state a cargo of wheat-grain was loaded into the central area of the boat to a height of 0.15 m above the sheer resulting in a volume of 2.10 m³, and a cargo of turf loaded into the forward area with a volume of 1.05 m³ (Figure 4.49), resulting in a combined cargo volume of 4.15 m³ with a combined weight of 1879 kg, and a crew of two men (Figure 4.50).

Poole Iron Age Logboat

Orca3D Weight and Cost Report
 3D Scanning Ireland
 Report Time: 03 November 2013, 13:08:55
 Model Name: D:\Dropbox\3D Scanning\Scans\Poole Logboat\Poole_2.3dm



Weight Items						
Object Name	Material	Weight (kgf)	LCG (m)	TCG (m)	VCG (m)	Weight Basis
☐ All Items						
Transom	Oak Heartwood Green	13.214	0.331	0.000	0.461	0.012 m³
Reconstructed Hull	Oak Heartwood Green	1396.229	4.381	0.000	0.181	1.301 m³
Aft Cargo Wheat Grain	Wheat - Grain	1423.688	3.219	0.000	0.382	2.094 m³
For'd Cargo turf	Turf @ 435 kg/m³	455.199	6.770	0.000	0.334	1.046 m³
Standing Crew	Person 80 kg	80.000	0.699	0.000	1.200	0.000 N/A
Standing Crew	Person 80 kg	80.000	9.001	0.000	1.177	0.000 N/A
SubTotal		3448.331	4.223	0.000	0.332	
Totals		3448.331	4.223	0.000	0.332	

Figure 4.49 Weight report State C: minimum freeboard

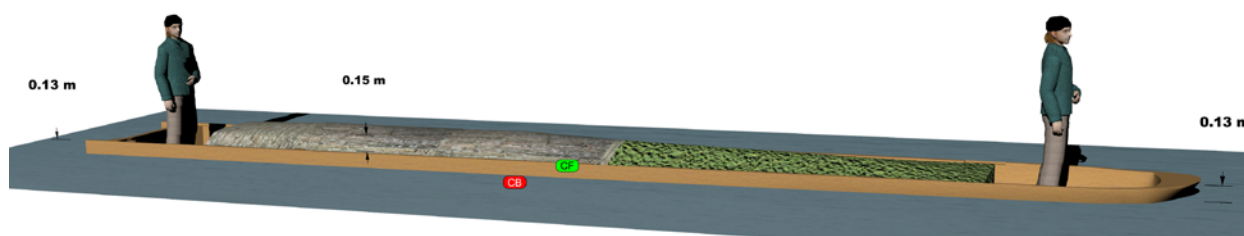

Figure 4.50 Reconstructed logboat with minimum draft (130 mm)

This resulted in: a draft of 0.453 m,
 Freeboard Aft of 0.130 m,
 Freeboard For'd of 0.130 m,
 GM_t of 0.179 m.

The logboat can heel to 10° with a righting moment of 109 kgf-m and reserve freeboard of 0.021m @ 10° of heel. At 12.5° heel the top edge aft would be 9 mm underwater.

In this minimum freeboard state the logboat could carry 2 men and 1879 kg of mixed cargo.

Test criteria: Minimum freeboard of 0.13 m, and the vessel has a positive metacentric height (GM_t).

The original 1974 analysis used 4 men standing and a cargo of 1723 kg.

In this configuration the hypothetical reconstruction is deemed to pass, with a crew of two men and carrying a cargo of 1879 kg.

State D (60 kg person) maximum men

The theoretical maximum number of paddlers which can be physically fitted into the boat. Using a human model of 1.65 m height, weighing 60 kg, has a centre of gravity 1.10 m above the feet when standing, 0.45 m above the knees when kneeling and 0.40 m above the seat when sitting. Two men standing and the remainder kneeling. McGrail describes this individual as a short, lean, wiry person (1978, 131).

2 men standing and 16 kneeling was the quantity from the original 1974 analysis (Figures 4.51 & 4.52).

Poole Iron Age Logboat

Orca3D Weight and Cost Report

3D Scanning Ireland

Report Time: 02 November 2013, 17:49:09

Model Name: D:\Dropbox\3D Scanning\Scans\Poole Logboat\Poole_2_3dm



Weight Items						
Object Name	Material	Weight (kgf)	LCG (m)	TCG (m)	VCG (m)	Weight Basis
☐ All Items						
Standing Crew	Person 60 kg	60.000	0.699	0.114	1.200	0.000 N/A
Standing Crew	Person 60 kg	60.000	1.156	-0.114	1.200	0.000 N/A
Kneeling Crew	Person 60 kg	60.000	8.524	0.000	0.540	0.000 N/A
Kneeling Crew	Person 60 kg	60.000	2.690	0.271	0.540	0.000 N/A
Kneeling Crew	Person 60 kg	60.000	2.690	-0.271	0.540	0.000 N/A
Kneeling Crew	Person 60 kg	60.000	3.690	0.256	0.540	0.000 N/A
Kneeling Crew	Person 60 kg	60.000	4.690	0.241	0.540	0.000 N/A
Kneeling Crew	Person 60 kg	60.000	5.690	0.226	0.540	0.000 N/A
Kneeling Crew	Person 60 kg	60.000	6.690	0.215	0.540	0.000 N/A
Kneeling Crew	Person 60 kg	60.000	7.690	0.189	0.540	0.000 N/A
Kneeling Crew	Person 60 kg	60.000	1.690	-0.271	0.540	0.000 N/A
Kneeling Crew	Person 60 kg	60.000	1.690	0.271	0.540	0.000 N/A
Kneeling Crew	Person 60 kg	60.000	9.319	0.000	0.540	0.000 N/A
Kneeling Crew	Person 60 kg	60.000	7.690	-0.189	0.540	0.000 N/A
Kneeling Crew	Person 60 kg	60.000	6.690	-0.215	0.540	0.000 N/A
Kneeling Crew	Person 60 kg	60.000	5.690	-0.226	0.540	0.000 N/A
Kneeling Crew	Person 60 kg	60.000	4.690	-0.241	0.540	0.000 N/A
Kneeling Crew	Person 60 kg	60.000	3.690	-0.256	0.540	0.000 N/A
Transom	Oak Heartwood Green	13.214	0.331	0.000	0.461	0.012 m³
Reconstructed Hull	Oak Heartwood Green	1396.229	4.381	0.000	0.181	1.301 m³
SubTotal		2489.444	4.516	0.000	0.370	
Totals		2489.444	4.516	0.000	0.370	

Figure 4.51 Weight report State D: maximum crew at 60 kg per person

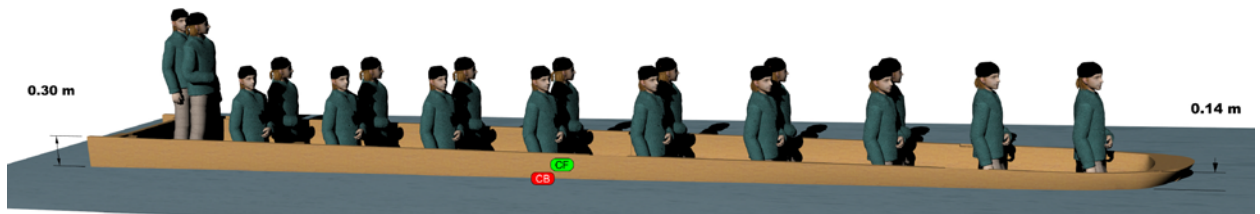

Figure 4.52 Reconstructed logboat with maximum crew at 60 kg per person

This resulted in: a draft of 0.307 m,
Freeboard Aft of 0.299 m,
Freeboard For'd of 0.142 m,
 GM_t of 0.180 m.

The logboat can heel to 20° with a righting moment of 153 kgf-m and reserve freeboard of 0.027m @ 20° of heel.

At 22.5° heel the top edge forward would be 4 mm underwater.

Test criteria: minimum freeboard greater than 0.13 m, and the vessel has a positive metacentric height (GM_t). In this configuration the hypothetical reconstruction is deemed to pass and is capable of transporting a crew of 18 men weighing an average of 60 kg each.

State D (80 kg person) maximum men

The theoretical maximum number of paddlers which can be physically fitted into the boat. Using a human model of 1.70 m height, weighing 80 kg, has a centre of gravity 1.20 m above the feet when standing, 0.55 m above the knees when kneeling and 0.50 m above the seat when sitting. Two men standing and the remainder kneeling. This is using a human model larger than McGrail’s short, lean wiry person.

2 men standing and 16 kneeling was the quantity from the original 1974 analysis (Figures 4.53 & 4.54).

Poole Iron Age Logboat
 Orca3D Weight and Cost Report
 3D Scanning Ireland
 Report Time: 03 November 2013, 13:36:10
 Model Name: D:\Dropbox\3D Scanning\Scans\Poole Logboat\Poole_2.3dm



Weight Items						
Object Name	Material	Weight (kgf)	LCG (m)	TCG (m)	VCG (m)	Weight Basis
☐ All Items						
Transom	Oak Heartwood Green	13.214	0.331	0.000	0.461	0.012 m³
Reconstructed Hull	Oak Heartwood Green	1396.229	4.381	0.000	0.181	1.301 m³
Standing Crew	Person 80 kg	80.000	0.699	0.114	1.300	0.000 N/A
Standing Crew	Person 80 kg	80.000	1.039	-0.114	1.284	0.000 N/A
Kneeling Crew	Person 80 kg	80.000	2.690	0.271	0.640	0.000 N/A
Kneeling Crew	Person 80 kg	80.000	2.690	-0.271	0.640	0.000 N/A
Kneeling Crew	Person 80 kg	80.000	1.690	-0.271	0.640	0.000 N/A
Kneeling Crew	Person 80 kg	80.000	1.690	0.271	0.640	0.000 N/A
Kneeling Crew	Person 80 kg	80.000	8.524	0.000	0.640	0.000 N/A
Kneeling Crew	Person 80 kg	80.000	9.319	0.000	0.640	0.000 N/A
Kneeling Crew	Person 80 kg	80.000	3.690	0.256	0.640	0.000 N/A
Kneeling Crew	Person 80 kg	80.000	4.690	0.241	0.640	0.000 N/A
Kneeling Crew	Person 80 kg	80.000	5.690	0.226	0.640	0.000 N/A
Kneeling Crew	Person 80 kg	80.000	6.690	0.215	0.640	0.000 N/A
Kneeling Crew	Person 80 kg	80.000	7.690	0.189	0.640	0.000 N/A
Kneeling Crew	Person 80 kg	80.000	7.690	-0.189	0.640	0.000 N/A
Kneeling Crew	Person 80 kg	80.000	6.690	-0.215	0.640	0.000 N/A
Kneeling Crew	Person 80 kg	80.000	5.690	-0.226	0.640	0.000 N/A
Kneeling Crew	Person 80 kg	80.000	4.690	-0.241	0.640	0.000 N/A
Kneeling Crew	Person 80 kg	80.000	3.690	-0.256	0.640	0.000 N/A
SubTotal		2849.444	4.542	0.000	0.451	
Totals		2849.444	4.542	0.000	0.451	

Figure 4.53 Weight report State D: maximum crew at 80 kg per person

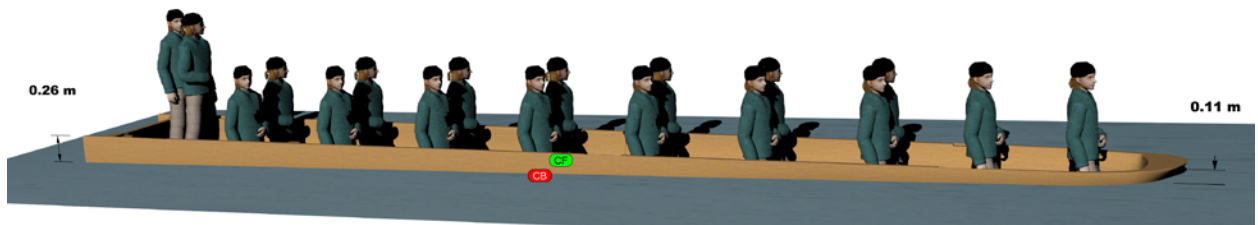

Figure 4.54 Reconstructed logboat with maximum crew at 80 kg per person

This resulted in: a draft of 0.342 m,
 Freeboard Aft of 0.263 m,
 Freeboard For'd of 0.108 m,
 GM_t of 0.081 m.

The logboat can heel to 15° with a righting moment of 61 kgf-m and reserve freeboard of 0.020m @ 15° of heel. At 17.5° heel the top edge forward would be 7 mm underwater.

Test criteria: minimum freeboard greater than 0.13 m, and the vessel has a positive metacentric height (GM_t). In this configuration the hypothetical reconstruction is deemed to fail as the freeboard forward is less than the minimum and is not capable of transporting a crew of 18 men weighing an average of 80 kg each.

Speed potential

Firstly, a target speed will need to be set for the vessel. In the area of operation in and around Poole Harbour, the vessel could encounter average tidal rates of 1.7 to 4 knots, with peak tidal currents in excess of 5 knots (Compass Hydrographic Services Ltd. 2006), with localised extremes in excess of 6 knots. Over the total area, tidal current averages in the region of 1–2 knots could be expected.

For a displacement hull like the Poole logboat which is sitting in the water, as it moves forward it generates a bow and a stern wave, the boat sitting in the trough between the two waves. As the boat accelerates to higher speeds a greater amount of power is required to overcome this wave resistance, until a stage is reached where the power required to accelerate further becomes exponential. This point is referred to as the displacement trap. The displacement trap results in a theoretical maximum hull speed, which is calculated as 1.34 times the square root of the waterline length (LWL) in feet (Marchaj 1964, 297).

From the previous calculations of the various loading states, the Poole logboat has waterline lengths of: State A 9.956 m; State B 9.942 m; State C 9.946 m; and State D 9.966 m, giving an average of 9.953 m (32.65 feet) waterline length.

Boats which do achieve speeds where velocity $(V)/(\sqrt{LWL}) > 1.40$ may appear to be planing. At speeds $(V)/(\sqrt{LWL}) > 1.70$ dynamic lift begins and boats will be said to be semi-planing, and at speeds $(V)/(\sqrt{LWL}) > 4.20$ boats are truly planing or skimming (Marchaj 1964, fig 158). Displacement boats like the Poole logboat can only exceed $(V)/(\sqrt{LWL}) = 1.40$ in ideal conditions or with excessive use of mechanical power.

From $1.34 \sqrt{LWL}$ the Poole logboat has a theoretical max hull speed of:

$$1.34 \times \sqrt{32.65} = 7.7 \text{ knots.}$$

A Holtrop powering analysis (Holtrop 1984) was carried out using the Orca 3D marine plug-in for Rhinoceros 3D on each of the flotation conditions (Table 4.6).

Table 4.6 Overall characteristics and Holtrop analysis results for the various flotation conditions

	State A	State B	State C	State D
Length overall LOA	10.08 m	10.08 m	10.08 m	10.08 m
Beam Overall BOA	1.22 m	1.22 m	1.22 m	1.22 m
Waterline length Lwl	9.942 m	9.946 m	9.966 m	9.956 m
Waterline Beam Bwl	1.201 m	1.22 m	1.22 m	1.20 m
Draft T	0.296 m	0.416 m	0.453 m	0.307 m
Freeboard F	0.308 m	0.15 m	0.13 m	0.299 m
Displacement	2369.4 kg	3130.6 kg	3448.3 kg	2489.4 kg
Waterplane Area	9.876 m ²	9.997 m ²	10.076 m ³	9.94 m ²
Wetted Surface Area	13.303 m ²	15.007 m ²	15.703 m ³	13.56 m ²
Displacement Volume	2.31 m ³	3.05 m ³	3.40 m ³	2.43 m ³
Prismatic Coefficient Cp	0.820	0.712	0.710	0.862
Block Coefficient Cb	0.652	0.604	0.609	0.661
Volumetric Coefficient	2.35 x10-3	3.11 x10-3	3.40 x10-3	2.46 x10-3
Slenderness Coefficient Lwl/Bwl	8.276	8.154	8.156	8.275
Midship Coefficient Cx	0.796	0.848	0.858	0.8
Downflooding angle	24°	15.5°	12°	22°
Righting moment at down flooding angle	196 kgf/m	151 kgf/m	134 kgf/m	164 kgf/m
Displacement/Length ratio DLR	67.190	88.688	97.104	70.308
Moment to Trim	75.3 kgf-m/cm	75.5 kgf-m/cm	76.5 kgf-m/cm	75.9 kgf-m/cm
Weight to Immerse	101.3 kgf/cm	102.6 kgf-m/cm	103.4 kgf/cm	101.9 kgf/cm
Power required to achieve 0.5 knots	1.2 W (0.002 hp)	1.3 W (0.002 hp)	1.3 W (0.002 hp)	1.2 W (0.002 hp)
Power required to achieve 1 knots	8.9 W (0.012 hp)	9.7 W (0.013 hp)	9.9 W (0.013 hp)	9.1 W (0.012 hp)
Power required to achieve 1.5 knots	28.6 W (0.038 hp)	31.0 W (0.042 hp)	31.9 W (0.043 hp)	29.1 W (0.039 hp)
Power required to achieve 2 knots	65.1 W (0.087 hp)	70.8 W (0.095 hp)	72.8 W (0.098 hp)	66.3 W (0.088 hp)
Power required to achieve 2.5 knots	123.2 W (0.165 hp)	134.1 W (0.180 hp)	137.9 W (0.185 hp)	125.6 W (0.168 hp)
Power required to achieve 3 knots	208.0 W (0.279 hp)	227.2 W (0.305 hp)	234.2 W (0.314 hp)	212.3 W (0.285 hp)
Power required to achieve 3.5 knots	325.1 W (0.436 hp)	359.0 W (0.481 hp)	371.6 W (0.498 hp)	332.8 W (0.446 hp)
Power required to achieve 4 knots	481.0 W (0.645 hp)	541.1 W (0.726 hp)	564.1 W (0.756 hp)	494.1 W (0.662 hp)
Power required to achieve 4.5 knots	681.8 W (0.914 hp)	788.1 W (1.056 hp)	829.8 W (1.113 hp)	703.3 W (0.943 hp)
Power required to achieve 5 knots	932.2 W (1.250 hp)	1.11 kW (1.490 hp)	1.18 kW (1.586 hp)	966.7 W (1.296 hp)
Power required to achieve 7.5 knots *	2.94 kW (3.940 hp)	4.24 kW (5.682 hp)	4.77 kW (6.393 hp)	3.09 kW (4.142 hp)

* Displacement hull speed

State A Restricted draft to 300mm: 1 man standing and 12 kneeling and 0 kg equipment

State B Standard Freeboard set at 150mm: 2 men standing and 1561 kg turf extending to 0.25 m above the sheer

State C Minimum Freeboard set at 130mm: 2 men standing and 1879 kg cargo extending to 0.15 m above the sheer

State D Maximum Crew

Propulsion

Figures indicate the maximum output of a man rowing, on a fixed seat, is about 1 hp (750 watts) sustainable for a short time; an average male can deliver approx 0.3 hp (250 watts) for 20 minutes and 60–70 watts output is considered comfortable (Nayling and McGrail 2004, 189). As the logboat does not have fixed rowing positions, paddling or poling would be the standard form of propulsion.

Power output figures for an athlete paddling an Olympic-style canoe indicate averages of 163 watts for females and 291 watts for males (Garrett and Kirkendall 2000, 38). These figures are based on a series of five 30-second sprints undertaken by professional athletes. An ordinary healthy individual can produce less than 70–80 % as much power as a professional athlete (Wilkie 1960). Wilkie also notes that the power output of the human body is limited in the following manner:

1. Single movements (less than 1 sec) to less than 6 hp (4476 watts);
2. Brief bouts of exercise (1 to 5 min) between 2.0 and 0.5 hp (1491–375 watts);
3. Steady work (5 to 150 min) between 0.5 and 0.4 hp (375 watts);
4. Long-term work (lasting all day) to perhaps 0.2 hp (150 watts).

An average man paddling could potentially generate a power output of 375 watts for brief bouts, reducing to 50 watts for long-term work. A combined total of 12 paddlers could potentially generate $50W \times 12 = 0.54$ kW of power, but probably closer to 0.5 kW allowing for inefficiencies such as lack of synchronisation. With 0.5 kW of power available, the Poole logboat could potentially achieve speeds in the region of 3.5 to 4 knots (Table 4.6) while paddling with 12 crew.

With an average man generating between 2.0 and 0.3 hp while poling the logboat in shallower waters, two men poling as in States C or D could propel the vessel while carrying a cargo of 1879 kg in shallow waters at speeds approaching 4 knots. These figures would suggest the Poole logboat could be easily propelled by paddle in open water, or poling in shallow waters, or towed by one to two men, or a single horse, in narrow river channels or close to a river bank.

Concluding remarks

The results of the 1974 analysis indicated a logboat which was capable of safely carrying a maximum crew of 18, with two standing and the remaining 16 kneeling, and as a cargo vessel with a crew of four men standing, a maximum of 1723 kg of cargo could be carried safely. The logboat was classified as a ‘first rate all-round logboat propelled by pole or paddle at very good speeds, with a deadweight capability (load carrying) of 1688 kg at standard freeboard’ (McGrail 1978, 257).

It should be noted that the majority of hydrostatic coefficients such as:

- Displacement
- Volumetric coefficient = $\text{Displacement} / (\text{LWL})^3$
- Prismatic coefficient = $\text{Displacement} / (\text{LWL} \times A_x)$
- Block coefficient = $\text{Displacement} / (\text{LWL} \times \text{BWL} \times T)$

are dependent on knowing the underwater volume of the vessel. This is traditionally calculated using Simpson’s Rule:

$$V = h/3(A_0 + 4A_1 + 2A_2 + 4A_3 + 2A_4 + 4A_5 + 2A_6 + 4A_7 + 2A_8 + 4A_9 + A_{10})$$

where:

- V is underwater volume
- h is the section interval
- A is the section area at each of the 10 stations.
- Displacement = Underwater Volume \times specific weight of (sea)water (1025 kg).

The area of each section is typically calculated from the cross-sectional curves taken from the line drawing of the vessel, and again using Simpson's Rule to calculate the cross-sectional area at each station. Additional hydrostatic data such as Longitudinal Centre of Buoyancy (LCB) and Longitudinal Centre of Gravity (LCG) are also required in order to determine the fore and aft trim of the vessel. These are calculated again using Simpson's Rule:

$$LCB = \text{Sum}(\text{Area} \times \text{Lever Arm} \times \text{SM}) / \text{Sum}(\text{Area} \times \text{SM})$$

$$LCF = \text{Sum}(\text{beam} \times \text{SM} \times \text{Lever Arm}) / \text{Sum}(\text{beam} \times \text{SM})$$

$$LCG = \text{Sum}(\text{Lever Arms}) / \text{Sum}(\text{weights}),$$

where the Lever Arm is the distance aft from a fixed reference point.

All of these calculations create a 'snapshot' of the vessel in a single particular flotation condition, and it would be required to repeat all of the individual calculations as the flotation condition is altered by the addition or repositioning of crew, cargo or ballast. As can be seen, this involves an onerous amount of calculations, whether done using pen, paper and a calculator, or even with the aid of a spreadsheet. The use of specialised CAD and naval architecture software, using an accurate graphical representation of the vessel, will rapidly and simply complete all of these required calculations to provide real-time hydrostatic data, which is updated for each flotation condition.

With the Transverse Metacentric height (GM_t) from the 2013 digital results of the 1974 reconstruction ranging between 16 and 39%, and averaging 25.75% lower than the initial results, this would indicate a vessel substantially less stable than originally believed.

The initial results indicated a load-carrying capacity of 1688 kg at a standard freeboard of 0.15m; however, the digital version of this condition gives a load-carrying capacity of 1303 kg, 23% less than originally believed.

Additionally, it would appear from the digital results that the initial testing in 1974 did not take into account the effects of trim on the underwater hull shape when analysing the logboat for the various flotation conditions resulting from the cargo weight causing a bow down trim. This reduces the amount of freeboard forward from 0.15 m to 0.10 m in the standard freeboard (State C) and from 0.13 m to 0.02 m in the maximum cargo (State D) flotation conditions.

The second phase of this report re-examined the recorded logboat shape in order to create a hypothetical reconstruction, and proceeded to analyse this hypothetical reconstruction using the same methods and test criteria as used for the earlier 1974 reconstruction. The result of this methodology is the very accurate 3D recording of the recovered material, in the form of the initial 3D laser scanning of the physical logboat, to create a digital 3D CAD model, combined with an iterative process of modelling and testing, in an attempt to produce a more definitive reconstruction.

The hypothetical reconstruction resulted in a logboat with a flatter capital D cross-sectional profile shape, as opposed to the semi-circular profile proposed by McGrail; a sheerline height increased by 0.10 m; and a stern width of 1.22 m which is close to that recorded by Peers in 1964 (1.24 m) and the Poole Museum measurement of 1.22 m from 1974. This resulted in a logboat with a load-carrying capacity of between 1721 kg and 2079 kg, depending on the moisture content of the timber used, at a standard freeboard of 0.15 m and a downflooding angle of 15.5°.

The resulting reconstruction points towards a vessel with a good load-carrying capacity in the region of 1900 kg, while being easily propelled by two crew at a speed of 4 to 5 knots. It should be noted that the power and speed figures in Table 4.6 are theoretical, based on a perfectly clean and smooth underwater hull surface, as well as ideal weather conditions and sea state.

It should also be noted that the calculations used were based on the logboat being constructed using freshly felled ('green') oak with a weight of 1073 kg. If the timber was dried to 27% moisture content the overall weight of the logboat would be reduced by 400 kg, thereby increasing the cargo capacity to 2300 kg.

Acknowledgements

Thanks to Jessica Berry and MAST for organising this project and securing the necessary funding. Thanks are due also to Poole Waterfront Museum for facilitating access to the logboat and providing details and information from their archive. Thanks also to Damian Goodburn for discussions during the reconstruction process. Likewise thanks to Nigel Nayling, School of Archaeology, History and Anthropology, University of Wales: Trinity Saint David, and Dr Lucy Blue, Senior Lecturer, Centre for Maritime Archaeology, Faculty of Humanities, University of Southampton, for advice and comments.

Glossary and abbreviations

Overall dimensions

LOA: Length Overall – The length of the vessel, from forward end of stem to aft end of sternpost

Length Extreme – The length of the vessel, including fixtures and fittings such as bowsprit and rudder

BOA: Beam Overall – The maximum beam of the vessel

D: Depth Overall – The maximum depth of the vessel, from the deepest point in the water to the highest point above the water

Loa/Boa – The ratio of the Length Overall to the Beam Overall

Boa/D – The ratio of the Beam Overall to the Depth Overall

Waterline dimensions

Lwl: Waterline length – The waterline length of the vessel

Bwl: Waterline Beam – The waterline beam of the vessel

T: Navigational Draft – The distance, perpendicular to the flotation plane, from the flotation plane down to the deepest point on the vessel

Lwl/Bwl – The ratio of the Waterline Length to the Waterline Beam

Bwl/T – The ratio of the Waterline Beam to the Navigational Draft

D/T – The ratio of the Depth Overall to the Navigational Draft

Volumetric values

Displacement – the overall weight of the vessel, as defined in the input or calculated from the defined flotation condition

Volume – The integrated underwater volume of the vessel

LCB – the longitudinal centre of buoyancy of the resultant vessel orientation

TCB – the transverse centre of buoyancy of the resultant vessel orientation

VCB – the vertical centre of buoyancy of the resultant vessel orientation

Wetted surface Area – the area of the underwater surfaces

Moment to Trim – the longitudinal moment required to trim the vessel between the fore and aft ends of the waterline

Displ-Length Ratio – The displacement length ratio, which is always expressed in imperial units of long tons/ft³. It is defined as (Displacement in long tons / (Length in feet/100)³).

FB/Lwl – The ratio of LCB to LWL, measured from the forward end of LWL; a value less than 0.5 means that the LCB is forward of the midpoint of LWL

TCB/Bwl – The ratio of the transverse centre of buoyancy to the waterline beam

Waterplane values

AWP – the area of the waterplane of the resultant vessel orientation

LCF – the longitudinal centre of flotation of the resultant vessel orientation

TCF – the transverse centre of flotation of the resultant vessel orientation

Weight to Immerse – the weight required to sink the vessel one unit in the direction perpendicular to the equilibrium flotation plane

FF/Lwl – The ratio of LCF to LWL, measured from the forward end of LWL; a value less than 0.5 means that the LCF is forward of the midpoint of LWL

TCF/Bwl – The ratio of the transverse centre of flotation to the waterline beam

Sectional parameters

Ax – the maximum underwater sectional area calculated using sections. The maximum value is interpolated from the sections, by fitting a parabola to the station of maximum sectional area and the two stations on either side of it

Ax Location – The longitudinal location of the station of maximum area (see note on interpolation above)

Ax Location / Lwl – The ratio of Ax Location to LWL, measured from the forward end of LWL; a value less than 0.5 means that the Ax is forward of the midpoint of LWL

Hull form coefficients

Cb – the block coefficient of the resultant vessel orientation due to the defined flotation condition, defined as (displaced volume / (LWL x BWL x T)), where T is the maximum navigational

Cp – the prismatic coefficient of the resultant vessel orientation, defined as (displaced volume / (LWL x Ax)), where Ax is the maximum sectional area

Cvp – the vertical prismatic coefficient of the resultant vessel orientation, defined as (displaced volume / (AWP x T)), where T is the maximum navigational draft

Cx – the maximum section coefficient of the resultant model orientation, defined as (Ax / (BWL x T)), where T is the maximum navigational draft

Cwp – the waterplane coefficient of the resultant vessel orientation, defined as (AWP / (LWL x BWL))

Cws – the wetted surface coefficient of the resultant vessel orientation, defined as (wetted surface / SQRT(displaced volume * LWL))

Static stability parameters

Zero righting arm will correspond to the heel angle at the equilibrium flotation plane

The calculation of the righting arm allows the model to trim as it heels to maintain a true hydrostatic balance (this is true even if a Model Trim was entered to define the equilibrium flotation plane; the Model Trim is used to determine the centre of gravity, which is then used as the model is heeled)

I (transverse) – The transverse moment of inertia of the waterplane

I (longitudinal) – The longitudinal moment of inertia of the waterplane

BMt – the transverse metacentric radius (distance from the vertical centre of buoyancy to the transverse metacentre) of the resultant flotation condition

BmL – the longitudinal metacentric radius (distance from the vertical centre of buoyancy to the longitudinal metacentre) of the resultant flotation condition

Gmt – the transverse metacentric height (distance from the vertical centre of gravity to the transverse metacentre) of the resultant flotation condition

GmL – the longitudinal metacentric height (distance from the vertical centre of gravity to the longitudinal metacentre) of the resultant flotation condition

Mt – the height of the transverse metacentre in the resultant flotation condition, measured from the equilibrium flotation plane

Ml – the height of the longitudinal metacentre in the resultant flotation condition, measured from the equilibrium flotation plane

Chapter 5

The conservation of the Poole logboat

Jeremy Hutchings and James A Spriggs

Introduction

Since its discovery on 20 August 1964, the Poole logboat has experienced various levels of care and treatment that have undoubtedly influenced its current state of preservation. What sometimes appears to be a tortuously slow journey towards its final, stable condition has been due to factors that are outside those associated with its planned conservation. Lack of finances, staffing issues, and the accidental curtailment of the first attempted treatment all conspired to confound the course of progress. This chapter describes the conservation and storage history of the boat since its excavation and the different phases of work, culminating in its final successful treatment. Unfortunately there are few records of its early storage and initial, incomplete, treatment and what is known has had to be pieced together from analysis and scattered records. Its later conservation employing sugar (sucrose) was the first time that this treatment had been undertaken on a large scale in the UK and has been published as a series of papers in the International Proceedings of the ICOM/CC group on Wet Organic Archaeological Materials (Hutchings 1996; Hutchings and Spriggs 2004; 2009). The key events are summarised in Figure 5.1.

Boat discovered	20 August 1964
Excavation and recovery (stored in fresh water)	8 September 1964
Start of previous partial treatment (PEG)	1976 (no exact date available)
Previous partial treatment halted (stored in fresh water)	1988 (no exact date available)
Boat moved to new treatment site	April 1995
Sucrose treatment started (64%)	October 1995
Treatment solution changed (67%)	September 1997
Treatment solution changed (67%)	December 2003
Cleaning prior to drying	September 2004
Controlled Humidity Drying	July 2005
Final preparation for display	February 2007

Figure 5.1 Key dates in the treatment of the Poole logboat

Treatment prior to sucrose immersion

After the boat's recovery in 1964 it was stored in fresh water until the start of its first treatment in 1976 (see Figure 5.2). The treatment was carried out by Poole Museum under the supervision of conservators at the National Maritime Museum (NMM) and consisted of immersion in increasing concentrations of polyethylene glycol (PEG) 1540 polymer. Although little documentation exists from this period, we know that a circulatory pump and heater were installed, which indicates that a reasonably high concentration of PEG was achieved. During this treatment numerous core samples were taken by the NMM and the ingress of PEG 1540 into the wood was reported to be 'painfully slow'. After nine years its concentration in the wood reached an average of 25% at a depth of 60–80 mm and 52% at the surface; it is not known if this was based on the wet or dry weight of the wood. During the period from excavation to the commencement of treatment with PEG the logboat underwent at least one period of premature drying, which will have caused some of the splitting and other damage observed today. The treatment was halted in 1988 before completion, due to the accidental discharge of the PEG solution. This was replaced with fresh water as funds were not available for new PEG. The boat remained in water from 1988 to the beginning of the sucrose treatment in 1995, washing out much of the soluble PEG wax. In 1993, with a view to restarting treatment, a further set of core samples was taken by

the Mary Rose Trust to determine the composition of the wood and concentration of the remaining PEG. As the analysis was part of a commercial bid, the results were not released to the museum. The estimate of £120,000 was prohibitive so an alternative had to be found.

Selection of sucrose method

In 1994, the logboat's conservation was made a priority, and Jeremy Hutchings, then of the Area Museum Council for the South West, was contacted and asked to advise. Due to lack of funding, any proposed treatment had to be extremely cheap and capable of being maintained by Poole Museum staff with minimal external assistance. As the museum did not employ a conservator, technical levels of supervision needed to be within the capacity of the professional archaeologists and curators employed at the time. While there is an ethical imperative that conservation is carried out to the highest possible standard and undue risk is avoided, the situation did not exclude finding an alternative treatment. Sucrose impregnation was suggested by Jeremy Hutchings as a viable alternative for a boat of this size. Its use had already been widely published (Grosso 1981; Parrent 1985; Morgos *et al.* 1987; Morgos and Glattfelder-McQuirk 1990; Hoffmann 1990) and its practical application on a large scale had been investigated by Jeremy Hutchings (Hutchings 1992). Although it was untried on this scale in the UK, when risk and economies of scale were considered it was one of the few feasible methods for larger quantities of structural and ships' timbers that would be stored and displayed within a controlled environment. In general, sucrose treatment was reported as being a relatively inexpensive and simple method that gave good results. At its most successful, sucrose treatment was reported to achieve better shrinkage results than using PEG, but to be slightly less reliable (Hoffmann 1993).

The sucrose treatment option was accepted as the only means of achieving an adequate level of conservation within the resources of the museum, especially as it required little technical daily management and relatively simple and inexpensive treatment facilities. The major risk was microbiological proliferation within the treatment solution. This posed a problem in terms of the creation of a solution that is unpleasant to handle and potentially harmful to health. Additionally, active yeast colonies act on sucrose, breaking it down into glucose and fructose which do not crystallise, resulting in poorly conserved wood with a sticky surface. An earlier investigation (Hutchings 1992) indicated that impregnation at ambient room temperature using a single high concentration solution of sucrose successfully stabilises oak whilst reducing microbiological activity. Treatments carried out with a solution concentration below 50% weight of sucrose to weight of water (wt/wt) produced wood that had a tendency to crack longitudinally and cross-check perpendicular to the grain when subsequently dried, and microbiological activity was likely to occur in the treatment tanks if biocide was not used. The use of biocides is to be avoided, or at least limited, as not only are they expensive but they are also potentially hazardous to health and present solution disposal problems after use.



Figure 5.2 Boat in the tank in 1976 at Scaplin's Court, Poole Museum

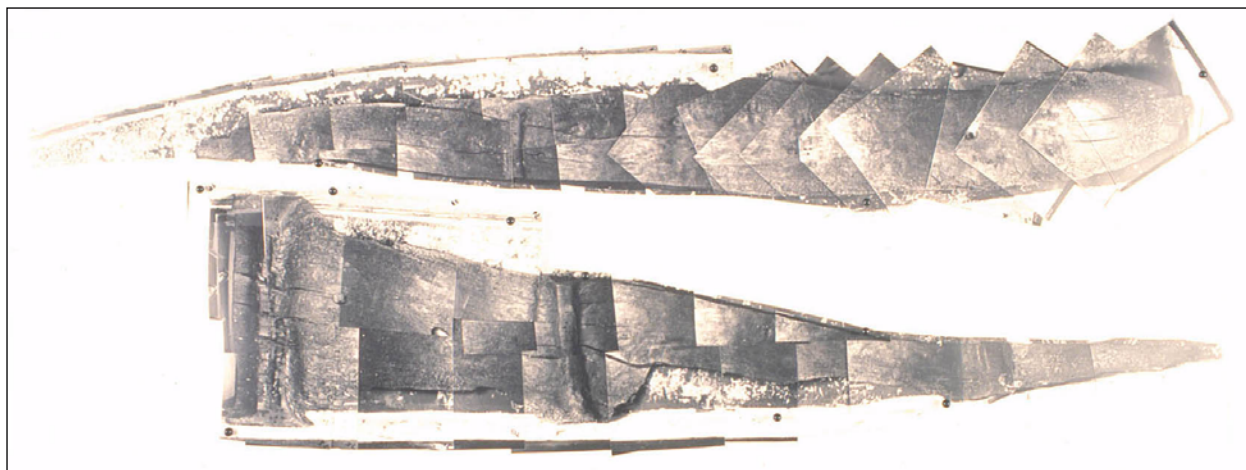

Figure 5.3 Photogrammetric record of boat

Pre-treatment documentation and investigation

Documentation of the object and selection of an appropriate regime are two essential steps before any conservation treatment can be undertaken. The boat's dimension and condition were documented by Goodburn (see Goodburn, Chapter 3) and a photogrammetric record was made by David Watkins (Assistant Keeper, Archaeology) and a museum photographer using a travelling gantry that ran along the sides of the treatment tank (Figure 5.3). Direct measurements were compared with the accurate 1:20 scale drawing made in 1974 and this, with a few additions, was found to be sufficiently accurate record. By this stage, the logboat's surfaces were somewhat abraded and deteriorated, making casting of surviving tool marks and other features of little value. As a large number of core samples had been taken during the previous treatment it was considered unethical to take many more and therefore the characterisation was limited to simple 'pin tests'. This, however, was of questionable validity due to the wide range of degradation encountered. A large-scale treatment, by its very nature, must be capable of adequately treating the various states of decay that are encountered.

The treatment regime was based on the premise that immersion in a concentrated solution of sucrose from the start would give the best shrinkage and surface appearance results while significantly limiting the biological activity. Even though sucrose is relatively inexpensive compared to other treatment chemicals, the 20,000 litres of solution still represented a significant cost. Sponsorship was sought during the documentation phase, which led to an offer in January 1994 by British Sugar plc to provide a stock 63% wt/wt sucrose solution, used for the manufacture of soft drinks. During 1994, more sponsorship was found and the logistics planned. A road tanker offered by Tankfreight Ltd was converted into a treatment tank by Forest Fusion Ltd, a local marine engineering specialist. Support cradles for transport and treatment were constructed by the Poole Museum Services technicians from materials donated by local manufacturers (see Figures 5.4, 5.7 and 5.9). Sections of marine ply were cut to fit the logboat profile and positioned at approximately 500 mm centres along the length. These were then supported using aluminium scaffolding poles fastened to the corners of the marine ply sections with metal brackets made from builder's joist hangers. Offcuts from neoprene wet-suit material were used to provide padding between the marine ply and logboat surfaces.

In April 1995 the local rowing club lifted the boat sections in their cradles through the tight confines of the previous treatment room at Scaplin's Court and British Road Services transported the boat to its new storage container, sited at a local authority depot near Poole, free of charge (Figure 5.4). Permission had already been obtained from the National Rivers Authority, Wessex Water and the fire brigade for the storage of 20,000 litres of sucrose in the new tank, together with a full risk assessment.



Figure 5.4 Boat being lifted into treatment tank in 1995

Throughout 1994 tests were conducted and experts consulted to determine the treatment risk associated with using a 63% sucrose concentration. The main concern was cellular collapse of the weakened wood structure through osmotic shock caused by the rapid movement of free water out of the wood cell wall to dilute the high concentration of sucrose in solution. Detailed discussions with scientists at the British Sugar technical laboratories suggested that this was highly unlikely in degraded wood, however fragile. This was confirmed by the Botany Department of the Open University, which stated that the pits in the cell walls are both numerous and of several orders of magnitude greater than a molecule of sucrose. Furthermore, there is no question of semi-permeable membranes being present in dead cells for such pressure differentials to exist. A seven-month experimental immersion of three samples of archaeological wood into 63% wt/wt sucrose solution, each reflecting the different degrees of degradation found in the boat, confirmed that damage was unlikely.

Impregnation treatment

The treatment started in October 1995 when British Sugar pumped the solution into the tank. A quantity of Kathon CG[®] biocide, donated by Chesham Chemicals, was added to achieve 0.1% concentration, sufficient to kill any yeast spores in the wood and prevent re-colonisation for a number of months. A lid over the tank was constructed from thick polyethylene sheeting and sealed with duct tape to prevent insect access. As the tank was situated outside, a tarpaulin acted as extra weather protection. During the first years the tank was inspected weekly.

The solution was monitored and wood cores analysed regularly until 1998 (Hutchings 1996; 2003). Samples were sent to the British Sugar laboratory in July 1996, November 1996, October 1997 and November 1998; the sucrose solution was replaced with a 67% solution in September 1997 due to concerns over increasing levels of yeast infection. Monitoring consisted of drawing two samples, one from near the solution surface, and one about 500 mm below the surface ('upper tank' and 'lower tank' in Figure 5.5).

According to the original plan, the impregnation should have been complete within five or six years, with the drying stage beginning in 2001. Although the monitoring regime operated well in the first few years, the low-maintenance, low-cost approach suffered a setback due to staff changes and consequent lack of continuity. Importantly, the covers to the tank failed at some point between 1998 and 2003, allowing rainwater and insects (mainly wasps) to reach the solution. This significantly degraded the solution, causing loss of concentration and biological breakdown. Once this problem was identified in 2003, the solution was tested to determine its level of degradation and replaced with a fresh solution, while funds were secured for the drying stage. By that time the boat had been immersed for eight years and the damage to the tank covers and the consequent ingress of rainwater and biological contamination demonstrate typical drawbacks of this type of long-term, low-maintenance treatment, especially when there is no overview and monitoring from a specialist conservator.

Monitoring of solution

Although the treatment was originally designed to be low maintenance, monitoring of progress and biological activity was identified as critical to its success. A simple method was devised to sample the top and middle of the solution without having to remove the cover. Two wide-bore polyethylene tubes were secured to the cradle holding the boat, one near the surface of the solution and the other 500 mm below the surface. These exited through the sealed cover and were kept sealed when not in use. To sample, a sterilised tube was pushed along the tube and solution drawn off. Approximately two litres were decanted before the 500 ml sample was taken. On each occasion, two samples were taken (Table 5.1).

The results presented in Table 5.1 show that the sucrose concentration became significantly reduced as the cover failed, allowing rain water and insects to enter. This led to the introduction of micro-organisms causing sugar inversion into glucose and fructose. The latter is consumed by osmophilic yeasts, capable of living in concentrated sugar solutions, accounting for the apparent loss of solids from solution in 2003. The relative proportions of glucose plus fructose (21% & 21%) to sucrose (29% & 24%) indicates that about one half, by weight, had inverted. By the time this author, Jim Spriggs, took samples in April 2003, the surface of the solution was covered with a thick scum of organic debris, principally dead wasps, a major source of microbial infection (Mietke and Martin 1999).

The presence of glucose and fructose in wood will cause the surface to become sticky and darken, especially in humid conditions. High humidity conditions during storage and display could easily cause deliquescence, and mobility of these sugars within the wood and onto the surface. Only the installation of expensive full air-conditioning would alleviate the problem, which was certainly not

Table 5.1 Analyses of sucrose syrup samples from 1996 to 2003 (British Sugar)

Date	16/7/96		12/11/96		31/10/97		6/11/98		24/4/03	
	Upper Tank	Lower Tank	Upper Tank	Lower Tank	Upper Tank	Lower Tank	Upper Tank	Lower Tank	Upper Tank	Lower Tank
Sucrose	63.4%	62%	62.7%	59.6%	67%	65.6%	-	-	29%	24%
Glucose	<0.1%	<0.1%	<0.1%	<0.1%	<0.7%	<0.7%	-	-	17%	17%
Fructose	<0.1%	<0.1 %	<0.1%	<0.1%	<1.3%	<1.3%	-	-	4%	4%
Total solids	64.1%	62%	63.5%	63.8%	68.7%	68.8%	-	-	>50%	>45%
Number of yeast	0	0	5	1	>3500	16	175	44	50	70
Number of moulds	0	0	258	185	6	6	3	1	160	30
Number of mesophiles	50	50	40	20	48	60	66	73	120	180
Osmphillic mould (Liq. sugar)	-	-	-	-	-	-	0	0	0	0
Osmophillic yeast (Liq. sugar)	-	-	-	-	-	-	<3000	<3000	1105	9104

budgeted for. Sucrose itself will withstand a degree of environmental fluctuation, allowing the wood to be displayed in a less rigidly controlled environment as it is less affected by humidity variations. If the boat had been dried at this point, there would also have been an increased risk of shrinkage due to insufficient impregnation. On this basis it was decided to replace the old solution with fresh sucrose solution in order to ensure that sucrose was the dominant sugar in the wood. The 67% sucrose solution was again provided free by British Sugar but, although recommended by Jim Spriggs, biocide was not added. Despite the cost of biocide being within the limits of the budget, the introduction of new Health and Safety Regulations required that a professional firm be hired for its application. This expense could not be covered by the project. Instead, considerable care was taken to minimise contamination by keeping the treatment tank tightly covered. During the change, additional core samples were taken to determine how far the solution had penetrated. The plan was to start the drying phase in early 2005.

Analysis of the wood

Approximately 70 core samples had already been taken from the boat prior to 1993. It was therefore considered necessary to present strong arguments for any further sampling. This was restricted to four occasions during the sucrose impregnation period. Each time, samples were taken through the full thickness of the boat from different locations. The results of the sugar content analysis carried out by British Sugar Operational Services Science Unit are presented in Tables 5.2 and 5.3.

As expected, the results from 1997 and 1998 show the slow rate with which the sucrose diffuses into the wood. More complete analysis was carried out in 2003 and 2005, giving results for the proportion of wood solids present at different depths, together with water and the various sugars.

The sample taken in 2003 (Figure 5.5) shows a higher density of wood in the centre of the core than at either end, together with a higher proportion of sugars to water in the centre, the high levels of fructose and glucose reflecting the significant degradation of the solution. The quantity of sucrose that has penetrated the wood was considered sufficient to render the wood stable on drying but the level of inverted sugars present in the outer layers of the wood is likely to result in the surface remaining sticky.

Analyses undertaken by British Sugar in May 2005 show an average of 91.3% sucrose by weight of solids. Wood core samples taken at that time contained an average of 21.1% sucrose, 8.7% glucose and fructose inverts (Figure 5.6). Analysis also showed an increase in overall penetration into the wood compared to the previous wood core data from 2003 (Figure 5.5).

Table 5.2 Wood core sample analysis, October 1997
(% sucrose content)

	sample 1	sample 2	sample 3	sample 4
top	27%	15.8%	22.9%	24.4%
middle	29.8%	4.2%	3.5%	16.7%
bottom	28.7%	14.5%	24.8%	36.4%

Table 5.3 Wood core sample analysis, November 1998
(% sucrose content)

	water content	sucrose content
bottom (0 cm)	75%	24%
2.5 cm	62%	0%
middle (5 cm)	45%	5%
7.5 cm	52%	7%
top (10cm)	61%	19%

The proportion of sucrose to water compares well with the original 67% concentration of the solution. For example, at 40 mm along the sample there is approximately 60% wood, 25% sugars and 15% water, which equates to a 62.5% concentration. As expected, the levels of fructose and glucose within the core are higher than at the surface, reflecting the degradation of the previous treatment solution. However, their presence is likely to be beneficial in this location as it will improve the stabilisation of the less-degraded wood structure. The ratio of fructose and glucose to sucrose on the outer surface is low enough not to cause a sticky surface or prevent crystallisation. The conclusion was that the wood was sufficiently stabilised for drying to begin.

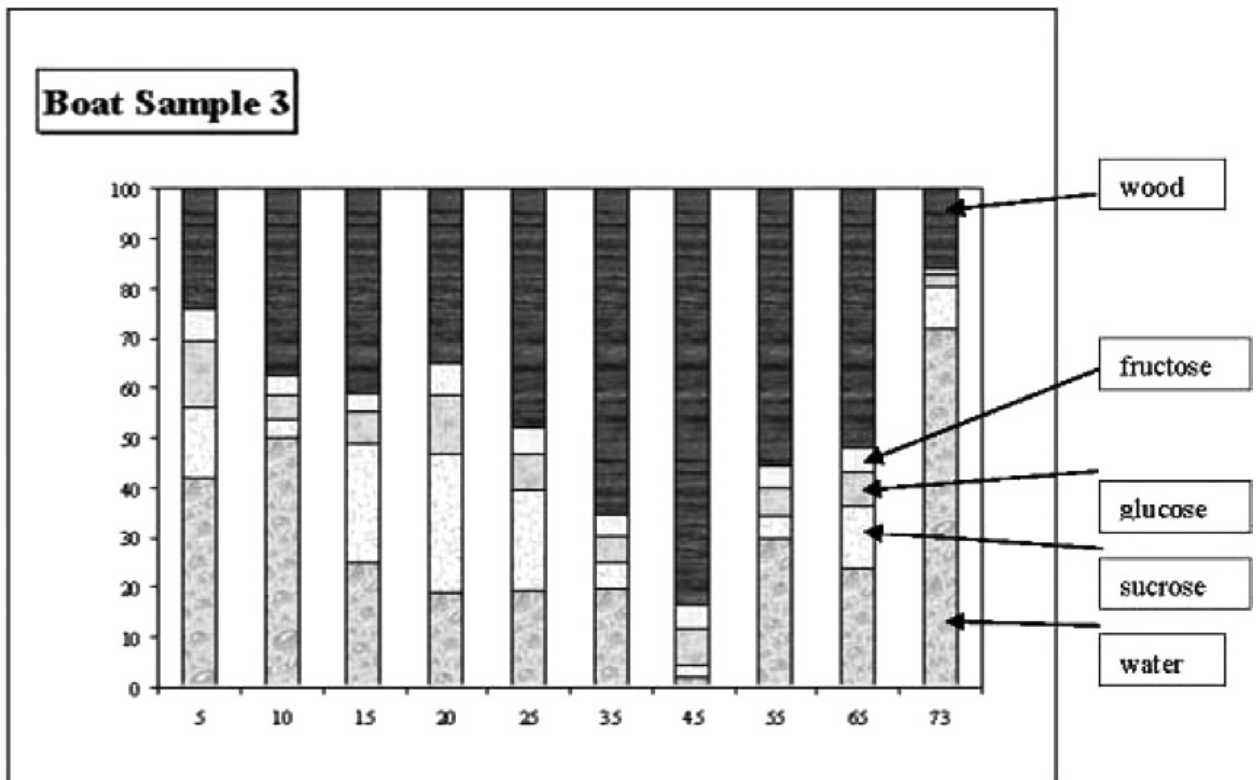

Figure 5.5 Wood core sample analysis, December 2003

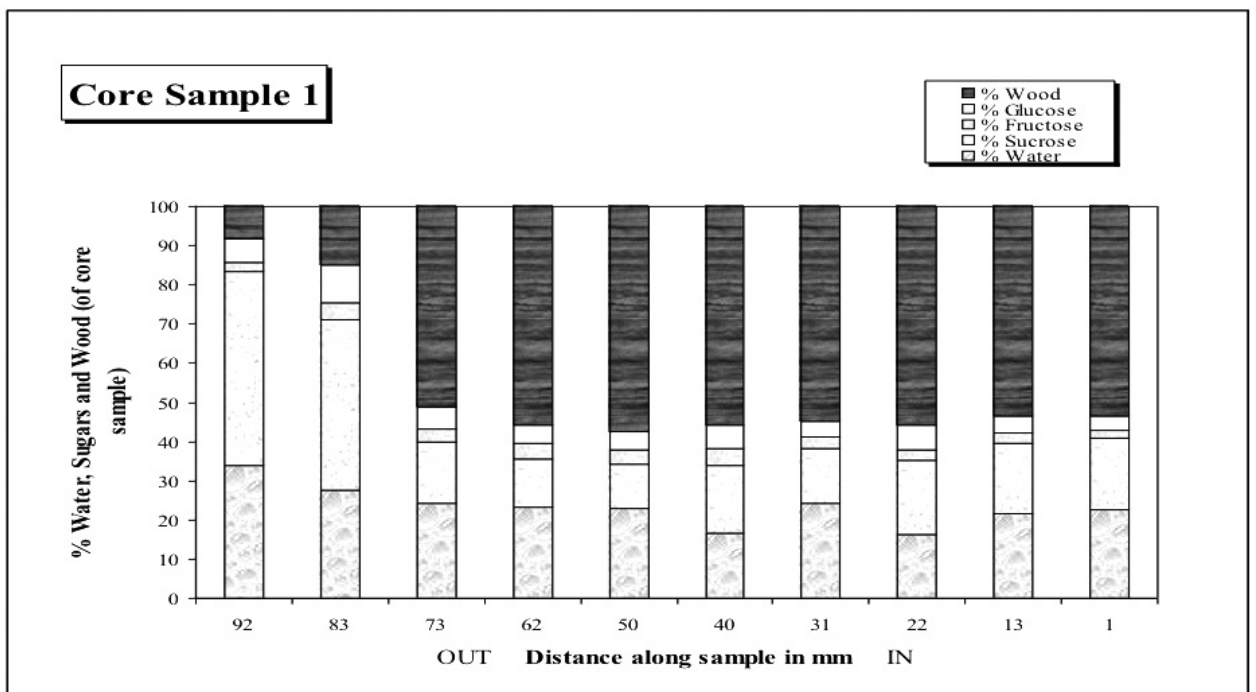

Figure 5.6 Wood core sample analysis, May 2005

Selection of drying regime

Once the final stage of the impregnation treatment was underway a date could be set for the drying phase. Circumstances had changed since the beginning of the project: originally it was assumed that the drying process would be carried out as cheaply as possible. If the boat was allowed to dry slowly in a heated

but otherwise uncontrolled environment, it was estimated that the process would take between three to six years. However, the boat was to become a major exhibit in the newly refurbished Poole Waterfront Museum, due to open during 2007 with Heritage Lottery Fund (HLF) support. The original plan was now no longer possible as the drying phase needed to be completed in less than two years. A subsidiary but no less important aspect of the project was to establish the efficiency of the sucrose technique. One condition of the HLF funding was that the treatment had to be finished in the spirit of the original conservation strategy: i.e. that it should be simple, cheap and ostensibly carried out by museum staff, with periodic supervision of specialist conservators. It was therefore necessary to re-examine the drying process to establish if this schedule could be achieved, with drying taking place as efficiently and safely as possible. To this end, Jim Spriggs of the York Archaeological Trust was brought in to plan the work, estimate the cost (Spriggs 2003) and manage the final stages of the logboat's conservation, with essential input from Jeremy Hutchings. The budget for this stage was £29,000, covering consultancy, equipment and specialist services costs.

It was also an appropriate time to select suitable display conditions, as these would dictate the wood's final equilibrium moisture content (EMC) and thus the end point of the drying process. Although drying is widely discussed in the literature as part of waterlogged wood treatment (e.g. Allen and Spriggs 2001), little is published on how this part of a regime is selected. The lack of previous investigation into this aspect of waterlogged wood conservation is surprising since it represents a critical step when irreversible damage is most likely to occur. Drying is limited by the speed of two processes: the rate of evaporation from the surface and the rate of movement of the water from the core to the surface (Forest Products Laboratory 1999). It proceeds at an optimal rate as long as the moisture movement from the interior is fast enough to maintain constant EMC at the surface. If the rate of moisture loss from the surface exceeds this rate then the surface will become drier than the core and there will be an increased risk of differential shrinkage, which leads to deformation, cracking and cross-checking. If the rate of evaporation is too slow, the drying process will be inefficient, which could result in excessive leaching of the treatment solution, mould and bacterial colonisation

With the economics of timber production in mind, the authors examined the commercial seasoning of green timber and made comparisons with experimental data measuring the EMC of sucrose-treated archaeological wood. The principles of drying were also investigated and an experiment was carried out to characterise how treated archaeological wood reacts to changes in relative humidity (see Hutchings and Spriggs 2004). The research established that sucrose-treated wood has an EMC of 15% at 55% Relative Humidity (RH) (ibid, figure 10), which approximates to typical display conditions for hygroscopic materials in a European museum (Thomson 2003, 87). To avoid strain within the wood above a point where mechanical damage could occur, a theoretical drying ratio of 1:2 between the EMC of the wood and the environmental conditions within the chamber was selected. The drying was proposed in steps, starting with a reduction to 31% wt/wt moisture content within the wood induced by chamber conditions of 66% RH. Once the moisture content of the wood had stabilised, the RH would be reduced to 63%, 59% and 54% respectively, the wood weight being allowed to stabilise between steps. The final chamber humidity level mirrors a typical museum environment of 50% ± 10% (MGC 1992).

The time taken for the sucrose-treated wood to reach equilibrium in ambient conditions of 55% RH from its saturated state had been conservatively estimated to be two to three times that of fresh oak timber (Hutchings and Spriggs 2004). As the gallery was due to open two years from the start of drying, this was somewhat worrying. However, this rough estimate had been generated for planning purposes from the results of small-scale experiments and was likely to contain a high level of uncertainty. Nevertheless, it was important to maintain the theoretical safe drying gradient. The rate of drying would be closely monitored and it was anticipated that the boat could undergo its pre-display cleaning before it was fully dry. Experience suggested that the final drying and stabilisation would most likely occur during the first year of display.

Using the results of the final core analysis data, the boat was estimated to contain: 335.4 kg wood; 8.7 kg glucose and fructose; 152.8 kg sucrose; and 171.7 kg water. Taking into consideration the water of crystallisation for the sucrose, which is generally quoted as $n = 5\text{H}_2\text{O}/\text{sucrose}$ (Mathlouthia and Genotelleb 1998) and the natural water content of wood, typically 8 to 10% at 55% RH,¹ the total amount of water to be removed was calculated as 98.3 litres. The equipment selected (see below) would operate comfortably at temperatures between 25°C and 35°C, and the suppliers advised that initially the lowest operating temperature should be used to avoid too rapid evaporation of the water near the wood surface. The temperature could then be gradually increased during the later stages to ensure that the water deep within wood was efficiently removed. It was decided that an upper operating temperature of 25°C should be maintained to avoid risk of thermal damage.

The effect of an increasing concentration of sugars within the wood as water was extracted during drying has not been precisely determined. However, concentrated solutions will rapidly crystallise below 60% RH, releasing moisture, which may explain the large quantity of water extracted when the dehumidifier humidistat was initially set at 70% (equivalent to approximately 58% RH in the chamber). Once crystallisation is complete, the residual water associated with hydration will diffuse more slowly towards the surface.

Cleaning and preparation for controlled drying

In May 2005, the two logboat sections were craned out of the treatment tank. As anticipated from earlier inspections, the boat sections and support cradles were encrusted with thick deposits of sugar crystals on the upper surfaces which had formed as the solution evaporated. Under the direction of the authors, the boat sections were cleaned as gently as possible by contractors using a high-pressure industrial power hose fed with heated water (Figure 5.7). The water pressure was reduced to a minimum to avoid damage from over cleaning as well as possible abrasion and loss of the fragile wood surface from the force of the water jet. The upper surface was more compact than the underside and thus could withstand a greater degree of cleaning; the underside had retained much of its 10 mm thick degraded surface.

Even after the initial cleaning, the upper surface appeared smooth as the wood dried, with a pleasing rich-brown colour. The underside was much rougher, with cupping of the degraded wood surface, and the re-deposited sucrose was more difficult to remove. Fragments of sucrose that remained, especially crystals lodged in corners and cracks, were picked out with wooden tools, avoiding any use of sharp metal tools. Larger areas of deposit were split away by lightly tapping with hammers. Crystals within the cracked and open end grain of the wood at the bow and stern were extremely difficult to remove without damage (Figure 5.8). Those left were removed later, after the drying phase. A few litres of tank solution had been reserved for brushing onto areas of wood



Figure 5.7 Power-hosing sucrose crust from boat in May 2005

¹ <http://www.kiln-direct.com>



Figure 5.8 Sucrose crystals in open grain and the transom slot in May 2005 (photo courtesy of Jeremy Hutchings)

from which sucrose had leached during pressure cleaning. This was particularly the case adjacent to stubborn areas of sucrose deposits where the hot water jet had been allowed to dwell on the surface for longer than a few seconds. When cleaning was complete, each section was wrapped in polythene and transported to the drying chamber which had been constructed in a room within Poole Museum's Scaplin's Court. Assisted by 15 volunteers from the local rowing club, the two boat sections were carefully manoeuvred into the chamber. The cradles provided some protection during transportation and helped to retain the curvature of each section of the hull during drying, thereby ensuring the fit of the two halves when placed on display.

In keeping with the original conservation strategy, monitoring using simple methods was selected as the boat sections were dried. Each section was periodically weighed using a pair of 1200 mm long transducer weigh-beams, pre-calibrated to an accuracy of ± 200 gms.² Dimensional changes were monitored via pairs of brass pins inserted into the wood; 15 were located in the bow section and 19 in the stern. The majority of the paired pins were placed in the tangential wood axis, a number of which monitored pre-existing cracks. Three sets of pins were placed in a radial orientation with no measurements taken longitudinally.

The controlled drying process

Controlled air drying was proposed for this project after research indicated that by maintaining a strict drying gradient, the sucrose-treated archaeological wood could be dried in the time available while minimising the risk of damage. To keep costs low, a commercially available 'Hobby' kiln kit, intended for the small-scale seasoning of freshly cut timber, was selected and the drying chamber was constructed by

² The standard accuracy for transducer weight beams of this type is ± 500 gms. As this was considered to be too inaccurate for the purpose, HST Scales Ltd fitted more accurate components at no extra cost.



Figure 5.9 Keith Jarvis, Curator of Archaeology at Poole Museum, in the drying chamber

technical staff at Poole Museum, with guidance from the suppliers, Arrowsmiths Ltd.³ The equipment was simple to install and could be run from a domestic electricity supply. It comprised of six 75-Watt fans, arranged in two groups of three, mounted in the upper side walls; the central fan in each bank contained a 500-Watt heating element. A single 350-Watt freezing coil dehumidifier unit was mounted between the two groups of fans (Figure 5.9). Air circulation within the chamber was directed using sheets of thin hardboard as baffles, placed on top of the boat cradles (Hutchings and Spriggs 2004).

The fans were switched manually and the central heater fans automatically via a thermostat. The dehumidifier was also switched automatically via a manually adjusted humidistat. The condensate drained into a 5-litre measuring cylinder outside the chamber. A vent-fan, triggered by a thermostat, was mounted close to the dehumidifier to supply cool air from the outside in case the chamber overheated. Although the control circuitry was crude and the humidistat uncalibrated, the equipment was sufficient to ensure relatively stable drying conditions and simple enough for museum staff to operate under regular guidance from Jim Spriggs. The errors encountered are discussed later.

Operation and monitoring of the chamber

Before drying commenced, two Hanwell ‘Humbug™’ RH/temp data-loggers were positioned close to the wood surface. These were set to log over a six-month period, to be downloaded during the planned six-monthly maintenance sessions when the boat sections would be weighed, pin measurements taken, and equipment checked.

³ Details of the chamber construction given in Hutchings and Spriggs 2007.

In July 2005 the equipment was switched on, the dehumidifier set to 75% RH, and the temperature gradually increased from ambient to 25°C. No water was extracted via the dehumidifier so after one week the humidistat was lowered to 70% RH, at which point between 500ml to 4 litres of water condensed per day over nine days. As this was above what was planned, the humidistat was adjusted to 72.5% RH until the rate was between 250 to 350 ml per day. These conditions were maintained for 50 days until no further water was being removed. The humidistat was then reduced to 69%. The RH was again reduced to 66% on day 77, 64% on day 97, 60% on day 104 and 55% on day 129. The relative humidity remained at around 55% for 253 days until the drying process was halted on 1 August 2006, after 381 days. By this date the logboat had lost a total equivalent of 108 litres, calculated by weight loss – approximately 10% more than was originally estimated. At that time the control settings were adjusted to maintain conditions and prevent unwanted drying until it was possible to move the boat sections to their new display area, some months later. The actual conditions, as recorded by the more accurate Hanwell ‘Humbug™’ RH/temp data-loggers, were approximately 10% lower than the uncalibrated humidistat settings. Although not significant during the drying phase, this discrepancy was taken into consideration when stabilising the boat to gallery conditions.

The combined weight loss due to water evaporation, calculated by subtracting the weight of the boat cradles from the combined balance readings, follows the smooth curve shown in Figure 5.10, which reduces as the boat reaches its final equilibrium conditions. This represents the rate at which water is evaporating from the surface. For example, the initial gradient represents an average of 2.25 litres of water extracted per week. This is under two-thirds of the maximum 3.6 litres per week estimated earlier, demonstrating a cautious start to the drying process. The central part of the drying averaged 3.20 litres per week, which tailed off to 1.65 litres per week and 0.86 litres per week towards the end of the process. During the stable period after the drying process had stopped, the boat continued to lose a small amount of water, estimated to be 220 ml per week. Visual observations made by the curatorial staff at Poole Museum indicate that it continued to lose small amounts of water for some months after the boat had been placed on display, as predicted.

The conditions within the drying chamber recorded by the environmental data-loggers indicated that between the middle of November 2005 and the beginning of May 2006 the chamber remained between 22% and 32% RH and the temperature between 23°C and 28°C, with a single prolonged dip to 18°C in April 2006. Although the fans operated continuously,⁴ the dehumidifier equipment was not triggered for almost 5.5 months of the 16-month active drying process. During this time, from mid-December 2005 to mid-May 2006, no condensate was measured (Figure 5.12); however, the weight reduction indicates that drying continued at a steady rate (see Figure 5.10). It also demonstrated that weighing was a more reliable form of monitoring.

One explanation for the conditions monitored in the chamber can be found by examining the external weather conditions for Poole recorded by the UK Met Office.⁵ Whilst the external humidity conditions remain within a narrow band between 74% and 85% throughout the year (due to the maritime climate in Poole Harbour), there is a significant change in temperature from a minimum of 3.6°C in February to a maximum of 18.4°C in July. The chamber was situated in an unheated room within Scaplin’s Court and had unbaffled air intake vents along one side wall as security against overheating. The fans within the chamber would have exchanged air between inside and outside at a high rate. As the air entering the chamber is heated to 25°C, the humidity is estimated to drop to 20% RH during the colder winter months without the aid of a dehumidifier, thereby drying the boat without triggering the dehumidifier, which, in reality, was set to operate at approximately 35% RH during this period. This explains why a uniform weight loss occurred (see Figure 5.10), despite the dehumidifier only extracting moisture from the beginning of May 2006 when the external RH and temperature conditions caused the RH within the chamber to go above 33%. If the amount of water measured by weight loss is extrapolated over

⁴ Recorded in the logbook kept by Poole Museum staff.

⁵ <http://www.metoffice.gov.uk/>

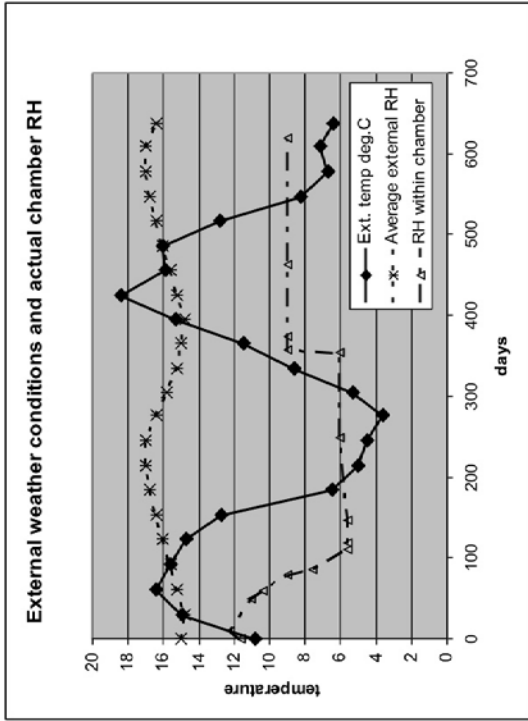

Figure 5.11 External weather conditions in Poole compared to actual conditions within the chamber

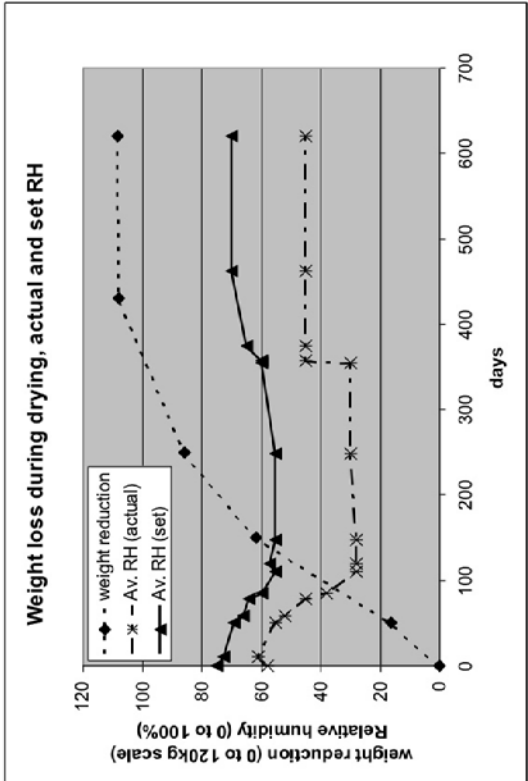

Figure 5.10 Graph showing reduction in weight of the boat versus set RH on humidistat and actual RH within the chamber, over time

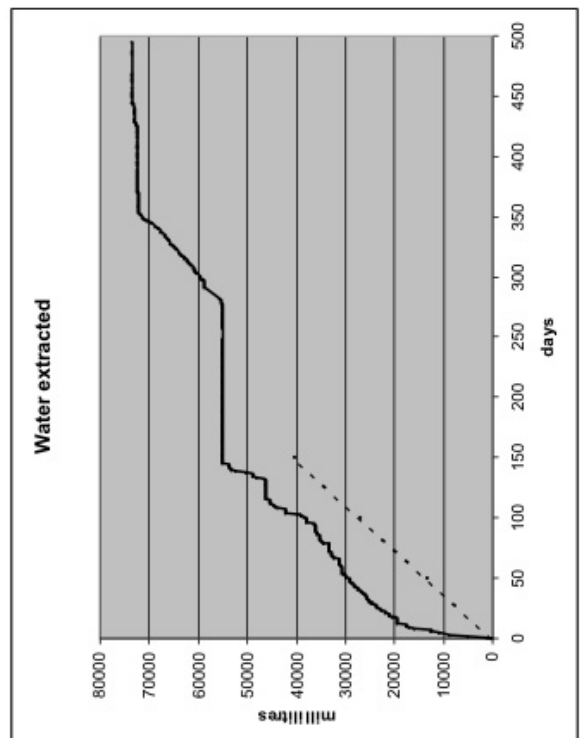
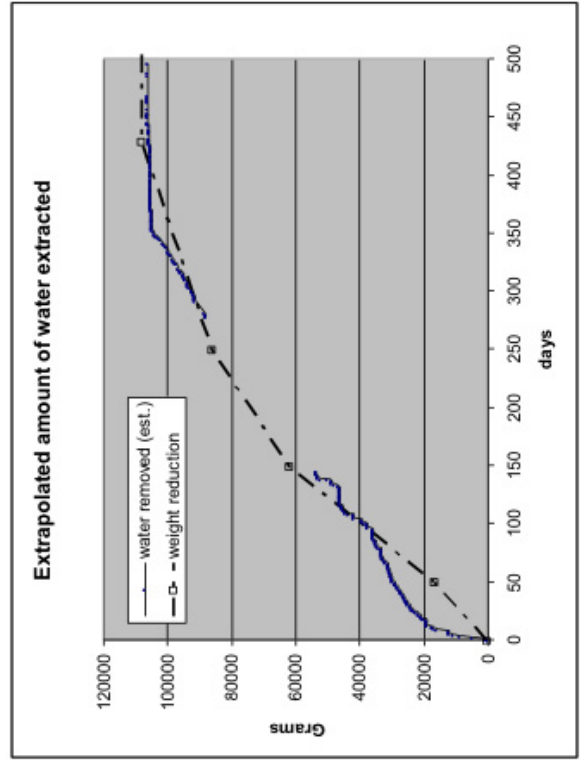
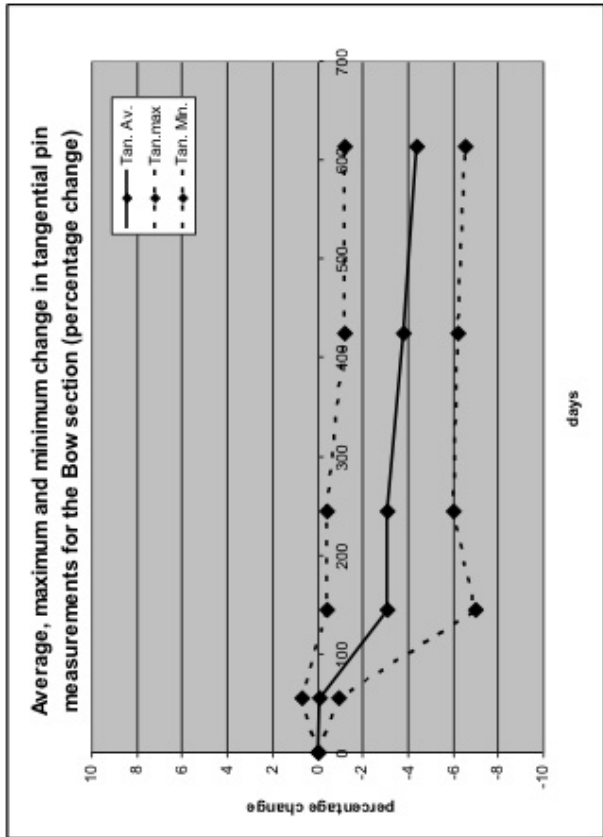
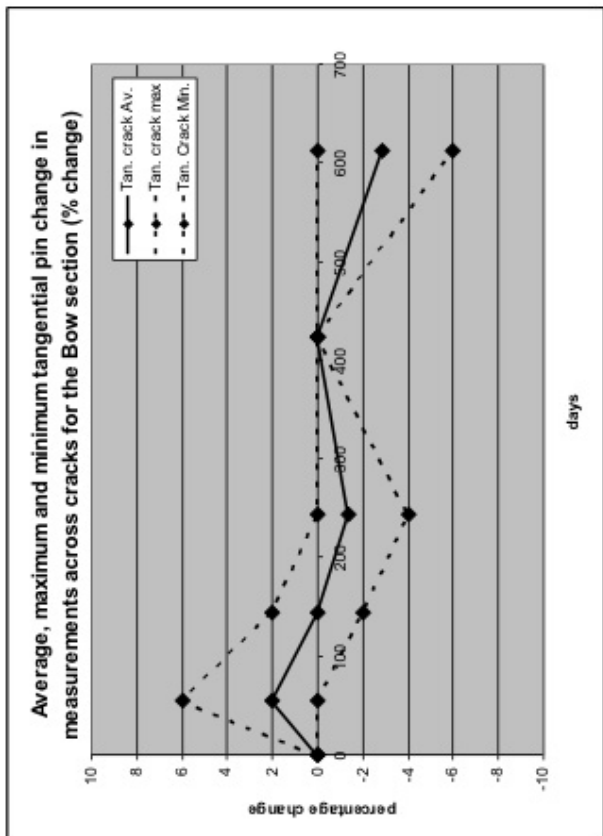

Figure 5.12 a: Recorded amount of water extracted; b: extrapolated amount once the period when no water was detected is removed



b



a

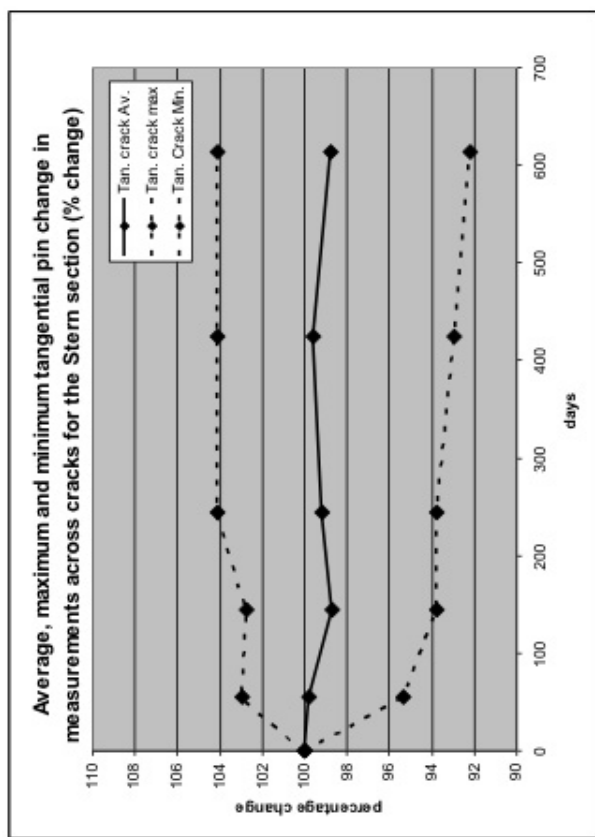

d

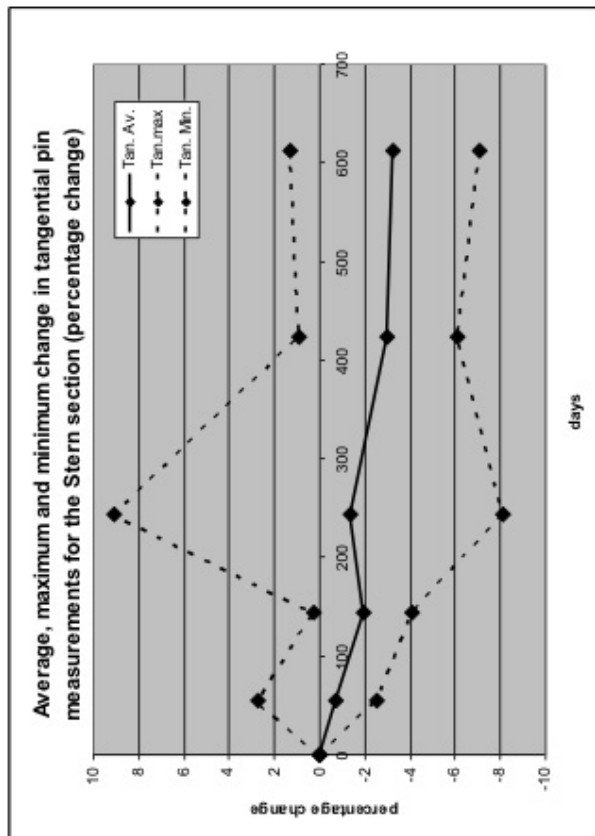

c

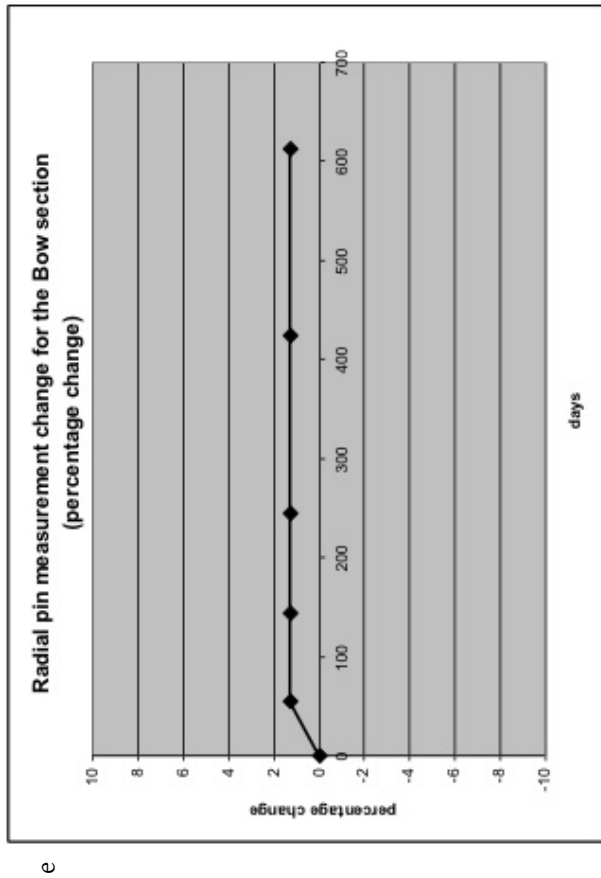

e

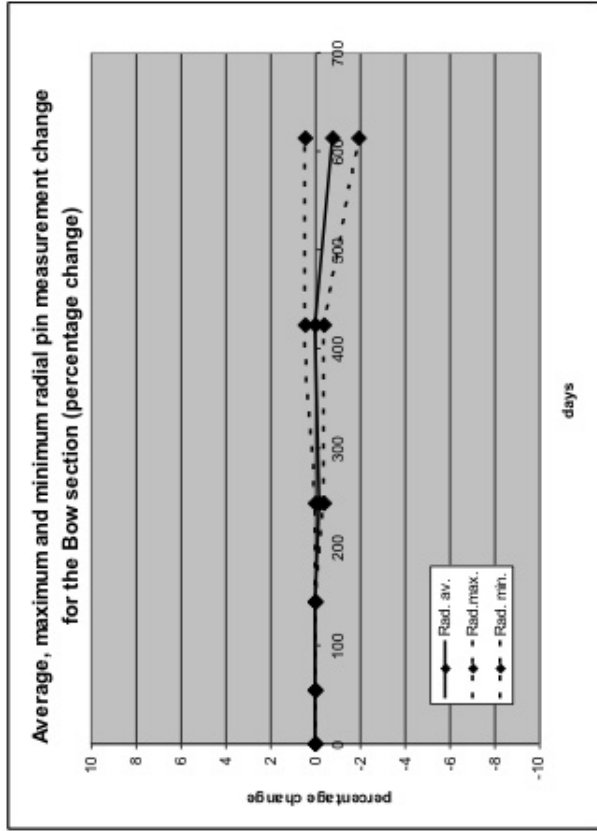

f

Figure 5.13 a: Average, maximum and minimum tangential pin change in measurements across cracks for the bow section (% change); b: Average, maximum and minimum tangential pin change in measurements for the bow section (% change); c: Average, maximum and minimum change in tangential pin measurements for the stern section (% change); d: Average, maximum and minimum tangential pin change in measurements across cracks for the stern section (% change); e: Radial pin measurement change of the bow section (% change); f: Average maximum and minimum radial pin measurement change for the bow section (% change)

the period when no condensate was measured, a similar curve is obtained (Figure 5.12a and b).

The weight change, as shown in Figure 5.10, indicates that the drying of the logboat progressed steadily despite the fluctuations in RH within the chamber. This further confirms sucrose-treated wood’s lack of sensitivity to a fluctuating environment. As the dehumidifier did not operate for a significant proportion of time, air circulation and heating from the banks of fans appear to be the main contributor to a rapid and successful drying operation.

Pin measurements: shrinkage?

The distances between the pairs of brass pins that were inserted into the wood prior to drying were measured by Jim Spriggs on each inspection during the drying process. The average, maximum and minimum percentage change for each orientation and across the cracks is given in Figure 5.13 a–f.

The pin measurements show very little shrinkage of the wood and movement across the cracks. The tangential measurement (Figure 5.13 a–d) indicate an average shrinkage of 3–5.5%, with a maximum of 7%. Radial measurements indicate minimal change during drying, with an average of less than 1% and a maximum of 2% (Figure 5.13 e and f). Although there is not a pronounced difference between the average rate of shrinkage at different stages of drying, the greatest degree of shrinkage appeared to have occurred in the first quarter, as predicted, reflecting measurements typically encountered in large-scale PEG treatment.

Preparation for display

In February 2007, a team of volunteers moved the two boat sections, still in their cradles, into the newly refurbished Poole Waterfront Museum. The support cradles were removed for the first time in over 10 years and the final work of preparing the boat sections for display began. Under the authors' supervision, museum staff and volunteers from the local archaeological society lightly brushed the boat sections to remove loose sugar crystals and other debris, and final treatment record photographs were taken. The measuring pins and labels were removed and any remaining patches of white sugar crystals, on the surface and lodged in cracks, were cleaned using warm water and absorbent tissue (Figure 5.14).

Where possible and without further damage, the sugar crystals lodged in splits and the end-grain of the wood were removed with wooden tools. Those too risky to remove were left *in situ*. A final general clean, working systematically from one end, produced an even surface appearance that is a pleasant mid-brown colour, not dissimilar to wood treated with low percentages of polyethylene glycol polymer followed by freeze-drying. The 77 holes from sampling throughout its long treatment history were plugged with melted Liberon™ wax wood filler, dark oak (no. 10), which is typically used to restore furniture and is readily available from a good hardware shop (Figure 5.15).

Conclusions

The low levels of shrinkage achieved, averaging 4% tangentially and 0% radially, combined with a pleasing appearance, are immediate indicators of success despite the extended impregnation time and various early setbacks. The choice of controlled air-drying, as used to season timber, has been shown to be successful as it shortened the drying time and reduced the risk from uncontrolled dehydration. The drying took place without incident, and was quicker than originally (conservatively) estimated due to the efficiency of the drying equipment.

An estimated total of 108 litres of water was extracted from the logboat, which is close to



Figure 5.14 Localised cleaning using water and absorbent paper



Figure 5.15 Plugging core sample holes with coloured Liberon™ wax filler

the original estimate of 98 litres required for its stabilisation at 55% RH. Measurement of the amount of water (condensate) produced by the dehumidifier in the drying chamber was found to be an unreliable indicator of progress and led to some unnecessarily low adjustments in RH when no water appeared to be extracted. In hindsight, more frequent measurements of weight would have been a better measure but this would have required more frequent access to the chamber, with commensurate disturbance to the drying conditions and increased staff time. Whether constant monitoring is really required is debatable, as the RH within the chamber dropped to 20% RH over the winter months without disturbing the drying rate (see Figure 5.10). As discussed, the rate of moisture loss may be limited by the rate that moisture moves within the wood; therefore, below a certain relative humidity it may have little or no effect. The principal danger from very low RH within the chamber is the potential of over drying of the wood surface, causing excessive cracking; this was not observed.

Although less acute than during the impregnation stage, and despite the high level of commitment from those involved, daily monitoring and the adjustment of equipment continued to be problematic due to the lack of an on-site conservator. This led to a certain amount of guesswork by the project conservators and staff. Maintaining such a long-term project on a constrained budget is always likely to be difficult as materials and assistance generously given at the outset of the project cannot be repeatedly relied on throughout. The intentional adoption of a 'low maintenance' treatment, although having many benefits, does not equate to 'no maintenance' and, when combined with staff discontinuity, it is not surprising that this led to periods of neglect. The controlled drying process, although not as simple as natural air drying, followed in the spirit of the treatment and increased the certainty that conservation would be complete before the deadline. While difficult to quantify, the drying method chosen is judged to have been cost-effective as it dramatically reduced drying time and greatly reduced the chances of further damage.

The slow response of sucrose-treated wood to changes in humidity is beneficial with respect to the impact of environmental fluctuations once the boat is on display. Its insensitivity to rapid change in RH below 70% (syrup formation point) indicates that it should be capable of withstanding conditions in a moderately controlled gallery, nominally between 40% and 65% RH, without incurring damage. Thus tight control of the environment is unnecessary and allows the boat to be exhibited within a display case without the need for full air-conditioning or complex microclimate control.

Acknowledgements

The authors wish to acknowledge the help received from:
British Sugar plc;
Staff of the British Sugar Operational Services Science Unit;
Members of Poole Amateur Rowing Club;
Members of the Dorset Natural History and Archaeological Society.

Chapter 6

The display and interpretation of the Poole logboat

Katie Morton and David Watkins

Introduction

Poole Museum has an important maritime collection based around four sites/vessels:

- The Poole Logboat – an Iron Age vessel recovered from Poole Harbour;
- Poole Foundry Boatyard – a medieval boatyard on the shoreline of the Old Town;
- The Studland Bay Wreck – a 16th-century Spanish merchant ship in Poole Bay;
- The Swash Channel Wreck – a recently excavated Dutch early 17th-century armed merchant ship discovered near the entrance to Poole Harbour.

This unique collection forms one of Poole Museum Services' major assets.

The Poole logboat is one of the largest discovered in Britain. Housing an object of this size and type presents significant challenges in conservation and interpretation. These problems began at the time of the logboat's discovery in 1964 and continue in to the future (Figure 6.1).

This chapter will explore the decisions that have been taken over the years in how to present the Poole logboat to the public, and the barriers that have been encountered along the way. It will also consider how this interpretation might be expanded and developed in the future.



Figure 6.1 The Poole logboat when it was first raised in 1964

Initial display

There has been significant public interest in the logboat ever since its discovery in the 1960s. It was first displayed in a water-filled tank at Scaplen's Court, a 15th-century building in Poole close to the current museum. It would have been hard to see much of the logboat in its specially constructed tank; nonetheless, it was described by the *Poole and Dorset Herald* in June 1965 as the Museum's 'star item' and it may have contributed to a rise in visitor numbers that year.

Interpretation took the form of text panels and an accompanying booklet, reflecting the style of interpretation most prevalent at the time. The text was dense, detailed and technical, with few concessions to the diversity of interest, age and ability amongst visitors.

Eventually the logboat was taken off public display, although it continued to be viewed on special open days.

Initial conservation

The initial objectives for the logboat were to conserve it, with the minimum of damage, shrinkage or distortion to its form, and then to put it on display. However, in the 1960s, conservation techniques for waterlogged wood were still developing and the conservation of the logboat was beset with difficulties.

Dr A E A Werner, Keeper of the Laboratory at the British Museum, was initially consulted. He recommended a conservation regime of immersion in fresh water for two years, followed by gradual drying and treatment with polyethylene glycol (PEG). However, Graham Smith – Curator of Poole Museum from 1972 to 1993 – reported that this programme never materialised.

Renewed efforts by Graham Smith led to a new conservation programme in 1976 which aimed to achieve a 50% impregnation with polyethylene glycol. This project was overseen by the National Maritime Museum's Archaeological Research Centre and Dorset County Museum's conservation laboratory. However, this treatment phase was ultimately only partially successful. By 1987, tests showed that the absorption rate of polyethylene glycol had been very slow and there was no foreseeable date for the logboat's display.

1990s Museum redisplay

A major redisplay of Poole Museum as 'Waterfront' was planned for the 1990s and the logboat's position in this was problematic. As conservation plans were still uncertain it was decided to use a fibreglass model of the logboat, with a diorama as a backdrop. Part of this model was a replica of the logboat as it exists now and part as it may have looked when first constructed. A painted backdrop gave an impression of Poole Harbour as it might have appeared with the lower sea levels prevailing in the Iron Age (Figure 6.2).

This approach reflected contemporary museum trends towards dialogue with the visitor and the use of diverse learning styles. The most significant disadvantage was the lack of the genuine artefact. In addition, dioramas present a very static view of the past. There could be many different interpretations about how the logboat was used, and by whom. A diorama's limitations are that it can only present one single interpretation, and one single moment in time.

Sucrose conservation

Alternative conservation plans were investigated and sucrose treatment was chosen as the most appropriate. This began in 1995: once again, the logboat was undergoing pioneering treatment – one that would eventually prove successful.



Figure 6.2 Diorama of the Poole logboat at Poole Waterfront Museum, late 1990s

Reconstruction projects

Plans for the display of the actual logboat were influenced by the boat reconstruction projects which it inspired. The idea of reconstructing it first emerged in the late 1980s, when Dr Peter Reynolds of Butser Ancient Farm was initially approached to carry out the project. The idea was that replicas would be displayed alongside the newly conserved original logboat in the new museum. Accompanying this would be film footage of the boats being made and computer graphics which would play out various ‘what if?’ scenarios. These ideas were never realised, largely for logistical reasons, not least that it would have been impossible to fit a full-size replica inside the museum. More significantly, the conservation of the logboat was problematic at this time, so the idea of displaying a replica next to the original was abandoned.

The project eventually came to fruition in the mid-1990s, led by experimental archaeologist Jake Keen of the nearby Cranborne Ancient Technology Centre. This time the project also had learning and public archaeology at its heart, involving as many local schools as possible. Schools were involved in all phases of the boat’s construction. One of the replicas was made from a suitable oak log obtained locally, with a ceremony when the tree was felled led by a local educational theatre group (see Chapter 3).

Both cutting and burning were attempted during the hollowing-out phase. The latter was less successful than the former. The log was felled, trimmed, split with wooden wedges and roughed out *in situ*, after which it was moved for the final phase of finishing. The results of these experiments were never published, but they did shed light on construction techniques. While considerable effort was involved, it was shown that the construction was within the capacity of a small Iron Age community. The film of this process can be seen in an audiovisual display next to the logboat on Poole Museum’s ground floor. Another film shows footage of sea trials.

Two replicas of the logboat were built. One of the main objectives of the experiment was to understand better how the boat was used by carrying out handling and loading trials. Handling of the replicas did prove difficult; one was sailed successfully into Christchurch Harbour but it was only a partial replica made of pine instead of oak.

The reconstruction projects proved successful in generating enthusiasm for the logboat amongst the local community and increasing knowledge and understanding of how it was constructed.

The present display

By the late 1990s, the museum displays were due an update. A Heritage Lottery Fund (HLF) capital grant of £750,000, plus donations from the local community, generated £1.3 million in total for the redevelopment of the museum. The HLF grant also included £35,000 to complete the conservation of the logboat and display it in the new museum. For the first time, it would be possible to create a semi-permanent display using the actual logboat rather than a replica.

Interpretation in general would be story-led rather than object-led, and these stories could be changed over time. One of the exceptions to this rule was the logboat, recognised as a key object. The new museum would focus primarily on the story of Poole by concentrating on three broad themes: People, Places, and Maritime. The logboat was the binding object that could unite these themes.

An important issue in deciding how to display the vessel was the space limitations. The weight of the logboat in 2001 was estimated to be around 850 kg. The dimensions of the boat were 10.01 m long, 1.52 m wide and c. 0.50 m high. The weight of the logboat and its colossal size meant that an early plan to display it on the first floor was abandoned. It was to be installed on ground level, at the entrance to the museum, and would therefore be one of the first objects visitors would see. This visual statement would set the tone for the museum as a whole: here was a rare case in which the logistics and physical limitations of the space had actually helped to improve the display.

Rather than recreate a diorama for the vessel, a more minimalist style of backdrop was chosen – a stark, plain white background. This was designed to prevent overcrowding the logboat with too much imagery and to avoid speculative attempts to depict the people who might have used it (Figure 6.3).

This chimed with the overall style of the newly redeveloped museum, which was



Figure 6.3 The logboat as it is displayed today



Figure 6.4 Digitally recording the logboat in 2013

designed with the aim of creating a lighter, more contemporary and more spacious atmosphere. Many extraneous fixtures and fittings were removed during the redevelopment, both to simplify and enlarge the display space and to reveal as much of the fabric of the 19th-century warehouse as possible. The use of colour was carefully considered, with background tones kept to a minimum, bringing the objects themselves to the fore by reducing the visual clutter around them.

Roundels were placed on the purpose-built case pointing out key facts about the logboat. These were designed to be quick and easy references to help visitors understand the significance and importance of the vessel.

In 2013, the logboat was digitally recorded using laser scanning techniques to create a 3D virtual model (Figure 6.4).

The ground-floor gallery focuses exclusively on the logboat, speculating about the people that built it, how it was built, what it was used for, and its chronological link with the Green Island jetty (Table 6.1).

The aspects of the logboat most frequently commented upon are the sugar conservation method, its size, and its rarity. A series of graphics panels also cover the following themes:

- The Iron Age environment;
- The significance and importance of the Poole logboat;
- Iron Age boat builders (incorporating the story of the Green Island Causeway);
- What was the logboat used for?
- How has the logboat survived?
- How the logboat was built.

Table 6.1 Styles of interpretation in the ground-floor logboat gallery

Written	Visual	Audio	Kinaesthetic
Text panels Roundels featuring short facts about the logboat, e.g. 'The largest logboat ever found in southern Britain'	Images in graphic interpretation panels Video footage of children working on the logboat replica in 1994 Computer animation showing the changing shape of Poole Harbour	Point on museum sensory trail – sound of a large tree being felled	Replica tools on display – blades are fixed and covered in perspex

A computer graphic shows where the logboat was found off Brownsea Island in Poole Harbour, and how the shape of the harbour has changed over the last 20,000 years. While the computer graphic already looks fairly basic at the time of writing, it does put the vessel in the context of its landscape.

Text panels detail the logboat's narrative, but observation has shown that visitors are unlikely to read these panels closely (Figure 6.5). Rather than offering one single definitive interpretation, current interpretation aims to encourage visitors to come to their own conclusions about the logboat based on such questions as:

- What was its significance to the people that built and used it?
- How was it used in the context of Poole's bustling Iron Age port?

At the moment, interpretation around the vessel tries to highlight these questions, as well as adding context about the landscape and port at the time of its use. The vessel's interpretation extends beyond the museum walls: there is even a Twitter account dedicated to @LoggieLogboat. It is almost as though the logboat has developed its own personality.

The future interpretation of the logboat

The challenge for future interpretation is to bring visitors in to a new relationship with this extraordinary artefact: to encourage a challenging dialogue between the professional people who have conserved, researched and presented the logboat and those who view it. Rather than receive the interpretation as a final statement of fact, the visitor will be encouraged to explore the many questions that still surround the vessel.

This could take the form of a 'comments wall' where people could be encouraged to share their questions and ideas about the logboat, or perhaps online or through particular events. Perhaps by providing audiences with a platform to share their own ideas and develop conversations, the museum could encourage richer discussions, as well as a more reflective experience for the visitor.

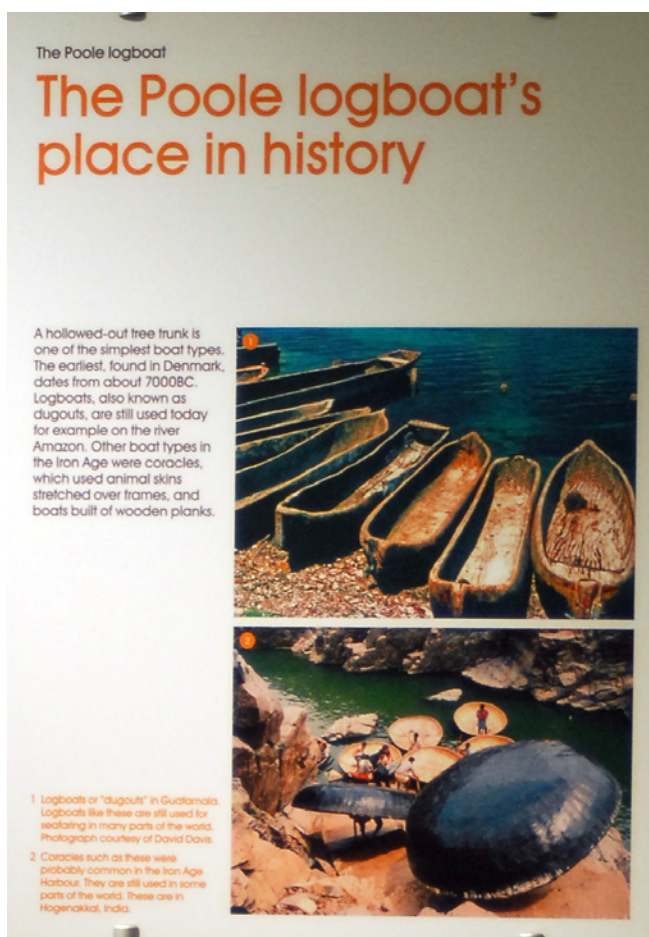

Figure 6.5 Text panel from the current display at Poole Museum

The British Museum has adopted a system of using ‘gateway objects’ to introduce people to wider topics by placing key concepts close to important objects, rather than relying heavily on text panels. The objects in question must be highly recognisable and work as an ‘intellectual gateway’ to understanding wider themes. Poole’s logboat could certainly be an effective ‘gateway’ object.

New topics

There is exciting scope to expand on the nature of Poole Harbour and its communities in the Middle Iron Age. Archaeological evidence indicates that sea level was about 2.7m lower at this period. This would totally change the nature of the harbour, which is relatively very shallow in relation to its area. The area of the logboat’s discovery should be investigated for potential settlement evidence.

We can also expand on the luck of the discovery:

- The chance discovery by a dredger of one section of the logboat;
- The recognition by the finders that it was of sufficient interest to inform Poole Museum;
- The return to the findspot by divers who discovered the other section.

New technologies

No discussion of interpretation in the future would be complete without mention of the rapidly changing digital and technological advances taking place. There is a danger, however, that any such debate will be outdated by the time it comes to print. Augmented reality could be employed to visualise the logboat as it might have been when first built, and to help interpret what an Iron Age Poole Harbour looked like. 3D scanning, carried out for this monograph by the Maritime Archaeology Sea Trust (MAST), and printing may also be employed to help the public see the boat from all angles – particularly useful as only one side of the vessel is visible in its display case.

Increasingly sophisticated computer graphic technology could be used to portray the logboat and its surrounding landscape more vividly. Mobile technology raises the possibility of using augmented reality, for instance, to allow smart-phone users to point their devices towards a view of the harbour and see a representation of Poole in the Iron Age. This kind of technology has been used successfully by the Museum of London in their StreetMuseum app, albeit using photographs from their archives rather than archaeological reconstructions.

The generation of new research, together with the constant growth of new digital technologies, presents exciting opportunities to revise and develop the interpretation of the vessel for the future. More multi-sensory resources could cater for a wider range of learning styles. This could involve more tactile exhibits related to the vessel. An audio trail around the museum includes the sound of a tree being felled, but perhaps sound could be used more imaginatively to breathe added life into the display. In the future, there is likely to be a reduced reliance on traditional text panels and a greater emphasis on digital technologies.

While important strides have been made in developing the vessel’s interpretation, there is still a great deal of potential to create an exciting, innovative interpretation of what is, and will remain, a star object for Poole.

Bibliography

- Allen, J. and M. Fulford, 1996. The distribution of south-east Dorset black burnished category I pottery in south-west Britain. *Britannia* 27: 223–81.
- Allen, S. J. and J. A. Spriggs 2001. The Redisplay of Viking house timbers in Jorvik, York, in P. Hoffmann, J. A. Spriggs, T. Grant, C. Cook and A. Recht (eds) *Proceedings of the 8th ICOM Group on Wet Organic Archaeological Materials Conference*: 137–44. Stockholm 2001.
- Best, E. 1976. *The Maori Canoe*. Wellington: Shearer.
- Bournemouth University, 2001. Early history of the English Channel project, <http://csweb.bournemouth.ac.uk/ehc> [accessed 9 October 2018].
- Bowen, H. C. 1975–76. A Romano-British site off Brownsea Island. *National Trust Yearbook 1975–76*, 42–3.
- BP Exploration, 1991. *Understanding Poole Bay. The hydraulic studies*. Poole: BP Exploration Operation Co Ltd.
- Bristow, C. R., E. C. Freshney and I. E. Penn, 1991. *Geology of the Country around Bournemouth*. Memoir for 1:50,000 geological sheet (329, England and Wales), HMSO.
- Bromby, A. 1969. Site report on excavations on Green Island. Manuscript PM62 (Green Island), Poole Museum.
- Bryant, L. and W. Horner, 1990. Dorset, in B Coles (ed.) *Organic archaeological remains in southwest Britain. A survey of the available evidence*: 35–56. WARP Occasional Paper 4. Exeter: University of Exeter.
- Brunning, R., S. Johnson and R. Morgan 2000. Wood and woodworking at Goldcliffe 400–1 BC, in M. Bell, A. Caseldine and H. Neumann (eds) *Prehistoric Intertidal Archaeology in the Welsh Severn Estuary*, 169–207. CBA Research Report 120. York: Council for British Archaeology.
- Bugler, J. 1967. Poole Harbour ‘causeway’. *Proceedings of the Dorset Natural History and Archaeological Society* 88: 158–60.
- Calkin, J. 1951. The Bournemouth Area in Neolithic and Early Bronze Age times. *Proceedings of the Dorset Natural History and Archaeological Society* 73: 32–70.
- Calkin, J. 1955. ‘Kimmeridge coal-money’. The Romano-British shale armlet industry. *Proceedings of the Dorset Natural History and Archaeological Society* 75: 45–71.
- Christensen, A. E. 1968. Sjøvollen Ship. *Viking* 32: 131–53.
- Clark, P. (ed.) 2004. *The Dover Bronze Age Boat*. London: English Heritage.
- Coles, J. and B. Orme 1985. *Prehistoric woodworking from the Somerset Levels: 2. Species selection and prehistoric woodlands*. Somerset Levels Paper 11, 7–24. Exeter: Severn Estuary Levels Research Committee.
- Compass Hydrographic Services Ltd. 2006. Measurement of the Changes in Flow Regime at Poole Harbour Entrance Following Channel Deepening For Poole Harbour Commissioners. Report No. 06/09/10047/1/JAT. https://www.phc.co.uk/downloads/environment/env_harbourmon_appen06_0807.pdf [accessed 5 November 2018].
- Cook, R. 2007. Spatial and temporal scales of the morphodynamic evolution within the Studland complex. Unpublished PhD dissertation, Bournemouth University.
- Cox, P. 1985. Excavation and survey on Furzey Island, Poole Harbour (SZ011871) – an interim note. *Proceedings of the Dorset Natural History and Archaeological Society* 107: 157–8.
- Cox, P. 1988. Excavation and survey on Furzey Island, Poole Harbour, Dorset. *Proceedings of the Dorset Natural History and Archaeological Society* 110: 49–72.
- Cox, P. and C. Hearne 1991. *Redeemed from the heath. Archaeology of the Wytch Farm oilfield (1987–90)*. Dorset Natural History and Archaeological Society Monograph Series 9. Dorchester: Dorset Natural History and Archaeological Society.
- Crumlin-Pedersen, O. and S. McGrail 2006. Some Principles for the Reconstruction of Ancient Boat Structures. *International Journal of Nautical Archaeology* 35(1): 53–57.
- Cunliffe, B. 1972. The late Iron Age metalwork from Bulbury, Dorset. *Antiquaries Journal* 52: 293–308.
- Cunliffe, B. 1987. *Hengistbury Head, Dorset. Volume 1: The prehistoric and Roman settlement, 3500 BC – AD 500*. Oxford: Oxford University Committee for Archaeology.
- Cunnington, E. 1884. On a hoard of bronze, iron, and other objects found in Belbury Camp, Dorset. *Archaeologia* 68: 115–20.
- Darrah, R. 2004a, Woodland management and timber conversion, in P. Clark (ed.) 2004, 106–23.
- Darrah, R. 2004b, The reconstruction experiment, in P. Clark (ed.) 2004, 164–88.
- Edwards, R. 2001. Mid- to late Holocene relative sea-level change in Poole Harbour, southern England. *Journal of Quaternary Science* 16 (3): 221–35.

- Farrar, R. 1963. Archaeological notes and news. *Proceedings of the Dorset Natural History and Archaeological Society* 86: 94–106.
- Farrar, R. 1964. Iron Age and Roman occupation on Green Island, Poole Harbour, in *Archaeological Notes and News. Proceedings of the Dorset Natural History and Archaeological Society* 85: 104–5.
- Farrar, R. 1967. The ancient occupation of Green Island, Poole Harbour, in *Archaeological Notes and News. Proceedings of the Dorset Natural History and Archaeological Society* 88: 121.
- Farrar, R. 1977. A Romano-British black-burnished ware industry at Ower in the Isle of Purbeck, Dorset, in J Dore and K Green (eds) *Roman pottery industries in Britain and beyond*: 199–228. British Archaeological Reports Supplementary Series 30. Oxford: British Archaeological Reports.
- Farrar, R. 1982. The Black Burnished ware factory at Redcliff, Arne. *Proceedings of the Dorset Natural History and Archaeological Society* 104: 186–7.
- Forest Products Laboratory 1999. *Wood handbook – Wood as an engineering material*. Gen. Tech. Rep. FPL-GTR-113. Madison, WI: U.S. Department of Agriculture, Forest Service, Forest Products Laboratory.
- Fox, C. 1926. A dugout canoe from south Wales: with notes on the chronology, typology, and distribution of monoxyulous craft in England and Wales. *Antiquaries Journal* 6: 121–51.
- Garrett, W. E. and D. T. Kirkendall 2000. *Exercise and Sport Science*. Philadelphia: Lippincott Williams & Wilkins.
- Goodburn, D. 1989. Toolmarks on the logboat, in P. Marsden (ed.) *A Late Saxon logboat from Clapton, London Borough of Hackney, Intl Journal Nautical Archaeology* 18:2, 97–103.
- Goodburn, D. 1994. Notes on the potential of the Poole dugout for further research, its national importance and current condition. Unpublished report for Poole Museum Service.
- Goodburn, D. 2002. *An Archaeology of Early English Boatbuilding Practice c. AD 900–1600*: Based mainly on finds from SE England. Unpublished PhD dissertation, UCL London, Institute of Archaeology.
- Goodburn, D. 2003. Prehistoric Woodwork, in R. Masefield, N. Branch, P. Couldrey, D. Goodburn and I. Tyers, *A Later Bronze Age Well Complex at Swalecliffe, Kent, Antiquaries Jnl* 83: 98–105.
- Goodburn, D. 2004. Assembly and construction techniques, in P. Clark (ed.) 2004, 124–61.
- Goodburn, D. 2010. Reconstructing manufacture: Tools, Techniques and Logistics, in D. Strachan 2010, 97–113.
- Goodburn, D. and M. Redknap 1988. Replicas and wrecks from the Thames area. *London Archaeologist* 6:1, 7–10 and 19–22.
- Green, F. 1940. *Poole Harbour: a hydrographic survey*. London: Geographical Publications.
- Grosso, G. H. 1981. Experiments with sugar in conserving waterlogged wood. *ICOM Committee for Conservation. 6th Triennial meeting, Ottawa*. Preprints 81/7/7/1–9.
- Hathaway, S. J. 2005. Poole Harbour: a review of early and more recent archaeological investigations with evidence for Iron Age and Romano-British salt production. *Proceedings of the Dorset Natural History and Archaeological Society* 127: 53–7.
- Hathaway, S. 2013. Making the invisible, visible. Iron Age and Roman salt-production in southern Britain. Unpublished PhD dissertation, Bournemouth University.
- Hawkins, A. 1971. Sea-level changes around south-west England. *The Colston Papers* 23: 67–87.
- Hearne, C. and R. Smith 1991. A late Iron Age settlement and black-burnished ware (BB1) production site at Worgret, near Wareham, Dorset (1986–87). *Proceedings of the Dorset Natural History and Archaeological Society* 113: 55–105.
- Hoffmann, P. 1990. Sucrose for the stabilization of waterlogged wood – some investigations into anti-shrinking-efficiency (ASE) and penetration, in P. Hoffman (ed.) *Proceedings of the 4th ICOM Group on Wet Organic Archaeological Materials Conference*: 317–28 . Bremerhaven 1990.
- Hoffmann, P. 1993. Sucrose for the stabilization of waterlogged wood II – stabilisation and the degree of degradation, in P. Hoffman *Proceedings of the 5th ICOM Group on Wet Organic Archaeological Materials Conference*, 357–80. Portland, Maine 1993.
- Holtrop, J. 1984. A Statistical Re-Analysis of Resistance and Propulsion Data. *International Shipbuilding Progress* 31(363): 272–6.
- Horsey, I. 1992. *Excavations in Poole 1973–1983*. Dorset Natural History and Archaeological Society Monograph 10. Dorchester: Dorset Natural History and Archaeological Society.
- Hutchings, J. 1992. Investigation into the large-scale treatment of waterlogged wood with sucrose solution. Unpublished dissertation for post-graduate Diploma in Archaeological Conservation, Durham University.
- Hutchings, J. 1996. Conservation of the Poole logboat: sucrose treatment on a large scale, in P. Hoffmann, T. Daley, T. Grant and J. A. Spriggs (eds) *Proceedings of the 6th ICOM Group on Wet Organic Archaeological Materials Conference*: 281–91. York 1996.

- Hutchings, J. 2003. Statement on current status and future requirements for completion of treatment and display of the Poole Logboat. Unpublished internal report for Poole Museum.
- Hutchings, J. and J. A. Spriggs 2004. The Poole logboat: A treatment update, and investigation into a suitable drying regime for large-scale sucrose-impregnated waterlogged wood, in P. Hoffmann, K. Strætkvern, J. A. Spriggs and D. Gregory (eds) *Proceedings of the 9th ICOM/CC Group on Wet Organic Archaeological Materials Conference*: 333–53. Copenhagen 2004.
- Hutchings, J. and J. A. Spriggs 2009. Conservation of the Poole Logboat, part 3: Slow drying and display, in H. Huismann and K. Strætkvern (eds) *Proceedings of the 10th ICOM/CC Group on Wet Organic Archaeological Materials Conference*: 271–90. Amsterdam 2007.
- Hutchins, J. 1803 (2nd edn). *The history and antiquities of the county of Dorset*. 3 volumes. London: Nichols and Sons.
- Hutchins, J. 1862–73 (3rd edn). *The history and antiquities of the county of Dorset*. 4 volumes. London: Nichols and Sons.
- Ivamy, E. R. Hardy and Chalmers, Sir Mackenzie D. E. S. 1976. *Chalmers' Marine Insurance Act 1906*. London: Butterworths.
- Jarvis, K. 1985. Observations for sea-level changes on the south-east side of Furzey Island, Poole Harbour. *Proceedings of the Dorset Natural History and Archaeological Society* 107: 153–4.
- Jarvis, K. 1992. An inter-tidal zone Romano-British site on Brownsea Island. *Proceedings of the Dorset Natural History and Archaeological Society* 114: 89–95.
- Jones, G. 2017. Sourcing the clay: Iron Age pottery production around Poole Harbour and the Isle of Purbeck, Dorset, UK. Unpublished PhD dissertation, Bournemouth University.
- Jones, T., N. Nayling and P. Tanner 2013. Digitally Reconstructing the Newport Medieval Ship: 3D Designs and Dynamic Visualisations for Recreating the Original Hull Form, Loading Factors, Displacement and Sailing Characteristics, in C. Breen and W. Forsythe (eds) *ACUA Underwater Archaeology Proceedings 2013*, 123–29. Advisory Council on Underwater Archaeology.
- Kiln-direct 2002–2011. Developing a drying schedule based on a drying gradient, www.kiln-direct.com [accessed 13 November 2018]
- Ladle, L. 1993. *The Studland Bay Wreck*. Poole, Poole Museum Service.
- Ladle, L. and A. Woodward (eds) 2009. *Excavations at Bestwall Quarry, Wareham 1992–2005. Volume 1: Prehistoric Landscape*. Dorset Natural History and Archaeological Society Monograph 19. Dorchester, Dorset Natural History and Archaeological Society.
- Lincoln, L. 1991. *Coast Salish Canoes*. Seattle: Center for Wooden Boats.
- McGrail, S. and R. Switsur 1975. Early boats and their chronology. *International Journal of Nautical Archaeology and Underwater Exploration* 4: 191–200.
- McGrail, S. 1977. Searching for patterns among the logboats of England and Wales, in *Sources and Techniques in Boat Archaeology*, 115–35. BAR Supplementary Series 29. Greenwich: National Maritime Museum.
- McGrail, S. 1978 *Logboats of England and Wales*. BAR British Series 51.
- McGrail, S. 1998. *Ancient Boats in North-West Europe: The Archaeology of Water Transport to AD 1500*. Longman Archaeology Series. London: Longman.
- McGrail, S. 2001. *Boats of the World - From the Stone Age to Medieval Times*. Oxford: Oxford University Press.
- McKee, E. 1974. *Building and Trials of the Replica of an Ancient Boat: The Gokstad Faering, Part 2: The Sea Trials*. Maritime Monographs and Reports No. 11. Greenwich: National Maritime Museum.
- Marchaj, C. A. 1964. *Sailing Theory and Practice*. London: Adlard Coles.
- Markey, M., E. Wilkes and T. Darvill 2002. Poole Harbour. Iron Age port. *Current Archaeology* 181: 7–11.
- Markey, M. forthcoming. An Iron Age port in Poole Harbour, Dorset. *Proceedings of the Dorset Natural History and Archaeological Society*.
- Marsden, P. 2004, Description of the boat, in P. Clark (ed.) 2004, 32–94.
- Mathlouthia, M. and J. Genotelleb 1998. Role of water in sucrose crystallization. *Carbohydrate Polymers* 37: 335–42.
- May, V. J. 1969. Reclamation and shoreline change in Poole Harbour, Dorset. *Proceedings of the Dorset Natural History and Archaeological Society* 90: 141–54.
- Maynard, D. 1988. Excavations on a pipeline near the River Frome, Worgret, Dorset. *Proceedings of the Dorset Natural History and Archaeological Society* 110: 77–98.
- Mietke, H. and D. Martin 1999. Sugar Preservation of the Friesland Ship: Chemical and Microbiological Investigations and Insights, in C. Bonnot-Diconne, X. Hiron, Q. K. Tran and P. Hoffmann *Proceedings of the 7th ICOM/CC Group on Wet Organic Archaeological Materials Conference*: 204–9. Grenoble 1998.
- Millett, M., S. McGrail, J. D. Creighton, C. W. Gregson, S. V. E. Heal, J. Hillam, L. Holdridge, D. Jordan, P. J. Spencer, S. Stallibrass, D. Stevens, and J. Turner 1987 The Archaeology of the Hasholme Logboat. *Archaeological Journal* 144: 69–155.

- Monteith, J. and E. Craig-Atkins 2012. Ower, Corfe Castle. *Proceedings of the Dorset Natural History and Archaeological Society* 133: 104–5.
- Morgos, A., L. Glattfelder-McQuirk and E. Gondár 1987. The cheapest method for conservation of waterlogged wood: the use of unheated sucrose solution. *ICOM Committee for Conservation, 8th Triennial Meeting, Sydney*. Preprints 313–19.
- Morgos, A. and L. Glattfelder-McQuirk 1990. The sucrose conservation of 15th–16th century waterlogged wooden finds. *ICOM Committee for Conservation, 9th Triennial Meeting, Dresden*. Preprints 241–3.
- Morken, R. 1980. Langskip, Knarr Og Kogge. *Bergen* (s 31 f).
- Mowat, R. 1996. *Logboats of Scotland*. Oxbow Monograph 68. Oxford: Oxbow.
- Museum and Galleries Commission 1992. *MGC standards in the museum care of archaeological collections 1992*. London: Museum and Galleries Commission.
- Nayling, N., D. Maynard and S. McGrail 1994. Barland's Farm, Magor, Gwent: a Romano-Celtic boat. *Antiquity* 68: 596–603.
- Nayling, N. and S. McGrail 2004. *The Barland's Farm Romano-Celtic Boat*. CBA Research Report 138. York: Council for British Archaeology.
- Needham, S., D. Parham and C. Frieman 2013. *Claimed by the Sea: Salcombe, Langdon and Other Marine Finds of the Bronze Age*. CBA Research Report 173. York: Council for British Archaeology.
- O'Sullivan, A. 1997. Neolithic, Bronze Age and Iron Age Woodworking Techniques, in B. Raftery, Trackway Excavations in the Mount Dillon Bogs, Co. Longford, 1985–1991, *Trans Irish Archaeological Wetland Unit* 3, 291–342.
- Palmer, J. 2001. Roman Purbeck stone, a new database. *Proceedings of the Dorset Natural History and Archaeological Society* 123: 104–9.
- Parrent, J. M. 1985. The conservation of waterlogged wood using sucrose. *Studies in Conservation* 30: 63–72.
- Parry, S. and S. McGrail 1991. A prehistoric plank boat fragment and a hard from Caldicot Castle Lake, Gwent, Wales. *International Journal of Nautical Archaeology* 20 (4): 321–4.
- Peacock, D. (ed) 1977. *Pottery and early commerce*. London: Academic Press.
- Peers, R. 1965. Dugout Canoe from Poole Harbour, Dorset. *Proceedings of the Dorset Natural History and Archaeological Society* 86: 131–4.
- Peterken, G. 1996. *Natural Woodland*. Cambridge: Cambridge University Press.
- Piggott, S. 1983. *The Earliest Wheeled Transport from the Atlantic Coast to the Caspian Sea*. London: Thames and Hudson.
- Plint, A. G. 1983. Facies, environments and sedimentary cycles in the Middle Eocene, Bracklesham Formation of the Hampshire Basin: evidence for global sea-level changes? *Sedimentology* 30: 625–54.
- Rackham, O. 1976. *Trees and woodland in the British landscape*. London: Dent.
- Rasmussen, H. 1953, Hasselø-Ege. *Kuml* 3(3), 15–46.
- RCHME, 1970. *An inventory of the historical monuments in the county of Dorset*. London: HMSO.
- Redknap, M. and D. Goodburn forthcoming. Logboats from the Lake, in A. Lane and M. Redknap (eds) *Llangorse Crannog. The excavation of an early medieval royal site in the kingdom of Brycheiniog*.
- Roberts, K. and P. Shackleton 1983. *The Canoe*. Toronto: Macmillan Canada.
- Robinson, A. 1955. The harbour entrances of Poole, Christchurch and Pagham. *Geographical Journal* 121: 33–50.
- Sands, R. 1997. *Prehistoric Woodworking: The Analysis and Interpretation of Bronze and Iron Age Toolmarks*. Wood in Archaeology Vol 1. London: UCL Institute of Archaeology Publications.
- Sands, R. 2010. Characterisation of the transom toolmarks, in D. Strachan 2010, 75–80.
- Scaife, R. 1991. Pollen investigation and vegetational history, in P Cox and C Hearne *Redeemed from the heath. The archaeology of Wytch Farm oilfield (1987–90)*. Dorset Natural History and Archaeological Society Monograph Series 9: 180–97. Dorchester: Dorset Natural History and Archaeological Society.
- Scaife, R. 2009. The changing prehistoric vegetation and environment of the Poole Harbour region, in: L. Ladle and A. Woodward (eds), *Excavations at Bestwall Quarry, Wareham 1992–2005. Volume 1: Prehistoric Landscape*. Dorset Natural History and Archaeological Society Monograph 19: 16–36. Dorchester, Dorset Natural History and Archaeological Society.
- Spriggs, J. A. 2003. The Poole Iron-Age Log-boat – The Way Ahead. York Archaeological Trust internal report for Poole Museums.
- Steckel, R. H. 2004. New Light on the 'Dark Ages': The Remarkably Tall Stature of Northern European Men during the Medieval Era. *Social Science History* 28(2): 211–29.
- Strachan, D. 2010. *Carpow in Context: A Late Bronze Age Logboat from the Tay*. Edinburgh: Society of Antiquaries of Scotland.

- Strachan, D. and D. Goodburn, 2010. Considering propulsion and performance, in D. Strachan 2010, 115–23.
- Syratt, W. 1984. *Wytch Farm oilfield development. Environmental impact assessment. Volume I the existing environment – Poole Harbour and the Isle of Purbeck*. Bournemouth: BP Petroleum Development Ltd.
- Tanner, P. 2013. 3D Laser Scanning for the Digital Reconstruction and Analysis of a 16th-Century Clinker Built Sailing Vessel, in C. Breen and W. Forsythe (eds) *ACUA Underwater Archaeology Proceedings 2013, SHA Leicester*: 137–49. Advisory Council on Underwater Archaeology.
- Tully, D. and P. Tanner 2012. 3D Laser Scanning in Boat Recording. *Nautical Archaeology Newsletter*, Spring 2012, 3.
- Thomson, G. 2003. *The Museum Environment, Second Edition*. Oxford: Butterworth-Heinemann.
- Trim, P. J. 2018. Clay, Iron and Charcoal: an experimental investigation of the colour change and production of Romano-British Black Burnished Ware (SEDBB1). *Proceedings of the Dorset Natural History and Archaeological Society* 139, 208–19.
- Ward, E. 1922. *English coastal evolution*. London: Methuen.
- Watkins, D. 1994. *The Foundry: excavations on Poole waterfront 1986–87*. Dorset Natural History and Archaeological Society Monograph 14. Dorchester, Dorset Natural History and Archaeological Society.
- Wilkes, E. M. 2004. Iron Age maritime nodes on the English Channel coast. An investigation into the location, nature and context of early ports and harbours. Unpublished PhD dissertation, Bournemouth University.
- Wilkes, E. M. 2007. Prehistoric sea journeys and port approaches: the south coast and Poole Harbour, in V. Cummings and R. Johnston (eds) *Prehistoric Journeys*: 121–30. Oxford: Oxbow Books.
- Wilkes, E. M. 2010a. The Iron Age of Poole Harbour Islands and Ower Peninsula, in B. Dyer and T. Darvill (eds) *The Book of Poole Harbour*: 66–8. Wimborne Minster: Poole Harbour Heritage Project.
- Wilkes, E. M. 2010b. Iron Age and Roman Farmsteads around Poole Harbour, in B. Dyer and T. Darvill (eds) *The Book of Poole Harbour*: 69–70. Wimborne Minster: Poole Harbour Heritage Project.
- Wilkes, E. M. 2013. Iron Age ports, harbours and structures on the northern Channel coast, in M. Y. Daire (ed.) *Anciens peuplements littoraux et relations homme/milieu sur les côtes de l'Europe atlantique [Ancient maritime communities and the relationship between people and environment along the European Atlantic coasts]*, 275–82. BAR International Series S2570. Oxford: Archaeopress.
- Wilkes, E. and I. Hewitt 2000. *Poole Harbour littoral: the Holton Lee Project 2000*. School of Conservation Sciences Research Report 8. Bournemouth: Bournemouth University.
- Wilkie, D. R. 1960. Man as a source of mechanical power. *Ergonomics* 3(1), January: 1–8.
- Williams, D. 1977. The Romano-British black-burnished industry: an essay on characterisation by heavy mineral analysis, in D Peacock (ed.) *Pottery and early commerce*: 163–220. London: Academic Press.
- Williams, D. 1988. The impact of the Roman amphora trade on pre-Roman Britain, in T. Champion (ed.) *Centre and periphery, comparative studies in archaeology*: 142–50. *One World Archaeology* 11. London: Unwin Hyman.
- Woodward, P. 1987. Excavations of a late Iron Age trading settlement and Romano-British BB1 pottery production site at Ower, Dorset, in N. Sunter and P. Woodward *Romano-British industries in Purbeck*: 44–124. Dorset Natural History and Archaeological Society Monograph 6. Dorchester: Dorset Natural History and Archaeological Society.

Index

Entries in **bold** refer to the Figures

- archaeological conservation
 - history of 1, 12, 106
 - methods of *see* methods of conservation
 - monitoring of 90, 91, 96, 97, 98, 101, 103
- Arrowsmiths Ltd 97
- British Museum 111
- British Road Services 89
- British Sugar 1, 89, 90, 92
- Bronze age remains 10
- Brownsea Island 5, 7, 8, 9
- burials 8
- Butser Ancient Farm 107
- cargo 44, 45, 48–9, 51, 61, 72, 73, 75–8, 83
- centre of buoyancy 67, 70, 72, 84
- centre of mass 71–2, 73
- Chesham Chemicals 90
- Christchurch Harbour 11, 34
- climate 7
- Cranborne Centre for Ancient Technology 11, 107
- crew 44, 45, 48, 51, 57, 61, 72, 73, 74–81, 83
- currents *see* tides and currents
- degree of heel 44, 49, 71, 73, 74, 76–9, 81
- dioramas 106, **107**
- Dorchester Museum 1
- Dorset County Museum 106
- Downing, Annette 1
- draft 45, 48–9
- dredging 5, 7
- enclosures 9
- ethnography of logboat building 20, 24
- exchange networks *see* trade networks
- experimental archaeology 11, 29, 107
- flotation conditions 67, 73–81, 84
- Forest Fusion Ltd 89
- Fox, Cyril 12, 15, 24
- freeboard 44, 45, 48–9, 51, 73, 74, 76–9, 81, 84
- funding
 - corporate 1
 - Heritage Lottery 1, 94, 108
 - sponsorship 89
- Furzey Island 5, 8, 9
- Green Island 1, 5, 8, 9, 109
- Hanwell ‘Humbug’ data-loggers 97, 98
- Hengistbury Head 7, 9
- Hutchings, Jeremy 1, 88, 94
- Hutchins, John 8
- Jarvis, Keith **97**
- jetties 9, *see also* South Deep moles
- Keen, Jake 11, 107
- laser scanning 2, 14, 35, 38, 109, 111
- loading states 44, 45, 48–51, 73–81
- logboats ix, 12–13, 63–4
 - Brigg 18, 29
 - Canewdon 34
 - Carpow 14
 - Clapton 15
 - construction of 20
 - design of 15–16
 - distortion of 15–16
 - Hasholme 20, 21
 - Hasselo 65
 - Holme Pierrepont 1 64
 - Kentmere 1 64, 65
 - Loch Doon 1, 15
 - reconstructions of 11, 15, 29, 33–4
 - Short Ferry 64
 - Warrington 2, 64
- McGrail, Seán 12–13, 15, 18, 39
- maritime archaeology 12
- Mary Rose Trust 88
- masts 33, 65
- metacentric height 44, 48–9, 51, 73, 74, 76–9, 81, 84
- metal-working 8
- metalwork
 - Bronze age 10
- methods of conservation
 - air drying 2, 93–8, **99**, 102–3
 - development of 12, 106
 - freeze drying 1
 - polyethylene glycol 1, 87
 - sucrose treatment 1, 2, 87, 88, 89–90, **90**, 91–5, 103, 106
 - wood analysis 92, **93**, 95

- museum curation
 - use of new technology in 111
 - trends in 106, 108–9, 110–11
- National Maritime Museum 1, 12, 106
- National River Authority 89
- Newport medieval ship reconstruction 38, 51
- oak timber
 - behaviour of when drying 14, 15
 - green 14, 15, 31, 70–71
 - heartwood 18, 70
 - sapwood 18
 - seasoned 14, 70–71
 - seasoning time 15
 - shakes 15
 - weight of 20, 31, 67, 70–71, **99**
- Open University 90
- Ower Peninsular 8, 9
- paddles 10, 23, 34
- Piggott, Stuart 29
- Poole Harbour 5, **6**, 106, 111
 - archaeology of 8–10
 - geology of 5, 7
 - environment of 7
- Poole Harbour Commissioners 1
- Poole Iron Age logboat
 - 3D laser scan of **36–7**, **40–41**, **46–7**, **58–9**
 - bottom holes 27, 33, **62–3**, 63, 65
 - caulking 31, 61
 - cleaning 95–6, 102
 - conservation of 1–2, 87–103, 106, *see also* methods of conservation
 - construction of *see* Poole Iron Age logboat, construction of
 - construction of
 - dating of 8
 - design of 3, 8, 33
 - deterioration of 12, 16, 26, 54
 - dimensions, original 14, 16, 52, **53–4**
 - dimensions, present day 38–9, 96
 - discovery ix
 - display of 94, 102, 103, 105–6, **107**, 107, 108, **108**, 109–10
 - drawings and photographs of ix, 16–17, 35, 38, **38**, **40–43**, **46–7**, **58–9**, **68–9**, 89, **89**
 - false frame/transverse ridges 27, 30, 56, 57, **60**, 61
 - find location 1, 8–9, 110
 - functional division of 56–7, 61, **61**
 - future interpretations of 110–11
 - hogging of 38, 51, **51**, 52
 - hull step 56, **56**, **57**
 - interpretation to the public 105–10
 - load-carrying capacity 84, 85
 - means of propulsion 34, 61, 83
 - moisture content 94
 - moving of 20, 24, 26, 31, 32, **32**
 - oval mark 29
 - recording of 2, 12, 35, 109, **109**, *see also* laser scanning
 - recovery **105**
 - seaworthiness of 17, 32, 35, 71, 72–3, 84
 - shape 17, 24, 52, **53–4**, 55, **55**, 56, **56**, 67, 70, 81
 - shrinkage and distortion 15–16, 39, 52, 94, **100–101**, 101, 102
 - speed of 61, 65, 77, 81, 84
 - stem feature 56, **56**, **57**
 - thwarts 64, **64**, 65
 - toolmarks 12, 13, **14**, 27, **28**, 29
 - transom groove 26–7, 31, **62**
 - transom plank 27, 29, 61
 - tree anatomical features 13, **14**, 18
 - use of 1
 - visual examination of 13–14
 - volume of hollow 39
 - volume of wood 39
 - wear 12, 33
 - weight 17, 24, 26, 31–2, 39, 70, 71, 73, 85, 96, 101
- Poole Iron Age logboat, construction of 11, **22**, 23–7, **25**, **66**
 - hollowing out of half-log 23–4
 - marking of 31
 - number of people involved 23, 24, 32
 - shaping of 24–6
 - splitting of log 23
 - storage of 87
 - timescale 32
 - tool use 21, 23, 25, 26, 27
 - use of fats and oils 31
 - waste timber from 23
- Poole Iron Age logboat, parent tree of 11, 16, 18, **19**, 20, **53–4**, 54, **55**, 55, 65, **66**
 - felling of 21, **22**
 - selection of 20–21
 - weight of 20, 67
- Poole Iron Age logboat, reconstruction of ix, 15, 20, 34, 82–5, 107–8

- drawings of **44, 46–7, 56, 58–9, 61, 64, 65, 66, 68–9**
- repairing distortion 51–2, **52**
- testing of 44–5, 48–9, 54, 67, 70–81, 83–4, 108
- Poole Museum 1, 87, 88, 89, 105, 106, *see also* Poole Waterfront Museum
- Poole Rowing Club 1, 2, 89
- Poole Waterfront Museum 2, 13, 94, 102, 106
- pottery 8, 9
- pottery industry 8
- prehistoric boat-building traditions 2, 24
- prehistoric boats 33 *see also* logboats
 - Dover Boat, the 14
- prehistoric tool kits, *see* tools
- prehistoric wooden structures 29
- public archaeology 107–8
- Purbeck marble 8, 9
- Rackham, Oliver 17,
- radiocarbon dating ix, 8, 9, 30
- religion 20
- salt production 8, 9
- Scaplen's Court Museum 1, 2, 89, 96, 106
- sea level 5, 111
 - relative changes in 7
- shale-working 8, 9
- sheerline 33, 39, 54
- Smith, Graham 1, 106
- South Deep moles 1, 9–10
- Spriggs, Jim 1, 2, 91, 94, 101
- Tankfreight Ltd 89
- tides and currents 5, 7, 81
- tools 23, 29
 - adzes 23, 25–7, 29, 30, 33
 - axes 10, 18, 21, 25–7, 29, 30
 - gouge 27, 30
 - knife 29
 - mallets 30
 - wedges 30
- trade networks 1, 8, 9
- transom planks 15
- tree growth rings 18, 20
- vertical centre of gravity 44, *see also* centre of mass
- waterlogged wood 12, 14, 15, 16, 23–4, 94, 106
- Watkins, David 1, 89
- Werner, Dr A E A 106
- Wessex Water 89
- woodland, prehistoric 17–18, 20