

B. Done

A377 ✓

MR 78-3

# Ecological Effects of an Artificial Island, Rincon Island, Punta Gorda, California

by

G.F. Johnson and L.A. deWit

MISCELLANEOUS REPORT NO. 78-3

SEPTEMBER 1978

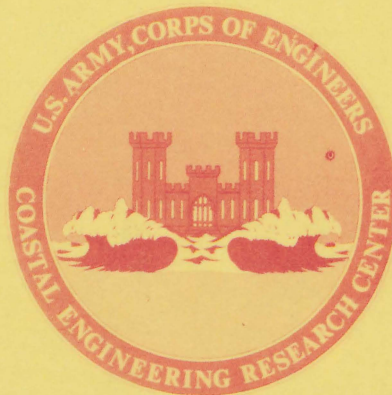

Approved for public release;  
distribution unlimited.

Prepared for

**U.S. ARMY, CORPS OF ENGINEERS  
COASTAL ENGINEERING  
RESEARCH CENTER**

Kingman Building  
Fort Belvoir, Va. 22060

Reprint or republication of any of this material shall give appropriate credit to the U.S. Army Coastal Engineering Research Center.

Limited free distribution within the United States of single copies of this publication has been made by this Center. Additional copies are available from:

*National Technical Information Service  
ATTN: Operations Division  
5285 Port Royal Road  
Springfield, Virginia 22151*

Contents of this report are not to be used for advertising, publication, or promotional purposes. Citation of trade names does not constitute an official endorsement or approval of the use of such commercial products.

The findings in this report are not to be construed as an official Department of the Army position unless so designated by other authorized documents.

UNCLASSIFIED

SECURITY CLASSIFICATION OF THIS PAGE (When Data Entered)

REPORT DOCUMENTATION PAGE		READ INSTRUCTIONS BEFORE COMPLETING FORM
1. REPORT NUMBER MR 78-3	2. GOVT ACCESSION NO.	3. RECIPIENT'S CATALOG NUMBER
4. TITLE (and Subtitle) ECOLOGICAL EFFECTS OF AN ARTIFICIAL ISLAND, RINCON ISLAND, PUNTA GORDA, CALIFORNIA		5. TYPE OF REPORT & PERIOD COVERED Miscellaneous Report
		6. PERFORMING ORG. REPORT NUMBER
7. AUTHOR(s) G.F. Johnson L.A. deWit		8. CONTRACT OR GRANT NUMBER(s) DACW 72-76-C-0011
9. PERFORMING ORGANIZATION NAME AND ADDRESS Dames & Moore 1100 Greendon Avenue Los Angeles, California 90024		10. PROGRAM ELEMENT, PROJECT, TASK AREA & WORK UNIT NUMBERS G31532
11. CONTROLLING OFFICE NAME AND ADDRESS Department of the Army Coastal Engineering Research Center Kingman Building, Fort Belvoir, Virginia 22060		12. REPORT DATE September 1978
		13. NUMBER OF PAGES 108
14. MONITORING AGENCY NAME & ADDRESS (if different from Controlling Office)		15. SECURITY CLASS. (of this report) UNCLASSIFIED
		15a. DECLASSIFICATION/DOWNGRADING SCHEDULE
16. DISTRIBUTION STATEMENT (of this Report)  Approved for public release; distribution unlimited.		
17. DISTRIBUTION STATEMENT (of the abstract entered in Block 20, if different from Report)		
18. SUPPLEMENTARY NOTES		
19. KEY WORDS (Continue on reverse side if necessary and identify by block number)		
Artificial island		Microecosystem
Bottom sediment		Punta Gorda, California
Ecological effects		Rincon Island
20. ABSTRACT (Continue on reverse side if necessary and identify by block number) This study documents marine ecological conditions at Rincon Island, located approximately 0.8 kilometer offshore between Ventura and Santa Barbara, California, in a depth of 14 meters. The island, which was constructed between 1957 and 1958 to serve as a permanent platform for oil and gas production, is particularly suitable for ecological study. Habitat features associated with the armor rock and concrete tetrapods surrounding the island support a "microecosystem" which differs in biotic composition from surrounding natural bottom areas. <span style="float: right;">(continued)</span>		

Major associations of macrobiota (organisms >1 millimeter in size) were distinguished on the basis of cooccurrences of conspicuously dominant organisms. Thirteen major associations, covering various parts of the island between the upper intertidal zone and shell debris or natural bottom at the foot of the rock revetments, were defined. The boundaries of each of the major associations and certain questionable or transition zones were mapped over the entire island. These associations were further characterized by extensive measurements of biomass and abundance of macrobiota occurring in quadrats placed according to a stratified random sampling scheme. Using these data, statistically based comparisons of biotic character were made between certain transition areas and definite associations. In some cases, questionable associations were lumped together.

A major part of the study was devoted to analysis of seasonal dynamics in biotic composition. Permanent transects extending from the high intertidal to natural bottom were established normal to each of the four cardinal sides of the island. All macrobiota were censused in duplicate 1-square meter quadrats along each transect during each of the four seasons. Data analysis indicated that many species exhibit significant variability in abundance from one season to the next.

Other studies included a gill net survey of fish fauna, mapping of mussel "talus" beds at the base of the island, and a survey of biota along a natural bottom transect between the island and shore.

In general, the findings indicate a rich and varied fauna and flora associated with the high-relief solid substrate of Rincon Island which differs substantially from the more depauperate natural bottom habitats in the area.

## PREFACE

The U.S. Army Coastal Engineering Research Center (CERC) conducts and sponsors research to provide definitive information on the ecological impacts of constructing coastal structures such as groins, jetties, breakwaters, and islands. Rincon Island, Punta Gorda, California, was the first major artificial island to be constructed with full ocean exposure. This report describes an 18-month study sponsored by CERC to examine ecological effects of construction of Rincon Island (CERC Contract No. DACW 72-76-C-0011).

The report was prepared by G.F. Johnson, Project Marine Ecologist, and L.A. deWit, Staff Marine Ecologist, with supervision provided by Dr. B.A. Wales, Principal-in-Charge; all of Dames & Moore, Consultants in the Environmental and Applied Earth Sciences, Los Angeles, California. Professor W.L. Brisby of Moorpark College, Moorpark, California, participated in the fieldwork and provided valuable consultation and review.

Special recognition is due to the following students of Professor Brisby, who were responsible for a major part of the field data acquisition: G. Wilson, D. Ospenson, D. Rasmussen, and R. Dawson. The authors gratefully acknowledge the interest in the project and valuable assistance provided by Dr. J. Siva, J. Hundley, C. Miller, and R. Carlson, all of Atlantic Richfield Corporation.

Marine Ecological Consultants, Inc. of Solana Beach, California, were subcontractors for taxonomic work. Dr. K.R. Critchlow of Dames & Moore assisted during two of the seasonal surveys of permanent transects. Dr. R.A. Park III, Professor of Geology and Ecosystem Analysis, Renssalaer Polytechnic Institute, directed an analysis of data using an R-mode cluster analysis computer program.

A.K. Hurme of the CERC Coastal Ecology Branch was the technical monitor for this contract under the general supervision of E.J. Pullen, Chief, Coastal Ecology Branch.

Comments on this publication are invited.

Approved for publication in accordance with Public Law 166, 79th Congress, approved 31 July 1945, as supplemented by Public Law 172, 88th Congress, approved 7 November 1963.

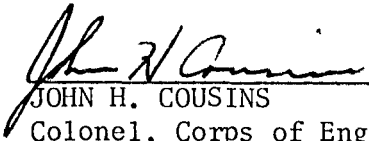
  
JOHN H. COUSINS  
Colonel, Corps of Engineers  
Commander and Director

## CONTENTS

	Page
CONVERSION FACTORS, U.S. CUSTOMARY TO METRIC (SI) . . . . .	6
I INTRODUCTION . . . . .	7
II PROJECT SETTING. . . . .	8
III PREVIOUS RELATED STUDIES . . . . .	8
1. General Studies of Artificial Habitat. . . . .	8
2. Previous Studies at Rincon Island. . . . .	11
IV STUDY METHODS. . . . .	12
1. General. . . . .	12
2. Reconnaissance Dives . . . . .	13
3. Talus Bed Measurements . . . . .	13
4. Seasonal Survey of Permanent Transects . . . . .	13
5. Mapping of Major Species Associations. . . . .	13
6. Quantitative Characterization of Species Associations. . . . .	17
7. Natural Bottom Survey. . . . .	19
8. Gill Net Surveys . . . . .	20
V RESULTS AND DISCUSSION . . . . .	20
1. General. . . . .	20
2. Volume and Dimensions of Talus Beds. . . . .	20
3. Analysis of Seasonal Data from Permanent Transects . . . . .	39
4. Distribution of Major Species Associations . . . . .	50
5. Quantitative Characteristics of Major Species Associations. . . . .	51
6. Gill Net Survey Results. . . . .	55
7. Natural Bottom Survey Results. . . . .	58
VI SUMMARY AND CONCLUSIONS. . . . .	62
LITERATURE CITED . . . . .	64
APPENDIX	
A DETAILED METHODOLOGY . . . . .	67
B SUMMARY DATA, SURVEY OF PERMANENT SEASONAL TRANSECTS . . . . .	74
C R-MODE DENDROGRAMS AND BOUNDARIES OF PRELIMINARY SPECIES ASSOCIATIONS . . . . .	82
D SUMMARY DATA, QUANTITATIVE CHARACTERIZATION OF MAJOR SPECIES ASSOCIATIONS . . . . .	92
E OBSERVATIONS ALONG NATURAL BOTTOM TRANSECT . . . . .	101
F SIEVE ANALYSIS OF NATURAL BOTTOM SEDIMENT SAMPLES. . . . .	103
G GLOSSARY . . . . .	107

CONTENTS--Continued

TABLES

	Page
1 Master species list for Rincon Island. . . . .	21
2 Seasonal transect data summary . . . . .	49
3 Gill net catch per hour at Rincon Island . . . . .	56
4 Biota of natural bottom sediment samples . . . . .	60

FIGURES

1 Aerial photograph of Rincon Island, spring 1977. . . . .	9
2 Local bathymetry of Rincon Island. . . . .	10
3 Locations of permanent seasonal transects, gill nets, natural bottom transect, and sediment grab sampling stations. . . . .	14
4 Structure of permanent seasonal transects. . . . .	15
5 North-side talus bed and armor rock measurements . . . . .	30
6 West-side talus bed and armor rock measurements. . . . .	31
7 South-side talus bed and armor rock measurements . . . . .	32
8 East-side talus bed and armor rock measurements. . . . .	33
9 Major species associations, northwest quadrant . . . . .	34
10 Major species associations, southwest quadrant . . . . .	35
11 Major species associations, southeast quadrant . . . . .	36
12 Major species associations, northeast quadrant . . . . .	37
13 Seasonal overview of distribution of major species associations and substrate character, north-side permanent transect. . . . .	40
14 Seasonal overview of distribution of major species associations and substrate character, west-side permanent transect . . . . .	41
15 Seasonal overview of distribution of major species associations and substrate character, south-side permanent transect. . . . .	42
16 Seasonal overview of distribution of major species associations and substrate character, east-side permanent transect . . . . .	43
17 Vertical distribution for dominant biota, north side . . . . .	44
18 Vertical distribution for dominant biota, west side. . . . .	45
19 Vertical distribution for dominant biota, south side . . . . .	46
20 Vertical distribution for dominant biota, east side. . . . .	47
21 Dominant biota and substrate type along natural bottom transect.	59

CONVERSION FACTORS, U.S. CUSTOMARY TO METRIC (SI)  
UNITS OF MEASUREMENT

U.S. customary units of measurement used in this report can be converted to metric (SI) units as follows:

Multiply	by	To obtain
inches	25.4	millimeters
	2.54	centimeters
square inches	6.452	square centimeters
cubic inches	16.39	cubic centimeters
feet	30.48	centimeters
	0.3048	meters
square feet	0.0929	square meters
cubic feet	0.0283	cubic meters
yards	0.9144	meters
square yards	0.836	square meters
cubic yards	0.7646	cubic meters
miles	1.6093	kilometers
square miles	259.0	hectares
knots	1.852	kilometers per hour
acres	0.4047	hectares
foot-pounds	1.3558	newton meters
millibars	$1.0197 \times 10^{-3}$	kilograms per square centimeter
ounces	28.35	grams
pounds	453.6	grams
	0.4536	kilograms
ton, long	1.0160	metric tons
ton, short	0.9072	metric tons
degrees (angle)	0.01745	radians
Fahrenheit degrees	5/9	Celsius degrees or Kelvins <sup>1</sup>

<sup>1</sup>To obtain Celsius (C) temperature readings from Fahrenheit (F) readings, use formula:  $C = (5/9) (F - 32)$ .

To obtain Kelvin (K) readings, use formula:  $K = (5/9) (F - 32) + 273.15$ .



# ECOLOGICAL EFFECTS OF AN ARTIFICIAL ISLAND

Rincon Island, Punta Gorda, California

by

*G.F. Johnson and L.A. deWit*

## I. INTRODUCTION

Several studies on the ecological effects of the addition of artificial substrate in a nearshore coastal marine environment have been conducted in the past. The California Department of Fish and Game, for example, has made detailed studies at oil platforms and in areas where artificial reefs composed of streetcars, old car bodies, concrete cubicles, and riprap have been established (Carlisle, Turner, and Ebert; 1964; Turner, Ebert, and Given, 1969).

In general, these studies conclude that the habitat features created by the addition of solid substrate are beneficial to the local ecosystem, especially in areas where such substrate is limited. In time, communities of organisms develop which usually support more species than the sedimentary habitat that existed before the addition of hard, high-relief substrate. The biomass of the encrusting flora and fauna is an important food source for species of recreational, commercial, or aesthetic value which would otherwise not populate the area. In addition, physical characteristics of the solid substratum, such as crevices and vertical relief in an otherwise featureless bottom, attract a variety of fishes.

The armor rock revetments of Rincon Island represent a significant addition of solid substratum to the local nearshore marine environment which has contributed to an enhancement in the richness of local marine communities (Carlisle, Turner, and Ebert, 1964; Brisby's Biota Appendix in Keith and Skjei, 1974). Although observations on Rincon Island's marine life have been made since these studies, no comprehensive delineation of major habitats nor detailed characterization of communities extant at any one time or on a seasonal basis has been done. This study was undertaken with the recognition that this information would be valuable in understanding the ecological consequences of artificial island construction. The objectives of the study were to:

- (a) Delineate, map, and quantitatively characterize major species associations around Rincon Island, and compare these with the biota of the natural bottom between the island and shore;
- (b) document the morphology and volume of the beds of shell debris lying along the flanks of each of the four cardinal sides of the island;

- (c) establish permanent transects on each side of the island and survey major benthic organisms along these transects on a seasonal basis, documenting changes in biotic composition and habitat character; and
- (d) conduct a gill net survey of the fish on each side of the island; and
- (e) expand the existing species list of the area.

## II. PROJECT SETTING

Rincon Island is located in the Santa Barbara Channel approximately midway between the cities of Santa Barbara and Ventura, California. The island is about 0.8 kilometer off Punta Gorda in about 14 meters of water, and is connected to the mainland by a causeway (Fig. 1). The extreme tidal range at the island is 3.05 meters. Mean sea level (MSL) lies 0.79 meter above mean lower low water (MLLW). The island covers about 0.026 square kilometer of ocean floor and the area above MLLW is approximately 0.013 square kilometer.

The island is constructed of rock revetments containing sandfill. It was constructed in stages between February 1957 and September 1958, using many types and gradations of quarry rock. The most exposed face (west side) is protected with 1,130 concrete tetrapods, each weighing about 31,000 kilograms. The general shape of the island and the local bathymetry are shown in Figure 2 (Dames & Moore, 1974). Bottom conditions vary uniformly throughout the area (Blume and Keith, 1959). The sediment consists of silty sand ranging into sandy silt with a thickness ranging from 4.3 to 7.6 meters. It overlies a geologically recent shale or "siltstone" formation. Average bottom slope is 3 percent.

Details of the construction and engineering considerations in the design of Rincon Island are summarized in Keith and Skjei (1974) and Blume and Keith (1959).

## III. PREVIOUS RELATED STUDIES

### 1. General Studies of Artificial Reef Habitat.

The value of artificial structures for attracting marine fishes was the subject of many papers presented at an International Artificial Reef Conference, cosponsored by Texas A&M University, the Texas Coastal and Marine Council, and the National Marine Fisheries Service (Colunga and Stone, 1974). The fish-attracting properties of nearshore artificial reefs composed of tires, car bodies, and riprap on the gulf and Atlantic coasts have been documented by Buchanan (1972), Stone (1972, 1973); Stone, Buchanan, and Parker (1973); and Stone, Buchanan, and Steimle (1974). The latter investigators reported an increase in the fish-carrying capacity of an area 300 to 1,800 times that of the open bottom before reef construction.

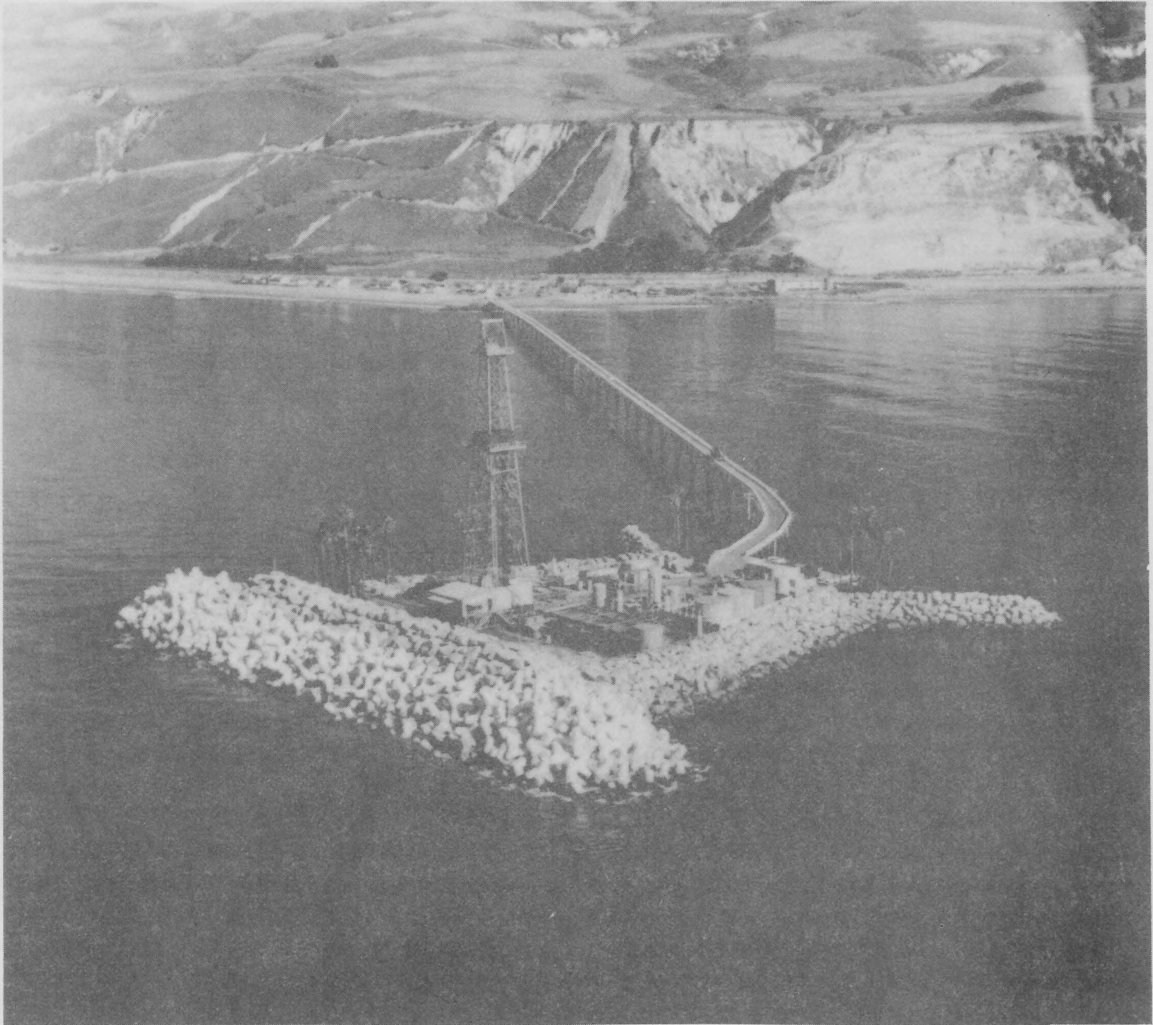

Figure 1. Aerial photograph of Rincon Island, spring 1977.

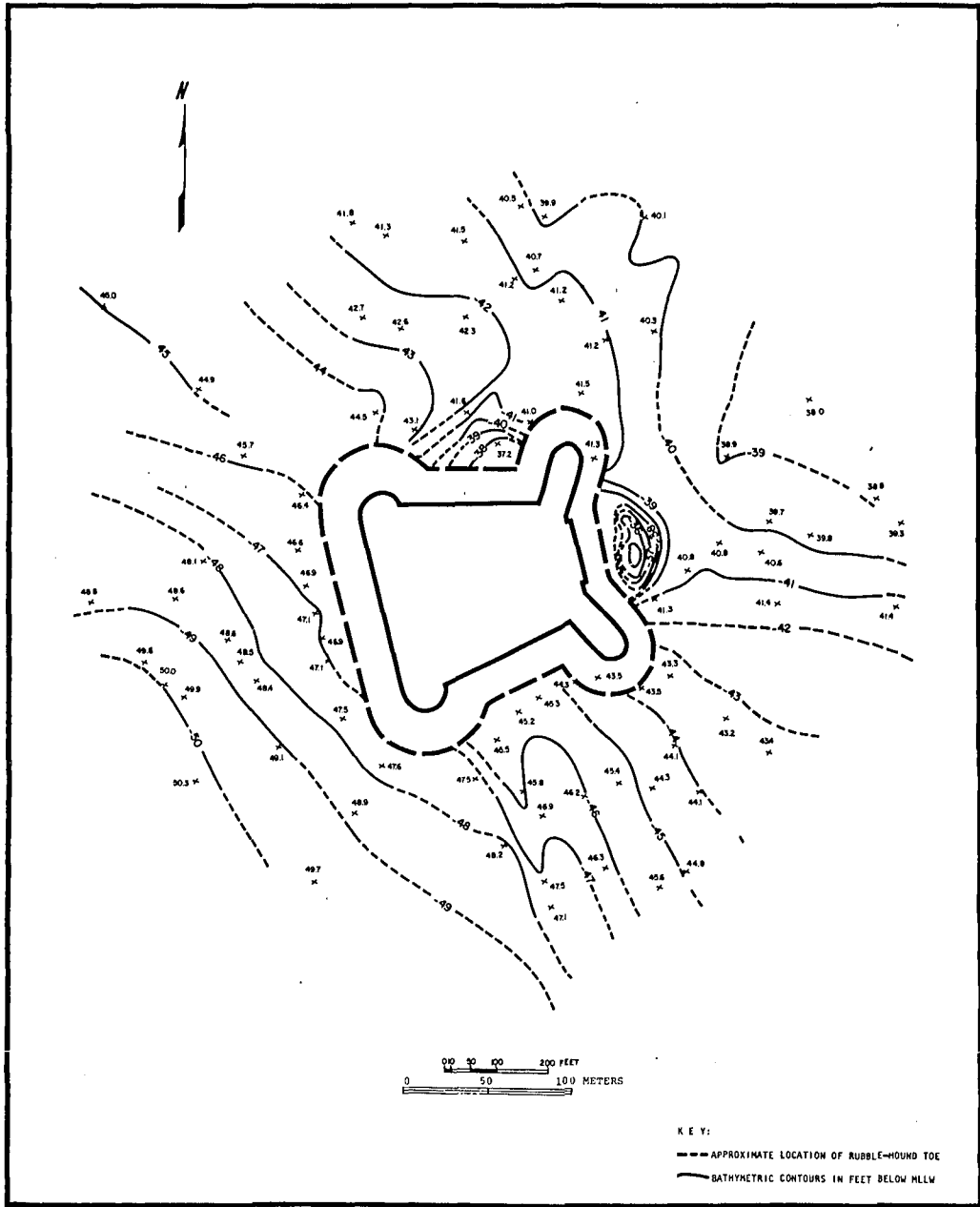

Figure 2. Local bathymetry of Rincon Island (from Dames & Moore, 1974).

Studies of artificial substrate properties affecting fish attraction and ecological succession in southern California were reported by Carlisle, Turner, and Ebert (1964), Turner, Ebert, and Given (1969), and Fager (1971). Carlisle, Turner, and Ebert (1964) conducted visual surveys of biota in bottom areas before and after artificial reef establishment, noting that fishes were attracted within hours of reef construction. Carlisle, Turner, and Ebert (1964) also made ecological observations at a number of offshore oil installations, including Rincon Island. They concluded that these sites exhibited similar attractions for fish and, more generally, that "habitat changes brought about by establishing offshore oil-drilling installations were generally beneficial to the flora and fauna."

Results of a 4-year study of various aspects of manmade reef ecosystems and optimal materials for reef construction, conducted by the California Department of Fish and Game, were published by Turner, Ebert, and Given (1969). Of four types of reef construction materials evaluated, quarry rock was judged optimal on the basis of practicalities of cost and handling, fish attraction (although concrete shelters were better in this regard), and minimal sediment disturbance. More than 200 invertebrate taxa were recorded during the study. Succession on the newly established reefs proceeded from an initial barnacle-hydroid phase, into a mollusk-polychaete assemblage, to an ascidian-sponge stage, and finally a stage characterized by the presence of abundant encrusting ectoprocts (moss animals). Aggregate anemones, gorgonians, and stony corals appeared in later stages. Approximately 5 years was required for successional change to cease on these artificial reefs.

## 2. Previous Studies of Rincon Island.

The California Department of Fish and Game biologists made an initial survey of Rincon Island in July 1958, 18 months after construction of the island began (Carlisle, Turner, and Ebert, 1964). They conducted 26 observational dives over the period, August 1958 to December 1960. Despite many fluctuations, possibly due to water clarity or incoming year classes of fishes, an overall upward trend in fish populations was observed. Toward the end of the survey period the biota of the island had the appearance of "a well-balanced animal community." Fifty-three species of fish belonging to 44 genera in 22 families were observed during this study. About 97 percent of the fish fauna belonged to the following groups: silver-side, (*Atherinidae*), surfperch (*Embiotocidae*), sea bass (*Serranidae*), damselfish (*Pomocentridae*), rockfish (*Scorpaenidae*), and halfmoon (*Scorpidae*). The biologists noted populations of large, active fishes in turbulent waters along the west (seaward) side of the island, sedentary forms such as sculpin (*Cottidae*), and rockfish occupying spaces among the rocks, and the young of many species (especially kelp bass (*Paralabrax clathratus*), blacksmith (*Chromis*

*punctipinnis*), and species of surfperch and rockfish) apparently using the kelp beds in the lee of the island as nursery grounds.

Approximately 54 months after island construction, the invertebrate fauna and algae were surveyed along a transect on the east (lee) side of the island by sampling a 0.09-square meter area at each 3.05-meter depth interval. This sampling was augmented with numerous diving observations. The results of the survey are summarized in Appendix H of Carlisle, Turner, and Ebert (1964). Relatively high densities and a pronounced vertical zonation in major taxonomic groups were apparent.

The work of the California Department of Fish and Game biologists provided an idea of the pattern of early colonization for Rincon Island. Brisby's Biota Appendix in Keith and Skjei (1974) provided valuable insight into the contrast between ecological conditions associated with the island and those of the natural bottom at the site of the island before its construction. Brisby knew the area before construction, and has had an arrangement with the Atlantic Richfield Company to use the island since its construction as a field station for educational purposes. His study methods involved use of scuba techniques, surface craft, mechanical collecting gear (including Peterson grabs, dredges, trawls, traps, and other fishing gear), and underwater photography. Brisby's conclusions provide a basic introduction to the island's ecology.

In summary, Brisby found that with construction of the island, the area developed from a biologically depauperate condition into a mature and balanced reef. Before construction, only 14 species of benthic fish were observed. After establishment of a "climax" community on the island, 298 species, representing all major marine phyla, were recorded. Ecological characteristics were somewhat different on each of the four sides of the island, owing to differences in degree of exposure to waves and currents. High water turbidity typified conditions on the landward side of the island. The seaward side was reported to be particularly rich in life. The other two sides were observed to provide an intermediate environment and each, because of differences in exposure, had a somewhat different ecology. "Talus slopes" of mollusk shells were observed along the bases of the three seaward sides.

#### IV. STUDY METHODS

##### 1. General.

This study was divided into five major subtasks. Detailed information on specific methodologies is provided in Appendix A.

## 2. Reconnaissance Dives.

The first subtask involved reconnaissance dives by two diver biologists to make a preliminary survey of major species associations around the island. A limited amount of randomly placed quadrat sampling was done to determine variability in densities of biota.

## 3. Talus Bed Measurements.

The second subtask was to calculate the volume of the mounds of mollusk shells and shell fragments at the base of the rock revetments around the island (shell "talus"). The dimensions of the talus beds were determined and volumes of shell debris in the beds along each of the four cardinal sides were estimated.

Dimensions of the shell talus beds were determined by the following method. Divers swam along each of the cardinal sides of the island, noting significant changes in the morphology of the talus bed (i.e., changes in slope or upper and lower margin). Where such changes occurred, the distance between the upper and lower margins was measured using a steel tape. Depths of the upper and lower margins were also recorded to +0.2 meter. Cross-sectional geometry of the talus bed at each measurement point was determined from the distance from the waterline, water depth, and slope of the rock revetment. These cross sections were plotted on base charts for each of the four cardinal sides. The volume of the accumulated shell material along each side of the island was then estimated. Boundaries of the talus beds were charted.

## 4. Seasonal Survey of Permanent Transects.

The third subtask was to survey permanent transects on the island to determine seasonal variability in densities of macrobiota. Transects, extending from the upper limit of the wave splash zone to the limit of the island's influence on the bottom, were established on the four cardinal sides of the island (Fig. 3). These transects were surveyed during each season for 1 year (see App. B for a summary of the data).

Heavy stakes of steel angle iron marked the upper and lower limits of each transect. A single stake was anchored in the armor rock above the splash zone on each side of the island, marking the upper limit of the transect. Three identical stakes were driven into the natural bottom sediment near the seaward margin of the talus bed, and were aligned parallel to each side. The three stakes were connected with 0.6-centimeter-diameter polyethylene line and floats were attached to each stake to facilitate locating them during conditions of restricted visibility (Fig. 4).

A nylon line marked off in 1-meter increments, was used as the transect line. During each survey, one end of the transect line was

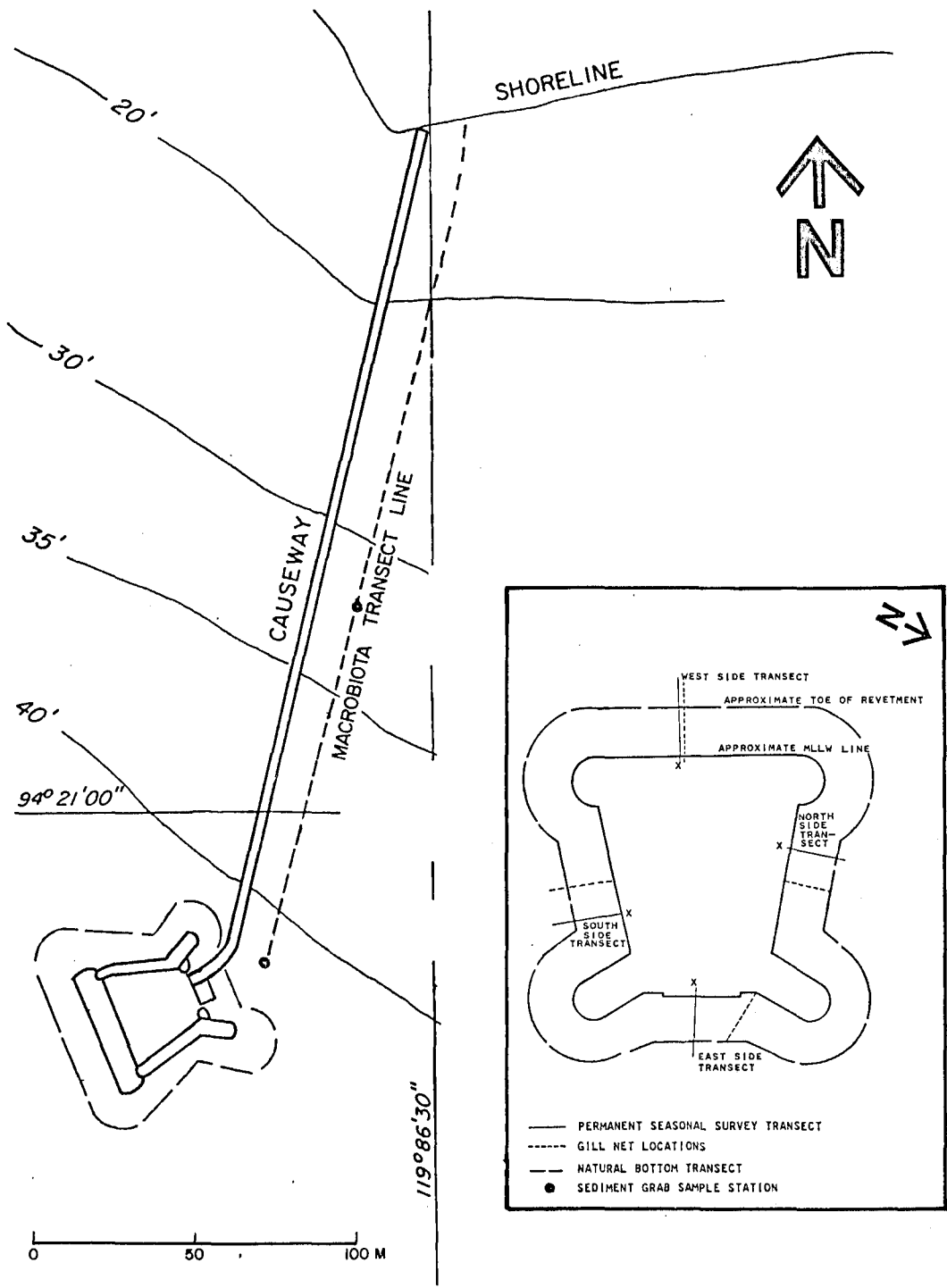

Figure 3. Locations of permanent seasonal transects, gill nets, natural bottom transect, and sediment grab sampling stations. (Depth contours in feet below MLLW.)



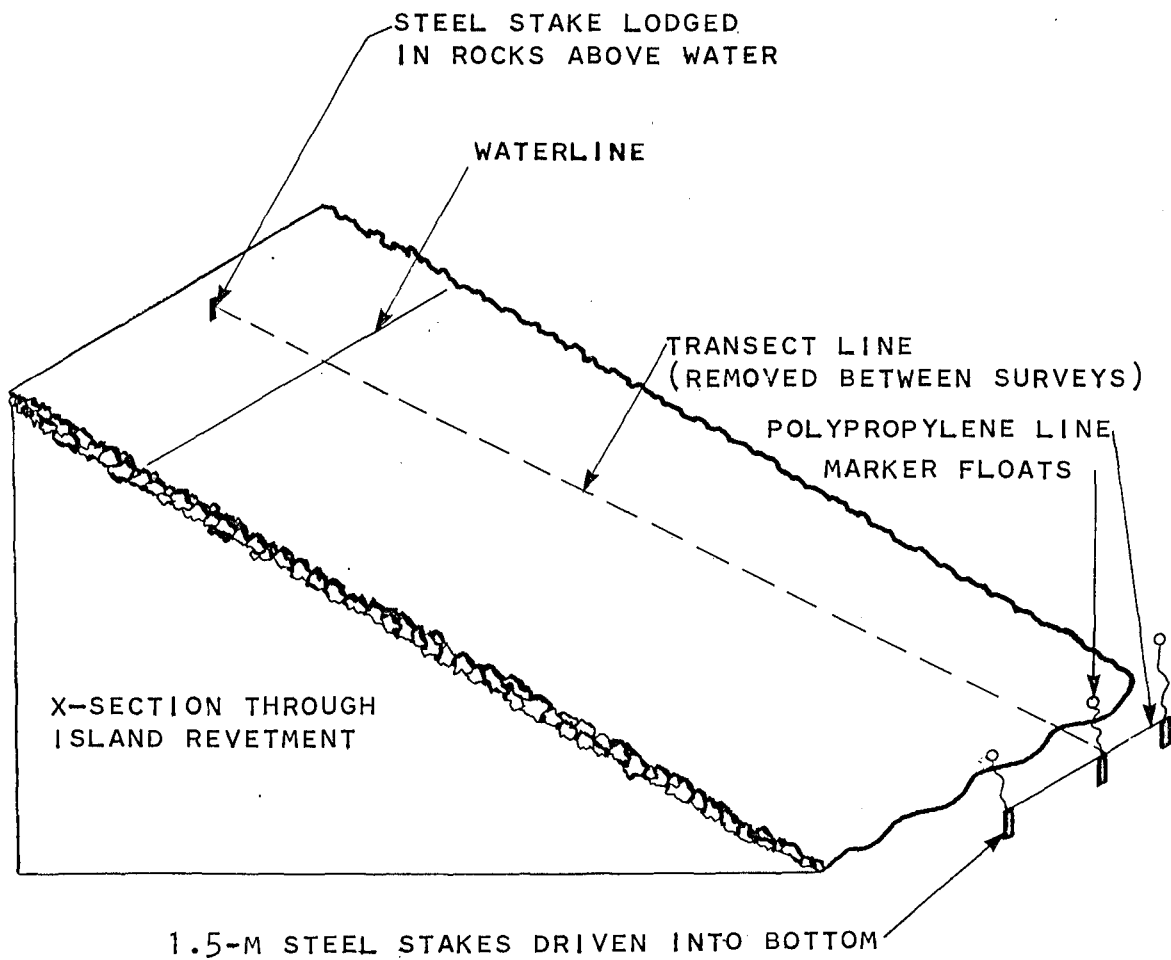

Figure 4. Structure of permanent seasonal survey transects.

attached to the upper (splash zone) marker stake and the other end was attached to the center stake on the bottom. This ensured examination of the same area on each side during the four seasonal surveys. Divers carrying 1-square meter quadrats, underwater clipboards, and plastic collecting bags swam the transect lines, recording data on densities of all species of macrobiota (in duplicate samples) at 1-meter increments.

Seasonal density values were recorded as percent of unit area covered for algae and encrusting colonial animals or as number per unit area for species for which individuals could be counted. Certain species (e.g., *Serpulorbis squamigerus*, the scaled worm shell) were recorded for both numbers of individuals and percent coverage. Species of uncertain identity were collected, making notation of the quadrat number from which they were collected, and later identified. Each transect was photographed using an underwater camera.

The marker stakes remained intact during the entire year of survey. They were located on each sampling trip except one on the north side of the island. Extreme water turbidity precluded attachment of the transect line to the bottom marker. In this case, the transect was repeated by placing the line on structures (including a submerged pipeline) recognized from previous surveys.

The same two diver biologists recorded the data on each seasonal survey with the exception of the north side during the summer (August 1976) and the west side during the winter (February 1977) surveys, when another diver was used. Heavy surf prevented collection of complete data on the west-side transect during the fall (November 1976) and winter (February-March 1977). Data were not collected in the upper zone during either of these two seasons.

All data were transcribed from the field sheets to data tables which listed densities of both plants and animals in each quadrat. Fifty-four of the more common species were analyzed for seasonal abundance. Details of the methods used in the analyses of the permanent transect data for significant seasonal differences in species densities are provided in Subsection 2 of Appendix A.

##### 5. Mapping of Major Species Associations.

The fourth subtask was to chart the distribution of major species associations over all submerged parts of the island. A series of charts was prepared depicting the boundaries of major species associations and the spatial disposition of these associations, accurate to  $\pm 0.2$  meter in depth and  $\pm 0.3$  meter in horizontal distance from permanent reference points on the island. This phase of the work required identification of faunal and floral associations on the basis of substrate character and recurrent groups of species that were conspicuous by virtue of size, abundance, or biomass.

Initial identification of major species associations was based on subjective judgment developed during reconnaissance and permanent transect diving. These preliminary identifications were corroborated by computer analysis of the field data. An R-mode cluster analysis program (unweighted pair-group arithmetic average clustering method (UPGMA) as described by Sneath and Sokal, 1973) was used. Input data consisted of presence-absence designations for all species encountered in each 1-square meter quadrat from the east and north sides for the summer (August) and fall (November) seasonal surveys.

The program generates a matrix of similarity for all species. A CALCOMP plotter program was used to generate dendrograms showing the aggregate hierarchical classification among species (see App. C). On the basis of this information, 13 tentative species associations were identified.

Measurements were made to the boundaries of the various species associations from fixed reference points around the island. Depths (referenced to MLLW) and distances were recorded at transition zones or boundaries between associations. These measurements were taken along transects located at 10-meter intervals around the island (5-meter intervals were used around the four corners of the island to assure adequate radial coverage). The starting point for each transect was the upper boundary of the barnacle-limpet zone. In plotting the data, boundaries of associations were extrapolated between transect lines to depict the distributions of the associations. Actual distances were plotted on a base chart of the island. Boundaries of the talus beds, measured during the fourth subtask, were also plotted on this chart. The actual distances were then trigonometrically rectified for plan view plotting according to the methodology in Appendix A,3.

Areas covered by each species association were determined by cutting out the associations on the base chart (before trigonometric rectification), weighing the pieces from each association on a Mettler analytical balance to a precision of  $\pm 0.001$  gram, and calculating the percent each association represents of the total area of the island bounded by the upper limit of the barnacle-limpet zone and the lower limit of rock on the bottom.

## 6. Quantitative Characterization of Species Associations.

The fifth subtask involved quantitative characterization of the species associations. Biomass and densities of macrobiota around the island were measured. Analysis of these data provided the rationale for separating or combining associations lying adjacent to one another or on different sides of the island.

Densities and biomass of macrobiota within the associations were determined using randomly placed sample quadrats. Quadrats used in all associations except those in the upper intertidal were of 0.25-square meter size. Duplicate 0.01-square meter quadrats were used in the upper zones. Numbers drawn from a random numbers table, equating to vertical and horizontal distances from permanent points on the island, were used in locating the sampling quadrats.

Divers measured the distances with an underwater steel tape and then, looking away from the bottom, released the quadrat about 1 meter above the bottom. This minimized sampling bias. If the quadrat came to lie in or over a crevice between rocks, it was released a second time.

The depth of the quadrat and time of sampling were recorded and the area within the quadrat was photographed. A record was made of the densities of each species within the quadrat (numbers or percent coverage). Large organisms less than 50 percent enclosed within the quadrat boundaries were not recorded. All detachable macrobiota were removed and placed in labeled plastic bags for subsequent biomass measurement. The contents of each collecting bag were wet-blotted and weighed on a triple-beam balance (precision approximately  $\pm 0.2$  gram). Wet weights were recorded for each species.

To develop biomass data on organisms that are permanently attached to the substrate, measured areas were scraped by a diver using a steel chisel and hammer. The removed fragments were collected, using a specially designed slurp gun, fitted with a collecting chamber lined with Nitex plankton netting of 333-micrometer mesh size. Contents of the collecting chamber were subsequently weighed as described above.

All raw data (numbers, percent coverage, and wet weight for each species) were tabulated for each quadrat. Tables were arranged in columnar form with species categories across the top and quadrat numbers along the left-hand margin. Quadrats were grouped according to the association and the sampling locations. Quadrats within transition zones and from apparently similar associations on different sides of the island were separated to facilitate testing against "type" association quadrats (those lying well within the boundaries of distinct associations). These quadrats were then either combined with or separated from type associations.

This method of tabulation permitted calculation of summary statistics for all species in each association which in turn facilitated intercomparison of the characteristics of these associations. The following summary statistics were calculated: Frequency (ratio of number of quadrats of occurrence to number of quadrats sampled in each group); mean abundance and 95-percent confidence limits for the mean abundance; and average weight per individual (or per 100-square

centimeter coverage for species whose densities were estimated as percent coverage).

Comparison of summary statistics on biomass and densities permitted separation of associations in a subjective manner for the intertidal associations (down to and including the macrophytic algae zone). However, this approach was too arbitrary when it came to identifying possible differences between similar associations on different sides of the island or between associations grading into one another on the same side. For these instances, a more rigorous statistical test was necessary. Application of parametric statistical tests requires that the data be normally distributed. This was not the case for most of the data collected during quantitative sampling. Also, it is unlikely that data transformation could be effectively used to normalize the data. The nonparametric Wilcoxon "t" test (Tate and Clelland, 1957) was applied to test differences between densities of selected dominant species within potentially similar associations and between dissimilar associations. An association on the north side, which is dominated by the encrusting coralline alga, *Lithothamnium-Lithophyllum* complex, was selected as the type association against which most other associations were tested.

#### 7. Natural Bottom Survey.

In addition to the above subtasks, ecological conditions in nearby natural bottom habitats were investigated. This information was to aid in interpreting the ecological changes induced by the presence of the island.

The composition of the epibenthic macrobiota (plants and animals) on or just above the surface of the sediment or rock on the natural bottom between the island and shore was surveyed along a transect located away from the influence of the island and causeway (Fig. 3). The transect survey was completed in two segments. The first segment, over a depth of 13.7 meters MLLW near the island to a depth 6.1 meters MLLW toward shore, was surveyed by divers using Farallon underwater propulsion units. The second segment, extending from shore to the 6.1-meter MLLW depth, was surveyed by divers entering through the surf and swimming offshore. Triplicate sediment samples for infauna (animals inhabiting the sediments) were taken at the outer terminus of the transect at a 13.7-meter depth and at a point midway in the transect at a depth of 10.7 meters MLLW (Fig.3). The samples were collected by pushing 3.13-liter lidless coffee cans into the sediment and carefully sealing both ends of the cylinder with plastic caps. Samples for grain-size analysis were collected by pushing 0.2-liter jars 10 centimeters into the sediment. Infaunal samples were sieved through 1-millimeter sieve screens and preserved for later taxonomic analysis.

## 8. Gill Net Survey.

A gill net survey was conducted on 15 and 16 June 1977. A single multimesh nylon monofilament net, 30.5 meters long and 2.4 meters deep, was deployed obliquely along each cardinal side of the island (Fig. 3). The nets consisted of ten 3.05-meter-long panels with two panels each of 1.27-, 2.54-, 3.81-, 5.08-, and 6.35-centimeter bar mesh. Position of these panels in the net was random. When deployed, the nets extended from the intertidal zone of the island to the toe of the island revetment. The nets were fished for two periods: a daytime period of about 4 hours, and a day-night period ranging from a minimum of 17 hours (west side) to a maximum of 23.5 hours (east side).

Fishes caught in each net were removed and identified, and a record was made of the standard length (snout to distal end of caudal peduncle) for bony fishes and total length (snout to end of caudal fin) for sharks. Lengths were recorded to the nearest 0.5 centimeter. Numbers of individuals occurring in each mesh size were also recorded. Summary data tables were prepared listing numbers of individuals, mean length, and length range for each species captured on each side of the island.

## V. RESULTS AND DISCUSSION

### 1. General.

A total of 330 species of macrobiota was identified during this study; 160 of these taxa had not been reported as occurring at Rincon Island. This addition to the number of species reported in Keith and Skjei (1974) brings the total species list to 458. Many additional species undoubtedly exist among the island's varied habitats. An updated master list of taxa of Rincon Island is given in Table 1.

### 2. Volume and Dimensions of Talus Beds.

Dimensions of the shell talus beds along each of the four cardinal sides are shown in perspective view in Figures 5 to 8 and in plan view in Figures 9 to 12. (The upper boundaries of the talus beds do not match precisely with the lower boundaries of the deepest associations in these figures for two reasons: First, talus bed measurements were taken at positions of change of the talus bed geometry, while associations were measured along fixed transects; second, the deepest association frequently extended into the talus bed on isolated rocks.) Approximate volumes of shell calculated from the measurement of talus bed dimensions are as follows:

West side:	1,450 cubic meters
South side:	98 cubic meters

Table 1. Master species list for Rincon Island.

Scientific name <sup>1</sup>	Common name	Occurrence during present study			
		North	West	South	East
<b>ALGAE</b>					
DIVISION CHLOROPHYTA					
GREEN ALGAE					
<i>Bryopsis corticulans</i> <sup>2</sup>					
<i>Chaetomorpha aerea</i> <sup>2</sup>					
<i>Cladophora</i> sp.					X
<i>Codium fragile</i>	Deadman's fingers			X	
<i>Derbesia marina</i>		X			
cf. <i>Enteromorpha</i> sp.				X	X
<i>Ulva</i> sp.	Sea lettuce	X	X		X
Unid. green algae #1				X	
DIVISION CYANOPHYTA					
BLUE-GREEN ALGAE					
cf. <i>Phormidium</i> sp.		X	X	X	X
DIVISION PHAEOPHYTA					
BROWN ALGAE					
<i>Cystoseira osmundacea</i>		X			X
<i>Desmarestia herbaceae</i> <sup>2</sup>					
<i>Dictyota binghamiae</i>		X			
<i>D. flabellata</i> <sup>2</sup>			X	X	X
<i>Ectocarpus</i> sp.					
<i>Egregia menziesii</i> (=laevigata)	Feather-boa kelp	X	X		
<i>Giffordia granulosa</i>					X
<i>Halidrys dioica</i> <sup>2</sup>					
<i>Macrocystis</i> sp.	Giant kelp	X			
<i>Petrospongium rugosum</i> <sup>2</sup>					
<i>Pterygophora californica</i> <sup>2</sup>					
<i>Ralfsia pacifica</i>					
<i>Taonia lennebackeriae</i>					X
Unid. brown alga #1					X
Unid. brown alga #2					X
Unid. brown alga #3					X
Unid. juv. laminariales					X
DIVISION RHODOPHYTA					
RED ALGAE					
<i>Antithamnion</i> sp.					X
<i>Bossiella orbigniana</i>		X	X	X	
<i>Bossiella</i> sp. <sup>2</sup>					
<i>Callithamnion</i> sp. <sup>2</sup>					
<i>Callophyllis flabellulata</i>					X
<i>Ceramium codicola</i>					
cf. <i>Ceramium</i> sp.		X	X	X	X
<i>Corallina officinalis</i>		X	X	X	
<i>Cryptopleura</i> cf. <i>crispa</i>					
<i>Delesseria</i> sp.					X
<i>Gelidium coulteri</i>		?		X	
<i>G. cf. robustum</i>		X		X	
<i>G. purpurascens</i>		X			
<i>G. cartilagineum</i>		?	X		X
<i>G. sp. #1</i>					X
<i>G. sp. #2</i>		X			X
<i>Gigartina canaliculata</i>			X	X	X
<i>G. cf. exasperata</i>			X	X	X
<i>G. sp.</i>				X	
<i>G. spinosa armata</i>		X		X	
<i>G. sp. (juv.)</i>				X	X
<i>Grateloupia doryphora</i> (=abreviata)		X		X	
<i>Hildenbrandia prototypus</i> <sup>2</sup>					
<i>Laurencia pacifica</i>			X		
<i>Lithothamnium/Lithophyllum</i> complex		X	X	X	X
<i>Lithothrix aspergillum</i>					
<i>Lomentaria hakodatensis</i>					X
<i>Microcladia</i> cf. <i>coulteri</i>					
<i>Neoagardhiella</i> (=Agardhiella) sp.		X			X
<i>Peyssonellia</i> sp.		X	X	X	X

See footnotes at end of table.

Table 1. Master species list for Rincon Island.--Continued.

Scientific name <sup>1</sup>	Common name	Occurrence during present study			
		North	West	South	East
DIVISION RHODOPHYTA (Continued)					
<i>Platythamnion villosum</i>					
<i>P. sp.</i>		X	X		X
<i>Polysiphonia simplex</i>				X	
<i>P. cf. pacifica</i>				X	
<i>P. spp.</i>					X
<i>Porphyra perforata</i> <sup>2</sup>					
<i>Prionitis lanceolata</i>		X	X	X	X
<i>Pterosiphonia dendroidea</i>					
<i>Pterosiphonia sp.</i>			X		X
<i>Rhodoglossum affine</i>		X	X	X	
<i>Rhodymenia sp.</i>			X	X	X
<i>R. californica</i>		X			
cf. <i>R. sp.</i>					X
<i>Schizymenia pacifica</i>					
<i>Stenogramme interrupta</i>		X	X	X	X
<i>Tiffaniella snyderiae</i>					X
<i>Veleroa subulata/Murrayellopsis dawsonii</i> complex		X	X	X	X
Unid. red alga #1		X		X	
Unid. red alga #2				X	
Unid. filamentous red alga #1				X	
Unid. juvenile red alga				X	
Unid. filamentous red alga #2					X
Unid. "leafy" red alga					X
Unid. "tall" red alga					X
Unid. red alga #3					X
Unid. red alga #4					X
Unid. red alga #5					X
Unid. "flat" red alga					X
Unid. red alga #6			X		
Unid. red alga #7			X		
Unid. coralline #1		X			
Unid. coralline #2			X		
Unid. coralline #3					X
PHYLUM PORIFERA					
SPONGES					
<i>Cliona celata californiana</i>	Boring sponge	X	X	X	X
<i>Geodia mesotriaenia</i> <sup>2</sup>	Geode sponge				
<i>Halichoclona gellindra</i> <sup>2</sup>	Lavender sponge				
<i>Haliclona ecbasis</i> <sup>2</sup>	Lavender-blue encrusting sponge				
<i>Hymenamphiasira (=Hymeniacion)</i> cyanocrypta	Blue leaf sponge	X	X		X
<i>Hymeniacion ungodon</i> <sup>2</sup>	Little leaf sponge				
<i>H. sinapium</i>	Yellow leaf sponge				
<i>Leucetta losangelensis</i>			X	X	
<i>Leucilla (=Rhabdodermella) nuttingi</i>	Urn sponge			X	X
<i>Leuconia heathi</i> <sup>2</sup>	Thistle sponge				
<i>Leucosolenia sp.</i> <sup>2</sup>	Finger sponge				
<i>Lissodendoryx noxiosa</i> <sup>2</sup>	Noxious sponge				
<i>Sphaciospongia confoederata</i>	Liver sponge		X		
<i>Tedania toxicalis</i>	Sponge				
<i>Tethya aurantia</i> <sup>2</sup>	Orange puff-ball sponge				
<i>Verongia thiona</i>	Sulfur sponge		X	X	
Unid. "sulfur" sponge			X	X	
Unid. red sponge #1					X
Unid. purple sponge #2		X			
Unid. orange sponge #3		X			X
Unid. yellow sponge #4		X			

See footnotes at end of table.



Table 1. Master species list for Rincon Island.--Continued.

Scientific name <sup>1</sup>	Common name	Occurrence during present study			
		North	West	South	East
PHYLUM PORIFERA (Continued)					
Unid. grey sponge #5				X	
Unid. sponge #6		X			
Unid. sponge #7			X		
Unid. "white" sponge			X	X	
PHYLUM CNIDARIA					
CLASS HYDROZOA					
<i>Aglaophenia struthionides</i>	ANEMONES, HYDROIDS, CORALS, GORGONIANS				
<i>Antennella avalonia</i>	HYDROIDS				
<i>Campanularia</i> sp. <sup>2</sup>	Ostrich plume hydroid	X	X		X
cf. <i>Eudendrium</i> sp.	Campanulate hydrozoan				X
<i>Obelia</i> sp.			X		
<i>Sertularia</i> cf. <i>furcata</i>					
cf. <i>Plumularia</i> sp.		X	X	X	X
cf. <i>P. lagenifera</i>					X
cf. <i>Sertularia</i> sp.			X		
Unid. green hydroid			X		
Unid. hydroid sp. #1			X		
Unid. hydroids		X	X	X	X
CLASS ANTHOZOA					
ANEMONES/CORALS					
<i>Anthopleura xanthogrammica</i> / <i>A. elegantissima</i> <sup>3</sup>	Green anemone	X	X	X	X
<i>Antropora tinctoria</i>		X		X	
<i>Astrangia lajollaensis</i>	Colonial coral	X	X	X	X
<i>Balanophyllia elegans</i>	Solitary orange coral	X		X	X
<i>Cerianthopsis</i> sp.	Burrowing anemone				
<i>Corynactis californica</i>	Colonial red anemone	X	X	X	X
<i>Eugorgia rubens</i> <sup>2</sup>	Purple sea fan				
cf. <i>Epiactis prolifera</i>	Prolific anemone			X	
<i>Lophogorgia chilensis</i>	Pink gorgonian	X	X	X	X
<i>Metridium</i> sp. <sup>2</sup>	Solitary anemone				
<i>Muricea californica</i> / <i>M. fruticosa</i> <sup>3</sup>	California/rust gorgonians	X	X	X	
cf. <i>Pachycerianthus</i> sp.	Tube anemone	X		X	
<i>Paracyathus stearnsii</i>	Solitary coral	X	X	X	X
<i>Renilla kollikeri</i> <sup>2</sup>	Sea pansy				
<i>Stylatula elongata</i> <sup>2</sup>	Elongate sea pen				
<i>Tealia</i> sp.	Anemone	X			
Unid. anemone #1			X	X	
Unid. white anemone #2			X		
Unid. burrowing anemone			X		
Unid. red cerianthid			X		
PHYLUM ANNELIDA					
WORMS					
<i>Chaetopterus variopedatus</i> <sup>2</sup>	Parchment tube worm	X			
cf. <i>Chaetopterus</i> sp.	Parchment tube worm				
<i>Dexiospira spirillum</i>					X
<i>Diopatra ornata</i>		X	X	X	X
<i>Dodecaceria fewkesi</i>		X	X	X	X
<i>Eudistylia polymorpha</i> <sup>2</sup>	Feather-duster worm	X	X	X	X
<i>Eudistylia</i> sp.	Feather-duster worm				
<i>Eunereis longipes</i> <sup>2</sup>	Nereid worm				
<i>Eupomatus gracilis</i>		X			X
<i>Halosydna tuberculifera</i>	Scale worm				
<i>H. brevisetosa</i> <sup>2</sup>	Scale worm				

See footnotes at end of table.

Table 1. Master species list for Rincon Island.--Continued.

Scientific name <sup>1</sup>	Common name	Occurrence during present study			
		North	West	South	East
PHYLUM ANNELIDA (continued)					
<i>Nereis eakini</i> <sup>1</sup>	Nereid worm				
<i>N. mediator</i> <sup>2</sup>	Nereid worm				
<i>Paleonotus bellis</i> <sup>2</sup>	Chrysopetalid worm				
<i>Salmacina tribranchiata</i>	Colonial tube worm		X		
<i>Serpula vermicularis</i> <sup>2</sup>	Serpulid worm				X
<i>Spirorbis eximius</i>					
<i>Polyopthalmus pictus</i>					
Unid. serpulids		X	X	X	
Unid. Syllidae					
PHYLUM ARTHROPODA	JOINT-LEGGED ANIMALS				
CLASS CRUSTACEA	CRUSTACEANS				
<i>Alpheus clamator</i>	Shrimp				
<i>Ampithoe</i> sp.	Amphipod				X
<i>Balanus cariosus</i> <sup>2</sup>	Acorn barnacle				
<i>B. crenatus</i> <sup>2</sup>	Acorn barnacle				
<i>B. galeata</i>					
<i>B. glandula</i>	Acorn barnacle	X	X	X	X
<i>B. nubilus</i>	Acorn barnacle		X	X	X
<i>B. pacificus</i>	Acorn barnacle	X	X	X	X
<i>B. tintinnabulum</i>	Acorn barnacle		X	X	
<i>B. sp.</i>	Acorn barnacle				X
<i>Cancer antennarius</i> <sup>2</sup>	Rock crab				
<i>C. anthonyi</i> <sup>2</sup>	Yellow crab				
<i>Cancer</i> cf. <i>productus</i>	Rock crab				
<i>Chthamalus fissus</i>	Acorn barnacle	X	X	X	X
<i>Crangon dentipes</i> <sup>2</sup>	Pistol shrimp				
<i>Erichthonius brasiliensis</i>	Amphipod				X
<i>Heptacarpus palpator</i>	Shrimp				
<i>Hippolytina californica</i> <sup>2</sup>	Red rock shrimp				
<i>Hyale frequens</i>	Amphipod				X
<i>Jaeropsis dubia</i>	Iso pod		X		
<i>Loxorhynchus crispatus</i>	Sheep crab	X	X	X	
<i>L. grandis</i> <sup>2</sup>	Sheep crab				
<i>Membranobalanus orcutti</i>	Barnacle				
<i>Munna chromatoccephala</i>	Amphipod				
<i>Pachycheles pubescens</i>	Hermit crab	X			
<i>Pachygrapsus crassipes</i>	Striped shore crab	X	X	X	X
<i>Paguristes turgidus</i> <sup>2</sup>	Hermit crab				
<i>P. ulreyi</i>	Hermit crab	X	X	X	
<i>Pagurus californiensis</i>	Hermit crab		X		
<i>Pandalus gurneyi</i> <sup>2</sup>	Shrimp				
<i>Panulirus interruptus</i>					
<i>Petrolisthes cinctipes</i> <sup>2</sup>	Porcelain crab				
<i>P. sp.</i>	Porcelain crab				
<i>Pollicipes polymerus</i>	Gooseneck barnacle		X	X	
cf. <i>Isocheles pilosus</i>	Hermit crab		X		
<i>Pugettia producta</i>	Kelp crab				
<i>P. sp.</i>	Kelp crab				
<i>Scyra acutifrons</i> <sup>2</sup>	Masking crab				
<i>Spirontocaris brevirostris</i> <sup>2</sup>	Bent-back shrimp				
<i>Tetraclita squamosa rubescens</i>	Thatched barnacle	X	X	X	X
Unid. pagurids	Hermit crabs	X		X	X
Unid. shrimp		X			
Unid. barnacles				X	X
PHYLUM MOLLUSCA	SNAILS, NUDIBRANCHES, CLAMS, OCTOPUSES				
CLASS GASTROPODA	SNAILS AND NUDIBRANCHES				
<i>Acanthina spirata</i>	Oyster drill		X		
<i>Acanthodoris lutea</i>	Nudibranch	X		X	X
<i>Acmaea mitra</i>	White-cap limpet	X			

See footnotes at end of table.

Table 1. Master species list for Rincon Island.--Continued.

Scientific name <sup>1</sup>	Common name	Occurrence during present study			
		North	West	South	East
CLASS GASTROPODA (Continued)					
<i>A. persona</i> <sup>2</sup>	Mask limpet			X	X
<i>Amphissa</i> sp. <sup>2</sup>	<i>Amphissa</i>				
<i>Anisodoris nobilis</i>	Nudibranch	X		X	X
<i>Antiopella barbarenaensis</i>	Nudibranch				X
<i>Aplysia californica</i>	Sea hare	X			
<i>A. vaccaria</i>	Sea hare				
<i>Archidoris montereyensis</i>	Light yellow sea slug				
<i>Armina californica</i> <sup>2</sup>	Pansy sea slug				
<i>Astraea undosa</i> <sup>2</sup>	Wavy turban snail				
<i>Cadlina luteomarginata</i>	Nudibranch	X			
<i>Callistochiton crassicosatus</i>	Chiton				
<i>Calliostoma annulatum</i>	Purple-ringed top shell	X			
<i>C. canaliculatum</i>	Channeled top shell	X	X	X	
<i>C. gloriosum</i>	Glorious top-shell				
<i>C. supragranosum</i> <sup>2</sup>	Granulose top-shell				
<i>Ceratostoma nuttalli</i>	Nuttall's hornmouth	X	X	X	X
<i>Collisella</i> cf. <i>conus</i>	Limpet	X		X	
<i>C. digitalis</i>	Fingered limpet	X	X	X	X
<i>C. cf. limatula</i>	File limpet				X
<i>C. pelta</i> <sup>2</sup>	Shield limpet				
<i>C. scabra</i>	Rough limpet	X		X	X
<i>C. sp. #1</i>	Limpet			X	
<i>C. sp. #2</i> (ridges)	Limpet				
<i>C. sp. #3</i>	Limpet				X
<i>C. cf. strigatella</i>	Limpet		X		
<i>Conus californicus</i>	California cone	X	X		X
<i>Coryphella trilineata</i>	Nudibranch				
<i>Crepidula</i> cf. <i>aculeata</i>	Spiny slipper shell				X
<i>Crepidatella lingulata</i>	Half-slipper shell	X			
<i>Cypraea spadicea</i>	Chestnut cowry	X	X	X	
<i>Diaulula sandiegensis</i>	Circle-spotted sea slug	X		X	X
<i>Diodora aspera</i>	Rough keyhole limpet	X		X	X
<i>Doriopsilla albopunctata</i> (= <i>Dendrodoris fulva</i> )	Yellow sea slug	X	X	X	X
<i>Fissurella volcano</i>	Volcano limpet				
<i>Flabellinopsis iodinea</i>	Purple sea slug	X			X
<i>Haliotis corrugata</i> <sup>2</sup>	Pink abalone				
<i>H. cracherodii</i> <sup>2</sup>	Black abalone				
<i>H. fulgens</i> <sup>2</sup>	Green abalone				
<i>H. rufescens</i>	Red abalone	X			
<i>Hermisenda crassicornis</i>	Yellow-green sea slug		X		X
<i>Hypselodoris californiensis</i> <sup>2</sup>	Blue-orange sea slug				
<i>Jaton festivus</i> <sup>2</sup>	Festive murex				
<i>Kelletia kelletii</i>	Kellet's whelk	X	X	X	X
<i>Laila cockerelli</i> <sup>2</sup>	Orange-white sea slug				
<i>Littorina planaxis</i> <sup>2</sup>	Eroded periwinkle				
<i>L. scutulata</i> <sup>2</sup>	Checkered periwinkle				
<i>L. sp.</i>	Periwinkle			X	
<i>Lottia gigantea</i>	Owl limpet	X	X	X	X
<i>Maxwellia gemma</i>	Gem murex	X			
<i>Megathura crenulata</i>	Giant keyhole limpet	X	X	X	X
<i>Mitrella carinata</i>	Carinate dove shell				X
<i>Mitra idae</i>	Ida's mitre		X	X	
<i>Nassarius mendicus</i>	Lean nassa			X	
<i>Navanax inermis</i>	Nudibranch	X			X
<i>Neosimnia</i> sp. <sup>2</sup>	Pink louse shell				
<i>Norrisia norrisii</i> <sup>2</sup>	Smooth turban				
<i>Ocenebra foveolata</i>		X			

See footnotes at end of table.

Table 1. Master species list for Rincon Island.--Continued.

Scientific name <sup>1</sup>	Common name	Occurrence during present study			
		North	West	South	East
CLASS GASTROPODA (Continued)					
<i>O. poulsoni</i> <sup>2</sup>	Poulson's dwarf triton				
<i>O. cf. barborensis</i>					
<i>O. sp.</i>			X		
<i>Polycera tricolor</i>	Nudibranch	X			
<i>Pteropurpura festiva</i>	Festive murex	X	X	X	
<i>P. macroptera</i>	Murex				X
<i>Pterynotus trialatus</i> <sup>2</sup>	Three-winged murex				
<i>Serpulorbis squamigerus</i>	Scaled worm shell		X	X	X
<i>Simnia (Neosimnia) vidleri</i>	Vidler's simnia	X			X
<i>Tegula aureotincta</i> <sup>2</sup>	Gilded tegula				
<i>T. brunnea</i> <sup>2</sup>	Brown tegula				
<i>T. funebris</i>	Black turban snail				
<i>Triopha maculata</i>	Nudibranch				
<i>Tritonia festiva</i>	Nudibranch	X			
Unid. limpet #1				X	
Unid. limpet #2				X	
Unid. blue/white eolid		X			
Unid. navanax-like eolid		X			
Unid. gastropod #1		X			
Unid. dorid #1		X			
Unid. chiton #1		X			
Unid. limpet #3		X			
Unid. eolid #1					X
Unid. eolid #2			X		
CLASS PELECYPODA					
CLAMS AND SCALLOPS					
<i>Anomia peruviana/</i>	Pearly jingle/				
<i>Pododesmus cepio</i> <sup>3</sup>	Abalone jingle	X	X	X	X
<i>Bankia setacea</i> <sup>2</sup>	Ship worm				
<i>Chaceia ovoidea</i> <sup>2</sup>	Wart-necked piddock				
<i>Chama pellucida</i>	Agate chama		?		X
<i>Chlamys latiaurata</i> <sup>2</sup>	Kelp scallop				
<i>Gari californica</i> <sup>2</sup>	Sunset clam				
<i>Hiatella arctica</i>	Nestling clam			X	X
<i>Hinnites multirugosus</i>	Rock scallop				
<i>Kellia laperousii</i>				X	
<i>Lima hemphilli</i> <sup>2</sup>	File shell				
<i>Lithophaga plumula</i>	Date mussel				
<i>Mytilus californianus</i>	California mussel	X	X		
<i>M. edulis</i>	Bay mussel	X		X	X
<i>Nettastonnella rostrata</i> <sup>2</sup>	Beaked piddock				
<i>Parapholas sp.</i>	Boring clam	X	X	X	
<i>Pecten diegensis</i>	San Diego scallop				
<i>Penitella penita</i> <sup>2</sup>	Flap-tipped piddock				
<i>Pseudochama exogyra</i>	Reversed chama				
<i>Semele rupicola</i> <sup>2</sup>	Rock dwelling semele				
<i>Teredo diegensis</i> <sup>2</sup>	Ship worm				
Unid. pholads				X	X
Unid. boring clam				X	
CLASS CEPHALOPODA					
OCTOPUSES AND SQUIDS					
<i>Octopus bimaculoides</i>	Two-spot octopus				
<i>Octopus sp.</i>		X	X		
CLASS POLYPLACOPHORA					
<i>Mopalia muscosa</i> <sup>2</sup>					
<i>Callistochiton crassicosatus</i>					

See footnotes at end of table.

Table 1. Master species list for Rincon Island.--Continued.

Scientific name <sup>1</sup>	Common name	Occurrence during present study			
		North	West	South	East
PHYLUM ECTOPROCTA	MOSS ANIMALS				
<i>Antropora tincta</i>			X	X	X
<i>Bugula neritina</i>		X	X	X	X
<i>Crisia occidentalis</i>				X	
<i>Diaperoecia californica</i>		X	X		X
<i>Filicrisia franciscana</i>				X	
<i>Lagenipora punctulata</i>		X	X	X	X
<i>Hippothoa hyalina</i>					
<i>Membranipora membranacea</i>					
<i>M. savarti</i> <sup>2</sup>					
<i>M. tuberculata</i>			X		
<i>Phidolopora pacifica</i>		X	X	X	X
<i>Rhyncozoon rostratum</i>		X	X	X	X
<i>Scrupocellaria diegensis</i>		X	X	X	X
<i>Smittina</i> sp. <sup>2</sup>					
<i>Thalamoporella californica</i> <sup>2</sup>					
Unid. encrusting ectoprocts		X	X	X	X
Unid. ectoproct #1			X		X
Unid. yellow ectoproct			X		X
PHYLUM ECHINODERMATA	SEASTARS, URCHINS, BRITTLE STARS, CUCUMBERS				
CLASS ASTEROIDEA <sup>2</sup>	SEASTARS				
<i>Astropecten armatus</i> <sup>2</sup>	Sand starfish				
<i>Patiria miniata</i>	Bat star	X	X	X	X
<i>Pisaster brevispinus</i>	Pink seastar	X	X	X	
<i>P. giganteus</i>	Giant seastar	X	X	X	X
<i>P. ochraceus</i>	Ochre seastar	X	X	X	X
<i>P. sp. (juv.)</i>					X
<i>Solaster dawsoni</i> <sup>2</sup>	Sunburst starfish				
CLASS ECHINOIDEA	URCHINS				
<i>Lytechinus pictus</i>	Pale urchin			X	
<i>Strongylocentrotus franciscanus</i>	Red urchin	X	X	X	X
<i>S. purpuratus</i>	Purple urchin	X	X	X	X
CLASS OPHIUROIDEA	BRITTLE STARS				
<i>Ophiopsilla californica</i>			X		
<i>Ophiopteris papillosa</i> <sup>2</sup>	Brittle star				
<i>Ophiothrix spiculata</i>		X	X		
Unid. ophiuroid				X	X
CLASS HOLOTHUROIDEA	SEA CUCUMBERS				
<i>Cucumaria</i> sp. <sup>2</sup>	Sea cucumber				
<i>Dermasterias imbricata</i> <sup>2</sup>	Leather star				
<i>Eupentacta quinquesemita</i> <sup>2</sup>	Yellow sea cucumber				
<i>Parastichopus californicus/</i> <i>P. parvimensis</i> <sup>3</sup>		X	X	X	X
Unid. holothuroid		X		X	
Unid. burrowing holothuroid		X	X		
PHYLUM CHORDATA	CHORDATES				
CLASS ASCIDIACEA	TUNICATES (Sea squirts)				
cf. <i>Amaroucium californicum</i>					X
<i>Aplidium californicum</i>					
<i>Boletenia villosa</i>		X		X	X
<i>Chelyosoma productum</i> <sup>2</sup>	Simple sea squirt				
<i>Cystodytes lobatus</i> <sup>2</sup>	Compound sea squirt				
<i>Didemnum carnulentum</i>			X		
<i>Pyura haustor</i>	Tunicate				

See footnotes at end of table.

Table 1. Master species list for Rincon Island.--Continued.

Scientific name <sup>1</sup>	Common name	Occurrence during present study			
		North	West	South	East
CLASS ASCIDIACEA (Continued)					
<i>Styela gibbsii</i>					X
<i>S. montereyensis</i>		X	X	X	
<i>S. sp.</i>			X		
Unid. white tunicate				X	
Unid. orange tunicate				X	
Unid. encrusting pink tunicate					X
CLASS CHONDRICHTHYES		CARTILAGINOUS FISHES			
<i>Cephaloscyllium ventriosum</i>	Swell shark				
<i>Cetorhinus maximus</i>	Basking shark				
<i>Heterodontus francisci</i> <sup>2</sup>	Horn shark				
<i>Prionace glauca</i> <sup>2</sup>	Blue shark				
<i>Rhinobatos productus</i> <sup>2</sup>	Shovelnose guitarfish				
<i>Sphyrna zygaena</i> <sup>2</sup>	Smooth hammerhead shark				
<i>Squalus acanthias</i>	Spiny dogfish				
<i>Triakis semifasciata</i> <sup>2</sup>	Leopard shark				
<i>Urolophus halleri</i> <sup>2</sup>	Round stingray				
CLASS OSTEICHTHYES		BONY FISHES			
<i>Alloclinus holderi</i> <sup>2</sup>	Island kelpfish				
<i>Amphistichus argenteus</i>	Barred surfperch				
<i>A. koelzi</i> <sup>2</sup>	Calico surfperch				
<i>Anisotremus davidsoni</i> <sup>2</sup>	Sargo				
<i>Artemius lateralis</i> <sup>2</sup>	Smoothhead sculpin				
<i>Atherinops affinis</i>	Topsmelt				
<i>Atherinopsis californiensis</i>	Jacksmelt				
<i>Brachyistius frenatus</i>	Kelp perch				
<i>Cheilotrema saturnum</i>	Black croaker				
<i>Chromis punctipinnis</i>	Blacksmith				
<i>Citharichthys sordidus</i> <sup>2</sup>	Pacific sanddab				
<i>Clinocottus globiceps</i>	Mosshead sculpin				
<i>Clupea harengus pallasi</i>	Pacific herring				
<i>Coryphopterus nicholsi</i>	Blue-spot goby				
<i>Cymatogaster aggregata</i> <sup>2</sup>	Shiner surfperch				
<i>Cynoscion nobilis</i>	White seabass				
<i>Embiotoca jacksoni</i>	Black perch				
<i>E. lateralis</i>	Striped seaperch				
<i>Genyonemus lineatus</i>	White croaker				
<i>Gibbonsia metzi</i> <sup>4</sup>	Striped kelpfish				
<i>G. montereyensis</i> <sup>2</sup>	Crevice kelpfish				
<i>Girella nigricans</i>	Opaleye				
<i>Gymnothorax mordax</i> <sup>2</sup>	California moray				
<i>Halichoeres semicinctus</i> <sup>2</sup>	Rock wrasse				
<i>Heterostichus rostratus</i>	Giant kelpfish				
<i>Hyperprosopon argenteum</i>	Walleye surfperch				
<i>H. ellipticum</i> <sup>2</sup>	Silver surfperch				
<i>Hypsoblennius gilberti</i> <sup>2</sup>	Rockpool blenny				
<i>Hypsurus caryi</i> <sup>2</sup>	Rainbow surfperch				
<i>Hypsypops rubicunda</i>	Garibaldi				
<i>Leuresthes tenuis</i> <sup>2</sup>	California grunion				
<i>Lynthrypnus dalli</i> <sup>2</sup>	Bluebanded goby				
<i>Medialuna californiensis</i>	Halfmoon				
<i>Mola mola</i> <sup>2</sup>	Ocean sunfish				
<i>Myliobatus californica</i> <sup>2</sup>	Bat ray				
<i>Oncorhynchus kisutch</i> <sup>2</sup>	Coho salmon				
<i>Ophiodon elongatus</i>	Lingcod				
<i>Oxyjulis californicus</i>	Senorita				
<i>Oxylebius pictus</i>	Convict fish				
<i>Paralabrax clathratus</i>	Kelp bass				
<i>P. maculato-fasciatus</i> <sup>2</sup>	Spotted sand bass				

See footnotes at end of table.

Table 1. Master species list for Rincon Island.--Continued.

Scientific name <sup>1</sup>	Common name	Occurrence during present study			
		North	West	South	East
CLASS OSTEICHTHYES (Continued)					
<i>P. nebulifer</i>	Barred sand bass				
<i>Paralichthys californicus</i>	California halibut				
<i>Pimelometopon pulchrum</i>	California sheephead				
<i>Platichthys stellatus</i> <sup>2</sup>	Starry flounder				
<i>Phanerodon furcatus</i>	White seaperch				
<i>Porichthys</i> spp.	Midshipman				
<i>Rathbunella hypoplecta</i>	Smooth ronquil	X			X
<i>Rhacochilus toxotes</i>	Rubberlip seaperch				
<i>Rhacochilus vacca</i>	Pile perch				
<i>Sardinops sagax</i> <sup>2</sup>	Pacific sardine				
<i>Scomber japonicus</i> <sup>2</sup>	Pacific mackerel				
<i>Scomberomorus concolor</i> <sup>2</sup>	Monterey Spanish mackerel				
<i>Scorpaena guttata</i>	California scorpionfish				
<i>Scorpaenichthys marmoratus</i>	Cabezon	X			
<i>Sebastes atrovirens</i>	Kelp rockfish				
<i>S. auriculatus</i>	Brown rockfish	X			
<i>S. cf. caurinus</i>	Copper rockfish				
<i>S. chlorostictus</i> <sup>2</sup>	Greenspotted rockfish				
<i>S. elongatus</i> <sup>2</sup>	Greenstriped rockfish				
<i>S. miniatus</i> <sup>2</sup>	Vermilion rockfish				
<i>S. mystinus</i>	Blue rockfish				
<i>S. paucispinis</i> <sup>2</sup>	Bocaccio				
<i>S. rastrelliger</i> <sup>2</sup>	Grass rockfish				
<i>S. rubrivinctus</i> <sup>2</sup>	Flag rockfish				
<i>S. serranoides</i>	Olive rockfish				
<i>S. serriceps</i> <sup>2</sup>	Treefish				
<i>S. sp. #1</i>					
<i>S. sp. #2</i>					
<i>Seriphus politus</i>	Queenfish				
<i>Sphyræna argentea</i> <sup>2</sup>	Pacific barracuda				
<i>Symphurus atricauda</i> <sup>2</sup>	California tonguefish				
<i>Syngnathus californiensis</i> <sup>2</sup>	Kelp pipefish				
<i>Thunnus alalunga</i> <sup>2</sup>	Albacore				
<i>Trachurus symmetricus</i> <sup>2</sup>	Mack mackerel				
Unid. blenny					X

<sup>1</sup>Taxa without superscript were observed during this study.

<sup>2</sup>Taxa reported by Carlisle, Turner, and Ebert (1969) or Brisby in Keith and Skjei (1974), but not observed during this study.

<sup>3</sup>The two species were not differentiated during this study.

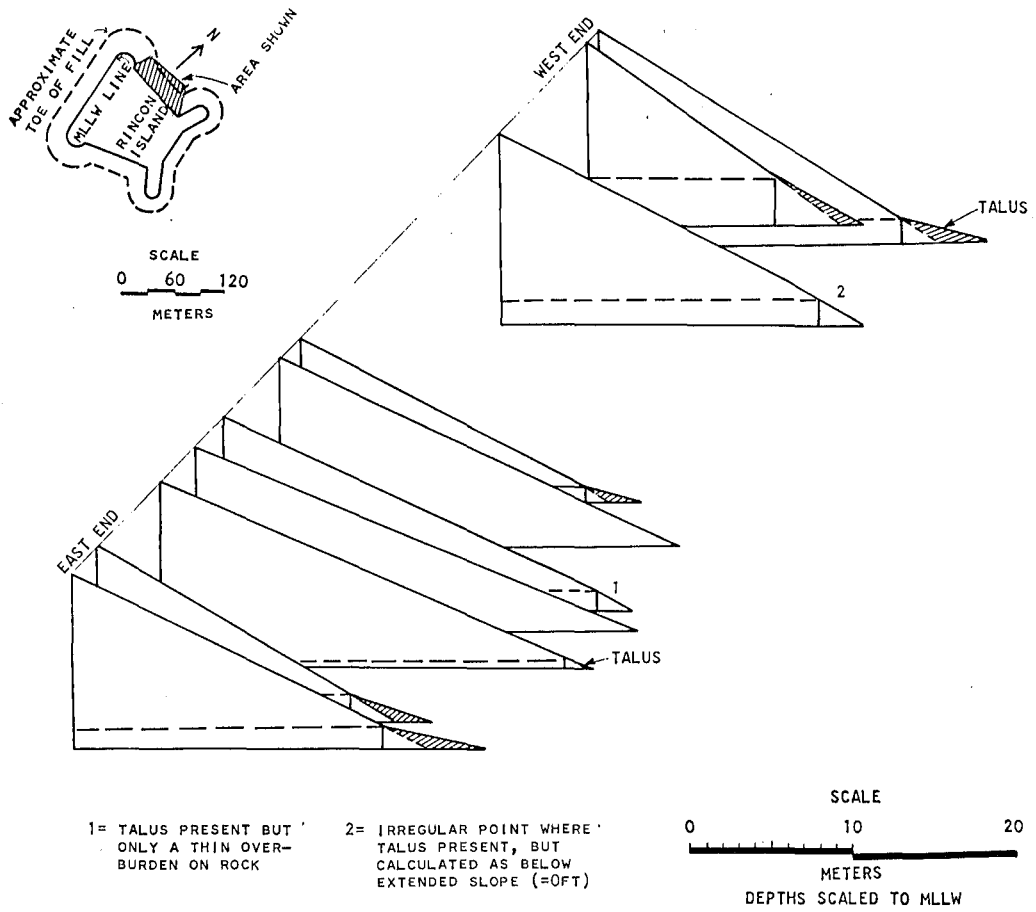

Figure 5. North-side talus bed and armor rock measurements, 15 October 1976.



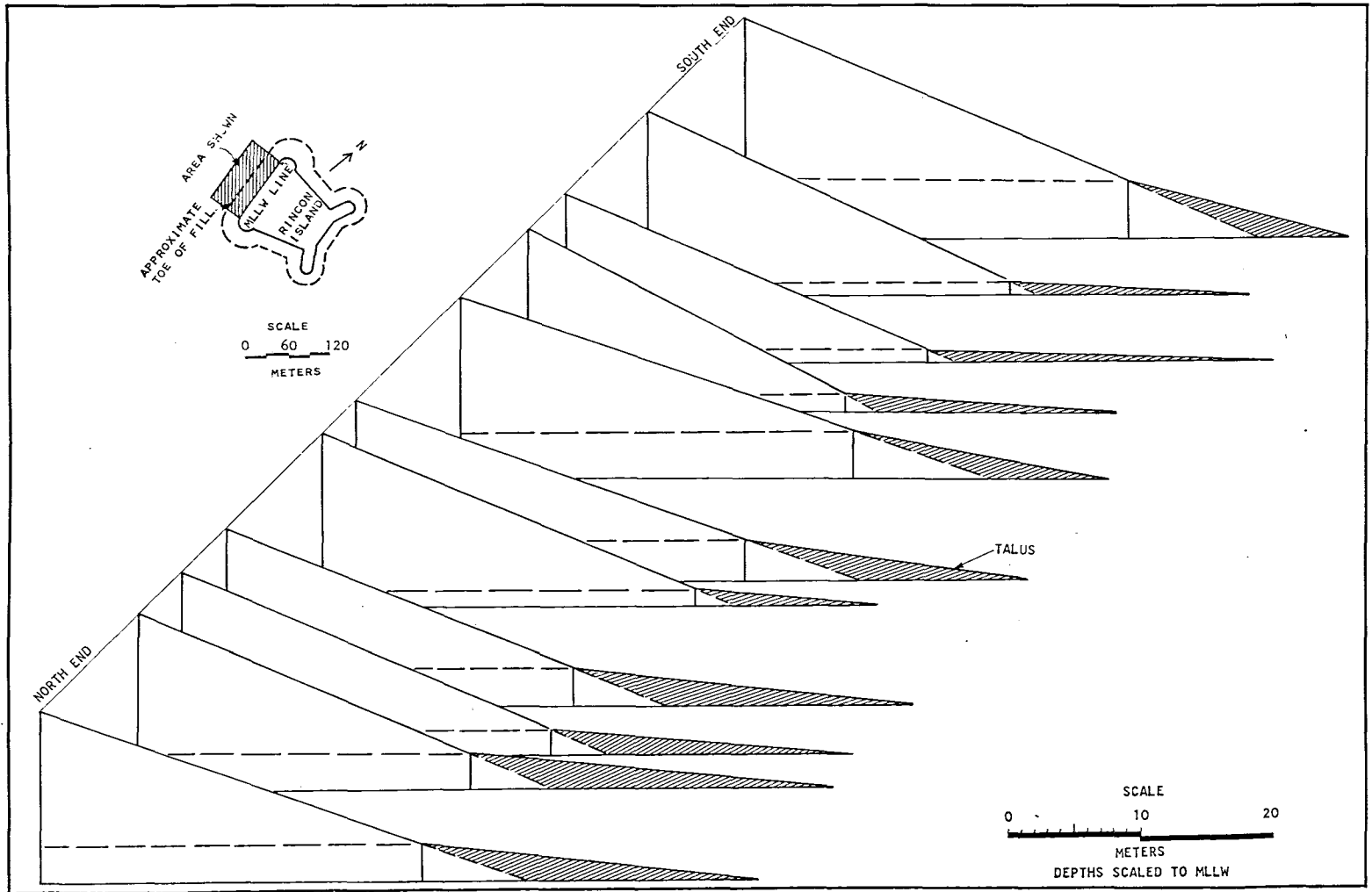

Figure 6. West-side talus bed and armor rock measurements, 15 October 1976.

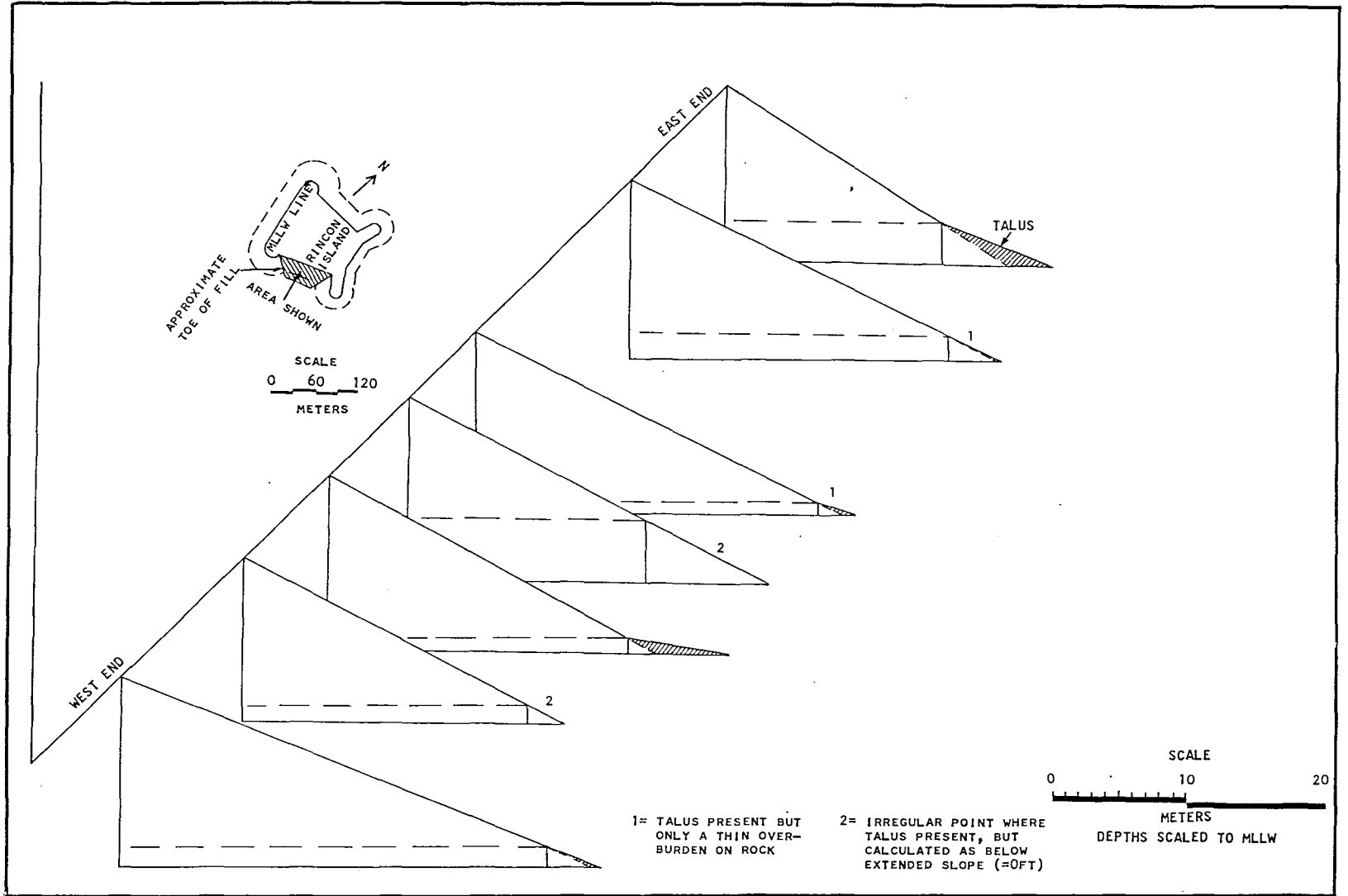

Figure 7. South-side talus bed and armor rock measurements, 19 November 1976.

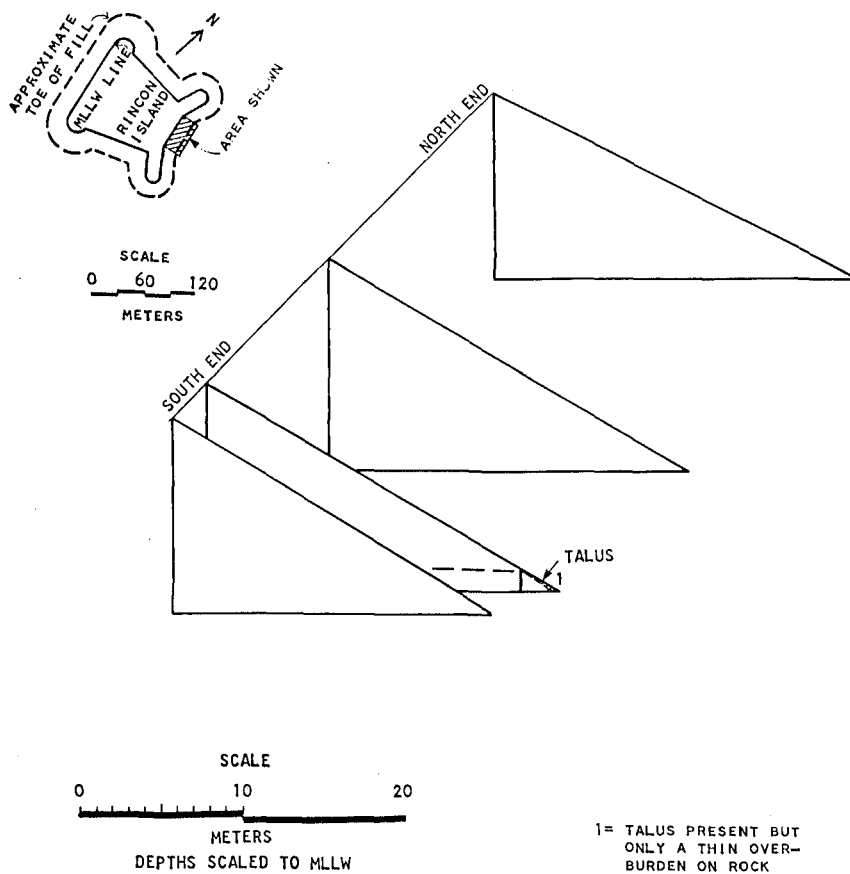

Figure 8. East-side talus bed and armor rock measurements, 15 October 1976.

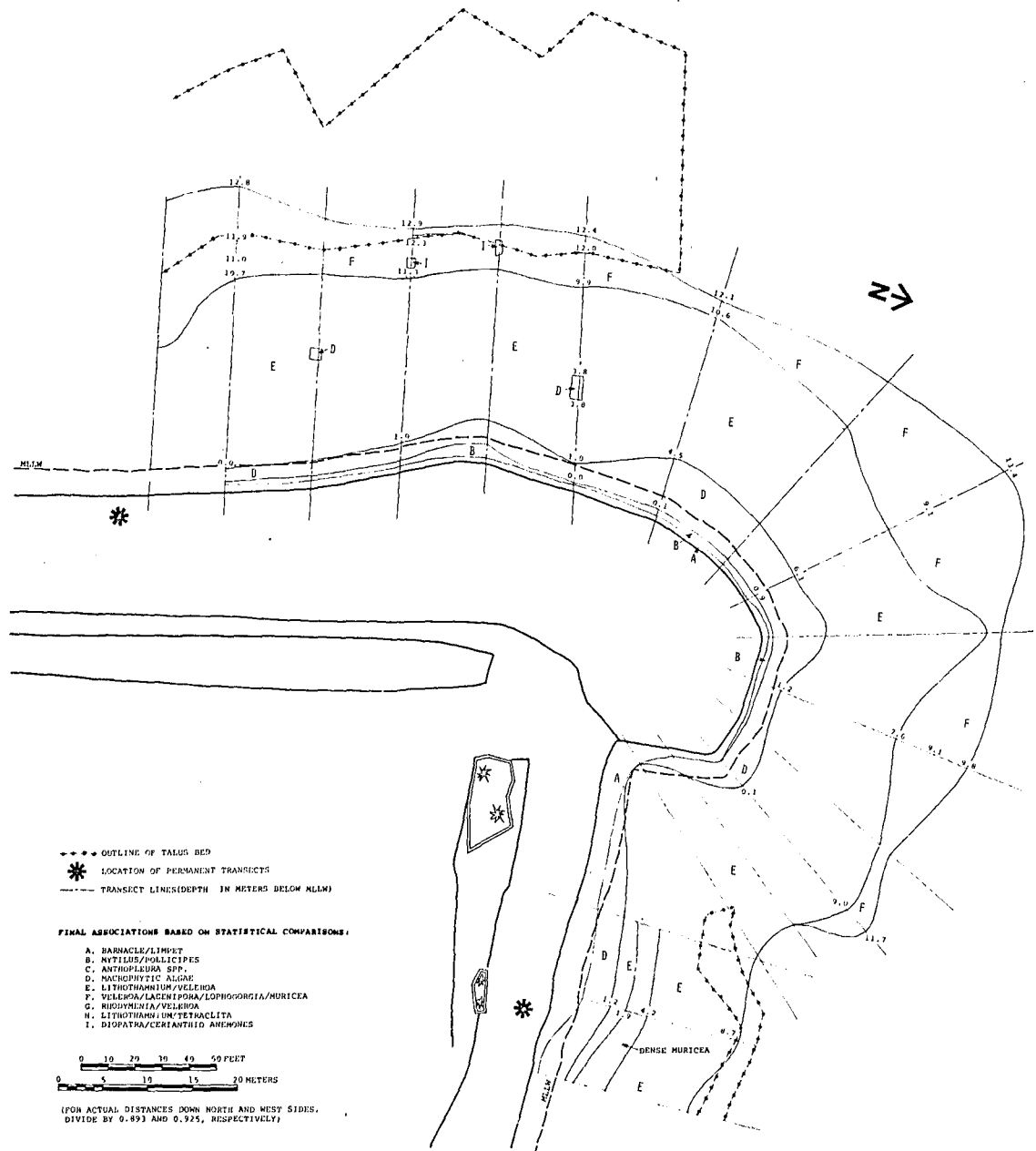

Figure 9. Major species associations, northwest quadrant.

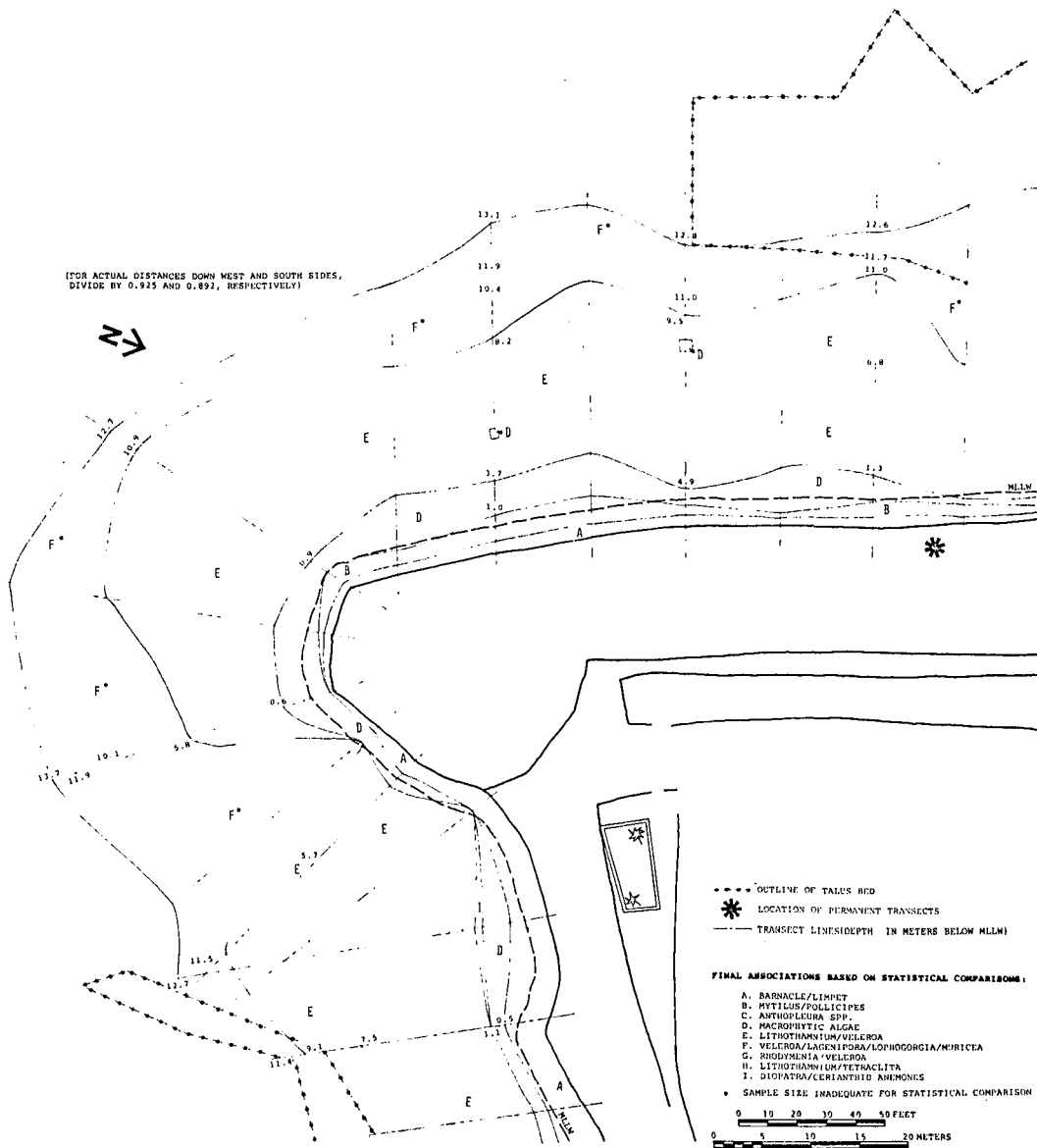

Figure 10. Major species associations, southwest quadrant.

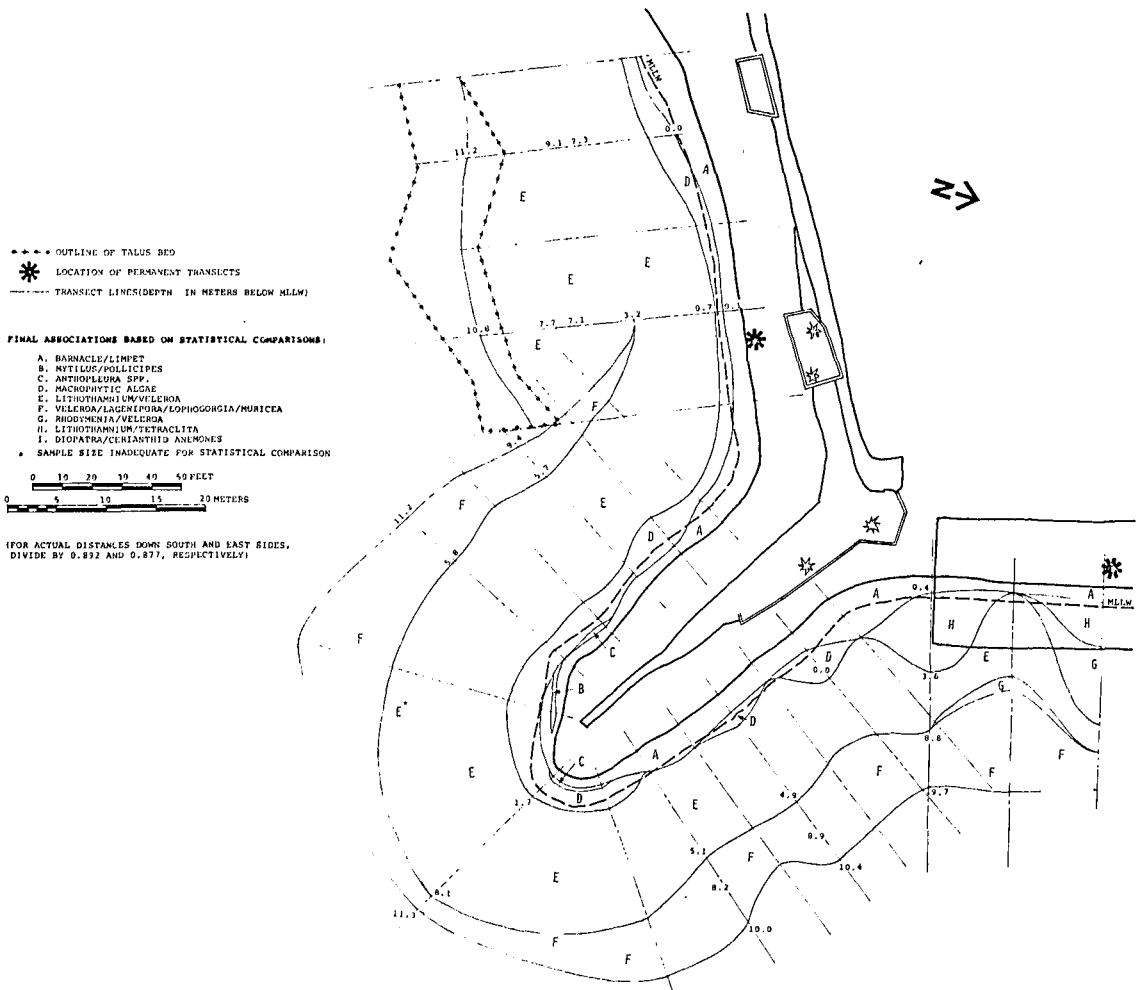

Figure 11. Major species associations, southeast quadrant.

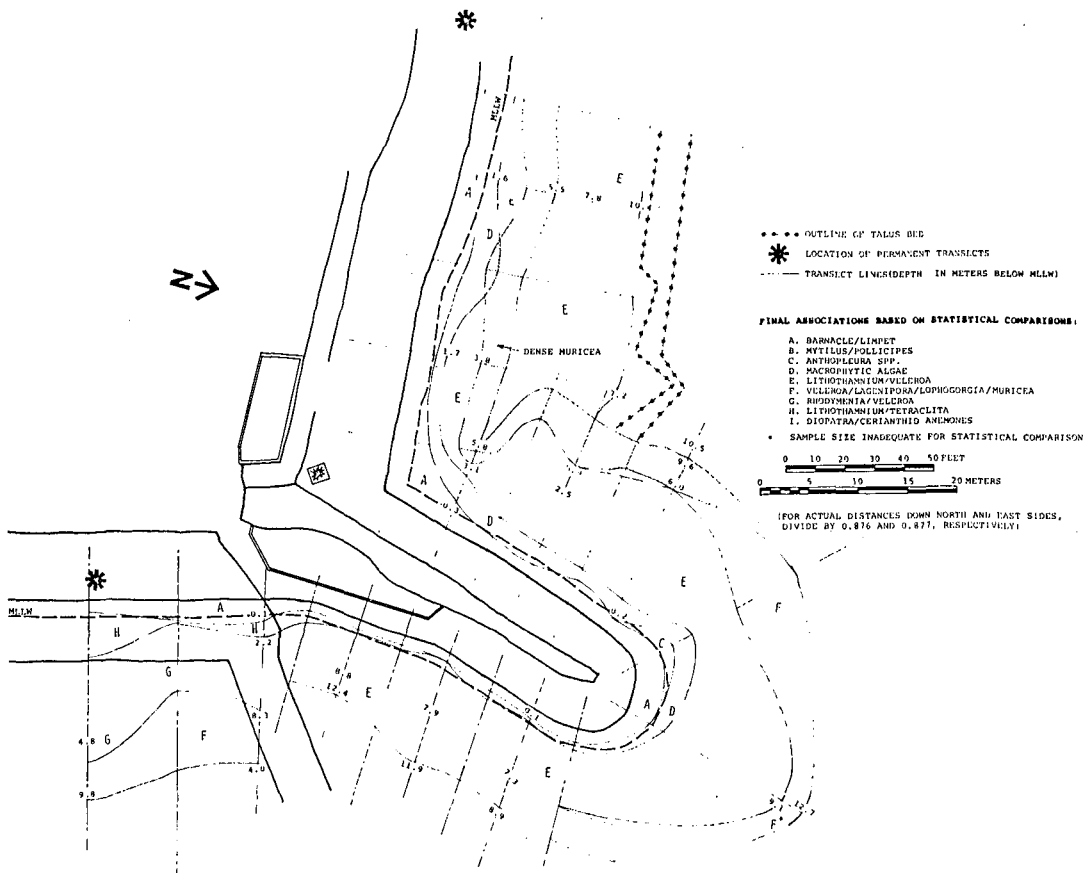

Figure 12. Major species associations, northeast quadrant.

North side:	49 cubic meters
East side:	No significant accumulation.
Total:	1,597 cubic meters

These figures apply only to the talus beds shown in Figures 9 to 12. The talus beds extended around the southwest and northwest wings of the island and contained a large volume of shell debris. At the west edge of each of these wings, talus beds were of dimensions similar to those lying along the west side. The beds diminished markedly on the flanks of the southwest and northwest wings where they adjoin the south and north sides, respectively, of the island. No significant shell talus accumulations were observed around the base of either the northeast or the southeast wing.

The west-side talus beds, averaging 16.5 cubic meters per meter of lineal distance along the west revetment, were considerably more voluminous and extensive than the beds on the other sides. This is because the tetrapods on the west side supported a very heavy growth of mussels (*Mytilus californianus*) in the intertidal zone. Parts of this are sometimes removed by heavy surf, which is most pronounced on the west (seaward) side. Some of the detached mussels gravitate into quarry rock and tetrapod interstices, but many accumulate at the foot of the revetments.

West-side talus beds were composed almost entirely of mussel shells, many of which were of unusually large size for this species. Paine (1976) reported a specimen of *M. californianus* exceeding 26.6 centimeters in length from a subtidal mussel bed on Duncan Rock off Washington. The previous record was 25.1 centimeters, as reported by Chan (1973). A mussel measuring 25 centimeters has been reported at an offshore oil platform in southern California (Southern California Coastal Water Research Project, 1976). Although no measurements were taken on shells in the Rincon Island talus bed, many specimens apparently approaching this size were observed. Some shells of *Pododesmus cepio* were also present in the west-side talus area. The seaward boundary of the west-side talus bed (where it graded into natural sedimentary bottom) was very distinct and lacking in irregularities. The inner margin was somewhat irregular and interspersed with isolated rocks. Isolated pockets of talus existed above the upper margin of the main talus bed.

In contrast, the east side was nearly devoid of shell talus. Only one pocket of talus was observed, approximately 4 meters from the south boundary of the side. Small mounds of mussel shells were observed at the bases of causeway pilings. The east side is the most sheltered side, and appears to act as a deposition site for sediment carried to the rear of the island in turbulent eddies (Keith and Skjei, 1974). The middepth and deeper parts of the east-side revetments were always overlain by a veneer of fine sediment: the



transition from rock revetment to sedimentary bottom is distinct, primarily because of a contrast in slope of the two substrate types.

The north- and south-side talus beds are intermediate in size between those of the west and east sides. The upper and lower margins are highly irregular on both the north and south sides. Some "fingers" of talus extend more than 3 meters up the north-side revetment, and an isolated shallow pocket of talus exists in a flat area about half way down the side near the location of the permanent transect. The sediment lying near the base of the island on both the north and south sides is inclined, possibly because it overlies a buried part of the talus bed. Many isolated rocks punctuate the natural bottom sediment, particularly along the north side. Shells of the bivalves, *Pododesmus cepio* (jingles), *Hinnites multirugosus* (rock scallop), and unidentified species form the bulk of the talus beds on the north and south sides. Some *Mytilus* talus exists near the west end of the north side which may have been carried around from the west side by currents. Biota frequently encountered in association with the talus beds include the tube worm, *Diopatra ornata*; the tube anemone, *Pachycerianthus* sp; the nudibranch, *Dendrodoris fulva*; the whelk, *Kelletia kelletii*; the bat star, *Patiria miniata*; and hermit crabs including *Paguristes ulreyi* and *Isocheles pilosus*.

### 3. Analysis of Seasonal Data from Permanent Transects.

An overview of the vertical distribution of tentatively discriminated major species associations, synthesized from data of the first two seasonal permanent transect surveys (summer and fall, 1976) is graphically represented for each side of the island in Figures 13 to 16. Figures 17 to 20 augment information provided in Figures 13 to 16 by illustrating the vertical distributions of selected dominant macrobiota over the permanent transects. A broad vertical pattern for *Patiria miniata* is apparent on all sides. Also noteworthy is the dominance of the *Lithothamnium-Lithophyllum* complex over the upper reaches of all but the east side. The east side also appears unique in that distributions of several species are much less restricted vertically than is the case on the other sides (e.g., the red algae, *Veleroa subulata*-*Murrayellopsis dawsonii* complex and the abundant ectoproct, *Lagenipora punctulata*).

A total of 250 taxa of macrobiota was identified during the four seasons of the permanent transect sampling program. These taxa are listed in Table 1 together with information on which side of the island each occurred. The species occurring in transects on all four sides of the island may be regarded as ubiquitous and generally the dominant macrobiota over the entire island. Many of the species listed in Table 1 undoubtedly occur on more sides of the island than indicated. An example is the giant kelp, *Macrocystis* sp. Kelp is most

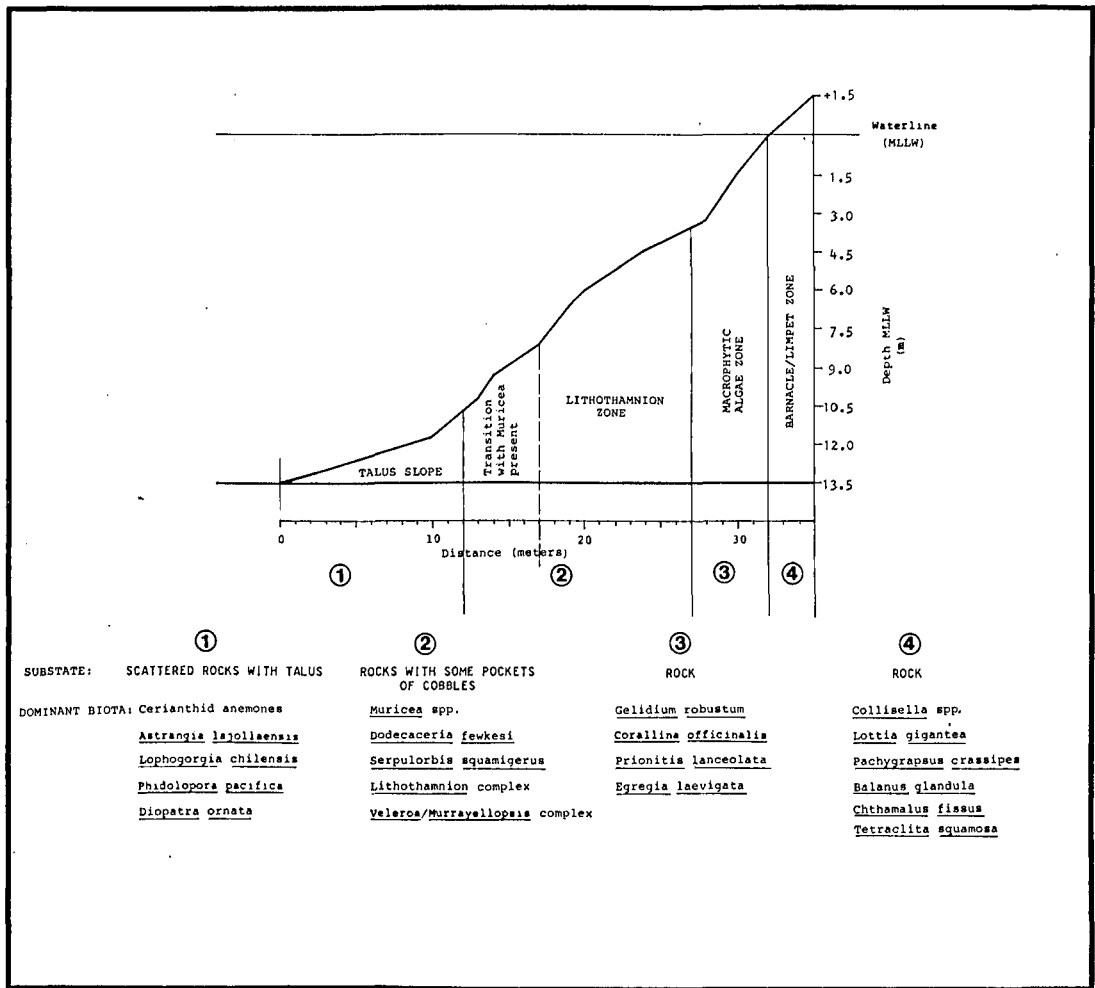

Figure 13. Seasonal overview of distribution of major species associations and substrate character, north-side permanent transect.

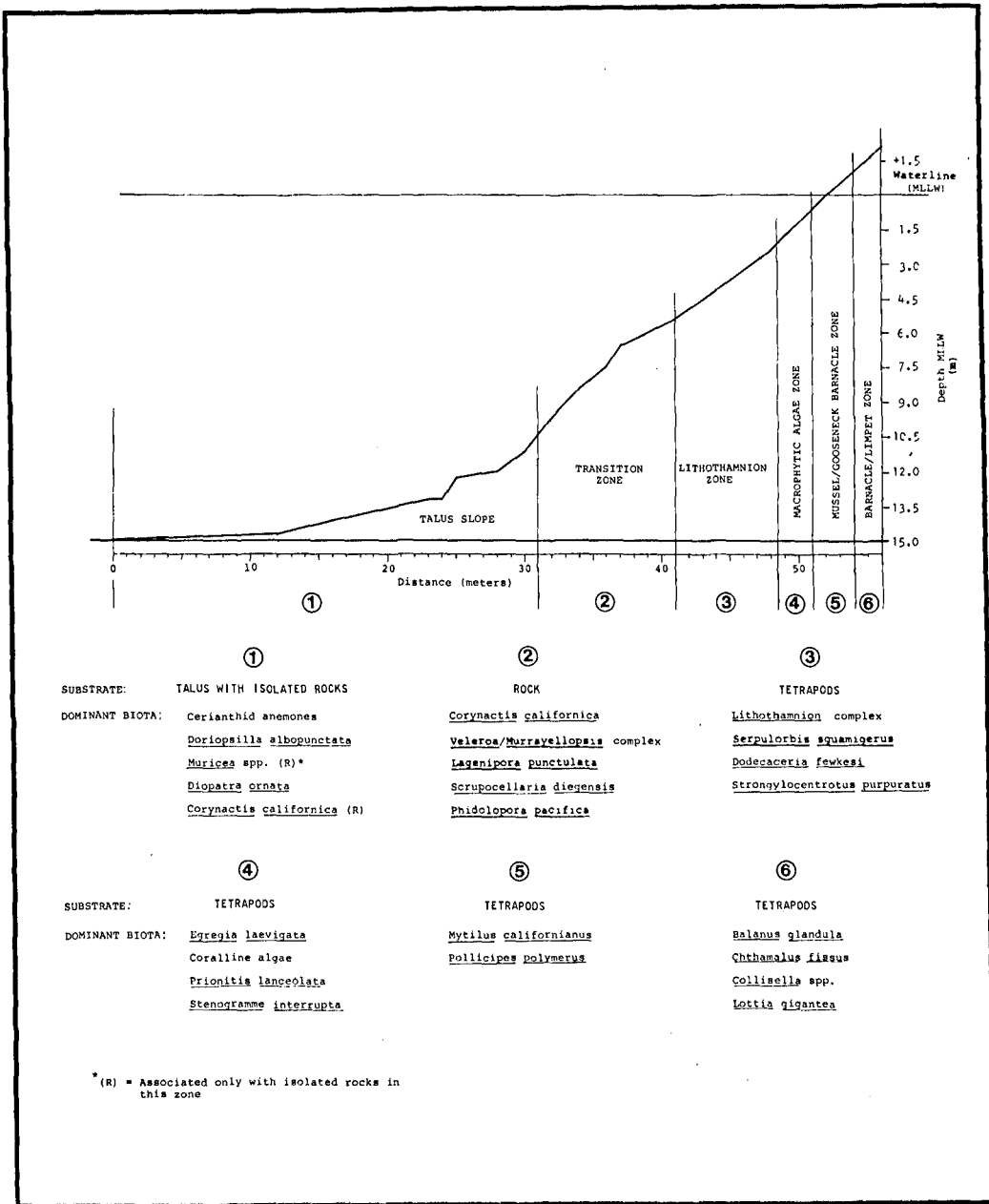

Figure 14. Seasonal overview of distribution of major species associations and substrate character, west-side permanent transect.

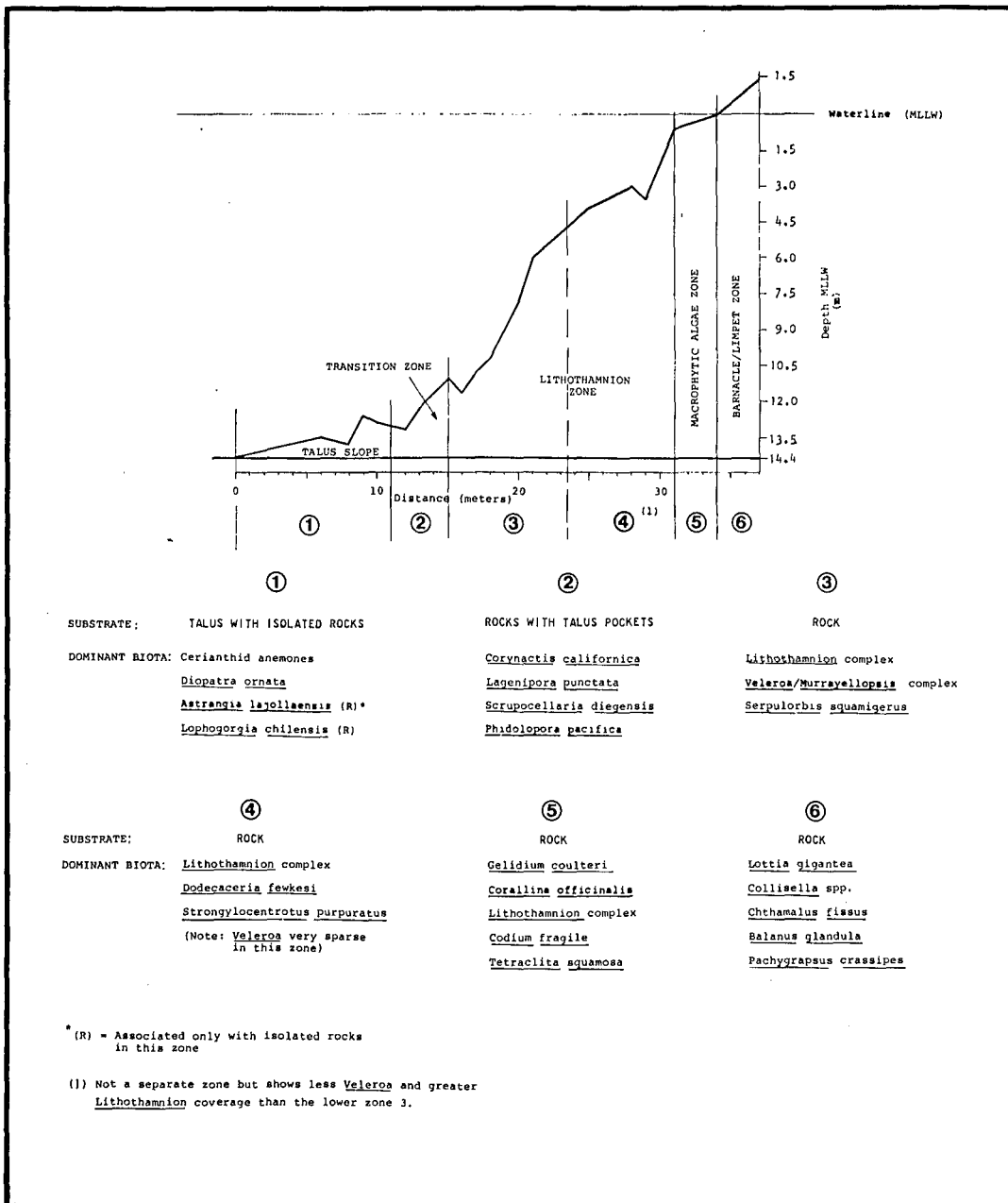

Figure 15. Seasonal overview of distribution of major species associations and substrate character, south-side permanent transect.

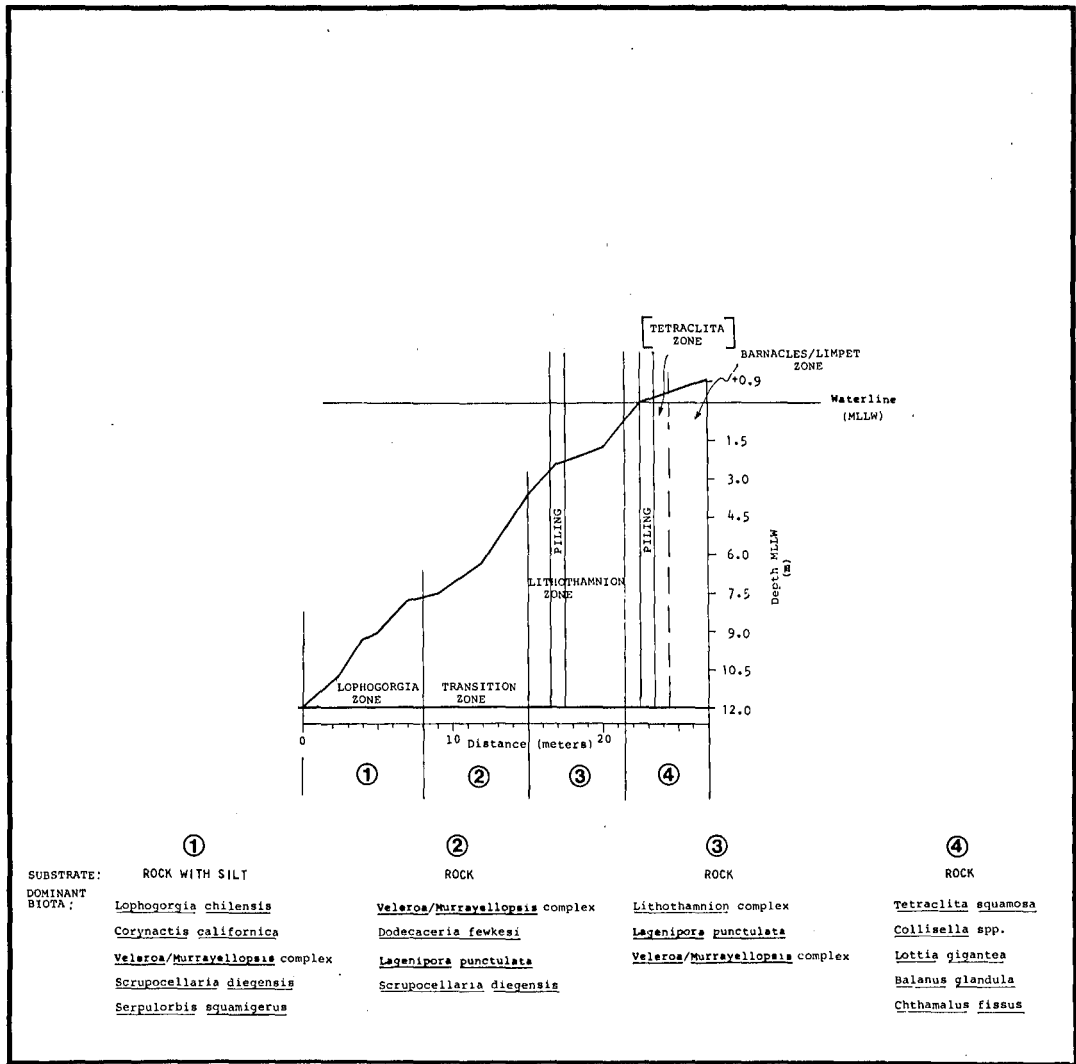
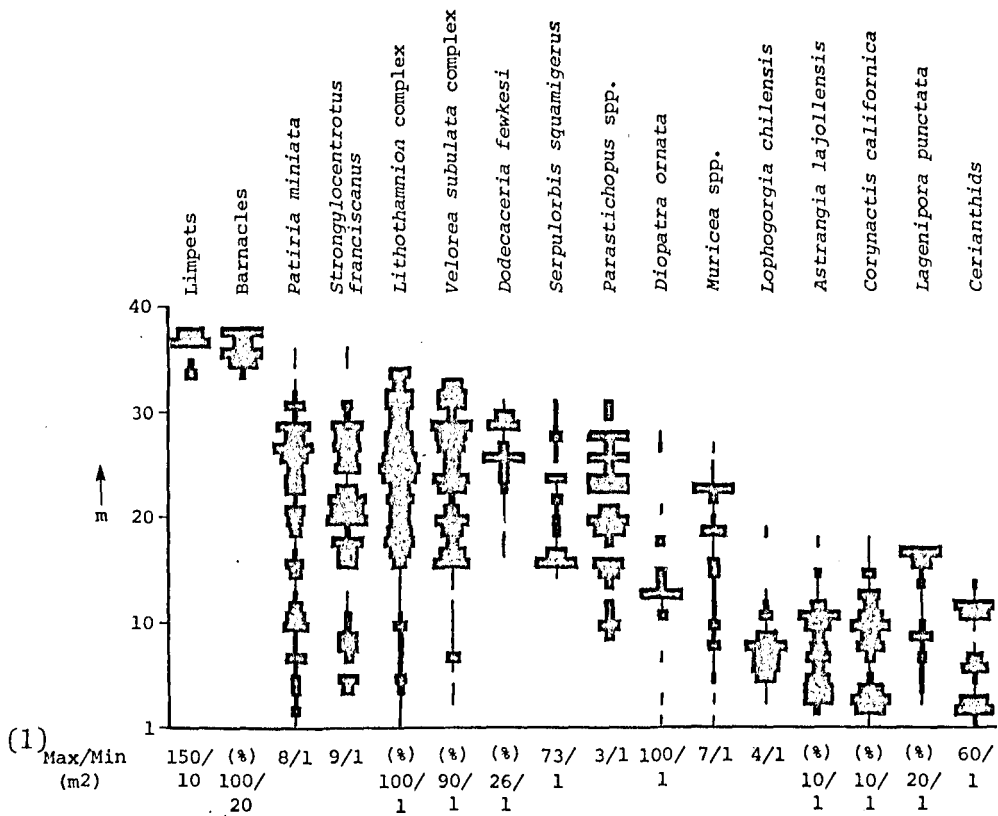
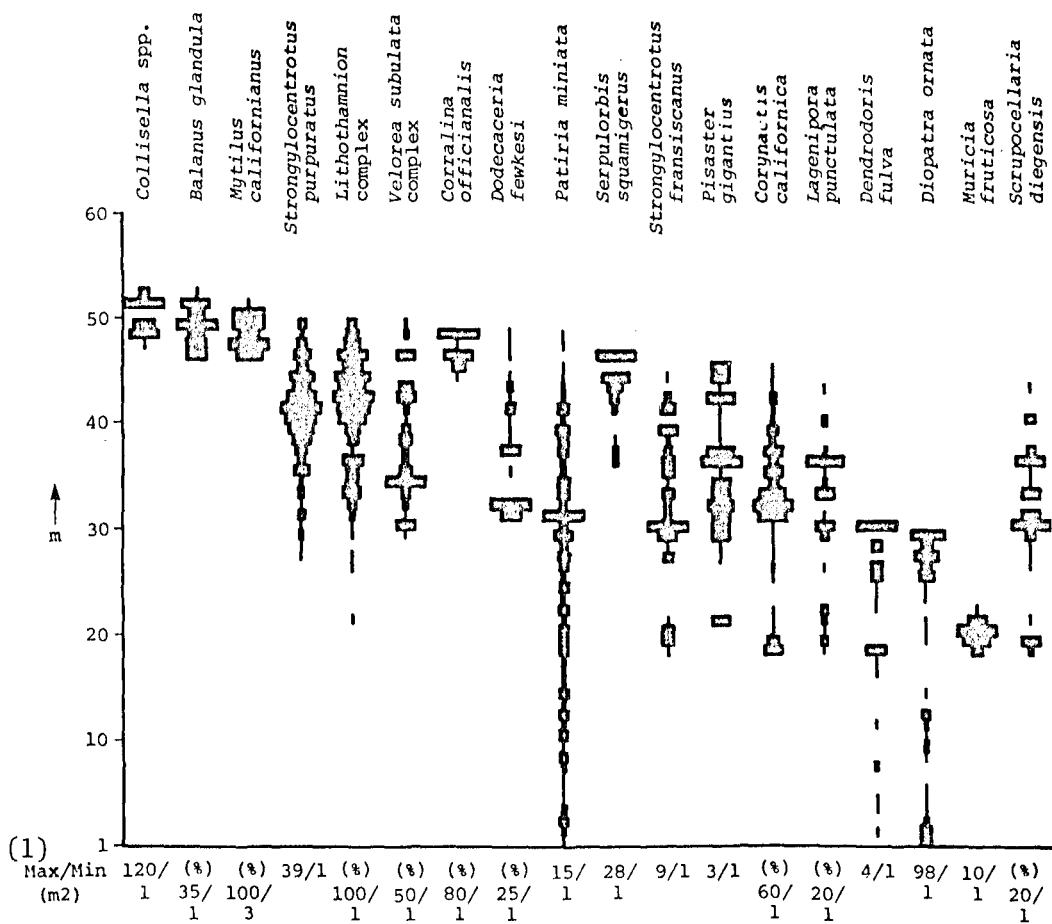

Figure 16. Seasonal overview of distribution of major species associations and substrate character, east-side permanent transect.



(1) Values below each column indicate maximum (upper value) and minimum (lower value) densities encountered in 1-square meter quadrats over those depths where each species occurred. Values below the (%) signs represent percent coverage for encrusting forms. The remaining values represent numerical densities.

Figure 17. Vertical distribution for dominant biota, north side.



(1) Values below each column indicate maximum (upper value) and minimum (lower value) densities encountered in 1-square meter quadrats over those depths where each species occurred. Values below the (%) signs represent percent coverage for encrusting forms. The remaining values represent numerical densities.

Figure 18. Vertical distribution for dominant biota, west side.

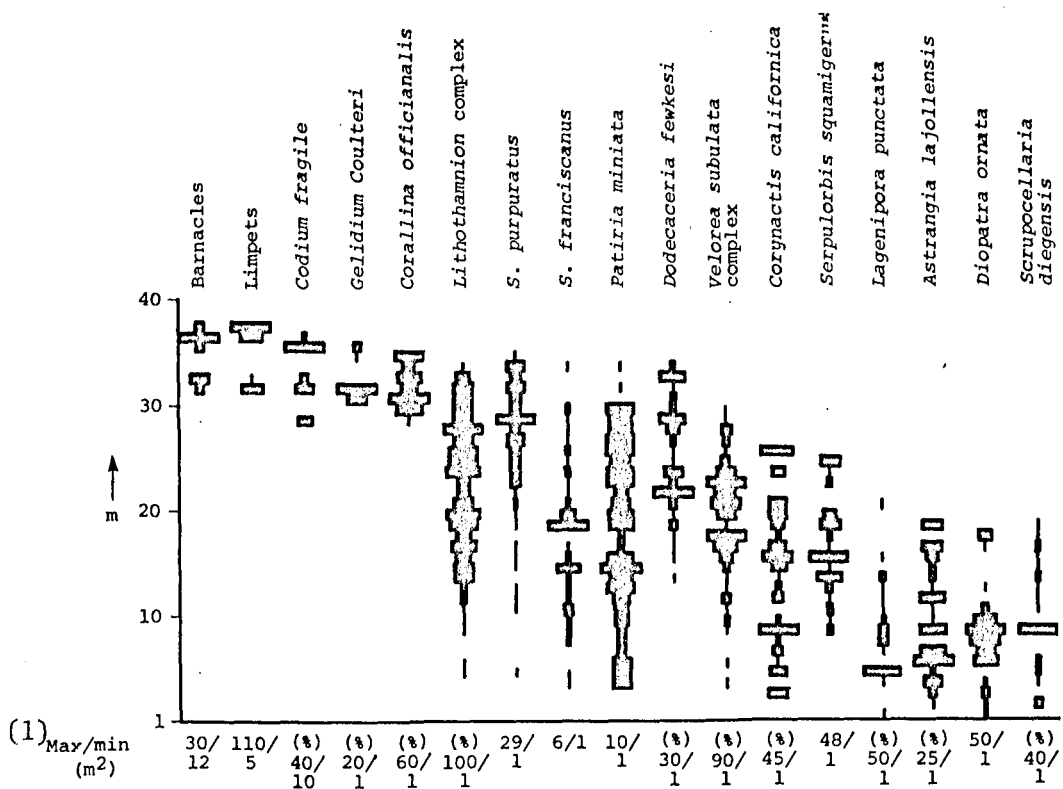

(1) Values below each column indicate maximum (upper value) and minimum (lower value) densities encountered in 1-square meter quadrats over those depths where each species occurred. Values below the (%) signs represent percent coverage for encrusting forms. The remaining values represent numerical densities.

Figure 19. Vertical distribution for dominant biota, south side.



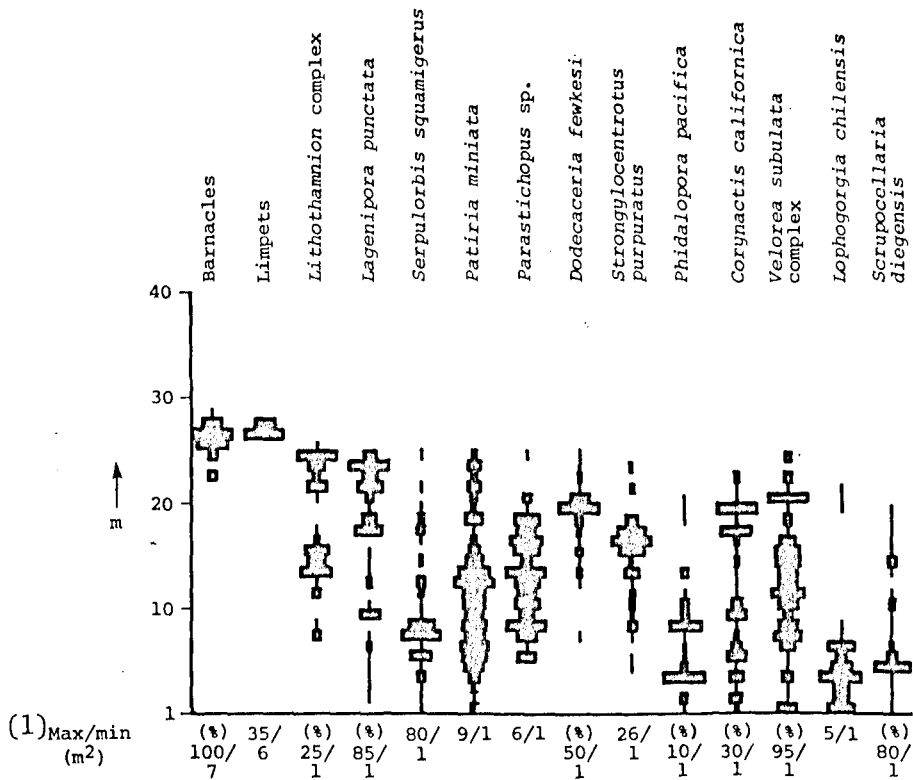

(1) Values below each column indicate maximum (upper value) and minimum (lower value) densities encountered in 1-square meter quadrats over those depths where each species occurred. Values below the (%) signs represent percent coverage for encrusting forms. The remaining values represent numerical densities.

Figure 20. Vertical distribution for dominant biota, east side.

abundant on the south end of the west side of the island, but sparse in the central part, which is where the transect was located. This small kelp bed on the southwest wing of the island varied considerably in size during the course of the study. Heavy wave action and grazing by sea urchins may have offset normal seasonal growth. Also, many species, in addition to those listed in Table 1, have distributions that did not coincide with the permanent transects. Some of these were collected during quantitative characterization of major species associations using randomly placed quadrats. Others were found during reconnaissance dives.

The analysis of the permanent transect data for significant seasonal differences in species densities is summarized in Appendix B, Table B-1. Table 2 provides a summary of the permanent seasonal transect data. The table shows that a total of 37 of the 52 taxa (71 percent) examined exhibited significant variability in mean abundance in the transects, apparently due in most cases to seasonal changes in population densities. Twenty of these taxa were absent from the transects during one or more seasons. Seventeen taxa showed significant seasonal differences despite being present in the transects during all four seasons. Table 2 also indicates the side of the island and season of maximum abundance in the transects for each species.

Among echinoderms, the urchins (*Strongylocentrotus franciscanus* and *S. purpuratus*) and cucumbers (*Parastichopus* spp.) showed apparent seasonal differences, while none of the four starfish species examined were significantly variable. The results for motile species such as these must be interpreted with caution: seasonal differences may reflect changes in distribution rather than actual variations in abundance. All three ectoproct (moss animal) species examined, which collectively account for the bulk of ectoproct biomass on the island, showed seasonal variability. Gorgonians of genus *Muricea* varied seasonally; *Lophogorgia chilensis* did not. Among other coelenterates, significant differences were shown by the anemone, *Corynactis californica*, and the coral, *Paracyathus stearnsii*, but not by *Anthopleura* sp. or *Astrangia lajollaensis*. The two sponges examined showed seasonal differences. Most of the red algae species (Codes 22 to 45 in Table 2, and Table B-1) were seasonally variable, as was expected. The only exceptions were *Laurencia pacifica*, *Prionitis lanceolata*, and *Rhodoglossum affine*. Most red algae showed peak densities in spring and summer, as was the case with the green algae (Codes 1 to 6 in Table 2, and Table B-1) and generally with the browns (Codes 11 to 20). Conversely, the widely distributed blue-green alga, *Phormidium* sp., was most abundant during the winter.

Table 2. Seasonal transect data summary.

Species Code <sup>1</sup>	Species	Common Name	Seasonal Variability <sup>2</sup>	High Density	
				Side	Season
1	<i>Enteromorpha</i> sp.		(S)	East	Summer
2	<i>Ulva</i> sp.	Sea lettuce	NS	East	Summer
6	<i>Codium fragile</i>	Deadman's fingers	(S)	South	Summer
11	<i>Cystoseira osmundacea</i>		(S)	North	Spring
12	<i>Egregia menziesii</i>		NS	West	Summer
16	Unid. juv. laminariales		(S)	East	Fall
20	<i>Dictyota flabellata</i>		(S)	West	Spring
22	<i>Bossiella orbigniana</i>		(S)	West	Spring
24	<i>Corallina officinalis</i>		S	South	Summer
25	<i>Gelidium coulteri</i>		(S)	South	Fall
26	<i>G. robustum</i>		(S)	North	Spring
29	<i>Gigartina canaliculata</i>		(S)	East	Winter
30	<i>G. exasperata</i>		(S)	West	Summer
34	<i>Laurencia pacifica</i>		NS	West	Winter
35	<i>Lithothamnion-</i> <i>Lithophyllum</i> complex		S	South	Spring
37	<i>Peyssonellia</i> sp.		(S)	South	Winter
39	<i>Prionitis lanceolata</i>		NS	North	Spring
40	<i>Rhodoglossum affine</i>		NS	North	Summer
41	<i>Rhodymenia</i> sp.		(S)	East	Spring
42	<i>R. californica</i>		(S)	North	Winter
44	<i>Stenogramme</i> sp.		(S)	North	Summer
45	<i>S. interrupta</i>		(S)	East	Summer
48	cf. <i>Phormidium</i> sp.		(S)	East	Winter
68	<i>Cliona</i> sp.	Boring sponge	S	West	Winter
89	<i>Hymenamphistra cyanocrypta</i>	Blue leaf sponge	(S)	East	Summer
103	<i>Anthopleura</i> sp.	Anemone	NS	South	Spring
104	<i>Astrangia lajollaensis</i>	Colonial coral	NS	East	Spring
106	<i>Corynactis californica</i>	Colonial red anemone	S	West	Spring
108	<i>Lophogorgia chilensis</i>	Pink gorgonian	NS	East	Spring
109	<i>Muricea</i> spp.	Gorgonians	S	North	Winter
110	<i>Paracyathus stearnsii</i>	Solitary coral	S	East	Winter
128	<i>Anomia peruviana</i>	Jingles	(S)	East	Spring
	<i>Pododesmus cepio</i>				
148	<i>Doriopsilla albopunctata</i>	Yellow sea slug	S	West	Summer
153	<i>Kelletia kelletii</i>	Kellet's whelk	(S)	West	Spring
155	<i>Lottia gigantea</i>	Owl limpet	NS	South	Summer
157	<i>Megathura crenulata</i>	Giant keyhole limpet	S	West	Summer
158	<i>Mytilus californianus</i>	California mussel	NS	North	Spring
159	<i>M. edulis</i>	Bay mussel	(S)	North	Winter
170	<i>Serpulorbis squamigerus</i>	Scaled worm shell	S	North	Fall
185	<i>Diopatra ornata</i>	Worm	S	South	Fall
186	<i>Dodecaceria fewkesi</i>	Worm	S	North	Summer
187	<i>Eudistylia</i> sp.	Feather-duster worm	NS	North	Winter
200	<i>Lagenipora punctulata</i>	Moss animal	S	East	Fall
201	<i>Phidolopora pacifica</i>	Lace moss animal	S	East	Summer
202	<i>Scrupocellaria diegensis</i>	Moss animal	S	East	Fall
228	<i>Parastichopus</i> spp.	Sea cucumber	S	East	Spring
229	<i>Patiria miniata</i>	Bat star	NS	North	Winter
230	<i>Pisaster brevispinus</i>	Pink seastar	NS	North	Summer
231	<i>P. giganteus</i>	Giant seastar	NS	West	Winter
232	<i>P. ochraceus</i>	Ochre seastar	NS	East	Winter
241	<i>Strongylocentrotus franciscanus</i>	Red urchin	S	North	Spring
242	<i>S. purpuratus</i>	Purple urchin	S	West	Fall

<sup>1</sup>Species code referenced in Appendix B, Table B-1.<sup>2</sup>(S) = Significant, based on absence during one or more seasons

S = Significant, despite presence during all seasons

NS = Not significant at the 95 percent confidence level

#### 4. Distribution of Major Species Associations.

Dendograms resulting from the computer analysis are presented in Appendix C. The species groups identified by the computer generally agreed with the field observations. Clusters are particularly distinct for intertidal associations, as might be expected. On the basis of this exercise and first-hand field observations, the following 13 species associations (not including the shell talus beds) were tentatively identified and designated with generic names of conspicuously dominant species:

- a. *Diopatra/cerianthid* anemones
- b. *Astrangia/gorgonians*
- c. *Lagenipora/Scrupocellaria*
- d. *Lithothamnium* complex/*Serpulorbis/Veleroa*
- e. Macrophytic algae
- f. *Mytilus/Pollicipes*
- g. Barnacles/limpets
- h. *Corynactis/Astrangia*
- i. *Lithothamnium* complex/*Serpulorbis/Dodecaceria/Veleroa*
- j. *Astrangia/Corynactis/Lophogorgia*
- k. *Tetraclita/Lithothamnium* complex
- l. *Lithothamnium/Lagenipora/Veleroa*
- m. *Lophogorgia/Corynactis/Veleroa*

The results of the fieldwork which entailed charting of the boundaries of these preliminary or tentatively identified associations relative to permanent features on the island are shown in Appendix C (Figs. C-3 to C-6). The scale on each of these charts may be used to determine plan view distances and actual (i.e., measured down the slope of each side) distances of all association boundaries from permanent features on the island. Permanent features include: navigational warning devices, surveyor triangulation points, and corners of concrete planter boxes used for landscaping the island.

Over most transects, boundaries between associations were distinct. Certain areas which appeared to have characteristics in common with adjacent associations are labeled "transition" zones in the charts. The intertidal associations 5, 6, 7, and 11 were particularly distinct. They contained species not found in other associations, their boundaries were sharply defined, and they were generally much narrower than the remaining (subtidal) associations. Associations 4 and 9, characterized by heavy coverages of *Lithothamnium* complex, accounted for the largest subtidal area of the island.

The east (protected) side differs in the general pattern of associations from the other three (more exposed) sides. Over most of the east side, sea cucumbers (*Parastichopus*), gorgonians (*Muricea*, *Lophogorgia*), stony corals (*Astrangia*, *Paracyathus*), and ectoprocts (*Lagenipora*, *Scrupocellaria*) occurred in abundance. These groups were

generally restricted to the deeper waters on the other three sides. On the east side, a layer of silt varying in thickness from a few millimeters to over a centimeter covered most rock surfaces up to the lower intertidal. This silt precludes growth of some encrusting organisms (especially *Lithothamnium* complex), while others (e.g., *Veleroa* complex) seem tolerant of it.

##### 5. Quantitative Characteristics of Major Species Associations.

The following average biomass values were developed for common attached biota not amenable to routine quantitative removal from the substrate:

*Dodecaceria fewkesi* (animals only, no tubes): 465 grams per  
0.25 square meter  
*Lithothamnium* complex: 783 grams per 0.25 square meter  
*Serpulorbis squamigerus* (animals only, no shells): 1.9 grams  
per individual  
*Veleroa* complex: 242 grams per 0.25 square meter  
*Corynactis californica*: 190 grams per 0.25 square meter

When the 250 quantitative quadrats were grouped according to the preliminary association in which the quadrat was placed and the side of the island sampled, 26 groups or "subareas" resulted (see App. D, Table D-1). The designation of each of the 26 subareas in Table D-1 corresponds to the numerical association designations in Figures C-3 to C-6. For example, the data in Table D-1 for south-side association 5, refer to the macrophytic algae association on the south side only. Data for this association in other areas of the island are found under correspondingly different designations.

For all species encountered in each of the 26 subareas, the following summary statistics are tabulated in Tables D-1 and D-2: frequency of occurrence (ratio of occupied quadrats to total number of quadrats examined in the subarea; mean abundance per quadrat (numerical or percent coverage); 95-percent confidence limits for mean abundance; and average weight per individual (or per 100-square centimeter coverage for species with densities estimated as percent coverage). Multiplication of the value for mean density by the average weight value yields an estimate of biomass for any species in any of the 26 groupings. Reliability of this estimate will be best for common species whose densities are relatively uniform from one quadrat to the next, as indicated by relatively narrow confidence limits for the mean. Table D-3 contains information on areas covered by each of the 26 subareas which were subjected to statistical analysis.

The resulting biomass data are useful in characterizing and comparing the major species associations of Rincon Island. However, the

data are of limited use beyond this for species whose weight is largely composed of nonliving material (e.g., clams, stony ectoprocts).

Species associations as determined by statistical differences within and between the 13 preliminary associations on each side of the island are shown in Figures 9 to 12. These associations may be compared with the preliminary species associations of Figures C-3 to C-6. Based upon statistical analysis, 4 of the 13 preliminary associations were combined with other associations, resulting in a total of 9 distinctly different major species associations. Areas covered by each of these final associations are given in Table D-3.

The quantitative characteristics of these major species associations are discussed below.

a. Barnacle-Limpet Association. This uppermost association (association A in Figs. 9 to 12) was relatively uniform in composition on all sides of the island. Dominant biota include acorn barnacles (*Chthamalus fissus*, *Balanus glandula*, and *Tetraclita squamosa*, in descending order of abundance) and limpets (*Collisella digitalis*, *C. scabra*, and *Lottia gigantea*).

The thatched barnacle, *Tetraclita squamosa*, was the species with the highest biomass in the aggregate samples. The only algae occurring in the samples from this zone were small amounts of *Enteromorpha* sp. and patches of *Ralfsia* sp.

b. Mytilus/Pollicipes Association. This association (association B in Figs. 9 to 12) is largely confined to a narrow band (about 2 meters wide) on the west side of the island. A small area of this association also exists on the southwest wing, but it was not sampled. The association is dominated in biomass by the California mussel (*Mytilus californianus*), which has an average biomass of 16.9 kilograms per square meter, and gooseneck barnacles (*Pollicipes polymerus*) which average 1.0 kilograms per square meter. A few limpets, striped shore crabs (*Pachygrapsus crassipes*), and acorn barnacles (*Balanus* spp.) are also found here. Small bay mussels (*Mytilus edulis*) were common below the surface layer of larger California mussels. Both species also occur in small numbers on the north and south sides, but only *M. edulis* was found on the east (most sheltered) side. Algae occurring in this association include *Bossiella orbigniana* and *Lithothamnium* complex. The *Mytilus-Pollicipes* association is higher in biomass per unit area than any other association on the island.

c. Anthopleura spp. Association. This association (association C in Figs. 9 to 12) is composed almost entirely of green anemones of the genus *Anthopleura*. Although *Anthopleura* spp. occur in large numbers in the macrophytic algae zone, their occurrence in

large patches which could reasonably be labeled as a distinct association was limited to a few areas on the southeast and northeast "wings" of the island.

d. Macrophytic Algae Association. The macrophytic algae association (association D in Figs. 9 to 12), extends around the island in a continuous band except on the east side under the wharf, where light is presumably the limiting factor. Its composition is variable from side to side. Statistical comparisons between association D in various parts of the island and association E on the north side (the type *Lithothamnium* association) generally showed no significant differences for the three taxa selected as characteristic dominants for association E (*Lithothamnium* complex, *Veleroa* complex, and *Dodecaceria fewkesi*). The only exceptions were the south side, which had significantly less *Veleroa* and *Dodecaceria* than association E, and the southeast wing, which had significantly less *Veleroa*. Thus, it appears reasonable to consider association D as an extension of association E, overgrown by macrophytes to depths where physical conditions (including illumination) are favorable.

*Lithothamnium* dominates algal biomass on all sides of the island. The macrophytic algae zone on the south side is unusual in that *Lithothamnium* complex there is composed of much thicker and irregular patches than elsewhere on the island. The south side also supports the densest growths of a coralline alga (*Corallina officinalis*) and a green alga (*Codium fragile*). Other common species on the south side include feather boa kelp (*Egregia menziesii*), *Gelidium robustum*, and *Gigartina canaliculata*. The north side also supports substantial beds of *Egregia*. Other north-side macrophytic dominants include *Prionitis lanceolata* and *Gelidium robustum*. *Cystoseira osmundacea* and coralline algae are abundant in some areas of the north side. Quantitative data for the west side are of limited value in characterizing the macrophytic algae because none occurred in any of the random west-side quadrats. Qualitative observations and results of the seasonal surveys suggest that this zone is dominated by *Egregia*, *Cystoseira*, coralline algae, and *Gigartina canaliculata*. A bed of giant kelp (*Macrocystis* sp.) is located at the south end of the west side of the island. Judging from earlier air photos, however, the present kelp bed is small compared to the extensive beds that have existed in the past. Large numbers of sea urchins now exist on the island and may account for this phenomenon. It is possible that kelp and urchins alternate in cycles of abundance on the island. The inverse relationship between urchin and algae abundance has been discussed, for example, by North (1962).

e. *Lithothamnium-Veleroa* Association.

The *Lithothamnium* association (association E in Figs. 9 to 12) is characterized by high concentrations of *Lithothamnium* complex,

*Veleroa* complex, and *Dodecaceria fewkesi*. Macrophytic algae and deeper dominants such as *Corynactis*, *Astrangia*, gorgonians, and ectoprocts are scarce. An exception to this generalization is found on the north side, where a dense band of gorgonians (*Muricea fruticosa* and *M. californica*) exists (see Figs. 9 to 12). Dense growths of ectoprocts (mostly *Lagenipora punctulata*, *Scrupocellaria diegensis*, and *Phidolopora pacifica*) and *Serpulorbis squamigerus* are found at the bases of the gorgonians, apparently taking advantage of sheltered habitat conditions. A quadrat from the northeast wing *Lithothamnium-Veleroa* association (outside the dense *Muricea* band) produced the highest number of species (37) of all 250 quadrats analyzed. Bat stars (*Patiria miniata*) and urchins are abundant over the *Lithothamnium-Veleroa* association on all sides. The giant key-hole limpet (*Megathura crenulata*) is frequently encountered here, as are sea cucumbers (*Parastichopus californicus* and *P. parvimensis*). This association accounts for more subtidal areal coverage than all other associations combined and it is highly uniform in species composition around the island. Despite relatively intensive sampling, no statistically significant differences in biomass of the characteristic dominants (*Lithothamnium*, *Veleroa*, and *Dodecaceria*) were found between this association on the north side and similar associations elsewhere on the island (associations 4, 9, and 12 in Figs. C-3 to C-6 were found not significantly different from the north-side *Lithothamnium-Veleroa* association).

f. *Veleroa-Lagenipora-Lophogorgia-Muricea* Association.

In deeper areas of the *Lithothamnium* zone around the island, the upper parts of the rocks support species representative of that association, while ectoprocts abound on the side and undersurfaces. Deeper yet, the dominant taxa are distinctly different from those characteristic of the *Lithothamnium* association. Taxa commonly occurring in this area include *Veleroa* complex, solitary and colonial corals *Paracyathus stearnsii*, *Balanophyllia elegans*, and *Astrangia lajollaensis*, gorgonians *Muricea* spp. *Lophogorgia chilensis*, colonial anemones (*Corynactis californica*), ectoprocts (*Scrupocellaria diegensis*, *Lagenipora punctulata*, and *Phidolopora pacifica*) and the scaled worm shell gastropod, *Serpulorbis squamigerus*. During the phase of work involving charting of the major species associations, five associations were provisionally discriminated (2, 3, 8, 10, and 13 in Figs. C-3 to C-6) in this deeper area. Although this group of associations is distinctly different from the *Lithothamnium* association, there was no statistical reason on the basis of the data and observations to separate any of the five preliminary associations from one another. Accordingly, these deep associations are combined under the letter designation F in Figs. 9 to 12. A large "transition zone" on the west side was not significantly different from the *Lithothamnium* association; however, two smaller transition areas, one on the northwest wing and one on the southeast wing, were significantly different.



g. Rhodymenia-Veleroa Association.

On the east side, an association exists which is significantly depauperate in *Lithothamnium* complex and significantly enriched (relative to adjacent *Lithothamnium* associations) in the red alga, *Rhodymenia* sp. This is the *Rhodymenia-Veleroa* association, labeled G in Figs. 9 to 12. High densities of *Veleroa* complex, ectoprocts, colonial anemones, corals, *Serpulorbis squamigerus*, and the densest growths of *Dodecaceria fewkesi* on the island are found here. Nudibranches, especially *Flabellinopsis iodinea*, are also common in this zone. The more fragile branching ectoprocts which occur in deeper water on all four sides of the island exist at shallow depths only on the east side, apparently because wave forces are much reduced relative to the other three more exposed sides.

h. Lithothamnium-Tetraclita Association.

Above the *Rhodymenia-Veleroa* association (association G) on the east side, an association composed almost entirely of *Lithothamnium* complex and the large thatched barnacle, *Tetraclita squamosa* occurs over extensive shallow subtidal and intertidal areas (association H in Figs. 9 to 12). Although the two species are found in association in other parts of the island's intertidal and shallow subtidal areas, these occurrences are very limited in extent.

i. Diopatra-Cerianthid Anemones Association.

Small pockets of shell talus, usually partially covered with silt, are commonly found in the deeper areas of association F. These areas are designated as association I in Figures 9 to 12, and they extend over the talus beds to the natural bottom. The tube worm, *Diopatra ornata*; tube anemones, *Pachycerianthus* spp.; bat stars, *Patiria miniata*, and nudibranches (*Dendrodoris fulva*) are very common in these associations.

6. Gill Net Survey Results.

Results of the gill net survey are summarized in Table 3. The nets yielded a total of 270 fishes of 23 species. Five taxa accounted for 61 percent of individuals captured. In decreasing order, they were: olive rockfish, *Sebastes serranoides*; midshipman, *Porichthys* spp.; walleye surfperch, *Hyperprosopon argenteum*; swell shark, *Cephaloscyllium ventriosum*; and white seaperch, *Phanerodon furcatus*. Four of these species (all except *C. ventriosum*) were captured on all four sides of the island. The highest number of individuals and species was captured on the east (most protected) side of the island. Average catch rates were highest during the day on the west side, lowest on the east side. However, for the gill net sets overlapping day and night periods, this pattern was reversed. The south and east sides had the greatest number (15) of species in common; the north and west sides were least similar in this respect.

Table 3. Gill net catch per hour at Rincon Island.

SPECIES	COMMON NAME	North						South							
		Day			Day-Night			Day			Day-Night				
		4 Hrs		23 Hrs		4 Hrs		21 Hrs		4 Hrs		21 Hrs			
		No.	Mean Length (cm)	Length Range (cm)	No.	Mean Length (cm)	Length Range (cm)	Total	No.	Mean Length (cm)	Length Range (cm)	Total			
SHARKS															
<i>Cephaloscyllium ventriosum</i>	Swell shark			9	62.6	53-72	9					9	63.3	58-85	9
<i>Squalus acanthias</i>	Spiny dogfish			1	88		1					1	93		1
TOADFISHES															
<i>Porichthys</i> spp.	Midshipman			23	24.3	15-31	23					6	19.2	18-20	6
ROCKFISHES															
<i>Sebastes cf. caurinus</i>	Copper rockfish											3	14.5	13-17	3
<i>S. mystinus</i>	Blue rockfish														
<i>S. serranoides</i>	Olive rockfish			9	24.3	17-31	9	1	18	18		26	20.9	17.5-27	27
<i>S. auriculatus</i>	Brown rockfish			1	19		1	1	18	18					1
<i>S. atrovirens</i>	Kelp rockfish			1	21		1								1
<i>S. sp. #1</i>	Kelp rockfish											1			1
<i>S. sp. #2</i>	Kelp rockfish														
GREENLINGS															
<i>Ophiodon elongatus</i>	Lingcod											1	55		1
SCULPINS															
<i>Scorpaenichthys marmoratus</i>	Cabezon			2	17.5	14-21	2					1	27		1
SEABASSES															
<i>Paralabrax clathratus</i>	Kelp bass											3	26	16-32	3
CROAKERS															
<i>Cheilotrema saturnum</i>	Black croaker			1	24.5		1								
<i>Genyonemus lineatus</i>	White croaker											1	9		1
<i>Seriphus politus</i>	Queenfish			3	19.3	18.5-20.5	3								
OPALEYES/BLACKSMITHS															
<i>Girella nigricans</i>	Opaleye			4	40.5	39-43	4					1	34		1
<i>Chromis punctipinnis</i>	Blacksmith			2	11	6-16	2								
SURFPERCHES															
<i>Embiotoca jacksoni</i>	Black perch	2	17.5	16-19	5	18.6	12-24	7	1	20	3	19	15-23	4	
<i>Phanerodon furcatus</i>	White seaperch			8	14.3	12-18	8				2	19	13-25	2	
<i>Rhacochilus vacca</i>	Pile perch								1	11				1	
<i>Rhacochilus toxotes</i>	Rubberlip surfperch										3	30.5	27-33	3	
<i>Hyperprosopon argenteum</i>	Walleye surfperch			1	12		1				3	12.5	11-13.5	3	
TOTAL NOS.		2		70			72	4			64			68	
TOTAL SPP.		1		14			14	4			15			17	
Average Catch/Hour (all species)		0.5		3.0			2.7	1.0			3.1			2.1	

Table 3. Gill net catch per hour at Rincon Island.--Continued.

SPECIES	COMMON NAME	East						West						GRAND TOTAL FOUR SIDES
		Side:		Day		Day-Night		Day		Day-Night				
		Time:		4 Hrs		23.5 Hrs		4 Hrs		17 Hrs				
		Hours Fished:		Mean Length (cm)	Length Range (cm)	No.	Mean Length (cm)	Length Range (cm)	Total	Mean Length (cm)	Length Range (cm)	No.	Mean Length (cm)	
<b>SHARKS</b>														
<i>Cephaloscyllium ventriosum</i>	Swell shark			4	55.8	53-58	4							22
<i>Squalus acanthias</i>	Spiny dogfish													2
<b>TOADFISHES</b>														
<i>Porichthys</i> spp.	Midshipman			4	23.8	18-26	4			11	18.8	17-21	11	44
<b>ROCKFISHES</b>														
<i>Sebastes</i> cf. <i>caurinus</i>	Copper rockfish			1	13.5		1							4
<i>S. mystinus</i>	Blue rockfish			2	16.5	16-17.5	2	2	17	15-19	2	15	14-16	6
<i>S. serranoides</i>	Olive rockfish	1	18	18	14	19.9	10.5-23.5	15	1	22	5	20.8	18-24	57
<i>S. auriculatus</i>	Brown rockfish			2	22.3	19-25.5	2							4
<i>S. atrovirens</i>	Kelp rockfish			1	23		1							2
<i>S. sp. #1</i>	Kelp rockfish													1
<i>S. sp. #2</i>	Kelp rockfish			1	20		1							1
<b>GREENLINGS</b>														
<i>Ophiodon elongatus</i>	Lingcod			1	47		1							2
<b>SCULPINS</b>														
<i>Scorpaenichthys marmoratus</i>	Cabezon			1	31		1							4
<b>SEABASSES</b>														
<i>Paralabrax clathratus</i>	Kelp bass			2	42	41-43	2							5
<b>CROAKERS</b>														
<i>Cheilotrema saturnum</i>	Black croaker									8	29.4	27-31	8	9
<i>Genyonemus lineatus</i>	White croaker			3	17	15.5-18.5	3							3
<i>Seriphus politus</i>	Queenfish			3	18.5	17.5-19.5	3			1	17		1	8
<b>OPALEYES/BLACKSMITHS</b>														
<i>Girella nigricans</i>	Opaleye			2	35	34-36	2			3	34.3	31-37	3	10
<i>Chromis punctipinnis</i>	Blacksmith			2	16	16	2	8		14-20			8	12
<b>SURFFERCHES</b>														
<i>Embiotoca jacksoni</i>	Black perch			3	17	15-19	3	1	11	11	2	20.5	20-21	3
<i>Phanerodon furcatus</i>	White seaperch			5	14.7	11-18.5	5				3	16	13-21	3
<i>Rhacochilus vacca</i>	Pile perch			2	20.5	17-24	2				1	21		4
<i>Rhacochilus toxotes</i>	Rubberlip surfperch			4	26.1	23.5-29	4	2	2	21-25	1	31	31	10
<i>Hyperprosopon argenteum</i>	Walleye surfperch			17	14.2	10-17	17				2	16.5	16-17	23
TOTAL NOS.				76			77	14			39			270
TOTAL SPP.				20			20	5			11			23
Average Catch/Hour (all species)				3.2			2.8	3.5			2.3			2.5

White croakers (*Genyonemus lineatus*) were captured only on the east side and an unidentified species of rockfish was captured only on the south side.

## 7. Natural Bottom Survey Results.

Figure 3 shows the location of the natural bottom transect and sampling stations for sediment infauna. Dominant epibiota (organisms on the surface of rocks or sediments) and substrate type encountered along this transect are shown in Figure 21. In general, the deeper areas of the transect, which are representative of the natural bottom existing before the island was constructed, are predominantly sedimentary (sandy silt grading into silty sand in the shoreward direction). On the basis of diver observations, it may be stated that the biomass, numbers, and variety of epibiota encountered visually over natural bottom areas are much lower than that of epibiota observed on the rock revetments of the island. Although rocky areas exist in the shallower parts of the transect, the biota they support was observed to be of lower abundance and variety than the biota occurring at corresponding depths on the island. The macrophytic algae band is broader over the transect than on the island; however, zonation in general is much less distinct over the natural bottom transect than over the island's revetments. A more detailed account of biota and habitat types observed along this transect is provided in Appendix E.

The results of analysis of the sedimentary infauna samples are summarized in Table 4 (data on grain-size distributions for the two sediments sampled are given in App. F). A total of 62 species was encountered in the six samples. Disregarding sample 4 (a part of which was lost), polychaetes accounted for 35 percent of the wet weight biomass and 50 percent of the taxa present in the samples taken collectively.

Diversity, as represented by Simpson's Index, was relatively uniform and high, averaging about 0.93 for the five complete samples. These high numbers reflect the relatively even distribution of individuals among the species present and the fact that the proportion of total individuals accounted for by any single species is small in these samples.

The biomass values, which averaged approximately 0.7 gram per sample, convert to approximately 14 grams per 0.25 square meter of sedimentary bottom. Even considering the added contribution of epifaunal biomass, the quantitative samples indicate that the biomass of natural bottom habitats is much lower overall than that of the rock revetments of the island (see Tables D-1 and D-2). Also, the number of species encountered during limited sampling of natural bottom areas is much less than recorded on the rock habitats of the island.

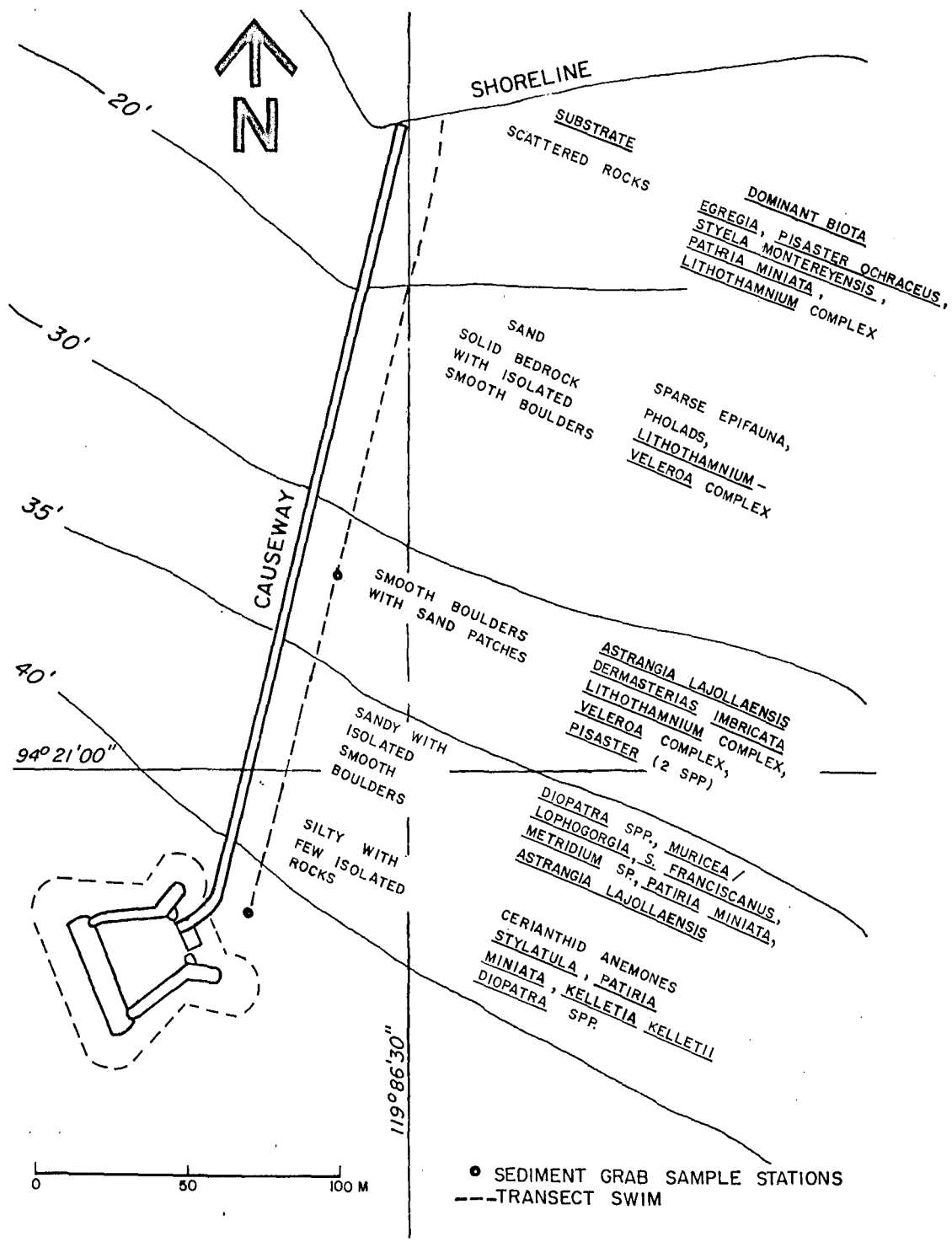

Figure 21. Dominant biota and substrate type along natural bottom transect. (Depth contours in feet below MLLW.)

Table 4. Biota of natural bottom sediment samples.

Station No.	1	1	1	2	2	2	
Grab sample replicate No.	1	2	3	1 <sup>1</sup>	2	3	
Taxon	Depth (m):	13.7	13.7	13.7	10.7	10.7'	10.7
<b>PLATYHELMINTHES</b>							
Unid. flatworm			1				
<b>NEMERTINA</b>							
Nemertean sp. #1	2	1	1		3	1	
Nemertean sp. #2		1	1				
Nemertean sp. #3	1						
Nemertean sp. #4			1				
<b>MOLLUSCA</b>							
Pelecypoda							
<i>Axinopsida sericata</i>		2	2				
<i>Thracia curta</i> <sup>2</sup>			1				
<i>Naculana</i> sp. (juv.)			1				
<i>Macoma</i> sp. (juv.)					1		
<b>SIPUNCULIDA</b>							
Unid. sipunculid	1	1	1		2	1	
<b>ANNELIDA</b>							
Polychaeta							
<i>Driloneris falcata</i>	1						
<i>Lumbrineris</i> sp.	1	2	1			1	
<i>Sigambra tentaculata</i>	2	2					
<i>Haploscoloplos mexicanus</i>	2	5	2				
<i>Spiophanes missionensis</i>	1	1					
<i>Tauberia gracilis</i>	6						
<i>Axiothella</i> sp.	2	2					
<i>Cossura candida</i>	3						
Unid. Polynoidae	1						
<i>Tharyx</i> sp.	8	2	2				
<i>Ampharete labrops</i>	1	1	1		1	1	
<i>Notomastus</i> sp.	1	3	3				
<i>Glycera</i> sp.	1		1				
<i>Loimia medusa</i>	1				1		
<i>Scoloplos armiger</i>						1	
<i>S. acmeceps profundus</i>					3	1	
<i>Mediomastus californiensis</i>			1		1	2	
<i>Protodorvillea gracilis</i>					2	2	
<i>Sthenelanellella uniformis</i>		2	3				
<i>Pista fasciata</i>		1	1	1			
<i>Glycera capitata</i>		1					
<i>Ancistrosyllis hamata</i>			1				
<i>Nephtys caecoides</i>			1				
<i>Polydora</i> sp.			1				
<i>Amaena occidentalis</i>					1		
<i>Polycirrus perplexus</i>					1		
<i>Prionospio</i> nr. <i>malmgreni</i>					1		
<i>Praxiella affinis pacifica</i>					1		
<i>Diopatra ornata</i>					1		
<i>Spiochaetopterus costarum</i>					2		
<i>Typosyllis hyalina</i>					1		

See footnotes at end of table.

Table 4. Biota of natural bottom sediment samples.--Continued.

Station No.	1	1	1	2	2	2	
Grab sample replicate No.:	1	2	3	1 <sup>1</sup>	2	3	
Taxon	Depth (m):	13.7	13.7	13.7	10.7'	10.7	10.7
<b>ARTHROPODA CRUSTACEA</b>							
<b>AMPHIPODA</b>							
<i>Ampelisca cristata</i>	1						
<i>Paraphoxus obtusidiens</i>				2	2		
<i>Synchelidium</i> sp.				2	1		
<i>Monoculodes</i> cf. <i>hartmanae</i>				1			
<i>Aorides columbiae</i>				1			
<i>Metaphoxus frequens</i>						1	
<i>Paraphoxus heterocuspoidatus</i>					1		
<b>DECAPODA</b>							
<i>Cancer</i> sp. (juv.)						1	
Pinnotheridae (juv.)	1		1		1		
<b>CUMACEA</b>							
<i>Diastylopsis tenuis</i>				6		3	
<i>Cyclaspis</i> sp. <sup>3</sup>					1		
<i>Hemilamprops californica</i>	1		1	2		3	
<i>Lamprops</i> cf. <i>carinata</i>				2	1		
<b>OSTRACODA</b>							
<i>Asteropella</i> sp.						1	
<b>ISOPODA</b>							
<i>Serolis carinata</i>						1	
<b>ECHINODERMATA</b>							
<b>OPHIUROIDEA</b>							
<i>Amphiodia digitata</i>		1	1				
<i>A.</i> sp. (juv.)		2					
<i>Amphipholis squamata</i>							
<i>Amphiodia occidentalis</i>			4				
<b>HOLOTHUROIDEA</b>							
Unid. holothurian					1		
<b>CHORDATA</b>							
<b>CEPHALOCHORDATA</b>							
<i>Branchiostoma californiense</i>			1		5		
Total species	20	17	25	7	23	14	
Total individuals	38	30	35	16	35	20	
Simpson's index of diversity <sup>4</sup>	0.94	0.92	0.95	0.79	0.94	0.91	
<b>Wet weight (gm)</b>							
Polychaetes	0.42	0.19	0.19	0.01	0.22	0.18	
Total	0.44	0.72	1.20	0.02	0.86	0.22	

<sup>1</sup> A part of this sample was lost

<sup>2</sup> A hard bottom-type species.

<sup>3</sup> Undescribed species

<sup>4</sup>  $D = 1 - \sum_{i=1}^s (p_i)^2$

## VI. SUMMARY AND CONCLUSIONS

Rincon Island's rock revetments offer a diversity of habitat features for a great variety of marine species which do not occur in adjacent natural bottom areas. This study added 160 taxa of macrobiota to the master species list for the island, bringing the total to 458.

Extensive beds of mollusk shells lie at the bases of the three sides of the island most exposed to wave action. The bed on the west (seaward-facing) side is the most extensive; it is composed primarily of shells of the California mussel, *Mytilus californianus*. The volume of shell on the north and south sides combined are an order of magnitude less than on the west-side bed. Species other than mussels characterize these beds. Shell accumulations are lacking along the flanks of the east (landward) side.

Densities of 53 common taxa occurring in permanent transects on each of the four sides of the island were analyzed for seasonal variability. About three-fourths of these showed statistically significant variation. This was the case for most of the algae tested and generally for ectoprocts, sea urchins, and certain worms, coelenterates, and sponges.

Thirteen major species associations were provisionally identified on the basis of dominant biotic components. Detailed charts of the boundaries of these associations, referenced to permanent features on the island, were prepared from field measurements of depths and distances. Sharpness of the boundaries generally decreases with depth. In general, the associations are continuous horizontally around the island and grade into one another vertically.

Statistical analysis of species abundance and biomass data from each of the 13 preliminary major species associations provided a basis for final characterization of associations. Five of the preliminary 13 associations could not be differentiated statistically. Combination of these and addition of one association resulted in a total of nine distinctly different major species associations. An association dominated by acorn barnacle and limpet biomass encircles the island in the uppermost part of the intertidal. Below this on the west side lies a mussel-gooseneck barnacle association, which exceeds all other associations in biomass per unit area. Small pockets of an intertidal anemone association are found on the southeast wing. Starting at about the MLLW line and extending a few meters down the revetments, a macrophytic algae association is found on all but the east sides. Below this is a broad zone characterized by encrusting and filamentous algae and a species of polychaete worm. The deeper parts of the revetments are characterized by an association dominated by ectoprocts, colonial anemones, corals, and gorgonians. Talus beds



with high densities of tube worms and tube anemones separate the deep associations from natural bottom on all sides except the east side. Two associations are unique to the east side. The shallower of the two is composed almost entirely of large barnacles and encrusting algae. The deeper association has high densities of certain species of red algae.

Twenty-three species of fishes were captured in gill nets placed on all four sides of the island. Rockfish, surfperch, toadfish, and swell sharks dominated the catch. Nets on the west (most exposed) side yielded the highest catch (numbers and species) during day-time sets. The east-side nets had the highest catches in the combined day-night sets.

The biota along a transect over natural bottom from near the island to shore were considerably lower in abundance or density and in number of species relative to biota at corresponding depths on the island's revetments. This was especially the case for sedimentary bottom in deeper water where the island is situated. Samples of natural sediments were dominated by polychaete worms (35 percent of biomass and 50 percent of species), small crustaceans, clams, ribbon worms, and brittle stars.

The construction of Rincon Island has had a major beneficial effect on local ecological conditions. The quarry rock and tetrapod construction materials offer habitat features which are not found in a natural sedimentary bottom area. The solid substratum is colonized by a high diversity of encrusting and attached biota. Many of these are habitat-forming species in the sense that they provide shelter and food for additional species. High vertical relief and vast amounts of interstitial space attract many species of fishes which are seldom or never encountered over sedimentary bottom areas.

## LITERATURE CITED

- BLUME, J.A., and KEITH, J.M., "Rincon Offshore Island and Open Causeway," *Journal of the Waterways and Harbors Division*, American Society of Civil Engineers, Vol. 85, No. WW3, Sept. 1959, pp. 61-93.
- BUCHANAN, C.C., "A Comparison of Sport Fishing Statistics from Man-Made and Natural Habitats in the New York Bight," *Coastal Plains Center for Marine Development Services, Seminar Series*, No. 1, 1972, pp. 27-37.
- CARLISLE, J.G., Jr., TURNER, C.H., and EBERT, E.E., "Artificial Habitat in the Marine Environment," Fish Bulletin 124, The Resources Agency of California, Department of Fish and Game, Long Beach, California, 1964.
- CHAN, G.L., "Subtidal Mussel Beds in Baja California With a New Record Size for *Mytilus californianus*, *The Veliger*," Vol. 16, 1973, pp. 239-240.
- COLUNGA, L., and STONE, R. eds., *Proceedings of an International Conference on Artificial Reefs*, Center for Marine Resources, Texas A & M University; National Marine Fisheries Service; and Texas Coastal and Marine Council, Houston, Tex., 1974.
- DAMES & MOORE, "A Study of the Performance of Certain Artificial Islands on the Pacific Coast of the United States," Report No. 2443-079-10, Los Angeles, Calif., 1974.
- FAGER, E.W., "Patterns in Development of a Marine Community," *Limnology and Oceanography*, Vol. 16, No. 2, Mar. 1971, pp. 241-253.
- KEITH, J.M., and SKJEI, "Engineering and Ecological Evaluation of Artificial-Island Design, Rincon Island, Punta Gorda, California," TM-43, U.S. Army, Corps of Engineers, Coastal Engineering Research Center, Fort Belvoir, Va., Mar. 1974.
- NORTH, W.J., "Ecology of the Rocky Nearshore Environment in Southern California and Possible Influences of Discharged Wastes," International Conference on Water Pollution Research, London, Sept. 1962, pp. 247-273.
- PAINE, R.T., "Biological Observations on a Subtidal *Mytilus californianus* Bed," *The Veliger*, Vol. 19, 1976, pp. 125-130.

- SNEATH, P.H.A., and SOKAL, R.R., *Numerical Taxonomy: the Principles and Practice of Numerical Classification*, Freeman & Company, San Francisco, 1973.
- SOKAL, R.R., and ROHLF, F.J., *Biometry, the Principles and Practice of Statistics in Biological Research*, Freeman & Company, San Francisco, 1969.
- SOOT-RYEN, T., "A Report on the Family Mytilidae (Pelecypoda)," *Allen Hancock Pacific Expedition*, Vol. 20, No. 1, University of Southern California Press, Los Angeles, Calif., 1955.
- SOUTHERN CALIFORNIA COASTAL WATER RESEARCH PROJECT, 1976 Annual Report, El Segundo, Calif., 1976, pp. 179-186.
- STONE, R.B., "Artificial Reefs of Waste Material for Habitat Improvement," *Marine Pollution Bulletin*, Vol. 3, No. 2, Feb. 1972, pp. 27-28.
- STONE, R.B., "Artificial Reefs and Coastal Fishery Resources," *Proceedings of the 10th Space Congress*, Canaveral Council of Technical Societies, 1973, pp. 2-19.
- STONE, R.B., BUCHANAN, C.C., and PARKER, R.O., "Expansion and Evaluation of an Artificial Reef of Murrells Inlet, S.C.," Final Report, Coastal Plains Regional Commission, Washington, D.C., 1973, p. 55.
- STONE, R.B., BUCHANAN, C.C., and STEIMLE, F.W., Jr., "Scrap Tires as Artificial Reefs," Report SW-119, U.S. Environmental Protection Agency, Washington, D.C., 1974.
- TATE, M.W., and CLELLAND, R.C., *Nonparametric and Shortcut Statistics in the Social, Biological, and Medical Sciences*, Interstate, Danville, Ill., 1957.
- TURNER, C.H., EBERT, E.E., and GIVEN, R.R., "Man-made Reef Ecology," Fish Bulletin 146, The Resources Agency of California, Department of Fish and Game, Long Beach, Calif., 1969.



## APPENDIX A

### DETAILED METHODOLOGY

#### 1. Details of Talus Bed Measurement and Data Processing Methodology.

An initial dive was made to calibrate depth gages of all divers and to verify criteria for use in determining the inshore and offshore boundaries of the talus bed. The north side had an irregular fill base (where rock and talus meet), and a heavy sediment overburden downslope which made the talus boundary difficult to determine.

Using a steel tape, a metered line, and an underwater slate, one diver made the first measurement of the rock revetment, holding the free end of the 30.5-meter steel tape on an azimuth perpendicular to the cardinal side. When the diver reached the end of the rock revetment (beginning of the talus bed), the depth, distance, and time were recorded. Three divers then swam to the first diver's location. Measurements were taken on the cardinal sides between the points where the angle of the side changed direction (beginning of "wing" of the island). The first team of two divers measured the talus bed width (inner to outer margin) by having one diver hold the free end of a 50-meter line (marked) in meter intervals) while the second diver swam along the perpendicular azimuth to the outer edge of the talus bed. At this point the second diver recorded depth, time, and distance. The first diver was then signaled to join the second diver at the outer edge. The pair then measured the outer edge of the talus along the entire length of the side, using the method discussed below. A second team of two divers measured the talus along the inner edge.

Swimming along an azimuth parallel to the side, one diver deployed the steel tape along the inner or outer edge of the talus bed (the second diver held the free end of the tape and remained at the start point) until a change in depth ( $+0.15$  meter) or direction ( $+10^\circ$ ) was noted. At that point the first diver stopped, noted distance swum, depth, and time. The second diver was then signaled to swim to the first diver. From this point the first diver swam up the revetment to the waterline. At the waterline, the diver noted distance and time. He then returned to the bottom where the second diver was waiting. The width of the talus bed was measured from this point to the outer edge where again time, depth, and distance were recorded. The first diver returned to the second diver and repeated the process, moving along the cardinal side. The team on the outer edge used an identical method except that team measured the width of the talus bed from the outer to inner edge. Each time a talus width was measured, the corresponding distance up the revetment (waterline to inner edge of talus bed) was measured. This method allowed multiple points of measurement and allowed divers to observe changes at the outside and inside limits of the bed.

The following diagrams illustrate the methodology used for charting the talus beds.

- (1) Line of measured distance (waterline to talus bed-revetment border) ( $d^1$ ) and width of talus bed ( $d^2$ ) was drawn on quadrangle paper (1 cm = 2.4m)

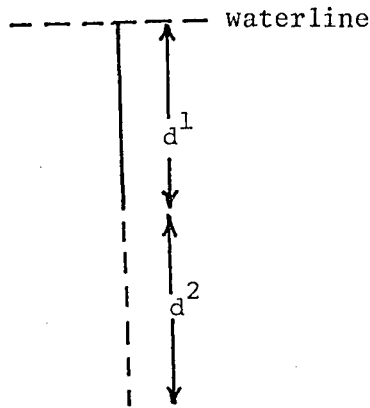

- (2) The next line (distance between revetment measurement points) was then plotted in the form of circle with that distance ( $d^3$ ) as the radius.

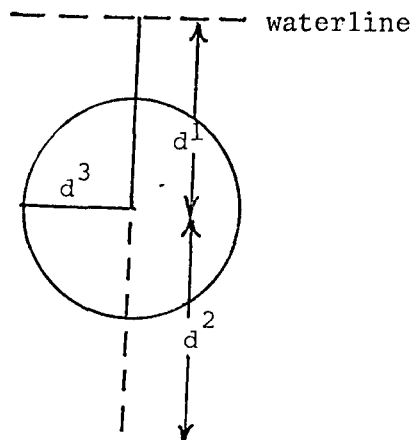

- (3) The length of the second revetment measurement ( $d^4$ ) was then plotted to where it intersected the circle. This gave the distance between measurements at the waterline ( $d^5$ ) which could be converted for three-dimensional diagraming.

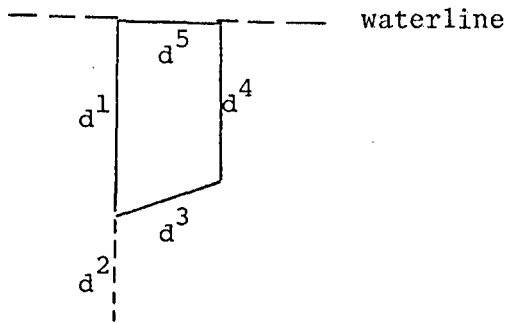

(4) The second talus bed length ( $d^6$ ) was then plotted as shown

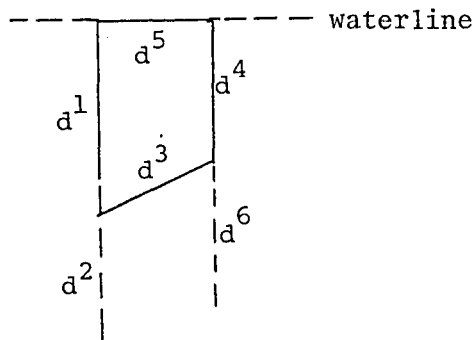

(5) This methodology was continued along the entire side until a planar view of that side was constructed.

(6) To show these data in three-dimensional diagram, the planar diagram was converted to a series of triangles using  $d^1$  as the hypotenuse of the revetment and  $d^2$  as the hypotenuse of the talus. Depths (height) were converted to MLLW by adding or subtracting the number of meters difference according to time (e.g., at 1330 hours, 15 October 1976 tide at Rincon Island (Ventura) was +0.76 meter; thus, 0.76 meter would be subtracted from the height of the "revetment triangle").

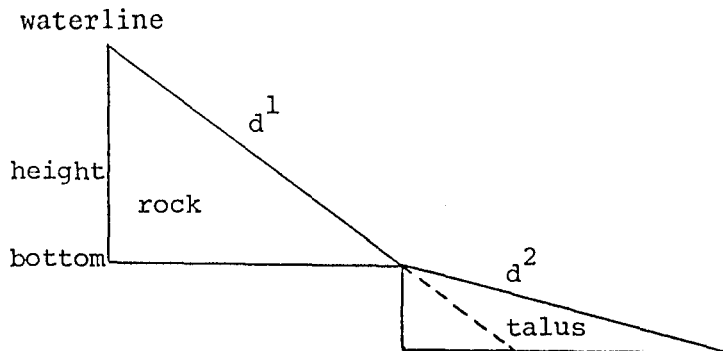

- (7) The series of triangles was then placed in perspective by converting the distance between measurements ( $d^5$ ) to a distance 0.71 times  $d^5$ . The 0.71 conversion allowed a three-dimensional depiction of these triangles scaled to the total side of the island. ( $0.71 = \sin \text{ of a right triangle} = 1/\sqrt{2}$ )

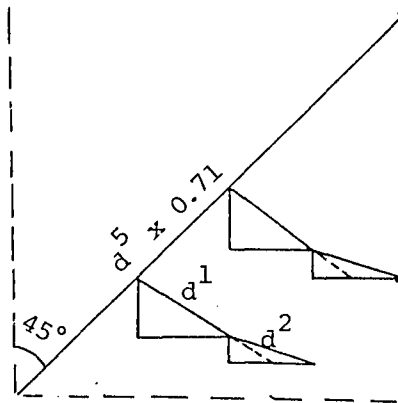

## 2. Permanent Transects Seasonal Data Analysis Methods.

The master species list for the seasonal surveys included 250 taxonomic categories (70 were marine algae and 180 were marine invertebrate taxa). From this master list 24 taxa of marine algae and 30 taxa of invertebrates were selected for special study of seasonal variability. Proportionately, more algal taxa were used than invertebrate taxa, because seasonal effects are often well pronounced among algae, especially reds (*Rhodophyta*). The only algal taxa omitted from the analysis were those of uncertain identity or which (a) occurred in low density, and (b) were found on only one side and during only one season. The number of invertebrate taxa selected for analysis was in part dictated by data-handling considerations. Even when unidentified taxa were eliminated, the amount of data remaining was formidable. Many of these taxa were observed at such low frequencies as to be of little value in any seasonal analysis. Either these species are uncommon on the island; the transects missed their centers of abundance; or, if they were seasonally abundant, their peaks in abundance did not overlap the sampling periods. Many taxa were observed only once (i.e., in only one quadrat). It is assumed that most if not all of the singular-occurrence taxa and most of the low-frequency taxa were generally uncommon on the island. Observations elsewhere on the island during other times of the year (i.e., during reconnaissance diving, measurement of boundaries of associations, and biomass measurements) tend to corroborate this. For these reasons, these rarely encountered taxa were excluded from the seasonal analysis.



For the 54 taxa selected for the seasonal effects analysis, additional analysis was necessary to maximize data utility. A bias factor existed if a particular species occurred over a limited part of a permanent transect, and its density was calculated by dividing total abundance by  $n$ , the total number of quadrat samples taken in the permanent transect. This provided a value for mean density over the entire island; however, this would be justified only for species ubiquitously distributed (i.e., over the entire length of the transect). The distribution of only one species, the starfish, *Patiria miniata*, approaches this (see Figs. 17 to 20). A better approach would be to divide total abundance by the number ( $n$ ) of quadrats where the species may reasonably be expected to occur, and express mean density with reference to the parts of the island over which the species actually occurs (or those associations of which it is a member). Mean densities of each species may be more meaningfully compared to resolve seasonal differences using this approach. Briefly, the mechanics of this data processing operation involved scanning the raw data tables to bracket the upper and lower occurrence limits for each species and then logging onto computer keypunch forms the frequency of every density value observed (including zero density values for quadrats lacking a given species, but falling within its range of occurrence).

Before the data were subjected to parametric statistical analysis, it was necessary to perform data transformations to normalize the data. For species whose densities were recorded as percentage coverage, the values were transformed to angles through the use of the arcsine transformation ( $\theta = \arcsin \sqrt{\rho}$ , where  $\rho$  is a proportion). This transformation rendered a distribution of percentages or proportions more nearly normal by stretching out both tails of the distribution and compressing the middle values (Sokal and Rohlf, 1969). Numerical densities were subjected to the square root transformation. Because zero values were frequent in the data, the computer was programmed to add 0.5 to all values before data transformation. The transformation was then of the form  $\sqrt{Y + \frac{1}{2}}$  (Sokal and Rohlf, 1969).

The actual calculations of the means used all the raw data for variances to be calculated for each of the 54 taxa examined. Seasonal means (data for all four sides lumped) were first tested for significant differences by performing an F test (variance ratio test) to determine whether variances for two seasons under comparison were equal. If the F test was nonsignificant (variances probably equal), the following student's  $t$  test for differences between seasonal means was applied (Sokal and Rohlf, 1969):

$$t_s = \frac{(\bar{Y}_1 - \bar{Y}_2) - (\mu_1 - \mu_2)}{\sqrt{\frac{s_1^2}{n_2} + \frac{s_2^2}{n_1}}}$$

with  $n_1 = n_2$  2 df. When significant F ratios were found, indicating disparate variances, an approximate t test was used (Sokal and Rohlf, 1969):

$$t'_s = \frac{(\bar{Y}_1 - \bar{Y}_2) (\mu_1 - \mu_2)}{\sqrt{\frac{s_1^2}{n_1} + \frac{s_2^2}{n_2}}}$$

Summary data for all 54 species selected for seasonal analysis are presented in Table B-1. For each species, this table presents transformed and untransformed means, standard deviations, transformed variances, transformed range data, and an indication of whether the F and t tests are significant at the 95-percent confidence level.

These values are tabulated for each of the four seasons with data combined for all four sides, and for each of the four sides with data combined for all four seasons. Side differences were not tested for significance.

Note that the values in Table B-1 of Appendix B for mean densities for each species refer to their abundance only over the parts of the island wherein the species may reasonably be expected to occur--not over the entire extent of the island revetments.

Because of the lack of data during two seasons for the west-side macrophytic algae, *Mytilus-Pollicipes*, and barnacle-limpet zones, special consideration was required for the species that occurred in these zones. These included most of the algae species and the following invertebrates: *Anthopleura* sp., *Lottia gigantea*, *Mytilus californianus*, and *Pisaster ochraceus*. For these species, means for seasons 1 and 4 were compared since data from seasons 2 and 3 were questionable. A rerun of the entire analysis for all these species resulted in changes from significant to nonsignificant (at the 95-percent confidence level) for only four species: *Laurencia pacifica*, *Rhodoglossum affine*, *Lottia gigantea*, and *Pisaster ochraceus*. No species changed from nonsignificant to significant with the reanalysis.

### 3. Methodology for Preparation of Figures 9 to 12 and Appendix C Figures C-3 to C-6 (Boundaries of Major Associations).

ARCO Drawing No. CE-1-8, dated 3 March 1965, was used as a base chart for plotting field-acquired data on boundaries of species associations. Different tide levels were shown on the drawing for four different parts of the island; these levels corresponded to times when measurements were taken over the four parts of the island. Spot measurements taken between fixed reference points and the waterline (which was not at MLLW) at times of corresponding tidal heights agreed well with the distances represented on the drawing.

The first step was to adjust the waterline to MLLW. This was done by dividing the tidal height (e.g., +1.2 meters MLLW) by the tangent of the side-slope angle. The slope angle for each side was determined by averaging data obtained during the talus bed measurement phase of this project (see Figs. 5 to 8). The resulting MLLW line is as it would appear if observed directly from some altitude above the island. True distances measured down the slope of each side may be determined using the scale provided on each island sector chart (Figs. 9 to 12 and Figs. C-3 to C-6).

Next, distances measured from fixed reference points at the top edge of the island to the upper limit of the splash zone (barnacle-limpet association) were trigonometrically corrected for slope and plotted. The width of the zone bounded at the top by the barnacle-limpet line and at the bottom by the MLLW line (representing the main part of the intertidal zone) was uniform around the island, providing a positive check on accuracy of the waterline shown on the drawing. Only 2 of the 15 points showed discrepancies. One on the south side was off by about 1.2 meters, and the decision was made to redraw the MLLW line at this point to maintain width uniformity for the intertidal. The other, on the west side, was off by almost 6.1 meters (the measurement during this study indicated a shorter distance). This discrepancy may be due to movements of tetrapods in response to wave forces since the 1965 drawing (a semisubmerged tetrapod lies just seaward of the "first" waterline); or the difference may be a result of the manner in which the measuring tape was laid over the tetrapods (i.e., a greater distance would result if the tape were placed over the highest points on the tetrapods).

The top margin of the barnacle-limpet zone served as the reference point for all distance measurements taken during the association mapping phase of the project. Distances to association boundaries measured down the slope of each side of the island were multiplied by the sine of the average slope for each side. These corrected distances were plotted in Figures 9 to 12 and Figures C-3 to C-6.

APPENDIX B  
SUMMARY DATA, SURVEY OF  
PERMANENT SEASONAL  
TRANSECTS

Table B-1. Summary data: seasonal surveys of permanent transects.

SPECIES	CON	SIDE/ SEASON	TRANSFORMED					UNTRANSFORMED		N	P	Q	Species
			MAX	MIN	S**2	S.DEV.	MEAN	S.DEV.	MEAN				
1	1	1	.524	0.000	.003	.053	.005	2.525	.255	98.	-	(S) cf. <i>Enteromorpha</i> sp.	
1	1	2	0.000	0.000	0.000	0.000	0.000	0.000	0.000	98.			
1	1	3	0.000	0.000	0.000	0.000	0.000	0.000	0.000	98.			
1	1	4	0.000	0.000	0.000	0.000	0.000	0.000	0.000	92.			
1	1	5	0.000	0.000	0.000	0.000	0.000	0.000	0.000	98.			
1	1	6	0.000	0.000	0.000	0.000	0.000	0.000	0.000	128.			
1	1	7	.524	0.000	.002	.050	.005	2.584	.227	110.			
1	1	8	0.000	0.000	0.000	0.000	0.000	0.000	0.000	98.			
		COMBINED	.524	0.000	.001	.027	.001	1.293	.067	374.			
2	1	1	.464	0.000	.007	.084	.024	2.801	.735	98.	S NS	<i>Ulva</i> sp.	
2	1	2	.322	0.000	.001	.038	.007	1.051	.144	98.			
2	1	3	.580	0.000	.004	.060	.006	3.128	.326	98.			
2	1	4	.464	0.000	.003	.051	.008	2.095	.250	92.			
2	1	5	.322	0.000	.002	.041	.004	1.103	.165	98.			
2	1	6	.071	0.000	.000	.009	.001	.062	.008	128.			
2	1	7	.580	0.000	.011	.103	.033	4.223	1.098	112.			
2	1	8	0.000	0.000	0.000	0.000	0.000	0.000	0.000	98.			
		COMBINED	.580	0.000	.004	.061	.012	2.407	.368	376.			
6	1	1	.685	0.000	.109	.330	.423	20.616	22.500	4.	-	(S) <i>Codium fragile</i>	
6	1	2	.464	0.000	.054	.232	.348	10.000	15.000	4.			
6	1	3	0.000	0.000	0.000	0.000	0.000	0.000	0.000	8.			
6	1	4	.685	0.000	0.000	0.000	0.000	0.000	0.000	3.			
6	1	5	0.000	0.000	0.000	0.000	0.000	0.000	0.000	0.			
6	1	6	.685	0.000	.066	.257	.162	13.572	7.895	14.			
6	1	7	0.000	0.000	0.000	0.000	0.000	0.000	0.000	0.			
6	1	8	0.000	0.000	0.000	0.000	0.000	0.000	0.000	0.			
		COMBINED	.685	0.000	.066	.257	.162	13.572	7.895	14.			
11	1	1	0.000	0.000	0.000	0.000	0.000	0.000	0.000	30.	(S)	<i>Cystoseira osmundacea</i>	
11	1	2	.142	0.000	.001	.030	.008	.306	.069	28.			
11	1	3	0.000	0.000	0.000	0.000	0.000	0.000	0.000	24.			
11	1	4	.247	0.000	.002	.048	.009	1.177	.231	20.			
11	1	5	.247	0.000	.002	.044	.009	1.061	.188	32.			
11	1	6	0.000	0.000	0.000	0.000	0.000	0.000	0.000	20.			
11	1	7	.142	0.000	.001	.023	.005	.302	.054	46.			
11	1	8	0.000	0.000	0.000	0.000	0.000	0.000	0.000	14.			
		COMBINED	.247	0.000	.001	.028	.004	.597	.076	112.			
12	2	1	2.739	0.000	.230	.479	.715	1.291	.300	30.	S NS	<i>Kyegia menziesii</i>	
12	2	2	1.225	.707	.010	.098	.725	.189	.036	28.			
12	2	3	1.225	.707	.010	.098	.725	.189	.036	28.			
12	2	4	1.225	.707	.010	.102	.727	.194	.038	26.			
12	2	5	1.225	.707	.037	.191	.784	.369	.156	32.			
12	2	6	.707	0.000	.084	.290	.566	0.000	0.000	20.			
12	2	7	.707	.707	.000	.000	.707	0.000	0.000	46.			
12	2	8	2.739	.707	.295	.543	.852	1.871	.510	14.			
		COMBINED	2.739	0.000	.067	.259	.723	.689	.107	112.			
16	1	1	0.000	0.000	0.000	0.000	0.000	0.000	0.000	0.	(S)	<i>Unid. juvenilis</i> <i>Laminariales</i>	
16	1	2	.580	0.000	.011	.104	.077	4.240	1.580	56.			
16	1	3	0.000	0.000	0.000	0.000	0.000	0.000	0.000	0.			
16	1	4	0.000	0.000	0.000	0.000	0.000	0.000	0.000	0.			
16	1	5	0.000	0.000	0.000	0.000	0.000	0.000	0.000	0.			
16	1	6	0.000	0.000	0.000	0.000	0.000	0.000	0.000	0.			
16	1	7	.580	0.000	.011	.104	.077	4.240	1.580	56.			
16	1	8	0.000	0.000	0.000	0.000	0.000	0.000	0.000	0.			
		COMBINED	.580	0.000	.011	.104	.077	4.240	1.580	56.			
20	1	1	0.000	0.000	0.000	0.000	0.000	0.000	0.000	30.	(S)	<i>Dictyota flabellata</i>	
20	1	2	.100	0.000	.000	.019	.004	.189	.036	28.			
20	1	3	0.000	0.000	0.000	0.000	0.000	0.000	0.000	28.			
20	1	4	.464	0.000	.008	.091	.018	3.922	.749	26.			
20	1	5	0.000	0.000	0.000	0.000	0.000	0.000	0.000	32.			
20	1	6	0.000	0.000	0.000	0.000	0.000	0.000	0.000	20.			
20	1	7	.100	0.000	.000	.015	.002	.147	.022	46.			
20	1	8	.464	0.000	.015	.124	.033	5.345	1.429	14.			
		COMBINED	.464	0.000	.002	.045	.005	1.841	.184	112.			

See footnotes at end of table.

SPECIES	CON	SIDE / 2 SEASON	TRANSFORMED					UNTRANSFORMED		N	Σ t	Species
			MAX 3	MIN 4	S > 5	S.D.E.V. 6	MEAN	S.D.E.V.	MEAN			
37	1	1	.142	0.000	.001	.025	.005	.347	.064	104	(S)	<i>Peysssonellia sp.</i>
		2	.071	0.000	.000	.017	.004	.122	.031	112		
		3	.174	0.000	.001	.025	.005	.356	.066	104		
		4	0.000	0.000	0.000	0.000	0.000	0.000	0.000	112		
		5	.142	0.000	.000	.021	.005	.235	.045	88		
		6	.174	0.000	.001	.026	.005	.345	.071	120		
		7	.071	0.000	.000	.016	.001	.070	.010	102		
		8	.142	0.000	.000	.018	.003	.204	.031	124		
COMBINED			.174	0.000	.000	.020	.004	.256	.040	436		
39	1	1	.322	0.000	.004	.064	.014	1.877	.403	42	S NS	<i>Frionitis lanceolata</i>
		2	.354	0.000	.002	.047	.007	1.664	.231	42		
		3	.464	0.000	.007	.061	.021	2.954	.667	40		
		4	.785	0.000	.015	.121	.033	6.706	1.347	42		
		5	.785	0.000	.010	.094	.025	4.777	.519	144		
		6	.201	0.000	.002	.045	.010	.844	.200	40		
		7	0.000	0.000	0.000	0.000	0.000	0.000	0.000	0		
		8	.322	0.000	.002	.050	.004	1.411	.242	42		
COMBINED			.785	0.000	.007	.065	.020	3.945	.680	236		
40	1	1	.524	0.000	.022	.144	.053	6.575	2.168	16	NS NS	<i>Rhodoglossum affine</i>
		2	.100	0.000	.003	.050	.025	.500	.250	4		
		3	0.000	0.000	0.000	0.000	0.000	0.000	0.000	16		
		4	.322	0.000	.011	.104	.047	2.887	1.214	14		
		5	.524	0.000	.015	.121	.045	4.844	1.529	14		
		6	.100	0.000	.001	.024	.000	.736	.044	14		
		7	0.000	0.000	0.000	0.000	0.000	0.000	0.000	0		
		8	0.000	0.000	0.000	0.000	0.000	0.000	0.000	0		
COMBINED			.524	0.000	.010	.100	.031	4.963	1.014	42		
41	1	1	0.000	0.000	0.000	0.000	0.000	0.000	0.000	124	(S)	<i>Rhodymenia sp.</i>
		2	.322	0.000	.002	.047	.012	1.234	.245	104		
		3	.398	0.000	.003	.057	.013	1.825	.323	116		
		4	.785	0.000	.017	.124	.045	6.543	1.668	116		
		5	.685	0.000	.006	.080	.014	4.024	.589	112		
		6	.226	0.000	.001	.026	.004	.516	.070	124		
		7	.785	0.000	.008	.091	.027	4.141	.820	222		
		8	0.000	0.000	0.000	0.000	0.000	0.000	0.000	0		
COMBINED			.785	0.000	.006	.076	.017	3.506	.556	442		
42	1	1	0.000	0.000	0.000	0.000	0.000	0.000	0.000	124	(S)	<i>Rhodymenia californica</i>
		2	0.000	0.000	0.000	0.000	0.000	0.000	0.000	106		
		3	1.107	0.000	.012	.107	.014	7.477	.743	116		
		4	0.000	0.000	0.000	0.000	0.000	0.000	0.000	116		
		5	1.107	0.000	.012	.109	.015	7.609	.821	112		
		6	0.000	0.000	0.000	0.000	0.000	0.000	0.000	124		
		7	0.000	0.000	0.000	0.000	0.000	0.000	0.000	222		
		8	0.000	0.000	0.000	0.000	0.000	0.000	0.000	0		
COMBINED			1.107	0.000	.003	.054	.004	3.750	.194	442		
44	1	1	.685	0.000	.005	.073	.024	4.204	.455	84	(S)	<i>Stenogramma sp.</i>
		2	0.000	0.000	0.000	0.000	0.000	0.000	0.000	70		
		3	0.000	0.000	0.000	0.000	0.000	0.000	0.000	72		
		4	0.000	0.000	0.000	0.000	0.000	0.000	0.000	74		
		5	.685	0.000	.007	.084	.010	4.924	.606	84		
		6	0.000	0.000	0.000	0.000	0.000	0.000	0.000	124		
		7	0.000	0.000	0.000	0.000	0.000	0.000	0.000	84		
		8	0.000	0.000	0.000	0.000	0.000	0.000	0.000	84		
COMBINED			.685	0.000	.002	.034	.002	2.244	.132	304		
45	1	1	.580	0.000	.015	.124	.045	5.068	1.621	47	(S)	<i>Stenogramma interrupta</i>
		2	0.000	0.000	0.000	0.000	0.000	0.000	0.000	70		
		3	0.000	0.000	0.000	0.000	0.000	0.000	0.000	72		
		4	0.000	0.000	0.000	0.000	0.000	0.000	0.000	74		
		5	0.000	0.000	0.000	0.000	0.000	0.000	0.000	64		
		6	.322	0.000	.001	.031	.004	.440	.044	124		
		7	.684	0.000	.015	.124	.044	4.650	1.604	48		
		8	.580	0.000	.004	.044	.022	4.203	.442	41		
COMBINED			.580	0.000	.005	.064	.013	2.802	.464	304		
48	1	1	0.000	0.000	0.000	0.000	0.000	0.000	0.000	114	(S)	<i>cf. Phormidium sp.</i>
		2	0.000	0.000	0.000	0.000	0.000	0.000	0.000	114		
		3	.524	0.000	.004	.064	.017	2.404	.432	114		
		4	.322	0.000	.002	.041	.006	1.131	.171	42		
		5	.174	0.000	.001	.026	.005	.373	.069	102		
		6	.322	0.000	.002	.041	.008	1.035	.169	160		
		7	.524	0.000	.004	.064	.008	2.647	.337	44		
		8	.100	0.000	.000	.011	.001	.112	.012	0		
COMBINED			.524	0.000	.002	.034	.006	1.340	.151	431		

See footnotes at end of table.

SPECIES	CON	SIDE/ SEASON	TRANSFORMED				UNTRANSFORMED		n	P	t	9	Species
			MAX	MIN	S.D.	MEAN	S.D.	MEAN					
68	1	1	.174	0.000	.001	.026	.000	.357	.000	144.		S S Cliona sp.	
68	1	2	.226	0.000	.002	.042	.011	.799	.149	140.			
68	1	3	.398	0.000	.005	.070	.032	1.700	.568	134.			
68	1	4	.322	0.000	.004	.066	.028	1.564	.504	141.			
68	1	5	.226	0.000	.002	.039	.011	.620	.162	140.			
68	1	6	.174	0.000	.001	.036	.010	.550	.141	134.			
68	1	7	.322	0.000	.002	.050	.017	1.072	.271	140.			
68	1	8	.398	0.000	.005	.080	.037	2.002	.750	136.			
		COMBINED	.398	0.000	.003	.055	.019	1.246	.331	564.			
89	1	1	.226	0.000	.003	.052	.016	1.008	.283	30.	(S)	Hymenamphista cyanocrypta	
89	1	2	0.000	0.000	0.000	0.000	0.000	0.000	0.000	20.			
89	1	3	0.000	0.000	0.000	0.000	0.000	0.000	0.000	20.			
89	1	4	.142	0.000	.001	.032	.007	.447	.100	20.			
89	1	5	.071	0.000	.000	.015	.002	.404	.016	42.			
89	1	6	0.000	0.000	0.000	0.000	0.000	0.000	0.000	0.			
89	1	7	.226	0.000	.001	.036	.008	.772	.146	40.			
89	1	8	.174	0.000	.001	.031	.008	.640	.136	22.			
		COMBINED	.226	0.000	.001	.032	.006	.607	.103	102.			
103	2	1	3.937	.707	.206	.458	.005	1.076	.352	80.	S NS	Anthopleura sp.	
103	2	2	3.536	.707	.197	.371	.787	1.331	.270	80.			
103	2	3	4.528	.707	.210	.467	.790	2.231	.300	100.			
103	2	4	4.528	.707	.265	.515	.815	2.447	.427	90.			
103	2	5	1.225	.707	.010	.090	.726	.187	.037	130.			
103	2	6	4.528	.707	1.306	1.143	1.263	5.422	2.364	80.			
103	2	7	1.581	.707	.019	.135	.738	.294	.056	120.			
103	2	8	2.915	.707	.094	.307	.777	1.025	.197	60.			
		COMBINED	4.528	.707	.207	.455	.801	2.051	.349	370.			
104	1	1	.464	0.000	.005	.077	.026	2.387	.639	100.	S NS	Astrangia lajollaensis	
104	1	2	.247	0.000	.003	.050	.024	1.002	.340	140.			
104	1	3	.322	0.000	.005	.074	.037	1.659	.667	140.			
104	1	4	.398	0.000	.004	.090	.039	2.722	.937	150.			
104	1	5	.398	0.000	.003	.059	.019	1.567	.371	136.			
104	1	6	.464	0.000	.005	.089	.037	2.795	.891	140.			
104	1	7	.398	0.000	.005	.096	.060	2.312	1.144	160.			
104	1	8	.226	0.000	.001	.025	.003	.506	.061	132.			
		COMBINED	.464	0.000	.006	.076	.032	2.072	.658	590.			
106	1	1	.866	0.000	.030	.172	.117	8.928	3.900	100.	S S	Corynactis californica	
106	1	2	.464	0.000	.013	.114	.056	4.008	1.530	50.			
106	1	3	1.107	0.000	.036	.189	.127	10.700	4.477	172.			
106	1	4	1.173	0.000	.044	.210	.114	12.552	4.663	140.			
106	1	5	.322	0.000	.005	.060	.025	1.724	.510	40.			
106	1	6	1.107	0.000	.029	.170	.078	9.426	2.967	150.			
106	1	7	.785	0.000	.014	.118	.089	4.769	2.066	180.			
106	1	8	1.173	0.000	.062	.249	.215	15.363	9.077	130.			
		COMBINED	1.173	0.000	.034	.186	.114	10.379	4.074	506.			
108	2	1	2.345	.707	.138	.366	.868	.944	.388	90.	NS NS	Lophogorgia chilensis	
108	2	2	2.345	.707	.136	.369	.860	.978	.350	100.			
108	2	3	2.550	.707	.147	.384	.852	1.074	.371	97.			
108	2	4	2.345	.707	.163	.404	.896	1.056	.463	82.			
108	2	5	1.581	.707	.011	.106	.725	.225	.037	136.			
108	2	6	2.345	.707	.091	.302	.786	.840	.206	34.			
108	2	7	2.550	.707	.216	.464	.968	1.244	.657	207.			
108	2	8	0.000	0.000	0.000	0.000	0.000	0.000	0.000	0.			
		COMBINED	2.550	.707	.144	.379	.864	1.010	.390	377.			
109	2	1	2.121	.707	.200	.447	.975	1.125	.647	30.	S S	Muricea spp.	
109	2	2	2.739	.707	.348	.590	1.105	1.604	1.059	34.			
109	2	3	4.528	.707	1.502	1.225	1.459	5.678	3.059	34.			
109	2	4	3.937	.707	.722	.850	1.140	3.670	1.500	30.			
109	2	5	4.528	.707	.709	.841	1.168	3.622	1.568	136.			
109	2	6	0.000	0.000	0.000	0.000	0.000	0.000	0.000	0.			
109	2	7	0.000	0.000	0.000	0.000	0.000	0.000	0.000	0.			
109	2	8	0.000	0.000	0.000	0.000	0.000	0.000	0.000	0.			
		COMBINED	4.528	.707	.708	.841	1.168	3.622	1.566	136.			
110	2	1	1.871	.707	.021	.146	.730	.354	.055	110.	S S	Paraclythrus stearnii	
110	2	2	2.121	.707	.060	.245	.793	.547	.189	100.			
110	2	3	2.121	.707	.071	.267	.812	.627	.231	100.			
110	2	4	1.871	.707	.063	.252	.804	.555	.209	91.			
110	2	5	2.121	.707	.041	.284	.793	.743	.208	40.			
110	2	6	1.581	.707	.021	.144	.737	.314	.054	157.			
110	2	7	2.121	.707	.071	.266	.817	.614	.234	100.			
110	2	8	0.000	0.000	0.000	0.000	0.000	0.000	0.000	0.			
		COMBINED	2.121	.707	.054	.232	.784	.544	.168	111.			

See footnotes at end of table.

SPECIES	CON	SIDE/ SEASON	TRANSFORMED					UNTRANSFORMED			F	8	9	Species
			MAX	MIN	S.D.P.	S.D.E.V.	MEAN	S.D.E.V.	MEAN	7				
128	2	1	.707	.707	.000	.000	.707	0.000	0.000	4.1	(S)	<i>Anomia peruviana</i> <i>Pododesmus cepio</i>		
128	2	2	1.225	.707	.009	.097	.725	.187	.036	44.				
128	2	3	1.225	.707	.010	.101	.727	.154	.039	102.				
128	2	4	2.739	.707	.060	.245	.756	.708	.131	24.				
128	2	5	1.225	.707	.011	.104	.724	.201	.042	114.				
128	2	6	.707	.707	.000	.000	.707	0.000	0.000	52.				
128	2	7	2.739	.707	.034	.184	.738	.572	.078	146.				
128	2	8	0.000	0.000	0.000	0.000	0.000	0.000	0.000	0.				
		COMBINED	2.739	.707	.011	.143	.730	.419	.053	337.				
148	2	1	2.121	.707	.064	.261	.818	.598	.237	144.	S S	<i>Doriopsilla</i> <i>albopunctata</i>		
148	2	2	1.225	.707	.008	.092	.724	.177	.032	144.				
148	2	3	1.871	.707	.023	.142	.734	.346	.070	146.				
148	2	4	2.121	.707	.060	.244	.795	.572	.191	144.				
148	2	5	1.871	.707	.036	.190	.743	.423	.114	136.				
148	2	6	1.581	.707	.015	.124	.736	.248	.056	248.				
148	2	7	1.581	.707	.027	.163	.752	.343	.042	120.				
148	2	8	2.121	.707	.074	.273	.816	.651	.240	240.				
		COMBINED	2.121	.707	.041	.204	.770	.466	.134	744.				
153	2	1	1.871	.707	.042	.205	.775	.444	.143	144.	(S)	<i>Kelleteria</i> <i>kelleterii</i>		
153	2	2	.707	.707	.000	.000	.707	0.000	0.000	146.				
153	2	3	1.871	.707	.014	.116	.725	.270	.040	176.				
153	2	4	2.121	.707	.052	.227	.777	.544	.155	146.				
153	2	5	1.871	.707	.030	.173	.748	.347	.090	144.				
153	2	6	1.581	.707	.008	.088	.718	.194	.023	132.				
153	2	7	1.871	.707	.027	.166	.751	.367	.042	120.				
153	2	8	2.121	.707	.035	.186	.755	.437	.105	244.				
		COMBINED	2.121	.707	.027	.164	.745	.377	.082	634.				
155	2	1	4.528	.707	1.038	1.019	1.201	4.673	1.960	50.	S NS	<i>Lottia gigantea</i>		
155	2	2	3.674	.707	.519	.720	.937	2.953	.875	24.				
155	2	3	3.240	.707	.269	.519	.925	1.738	.619	42.				
155	2	4	3.240	.707	.376	.615	.936	2.119	.750	48.				
155	2	5	3.082	.707	.530	.728	1.185	2.423	1.421	34.				
155	2	6	4.183	.707	1.157	1.073	1.242	4.628	2.295	44.				
155	2	7	1.225	.707	.009	.097	.725	.187	.036	56.				
155	2	8	4.528	.707	.602	.776	.919	3.939	.923	26.				
		COMBINED	4.528	.707	.577	.760	1.015	3.191	1.104	164.				
157	2	1	1.581	.707	.033	.180	.765	.375	.118	169.	S S	<i>Negathura crenulata</i>		
157	2	2	1.581	.707	.013	.112	.728	.232	.043	142.				
157	2	3	1.225	.707	.013	.115	.734	.222	.051	136.				
157	2	4	1.581	.707	.022	.150	.746	.311	.078	166.				
157	2	5	1.225	.707	.016	.127	.740	.246	.064	171.				
157	2	6	1.225	.707	.005	.070	.717	.135	.019	184.				
157	2	7	1.225	.707	.008	.091	.723	.175	.032	222.				
157	2	8	1.581	.707	.056	.236	.806	.506	.205	132.				
		COMBINED	1.581	.707	.021	.144	.744	.294	.074	633.				
158	2	1	3.240	.707	.313	.560	.861	2.105	.542	24.	S NS	<i>Mytilus</i> <i>californianus</i>		
158	2	2	.707	.707	0.000	0.000	.707	0.000	0.000	2.				
158	2	3	3.808	.707	.437	.661	.848	2.965	.636	22.				
158	2	4	11.853	.707	4.790	2.189	1.180	27.439	5.500	26.				
158	2	5	11.853	.707	2.860	1.691	1.057	20.283	3.417	48.				
158	2	6	1.871	.707	.117	.343	.813	.883	.273	22.				
158	2	7	0.000	0.000	0.000	0.000	0.000	0.000	0.000	0.				
158	2	8	.707	.707	0.000	0.000	.707	0.000	0.000	4.				
		COMBINED	11.853	.707	1.891	1.375	.965	16.354	2.247	74.				
159	2	1	3.240	.707	.267	.517	.813	2.041	.417	24.	(S)	<i>Mytilus edulis</i>		
159	2	2	0.000	0.000	0.000	0.000	0.000	0.000	0.000	0.				
159	2	3	14.509	.707	11.906	3.450	1.570	52.500	13.125	16.				
159	2	4	0.000	0.000	0.000	0.000	0.000	0.000	0.000	0.				
159	2	5	14.509	.707	5.414	2.327	1.161	34.992	6.111	26.				
159	2	6	.707	.707	0.000	0.000	.707	0.000	0.000	4.				
159	2	7	0.000	0.000	0.000	0.000	0.000	0.000	0.000	0.				
159	2	8	0.000	0.000	0.000	0.000	0.000	0.000	0.000	0.				
		COMBINED	14.509	.707	4.878	2.209	1.115	33.201	5.500	40.				

See footnotes at end of table.



SPECIES	CON	SIDE/ SEASON	TRANSFORMED					UNTRANSFORMED		7	8	9	Species
			MAX	MIN	S**2	S.D.E.V.	MEAN	S.D.E.V.	MEAN				
170	2	1	8.860	.707	2.402	1.550	1.359	11.308	4.739	203.	S	S	<i>Serpulorbis squamigerus</i>
170	2	2	8.972	.707	3.309	1.839	1.675	13.803	7.586	176.			
170	2	3	6.364	.707	1.454	1.206	1.276	6.421	2.580	176.			
170	2	4	10.025	.707	3.121	1.767	1.561	13.685	5.107	190.			
170	2	5	8.972	.707	4.630	2.152	2.187	16.356	6.886	186.			
170	2	6	8.860	.707	1.427	1.195	1.058	9.157	2.080	220.			
170	2	7	10.025	.707	2.532	1.591	1.521	12.038	4.338	221.			
170	2	8	6.205	.707	1.282	1.096	1.164	6.088	2.081	132.			
		COMBINED	10.025	.707	2.602	1.613	1.467	11.679	4.250	745.			
185	2	1	7.106	.707	.993	.995	1.076	6.082	1.662	106.	S	S	<i>Diopatra ornata</i>
185	2	2	9.925	.707	2.566	1.602	1.522	12.621	4.358	106.			
185	2	3	7.106	.707	1.977	1.406	1.301	9.490	3.111	106.			
185	2	4	7.106	.707	1.527	1.236	1.219	6.130	2.500	110.			
185	2	5	7.106	.707	1.673	1.293	1.308	7.773	2.884	111.			
185	2	6	7.106	.707	1.628	1.276	1.279	7.538	3.295	94.			
185	2	7	0.000	0.000	0.000	0.000	0.000	0.000	0.000	0.			
185	2	8	9.925	.707	1.864	1.365	1.199	10.491	2.794	200.			
		COMBINED	9.925	.707	1.779	1.334	1.280	9.402	2.913	974.			
186	1	1	.785	0.000	.022	.147	.092	6.576	2.788	143.	S	S	<i>Dodecaceria fewkesi</i>
186	1	2	.535	0.000	.007	.082	.036	2.883	.778	154.			
186	1	3	.398	0.000	.007	.082	.036	2.342	.775	117.			
186	1	4	.685	0.000	.017	.131	.085	4.944	2.311	161.			
186	1	5	.685	0.000	.017	.132	.081	5.211	2.262	166.			
186	1	6	.580	0.000	.010	.099	.050	3.800	1.154	169.			
186	1	7	.785	0.000	.018	.133	.076	5.547	2.198	164.			
186	1	8	.524	0.000	.009	.097	.045	3.532	1.049	101.			
		COMBINED	.785	0.000	.014	.119	.065	4.721	1.735	500.			
187	2	1	1.871	.707	.036	.190	.761	.425	.115	130.	S	NS	<i>Eudiatylia</i> sp.
187	2	2	1.871	.707	.027	.165	.738	.404	.071	126.			
187	2	3	1.581	.707	.049	.220	.777	.468	.152	112.			
187	2	4	2.121	.707	.042	.206	.759	.512	.117	126.			
187	2	5	2.121	.707	.059	.242	.780	.586	.167	148.			
187	2	6	1.871	.707	.038	.194	.754	.457	.106	160.			
187	2	7	1.225	.707	.006	.076	.715	.147	.022	46.			
187	2	8	1.581	.707	.022	.149	.748	.304	.082	122.			
		COMBINED	2.121	.707	.038	.195	.758	.450	.113	486.			
200	1	1	.885	0.000	.012	.110	.034	5.611	1.160	166.	S	S	<i>Lagenipora punctulata</i>
200	1	2	1.173	0.000	.036	.189	.087	11.566	3.478	182.			
200	1	3	.896	0.000	.028	.156	.059	8.252	2.426	156.			
200	1	4	.735	0.000	.013	.113	.043	5.092	1.331	160.			
200	1	5	.464	0.000	.005	.071	.025	2.145	.540	136.			
200	1	6	.580	0.000	.007	.083	.025	3.504	.694	160.			
200	1	7	1.173	0.000	.046	.215	.117	12.788	5.011	222.			
200	1	8	.464	0.000	.008	.065	.021	2.064	.443	132.			
		COMBINED	1.173	0.000	.021	.146	.056	8.056	2.045	650.			
201	1	1	.322	0.000	.004	.064	.027	1.572	.464	152.	S	S	<i>Phidolopora pacifica</i>
201	1	2	.398	0.000	.002	.046	.019	1.369	.222	133.			
201	1	3	.142	0.000	.001	.034	.013	.493	.130	140.			
201	1	4	.226	0.000	.002	.050	.026	.781	.307	132.			
201	1	5	.247	0.000	.002	.039	.013	.679	.167	144.			
201	1	6	.398	0.000	.003	.054	.019	1.444	.314	164.			
201	1	7	.322	0.000	.003	.056	.027	1.237	.368	176.			
201	1	8	.142	0.000	.002	.041	.019	.516	.203	74.			
		COMBINED	.398	0.000	.002	.050	.020	1.130	.243	543.			
202	1	1	.322	0.000	.004	.066	.020	1.864	.443	142.	S	S	<i>Scrupocellaria diegensis</i>
202	1	2	1.107	0.000	.032	.179	.072	11.429	2.901	132.			
202	1	3	.464	0.000	.006	.076	.026	2.364	.617	154.			
202	1	4	.464	0.000	.004	.062	.017	2.013	.400	150.			
202	1	5	.322	0.000	.004	.061	.020	1.561	.402	164.			
202	1	6	.464	0.000	.003	.055	.017	1.720	.319	160.			
202	1	7	1.107	0.000	.029	.172	.067	10.422	2.753	166.			
202	1	8	.322	0.000	.004	.064	.021	1.723	.442	74.			
		COMBINED	1.107	0.000	.011	.105	.032	5.737	1.033	602.			
228	2	1	2.550	.707	.177	.421	.996	1.063	.688	144.	S	S	<i>Parastichopus</i> spp.
228	2	2	2.121	.707	.070	.264	.767	.693	.189	170.			
228	2	3	3.536	.707	.244	.542	1.003	1.704	.798	143.			
228	2	4	3.536	.707	.274	.523	1.050	1.663	.875	140.			
228	2	5	2.345	.707	.148	.365	.974	.949	.594	164.			
228	2	6	1.871	.707	.045	.213	.796	.491	.162	160.			
228	2	7	3.536	.707	.379	.816	1.171	1.970	1.273	217.			
228	2	8	2.550	.707	.071	.267	.786	.711	.168	132.			
		COMBINED	3.536	.707	.211	.459	.958	1.352	.628	677.			

See footnotes at end of table.

SPECIES	CON <sup>1</sup>	SIDE/ SEASON <sup>2</sup>	TRANSFORMED					UNTRANSFORMED		N <sup>7</sup>	P <sup>8</sup>	t <sup>9</sup>	Species
			MAX <sup>3</sup>	MIN <sup>4</sup>	S*2 <sup>5</sup>	S.DEV. <sup>6</sup>	MEAN	S.DEV.	MEAN				
229	2	1	3.536	.707	.409	.639	1.315	2.104	1.638	301.	S	NS	<i>Patiria miniata</i>
229	2	2	3.937	.707	.359	.599	1.354	1.974	1.692	265.			
229	2	3	4.301	.707	.501	.708	1.368	2.497	1.871	294.			
229	2	4	3.808	.707	.429	.655	1.336	2.223	1.712	299.			
229	2	5	4.301	.707	.551	.742	1.515	2.700	2.344	291.			
229	2	6	3.536	.707	.516	.718	1.454	2.488	2.129	263.			
229	2	7	3.082	.707	.297	.545	1.277	1.580	1.427	232.			
229	2	8	3.937	.707	.283	.532	1.172	1.687	1.155	374.			
		COMBINED	4.301	.707	.425	.652	1.343	2.212	1.728	1140.			
230	2	1	1.225	.707	.011	.106	.730	.205	.044	206.	S	NS	<i>Pisaster brevispinus</i>
230	2	2	1.225	.707	.004	.061	.714	.117	.014	216.			
230	2	3	1.225	.707	.008	.089	.723	.172	.030	194.			
230	2	4	1.225	.707	.004	.063	.715	.122	.015	148.			
230	2	5	1.225	.707	.011	.107	.730	.207	.045	224.			
230	2	6	1.225	.707	.004	.065	.715	.126	.016	248.			
230	2	7	0.000	0.000	0.000	0.000	0.000	0.000	0.000	0.			
230	2	8	1.225	.707	.005	.073	.717	.141	.020	348.			
		COMBINED	1.225	.707	.007	.082	.720	.158	.028	1118.			
231	2	1	1.871	.707	.056	.236	.804	.520	.202	258.	NS	NS	<i>Pisaster giganteus</i>
231	2	2	2.121	.707	.049	.221	.798	.489	.185	254.			
231	2	3	2.345	.707	.063	.252	.814	.501	.226	244.			
231	2	4	2.121	.707	.051	.226	.791	.507	.177	254.			
231	2	5	1.871	.707	.046	.215	.806	.441	.196	148.			
231	2	6	1.581	.707	.038	.196	.782	.400	.149	248.			
231	2	7	2.121	.707	.058	.240	.812	.528	.216	222.			
231	2	8	2.345	.707	.067	.259	.807	.616	.218	376.			
		COMBINED	2.345	.707	.055	.234	.802	.522	.197	1014.			
232	2	1	1.225	.707	.008	.091	.723	.174	.032	126.	S	NS	<i>Pisaster ochraceus</i>
232	2	2	1.225	.707	.012	.110	.731	.213	.047	106.			
232	2	3	1.581	.707	.037	.192	.774	.401	.135	46.			
232	2	4	1.225	.707	.013	.115	.734	.222	.051	117.			
232	2	5	1.581	.707	.022	.149	.743	.315	.074	88.			
232	2	6	1.225	.707	.017	.131	.742	.252	.068	133.			
232	2	7	1.581	.707	.026	.162	.756	.330	.094	102.			
232	2	8	1.225	.707	.007	.086	.722	.196	.028	142.			
		COMBINED	1.581	.707	.017	.130	.739	.261	.063	445.			
241	2	1	3.082	.707	.224	.473	.976	1.380	.676	299.	S	S	<i>Strongylocentrotus</i>
241	2	2	2.915	.707	.194	.440	.943	1.235	.583	288.			
241	2	3	3.536	.707	.301	.548	1.016	1.767	.832	364.			
241	2	4	3.082	.707	.308	.555	1.072	1.704	.956	203.			
241	2	5	3.391	.707	.383	.619	1.167	1.981	1.243	292.			
241	2	6	2.550	.707	.202	.449	1.008	1.188	.717	276.			
241	2	7	2.121	.707	.096	.310	.856	.740	.329	222.			
241	2	8	3.536	.707	.248	.498	.924	1.614	.602	304.			
		COMBINED	3.536	.707	.254	.504	.996	1.530	.747	1094.			
242	2	1	6.285	.707	2.020	1.421	1.551	6.357	3.914	147.	S	S	<i>Strongylocentrotus purpuratus</i>
242	2	2	5.788	.707	1.714	1.311	1.933	6.035	4.950	219.			
242	2	3	4.637	.707	.576	.759	1.195	2.988	1.500	144.			
242	2	4	4.528	.707	.702	.838	1.209	3.354	1.650	148.			
242	2	5	3.391	.707	.157	.396	.868	1.256	.410	178.			
242	2	6	5.431	.707	.984	.942	1.385	4.371	2.394	216.			
242	2	7	5.148	.707	.482	.694	1.073	3.003	1.131	165.			
242	2	8	6.285	.707	1.978	1.406	1.480	7.988	4.126	149.			
		COMBINED	6.285	.707	1.382	1.176	1.510	5.810	3.159	748.			

See footnotes at end of table

- 
- <sup>1</sup><sub>1</sub> = Arcsin conversion used for data transformation  
<sub>2</sub> = Square root conversion used for data transformation
- <sup>2</sup><sub>1</sub> = summer (July 1976)  
<sub>2</sub> = fall (November 1976)  
<sub>3</sub> = winter (February 1977)  
<sub>4</sub> = spring (April 1977)  
<sub>5</sub> = north side  
<sub>6</sub> = south side  
<sub>7</sub> = east side  
<sub>8</sub> = west side
- <sup>3</sup>Maximum value of density (transformed)
- <sup>4</sup>Minimum value of density (transformed)
- <sup>5</sup>Variance
- <sup>6</sup>Standard deviation
- <sup>7</sup>N = number of quadrats examined over zone of occurrence
- <sup>8</sup>F = "F ratio" (ratio of variances)
- <sup>9</sup>t = "Student's t," the deviation of the estimated mean from that of the sample population
- S = Significant (95 percent confidence level)
- NS = Not significant (95 percent confidence level)
- (S) = Significant difference in means due to absence during at least one season

## APPENDIX C

### R-MODE DENDROGRAMS AND BOUNDARIES OF PRELIMINARY (TENTATIVELY IDENTIFIED) SPECIES ASSOCIATIONS

Note: In Figures C-3 to C-6, each association is labeled with an alpha or numeric designation. The number refers to the preliminary identity applied to each association for purposes of field recognition and charting of the boundaries of each major species association (see Sec. IV,4). The letter represents the designation of the identity of the association after the completion of statistical analysis of quantitative compositional data as described in Section V,5.

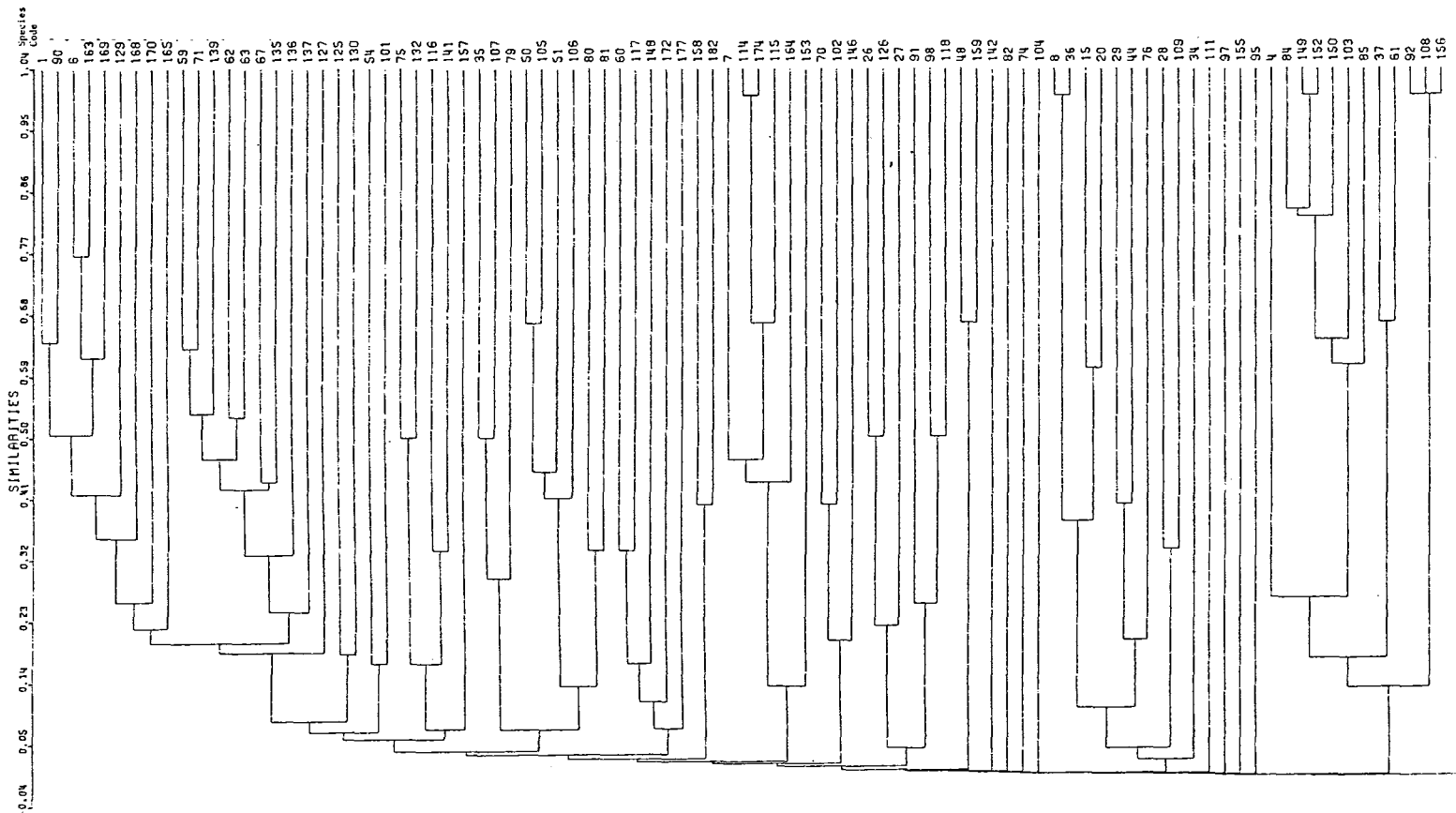

Figure C-1. North-side R-mode dendrogram showing similarities in occurrence among species surveyed in a permanent transect (species with high frequencies of co-occurrence cluster at high similarity values) See Table C-1 for key to species codes.

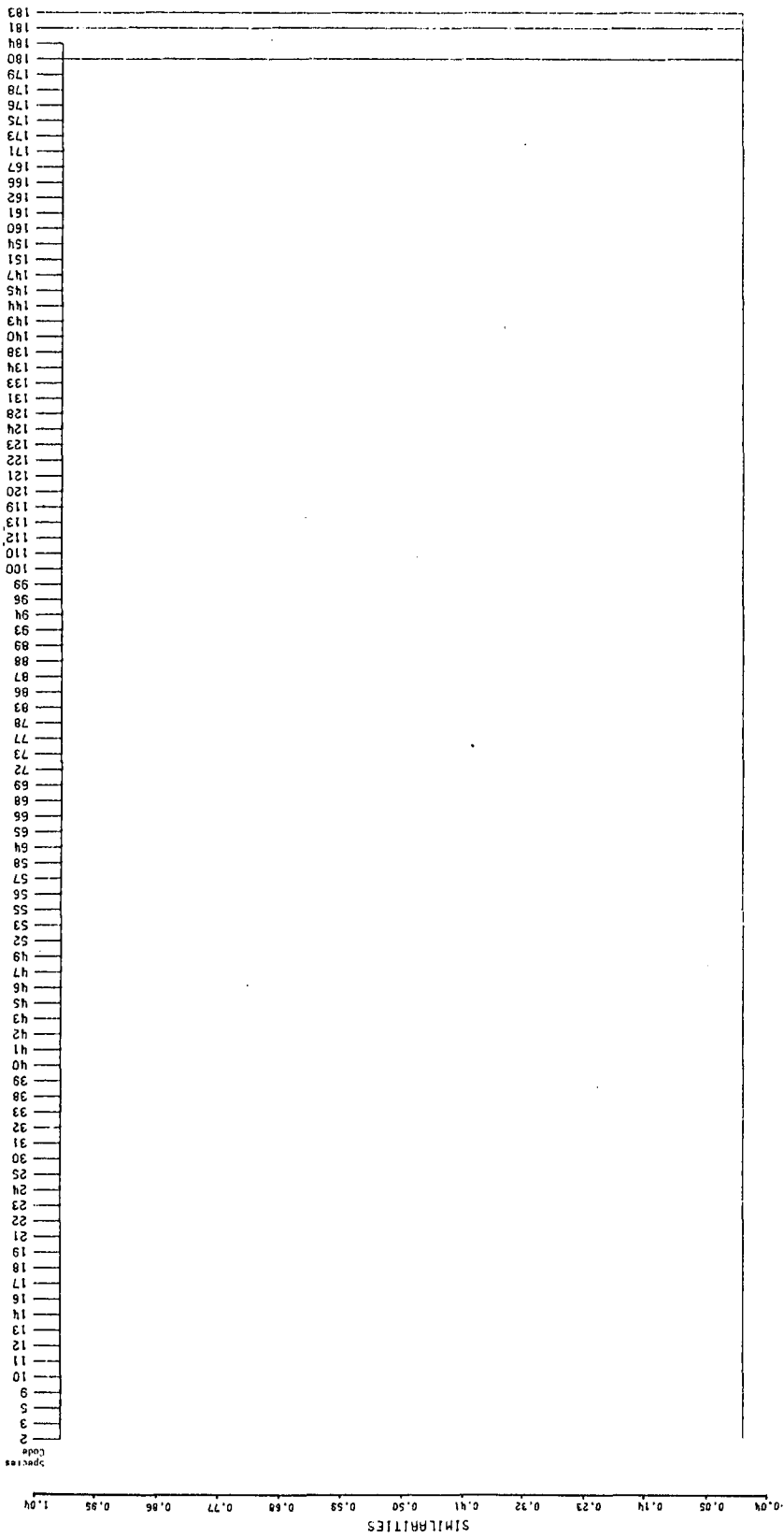

Figure C-1. North-side R-mode dendrogram.--Continued.

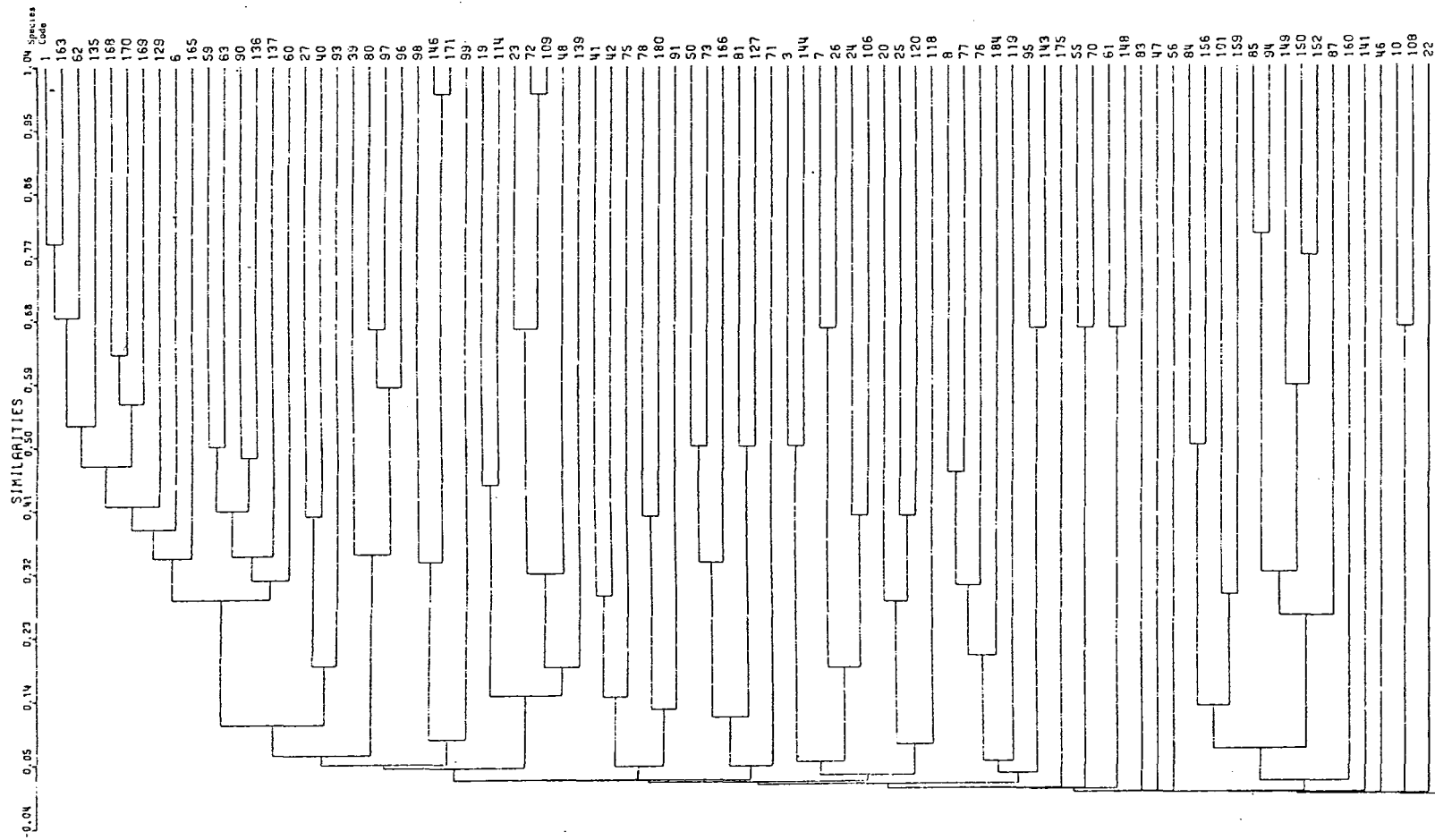

Figure C-2. East-side R-mode dendrogram showing similarities in occurrence among species surveyed in a permanent transect (species with high frequencies of co-occurrence cluster at high similarity values). See Table C-1 for key to species code.

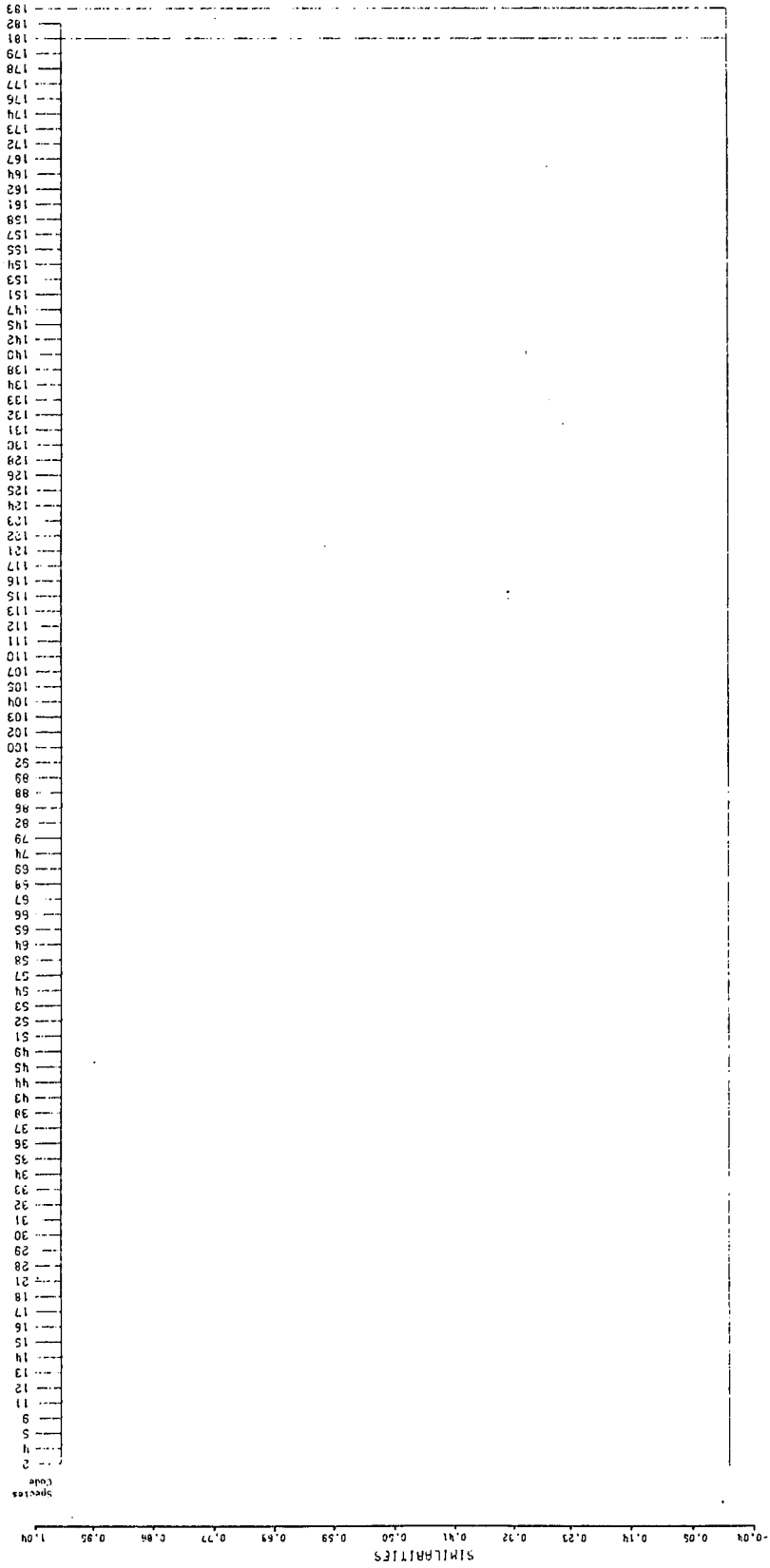

Figure C-2. East side R-mode dendrogram.--Continued.



Table C-1. Key to R-mode dendrograms (Figs. C-1 and C-2).

1. <i>Veleroa subulata</i>	62. <i>Corynactis californica</i>	123. Unid. orange cerata eolid (W)
2. <i>Codium fragile</i>	63. <i>Lophogorgia chilensis</i>	124. Unid. boring clam (S)
3. <i>Gelidium cartilagineum</i>	64. Unid. hydroid (S)	125. <i>Calliostoma annulatum</i>
4. <i>Grateloupia abbreviata</i>	65. Unid. anemone (S) #1	126. Unid. snail (N)
5. cf. <i>Fucus</i> sp.	66. Unid. anemone #2 (S)	127. <i>Diopatra ornata</i>
6. <i>Litho/Lithop.</i>	67. <i>Muricea fruticosa</i>	128. Unid. serpulids (W)
7. <i>Peyssonellia</i> sp.	68. Unid. yellow hydroid (W)	129. <i>Dodecaceria fewkesi</i>
8. <i>Stenogramme interrupta</i>	69. cf. <i>Sertularia</i> sp.	130. cf. <i>Eudistylia</i> sp.
9. <i>Corallina officinalis</i>	70. <i>Balanophyllia elegans</i>	131. cf. <i>Chaetopterus</i> sp.
10. Unid. fil green alga	71. <i>Cerianthid anemones</i>	132. Unid. cf. sabellid (N)
11. Unid. fil red alga	72. <i>Hydractinia</i> sp.	133. Unid. serpulid (E)
12. Unid. juv. red alga	73. Unid. "alternate" hydroid (E)	134. <i>Salmacina tribranchiata</i>
13. Unid. bushy red alga (cf. <i>G. coulteri</i> )	74. cf. <i>Tealia</i> sp.	135. <i>Lagenipora punctulata</i>
14. cf. <i>Enteromorpha</i> sp.	75. Unid. hydroids (N)	136. <i>Scrupocellaria diegensis</i>
15. <i>Prionitis lanceolata</i>	76. <i>Aglaothenia struthionides</i>	137. <i>Phidolopora pacifica</i>
16. Unid. "brown scum"	77. cf. <i>Eudendrium</i> sp.	138. Unid. yellow ectoproct (W)
17. Unid. red alga #1 (W)	78. cf. <i>Plumularia lagenifera</i>	139. Encrusting ectoprocts
18. Unid. red alga #2 (W)	79. <i>Pteropurpura festiva</i>	140. Unid. "brain coral" ectoproct
19. Unid. lobate red alga	80. cf. <i>Dendrodoris fulva</i>	141. <i>Antropora tincta</i>
20. <i>Eggregia laevigata</i>	81. <i>Kelletia kelletii</i>	142. <i>Diaperocia californica</i>
21. Unid. brown alga	82. <i>Calliostoma canaliculatum</i>	143. <i>Bugula neritina</i>
22. Unid. red alga #1 (E)	83. <i>Mitra idae</i>	144. Unid. ectoprocts (E)
23. Unid. red alga #2 (E) cf. <i>Callophyllis</i>	84. <i>Lottia gigantea</i>	145. <i>Membranipora tuberculata</i>
24. Unid. red alga #3 (E)	85. <i>Collisella digitalis</i>	146. <i>Balanus pacificus</i>
25. Unid. flat red alga (E)	86. <i>C. cf. strigatella</i>	147. <i>B. tintinnabulum</i>
26. cf. <i>Agardhiella</i> sp.	87. <i>C. scabra</i>	148. <i>B. nubilus</i>
27. cf. <i>Ceramium</i> sp.	88. <i>Conus californicus</i>	149. <i>Tetraclita squamosa rubescens</i>
28. Unid. red alga (N)	89. <i>Acanthina spirata</i>	150. <i>Chthamalus fissus</i>
29. cf. <i>Gelidium</i> sp.	90. <i>Serpulorbis squamigerus</i>	151. <i>Pollicipes polymerus</i>
30. <i>Gigartina spinosa armata</i>	91. <i>Megathura crenulata</i>	152. <i>Balanus glandula</i>
31. Unid. red alga (S)	92. <i>Mytilus californianus</i>	153. cf. <i>Paguristes ulreyi</i>
32. Unid. fil red alga (S)	93. cf. <i>Anisodoris nobilis</i>	154. Unid. pagurids (W)
33. Unid. "spindly gr-br alga"	94. cf. <i>Collisella limatula</i>	155. <i>Loxorhynchus crispatus</i>
34. <i>Macrocystis</i> sp.	95. <i>Dialula sandiegensis</i>	156. <i>Pachygrapsus crassipes</i>
35. Unid. green algal slime	96. <i>Hermisenda crassicornis</i>	157. Unid. pagurid (N)
36. Unid. coralline alga (N) (cf. <i>C. officinalis</i> )	97. <i>Navanax inermis</i>	158. Unid. shrimp (N)
37. <i>Rhodoglossum affine</i>	98. <i>Hinnites multirugosus</i>	159. Unid. barnacles
38. cf. <i>Microcladia</i> sp. (E)	99. <i>Chama pellucida</i>	160. Unid. small barnacle (E)
39. cf. <i>Gigartina exasperata</i>	100. Unid. gastropod sp. #1 (N)	161. Unid. pagurid (E)
40. Unid. fil red alga (E)	101. <i>Pholads</i> (cf. <i>Parapholas calif.</i> )	162. cf. <i>Isocheles pilosus</i>
41. Unid. leafy red (E)	102. Unid. dorid (N)	163. <i>Patiria miniata</i>
42. Unid. small brown alga (E)	103. <i>Collisella cf. conus</i>	164. <i>Pisaster brevispinus</i>
43. cf. <i>Platythamnion</i> sp. (W)	104. <i>Cypraea spadicea</i>	165. <i>P. giganteus</i>
44. cf. <i>Bossiella orbigniana</i>	105. <i>Acmaea mitra</i>	166. <i>P. ochraceus</i>
45. "Wiry" red alga (E)	106. <i>Pododesmus cepio</i>	167. <i>Parastichopus</i> sp. #1 (short knob-like projections)
46. "Spiny" red alga (E)	107. <i>Ceratostoma nuttalli</i>	168. <i>P. sp. #2</i> (long black-tipped projections)
47. Unid. sponge (W)	108. <i>Mytilus edulis</i>	169. <i>Strongylocentrotus franciscanus</i>
48. <i>Cliona</i> sp.	109. <i>Diodora aspera</i>	170. <i>S. purpuratus</i>
49. <i>Sphaciospongia confoederata</i>	110. <i>Nassarius mendicus</i>	171. cf. <i>Ophiopsilla californica</i>
50. <i>Hymeniacidon cyanocrypta</i>	111. Unid. black/yellow dorid (S)	172. Unid. holothuroid (N)
51. Unid. purple sponge (N)	112. Unid. nudibranch (S)	173. Unid. ophiuroid (S)
52. Unid. grey sponge (S)	113. Unid. orange dorid (S)	174. <i>Ophiothrix spiculata</i>
53. "Sulfur sponge" (S)	114. <i>Flabellinopsis iodinea</i>	175. Unid. ophiuroid (E)
54. Unid. sponge (N)	115. <i>Crepipatella lingulata</i>	176. <i>Lytechinus</i> sp.
55. <i>Rhabdodermella nuttingi</i>	116. <i>Maxwellia gemma</i>	177. <i>Boltenia villosa</i>
56. Unid. sponge (E)	117. <i>Octopus</i> sp.	178. Unid. tunicate (W)
57. cf. <i>Verongia thiona</i> 1	118. <i>Aplysia californica</i>	179. <i>Styela montereyensis</i>
58. <i>Leucetta losangelensis</i>	119. Unid. limpet (E)	180. cf. <i>Amaroucium</i> sp. (E)
59. <i>Astrangia lajollaensis</i>	120. cf. <i>Anomia</i> sp.	181. Unid. organisms
60. <i>Paracyathus stearnsii</i>	121. Unid. white spot dorid (W)	182. <i>Ocenebra foveolata</i>
61. <i>Anthopleura cf. xanthogrammica</i>	122. Unid. yellow dorid (W)	183. Not sampled
		184. Unid. coralline (E)
		185. <i>Collisella spp.</i> (E)

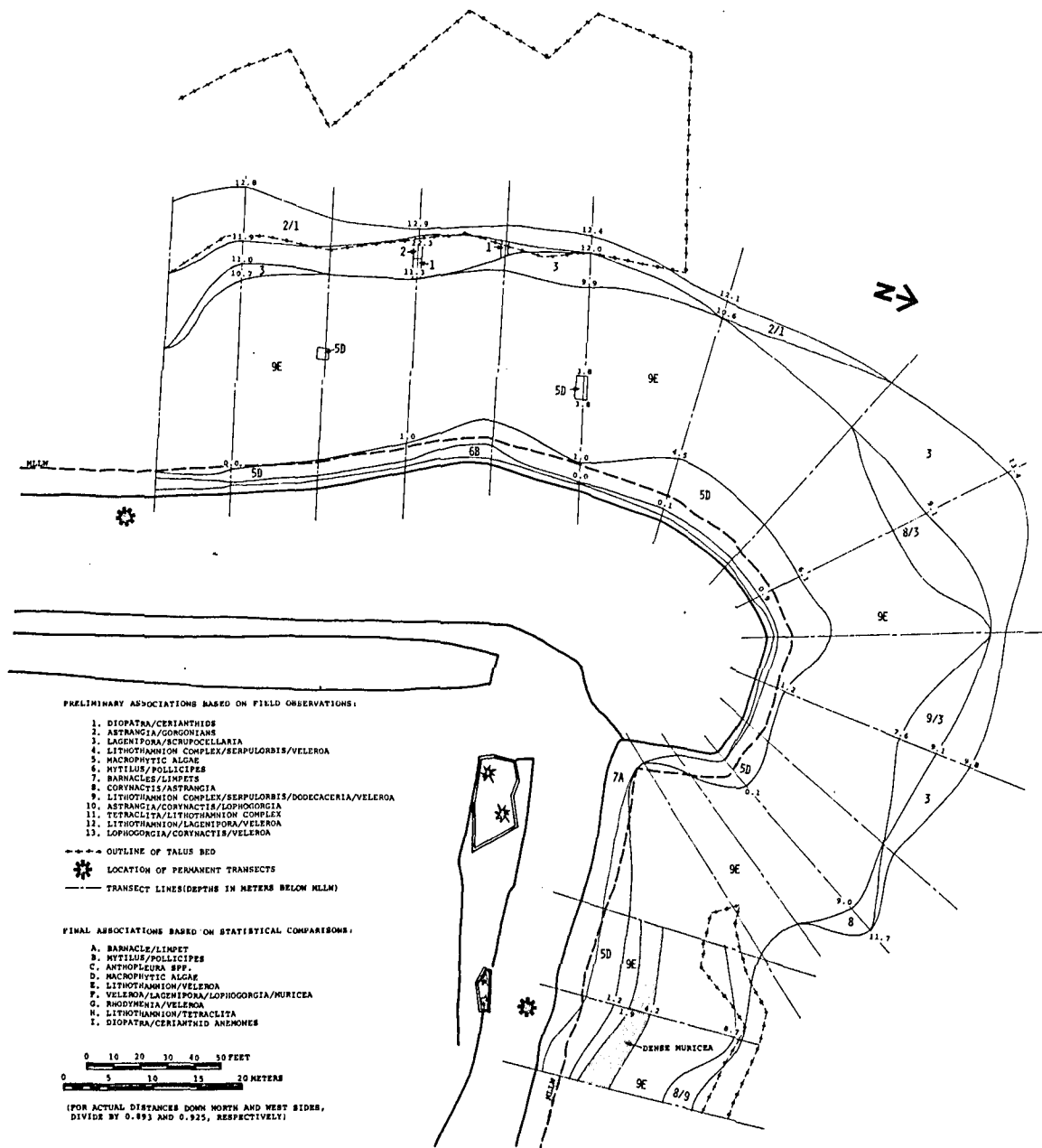

Figure C-3. Preliminary and final species associations, northwest quadrant.

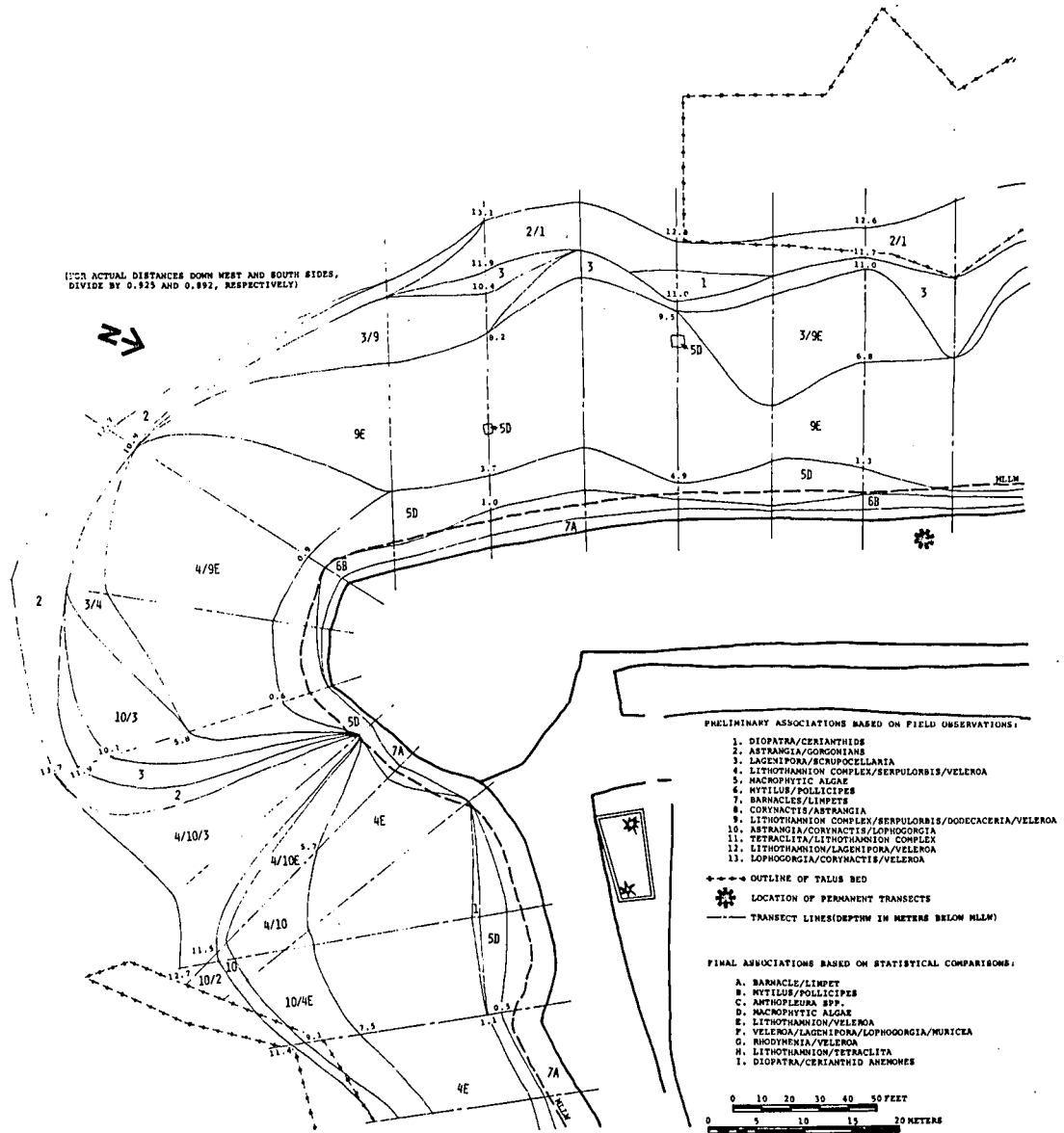

Figure C-4. Preliminary and final special associations, southwest quadrant.

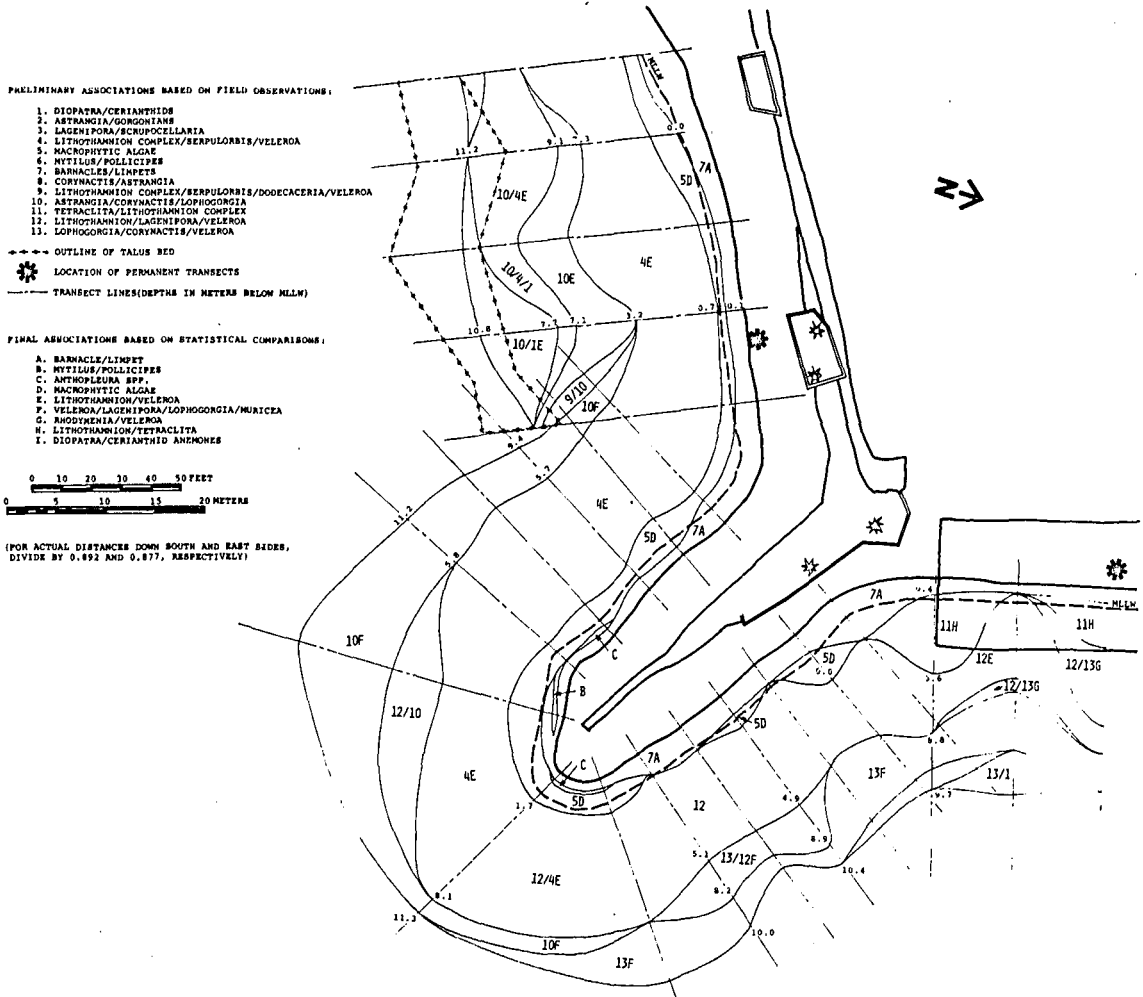

Figure C-5. Preliminary and final special associations, southeast quadrant.



## APPENDIX D

### SUMMARY DATA, QUANTITATIVE CHARACTERIZATION OF MAJOR SPECIES ASSOCIATIONS

Note: In order to calculate biomass values per unit area (0.25 square meter or, in the case of associations 6 and 7, 0.01 square meter), multiply values for average weight (average weight per individual specimen) by values for  $\bar{x}$  (mean abundance per unit area). See Section 5 for average weight values applicable to *Dodecaceria fewkesi*, *Lithothamnium* complex, *Serpulorbis squamigerus*, *Veleroa* complex, and *Corynactis californica*.

Table D-1. Summary data on numerical abundance and biomass of biota in major species associations (see Figs. C-3 to C-6).

Subarea number (corresponding with number in Table D-2)	Subareas for statistical comparisons	Statistical parameters	Common species in upper intertidal associations																	
			<i>Belanus glandula</i>	<i>Chthamalus fissus</i>	<i>Petrcellia squamosa</i>	<i>Pollicipes polymerus</i>	<i>Collisella digitalis</i>	<i>Collisella scabra</i>	<i>Collisella strigicella</i>	<i>Collisella</i> sp.	<i>Lottia gigantea</i>	<i>Mytilus edulis</i>	<i>Mytilus californianus</i>	<i>Lithothamnium</i> complex <sup>3</sup>	<i>Raflesia pacifica</i> <sup>5</sup>	<i>Enteromorpha</i> sp.	<i>Bosicella orbigniana</i> <sup>5</sup>	<i>Pachytrapsus crassipes</i>		
			f	f	f	f	f	f	f	f	f	f	f	f	f	f	f	f		
1	Association #7 (Barnacle-Limpet)	f <sup>1</sup> x <sup>2</sup> 95% cI <sup>3</sup> avg wt <sup>4</sup>	24/28 4.32 +1.82 0.65	21/28 23.18 +10.95 0.03	11/28 2.25 +1.42 5.8	1/28 0.04 +0.07 --	8/28 2.46 +2.84 0.33	8/28 0.57 +0.48 0.4	2/28 0.07 +0.10 --	4/28 0.14 +0.14 13.1	1/28 0.36 +0.73 --	2/28 0.71 1.15 --	2/28 0.43 +0.62 --	2/28 0.46 +0.68 --						
	Association #6 (Mytilus-Pollicipes)	f x 95% cI avg wt	3/6 12.50 +29.33 0.2	0 0 -- --	1/6 0.17 +0.43 1	5/6 20.00 +22.57 0.51	2/6 0.50 +0.89 2.13	0 0 -- --	1/6 1.17 +3.02 0.44	1/6 0.17 +0.43 lost	3/6 2.00 +2.41 0.75	2/6 16.33 +26.97 10.37	2/6 2.83 +5.20 --			2/6 4.5 +10.65 0.25	1/6 0.17 +0.43 1			
			Common species in lower intertidal and subtidal associations																	
			<i>Lithothamnium</i> <sup>5</sup>	<i>Veleroa</i> complex <sup>5</sup>	<i>Bosicella orbigniana</i> <sup>5</sup>	<i>Gelidium robustum</i> <sup>5</sup>	<i>Gelidium coulteri</i> <sup>5</sup>	<i>Corallina officinalis</i> <sup>5</sup>	<i>Gigartina canaliculata</i> <sup>5</sup>	<i>Gigartina spinosa</i> <sup>5</sup>	<i>Prionitis lancoolata</i> <sup>5</sup>	<i>Egria menziesii</i> <sup>5</sup>	<i>Cystoseira osmundacea</i> <sup>5</sup>	<i>Strongylocentrotus purpuratus</i>	<i>Patiria minata</i>	<i>Dodecaceria</i> <sup>6</sup>	<i>Pisaster ochraceus</i>	<i>Serpulorbis squamigerus</i> <sup>5</sup>	<i>Anthopleura elegantissima</i> <sup>5</sup>	
1	Association #5 (Macrophytic Algae) South Side	f x 95% cI avg wt	8/10 75.00 +28.85 --	2/10 9.7 +21.44 --	1/10 9.5 +21.48 --	2/10 7.05 +15.82 25.03	3/10 2.50 +4.46 7.75	5/10 20.00 +29.24 3.63	2/10 4.50 +6.84 5.71	1/10 -- -- --	1/10 0.5 +1.13 5	1/10 1.00 +2.26 47.9		2/10 0.9 +1.59 69.22	1/10 0.10 +2.23 51	0 -- -- --			4/10 11.1 +21.89 0.33	
	Association #5 North Side	f x 95% cI avg wt	8/10 76.50 +29.39 --	8/10 62.50 +24.73 --	0 0 -- --	4/10 5.05 +6.93 11.38	1/10 2.00 +4.53 2.55	1/10 1.50 +3.39 0.47	0 0 -- --	1/10 0.3 +88.95 0.67	2/10 9.5 +19.10 8.67	3/10 3.5 +5.61 20.2	1/10 0.2 +0.45 2.75	1/10 0.10 +23.32 97	4/10 0.60 +0.60 92	2/10 1.0 +1.65 --	0 -- -- --		2/10 1.7 +2.57 --	0 -- -- --
3	Association #5 West Side	f x 95% cI avg wt	4/5 74.00 +53.81 --	5/5 45.00 +35.10 --	0 0 -- --	0 0 -- --	0 0 -- --	0 0 -- --	0 0 -- --	0 0 -- --	0 0 -- --	0 0 -- --	0 0 -- --	5/5 4.0 +2.92 40.35	2/5 0.40 +7.76 92.5	4/5 3.60 +3.24 --	0 -- -- --		1/5 0.2 +0.32 --	0 -- -- --
	Association #5 Southwest Wing	f x 95% cI avg wt	4/4 19.25 +34.87 --	3/4 62.50 +69.15 --	1/4 0.4 +1.42 --	4/4 10.5 +15.66 11.43	0 0 -- --	0 0 -- --	0 0 -- --	0 0 -- --	1/4 15.00 +47.70 127.12	0 0 -- --	0 0 -- --	1/4 0.25 +0.80 197.0	2/4 0.75 +1.53 72.0	2/4 1.0 +1.83 --	1/4 0.25 +3.70 931.0	0 -- -- --		1/4 0.13 +0.40 2.0
5	Association #5 Northeast Wing	f x 95% cI avg wt	8/8 76.25 +32.15 --	5/8 36.25 +26.72 --	4/8 29 +33.32 4.56	3/8 10.63 +17.33 3.32	1/8 7.5 +17.69 0.4	1/8 1.25 +2.95 0.41	1/8 -- -- --	0 0 -- --	1/8 1.63 +2.08 12.08	0 0 -- --	2/8 0.75 +1.46 1.33	3/8 1.38 +2.31 95.3	1/8 0.38 +0.88 69.7	5/8 2.5 +2.09 --	1/8 0.13 +0.29 250.0	3/8 10.00 17.31 --	2/8 -- -- --	0 -- -- --
	Association #5 Northeast Wing #5 East Side	f x 95% cI avg wt	5/6 72.50 +42.80 --	3/6 29.17 +44.67 --	0 0 -- --	0 0 -- --	2/6 13.33 +21.85 0.35	2/6 5.67 +12.72 1.88	1/6 1.67 +4.32 3.2	1/6 1.67 +4.32 0.87	1/6 0.83 +2.16 15.6	0 0 -- --	0 0 -- --	1/6 0.17 +0.43 1.24	1/6 0.33 +0.87 90.0	1/6 1.6 +1.82 1.82	2/6 0.5 +0.61 332.0	0 -- -- --		1/6 0.33 +0.87 0.5
7	Association #5 Southeast Wing South Side	f x 95% cI avg wt	2/3 35.00 +140.06 --	0 0 -- --	0 0 -- --	2/3 2.33 +5.7 2.66	2/3 3.33 +10.34 5.61	0 0 -- --	1/3 1.0 +4.3 1.03	1/3 0.33 +1.44 7.9	0 0 -- --	1/3 0.33 +1.44 122.0	0 0 -- --	2/3 7.0 +28.01 3.29	0 0 -- --	2/3 1.17 +4 --	0 0 -- --		3/3 85.00 +24.86 0.22	0 -- -- --

See footnotes at the end of table.

Table D-1. Summary data on numerical abundance and biomass of biota in major species associations.--Continued.

		Lithothamnium complex <sup>5</sup>	Dedecacera fowkesi <sup>6</sup>	Veleroa complex <sup>5</sup>	Strongylocentrotus purpuratus	Strongylocentrotus franciscanus	Serpulorbis squamigerus <sup>5</sup>	Parastichopus spp.	Muricea spp. <sup>5</sup>	Parapholas sp.	Patiria miniata	Filamentous green alga <sup>5,7</sup>	Laurencia pacificus <sup>5</sup>	Corynactis californica <sup>5</sup>	Astrangia lajollaensis <sup>5</sup>	Doripsilla albopunctata	Phidolopora pacificus <sup>5</sup>	Pisaster giganteus	
8	Association #9 North Side (Lithothamnium-Lithophyllum complex/Veleroa subulata- Murraylophos dawsoni complex)	f <sup>1</sup>	20/20	9/20	17/20	3/20	8/20	3/20	6/20	5/20	6/20	7/20	4/20				1/20	1/20	
		$\bar{x}$ <sup>2</sup>	74.0	5.45	35.15	0.20	0.50	6.90	0.45	0.15	1.55	0.85	3.90	1.00				0.10	0.05
		95% cI $\bar{x}$ <sup>3</sup>	+6.13	+6.16	+2.38	+0.24	+0.36	11.17	+0.39	+0.21	+1.57	+0.82	+3.60	+0.96				+0.21	+0.10
		avg wt <sup>4</sup>	--	--	--	68.3	379.6	--	220.2	727.0	--	--	--	1.16				0.25	1078.7
9	Association #9 South Side	f	10.11	5.11	9.11	5.11	1.11	1.11	0	0	5.11	0	1.11	1.11					
		$\bar{x}$	75.45	1.00	29.91	2.36	0.09	0.09	0.09			0.55	1.23	2.73					
		95% cI $\bar{x}$	+25.15	+0.67	+20.59	+1.91	+0.20		+0.2			+0.46	+1.76	+6.08					
		avg wt	--	--	--	--	--	--	--	--	--	--	--	--	--	--	--	--	
10	Association #9 West Side	f	10/10	1/10	9/10	5/10	2/10	0	0	0	0	4/10	1/10	8/10	1/10	0	1/10	0	
		$\bar{x}$	71.00	0.20	50.5	2	0.2	12.9	0	0	0	0.4	10	0.2	0.05		0.7		
		95% cI $\bar{x}$	+21.64	+0.45	+23.69	+1.72	+0.3	+0.37	+0.88			+0.37	+22.61	+0.45	+13.42	+0.11		+1.58	
		avg wt	--	--	--	--	--	67.63	2.25	--	--	--	--	--	--	--	--	--	
11	Association #9-3 Transition West Side	f	5/5	0	5/5	1/5	2/5	0	1/5	0	0	2/5	0	1/5	2/5	1/5	2/5	2/5	
		$\bar{x}$	71.00		64	0.2	1	0.2				0.4		0.6	7.4	0.6	0.3	0.4	
		95% cI $\bar{x}$	+43.08		+37.85	+0.56	+1.75	+0.56		+0.56		+0.68		+1.66	+16.12	+1.66	+0.56	+0.68	
		avg wt	--	--	22.0	335.2	174.0	--	84.5	--	89.5	--	--	--	1.57	--	--	768.5	
12	Association #9 Southeast Wing East Side	f	2/2	0	2/2	0	0	1/2	0	0	1/2	0	0	0	0	0	0	0	
		$\bar{x}$	100.00		90			0.5				0.5							
		95% cI $\bar{x}$	0		0			0.88				+0.88							
		avg wt	--	--	--	--	--	375.0	--	--	--	81	--	--	--	--	--	--	
13	Association #9 Southeast Wing South Side	f	5/5	3/5	5/5	0	0	1/5	0	0	3/5	0	0	0	2/5	0	1/4	3/5	
		$\bar{x}$	87.00	0.9	58			0.2			0.8				4		0.5		
		95% cI $\bar{x}$	+20.39	+1.28	+16.18			+0.56			+1.04				+6.8		+1.24		
		avg wt	--	--	--	--	--	513.0	--	--	89.5	--	--	--	--	--	--	--	
14	Association #9 Southwest Wing	f	4/4	1/4	2/4	1/4	1/4	1/4	0	0	3/4	0	0	3/4	1/4	2/4	2/4	1/4	
		$\bar{x}$	31.88	0.75	40	0.75	0.25	1.50	0.25			1		7.25	0.25	0.5	4		
		95% cI $\bar{x}$	+64.79	+2.39	+77.89	+2.39	+0.8	+6.03	+0.8			+1.3		+10.49	+0.80	+0.92	+11.69		
		avg wt	--	--	69.0	490.0	--	--	--	--	52.5	--	--	--	0.5	3.67	--	--	
15	Association #9 Northeast Wing North Side	f	9/10	7/10	7/10	4/10	2/10	4/10	3/10	4/10	4/10	2/10	1/10	1/10	0	1/10	2/10	2/10	
		$\bar{x}$	75.30	5/4	33	0.6	0.2	9	0.5	4.5	0.5	4.5	0.2	0.2		0.10	2.05		
		95% cI $\bar{x}$	+28.56	+4.24	+24.62	+0.6	+0.3	+12.77	+0.51	+20.35		+0.51	+8.99	+0.45		+0.23	+4.51		
		avg wt	--	--	62.33	347.5	--	35.87	76.4	--	76.4	--	0.8	--	--	--	3.65	--	
16	Association #9-8 Transition Northeast Wing North Side	f	0	0	1/1	0	0	1/1	0	0	1/1	0	0	1/1	0	0	1/1	0	
		$\bar{x}$			80.0			5				1		6.0			0		
		95% cI $\bar{x}$			0			0				0		--			0		
		avg wt	--	--	--	--	--	--	--	--	96	--	--	--	--	--	3.3	--	
17	Association #9 Northwest Wing	f	2/3	0	3/3	1/3	0	1/3	0	0	2/3	1/3	2/3	2/3	1/3	0	1/3	1/3	
		$\bar{x}$	40.00		40	0.33		5.67				1	0.17	10.17	0.33		0.67		
		95% cI $\bar{x}$	+131.54		+62.4	+1.44		+24.38				63.09	+0.71	+42.7	+1.44		+2.86		
		avg wt	--	--	--	35.0	--	--	--	--	--	53.67	--	--	--	--	--	--	

See footnotes at the end of table.



Table D-1. Summary data on numerical abundance and biomass of biota in major species associations.--Continued.

			<i>Veleroa</i> complex <sup>5</sup>	<i>Scrupocellaria</i> <i>diegensis</i> <sup>5</sup>	<i>Serpularia</i> <i>squamigerus</i> <sup>5</sup>	<i>Phidolopora</i> <i>pacifica</i> <sup>5</sup>	<i>Lophogorgia</i> <i>chilensis</i> <sup>5</sup>	<i>Astrangia</i> <i>lajollaensis</i> <sup>5</sup>	<i>Patiria</i> <i>miniata</i>	<i>Corynactis</i> <i>californica</i> <sup>5</sup>	<i>Lagenipora</i> <i>punctulata</i> <sup>5</sup>	<i>Rhodomymeria</i> cf. <i>californica</i> <sup>5</sup>	<i>Strongylocentrotus</i> <i>franciscanus</i>	<i>Parastichopus</i> sp. <sup>5</sup>	<i>Balanus</i> <i>pacificus</i>	<i>Phormidium</i> sp. <sup>5</sup>	<i>Muricea</i> spp. <sup>5</sup>	<i>Bugula</i> <i>heritima</i> <sup>5</sup>	<i>Plumularia</i> sp. <sup>5</sup>
18	Association #3 West Side ( <i>Lagenipora</i> - <i>Scrupocellaria</i> )	f <sup>1</sup> x <sup>2</sup> 95% clix <sup>3</sup> avg wt <sup>4</sup>	1/5 12.0 +33.87 --	2/5 1.4 +2.42 --	4/5 2.40 +2.57 --	1/5 0.10 +0.27 --		1/5 5.0 +13.88 --	4/5 1.0 +0.88 89.4	3/5 24 +41.02 --	1/5 0.1 +0.27 --		1/5 0.20 +0.56 356.0	2/5 0.40 +0.68 186.0	3/5 3.8 +6.23 0.08	2/5 12.0 +20.39 --		0	
19	Association #3 Northwest Wing	f x 95% clix avg wt	2/5 22 +54.38 --	2/5 0.8 +1.37 1.6	2/5 0.60 +1.10 --	1/5 0.2 +0.34 --		2/5 4.0 +8.09 --	2/5 0.60 +1.10 95.33	2/5 16.60 +44.02 --	0		1/5 0.20 +0.56 280.0	0	1/5 0.20 +0.56 --	0		1/5 0.10 +0.27 --	
20	Association #10 SE Wing South Side ( <i>Astrangia</i> , <i>Corynactis</i> , <i>Lophogorgia</i> )	f x 95% clix avg wt	4/5 49 +58.94 --	3/5 8.2 +22.07 2.68	1/5 1.20 +3.09 --	2/5 0.5 +1.08 --	1/5 0.6 +1.66 --	1/5 1.0 +2.78 --	1/5 0.60 +1.66 72.67	1/5 8.0 +22.20 --	3/5 0.6 +1.02 --	1/5 0.10 +0.27 --	1/5 0.20 +0.56 252.0	0		1/5 0.10 +0.27 --	1/5 4 +11.10 41.60	1/5 7.0 +19.42 --	
21	Association #12 East Side ( <i>Lithothamnion</i> - <i>Lagenipora</i> , <i>Veleroa</i> )	f x 95% clix avg wt	4/4 63.75 +30.00 --	1/4 0.13 +0.40 --	2/4 1.50 +3.78 --	0	0	2/4 8.75 +18.78 --	2/4 0.75 +0.10 104.0	1/4 6.25 +19.88 --	1/4 1.0 +3.18 --	3/4 5.13 +12.75 --	0	1/4 0.25 +0.80 215.0		0	0	0	
22	Association #13 East Side ( <i>Lophogorgia</i> , <i>Corynactis</i> , <i>Veleroa</i> )	f x 95% clix avg wt	1/1 75 00 --	1/1 1 00 --	1/1 35 00 --	1/1 5 00 3.2	1/1 30 00 10.57	0	1/1 1 00 113.0	1/1 4 00 --	1/1 10 00 24.1	1/1 1 00 --	0	1/1 1 00 148.0		0	0	0	
23	Association #12-13 Transition East Side	f x 95% clix avg wt	3/6 30 +46.33 --	0	1/6 1.00 +2.59 --	2/6 0.17 +0.27 --	0	0	4/6 1.25 +0.53 101.4	1/6 0.67 +1.78 --	2/6 10.83 +21.26 10.38	6/6 51.17 +40.05 --	0	2/6 0.33 +0.55 313.5		0	0	0	
24	Association #12-13 Transition Southeast Wing East Side	f x 95% clix avg wt	6/7 56 +45.22 --	2/7 0.57 +1.04 3	5/7 16.29 +19.60 --	3/7 1.21 +1.85 4.67	2/7 6.43 +10.91 7.87		3/7 0.43 +0.49 94.5	2/7 2.86 +4.51 --	3/7 1.86 +2.23 6.6			1/7 0.14 +0.35 95.0				2/7 2.14 +3.63 --	

<sup>1</sup>Frequency (ratio of number of quadrats of occurrence to total number of quadrats examined)<sup>2</sup>Mean abundance per 0.25-square meter area (Note: For associations 6 and 7 only, this value represents mean abundance per 0.01-square meter area)<sup>3</sup>Ninety-five percent confidence limits for mean abundance<sup>4</sup>Average wet weight biomass per individual specimen in grams<sup>5</sup>Mean abundance expressed as percent coverage of 0.25-square meter quadrat, rather than as counts<sup>6</sup>Mean abundance expressed as (cm<sup>2</sup>)/(6.45)=(in<sup>2</sup>) of coverage<sup>7</sup>Presumably, the *DERBESIA MARINA* predominate with other green algae present

Table D-2. Summary numerical and biomass data for less common species (see Table D-1 for common species) occurring in preliminary major species associations (see Figs. C-3 to C-6).

Subarea number <sup>#</sup>	Species in preliminary major species associations	Statistical parameters				Subarea number	Species in preliminary major species associations	Statistical parameters			
		f <sup>†</sup>	$\bar{x}$ <sup>2</sup>	95% cl $\bar{x}$ <sup>3</sup>	avg wt <sup>4</sup>			f	$\bar{x}$	95% cl $\bar{x}$	avg wt
1	S. Association #5 (Macrophytic)					4	SW Wing Association #5				
	<i>Ceramium</i> sp. <sup>5</sup>	1/10	0.30	+0.68	--		<i>Bugula neritina</i> <sup>5</sup>	1/4	1.25	+3.98	2.6
	<i>Lithothrix aspergillum</i> <sup>5</sup>	1/10	0.05	+0.11	--		<i>Corynactis californica</i> <sup>5</sup>	2/4	7.5	+13.77	--
	<i>Parastichopus</i> spp.	1/10	0.10	+0.23	125.0		<i>Gigartina exasperata</i> <sup>5</sup>	1/4	1.25	+3.98	59.8
	<i>Rhodoglossum affine</i> <sup>5</sup>	1/10	0.20	+0.45	3		<i>Lagenipora</i> <sup>5</sup>	1/4	0.13	+0.4	--
	<i>Schizymenia pacifica</i> <sup>5</sup>	1/10	--	--	--		<i>Leucetta losangelensis</i> <sup>5</sup>	3/4	0.38	+0.4	--
	Unid. alga <sup>5</sup>	1/10	0.05	+0.11	--		<i>Megathura crenulata</i>	1/4	0.25	+0.8	284.0
Unid. green alga <sup>5</sup>	1/10	0.20	+0.45	--	<i>Pterosiphonia</i> <sup>5</sup>	3/4	0.75	+2.39	--		
2	N. Association #5					<i>Rhodoglossum affine</i> <sup>5</sup>	1/4	0.25	+0.8	--	
	<i>Aglaothenia struthionides</i> <sup>5</sup>	1/10	0.5	+1.13	5.4	<i>Scrupocellaria</i> <sup>5</sup>	1/4	0.13	+0.4	--	
	<i>Balanus</i> sp.	1/10	0.40	+0.49	--	<i>Styela montereyensis</i>	2/4	0.5	+0.92	19.60	
	<i>Scrupocellaria diegensis</i> <sup>5</sup>	4/10	0.40	+0.89	--	cf. <i>Pugettia</i> sp.	1/4	0.25	+0.8	17.0	
	cf. <i>Stenogramme</i> <sup>5</sup>	1/10	0.20	+0.45	5.05	Unid. barnacles	2/4	3.25	+7.5	--	
	<i>Strongylocentrotus franciscanus</i>	1/10	0.10	+0.23	404.0	Unid. fine red alga <sup>5</sup>	1/4	3.75	+11.93	0.67	
	Unid. alga <sup>5</sup>	2/10	1.5	+2.42	0.7	Unid. flat red <sup>5</sup>	1/4	10	+31.8	--	
	<i>Ulva</i> sp. <sup>5</sup>	3/10	0.40	+0.67	--	Unid. hydroids	1/4	0.5	+1.59	--	
	Unid. coralline alga <sup>5</sup>	1/10	0.05	+0.11	--	Unid. orange sponge <sup>5</sup>	1/4	0.13	+0.4	--	
	Unid. flat red <sup>5</sup>	2/10	1.0	+1.51	10.5						
	Unid. tunicate <sup>5</sup>	1/10	0.10	+0.23	--						
3	W. Association #5					5	NE Wing Association #5 (N Side)				
	<i>Balanus pacificus</i>	1/5	2.0	+5.55	--	<i>Bugula neritina</i> <sup>5</sup>	1/8	0.25	+0.58	--	
	cf. <i>Cliona</i> <sup>5</sup>	2/5	0.4	+1.1	--	<i>Eudistylia</i>	1/8	0.13	+0.29	--	
	<i>Corynactis californica</i> <sup>5</sup>	3/5	4.6	+7.68	--	<i>Laurencia pacifica</i> <sup>5</sup>	1/8	3.13	+7.27	--	
	<i>Fissurella volcano</i> <sup>5</sup>	1/5	0.20	+0.56	2	<i>Megathura crenulata</i>	1/8	0.13	+0.29	421.0	
	<i>Laurencia pacifica</i> <sup>5</sup>	1/5	0.60	+1.66	--	<i>Rhodoglossum affine</i> <sup>5</sup>	1/8	0.25	+0.58	--	
	<i>Megathura crenulata</i>	1/5	0.20	+0.56	482.0	fil. green alga <sup>5</sup>	3/8	1.13	+1.49	--	
	<i>Parastichopus</i> spp.	1/5	0.20	+0.56	197.0	Unid. coralline alga <sup>5</sup>	1/8	3.13	+7.27	--	
	<i>Pisaster giganteus</i>	1/5	0.20	+0.56	623.0	Unid. green alga <sup>5</sup>	1/8	0.25	+0.58	--	
	Unid. anemones	1/5	1.40	+3.88	--						
	Unid. flat red <sup>5</sup>	1/5	0.40	+1.1	--	6	NE Wing Association #5 (E Side)				
	Unid. nudibranch	1/5	0.40	+1.1	--	<i>Tetraclita squamosa</i> <sup>5</sup>	1/6	8.33	+21.41	--	
	fil. green alga <sup>5</sup>	3/5	11.67	+19.72	--	<i>Ulva</i> sp. <sup>5</sup>	1/6	0.08	+0.21	--	
	Unid. barnacles	2/5	1.80	+3.76	--	fil. green alga <sup>5</sup>	2/6	13.5	+25.61	--	
	Unid. fil. red <sup>5</sup>	5/10	0.10	+0.27	--	Unid. flat green <sup>5</sup>	1/6	0.33	+0.86	--	
Unid. hydroids <sup>5</sup>	1/5	0.60	+1.66	--	Unid. fil. brown alga <sup>5</sup>	1/6	15.83	+40.68	3.01		

See footnotes at end of table.

Table D-2. Summary numerical and biomass data for less common species occurring in preliminary major species associations.--continued.

	f	$\bar{x}$	95% cl $\bar{x}$	avg wt		f	$\bar{x}$	95% cl $\bar{x}$	avg wt
<b>7 SE Wing Association #5 (S. Side)</b>					<b>9 S. Association #9 4 (Litho.)</b>				
<i>Balanus</i> sp.	1/3	0.67	+2.86	--	<i>Anthopleura xanthogrammica</i> <sup>5</sup>	2/11	1.91	+4.04	--
<i>Cryptopleura</i> sp. <sup>5</sup>	3/3	1.67	+1.44	2.06	<i>Balanus</i> sp.	1/11	0.27	+0.6	--
<i>Hymeniacion sinapium</i> <sup>5</sup>	1/3	0.33	+1.44	6.0	<i>Chama pellucida</i>	1/11	0.09	+0.2	1.6
<i>Mytilus californianus</i>	2/3	5.33	+20.85	0.14	<i>Chaetopterus variopedatus</i>	1/11	0.73	+1.62	3.25
<i>Ulva</i> sp. <sup>5</sup>	2/3	1.17	+4.0	--	<i>Corallina officinalis</i> <sup>5</sup>	1/11	1.81	+4.05	3.05
Unid. coralline <sup>5</sup>	3/3	5.67	+9.42	1.0	<i>Diaperoecia californica</i> <sup>5</sup>	1/11	0.45	+1.01	9.2
Unid. flat fil. brown alga <sup>5</sup>	1/3	0.33	+1.44	8.8	<i>Gelidium robustum</i> <sup>5</sup>	1/11	1.96	+2.13	6.29
Unid. flat green <sup>5</sup>	1/3	0.17	+0.72	--	<i>G. coulteri</i> <sup>5</sup>	1/11	0.91	+2.03	6.6
Unid. polychaete	2/3	0.67	+1.44	--	<i>Lucetta losangelensis</i> <sup>5</sup>	1/11	1.23	+1.76	1.2
Unid. flat red <sup>5</sup>	1/3	1.67	+7.18	5.6	<i>Microcladia</i> sp. <sup>5</sup>	1/11	1.23	+1.76	--
Unid. fine red <sup>5</sup>	1/3	0.67	+2.86	--	<i>Pyura haustor (tunicate)</i>	1/11	0.18	+0.4	0.3
					<i>Ulva</i> sp. <sup>5</sup>	2/11	0.41	+0.81	0.09
<b>8 N. Association #9 (Lith)</b>					Unid. fish (goby or?)	2/11	0.18	+0.27	--
<i>Balanus</i> sp.	1/20	0.15	+0.31	--	Unid. hydroid <sup>5</sup>	1/11	0.18	+0.4	--
<i>Calliostoma gloriosum</i>	1/20	0.05	+0.1	3.2	fil. brown alga <sup>5</sup>	1/11	1.23	+1.76	--
<i>Chama pellucida</i>	1/20	0.10	+0.21	16.0	Unid. fil. red <sup>5</sup>	2/11	1.91	+4.04	--
<i>Cliona</i> sp. <sup>5</sup>	1/20	0.10	+0.21	--	Unid. flat red <sup>5</sup>	2/11	0.32	+0.6	--
<i>Conus californicus</i>	1/20	0.05	+0.1	0.3					
<i>Crepidatella lingulata</i>	4/20	0.2	+0.19	0.8	<b>10 W. Association #9 (Litho)</b>				
<i>Dendrodoris fulva</i>	1/20	0.10	+0.21	--	Brown sponge <sup>5</sup>	1/10	0.05	+0.11	--
<i>Diopatra ornata</i>	1/20	0.05	+0.1	--	<i>Chama pellucida</i>	1/10	0.6	+1.36	3.33
<i>Eudistylia</i> sp.	1/20	0.15	+0.31	--	<i>Cliona celata californiana</i> <sup>5</sup>	1/10	1.0	+2.26	19.3
<i>Gelidium</i> sp. <sup>5</sup>	1/20	0.5	+1.05	--	<i>Doriopsilla albopunctata</i>	2/10	0.2	+0.3	1.15
<i>Hinnites multirugosus</i>	1/20	0.05	+0.1	14.5	<i>Hermisenda crassicornis</i>	1/10	0.1	+0.23	--
<i>Lophogorgia chilensis</i> <sup>5</sup>	1/20	0.05	+0.1	20.8	<i>Lagenipora punctulata</i> <sup>5</sup>	1/10	1.20	+1.39	--
<i>Pecten diegensis</i>	1/20	0.05	+0.1	--	<i>Leucetta losangelensis</i> <sup>5</sup>	2/10	0.35	+0.67	0.93
<i>Pseudochama exogyra</i>	1/20	0.05	+0.1	9.4	<i>Salmacina tribranchiata</i> <sup>5</sup>	1/10	0.7	+1.58	3
<i>Pteropurpura festiva</i>	3/20	0.15	+0.17	2.83	<i>Scrupocellaria diegensis</i> <sup>5</sup>	1/10	1.8	+1.61	--
<i>Pteropurpura</i> sp.	1/20	0.25	+0.52	--	<i>Spheciospongia confoederata</i> <sup>5</sup>	1/10	1.5	+3.39	15.0
<i>Rhodymenia</i> 5	2/20	1.25	+2.09	--	Unid. ectoproct <sup>5</sup>	1/10	0.8	+1.81	1.38
<i>Salmacina tribranchiata</i> <sup>5</sup>	1/20	0.05	+0.1	--	Unid. flat red alga <sup>5</sup>	3/10	2.15	+4.49	--
<i>Scrupocellaria diegensis</i> <sup>5</sup>	2/20	1.25	+2.09	--	Unid. hydroids <sup>5</sup>	1/10	1.0	+2.26	--
<i>Styela</i>	1/20	0.05	+0.1	--	Unid. red alga <sup>5</sup>	2/10	1.6	+3.38	2.8
<i>Ulva</i> sp. <sup>5</sup>	1/20	0.18	+0.31	--	fil. brown alga <sup>5</sup>	1/10	3.1	+4.58	--
Unid. coralline <sup>5</sup>	2/20	0.13	+0.22	0.2	Unid. barnacles	1/10	0.2	+0.45	--
Unid. green alga <sup>5</sup>	1/20	0.25	+0.52	--	Unid. sponge <sup>5</sup>	1/10	0.05	+0.11	--
Unid. flat red <sup>5</sup>	2/20	0.15	+0.23	--	Unid. fil red alga <sup>5</sup>	1/10	1.5	+3.39	--
Unid. sponge <sup>5</sup>	1/20	0.10	+0.21	--					
Unid. white sponge <sup>5</sup>	1/20	0.05	+0.1	--					
Unid. porcellanid crab	1/20	0.05	+0.1	2.5					
Unid. ophiuroids	1/20	0.10	+0.21	--					
Unid. shrimp	1/20	0.10	+0.21	--					

See footnotes at end of table.

Table D-2. Summary numerical and biomass data for less common species occurring in preliminary major species associations.--continued.

	f	$\bar{x}$	95% cl $\bar{x}$	avg wt		f	$\bar{x}$	95% cl $\bar{x}$	avg wt
<b>11 W. Association 3<sub>9</sub> Transition</b>					<b>15 Northeast Wing (North Side)</b>				
cf. <i>Balanus pacificus</i>	2/5	8.6	+14.93	--	<i>Balanus pacificus</i>	1/10	0.2	+0.45	--
<i>Chaetopterus</i> sp.	1/5	2.0	+5.55	7.0	<i>Cypraea spadicea</i>	1/10	0.3	+0.68	24.3
cf. <i>Cliona</i> <sup>5</sup>	1/5	2.0	+5.55	--	<i>Hinnites multirugosus</i>	1/10	0.10	+0.23	20.0
<i>Diaperoecia californica</i> <sup>5</sup>	2/5	1.4	+1.72	4.6	<i>Lagenipora punctulata</i> <sup>5</sup>	1/10	1.5	+3.39	5.2
<i>Eudistylia</i> sp.	1/5	0.2	+0.56	--	<i>Octopus bimaculoides</i>	1/10	0.1	+0.23	70.0
<i>Lagenipora punctulata</i> <sup>5</sup>	1/5	3	+8.33	17.87	<i>Scrupocellaria diegensis</i> <sup>5</sup>	1/10	1.0	+2.26	13.6
<i>Ocenebra foveolata</i>	1/5	0.2	+0.56	1.0	<i>Simnia vidleri</i>	1/10	0.1	+0.23	--
<i>Pteropurpura festiva</i>	1/5	0.2	+0.56	2.4	<i>Tedania toxicalis</i> (sponge) <sup>5</sup>	1/10	1.0	+2.26	2.3
<i>Salmacina tribranchiata</i>	1/5	2.0	+5.55	3.2	Unid. nudibranch	1/10	0.4	+0.9	--
<i>Scrupocellaria diegensis</i> <sup>5</sup>	3/5	5.2	+10.47	0.54	Unid. hydroids <sup>5</sup>	1/10	0.05	+0.11	--
Unid. flat red alga <sup>5</sup>	2/5	8.6	+21.84	--	Unid. green alga <sup>5</sup>	1/10	0.5	+1.13	--
Unid. hydroids <sup>5</sup>	2/5	2.0	+3.51	--					
Unid. red alga <sup>5</sup>	1/5	0.1	+0.27	--	Other species present at frequency 1/10:				
Unid. sponge <sup>5</sup>	1/5	0.1	+0.27	--	<i>Chama pellucida</i>	<i>Doriopsilla albopunctata</i>			
					<i>Didemnum</i> sp.	<i>Ceratostoma nuttalli</i>			
<b>12 Southeast Wing (East Side)</b>					<i>Alpheus clamator</i>	<i>Ocenebra foveolata</i>			
Unid. green alga sp. <sup>5</sup>	1/2	2.0	+12.51	--	<i>Loxorhynchus</i> sp.	<i>Halosydna tuberculifer</i>			
Unid. green alga sp. #2 <sup>5</sup>	1/2	2.0	+12.51	--	<i>Bugula neritina</i>	<i>Syllidae</i> (juv.)			
Unid. fil red alga <sup>5</sup>	1/2	10.0	+127.46	2	<i>Ulva</i> sp.	<i>Salmacina tribranchiata</i>			
					<i>Crisia occidentalis</i>	<i>Heptacarpus palpator</i>			
<b>13 Southeast Wing (Litho Assn) (S. Side)</b>					<i>Hiatella arctica</i>	<i>Erichthonius brasiliensis</i>			
<i>Lagenipora punctulata</i> <sup>5</sup>	1/5	0.1	+0.27	--	<i>Chama pellucida</i>	<i>Ophiothrix spiculata</i>			
Unid. anemone	2/5	1.4	+2.42	--	<i>Lithophaga plumula</i>				
Unid. ectoproct <sup>5</sup>	1/5	0.1	+0.27	--					
Unid. fil red alga #1 <sup>5</sup>	1/4	0.5	+1.59	0.05	<b>16 Northwest Wing (Transition)</b>				
Unid. fil red alga #2 <sup>5</sup>	1/4	0.25	+0.4	0.1	(Probably Association 8)				
					<i>Bugula neritina</i> <sup>5</sup>	1/1	1	0	--
<b>14 Southwest Wing (Litho/Corynactis)</b>					<i>Diaperoecia californica</i> <sup>5</sup>	1/3	0.17	+0.72	--
<i>Diaperoecia californica</i> <sup>5</sup>	1/4	0.13	+0.8	--	<i>Scrupocellaria diegensis</i> <sup>5</sup>	1/3	1.67	+7.18	3.6
<i>Lagenipora punctulata</i> <sup>5</sup>	1/4	2.5	+7.95	2.3	<i>Ulva</i> sp. <sup>5</sup>	1/1	0.5	0	--
<i>Loxorhynchus crispatus</i>	1/4	0.25	+0.4	2	Unid. flat red (cf. <i>Polysiphonia</i> ) <sup>5</sup>	1/3	13.33	+57.39	--
<i>Leucetta losangelensis</i> <sup>5</sup>	1/4	0.5	+1.59	--	Unid. hydroids <sup>5</sup>	1/3	0.33	+1.44	--
<i>Pachycheles pubescens</i>	1/4	0.25	+0.4	0.2	Unid. phoronids <sup>5</sup>	1/1	0.5	0	--
<i>Parastichopus</i> spp.	1/4	0.25	+0.4	183.0	Unid. sponge <sup>5</sup>	1/1	0.5	0	--
<i>Pterosiphonia dendroidea</i> <sup>5</sup>	1/4	1.0	+3.18	--	Unid. orange tunicate <sup>5</sup>	1/1	0.5	0	--
<i>Scrupocellaria diegensis</i> <sup>5</sup>	2/4	4.0	+11.69	0.67					
Unid. nudibranch	1/4	0.25	+0.4	0.5	<b>17 Northeast Wing (North Side)</b>				
Unid. hydroids <sup>5</sup>	2/4	1.5	+2.75	--	8-9 Transition				
Unid. green alga <sup>5</sup>	1/4	0.13	+0.8	--	<i>Balanus pacificus</i>	1/1	1	0	--
Unid. barnacles	2/4	10.75	+26.39	--	<i>Diopatra tubes</i>	1/1	3	0	--
Unid. yellow sponge <sup>5</sup>	1/4	2.5	+7.95	--	<i>Scrupocellaria diegensis</i> <sup>5</sup>	1/1	10	0	2.8
Unid. fil red alga #1 <sup>5</sup>	1/4	0.5	+1.59	--	Unid. flat red (cf. <i>Polysiphonia</i> ) <sup>5</sup>	1/1	4	0	--
Unid. barnacles	2/4	2.0	+3.90	--	Unid. hydroids <sup>5</sup>	1/1	3	0	--
					Unid. yellow sponge <sup>5</sup>	1/1	4.0	0	--

See footnotes at end of table.

Table D-2. Summary numerical and biomass data for less common species occurring in tentative major species associations.--Continued.

	f	$\bar{x}$	95% cI $\bar{x}$	avg wt		f	$\bar{x}$	95% cI $\bar{x}$	avg wt
<b>18 W. Association #3 (Lagenipora-scrupocecellaria)</b>					<b>21 Continued</b>				
Callistochiton	1/5	0.2	+0.56	2.1	E. Association #12				
Corypheella trilineata (nud)	1/5	0.2	+0.56	--	cf. Gelidium sp. <sup>5</sup>	1/4	0.13	+0.4	--
cf. Didemnum carnulentum <sup>5</sup>	1/5	0.1	+0.27	--	Hermisenda crassicornis	1/4	0.5	+1.59	--
Doriopsilla albopunctata	2/5	0.80	+1.37	1.8	Navanax inermis	1/4	0.25	+0.8	2.5
Lithothamnium complex <sup>5</sup>	5/5	43.0	+33.87	--	Paracyathus stearnsii	1/4	0.25	+0.8	--
Leucetta losangelensis <sup>5</sup>	1/5	0.10	+0.27	--	cf. Ulva sp. <sup>5</sup>	2/4	12	+35.06	--
cf. Pododesmus cepio	1/5	0.2	+0.56	186.0	Unid. phoronids <sup>5</sup>	3/4	0.38	+0.4	--
Strongylocentrotus purpuratus	1/5	12.0	+33.3	113.0	Unid. hydroid <sup>5</sup>	1/4	0.13	+0.4	--
Unid. flat red alga <sup>5</sup>	2/5	0.7	+1.61	--					
Unid. hydroids <sup>5</sup>	1/5	0.1	+0.27	--	<b>22 E. Association #13</b>				
Unid. gastropod	1/5	0.2	+0.56	--	Antiopella barbarenais	1/1	1	0	4.0
Unid. crab cf. C. productus	1/5	0.2	+0.56	12.0	Diaperoecia californica <sup>5</sup>	1/1	5	0	1.9
					Paracyathus stearnsii	1/1	1	0	3.0
<b>19 NW Wing Association #3</b>					Salmacina tribranchiata <sup>5</sup>	1/1	0.5	0	1.5
Balanus nubilus	1/5	1.0	+1.66	--	Unid. hydroid <sup>5</sup>	1/1	0.5	0	1.5
Peyssonellia sp. <sup>5</sup>	1/5	0.8	+2.22	--	Unid. ophiuroids	1/1	30	0	--
Leucilla nuttingi <sup>5</sup>	1/5	0.6	+1.66	0.27	Unid. red sponge <sup>5</sup>	1/1	0.5	0	--
Lithothamnium <sup>5</sup>	1/5	0.10	+0.27	--	Unid. snail	1/1	1	0	0.5
Leucetta losangelensis <sup>5</sup>	1/5	1.0	+2.78	1.12					
Triopha maculata	1/5	0.2	+0.56	--	<b>23 E. Association 12-13</b>				
Unid flat red alga <sup>5</sup>	1/5	6.0	+16.66	--	Anthopleura elegantissima <sup>5</sup>	1/6	0.33	+0.86	--
					Cystoseira osmundacea <sup>5</sup>	1/6	0.17	+0.43	--
<b>20 SE Wing Association #10</b>					Diaperoecia californica <sup>5</sup>	1/6	0.08	+0.21	--
Antropora tincta <sup>5</sup>	1/5	0.10	+0.27	--	Dodecaceria fewkesi <sup>6</sup>	2/6	0.67	+1.27	--
Aplidium californicum	1/5	1.0	+2.78	3.8	Doriopsilla albopunctata	1/6	0.17	+0.46	1.5
Eudistylia	1/5	--	--	--	Hinnites multirugosus	1/6	0.17	+0.43	5.0
Leucetta losangelensis <sup>5</sup>	1/5	0.10	+0.27	--	Lithothamnium complex <sup>5</sup>	1/6	0.08	+0.21	--
Mitra idae	1/5	0.20	+0.56	6.0	Ocenebra foveolata	1/6	0.17	+0.43	--
Petrolisthes sp.	1/5	0.2	+0.56	1.5	cf. Ocenebra barbarenais	1/6	0.17	+0.43	0.2
Pteropurpura festiva	1/5	0.20	+0.56	1.0	Parapholas sp.	1/6	0.17	+0.43	--
Unid. ectoproct <sup>5</sup>	1/5	0.10	+0.37	--	Paracyathus stearnsii	2/6	0.5	+0.88	1.0
Unid. holothuroid	1/5	0.10	+0.27	--	cf. Ulva sp. <sup>5</sup>	3/6	10.17	+22.87	0.08
Unid. pagurid crab	1/5	0.20	+0.56	9.0	Unid. phoronids <sup>5</sup>	1/6	0.08	+0.21	--
Unid. polyclad	1/5	0.20	+0.56	--	Unid. hydroid <sup>5</sup>	1/6	0.83	+1.4	--
Unid. phoronids <sup>5</sup>	2/5	0.2	+0.34	--	Unid. ophiuroids	1/6	2.5	+6.42	--
					Unid. flat brown <sup>5</sup>	1/6	0.08	+0.21	--
<b>21 E. Association #12</b>					<b>24 East Side Association 12-13</b>				
Balanus tintinnabulum	1/4	0.25	+0.8	1.0	Southeast Wind (East Side)	1/7	0.14	+0.35	15.0
Dodecaceria fewkesi <sup>6</sup>	1/4	0.5	+1.59	--	Kelletia kelletii	1/7	0.07	+0.18	--
Flabellinopsis iodinea	1/4	0.25	+0.8	--	Unid. red sponge <sup>5</sup>	3/7	0.79	+1.13	--
					Unid. flat red alga <sup>5</sup>				

\* Subarea number corresponds with number in Table D-1.

<sup>1</sup>Frequency (ratio of number of quadrats of occurrence to total number of quadrats examined)

<sup>2</sup>Mean abundance per 0.25-square meter area (Note: For associations 6 and 7 only, this value represents mean abundance per 0.01-square meter area)

<sup>3</sup>Ninety-five percent confidence limits for mean abundance

<sup>4</sup>Average wet weight biomass per individual specimen in grams

<sup>5</sup>Mean abundance expressed as percent coverage of 0.25-square meter quadrat, rather than as counts

<sup>6</sup>Mean abundance expressed as (cm<sup>2</sup>)/(6.45)=(in<sup>2</sup>) of coverage

Table D-3. Areal coverages of major species associations (areal coverages are expressed as percent of total island area between the upper limit of the barnacle-limpet zone and the lower limit of revetment rock on the bottom).

Provisional Species Associations (numerical designations for associations on various sides of the island correspond to those designations in Table D-1 and Figs. C-3 to C-6).

Table D-1 Subarea	Percent Coverage	Table D-1 Subarea	Percent coverage
Upper Intertidal		11	2.15
Association #7 (Barnacle-Limpet)	6.70	12	3.57
Association #6 ( <i>Mytilus-Pollicipes</i> )	1.28	13	3.80
Lower Intertidal and Subtidal		14	4.80
1	0.76	15	3.62
2	0.95	16	1.22
3	2.11	17	1.85
4	0.91	18	1.78
5	0.54	19	2.36
6	0.23	20	2.66
7	0.70	21	1.02
8	4.21	22	1.40
9	5.27	23	1.69
10	12.40	24	0.66
Remaining island area not quantitatively sampled:			<u>31.36</u>
		Total	100.00
			(15,560 m <sup>2</sup> )

Final Species Associations (see Figs. 9 to 12)

Association Designation	Percent Coverage
A Barnacle-limpet	6.70
B <i>Mytilus-Pollicipes</i>	1.28
C <i>Anthopleura</i> spp.	0.10
D Macrophytic algae	7.38
E <i>Lithothamnium</i> complex	53.47
F <i>Veleroa-Lagenipora-Lophogorgia-Muricea</i>	29.1
G <i>Rhodomenia-Veleroa</i>	1.02
H <i>Lithothamnium-Tetraclita</i>	0.61
I <i>Diopatra-cerianthid</i> anemones	<u>0.34<sup>1</sup></u>
Total	100.00
	(15,560 m <sup>2</sup> )

<sup>1</sup>Present as small isolated pockets on the lower parts of association F and, on the north side, association E.

## APPENDIX E

### OBSERVATIONS ALONG NATURAL BOTTOM TRANSECT

The following is a discussion of substrate and biotic composition of the first segment of the transect (13.7- to 6.1-meter depth).

Over the depth range 13.7 to 11.3 meters, the substrate is silt with some shell fragments. The sediment is very soft and similar to that existing at the base of the east side of the island. The dominant biota are sea pens (*Stylatula elongata*), bat stars (*Patiria miniata*), whelks (*Kelletia kelletii*), and cerianthid anemones. On a few isolated rocks (maximum vertical relief 0.25 meter) stony corals (*Astrangia lajollaensis*) were present and the tectibranch, *Navanax inermis*, was observed.

At about 10.7 meters the substrate is more sandy with many shell fragments. Isolated smooth boulders (1- to 2-meter diameter) are present with the evidence that they are intermittently covered with sand (no epiphytic algae present). *Diopatra* spp. are common to abundant in patches of up to about 100 individuals. *Kelletia*, *Patiria*, and *Strongylocentrotus franciscanus* are present. Vertical pipes (about 1 meter high) were observed with cf. *Metridium* sp. attached. *Diaulula sandiegensis*, *Corynactis californica*, *Cancer* sp., cf. *Stylatula*, and cerianthid anemones were present. Also at this depth, gorgonians (*Muricea* spp. and *Lophogorgia chilensis*) appear on isolated rocks, with *Muricea* common to locally abundant.

From 10.7 to 9.1 meters, smooth boulders, as described above, dominate the substrate. However, these boulders are more heavily encrusted with *Astrangia*, *Veleroa*, and *Lithothamnium* complex. Around the rock bases, where some sand is present, *Diopatra ornata* occur. The midshipman (*Porichthys* spp.), juvenile olive rockfish (*Sebastes serranoides*) and sanddabs (*Citharichthys* sp.) are also present. *Lithothamnium* coverage ranges up to 15 to 20 percent of exposed rock areas. Also present on vertical pipes and rocks are sponges (*Leucetta losangelensis*), *Metridium*, and *Strongylocentrotus franciscanus*. *Strongylocentrotus purpuratus* was also observed along these depths, but this species was not abundant. *Cypraea spadicea*, *Tethya aurantia*, *Pisaster brevispinus*, *P. giganteus*, and *Dermasterias imbricata* were also present to common on the solid substrate.

From 7.6 to 6.1 meters the substrate changes from smooth boulders to solid shale bedrock with isolated boulders and sand patches. Pholad bivalves, starfish, and urchins dominate the macrobiota. Some red alga (*Veleroa* complex and *Lithothamnium*) are present; also juvenile red algae was observed attached to the rock.

The next segment of the transect, extending from a depth of about 4.6 meters to shore, is predominantly sand and largely depauperate in macrobiota (visibility was very poor during the two occasions this area was examined). From this point shoreward, scattered rocks (30- to 60-centimeter diameter) were commonly encountered. Acorn barnacles were abundant on these rocks, and coverages of *Lithothamnium* complex and the tunicate, *Styela montereyensis* average about 15 and 45 percent, respectively. Other organisms present to common in this nearshore zone include starfish (*Patiria miniata* and *Pisaster ochraceus*), feather boa kelp (*Egregia menziesii*), hydroids and tunicates. Tunicates are especially abundant (60 to 70 percent coverage) between depths of 4.3 to 3.7 meters.

In general, the deeper parts of this transect are predominantly silt. Where rocks occur, they are comparable to the deeper areas of the east-side permanent transect (i.e., very little epibiota, and much silt). Farther inshore along the natural bottom transect, less silt and more sand are present. The rocks, which are smoother than in deeper water, resemble deeper rocks on the north side of the island in that much *Astrangia lajollaensis* is present but differs in that ectoprocts are for the most part missing.



APPENDIX F  
SIEVE ANALYSIS OF NATURAL BOTTOM  
SEDIMENT SAMPLES

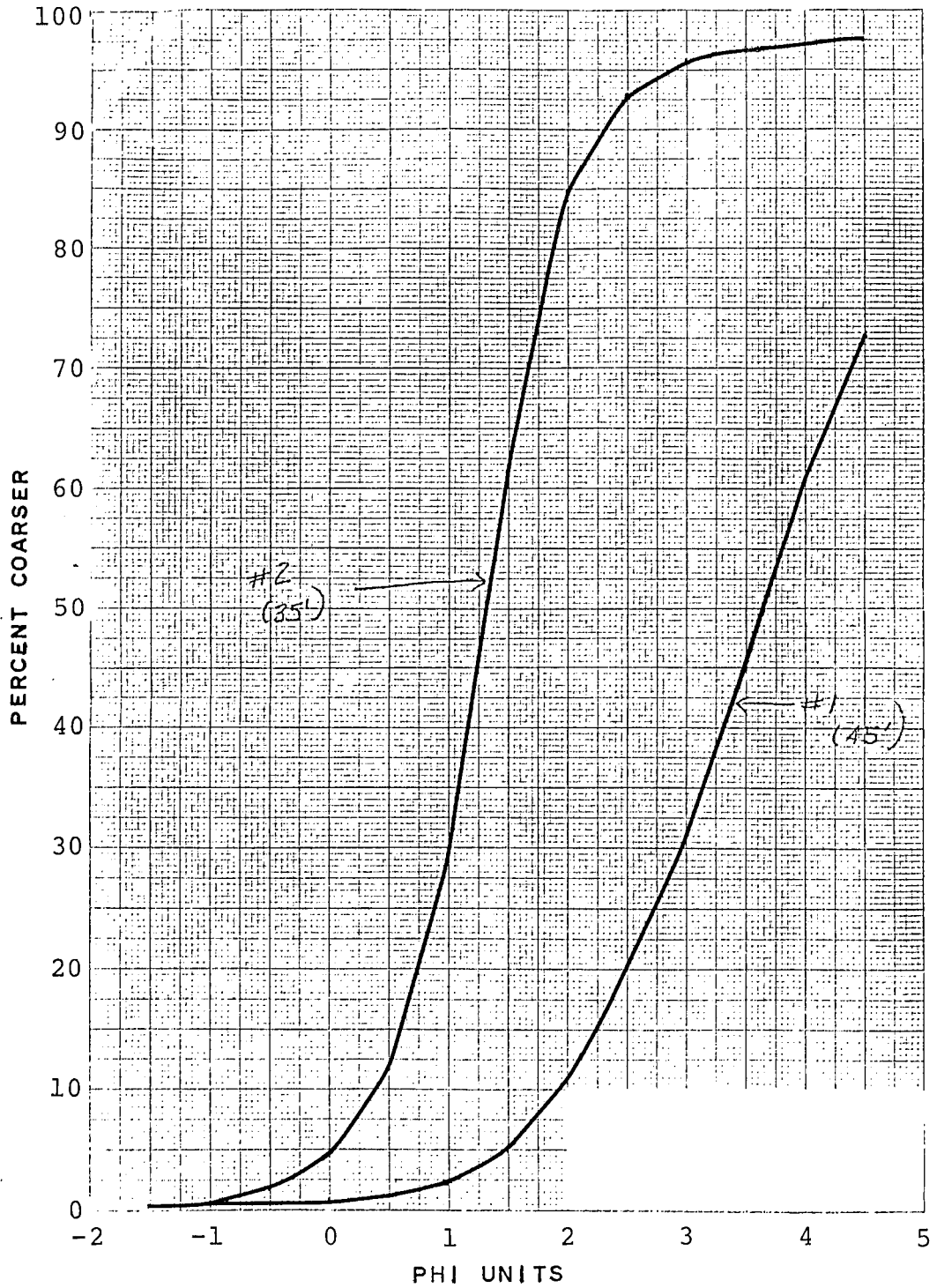

Figure F-1. Sieve analysis results from natural bottom sediments (station locations shown on Fig. 18).

Table F-1. Sieve analysis, natural bottom sediments, Sample 1  
(Sample location shown on Figure 18.).

SIEVE ANALYSIS  
Mech. Anal. Sheet No. 3  
(Revised Nov. 1930)

Sample Date and No. SED SAMPLE #1<sup>4507</sup>  
Locality 45'

$N_{84} = 2.25$   $M_{84} = 3.65$   
 $N_{16} = \frac{1}{2.25} = 0.444$   
 $N_{84} - N_{16} = 2.25 - 0.444 = 1.806$   
 $M_{84} - M_{16} = 3.65 - 0.444 = 3.206$   
 $S/\sigma_{\phi} = \frac{1.806}{3.206} = 0.563$

Analyzed by D. AUBREY Date 27 AUG 77

RINCON

SAMPLE DESCRIPTION

Color \_\_\_\_\_ Size \_\_\_\_\_

Sorting \_\_\_\_\_ Roundness \_\_\_\_\_

Composition \_\_\_\_\_

Size Range $\phi$	Dish No.	Wt. Dish Sample	Wt. of Dish	Wt. of Sample	% of Total Wt.	Cum %	Notes
Before Sieving	4	118.820	40.625	78.125		100%	
-2 to -1½		34.550	34.278	.272		0.3	SHELL FRAGS
-1½ to -1		34.653		.375		0.5	" "
-1 to -½		34.769		.491		0.6	" "
-½ to 0		34.892		.614		0.8	" "
0 to ½		35.169		.891		1.1	
½ to 1		36.089		1.811		2.3	
1 to 1½		38.215		3.937		5.0	
1½ to 2		42.832		8.551		10.9	
2 to 2½		49.951		15.623		20.0	
2½ to 3		58.585		24.307		31.1	
3 to 3½		69.169		34.891		44.7	
3½ to 4		81.691		47.413		60.7	
4-4½-4½		91.026		56.748		72.6	

< 4½  $\phi$

Table F-2. Sieve analysis, natural bottom sediments, Sample 2  
(Location shown on Figure 18.).

SIEVE ANALYSIS  
Mech. Anal. Sheet No. 3  
(Revised Nov. 1950)

Sample Date and No. SBD SAMPLE #2<sup>4507</sup>  
Locality 35'

$$\begin{aligned} \phi_{84} & \frac{1.96}{.62} & M_{3\phi} & = & 1.31 \\ \phi_{16} & & & & \\ \phi_{84} - \phi_{16} & \frac{1.34(\frac{1}{2})}{.52(\frac{1}{2})} = \sigma_{\phi} & & = & .67 \\ \phi_{84} + \phi_{16} & \frac{3.52(\frac{1}{2})}{.48} = M_{\phi} & & = & 1.79 \\ M_{\phi} - M_{3\phi} & & = S & = & .48 \\ S/\sigma_{\phi} & & = \alpha_{\phi} & = & .72 \end{aligned}$$

Analyzed by D. AUBREY Date 27 AUG 77

SAMPLE DESCRIPTION

Color \_\_\_\_\_ Size \_\_\_\_\_  
Sorting \_\_\_\_\_ Roundness \_\_\_\_\_  
Composition \_\_\_\_\_

Size Range $\phi$	Dish No.	Wt. Dish Sample	Wt. of Dish	Wt. of Sample	% of Total Wt.	Cum %	Notes
Before Sieving	8	148.930	40.675	108.285		100%	
-2 to -1½		34.527	34.278	.249		0.2	SHELL FRAGS
-1½ to -1		34.917		.639		0.6	" "
-1 to -½		36.111		1.833		1.7	" "
-½ to 0		39.031		4.753		4.4	" "
0 to ½		46.957		12.679		11.7	
½ to 1		56.272		31.994		29.5	
1 to 1½		100.922		66.644		61.5	
1½ to 2		126.101		91.823		84.8	
2 to 2½		134.991		100.713		93.0	
2½ to 3		138.027		103.749		95.8	
3 to 3½		139.093		104.815		96.8	
3½ to 4		139.462		105.184		97.1	
< 4		139.810		105.532		97.5	

## APPENDIX G

### GLOSSARY

- armor rock - Heavy rock, usually weighing 500 pounds or more, used to protect a coastal structure or shore from heavy wave attack.
- associations - In ecology, a subunit of community organization identified by its major organisms.
- azimuth - In this case, the arc of the horizon measured in degrees, clockwise from north to the point toward which the diver is swimming.
- bathymetry - The measurement of depths of water in oceans, seas, and lakes, also information derived from such measurements.
- benthic - Pertaining to the subaquatic bottom.
- biomass - The amount of living material in a unit area for a unit time.
- biota - The living part of a system; flora and fauna.
- caudal peduncle - The constricted part of a fish immediately ahead of the tail fin.
- climatic community - a community that is in equilibrium with the general climate.
- climax - The final stage in community succession.
- complex - An assemblage of interconnected or interacting parts.
- dendrogram - The type of diagram commonly referred to as a "family tree" designed to show postulated relationships between taxa.
- depauperation - Falling short of usual development or size.
- ecosystem - The living organisms and the nonliving environment interacting in a given area.
- ectoprocts - A bryozoan (moss animal) of the group Ectoprocta.
- epibiota - Life forms attached to or living upon surfaces.
- F test - A method used to test the hypothesis that the means in several classes statistically are similar.
- genus - A unit of biological classification (taxa) which includes one or several species that share certain fundamental characteristics, supposedly by common evolutionary descent.
- gill net - A single-webbed net with meshes sized to catch in the gills of the fish being sought.
- infauna - The animals that live in the bottom sediment.
- intertidal zone - The zone bounded by the high and low water extremes of the tide.
- macrobiota - Large forms of life visible to the naked eye.
- macrophytic - Refers to large aquatic plants, e.g., kelps.
- nonparametric test - A statistical test that is not concerned with the specific parameters, but rather with the distribution of the variates. Also referred to as distribution free. See parameter.

parameter - A parameter is a measurable characteristic of a population. The mean is an example of a parameter.

quadrat - A plot usually square but occasionally rectangular or circular, in which the organisms are intensely examined and one or several of which form the basis for assessing the entire population of the area.

revetment - A facing of stone, concrete, etc., built to protect a scarp, embankment, or a shore structure against erosion by wave actions or currents.

riprap - A layer, facing, or protective mound of stones randomly placed to prevent erosion, scour, or sloughing of a structure or embankment. Also, the stone so used.

Simpson's Index - An index of the proportions and numbers of species and individuals in a community used to measure the diversity.

species - A group of individuals having common attributes and designated by a common name.

splash zone - The zone immediately landward of the mean high water level affected by the wave spray.

substrate - The base on which an organism lives.

subtidal - Below mean low water (lower low on the Pacific coast of the United States).

succession - In ecology, an orderly process of community development and changes with time which result from interactions between species and environment.

taxa - A taxonomic group or entity such as genus or species in a formal system of scientific nomenclature.

tetrapod - A massive concrete shape for wave protection consisting of a central body and four equal-length limbs radiating out at equal angles from the central body. The tetrapods at Rincon Island weigh between 19.5 and 38.0 tons each.

transect - A line (or belt) through a community along which the important characteristics of the individuals of the species being studied are observed and noted; sampling along a transect may be plotless or refer to specific plots located along a line.

turbidity - An optical condition of water resulting from suspended matter; water is turbid when its load of suspended materials is conspicuous.

Wilcoxon "t" test - A nonparametric test used to statistically determine whether the ranked differences between measurements came from the same or different populations.

Johnson, G. F.

Ecological effects of an artificial island, Rincon Island, Punta Gorda, California / by G. F. Johnson and L. A. deWit. - Ft. Belvoir, Va. : U.S. Coastal Engineering Research Center ; Springfield, Va. : available from National Technical Information Service, 1978.

106 p. : ill. (Miscellaneous report - U.S. Coastal Engineering Research Center ; no. 78-3) (Contract - U.S. Coastal Engineering Research Center ; DACW72-76-C-0011)

Bibliography : p. 64.

This study documents marine ecological conditions at Rincon Island, located approximately 0.8 kilometer offshore between Ventura and Santa Barbara, California. The island was constructed between 1957 and 1958 to serve as a permanent platform for oil and gas production.

1. Artificial islands. 2. Ecological effects. 3. Rincon Island, Calif. 4. Punta Gorda, Calif. I. Title. II. deWit, L. A., joint author. III. Series: U.S. Coastal Engineering Research Center. Miscellaneous report no. 78-3. IV. Series: U.S. Coastal Engineering Research Center. Contract DACW72-76-C-0011.

TC203

.U581mr

no. 78-3

627

Johnson, G. F.

Ecological effects of an artificial island, Rincon Island, Punta Gorda, California / by G. F. Johnson and L. A. deWit. - Ft. Belvoir, Va. : U.S. Coastal Engineering Research Center ; Springfield, Va. : available from National Technical Information Service, 1978.

106 p. : ill. (Miscellaneous report - U.S. Coastal Engineering Research Center ; no. 78-3) (Contract - U.S. Coastal Engineering Research Center ; DACW72-76-C-0011)

Bibliography : p. 64.

This study documents marine ecological conditions at Rincon Island, located approximately 0.8 kilometer offshore between Ventura and Santa Barbara, California. The island was constructed between 1957 and 1958 to serve as a permanent platform for oil and gas production.

1. Artificial islands. 2. Ecological effects. 3. Rincon Island, Calif. 4. Punta Gorda, Calif. I. Title. II. deWit, L. A., joint author. III. Series: U.S. Coastal Engineering Research Center. Miscellaneous report no. 78-3. IV. Series: U.S. Coastal Engineering Research Center. Contract DACW72-76-C-0011.

TC203

.U581mr

no. 78-3

627

Johnson, G. F.

Ecological effects of an artificial island, Rincon Island, Punta Gorda, California / by G. F. Johnson and L. A. deWit. - Ft. Belvoir, Va. : U.S. Coastal Engineering Research Center ; Springfield, Va. : available from National Technical Information Service, 1978.

106 p. : ill. (Miscellaneous report - U.S. Coastal Engineering Research Center ; no. 78-3) (Contract - U.S. Coastal Engineering Research Center ; DACW72-76-C-0011)

Bibliography : p. 64.

This study documents marine ecological conditions at Rincon Island, located approximately 0.8 kilometer offshore between Ventura and Santa Barbara, California. The island was constructed between 1957 and 1958 to serve as a permanent platform for oil and gas production.

1. Artificial islands. 2. Ecological effects. 3. Rincon Island, Calif. 4. Punta Gorda, Calif. I. Title. II. deWit, L. A., joint author. III. Series: U.S. Coastal Engineering Research Center. Miscellaneous report no. 78-3. IV. Series: U.S. Coastal Engineering Research Center. Contract DACW72-76-C-0011.

TC203

.U581mr

no. 78-3

627

Johnson, G. F.

Ecological effects of an artificial island, Rincon Island, Punta Gorda, California / by G. F. Johnson and L. A. deWit. - Ft. Belvoir, Va. : U.S. Coastal Engineering Research Center ; Springfield, Va. : available from National Technical Information Service, 1978.

106 p. : ill. (Miscellaneous report - U.S. Coastal Engineering Research Center ; no. 78-3) (Contract - U.S. Coastal Engineering Research Center ; DACW72-76-C-0011)

Bibliography : p. 64.

This study documents marine ecological conditions at Rincon Island, located approximately 0.8 kilometer offshore between Ventura and Santa Barbara, California. The island was constructed between 1957 and 1958 to serve as a permanent platform for oil and gas production.

1. Artificial islands. 2. Ecological effects. 3. Rincon Island, Calif. 4. Punta Gorda, Calif. I. Title. II. deWit, L. A., joint author. III. Series: U.S. Coastal Engineering Research Center. Miscellaneous report no. 78-3. IV. Series: U.S. Coastal Engineering Research Center. Contract DACW72-76-C-0011.

TC203

.U581mr

no. 78-3

627

