

# Table of Superdeformed Nuclear Bands and Fission Isomers

by Richard B. Firestone and Balraj Singh

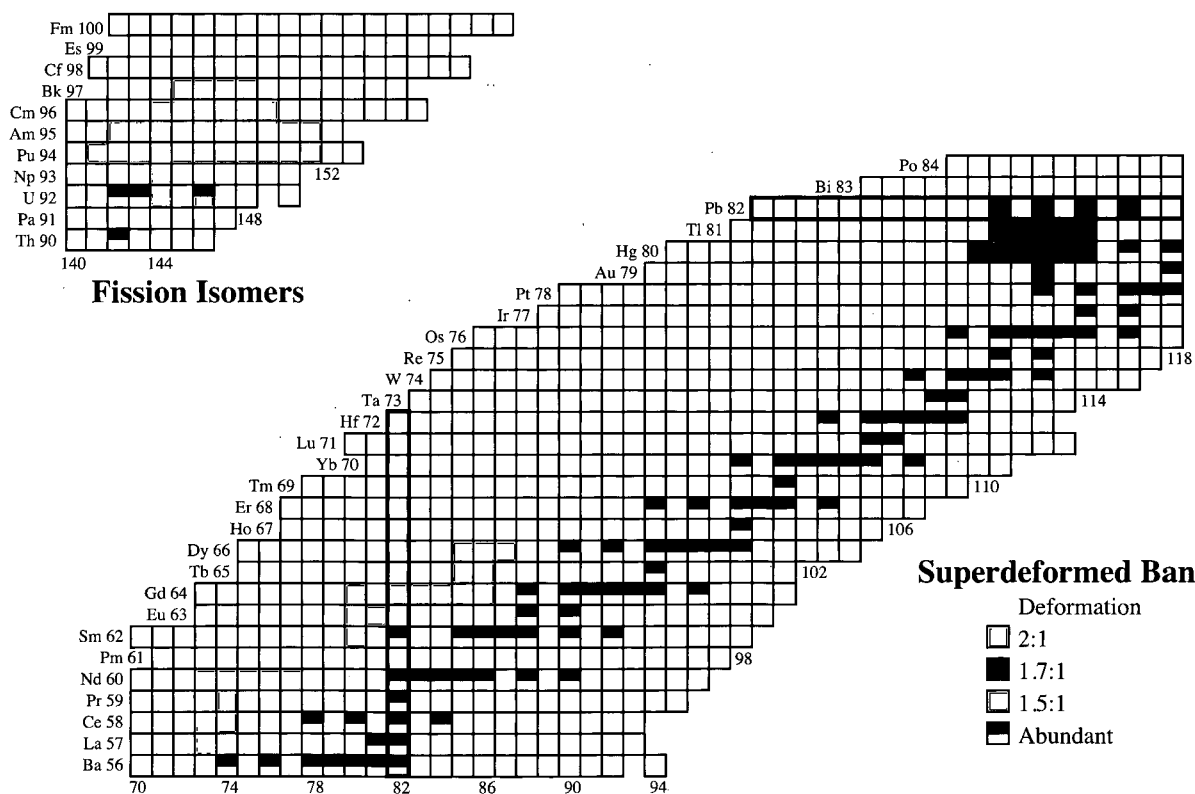

REFERENCE COPY  
Does Not Circulate  
Copy 1  
81dg. 50 Library.  
LBL-35916

## **DISCLAIMER**

This document was prepared as an account of work sponsored by the United States Government. While this document is believed to contain correct information, neither the United States Government nor any agency thereof, nor the Regents of the University of California, nor any of their employees, makes any warranty, express or implied, or assumes any legal responsibility for the accuracy, completeness, or usefulness of any information, apparatus, product, or process disclosed, or represents that its use would not infringe privately owned rights. Reference herein to any specific commercial product, process, or service by its trade name, trademark, manufacturer, or otherwise, does not necessarily constitute or imply its endorsement, recommendation, or favoring by the United States Government or any agency thereof, or the Regents of the University of California. The views and opinions of authors expressed herein do not necessarily state or reflect those of the United States Government or any agency thereof or the Regents of the University of California.

# Table of Superdeformed Nuclear Bands and Fission Isomers\*

by Richard B. Firestone<sup>†</sup> and Balraj Singh<sup>‡</sup>  
June, 1994

<sup>†</sup>Lawrence Berkeley Laboratory, Berkeley CA, 94720

<sup>‡</sup>McMaster University, Hamilton, Ontario CANADA

\* This work was supported by the Director, Office of Energy Research, Office of High-Energy and Nuclear Physics, Nuclear Physics Division of the U.S. Department of Energy under contract DE-AC03-76SF00098, subcontract LBL no. 4573810; and by the Natural Sciences and Engineering Research Council (NSERC) of Canada.



## INDEX

Introduction .....	v
Summary Table of Superdeformed Bands .....	ix
Summary Table of Fission Isomers .....	xi
Table of Superdeformed Nuclear Bands .....	1
Table of Fission Isomers .....	54
References for Superdeformed Nuclear Bands (Experimental) .....	I
References for Superdeformed Nuclear Bands (Theoretical) .....	XVII
References for Fission Isomers .....	XXVII

## Introduction

A minimum in the second potential well of deformed nuclei was predicted<sup>(1)</sup> and the associated shell gaps are illustrated in the harmonic oscillator potential shell energy surface calculations shown in figure 1<sup>(2,3)</sup>. A strong superdeformed minimum in  $^{152}\text{Dy}$  was predicted for  $\beta_2 \sim 0.65$ <sup>(4,5,6)</sup>. Subsequently, a discrete set of  $\gamma$ -ray transitions in  $^{152}\text{Dy}$  was observed<sup>(7)</sup> and assigned to the predicted superdeformed band. Extensive research at several laboratories has since focused on searching for other mass regions of large deformation<sup>(8-12)</sup>. A new generation of  $\gamma$ -ray detector arrays (Gammasphere, Eurogam, and GASP) is already producing a wealth of information about the mechanisms for feeding and deexciting superdeformed bands. These bands have been found in three distinct regions near  $A=130$ , 150, and 190. This research extends upon previous work in the actinide region near  $A=240$  where fission (shape) isomers were identified and also associated with the second potential well<sup>(13)</sup>. Quadrupole moment measurements for selected cases in each mass region are consistent with assigning the bands to excitations in the second local minimum.

As part of our commitment to maintain nuclear structure data as current as possible in the Evaluated Nuclear Structure Reference File (ENSDF)<sup>(14)</sup> and the *Table of Isotopes*<sup>(15)</sup>, we have updated the information on superdeformed nuclear bands. As of April, 1994, we have compiled data from 86 superdeformed bands and 46 fission isomers identified in 73 nuclides for this report. Partial data for superdeformed bands and fission isomers are shown in the band drawings.

For each nuclide there is a complete level table listing both normal and superdeformed band assignments; level energy, spin, parity, half-life, magnetic moments, decay branchings; and the energies, final levels, relative intensities, multipolarities, and mixing ratios for transitions deexciting each level. Mass excess, decay energies, and proton and neutron separation energies are also provided from the evaluation of Audi and Wapstra<sup>(16)</sup>.

For superdeformed bands we provide the following quantities.

**Level energies:** For SD bands, since the absolute level energies are not yet known, only relative values are given. In the drawings the SD bands are shown with a common baseline for convenient display of multiple bands in a nucleus.

**Level half-lives:** Measured values are quoted in the tables only.

**Level spins:** The spin value is generally given only for the first member of the SD band. This value is typically suggested by the authors and has some uncertainty ( $\sim 1-2 \hbar$ ) associated with it. Since linking to normal states is unobserved, except for tentative assignments in  $^{133,135}\text{Nd}$ , there is no direct confirmation of these spins. The cascading transitions are all assumed as E2 which is consistent with angular correlation data and short level half-lives in several cases. The parities are not shown because of insufficient evidence at this time.

**$\gamma$ -ray energies:** The energies are adopted from the most complete set of data for each band. We have not averaged values because uncertainties are not usually available. Typical energy uncertainties range from 0.1-0.3 keV for intense transitions to 2 keV for weaker  $\gamma$ -rays.

**$\gamma$ -ray intensities:** The values given are relative intensities normalized to 1.0 for the most intense transition in the cascade. These values are generally read off of the intensity figures in the papers. Correction for internal conversion is assumed to have been applied. When more than one measurement exists, the most complete set of intensities has been chosen. Absolute intensities can be obtained by multiplying the relative intensities by the %-feeding in Table I.

**Moments:** Transition Quadrupole moments for SD states are deduced from Doppler broadening of  $\gamma$ -rays. The SD quadrupole moment is typically an average value for the band corresponding to the intrinsic (transition) moment. For fission isomers the quadrupole moments are also intrinsic. The values appear in the summary tables only.

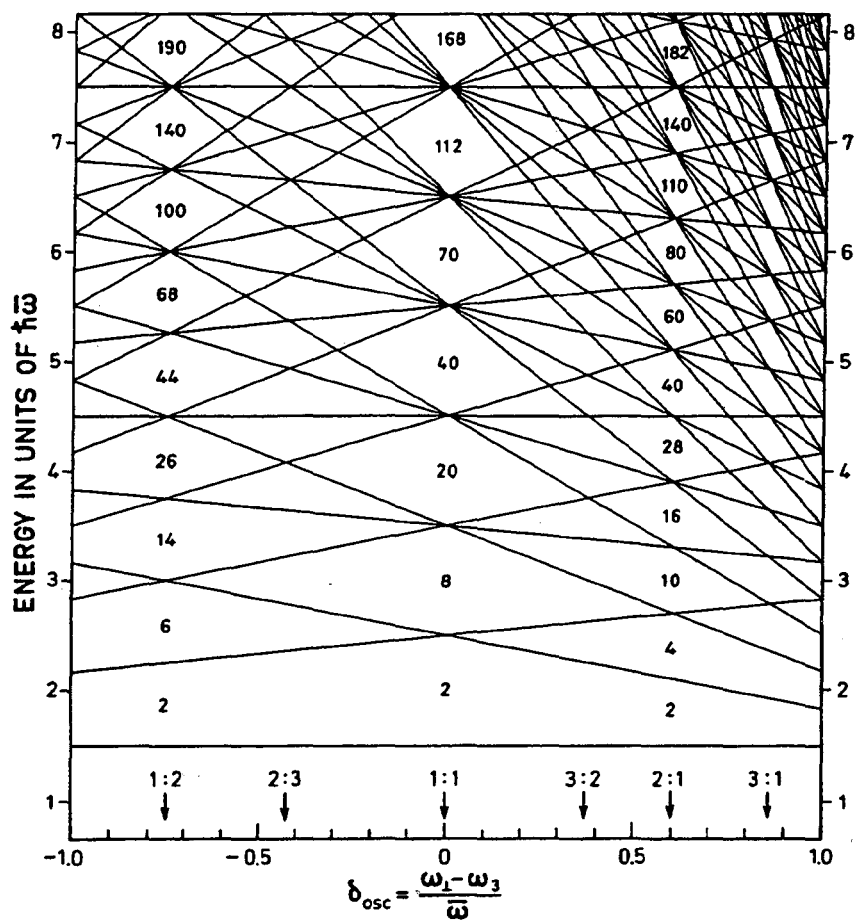

Figure 1. Single-particle level energies calculated for an axially symmetric harmonic oscillator (from reference 2).

The following calculated quantities<sup>(17,18)</sup> are provided ( $E_\gamma$  in MeV):

Rotational frequency:

$$\hbar\omega(J) = \frac{E_\gamma((J+2) \rightarrow J) + (E_\gamma(J \rightarrow (J-2)))}{4} \text{ MeV}$$

Kinetic moment of inertia<sup>†</sup>:

$$I_1(J) = \frac{2J-1}{E_\gamma(J \rightarrow (J-2))} \hbar^2 \text{ MeV}^{-1}$$

Dynamic moment of inertia:

$$I_2(J) = \frac{4}{E_\gamma((J+2) \rightarrow J) - E_\gamma(J \rightarrow (J-2))} \hbar^2 \text{ MeV}^{-1}$$

We have not attempted to label bands according to particle or intruder configurations or according to their isospectral behavior. The reader is referred to the original papers for information about reactions populating these bands and fission isomers. References with keyword abstracts have been provided from the Nuclear Structure Reference (NSR) file<sup>(19)</sup>. They are divided into three sections for superdeformed band experiment, superdeformed band theory, and fission isomers. The theoretical references before 1986 were not completely scanned for superdeformation.

We express our gratitude to the many nuclear data evaluators for creating the ENSDF file and to the staff at the National Nuclear Data Center at Brookhaven National Laboratory for maintaining ENSDF. Many useful suggestions were provided by members of the high-spin physics group at Lawrence Berkeley Laboratory. Special recognition should go to S.Y. Frank Chu, J.A. Cizewski, J.D. Garrett, and J.C. Waddington for their detailed comments and suggestions. This work was supported by the Director, Office of Energy Research, Office of High-Energy and Nuclear Physics, Nuclear Physics Division of the U.S. Department of Energy under contract DE-AC03-76SF00098, subcontract LBL no. 4573810; and by the Natural Sciences and Engineering Research Council (NSERC) of Canada.

<sup>†</sup>Approximate since spins are uncertain.

#### References:

1. V.M. Strutinski, Nucl. Physics **A95**, 420 (1967); *ibid* **A122**, 1 (1968).
2. A. Bohr and B.R. Mottelson, Nuclear Structure, Vol. II, p. 591, New York, Benjamin (1975).
3. J.R. Nix, Ann. Rev. of Nucl. Sci. **22**, 65 (1972).
4. T. Bengtsson *et al*, Phys. Scr. **24**, 200(1981).
5. K. Neergard *et al*, Nucl. Phys. **A262**, 61 (1976).
6. G. Andersson *et al*, Nucl. Phys. **A268**, 205 (1976).
7. P.J. Twin *et al*, Phys. Rev. Lett. **57**, 811 (1986).
8. J.F. Sharpey-Schafer and J. Simpson, Prog. Part. Nucl. Phys. **21**, 293 (1988).
9. P.J. Nolan and P.J. Twin, Ann. Rev. Nucl. Part. Sci. **38**, 533 (1988).
10. R.V.F. Janssens and T.L. Khoo, Ann. Rev. Nucl. part. Sci. **41**, 321 (1991).
11. J.F. Sharpey-Schafer, Progr. Part. Nucl. Phys. **28**, 187 (1992).
12. X.-L. Han and C.-L. Wu, At. Data and Nucl. Data Tables **52**, 43 (1992).
13. S.M. Polikanov *et al*, Soviet Phys. JETP **15**, 1016 (1962).
14. Evaluated Nuclear Structure Data File (ENSDF), maintained at the National Nuclear Data Center, Brookhaven National Laboratory, Upton, NY.
15. *Table of Isotopes*, to be published in 1995.
16. G. Audi and A.H. Wapstra, Nucl. Phys. **A565**, 1 (1993).
17. A. Bohr and B.R. Mottelson, Phys. Scr. **24**, 71 (1981).
18. F.S. Stephens, Phys. Scr. **T5**, 5 (1983).
19. Nuclear Structure Reference file (NSR), scanned by S. Ramavataram, maintained at the National Nuclear Data Center, Brookhaven National Laboratory, Upton, NY.





Table I  
Summary of Superdeformed Bands

Nuclide	Band	$E_{\gamma}$ -range ( $N_{\gamma}$ )	J-range	%-feeding	$Q_0^a$	Principal References
$^{130}\text{La}$	SD-1	762-1412 (9)	(16)-(34)	10		89Go13
$^{131}\text{Ce}$	SD-1	592-1732 (16)	(29/2)-(93/2)	5	5.55	88Lu01,90He12,93Mu09
$^{132}\text{Ce}$	SD-1	809-2201 (19)	(18)-(56)	5	8.07	87Ki02,90Di01,93SaZZ
	SD-2	847-1548 (11)	(J)-(J+22)	1		93SaZZ
	SD-3	864-1533 (10)	(J)-(J+20)	0.8		93SaZZ
$^{133}\text{Pr}$	SD-1	840-1489 (10)	(J)-(J+20)	0.5		93WiZX
	SD-2 <sup>d</sup>					93WiZX
	SD-3 <sup>d</sup>					93WiZX
	SD-4 <sup>d</sup>					93WiZX
$^{133}\text{Nd}$	SD-1 <sup>b</sup>	345-1631 (18)	(17/2)-(89/2)	20	6.07	87Wa18,92Mu09,93Ba20
$^{134}\text{Nd}$	SD-1	591-1473 (13)	(14)-(40)	5		87Be32,87Wa18
$^{135}\text{Nd}$	SD-1 <sup>b</sup>	546-1449 (14)	(25/2)-(81/2)	10	7.4 10 <sup>f</sup>	87Be57,90Di01,93Wi09
$^{136}\text{Nd}$	SD-1	718-1480 (12)	(16)-(40)	2		87Be32
$^{137}\text{Nd}$	SD-1	635-1431 (14)	(25/2)-(81/2)	13	4.05	87Wa18,92Mu09
$^{142}\text{Sm}$	SD-1	800-1603 (14)	(29)-(57)	0.5 1		93Ha03
$^{143}\text{Eu}$	SD-1	484-1743 (22)	(37/2)-(125/2)	1.1	13 1	93At01
$^{144}\text{Eu}$	SD-1 <sup>b</sup>			0.1		93Mu16
$^{144}\text{Gd}$	SD-1	846-1418 (14)	(J)-(J+28)	0.2		94LuAA
$^{146}\text{Gd}$	SD-1	826-1533 (15)	(33)-(63)	0.65 19	12 2	90He14,91Rz01,92HaZR
	SD-2	807-1532 (14)	(32)-(60)	0.39(12)	8 2	92StZU
$^{147}\text{Gd}$	SD-1	697-1516 (17)	(55/2)-(123/2)	0.87 19		91Zu01,92HaZR
	SD-2	731-1559 (16)	(61/2)-(125/2)	0.57 15		
$^{148}\text{Gd}$	SD-1	652-1580 (18)	(27)-(63)	1.30 15		88De10,92HaZR
	SD-2	788-1437 (14)	(32)-(60)	0.62 20		
$^{149}\text{Gd}$	SD-1	618-1730 (22)	(51/2)-(139/2)	2.5	17 2	88Ha02,90Ha31,93FI03,93FI07
	SD-2	877-1506 (14)	(71/2)-(127/2)	1.0		
	SD-3	896-1485 (12)	(77/2)-(125/2)	0.3		
	SD-4 <sup>d</sup>					93FI03
	SD-5 <sup>d</sup>					93FI03
	SD-6 <sup>d</sup>					93FI03
	SD-7 <sup>d</sup>					93FI03
	SD-8 <sup>d</sup>					93FI03
$^{150}\text{Gd}$	SD-1	780-1494 (17)	(30)-(64)	1.0	17 3	90By01,91Fa07,93Be37
	SD-2	728-1584 (19)	(29 <sup>-</sup> )-(67 <sup>-</sup> )	0.5		
	SD-3	617-1567 (19)	(24 <sup>-</sup> )-(62 <sup>-</sup> )	0.45		
	SD-4	688-1600 (18)	(27 <sup>-</sup> )-(63 <sup>-</sup> )	0.4		93Be37
	SD-5 <sup>d</sup>			0.4		93Be37
$^{150}\text{Tb}$	SD-1	598-1487 (18)	(24)-(60)	1.0		89De10,90Ha31
$^{151}\text{Tb}$	SD-1	728-1535 (18)	(57/2)-(129/2)	1.0		90By01,92Mu10,93Be29,93Cu06
	SD-2	602-1497 (20)	(49/2)-(129/2)	0.3		
$^{151}\text{Dy}$	SD-1	522-1490 (20)	(47/2)-(127/2)	1.3		88Ra19,92Mu10
$^{152}\text{Dy}$	SD-1	602-1449 (19)	(22)-(60)	1.47 7	18 3	91Be12,92Sm01
	SD-2	855-1482 (15)	(J)-(J+30)	0.21 3		
	SD-3 <sup>d</sup>			0.15 3		93DaZV
	SD-4 <sup>d</sup>			0.10 5		93DaZV
$^{153}\text{Dy}$	SD-1	810-1406 (14)	(71/2)-(127/2)	0.25		89Jo04
	SD-2	816-1388 (13)	(71/2)-(123/2)	0.18		
	SD-3	895-1410 (12)	(77/2)-(125/2)	0.13		

Table I (continued)  
Summary of Superdeformed Bands

Nuclide	Band	$E_{\gamma}$ -range (N <sub><math>\gamma</math></sub> )	J-range	%-feeding	$Q_0^a$	Principal References
<sup>191</sup> Au	SD-1	229-678 (13)	(19/2)-(71/2)	0.15		93Vo04
<sup>189</sup> Hg	SD-1	366-708 (10)	(29/2)-(69/2)	0.5		92Be18
<sup>190</sup> Hg	SD-1	360-812 (14)	(14)-(42)		18.3	91Dr04,93Ca23
<sup>191</sup> Hg	SD-1	351-754 (12)	(29/2,31/2)-(77/2,79/2)	2.0	18.3	90Ca18,89Mo08
	SD-2	292-699 (12)	(25/2)-(73/2)	1.0	-18	
	SD-3	312-708 (12)	(27/2)-(75/2)	0.8		
<sup>192</sup> Hg	SD-1	215-882 (20)	(8)-(48)	2.0	20.2	92La07,90Mo16,93Ha20,94GaAA
<sup>193</sup> Hg	SD-1	233-881 (20)	(19/2)-(99/2)	1.6	e	93Jo09,90He09,90Cu05,93Fa07
	SD-2 <sup>f</sup>	254-876 (19)	(21/2)-(97/2)	2.1		
	SD-3	234-860 (19)	(19/2)-(95/2)	0.9		
	SD-4 <sup>f</sup>	254-876 (19)	(21/2)-(97/2)	2.1		
	SD-5	291-831 (16)	(27/2,29/2)-(91/2,93/2)	1.1		
	SD-6	240-858 (17)	(J)-(J+34)			
<sup>194</sup> Hg	SD-1	254-843(18)	(10)-(46)	7.0	17.2 <sup>20</sup>	92ShZR,90St12,90Be11,90Ri05
	SD-2	262-793 (16)	(11)-(43)			
	SD-3	201-807 (18)	(8)-(44)	2.0	17.6 <sup>30</sup>	94HuAA
<sup>191</sup> Tl	SD-1	318-656 (10)	(J)-(J+20)	0.4		92PiZR,92YuZY,94PiAA
	SD-2	378-633 (8)	(J)-(J+16)	0.4		
<sup>192</sup> Tl	SD-1	358-629 (8)	(J)-(J+16)	0.9		92Li21
	SD-2	378-637 (8)	(J)-(J+16)	0.5		
	SD-3	376-641 (8)	(J)-(J+16)	1.1		
	SD-4	357-619 (8)	(J)-(J+16)	0.7		
	SD-5	381-642 (8)	(J)-(J+16)	0.5		
	SD-6	406-634 (7)	(J)-(J+14)	0.3		
<sup>193</sup> Tl	SD-1	228-678(13)	(19/2)-(71/2)	0.5		90Fe07
	SD-2	248-685(13)	(21/2)-(73/2)	0.5		
<sup>194</sup> Tl	SD-1	268-704(13)	(12)-(38)	1.5		91Az03,90St11
	SD-2	209-686(14)	(9)-(37)	1.0		
	SD-3	241-718(14)	(10,11)-(38,39)	0.9		
	SD-4	220-703(14)	(9,10)-(37,38)	0.6		
	SD-5	188-628(13)	(8,9)-(34,35)	0.6		
	SD-6	207-613(12)	(9,10)-(33,34)	0.8		
<sup>195</sup> Tl	SD-1	330-716(12)	(29/2)-(77/2)	0.5		91Az04
	SD-2	351-680(10)	(31/2)-(71/2)	0.25		
<sup>192</sup> Pb	SD-1	263-636(11)	(10,11)-(32,33)			91He11,93Pi01 <sup>9</sup>
<sup>194</sup> Pb	SD-1	170-739(16)	(6)-(38)	1.0	20.3	90Hu10,90Br10,93Wi02,93Ha20
<sup>196</sup> Pb	SD-1	170-689(14)	(4)-(32)	1.3	18.3 <sup>30</sup>	91Wa14,93Mo19,93Da04
<sup>198</sup> Pb	SD-1?	304-553(7)	(12)-(26)			91Wa14

<sup>a</sup> Transition or intrinsic quadrupole moment in eb.

<sup>b</sup> Linking transitions to normal states have been reported by 93Lu04 (for <sup>133</sup>Nd) and 93Wi09 (for <sup>135</sup>Nd).

<sup>c</sup>  $Q_0=1.4$  eb reported for first member of SD band (93Wi09).

<sup>d</sup> Discrete  $\gamma$ -ray data are not yet available for this band.

<sup>e</sup>  $g_{\kappa}(\text{intrinsic})=-0.61$  11 (93Jo09).

<sup>f</sup> Unresolved bands.

<sup>9</sup> Report non-observation of SD band in <sup>192</sup>Pb.

Table II  
Summary of Fission (Shape) Isomers

Nuclide	E(Isomer) <sup>a</sup>	J <sup>π</sup>	t <sub>1/2</sub>	%IT <sup>b</sup>	Q <sub>0</sub>	Selected references
<sup>236</sup> U	2750 10 <sup>cd</sup>	(0+)	120 ns 2	87 6	32 5	78Gu02,80Me15,89Ma57,90Ma59
<sup>238</sup> U	2557.6 5 <sup>cd</sup> 2557.6+y	0+	298 ns 18 >1 ns	-95	29 3	69La14,79U101,82Go02,92St05 89Me40
<sup>237</sup> Np	2800 400		45 ns 5	e		73Wo03,77Mi09
<sup>235</sup> Pu	3000 200		25 ns 5			69Me11,70Bu02,78SoZP,89SoZZ
<sup>236</sup> Pu	-3000 4000 200	(0+)	37 ps 4 34 ns 8		37 <sup>+14</sup> <sub>-8</sub>	74MeYP,77Me08 69La14,71Br39
<sup>237</sup> Pu	-2600 -2900		85 ns 15 1.1 μs 1	f		69La14,79Gu03,82Ra04 70Po01,73Va16,79Gu03
<sup>238</sup> Pu	-2400 -3500	(0+)	0.6 ns 2 6.0 ns 15			73Li01,74MeYP 70Bu02,71Br39,73Na35,92DeZZ
<sup>239</sup> Pu	3100 200 <sup>c</sup> -3300 <sup>d</sup>	(5/2+) (9/2-)	7.5 μs 10 2.6 <sup>+40</sup> <sub>-12</sub> ns		36 4	70Po01,77Ha01,79Ba02 77GoZH,80Gu20
<sup>240</sup> Pu	-2800 <sup>c</sup>	(0+)	3.7 ns 3			71Br39,72Sp06,73Be10,86De04
<sup>241</sup> Pu	-2200 -2300		21 μs 3 32 ns 5			70Po01,70Ga10,73Be05 69La14,81Gu04
<sup>242</sup> Pu	-2200 2200+y		3.5 ns 6 28 ns			74Me10,75Me28 69La14,70Po01
<sup>243</sup> Pu	1700 300		45 ns 15			69La14,70Vi05,80Bj02
<sup>244</sup> Pu	x		0.40 ns 10			74MoYC
<sup>245</sup> Pu	2000 400		90 ns 30			71Au06,80Bj02
<sup>237</sup> Am	-2400		5 ns 2			70Po01,71Br39,73Br38
<sup>238</sup> Am	-2500		35 μs 10			67Bo23,72Br35,73FL03
<sup>239</sup> Am	2500 200	(7/2+)	163 ns 12	g		69La14,72Br35,85Ra28
<sup>240</sup> Am	3000 200		0.94 ms 4	32.7 20 <sup>h</sup>		71Br39,79Be46,85Jo04
<sup>241</sup> Am	-2200		1.0 μs 3			69La14,72Br35,73Be04,93Ku16
<sup>242</sup> Am	2200 80		14.0 ms 10			62Po09,63Pe27,85Ku18,92Ba67
<sup>243</sup> Am	2300 200		5.5 μs 5			70Po01,72Wo07,87Gu03
<sup>244</sup> Am	2800 400 2800+y		0.90 ms 15 -6.5 μs			68Bj04,69Bo25,72Wo07 69SIZZ
<sup>245</sup> Am	2400 400		0.64 μs 6			72Wo07,73Br38,80Bj02
<sup>246</sup> Am	-2000		73 μs 10			72Wo07,83Po14
<sup>240</sup> Cm	-2000 -3000		10 ps 3 55 ns 12			76Si01 76Si01,78U101
<sup>241</sup> Cm	-2300		15.3 ns 10			69Me11,71Br39,72Vy07
<sup>242</sup> Cm	1900 200 -2800		40 ps 15 0.18 μs 7			75Me28,76Si01 71Re11,71Br39,73Br38
<sup>243</sup> Cm	1900 300		42 ns 6			69MeZX,71Re11,80Bj02
<sup>244</sup> Cm	-2200 -3500		<5 ps >100 ns			69Me11,71Re11,80Bj02,80Me15 69Me11,80Me15,89Ha40
<sup>245</sup> Cm	2100 300		13.2 ns 18			71Br39,72Wo07,80Bj02
<sup>242</sup> Bk	x x+y		9.5 ns 20 0.60 μs 10			72Wo07 72Wo07
<sup>243</sup> Bk	-2200 <sup>i</sup> (?)		5 ns (?)			72Ga42,72Vy07
<sup>244</sup> Bk	x		0.82 μs 6			72Ga42,72Wo07
<sup>245</sup> Bk	-1560		2 ns 1			71Re11,72Ga42,72We09

<sup>a</sup> Systematics of fission isomers suggest x=1600-2600; y<1000

<sup>b</sup> %SF(<sup>236</sup>U isomer)=13.6, %SF(<sup>238</sup>U isomer)=5. For all other isomers, only SF decay has been observed.

<sup>c</sup> Rotational bands built on these states are shown in the figures.

<sup>d</sup> Deexcitation to normal states is shown in the figures.

<sup>e</sup> Some evidence for isomeric decay has been reported.

<sup>f</sup> g-factor=-0.45 3

<sup>g</sup> g-factor=0.74 5

<sup>h</sup> Q<sub>0</sub>=29.0 13 (85Jo04)

<sup>i</sup> Questionable existence



# 130La 57La

$\Delta$ : (-81670)  $S_n$ : (8400)  $S_p$ : (3890)  $Q_{EC}$ : (5600)  $Q_\alpha$ : (250)

Nuclear Bands

A SD band

Levels and  $\gamma$ -ray branchings:

0, 3<sup>(\*)</sup>, 8.7 m, %EC+% $\beta^+$ =100  
 130.8 s (?), (1<sup>+</sup>)  $\gamma_0$  130.8 s ( $t_{1/2}$ )  
 0+x  
 5.1+x5, (4)  
 45.1+x8  
 88.4+x7, (3<sup>-</sup>)  
 113.9+x4, (5)  $\gamma_{0+x}$  113.9 s ( $t_{1/2}$ )  
 150.3+x7, (5)  $\gamma_{45+x}$  105.25 s ( $t_{1/2}$ )  
 160.3+x5, (4)  
 160.4+x6, (4<sup>-</sup>)  $\gamma_{88+x}$  72.03 s ( $t_{1/2}$ )  $\gamma_{114+x}$  46.410 s ( $t_{1/2}$ )  
 279.1+x6, (5<sup>-</sup>)  $\gamma_{160.4+x}$  118.73 s ( $t_{1/2}$ ) (M1)  $\gamma_{88+x}$  190.75 s ( $t_{1/2}$ )  
 385.4+x4, (6<sup>+</sup>)  $\gamma_{278+x}$  106.45 s ( $t_{1/2}$ )  $\gamma_{160.3+x}$  225.13 s ( $t_{1/2}$ ) Q  
 $\gamma_{150+x}$  235.15 s ( $t_{1/2}$ ) D  $\gamma_{114+x}$  271.53 s ( $t_{1/2}$ ) D  $\gamma_{5+x}$  380.33 s ( $t_{1/2}$ )  
 Q  $\gamma_{0+x}$  385.45 s ( $t_{1/2}$ )  
 456.3+x6, (6<sup>-</sup>)  $\gamma_{279+x}$  177.23 s ( $t_{1/2}$ ) (M1)  $\gamma_{160.4+x}$  295.93 s ( $t_{1/2}$ ) (E2)  
 522.9+x5, (7<sup>-</sup>)  $\gamma_{385+x}$  137.53 s ( $t_{1/2}$ ) (M1)  
 677.5+x6, (7<sup>-</sup>)  $\gamma_{456+x}$  221.23 s ( $t_{1/2}$ ) (M1)  $\gamma_{279+x}$  398.43 s ( $t_{1/2}$ ) (E2)  
 802.3+x6, (8<sup>+</sup>)  $\gamma_{523+x}$  279.43 s ( $t_{1/2}$ ) (M1)  $\gamma_{385+x}$  416.910 s ( $t_{1/2}$ )  
 947.0+x6, (8<sup>-</sup>)  $\gamma_{678+x}$  269.55 s ( $t_{1/2}$ ) (M1)  $\gamma_{456+x}$  490.73 s ( $t_{1/2}$ ) (E2)  
 1048.6+x6, (9<sup>-</sup>)  $\gamma_{802+x}$  246.33 s ( $t_{1/2}$ ) (M1)  $\gamma_{523+x}$  525.73 s ( $t_{1/2}$ ) (E2)  
 1250.2+x7, (9<sup>-</sup>)  $\gamma_{947+x}$  303.23 s ( $t_{1/2}$ ) (M1)  $\gamma_{678+x}$  572.73 s ( $t_{1/2}$ ) (E2)  
 1422.8+x6, (10<sup>+</sup>)  $\gamma_{1049+x}$  374.35 s ( $t_{1/2}$ )  $\gamma_{802+x}$  620.63 s ( $t_{1/2}$ ) (E2)  
 1597.3+x7, (10<sup>-</sup>)  $\gamma_{1250+x}$  347.15 s ( $t_{1/2}$ )  $\gamma_{947+x}$  650.33 s ( $t_{1/2}$ ) (E2)  
 1748.5+x6, (11<sup>+</sup>)  $\gamma_{1423+x}$  325.73 s ( $t_{1/2}$ ) (M1)  $\gamma_{1049+x}$  700.03 s ( $t_{1/2}$ ) (E2)  
 1970.1+x7, (11<sup>-</sup>)  $\gamma_{1597+x}$  372.85 s ( $t_{1/2}$ )  $\gamma_{1250+x}$  719.93 s ( $t_{1/2}$ ) (E2)  
 2194.1+x6, (12<sup>+</sup>)  $\gamma_{1749+x}$  445.65 s ( $t_{1/2}$ )  $\gamma_{1423+x}$  771.33 s ( $t_{1/2}$ ) (E2)  
 2384.4+x7, (12<sup>-</sup>)  $\gamma_{1970+x}$  414.35 s ( $t_{1/2}$ ) (M1)  $\gamma_{1597+x}$  787.13 s ( $t_{1/2}$ ) (E2)  
 2586.7+x6, (13<sup>+</sup>)  $\gamma_{2194+x}$  392.63 s ( $t_{1/2}$ ) (M1)  $\gamma_{1749+x}$  838.23 s ( $t_{1/2}$ ) (E2)  
 2818.2+x7, (14<sup>-</sup>)  $\gamma_{2384+x}$  433.85 s ( $t_{1/2}$ ) (M1)  $\gamma_{1970+x}$  848.13 s ( $t_{1/2}$ ) (E2)  
 3096.2+x7, (14<sup>+</sup>)  $\gamma_{2587+x}$  509.55 s ( $t_{1/2}$ )  $\gamma_{2194+x}$  902.15 s ( $t_{1/2}$ ) (E2)  
 3289.6+x7, (14<sup>-</sup>)  $\gamma_{2818+x}$  471.35 s ( $t_{1/2}$ ) (M1)  $\gamma_{2384+x}$  905.15 s ( $t_{1/2}$ ) (E2)  
 3541.6+x7, (15<sup>+</sup>)  $\gamma_{3096+x}$  445.45 s ( $t_{1/2}$ )  $\gamma_{2587+x}$  954.95 s ( $t_{1/2}$ ) (E2)  
 3771.4+x8, (15<sup>-</sup>)  $\gamma_{3290+x}$  481.85 s (M1)  $\gamma_{2818+x}$  953.110  
 4105.1+x7, (16<sup>+</sup>)  $\gamma_{3542+x}$  563.55 s ( $t_{1/2}$ ) (M1)  $\gamma_{3096+x}$  1008.95 s ( $t_{1/2}$ ) (E2)  
 4271.6+x8, (16<sup>-</sup>)  $\gamma_{3771+x}$  500.210 s ( $t_{1/2}$ )  $\gamma_{3290+x}$  982.05 s ( $t_{1/2}$ ) (E2)  
 4589.7+x8, (17<sup>+</sup>)  $\gamma_{4105+x}$  484.67 s ( $t_{1/2}$ )  $\gamma_{3542+x}$  1048.15 s ( $t_{1/2}$ ) (E2)  
 4720.3+x8, (17<sup>-</sup>)  $\gamma_{4272+x}$  448.65 s ( $t_{1/2}$ ) (M1)  $\gamma_{3771+x}$  948.87 s ( $t_{1/2}$ ) (E2)  
 5185.0+x9, (18<sup>+</sup>)  $\gamma_{4720+x}$  464.85 s ( $t_{1/2}$ ) (M1)  $\gamma_{4272+x}$  913.47 s ( $t_{1/2}$ ) (E2)  
 5185.2+x8, (18<sup>-</sup>)  $\gamma_{4590+x}$  595.67 s ( $t_{1/2}$ ) (M1)  $\gamma_{4105+x}$  1080.27 s ( $t_{1/2}$ ) (E2)  
 5644.6+x8, (19<sup>+</sup>)  $\gamma_{5185.0+x}$  459.45 s ( $t_{1/2}$ ) (M1)  $\gamma_{4720+x}$  924.25 s ( $t_{1/2}$ ) (E2)  
 5696.8+x10, (19<sup>-</sup>)  $\gamma_{5185.0+x}$  511.710 s ( $t_{1/2}$ )  $\gamma_{4590+x}$  1107.1 s ( $t_{1/2}$ ) (E2)  
 6156.9+x8, (20<sup>+</sup>)  $\gamma_{5645+x}$  512.45 s ( $t_{1/2}$ ) (M1)  $\gamma_{5185.0+x}$  971.85 s ( $t_{1/2}$ ) (E2)  
 6658.2+x10, (21<sup>-</sup>)  $\gamma_{6157+x}$  501.510 s ( $t_{1/2}$ )  $\gamma_{5645+x}$  1013.47 s ( $t_{1/2}$ ) (E2)  
 6818.8+x18, (21<sup>+</sup>)  $\gamma_{6697+x}$  1122.014 s ( $t_{1/2}$ ) (E2)  
 7203.3+x11, (22<sup>-</sup>)  $\gamma_{6658+x}$  545.010 s ( $t_{1/2}$ )  $\gamma_{6157+x}$  1046.510 s (E2)  
 7759.0+x12, (23<sup>-</sup>)  $\gamma_{7203+x}$  555.810 s ( $t_{1/2}$ )  $\gamma_{6658+x}$  1100.810 s ( $t_{1/2}$ ) (E2)  
 7949.8+x23, (23<sup>+</sup>)  $\gamma_{6819+x}$  1131.014 s ( $t_{1/2}$ ) (E2)  
 8282.7+x13, (24<sup>-</sup>)  $\gamma_{7759+x}$  523.710 s ( $t_{1/2}$ ) (M1)  $\gamma_{7203+x}$  1079.510 s ( $t_{1/2}$ ) (E2)  
 0+y, (7)  
 86.9+y8, (9)  
 358.8+y5, (9)  $\gamma_{0+y}$  358.85 s ( $t_{1/2}$ ) Q  
 489.7+y6, (10)  $\gamma_{359+y}$  130.93 s ( $t_{1/2}$ ) D  $\gamma_{87+y}$  402.85 s ( $t_{1/2}$ )  
 732.6+y7, (11)  $\gamma_{490+y}$  242.93 s ( $t_{1/2}$ ) (M1)  
 1046.6+y8, (12)  $\gamma_{733+y}$  314.03 s ( $t_{1/2}$ ) (M1)  
 1418.2+y8, (13)  $\gamma_{1047+y}$  371.63 s ( $t_{1/2}$ ) (M1)  
 1841.2+y9, (14)  $\gamma_{1418+y}$  423.03 s ( $t_{1/2}$ ) (M1)  
 2305.6+y9, (15)  $\gamma_{1841+y}$  464.43 s ( $t_{1/2}$ ) (M1)  
 2807.9+y10, (16)  $\gamma_{2306+y}$  502.35 s ( $t_{1/2}$ ) (M1)  $\gamma_{1841+y}$  966.77 s ( $t_{1/2}$ ) (E2)  
 3340.0+y11, (17)  $\gamma_{2808+y}$  532.15 s ( $t_{1/2}$ ) (M1)  $\gamma_{2306+y}$  1034.412 s ( $t_{1/2}$ ) (E2)

3889.5+y11, (18)  $\gamma_{3340+y}$  549.55 s ( $t_{1/2}$ ) (M1)  $\gamma_{2808+y}$  1081.612 s ( $t_{1/2}$ ) (E2)  
 4462.0+y12, (19)  $\gamma_{3890+y}$  572.55 s ( $t_{1/2}$ ) (M1)  $\gamma_{3340+y}$  1122.012 s ( $t_{1/2}$ ) (E2)  
 5054.8+y14, (20)  $\gamma_{4462+y}$  592.810 s ( $t_{1/2}$ ) (M1)  $\gamma_{3890+y}$  1165.312 s ( $t_{1/2}$ ) (E2)  
 5638.0+y17, (21)  $\gamma_{5055+y}$  583.210 s ( $t_{1/2}$ ) (M1)  
 A z, J=(16)  
 A 762.4+z, J+2  $\gamma_{762.4}$  ( $t_{1/2}$ )  $I^{(1)}=45.9, I^{(2)}=44.9, \eta\omega=0.403$   
 A 1613.9+z, J+4  $\gamma_{762.4}$  851.5 s ( $t_{1/2}$ )  $I^{(1)}=45.8, I^{(2)}=58.0, \eta\omega=0.443$   
 A 2534.4+z, J+6  $\gamma_{1614+z}$  920.5 s ( $t_{1/2}$ )  $I^{(1)}=46.7, I^{(2)}=51.8, \eta\omega=0.480$   
 A 3532.1+z, J+8  $\gamma_{2534+z}$  997.7 s ( $t_{1/2}$ )  $I^{(1)}=47.1, I^{(2)}=53.4, \eta\omega=0.518$   
 A 4604.7+z, J+10  $\gamma_{3532+z}$  1072.6 s ( $t_{1/2}$ )  $I^{(1)}=47.5, I^{(2)}=52.8, \eta\omega=0.555$   
 A 5753.0+z, J+12  $\gamma_{4606+z}$  1148.3 s ( $t_{1/2}$ )  $I^{(1)}=47.9, I^{(2)}=49.3, \eta\omega=0.594$   
 A 6982.4+z, J+14  $\gamma_{5753+z}$  1229.4 s ( $t_{1/2}$ )  $I^{(1)}=48.0, I^{(2)}=44.8, \eta\omega=0.637$   
 A 8301.0+z, J+16  $\gamma_{6982+z}$  1318.6 s ( $t_{1/2}$ )  $I^{(1)}=47.8, I^{(2)}=42.6, \eta\omega=0.683$   
 A 9713.4+z, J+18  $\gamma_{8301+z}$  1412.4 s ( $t_{1/2}$ )  $I^{(1)}=47.4$

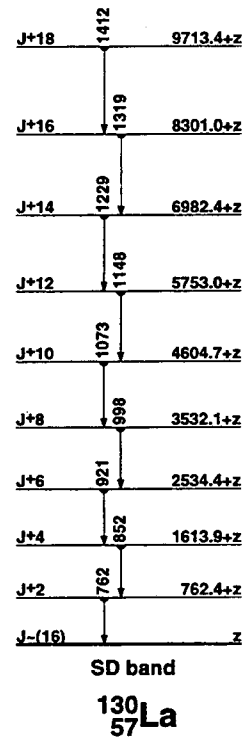

131  
58 Ce

$\Delta$ : -79700 400  $S_n$ : (8300)  $S_p$ : (5300)  $Q_{EC}$ : 4000 400  $Q_\alpha$ : 700 400

Nuclear Bands

- A  $vh_{11/2}$
- B  $v_{9/2}$
- C  $v_{7/2}^{\pi h_{11/2}}$
- D 3 QP band
- E  $vh_{11/2}(\pi h_{11/2})^2$
- F SD band

Levels and  $\gamma$ -ray branchings:

- B 0, (7/2<sup>+</sup>), 10.33 m, %EC+% $\beta$ <sup>+</sup>=100  
0+x, (1/2<sup>+</sup>), 5.0 10 m, %EC+% $\beta$ <sup>+</sup>=100  
72.82+x 4, (3/2<sup>+</sup>)  $\gamma_{0+x}$  72.826 (†, 64.6)
- A 162.00 9, (9/2<sup>-</sup>), 70.5 ns  $\gamma_0$  161.91 (†, 100) (E1)
- B 257.31 19, (9/2<sup>-</sup>)  $\gamma_2$  257.22 (†, 100) M1+E2  
266.16+x 5  $\gamma_{73+x}$  193.366 (†, 5.65)  $\gamma_{0+x}$  266.137 (†, 100)  
279.54+x 5  $\gamma_{73+x}$  206.726 (†, 56.4)  $\gamma_{0+x}$  279.557 (†, 100 10)  
285.40+x 5  $\gamma_{73+x}$  212.557 (†, 56.4)  $\gamma_{0+x}$  285.397 (†, 100 10)
- A 300.24 13, (11/2<sup>-</sup>)  $\gamma_{162}$  138.21 (†, 100) M1+E2  
324.33+x 6  $\gamma_{73+x}$  251.477 (†, 40.326)  $\gamma_{0+x}$  324.358 (†, 100 9)  
364.81+x 6  $\gamma_{285+x}$  79.36 10 (†, 14.4)  $\gamma_{73+x}$  292.047 (†, 100 10)  $\gamma_{0+x}$  364.72 (†, 74.20)  
384.70 10  $\gamma_{162}$  222.63 10 (†, 100 9)  $\gamma_0$  385.02 (†, 45.14)  
407.82+x 9  $\gamma_{280+x}$  128.22 (†, 5.321)  $\gamma_{73+x}$  334.95 10 (†, 100 11)  
440.58 10  $\gamma_{162}$  278.53 16 (†, 18.7)  $\gamma_0$  440.60 12 (†, 100 10)
- B 542.54 21, (11/2<sup>+</sup>)  $\gamma_{257}$  285.22 (†, 100 20)  $\gamma_0$  543.55 (†, 91.9) E2  
581.73+x 15  $\gamma_{266+x}$  315.52 (†, 100 11)  $\gamma_{0+x}$  581.82 (†, 80.18)  
585.02+x 11  $\gamma_{280+x}$  305.42 10 (†, 100)  
588.94 13  $\gamma_{162}$  426.94 12 (†, 100)  
599.96 21  $\gamma_{300}$  299.63 (†, 95.40)  $\gamma_{162}$  438.05 (†, 100)
- A 636.89 24, (13/2<sup>-</sup>)  $\gamma_{300}$  336.43 (†, 100 7) M1+E2  $\gamma_{162}$  475.34 (†, 27.4) E2  
785.26+x 8  $\gamma_{408+x}$  377.25 17 (†, 21.6)  $\gamma_{266+x}$  420.45 15 (†, 100 15)  
 $\gamma_{73+x}$  712.46 12 (†, 51.5)  $\gamma_{0+x}$  785.42 (†, 37.5)
- A 809.8 3, (15/2<sup>-</sup>)  $\gamma_{637}$  173.02 (†, 14.3) M1+E2  $\gamma_{300}$  509.45 (†, 100 17)  
865.59+x 12  $\gamma_{585+x}$  280.42 16 (†, 100 40)  $\gamma_{280+x}$  586.15 13 (†, 72.14)
- B 866.0 4, (13/2<sup>+</sup>)  $\gamma_{543}$  323.43 (†, 18.4) M1+E2  $\gamma_{257}$  609.46 (†, 100 18) E2  
884.18 19  $\gamma_{605}$  284.22 (†, 100 40)  $\gamma_{385}$  499.52 (†, 95.20)  
947.42 21  $\gamma_{257}$  690.6 (†, 100)  $\gamma_{162}$  785.42 (†, 550.67)  
1054.63+x 8  $\gamma_{408+x}$  646.5 (†, 17)  $\gamma_{285+x}$  769.21 10 (†, 92.8)  $\gamma_{280+x}$  775.12 10 (†, 100.8)
- 1176.5 5, (15/2<sup>-</sup>)  $\gamma_{610}$  367  $\gamma_{637}$  539.55 (†, 100 13) M1+E2
- B 1211.9 5, (15/2<sup>+</sup>)  $\gamma_{866}$  345.94 (†, 8.3)  $\gamma_{543}$  669.17 (†, 100.8) E2  
1213.43+x 11  $\gamma_{785+x}$  428.158 (†, 100 14)  $\gamma_{266+x}$  848.72 (†, 17.4)
- A 1295.1 4, (17/2<sup>-</sup>)  $\gamma_{810}$  485.54 (†, 84.11) M1+E2  $\gamma_{637}$  657.86 (†, 100 17) E2  
1408.8 11
- A 1451.7 6, (19/2<sup>-</sup>)  $\gamma_{1285}$  156  $\gamma_{810}$  641.76 (†, 100) E2
- B 1590.8 6, (17/2<sup>+</sup>)  $\gamma_{1212}$  379  $\gamma_{866}$  724.87 (†, 100) E2  
1695.8 7, (17/2<sup>-</sup>)  $\gamma_{1177}$  519.35 (†, 100) M1+E2  
1805.3 7, (19/2<sup>-</sup>)  $\gamma_{1285}$  510(?)  $\gamma_{1177}$  629  $\gamma_{810}$  996
- B 1976.2 7, (19/2<sup>+</sup>)  $\gamma_{1591}$  385(?)  $\gamma_{1212}$  764.37 (†, 100) E2  
1994.26+x 15  $\gamma_{1055+x}$  940.2 (†, 23)  $\gamma_{324+x}$  1669.72 (†, 71.10)  $\gamma_{73+x}$  1921.83 (†, 100.16)  $\gamma_{0+x}$  1994.33 (†, 71.16)
- A 2067.4 7, (21/2<sup>-</sup>)  $\gamma_{1452}$  615  $\gamma_{1285}$  773
- A 2202.0 8, (23/2<sup>-</sup>)  $\gamma_{2057}$  135  $\gamma_{1452}$  749.97 (†, 100) E2  
2286.5 11  $\gamma_{1409}$  878  
2313.3 10(?), (19/2<sup>-</sup>)  $\gamma_{1696}$  617.56(?) (†, 100) M1+E2
- D 2352.0 8, (19/2<sup>+</sup>)  $\gamma_{1409}$  943  $\gamma_{1212}$  1140
- B 2386.6 8, (21/2<sup>+</sup>)  $\gamma_{1976}$  411  $\gamma_{1591}$  795.68 (†, 100) E2
- D 2505.3 8, (21/2<sup>+</sup>)  $\gamma_{2352}$  153  $\gamma_{2287}$  219  $\gamma_{1976}$  529  $\gamma_{1591}$  915
- 2563.7 8, (23/2<sup>-</sup>)  $\gamma_{2067}$  496  $\gamma_{1805}$  759  $\gamma_{1452}$  1112
- D 2685.1 8, (23/2<sup>+</sup>)  $\gamma_{2505}$  180  $\gamma_{2387}$  298  $\gamma_{2352}$  333  $\gamma_{1976}$  709
- C 2761.1 9, (23/2<sup>+</sup>)  $\gamma_{2387}$  375  $\gamma_{1976}$  784.6 7 (†, 100) E2
- D 2909.1 10, (25/2<sup>+</sup>)  $\gamma_{2585}$  224  $\gamma_{2505}$  404
- A 2912.3 9, (25/2<sup>-</sup>)  $\gamma_{2202}$  710  $\gamma_{2067}$  845
- A 3028.7 10, (27/2<sup>-</sup>)  $\gamma_{2202}$  826.68 (†, 100) E2
- C 3035.5 10, (25/2<sup>+</sup>)  $\gamma_{2761}$  274  $\gamma_{2387}$  649
- E 3069.4 11, (25/2<sup>-</sup>)  $\gamma_{2912}$  157  $\gamma_0$  1086(?)
- D 3198.1 11, (27/2<sup>+</sup>)  $\gamma_{2909}$  289  $\gamma_{2585}$  513
- C 3271.9 11, (27/2<sup>-</sup>)  $\gamma_{3036}$  236  $\gamma_{2761}$  511
- E 3287.4 9, (27/2<sup>-</sup>)  $\gamma_{3069}$  218  $\gamma_{3029}$  258(?)  $\gamma_{2912}$  375  $\gamma_{2584}$  724

- D 3522.1 12, (29/2<sup>+</sup>)  $\gamma_{3198}$  324  $\gamma_{2909}$  613
- C 3539.2 12, (29/2<sup>-</sup>)  $\gamma_{3272}$  267  $\gamma_{3036}$  504
- E 3543.9 11, (29/2<sup>-</sup>)  $\gamma_{3287}$  257  $\gamma_{3069}$  475(?)  $\gamma_{3029}$  515
- E 3817.7 11, (31/2<sup>-</sup>)  $\gamma_{3544}$  274  $\gamma_{3287}$  530  $\gamma_{3029}$  789
- C 3840.0 13, (31/2<sup>+</sup>)  $\gamma_{3539}$  301  $\gamma_{3272}$  568
- D 3893.1 13, (31/2<sup>-</sup>)  $\gamma_{3522}$  371  $\gamma_{3198}$  695
- A 3920.7 14, (31/2<sup>-</sup>)  $\gamma_{3029}$  892
- E 4152.8 12, (33/2<sup>-</sup>)  $\gamma_{3818}$  335  $\gamma_{3544}$  609
- C 4177.2 14, (33/2<sup>+</sup>)  $\gamma_{3840}$  337  $\gamma_{3539}$  638
- D 4313.1 13, (33/2<sup>-</sup>)  $\gamma_{3893}$  420  $\gamma_{3522}$  791
- E 4510.7 13, (35/2<sup>-</sup>)  $\gamma_{4153}$  358  $\gamma_{3818}$  693
- C 4548.8 14, (35/2<sup>+</sup>)  $\gamma_{4177}$  371  $\gamma_{3840}$  709
- D 4745.1 14, (35/2<sup>+</sup>)  $\gamma_{4313}$  432  $\gamma_{3893}$  852
- A 4842.8 17, (35/2<sup>-</sup>)  $\gamma_{3921}$  922
- E 4908.9 13, (37/2<sup>-</sup>)  $\gamma_{4511}$  398  $\gamma_{4153}$  756
- C 4954.8 15, (37/2<sup>+</sup>)  $\gamma_{4549}$  405  $\gamma_{4177}$  778
- D 5244.1 17, (37/2<sup>-</sup>)  $\gamma_{4313}$  931
- E 5341.5 14, (39/2<sup>-</sup>)  $\gamma_{4809}$  432  $\gamma_{4511}$  831
- C 5389.4 16, (39/2<sup>+</sup>)  $\gamma_{4955}$  434  $\gamma_{4549}$  841
- D 5714.1 18, (39/2<sup>-</sup>)  $\gamma_{4745}$  969
- E 5796.6 15, (41/2<sup>-</sup>)  $\gamma_{5342}$  455  $\gamma_{4909}$  888
- A 5804.8 20, (39/2<sup>-</sup>)  $\gamma_{4843}$  962
- C 5859.6 17, (41/2<sup>+</sup>)  $\gamma_{5389}$  470  $\gamma_{4955}$  905
- E 6292.6 16, (43/2<sup>-</sup>)  $\gamma_{5797}$  496  $\gamma_{5342}$  951
- C 6351.4 19, (43/2<sup>+</sup>)  $\gamma_{5860}$  491(?)  $\gamma_{5389}$  962
- D 6742.1 20, (43/2<sup>+</sup>)  $\gamma_{5714}$  1028
- E 6808.7 18, (45/2<sup>-</sup>)  $\gamma_{6293}$  515(?)  $\gamma_{5797}$  1012
- C 6879.6 19, (45/2<sup>+</sup>)  $\gamma_{6351}$  529(?)  $\gamma_{5860}$  1020
- E 7354.6 19, (47/2<sup>-</sup>)  $\gamma_{6809}$  547(?)  $\gamma_{6293}$  1062
- C 7421.4 21, (47/2<sup>+</sup>)  $\gamma_{6361}$  1070
- D 7801.1 23, (49/2<sup>-</sup>)  $\gamma_{6742}$  1059
- E 7931.7 21, (49/2<sup>-</sup>)  $\gamma_{6809}$  1123
- C 8008.6 22, (49/2<sup>+</sup>)  $\gamma_{6890}$  1129
- C 8576.4 23(?), (51/2<sup>+</sup>)  $\gamma_{7421}$  1155(?)
- F y, J=(29/2)
- F 592+y, J+2  $\gamma_2$  592 (†, 0.60)  $I^{(1)}=54.1, I^{(2)}=57.1, \eta\omega=0.314$
- F 1254+y, J+4  $\gamma_{592+y}$  662 (†, 1.00)  $I^{(1)}=54.4, I^{(2)}=56.3, \eta\omega=0.349$
- F 1987+y, J+6  $\gamma_{1254+y}$  733 (†, 0.90)  $I^{(1)}=54.6, I^{(2)}=55.6, \eta\omega=0.385$
- F 2792+y, J+8  $\gamma_{1987+y}$  805 (†, 0.90)  $I^{(1)}=54.7, I^{(2)}=57.1, \eta\omega=0.420$
- F 3667+y, J+10  $\gamma_{2792+y}$  875 (†, 0.95)  $I^{(1)}=54.9, I^{(2)}=58.0, \eta\omega=0.455$
- F 4611+y, J+12  $\gamma_{3667+y}$  944 (†, 0.90)  $I^{(1)}=55.1, I^{(2)}=58.0, \eta\omega=0.489$
- F 5624+y, J+14  $\gamma_{4611+y}$  1013 (†, 0.85)  $I^{(1)}=55.3, I^{(2)}=58.0, \eta\omega=0.524$
- F 6706+y, J+16  $\gamma_{5624+y}$  1082 (†, 0.70)  $I^{(1)}=55.5, I^{(2)}=56.3, \eta\omega=0.559$
- F 7859+y, J+18  $\gamma_{6706+y}$  1153 (†, 0.60)  $I^{(1)}=55.5, I^{(2)}=54.8, \eta\omega=0.595$
- F 9085+y, J+20  $\gamma_{7859+y}$  1226 (†, 0.50)  $I^{(1)}=55.5, I^{(2)}=51.9, \eta\omega=0.632$
- F 10388+y, J+22  $\gamma_{9085+y}$  1303 (†, 0.40)  $I^{(1)}=55.3, I^{(2)}=50.6, \eta\omega=0.671$
- F 11770+y, J+24  $\gamma_{10388+y}$  1382 (†, 0.40)  $I^{(1)}=55.0, I^{(2)}=46.0, \eta\omega=0.713$
- F 13239+y, J+26  $\gamma_{11770+y}$  1469 (†, 0.30)  $I^{(1)}=54.5, I^{(2)}=48.2, \eta\omega=0.755$
- F 14791+y, J+28  $\gamma_{13239+y}$  1552  $I^{(1)}=54.1, I^{(2)}=46.0, \eta\omega=0.798$
- F 16430+y, J+30  $\gamma_{14791+y}$  1639  $I^{(1)}=53.7, I^{(2)}=43.0, \eta\omega=0.843, I^{(3)}=53.7$
- F 18162+y, J+32  $\gamma_{16430+y}$  1732  $I^{(1)}=53.1$

132  
58 Ce

$\Delta$ : (-82450)  $S_n$ : (10800)  $S_p$ : (6000)  $Q_{EC}$ : (1290)  $Q_\alpha$ : (540)

Nuclear Bands

- A SD-1 band
- B SD-2 band
- C SD-3 band

Levels and  $\gamma$ -ray branchings:

- 0, 0<sup>+</sup>, 3.51 11 h, %EC+% $\beta$ <sup>+</sup>=100  
325.54 16, 2<sup>+</sup>, 41.3 ps  $\gamma_0$  325.52 (†, 100) E2  
822.36 16, (2<sup>+</sup>)  $\gamma_{326}$  496.92 (†, 100 12)  $\gamma_0$  822.42 (†, 69.7)  
859.13 24, 4<sup>+</sup>, 3.7 ps  $\gamma_{326}$  533.13 (†, 100) E2  
1199.66 20, (3<sup>+</sup>)  $\gamma_{859}$  340.55 (†, <3.5)  $\gamma_{822}$  377.22 (†, 25.6)  $\gamma_{326}$  874.22 (†, 100 10)  
1383.94 23, (4<sup>+</sup>)  $\gamma_{859}$  524.62 (†, 74.22)  $\gamma_{822}$  561.82 (†, 100 22)

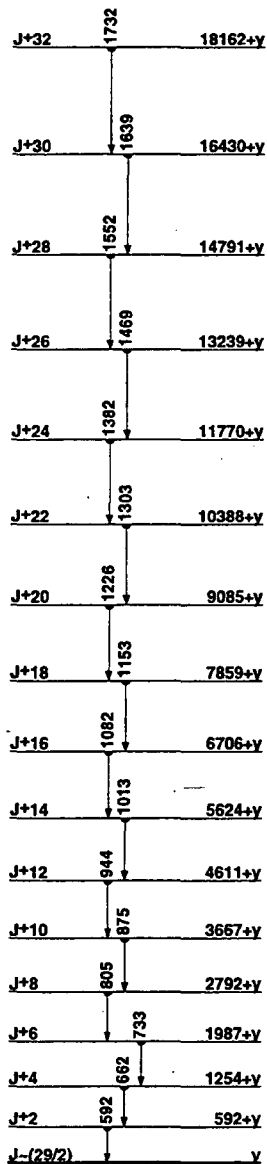

SD band

$^{131}\text{Ce}$   
 $^{58}\text{Ce}$

$^{132}\text{Ce}$  (Continued)

- 1497.5624  $\gamma_{822} 675.22$  ( $t_{1/2} 10.13$ )  $\gamma_{326} 1172.06$  ( $t_{1/2} 16.8$ )
- 1542.86.6<sup>+</sup>, 0.74 ps  $\gamma_{859} 683.75$  ( $t_{1/2} 100$ ) E2
- 1656.25.5<sup>+</sup>  $\gamma_{1200} 456.54$  ( $t_{1/2} 100$ )
- 1734.5625  $\gamma_{822} 972.22$  ( $t_{1/2} 100.30$ )  $\gamma_{326} 1409.08$  ( $t_{1/2} 44.15$ )
- 1893.0(?)  $\gamma_{1200} 692.7$   $\gamma_{859} 1034$   $\gamma_{822} 1071$
- 2330.78.8<sup>+</sup>, 0.72 ps  $\gamma_{1543} 787.95$  ( $t_{1/2} 100$ ) E2
- 2340.8.8<sup>+</sup>, 9<sup>+</sup>, 131 ms  $\gamma_{1543} 798$  ( $t_{1/2} 100$ )
- 2507.66  $\gamma_{1498} 1010.09$  ( $t_{1/2} 100.19$ )  $\gamma_{1200} 1308.06$  ( $t_{1/2} 58.12$ )
- 3158.511, 10<sup>+</sup>, 0.8321 ps  $\gamma_{2331} 827.79$  ( $t_{1/2} 100$ ) E2
- 3309.6.10<sup>+</sup>  $\gamma_{3159} 151$  ( $t_{1/2} 17$ )  $\gamma_{2331} 979$  ( $t_{1/2} 100$ )
- 3670.712, 12<sup>+</sup>, 7.74 ps  $\gamma_{3310} 361$  ( $t_{1/2} 32$ ) E2  $\gamma_{3159} 512.26$  ( $t_{1/2} 100$ ) E2
- 4240.413, 14<sup>+</sup>, 1.737 ps  $\gamma_{3571} 569.76$  ( $t_{1/2} 100$ ) E2
- 4939.015, 16<sup>+</sup>, 0.434 ps  $\gamma_{4240} 698.67$  ( $t_{1/2} 100$ ) E2
- 5762.418, 18<sup>+</sup>, 0.322 ps  $\gamma_{4939} 823.49$  ( $t_{1/2} 100$ ) E2
- 6701.20<sup>+</sup>  $\gamma_{5762} 939$  ( $t_{1/2} 100$ ) (E2)

- 7732.22<sup>+</sup>  $\gamma_{6701} 1031$  ( $t_{1/2} 100$ ) (E2)
- 8845.24<sup>+</sup>  $\gamma_{7732} 1113$  ( $t_{1/2} 100$ ) (E2)
- 10032.26<sup>+</sup>  $\gamma_{8845} 1187$  ( $t_{1/2} 100$ ) (E2)
- 11272.28<sup>+</sup>  $\gamma_{10032} 1240$  ( $t_{1/2} 100$ ) (E2)

- A x, J=(18)
- A 809+x, J+2, 5920 fs  $\gamma_x 809$  ( $t_{1/2} 0.8510$ )  $I^{(1)}=48.2, I^{(2)}=71.4, \eta\omega=0.418$
- A 1674+x, J+4, 6214 fs  $\gamma_{809+x} 865$  ( $t_{1/2} 1.007$ )  $I^{(1)}=49.7, I^{(2)}=62.5, \eta\omega=0.449$
- A 2603+x, J+6, 2812 fs  $\gamma_{1674+x} 929$  ( $t_{1/2} 1.1012$ )  $I^{(1)}=50.6, I^{(2)}=60.6, \eta\omega=0.481$
- A 3598+x, J+8, <17 fs  $\gamma_{2603+x} 995$  ( $t_{1/2} 1.0313$ )  $I^{(1)}=51.3, I^{(2)}=61.5, \eta\omega=0.514$
- A 4658+x, J+10, <21 fs  $\gamma_{3598+x} 1060$  ( $t_{1/2} 1.059$ )  $I^{(1)}=51.9, I^{(2)}=59.7, \eta\omega=0.547$
- A 5785+x, J+12, 147 fs  $\gamma_{4658+x} 1127$  ( $t_{1/2} 0.913$ )  $I^{(1)}=52.4, I^{(2)}=58.8, \eta\omega=0.581$
- A 6980+x, J+14, 108 fs  $\gamma_{5785+x} 1195$  ( $t_{1/2} 0.947$ )  $I^{(1)}=52.7, I^{(2)}=58.0, \eta\omega=0.615$
- A 8244+x, J+16, <14 fs  $\gamma_{6980+x} 1264$  ( $t_{1/2} 0.843$ )  $I^{(1)}=53.0, I^{(2)}=56.3, \eta\omega=0.650$
- A 9579+x, J+18, <7 fs  $\gamma_{8244+x} 1335$  ( $t_{1/2} 0.6211$ )  $I^{(1)}=53.2, I^{(2)}=54.1, \eta\omega=0.686$
- A 10988+x, J+20, <10 fs  $\gamma_{9579+x} 1409$  ( $t_{1/2} 0.519$ )  $I^{(1)}=53.2, I^{(2)}=50.6, \eta\omega=0.724$
- A 12476+x, J+22, <10 fs  $\gamma_{10988+x} 1488$  ( $t_{1/2} 0.297$ )  $I^{(1)}=53.1, I^{(2)}=50.6, \eta\omega=0.764$
- A 14043+x, J+24, <24 fs  $\gamma_{12476+x} 1567$  ( $t_{1/2} 0.393$ )  $I^{(1)}=53.0, I^{(2)}=47.1, \eta\omega=0.805$
- A 15695+x, J+26, <7 fs  $\gamma_{14043+x} 1652$  ( $t_{1/2} 0.465$ )  $I^{(1)}=52.7, I^{(2)}=44.4, \eta\omega=0.849$
- A 17437+x, J+28  $\gamma_{15695+x} 1742$  ( $t_{1/2} 0.217$ )  $I^{(1)}=52.2, I^{(2)}=42.6, \eta\omega=0.895$
- A 19273+x, J+30  $\gamma_{17437+x} 1836$  ( $t_{1/2} 0.2510$ )  $I^{(1)}=51.7, I^{(2)}=42.6, \eta\omega=0.942$
- A 21203+x, J+32  $\gamma_{19273+x} 1930$   $I^{(1)}=51.3, I^{(2)}=40.0, \eta\omega=0.990$
- A 23233+x, J+34  $\gamma_{21203+x} 2030$   $I^{(1)}=50.7, I^{(2)}=47.6, \eta\omega=1.036$
- A 25347+x, J+36  $\gamma_{23233+x} 2114$   $I^{(1)}=50.6, I^{(2)}=46.0, \eta\omega=1.079$
- A 27548+x, J+38  $\gamma_{25347+x} 2201$   $I^{(1)}=50.4, I^{(1)}=50.4, I^{(1)}=50.4$
- B y, J
- B 847+y, J+2  $\gamma_y 847$   $I^{(2)}=66.7, \eta\omega=0.439$
- B 1754+y, J+4  $\gamma_{847+y} 907$   $I^{(2)}=58.8, \eta\omega=0.471$
- B 2729+y, J+6  $\gamma_{1754+y} 975$   $I^{(2)}=59.7, \eta\omega=0.504$
- B 3771+y, J+8  $\gamma_{2729+y} 1042$   $I^{(2)}=59.7, \eta\omega=0.538$
- B 4880+y, J+10  $\gamma_{3771+y} 1109$   $I^{(2)}=57.1, \eta\omega=0.572$
- B 6059+y, J+12  $\gamma_{4880+y} 1179$   $I^{(2)}=58.0, \eta\omega=0.607$
- B 7307+y, J+14  $\gamma_{6059+y} 1248$   $I^{(2)}=55.6, \eta\omega=0.642$
- B 8627+y, J+16  $\gamma_{7307+y} 1320$   $I^{(2)}=55.6, \eta\omega=0.678$
- B 10019+y, J+18  $\gamma_{8627+y} 1392$   $I^{(2)}=52.6, \eta\omega=0.715$
- B 11487+y, J+20  $\gamma_{10019+y} 1468$   $I^{(2)}=50.0, \eta\omega=0.754$
- B 13035+y, J+22  $\gamma_{11487+y} 1548$
- C z, J
- C 864+z, J+2  $\gamma_z 864$   $I^{(2)}=64.5, \eta\omega=0.448$
- C 1790+z, J+4  $\gamma_{864+z} 926$   $I^{(2)}=54.8, \eta\omega=0.481$
- C 2789+z, J+6  $\gamma_{1790+z} 999$   $I^{(2)}=59.7, \eta\omega=0.516$
- C 3855+z, J+8  $\gamma_{2789+z} 1066$   $I^{(2)}=58.8, \eta\omega=0.550$
- C 4989+z, J+10  $\gamma_{3855+z} 1134$   $I^{(2)}=54.8, \eta\omega=0.585$
- C 6196+z, J+12  $\gamma_{4989+z} 1207$   $I^{(2)}=51.9, \eta\omega=0.623$
- C 7480+z, J+14  $\gamma_{6196+z} 1284$   $I^{(2)}=52.6, \eta\omega=0.661$
- C 8840+z, J+16  $\gamma_{7480+z} 1360$   $I^{(2)}=45.5, \eta\omega=0.702$
- C 10288+z, J+18  $\gamma_{8840+z} 1448$   $I^{(2)}=47.1, \eta\omega=0.745$
- C 11821+z, J+20  $\gamma_{10288+z} 1533$



**133Pr**  
**59Pr**

$\Delta: (-78060) S_n: (10800) S_p: (2900) Q_{EC}: (4300) Q_{\alpha}: (860)$

**Nuclear Bands**

A SD band

Levels:

- 0, 5/2<sup>(+)</sup>, 6.53 m, %EC+%β<sup>+</sup>=100
- A x, J
- A 840+x, J+2  $\gamma_{840} I^{(2)}=58.8, \eta\omega=0.437$
- A 1748+x, J+4  $\gamma_{1748+x} 908 I^{(2)}=57.1, \eta\omega=0.472$
- A 2726+x, J+6  $\gamma_{2726+x} 978 I^{(2)}=56.3, \eta\omega=0.507$
- A 3775+x, J+8  $\gamma_{3775+x} 1049 I^{(2)}=55.6, \eta\omega=0.542$
- A 4896+x, J+10  $\gamma_{4896+x} 1121 I^{(2)}=56.3, \eta\omega=0.578$
- A 6088+x, J+12  $\gamma_{6088+x} 1192 I^{(2)}=54.8, \eta\omega=0.614$
- A 7353+x, J+14  $\gamma_{7353+x} 1265 I^{(2)}=71.4, \eta\omega=0.647$
- A 8674+x (?), J+16  $\gamma_{8674+x} 1321 (?) I^{(2)}=44.0, \eta\omega=0.683$
- A 10086+x (?), J+18  $\gamma_{10086+x} 1412 (?) I^{(2)}=51.9, \eta\omega=0.725$
- A 11575+x (?), J+20  $\gamma_{11575+x} 1489 (?)$

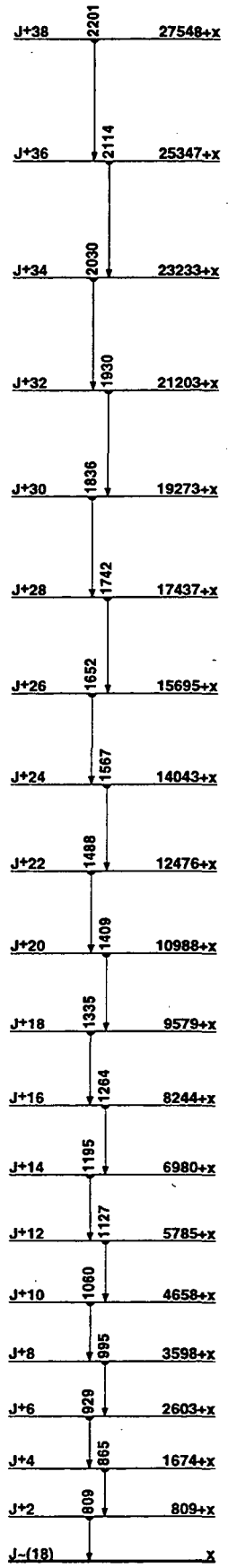

SD-1 band

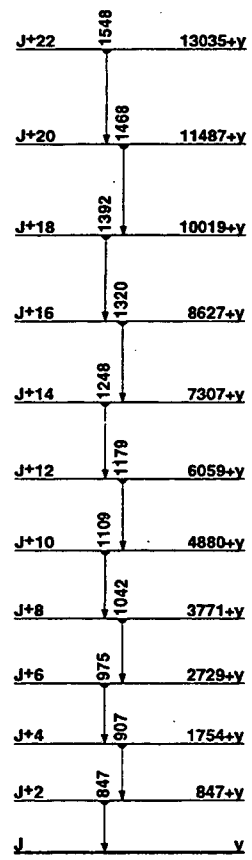

SD-2 band

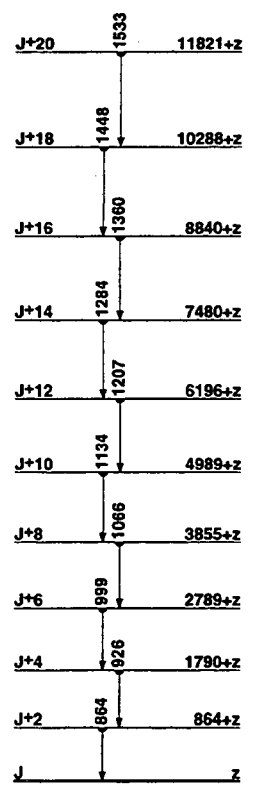

SD-3 band

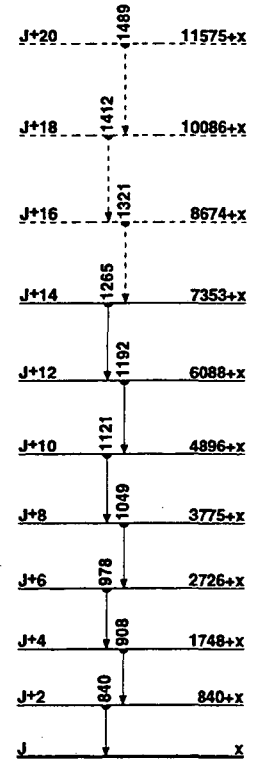

SD band

**133Pr**  
**59Pr**

**132Ce**  
**58Ce**

**<sup>133</sup>Nd**  
**<sub>60</sub>Nd**

$\Delta: (-72500)$   $S_n: (8900)$   $S_p: (4400)$   $Q_{EC}: (5600)$   $Q_\alpha: (1400)$

**Nuclear Bands**

A SD band

**Levels and  $\gamma$ -ray branchings:**

- 0, 70 10 s, %EC+% $\beta^+$ =100  
 0+x, (9/2<sup>-</sup>), <2 m, %EC+% $\beta^+$ =100  
 162.9+x, (11/2<sup>-</sup>)  $\gamma_{0+x}$  162.8 (t<sub>1/2</sub> 100) M1+E2  
 470.7+x, (13/2<sup>-</sup>)  $\gamma_{163+x}$  307.7 (t<sub>1/2</sub> 91 18) M1+E2  $\gamma_{0+x}$  470.8 (t<sub>1/2</sub> 100 12) E2  
 660.8+x, (15/2<sup>-</sup>)  $\gamma_{471+x}$  190.3 (t<sub>1/2</sub> 19 4) M1+E2  $\gamma_{163+x}$  498.0 (t<sub>1/2</sub> 100) E2  
 974.3+x, (15/2<sup>-</sup>)  $\gamma_{471+x}$  503.6 (t<sub>1/2</sub> =100)  
 1088.9+x, (17/2<sup>-</sup>)  $\gamma_{661+x}$  428.3 (t<sub>1/2</sub> 100 16) M1+E2  $\gamma_{471+x}$  618  
 1284.8+x, (19/2<sup>-</sup>)  $\gamma_{661+x}$  624.0 (t<sub>1/2</sub> 100) E2  
 1994.4+x, (23/2<sup>-</sup>)  $\gamma_{1285+x}$  709.6 (t<sub>1/2</sub> <100) E2  
 2765+x, (27/2<sup>-</sup>)  $\gamma_{1894+x}$  770.5 (t<sub>1/2</sub> 100) (E2)  
 A y, (17/2)  $\gamma_{667}$   $\gamma_{1189}$   
 A 345+y, (21/2)  $\gamma_y$  345 I<sup>(1)</sup>=58.0, I<sup>(2)</sup>=41.7,  $\hbar\omega$ =0.197  $\gamma_{409}$   
 A 786+y, (25/2)  $\gamma_{345+y}$  441 (t<sub>1/2</sub> 0.65) I<sup>(1)</sup>=54.4, I<sup>(2)</sup>=54.8,  $\hbar\omega$ =0.239  
 A 1300+y, (29/2)  $\gamma_{307}$   $\gamma_{786+y}$  514 (t<sub>1/2</sub> 0.70) I<sup>(1)</sup>=54.5, I<sup>(2)</sup>=44.4,  $\hbar\omega$ =0.279  $\gamma_{633}$   
 A 1904+y, (33/2)  $\gamma_{1300+y}$  604 (t<sub>1/2</sub> 1.00) I<sup>(1)</sup>=53.0, I<sup>(2)</sup>=50.6,  $\hbar\omega$ =0.322  
 A 2587+y, (37/2)  $\gamma_{1904+y}$  683 (t<sub>1/2</sub> 0.90) I<sup>(1)</sup>=52.7, I<sup>(2)</sup>=50.6,  $\hbar\omega$ =0.361  
 A 3349+y, (41/2)  $\gamma_{2587+y}$  762 (t<sub>1/2</sub> 1.00) I<sup>(1)</sup>=52.5, I<sup>(2)</sup>=54.1,  $\hbar\omega$ =0.400  
 A 4185+y, (45/2)  $\gamma_{3349+y}$  836 (t<sub>1/2</sub> 0.75) I<sup>(1)</sup>=52.6, I<sup>(2)</sup>=58.8,  $\hbar\omega$ =0.435  
 A 5089+y, (49/2)  $\gamma_{4185+y}$  904 (t<sub>1/2</sub> 0.75) I<sup>(1)</sup>=53.1, I<sup>(2)</sup>=63.5,  $\hbar\omega$ =0.468  
 A 6056+y, (53/2)  $\gamma_{5089+y}$  967 (t<sub>1/2</sub> 0.60) I<sup>(1)</sup>=53.8, I<sup>(2)</sup>=64.5,  $\hbar\omega$ =0.499  
 A 7085+y, (57/2)  $\gamma_{6056+y}$  1029 (t<sub>1/2</sub> 0.60) I<sup>(1)</sup>=54.4, I<sup>(2)</sup>=63.5,  $\hbar\omega$ =0.530  
 A 8177+y, (61/2)  $\gamma_{7085+y}$  1092 (t<sub>1/2</sub> 0.40) I<sup>(1)</sup>=54.9, I<sup>(2)</sup>=60.6,  $\hbar\omega$ =0.563  
 A 9335+y, (65/2)  $\gamma_{8177+y}$  1158 (t<sub>1/2</sub> 0.20) I<sup>(1)</sup>=55.3, I<sup>(2)</sup>=57.1,  $\hbar\omega$ =0.597  
 A 10563+y, (69/2)  $\gamma_{9335+y}$  1228 (t<sub>1/2</sub> 0.20) I<sup>(1)</sup>=55.4, I<sup>(2)</sup>=55.6,  $\hbar\omega$ =0.632  
 A 11863+y, (73/2)  $\gamma_{10563+y}$  1300 (t<sub>1/2</sub> 0.10) I<sup>(1)</sup>=55.4, I<sup>(2)</sup>=51.9,  $\hbar\omega$ =0.669  
 A 13240+y, (77/2)  $\gamma_{11863+y}$  1377 (t<sub>1/2</sub> 0.05) I<sup>(1)</sup>=55.2, I<sup>(2)</sup>=49.4,  $\hbar\omega$ =0.709  
 A 14698+y, (81/2)  $\gamma_{13240+y}$  1458 I<sup>(1)</sup>=54.9, I<sup>(2)</sup>=47.1,  $\hbar\omega$ =0.750  
 A 16241+y, (85/2)  $\gamma_{14698+y}$  1543 I<sup>(1)</sup>=54.4, I<sup>(2)</sup>=45.5,  $\hbar\omega$ =0.793  
 A 17872+y, (89/2)  $\gamma_{16241+y}$  1631 I<sup>(1)</sup>=54.0

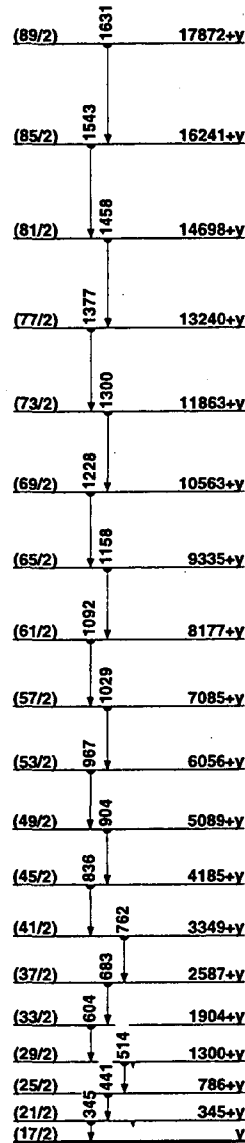

SD band

**<sup>133</sup>Nd**  
**<sub>60</sub>Nd**

**134Nd**  
**60Nd**

$\Delta$ : (-75760)  $S_n$ : (11400)  $S_p$ : (5000)  $Q_{EC}$ : 2770 150  $Q_\alpha$ : (1300)

**Nuclear Bands**

A SD band

**Levels and  $\gamma$ -ray branchings:**

0, 0<sup>+</sup>, 8.5 15 m, %EC+% $\beta^+$ =100

- 294.30 16, 2<sup>+</sup>, 64.4 ps,  $\mu=-1.2336$   $\gamma_{294}$  294.22 (t<sub>100</sub>) E2
- 753.73 16, (2<sup>+</sup>)  $\gamma_{294}$  459.32 (t<sub>90</sub> 10)  $\gamma_{753}$  753.82 (t<sub>100</sub> 10)
- 788.97 21, 4<sup>+</sup>, <3.5 ps  $\gamma_{294}$  494.72 (t<sub>100</sub>) E2
- 1089.02 21, (3<sup>+</sup>)  $\gamma_{754}$  335.33 (t<sub>24</sub> 5)  $\gamma_{294}$  794.72 (t<sub>100</sub> 8)
- 1313.01 21, (4<sup>+</sup>)  $\gamma_{789}$  523.82 (t<sub>52</sub> 10)  $\gamma_{754}$  559.22 (t<sub>100</sub> 15)
- 1383.8 4  $\gamma_{789}$  594.74 (t<sub>60</sub> 26)  $\gamma_{1384}$  1384.05 (t<sub>100</sub> 30)
- 1420.10 25, 6<sup>+</sup>, <9 ps  $\gamma_{789}$  631.32 (t<sub>100</sub>) E2
- 1605.0 3  $\gamma_{1089}$  516.03 (t<sub>100</sub> 14)  $\gamma_{754}$  851.33 (t<sub>34</sub> 7)
- 1669.3 6  $\gamma_{294}$  1375.05 (t<sub>100</sub>)
- 1670.9 5  $\gamma_{789}$  881.94 (t<sub>100</sub>)
- 1697.6 4, (5<sup>+</sup>)  $\gamma_{1089}$  608.63 (t<sub>100</sub>)
- 1910.6 3, (6<sup>+</sup>)  $\gamma_{1420}$  491.1 (t<sub><20</sub>)  $\gamma_{1313}$  597.32 (t<sub>100</sub> 10)
- 1956.2 3, (5<sup>+</sup>)  $\gamma_{789}$  1167.32 (t<sub>100</sub>) (E1)
- 2036.4 5  $\gamma_{789}$  1247.44 (t<sub>100</sub>)
- 2126.5 3, 8<sup>+</sup>  $\gamma_{1420}$  706.42 (t<sub>100</sub>) E2
- 2231.6 6  $\gamma_{789}$  1442.65 (t<sub>100</sub>)
- 2293.1 4, (8<sup>+</sup>), 410 30  $\mu$ s, %IT=100  $\gamma_{2127}$  166.53 (t<sub>100</sub> 7) E1  $\gamma_{1420}$  874 (t<sub>7</sub> 2)
- 2340.6 3, (7<sup>+</sup>)  $\gamma_{1956}$  384.62 (t<sub>34</sub> 5) (E2)  $\gamma_{1420}$  920.42 (t<sub>100</sub> 2) (E1)
- 2412.5 3, (6<sup>+</sup>)  $\gamma_{1420}$  992.42 (t<sub>100</sub>)
- 2467.2 3, (8<sup>+</sup>)  $\gamma_{1911}$  556.32 (t<sub>100</sub> 7)  $\gamma_{1420}$  1047.32 (t<sub>95</sub> 9)
- 2728.5 3, (8<sup>+</sup>)  $\gamma_{2413}$  316.02 (t<sub>33</sub> 5) (E2)  $\gamma_{2341}$  387.92 (t<sub>100</sub> 11) D
- 2816.9 4, 10<sup>+</sup>, 9.0 14 ps,  $\mu=0$   $\gamma_{2127}$  690.42 (t<sub>100</sub>) E2
- 2840.7 4, (9<sup>+</sup>)  $\gamma_{2341}$  500.12 (t<sub>100</sub>) (E2)
- 3052.0 3, (10<sup>+</sup>)  $\gamma_{2467}$  584.72 (t<sub>100</sub> 7)  $\gamma_{2127}$  925.62 (t<sub>100</sub> 10) (E2)
- 3200.2 4, (10<sup>+</sup>)  $\gamma_{2728}$  471.72 (t<sub>100</sub>) (E2)
- 3436.5 4, (12<sup>+</sup>)  $\gamma_{3052}$  384.62 (t<sub>83</sub> 4) (E2)  $\gamma_{2817}$  619.52 (t<sub>100</sub> 6)
- 3453.0 4, (11<sup>+</sup>)  $\gamma_{2841}$  612.32 (t<sub>100</sub>) (E2)
- 3483.0 4, 12<sup>+</sup>  $\gamma_{2817}$  666.02 (t<sub>100</sub>) E2
- 3863.0 5, (12<sup>+</sup>)  $\gamma_{3200}$  662.82 (t<sub>100</sub>) (E2)
- 4028.2 4, (14<sup>+</sup>)  $\gamma_{3483}$  545  $\gamma_{3437}$  591.72 (t<sub>100</sub>) (E2)
- 4175.4 5, (13<sup>+</sup>)  $\gamma_{3453}$  722.42 (t<sub>100</sub>) (E2)
- 4183.7 5, 14<sup>+</sup>  $\gamma_{3483}$  700.72 (t<sub>100</sub>) E2
- 4607.5 5, (14<sup>+</sup>)  $\gamma_{3863}$  744.52 (t<sub>100</sub>) (E2)
- 4776.7 5, (16<sup>+</sup>)  $\gamma_{4028}$  748.52 (t<sub>100</sub>) (E2)
- 4942.7 5, 16<sup>+</sup>  $\gamma_{4184}$  759.02 (t<sub>100</sub>) E2
- 4947.9 5, (15<sup>+</sup>)  $\gamma_{4175}$  772.52 (t<sub>100</sub>) (E2)
- 5345.9 5, (16<sup>+</sup>)  $\gamma_{4608}$  738.42 (t<sub>100</sub>) (E2)
- 5629.7 11, (18<sup>+</sup>)  $\gamma_{4777}$  853.1 (t<sub>100</sub>) (E2)
- 5711.0 6, (17<sup>+</sup>)  $\gamma_{4948}$  763.12 (t<sub>100</sub>)
- 5777.7 11, 18<sup>+</sup>  $\gamma_{4943}$  835.1 (t<sub>100</sub>) E2
- 6082.5 6, (18<sup>+</sup>)  $\gamma_{5346}$  736.62 (t<sub>100</sub>)
- 6488.0 12, (19<sup>+</sup>)  $\gamma_{5711}$  777 (t<sub>100</sub>)
- 6531.7 15, (20<sup>+</sup>)  $\gamma_{5630}$  902 (t<sub>100</sub>)
- 6710.7 15, 20<sup>+</sup>  $\gamma_{5776}$  933 (t<sub>100</sub>) E2
- 6891.5 12, (20<sup>+</sup>)  $\gamma_{6083}$  809 (t<sub>100</sub>)
- 7358.0 15, (21<sup>+</sup>)  $\gamma_{6488}$  870 (t<sub>100</sub>)
- 7467.7 18, (22<sup>+</sup>)  $\gamma_{6532}$  936 (t<sub>100</sub>)
- 7744.7 18, (22<sup>+</sup>)  $\gamma_{6711}$  1034 (t<sub>100</sub>)
- 7804.5 16, (22<sup>+</sup>)  $\gamma_{6892}$  913 (t<sub>100</sub>)
- 8328.0 18, (23<sup>+</sup>)  $\gamma_{7358}$  970 (t<sub>100</sub>)
- 8453.7 21, (24<sup>+</sup>)  $\gamma_{7468}$  986 (t<sub>100</sub>)
- 8812.5 19, (24<sup>+</sup>)  $\gamma_{7805}$  1008 (t<sub>100</sub>)
- 8869.7 21, (24<sup>+</sup>)  $\gamma_{7745}$  1125 (t<sub>100</sub>)
- 9371.1 21, (25<sup>+</sup>)  $\gamma_{8328}$  1043 (t<sub>100</sub>)
- 9501.7 23, (26<sup>+</sup>)  $\gamma_{8454}$  1048 (t<sub>100</sub>)
- 10079.7 23, (26<sup>+</sup>)  $\gamma_{8870}$  1210 (t<sub>100</sub>)
- 10616.7 25, (28<sup>+</sup>)  $\gamma_{9502}$  1115 (t<sub>100</sub>)
- 11787.3, (30<sup>+</sup>)  $\gamma_{10617}$  1170 (t<sub>100</sub>)

A x, J=(14)

A 591+x, J+2  $\gamma_{591}$  (t<sub>0.5</sub> 1) I<sup>(1)</sup>=52.5, I<sup>(2)</sup>=55.6,  $\eta\omega=0.314$

A 1254+x, J+4  $\gamma_{591+x}$  663 (t<sub>1.0</sub> 1) I<sup>(1)</sup>=52.8, I<sup>(2)</sup>=56.3,  $\eta\omega=0.349$

A 1988+x, J+6  $\gamma_{1254+x}$  734 (t<sub>1.1</sub> 1) I<sup>(1)</sup>=53.1, I<sup>(2)</sup>=54.8,  $\eta\omega=0.385$

A 2795+x, J+8  $\gamma_{1988+x}$  807 (t<sub>0.9</sub> 1) I<sup>(1)</sup>=53.3, I<sup>(2)</sup>=58.0,  $\eta\omega=0.421$

A 3671+x, J+10  $\gamma_{2795+x}$  876 (t<sub>1.0</sub> 1) I<sup>(1)</sup>=53.7, I<sup>(2)</sup>=58.0,  $\eta\omega=0.455$

A 4616+x, J+12  $\gamma_{3671+x}$  945 (t<sub>1.1</sub> 1) I<sup>(1)</sup>=54.0, I<sup>(2)</sup>=58.8,  $\eta\omega=0.489$

A 5629+x, J+14  $\gamma_{4616+x}$  1013 (t<sub>1.0</sub> 1) I<sup>(1)</sup>=54.3, I<sup>(2)</sup>=56.3,  $\eta\omega=0.524$

A 6713+x, J+16  $\gamma_{5629+x}$  1084 (t<sub>0.8</sub> 1) I<sup>(1)</sup>=54.4, I<sup>(2)</sup>=58.0,  $\eta\omega=0.559$

A 7866+x, J+18  $\gamma_{6713+x}$  1153 (t<sub>0.6</sub> 1) I<sup>(1)</sup>=54.6, I<sup>(2)</sup>=54.1,  $\eta\omega=0.595$

A 9093+x, J+20  $\gamma_{7866+x}$  1227 (t<sub>0.5</sub> 1) I<sup>(1)</sup>=54.6, I<sup>(2)</sup>=51.9,  $\eta\omega=0.633$

A 10397+x, J+22  $\gamma_{9093+x}$  1304 (t<sub>0.5</sub> 1) I<sup>(1)</sup>=54.4, I<sup>(2)</sup>=49.4,  $\eta\omega=0.672$

A 11782+x(?), J+24  $\gamma_{10397+x}$  1385(?) (t<sub>0.3</sub> 1) I<sup>(1)</sup>=54.2, I<sup>(2)</sup>=45.5,  $\eta\omega=0.714$

A 13255+x(?), J+26  $\gamma_{11782+x}$  1473(?) (t<sub>0.4</sub> 1) I<sup>(1)</sup>=53.6

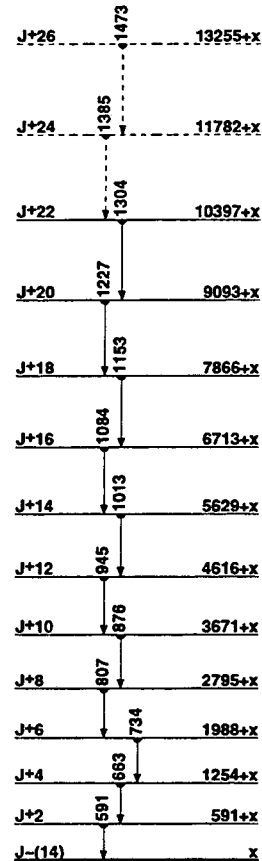

SD band

**134Nd**  
**60Nd**

# 135Nd 60Nd

$\Delta$ : (-76160)  $S_n$ : (8500)  $S_p$ : (4900)  $Q_{EC}$ : (4750)  $Q_\alpha$ : (1100)

## Nuclear Bands

A SD band

### Levels and $\gamma$ -ray branchings:

- 0,  $9/2^-$ , 12.46 m, %EC+% $\beta^+$ =100  
 0+x(?), 5.55 m, %EC+% $\beta^+$ =100  
 198.52, (11/2<sup>-</sup>)  $\gamma_0$  198.52 (†,100) M1+E2  
 463.51(?)  $\gamma_0$  463.51 (†,100)  
 560.54, (13/2<sup>-</sup>)  $\gamma_{199}$  362.24 (†,100 10) M1+E2  $\gamma_0$  560.36 (†,455)  
 792.84, (15/2<sup>-</sup>)  $\gamma_{561}$  232.23 (†,394) M1+E2  $\gamma_{199}$  594.16 (†,100 10) E2  
 1158.86(?)  $\gamma_{199}$  962.010 (†,70)  $\gamma_0$  1158.26 (†,100 30)  
 1176.92  $\gamma_{464}$  713.42 (†,81 10)  $\gamma_{199}$  978.32 (†,100 7)  $\gamma_0$  1177.03 (†,465)  
 1269.65, (17/2<sup>-</sup>)  $\gamma_{783}$  476.55 (†,100 10) M1+E2  $\gamma_{561}$  709.67 (†,536) E2  
 1520.26, (19/2<sup>-</sup>)  $\gamma_{1270}$  250.63 (†,93)  $\gamma_{783}$  727.67 (†,100 10) E2  
 A y, J=(25/2), 1.76 ps  $\gamma$  549.6 (†,0.186)  $\gamma$  620.3 (†,0.103)  $\gamma$  767(?) (†, <0.1)  
 $\gamma$  949(?)  
 A 545.9+y, J+2, 1.04 ps  $\gamma$  529.4 (†,0.206)  $\gamma$  545.9 (†,0.836)  $I^{(1)}$ =51.3,  
 $I^{(2)}$ =70.4,  $\eta\omega$ =0.287  
 A 1148.6+y, J+4, 0.44-<sup>+26</sup><sub>-8</sub> ps  $\gamma_{546+y}$  602.7 (†,1.05 10)  $I^{(1)}$ =53.1,  $I^{(2)}$ =54.2,  
 $\eta\omega$ =0.320  
 A 1825.1+y, J+6, 0.21-<sup>+14</sup><sub>-6</sub> ps  $\gamma_{1148+y}$  676.5 (†,0.806)  $I^{(1)}$ =53.2,  $I^{(2)}$ =55.0,  
 $\eta\omega$ =0.356  
 A 2574.3+y, J+8, <0.15 ps  $\gamma_{1825+y}$  749.2 (†,0.756)  $I^{(1)}$ =53.4,  $I^{(2)}$ =58.7,  
 $\eta\omega$ =0.392  
 A 3391.7+y, J+10  $\gamma_{2574+y}$  817.4 (†,0.657)  $I^{(1)}$ =53.8,  $I^{(2)}$ =61.4,  $\eta\omega$ =0.425  
 A 4274.2+y, J+12  $\gamma_{3392+y}$  882.5 (†,0.667)  $I^{(1)}$ =54.4,  $I^{(2)}$ =62.4,  $\eta\omega$ =0.457  
 A 5220.8+y, J+14  $\gamma_{4274+y}$  946.6 (†,0.557)  $I^{(1)}$ =54.9,  $I^{(2)}$ =62.0,  $\eta\omega$ =0.489  
 A 6231.9+y, J+16  $\gamma_{5221+y}$  1011.1 (†,0.426)  $I^{(1)}$ =55.4,  $I^{(2)}$ =59.6,  $\eta\omega$ =0.522  
 A 7310.1+y, J+18  $\gamma_{6232+y}$  1078.2 (†,0.336)  $I^{(1)}$ =55.6,  $I^{(2)}$ =59.1,  $\eta\omega$ =0.556  
 A 8456.0+y, J+20  $\gamma_{7310+y}$  1145.9 (†,0.256)  $I^{(1)}$ =55.9,  $I^{(2)}$ =57.4,  $\eta\omega$ =0.590  
 A 9671.6+y, J+22  $\gamma_{8456+y}$  1215.6 (†,0.165)  $I^{(1)}$ =55.9,  $I^{(2)}$ =55.6,  $\eta\omega$ =0.626  
 A 10959.1+y, J+24  $\gamma_{9672+y}$  1287.5 (†,0.094)  $I^{(1)}$ =55.9,  $I^{(2)}$ =53.7,  $\eta\omega$ =0.662  
 A 12321.1+y, J+26  $\gamma_{10959+y}$  1362 (†, <0.1)  $I^{(1)}$ =55.8,  $I^{(2)}$ =46.0,  $\eta\omega$ =0.703  
 A 13770.1+y, J+28  $\gamma_{12321+y}$  1449(?)  $I^{(1)}$ =55.2

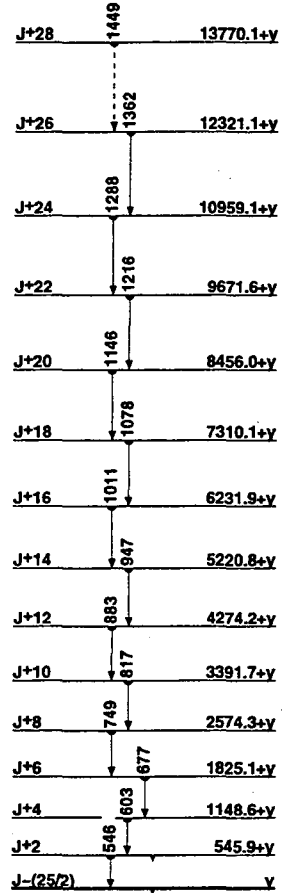

SD band

**135Nd**  
**60Nd**

136Nd  
60Nd

$\Delta$ : -79160 60  $S_n$ : (11070)  $S_p$ : 5540 160  $Q_{EC}$ : 2211 25  $Q_\alpha$ : (860)

Nuclear Bands

- A GS band
- B  $\gamma$  band
- C  $\pi h_{11/2}^{-} \nu g_{7/2}$   $\alpha = -1$
- D  $\pi h_{11/2}^{-} \nu g_{7/2}$   $\alpha = 0$
- E Aligned ( $\nu h_{11/2}$ )<sup>2</sup>
- F Aligned ( $\pi h_{11/2}$ )<sup>2</sup>
- G  $\nu h_{11/2}^{-} \nu g_{7/2}$   $\alpha = -1, \gamma = 60^\circ$
- H  $h_{11/2}^{-} g_{7/2}$   $\alpha = -1$
- I  $\nu h_{11/2}^{-} \nu g_{7/2}$   $\alpha = 0, \gamma = 60^\circ$
- J  $h_{11/2}^{-} g_{7/2}$
- K SD band

Levels and  $\gamma$ -ray branchings:

- A 0, 0<sup>+</sup>, 50.65 33 m, %EC+% $\beta$ <sup>+</sup>=100
- A 373.6 3, 2<sup>+</sup>  $\gamma_{374}$  373.82 (t<sub>1/2</sub> 100) E2
- B 862.51 16, 2<sup>+</sup>  $\gamma_{374}$  488.72 (t<sub>1/2</sub> 98 10) E2+M1  $\gamma_{863}$  862.52 (t<sub>1/2</sub> 100 10) E2
- A 976.3 4, 4<sup>+</sup>, <8 ps  $\gamma_{374}$  602.72 (t<sub>1/2</sub> 100) E2
- B 1231.04 18, (3<sup>+</sup>)  $\gamma_{976}$  254.72 (t<sub>1/2</sub> 2)  $\gamma_{863}$  368.72 (t<sub>1/2</sub> 27 3)  $\gamma_{374}$  857.22 (t<sub>1/2</sub> 100 10) E2+M1
- B 1541.77 20, (4<sup>+</sup>)  $\gamma_{976}$  565.22 (t<sub>1/2</sub> 33 4)  $\gamma_{863}$  679.22 (t<sub>1/2</sub> 100 10)
- A 1746.8 5, 6<sup>+</sup>, <14 ps  $\gamma_{976}$  770.32 (t<sub>1/2</sub> 100) E2
- 1775.6 3  $\gamma_{374}$  1401.82 (t<sub>1/2</sub> 100)
- 1817.83 21  $\gamma_{1231}$  586.92 (t<sub>1/2</sub> 100 10)  $\gamma_{863}$  955.22 (t<sub>1/2</sub> 100 10)
- 1926.03 24  $\gamma_{1231}$  695.02 (t<sub>1/2</sub> 100)
- C 2035.9 5, 5(-)  $\gamma_{976}$  1059.42 (t<sub>1/2</sub> 100) D
- B 2045.9 5, (5<sup>+</sup>)  $\gamma_{1542}$  503.72 (t<sub>1/2</sub> 4.3 4)  $\gamma_{1231}$  814.72 (t<sub>1/2</sub> 100 10) Q  $\gamma_{976}$  1069.12 (t<sub>1/2</sub> 16.1 16)
- 2181.2 3  $\gamma_{976}$  1204.72 (t<sub>1/2</sub> 100)
- 2227.93 24, (3,4,5)  $\gamma_{2036}$  192.42 (t<sub>1/2</sub> 7 8)  $\gamma_{976}$  1251.32 (t<sub>1/2</sub> 100 10)
- 2346.22 25  $\gamma_{2046}$  300.62 (t<sub>1/2</sub> 100 10)  $\gamma_{1926}$  420.22 (t<sub>1/2</sub> 31 3)
- 2416.7 3  $\gamma_{2046}$  371.72 (t<sub>1/2</sub> 100)
- C 2439.9 5, 7(-), 21 7 ps  $\gamma_{2036}$  404.52 (t<sub>1/2</sub> 29.4 10) E2  $\gamma_{1747}$  693.12 (t<sub>1/2</sub> 100.0 14)
- D 2483.9 5, 6(-)  $\gamma_{2046}$  438.14 (t<sub>1/2</sub> 59 9)  $\gamma_{2036}$  448.05 (t<sub>1/2</sub> 77 9) D  $\gamma_{1747}$  737.15 (t<sub>1/2</sub> 100 18) D
- 2522.9 3  $\gamma_{863}$  1660.42 (t<sub>1/2</sub> 100)
- A 2632.7 7, 8<sup>+</sup>, <7 ps  $\gamma_{1747}$  886.13 (t<sub>1/2</sub> 100) E2
- D 2757.8 5, 8(-)  $\gamma_{2484}$  273.93 (t<sub>1/2</sub> 66 4) Q  $\gamma_{2440}$  317.93 (t<sub>1/2</sub> 100 4) D
- C 2941.1 5, 9(-), 6 2 ps  $\gamma_{2440}$  501.23 (t<sub>1/2</sub> 100) E2
- D 3244.4 6, (10<sup>-</sup>)  $\gamma_{2941}$  303.33 (t<sub>1/2</sub> 31 3) D  $\gamma_{2758}$  486.53 (t<sub>1/2</sub> 100 4) Q
- E 3278.7 6, 10<sup>+</sup>  $\gamma_{2633}$  645.83 (t<sub>1/2</sub> 100) Q
- F 3296.5 6, 10<sup>+</sup>, 51 6 ps,  $\mu = +11.7$  39  $\gamma_{2941}$  355.43 (t<sub>1/2</sub> 35.9 9)  $\gamma_{2633}$  663.53 (t<sub>1/2</sub> 100.0 21) E2
- A 3552.6 6, 10<sup>+</sup>  $\gamma_{2633}$  919.73 (t<sub>1/2</sub> 100) Q
- C 3602.3 6, 11(-)  $\gamma_{2941}$  661.23 (t<sub>1/2</sub> 100) Q
- F 3686.5 6, 12<sup>+</sup>, 19 3 ps,  $\mu = +14.0$  46  $\gamma_{2297}$  390.73 (t<sub>1/2</sub> 100) E2
- G 3768.2 7, (9<sup>-</sup>)  $\gamma_{2633}$  1135.15 (t<sub>1/2</sub> 100) D
- E 3997.3 7, (12<sup>+</sup>)  $\gamma_{3279}$  718.63 (t<sub>1/2</sub> 100) Q
- D 4016.8 8, (12<sup>-</sup>)  $\gamma_{3244}$  772.45 (t<sub>1/2</sub> 100)
- G 4320.0 6, (11<sup>-</sup>)  $\gamma_{3768}$  551.83 (t<sub>1/2</sub> 29 3) Q  $\gamma_{3553}$  767.53 (t<sub>1/2</sub> 100 3) D
- F 4347.5 6, 14<sup>+</sup>, <4 ps  $\gamma_{3687}$  661.03 (t<sub>1/2</sub> 100) E2
- C 4426.6 6, (13<sup>-</sup>)  $\gamma_{3602}$  824.33 (t<sub>1/2</sub> 4.7 3) Q
- H 4455.7 7, (12<sup>-</sup>)  $\gamma_{3687}$  769.25 (t<sub>1/2</sub> 15.7 9)
- E 4849.1 8, (14<sup>+</sup>)  $\gamma_{3997}$  851.83 (t<sub>1/2</sub> 100) Q
- J 4855.9 7, (13<sup>-</sup>)  $\gamma_{3687}$  1169.35 (t<sub>1/2</sub> 100) D
- I 5022.5 7, (12<sup>-</sup>)  $\gamma_{4320}$  702.53 (t<sub>1/2</sub> 100) D
- D 5022.7 8, (14<sup>-</sup>)  $\gamma_{4017}$  1005.93 (t<sub>1/2</sub> 100) Q
- G 5032.0 7, (13<sup>-</sup>)  $\gamma_{4320}$  711.95 (t<sub>1/2</sub> 100) Q
- H 5132.7 8, (14<sup>-</sup>)  $\gamma_{4456}$  677.05 (t<sub>1/2</sub> 7 4 12) Q  $\gamma_{4348}$  785.25 (t<sub>1/2</sub> 100 6) D
- F 5192.2 7, (16<sup>+</sup>)  $\gamma_{4348}$  844.73 (t<sub>1/2</sub> 100) Q
- C 5415.8 7, (15<sup>-</sup>)  $\gamma_{4427}$  989.13 (t<sub>1/2</sub> 1.9 3) Q
- J 5570.2 7, (15<sup>-</sup>)  $\gamma_{4856}$  714.33 (t<sub>1/2</sub> 93 22) Q  $\gamma_{4348}$  1222.74 (t<sub>1/2</sub> 100 36) D
- I 5695.6 7, (14<sup>-</sup>)  $\gamma_{5032}$  663.35 (t<sub>1/2</sub> 72 21)  $\gamma_{5022.5}$  673.13 (t<sub>1/2</sub> 100 7) Q
- E 5844.1 8, (16<sup>+</sup>)  $\gamma_{4849}$  994.93 (t<sub>1/2</sub> 100) Q
- G 5876.0 9(?), (15<sup>-</sup>)  $\gamma_{5032}$  844.05(?)
- H 5942.2 9, (16<sup>-</sup>)  $\gamma_{5133}$  809.55 (t<sub>1/2</sub> 100)
- D 6040.4 9, (16<sup>-</sup>)  $\gamma_{5022.7}$  1017.73 (t<sub>1/2</sub> 100) Q
- F 6191.7 7, (18<sup>+</sup>)  $\gamma_{5192}$  999.53 (t<sub>1/2</sub> 100) Q

- C 6360.6 7, (17<sup>-</sup>)  $\gamma_{5416}$  944.83 (t<sub>1/2</sub> 84 8) Q  $\gamma_{5192}$  1168.43 (t<sub>1/2</sub> 100 8) D
- J 6472.1 9(?), (17<sup>-</sup>)  $\gamma_{5570}$  901.95(?)
- I 6522.7 8, (16<sup>-</sup>)  $\gamma_{5696}$  827.13 (t<sub>1/2</sub> 100)
- D 6675.9 9, (18<sup>-</sup>)  $\gamma_{6040}$  635.53 (t<sub>1/2</sub> 100)
- E 6756.3 9, (18<sup>+</sup>)  $\gamma_{5844}$  912.23 (t<sub>1/2</sub> 100) Q
- G 6771.0 14(?), (17<sup>-</sup>)  $\gamma_{5876}$  895.1(?)
- H 6930.8 10, (18<sup>-</sup>)  $\gamma_{5942}$  988.65 (t<sub>1/2</sub> 100) Q
- C 7142.1 8, (19<sup>-</sup>)  $\gamma_{6361}$  781.54 (t<sub>1/2</sub> 100) Q
- F 7238.1 9, (20<sup>+</sup>)  $\gamma_{5192}$  1046.45 (t<sub>1/2</sub> 100) Q
- I 7374.4 9(?), (18<sup>-</sup>)  $\gamma_{6523}$  851.73(?)
- J 7497.1 14(?), (19<sup>-</sup>)  $\gamma_{6472}$  1025.1(?)
- D 7533.4 10, (20<sup>-</sup>)  $\gamma_{6676}$  857.54 (t<sub>1/2</sub> 100)
- H 8025.8 14(?), (20<sup>-</sup>)  $\gamma_{6931}$  1095.1(?)
- C 8050.1 9, (21<sup>-</sup>)  $\gamma_{7142}$  908.05 (t<sub>1/2</sub> 100) Q
- F 8329.1 14(?), (22<sup>+</sup>)  $\gamma_{7238}$  1091.1(?)
- D 8566.4 14(?), (22<sup>-</sup>)  $\gamma_{7533}$  1033.1(?)
- C 9072.7 11(?), (23<sup>-</sup>)  $\gamma_{8050}$  1022.65(?)
- D 9728.4 18(?), (24<sup>-</sup>)  $\gamma_{8566}$  1162.1(?)
- C 10175.7 15(?), (25<sup>-</sup>)  $\gamma_{9073}$  1103.1(?)
- K x, J=(16)
- K 718+x, J+2  $\gamma_x$  718 (t<sub>1/2</sub> 0.4 1) I<sup>(1)</sup>=48.7, I<sup>(2)</sup>=51.3,  $\eta\omega=0.379$
- K 1514+x, J+4  $\gamma_{718+x}$  796 (t<sub>1/2</sub> 1.0 1) I<sup>(1)</sup>=49.0, I<sup>(2)</sup>=65.6,  $\eta\omega=0.413$
- K 2371+x, J+6  $\gamma_{1514+x}$  857 (t<sub>1/2</sub> 1.1 1) I<sup>(1)</sup>=50.2, I<sup>(2)</sup>=64.5,  $\eta\omega=0.444$
- K 3290+x, J+8  $\gamma_{2371+x}$  919 (t<sub>1/2</sub> 1.0 1) I<sup>(1)</sup>=51.1, I<sup>(2)</sup>=61.5,  $\eta\omega=0.476$
- K 4274+x, J+10  $\gamma_{3290+x}$  984 (t<sub>1/2</sub> 0.9 1) I<sup>(1)</sup>=51.8, I<sup>(2)</sup>=60.6,  $\eta\omega=0.508$
- K 5324+x, J+12  $\gamma_{4274+x}$  1050 (t<sub>1/2</sub> 0.8 1) I<sup>(1)</sup>=52.4, I<sup>(2)</sup>=58.8,  $\eta\omega=0.542$
- K 6442+x, J+14  $\gamma_{5324+x}$  1118 (t<sub>1/2</sub> 0.7 1) I<sup>(1)</sup>=52.8, I<sup>(2)</sup>=58.8,  $\eta\omega=0.576$
- K 7628+x, J+16  $\gamma_{6442+x}$  1186 (t<sub>1/2</sub> 0.6 1) I<sup>(1)</sup>=53.1, I<sup>(2)</sup>=57.1,  $\eta\omega=0.611$
- K 8884+x, J+18  $\gamma_{7628+x}$  1256 (t<sub>1/2</sub> 0.5 1) I<sup>(1)</sup>=53.3, I<sup>(2)</sup>=57.1,  $\eta\omega=0.646$
- K 10210+x, J+20  $\gamma_{8884+x}$  1326 (t<sub>1/2</sub> 0.4 1) I<sup>(1)</sup>=53.5, I<sup>(2)</sup>=54.8,  $\eta\omega=0.681$
- K 11609+x, J+22  $\gamma_{10210+x}$  1399 (t<sub>1/2</sub> 0.3 1) I<sup>(1)</sup>=53.6, I<sup>(2)</sup>=49.4,  $\eta\omega=0.720$
- K 13089+x, J+24  $\gamma_{11609+x}$  1480(?) (t<sub>1/2</sub> 0.2 1) I<sup>(1)</sup>=53.4

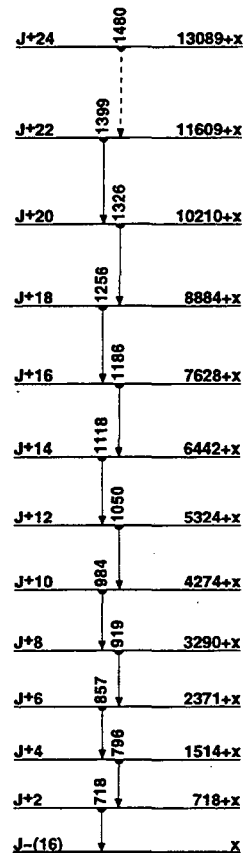

SD band

136Nd  
60Nd

**137  
60Nd**

$\Delta$ : -79510 70  $S_n$ : 8430 60  $S_p$ : 5430 60  $Q_{EC}$ : 3690.50  $Q_\alpha$ : (450)

**Nuclear Bands**

A SD band

**Levels and  $\gamma$ -ray branchings:**

0, 1/2<sup>+</sup>, 38.5 15 m, %EC+% $\beta$ <sup>+</sup>=100

108.62, 3/2<sup>+</sup>  $\gamma_{108.62}$  (†,100) M1(+E2)

268.73, (3/2)<sup>+</sup>  $\gamma_{109}$  160.54 (†,19.44) M1,E2  $\gamma_{268.73}$  (†,100.0 $\theta$ ) M1,E2

286.02, 5/2<sup>+</sup>  $\gamma_{109}$  177.52 (†,100.0 $\theta$ ) M1(+E2)  $\gamma_{286.02}$  (†,39.92) E2

519.65, 11/2<sup>+</sup>, 1.60 15 s, %IT=100  $\gamma_{286}$  233.63 (†,100) E3

614.96, 7/2<sup>+</sup>  $\gamma_{286}$  328.55 (†,47.1) M1,E2  $\gamma_{109}$  506.010 (†,100 25)

797.86  $\gamma_{286}$  512.010(?)  $\gamma_{269}$  529.24 (†,100)

834.56, (7/2)<sup>+</sup>  $\gamma_{286}$  548.83 (†,100 2)  $\gamma_{269}$  565.63 (†, <66)

851.56, (7/2)<sup>+</sup>  $\gamma_{286}$  565.63 (†, <395)  $\gamma_{109}$  743.34 (†,100 6)

976.86, 9/2<sup>+</sup>  $\gamma_{620}$  457.35 (†,100 2)  $\gamma_{286}$  690.83 (†,69 2) M2

1100.0 10, (13/2)<sup>-</sup>  $\gamma_{520}$  581.1 (†,100) D+Q

1188.66, (15/2)<sup>-</sup>  $\gamma_{520}$  669.03 (†,100) Q

1374.57, (7/2<sup>-</sup>, 5/2<sup>-</sup>)  $\gamma_{977}$  397.73 (†,100 3)  $\gamma_{615}$  759.55 (†,91 3)

1510.68, (11/2)<sup>-</sup>  $\gamma_{1100}$  410.65 (†,100 2) M1,E2  $\gamma_{977}$  533.84 (†, <75)

$\gamma_{852}$  658.63 (†,7.5 5)

1682.0 14, (15/2)<sup>-</sup>  $\gamma_{1189}$  493.5(?) (†,10 1)  $\gamma_{1100}$  582.1 (†,100 8) M1+E2

1707.18, (9/2, 11/2)<sup>-</sup>  $\gamma_{615}$  1092.25 (†,100)

1788.5(?)  $\gamma_{1375}$  414.05 (†,100) M1,E2

1894.4 14, (17/2)<sup>-</sup>  $\gamma_{1189}$  705.63 (†,100 3) M1+E2  $\gamma_{1100}$  794.1 (†,26 4) Q

1899.5 8, 9/2<sup>-</sup>, 11/2<sup>-</sup>  $\gamma_{1707}$  192.94 (†,8.3 5)  $\gamma_{1511}$  389.23 (†,43.5 5) M1,E2

$\gamma_{1375}$  525.14 (†,20.7 52)  $\gamma_{1100}$  798.65 (†,7.3 5)  $\gamma_{977}$  923.05 (†,35.2 10)

$\gamma_{852}$  1047.65 (†,10.4 5)  $\gamma_{835}$  1064.75 (†,14.5 5)  $\gamma_{615}$  1284.75 (†,100 2)

1976.5 15, (19/2)<sup>-</sup>  $\gamma_{1682}$  295.03 (†,86 4) Q  $\gamma_{1189}$  788.1 (†,100 15) Q

1987.7 9, (9/2, 11/2)<sup>-</sup>  $\gamma_{1789}$  199.05  $\gamma_{788}$  1189.95 (†,100 3)

2222.5 16, (19/2)<sup>-</sup>  $\gamma_{1894}$  328.13 (†,100) D

2370.2 10,  $\gamma_{1800}$  470.73 (†,100 1) M1,E2  $\gamma_{1375}$  994.75 (†,11.5 10)

2433.3 10  $\gamma_{1800}$  533.84 (†,100)

2629.1 17, (23/2)<sup>-</sup>  $\gamma_{2223}$  406.73 (†,100) Q

2722.5 10  $\gamma_{2370}$  352.33 (†,100 3) M1,E2  $\gamma_{1988}$  735.05 (†,27 1)  $\gamma_{1800}$  821.75

(†,60 3)

2803.9 10  $\gamma_{2433}$  370.63 (†,100 1) M1,E2  $\gamma_{2370}$  434.03 (†,22.9 12)

$\gamma_{1511}$  1293.55 (†,36 1)

2818.8 17, (21/2)<sup>-</sup>  $\gamma_{1894}$  924.5 (†,100)

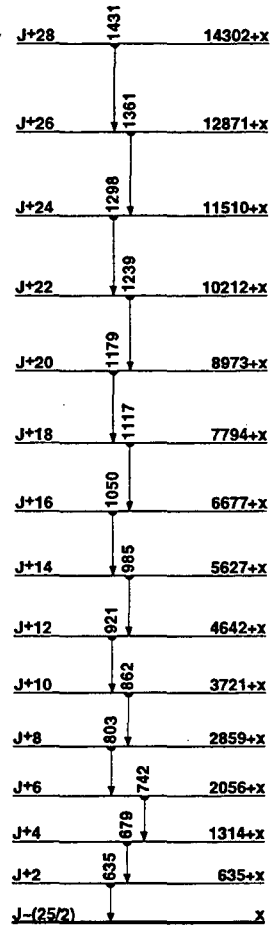

SD band

**137  
60Nd**

A x, J=(25/2)

A 635+x, J+2  $\gamma_{635}$  (†,0.60 7) I<sup>(1)</sup>=44.1, I<sup>(2)</sup>=90.9,  $\eta\omega$ =0.329

A 1314+x, J+4  $\gamma_{635+x}$  679 (†,0.85 8) I<sup>(1)</sup>=47.1, I<sup>(2)</sup>=63.5,  $\eta\omega$ =0.355

A 2056+x, J+6  $\gamma_{1314+x}$  742 (†,0.78 8) I<sup>(1)</sup>=48.5, I<sup>(2)</sup>=65.6,  $\eta\omega$ =0.386

A 2859+x, J+8  $\gamma_{2056+x}$  803 (†,0.80 8) I<sup>(1)</sup>=49.8, I<sup>(2)</sup>=67.8,  $\eta\omega$ =0.416

A 3721+x, J+10  $\gamma_{2859+x}$  862 (†,1.00 10) I<sup>(1)</sup>=51.0, I<sup>(2)</sup>=67.8,  $\eta\omega$ =0.446

A 4642+x, J+12  $\gamma_{3721+x}$  921 (†,0.90 10) I<sup>(1)</sup>=52.1, I<sup>(2)</sup>=62.5,  $\eta\omega$ =0.476

A 5627+x, J+14  $\gamma_{4642+x}$  985 (†,0.75 8) I<sup>(1)</sup>=52.8, I<sup>(2)</sup>=61.5,  $\eta\omega$ =0.509

A 6677+x, J+16  $\gamma_{5627+x}$  1050 (†,0.63 8) I<sup>(1)</sup>=53.3, I<sup>(2)</sup>=59.7,  $\eta\omega$ =0.542

A 7794+x, J+18  $\gamma_{6677+x}$  1117 (†,0.45 5) I<sup>(1)</sup>=53.7, I<sup>(2)</sup>=64.5,  $\eta\omega$ =0.574

A 8973+x, J+20  $\gamma_{7794+x}$  1179 (†,0.37 5) I<sup>(1)</sup>=54.3, I<sup>(2)</sup>=66.7,  $\eta\omega$ =0.604

A 10212+x, J+22  $\gamma_{8973+x}$  1239 (†,0.25 5) I<sup>(1)</sup>=54.9, I<sup>(2)</sup>=67.8,  $\eta\omega$ =0.634

A 11510+x, J+24  $\gamma_{10212+x}$  1298 (†,0.20 5) I<sup>(1)</sup>=55.5, I<sup>(2)</sup>=63.5,  $\eta\omega$ =0.665

A 12871+x, J+26  $\gamma_{11510+x}$  1361 (†,0.15 5) I<sup>(1)</sup>=55.8, I<sup>(2)</sup>=57.1,  $\eta\omega$ =0.698

A 14302+x, J+28  $\gamma_{12871+x}$  1431 (†,0.10 3) I<sup>(1)</sup>=55.9

**142Sm**  
**62**

$\Delta$ : -78987 15  $S_n$ : 11115 19  $S_p$ : 5790 30  $Q_{ec}$ : 2100 50  $Q_{\alpha}$ : (620)

**Nuclear Bands**

A SD band

**Levels and  $\gamma$ -ray branchings:**

- 0, 0<sup>+</sup>, 72.49 5 m, %EC+% $\beta^+$ =100
- 768.0 2, 2<sup>+</sup>  $\gamma_{768}$  768.0 2 ( $\dagger_{\gamma}$  100) E2
- 1450.2 8, (0<sup>+</sup>)  $\gamma_{768}$  682.2 7 ( $\dagger_{\gamma}$  100)
- 1572 6
- 1657.7 3, (2<sup>+</sup>)  $\gamma_{768}$  889.6 3 ( $\dagger_{\gamma}$  100 9)  $\gamma_0$  1658.1 5 ( $\dagger_{\gamma}$  98 23)
- 1784.1 3, 3<sup>+</sup>  $\gamma_{768}$  1016.1 2 ( $\dagger_{\gamma}$  100) (E1)
- 1791.2 3, 4<sup>+</sup>  $\gamma_{768}$  1023.3 2 ( $\dagger_{\gamma}$  100) E2
- 2055.4 4, 2<sup>+</sup>  $\gamma_{768}$  1287.4 3 ( $\dagger_{\gamma}$  100 9)  $\gamma_0$  2055.5 10 ( $\dagger_{\gamma}$  37 5)
- 2173.2 5, 0<sup>+</sup>  $\gamma_{768}$  1405.2 4 ( $\dagger_{\gamma}$  100)
- 2280 3, 0<sup>+</sup>
- 2347.7 3, 5<sup>-</sup>  $\gamma_{1791}$  556.6 2 ( $\dagger_{\gamma}$  100 3) E1  $\gamma_{1784}$  563.7 2 ( $\dagger_{\gamma}$  9.6 5) E2, (M1)
- 2371.8 4, 7<sup>-</sup>, 170 2 ns,  $\mu=+0.06$ ,  $Q=+1.12 27$   $\gamma_{2348}$  24.1 3 ( $\dagger_{\gamma}$  95.0) E2
- $\gamma_{1791}$  580.7 4 (?) ( $\dagger_{\gamma}$  95.0=0.5)
- 2415.9 1, (4)  $\gamma_{1784}$  637.8
- 2420.0 3, 6<sup>+</sup>, <2 ns  $\gamma_{1791}$  628.7 2 ( $\dagger_{\gamma}$  100)
- 2497 2
- 2582.2, 4<sup>+</sup>
- 2656 2
- 2747 6, (2<sup>+</sup>)
- 2867 1, 4<sup>+</sup>
- 2911.8 4, 7<sup>-</sup>  $\gamma_{2420}$  491.8  $\gamma_{2372}$  540.0 2 1 ( $\dagger_{\gamma}$  00) M1
- 2955 2, 4<sup>+</sup>
- 3002.9 1, (6<sup>+</sup>)  $\gamma_{1791}$  1211.7 ( $\dagger_{\gamma}$  100)
- 3007 5
- 3052 3
- 3112.9 4, 8<sup>-</sup>  $\gamma_{2912}$  200.9 5 ( $\dagger_{\gamma}$  65 12) E2, M1  $\gamma_{2372}$  741.2 2 ( $\dagger_{\gamma}$  100 12)
- 3118 4
- 3182 1
- 3219.8 5 (?)  $\gamma_{2372}$  848.0 3 ( $\dagger_{\gamma}$  100)
- 3245 4
- 3326.1 4, 8<sup>+</sup>  $\gamma_{2420}$  906.4 3 ( $\dagger_{\gamma}$  86 21)  $\gamma_{2372}$  954.3 2 ( $\dagger_{\gamma}$  100 14)
- 3386.6 5, 9<sup>-</sup>  $\gamma_{3113}$  273.8 5 ( $\dagger_{\gamma}$  100 17) E2, M1  $\gamma_{2912}$  474.4 5 ( $\dagger_{\gamma}$  63 8)
- 3570.8 4  $\gamma_{2420}$  1151.0 3 ( $\dagger_{\gamma}$  90 18)  $\gamma_{2372}$  1198.8 3 ( $\dagger_{\gamma}$  100 26)
- 3639.7 1, 11<sup>-</sup>  $\gamma_{3387}$  253.1 ( $\dagger_{\gamma}$  100)
- 3661.9 7, 10<sup>+</sup>, 480 60 ns  $\gamma_{3387}$  275.1  $\gamma_{3326}$  336.0  $\gamma_{2372}$  1290.3
- 3713.7 4  $\gamma_{2372}$  1341.9 2 ( $\dagger_{\gamma}$  100)
- 3798.6 4  $\gamma_{2912}$  886.7 2 ( $\dagger_{\gamma}$  88 9)  $\gamma_{2372}$  1426.8 3 ( $\dagger_{\gamma}$  100 19)
- 3825.7 8, 10<sup>+</sup>  $\gamma_{3662}$  163.9  $\gamma_{3387}$  438.9 ( $\dagger_{\gamma}$  100)
- 3974.4 8, 10<sup>-</sup>  $\gamma_{3387}$  587.7  $\gamma_{3113}$  861.6
- 4072.1 4, (7<sup>-</sup>)  $\gamma_{2420}$  1652.1 3 ( $\dagger_{\gamma}$  35 7)  $\gamma_{2372}$  1700.1 3 ( $\dagger_{\gamma}$  100 8)  $\gamma_{2348}$  1724.5 4 ( $\dagger_{\gamma}$  14 5)
- 4210.4 5  $\gamma_{2372}$  1838.6 3 ( $\dagger_{\gamma}$  100 11)
- 4293.8 9, 11<sup>-</sup>  $\gamma_{3974}$  319.4  $\gamma_{3387}$  907.2
- 4309.1 4, (7<sup>-</sup>)  $\gamma_{3326}$  982.0 5 ( $\dagger_{\gamma}$  47 10)  $\gamma_{2420}$  1889.0 4 ( $\dagger_{\gamma}$  29 6)  $\gamma_{2372}$  1937.6 3 ( $\dagger_{\gamma}$  100 12)
- 4371.6 1, 11<sup>-</sup>  $\gamma_{3974}$  397.1  $\gamma_{3387}$  985
- 4541.3 1, 11<sup>+</sup>  $\gamma_{3826}$  715.6
- 4546.7 1, 13<sup>-</sup>, 2.6 6 ns  $\gamma_{4372}$  175.1  $\gamma_{4284}$  252.9
- 4630.3 4  $\gamma_{2372}$  2258.4 2 ( $\dagger_{\gamma}$  100 9)
- 4745.7 1, 12<sup>+</sup>  $\gamma_{3826}$  920.0 ( $\dagger_{\gamma}$  100)
- 4970.1, (11<sup>+</sup>)  $\gamma_{3662}$  1308.4
- 5048.1, 12  $\gamma_{4570}$  78.1  $\gamma_{4746}$  302.5  $\gamma_{4541}$  506.7
- 5133.5, 13  $\gamma_{5048}$  85.5  $\gamma_{4746}$  387.7
- 5223.9, 14  $\gamma_{5134}$  90.5  $\gamma_{4547}$  677.1
- 5417.7, 15  $\gamma_{5224}$  193.8 ( $\dagger_{\gamma}$  100)
- 5763.6, 16  $\gamma_{5418}$  345.7 ( $\dagger_{\gamma}$  100)
- 5802.9, 16  $\gamma_{5418}$  385.2
- 6089.8  $\gamma_{5803}$  286.9

A x, J=(29)

- A 799.7+x, J+2  $\gamma_x$  799.7 2 ( $\dagger_{\gamma}$  0.64 11)  $I^{(1)}=76.3, I^{(2)}=66.2, \hbar\omega=0.415$
- A 1659.8+x, J+4  $\gamma_{800+x}$  860.1 3 ( $\dagger_{\gamma}$  0.77 12)  $I^{(1)}=75.6, I^{(2)}=66.3, \hbar\omega=0.445$
- A 2580.2+x, J+6  $\gamma_{1660+x}$  920.4 2  $I^{(1)}=75.0, I^{(2)}=66.1, \hbar\omega=0.475$
- A 3561.1+x, J+8  $\gamma_{2580+x}$  980.9 2 ( $\dagger_{\gamma}$  1.00)  $I^{(1)}=74.4, I^{(2)}=65.7, \hbar\omega=0.506$
- A 4602.9+x, J+10  $\gamma_{3561+x}$  1041.8 3 ( $\dagger_{\gamma}$  0.94 18)  $I^{(1)}=73.9, I^{(2)}=66.2, \hbar\omega=0.536$
- A 5705.1+x, J+12  $\gamma_{4603+x}$  1102.2 2 ( $\dagger_{\gamma}$  0.98 16)  $I^{(1)}=73.5, I^{(2)}=65.6, \hbar\omega=0.566$
- A 6868.3+x, J+14  $\gamma_{5705+x}$  1163.2 3 ( $\dagger_{\gamma}$  0.92 15)  $I^{(1)}=73.1, I^{(2)}=64.7, \hbar\omega=0.597$

- A 8093.3+x, J+16  $\gamma_{6868+x}$  1225.0 2 ( $\dagger_{\gamma}$  1.09 13)  $I^{(1)}=72.7, I^{(2)}=65.9, \hbar\omega=0.628$
- A 9379.0+x, J+18  $\gamma_{8093+x}$  1285.7 3 ( $\dagger_{\gamma}$  0.55 12)  $I^{(1)}=72.3, I^{(2)}=63.8, \hbar\omega=0.659$
- A 10727.4+x, J+20  $\gamma_{9379+x}$  1348.4 4 ( $\dagger_{\gamma}$  0.54 11)  $I^{(1)}=71.9, I^{(2)}=63.3, \hbar\omega=0.690$
- A 12139.0+x, J+22  $\gamma_{10727+x}$  1411.6 3 ( $\dagger_{\gamma}$  0.49 11)  $I^{(1)}=71.6, I^{(2)}=63.8, \hbar\omega=0.721$
- A 13613.3+x, J+24  $\gamma_{12139+x}$  1474.3 6 ( $\dagger_{\gamma}$  0.44 11)  $I^{(1)}=71.2, I^{(2)}=62.6, \hbar\omega=0.753$
- A 15151.5+x, J+26  $\gamma_{13613+x}$  1538.2 7 (?) ( $\dagger_{\gamma}$  0.34 10)  $I^{(1)}=70.9, I^{(2)}=61.3, \hbar\omega=0.785$
- A 16755.0+x, J+28  $\gamma_{15152+x}$  1603.5 8 (?) ( $\dagger_{\gamma}$  0.27 10)  $I^{(1)}=70.5$

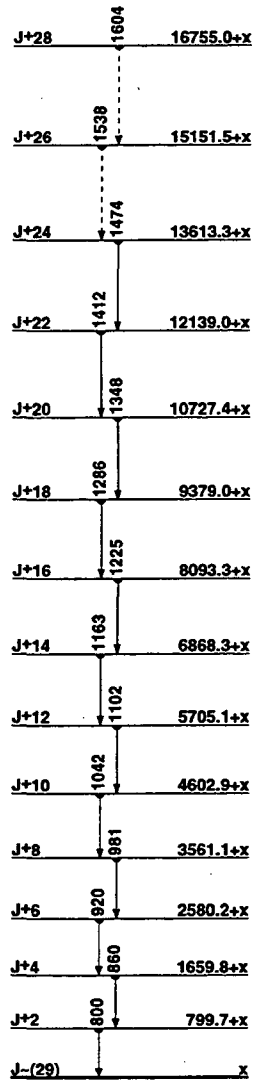

143Eu  
63Eu

$\Delta$ : -74360 40  $S_n$ : 10800 100  $S_p$ : 2660 40  $Q_{EC}$ : 5170 40  $Q_\alpha$ : 740 60

Nuclear Bands

A SD band

Levels and  $\gamma$ -ray branchings:

- 0, 5/2<sup>+</sup>, 2.63 s m, %EC+% $\beta^+$ =100  
 258.82 3, (3/2)<sup>+</sup>  $\gamma_0$  258.813 (t<sub>1/2</sub> 100) (M1)  
 271.93 3, 7/2<sup>+</sup>  $\gamma_0$  271.943 (t<sub>1/2</sub> 100) M1  
 389.51 4, 11/2<sup>+</sup>, 50.0 s  $\mu$ s  $\gamma_{272}$  117.575 (t<sub>1/2</sub> 100 8) M2  $\gamma_0$  389.475 (t<sub>1/2</sub> 53 4) E3  
 463.61 5, (1/2)<sup>+</sup>  $\gamma_{259}$  204.775 (t<sub>1/2</sub> 100 7) M1, E2  $\gamma_0$  463.71 (t<sub>1/2</sub> 51 4)  
 804.1 3  $\gamma_{464}$  340.53 (t<sub>1/2</sub> 100)  
 812.90 10, (1/2, 3/2)<sup>+</sup>  $\gamma_{259}$  554.13 (t<sub>1/2</sub> 14 7)  $\gamma_0$  812.91 (t<sub>1/2</sub> 100 10)  
 906.94 6, 9/2<sup>+</sup>  $\gamma_0$  906.966 (t<sub>1/2</sub> 100) E2  
 977.48 4, (9/2)<sup>-</sup>  $\gamma_{390}$  588.003 (t<sub>1/2</sub> 100) M1+E2  
 1057.42 6, 11/2<sup>+</sup>  $\gamma_{272}$  785.566 (t<sub>1/2</sub> 100) E2  
 1057.66 5, 13/2<sup>+</sup>  $\gamma_{390}$  668.103 (t<sub>1/2</sub> 100) M1+E2:  $\delta = -0.75_{-73}^{+23}$   
 1088.31 11  $\gamma_{390}$  698.81 (t<sub>1/2</sub> 100)  
 1188.42 5, 11/2<sup>-</sup>  $\gamma_{1067}$  131.11 (t<sub>1/2</sub> 3.5 6)  $\gamma_{977}$  210.91 (t<sub>1/2</sub> 10 1) M1  $\gamma_{390}$  798.89 6  
 (t<sub>1/2</sub> 100 7) E2+M1  
 1213.94 10, 11/2<sup>-</sup>  $\gamma_{390}$  824.43 9 (t<sub>1/2</sub> 100) E2(+M1)  
 1256.88 6, 11/2<sup>+</sup>  $\gamma_{272}$  984.93 5 (t<sub>1/2</sub> 100) E2  
 1306.10 6, 15/2<sup>+</sup>  $\gamma_{1058}$  248.41 (t<sub>1/2</sub> 67 9) D  $\gamma_{390}$  916.53 5 (t<sub>1/2</sub> 100 17) E2  
 1331.24 11, 11/2<sup>+</sup>  $\gamma_{272}$  1059.31 (t<sub>1/2</sub> 100) Q  
 1405.58 21  $\gamma_{977}$  428.12 (t<sub>1/2</sub> 100)  
 1497.74 20  $\gamma_{907}$  590.82 (t<sub>1/2</sub> 100 50)  $\gamma_{272}$  1225.85 (t<sub>1/2</sub> 75 25)  
 1543.0 4 (?), (1/2, 3/2)<sup>+</sup>  $\gamma_{259}$  1284.24 (t<sub>1/2</sub> 100)  
 1565.24 21  $\gamma_{272}$  1293.32 (t<sub>1/2</sub> 100)  
 1602.62 7  $\gamma_{1057}$  545.31 (t<sub>1/2</sub> 50 7)  $\gamma_{977}$  625.23 8 (t<sub>1/2</sub> 100 7)  $\gamma_{390}$  1213.1 3 (t<sub>1/2</sub> 47 7)  
 1676.50 8  $\gamma_{272}$  1404.56 7 (t<sub>1/2</sub> 100)  
 1723.6 4 (?), (1/2, 3/2)<sup>+</sup>  $\gamma_{259}$  1464.8 4 (t<sub>1/2</sub> 100)  
 1754.23 8  $\gamma_{1257}$  497.31 (t<sub>1/2</sub> 70 10)  $\gamma_{977}$  776.81 (t<sub>1/2</sub> 100 10) M1  
 1761.74 21  $\gamma_{272}$  1489.8 2 (t<sub>1/2</sub> 100)  
 1892.45 8, (15/2)<sup>-</sup>  $\gamma_{1058}$  834.31 (t<sub>1/2</sub> 47 4)  $\gamma_{390}$  1503.41 (t<sub>1/2</sub> 100 7)  
 1903.62 15  $\gamma_{1058}$  845.5 2 (t<sub>1/2</sub> 46 15)  $\gamma_{977}$  926.6 2 (t<sub>1/2</sub> 100 14)  
 1908.08 10, (15/2)<sup>-</sup>  $\gamma_{1306}$  601.7 2 (t<sub>1/2</sub> 100 9)  $\gamma_{1058}$  850.5 1 (t<sub>1/2</sub> 24 4)  
 1970.6 3  $\gamma_{977}$  993.1 3 (t<sub>1/2</sub> 100)  
 2018.72 5, (9/2)<sup>-</sup>  $\gamma_{1188}$  830.1 1 (t<sub>1/2</sub> 18 2)  $\gamma_{977}$  1041.35 5 (t<sub>1/2</sub> 100 8)  $\gamma_{390}$  1629.31  
 (t<sub>1/2</sub> 64 6)  $\gamma_{272}$  1746.4 1 (t<sub>1/2</sub> 25 3)  
 2065.07 6, (9/2)<sup>-</sup>  $\gamma_{977}$  1087.31 (t<sub>1/2</sub> 29 6)  $\gamma_{907}$  1158.21 (t<sub>1/2</sub> 21 3)  $\gamma_{390}$  1675.9 3  
 (t<sub>1/2</sub> 18 3)  $\gamma_{272}$  1793.21 7 (t<sub>1/2</sub> 100 6)  
 2092.15 7  $\gamma_{390}$  1702.5 1 (t<sub>1/2</sub> 36 3)  $\gamma_{272}$  1820.27 7 (t<sub>1/2</sub> 100 8)  
 2116.83 10, 17/2<sup>-</sup>  $\gamma_{1908}$  208.5  $\gamma_{1306}$  810.4 2  $\gamma_{1058}$  1059.31 Q  
 2121.26 11, (15/2)<sup>-</sup>  $\gamma_{1058}$  1063.6 1 (t<sub>1/2</sub> 100) Q  
 2196.69 5, (11/2)<sup>-</sup>  $\gamma_{1892}$  304.2 2 (t<sub>1/2</sub> 13 1) M1+E2  $\gamma_{1003}$  594.31 (t<sub>1/2</sub> 7 6 7)  
 $\gamma_{1306}$  890.52 9 (t<sub>1/2</sub> 43 4)  $\gamma_{1188}$  1008.28 5 (t<sub>1/2</sub> 18 2) M1  $\gamma_{1058}$  1138.91 (t<sub>1/2</sub> 11 1)  
 $\gamma_{977}$  1219.21 7 (t<sub>1/2</sub> 54 4)  $\gamma_{390}$  1807.14 7 (t<sub>1/2</sub> 100 3) Q+D  
 2209.3 3  $\gamma_{977}$  1231.8 3 (t<sub>1/2</sub> 100)  
 2254.33 12  $\gamma_{1057}$  1196.9 1 (t<sub>1/2</sub> 100 8)  $\gamma_{977}$  1276.9 5 (t<sub>1/2</sub> 28 9)  
 2275.58 10  $\gamma_{1188}$  1087.31 (t<sub>1/2</sub> 100 20)  $\gamma_{977}$  1297.6 2 (t<sub>1/2</sub> 42 7)  $\gamma_{390}$  1886.0 2  
 (t<sub>1/2</sub> 90 10)  
 2318.4 9, (19/2)<sup>-</sup>  $\gamma_{1306}$  1012.4 (t<sub>1/2</sub> 100)  
 2329.58 20, (17/2)<sup>-</sup>  $\gamma_{1058}$  1271.9 2 (t<sub>1/2</sub> 100) Q  
 2331.89 21  $\gamma_{977}$  1354.4 2 (t<sub>1/2</sub> 100)  
 2351.12 10  $\gamma_{1188}$  1162.8 2 (t<sub>1/2</sub> 100 8)  $\gamma_{977}$  1373.6 1 (t<sub>1/2</sub> 69 8)  
 2357.84 14  $\gamma_{1214}$  1143.9 1 (t<sub>1/2</sub> 100)  
 2378.31 12, 19/2<sup>-</sup>  $\gamma_{1306}$  1072.2 1 (t<sub>1/2</sub> 100) E2  
 2417.6 6  $\gamma_{1058}$  1329.3 5 (t<sub>1/2</sub> 100)  
 2457.46 11, 17/2<sup>-</sup>  $\gamma_{1908}$  550.5  $\gamma_{1306}$  1151.3 1 M1+E2:  $\delta = -4.16_{-54}^{+43}$   
 2474.1 10, 21/2<sup>(\*)</sup>, 5.8 15 ns  $\gamma_{2318}$  155.7 (t<sub>1/2</sub> 100) (E1)  
 2559.46 22, 19/2<sup>-</sup>  $\gamma_{2457}$  101.6 3 (t<sub>1/2</sub> 22 1) M1(+E2):  $\delta = +0.09$  14  $\gamma_{2330}$  229.6  
 $\gamma_{2117}$  443.0 3 (t<sub>1/2</sub> 100 4) D(+Q):  $\delta = +0.00$  5  
 2600.63 12  $\gamma_{1214}$  1386.6 9 7 (t<sub>1/2</sub> 100)  
 2610.8 5  $\gamma_{977}$  1633.3 6 (t<sub>1/2</sub> 33 17)  $\gamma_{272}$  2338.9 8 (t<sub>1/2</sub> 100 33)  
 2612.1 8, 21/2<sup>(\*)</sup>  $\gamma_{2474}$  138.1  $\gamma_{2378}$  233.4  
 2630.4 6, 21/2<sup>-</sup>  $\gamma_{2559}$  70.4 M1  $\gamma_{2378}$  251.6  $\gamma_{2117}$  514.9  
 2812.0 9, 23/2<sup>-</sup>  $\gamma_{2630}$  181.9 M1  $\gamma_{2612}$  199.5  
 3112.2 4, 21/2<sup>-</sup>  $\gamma_{2559}$  552.7 3 (t<sub>1/2</sub> 100) D(+Q):  $\delta = -0.13_{-11}^{+10}$   
 3294.3 5, (23/2)<sup>-</sup>  $\gamma_{3112}$  182.1 3 (t<sub>1/2</sub> 100) (D)  
 3343.8 12, 25/2<sup>-</sup>  $\gamma_{2812}$  531.8 (t<sub>1/2</sub> 100)  
 3364.6 10, 25/2<sup>-</sup>  $\gamma_{2812}$  552.7 3 (t<sub>1/2</sub> 100) D(+Q):  $\delta = -0.13_{-11}^{+10}$

- 3470.0 6 (?), (25/2)<sup>-</sup>  $\gamma_{3224}$  175.7 3 (t<sub>1/2</sub> 100)  
 3629.3 12 (?), (27/2)<sup>-</sup>  $\gamma_{3470}$  159.3 (t<sub>1/2</sub> 100) D  
 3749.4 12, 27/2<sup>-</sup>  $\gamma_{3365}$  384.8  $\gamma_{3344}$  405.6  
 4319.0 12, 29/2<sup>-</sup>  $\gamma_{3749}$  569.5  $\gamma_{3365}$  954.4  $\gamma_{3344}$  975.1  
 4494.6 16 (?), 31/2<sup>-</sup>  $\gamma_{4319}$  175.6 (t<sub>1/2</sub> 100) D(+Q):  $\delta = -0.02$  10  
 4653.9 16, 33/2<sup>-</sup>  $\gamma_{4495}$  159.3 3 (t<sub>1/2</sub> 100) D(+Q):  $\delta = +0.00_{-19}$   
 4947.3 19, 35/2<sup>-</sup>  $\gamma_{4654}$  293.4 (t<sub>1/2</sub> 100)

- A x, J=(37/2)  
 A 483.7+x, J+2  $\gamma_x$  483.7 4 (t<sub>1/2</sub> 0.29 3) I<sup>(1)</sup>=82.7, I<sup>(2)</sup>=63.7,  $\eta\omega=0.258$   
 A 1030.2+x, J+4  $\gamma_{484+x}$  546.5 4 (t<sub>1/2</sub> 0.71 4) I<sup>(1)</sup>=80.5, I<sup>(2)</sup>=63.7,  $\eta\omega=0.289$   
 A 1639.5+x, J+6  $\gamma_{1030+x}$  609.3 2 (t<sub>1/2</sub> 1.01 7) I<sup>(1)</sup>=78.8, I<sup>(2)</sup>=64.1,  $\eta\omega=0.320$   
 A 2311.5+x, J+8  $\gamma_{1640+x}$  671.7 2 (t<sub>1/2</sub> 0.88 6) I<sup>(1)</sup>=77.4, I<sup>(2)</sup>=65.4,  $\eta\omega=0.351$   
 A 3044.1+x, J+10  $\gamma_{2312+x}$  732.9 2 (t<sub>1/2</sub> 1.00 7) I<sup>(1)</sup>=76.4, I<sup>(2)</sup>=65.6,  $\eta\omega=0.382$   
 A 3838.0+x, J+12  $\gamma_{3044+x}$  793.9 2 (t<sub>1/2</sub> 0.95 6) I<sup>(1)</sup>=75.6, I<sup>(2)</sup>=66.4,  $\eta\omega=0.412$   
 A 4692.1+x, J+14  $\gamma_{3838+x}$  854.1 2 (t<sub>1/2</sub> 1.02 6) I<sup>(1)</sup>=74.9, I<sup>(2)</sup>=67.6,  $\eta\omega=0.442$   
 A 5605.4+x, J+16  $\gamma_{4692+x}$  913.3 2 (t<sub>1/2</sub> 0.98 8) I<sup>(1)</sup>=74.5, I<sup>(2)</sup>=67.1,  $\eta\omega=0.472$   
 A 6578.3+x, J+18  $\gamma_{5605+x}$  972.9 2 (t<sub>1/2</sub> 1.04 8) I<sup>(1)</sup>=74.0, I<sup>(2)</sup>=67.9,  $\eta\omega=0.501$   
 A 7610.1+x, J+20  $\gamma_{6578+x}$  1031.8 2 (t<sub>1/2</sub> 1.03 7) I<sup>(1)</sup>=73.7, I<sup>(2)</sup>=67.9,  $\eta\omega=0.531$   
 A 8700.8+x, J+22  $\gamma_{7610+x}$  1090.7 2 (t<sub>1/2</sub> 0.95 6) I<sup>(1)</sup>=73.3, I<sup>(2)</sup>=69.1,  $\eta\omega=0.560$   
 A 9849.4+x, J+24  $\gamma_{8701+x}$  1148.6 4 (t<sub>1/2</sub> 0.75 11) I<sup>(1)</sup>=73.1, I<sup>(2)</sup>=67.8,  $\eta\omega=0.589$   
 A 11057.0+x, J+26  $\gamma_{9849+x}$  1207.6 4 (t<sub>1/2</sub> 0.65 10) I<sup>(1)</sup>=72.9, I<sup>(2)</sup>=68.5,  $\eta\omega=0.618$   
 A 12323.0+x, J+28  $\gamma_{11057+x}$  1266.0 4 (t<sub>1/2</sub> 0.58 11) I<sup>(1)</sup>=72.7, I<sup>(2)</sup>=67.8,  $\eta\omega=0.648$   
 A 13648.0+x, J+30  $\gamma_{12323+x}$  1325.0 4 (t<sub>1/2</sub> 0.50 10) I<sup>(1)</sup>=72.5, I<sup>(2)</sup>=67.5,  $\eta\omega=0.677$   
 A 15032.3+x, J+32  $\gamma_{13648+x}$  1384.3 6 (t<sub>1/2</sub> 0.29 9) I<sup>(1)</sup>=72.2, I<sup>(2)</sup>=67.2,  $\eta\omega=0.707$   
 A 16476.1+x, J+34  $\gamma_{15032+x}$  1443.8 10 (t<sub>1/2</sub> 0.20 10) I<sup>(1)</sup>=72.0, I<sup>(2)</sup>=67.5,  $\eta\omega=0.737$   
 A 17979.2+x, J+36  $\gamma_{16476+x}$  1503.1 10 (t<sub>1/2</sub> 0.12 7) I<sup>(1)</sup>=71.9, I<sup>(2)</sup>=66.2,  $\eta\omega=0.767$   
 A 19542.7+x, J+38  $\gamma_{17979+x}$  1563.5 10 (t<sub>1/2</sub> 0.09 6) I<sup>(1)</sup>=71.6, I<sup>(2)</sup>=67.2,  $\eta\omega=0.797$   
 A 21165.7+x, J+40  $\gamma_{19543+x}$  1623 2 I<sup>(1)</sup>=71.5, I<sup>(2)</sup>=65.6,  $\eta\omega=0.827$   
 A 22849.7+x, J+42  $\gamma_{21166+x}$  1684 2 I<sup>(1)</sup>=71.3, I<sup>(2)</sup>=67.8,  $\eta\omega=0.857$   
 A 24592.7+x, J+44  $\gamma_{22850+x}$  1743 2 I<sup>(1)</sup>=71.1



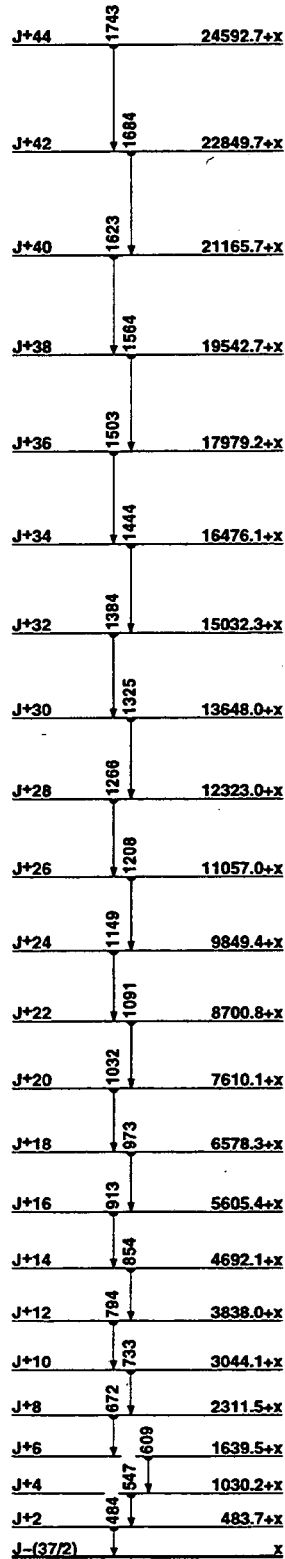

SD band

<sup>143</sup>Eu  
63Eu

$\Delta: -75647.21$   $S_n: 9360.40$   $S_p: 3409.21$   $Q_{EC}: 6329.21$   $Q_\alpha: 320.50$

Nuclear Bands

A SD band

Levels and  $\gamma$ -ray branchings:

0.0, 1<sup>+</sup>, 10.2 1 s, %EC+% $\beta^+$ =100,  $\mu=1.893$  13,  $Q=0.10$  3

333.14, (2)<sup>+</sup>  $\gamma_{333} 333.32$  (t<sub>100</sub>) (t<sub>30</sub> 15) M1

347.44, (3)<sup>+</sup>  $\gamma_{347} 13.8$   $\gamma_{347} 347.12$  (t<sub>100</sub>) E2

580.64, (4)<sup>+</sup>  $\gamma_{347} 233.32$  (t<sub>100</sub> 5) M1  $\gamma_{333} 247.55$  (t<sub>7.5</sub> 35) M1, E2

604.47, (3)<sup>+</sup>  $\gamma_{347} 257.3$  (t<sub>37.0</sub>)  $\gamma_{333} 271.1$  (t<sub>100</sub>) M1, (E2)

621.55, (2,3)<sup>+</sup>  $\gamma_{347} 274.4$  (t<sub>51.2</sub>)  $\gamma_{333} 288.2$  (t<sub>13.0</sub>)  $\gamma_{621.5}$  (t<sub>100</sub>) E2, (M1)

629.65, (2)<sup>-</sup>  $\gamma_{347} 282.4$  (t<sub>4.3</sub>) M1  $\gamma_{629.5}$  (t<sub>100</sub>) E1

762.94, (5)<sup>+</sup>  $\gamma_{581} 182.42$  (t<sub>100</sub> 18) M1, E2  $\gamma_{347} 415.33$  (t<sub>68</sub> 27) E2

784.07, (2)<sup>+</sup>  $\gamma_{581} 203.6$  (t<sub>4.2</sub>) M1  $\gamma_{333} 450.7$  (t<sub>100</sub>) M1, E2

887.74, (5)<sup>-</sup>  $\gamma_{783} 124.82$  (t<sub>2.9</sub> 6)  $\gamma_{581} 307.02$  (t<sub>100</sub> 5) E1

894.79, (4)<sup>+</sup>  $\gamma_{604} 290.2$  (t<sub>100</sub>) M1, E2  $\gamma_{581} 314.1$  (t<sub>46.4</sub>)

908.06  $\gamma_{347} 560.8$  (t<sub>48.4</sub>)  $\gamma_{604} 907.9$  (t<sub>100</sub>)

926.35, (6)<sup>-</sup>, 28.2 ns  $\gamma_{688} 38.73$  (t<sub>100</sub> 63) (M1+E2)  $\gamma_{783} 163.15$  (t<sub>38</sub> 25)

974.85  $\gamma_{622} 353.3$   $\gamma_{333} 641.5$  (t<sub>100</sub>)  $\gamma_{604} 974.8$  (t<sub>42.3</sub>)

1048.8 11, (4)  $\gamma_{926} 122.5$  (t<sub>100</sub>)

1074.18  $\gamma_{333} 740.9$  (t<sub>100</sub>)

1120.46, (7)<sup>-</sup>  $\gamma_{926} 194.14$  (t<sub>100</sub>) M1

1127.97, (8)<sup>-</sup>, 1.0 1  $\mu$ s  $\gamma_{1128} 7.5$  (t<sub>64</sub> 21)  $\gamma_{926} 201.65$  (t<sub>100</sub>) E2

1145.66  $\gamma_{784} 361.6$  (t<sub>13.8</sub>)  $\gamma_{604} 541.2$  (t<sub>55.2</sub>)  $\gamma_{333} 812.3$  (t<sub>100</sub>)

$\gamma_{604} 1145.6$  (t<sub>89.7</sub>)

1194.46, (6,7)<sup>-</sup>  $\gamma_{926} 268.13$  (t<sub>100</sub>) M1, E2

1201.46  $\gamma_{622} 579.9$  (t<sub>21.2</sub>)  $\gamma_{333} 868.1$  (t<sub>100</sub>)  $\gamma_{604} 1201.4$  (t<sub>20</sub>)

1293.55  $\gamma_{608} 385.6$   $\gamma_{630} 664.0$  (t<sub>35.3</sub>)  $\gamma_{333} 960.2$   $\gamma_{604} 1293.5$  (t<sub>45.3</sub>)

1304.28  $\gamma_{347} 956.9$  (t<sub>100</sub>)

1338.27, (9)<sup>-</sup>, 5.0 5 ns  $\gamma_{1128} 210.33$  (t<sub>100</sub>) M1

1402.37  $\gamma_{347} 1055.1$  (t<sub>100</sub>)

1559.87  $\gamma_{333} 1226.6$  (t<sub>100</sub>)  $\gamma_{604} 1559.9$  (t<sub>53.7</sub>)

1669.57, (9)<sup>+</sup>  $\gamma_{1338} 331.32$  (t<sub>70</sub> 8)  $\gamma_{1128} 541.74$  (t<sub>100</sub> 25) E1

1804.7 12  $\gamma_{1201} 603.3$  (t<sub>100</sub>)

1930.48  $\gamma_{630} 1300.7$  (t<sub>71.4</sub>)  $\gamma_{347} 1583.1$  (t<sub>100</sub>)

2161.59, (10)<sup>+</sup>  $\gamma_{1670} 492.05$  (t<sub>100</sub>) M1

2362.17  $\gamma_{347} 2015.0$  (t<sub>19.0</sub>)  $\gamma_{333} 2028.8$  (t<sub>9.2</sub>)  $\gamma_{604} 2362.1$  (t<sub>100</sub>)

2432.64  $\gamma_{1560} 872.7$  (t<sub>3.3</sub>)  $\gamma_{1402} 1030.4$  (t<sub>0.84</sub>)  $\gamma_{1304} 1128.6$  (t<sub>6.6</sub>)

$\gamma_{1294} 1139.1$  (t<sub>4.3</sub>)  $\gamma_{1201} 1231.2$  (t<sub>14.8</sub>)  $\gamma_{1146} 1287.0$  (t<sub>5.4</sub>)  $\gamma_{1074} 1358.4$

(t<sub>1.7</sub>)  $\gamma_{975} 1457.8$  (t<sub>10.6</sub>)  $\gamma_{608} 1524.7$  (t<sub>3.6</sub>)  $\gamma_{630} 1803.1$  (t<sub>12.5</sub>)

$\gamma_{604} 2432.6$  (t<sub>100</sub>)

2692.77, (1<sup>+</sup>)  $\gamma_{975} 1717.9$  (t<sub>19.6</sub>)  $\gamma_{622} 2071.2$  (t<sub>35.3</sub>)  $\gamma_{604} 2692.7$  (t<sub>100</sub>)

2709.68  $\gamma_{622} 2088.1$  (t<sub>47.2</sub>)  $\gamma_{604} 2709.6$  (t<sub>100</sub>)

2804.65, (1<sup>+</sup>)  $\gamma_{1402} 1402.4$  (t<sub>14.8</sub>)  $\gamma_{1294} 1511.1$  (t<sub>13.8</sub>)  $\gamma_{975} 1829.8$

(t<sub>27.6</sub>)  $\gamma_{622} 2183.1$  (t<sub>26.2</sub>)  $\gamma_{347} 2457.5$  (t<sub>11.4</sub>)  $\gamma_{333} 2471.3$  (t<sub>100</sub>)

$\gamma_{604} 2804.6$  (t<sub>7.6</sub>)

2827.97  $\gamma_{630} 2198.4$  (t<sub>100</sub>)  $\gamma_{333} 2494.6$  (t<sub>85.1</sub>)  $\gamma_{604} 2827.9$  (t<sub>61.7</sub>)

A x(?), J

**144Gd**  
**64**

$\Delta: (-71910) S_n: (11600) S_p: (4840) Q_{Ec}: (3740) Q_{\alpha}: (1000)$

**Nuclear Bands**

A SD band

Levels and  $\gamma$ -ray branchings:

0, 0<sup>+</sup>, 4.5  $\tau$  m, %EC+% $\beta$ <sup>+</sup>=100

743.0, 2<sup>+</sup>  $\gamma_{743.0}$  (t<sub>1/2</sub> 100) E2

1702.3, (3<sup>-</sup>)  $\gamma_{743}$  959.36 (t<sub>1/2</sub> 100) (E1+M2):  $\delta=+0.125$

1744.6, (4<sup>+</sup>)  $\gamma_{743}$  1001.6 (t<sub>1/2</sub> 100)

1876.4, (2<sup>+</sup>)  $\gamma_{743}$  1133.4 (t<sub>1/2</sub> 75)  $\gamma_0$  1876.4 (t<sub>1/2</sub> 100)

1886.8, (0<sup>+</sup>)  $\gamma_{743}$  1143.9 (t<sub>1/2</sub> 100)

2223.5, (2<sup>+</sup>)  $\gamma_{743}$  1483.5 (t<sub>1/2</sub> 100)  $\gamma_0$  2226.5 (t<sub>1/2</sub> 80)

2302.7, (5<sup>-</sup>)  $\gamma_{1745}$  558.0 (t<sub>1/2</sub> 100) E1  $\gamma_{1702}$  600.3 (t<sub>1/2</sub> 59.7)

2330.5, (4<sup>-</sup>)  $\gamma_{1702}$  628.0 (t<sub>1/2</sub> 100)

2354.3, (6<sup>+</sup>)  $\gamma_{1745}$  609.7(?) (t<sub>1/2</sub> 100)

2442.5, (5<sup>-</sup>)  $\gamma_{2303}$  139.7 (t<sub>1/2</sub> 42.9)  $\gamma_{1745}$  697.9 (t<sub>1/2</sub> 100)

2462.1, (0<sup>+</sup>, 1<sup>+</sup>, 2<sup>+</sup>)  $\gamma_{743}$  1719.1 (t<sub>1/2</sub> 100)

2471.9, (7<sup>-</sup>), 132 ns  $\gamma_{2303}$  169.1 (t<sub>1/2</sub> 100) E2

2787.0, (7<sup>-</sup>)  $\gamma_{2472}$  315.0 (t<sub>1/2</sub> 100) M1

2788.0  $\gamma_{2303}$  485.3 (t<sub>1/2</sub> 100)

2862.0, (6<sup>+</sup>)  $\gamma_{1745}$  1117.4 (t<sub>1/2</sub> 100)

2912.7  $\gamma_{2443}$  470.2 (t<sub>1/2</sub> 100)

3016.9, (5<sup>-</sup>, 6<sup>-</sup>, 7<sup>-</sup>)  $\gamma_{2443}$  573.5(?) (t<sub>1/2</sub> 40)  $\gamma_{2303}$  712.8 (t<sub>1/2</sub> 100)

3018, (8<sup>-</sup>)  $\gamma_{2787}$  231.5 (t<sub>1/2</sub> 67) M1  $\gamma_{2472}$  546.4 (t<sub>1/2</sub> 100) M1+E2

3244, (8<sup>-</sup>)  $\gamma_{3018}$  226.1 (t<sub>1/2</sub> 100)

3346, (9<sup>-</sup>)  $\gamma_{3244}$  101.7 (t<sub>1/2</sub> 7.6)  $\gamma_{3018}$  327.8 (t<sub>1/2</sub> 100) M1

3433, (10<sup>+</sup>), 145.30 ns,  $\mu=12.76$  14,  $Q=1.46$  6  $\gamma_{3346}$  87.3 (t<sub>1/2</sub> 100) E1  $\gamma_{3018}$  415.3 (t<sub>1/2</sub> 18.9) M2

3697, (10<sup>+</sup>)  $\gamma_{3433}$  263.8  $\gamma_{3346}$  351.3

3910, (10<sup>+</sup>)  $\gamma_{3346}$  564.3  $\gamma_{3018}$  892.0

4144, (11<sup>+</sup>)  $\gamma_{3433}$  711.4 (t<sub>1/2</sub> 100)

4267, (11<sup>+</sup>)  $\gamma_{3346}$  921.3 (t<sub>1/2</sub> 100)

4451, (12<sup>+</sup>)  $\gamma_{3433}$  1017.8 (t<sub>1/2</sub> 100)

4756, (12<sup>+</sup>)  $\gamma_{4144}$  611.5 (t<sub>1/2</sub> 100)

5133, (13<sup>+</sup>)  $\gamma_{4756}$  377.8  $\gamma_{4144}$  989.3

5179, (12)  $\gamma_{4451}$  711.4 (t<sub>1/2</sub> 100)

5369, (14)  $\gamma_{5133}$  235.9 (t<sub>1/2</sub> 100)

5497, (13)  $\gamma_{4451}$  1046 (t<sub>1/2</sub> 100)

5626, (14)  $\gamma_{5497}$  129.1  $\gamma_{5133}$  492.2

5722, (15)  $\gamma_{5369}$  352.9 (t<sub>1/2</sub> 100)

5834, (15)  $\gamma_{5626}$  208.5 (t<sub>1/2</sub> 100)

A x, J

A 846.3+x, J+2  $\gamma_{846.3}$  (t<sub>1/2</sub> 0.36 10) I<sup>(2)</sup>=122.,  $\eta\omega=0.431$

A 1725.2+x, J+4  $\gamma_{846+x}$  878.94 (t<sub>1/2</sub> 0.64 12) I<sup>(2)</sup>=175.,  $\eta\omega=0.445$

A 2626.9+x, J+6  $\gamma_{1725+x}$  901.72 (t<sub>1/2</sub> 0.89 13) I<sup>(2)</sup>=400.,  $\eta\omega=0.448$

A 3518.6+x, J+8  $\gamma_{2627+x}$  891.73 (t<sub>1/2</sub> 0.99 14) I<sup>(2)</sup>=96.,  $\eta\omega=0.456$

A 4451.9+x, J+10  $\gamma_{3518+x}$  933.32 (t<sub>1/2</sub> 1.00) I<sup>(2)</sup>=86.,  $\eta\omega=0.478$

A 5431.6+x, J+12  $\gamma_{4452+x}$  979.72 (t<sub>1/2</sub> 0.93 12) I<sup>(2)</sup>=78.,  $\eta\omega=0.503$

A 6462.6+x, J+14  $\gamma_{5432+x}$  1031.03 (t<sub>1/2</sub> 0.95 12) I<sup>(2)</sup>=75.,  $\eta\omega=0.529$

A 7546.9+x, J+16  $\gamma_{6463+x}$  1084.32 (t<sub>1/2</sub> 1.00 12) I<sup>(2)</sup>=72.,  $\eta\omega=0.556$

A 8686.5+x, J+18  $\gamma_{7547+x}$  1139.63 (t<sub>1/2</sub> 0.97 11) I<sup>(2)</sup>=72.,  $\eta\omega=0.584$

A 9881.4+x, J+20  $\gamma_{8687+x}$  1194.93 (t<sub>1/2</sub> 0.72 10) I<sup>(2)</sup>=71.,  $\eta\omega=0.611$

A 11131.9+x, J+22  $\gamma_{9881+x}$  1250.54 (t<sub>1/2</sub> 0.79 10) I<sup>(2)</sup>=71.,  $\eta\omega=0.639$

A 12438.5+x, J+24  $\gamma_{11132+x}$  1306.65 (t<sub>1/2</sub> 0.69 11) I<sup>(2)</sup>=69.,  $\eta\omega=0.668$

A 13802.4+x, J+26  $\gamma_{12439+x}$  1363.97 (t<sub>1/2</sub> 0.52 10) I<sup>(2)</sup>=73.,  $\eta\omega=0.695$

A 15220.5+x, J+28  $\gamma_{13802+x}$  1418.19 (t<sub>1/2</sub> 0.34 12)

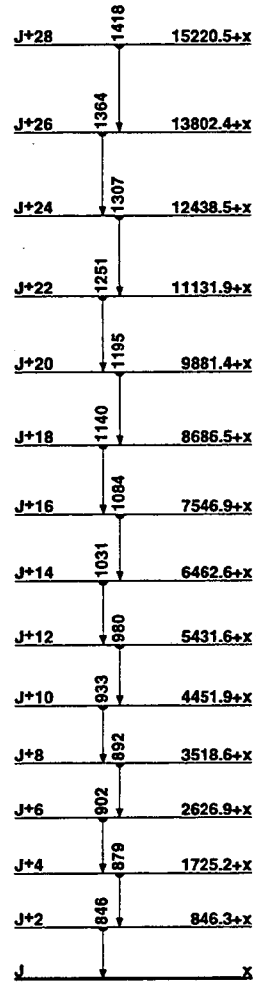

SD band

**144Gd**  
**64**

146  
64Gd

$\Delta$ : -760975  $S_n$ : 1122040  $S_p$ : 53855  $Q_{ec}$ : 10308  $Q_\alpha$ : 46516

Nuclear Bands

- A SD-1 band
- B SD-2 band

Levels and  $\gamma$ -ray branchings:

0, 0<sup>+</sup>, 48.27 10 d, %EC=100  
 1579.4 1, 3<sup>+</sup>, 1.06 12 ns  $\gamma_0$  1579.41 ( $t_{1/2}$ ) E3  
 1971.9 3, 2<sup>+</sup>, <1 ps  $\gamma_0$  1972.03 ( $t_{1/2}$ ) E2  
 2165.0 3, 0<sup>+</sup>, 375.40 ps  $\gamma_{1972}$  193.05 ( $t_{1/2}$ =23)  $\gamma_0$  2165.03 ( $t_{1/2}$  100 17) E0  
 2611.5 2, 4<sup>+</sup>  $\gamma_{1972}$  638.1 ( $t_{1/2}$ =1.7)  $\gamma_{1579}$  1032.11 ( $t_{1/2}$  100 10) E1  
 2658.0 2, 5<sup>-</sup>  $\gamma_{1579}$  1078.61 ( $t_{1/2}$ ) E2  
 2967.6 3, 4<sup>+</sup>, (2<sup>+</sup>)  $\gamma_{1579}$  1388.22 ( $t_{1/2}$ ) E1  
 2982.0 3, 7<sup>-</sup>, 7.24 ns  $\gamma_{2658}$  324.01 ( $t_{1/2}$ ) E2  
 2986 1  $\gamma_0$  2986.1 ( $t_{1/2}$ )  
 2996.6 4, 4<sup>-</sup>  $\gamma_{1579}$  1417.23 ( $t_{1/2}$ )  
 3020 2, 0<sup>+</sup>  $\gamma_0$  3020.2 ( $t_{1/2}$ ) E0  
 3031.2 3, 3<sup>+</sup>  $\gamma_{1972}$  1059.32 ( $t_{1/2}$  100 30) M1  $\gamma_{1579}$  1451.73 ( $t_{1/2}$  50 20)  
 3098 2, 6<sup>-</sup>  $\gamma_{2982}$  116.7  $\gamma_{2658}$  440.91 M1  
 3182.5 3, 8<sup>-</sup>  $\gamma_{2982}$  200.51 ( $t_{1/2}$ ) M1+E2:  $\delta=0.101$   
 3231 5  
 3287.2, (3,5)<sup>+</sup>  $\gamma_{2612}$  675.72 ( $t_{1/2}$ ) M1  
 3290.2, 7<sup>-</sup>  $\gamma_{2982}$  308.22 ( $t_{1/2}$ ) M1+E2  
 3293.5 3, 8<sup>-</sup>, <300 ps  $\gamma_{3183}$  111.11 ( $t_{1/2}$  32.4) M1  $\gamma_{2982}$  311.42 ( $t_{1/2}$  100 9)  
 M1+E2:  $\delta=0.160$   
 3312.8 5, 5<sup>(-)</sup>  $\gamma_{2658}$  654.84 ( $t_{1/2}$  100 29) (M1)  $\gamma_{2612}$  701.65 ( $t_{1/2}$ =8.8)  
 3354 5  
 3378 5  
 3384.0 5, 6<sup>-</sup>  $\gamma_{3098}$  285.22 ( $t_{1/2}$  24 6) M1  $\gamma_{2982}$  402.02 ( $t_{1/2}$  29 12)  $\gamma_{2658}$  726.12  
 ( $t_{1/2}$  100 12) M1  
 3389 1, (3)  $\gamma_{1972}$  1417.1 ( $t_{1/2}$ )  
 3411.9 5, 4<sup>(+)</sup>  $\gamma_{2987}$  415.23 ( $t_{1/2}$  100 33) (E1)  $\gamma_{2612}$  800.65 ( $t_{1/2}$ )  
 3416 1, 4  $\gamma_{1579}$  1837 ( $t_{1/2}$  1100) D  
 3422.7 5, (4)  $\gamma_{1579}$  1843.35 ( $t_{1/2}$ ) D  
 3428.1 5, 9<sup>-</sup>, <300 ps  $\gamma_{2294}$  134.61 ( $t_{1/2}$  100 6) M1+E2:  $\delta=0.071$   $\gamma_{3183}$  245.62  
 ( $t_{1/2}$  7.5 25) M1+E2:  $\delta=0.904$   $\gamma_{2982}$  446.12 ( $t_{1/2}$  7.5 25) E2  
 3436.3 5, (3)  $\gamma_{1972}$  1464.33 ( $t_{1/2}$ ) D  
 3442 5  
 3456 1, (5)  $\gamma_{1579}$  1877.1 ( $t_{1/2}$ ) Q  
 3456.9, 6<sup>+</sup>  $\gamma_{2658}$  798.93 ( $t_{1/2}$ ) E1  
 3460 1, (5)  $\gamma_{1579}$  1881.1 ( $t_{1/2}$ ) Q  
 3463 1, (4)  $\gamma_{1579}$  1884.1 ( $t_{1/2}$ ) D  
 3484.9 5, 6<sup>+</sup>  $\gamma_{2658}$  826.92 ( $t_{1/2}$ ) E1  
 3485 2, 0<sup>+</sup>  $\gamma_0$  3485.2 ( $t_{1/2}$ ) E0  
 3639 2, 0<sup>+</sup>  $\gamma_0$  3639.2 ( $t_{1/2}$ ) E0  
 3660.2 5, 6<sup>+</sup>  $\gamma_{2658}$  1002.24 ( $t_{1/2}$ ) E1  
 3779.0 5, 8<sup>+</sup>  $\gamma_{2982}$  797.03 ( $t_{1/2}$ ) E1  
 3783.7 5, (5,6)<sup>+</sup>  $\gamma_{2612}$  1172.25 ( $t_{1/2}$ ) M1, E2  
 3854.2 5, 7<sup>-</sup>  $\gamma_{3183}$  671.73 ( $t_{1/2}$  63 13) M1  $\gamma_{3098}$  755.05 ( $t_{1/2}$ =63) D  $\gamma_{2982}$  872.23  
 ( $t_{1/2}$  100 38) M1  
 3864.4 4, 10<sup>+</sup>, <300 ps  $\gamma_{3428}$  436.31 ( $t_{1/2}$ ) E1  
 3948  
 4107.1 5, 8<sup>+</sup>  $\gamma_{3183}$  924.63 ( $t_{1/2}$  100 33) E1  $\gamma_{2982}$  1125.73 ( $t_{1/2}$  100 33) D  
 4248.3 6, (9,10<sup>-</sup>)  
 4330  
 4501.3 6, 10<sup>-</sup>  $\gamma_{3428}$  1073.63 ( $t_{1/2}$ ) D+Q  
 4534, 0<sup>+</sup>  
 4540.7, 10<sup>(+)</sup>  $\gamma_{3428}$  1112.63 ( $t_{1/2}$ ) D  
 4666.5 5, 11, 12<sup>+</sup>  $\gamma_{3864}$  802.14 ( $t_{1/2}$ )  
 4700  
 4719.1, 4<sup>-</sup>  $\gamma_{3423}$  1296.7  $\gamma_{2658}$  2060.9  $\gamma_{1579}$  3139.8  
 4740 30  
 4828.3, (5)<sup>-</sup>  $\gamma_{2997}$  1831.9  
 5000  
 5094.8, (11<sup>+</sup>)  $\gamma_{4501}$  592.8 ( $t_{1/2}$  43) D  $\gamma_{3864}$  1229.9 ( $t_{1/2}$ ) D  
 5276.9, (11<sup>+</sup>)  $\gamma_{4501}$  775  $\gamma_{3864}$  1412.53  
 5350.9, (12<sup>+</sup>)  $\gamma_{3864}$  1486.0 Q  
 5447.5, (12<sup>+</sup>)  $\gamma_{4667}$  781.1  $\gamma_{3864}$  1582.9  
 5791.9, (13<sup>+</sup>)  $\gamma_{5448}$  343.5  $\gamma_{5351}$  441.1 ( $t_{1/2}$  73) D  $\gamma_{6277}$  514.0  $\gamma_{5095}$  697.0 ( $t_{1/2}$ )  
 Q  
 5894.4, (14<sup>+</sup>)  $\gamma_{5792}$  102.5 D+Q  $\gamma_{5448}$  446.5  $\gamma_{5351}$  543.7

5996.2, (14<sup>+</sup>)  $\gamma_{5351}$  645.3  
 6120.3, (15<sup>+</sup>)  $\gamma_{5996}$  124  $\gamma_{5894}$  225.9 D+Q  $\gamma_{5792}$  328  
 6399.1, (16<sup>+</sup>)  $\gamma_{6120}$  278.8 D  $\gamma_{5996}$  402  $\gamma_{5894}$  504.5 Q  
 6470 30  
 7034.3, (16<sup>+</sup>)  $\gamma_{6120}$  914.0 D  
 7164.9, (17<sup>+</sup>)  $\gamma_{7034}$  130.6  $\gamma_{6399}$  765.8 D  $\gamma_{6120}$  1046  $\gamma_{5996}$  1166  
 7513.6  $\gamma_{7034}$  479.3(?)  $\gamma_{6399}$  1114.5  
 7740  $\gamma_{7514}$  226  
 8030.3, (18), 1.5 6 ns  $\gamma_{7740}$  291  $\gamma_{7514}$  517(?)  $\gamma_{7165}$  865.4 D  
 8916.0, (20, 19), 4.3 3 ns  $\gamma_{6030}$  885.7  
 A x, J=(33)  
 A 825.6+x, J+2  $\gamma$  825.64 ( $t_{1/2}$  0.80 15)  $I^{(1)}=83.6$ ,  $I^{(2)}=75.$ ,  $\eta\omega=0.426$   
 A 1704.3+x, J+4  $\gamma_{626+x}$  878.74 ( $t_{1/2}$  1.03 15)  $I^{(1)}=83.1$ ,  $I^{(2)}=77.$ ,  $\eta\omega=0.452$   
 A 2634.7+x, J+6  $\gamma_{1704+x}$  930.44 ( $t_{1/2}$  1.04 10)  $I^{(1)}=82.8$ ,  $I^{(2)}=75.$ ,  $\eta\omega=0.479$   
 A 3618.4+x, J+8  $\gamma_{2636+x}$  983.74 ( $t_{1/2}$  0.95 10)  $I^{(1)}=82.3$ ,  $I^{(2)}=73.$ ,  $\eta\omega=0.505$   
 A 4656.5+x, J+10  $\gamma_{3618+x}$  1038.14 ( $t_{1/2}$  1.37 30)  $I^{(1)}=81.9$ ,  $I^{(2)}=73.$ ,  $\eta\omega=0.533$   
 A 5749.1+x, J+12  $\gamma_{4657+x}$  1092.64 ( $t_{1/2}$  1.00 10)  $I^{(1)}=81.5$ ,  $I^{(2)}=72.$ ,  $\eta\omega=0.560$   
 A 6896.9+x, J+14  $\gamma_{5749+x}$  1147.84 ( $t_{1/2}$  0.65 20)  $I^{(1)}=81.0$ ,  $I^{(2)}=74.$ ,  $\eta\omega=0.587$   
 A 8098.1+x, J+16  $\gamma_{6897+x}$  1201.25 ( $t_{1/2}$  0.89 15)  $I^{(1)}=80.8$ ,  $I^{(2)}=80.$ ,  $\eta\omega=0.613$   
 A 9349.1+x, J+18  $\gamma_{8098+x}$  1251.05 ( $t_{1/2}$  0.66 15)  $I^{(1)}=80.7$ ,  $I^{(2)}=82.$ ,  $\eta\omega=0.638$   
 A 10648.5+x, J+20  $\gamma_{9349+x}$  1299.47 ( $t_{1/2}$  0.38 8)  $I^{(1)}=80.8$ ,  $I^{(2)}=91.$ ,  $\eta\omega=0.661$   
 A 11991.5+x, J+22  $\gamma_{10649+x}$  1343.05 ( $t_{1/2}$  0.47 15)  $I^{(1)}=81.2$ ,  $I^{(2)}=77.$ ,  $\eta\omega=0.684$   
 A 13386.2+x, J+24  $\gamma_{11992+x}$  1394.75 ( $t_{1/2}$  0.22 10)  $I^{(1)}=81.0$ ,  $I^{(2)}=77.$ ,  $\eta\omega=0.710$   
 A 14832.8+x, J+26  $\gamma_{13386+x}$  1446.66 ( $t_{1/2}$ =0.10)  $I^{(1)}=80.9$ ,  $I^{(2)}=77.$ ,  $\eta\omega=0.736$   
 A 16331+x, J+28  $\gamma_{14833+x}$  1498  $I^{(1)}=80.8$ ,  $I^{(2)}=114.$ ,  $\eta\omega=0.758$   
 A 17884+x, J+30  $\gamma_{16331+x}$  1533  $I^{(1)}=81.5$   
 B y, J=(32)  
 B 806.7+y, J+2  $\gamma$  806.74 ( $t_{1/2}$  0.79 40)  $I^{(1)}=83.1$ ,  $I^{(2)}=81.$ ,  $\eta\omega=0.416$   
 B 1662.4+y, J+4  $\gamma_{807+y}$  855.73 ( $t_{1/2}$  0.94 15)  $I^{(1)}=83.0$ ,  $I^{(2)}=77.$ ,  $\eta\omega=0.441$   
 B 2570.0+y, J+6  $\gamma_{1662+y}$  907.65 ( $t_{1/2}$  0.81 15)  $I^{(1)}=82.6$ ,  $I^{(2)}=72.$ ,  $\eta\omega=0.468$   
 B 3533.0+y, J+8  $\gamma_{2570+y}$  963.04 ( $t_{1/2}$  1.00 15)  $I^{(1)}=82.0$ ,  $I^{(2)}=74.$ ,  $\eta\omega=0.495$   
 B 4549.9+y, J+10  $\gamma_{3533+y}$  1016.95 ( $t_{1/2}$  1.10 25)  $I^{(1)}=81.6$ ,  $I^{(2)}=72.$ ,  $\eta\omega=0.522$   
 B 5622.0+y, J+12  $\gamma_{4550+y}$  1072.15 ( $t_{1/2}$  0.93 15)  $I^{(1)}=81.1$ ,  $I^{(2)}=72.$ ,  $\eta\omega=0.550$   
 B 6749.6+y, J+14  $\gamma_{5622+y}$  1127.66 ( $t_{1/2}$  0.89 20)  $I^{(1)}=80.7$ ,  $I^{(2)}=68.$ ,  $\eta\omega=0.578$   
 B 7935.7+y, J+16  $\gamma_{6750+y}$  1186.15 ( $t_{1/2}$  0.73 15)  $I^{(1)}=80.1$ ,  $I^{(2)}=71.$ ,  $\eta\omega=0.607$   
 B 9177.9+y, J+18  $\gamma_{7936+y}$  1242.25 ( $t_{1/2}$  0.67 40)  $I^{(1)}=79.7$ ,  $I^{(2)}=69.$ ,  $\eta\omega=0.635$   
 B 10477.4+y, J+20  $\gamma_{9178+y}$  1299.55 ( $t_{1/2}$  0.57 15)  $I^{(1)}=79.3$ ,  $I^{(2)}=65.$ ,  $\eta\omega=0.665$   
 B 11837.6+y, J+22  $\gamma_{10477+y}$  1360.210 ( $t_{1/2}$  0.35 30)  $I^{(1)}=78.7$ ,  $I^{(2)}=70.$ ,  $\eta\omega=0.694$   
 B 13254.8+y, J+24  $\gamma_{11838+y}$  1417.210 ( $t_{1/2}$  0.36 20)  $I^{(1)}=78.3$ ,  $I^{(2)}=71.$ ,  $\eta\omega=0.723$   
 B 14727.8+y, J+26  $\gamma_{13255+y}$  1473  $I^{(1)}=78.1$ ,  $I^{(2)}=67.$ ,  $\eta\omega=0.751$   
 B 16259.8+y, J+28  $\gamma_{14728+y}$  1532  $I^{(1)}=77.7$

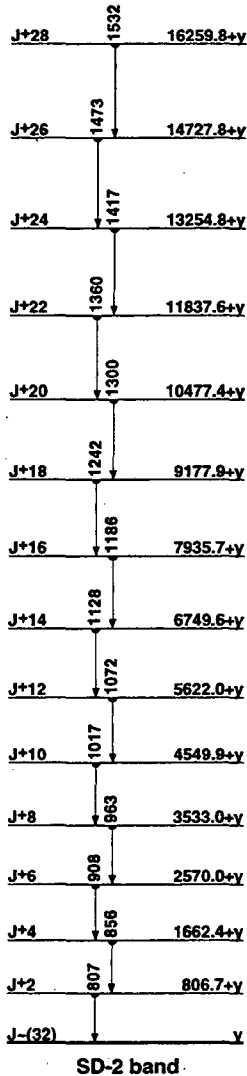
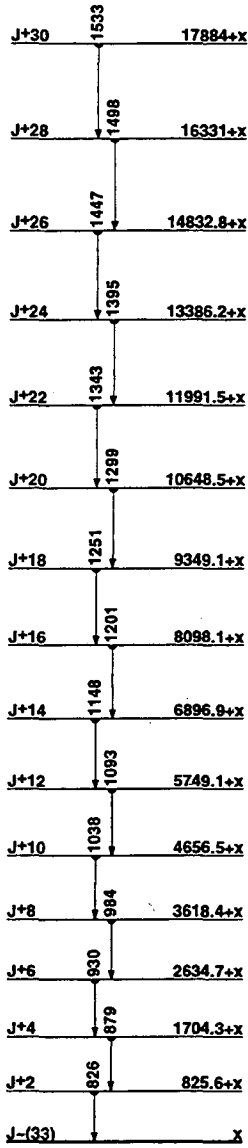

<sup>146</sup>Gd  
64

<sup>147</sup>Gd  
64

$\Delta$ : -75367.4 S<sub>n</sub>: 7341.4 S<sub>p</sub>: 5529.7 Q<sub>EC</sub>: 2188.3 Q<sub>α</sub>: 1735.220

Nuclear Bands

- A v<sub>1/2</sub>(3)
- B SD-1 band
- C SD-2 band

Levels and γ-ray branchings:

- 0, 7/2<sup>-</sup>, 38.06 12 h, %EC+%β<sup>+</sup>=100, μ=1.02 9
- 997.1 1, 13/2<sup>+</sup>, 21.4 11 ns, μ=+0.487 20, Q=-0.73 7 γ<sub>997.1</sub> (t<sub>1/2</sub> 100) E3
- 1152.4 1, 3/2<sup>+</sup>, <0.2 ns γ<sub>1152.4</sub> (t<sub>1/2</sub> 100) E2
- 1292.31 14, (1/2)<sup>+</sup>, <0.2 ns γ<sub>1152</sub> 139.9 (t<sub>1/2</sub> 100 8) E1
- 1397.01 10, 9/2<sup>-</sup>, 0.35 21 ps γ<sub>1397.0</sub> (t<sub>1/2</sub> 100 8) M1+E2
- 1412.01 18, 3/2<sup>+</sup>, <0.2 ns γ<sub>1292</sub> 119.7 (t<sub>1/2</sub> 100 11) M1
- 1509.2 10 γ<sub>1292</sub> 273.5 (t<sub>1/2</sub> 100 23)
- A 1628.34, 7/2<sup>+</sup>, 0.42 21 ps γ<sub>1628.3</sub> (t<sub>1/2</sub> 100 37) E1
- A 1643.03, 9/2<sup>+</sup> γ<sub>1643.0</sub> (t<sub>1/2</sub> 100 10) E1
- A 1699.36 24, 3/2<sup>+</sup> γ<sub>1292</sub> 407.03 (t<sub>1/2</sub> 50 14) M1+E2 γ<sub>1152</sub> 547.03 (t<sub>1/2</sub> 100 18) E1
- A 1701.60 23, 11/2<sup>+</sup> γ<sub>997</sub> 704.52 (t<sub>1/2</sub> 100 9) M1
- A 1759.2 11, (1/2)<sup>+</sup> γ<sub>1412</sub> 347.2 10 (t<sub>1/2</sub> 100 37) M1

- 1797.1 4, 9/2<sup>-</sup>, 0.14 7 ps γ<sub>1797.1</sub> (t<sub>1/2</sub> 100 11) M1+E2
- 1846.8 10, (1/2)<sup>-</sup> γ<sub>1412</sub> 434.8 γ<sub>1292</sub> 554.7 γ<sub>1152</sub> 694.4 10 (t<sub>1/2</sub> 100 60) M1
- 1944.1, 11/2<sup>-</sup> γ<sub>997</sub> 947 (t<sub>1/2</sub> 20) γ<sub>1944.1</sub> (t<sub>1/2</sub> 100) E2
- 2028.9 10, 15/2<sup>(+)</sup> γ<sub>1759</sub> 253.6(?) (t<sub>1/2</sub> 402.5 8) γ<sub>997</sub> 1031.8 (t<sub>1/2</sub> 100 10) (M1+E2)
- 2078.4 γ<sub>2078.4</sub> (t<sub>1/2</sub> 100)
- 2385.9 3, (13/2)<sup>-</sup> γ<sub>1759</sub> 609.6 (t<sub>1/2</sub> 100 10) γ<sub>997</sub> 1388.8 (t<sub>1/2</sub> 59 7) E1
- 2438.91 23, (15/2)<sup>-</sup> γ<sub>997</sub> 1441.82 (t<sub>1/2</sub> 100 10) E1
- 2488.22 14, 17/2<sup>+</sup> γ<sub>2029</sub> 459.2(?) (t<sub>1/2</sub> <2.41) γ<sub>1628</sub> 894.3 (t<sub>1/2</sub> 10.7 14) γ<sub>997</sub> 1491.0 (t<sub>1/2</sub> 100 7) E2
- 2489.8 4 γ<sub>1702</sub> 788.23 (t<sub>1/2</sub> 100 14)
- 2572.27 16, 19/2<sup>-</sup>, 0.37 8 ns γ<sub>2488</sub> 84.01 (t<sub>1/2</sub> 85 12) γ<sub>997</sub> 1575.23 (t<sub>1/2</sub> 100 19) E3
- 2625.9 10 γ<sub>997</sub> 1628.8 10 (t<sub>1/2</sub> 100 38)
- 2736.0 5 γ<sub>2386</sub> 350.14 (t<sub>1/2</sub> 100 40)
- 2760.47 17, 21/2<sup>+</sup>, 4.5 2 ns, μ=+7.6 12 γ<sub>2572</sub> 188.02 (t<sub>1/2</sub> 25 3) γ<sub>2488</sub> 272.31 (t<sub>1/2</sub> 100 8) E2
- 2763.81 17, (19/2)<sup>+</sup> γ<sub>2488</sub> 275.61 (t<sub>1/2</sub> 100 11) M1
- 2941.6 5 γ<sub>2488</sub> 453.44 (t<sub>1/2</sub> 100 38)
- 2942.7 3 γ<sub>2764</sub> 178.94 (t<sub>1/2</sub> 48 14) γ<sub>2760</sub> 182.23 (t<sub>1/2</sub> 100 14)
- 2960.3 10 γ<sub>2488</sub> 472.1 10 (t<sub>1/2</sub> 100 67)
- 2971.5, 9/2<sup>-</sup>, 11/2<sup>-</sup> γ<sub>1944</sub> 1027.7 (t<sub>1/2</sub> 50) γ<sub>1397</sub> 1574.2 (t<sub>1/2</sub> 17) γ<sub>2971.5</sub> (t<sub>1/2</sub> 100)
- 3005.6, 9/2<sup>-</sup>, 11/2<sup>-</sup> γ<sub>1397</sub> 1608.0 (t<sub>1/2</sub> 100) γ<sub>3005.6</sub> (t<sub>1/2</sub> 100)
- 3038.32 20, 23/2<sup>+</sup> γ<sub>2760</sub> 277.92 (t<sub>1/2</sub> 100 15) M1+E2
- 3082.5 5 γ<sub>2764</sub> 318.74 (t<sub>1/2</sub> 100 30)
- 3170.0 5 γ<sub>2760</sub> 409.54 (t<sub>1/2</sub> 100 38)
- 3185.8, 23/2<sup>+</sup> γ<sub>2760</sub> 425.63 (t<sub>1/2</sub> 100 28) M1(+E2)
- 3204.8, 9/2<sup>-</sup>, 11/2<sup>-</sup> γ<sub>1944</sub> 1260.0 (t<sub>1/2</sub> 50) γ<sub>1759</sub> 1407.0 (t<sub>1/2</sub> 25) γ<sub>1397</sub> 1809.0 (t<sub>1/2</sub> 38) γ<sub>3204.8</sub> (t<sub>1/2</sub> 100)
- 3227.9 5 γ<sub>2764</sub> 464.14 (t<sub>1/2</sub> 100 43)
- 3322.7, 9/2<sup>-</sup>, 11/2<sup>-</sup> γ<sub>3038</sub> 321.84 (t<sub>1/2</sub> 100 38)
- 3360.1 5 γ<sub>3038</sub> 321.84 (t<sub>1/2</sub> 100 38)
- 3399.08 19, 25/2<sup>+</sup> γ<sub>3038</sub> 360.81 (t<sub>1/2</sub> 100) M1+E2; δ=0.18 γ<sub>2760</sub> 638.61 (t<sub>1/2</sub> 10)
- 3581.97 21, 27/2<sup>-</sup>, 26.8 7 ns, μ=+11.34 23, Q=-1.26 8 γ<sub>3399</sub> 182.91 (t<sub>1/2</sub> 100 20) E1 γ<sub>3038</sub> 543.71 (t<sub>1/2</sub> 16) γ<sub>2760</sub> 821.32 (t<sub>1/2</sub> 5.5)
- 3691.94 21, 25/2<sup>-</sup> γ<sub>3582</sub> 110.01 M1 γ<sub>3186</sub> 505.32 γ<sub>3038</sub> 653.61 (t<sub>1/2</sub> 100)
- 3872.9, 13/2<sup>-</sup>, 11/2<sup>-</sup> γ<sub>997</sub> 2875.7 (t<sub>1/2</sub> 100)
- 4006.94 23, 27/2<sup>-</sup> γ<sub>3582</sub> 424.82 (t<sub>1/2</sub> 100)
- 4070.32 22, 27/2<sup>-</sup> γ<sub>3582</sub> 378.42 (t<sub>1/2</sub> 100) M1 γ<sub>3399</sub> 671.32 (t<sub>1/2</sub> 20)
- 4230.00 22, 29/2<sup>-</sup> γ<sub>4070</sub> 159.71 (t<sub>1/2</sub> 100) M1 γ<sub>4007</sub> 223.01 (t<sub>1/2</sub> 29)
- 4450.96 22, 29/2<sup>-</sup> γ<sub>4007</sub> 444.12 (t<sub>1/2</sub> 68) E2 γ<sub>3582</sub> 869.01 (t<sub>1/2</sub> 100) M1
- 4617.92 22, 29/2<sup>+</sup> γ<sub>3582</sub> 1035.91 (t<sub>1/2</sub> 100) E1
- 4844.08 22, 31/2<sup>+</sup> γ<sub>4451</sub> 393.12 (t<sub>1/2</sub> 61) γ<sub>4230</sub> 614.02 (t<sub>1/2</sub> 100) E2 γ<sub>3582</sub> 1262.02 (t<sub>1/2</sub> 60)
- 4948.76 23, 31/2<sup>+</sup> γ<sub>4451</sub> 330.81 (t<sub>1/2</sub> 100) M1 γ<sub>4451</sub> 498.12 (t<sub>1/2</sub> 14)
- 4971.93 22, 31/2<sup>-</sup> γ<sub>3582</sub> 1390.01 (t<sub>1/2</sub> 100) E2
- 5265.10 22, 31/2<sup>-</sup> γ<sub>4844</sub> 421.01 (t<sub>1/2</sub> 49) M1(+E2) γ<sub>4451</sub> 814.11 (t<sub>1/2</sub> 34) M1(E2) γ<sub>3582</sub> 1683.22 (t<sub>1/2</sub> 100) E2
- 5382.32 22, 33/2<sup>-</sup> γ<sub>5265</sub> 117.21 (t<sub>1/2</sub> 100) M1 γ<sub>4872</sub> 410.62 (t<sub>1/2</sub> 13) γ<sub>4949</sub> 433.83 (t<sub>1/2</sub> 9) γ<sub>4844</sub> 538.12 (t<sub>1/2</sub> 27) γ<sub>4230</sub> 1152.31 (t<sub>1/2</sub> 50) E2
- 5557.1 4, 35/2<sup>+</sup> γ<sub>4949</sub> 608.43 (t<sub>1/2</sub> 100) E2
- 5583.05 25, 35/2<sup>-</sup> γ<sub>5382</sub> 200.72 (t<sub>1/2</sub> 100) M1 γ<sub>4972</sub> 611.12 (t<sub>1/2</sub> 23) E2
- 5923.2 3, 37/2<sup>-</sup> γ<sub>5583</sub> 340.11 (t<sub>1/2</sub> 100) M1
- 6236.1 3, (35/2)<sup>+</sup> γ<sub>4949</sub> 1287.32 (t<sub>1/2</sub> 100)
- 6471.4 3, 39/2<sup>-</sup> γ<sub>5923</sub> 548.21 (t<sub>1/2</sub> 100) M1+E2
- 6541.4 5(?) (37/2)<sup>+</sup> γ<sub>5557</sub> 984.33 (t<sub>1/2</sub> 100) (M1+E2)
- 6621.4 3, 39/2<sup>+</sup> γ<sub>6541</sub> 80.33(?) D γ<sub>5923</sub> 698.21 (t<sub>1/2</sub> 100) E1 γ<sub>5557</sub> 1064.43 (t<sub>1/2</sub> 67) E2
- 6826.5(?) γ<sub>6236</sub> 590.81(?) (t<sub>1/2</sub> 100) (E2)
- 6906.7 3, 41/2<sup>+</sup> γ<sub>6621</sub> 285.42 (t<sub>1/2</sub> 95) M1+E2 γ<sub>6471</sub> 435.32 (t<sub>1/2</sub> 100) (E1) γ<sub>5923</sub> 984.1 (t<sub>1/2</sub> 19)
- 7035.4 3, 41/2<sup>+</sup> γ<sub>6821</sub> 208.34 (t<sub>1/2</sub> 20) γ<sub>6621</sub> 414.01 (t<sub>1/2</sub> 100) M1+E2
- 7389.3 4, 45/2<sup>+</sup> γ<sub>7035</sub> 353.53 (t<sub>1/2</sub> 45) γ<sub>6907</sub> 482.53 (t<sub>1/2</sub> 100) E2
- 7665.4(?) (39/2, 41/2) γ<sub>5923</sub> 1743.1(?) (t<sub>1/2</sub> 100)
- 7825.4 4(?) γ<sub>5923</sub> 1902.1(?) (t<sub>1/2</sub> 100)
- 7873.8 4, 41/2<sup>+</sup> γ<sub>7665</sub> 208.64(?) (t<sub>1/2</sub> 63) γ<sub>7035</sub> 638.75 (t<sub>1/2</sub> 59) E1 γ<sub>6621</sub> 1253.1(?) (t<sub>1/2</sub> 14) γ<sub>5923</sub> 1951.1 (t<sub>1/2</sub> 100) Q
- 7963.9 4(?) γ<sub>6907</sub> 1057.32 (t<sub>1/2</sub> 100) E1
- 7993.9 4, 43/2<sup>+</sup> γ<sub>7874</sub> 120.11 (t<sub>1/2</sub> 100) M1 γ<sub>7825</sub> 168.52 (t<sub>1/2</sub> 22) γ<sub>7389</sub> 604.51 (t<sub>1/2</sub> 13) γ<sub>7035</sub> 959 (E1) γ<sub>6907</sub> 1087.53 (t<sub>1/2</sub> 11)
- 8153.6 4(?) (47/2)<sup>+</sup> γ<sub>7389</sub> 764.42 (t<sub>1/2</sub> 100) M1
- 8333.4 4, 45/2<sup>+</sup> γ<sub>7994</sub> 339.03 (t<sub>1/2</sub> 100) E1 γ<sub>7964</sub> 369.52 (t<sub>1/2</sub> 12) E1

**<sup>147</sup>Gd (Continued)**  
**<sup>64</sup>Gd**

- 8587.84, (49/2<sup>+</sup>), 510.20 ns,  $\mu=+10.92$ ,  $Q=-3.2418$   $\gamma_{8333}^{254.41}$  ( $t_{1/2}$ ) E2  
 $\gamma_{8154}^{434.53}$  ( $t_{1/2}$ )  $\gamma_{7994}^{594.3(?)}$  ( $t_{1/2}$ ) (E3)  
 9241, (51/2)  $\gamma_{8588}^{653.0}$  ( $t_{1/2}$ ) D(+Q):  $\delta=+0.098$   
 9507.0, (51/2<sup>+</sup>), <1 ps  $\gamma_{8588}^{919.1}$  ( $t_{1/2}$ ) M1+E2:  $\delta=+0.65_{-12}^{+16}$   
 9691.2, (53/2<sup>+</sup>), 3.17 ps  $\gamma_{8588}^{1103.4}$  ( $t_{1/2}$ ) E2  
 9879.8, (53/2<sup>-</sup>), = 76 ps  $\gamma_{9691}^{188.5}$  ( $t_{1/2}$ ) (E1)  $\gamma_{9507}^{372.7}$  ( $t_{1/2}$ )  
 E1(+M2):  $\delta=-0.054$   $\gamma_{9241}^{638.8}$   $\gamma_{8588}^{1291.9}$  ( $t_{1/2}$ ) E3+M2  
 10271.6, (55/2<sup>-</sup>)  $\gamma_{9691}^{580.4}$   
 10487.6, (55/2<sup>+</sup>)  $\gamma_{9691}^{796.3}$  ( $t_{1/2}$ ) M1+E2:  $\delta=+0.294$   $\gamma_{9241}^{1246.9}$   
 10688.7, (57/2<sup>-</sup>), 10.3 ps  $\gamma_{9880}^{808.9}$  ( $t_{1/2}$ ) E2  
 10747.2, (57/2<sup>+</sup>)  $\gamma_{10488}^{259.6}$  ( $t_{1/2}$ ) M1  $\gamma_{9691}^{1056.1}$  ( $t_{1/2}$ ) E2  
 10993.3, (59/2<sup>-</sup>), 0.805 ns  $\gamma_{10747}^{246.2}$  ( $t_{1/2}$ ) E1  $\gamma_{10689}^{304.5}$  ( $t_{1/2}$ )  
 M1+E2:  $\delta=+0.274$   $\gamma_{10272}^{721}$   
 11232.2, (61/2<sup>-</sup>), 17.3 ps  $\gamma_{10993}^{238.9}$  ( $t_{1/2}$ ) M1  $\gamma_{10689}^{543.6}$  ( $t_{1/2}$ ) E2  
 11850.7, (65/2<sup>-</sup>)  $\gamma_{11232}^{618.6}$  ( $t_{1/2}$ ) E2  
 11930.3, (61/2)  $\gamma_{10993}^{936.8}$  ( $t_{1/2}$ ) D(+Q):  $\delta=-0.076$   
 12208.6, (65/2<sup>-</sup>), = 1.4 ps  $\gamma_{11232}^{976.4}$  ( $t_{1/2}$ ) E2  
 12548.7, (65/2)  $\gamma_{11930}^{618.3}$  ( $t_{1/2}$ ) E2  
 13104.7, (67/2,69/2)  $\gamma_{12209}^{896.1}$  ( $t_{1/2}$ ) E2  
 13265.1, (67/2)  $\gamma_{12549}^{716.3}$  ( $t_{1/2}$ )  $\gamma_{11851}^{1414.5}$  ( $t_{1/2}$ ) D  
 13416, 67/2  $\gamma_{12209}^{1208.0}$  ( $t_{1/2}$ ) D  
 13446, (69/2,71/2)  $\gamma_{13105}^{341.3}$   
 13446.5, (69/2)  $\gamma_{13265}^{181.3}$  ( $t_{1/2}$ )  $\gamma_{12549}^{897.9}$  ( $t_{1/2}$ ) E2  
 14433.2, (71/2)  $\gamma_{13446}^{986.7}$  ( $t_{1/2}$ ) M1+E2:  $\delta=+0.556$   
 14793(?)  
 15174.8, (73/2)  $\gamma_{14433}^{741.6}$  ( $t_{1/2}$ ) D  
 15390, (73/2)  $\gamma_{15175}^{215.5}$  ( $t_{1/2}$ ) D+Q:  $\delta=+0.34_{-26}^{+14}$   $\gamma_{14793}^{597.4}$  ( $t_{1/2}$ )  
 15691, (75/2)  $\gamma_{15390}^{300.3}$  ( $t_{1/2}$ ) D  
 16777  $\gamma_{15691}^{1086}$  ( $t_{1/2}$ )  
 16937, (79/2)  $\gamma_{15691}^{1246}$  ( $t_{1/2}$ )  
**B**  
 x, J=(55/2)  
 B 696.9+x, J+2  $\gamma_{696.9}$  ( $t_{1/2}$ )  $I^{(1)}=83.2$ ,  $I^{(2)}=83.2$ ,  $\eta\omega=0.360$   
 B 1441.9+x, J+4  $\gamma_{697+x}^{745.05}$  ( $t_{1/2}$ )  $I^{(1)}=83.2$ ,  $I^{(2)}=79.4$ ,  $\eta\omega=0.385$   
 B 2237.3+x, J+6  $\gamma_{442+x}^{795.44}$  ( $t_{1/2}$ )  $I^{(1)}=83.0$ ,  $I^{(2)}=76.5$ ,  $\eta\omega=0.411$   
 B 3085.0+x, J+8  $\gamma_{2237+x}^{847.74}$  ( $t_{1/2}$ )  $I^{(1)}=82.6$ ,  $I^{(2)}=76.8$ ,  $\eta\omega=0.437$   
 B 3984.8+x, J+10  $\gamma_{3085+x}^{899.87}$  ( $t_{1/2}$ )  $I^{(1)}=82.2$ ,  $I^{(2)}=73.5$ ,  $\eta\omega=0.464$   
 B 4939.0+x, J+12  $\gamma_{3985+x}^{954.25}$  ( $t_{1/2}$ )  $I^{(1)}=81.7$ ,  $I^{(2)}=72.6$ ,  $\eta\omega=0.491$   
 B 5948.3+x, J+14  $\gamma_{4939+x}^{1009.35}$  ( $t_{1/2}$ )  $I^{(1)}=81.2$ ,  $I^{(2)}=72.3$ ,  $\eta\omega=0.518$   
 B 7012.9+x, J+16  $\gamma_{5948+x}^{1064.65}$  ( $t_{1/2}$ )  $I^{(1)}=80.8$ ,  $I^{(2)}=70.9$ ,  $\eta\omega=0.546$   
 B 8133.9+x, J+18  $\gamma_{7013+x}^{1121.05}$  ( $t_{1/2}$ )  $I^{(1)}=80.3$ ,  $I^{(2)}=73.7$ ,  $\eta\omega=0.574$   
 B 9309.2+x, J+20  $\gamma_{8134+x}^{1175.35}$  ( $t_{1/2}$ )  $I^{(1)}=80.0$ ,  $I^{(2)}=75.9$ ,  $\eta\omega=0.601$   
 B 10537.2+x, J+22  $\gamma_{9309+x}^{1228.07}$  ( $t_{1/2}$ )  $I^{(1)}=79.8$ ,  $I^{(2)}=81.0$ ,  $\eta\omega=0.626$   
 B 11814.6+x, J+24  $\gamma_{10537+x}^{1277.45}$  ( $t_{1/2}$ )  $I^{(1)}=79.8$ ,  $I^{(2)}=87.7$ ,  $\eta\omega=0.650$   
 B 13137.6+x, J+26  $\gamma_{11815+x}^{1323.07}$  ( $t_{1/2}$ )  $I^{(1)}=80.1$ ,  $I^{(2)}=90.1$ ,  $\eta\omega=0.673$   
 B 14505.0+x, J+28  $\gamma_{13138+x}^{1367.45}$  ( $t_{1/2}$ )  $I^{(1)}=80.4$ ,  $I^{(2)}=85.3$ ,  $\eta\omega=0.695$   
 B 15919.3+x, J+30  $\gamma_{14505+x}^{1414.37}$  ( $t_{1/2}$ )  $I^{(1)}=80.6$ ,  $I^{(2)}=82.3$ ,  $\eta\omega=0.719$   
 B 17382.2+x, J+32  $\gamma_{15919+x}^{1462.97}$  ( $t_{1/2}$ )  $I^{(1)}=80.7$ ,  $I^{(2)}=75.8$ ,  $\eta\omega=0.745$   
 B 18897.9+x, J+34  $\gamma_{17382+x}^{1515.715}$  ( $t_{1/2}$ )  $I^{(1)}=80.5$   
**C**  
 y, J=(61/2)  
 C 731.2+y, J+2  $\gamma_{731.25}$  ( $t_{1/2}$ )  $I^{(1)}=87.5$ ,  $I^{(2)}=84.4$ ,  $\eta\omega=0.377$   
 C 1509.8+y, J+4  $\gamma_{731+y}^{778.64}$  ( $t_{1/2}$ )  $I^{(1)}=87.3$ ,  $I^{(2)}=82.0$ ,  $\eta\omega=0.402$   
 C 2337.2+y, J+6  $\gamma_{1510+y}^{827.44}$  ( $t_{1/2}$ )  $I^{(1)}=87.0$ ,  $I^{(2)}=80.0$ ,  $\eta\omega=0.426$   
 C 3214.6+y, J+8  $\gamma_{2337+y}^{877.44}$  ( $t_{1/2}$ )  $I^{(1)}=86.6$ ,  $I^{(2)}=77.8$ ,  $\eta\omega=0.452$   
 C 4143.4+y, J+10  $\gamma_{3215+y}^{928.84}$  ( $t_{1/2}$ )  $I^{(1)}=86.1$ ,  $I^{(2)}=76.6$ ,  $\eta\omega=0.477$   
 C 5124.4+y, J+12  $\gamma_{4143+y}^{981.04}$  ( $t_{1/2}$ )  $I^{(1)}=85.6$ ,  $I^{(2)}=74.1$ ,  $\eta\omega=0.504$   
 C 6159.4+y, J+14  $\gamma_{5124+y}^{1035.04}$  ( $t_{1/2}$ )  $I^{(1)}=85.0$ ,  $I^{(2)}=72.9$ ,  $\eta\omega=0.531$   
 C 7249.3+y, J+16  $\gamma_{6159+y}^{1089.95}$  ( $t_{1/2}$ )  $I^{(1)}=84.4$ ,  $I^{(2)}=71.2$ ,  $\eta\omega=0.559$   
 C 8395.4+y, J+18  $\gamma_{7249+y}^{1146.15}$  ( $t_{1/2}$ )  $I^{(1)}=83.8$ ,  $I^{(2)}=69.9$ ,  $\eta\omega=0.587$   
 C 9598.7+y, J+20  $\gamma_{8395+y}^{1203.35}$  ( $t_{1/2}$ )  $I^{(1)}=83.1$ ,  $I^{(2)}=69.0$ ,  $\eta\omega=0.616$   
 C 10860.0+y, J+22  $\gamma_{9599+y}^{1261.35}$  ( $t_{1/2}$ )  $I^{(1)}=82.5$ ,  $I^{(2)}=68.7$ ,  $\eta\omega=0.645$   
 C 12179.5+y, J+24  $\gamma_{10860+y}^{1319.55}$  ( $t_{1/2}$ )  $I^{(1)}=81.8$ ,  $I^{(2)}=66.1$ ,  $\eta\omega=0.675$   
 C 13559.5+y, J+26  $\gamma_{12180+y}^{1380.05}$  ( $t_{1/2}$ )  $I^{(1)}=81.2$ ,  $I^{(2)}=67.8$ ,  $\eta\omega=0.705$   
 C 14998.5+y, J+28  $\gamma_{13560+y}^{1439.06}$  ( $t_{1/2}$ )  $I^{(1)}=80.6$ ,  $I^{(2)}=65.0$ ,  $\eta\omega=0.735$   
 C 16499.0+y, J+30  $\gamma_{14999+y}^{1500.510}$  ( $t_{1/2}$ )  $I^{(1)}=80.0$ ,  $I^{(2)}=68.4$ ,  $\eta\omega=0.765$   
 C 18058.0+y, J+32  $\gamma_{16499+y}^{1559.015}$  ( $t_{1/2}$ )  $I^{(1)}=79.5$

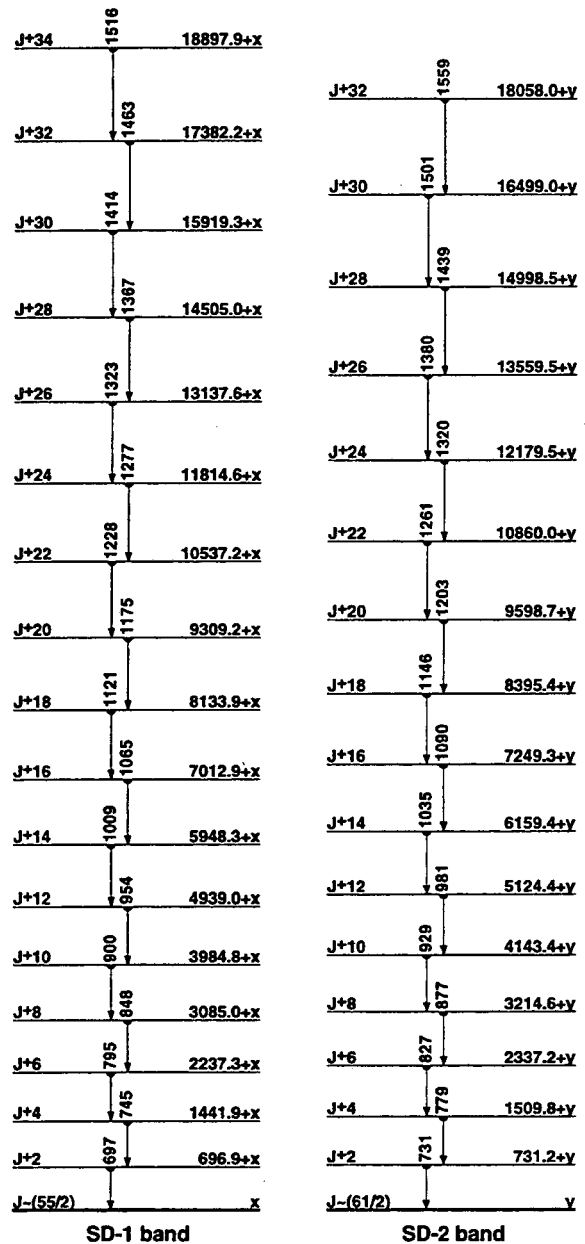

**<sup>147</sup>Gd**  
**<sup>64</sup>Gd**

148  
64Gd

$\Delta$ : -76279.3  $S_n$ : 8983.814  $S_p$ : 6014.3  $Q_\alpha$ : 3271.213

Nuclear Bands

- A SD-1 band
- B SD-2 band

Levels and  $\gamma$ -ray branchings:

0, 0<sup>+</sup>, 74.6 30 y, % $\alpha$ =100  
 784.430 16, 2<sup>+</sup>  $\gamma_{784}$  784.430 16 (t<sub>1/2</sub> 100) E2  
 1273.479 20, 3<sup>-</sup>  $\gamma_{784}$  489.049 12 (t<sub>1/2</sub> 100) E1  
 1416.377 23, 4<sup>+</sup>  $\gamma_{1273}$  142.878 14 (t<sub>1/2</sub> 2.90 13) E1  $\gamma_{784}$  631.947 17 (t<sub>1/2</sub> 100.0 19) E2  
 1811.0, 6<sup>+</sup>  $\gamma_{1416}$  394.6 (t<sub>1/2</sub> 100) E2  
 1834.58 5, \*  $\gamma_{784}$  1050.154 (t<sub>1/2</sub> 100) E2, M1  
 1863.42 5, 2<sup>+</sup>  $\gamma_{1335}$  589.97 (t<sub>1/2</sub> 5.2 3)  $\gamma_{784}$  1079.025 25 (t<sub>1/2</sub> 100.0 19) E2+M1:  $\delta$ =4.6<sup>-14</sup>  $\gamma_0$  1863.391 38 (t<sub>1/2</sub> 49.3 10)  
 1912.95 10, 4<sup>-</sup>  $\gamma_{1273}$  639.477 (t<sub>1/2</sub> 100) M1  
 2082.04 15, 5<sup>-</sup>  $\gamma_{813}$  169.2  $\gamma_{811}$  270.9 (t<sub>1/2</sub> 38) E1  $\gamma_{1416}$  665.6 (t<sub>1/2</sub> <39)  $\gamma_{1273}$  808.56 7 (t<sub>1/2</sub> 100) E2  
 2188.65 20, 2<sup>+</sup>  $\gamma_{1273}$  915.30 12 (t<sub>1/2</sub> 14)  $\gamma_{784}$  1404.224 35 (t<sub>1/2</sub> 100) E2, M1  $\gamma_0$  2188.65 7 (t<sub>1/2</sub> 80)  
 2233.59 6, 3<sup>-</sup>  $\gamma_{1273}$  960.09 7 (t<sub>1/2</sub> <100) E2, M1  $\gamma_{784}$  1449.16 4 (t<sub>1/2</sub> 85)  
 2310.88 7, 2<sup>+</sup>  $\gamma_{784}$  1526.45 7 (t<sub>1/2</sub> 55)  $\gamma_0$  2311.03 7 (t<sub>1/2</sub> 100)  
 2424.09 15, \*  $\gamma_{1416}$  1007.72 9 (t<sub>1/2</sub> <100)  $\gamma_{784}$  1639.66 22 (t<sub>1/2</sub> 65) M1, E2  
 2503.86 15, -  $\gamma_{1273}$  1230.18 5 (t<sub>1/2</sub> 56) E2, M1  $\gamma_{784}$  1719.63 20 (t<sub>1/2</sub> 100)  
 2506.4 5, 3<sup>-</sup>  $\gamma_{1416}$  1089.411 28 (t<sub>1/2</sub> 100) E1  $\gamma_{784}$  1722.47 28 (t<sub>1/2</sub> 15.3)  
 2522.0 3, 4<sup>+</sup>  $\gamma_{1416}$  1105.65 11 (t<sub>1/2</sub> 100) M1, E2  $\gamma_{1273}$  1248.2 8 (t<sub>1/2</sub> 33)  $\gamma_{784}$  1737.9 6 (t<sub>1/2</sub> 27)  
 2563.8 3, 7<sup>-</sup>  $\gamma_{2082}$  481.65 10 (t<sub>1/2</sub> 100) E2  $\gamma_{1811}$  752.8 2 (t<sub>1/2</sub> 23.3) E1  
 2615.0 8, 2<sup>+</sup>  $\gamma_{1273}$  1342.2 6 (t<sub>1/2</sub> 9.2)  $\gamma_{784}$  1830.14 4 (t<sub>1/2</sub> 100)  $\gamma_0$  2614.3 6 (t<sub>1/2</sub> 38)  
 2632.8 2, 5<sup>-</sup>  $\gamma_{784}$  1848.36 8 (t<sub>1/2</sub> 100)  
 2693.3 2, 8<sup>+</sup>  $\gamma_{2564}$  129.5 2 (t<sub>1/2</sub> 2.7 4)  $\gamma_{1811}$  882.3 E2  
 2694.6, 9<sup>-</sup>, 16.5 3 ns,  $\mu$ =-0.162 18,  $Q$ =1.01 5  $\gamma_{2564}$  130.8 E2  $\gamma_{1811}$  883.6 E3  
 2700.3 2, (2<sup>+</sup>)  $\gamma_{1273}$  1426.49 8 (t<sub>1/2</sub> 44)  $\gamma_{784}$  1915.54 19 (t<sub>1/2</sub> 63)  $\gamma_0$  2700.5 20 (t<sub>1/2</sub> 100)  
 2763 3, 4<sup>+</sup>  
 2872.9 4  $\gamma_{1913}$  960.09 7 (t<sub>1/2</sub> <100)  $\gamma_{1273}$  1599.39 6 (t<sub>1/2</sub> 100)  $\gamma_{784}$  2089 1 (t<sub>1/2</sub> 41)  
 2886.3 2  $\gamma_{2504}$  382.0 8 (t<sub>1/2</sub> 24)  $\gamma_{1416}$  1470.1 8 (t<sub>1/2</sub> 20)  $\gamma_{784}$  2101.8 7 10 (t<sub>1/2</sub> 100)  
 2915.3 3  $\gamma_{1913}$  1002.48 9 (t<sub>1/2</sub> 28)  $\gamma_{1273}$  1641.98 21 (t<sub>1/2</sub> 37)  $\gamma_{784}$  2131.14 11 (t<sub>1/2</sub> 100)  
 2936.3, 7<sup>-</sup>  $\gamma_{1811}$  1125.3 (t<sub>1/2</sub> 100)  
 3029.3, 8<sup>-</sup>  $\gamma_{2695}$  334.7 (t<sub>1/2</sub> 100) M1  $\gamma_{2564}$  465.6 (t<sub>1/2</sub> 58) M1  
 3065  $\gamma_{1835}$  1230  
 3076.1 4  $\gamma_{1273}$  1802.62 24 (t<sub>1/2</sub> 100)  
 3089.5 4  $\gamma_{2082}$  1007.72 9 (t<sub>1/2</sub> <100) (E2, M1)  $\gamma_{1273}$  1816.06 9 (t<sub>1/2</sub> 68)  $\gamma_0$  3090.5 15 (t<sub>1/2</sub> 25)  
 3130.9 2  $\gamma_{784}$  2345.1 8 (t<sub>1/2</sub> 63)  $\gamma_0$  3130.8 9 16 (t<sub>1/2</sub> 100)  
 3152.1, 8<sup>-</sup>  $\gamma_{3029}$  122.9 D+Q  $\gamma_{2695}$  457.6  $\gamma_{2564}$  588.3  
 3295.0 2  $\gamma_{784}$  2510.56 15 (t<sub>1/2</sub> 100)  $\gamma_0$  3295.5 10 (t<sub>1/2</sub> 33)  
 3310.0 (?), 8<sup>-</sup>  $\gamma_{2936}$  373.7 (t<sub>1/2</sub> 100)  
 3366.8, 9<sup>-</sup>  $\gamma_{3310}$  57  $\gamma_{3152}$  214.7  $\gamma_{3029}$  337.2  $\gamma_{2936}$  430.5 (t<sub>1/2</sub> 100)  $\gamma_{2693}$  673.8 (t<sub>1/2</sub> 78)  $\gamma_{2564}$  803.2  
 3574.9 4  $\gamma_{1273}$  2301.44 21 (t<sub>1/2</sub> 100)  $\gamma_0$  3574.6 10 (t<sub>1/2</sub> 90)  
 3701.3, 11<sup>-</sup>  $\gamma_{2695}$  1006.7 (t<sub>1/2</sub> 100) E2  
 3757.9, 10<sup>+</sup>  $\gamma_{2695}$  1063.3 (t<sub>1/2</sub> 100)  
 3822, 10<sup>+</sup>  $\gamma_{3758}$  63  $\gamma_{2693}$  1128  $\gamma_{2633}$  1129  
 3917.4, 10<sup>-</sup>  $\gamma_{3367}$  550.3  $\gamma_{3152}$  765.3  $\gamma_{3029}$  888.3  
 3980.1, 12<sup>+</sup>  $\gamma_{3758}$  221.6  $\gamma_{3701}$  278.8 E1  $\gamma_{2695}$  1285.4  
 4050.8 15  $\gamma_{1416}$  2634.6 10 (t<sub>1/2</sub> 39)  $\gamma_{1273}$  2777.5 10 (t<sub>1/2</sub> 19)  $\gamma_{784}$  3266.4 10 (t<sub>1/2</sub> 100)  
 4068.7 15  $\gamma_{1913}$  2155.33 25 (t<sub>1/2</sub> 100)  $\gamma_{1273}$  2794.6 10 (t<sub>1/2</sub> 51)  $\gamma_0$  4066.8 10 (t<sub>1/2</sub> 43)  
 4121.2, 11<sup>-</sup>  $\gamma_{3701}$  420.1  $\gamma_{3367}$  754.2  
 4429.4, 12<sup>-</sup>  $\gamma_{4121}$  308.2  $\gamma_{3980}$  449.1  $\gamma_{3811}$  511  $\gamma_{3701}$  728.3  
 4499.8, 12<sup>+</sup>  $\gamma_{3980}$  519.7 (t<sub>1/2</sub> 100)  $\gamma_{3822}$  678  $\gamma_{3758}$  742.1 (t<sub>1/2</sub> 100)  $\gamma_{3701}$  799  
 4542.3 4  $\gamma_{1416}$  3125.44 29 (t<sub>1/2</sub> 47)  $\gamma_{1273}$  3269.22 30 (t<sub>1/2</sub> 100)  
 4550.6, 13<sup>-</sup>  $\gamma_{4429}$  121.2  $\gamma_{4121}$  429.4  $\gamma_{3980}$  570  
 4905.5, 14<sup>-</sup>  $\gamma_{4551}$  354.9  
 5025.1, 14<sup>+</sup>  $\gamma_{4551}$  475  $\gamma_{4506}$  525.3  $\gamma_{3980}$  1045.1  
 5116.9, 15<sup>-</sup>  $\gamma_{4906}$  211.4 (t<sub>1/2</sub> 100)  $\gamma_{4551}$  566.3 (t<sub>1/2</sub> 100)  
 5167.4, 14<sup>+</sup>  $\gamma_{3980}$  1187.3 (t<sub>1/2</sub> 100)  
 5354.7, 16<sup>+</sup>  $\gamma_{5117}$  237.9 (t<sub>1/2</sub> 14)  $\gamma_{5025}$  329.6 (t<sub>1/2</sub> 100)  
 5437.7, 16<sup>-</sup>  $\gamma_{5117}$  320.8  $\gamma_{4906}$  532  
 5578  $\gamma_{5167}$  411  
 5689, 17  $\gamma_{5355}$  334  
 5800  $\gamma_{5578}$  222  
 5831.8, 18<sup>+</sup>  $\gamma_{5689}$  142  $\gamma_{5355}$  476.8  
 5882, 17  $\gamma_{5438}$  444  
 5933, 17  $\gamma_{5800}$  133  $\gamma_{5438}$  495  $\gamma_{5355}$  578  $\gamma_{5117}$  816  
 6268, 18  $\gamma_{5832}$  436  
 6381, 18  $\gamma_{5933}$  448  $\gamma_{5882}$  499  $\gamma_{5832}$  549  
 6545, 18<sup>-</sup>  $\gamma_{5933}$  612  $\gamma_{5689}$  855  
 6574, 19<sup>+</sup>  $\gamma_{6381}$  193  $\gamma_{6268}$  306  $\gamma_{5832}$  742  
 6640, 19<sup>-</sup>  $\gamma_{5832}$  808  
 6834, 20<sup>-</sup> = 2 ns  $\gamma_{6640}$  194  $\gamma_{6574}$  259  $\gamma_{6545}$  289  $\gamma_{5832}$  1002  
 7051, 19<sup>+</sup>  $\gamma_{6381}$  670  $\gamma_{5832}$  1219  
 7110, 20<sup>+</sup>  $\gamma_{5832}$  1278  
 7155, 21<sup>-</sup>  $\gamma_{5834}$  321  $\gamma_{6640}$  516  
 7273, 20<sup>+</sup>  $\gamma_{7051}$  223  $\gamma_{6574}$  699  
 7333  $\gamma_{6574}$  759  
 7530, 21<sup>+</sup>  $\gamma_{7333}$  197  $\gamma_{7273}$  257  $\gamma_{7110}$  420  $\gamma_{7051}$  479  
 7790, 22<sup>+</sup>  $\gamma_{7530}$  260  $\gamma_{7110}$  680  
 8003, 22<sup>-</sup>  $\gamma_{7155}$  849  $\gamma_{6834}$  1170  
 8241, 22<sup>-</sup>  $\gamma_{6834}$  1408  
 8304, 23<sup>-</sup>  $\gamma_{7155}$  1149  
 8308, 23<sup>+</sup>  $\gamma_{7790}$  518  
 8363, 23<sup>-</sup>  $\gamma_{7790}$  574  $\gamma_{7155}$  1208  
 8453, 23<sup>-</sup>  $\gamma_{8304}$  151  $\gamma_{8241}$  213  $\gamma_{8003}$  451  $\gamma_{7790}$  664  
 8608, 23  $\gamma_{7790}$  818  
 8637, 24<sup>-</sup>  $\gamma_{8453}$  184  $\gamma_{8308}$  330  $\gamma_{8003}$  634  
 8831, 24  $\gamma_{8608}$  223  $\gamma_{8453}$  377  $\gamma_{8363}$  468  $\gamma_{8308}$  523  
 8986, 25<sup>-</sup>  $\gamma_{8831}$  155  $\gamma_{8637}$  348  $\gamma_{8363}$  623  
 9241, 25<sup>-</sup>  $\gamma_{8637}$  604  
 9258  $\gamma_{8637}$  620  $\gamma_{8363}$  895  
 9652, 26<sup>-</sup>  $\gamma_{8986}$  666  
 9755, 26<sup>-</sup>  $\gamma_{9241}$  514  $\gamma_{8986}$  771  
 9933, 26  $\gamma_{8831}$  1102  
 9956  $\gamma_{9241}$  714  
 10045, 25<sup>-</sup>  $\gamma_{9258}$  788  $\gamma_{8363}$  1682  $\gamma_{8304}$  1742  
 10060, 27  $\gamma_{9755}$  305  
 10317, 27<sup>-</sup>  $\gamma_{10045}$  272  $\gamma_{9956}$  361  $\gamma_{9755}$  560  $\gamma_{9652}$  665  $\gamma_{8986}$  1331  
 10472, 27<sup>-</sup>  $\gamma_{9755}$  717  
 10694, 27<sup>-</sup>  $\gamma_{9652}$  1042  
 10757, 28  $\gamma_{10060}$  697  
 10867, 28  $\gamma_{10060}$  807  
 11157, 28  $\gamma_{10694}$  464  $\gamma_{10472}$  684  $\gamma_{10317}$  840  
 11183, 29  $\gamma_{10060}$  1123  
 11455, 29  $\gamma_{11183}$  271  $\gamma_{11157}$  298  
 11478  $\gamma_{10317}$  1160  
 11546, 29<sup>-</sup>  $\gamma_{10694}$  852  $\gamma_{10317}$  1228  
 11585, 30  $\gamma_{11455}$  130  
 11725, 30  $\gamma_{11183}$  542  $\gamma_{10867}$  858  $\gamma_{10757}$  967  
 12011  $\gamma_{11455}$  556  
 12061, 30<sup>-</sup>  $\gamma_{11183}$  878  
 12139, 31<sup>-</sup>  $\gamma_{12061}$  74  $\gamma_{11725}$  411  $\gamma_{11585}$  554  $\gamma_{11546}$  593  $\gamma_{11478}$  661  
 12283, 30<sup>-</sup>  $\gamma_{11455}$  890  $\gamma_{11157}$  1126  
 12380, 31  $\gamma_{11455}$  925  
 12527, 32  $\gamma_{12283}$  244  $\gamma_{12139}$  391  $\gamma_{11585}$  943  
 12681, 31  $\gamma_{11585}$  1096  
 13037, 33  $\gamma_{12681}$  361  $\gamma_{12527}$  510  $\gamma_{12380}$  657  
 13123, 33<sup>-</sup>  $\gamma_{12139}$  987  
 13146, 32  $\gamma_{12681}$  462  $\gamma_{12380}$  766  $\gamma_{12139}$  1009  
 13242, 32  $\gamma_{12681}$  561  
 13352, 34  $\gamma_{12527}$  825  
 13734, 34  $\gamma_{1811}$  13242 492  $\gamma_{13146}$  588  $\gamma_{13037}$  697  
 13868, 35, = 2 ns  $\gamma_{13734}$  134  $\gamma_{12527}$  1340  
 13886  $\gamma_{13037}$  849  
 14009, 34  $\gamma_{13037}$  972  
 14144, 35  $\gamma_{13037}$  1107  
 14827, 37  $\gamma_{13868}$  959  
 14923, 36  $\gamma_{14144}$  779  $\gamma_{13868}$  1036  $\gamma_{13868}$  1056  
 15122, 38  $\gamma_{14827}$  295

**<sup>148</sup>Gd (Continued)**

15164.38  $\gamma_{14827}^{337}$   
 15726  $\gamma_{14923}^{903}$   
 16076  $\gamma_{15726}^{350}$   
 16111.38  $\gamma_{14923}^{1188}$   
 16203.40  $\gamma_{15164}^{1039}$   
 16256.40  $\gamma_{15164}^{1092}$   
 16406.40  $\gamma_{16111}^{295}$   
 16472.39  $\gamma_{15164}^{1308}$   
 17240  $\gamma_{16406}^{834}$   
 17318  $\gamma_{16472}^{846}$   
 17370.42  $\gamma_{16406}^{964}$   
 18481.44  $\gamma_{17370}^{1111}$   
 19148  $\gamma_{18481}^{667}$

- A x, J=(27)  
 A 652.3+x, J+2  $\gamma_{652.3}^{3(?)}$  ( $\dagger 0.115$ )  $I^{(1)}=87.4, I^{(2)}=84.4, \eta\omega=0.338$   
 A 1352.0+x, J+4  $\gamma_{652+x}^{699.73}$  ( $\dagger 0.6910$ )  $I^{(1)}=87.2, I^{(2)}=84.0, \eta\omega=0.362$   
 A 2099.3+x, J+6  $\gamma_{1352+x}^{747.33}$  ( $\dagger 0.997$ )  $I^{(1)}=87.0, I^{(2)}=81.0, \eta\omega=0.386$   
 A 2896.0+x, J+8  $\gamma_{2099+x}^{796.73}$  ( $\dagger 0.9010$ )  $I^{(1)}=86.6, I^{(2)}=80.2, \eta\omega=0.411$   
 A 3742.6+x, J+10  $\gamma_{2896+x}^{846.63}$  ( $\dagger 0.8715$ )  $I^{(1)}=86.2, I^{(2)}=78.0, \eta\omega=0.436$   
 A 4640.5+x, J+12  $\gamma_{3743+x}^{897.93}$  ( $\dagger 1.007$ )  $I^{(1)}=85.8, I^{(2)}=76.6, \eta\omega=0.462$   
 A 5590.6+x, J+14  $\gamma_{4641+x}^{950.13}$  ( $\dagger 1.018$ )  $I^{(1)}=85.3, I^{(2)}=74.3, \eta\omega=0.488$   
 A 6594.5+x, J+16  $\gamma_{5591+x}^{1003.94}$  ( $\dagger 0.9110$ )  $I^{(1)}=84.7, I^{(2)}=73.4, \eta\omega=0.516$   
 A 7652.9+x, J+18  $\gamma_{6595+x}^{1058.44}$   $I^{(1)}=84.1, I^{(2)}=71.6, \eta\omega=0.543$   
 A 8767.2+x, J+20  $\gamma_{7653+x}^{1114.34}$  ( $\dagger 0.9010$ )  $I^{(1)}=83.5, I^{(2)}=71.0, \eta\omega=0.571$   
 A 9937.8+x, J+22  $\gamma_{8767+x}^{1170.64}$  ( $\dagger 0.857$ )  $I^{(1)}=82.9, I^{(2)}=70.2, \eta\omega=0.600$   
 A 11165.4+x, J+24  $\gamma_{9938+x}^{1227.64}$  ( $\dagger 0.666$ )  $I^{(1)}=82.3, I^{(2)}=69.4, \eta\omega=0.628$   
 A 12450.6+x, J+26  $\gamma_{11165+x}^{1285.24}$  ( $\dagger 0.555$ )  $I^{(1)}=81.7, I^{(2)}=68.5, \eta\omega=0.657$   
 A 13794.2+x, J+28  $\gamma_{12451+x}^{1343.64}$  ( $\dagger 0.548$ )  $I^{(1)}=81.1, I^{(2)}=67.5, \eta\omega=0.687$   
 A 15197.1+x, J+30  $\gamma_{13794+x}^{1402.95}$  ( $\dagger 0.337$ )  $I^{(1)}=80.5, I^{(2)}=68.0, \eta\omega=0.716$   
 A 16658.8+x, J+32  $\gamma_{15197+x}^{1461.75}$  ( $\dagger 0.243$ )  $I^{(1)}=80.0, I^{(2)}=68.6, \eta\omega=0.745$   
 A 18178.8+x, J+34  $\gamma_{16658+x}^{1520.06}$  ( $\dagger 0.204$ )  $I^{(1)}=79.6, I^{(2)}=67.1, \eta\omega=0.775$   
 A 19758.4+x, J+36  $\gamma_{18178+x}^{1579.69}$  ( $\dagger 0.144$ )  $I^{(1)}=79.1$   
 B y, J=(32)  
 B 787.8+y, J+2  $\gamma_{787.8}^{10(?)}$   $I^{(1)}=85.0, I^{(2)}=81.1, \eta\omega=0.406$   
 B 1624.9+y, J+4  $\gamma_{788+y}^{837.15}$  ( $\dagger 0.5315$ )  $I^{(1)}=84.8, I^{(2)}=76.5, \eta\omega=0.432$   
 B 2514.3+y, J+6  $\gamma_{1624+y}^{889.44}$  ( $\dagger 0.8320$ )  $I^{(1)}=84.3, I^{(2)}=80.3, \eta\omega=0.457$   
 B 3453.5+y, J+8  $\gamma_{2514+y}^{939.26}$  ( $\dagger 0.9413$ )  $I^{(1)}=84.1, I^{(2)}=79.8, \eta\omega=0.482$   
 B 4442.8+y, J+10  $\gamma_{3454+y}^{989.35}$  ( $\dagger 1.0313$ )  $I^{(1)}=83.9, I^{(2)}=80.0, \eta\omega=0.507$   
 B 5482.1+y, J+12  $\gamma_{4443+y}^{1039.34}$  ( $\dagger 1.0117$ )  $I^{(1)}=83.7, I^{(2)}=81.5, \eta\omega=0.532$   
 B 6570.5+y, J+14  $\gamma_{5482+y}^{1088.48}$  ( $\dagger 0.9613$ )  $I^{(1)}=83.6, I^{(2)}=85.1, \eta\omega=0.556$   
 B 7705.9+y, J+16  $\gamma_{6571+y}^{1135.47}$  ( $\dagger 0.9519$ )  $I^{(1)}=83.7, I^{(2)}=87.0, \eta\omega=0.579$   
 B 8887.3+y, J+18  $\gamma_{7706+y}^{1181.45}$  ( $\dagger 0.6913$ )  $I^{(1)}=83.8, I^{(2)}=80.6, \eta\omega=0.603$   
 B 10118.3+y, J+20  $\gamma_{8887+y}^{1231.05}$  ( $\dagger 0.5417$ )  $I^{(1)}=83.7, I^{(2)}=78.4, \eta\omega=0.628$   
 B 11400.3+y, J+22  $\gamma_{10118+y}^{1282.05}$  ( $\dagger 0.3515$ )  $I^{(1)}=83.5, I^{(2)}=80.2, \eta\omega=0.653$   
 B 12732.2+y, J+24  $\gamma_{11400+y}^{1331.96}$  ( $\dagger 0.2620$ )  $I^{(1)}=83.3, I^{(2)}=75.3, \eta\omega=0.679$   
 B 14117.2+y, J+26  $\gamma_{12732+y}^{1385.010}$  ( $\dagger 0.4820$ )  $I^{(1)}=83.0, I^{(2)}=76.9, \eta\omega=0.706$   
 B 15554.2+y, J+28  $\gamma_{14117+y}^{1437.010}$  ( $\dagger 0.1811$ )  $I^{(1)}=82.8$

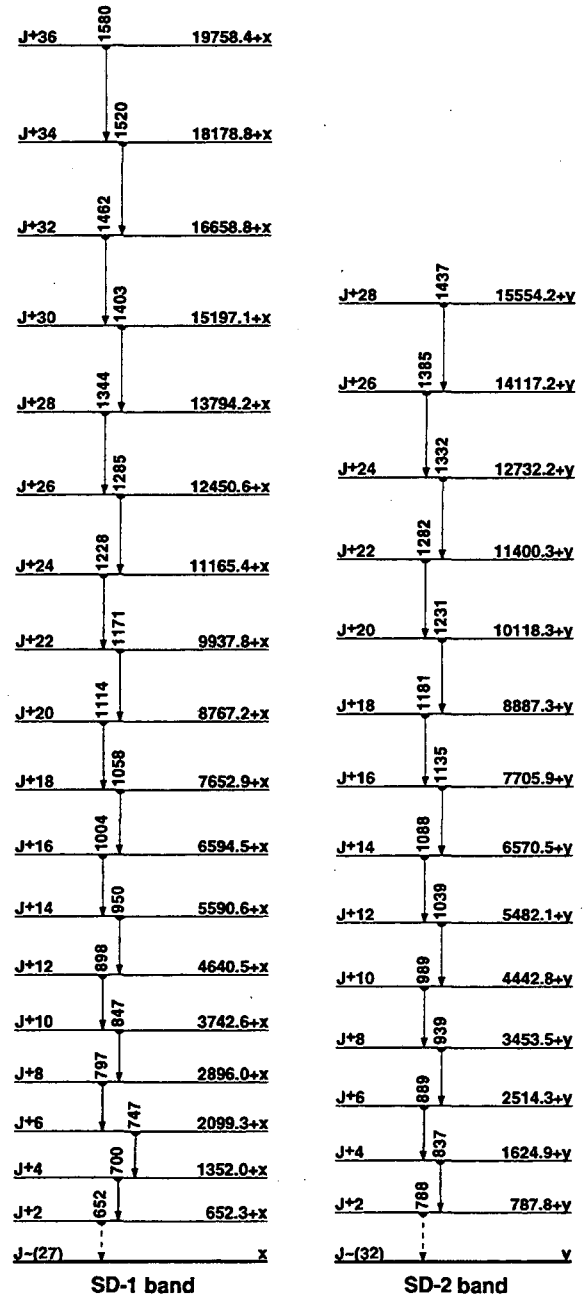

**<sup>148</sup>Gd**

149Gd  
64Gd

Δ: -75135 S<sub>n</sub>: 69273 S<sub>p</sub>: 618518 Q<sub>EC</sub>: 13196 Q<sub>α</sub>: 31013

Nuclear Bands

- A SD-1 band
- B SD-2 band
- C SD-3 band
- D SD-4 band
- E SD-5 band
- F SD-6 band
- G SD-7 band
- H SD-8 band

I (v<sub>f7/2</sub>)<sup>3</sup>

J (v<sub>h9/2</sub>)(v<sub>f7/2</sub>)<sup>3</sup>

K (v<sub>f7/2</sub>)<sup>3</sup>(3)

L (v<sub>f7/2</sub>)<sup>2</sup>(v<sub>h9/2</sub>)(πd<sub>5/2</sub>)<sup>2</sup>(πh<sub>11/2</sub>)<sup>2</sup>

M (v<sub>f7/2</sub>)<sup>2</sup>(v<sub>i13/2</sub>)(πd<sub>5/2</sub>)<sup>2</sup>(πh<sub>11/2</sub>)<sup>2</sup>

N (v<sub>f7/2</sub>)(v<sub>h9/2</sub>)(v<sub>i13/2</sub>)(πd<sub>5/2</sub>)<sup>2</sup>(πh<sub>11/2</sub>)<sup>2</sup>

O (v<sub>f7/2</sub>)(v<sub>h9/2</sub>)(v<sub>i13/2</sub>)(πd<sub>5/2</sub>)<sup>3</sup>(πg<sub>7/2</sub>)<sup>3</sup>

P (v<sub>f7/2</sub>)(v<sub>h9/2</sub>)(v<sub>i13/2</sub>)(πd<sub>5/2</sub>)<sup>2</sup>(πg<sub>7/2</sub>)<sup>1</sup>

Levels and γ-ray branchings:

- I 0, 7/2<sup>-</sup>, 9.28 10 d, %EC+%β<sup>+</sup>=100, %α=4.3×10<sup>-4</sup>, μ=0.884
- I 164.988 15, 5/2<sup>-</sup>, 1.71 ns, μ=-0.9023 γ<sub>0</sub>164.982 (†100) M1+E2: δ=-0.932
- I 352.235 15, 3/2<sup>-</sup>, 0.435 ns γ<sub>165</sub>187.222 (†14.62) M1+E2: δ=+0.5<sup>-</sup><sub>1</sub>  
γ<sub>0</sub>352.242 (†1003) E2
- I 775.20 8, 11/2<sup>-</sup> γ<sub>0</sub>775.21 (†100) E2
- J 795.82 8, 9/2<sup>-</sup> γ<sub>165</sub>630.53(?) (†15) γ<sub>0</sub>795.91 (†1005) M1+E2: δ=+0.191  
817.102, 3/2<sup>-</sup> γ<sub>352</sub>464.852 (†34.85) M1(+E2): δ=-0.1014 γ<sub>165</sub>652.122  
(†1001) M1+E2: δ=-0.575 γ<sub>0</sub>817.12 (†71.411) E2
- K 873.35 9, 11/2<sup>+</sup>, 1.66 ns γ<sub>796</sub>77.61 (†1001) E1 γ<sub>775</sub>98.71 (†451) E1  
γ<sub>0</sub>873.12(?) (†4.22)
- K 955.81 11, (13/2)<sup>+</sup> γ<sub>873</sub>82.32 (†431) M1 γ<sub>775</sub>180.51 (†1001) E1  
1026.842, 3/2<sup>+</sup> γ<sub>352</sub>674.616 (†9.12) E1 γ<sub>165</sub>861.862 (†1001)  
E1(+M2): δ=-0.056  
1085.23, (5/2<sup>-</sup>, 7/2<sup>-</sup>, 9/2<sup>-</sup>) γ<sub>796</sub>289.33 (†10025) γ<sub>165</sub>920.5 (†3812) γ<sub>0</sub>1085.5  
(†7538)
- 1124.893, 1/2<sup>+</sup>, 3/2<sup>+</sup>, 5/2<sup>+</sup> γ<sub>1027</sub>98.12 (†9.311) M1 γ<sub>817</sub>307.797 (†16.511)  
γ<sub>352</sub>772.653 (†1002) E1
- 1144.095, 3/2<sup>+</sup>, 5/2<sup>+</sup> γ<sub>1027</sub>117.2 (†4.2) γ<sub>352</sub>791.8 (†125) γ<sub>165</sub>979.096  
(†1005) E1 γ<sub>0</sub>1144.099 (†595) D, E2
- 1167.116, (3/2<sup>+</sup>) γ<sub>165</sub>1002.1 (†58.4) γ<sub>0</sub>1167.107 (†1005) (M2)
- 1205.672, (1/2<sup>-</sup>) γ<sub>817</sub>388.572 (†100.07) M1+E2: δ=-0.219 γ<sub>352</sub>853.431  
(†84.112) E2+M1: δ=-8<sup>-</sup><sub>23</sub> γ<sub>165</sub>1040.654 (†7.92) (E2) γ<sub>0</sub>1205.6(?)  
(†<0.1)
- 1348.73 9, 1/2<sup>-</sup>, 3/2<sup>-</sup>, 5/2<sup>-</sup> γ<sub>1027</sub>321.9 (†147) γ<sub>352</sub>996.51 (†1007)  
γ<sub>165</sub>1183.72 (†5714)
- 1402.90 7, (5/2<sup>-</sup>) γ<sub>1085</sub>317.4 (†144) γ<sub>796</sub>606.7 (†4.2) γ<sub>0</sub>1402.919 (†1006)
- I 1483.80 11, (15/2<sup>-</sup>) γ<sub>966</sub>527.81 (†44.2) E1 γ<sub>775</sub>708.71 (†1001) E2
- 1487.60 7, 1/2<sup>-</sup>, 3/2<sup>-</sup>, 5/2<sup>-</sup> γ<sub>817</sub>670.4 (†5.215) γ<sub>352</sub>1135.31 (†1003)  
M1(+E2): δ<0.7 γ<sub>165</sub>1322.71 (†7.57)
- 1544.135, (3/2<sup>-</sup>, 5/2<sup>-</sup>) γ<sub>352</sub>1191.898 (†1007) γ<sub>165</sub>1379.11 (†1005)  
γ<sub>0</sub>1544.12 (†215)
- 1557.38 6, 1/2<sup>-</sup>, 3/2<sup>-</sup>, 5/2<sup>-</sup> γ<sub>1167</sub>390.3 (†297) γ<sub>1144</sub>413.31 (†312)  
γ<sub>1125</sub>432.52 (†184) γ<sub>817</sub>740.21 (†1004) γ<sub>352</sub>1205.208 (†959)  
γ<sub>165</sub>1392.33 (†134)
- 1597.29 11, 1/2, 3/2, 5/2<sup>-</sup> γ<sub>1125</sub>472.41 (†10015) γ<sub>817</sub>780.2 (†92) γ<sub>352</sub>1245.1  
(†114)
- J 1609.05 13, (13/2<sup>-</sup>) γ<sub>796</sub>813.22 (†1001) (E2) γ<sub>775</sub>834.02 (†993) D(+Q)
- 1614.05 6, 3/2<sup>+</sup> γ<sub>1167</sub>446.76 (†2.819) γ<sub>1144</sub>469.9 (†0.96) γ<sub>1027</sub>587.2  
(†5.719) γ<sub>817</sub>796.9 (†1.99) γ<sub>352</sub>1261.72 (†122) γ<sub>165</sub>1449.108 (†1004)  
E1
- 1655.19 6, (3/2<sup>+</sup>) γ<sub>1403</sub>252.31 (†112) γ<sub>1206</sub>449.6 (†7.722) γ<sub>1167</sub>488.12  
(†112) γ<sub>1027</sub>628.42 (†9.922) γ<sub>817</sub>838.12 (†91) γ<sub>352</sub>1302.928 (†1003)  
E1 γ<sub>165</sub>1490.32 (†223)
- K 1739.72, (17/2)<sup>+</sup> γ<sub>966</sub>784.12 (†100) E2
- 1750.61 9, 1/2<sup>-</sup>, 3/2<sup>-</sup>, 5/2<sup>-</sup> γ<sub>1403</sub>347.7 (†7910) γ<sub>1125</sub>625.73 (†105)  
γ<sub>1027</sub>723.8 (†6310) γ<sub>352</sub>1398.33 (†3210) γ<sub>165</sub>1585.61 (†1005)  
γ<sub>0</sub>1751.04(?) (†2111)
- 1751.12(?) γ<sub>873</sub>877.82(?) (†100)
- 1772.83 5, 1/2<sup>-</sup>, 3/2<sup>-</sup> γ<sub>1125</sub>648.01 (†1009) γ<sub>1027</sub>746.01 (†493)  
γ<sub>817</sub>955.715 (†774) (E1) γ<sub>352</sub>1420.61 (†141) γ<sub>0</sub>1772.8(?) (†33)
- 1844.31 7, 1/2<sup>-</sup>, 3/2, 5/2<sup>-</sup> γ<sub>1167</sub>677.21 (†10010) γ<sub>1027</sub>817.5 (†3510)  
γ<sub>817</sub>1027.22 (†105) γ<sub>352</sub>1492.23 (†6010) γ<sub>165</sub>1679.31 (†9010)
- 1992.49 4, 3/2<sup>-</sup> γ<sub>1773</sub>219.7 (†0.316) γ<sub>1614</sub>378.51 (†3.85) γ<sub>1544</sub>448.5  
(†1.43) γ<sub>1206</sub>786.81 (†4.13) γ<sub>1167</sub>825.4 (†1.95) γ<sub>1027</sub>965.635  
(†16.28) γ<sub>817</sub>1175.4 (†1004) M1 γ<sub>352</sub>1640.266 (†97.33) E2(+M1): δ>1  
γ<sub>165</sub>1827.5 (†33.52) M1(+E2): δ<1 γ<sub>0</sub>1992.5(?) (†0.55)
- 1999.5 3(?) (15/2<sup>+</sup>) γ<sub>1609</sub>390.52 (†100) E1
- 2058.01 13, (17/2<sup>-</sup>) γ<sub>1609</sub>448.92 (†192) (E2) γ<sub>1484</sub>574.21 (†1001) M1
- 2088.47 9, 1/2<sup>-</sup>, 3/2, 5/2<sup>-</sup> γ<sub>1403</sub>685.6 (†3111) γ<sub>1144</sub>944.42 (†7128)  
γ<sub>1125</sub>963.6 (†5728) γ<sub>1027</sub>1061.61 (†10014) γ<sub>352</sub>1736.32 (†9313)  
γ<sub>165</sub>1923.4 (†169)
- 2126.66, 1/2, 3/2, 5/2<sup>-</sup> γ<sub>1403</sub>723.7 (†10025) γ<sub>1125</sub>1001.7(?) (†<37)  
γ<sub>352</sub>1774.4 (†7525)
- 2158.36 4, (3/2<sup>+</sup>) γ<sub>1614</sub>544.3 (†1.14) γ<sub>1544</sub>614.21 (†7.38) γ<sub>1488</sub>670.8  
(†3.58) γ<sub>1206</sub>952.71 (†6.98) γ<sub>1125</sub>1033.4 (†10.819) (M1) γ<sub>1027</sub>1131.657  
(†34.211) (M1) γ<sub>817</sub>1341.196 (†1004) E1 γ<sub>352</sub>1806.01 (†19.211)  
γ<sub>165</sub>1993.3 (†2.38)
- 2199.90 11, 1/2<sup>-</sup>, 3/2, 5/2<sup>-</sup> γ<sub>1403</sub>797.0 (†115) γ<sub>1206</sub>994.3 (†215)  
γ<sub>1167</sub>1032.8 (†5316) γ<sub>1144</sub>1055.8 (†7421) γ<sub>1125</sub>1075.01 (†425)  
γ<sub>352</sub>1847.7 (†475) γ<sub>165</sub>2034.8 (†10016)
- J 2231.62, (17/2<sup>-</sup>) γ<sub>1609</sub>622.72 (†934) (E2) γ<sub>1484</sub>747.62 (†1004)
- 2261.54 9, 1/2<sup>-</sup>, 3/2, 5/2<sup>-</sup> γ<sub>1488</sub>774.0 (†7.4) γ<sub>1403</sub>858.6 (†328) γ<sub>1167</sub>1094.33  
(†124) γ<sub>1144</sub>1117.5 (†488) γ<sub>1125</sub>1136.6 (†128) γ<sub>1027</sub>1234.72 (†305)  
γ<sub>817</sub>1444.4 (†368) γ<sub>352</sub>1909.31 (†1008) γ<sub>165</sub>2096.5 (†164)  
γ<sub>0</sub>2261.5(?) (†1212)
- 2300.72 6, 1/2<sup>-</sup>, 3/2, 5/2<sup>-</sup> γ<sub>1614</sub>686.668 (†484) γ<sub>1125</sub>1175.8 (†467) γ<sub>1027</sub>1273.9  
(†3.517) γ<sub>817</sub>1483.61 (†597) γ<sub>352</sub>1948.51 (†1004) γ<sub>165</sub>2135.72  
(†264)
- 2314.17, 1/2<sup>-</sup>, 3/2, 5/2<sup>-</sup> γ<sub>817</sub>1497.0 (†10025) γ<sub>165</sub>2149.1 (†7525)
- 2383.42, (19/2<sup>-</sup>) γ<sub>2068</sub>325.22 (†671) (M1+E2): δ=-0.095 γ<sub>1740</sub>643.72  
(†1002) E1 γ<sub>1484</sub>899.52 (†772) Q
- K 2401.12, (21/2)<sup>+</sup> γ<sub>1740</sub>661.41 (†100) E2
- 2482.75 19, 1/2, 3/2, 5/2<sup>-</sup> γ<sub>1206</sub>1277.0 (†2914) γ<sub>1144</sub>1338.6 (†3614)  
γ<sub>1125</sub>1357.8 (†96) γ<sub>352</sub>2130.52 (†10014)
- 2503.72, 1/2<sup>-</sup>, 3/2, 5/2<sup>-</sup> γ<sub>352</sub>2151.5 (†2211) γ<sub>165</sub>2338.72 (†10022)
- 2514.63(?) γ<sub>1751.1</sub> 763.42(?) (†100)
- J 2523.92, (21/2<sup>-</sup>) γ<sub>2232</sub>292.32 (†192) (E2) γ<sub>2068</sub>465.92 (†1001) E2
- 2570.13, 1/2, 3/2, 5/2<sup>-</sup> γ<sub>1206</sub>1363.8 (†359) γ<sub>1167</sub>1402.4 (†126)  
γ<sub>1027</sub>1543.43 (†10025)
- 2590.06 10, 1/2, 3/2, 5/2<sup>-</sup> γ<sub>1544</sub>1045.9 (†2412) γ<sub>1488</sub>1102.5 (†186) γ<sub>1403</sub>1187.1  
(†2918) γ<sub>1206</sub>1384.4 (†126) γ<sub>1125</sub>1465.1 (†74) γ<sub>1027</sub>1563.2 (†85)  
γ<sub>817</sub>1772.9 (†3512) γ<sub>352</sub>2237.81 (†10012)
- 2599.31 9, 1/2<sup>-</sup>, 3/2, 5/2<sup>-</sup> γ<sub>1544</sub>1055.1 (†124) γ<sub>1488</sub>1111.7 (†63) γ<sub>1125</sub>1474.3  
(†84) γ<sub>1027</sub>1572.4 (†63) γ<sub>817</sub>1782.21 (†1008) γ<sub>352</sub>2247.02 (†688)  
γ<sub>165</sub>2434.54 (†204)
- 2613.25, 1/2<sup>-</sup>, 3/2, 5/2<sup>-</sup> γ<sub>1992</sub>620.7 (†5012) γ<sub>1125</sub>1488.3 (†4412) γ<sub>1027</sub>1586.4  
(†256) γ<sub>352</sub>2261.0 (†10012) γ<sub>165</sub>2448.2 (†8112)
- 2683.42 9, 1/2, 3/2, 5/2<sup>-</sup> γ<sub>1614</sub>1069.6 (†145) γ<sub>1544</sub>1139.5 (†195) γ<sub>1206</sub>1477.72  
(†3810) γ<sub>1144</sub>1539.64 (†2910) γ<sub>1125</sub>1558.51 (†5210) γ<sub>1027</sub>1656.8  
(†10010)
- 2702.94, 1/2<sup>-</sup>, 3/2, 5/2<sup>-</sup> γ<sub>1206</sub>1497.6 (†3614) γ<sub>1144</sub>1556.2 (†6020)  
γ<sub>165</sub>2538.34 (†10040)
- 2757.21 9, 1/2, 3/2, 5/2<sup>-</sup> γ<sub>1488</sub>1269.7 (†53) γ<sub>1125</sub>1632.3 (†93) γ<sub>1027</sub>1730.4 (†7)  
γ<sub>817</sub>1940.11 (†1009) γ<sub>352</sub>2404.92 (†316)
- 2768.04, 1/2, 3/2, 5/2<sup>-</sup> γ<sub>1144</sub>1623.8 (†6730) γ<sub>352</sub>2415.84 (†10033)
- 2808.65, 1/2, 3/2, 5/2<sup>-</sup> γ<sub>1488</sub>1320.9 (†2612) γ<sub>1167</sub>1641.3 (†3216) γ<sub>817</sub>1991.8  
(†8040) γ<sub>352</sub>2456.2 (†10020)
- 2824.97 8, 1/2, 3/2, 5/2<sup>-</sup> γ<sub>1544</sub>1280.81 (†111) γ<sub>1488</sub>1337.5 (†31) γ<sub>1403</sub>1422.1  
(†62) γ<sub>1027</sub>1798.2 (†182) γ<sub>817</sub>2007.91 (†1003) E2(+M1): δ>2  
γ<sub>352</sub>2472.72 (†132)
- 2830.6 10, 1/2, 3/2, 5/2<sup>-</sup> γ<sub>352</sub>2478.3 (†100)
- 2856.4 γ<sub>2401</sub>455.33 (†100)
- 2861.85, 1/2<sup>-</sup>, 3/2, 5/2<sup>-</sup> γ<sub>1206</sub>1656.2 (†4020) γ<sub>1167</sub>1694.7 (†6040) γ<sub>1027</sub>1835.0  
(†5016) γ<sub>817</sub>2044.7 (†3416) γ<sub>165</sub>2696.8 (†10040)
- 2913.08 10, 1/2, 3/2, 5/2<sup>-</sup> γ<sub>1544</sub>1368.9 (†153) γ<sub>1488</sub>1425.63 (†216) γ<sub>1206</sub>1707.53  
(†93) γ<sub>1125</sub>1788.1 (†93) γ<sub>352</sub>2560.81 (†1006)
- 2918.27, 1/2<sup>-</sup>, 3/2, 5/2<sup>-</sup> γ<sub>1403</sub>1515.3 (†10050) γ<sub>165</sub>2753.2 (†6020)
- 2922.73, 1/2, 3/2, 5/2<sup>-</sup> γ<sub>1167</sub>1755.6 (†2320) γ<sub>1027</sub>1895.9 (†74) γ<sub>817</sub>2105.63  
(†10020)
- 2961.56, 1/2<sup>-</sup>, 3/2, 5/2<sup>-</sup> γ<sub>1206</sub>1755.8 (†7730) γ<sub>165</sub>2796.5 (†10033) γ<sub>0</sub>2961.4(?)  
(†<100)



149  
64 Gd (Continued)

2977.7.2, 1/2(-),3/2	$\gamma_{1403}$ 1574.8 (†,86.28)	$\gamma_{1167}$ 1810.62 (†,100.14)			(†,100.25) $\gamma_{165}$ 3370.1 (†,20.10)
$\gamma_{112}$ 1852.8 (†,28.14)	$\gamma_{1027}$ 1950.9 (†,23.11)	$\gamma_{617}$ 2160.6 (†,33.13)			3543.9.4, 1/2(-),3/2 $\gamma_{165}$ 3378.94 (†,100)
$\gamma_{165}$ 2812.7 (†,57.14)					3611.4.2, (25/2) $\gamma_{3228}$ 383.73 (†,12.1) D $\gamma_{2524}$ 1087.61 (†,100.1) E2
2999.64.7, 1/2(-),3/2	$\gamma_{1655}$ 1344.5 (†,4.2.2)	$\gamma_{1697}$ 1402.4 (†,1.9.10)			3631.9.3, (27/2), 0.7 ns $\gamma_{3387}$ 245.02 (†,42.1) D $\gamma_{3284.3}$ 337.72 (†,55.1) D
$\gamma_{1488}$ 1512.12 (†,19.4)	$\gamma_{1349}$ 1651.0 (†,1.6.10)	$\gamma_{1206}$ 1794.1 (†,3.5.16) L			$\gamma_{7134}$ 497.33 (†,100.2) (E2)
$\gamma_{1144}$ 1855.6 (†,6.4)	$\gamma_{1125}$ 1874.61 (†,63.4)	$\gamma_{1027}$ 1972.92 (†,38.4)			3765.2.4, (29/2) $\gamma_{3357}$ 378.23 (†,100)
$\gamma_{617}$ 2182.61 (†,100.6)	$\gamma_{352}$ 2647.6 (†,48.2)	$\gamma_{165}$ 2834.7 (†,6.2)			4054.3.4, (29/2) $\gamma_{653}$ 422.53 (†,100) D
3003.4.5, 1/2(-),3/2	$\gamma_{1206}$ 1797.8 (†,25.13)	$\gamma_{1125}$ 1878.5 (†,100.25)			4323.7.3, (29/2) $\gamma_{3611}$ 712.32 (†,100) (E2)
$\gamma_{1027}$ 1976.6 (†,38.25)	$\gamma_{617}$ 2186.3 (†,38.25)	$\gamma_{165}$ 2838.4 (†,38.25)			4340.0.4, (31/2) $\gamma_{4054}$ 285.63 (†,22.1) D $\gamma_{3632}$ 708.03 (†,100.3) (E2)
3021.05.18, 1/2(-),3/2	$\gamma_{1655}$ 1366.0 (†,13.7)	$\gamma_{1144}$ 1877.1 (†,20.13)			4342.7.4(?), (29/2) $\gamma_{3357}$ 955.63 (†,100)
$\gamma_{1125}$ 1896.3 (†,17.6)	$\gamma_{1027}$ 1994.4 (†,20.7)	$\gamma_{617}$ 2204.1 (†,20.7)			4571.8.5 $\gamma_{4324}$ 248.13(?) (†,100)
$\gamma_{100.13}$ $\gamma_{165}$ 2856.02 (†,60.13)					M 4719.3.4, (33/2) $\gamma_{4343}$ 376.63(?) (†,5.7.4) (E2) $\gamma_{4340}$ 379.43 (†,100.1) D
3057.0.4, 1/2(-),3/2	$\gamma_{165}$ 2892.04 (†,100)				L 4801.4.4, (33/2) $\gamma_{4340}$ 461.03 (†,10.1) $\gamma_{4054}$ 747.43 (†,100.3) (E2)
3070.8.7, 1/2(-),3/2	$\gamma_{617}$ 2253.7 (†,100.27)	$\gamma_{165}$ 2905.8 (†,66.24)			M 4052.2.4, (35/2) $\gamma_{4801}$ 250.83 (†,18.1) $\gamma_{4340}$ 712.33 (†,100.1) (E2)
3079.8.3, 1/2,3/2	$\gamma_{1167}$ 1912.73 (†,100)				L 5300.3.4, (37/2) $\gamma_{6052}$ 248.03 (†,69.1) D $\gamma_{4801}$ 498.83 (†,100.3) (E2)
3084.4.3, (23/2) $\gamma_{2401}$ 683.32 (†,100)					M 5462.5.4, (37/2) $\gamma_{6052}$ 410.53 (†,22.1) D $\gamma_{4719}$ 743.23 (†,100.1) (E2)
3099.76.10, 1/2(-),3/2	$\gamma_{1027}$ 2073.0 (†,7.2)	$\gamma_{617}$ 2282.61 (†,100.7)			L 5633.5.5, (41/2) $\gamma_{6300}$ 333.23 (†,100) (E2)
$\gamma_{165}$ 2935.13 (†,26.5)					M 5660.2.5, (39/2) $\gamma_{6300}$ 359.63 (†,100) D
3124.07.10, 1/2,3/2	$\gamma_{1206}$ 1918.4 (†,8.4)	$\gamma_{1027}$ 2097.1 (†,27.7)	$\gamma_{352}$ 2771.81 (†,100.13)		$\gamma_{5660}$ 438.43 (†,29.1) (M1+E2); $\delta=+0.162$ $\gamma_{5463}$ 636.63 (†,100.2) (E2)
3124.07.10, 1/2,3/2	$\gamma_{165}$ 2959.0(?) (†, <20)				6264.8.5 $\gamma_{6334}$ 631.33(?) (†,100)
3134.4.2, (23/2) $\gamma_{2401}$ 733.43 (†,51.1) D					M 6470.2.5, (45/2) $\gamma_{6255}$ 205.43(?) (†,4.9.5) $\gamma_{6098}$ 371.43 (†,100.1) (E2)
3149.4.6, 1/2,3/2	$\gamma_{1206}$ 1943.7 (†,12.8)	$\gamma_{1125}$ 2024.4 (†,32.18)	$\gamma_{352}$ 2797.1 (†,100.20)		N 6656.4.6, (49/2), 2.8 ns $\gamma_{6470}$ 186.23 (†,100) (E2)
3175.59.15, 1/2(-),3/2	$\gamma_{1403}$ 1772.7 (†,20.10)	$\gamma_{1349}$ 1826.9 (†,10.4)			N 7821.5.6, (53/2) $\gamma_{6856}$ 1165.33 (†,100) (Q)
$\gamma_{1206}$ 1970.0 (†,40.10)	$\gamma_{1167}$ 2008.5 (†,30.20)	$\gamma_{1125}$ 2050.74 (†,50.20)			7824.4.7, (51/2) $\gamma_{6856}$ 1168.03 (†,100) D
$\gamma_{1027}$ 2148.8 (†,40.10)	$\gamma_{617}$ 2358.5 (†,8.5)	$\gamma_{352}$ 2823.32 (†,90.20)			7996.6.7, (53/2) $\gamma_{7824}$ 172.23 (†,100) (M1)
$\gamma_{165}$ 3010.63 (†,100.20)					8217.6.7, (53/2) $\gamma_{6856}$ 1560.93 (†,100) (Q)
3201.4.4, 1/2(-),3/2	$\gamma_{1544}$ 1657.3 (†,48.18)	$\gamma_{1403}$ 1798.5 (†,60.40)	$\gamma_{1167}$ 2034.3 (†,100.60)		8433.3.7, (55/2) $\gamma_{6218}$ 215.43 (†,13.1) $\gamma_{7822}$ 611.83 (†,100.1)
$\gamma_{1125}$ 2076.4 (†,80.20)	$\gamma_{617}$ 2384.3 (†,32.12)	$\gamma_{352}$ 2849.2 (†,36.14)			N 8557.0.7, (57/2) $\gamma_{6433}$ 123.33 (†,31.1) $\gamma_{7822}$ 735.83 (†,100.1) (E2)
$\gamma_{165}$ 3036.45 (†,60.20)					O 8940.3.7, (57/2) $\gamma_{8433}$ 507.13 (†,8.2.2) $\gamma_{7987}$ 943.83 (†,100.1) (Q)
3206.43.23, 1/2(-),3/2	$\gamma_{1614}$ 1592.4 (†,100.40)	$\gamma_{1544}$ 1662.3 (†,40.20)			9273.0.7(?), (57/2) $\gamma_{7987}$ 1276.43 (†,100) (Q)
$\gamma_{1488}$ 1718.9 (†,20.12)	$\gamma_{1403}$ 1803.5 (†,34.18)	$\gamma_{1206}$ 2000.8 (†,40.20)			9325.8.7, (59/2) $\gamma_{8557}$ 768.73 (†,100)
$\gamma_{1144}$ 2062.3 (†,22.14)	$\gamma_{1027}$ 2179.6 (†,100.20)	$\gamma_{617}$ 2389.33 (†,100.20)			P 9437.9.7(?), (59/2) $\gamma_{9273}$ 164.93 (†,25.1) $\gamma_{8557}$ 881.13 (†,100.2)
$\gamma_{352}$ 2854.2 (†,60.20)	$\gamma_{165}$ 3041.4 (†,40.20)				O 9501.6.7, (61/2) $\gamma_{9326}$ 175.63 (†,12.5.2) $\gamma_{8940}$ 561.43 (†,100.1) (E2)
3227.5.2, (23/2) $\gamma_{2524}$ 703.62 (†,100.2) E1	$\gamma_{2401}$ 826.43 (†,15.2)				P 10361.9.7, (63/2) $\gamma_{9502}$ 860.13 (†,45.1) $\gamma_{9433}$ 924.03 (†,100.4) (Q)
3231.2.3, 1/2(-),3/2	$\gamma_{617}$ 2414.0 (†,11.7)	$\gamma_{352}$ 2878.93 (†,100.28)	$\gamma_{165}$ 3066.1 (†,13.7)		O 10510.0.7, (63/2) $\gamma_{9502}$ 1008.33 (†,100)
3258.4.6, 1/2,3/2	$\gamma_{1027}$ 2231.5 (†,100.25)	$\gamma_{617}$ 2441.3 (†,63.29)	$\gamma_{352}$ 2906.1 (†,58.29)		O 10601.8.7, (65/2) $\gamma_{9502}$ 1100.53 (†,100) (Q)
3272.9.6, 1/2,3/2	$\gamma_{1027}$ 2246.1 (†,47.23)	$\gamma_{617}$ 2455.8 (†,100.33)	$\gamma_{352}$ 2920.7 (†,33.20)		O 10850.5.7, (63/2) $\gamma_{9502}$ 1348.73 (†,100)
3294.2.3, 1/2,3/2	$\gamma_{352}$ 2942.6 (†,100)				P 10930.3.7, (65/2) $\gamma_{10932}$ 568.33 (†,100.4) $\gamma_{9502}$ 1428.73 (†,81.4) (Q)
3294.3.2, (25/2) $\gamma_{2401}$ 893.21 (†,100.5) Q					P 11011.5.7, (65/2) $\gamma_{10851}$ 160.73 (†,48.2) $\gamma_{10510}$ 501.43 (†,100.4)
3313.62.16, 1/2(-),3/2(-)	$\gamma_{1614}$ 1699.5 (†,3.1)	$\gamma_{1544}$ 1769.4 (†,2.1)	$\gamma_{1488}$ 1826.0 (†,1.2)		P 11199.7.7, (67/2) $\gamma_{10930}$ 269.33 (†,18.1) $\gamma_{10602}$ 598.13 (†,100.1) $\gamma_{10362}$ 838.03 (†,50.2) (E2)
$\gamma_{1206}$ 2108.23 (†,10.2)	$\gamma_{1125}$ 2188.6 (†,3.1)	$\gamma_{617}$ 2496.42 (†,12.2)			11711.7.7, (67/2) $\gamma_{10602}$ 1109.93 (†,100)
$\gamma_{352}$ 2961.3 (†,100.4) (M1,E2)	$\gamma_{165}$ 3148.5 (†,1.7.6)				12268.3.8(?), (67/2) $\gamma_{11200}$ 1068.63 (†,100)
3319.0.4, 1/2(-),3/2	$\gamma_{1403}$ 1916.1 (†,100.50)	$\gamma_{352}$ 2966.8 (†,55.18)	$\gamma_{165}$ 3154.05 (†,68.18)		12383.7.7, (69/2) $\gamma_{11712}$ 672.13 (†,100.5) $\gamma_{11200}$ 1183.93 (†,78.8)
3340.6.6, 1/2,3/2	$\gamma_{1206}$ 2135.0 (†,67.33)	$\gamma_{1144}$ 2196.5 (†,100.33)	$\gamma_{617}$ 2523.5 (†,90.33)		$\gamma_{11012}$ 1372.03 (†,55.8) (Q)
3365.2.2, 1/2(-),3/2	$\gamma_{1488}$ 1877.7 (†,8.4)	$\gamma_{1144}$ 2221.1 (†,4.0.24)	$\gamma_{617}$ 2548.1 (†,12.4)		12469.0.8(?), (69/2) $\gamma_{10602}$ 1867.13 (†,100) (Q)
$\gamma_{165}$ 3200.22 (†,100.8)					12580.6.8, (71/2) $\gamma_{11712}$ 868.93 (†,100) (Q)
3384.7.10, 1/2,3/2	$\gamma_{352}$ 3032.4 (†,100)				12751.9.8(?), (71/2) $\gamma_{11200}$ 1552.43 (†,100) (Q)
3387.0.2, (27/2), 6.05 ns $\gamma_{3228}$ 159.61 (†,100.5) E2 $\gamma_{2524}$ 863.04 (†,16.1) (E3)					12967.1.7, (71/2) $\gamma_{12752}$ 215.43(?) (†,39.7) $\gamma_{12384}$ 583.13 (†,100.6)
3403.4.5, 1/2(-),3/2	$\gamma_{1614}$ 1859.3 (†,100.33)	$\gamma_{1488}$ 1915.8 (†,100.33)			$\gamma_{12288}$ 698.93 (†,90.4) (E2) $\gamma_{11200}$ 1767.43 (†,59.4) (Q)
$\gamma_{617}$ 2586.3 (†,100.33)	$\gamma_{352}$ 3051.2 (†,60.25)	$\gamma_{165}$ 3238.4 (†,50.17)			13189.1.8, (75/2) $\gamma_{12581}$ 608.63 (†,100) (E2)
3418.8.5, 1/2(-),3/2	$\gamma_{1488}$ 1931.0 (†,55.27)	$\gamma_{1206}$ 2212.9 (†,100.32)	$\gamma_{352}$ 3066.3 (†,73.32)		13278.6.8, (73/2) $\gamma_{12967}$ 311.43 (†,100)
$\gamma_{165}$ 3254.5 (†,68.32)					13567.2.8, (75/2) $\gamma_{13279}$ 288.63 (†,100)
3431.4.4, 1/2(-),3/2	$\gamma_{352}$ 3078.9 (†,100.33)	$\gamma_{165}$ 3266.44 (†,53.13)			14108.6.8, (77/2) $\gamma_{13567}$ 541.43 (†,100.4) $\gamma_{13189}$ 919.53 (†,74.4)
3442.8.6, 1/2,3/2	$\gamma_{1125}$ 2317.9 (†,100.37)	$\gamma_{617}$ 2625.7 (†,53.26)	$\gamma_{352}$ 3090.6 (†,42.21)		15163.3.9, (81/2) $\gamma_{14108}$ 1054.73 (†,100) (Q)
3466.8.6, 1/2(-),3/2	$\gamma_{1027}$ 2440.0 (†,58.33)	$\gamma_{617}$ 2649.7 (†,83.42)	$\gamma_{165}$ 3301.8 (†,100.50)		15997.4.9, (85/2) $\gamma_{15163}$ 834.13(?) (†,100)
3473.2.3, 1/2(-),3/2	$\gamma_{1027}$ 2446.4 (†,14.8)	$\gamma_{617}$ 2656.1 (†,20.3)	$\gamma_{165}$ 3308.23 (†,100.22)		x, J=(51/2)
3486.2.5, 1/2,3/2	$\gamma_{1167}$ 2319.0 (†,59.1)	$\gamma_{352}$ 3133.95 (†,100.1)			A 617.8+x, J+2 $\gamma_{617.8.1}$ (†,0.16.3) $I^{(1)}=87.4, I^{(2)}=86.2, \eta\omega=0.321$
3499.6.7, 1/2(-),3/2	$\gamma_{352}$ 3147.0 (†,90.40)	$\gamma_{165}$ 3335.0 (†,100.30)			A 1282.0+x, J+4 $\gamma_{618.4.2}$ (†,0.68.7) $I^{(1)}=87.3, I^{(2)}=84.0, \eta\omega=0.344$
3516.2.4, 1/2,3/2	$\gamma_{352}$ 3163.94 (†,100)				A 1993.8+x, J+6 $\gamma_{1282.4.2}$ $I^{(1)}=87.1, I^{(2)}=83.5, \eta\omega=0.368$
3535.1.4, 1/2(-),3/2	$\gamma_{1027}$ 2508.3 (†,18.10)	$\gamma_{617}$ 2718.0 (†,18.10)	$\gamma_{352}$ 3182.84 (†,100.25)		A 2753.5+x, J+8 $\gamma_{1994.4.2}$ 759.71 (†,0.88.9) $I^{(1)}=86.9, I^{(2)}=82.6, \eta\omega=0.392$
					A 3561.6+x, J+10 $\gamma_{2754.4.2}$ 808.11 (†,0.96.10) $I^{(1)}=86.6, I^{(2)}=81.6, \eta\omega=0.416$
					A 4418.7+x, J+12 $\gamma_{3562.4.2}$ 857.11 (†,1.00) $I^{(1)}=86.3, I^{(2)}=80.6, \eta\omega=0.441$
					A 5325.4+x, J+14 $\gamma_{4418.4.2}$ 906.71 (†,1.05.10) $I^{(1)}=86.0, I^{(2)}=79.4, \eta\omega=0.466$
					A 6282.5+x, J+16 $\gamma_{5325.4.2}$ 957.11 (†,0.98.10) $I^{(1)}=85.7, I^{(2)}=77.5, \eta\omega=0.491$
					A 7291.2+x, J+18 $\gamma_{6283.4.2}$ 1008.71 (†,0.95.10) $I^{(1)}=85.3, I^{(2)}=76.9, \eta\omega=0.517$
					A 8351.9+x, J+20 $\gamma_{7291.4.2}$ 1060.71 (†,0.90.9) $I^{(1)}=84.8, I^{(2)}=75.3, \eta\omega=0.544$
					A 9465.7+x, J+22 $\gamma_{8352.4.2}$ 1113.81 (†,0.83.8) $I^{(1)}=84.4, I^{(2)}=74.9, \eta\omega=0.570$
					A 10632.9+x, J+24 $\gamma_{9466.4.2}$ 1167.22 $I^{(1)}=84.0, I^{(2)}=73.3, \eta\omega=0.597$

149Gd (Continued)  
64

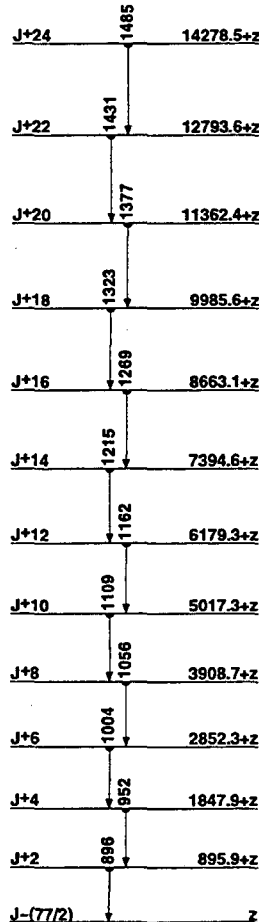
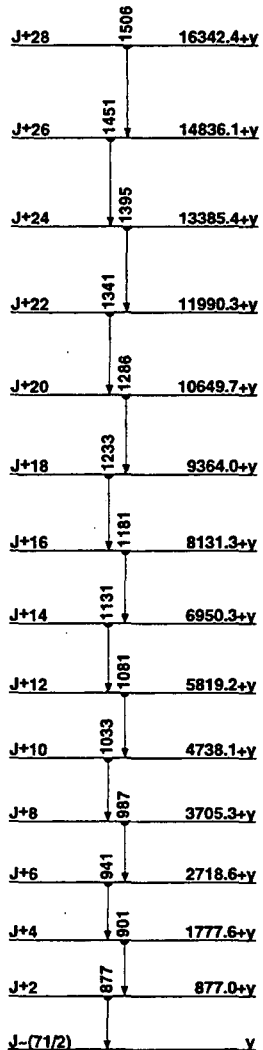
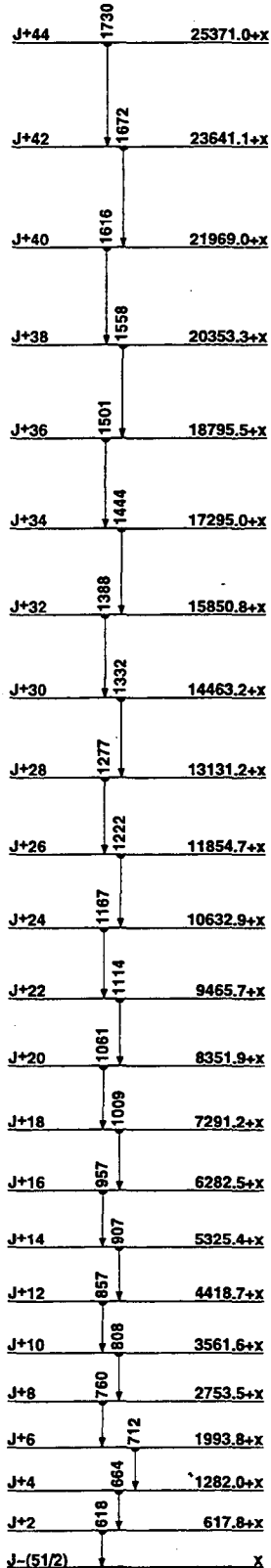

- B 2718.6+y, J+6  $\gamma_{1778+y}$  941.05  $I^{(1)}=87.1, I^{(2)}=87.5, \eta\omega=0.482$
- B 3705.3+y, J+8  $\gamma_{2719+y}$  986.73  $I^{(1)}=87.2, I^{(2)}=86.8, \eta\omega=0.505$
- B 4738.1+y, J+10  $\gamma_{3705+y}$  1032.83  $I^{(1)}=87.1, I^{(2)}=82.8, \eta\omega=0.528$
- B 5819.2+y, J+12  $\gamma_{4738+y}$  1081.15  $I^{(1)}=86.9, I^{(2)}=80.0, \eta\omega=0.553$
- B 6950.3+y, J+14  $\gamma_{5819+y}$  1131.14  $I^{(1)}=86.6, I^{(2)}=80.2, \eta\omega=0.578$
- B 8131.3+y, J+16  $\gamma_{6950+y}$  1181.04  $I^{(1)}=86.4, I^{(2)}=77.4, \eta\omega=0.603$
- B 9364.0+y, J+18  $\gamma_{8131+y}$  1232.74  $I^{(1)}=86.0, I^{(2)}=75.5, \eta\omega=0.630$
- B 10649.7+y, J+20  $\gamma_{9364+y}$  1285.74  $I^{(1)}=85.6, I^{(2)}=72.9, \eta\omega=0.657$
- B 11990.3+y, J+22  $\gamma_{10650+y}$  1340.64  $I^{(1)}=85.6, I^{(2)}=73.4, \eta\omega=0.684$
- B 13385.4+y, J+24  $\gamma_{11990+y}$  1395.14  $I^{(1)}=84.6, I^{(2)}=71.9, \eta\omega=0.711$
- B 14836.1+y, J+26  $\gamma_{13385+y}$  1450.75  $I^{(1)}=84.1, I^{(2)}=71.9, \eta\omega=0.739$
- B 16342.4+y, J+28  $\gamma_{14836+y}$  1506.35  $I^{(1)}=83.6, I^{(2)}=77.2$
- C z, J=(77/2)
- C 895.9+z, J+2  $\gamma_{895.94}$   $I^{(1)}=89.3, I^{(2)}=71.3, \eta\omega=0.462$
- C 1847.9+z, J+4  $\gamma_{896+z}$  952.06  $I^{(1)}=88.2, I^{(2)}=76.3, \eta\omega=0.489$
- C 2852.3+z, J+6  $\gamma_{1848+z}$  1004.44  $I^{(1)}=87.6, I^{(2)}=76.9, \eta\omega=0.515$
- C 3908.7+z, J+8  $\gamma_{2852+z}$  1056.44  $I^{(1)}=87.1, I^{(2)}=76.6, \eta\omega=0.541$
- C 5017.3+z, J+10  $\gamma_{3908+z}$  1108.64  $I^{(1)}=86.6, I^{(2)}=74.9, \eta\omega=0.568$
- C 6179.3+z, J+12  $\gamma_{5017+z}$  1162.04  $I^{(1)}=86.1, I^{(2)}=75.0, \eta\omega=0.594$
- C 7394.6+z, J+14  $\gamma_{6179+z}$  1215.34  $I^{(1)}=85.6, I^{(2)}=75.2, \eta\omega=0.621$
- C 8663.1+z, J+16  $\gamma_{7395+z}$  1268.54  $I^{(1)}=85.1, I^{(2)}=74.1, \eta\omega=0.648$
- C 9985.6+z, J+18  $\gamma_{8663+z}$  1322.54  $I^{(1)}=84.7, I^{(2)}=73.7, \eta\omega=0.675$
- C 11362.4+z, J+20  $\gamma_{9986+z}$  1376.85  $I^{(1)}=84.3, I^{(2)}=73.5, \eta\omega=0.702$
- C 12793.6+z, J+22  $\gamma_{11362+z}$  1431.25  $I^{(1)}=83.8, I^{(2)}=74.5, \eta\omega=0.729$
- C 14278.5+z, J+24  $\gamma_{12794+z}$  1484.95  $I^{(1)}=83.5, I^{(2)}=77.2$

$\underline{\quad\quad\quad} \nu$        $\underline{\quad\quad\quad} \omega$   
 SD-7 band      SD-8 band  
  
 $\underline{\quad\quad\quad} \sigma$        $\underline{\quad\quad\quad} \tau$        $\underline{\quad\quad\quad} \upsilon$   
 SD-4 band      SD-5 band      SD-6 band

150  
64Gd

$\Delta$ : -75717 S<sub>n</sub>: 87087 S<sub>p</sub>: 66068 Q<sub>a</sub>: 28096

Nuclear Bands

- A Octupole band
- B GS band
- C SD-1 band
- D SD-2 band
- E SD-3 band
- F SD-4 band
- G SD-5 band
- H  $\nu_{172}^{132} \times (10^4)$

Levels and  $\gamma$ -ray branchings:

- B 0, 0<sup>+</sup>, 1.79x10<sup>6</sup> eV, % $\alpha$ =100
- B 638.05 10, 2<sup>+</sup>  $\gamma_{638}$  638.05 10 (t<sub>100</sub>) E2
- A 1134.35 15, 3<sup>-</sup>  $\gamma_{638}$  496.3 1 (t<sub>100</sub>) E1
- 1207.22, 0<sup>+</sup>  $\gamma_{638}$  569.1 1 (t<sub>100</sub>) E2+M1  $\gamma_0$  1207.22 (t<sub>0</sub>) (t<sub>0</sub>, 1.14 3) E0
- B 1288.42, 4<sup>+</sup>  $\gamma_{1134}$  153.93 (t<sub>1.84</sub>)  $\gamma_{638}$  650.42 (t<sub>100</sub>) E2
- 1430.52, (2)<sup>+</sup>  $\gamma_{638}$  792.53 (t<sub>100</sub>) E2  $\gamma_0$  1430.51 10 (t<sub>49</sub>) (E2)
- 1518.52, 2<sup>+</sup>  $\gamma_{1134}$  384.43 (t<sub>1.42</sub>)  $\gamma_{638}$  880.3 1 (t<sub>100</sub>) M1+(E2+E0)
- $\gamma_0$  1518.52 (t<sub>76</sub>) E2
- 1592.72, 1  $\gamma_{1207}$  385.55 (t<sub>4.2</sub>)  $\gamma_{638}$  954.53 (t<sub>71.4</sub>) E1  $\gamma_0$  1592.71 (t<sub>100</sub>) M1
- 1700.12, (3<sup>+</sup>, 4<sup>+</sup>)  $\gamma_{1288}$  411.74 (t<sub>74.6</sub>) M1  $\gamma_{1134}$  565.7 1 (t<sub>100</sub>) (E1)
- $\gamma_{638}$  1061.95(?) (t<sub>10.5</sub>)
- A 1700.92, 5<sup>-</sup>  $\gamma_{1288}$  412.42 (t<sub>50</sub>) E1  $\gamma_{1134}$  566.72 (t<sub>100</sub>) E2
- 1814.33, 3<sup>-</sup>  $\gamma_{1288}$  526.03 (t<sub>26.11</sub>)  $\gamma_{638}$  1176.02 (t<sub>100</sub>) E1
- B 1936.84, 6<sup>+</sup>  $\gamma_{1701}$  235.93 (t<sub>-3</sub>)  $\gamma_{1288}$  648.43 (t<sub>100</sub>) E2
- 1947.53, 2<sup>-</sup>, 3<sup>-</sup>, 4<sup>-</sup>  $\gamma_{1134}$  813.13 (t<sub>100</sub>) E2+M1:  $\delta=1.05$
- 1955.62, 2<sup>+</sup>  $\gamma_{1519}$  437.1 1 (t<sub>68</sub>) M1+E2:  $\delta=1.24$   $\gamma_{1431}$  525.02 (t<sub>42.5</sub>) (M1)
- $\gamma_{1207}$  748.32 (t<sub>34.3</sub>)  $\gamma_{1134}$  821.12 (t<sub>100</sub>) E1  $\gamma_{638}$  1317.63 (t<sub>26.5</sub>)
- $\gamma_0$  1955.73(?)
- 1988.03, 4<sup>+</sup>  $\gamma_{1431}$  557.5 1 (t<sub>33</sub>) E2  $\gamma_{1288}$  699.42 (t<sub>30.3</sub>)  $\gamma_{638}$  1350.15 (t<sub>100</sub>) E2
- 2080.05, (2<sup>+</sup>, 3<sup>+</sup>, 4<sup>+</sup>)  $\gamma_{1431}$  649.55 (t<sub>100</sub>) (E2)  $\gamma_{1288}$  791.15 (t<sub>87.38</sub>) (E2)
- $\gamma_{638}$  1442.05 (t<sub>25.7</sub>)
- 2084.42, 2<sup>-</sup>, 3<sup>-</sup>  $\gamma_{1593}$  491.72 (t<sub>20.4</sub>)  $\gamma_{1134}$  950.02 (t<sub>100</sub>) (M1)  $\gamma_{638}$  1446.23 (t<sub>56.4</sub>)
- 2091.72, 2<sup>+</sup>  $\gamma_{1519}$  573.42 (t<sub>9.1</sub>) M1  $\gamma_{1431}$  661.03 (t<sub><6</sub>)  $\gamma_{1207}$  884.62 (t<sub>9.2</sub>)
- $\gamma_{1134}$  957.42 (t<sub>22.2</sub>) E1  $\gamma_{638}$  1453.62 10 (t<sub>100</sub>) (M1)  $\gamma_0$  2091.73 (t<sub>40.4</sub>)
- 2116.13, 6<sup>+</sup>  $\gamma_{1937}$  179.43(?) (t<sub>1</sub>=1.3) E2  $\gamma_{1701}$  415.32 (t<sub>25.11</sub>) E1
- $\gamma_{1288}$  827.48 10 (t<sub>100</sub>) E2
- 2180.12, 2<sup>+</sup>  $\gamma_{1134}$  1045.72 10 (t<sub>100</sub>) E1  $\gamma_{638}$  1542.02 (t<sub>31.3</sub>)  $\gamma_0$  2180.13 (t<sub>29.3</sub>)
- 2209.53, 2<sup>-</sup>, 3<sup>-</sup>  $\gamma_{1431}$  779.05 (t<sub>47.6</sub>)  $\gamma_{1134}$  1075.3 1 (t<sub>100</sub>) M1
- $\gamma_{638}$  1571.33(?) (t<sub>6.2</sub>)
- A 2211, 7<sup>-</sup>  $\gamma_{2116}$  95.52 (t<sub><3</sub>)  $\gamma_{1937}$  274.93 (t<sub><3</sub>) E1  $\gamma_{1701}$  511 (t<sub>100</sub>) E2
- 2262.43  $\gamma_{1519}$  743.82 (t<sub>50.12</sub>)  $\gamma_{638}$  1624.43 (t<sub>100</sub>) E2
- 2306.96, (5)<sup>-</sup>  $\gamma_{2211}$  =95  $\gamma_{1700}$  606.85 (t<sub>100</sub>)  $\gamma_{1288}$  1017.25 (t<sub>14.2</sub>)
- 2326.35  $\gamma_{1988}$  338.22 (t<sub>83.17</sub>)  $\gamma_{1948}$  378.85 (t<sub>67.33</sub>)  $\gamma_{1519}$  808 1(?)
- (t<sub>33.13</sub>)  $\gamma_{1431}$  895.93 (t<sub>100</sub>)  $\gamma_{638}$  1688.84 (t<sub>67.17</sub>)
- 2365.13, 1, 2<sup>+</sup>  $\gamma_{1593}$  772.62 (t<sub>25.4</sub>)  $\gamma_{1207}$  1157.75 (t<sub>25.8</sub>)  $\gamma_{638}$  1726.94 (t<sub>25.4</sub>)  $\gamma_0$  2365.13 (t<sub>100</sub>)
- 2392.55, 7<sup>+</sup>  $\gamma_{2211}$  180.93  $\gamma_{2116}$  276  $\gamma_{1937}$  455.72 M1
- 2408.83, 2<sup>+</sup>  $\gamma_{1431}$  978.13 (t<sub>20.7</sub>)  $\gamma_{1288}$  1120.13 (t<sub>27.7</sub>)  $\gamma_{1134}$  1274.62 (t<sub>33.7</sub>)  $\gamma_{638}$  1770.82 (t<sub>100</sub>)  $\gamma_0$  2408.83 (t<sub>65.13</sub>)
- 2416.95(?)  $\gamma_{638}$  1778.85 (t<sub>100</sub>)
- 2426.13, 1<sup>-</sup>, 2<sup>-</sup>  $\gamma_{1431}$  995.53 (t<sub>9.2</sub>)  $\gamma_{1134}$  1291.6 10 (t<sub>100</sub>)  $\gamma_{638}$  1788.1 10 (t<sub>100</sub>)  $\gamma_0$  2426.33 (t<sub>56.2</sub>)
- 2521.85  $\gamma_{1519}$  1003.83 (t<sub>48.8</sub>)  $\gamma_{1431}$  1091.23 (t<sub>100</sub>)  $\gamma_{1288}$  1233.04 (t<sub>100</sub>)  $\gamma_{1134}$  1387.04 (t<sub>60.20</sub>)  $\gamma_{638}$  1884.03 (t<sub>100</sub>)
- 2554.44, 8<sup>+</sup>  $\gamma_{2393}$  162.02 (t<sub>14.4</sub>) M1  $\gamma_{2211}$  343.07 10 (t<sub>59.19</sub>) E1
- $\gamma_{2116}$  438.37 10 (t<sub>100</sub>) E2
- 2559.03, 1, 2<sup>+</sup>  $\gamma_{1207}$  1351.95 (t<sub>100</sub>)  $\gamma_0$  2558.93 (t<sub>85.14</sub>)
- 2564.93  $\gamma_{1956}$  609.33(?) (t<sub>25.13</sub>)  $\gamma_{1431}$  1134.33 (t<sub>38.13</sub>)  $\gamma_{1134}$  1430.53 (t<sub>100</sub>) (E2)  $\gamma_{638}$  1926.83 (t<sub>50.13</sub>)
- 2627.45(?)  $\gamma_{1134}$  1493.15 (t<sub>100</sub>)
- 2654.53  $\gamma_{1988}$  666.32(?) (t<sub>100</sub>)  $\gamma_{1431}$  1224.25 (t<sub>92.31</sub>)
- 2678.63, (1, 2)<sup>+</sup>  $\gamma_{638}$  2040.63 (t<sub>100</sub>)  $\gamma_0$  2678.65 (t<sub>30.10</sub>)
- 2687.23, 1<sup>-</sup>, 2<sup>-</sup>, 3<sup>-</sup>  $\gamma_{2559}$  128.03(?) (t<sub>8.3</sub>)  $\gamma_{2084}$  602.82 (t<sub>50.8</sub>)  $\gamma_{1593}$  1094.43 (t<sub>50.8</sub>)  $\gamma_{1519}$  1168.72 (t<sub>100</sub>)  $\gamma_{1431}$  1256.65 (t<sub>12</sub>)  $\gamma_{1134}$  1552.72 (t<sub>25.8</sub>)
- 2755.13, 2<sup>+</sup>, 3, 4<sup>+</sup>  $\gamma_{1288}$  1466.64 (t<sub>20.4</sub>)  $\gamma_{1134}$  1620.73 (t<sub>40.10</sub>)  $\gamma_{638}$  2117.03 (t<sub>100</sub>)
- 2767.8(?) (8<sup>+</sup>)  $\gamma_{1937}$  831.05 (t<sub>100</sub>)
- 2786.94, (1<sup>-</sup>, 2<sup>-</sup>)  $\gamma_{1956}$  831.52 (t<sub>11.4</sub>)  $\gamma_{1431}$  1356.13 (t<sub>14.4</sub>)
- $\gamma_{1207}$  1580.03(?) (t<sub>7.4</sub>)  $\gamma_{1134}$  1652.73 (t<sub>14.7</sub>)  $\gamma_{638}$  2148.73 (t<sub>100</sub>)
- A 2816.2, 9<sup>-</sup>  $\gamma_{2211}$  605.03 (t<sub>100</sub>) E2
- 2828.45  $\gamma_{1700}$  1128.24 (t<sub>100</sub>)  $\gamma_{638}$  2190.35(?) (t<sub>32.8</sub>)
- 2845.84, 1, 2<sup>+</sup>  $\gamma_{1593}$  1253.13 (t<sub>9.2</sub>)  $\gamma_{1431}$  1415.02 (t<sub>29.7</sub>)  $\gamma_{1207}$  1638.6 10(?) (t<sub>7.4</sub>)  $\gamma_{638}$  2207.83 (t<sub>100</sub>)  $\gamma_0$  2845.63 (t<sub>18.4</sub>)
- 2906.0(?) (8<sup>+</sup>)  $\gamma_{2116}$  789.94(?) (t<sub>100</sub>) E2
- 2956.0(?)  $\gamma_{2828}$  128.03(?) (t<sub>9.4</sub>)  $\gamma_{2210}$  746.62 (t<sub>18.6</sub>)  $\gamma_{1988}$  968.42 (t<sub>36.9</sub>)
- $\gamma_{1956}$  1007.03 (t<sub>27.6</sub>)  $\gamma_{1431}$  1525.8 1 (t<sub>100</sub>)  $\gamma_{638}$  2318.23 (t<sub>100</sub>)
- 2985.06, 1, 2<sup>+</sup>  $\gamma_{2555}$  330.12 (t<sub>30.6</sub>)  $\gamma_{2559}$  425.95 (t<sub>98.51</sub>)  $\gamma_{1988}$  997.74 (t<sub>24.6</sub>)  $\gamma_{1593}$  1392.13(?) (t<sub>10.4</sub>)  $\gamma_{1431}$  1554.72 (t<sub>50.10</sub>)  $\gamma_{1207}$  1778.05 (t<sub>30.16</sub>)  $\gamma_{638}$  2347.23 (t<sub>50.10</sub>)  $\gamma_0$  2984.45 (t<sub>100</sub>)
- 3035.6 10, (1<sup>-</sup>, 2<sup>-</sup>)  $\gamma_{2828}$  609.33(?) (t<sub>12.6</sub>)  $\gamma_{2084}$  952.05 (t<sub>12.6</sub>)  $\gamma_{1593}$  1443.63 (t<sub>68.6</sub>)  $\gamma_{1519}$  1516.55 (t<sub>56.12</sub>)  $\gamma_{1431}$  1605.65 (t<sub>19.6</sub>)  $\gamma_{1134}$  1900.6 10 (t<sub>89.34</sub>)  $\gamma_{638}$  2396.54 (t<sub>100</sub>)  $\gamma_0$  3035.5 10 (t<sub>31.6</sub>)
- 3083.73(?)  $\gamma_{2080}$  1003.83 (t<sub>48.8</sub>)  $\gamma_{1134}$  1949.33 (t<sub>100</sub>)
- 3119.33  $\gamma_{1431}$  1688.24 (t<sub>100</sub>)  $\gamma_{1134}$  1985.12 (t<sub>33.11</sub>)
- 3178.36  $\gamma_{1519}$  1660.22 (t<sub>31.8</sub>)  $\gamma_{1134}$  2044.33 (t<sub>15.3</sub>)  $\gamma_{638}$  2539.53 (t<sub>100</sub>)
- 3220, 10<sup>-</sup>  $\gamma_{2816}$  404.33 (t<sub>100</sub>) M1+E2
- 3288, 10<sup>+</sup>  $\gamma_{2554}$  734.03 (t<sub>100</sub>) E2
- 3329.05  $\gamma_{1134}$  2194.95 (t<sub>100</sub>)  $\gamma_{638}$  2690.55(?) (t<sub>25.8</sub>)
- 3344.85, (2)<sup>+</sup>  $\gamma_{2210}$  1135.35 (t<sub>38.13</sub>)  $\gamma_{2092}$  1253.13 (t<sub>30.7</sub>)  $\gamma_{1593}$  1752.25 (t<sub>38.13</sub>)  $\gamma_{1431}$  1914.43 (t<sub>99.51</sub>)  $\gamma_{1288}$  2056.45 (t<sub>38.13</sub>)  $\gamma_{1207}$  2137.24(?) (t<sub>13.5</sub>)  $\gamma_{638}$  2706.64 (t<sub>100</sub>)  $\gamma_0$  3344.75 (t<sub>13.3</sub>)
- A 3366, 11<sup>-</sup>  $\gamma_{2816}$  =78(?)  $\gamma_{2220}$  146.23  $\gamma_{2816}$  550.33
- 3375.73  $\gamma_{1134}$  2241.34(?) (t<sub>49.25</sub>)  $\gamma_{638}$  2737.54 (t<sub>100</sub>)
- 3378.35  $\gamma_{1814}$  1564.22 (t<sub>49.16</sub>)  $\gamma_{638}$  2740.2 (t<sub>100</sub>)
- 3461, 1, 2<sup>+</sup>  $\gamma_{1288}$  2173.45 (t<sub>100</sub>)  $\gamma_0$  3460 1(?) (t<sub>20.10</sub>)
- 3510, (1<sup>-</sup>, 2<sup>-</sup>)  $\gamma_{1134}$  2376.54(?) (t<sub>42.17</sub>)  $\gamma_{638}$  2872.43 (t<sub>100</sub>)  $\gamma_0$  3509.85 (t<sub>27.10</sub>)
- 3658.55(?) (2<sup>+</sup>)  $\gamma_{1988}$  1670.5 10(?) (t<sub>100</sub>)  $\gamma_{1956}$  1703.14(?) (t<sub>34.16</sub>)
- $\gamma_0$  3658.25 (t<sub>46.7</sub>)
- 3726.96  $\gamma_{1431}$  2296.75(?) (t<sub>14.6</sub>)  $\gamma_{1134}$  2592.13 (t<sub>100</sub>)
- 3829.7 10(?) (1, 2<sup>+</sup>)  $\gamma_{1207}$  2622.15(?) (t<sub>82.34</sub>)  $\gamma_{638}$  3191.64 (t<sub>100</sub>)
- $\gamma_0$  3829.2 (t<sub>82.34</sub>)
- 3840.65  $\gamma_{3510}$  330.12 (t<sub>33.7</sub>)  $\gamma_{1431}$  2410.03 (t<sub>100</sub>)  $\gamma_{1288}$  2552.35(?) (t<sub>13.4</sub>)  $\gamma_{638}$  3202.54 (t<sub>22.4</sub>)
- 4022 1(?) (1, 2<sup>+</sup>)  $\gamma_{638}$  3383.65(?) (t<sub>100</sub>)  $\gamma_0$  4022 2(?) (t<sub>61.24</sub>)
- H 4104, 12<sup>+</sup>  $\gamma_{2888}$  817 (t<sub>100</sub>) E2
- 4111 1(?) (1<sup>-</sup>, 2<sup>-</sup>)  $\gamma_{1814}$  2296.75(?) (t<sub>50.20</sub>)  $\gamma_{1134}$  2976.25(?) (t<sub>50.20</sub>)
- $\gamma_{638}$  3473 1 (t<sub>50.10</sub>)  $\gamma_0$  4112 2 (t<sub>100</sub>)
- A 4131, 13<sup>-</sup>  $\gamma_{3366}$  764.72 (t<sub>100</sub>) E2
- 4145 1(?) (1<sup>-</sup>, 2<sup>-</sup>)  $\gamma_{2555}$  1580.03(?) (t<sub>100</sub>)  $\gamma_{1593}$  2552.35(?) (t<sub>60.20</sub>)
- $\gamma_{1134}$  3009.94 (t<sub>60.30</sub>)  $\gamma_0$  4146 2 (t<sub>30.10</sub>)
- 4165, 1, 2<sup>+</sup>  $\gamma_{2210}$  1955.73(?) (t<sub>34</sub>)  $\gamma_{1288}$  2876.63 (t<sub>100</sub>)  $\gamma_0$  4164 2 (t<sub>13.7</sub>)
- 4176.65  $\gamma_{2865}$  1191.14 (t<sub>100</sub>)  $\gamma_{2365}$  1811.85(?) (t<sub>67.33</sub>)
- $\gamma_{1134}$  3042.64(?) (t<sub>67.33</sub>)
- 4187, (12<sup>+</sup>)  $\gamma_{2220}$  966.63 (t<sub>100</sub>) E2
- 4207 2, (1, 2<sup>+</sup>)  $\gamma_{2555}$  1552.72 (t<sub>60.20</sub>)  $\gamma_{2409}$  1796.62 (t<sub>100</sub>)
- $\gamma_{1593}$  2614.44(?) (t<sub>40.8</sub>)  $\gamma_{1431}$  2774.73 (t<sub>48.12</sub>)  $\gamma_{638}$  3571 1(?) (t<sub>16.8</sub>)
- $\gamma_0$  4206 1 (t<sub>36.8</sub>)
- 4237 1(?) (1<sup>-</sup>, 2<sup>-</sup>)  $\gamma_{1134}$  3102.64 (t<sub>100</sub>)  $\gamma_0$  4236 2(?) (t<sub>1</sub>=11)
- 4246 2(?) (1, 2<sup>+</sup>)  $\gamma_0$  4246 1 (t<sub>100</sub>)
- 4258, 1 (1<sup>-</sup>, 2<sup>-</sup>)  $\gamma_{2426}$  1831.94 (t<sub>100</sub>)  $\gamma_{1134}$  3123.94(?) (t<sub>66.13</sub>)  $\gamma_0$  4257 2 (t<sub>13.7</sub>)
- 4265, 1, 2<sup>+</sup>  $\gamma_{4111}$  153.93 (t<sub>100</sub>)  $\gamma_{1288}$  2976.25(?) (t<sub>50.19</sub>)  $\gamma_{1134}$  3130.5 15 (t<sub>40.19</sub>)  $\gamma_0$  4265 2 (t<sub>50.10</sub>)
- 4284 2(?) (1, 2<sup>+</sup>)  $\gamma_0$  4284 2 (t<sub>100</sub>)
- 4290 2(?) (1, 2<sup>+</sup>)  $\gamma_0$  4290 1 (t<sub>100</sub>)
- 4314, 1, 2<sup>+</sup>  $\gamma_{2084}$  2230.05(?) (t<sub>100</sub>)  $\gamma_{2080}$  2233.75(?) (t<sub>82.21</sub>)
- $\gamma_{638}$  3675 2 (t<sub>82.21</sub>)  $\gamma_0$  4314 1 (t<sub>39.9</sub>)
- 4322, 1, 2<sup>+</sup>  $\gamma_{4022}$  300.45(?) (t<sub>60.20</sub>)  $\gamma_{2092}$  2230.05(?) (t<sub>66.20</sub>)
- $\gamma_{1700}$  2622.15(?) (t<sub>33.13</sub>)  $\gamma_{1288}$  3034.0 10 (t<sub>100</sub>)  $\gamma_{638}$  3685 2(?) (t<sub>33.13</sub>)  $\gamma_0$  4322 1 (t<sub>40.7</sub>)

**150  
64 Gd (Continued)**

4344 1, (1,2 <sup>+</sup> ) $\gamma_{3119}$ 1224.25 (†,100 33) $\gamma_{2080}$ 2263.04(?) (†,83 43)	D 11661.5+y, (53 <sup>-</sup> ) $\gamma_{10433+y}$ 1228.71 (†,0.97 18) $I^{(1)}=85.5, I^{(2)}=92.0, \eta\omega=0.625$
$\gamma_{1431}$ 2913.44 (†,58 25) $\gamma_{0}$ 4344.2(?) (†,8)	D 12933.7+y, (55 <sup>-</sup> ) $\gamma_{11662+y}$ 1272.22 (†,0.54 12) $I^{(1)}=85.7, I^{(2)}=71.8, \eta\omega=0.650$
4379 1(?), (1 <sup>+</sup> ,2 <sup>+</sup> ) $\gamma_{3376}$ 1003.83 (†,80 14) $\gamma_{2210}$ 2169.35(?) (†,100 20)	D 14261.6+y, (57 <sup>-</sup> ) $\gamma_{12934+y}$ 1327.93 (†,0.11 9) $I^{(1)}=85.1, I^{(2)}=79.5, \eta\omega=0.677$
$\gamma_{1700}$ 2678.65 (†,100 34) $\gamma_{0}$ 4379.2(?) (†,6)	D 15639.8+y, (59 <sup>-</sup> ) $\gamma_{14262+y}$ 1378.23 $I^{(1)}=84.9, I^{(2)}=79.1, \eta\omega=0.702$
4406 1, (1,2 <sup>+</sup> ) $\gamma_{1956}$ 2449.85(?) (†,42 15) $\gamma_{1207}$ 3197.74 (†,88 30) $\gamma_{638}$ 3769.2	D 17068.6+y, (61 <sup>-</sup> ) $\gamma_{15640+y}$ 1428.84 $I^{(1)}=84.7, I^{(2)}=76.2, \eta\omega=0.728$
(†,73 30) $\gamma_{0}$ 4406.2 (†,100 30)	D 18549.9+y, (63 <sup>-</sup> ) $\gamma_{17068+y}$ 1481.35 $I^{(1)}=84.4, I^{(2)}=77.5, \eta\omega=0.754$
4446 1, 1,2 <sup>+</sup> $\gamma_{1948}$ 2498.1(?) (†,92 46) $\gamma_{1207}$ 3238.1 (†,64 18) $\gamma_{0}$ 4446.1	D 20082.8+y, (65 <sup>-</sup> ) $\gamma_{18550+y}$ 1532.95 $I^{(1)}=84.2, I^{(2)}=78.9, \eta\omega=0.779$
(†,100 18)	D 21666.4+y, (67 <sup>-</sup> ) $\gamma_{20083+y}$ 1583.65 $I^{(1)}=84.0$
4524 1(?) $\gamma_{1134}$ 3389.85(?) (†,100 41) $\gamma_{638}$ 3885.2(?) (†,41 20)	E z, (24 <sup>-</sup> )
4530 2(?), (1,2 <sup>+</sup> ) $\gamma_{2080}$ 2449.85(?) (†,42 14) $\gamma_{1593}$ 2936.04(?) (†,100 28)	E 617.1+z, (26 <sup>-</sup> ) $\gamma_{2}$ 617.1 $I^{(1)}=82.6, I^{(2)}=84.7, \eta\omega=0.320$
$\gamma_{0}$ 4531.2(?) (†,14)	E 1281.4+z, (28 <sup>-</sup> ) $\gamma_{617+z}$ 664.3 $I^{(1)}=82.8, I^{(2)}=83.0, \eta\omega=0.344$
4545.5 $\gamma_{2409}$ 2137.24(?) (†,11 4) $\gamma_{2365}$ 2180.03 (†,100 11)	E 1993.9+z, (30 <sup>-</sup> ) $\gamma_{1281+z}$ 712.5 $I^{(1)}=82.8, I^{(2)}=81.1, \eta\omega=0.369$
$\gamma_{2282}$ 2283.55(?) (†,11 7) $\gamma_{2084}$ 2460.74 (†,22 7) $\gamma_{1700}$ 2845.63 (†,50 11)	E 2755.7+z, (32 <sup>-</sup> ) $\gamma_{1994+z}$ 761.8 $I^{(1)}=82.7, I^{(2)}=82.8, \eta\omega=0.393$
$\gamma_{1593}$ 2952.74 (†,15 4) $\gamma_{1134}$ 3411.35(?) (†,9 4)	E 3565.8+z, (34 <sup>-</sup> ) $\gamma_{2756+z}$ 810.1 $I^{(1)}=82.7, I^{(2)}=80.6, \eta\omega=0.417$
H 4738, 14 <sup>+</sup> $\gamma_{4104}$ 634 (†,100)	E 4425.5+z, (36 <sup>-</sup> ) $\gamma_{3566+z}$ 859.7 $I^{(1)}=82.6, I^{(2)}=79.7, \eta\omega=0.442$
4745.5 $\gamma_{2180}$ 2565.55(?) (†,36 14) $\gamma_{2084}$ 2661.03 (†,100 25) $\gamma_{1593}$ 3152.44	E 5335.4+z, (38 <sup>-</sup> ) $\gamma_{4426+z}$ 909.9 $I^{(1)}=82.4, I^{(2)}=76.3, \eta\omega=0.468$
(†,44 11) $\gamma_{1431}$ 3315.05(?) (†,19 11) $\gamma_{638}$ 4107.2 (†,75 25)	E 6297.7+z, (40 <sup>-</sup> ) $\gamma_{6335+z}$ 962.3 $I^{(1)}=81.1, I^{(2)}=77.1, \eta\omega=0.494$
A 4835, 15 <sup>-</sup> $\gamma_{4131}$ 704 (†,100)	E 7311.9+z, (42 <sup>-</sup> ) $\gamma_{6298+z}$ 1014.2 $I^{(1)}=81.8, I^{(2)}=74.6, \eta\omega=0.521$
H 5427, 16 <sup>+</sup> $\gamma_{4835}$ 594 $\gamma_{4738}$ 689	E 8379.7+z, (44 <sup>-</sup> ) $\gamma_{7312+z}$ 1067.8 $I^{(1)}=81.5, I^{(2)}=74.2, \eta\omega=0.547$
A 5451, 17 <sup>-</sup> $\gamma_{4835}$ 616 (†,100)	E 9501.4+z, (46 <sup>-</sup> ) $\gamma_{6380+z}$ 1121.7 $I^{(1)}=81.1, I^{(2)}=73.5, \eta\omega=0.574$
5631, 17 <sup>+</sup> $\gamma_{6427}$ 204 (†,100)	E 10677.5+z, (48 <sup>-</sup> ) $\gamma_{9501+z}$ 1176.1 $I^{(1)}=80.8, I^{(2)}=72.2, \eta\omega=0.602$
5765, 18 <sup>+</sup> $\gamma_{6631}$ 132 $\gamma_{6451}$ 314 D $\gamma_{5427}$ 336	E 11909.0+z, (50 <sup>-</sup> ) $\gamma_{10678+z}$ 1231.53 $I^{(1)}=80.4, I^{(2)}=72.1, \eta\omega=0.630$
6312, (19 <sup>-</sup> ) $\gamma_{5765}$ 547 (†,100)	E 13196.0+z, (52 <sup>-</sup> ) $\gamma_{11909+z}$ 1287.03 $I^{(1)}=80.0, I^{(2)}=71.7, \eta\omega=0.657$
6449, (20 <sup>+</sup> ) $\gamma_{5765}$ 686 (†,100)	E 14538.8+z, (54 <sup>-</sup> ) $\gamma_{13196+z}$ 1342.83 $I^{(1)}=79.7, I^{(2)}=71.6, \eta\omega=0.685$
6496, (21 <sup>-</sup> ) $\gamma_{6312}$ 184 (†,100)	E 15937.5+z, (56 <sup>-</sup> ) $\gamma_{14539+z}$ 1398.75 $I^{(1)}=79.4, I^{(2)}=70.7, \eta\omega=0.713$
7276, (23 <sup>-</sup> ) $\gamma_{6496}$ 780 (†,100)	E 17392.8+z, (58 <sup>-</sup> ) $\gamma_{16938+z}$ 1455.35 $I^{(1)}=79.0, I^{(2)}=70.5, \eta\omega=0.742$
7930, (25 <sup>-</sup> ) $\gamma_{7276}$ 654 (†,100)	E 18904.8+z, (60 <sup>-</sup> ) $\gamma_{17393+z}$ 1512.05 $I^{(1)}=78.7, I^{(2)}=72.3, \eta\omega=0.770$
8325, (27 <sup>-</sup> ) $\gamma_{7930}$ 395 (†,100)	E 20472.1+z, (62 <sup>-</sup> ) $\gamma_{18905+z}$ 1567.35 $I^{(1)}=78.5$
9410(?), (28 <sup>+</sup> ) $\gamma_{8325}$ 1085 (†,100)	F u, (27 <sup>-</sup> )
9497, (29 <sup>-</sup> ) $\gamma_{8325}$ 1172 (†,100)	F 688.3+u, (29 <sup>-</sup> ) $\gamma_{0}$ 688.33 $I^{(1)}=82.8, I^{(2)}=83.3, \eta\omega=0.356$
9582, (29 <sup>+</sup> ) $\gamma_{9410}$ 172 (†,100)	F 1424.6+u, (31 <sup>-</sup> ) $\gamma_{688+u}$ 736.33 $I^{(1)}=82.8, I^{(2)}=81.1, \eta\omega=0.380$
9851, (30 <sup>+</sup> ) $\gamma_{9582}$ 269 $\gamma_{9497}$ 354	F 2210.2+u, (33 <sup>-</sup> ) $\gamma_{1425+u}$ 785.6 $I^{(1)}=82.7, I^{(2)}=81.6, \eta\omega=0.405$
10532, (31 <sup>+</sup> ) $\gamma_{9582}$ 950 (†,100)	F 3044.8+u, (35 <sup>-</sup> ) $\gamma_{2210+u}$ 834.6 $I^{(1)}=82.7, I^{(2)}=79.1, \eta\omega=0.430$
11231, (33 <sup>+</sup> ) $\gamma_{10532}$ 699 (†,100)	F 3930.0+u, (37 <sup>-</sup> ) $\gamma_{3045+u}$ 885.2 $I^{(1)}=82.5, I^{(2)}=78.3, \eta\omega=0.455$
12185, (34 <sup>-</sup> ) $\gamma_{11231}$ 954 (†,100)	F 4866.3+u, (39 <sup>-</sup> ) $\gamma_{3930+u}$ 936.3 $I^{(1)}=82.2, I^{(2)}=76.9, \eta\omega=0.481$
12678, (36 <sup>-</sup> ,34 <sup>+</sup> ) $\gamma_{12185}$ 493 (†,100)	F 5854.6+u, (41 <sup>-</sup> ) $\gamma_{4866+u}$ 988.3 $I^{(1)}=82.0, I^{(2)}=76.3, \eta\omega=0.507$
C x, J=(30)	F 6895.3+u, (43 <sup>-</sup> ) $\gamma_{5855+u}$ 1040.7 $I^{(1)}=81.7, I^{(2)}=74.2, \eta\omega=0.534$
C 780+x(?) , J+2 $\gamma_{780}$ 1(?) (†,0.15) $I^{(1)}=80.8, I^{(2)}=114.6, \eta\omega=0.399$	F 7989.9+u, (45 <sup>-</sup> ) $\gamma_{6896+u}$ 1094.6 $I^{(1)}=81.3, I^{(2)}=74.2, \eta\omega=0.561$
C 1594.9+x, J+4 $\gamma_{780+x}$ 814.93 (†,0.82 9) $I^{(1)}=82.2, I^{(2)}=117.6, \eta\omega=0.416$	F 9138.4+u, (47 <sup>-</sup> ) $\gamma_{7980+u}$ 1148.5 $I^{(1)}=81.0, I^{(2)}=73.7, \eta\omega=0.588$
C 2443.8+x, J+6 $\gamma_{1595+x}$ 848.91 (†,1.03 8) $I^{(1)}=83.6, I^{(2)}=102.3, \eta\omega=0.434$	F 10341.2+u, (49 <sup>-</sup> ) $\gamma_{9138+u}$ 1202.8 $I^{(1)}=80.6, I^{(2)}=72.3, \eta\omega=0.615$
C 3331.8+x, J+8 $\gamma_{2444+x}$ 888.01 (†,0.19 9) $I^{(1)}=84.5, I^{(2)}=97.3, \eta\omega=0.454$	F 11599.3+u, (51 <sup>-</sup> ) $\gamma_{10341+u}$ 1258.1 $I^{(1)}=80.3, I^{(2)}=73.4, \eta\omega=0.643$
C 4260.9+x, J+10 $\gamma_{3332+x}$ 929.11 (†,1.03 10) $I^{(1)}=85.0, I^{(2)}=95.5, \eta\omega=0.475$	F 12911.9+u, (53 <sup>-</sup> ) $\gamma_{11599+u}$ 1312.6 $I^{(1)}=80.0, I^{(2)}=63.4, \eta\omega=0.672$
C 5231.9+x, J+12 $\gamma_{4261+x}$ 971.03 (†,0.93 9) $I^{(1)}=85.5, I^{(2)}=94.6, \eta\omega=0.496$	F 14287.6+u, (55 <sup>-</sup> ) $\gamma_{12912+u}$ 1375.73 $I^{(1)}=79.2, I^{(2)}=77.2, \eta\omega=0.701$
C 6245.2+x, J+14 $\gamma_{5232+x}$ 1013.32 (†,1.06 7) $I^{(1)}=85.9, I^{(2)}=93.2, \eta\omega=0.517$	F 15715.1+u, (57 <sup>-</sup> ) $\gamma_{14288+u}$ 1427.53 $I^{(1)}=79.2, I^{(2)}=71.4, \eta\omega=0.728$
C 7301.4+x, J+16 $\gamma_{6245+x}$ 1056.22 (†,1.10 6) $I^{(1)}=86.2, I^{(2)}=90.7, \eta\omega=0.539$	F 17198.6+u, (59 <sup>-</sup> ) $\gamma_{15715+u}$ 1483.55 $I^{(1)}=78.9, I^{(2)}=70.5, \eta\omega=0.756$
C 8401.7+x, J+18 $\gamma_{7301+x}$ 1100.32 (†,0.92 12) $I^{(1)}=86.3, I^{(2)}=90.9, \eta\omega=0.561$	F 18738.8+u, (61 <sup>-</sup> ) $\gamma_{17199+u}$ 1540.25 $I^{(1)}=78.6, I^{(2)}=67.3, \eta\omega=0.785$
C 9546.0+x, J+20 $\gamma_{8402+x}$ 1144.33 (†,1.00 9) $I^{(1)}=86.5, I^{(2)}=86.6, \eta\omega=0.584$	F 20338.4+u, (63 <sup>-</sup> ) $\gamma_{18739+u}$ 1599.65 $I^{(1)}=78.1$
C 10736.5+x, J+22 $\gamma_{9546+x}$ 1190.52 (†,0.98 6) $I^{(1)}=86.5, I^{(2)}=84.6, \eta\omega=0.607$	G v
C 11974.3+x, J+24 $\gamma_{10737+x}$ 1237.82 (†,0.82 8) $I^{(1)}=86.4, I^{(2)}=82.1, \eta\omega=0.631$	
C 13260.8+x, J+26 $\gamma_{11974+x}$ 1286.53 (†,0.56 7) $I^{(1)}=86.3, I^{(2)}=79.5, \eta\omega=0.656$	
C 14597.6+x, J+28 $\gamma_{13261+x}$ 1336.83 (†,0.52 6) $I^{(1)}=86.0, I^{(2)}=79.7, \eta\omega=0.681$	
C 15984.6+x, J+30 $\gamma_{14598+x}$ 1387.03 (†,0.35 6) $I^{(1)}=85.8, I^{(2)}=76.5, \eta\omega=0.707$	
C 17423.9+x, J+32 $\gamma_{15985+x}$ 1439.34 (†,0.21 4) $I^{(1)}=85.5, I^{(2)}=72.9, \eta\omega=0.733$	
C 18918.1+x, J+34 $\gamma_{17424+x}$ 1494.26 (†,0.10 8) $I^{(1)}=85.0$	
D y, (29 <sup>-</sup> )	
D 727.9+y, (31 <sup>-</sup> ) $\gamma_{727.9}$ $I^{(1)}=83.8, I^{(2)}=91.7, \eta\omega=0.375$	
D 1499.4+y, (33 <sup>-</sup> ) $\gamma_{728+y}$ 771.51 (†,0.34 12) $I^{(1)}=84.3, I^{(2)}=94.1, \eta\omega=0.396$	
D 2313.4+y, (35 <sup>-</sup> ) $\gamma_{1499+y}$ 814.01 (†,0.69 15) $I^{(1)}=84.8, I^{(2)}=93.5, \eta\omega=0.418$	
D 3170.2+y, (37 <sup>-</sup> ) $\gamma_{2313+y}$ 856.81 (†,0.84 12) $I^{(1)}=85.2, I^{(2)}=91.1, \eta\omega=0.439$	
D 4070.9+y, (39 <sup>-</sup> ) $\gamma_{3170+y}$ 900.71 (†,0.99 18) $I^{(1)}=85.5, I^{(2)}=90.7, \eta\omega=0.461$	
D 5015.7+y, (41 <sup>-</sup> ) $\gamma_{4071+y}$ 944.81 (†,0.96 21) $I^{(1)}=85.7, I^{(2)}=88.3, \eta\omega=0.484$	
D 6005.8+y, (43 <sup>-</sup> ) $\gamma_{5016+y}$ 990.11 (†,0.82 9) $I^{(1)}=85.8, I^{(2)}=87.0, \eta\omega=0.507$	
D 7041.9+y, (45 <sup>-</sup> ) $\gamma_{6006+y}$ 1036.11 (†,0.75 15) $I^{(1)}=85.9, I^{(2)}=86.8, \eta\omega=0.530$	
D 8124.1+y, (47 <sup>-</sup> ) $\gamma_{7042+y}$ 1082.21 (†,0.88 18) $I^{(1)}=85.9, I^{(2)}=83.3, \eta\omega=0.553$	
D 9254.3+y, (49 <sup>-</sup> ) $\gamma_{8124+y}$ 1130.21 (†,0.82 12) $I^{(1)}=85.8, I^{(2)}=82.8, \eta\omega=0.577$	
D 10432.8+y, (51 <sup>-</sup> ) $\gamma_{9254+y}$ 1178.51 (†,0.97 18) $I^{(1)}=85.7, I^{(2)}=79.7, \eta\omega=0.602$	

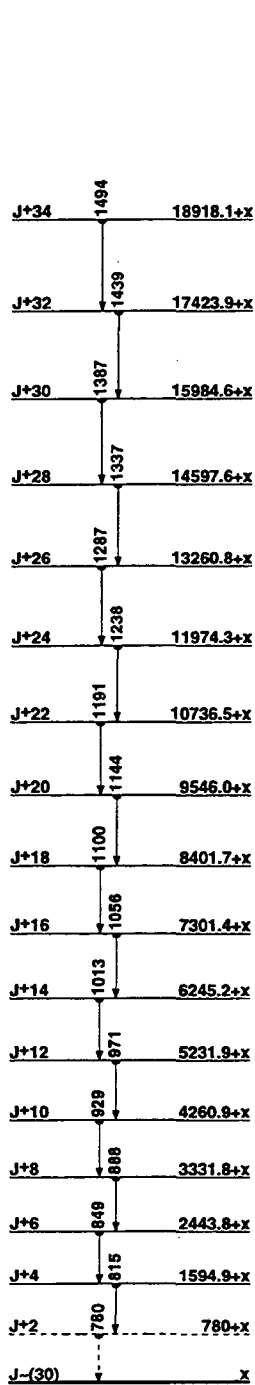

SD-1 band

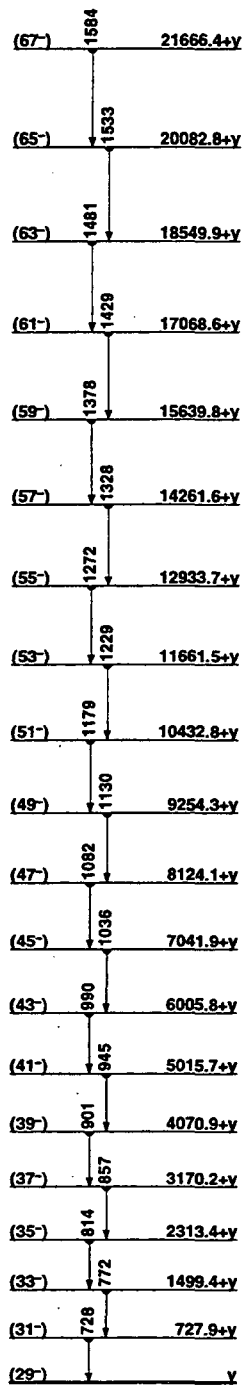

SD-2 band

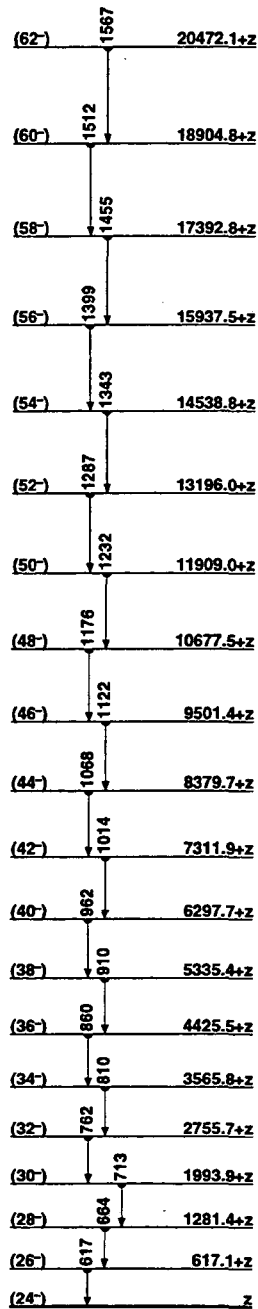

SD-3 band

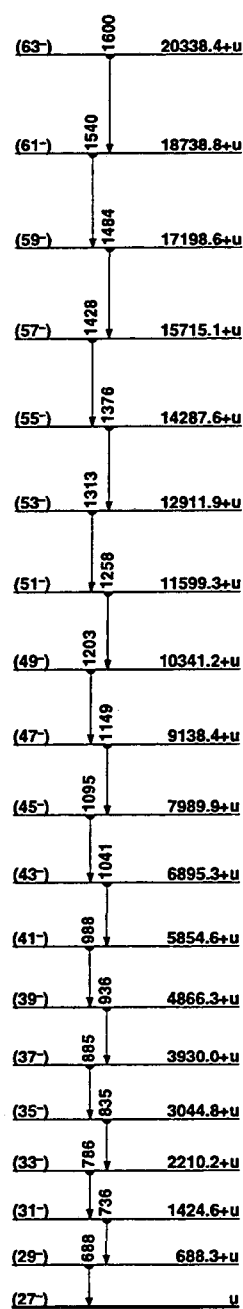

SD-4 band

SD-5 band

<sup>150</sup>Gd  
<sup>64</sup>Gd

**150Tb**  
**65Tb**

$\Delta$ : -71115  $S_n$ : 7688  $S_p$ : 3269  $Q_{EC}$ : 4656  $Q_{\alpha}$ : 3587.5

Nuclear Bands

A SD band

Levels and  $\gamma$ -ray branchings:

$0+y$  (?), ( $2^-$ ), 3.48 16 h, %EC+% $\beta^+$ =100, % $\alpha$ <0.05

$0+x$  (?), ( $8^+, 9^+$ ), 5.82 m, %EC+% $\beta^+$ =100

397.2+y z, ( $1^+$ )  $\gamma_{0+y}$  397.23(?) ( $\dagger$ , 100) E1

594.5+x, ( $10^+$ )  $\gamma_{0+x}$  594.5 ( $\dagger$ , 100)

758.7+x, ( $11^+$ )  $\gamma_{0+x}$  758.7 ( $\dagger$ , 100)

832.4+x, ( $10^-$ )  $\gamma_{0+x}$  832.4 ( $\dagger$ , 100)

874.2+x, ( $11^-$ )  $\gamma_{832+x}$  41.8  $\gamma_{758+x}$  115.5  $\gamma_{594+x}$  279.9

1111.9+x, ( $12^-$ )  $\gamma_{874+x}$  237.7  $\gamma_{758+x}$  353

1435.9+x, ( $13^+$ )  $\gamma_{758+x}$  677.2 ( $\dagger$ , 100)

1639+x, ( $13^-$ )  $\gamma_{874+x}$  764.8 ( $\dagger$ , 100)

1929.0+x, ( $14^-$ )  $\gamma_{1639+x}$  290.0  $\gamma_{1112+x}$  817.3

1937.6+x, ( $14^+$ )  $\gamma_{1436+x}$  501.7 ( $\dagger$ , 100)

2165.5+x, ( $16^+$ )  $\gamma_{1938+x}$  227.9 ( $\dagger$ , 100)

2265.5+x, ( $15^-$ )  $\gamma_{1639+x}$  626.5 ( $\dagger$ , 100)

2541.2+x, ( $16^-$ )  $\gamma_{2266+x}$  275.7  $\gamma_{2166+x}$  376  $\gamma_{1929+x}$  612.2

2896.3+x, ( $18^-$ )  $\gamma_{2541+x}$  355.1 ( $\dagger$ , 100)

3206.6+x, ( $19^-$ )  $\gamma_{2896+x}$  310.3 ( $\dagger$ , 100)

3419.6+x, ( $20^-$ )  $\gamma_{3207+x}$  213.6  $\gamma_{2896+x}$  523.3

3456.3+x (?)  $\gamma_{2896+x}$  560 (?) ( $\dagger$ , 100)

3950.1+x (?)  $\gamma_{3456+x}$  493.8 (?) ( $\dagger$ , 100)

4339.0+x  $\gamma_{3950+x}$  390.1 (?)  $\gamma_{3420+x}$  919.4

A z, J=(24)

- A 598.0+z, J+2  $\gamma_{598.0}$  598.03 ( $\dagger$ , 0.203)  $I^{(1)}=85.3, I^{(2)}=80.3, \eta\omega=0.311$
- A 1245.8+z, J+4  $\gamma_{698+z}$  647.83 ( $\dagger$ , 0.384)  $I^{(1)}=84.9, I^{(2)}=80.3, \eta\omega=0.336$
- A 1943.4+z, J+6  $\gamma_{1246+z}$  697.62 ( $\dagger$ , 1.00 10)  $I^{(1)}=84.6, I^{(2)}=79.1, \eta\omega=0.361$
- A 2691.6+z, J+8  $\gamma_{1943+z}$  748.22 ( $\dagger$ , 0.98 10)  $I^{(1)}=84.2, I^{(2)}=78.3, \eta\omega=0.387$
- A 3490.9+z, J+10  $\gamma_{2692+z}$  799.32 ( $\dagger$ , 1.00)  $I^{(1)}=83.8, I^{(2)}=78.0, \eta\omega=0.412$
- A 4341.5+z, J+12  $\gamma_{3491+z}$  850.62 ( $\dagger$ , 1.00 10)  $I^{(1)}=83.5, I^{(2)}=77.7, \eta\omega=0.438$
- A 5243.6+z, J+14  $\gamma_{4342+z}$  902.12 ( $\dagger$ , 1.04 10)  $I^{(1)}=83.1, I^{(2)}=75.9, \eta\omega=0.464$
- A 6198.4+z, J+16  $\gamma_{5244+z}$  954.82 ( $\dagger$ , 0.99 10)  $I^{(1)}=82.7, I^{(2)}=77.7, \eta\omega=0.490$
- A 7204.7+z, J+18  $\gamma_{6198+z}$  1006.33 ( $\dagger$ , 0.98 10)  $I^{(1)}=82.5, I^{(2)}=75.6, \eta\omega=0.516$
- A 8263.9+z, J+20  $\gamma_{7205+z}$  1059.23 ( $\dagger$ , 0.89 9)  $I^{(1)}=82.1, I^{(2)}=76.3, \eta\omega=0.543$
- A 9375.5+z, J+22  $\gamma_{8264+z}$  1111.63 ( $\dagger$ , 0.88 9)  $I^{(1)}=81.9, I^{(2)}=74.5, \eta\omega=0.569$
- A 10540.8+z, J+24  $\gamma_{9376+z}$  1165.33 ( $\dagger$ , 0.87 9)  $I^{(1)}=81.5, I^{(2)}=75.8, \eta\omega=0.596$
- A 11758.9+z, J+26  $\gamma_{10541+z}$  1218.13 ( $\dagger$ , 0.88 9)  $I^{(1)}=81.3, I^{(2)}=74.9, \eta\omega=0.622$
- A 13030.4+z, J+28  $\gamma_{11759+z}$  1271.53 ( $\dagger$ , 0.68 7)  $I^{(1)}=81.0, I^{(2)}=74.8, \eta\omega=0.649$
- A 14355.4+z, J+30  $\gamma_{13030+z}$  1325.04 ( $\dagger$ , 0.35 5)  $I^{(1)}=80.8, I^{(2)}=73.7, \eta\omega=0.676$
- A 15734.7+z, J+32  $\gamma_{14356+z}$  1379.34 ( $\dagger$ , 0.32 4)  $I^{(1)}=80.5, I^{(2)}=74.2, \eta\omega=0.703$
- A 17167.9+z, J+34  $\gamma_{15735+z}$  1433.24 ( $\dagger$ , 0.20 4)  $I^{(1)}=80.2, I^{(2)}=74.9, \eta\omega=0.730$
- A 18654.5+z, J+36  $\gamma_{17168+z}$  1486.65  $I^{(1)}=80.0$

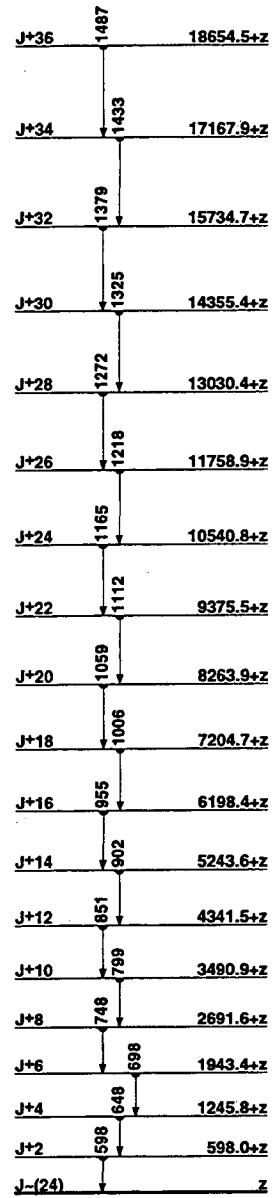

SD band

**150Tb**  
**65Tb**

151  
65 Tb

$\Delta$ : -71633 5 S<sub>n</sub>: 8590 9 S<sub>p</sub>: 3151 7 Q<sub>EC</sub>: 2565 4 Q <sub>$\alpha$</sub> : 3496 4

Nuclear Bands

- A  $\pi$ <sub>h</sub><sub>11/2</sub>(0<sup>+</sup>)
- B  $\pi$ <sub>h</sub><sub>11/2</sub>(3<sup>-</sup>)
- C SD-1 band
- D SD-2 band

Levels and  $\gamma$ -ray branchings:

0, 1/2<sup>(+)</sup>, 17.609 1 h, %EC+% $\beta$ <sup>+</sup>=100, % $\alpha$ =9.5 $\times$ 10<sup>-3</sup> 15  
 22.922 20, 3/2<sup>(+)</sup>, 4.05 7 ns  $\gamma_{22}$  22.922 (t<sub>100</sub>) M1+E2:  $\delta$ =0.031 4  
 72.39 3, (5/2<sup>-</sup>), 0.92 3 ns  $\gamma_{23}$  49.462 (t<sub>100</sub>) M1+E2:  $\delta$ =0.062  $\gamma_0$  72.50 10 (t<sub>0.5</sub>) (E2)  
 A 99.54 6, (11/2<sup>-</sup>), 25 3 s, %IT=93.8 4, %EC+% $\beta$ <sup>+</sup>=6.2 4  $\gamma_{72}$  27.1 1 E3  
 248.79 3, (5/2<sup>+</sup>, 7/2<sup>+</sup>), <0.26 ns  $\gamma_{72}$  176.40 1 (t<sub>100</sub>) M1+E2:  $\delta$ =0.51 17  
 $\gamma_{23}$  226.3 3 (t<sub>2.3</sub>) M1, E2  
 276.42 4  $\gamma_{72}$  204.03 2 (t<sub>100</sub>)  
 485.64 5, (7/2<sup>-</sup>)  $\gamma_{100}$  386.10 2 (t<sub>100</sub>) E2  $\gamma_{72}$  413.27 13 (t<sub>2.1</sub>)  
 548.85 5, (3/2<sup>+</sup>, 5/2<sup>+</sup>, 7/2<sup>+</sup>)  $\gamma_{276}$  272.43 23 (t<sub>4.0</sub>)  $\gamma_{249}$  300.00 16 (t<sub>2.9</sub>)  
 $\gamma_{72}$  476.56 10 (t<sub>100</sub>) M1  
 583.98 6, (5/2<sup>-</sup>)  $\gamma_{276}$  307.48 8 (t<sub>36</sub>)  $\gamma_{23}$  561.00 10 (t<sub>78</sub>)  $\gamma_0$  583.9 1 (t<sub>100</sub>)  
 646.02 5, (9/2<sup>-</sup>)  $\gamma_{486}$  160.40 2 (t<sub>2.7</sub>)  $\gamma_{100}$  546.31 10 (t<sub>100</sub>) M1  
 686.70 7  $\gamma_{23}$  614.30 10 (t<sub>61</sub>)  $\gamma_{23}$  663.67 10 (t<sub>100</sub>)  
 A 703.74 11, (15/2<sup>-</sup>)  $\gamma_{100}$  604.2 1 (t<sub>100</sub>) E2  
 711.93 5  $\gamma_{549}$  163.04 4 (t<sub>7.2</sub>)  $\gamma_{249}$  463.20 10 (t<sub>95</sub>) M1(+E2):  $\delta$ <0.82  
 $\gamma_{72}$  639.50 10 (t<sub>5.4</sub>)  $\gamma_{23}$  689.17 10 (t<sub>100</sub>)  $\gamma_0$  712.00 20 (t<sub><47</sub>)  
 841.11 9  $\gamma_{549}$  292.16 10 (t<sub>4.2</sub>)  $\gamma_{72}$  768.90 20 (t<sub>100</sub>)  $\gamma_{23}$  818.6 3 (t<sub>40</sub>)  
 856.81 7  $\gamma_{486}$  371.07 5 (t<sub>35.0</sub>)  $\gamma_{276}$  580.4 3 (t<sub>9.4</sub>)  $\gamma_{72}$  784.5 6 (t<sub>4.7</sub>)  
 $\gamma_{23}$  833.9 2 (t<sub>100</sub>)  
 886.43 7  $\gamma_{549}$  337.80 10 (t<sub>48</sub>)  $\gamma_{72}$  814.10 10 (t<sub>100</sub>)  
 887.35 11, (13/2<sup>-</sup>)  $\gamma_{100}$  787.8 1 (t<sub>100</sub>) (M1+E2)  
 917.78 7, (5/2<sup>+</sup>, 7/2<sup>+</sup>)  $\gamma_{687}$  230.90 13 (t<sub>12.9</sub>)  $\gamma_{584}$  333.17 26 (t<sub>4.7</sub>)  
 $\gamma_{100}$  432.16 10 (t<sub>100</sub>) M1  $\gamma_{276}$  642.26 (t<sub>4.7</sub>)  $\gamma_{72}$  845.46 10 (t<sub>49.8</sub>)  
 949.07 6  $\gamma_{646}$  303.00 5 (t<sub>75.4</sub>)  $\gamma_{549}$  400.67 16 (t<sub>16.4</sub>)  $\gamma_{249}$  700.32 10 (t<sub>100</sub>)  $\gamma_{23}$  926.0 5 (t<sub>26</sub>)  
 1082.61 6, (7/2<sup>-</sup>)  $\gamma_{646}$  436.86 10 (t<sub>25.0</sub>) M1  $\gamma_{549}$  533.66 18 (t<sub>9.4</sub>)  
 $\gamma_{486}$  596.77 10 (t<sub>51.4</sub>)  $\gamma_{72}$  1010.4 3 (t<sub>100</sub>)  
 B 1096.56 19, (15/2<sup>+</sup>)  $\gamma_{857}$  209.22 (t<sub>33</sub>)  $\gamma_{704}$  392.8 1 (t<sub>100</sub>) E1  
 1119.38 8  $\gamma_{549}$  570.70 10 (t<sub>79.6</sub>)  $\gamma_{249}$  870.36 10 (t<sub>100</sub>)  $\gamma_{100}$  1020.4 3 (t<sub>60</sub>)  
 1202.10 11  $\gamma_{657}$  345.13 16 (t<sub>10.3</sub>)  $\gamma_{646}$  556.40 23 (t<sub>13.3</sub>)  $\gamma_{549}$  653.20 20 (t<sub>27.0</sub>)  $\gamma_{72}$  1129.8 3 (t<sub>100</sub>)  
 1241.21 10, (7/2<sup>-</sup>, 9/2<sup>-</sup>)  $\gamma_{486}$  755.57 10 (t<sub>100</sub>)  $\gamma_{249}$  992.37 22 (t<sub>10.7</sub>)  
 $\gamma_{100}$  1141.8 3 (t<sub>99</sub>)  
 1319.4 3  $\gamma_{249}$  1070.6 3 (t<sub>100</sub>)  
 A 1319.53 15, (19/2<sup>-</sup>)  $\gamma_{704}$  615.8 1 (t<sub>100</sub>) E2  
 1433.86 8  $\gamma_{918}$  515.9 5 (t<sub>13.8</sub>)  $\gamma_{646}$  788.07 10 (t<sub>95</sub>)  $\gamma_{584}$  849.60 10 (t<sub>100</sub>)  $\gamma_{249}$  1185.6 3 (t<sub>51</sub>)  $\gamma_{100}$  1334.3 3 (t<sub>49</sub>)  
 1526.9 4  $\gamma_{704}$  823.2 3 (t<sub>100</sub>)  
 1582.29 12  $\gamma_{646}$  936.27 10 (t<sub>100</sub>)  
 1611.09 12  $\gamma_{1083}$  528.40 16 (t<sub>12.3</sub>)  $\gamma_{549}$  1062.5 3 (t<sub>51</sub>)  $\gamma_{249}$  1361.9 3 (t<sub>12.3</sub>)  $\gamma_{72}$  1538.1 3 (t<sub>100</sub>)  $\gamma_0$  1611.0 3 (t<sub>7.9</sub>)  
 1629.66 8  $\gamma_{949}$  680.41 10 (t<sub>46.8</sub>)  $\gamma_{918}$  712.00 20 (t<sub>58</sub>)  $\gamma_{646}$  983.73 10 (t<sub>100</sub>)  $\gamma_{486}$  1144.1 3 (t<sub>20</sub>)  $\gamma_{249}$  1381.2 3 (t<sub>18.1</sub>)  $\gamma_{100}$  1530.2 3 (t<sub>40.1</sub>)  
 1663.18 11  $\gamma_{918}$  745.40 10 (t<sub>45.6</sub>)  $\gamma_{549}$  1114.3 3 (t<sub>100</sub>)  
 B 1693.17 20, (19/2<sup>+</sup>)  $\gamma_{109}$  596.6 1 (t<sub>100</sub>) E2  
 1724.46 15, (5/2<sup>-</sup>)  $\gamma_{886}$  837.9 5 (t<sub>4.4</sub>)  $\gamma_{646}$  1175.5 3 (t<sub>21.9</sub>)  
 $\gamma_{249}$  1475.7 3 (t<sub>46.8</sub>)  $\gamma_{72}$  1652.1 3 (t<sub>31.4</sub>)  $\gamma_{23}$  1701.6 3 (t<sub>100</sub>)  
 1741.78 8  $\gamma_{949}$  793.08 10 (t<sub>29.1</sub>)  $\gamma_{657}$  884.62 10 (t<sub>37</sub>)  $\gamma_{712}$  1029.4 3 (t<sub>21.2</sub>)  $\gamma_{646}$  1096.1 3 (t<sub>100</sub>)  $\gamma_{486}$  1256.1 3 (t<sub>62</sub>)  $\gamma_{249}$  1493.3 3 (t<sub>15.8</sub>)  $\gamma_{23}$  1718.4 5 (t<sub>7</sub>)  
 1773.74 10  $\gamma_{918}$  855.84 10 (t<sub>87</sub>)  $\gamma_{584}$  1197.00 10 (t<sub>58</sub>)  $\gamma_{841}$  932.5 10 (t<sub>19</sub>)  $\gamma_{584}$  1190.6 3 (t<sub>28</sub>)  $\gamma_{486}$  1288.2 3 (t<sub>53</sub>)  $\gamma_{249}$  1525.1 3 (t<sub>100</sub>)  
 1841.63 11  $\gamma_{949}$  891.92 20 (t<sub>27.0</sub>)  $\gamma_{841}$  1000.4 3 (t<sub>5.7</sub>)  $\gamma_{712}$  1129.8 3 (t<sub>88</sub>)  $\gamma_{646}$  1196.8 3 (t<sub>36.3</sub>)  $\gamma_{486}$  1355.5 3 (t<sub>12.6</sub>)  $\gamma_{249}$  1593.1 3 (t<sub>100</sub>)  $\gamma_{72}$  1769.7 3 (t<sub>12.0</sub>)  
 A 2001.93 7, (23/2<sup>-</sup>)  $\gamma_{1320}$  682.4 1 (t<sub>100</sub>) E2  
 2045.6 3, (21/2<sup>+</sup>)  $\gamma_{1693}$  352.4 3 (t<sub>49</sub>)  $\gamma_{319}$  726.1 3 (t<sub>100</sub>)  
 2120.34 25, (23/2<sup>-</sup>)  $\gamma_{1320}$  800.8 2 (t<sub>100</sub>) E2  
 2180.53 19, (25/2<sup>-</sup>)  $\gamma_{2002}$  178.6 1 (t<sub>100</sub>) not NOTE1  
 B 2219.57 22, (23/2<sup>+</sup>)  $\gamma_{1693}$  526.4 1 (t<sub>100</sub>) (E2)

2375.31 21, (27/2<sup>-</sup>)  $\gamma_{2181}$  194.8 1 (t<sub>100</sub>) M1, E2  
 2468.4 3, (25/2<sup>+</sup>)  $\gamma_{2220}$  248.8 3 (t<sub>100</sub>) not NOTE1  $\gamma_{2181}$  287 (t<sub>19</sub>)  
 $\gamma_{2002}$  466 (t<sub>26</sub>)  
 B 2782.17 23, (27/2<sup>+</sup>)  $\gamma_{2468}$  313.9 3 (t<sub>5.5</sub>)  $\gamma_{2220}$  562.6 1 (t<sub>100</sub>) E2  
 2847.2 3, (29/2<sup>+</sup>)  $\gamma_{2782}$  65.1 3 (t<sub>16</sub>) (M1)  $\gamma_{2468}$  378.6 3 (t<sub>100</sub>)  
 $\gamma_{2375}$  472.0 3 (t<sub>62</sub>)  
 3108.1 (?)  $\gamma_{2782}$  325.7 3 (?) (t<sub>100</sub>)  
 3115.6 3, (31/2<sup>+</sup>)  $\gamma_{2847}$  268.4 1 (t<sub>100</sub>) M1, E2  
 3128.8 4, (31/2<sup>-</sup>)  $\gamma_{2375}$  753.4 3 (t<sub>100</sub>) E2  
 3159.0 4, (29/2<sup>-</sup>)  $\gamma_{2181}$  978.5 14 (t<sub>100</sub>) (E2)  
 3197.1 4  $\gamma_{2847}$  349.9 3 (t<sub>100</sub>)  
 3274.0 4, (33/2<sup>-</sup>)  $\gamma_{3116}$  158.4 3 (t<sub>100</sub>) D(+Q)  
 3287.6 4  $\gamma_{2847}$  440.4 3 (t<sub>100</sub>)  
 3808.4 5, (35/2<sup>-</sup>)  $\gamma_{3128}$  679.7 3 (t<sub>100</sub>) (E2)  
 3900.3 4, (35/2<sup>-</sup>)  $\gamma_{3116}$  784.7 3 (t<sub>100</sub>) (E2)  
 4147.9 5, (37/2<sup>-</sup>)  $\gamma_{3274}$  873.9 3 (t<sub>100</sub>) (E2)  
 4564.3 5, (39/2<sup>-</sup>)  $\gamma_{3900}$  664.0 3 (t<sub>100</sub>) (E2)  
 4774.0 6, (41/2<sup>-</sup>)  $\gamma_{4148}$  626.1 3 (t<sub>100</sub>) (E2)  
 5162.6 7, (45/2<sup>-</sup>)  $\gamma_{4774}$  388.6 3 (t<sub>100</sub>) (E2)  
 C x, J=(5/7/2)  
 C 728.0+x, J+2  $\gamma_x$  728.0 5 (t<sub>0.22</sub>) I<sup>(1)</sup>=82.4, I<sup>(2)</sup>=97.1,  $\eta$ =0.374  
 C 1497.2+x, J+4  $\gamma_{728+x}$  769.2 5 (t<sub>0.37</sub>) I<sup>(1)</sup>=83.2, I<sup>(2)</sup>=95.0,  $\eta$ =0.395  
 C 2308.5+x, J+6  $\gamma_{1497+x}$  811.3 3 (t<sub>0.83</sub>) I<sup>(1)</sup>=83.8, I<sup>(2)</sup>=93.7,  $\eta$ =0.416  
 C 3162.5+x, J+8  $\gamma_{2308+x}$  854.0 1 (t<sub>0.98</sub>) I<sup>(1)</sup>=84.3, I<sup>(2)</sup>=90.9,  $\eta$ =0.438  
 C 4060.5+x, J+10  $\gamma_{3163+x}$  898.0 1 (t<sub>1.01</sub>) I<sup>(1)</sup>=84.6, I<sup>(2)</sup>=89.3,  $\eta$ =0.460  
 C 5003.3+x, J+12  $\gamma_{4061+x}$  942.8 1 (t<sub>1.03</sub>) I<sup>(1)</sup>=84.9, I<sup>(2)</sup>=87.1,  $\eta$ =0.483  
 C 5992.0+x, J+14  $\gamma_{5003+x}$  988.7 2 (t<sub>0.90</sub>) I<sup>(1)</sup>=85.0, I<sup>(2)</sup>=86.6,  $\eta$ =0.506  
 C 7026.9+x, J+16  $\gamma_{5992+x}$  1034.9 2 (t<sub>0.99</sub>) I<sup>(1)</sup>=85.0, I<sup>(2)</sup>=84.0,  $\eta$ =0.529  
 C 8109.4+x, J+18  $\gamma_{7027+x}$  1082.5 1 (t<sub>1.05</sub>) I<sup>(1)</sup>=85.0, I<sup>(2)</sup>=83.9,  $\eta$ =0.553  
 C 9239.6+x, J+20  $\gamma_{8109+x}$  1130.2 2 (t<sub>1.08</sub>) I<sup>(1)</sup>=84.9, I<sup>(2)</sup>=82.1,  $\eta$ =0.577  
 C 10418.5+x, J+22  $\gamma_{9240+x}$  1178.9 2 (t<sub>0.95</sub>) I<sup>(1)</sup>=84.8, I<sup>(2)</sup>=80.6,  $\eta$ =0.602  
 C 11647.0+x, J+24  $\gamma_{10418+x}$  1228.5 2 (t<sub>0.90</sub>) I<sup>(1)</sup>=84.7, I<sup>(2)</sup>=80.0,  $\eta$ =0.627  
 C 12925.5+x, J+26  $\gamma_{11647+x}$  1278.5 2 (t<sub>0.85</sub>) I<sup>(1)</sup>=84.5, I<sup>(2)</sup>=77.7,  $\eta$ =0.652  
 C 14255.5+x, J+28  $\gamma_{12926+x}$  1330.0 9 (t<sub>0.50</sub>) I<sup>(1)</sup>=84.2, I<sup>(2)</sup>=78.9,  $\eta$ =0.678  
 C 15636.2+x, J+30  $\gamma_{14256+x}$  1380.7 2 (t<sub>0.27</sub>) I<sup>(1)</sup>=84.0, I<sup>(2)</sup>=77.2,  $\eta$ =0.703  
 C 17068.7+x, J+32  $\gamma_{15636+x}$  1432.5 5 (t<sub>0.16</sub>) I<sup>(1)</sup>=83.8, I<sup>(2)</sup>=79.2,  $\eta$ =0.729  
 C 18551.7+x, J+34  $\gamma_{17069+x}$  1483 (t<sub>0.15</sub>) I<sup>(1)</sup>=83.6, I<sup>(2)</sup>=76.9,  $\eta$ =0.755  
 C 20086.7+x (?), J+36  $\gamma_{18552+x}$  1535 (?) (t<sub>0.05</sub>) I<sup>(1)</sup>=83.4  
 D y, J=(49/2)  
 D 602+y, J+2  $\gamma_y$  602 (t<sub>0.12</sub>) I<sup>(1)</sup>=86.4, I<sup>(2)</sup>=88.9,  $\eta$ =0.312  
 D 1249+y, J+4  $\gamma_{602+y}$  647 (t<sub>0.56</sub>) I<sup>(1)</sup>=86.6, I<sup>(2)</sup>=88.9,  $\eta$ =0.335  
 D 1941+y, J+6  $\gamma_{1249+y}$  692 (t<sub>0.86</sub>) I<sup>(1)</sup>=86.7, I<sup>(2)</sup>=87.0,  $\eta$ =0.357  
 D 2679+y, J+8  $\gamma_{1941+y}$  738 (t<sub>0.94</sub>) I<sup>(1)</sup>=86.7, I<sup>(2)</sup>=88.9,  $\eta$ =0.380  
 D 3462+y, J+10  $\gamma_{2679+y}$  783 (t<sub>0.79</sub>) I<sup>(1)</sup>=86.8, I<sup>(2)</sup>=88.9,  $\eta$ =0.403  
 D 4290+y, J+12  $\gamma_{3462+y}$  828 (t<sub>0.83</sub>) I<sup>(1)</sup>=87.0, I<sup>(2)</sup>=83.3,  $\eta$ =0.426  
 D 5166+y, J+14  $\gamma_{4290+y}$  876 (t<sub>0.86</sub>) I<sup>(1)</sup>=86.8, I<sup>(2)</sup>=87.0,  $\eta$ =0.449  
 D 6088+y, J+16  $\gamma_{5166+y}$  922 (t<sub>0.98</sub>) I<sup>(1)</sup>=86.8, I<sup>(2)</sup>=83.3,  $\eta$ =0.473  
 D 7058+y, J+18  $\gamma_{6088+y}$  970 (t<sub>0.86</sub>) I<sup>(1)</sup>=86.6, I<sup>(2)</sup>=87.0,  $\eta$ =0.496  
 D 8074+y, J+20  $\gamma_{7058+y}$  1016 (t<sub>1.01</sub>) I<sup>(1)</sup>=86.6, I<sup>(2)</sup>=85.1,  $\eta$ =0.520  
 D 9137+y, J+22  $\gamma_{8074+y}$  1063 (t<sub>1.05</sub>) I<sup>(1)</sup>=86.5, I<sup>(2)</sup>=81.6,  $\eta$ =0.544  
 D 10249+y, J+24  $\gamma_{9137+y}$  1112 (t<sub>0.86</sub>) I<sup>(1)</sup>=86.3, I<sup>(2)</sup>=87.0,  $\eta$ =0.568  
 D 11407+y, J+26  $\gamma_{10249+y}$  1158 (t<sub>0.83</sub>) I<sup>(1)</sup>=86.4, I<sup>(2)</sup>=81.6,  $\eta$ =0.591  
 D 12614+y, J+28  $\gamma_{11407+y}$  1207 (t<sub>0.86</sub>) I<sup>(1)</sup>=86.2, I<sup>(2)</sup>=81.6,  $\eta$ =0.616  
 D 13870+y, J+30  $\gamma_{12614+y}$  1256 (t<sub>0.83</sub>) I<sup>(1)</sup>=86.0, I<sup>(2)</sup>=81.6,  $\eta$ =0.640  
 D 15175+y, J+32  $\gamma_{13870+y}$  1305 (t<sub>0.60</sub>) I<sup>(1)</sup>=85.8, I<sup>(2)</sup>=83.3,  $\eta$ =0.664  
 D 16528+y, J+34  $\gamma_{15175+y}$  1353 (t<sub>0.23</sub>) I<sup>(1)</sup>=85.7, I<sup>(2)</sup>=87.0,  $\eta$ =0.688  
 D 17927+y, J+36  $\gamma_{16528+y}$  1399 I<sup>(1)</sup>=85.8, I<sup>(2)</sup>=81.6,  $\eta$ =0.712  
 D 19375+y, J+38  $\gamma_{17927+y}$  1448 I<sup>(1)</sup>=85.6, I<sup>(2)</sup>=81.6,  $\eta$ =0.736  
 D 20872+y, J+40  $\gamma_{19375+y}$  1497 I<sup>(1)</sup>=85.5

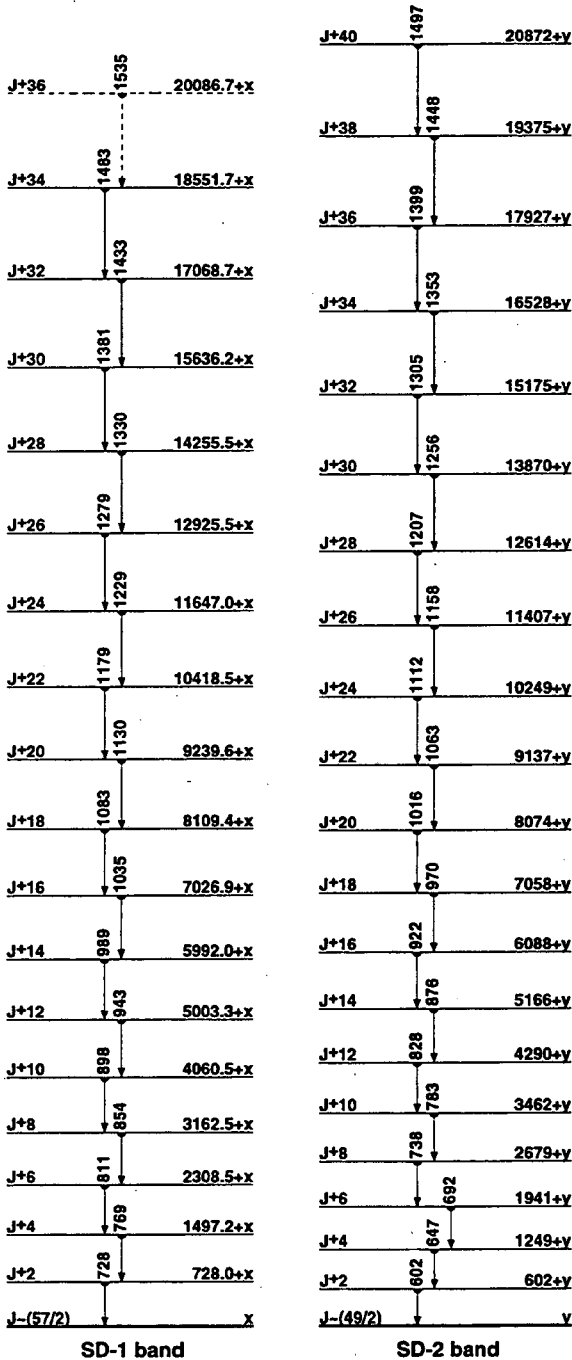

**151Tb**  
65

**151Dy**  
66

$\Delta$ : -68762.4  $S_n$ : 7513.5  $S_p$ : 4936.8  $Q_{EC}$ : 2871.5  $Q_\alpha$ : 4180.3

Nuclear Bands

A SD band

Levels and  $\gamma$ -ray branchings:

- 0,  $7/2^-$ , 17.93 m,  $\% \alpha = 5.64$ ,  $\% EC + \% \beta^+ = 94.44$
- 527.38 9,  $(9/2^-)$   $\gamma_{527.41}$  ( $\dagger_{100}$ ) D
- 775.57 11,  $(11/2^-)$   $\gamma_{775.5315}$  ( $\dagger_{100}$ ) E2
- 968.61 13,  $(13/2^-)$   $\gamma_{968.61}$  ( $\dagger_{100}$ ) D
- 984.75 22  $\gamma_{984.752}$  ( $\dagger_{100}$ )

- 1334.5 3  $\gamma_{985}$  350.88 ( $\dagger_{2213}$ )  $\gamma_{969}$  366.03 ( $\dagger_{10013}$ )  $\gamma_{776}$  559.45 ( $\dagger_{5013}$ )
  - 1348.7 1,  $(13/2^-)$   $\gamma_{776}$  573.25 ( $\dagger_{7.515}$ ) (D)  $\gamma_{527}$  821.325 ( $\dagger_{1002}$ ) E2
  - 1511.16 12,  $(15/2^-)$   $\gamma_{969}$  542.51 ( $\dagger_{103}$ ) (D)  $\gamma_{776}$  735.595 ( $\dagger_{1003}$ ) E2
  - 1549.52 19  $\gamma_{969}$  580.510 ( $\dagger_{14}$ )  $\gamma_{527}$  1021.55 ( $\dagger_{368}$ )  $\gamma_0$  1549.72 ( $\dagger_{1007}$ )
  - 1733.7 (?),  $(17/2^-)$   $\gamma_{969}$  765.33(?) ( $\dagger_{100}$ ) E2
  - 1856.6 3(?)  $\gamma_{985}$  871.010 ( $\dagger_{71}$ )  $\gamma_{776}$  1081.43 ( $\dagger_{10011}$ )
  - 1918.58 11,  $(17/2^-)$   $\gamma_{1511}$  407.41 ( $\dagger_{43.213}$ ) (D)  $\gamma_{1349}$  569.885 ( $\dagger_{1002}$ ) E2
  - 1961.3 6  $\gamma_{776}$  1185.710 ( $\dagger_{77}$ )  $\gamma_{527}$  1434.36 ( $\dagger_{10031}$ )
  - 2263.02 11,  $(21/2^-)$   $\gamma_{1919}$  344.444 ( $\dagger_{100}$ ) E2
  - 2402.0 (?),  $(21/2^-)$   $\gamma_{1734}$  668.33(?) ( $\dagger_{100}$ ) E2
  - 2554.3 3(?)  $\gamma_{776}$  1779.13 ( $\dagger_{1009}$ )  $\gamma_{527}$  2026.95 ( $\dagger_{413}$ )
  - 2582.9 5(?)  $\gamma_{776}$  1807.76 ( $\dagger_{5518}$ )  $\gamma_{527}$  2055.78 ( $\dagger_{10036}$ )
  - 2866.1 4(?)  $\gamma_{985}$  1881.43 ( $\dagger_{10011}$ )  $\gamma_{776}$  2090.411 ( $\dagger_{2111}$ )
  - 2911.66 12,  $(25/2^-)$   $\gamma_{2263}$  648.645 ( $\dagger_{100}$ ) E2
  - 2958.6 10,  $(27/2^-)$ , 1.36 ns  $\gamma_{2912}$  46.9 ( $\dagger_{100}$ ) M1
  - 3078.2 (?),  $(25/2^-)$   $\gamma_{2402}$  675.73(?) ( $\dagger_{100}$ ) E2
  - 3428.5 11,  $(29/2^-)$   $\gamma_{2955}$  469.9112 ( $\dagger_{100}$ ) D
  - 3733.9 11,  $(31/2^-)$   $\gamma_{3429}$  305.3 ( $\gamma_{2959}$  775.38 15 E2
  - 4306.3 11,  $(33/2^-)$   $\gamma_{3734}$  572.55 ( $\dagger_{10014}$ ) (D)  $\gamma_{3429}$  877.7916 ( $\dagger_{4313}$ ) (E2)
  - 4387.3 11,  $(35/2^-)$   $\gamma_{3734}$  653.376 ( $\dagger_{100}$ ) E2
  - 4741.5 11,  $(37/2^-)$   $\gamma_{4387}$  354.287 ( $\dagger_{1002}$ ) D  $\gamma_{4306}$  435.1613 ( $\dagger_{22.921}$ ) E2
  - 4903.8 11,  $(41/2^-)$ , 5.97 ns  $\gamma_{4742}$  162.325 ( $\dagger_{100}$ ) E2
  - 5742.9 11,  $(43/2^-)$   $\gamma_{4904}$  839.0210 ( $\dagger_{100}$ ) E1
  - 6007.2 11,  $(47/2^-)$   $\gamma_{5743}$  264.298 ( $\dagger_{100}$ ) E2
  - 6032.2 15,  $(49/2^-)$ , 11.98 ns  $\gamma_{6007}$  25.0 ( $\dagger_{100}$ ) D,E2
  - 7037.5 15,  $(51/2^-)$ , 1.26 ps  $\gamma_{6032}$  1005.33 ( $\dagger_{100}$ ) E1
  - 7219.5 15,  $(53/2^-)$ , 13.76 ps  $\gamma_{7038}$  182.079 ( $\dagger_{100}$ ) D
  - 8177.8 15,  $(55/2^-)$ , 4.515 ps  $\gamma_{7220}$  958.23 ( $\dagger_{100}$ ) M1
  - 8302.7 15,  $(57/2^-)$ , 20.812 ps  $\gamma_{6176}$  124.83 ( $\dagger_{142}$ ) D  $\gamma_{7220}$  1083.23 ( $\dagger_{10010}$ ) E2
  - 8680.3 15,  $(59/2^-)$ , 2.03 ps  $\gamma_{8303}$  377.73 ( $\dagger_{100}$ ) M1
  - 8891.7 15,  $(61/2^-)$ , 19.820 ps  $\gamma_{8680}$  211.53 ( $\dagger_{9910}$ ) D  $\gamma_{8303}$  589.03 ( $\dagger_{10010}$ ) E2
  - 9813.4 18(?)  $\gamma_{8680}$  11331(?)
  - 10029.8 16,  $(63/2^-)$ , <2 ps  $\gamma_{8892}$  1138.13 ( $\dagger_{100}$ ) (D)
  - 10131.3 18(?)  $\gamma_{8680}$  14511 ( $\dagger_{100}$ )
  - 10279.1 21(?)  $\gamma_{10131}$  1481 ( $\dagger_{100}$ )
  - 10320.7 18(?)  $\gamma_{10030}$  2911 ( $\dagger_{100}$ ) (D)
  - 10562.6 19(?)  $\gamma_{10321}$  2421  $\gamma_{10030}$  5331(?)  $\gamma_{8813}$  7491 (D)
  - 10749.9 22(?)  $\gamma_{10279}$  4711
  - 11143.5 21(?)  $\gamma_{10279}$  8641(?)  $\gamma_{10131}$  10121
  - 11840.7 22(?)  $\gamma_{11144}$  6971  $\gamma_{10760}$  10911
- A x, J=(47/2)
- A 522.4+x(?), J+2  $\gamma_{522.4}$ (?) ( $\dagger_{0.2115}$ )  $I^{(1)}=95.7, I^{(2)}=73.1, \hbar\omega=0.275$
  - A 1099.5+x, J+4  $\gamma_{522+x}$  577.1 ( $\dagger_{0.625}$ )  $I^{(1)}=93.6, I^{(2)}=78.4, \hbar\omega=0.301$
  - A 1727.6+x, J+6  $\gamma_{1100+x}$  628.1 ( $\dagger_{0.7810}$ )  $I^{(1)}=92.3, I^{(2)}=74.5, \hbar\omega=0.327$
  - A 2409.4+x, J+8  $\gamma_{1728+x}$  681.8 ( $\dagger_{0.817}$ )  $I^{(1)}=90.9, I^{(2)}=76.0, \hbar\omega=0.354$
  - A 3143.8+x, J+10  $\gamma_{2409+x}$  734.4 ( $\dagger_{0.9010}$ )  $I^{(1)}=89.9, I^{(2)}=77.8, \hbar\omega=0.380$
  - A 3929.6+x, J+12  $\gamma_{3144+x}$  785.8 ( $\dagger_{0.9110}$ )  $I^{(1)}=89.1, I^{(2)}=76.9, \hbar\omega=0.406$
  - A 4767.4+x, J+14  $\gamma_{3930+x}$  837.8 ( $\dagger_{1.0010}$ )  $I^{(1)}=88.3, I^{(2)}=78.0, \hbar\omega=0.432$
  - A 5656.5+x, J+16  $\gamma_{4767+x}$  889.1 ( $\dagger_{0.9310}$ )  $I^{(1)}=87.7, I^{(2)}=78.0, \hbar\omega=0.457$
  - A 6596.9+x, J+18  $\gamma_{5657+x}$  940.4 ( $\dagger_{1.0310}$ )  $I^{(1)}=87.2, I^{(2)}=78.4, \hbar\omega=0.483$
  - A 7588.3+x, J+20  $\gamma_{6597+x}$  991.4 ( $\dagger_{1.0715}$ )  $I^{(1)}=86.7, I^{(2)}=78.1, \hbar\omega=0.508$
  - A 8630.9+x, J+22  $\gamma_{7588+x}$  1042.6 ( $\dagger_{1.0210}$ )  $I^{(1)}=86.3, I^{(2)}=77.7, \hbar\omega=0.534$
  - A 9725.0+x, J+24  $\gamma_{8631+x}$  1094.1 ( $\dagger_{1.0010}$ )  $I^{(1)}=85.9, I^{(2)}=79.7, \hbar\omega=0.560$
  - A 10869.3+x, J+26  $\gamma_{9725+x}$  1144.3 ( $\dagger_{0.697}$ )  $I^{(1)}=85.6, I^{(2)}=79.4, \hbar\omega=0.585$
  - A 12064.0+x, J+28  $\gamma_{10869+x}$  1194.7 ( $\dagger_{0.5910}$ )  $I^{(1)}=85.4, I^{(2)}=80.2, \hbar\omega=0.610$
  - A 13308.6+x, J+30  $\gamma_{12064+x}$  1244.6 ( $\dagger_{0.5710}$ )  $I^{(1)}=85.2, I^{(2)}=82.1, \hbar\omega=0.634$
  - A 14601.9+x, J+32  $\gamma_{13308+x}$  1293.3 ( $\dagger_{0.487}$ )  $I^{(1)}=85.1, I^{(2)}=79.8, \hbar\omega=0.659$
  - A 15945.3+x, J+34  $\gamma_{14602+x}$  1343.4 ( $\dagger_{0.347}$ )  $I^{(1)}=84.9, I^{(2)}=80.0, \hbar\omega=0.684$
  - A 17338.7+x, J+36  $\gamma_{15945+x}$  1393.4 ( $\dagger_{0.387}$ )  $I^{(1)}=84.7, I^{(2)}=81.6, \hbar\omega=0.709$
  - A 18781.1+x, J+38  $\gamma_{17339+x}$  1442.4 ( $\dagger_{0.225}$ )  $I^{(1)}=84.6, I^{(2)}=83.5, \hbar\omega=0.733$
  - A 20271.4+x, J+40  $\gamma_{18781+x}$  1490.3 ( $\dagger_{0.095}$ )  $I^{(1)}=84.5$



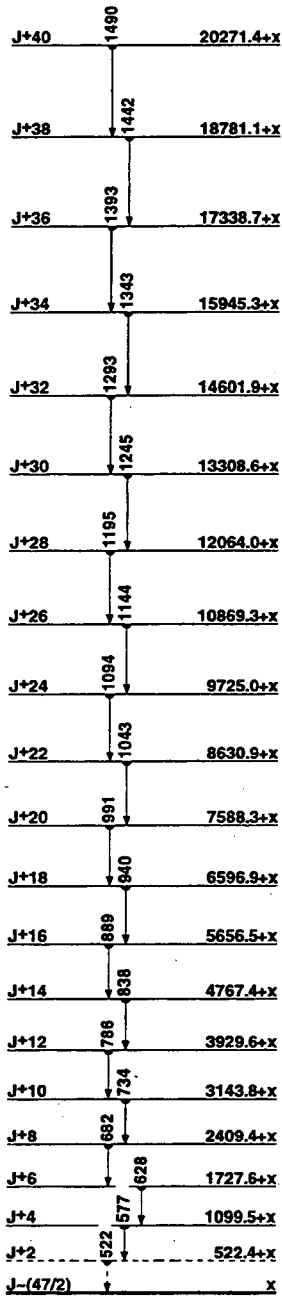

SD band

**151Dy**

**152Dy**

$\Delta: -70128.6$   $S_n: 9437.5$   $S_p: 5783.6$   $Q_{EC}: 600.40$   $Q_{\alpha}: 3727.4$

**Nuclear Bands**

- A Band Structure
- B SD-1 band
- C SD-2 band
- D SD-3 band
- E SD-4 band

**Levels and  $\gamma$ -ray branchings:**

- 0, 0<sup>+</sup>, 2.382 h, % $\alpha$ =0.1007, %EC=99.9007
- 613.82, 2<sup>+</sup>, 10.6 ps  $\gamma_0$  613.82 (†,100) E2
- 775.43, 0<sup>+</sup>  $\gamma_{614}$  161.63 (†,100) E2  $\gamma_0$  775.43 (†,0.01) E0
- 1198.73, 2<sup>+</sup>  $\gamma_{775}$  423.23 (†,29.14)  $\gamma_{614}$  584.82 (†,100.29) E0+M1+E2  $\gamma_0$  1198.05 (†,29.14)
- 1227.64, 3<sup>-</sup>  $\gamma_{614}$  613.83 (†,100)
- 1260.9, 4<sup>+</sup>  $\gamma_{614}$  647.2 (†,100) E2

- 1313.73, (2)<sup>+</sup>  $\gamma_{775}$  538.23 (†,50.20)  $\gamma_{614}$  700.12 (†,100.20) M1  $\gamma_0$  1313.73 (†,90.20)
- 1448.8, 2<sup>+</sup>  $\gamma_{1228}$  221.04 (†,=13)  $\gamma_{775}$  673.53 (†,63.25)  $\gamma_{614}$  835.53 (†,100.25) M1  $\gamma_0$  1448.75 (†,63.25)
- 1781.6, 5, 5<sup>-</sup>  $\gamma_{1261}$  520.71 (†,100.19) E1  $\gamma_{1228}$  554.22 (†,92.12) E2
- 1944.0, 4, 6<sup>+</sup>  $\gamma_{1782}$  162.72 (†,1.32)  $\gamma_{1261}$  683.31 (†,100.7) E2
- 1959.6, 6, (4)<sup>-</sup>  $\gamma_{1261}$  698.53 (†,100.20)  $\gamma_{1228}$  732.03 (†,40.12)
- 2152.0, 4, (2)<sup>-</sup>  $\gamma_{1449}$  703.04 (†,27.18)  $\gamma_{1314}$  838.02 (†,100.27)  $\gamma_{1228}$  924.54 (†,36.18)
- 2342.4, 7<sup>-</sup>  $\gamma_{1944}$  398.12 (†,100.8) E1  $\gamma_{1782}$  560.72 (†,78.8) E2
- 2411.7, (2)<sup>-</sup>  $\gamma_{1449}$  963.14 (†,29.15)  $\gamma_{1314}$  1098.03 (†,100.21)  $\gamma_{1199}$  1213.04 (†,29.15)  $\gamma_{614}$  1798.06 (†,43.21)
- 2435.8, (6)<sup>-</sup>  $\gamma_{1960}$  475.83 (†,75.37)  $\gamma_{1782}$  654.03 (†,100.38)
- 2437.1, 8<sup>+</sup>  $\gamma_{1944}$  492.91 (†,100) E2
- 2702.8, 8<sup>+</sup>  $\gamma_{2437}$  265.53 (†,4.6.18)  $\gamma_{2342}$  360.43 (†,3.7.18)  $\gamma_{1944}$  758.61 (†,100.7) E2
- 2788.2, (8)<sup>-</sup>  $\gamma_{2437}$  351.03 (†,44.10) E1  $\gamma_{2436}$  352.52 (†,100.8) E2  $\gamma_{2342}$  446.32 (†,16.5)
- 2905.7, 9<sup>-</sup>  $\gamma_{2788}$  117.22 (†,24.6) (M1)  $\gamma_{2703}$  203.1 (†,15.6) D  $\gamma_{2437}$  468.53 (†,26.9)  $\gamma_{2342}$  563.52 (†,100.12) E2
- 3084.9, 10<sup>+</sup>  $\gamma_{2703}$  381.63 (†,4)  $\gamma_{2437}$  647.21 (†,100) E2
- 3108.6, (10)<sup>-</sup>  $\gamma_{2906}$  203.1 (†,13.5)  $\gamma_{2788}$  320.52 (†,100.13) E2
- 3160.0, 11<sup>-</sup>, 3.9 ns  $\gamma_{2906}$  254.1 (†,100) E2
- 3172.5, 10<sup>-</sup>  $\gamma_{2906}$  266.83 (†,100) M1
- 3183.7, 10<sup>+</sup>  $\gamma_{2906}$  278.03 (†,67.20)  $\gamma_{2437}$  746.62 (†,100.20) E2
- 3395.6, 10<sup>+</sup>  $\gamma_{2703}$  692.8 (†,100) E2
- 3512.5, (8,9)<sup>+</sup>  $\gamma_{2906}$  607.03  $\gamma_{2703}$  809.82 (†,100) M1
- 3820.0, 12<sup>+</sup>  $\gamma_{3184}$  636.72 (†,56.4) E2  $\gamma_{3085}$  735.92 (†,100.9)  $\gamma_{3160}$  660.0 E2
- 3878.6, (9,10)<sup>+</sup>  $\gamma_{3511}$  366.22 (†,100.7) M1  $\gamma_{3184}$  694.73 (†,27.10)  $\gamma_{3109}$  770.03 (†,30.10)  $\gamma_{2703}$  1175.93 (†,63.17)
- 3970, 13<sup>-</sup>  $\gamma_{3160}$  808.8 (†,100) E2
- 3993, 13<sup>-</sup>  $\gamma_{3160}$  831.3 (†,100)
- 4030, 12<sup>+</sup>  $\gamma_{3395}$  633.9 (†,100) Q
- 4045.6, 10<sup>+</sup>  $\gamma_{3879}$  167.33 (†,21.7)  $\gamma_{3820}$  225.52 (†,100.7) E2  $\gamma_{3109}$  937.03 (†,28.14)  $\gamma_{2906}$  1139.92 (†,90.17)
- 4135  $\gamma_{3173}$  962.2 (†,100)
- 4431, 14<sup>+</sup>  $\gamma_{3970}$  461.0  $\gamma_{3820}$  610.1
- 4652, 14<sup>+</sup>  $\gamma_{4030}$  622.3 (†,100) Q
- 4676, (15)<sup>-</sup>  $\gamma_{3993}$  683 (†,100)
- 4735, 15<sup>-</sup>  $\gamma_{3993}$  742.4  $\gamma_{3970}$  765.3
- 4805  $\gamma_{4431}$  374.4  $\gamma_{3820}$  984.4
- 5035, 15<sup>+</sup>  $\gamma_{4805}$  229.9  $\gamma_{4735}$  300.3  $\gamma_{4431}$  604.5 M1
- 5089, 17<sup>+</sup>, 60.4 ns  $\gamma_{5035}$  53.4 (†,100) E2
- 5199, 16<sup>+</sup>  $\gamma_{4652}$  546.5 Q
- 5203, (17)<sup>-</sup>  $\gamma_{4676}$  527 (†,100) Q
- 5342, 18<sup>+</sup>  $\gamma_{5089}$  253.5 (†,100) D
- A 5765, 18<sup>+</sup>  $\gamma_{5199}$  565.8 (†,100) Q
- 5867, 19<sup>-</sup>  $\gamma_{5342}$  525.3 (†,100) E1
- 6130, 21<sup>-</sup>, 9.57 ns,  $\mu=+11.55$  126  $\gamma_{5867}$  262.4 (†,100) E2
- A 6374, 20<sup>+</sup>  $\gamma_{5765}$  609 (†,100) E2
- A 7055, 22<sup>+</sup>  $\gamma_{6374}$  681 (†,100) E2
- 7120, 23<sup>-</sup>  $\gamma_{6130}$  990.7 (†,100) E2
- 7662, 25<sup>-</sup>  $\gamma_{7120}$  541.3 (†,100) E2
- A 7809, 24<sup>+</sup>  $\gamma_{7055}$  754 (†,100) E2
- 7882, 27<sup>-</sup>, 1.62 ns  $\gamma_{7662}$  220.6 (†,100) E2
- A 8634, 26<sup>+</sup>  $\gamma_{7809}$  825 (†,100) E2
- 8849, 28<sup>+</sup>, 24.8 ps  $\gamma_{7882}$  967.0 (†,100) E1
- 8997, 29<sup>+</sup>, 35.10 ps  $\gamma_{8849}$  147.6 (†,100) M1
- 9400, 30<sup>+</sup>, 7.1 ps  $\gamma_{8997}$  402.5 (†,100) M1
- 9528, 28<sup>+</sup>  $\gamma_{8634}$  894 (†,100) E2
- 10013  $\gamma_{9400}$  613 (†,100)  $\gamma_{8997}$  1016 (†,50)
- 10110, 31<sup>+</sup>  $\gamma_{10013}$  97 (†,100)  $\gamma_{9400}$  711.5 (†,42) M1  $\gamma_{8997}$  1114.0 (†,70) E2
- 10258  $\gamma_{9400}$  858 (†,100)
- A 10490, 30<sup>+</sup>  $\gamma_{9528}$  962 (†,100) E2
- 10541, 32<sup>+</sup>, 6.26 ps  $\gamma_{10110}$  431.2 (†,100) M1  $\gamma_{9400}$  1142 (†,32)
- 10674  $\gamma_{10541}$  133 (†,100)
- 10795, 33<sup>+</sup>, 15.5 ps  $\gamma_{10541}$  254.2 D  $\gamma_{10110}$  684.9 E2

152 Dy (Continued)  
66 Dy

- 11209  $\gamma_{10541}$  668 ( $\dagger_{\gamma,100}$ )  $\gamma_{10258}$  952 ( $\dagger_{\gamma,44}$ )
- A 11518, 32<sup>+</sup>  $\gamma_{10490}$  1028 ( $\dagger_{\gamma,100}$ ) E2
- 11575, 34<sup>-</sup>  $\gamma_{10795}$  779.6 ( $\dagger_{\gamma,100}$ ) E1  $\gamma_{10574}$  901 ( $\dagger_{\gamma,15}$ )
- 11602  $\gamma_{10541}$  1061 ( $\dagger_{\gamma,100}$ )
- 11859  $\gamma_{11502}$  257 ( $\dagger_{\gamma,80}$ )  $\gamma_{10795}$  1064 ( $\dagger_{\gamma,100}$ )
- 11964, 35<sup>-</sup>, 1.24 ps  $\gamma_{11575}$  388.6 ( $\dagger_{\gamma,100}$ ) M1
- 12179  $\gamma_{11859}$  320 ( $\dagger_{\gamma,100}$ )  $\gamma_{11209}$  970 ( $\dagger_{\gamma,100}$ )
- 12326, 36<sup>-</sup>  $\gamma_{11964}$  362 ( $\dagger_{\gamma,100}$ ) D
- 12427  $\gamma_{12179}$  248 ( $\dagger_{\gamma,75}$ )  $\gamma_{11209}$  1219 ( $\dagger_{\gamma,100}$ )
- A 12611, 34<sup>+</sup>  $\gamma_{11518}$  1093 ( $\dagger_{\gamma,100}$ ) E2
- 12715  $\gamma_{12427}$  288 ( $\dagger_{\gamma,21}$ )  $\gamma_{12179}$  538 ( $\dagger_{\gamma,100}$ )  $\gamma_{11964}$  755 ( $\dagger_{\gamma,79}$ )
- 13494  $\gamma_{12326}$  1168 ( $\dagger_{\gamma,100}$ )
- 13515  $\gamma_{12326}$  1189 ( $\dagger_{\gamma,100}$ )
- 13688  $\gamma_{12326}$  1362 ( $\dagger_{\gamma,100}$ )
- 13720  $\gamma_{12715}$  1005 ( $\dagger_{\gamma,100}$ )

- A 13771, 36<sup>+</sup>  $\gamma_{12611}$  1160 ( $\dagger_{\gamma,100}$ ) E2
- 14740  $\gamma_{13720}$  1020 ( $\dagger_{\gamma,100}$ )
- A 14993, 38<sup>+</sup>  $\gamma_{13771}$  1222 ( $\dagger_{\gamma,100}$ ) E2
- 15632  $\gamma_{13720}$  1912 ( $\dagger_{\gamma,100}$ )
- 16275, 40<sup>+</sup>  $\gamma_{14993}$  1282 ( $\dagger_{\gamma,100}$ ) E2
- B x, (22)
- B 602.3+x, (24)  $\gamma_{602.3}$  ( $\dagger_{\gamma,0.173}$ ) E2  $I^{(1)}=78.0, I^{(2)}=89.1, \eta\omega=0.312$
- B 1249.5+x, (26)  $\gamma_{602+x}$  647.2 ( $\dagger_{\gamma,0.517}$ ) E2  $I^{(1)}=78.8, I^{(2)}=87.0, \eta\omega=0.335$
- B 1942.7+x, (28), 30 fs  $\gamma_{1250+x}$  693.22 ( $\dagger_{\gamma,1.0110}$ ) E2  $I^{(1)}=79.3, I^{(2)}=90.3, \eta\omega=0.358$
- B 2680.2+x, (30), 22 fs  $\gamma_{1943+x}$  737.52 ( $\dagger_{\gamma,0.9311}$ ) E2  $I^{(1)}=80.0, I^{(2)}=87.0, \eta\omega=0.380$
- B 3463.7+x, (32), 16 fs  $\gamma_{2680+x}$  783.53 ( $\dagger_{\gamma,0.9611}$ ) E2  $I^{(1)}=80.4, I^{(2)}=87.5, \eta\omega=0.403$
- B 4292.9+x, (34), 12 fs  $\gamma_{3464+x}$  829.22 ( $\dagger_{\gamma,1.018}$ ) E2  $I^{(1)}=80.8, I^{(2)}=85.3, \eta\omega=0.426$
- B 5169.0+x, (36), 9.3 fs  $\gamma_{4293+x}$  876.12 ( $\dagger_{\gamma,1.0811}$ ) E2  $I^{(1)}=81.0, I^{(2)}=85.1, \eta\omega=0.450$
- B 6092.1+x, (38), 7.1 fs  $\gamma_{5169+x}$  923.12 ( $\dagger_{\gamma,1.0410}$ ) E2  $I^{(1)}=81.2, I^{(2)}=85.3, \eta\omega=0.473$
- B 7062.1+x, (40), 5.5 fs  $\gamma_{6092+x}$  970.02 ( $\dagger_{\gamma,1.0011}$ ) E2  $I^{(1)}=81.4, I^{(2)}=85.1, \eta\omega=0.497$
- B 8079.1+x, (42), 4.4 fs  $\gamma_{7062+x}$  1017.02 ( $\dagger_{\gamma,0.9812}$ ) E2  $I^{(1)}=81.6, I^{(2)}=83.7, \eta\omega=0.520$
- B 9143.9+x, (44), 3.5 fs  $\gamma_{8079+x}$  1064.82 ( $\dagger_{\gamma,0.988}$ ) E2  $I^{(1)}=81.7, I^{(2)}=83.5, \eta\omega=0.544$
- B 10256.6+x, (46), 2.8 fs  $\gamma_{9144+x}$  1112.73 ( $\dagger_{\gamma,0.9010}$ ) E2  $I^{(1)}=81.8, I^{(2)}=83.2, \eta\omega=0.568$
- B 11417.4+x, (48), 2.3 fs  $\gamma_{10257+x}$  1160.83 ( $\dagger_{\gamma,0.876}$ ) E2  $I^{(1)}=81.8, I^{(2)}=83.5, \eta\omega=0.592$
- B 12626.1+x, (50), 1.8 fs  $\gamma_{11417+x}$  1208.73 ( $\dagger_{\gamma,0.8912}$ ) E2  $I^{(1)}=81.9, I^{(2)}=83.5, \eta\omega=0.616$
- B 13882.7+x, (52), 1.5 fs  $\gamma_{12626+x}$  1256.63 ( $\dagger_{\gamma,0.7510}$ ) E2  $I^{(1)}=82.0, I^{(2)}=83.2, \eta\omega=0.640$
- B 15187.4+x, (54), 1.2 fs  $\gamma_{13883+x}$  1304.73 ( $\dagger_{\gamma,0.627}$ ) E2  $I^{(1)}=82.0, I^{(2)}=82.8, \eta\omega=0.664$
- B 16540.4+x, (56), 1.0 fs  $\gamma_{15187+x}$  1353.03 ( $\dagger_{\gamma,0.498}$ ) E2  $I^{(1)}=82.0, I^{(2)}=82.1, \eta\omega=0.689$
- B 17942.1+x, (58), 0.90 fs  $\gamma_{16540+x}$  1401.74 ( $\dagger_{\gamma,0.307}$ ) E2  $I^{(1)}=82.0, I^{(2)}=83.9, \eta\omega=0.713$
- B 19391.5+x, (60), 0.69 fs  $\gamma_{17942+x}$  1449.46 ( $\dagger_{\gamma,0.166}$ ) E2  $I^{(1)}=82.1$
- C y, J
- C 855.5+y, J+2  $\gamma_{855.5}$   $I^{(2)}=100.8, \eta\omega=0.438$
- C 1750.7+y, J+4  $\gamma_{856+y}$  895.2  $I^{(2)}=107.2, \eta\omega=0.457$
- C 2683.2+y, J+6  $\gamma_{1751+y}$  932.5  $I^{(2)}=106.7, \eta\omega=0.476$
- C 3653.2+y, J+8  $\gamma_{2683+y}$  970  $I^{(2)}=102.0, \eta\omega=0.495$
- C 4662.4+y, J+10  $\gamma_{3653+y}$  1009.2  $I^{(2)}=100.0, \eta\omega=0.515$
- C 5711.6+y, J+12  $\gamma_{4662+y}$  1049.2  $I^{(2)}=90.7, \eta\omega=0.536$
- C 6804.9+y, J+14  $\gamma_{5712+y}$  1093.3  $I^{(2)}=90.5, \eta\omega=0.558$
- C 7942.4+y, J+16  $\gamma_{6805+y}$  1137.5  $I^{(2)}=87.3, \eta\omega=0.580$
- C 9125.7+y, J+18  $\gamma_{7942+y}$  1183.3  $I^{(2)}=84.9, \eta\omega=0.603$
- C 10356.1+y, J+20  $\gamma_{9126+y}$  1230.4  $I^{(2)}=84.6, \eta\omega=0.627$
- C 11633.8+y, J+22  $\gamma_{10356+y}$  1277.7  $I^{(2)}=81.0, \eta\omega=0.651$
- C 12960.9+y, J+24  $\gamma_{11634+y}$  1327.1  $I^{(2)}=82.6, \eta\omega=0.676$
- C 14336.4+y, J+26  $\gamma_{12961+y}$  1375.5  $I^{(2)}=77.4, \eta\omega=0.701$
- C 15763.6+y, J+28  $\gamma_{14336+y}$  1427.2  $I^{(2)}=73.0, \eta\omega=0.727$
- C 17245.6+y (?), J+30  $\gamma_{15764+y}$  1482 (?)

D z  
E u

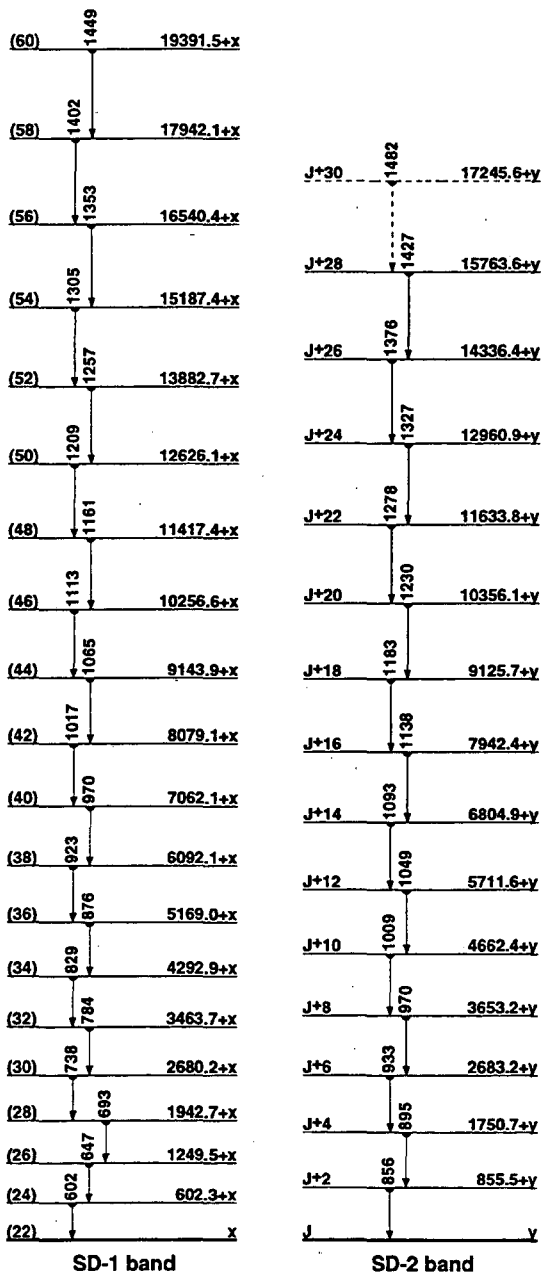

152 Dy  
66 Dy

153  
66 Dy

$\Delta$ : -691515  $S_n$ : 70956  $S_p$ : 571040  $Q_{EC}$ : 2170.619  $Q_\alpha$ : 35594

Nuclear Bands

- A  $h_{11/2}$
- B  $h_{9/2}$
- C Band Structure
- D  $i_{13/2}$
- E SD-1 band
- F SD-2 band
- G SD-3 band

Levels and  $\gamma$ -ray branchings:

0, 7/2<sup>(-)</sup>, 6.4 h,  $\mu = -0.7826$ ,  $Q = -0.025$ ,  $\%0 = 0.009414$ ,  
 $\%EC + \% \beta^+ = 99.990614$

108.71, (3/2<sup>-</sup>), 1.3510 ns  $\gamma_{108.72}$  (t<sub>1/2</sub> 100) E2

270.61, (3/2<sup>-</sup>, 5/2<sup>-</sup>, 7/2<sup>-</sup>), <0.25 ns  $\gamma_{108}$  161.52 (t<sub>1/2</sub> 100.5) M1+E2  $\gamma_{270.62}$  (t<sub>1/2</sub> 100.5) E2

- B 295.81, (9/2<sup>-</sup>)  $\gamma_{295.81}$  (t<sub>1/2</sub> 100) M1
- 365.92  $\gamma_{271}$  95.23 (t<sub>1/2</sub> 3.3)  $\gamma_{365.92}$  (t<sub>1/2</sub> 100 17)
- 500.9, (-), <0.2 ns  $\gamma_{271}$  230.21 (t<sub>1/2</sub> 100.7) M1  $\gamma_{108}$  391.72 (t<sub>1/2</sub> 22.5)
- 565.8  $\gamma_{108}$  456.82 (t<sub>1/2</sub> 100.50)  $\gamma_{565.52}$  (t<sub>1/2</sub> 60.20)
- 577.03  $\gamma_{108}$  468.22 (t<sub>1/2</sub> 88.13)  $\gamma_{577.03}$  (t<sub>1/2</sub> 100 19)
- 637.02, 11/2<sup>(-)</sup>  $\gamma_{296}$  341.0  $\gamma_{637.02}$  E2
- 688.52  $\gamma_{296}$  392.54 (t<sub>1/2</sub> 9.4)  $\gamma_{108}$  579.73 (t<sub>1/2</sub> 22.9)  $\gamma_{688.52}$  (t<sub>1/2</sub> 100.7)
- D 712.4, (13/2<sup>-</sup>)  $\gamma_{637}$  75.6 (t<sub>1/2</sub> 100) E1
- 830.04  $\gamma_{712}$  117.33 (t<sub>1/2</sub> 40.20)  $\gamma_{688}$  141.83 (t<sub>1/2</sub> 100.30)  $\gamma_{637}$  192.82 (t<sub>1/2</sub> 60.20)
- $\gamma_{577}$  253.82 (t<sub>1/2</sub> 50.10)  $\gamma_{108}$  721.05 (t<sub>1/2</sub> 20.10)
- B 837.1, (13/2<sup>-</sup>)  $\gamma_{296}$  541.24 (t<sub>1/2</sub> 100) (E2)
- 1040.6, (11/2<sup>-</sup>)  $\gamma_{712}$  328.1  $\gamma_{637}$  403.7
- A 1067.8, (11/2<sup>-</sup>)  $\gamma_{296}$  771.910 (t<sub>1/2</sub> 100)
- 1092.05  $\gamma_{688}$  404.13 (t<sub>1/2</sub> 50.25)  $\gamma_{108}$  1091.85 (t<sub>1/2</sub> 100.25)
- D 1160.2, (17/2<sup>-</sup>), 11.612 ps  $\gamma_{712}$  447.8 (t<sub>1/2</sub> 100) E2
- 1189.76  $\gamma_{637}$  552.05 (t<sub>1/2</sub> 100.50)  $\gamma_{296}$  893.95 (t<sub>1/2</sub> 75.25)  $\gamma_{1189.98}$  (t<sub>1/2</sub> 100.50)
- 1272.8, (13/2, 15/2<sup>-</sup>)  $\gamma_{712}$  560.43 (t<sub>1/2</sub> 48.9)  $\gamma_{637}$  636.0 (t<sub>1/2</sub> 100.24)
- 1276.96, (9/2<sup>-</sup>)  $\gamma_{296}$  910.44 (t<sub>1/2</sub> 28.4)  $\gamma_{108}$  1167.65 (t<sub>1/2</sub> 32.4)  $\gamma_{1276.54}$  (t<sub>1/2</sub> 100.8)
- 1304.1  $\gamma_{637}$  467.12 (t<sub>1/2</sub> 36)  $\gamma_{712}$  591.62 (t<sub>1/2</sub> 100.27)
- A 1321.2, (13/2<sup>-</sup>)  $\gamma_{1088}$  253.1 (t<sub>1/2</sub> 100)
- 1381.26  $\gamma_{688}$  693.05 (t<sub>1/2</sub> 8.3)  $\gamma_{566}$  815.55 (t<sub>1/2</sub> 16.5)  $\gamma_{296}$  1085.84 (t<sub>1/2</sub> 100.8)
- $\gamma_{1381.06}$  (t<sub>1/2</sub> 50.8)
- B 1454.6, (17/2<sup>-</sup>)  $\gamma_{637}$  617.55 (t<sub>1/2</sub> 100) (E2)
- 1501.45  $\gamma_{688}$  812.15 (t<sub>1/2</sub> 17.6)  $\gamma_{637}$  864.05 (t<sub>1/2</sub> 33.11)  $\gamma_{577}$  924.04 (t<sub>1/2</sub> 100 17)
- 1521.6
- 1581.07  $\gamma_{712}$  868.65 (t<sub>1/2</sub> 29.7)  $\gamma_{688}$  893.95 (t<sub>1/2</sub> 21.7)  $\gamma_{577}$  1004.14 (t<sub>1/2</sub> 29.14)
- $\gamma_{566}$  1015.44 (t<sub>1/2</sub> 100.14)  $\gamma_{296}$  1284.88 (t<sub>1/2</sub> 7.7)
- A 1584.2, (15/2<sup>-</sup>)  $\gamma_{1321}$  262.4  $\gamma_{1068}$  515
- C 1601, (17/2<sup>-</sup>)  $\gamma_{1273}$  328.1  $\gamma_{1160}$  440.7  $\gamma_{1041}$  560.4
- D 1648.4, (21/2<sup>-</sup>), 7.16 ps  $\gamma_{1160}$  488.2 (t<sub>1/2</sub> 100) E2
- 1753.6
- 1822.6  $\gamma_{1455}$  366.7 (t<sub>1/2</sub> 64.14) (E1)  $\gamma_{1304}$  518.5 (t<sub>1/2</sub> 100.21)  $\gamma_{1160}$  662.45 (t<sub>1/2</sub> 36.7)
- A 1861.4, (17/2<sup>-</sup>)  $\gamma_{1584}$  277.55  $\gamma_{1321}$  540.1
- 1892 (?)  $\gamma_{1160}$  731.810 (t<sub>1/2</sub> 100)
- 1953.0
- C 2042, (21/2<sup>-</sup>)  $\gamma_{1648}$  393.7  $\gamma_{1601}$  441.3
- A 2151.6, (19/2<sup>-</sup>)  $\gamma_{1861}$  290.14  $\gamma_{1584}$  568.0
- D 2180.7, (25/2<sup>-</sup>), 2.14 ps  $\gamma_{1648}$  532.31 (t<sub>1/2</sub> 100) E2
- 2194.8
- 2231 (?)  $\gamma_{1455}$  776 (t<sub>1/2</sub> 100)
- 2285.2  $\gamma_{1892}$  393.25 (t<sub>1/2</sub> 33.11)  $\gamma_{1823}$  462.44 (t<sub>1/2</sub> 100 11) E2
- A 2453.3, (21/2<sup>-</sup>)  $\gamma_{2152}$  301.75  $\gamma_{1861}$  592
- C 2523.2, (25/2<sup>-</sup>)  $\gamma_{2181}$  342.1  $\gamma_{2042}$  480.8
- 2686.4  $\gamma_{2285}$  401.23 (t<sub>1/2</sub> 100) (E2)
- 2746.4
- D 2762.2, (29/2<sup>-</sup>)  $\gamma_{2181}$  581.6 (t<sub>1/2</sub> 100) E2
- A 2763.0, (23/2<sup>-</sup>)  $\gamma_{2453}$  309.7  $\gamma_{2152}$  612
- C 3075.0, (29/2<sup>-</sup>)  $\gamma_{2623}$  551.8 (t<sub>1/2</sub> 100)
- A 3079.5, (25/2<sup>-</sup>)  $\gamma_{2763}$  316.5  $\gamma_{2453}$  626
- 3170  $\gamma_{2623}$  646.6 (t<sub>1/2</sub> 100)
- D 3389.1, (33/2<sup>-</sup>)  $\gamma_{2762}$  627.2 (t<sub>1/2</sub> 100) E2
- 3415.6
- C 3744, (33/2<sup>-</sup>)  $\gamma_{3075}$  668.9 (t<sub>1/2</sub> 100)
- 3829  $\gamma_{3389}$  439.5  $\gamma_{3170}$  659.6
- D 4063.1, (37/2<sup>-</sup>)  $\gamma_{3389}$  674.04 (t<sub>1/2</sub> 100) (E2)

- 4134 (?)
- C 4461, (37/2<sup>-</sup>)  $\gamma_{3744}$  717.6 (t<sub>1/2</sub> 100)
- 4487  $\gamma_{4063}$  423.4  $\gamma_{3829}$  657.9
- D 4783, (41/2<sup>-</sup>)  $\gamma_{4063}$  719.0 (t<sub>1/2</sub> 100)
- 5141  $\gamma_{4783}$  358.4  $\gamma_{4487}$  654.0  $\gamma_{4461}$  679.8
- 5207  $\gamma_{4487}$  720.3 (t<sub>1/2</sub> 100)
- C 5245, (41/2<sup>-</sup>)  $\gamma_{4487}$  757.6  $\gamma_{4461}$  783.4
- 5378  $\gamma_{5245}$  133.3 M1  $\gamma_{5207}$  170.3  $\gamma_{5141}$  236.6
- 5591, 2.3 ns  $\gamma_{5376}$  213.9 (t<sub>1/2</sub> 100)
- 5761  $\gamma_{5591}$  169.3 (t<sub>1/2</sub> 100)
- 6228  $\gamma_{5591}$  636.3 (t<sub>1/2</sub> 100)
- 6718  $\gamma_{5761}$  957.7 (t<sub>1/2</sub> 100)
- 7000  $\gamma_{6718}$  281.5 (t<sub>1/2</sub> 100)
- 7065  $\gamma_{6228}$  837.4 (t<sub>1/2</sub> 100)
- 7934  $\gamma_{7065}$  869.3 (t<sub>1/2</sub> 100)
- 8030  $\gamma_{7000}$  1029.9 (t<sub>1/2</sub> 100)
- 8452  $\gamma_{7934}$  518.0 (t<sub>1/2</sub> 100)
- 8638  $\gamma_{8030}$  608.1 (t<sub>1/2</sub> 100)
- E x, J=(71/2)
- E 809.6+x, J+2  $\gamma_{809.6}$  (t<sub>1/2</sub> 1.069) I<sup>(1)</sup>=91.4, I<sup>(2)</sup>=87.0,  $\eta = 0.416$
- E 1665.2+x, J+4  $\gamma_{810+x}$  855.6 (t<sub>1/2</sub> 1.09 12) I<sup>(1)</sup>=91.2, I<sup>(2)</sup>=89.3,  $\eta = 0.439$
- E 2565.6+x, J+6  $\gamma_{1665+x}$  900.4 (t<sub>1/2</sub> 0.79 8) I<sup>(1)</sup>=91.1, I<sup>(2)</sup>=89.7,  $\eta = 0.461$
- E 3510.6+x, J+8  $\gamma_{2566+x}$  945.0 (t<sub>1/2</sub> 1.00 6) I<sup>(1)</sup>=91.0, I<sup>(2)</sup>=87.5,  $\eta = 0.484$
- E 4501.3+x, J+10  $\gamma_{3511+x}$  990.7 (t<sub>1/2</sub> 0.88 12) I<sup>(1)</sup>=90.8, I<sup>(2)</sup>=88.1,  $\eta = 0.507$
- E 5537.4+x, J+12  $\gamma_{4501+x}$  1036.1 (t<sub>1/2</sub> 1.09 6) I<sup>(1)</sup>=90.7, I<sup>(2)</sup>=85.8,  $\eta = 0.530$
- E 6620.1+x, J+14  $\gamma_{5537+x}$  1082.7 (t<sub>1/2</sub> 1.18 12) I<sup>(1)</sup>=90.5, I<sup>(2)</sup>=87.9,  $\eta = 0.553$
- E 7748.3+x, J+16  $\gamma_{6620+x}$  1128.2 (t<sub>1/2</sub> 1.03 12) I<sup>(1)</sup>=90.4, I<sup>(2)</sup>=87.1,  $\eta = 0.576$
- E 8922.4+x, J+18  $\gamma_{7748+x}$  1174.1 (t<sub>1/2</sub> 0.94 8) I<sup>(1)</sup>=90.3, I<sup>(2)</sup>=84.2,  $\eta = 0.599$
- E 10144.0+x, J+20  $\gamma_{8922+x}$  1221.6 (t<sub>1/2</sub> 0.88 6) I<sup>(1)</sup>=90.0, I<sup>(2)</sup>=87.0,  $\eta = 0.622$
- E 11411.6+x, J+22  $\gamma_{10144+x}$  1267.6 (t<sub>1/2</sub> 0.79 21) I<sup>(1)</sup>=89.9, I<sup>(2)</sup>=87.0,  $\eta = 0.645$
- E 12725.2+x, J+24  $\gamma_{11412+x}$  1313.6 (t<sub>1/2</sub> 0.79 9) I<sup>(1)</sup>=89.8, I<sup>(2)</sup>=84.9,  $\eta = 0.669$
- E 14085.9+x, J+26  $\gamma_{12725+x}$  1360.7 (t<sub>1/2</sub> 0.39 11) I<sup>(1)</sup>=89.7, I<sup>(2)</sup>=87.9,  $\eta = 0.692$
- E 15492.1+x, J+28  $\gamma_{14086+x}$  1406.2 (t<sub>1/2</sub> 0.58 15) I<sup>(1)</sup>=89.6
- F y, J=(71/2)
- F 816.5+y, J+2  $\gamma_{816.5}$  I<sup>(1)</sup>=90.6, I<sup>(2)</sup>=87.7,  $\eta = 0.420$
- F 1678.6+y, J+4  $\gamma_{817+y}$  862.1 (t<sub>1/2</sub> 0.76 18) I<sup>(1)</sup>=90.5, I<sup>(2)</sup>=83.7,  $\eta = 0.443$
- F 2588.5+y, J+6  $\gamma_{1678+y}$  909.9 (t<sub>1/2</sub> 0.79 21) I<sup>(1)</sup>=90.1, I<sup>(2)</sup>=81.8,  $\eta = 0.467$
- F 3547.3+y, J+8  $\gamma_{2589+y}$  958.8 I<sup>(1)</sup>=89.7, I<sup>(2)</sup>=84.6,  $\eta = 0.491$
- F 4553.4+y, J+10  $\gamma_{3547+y}$  1006.1 I<sup>(1)</sup>=89.5, I<sup>(2)</sup>=86.8,  $\eta = 0.515$
- F 5605.6+y, J+12  $\gamma_{4553+y}$  1052.2 (t<sub>1/2</sub> 0.61 14) I<sup>(1)</sup>=89.3, I<sup>(2)</sup>=83.7,  $\eta = 0.538$
- F 6705.6+y, J+14  $\gamma_{5606+y}$  1100.0 (t<sub>1/2</sub> 0.61 14) I<sup>(1)</sup>=89.1, I<sup>(2)</sup>=82.3,  $\eta = 0.562$
- F 7854.2+y, J+16  $\gamma_{6706+y}$  1148.6 (t<sub>1/2</sub> 0.85 18) I<sup>(1)</sup>=88.8, I<sup>(2)</sup>=84.0,  $\eta = 0.586$
- F 9050.4+y, J+18  $\gamma_{7854+y}$  1196.2 (t<sub>1/2</sub> 0.82 6) I<sup>(1)</sup>=88.6, I<sup>(2)</sup>=83.5,  $\eta = 0.610$
- F 10294.5+y, J+20  $\gamma_{9050+y}$  1244.1 (t<sub>1/2</sub> 0.94 12) I<sup>(1)</sup>=88.4, I<sup>(2)</sup>=85.3,  $\eta = 0.634$
- F 11585.5+y, J+22  $\gamma_{10296+y}$  1291.0 (t<sub>1/2</sub> 0.94 12) I<sup>(1)</sup>=88.3, I<sup>(2)</sup>=80.5,  $\eta = 0.658$
- F 12926.2+y, J+24  $\gamma_{11586+y}$  1340.7 (t<sub>1/2</sub> 0.39 12) I<sup>(1)</sup>=88.0, I<sup>(2)</sup>=84.7,  $\eta = 0.682$
- F 14314.1+y, J+26  $\gamma_{12926+y}$  1387.9 (t<sub>1/2</sub> 0.55 9) I<sup>(1)</sup>=87.9
- G z, J=(77/2)
- G 894.6+z, J+2  $\gamma_{894.6}$  (t<sub>1/2</sub> 0.36 9) I<sup>(1)</sup>=89.4, I<sup>(2)</sup>=97.3,  $\eta = 0.458$
- G 1830.3+z, J+4  $\gamma_{895+z}$  935.7 (t<sub>1/2</sub> 0.45 14) I<sup>(1)</sup>=89.8, I<sup>(2)</sup>=90.1,  $\eta = 0.479$
- G 2810.4+z, J+6  $\gamma_{1830+z}$  980.1 (t<sub>1/2</sub> 0.45 6) I<sup>(1)</sup>=89.8, I<sup>(2)</sup>=82.3,  $\eta = 0.502$
- G 3839.1+z, J+8  $\gamma_{2810+z}$  1028.7 (t<sub>1/2</sub> 0.45 9) I<sup>(1)</sup>=89.4, I<sup>(2)</sup>=86.2,  $\eta = 0.526$
- G 4914.2+z, J+10  $\gamma_{3839+z}$  1075.1 (t<sub>1/2</sub> 0.55 9) I<sup>(1)</sup>=89.3, I<sup>(2)</sup>=82.3,  $\eta = 0.550$
- G 6037.9+z, J+12  $\gamma_{4914+z}$  1123.7 (t<sub>1/2</sub> 0.55 9) I<sup>(1)</sup>=89.0, I<sup>(2)</sup>=85.5,  $\eta = 0.574$
- G 7208.4+z, J+14  $\gamma_{6038+z}$  1170.5 (t<sub>1/2</sub> 0.39 9) I<sup>(1)</sup>=88.9, I<sup>(2)</sup>=81.0,  $\eta = 0.598$
- G 8428.3+z, J+16  $\gamma_{7208+z}$  1219.9 (t<sub>1/2</sub> 0.24 17) I<sup>(1)</sup>=88.5, I<sup>(2)</sup>=86.2,  $\eta = 0.622$
- G 9694.6+z, J+18  $\gamma_{8428+z}$  1266.3 (t<sub>1/2</sub> 0.21 9) I<sup>(1)</sup>=88.4, I<sup>(2)</sup>=82.6,  $\eta = 0.645$
- G 11009.3+z, J+20  $\gamma_{9695+z}$  1314.7 (t<sub>1/2</sub> 0.64 17) I<sup>(1)</sup>=88.2, I<sup>(2)</sup>=84.0,  $\eta = 0.669$
- G 12371.6+z, J+22  $\gamma_{11009+z}$  1362.3 (t<sub>1/2</sub> 0.27 6) I<sup>(1)</sup>=88.1, I<sup>(2)</sup>=83.9,  $\eta = 0.693$
- G 13781.6+z, J+24  $\gamma_{12372+z}$  1410.0 (t<sub>1/2</sub> 0.36 9) I<sup>(1)</sup>=87.9

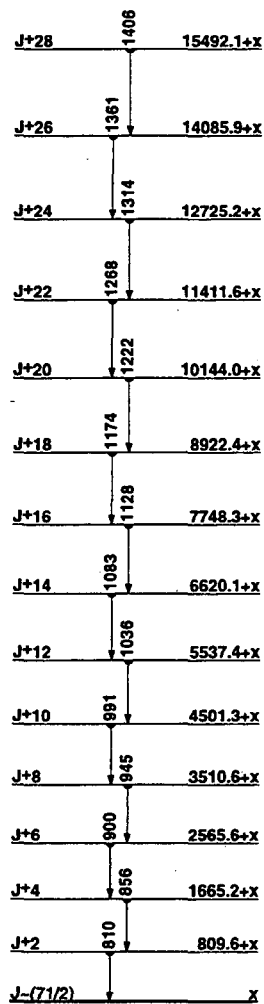

SD-1 band

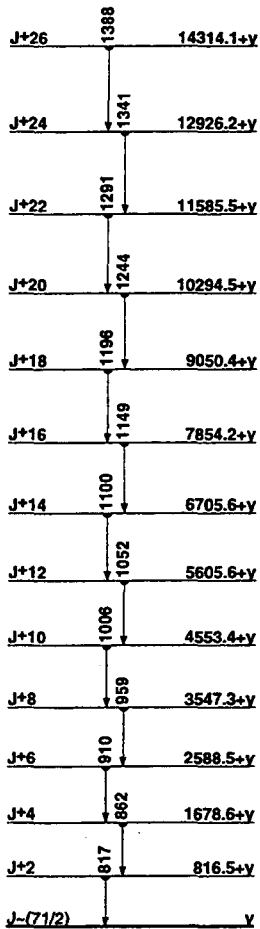

SD-2 band

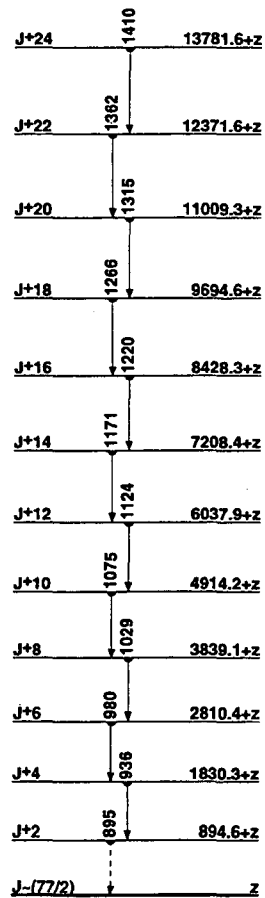

SD-3 band

<sup>153</sup>Dy  
66

# 191Au

$\Delta$ : -33860.50  $S_n$ : 9050.50  $S_p$ : 3820.50  $Q_{ec}$ : 1830.50  $Q_{\alpha}$ : 3430.50

### Nuclear Bands

- A Favored  $h_{11/2}$  decoupled band
- B Unfavored  $h_{11/2}$  decoupled band
- C Favored  $h_{9/2}$  decoupled band
- D Unfavored  $h_{9/2}$  decoupled band
- E SD band

### Levels and $\gamma$ -ray branchings:

- 0,  $3/2^+$ , 3.188 h, %EC+% $\beta^+$ =100,  $\mu=0.1387$   
 11.63, (1/2<sup>+</sup>), 15.55 ns  $\gamma_0$  11.2 (t<sub>100</sub>)  
 207.93, (3/2<sup>+</sup>)  $\gamma_{12}$  196.32 (t<sub>100</sub>) M1  
 252.52, (5/2<sup>+</sup>)  $\gamma_{12}$  240.92 (t<sub>23.319</sub>) E2  $\gamma_0$  252.52 (t<sub>100</sub>) M1+E2:  $\delta=0.93$
- A** 266.25, (11/2<sup>+</sup>), 0.9211 s, %IT=100,  $\mu=6.66$   $\gamma_{266}$  13.75 (t<sub>100</sub>) (E3)  
 331.45(?), (5/2<sup>+</sup>)  $\gamma_0$  331.45 (t<sub>100</sub>)  
 490.96, (7/2<sup>+</sup>)  $\gamma_{266}$  224.72 (t<sub>100</sub>) E2  
 521.35, (5/2<sup>+</sup>)  $\gamma_{266}$  268.85  $\gamma_0$  521.35 (t<sub>100</sub>) E2
- C** 540.38, (9/2<sup>+</sup>), 10.2 ns  $\gamma_{266}$  274.25 (t<sub>100</sub>) M1+E2:  $\delta=-0.09615$   
 662.55, (7/2<sup>+</sup>)  $\gamma_{266}$  410.05 (t<sub>100</sub>) M1  $\gamma_{208}$  454.65  $\gamma_0$  662.55 (t<sub>4110</sub>)
- A** 686.37, (15/2<sup>-</sup>)  $\gamma_{266}$  420.14 (t<sub>100</sub>) E2  
 788.65, (9/2<sup>+</sup>)  $\gamma_{621}$  267.35  $\gamma_{266}$  536.15 (t<sub>100</sub>) (E2)  
 844.86, (13/2<sup>-</sup>)  $\gamma_{686}$  158.55  $\gamma_{266}$  578.63 (t<sub>100</sub>) M1+E2:  $\delta=0.345$   
 876.77, (9/2<sup>+</sup>)  $\gamma_{491}$  385.85  $\gamma_{266}$  610.65 (t<sub>100</sub>) M1+E2
- D** 897.38, (11/2<sup>-</sup>)  $\gamma_{640}$  356.94 (t<sub>100</sub>) M1+E2:  $\delta=-0.254$
- C** 911.47, (13/2<sup>-</sup>)  $\gamma_{640}$  371.13 (t<sub>100</sub>) E2  $\gamma_{266}$  645.25 (t<sub>144</sub>)  
 1066.1(?), (3/2<sup>-</sup>)  $\gamma_{491}$  575.1 (t<sub>100</sub>)  
 1132.1, (11/2<sup>+</sup>)  $\gamma_{789}$  343.36 (t<sub>100</sub>) M1  
 1268.57, (11/2<sup>-</sup>)  $\gamma_{911}$  357.14 (t<sub>-286</sub>) M1+E2  $\gamma_{677}$  391.86  $\gamma_{491}$  777.65  
 (t<sub>100</sub>)  $\gamma_{266}$  1002.45 (t<sub>9123</sub>)  
 1341.36  $\gamma_{789}$  552.86 (t<sub>7415</sub>)  $\gamma_{663}$  678.86 (t<sub>100</sub>)  $\gamma_{621}$  820.06 (t<sub>5513</sub>)
- D** 1352.1, (15/2<sup>-</sup>)  $\gamma_{911}$  440.57 (t<sub>100</sub>) M1+E2  
 1356.1  $\gamma_{845}$  511.1 (t<sub>100</sub>)
- B** 1376.28, (17/2<sup>-</sup>)  $\gamma_{686}$  689.95 (t<sub>100</sub>) M1+E2  $\gamma_{266}$  1110.06 (t<sub>8221</sub>)  
 1394.1  $\gamma_{845}$  549.1 (t<sub>100</sub>)
- A** 1412.1, (19/2<sup>-</sup>)  $\gamma_{686}$  725.1 (t<sub>100</sub>) E2
- C** 1431.1, (17/2<sup>-</sup>)  $\gamma_{911}$  519.1 (t<sub>100</sub>) E2  
 1460.1, (13/2<sup>+</sup>)  $\gamma_{789}$  671.1 (t<sub>100</sub>)  
 1482.1  $\gamma_{845}$  637.1 (t<sub>100</sub>)  
 1550.1  $\gamma_{686}$  864.1 (t<sub>100</sub>)  
 1630.1  $\gamma_{911}$  718.26 (t<sub>100</sub>)  $\gamma_{897}$  732.47 (t<sub>174</sub>)  
 1991.1, <0.3 ns  $\gamma_{1412}$  579.47 (t<sub>100</sub>)  
 2024.1  $\gamma_{686}$  1338.1 (t<sub>100</sub>)
- C** 2032.2, 21/2<sup>-</sup>  $\gamma_{1431}$  601.1 (t<sub>100</sub>)  
 2041.1  $\gamma_{686}$  1355.1 (t<sub>100</sub>)  
 2130.1  $\gamma_{845}$  1285.1 (t<sub>100</sub>)  $\gamma_{266}$  1863.57 (t<sub>329</sub>)  
 2159.2, 0.9610 ns  $\gamma_{991}$  168.1 (t<sub>100</sub>)  
 2175.1  $\gamma_{845}$  1329.76 (t<sub>100</sub>)  $\gamma_{686}$  1488.26 (t<sub>256</sub>)  $\gamma_{266}$  1908.36 (t<sub>5514</sub>)
- A** 2187.1, (23/2<sup>-</sup>)  $\gamma_{1412}$  775.37 (t<sub>100</sub>) E2  
 2199.2  $\gamma_{991}$  208.1 (t<sub>100</sub>)  
 2219.1  $\gamma_{686}$  1533.1 (t<sub>100</sub>)  
 2235.1  $\gamma_{686}$  1549.1 (t<sub>100</sub>)  
 2348.1  $\gamma_{845}$  1504.1 (t<sub>100</sub>)  
 2423.2, <0.2 ns  $\gamma_{2159}$  264.1 (t<sub>100</sub>)
- A** 2447.2, (27/2<sup>-</sup>), 0.899 ns  $\gamma_{2187}$  260.1 (t<sub>100</sub>) E2  
 2490.1, >400 ns  $\gamma_{2423}$  67.1 (t<sub>100</sub>) (E2)
- A** 2503.1, (31/2<sup>-</sup>), 6.15 ns  $\gamma_{2447}$  56.1 (t<sub>100</sub>) (E2)  
 2748  $\gamma_{2447}$  301.1 (t<sub>100</sub>)
- B** 2804.1, (33/2<sup>-</sup>), <0.4 ns  $\gamma_{2503}$  301.1 (t<sub>100</sub>)  
 3147.1  $\gamma_{2748}$  399.1 (t<sub>100</sub>)
- A** 3203.1, (35/2<sup>-</sup>), <0.3 ns  $\gamma_{2804}$  399.1 (t<sub>100</sub>)  
 3822.1  $\gamma_{3147}$  674.1 (t<sub>100</sub>)
- E x, J=(19/2)
- E 229.5+x, (J+2)  $\gamma_x$  229.55 (t<sub>0.4515</sub>) I<sup>(1)</sup>=95.9, I<sup>(2)</sup>=97.3,  $\eta\omega=0.125$   
 E 500.1+x, (J+4)  $\gamma_{230+x}$  270.64 (t<sub>0.6220</sub>) I<sup>(1)</sup>=96.1, I<sup>(2)</sup>=97.3,  $\eta\omega=0.146$   
 E 811.8+x, (J+6)  $\gamma_{600+x}$  311.73 (t<sub>0.8715</sub>) I<sup>(1)</sup>=96.2, I<sup>(2)</sup>=99.8,  $\eta\omega=0.166$   
 E 1163.6+x, (J+8)  $\gamma_{812+x}$  351.82 (t<sub>1.0415</sub>) I<sup>(1)</sup>=96.6, I<sup>(2)</sup>=101.5,  $\eta\omega=0.186$   
 E 1554.8+x, (J+10)  $\gamma_{1164+x}$  391.22 (t<sub>1.0015</sub>) I<sup>(1)</sup>=97.1, I<sup>(2)</sup>=103.1,  $\eta\omega=0.205$   
 E 1984.8+x, (J+12)  $\gamma_{1555+x}$  430.02 I<sup>(1)</sup>=97.7, I<sup>(2)</sup>=106.4,  $\eta\omega=0.224$   
 E 2452.4+x, (J+14)  $\gamma_{1985+x}$  467.62 (t<sub>0.8615</sub>) I<sup>(1)</sup>=98.4, I<sup>(2)</sup>=108.7,  $\eta\omega=0.243$

- E 2956.8+x, (J+16)  $\gamma_{2452+x}$  504.44 (t<sub>0.8320</sub>) I<sup>(1)</sup>=99.1, I<sup>(2)</sup>=109.6,  $\eta\omega=0.261$
- E 3497.7+x, (J+18)  $\gamma_{2957+x}$  540.93 (t<sub>0.6915</sub>) I<sup>(1)</sup>=99.8, I<sup>(2)</sup>=114.3,  $\eta\omega=0.279$
- E 4073.6+x, (J+20)  $\gamma_{3498+x}$  575.96 (t<sub>0.5215</sub>) I<sup>(1)</sup>=100.7, I<sup>(2)</sup>=112.7,  $\eta\omega=0.297$
- E 4685.0+x, (J+22)  $\gamma_{4074+x}$  611.46 (t<sub>0.6620</sub>) I<sup>(1)</sup>=101.4, I<sup>(2)</sup>=120.5,  $\eta\omega=0.314$
- E 5329.6+x, (J+24)  $\gamma_{4686+x}$  644.66 (t<sub>0.5315</sub>) I<sup>(1)</sup>=102.4, I<sup>(2)</sup>=118.3,  $\eta\omega=0.331$
- E 6008.0+x, (J+26)  $\gamma_{5330+x}$  678.46 (t<sub>0.5415</sub>) I<sup>(1)</sup>=103.2

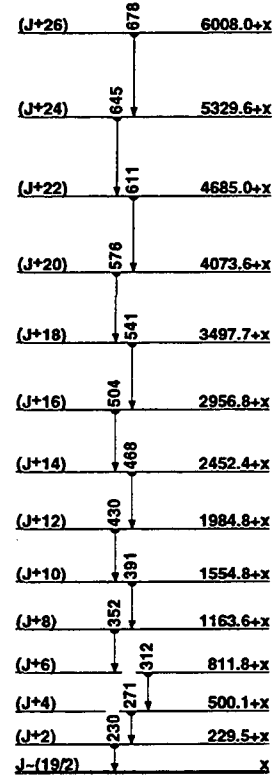

SD band  
191Au

# 189Hg 80Hg

$\Delta$ : (-29700)  $S_n$ : (7500)  $S_p$ : (4500)  $Q_{EC}$ : (3950)  $Q_\alpha$ : (4500)

## Nuclear Bands

### A SD band

#### Levels and $\gamma$ -ray branchings:

0,  $3/2^-$ , 7.6 m, %EC+% $\beta^+$ =100, % $\alpha$ <0.00003,  $\mu$ =-0.6086 s,  $Q$ =-0.76 35  
64.3 5, (5/2)<sup>-</sup>, 0.40 4 ns  $\gamma_{64.35}$  (†<sub>100</sub>) M1+E2:  $\delta$ =0.01  
0+x,  $13/2^+$ , 8.6 m, %EC+% $\beta^+$ =100, % $\alpha$ <0.00003,  $\mu$ =-1.058 6,  $Q$ =-0.66 26  
403.00+x 19,  $17/2^+$   $\gamma_{403}$  403.02 (†<sub>100</sub>) E2  
473.8+x 4, (15/2)<sup>+</sup>  $\gamma_{473.8}$  473.85 (†<sub>100</sub>) M1+E2:  $\delta$ =0.11 7  
1029.8+x 3,  $21/2^+$   $\gamma_{1029.8}$  626.82 (†<sub>100</sub>) E2  
1110.1+x 4, (19/2)<sup>+</sup>  $\gamma_{1110.1}$  636.34 (†<sub>100</sub> 10) E2  $\gamma_{1110.1}$  707.15 (†<sub>70</sub> 20)  
M1+E2:  $\delta$ =0.52 15  
1690.8+x 4, (21/2)<sup>-</sup>  $\gamma_{1690.8}$  580.74 (†<sub>100</sub> 11) E1  $\gamma_{1690.8}$  661.04 (†<sub>48</sub> 7) E1  
1762.8+x 3,  $25/2^+$   $\gamma_{1762.8}$  733.02 (†<sub>100</sub>) E2  
1916.7+x 5, (25/2)<sup>-</sup>  $\gamma_{1916.7}$  225.93 (†<sub>100</sub>) E2  
1976.1+x 5, (23/2)<sup>-</sup>  $\gamma_{1976.1}$  946.45 (†<sub>100</sub>) (E1)  
2220.4+x 5, (27/2)<sup>-</sup>  $\gamma_{2220.4}$  244.35 (†<sub>75</sub> 25)  $\gamma_{2220.4}$  457.55 (†<sub>100</sub> 12) (E1)  
2252.6+x 6, (29/2)<sup>-</sup>  $\gamma_{2252.6}$  335.93 (†<sub>100</sub>) E2  
2434.9+x 7, (29/2)<sup>-</sup>  $\gamma_{2434.9}$  518.25 (†<sub>100</sub>) (E2)  
2476.9+x 4,  $29/2^+$   $\gamma_{2476.9}$  714.13 (†<sub>100</sub>) E2  
2615.5+x 5,  $29/2^+$   $\gamma_{2615.5}$  852.75 (†<sub>100</sub>) E2  
2674.3+x 5,  $33/2^+$   $\gamma_{2674.3}$  58.85 (†<sub><1</sub>) E2  $\gamma_{2674.3}$  197.44 (†<sub>100</sub> 14) E2  
2686.0+x 6, (31/2)<sup>-</sup>  $\gamma_{2686.0}$  465.63 (†<sub>100</sub>) (E2)  
2820.7+x 7, (33/2)<sup>-</sup>  $\gamma_{2820.7}$  568.14 (†<sub>100</sub>) (E2)  
3123.7+x 7(?)  $\gamma_{3123.7}$  646.85 (†<sub>100</sub>)  
3139.7+x 9, (33/2)<sup>-</sup>  $\gamma_{3139.7}$  704.85 (†<sub>100</sub>)  
3153.5+x 7,  $37/2^+$   $\gamma_{3153.5}$  479.24 (†<sub>100</sub>) E2  
3343.8+x 8, (35/2)<sup>-</sup>  $\gamma_{3343.8}$  657.85 (†<sub>100</sub>) E2  
3540.2+x 9, (37/2)<sup>-</sup>  $\gamma_{3540.2}$  719.55 (†<sub>100</sub>)  
3793.1+x 9(?)  $\gamma_{3793.1}$  669.46 (†<sub>100</sub>)  
3875.2+x 8, (41/2)<sup>+</sup>  $\gamma_{3875.2}$  721.75 (†<sub>100</sub>)  
4378.3+x 10(?), (41/2)<sup>-</sup>  $\gamma_{4378.3}$  838.15(?) (†<sub>100</sub>)  
4741.4+x 10(?), (45/2)<sup>+</sup>  $\gamma_{4741.4}$  866.36(?) (†<sub>100</sub>)

A y, J=(29/2)

- A 366.4+y, J+2  $\gamma_{366.4}$  (†<sub>1.00</sub> 10)  $I^{(1)}$ =87.3,  $I^{(2)}$ =95.9,  $\eta$  $\omega$ =0.194
- A 774.5+y, J+4  $\gamma_{774.5}$  408.1 (†<sub>1.00</sub> 15)  $I^{(1)}$ =88.2,  $I^{(2)}$ =98.5,  $\eta$  $\omega$ =0.214
- A 1223.2+y, J+6  $\gamma_{1223.2}$  448.7 (†<sub>0.86</sub> 19)  $I^{(1)}$ =89.1,  $I^{(2)}$ =100.5,  $\eta$  $\omega$ =0.234
- A 1711.7+y, J+8  $\gamma_{1711.7}$  488.5 (†<sub>0.89</sub> 16)  $I^{(1)}$ =90.1,  $I^{(2)}$ =101.3,  $\eta$  $\omega$ =0.254
- A 2239.7+y, J+10  $\gamma_{2239.7}$  528.0 (†<sub>0.62</sub> 11)  $I^{(1)}$ =90.9,  $I^{(2)}$ =102.8,  $\eta$  $\omega$ =0.274
- A 2806.6+y, J+12  $\gamma_{2806.6}$  566.9 (†<sub>0.58</sub> 11)  $I^{(1)}$ =91.7,  $I^{(2)}$ =108.1,  $\eta$  $\omega$ =0.293
- A 3410.5+y, J+14  $\gamma_{3410.5}$  603.9 (†<sub>0.53</sub> 14)  $I^{(1)}$ =92.7,  $I^{(2)}$ =109.9,  $\eta$  $\omega$ =0.311
- A 4050.8+y, J+16  $\gamma_{4050.8}$  640.3 (†<sub>0.58</sub> 11)  $I^{(1)}$ =93.7,  $I^{(2)}$ =112.4,  $\eta$  $\omega$ =0.329
- A 4726.7+y, J+18  $\gamma_{4726.7}$  675.9  $I^{(1)}$ =94.7,  $I^{(2)}$ =126.2,  $\eta$  $\omega$ =0.346
- A 5434.3+y(?), J+20  $\gamma_{5434.3}$  707.6(?)  $I^{(1)}$ =96.1

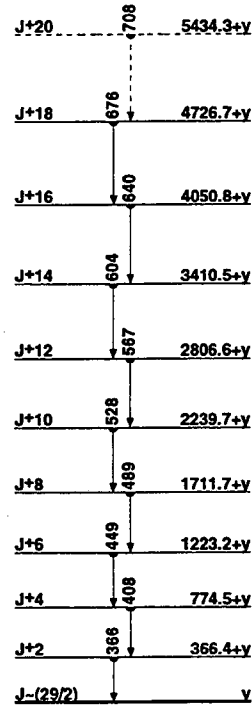

SD band

189Hg  
80Hg

# 190Hg 80Hg

$\Delta$ : (-31410)  $S_n$ : (9800)  $S_p$ : (5060)  $Q_{EC}$ : (1470)  $Q_\alpha$ : (3960)

## Nuclear Bands

- A GS band ( $\pi=+$ ,  $s=0$ )
- B ( $\pi=+$ ,  $s=0$ )
- C ( $\pi=+$ ,  $s=0$ )
- D ( $\pi=+$ ,  $s=1$ )
- E ( $\pi=+$ ,  $s=1$ )
- F ( $\pi=+$ ,  $s=0$ )
- G ( $\pi=+$ ,  $s=0$ )
- H Intruder band
- I SD band

## Levels and $\gamma$ -ray branchings:

- A 0, 0<sup>+</sup>, 20.05 m, %EC+% $\beta^+$ =100, % $\alpha$ <5 $\times$ 10<sup>-5</sup>  
 A 416.42, 2<sup>+</sup>  $\gamma_{100}$  416.42 (†,100) E2  
 A 1041.82, 4<sup>+</sup>  $\gamma_{416}$  625.42 (†,100) E2  
 1099.92, 2<sup>+</sup>  $\gamma_{416}$  683.52 (†,100 10) E2+M1:  $\delta=2.0$   $\gamma_{1099.92}$  (†,626) E2  
 H 1279.43, 0<sup>+</sup>  $\gamma_{416}$  863.02 (†,100)  $\gamma_{1279}$  (†,3.2) E0  
 1558.82, (2<sup>+</sup>)  $\gamma_{1100}$  458.73 (†,263)  $\gamma_{1042}$  515.412(?) (†,39 16)  $\gamma_{416}$  1142.53 (†,100.4) E2(+M1):  $\delta>2$   $\gamma_{1558.93}$  (†,263)  
 H 1571.13, 2<sup>+</sup>  $\gamma_{1279}$  292.02(?) (†,43)  $\gamma_{1042}$  529.02 (†,26 10)  $\gamma_{416}$  1155.02 (†,100.9) E0+M1+E2 -  $\gamma_{1571.02}$  (†,30 17)  
 1657.02, (3<sup>+</sup>)  $\gamma_{1100}$  557.02 (†,100 10) E2(+M1):  $\delta>3$   $\gamma_{1042}$  615.43 (†,67 7) E2+M1:  $\delta=1.43$   $\gamma_{416}$  1240.73 (†,212) (E2)  
 A 1772.92, 6<sup>+</sup>  $\gamma_{1042}$  731.12 (†,100) E2  
 D 1881.42, 5<sup>-</sup>  $\gamma_{1042}$  839.72 (†,100) E1  
 H 1975.23, 4<sup>+</sup>  $\gamma_{1571}$  404.02 (†,23 7)  $\gamma_{1042}$  933.02 (†,39 12) E0+M1+E2  
 $\gamma_{416}$  1559.02 (†,100 7)  
 2072.82, (4,5,6)<sup>+</sup>  $\gamma_{1042}$  1031.02 (†,100) M1+E2:  $\delta=0.93$   
 D 2078.22, 7<sup>-</sup>  $\gamma_{1881}$  196.82 (†,29 3) E2  $\gamma_{1773}$  305.32 (†,100 10) E1  
 2200.92(?), (5<sup>+</sup>)  $\gamma_{1657}$  543.92(?) E2  
 2251.72, (6,7)<sup>-</sup>  $\gamma_{1881}$  370.32 (†,100 10) E2(+M1):  $\delta>7$   $\gamma_{1773}$  478.33 (†,27 3)  
 F 2318.43, (8<sup>-</sup>)  $\gamma_{2078}$  240.22 (†,100 10) M1+E2:  $\delta=1.5$   $\gamma_{2318}$  405.33 (†,100 10) Q  
 2318.72, (4<sup>+</sup>,5,6<sup>+</sup>)  $\gamma_{2078}$  240.2(?)  $\gamma_{1881}$  437.63 (†,70 7)  $\gamma_{1042}$  1276.73 (†,100 10)  
 D 2335.32, (9<sup>-</sup>)  $\gamma_{2078}$  257.12 (†,100) (E2)  
 2391.94(?), (5 to 9)  $\gamma_{2078}$  313.73  
 2424.74(?), (5 to 9)  $\gamma_{2078}$  346.53  
 B 2464.93, (8<sup>+</sup>)  $\gamma_{1773}$  692.02 (†,100) E2  
 H 2510.03, 6<sup>+</sup>  $\gamma_{1975}$  535.02 (†,100 8)  $\gamma_{1773}$  737.02 (†,45 15) E0+M1+E2  
 $\gamma_{1042}$  1468.02 (†,51 4)  
 2572.93, (4 to 8)<sup>+</sup>  $\gamma_{1773}$  800.02 (†,100) E2  
 B 2596.93, (10<sup>+</sup>)  $\gamma_{2465}$  132.03 (†,100 10) E2  $\gamma_{2335}$  261.53 (†,62) D  
 B 2620.86, (12<sup>+</sup>), 23 ns,  $g=-0.212$ ,  $Q=1.17$   $\gamma_{2597}$  23.9  
 F 2724.03, (10<sup>-</sup>)  $\gamma_{2335}$  388.63 (†,53 16)  $\gamma_{2318}$  405.33 (†,100 10) Q  
 D 2865.34, (11<sup>-</sup>)  $\gamma_{2335}$  530.03 (†,100) Q  
 2930.94(?), (10<sup>+</sup>)  $\gamma_{2465}$  466.03 (Q)  
 B 3040.76, (14<sup>+</sup>)  $\gamma_{2621}$  479.92 (†,100) Q  
 F 3357.94, (12<sup>-</sup>)  $\gamma_{2724}$  633.93 (†,100) Q  
 D 3548.55, (13<sup>-</sup>)  $\gamma_{2865}$  683.23 (†,100) Q  
 3611.35(?), (12<sup>+</sup>)  $\gamma_{2931}$  680.43  
 B 3703.46, (16<sup>+</sup>)  $\gamma_{3041}$  662.72 (†,100) Q  
 G 3979.55, (14<sup>-</sup>)  $\gamma_{3358}$  621.63 (†,100) (Q)  
 E 4087.16, (15<sup>-</sup>)  $\gamma_{3549}$  538.63 (†,100) Q  
 G 4242.86, (16<sup>-</sup>)  $\gamma_{3980}$  263.43 (†,100 10) Q  $\gamma_{3703}$  539.43 (†,24 7)  
 E 4326.17, (17<sup>-</sup>)  $\gamma_{4087}$  239.03 (†,100)  
 B 4492.47, (18<sup>+</sup>)  $\gamma_{3703}$  789.03 (†,100) Q  
 G 4551.57, (18<sup>-</sup>)  $\gamma_{4243}$  308.73 (†,100) Q  
 E 4709.37, (19<sup>-</sup>)  $\gamma_{4326}$  383.23 (†,100) Q  
 G 5105.67, (20<sup>-</sup>)  $\gamma_{4552}$  554.13 (†,100) Q  
 C 5228.78, (20<sup>+</sup>)  $\gamma_{4492}$  736.33 (†,100) Q  
 E 5334.313, (21<sup>-</sup>)  $\gamma_{4703}$  625.1 (†,100)  
 B 5351.68, (20<sup>+</sup>)  $\gamma_{4492}$  859.23 (†,100)  
 C 5794.78, (22<sup>-</sup>)  $\gamma_{6229}$  566.03 (†,100)  
 E 6142.213, (23<sup>-</sup>)  $\gamma_{5334}$  807.83 (†,100) Q  
 6335.19, (24<sup>+</sup>)  $\gamma_{5795}$  540.43 (†,100)  
 C 6576.19, (24<sup>+</sup>)  $\gamma_{5795}$  781.43 (†,100)  
 I x, J=(14)  
 I 360.0+x, J+2  $\gamma_x$  360.02 (†,0.63 s) (E2)  $I^{(1)}=86.1$ ,  $I^{(2)}=94.6$ ,  $\eta\omega=0.191$

- I 762.3+x, J+4  $\gamma_{360+x}$  402.34 (†,1.08 s) (E2)  $I^{(1)}=87.0$ ,  $I^{(2)}=98.0$ ,  $\eta\omega=0.211$
- I 1205.4+x, J+6  $\gamma_{762+x}$  443.12 (†,0.91 s) (E2)  $I^{(1)}=88.0$ ,  $I^{(2)}=101.0$ ,  $\eta\omega=0.231$
- I 1688.1+x, J+8  $\gamma_{1205+x}$  482.72 (†,0.95 s) (E2)  $I^{(1)}=89.1$ ,  $I^{(2)}=104.4$ ,  $\eta\omega=0.251$
- I 2209.1+x, J+10  $\gamma_{1688+x}$  521.02 (†,0.92 12) (E2)  $I^{(1)}=90.2$ ,  $I^{(2)}=107.8$ ,  $\eta\omega=0.270$
- I 2767.2+x, J+12  $\gamma_{2209+x}$  558.12 (†,0.76 7) (E2)  $I^{(1)}=91.4$ ,  $I^{(2)}=110.2$ ,  $\eta\omega=0.288$
- I 3361.6+x, J+14  $\gamma_{2767+x}$  594.43 (†,0.55 6) (E2)  $I^{(1)}=92.5$ ,  $I^{(2)}=114.0$ ,  $\eta\omega=0.306$
- I 3991.1+x, J+16  $\gamma_{3362+x}$  629.54 (†,0.46 6) (E2)  $I^{(1)}=93.7$ ,  $I^{(2)}=117.3$ ,  $\eta\omega=0.323$
- I 4654.7+x, J+18  $\gamma_{3991+x}$  663.63 (†,0.34 5) (E2)  $I^{(1)}=94.9$ ,  $I^{(2)}=123.8$ ,  $\eta\omega=0.340$
- I 5350.6+x, J+20  $\gamma_{4655+x}$  695.95 (†,0.24 4) (E2)  $I^{(1)}=96.3$ ,  $I^{(2)}=129.0$ ,  $\eta\omega=0.356$
- I 6077.5+x, J+22  $\gamma_{5351+x}$  726.97 (†,0.21 6)  $I^{(1)}=97.7$ ,  $I^{(2)}=137.9$ ,  $\eta\omega=0.371$
- I 6833.4+x, J+24  $\gamma_{6078+x}$  755.915 (†,0.13 5) (E2)  $I^{(1)}=99.2$ ,  $I^{(2)}=142.3$ ,  $\eta\omega=0.385$
- I 7617.4+x, J+26  $\gamma_{6833+x}$  784.010 (†,0.12)  $I^{(1)}=100.8$ ,  $I^{(2)}=144.4$ ,  $\eta\omega=0.399$
- I 8429.1+x, J+28  $\gamma_{7617+x}$  811.710 (†,0.05)  $I^{(1)}=102.3$

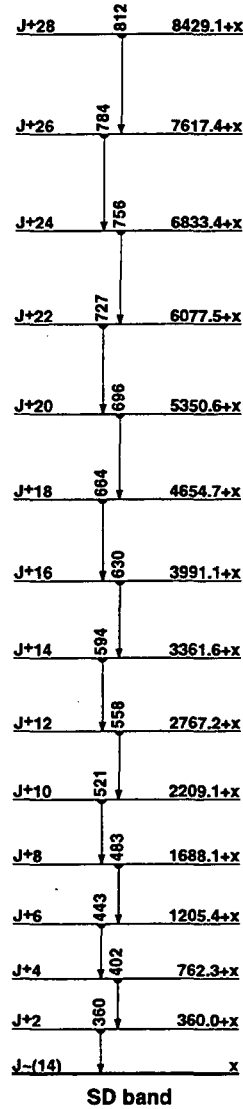

## 190Hg 80Hg

191  
80 Hg

$\Delta$ : -30680.90  $S_n$ : (7340)  $S_p$ : 5090.90  $Q_{ec}$ : 3180.70  $Q_\alpha$ : (3500)

Nuclear Bands

- A Favored  $i_{13/2}$  decoupled band
- B Unfavored  $i_{13/2}$  decoupled band
- C  $i_{13/2}$  semi-decoupled band
- D Band Structure
- E Band Structure
- F SD-1 band
- G SD-2 band
- H SD-3 band

Levels and  $\gamma$ -ray branchings:

- 0, (3/2<sup>-</sup>), 49.10 m, %EC+% $\beta^+$ =100,  $Q_\alpha$  = -0.41 41  
 51.62, (5/2<sup>-</sup>), 0.42 4 ns  $\gamma_{0+}$  51.62 (t<sub>100</sub>) M1+E2  
 103.73, (1/2<sup>-</sup>)  $\gamma_{0+}$  103.73 (t<sub>100</sub>) M1+E2  
 A 0+, 13/2<sup>+</sup>, 50.815 m, %EC+% $\beta^+$ =100,  $\mu$  = -1.0685,  $Q_\alpha$  = +0.7624  
 216.0+x2, (9/2<sup>+</sup>)  $\gamma_{0+}$  216.02 (t<sub>100</sub>) E2  
 265.0+x2, (11/2<sup>+</sup>)  $\gamma_{216+x}$  49.12 E2  $\gamma_{0+}$  265.02 (t<sub>100</sub>5) M1+E2:  $\delta$  = 1.9<sup>+10</sup><sub>-5</sub>  
 336.32, (5/2<sup>-</sup>)  $\gamma_{52}$  284.72 (t<sub>10.0</sub>10) M1  $\gamma_{0+}$  336.32 (t<sub>100</sub>6) M1+E2:  $\delta$  = 1.6<sup>-4</sup><sub>-6</sub>  
 375.53, (3/2<sup>-</sup>)  $\gamma_{104}$  271.84 (t<sub>1.4</sub>124)  $\gamma_{52}$  323.94 (t<sub>12</sub>6)  $\gamma_{0+}$  375.53 (t<sub>100</sub>18) M1  
 377.93, (7/2<sup>-</sup>)  $\gamma_{336}$  41.63  $\gamma_{52}$  326.32 (t<sub>100</sub>5) M1+E2:  $\delta$  = 1.02  $\gamma_{0+}$  377.92 (t<sub>13</sub>7)  
 A 390.4+x3, (17/2<sup>+</sup>)  $\gamma_{0+}$  390.43 (t<sub>100</sub>) (E2)  
 430.43, (1/2<sup>-</sup>, 3/2<sup>-</sup>, 5/2<sup>-</sup>)  $\gamma_{52}$  378.83 (t<sub>1</sub>345)  $\gamma_{0+}$  430.43 (t<sub>100</sub>14) M1+E2:  $\delta$  = 0.8<sup>-8</sup><sub>-8</sub>  
 534.7+x4  $\gamma_{216+x}$  318.74 (t<sub>100</sub>)  
 B 535.2+x2, (15/2<sup>+</sup>)  $\gamma_{0+}$  535.22 (t<sub>100</sub>) (M1+E2):  $\delta$  = 0.144  
 563.53, (7/2<sup>-</sup>)  $\gamma_{336}$  227.23 (t<sub>5.1</sub>24)  $\gamma_{52}$  511.93  $\gamma_{0+}$  563.53 (t<sub>100</sub>5) E2  
 588.6+x4, (7/2<sup>+</sup>)  $\gamma_{265+x}$  323.64 (t<sub>13</sub>7)  $\gamma_{216+x}$  372.73 (t<sub>100</sub>10) M1+E2:  $\delta$  = 1.8<sup>-4</sup><sub>-4</sub>  
 632.33, (9/2<sup>-</sup>)  $\gamma_{378}$  254.43 (t<sub>7</sub>3)  $\gamma_{52}$  580.73 (t<sub>100</sub>5) E2  
 659.14, (9/2<sup>-</sup>)  $\gamma_{378}$  281.23 (t<sub>77</sub>8) M1+E2:  $\delta$  = 0.85  $\gamma_{336}$  322.74 (t<sub>27</sub>14)  $\gamma_{52}$  607.53 (t<sub>100</sub>10) E2  
 691.83  $\gamma_{430}$  261.43 (t<sub>10.1</sub>25)  $\gamma_{336}$  355.53 (t<sub>8</sub>3)  $\gamma_{52}$  640.23 (t<sub>100</sub>10)  $\gamma_{0+}$  691.83 (t<sub>31</sub>8)  
 742.7+x3, (13/2<sup>+</sup>)  $\gamma_{535.2+x}$  207.53 (t<sub>10</sub>4)  $\gamma_{265+x}$  477.63 (t<sub>90</sub>10)  $\gamma_{216+x}$  526.73 (t<sub>11</sub>3)  $\gamma_{0+}$  742.73 (t<sub>100</sub>10) M1+E2:  $\delta$  > 1.6  
 761.1+x3, (11/2<sup>+</sup>)  $\gamma_{689+x}$  172.44 (t<sub>12</sub>7)  $\gamma_{265+x}$  496.03 (t<sub>100</sub>11) M1(+E2)  $\gamma_{216+x}$  545.13 (t<sub>40</sub>20) M1+E2:  $\delta$  > 1.6  $\gamma_{0+}$  761.13 (t<sub>52</sub>11)  
 880.39  $\gamma_{52}$  828.79 (t<sub>100</sub>)  
 900.0+x4  $\gamma_{265+x}$  635.04 (t<sub>37</sub>7)  $\gamma_{216+x}$  684.14 (t<sub>100</sub>10) E2  $\gamma_{0+}$  900.04 (t<sub>71</sub>10) M1+E2  
 911.34  $\gamma_{430}$  480.84 (t<sub>100</sub>77)  $\gamma_{378}$  533.44 (t<sub>96</sub>23)  $\gamma_{378}$  535.75 (t<sub>1</sub>=200)  $\gamma_{336}$  574.94 (t<sub>1</sub>=80)  
 952.14, (9/2<sup>-</sup>)  $\gamma_{430}$  521.74 (t<sub>29</sub>14)  $\gamma_{336}$  615.84 (t<sub>100</sub>12) (E2)  
 997.13, (5/2<sup>-</sup>, 7/2<sup>-</sup>, 9/2<sup>-</sup>)  $\gamma_{430}$  566.74 (t<sub>82</sub>15)  $\gamma_{378}$  619.23 (t<sub>100</sub>12) M1+E2:  $\delta$  = 0.9<sup>-5</sup><sub>-5</sub>  $\gamma_{336}$  660.83 (t<sub>92</sub>10)  
 1016.34, (11/2<sup>-</sup>)  $\gamma_{52}$  383.94 (t<sub>14</sub>4)  $\gamma_{378}$  638.44 (t<sub>100</sub>21)  
 A 1019.2+x4, (21/2<sup>+</sup>)  $\gamma_{390+x}$  628.83 (t<sub>100</sub>) (E2)  
 1024.1  $\gamma_{336}$  687.1 (t<sub>100</sub>)  
 1081.05  $\gamma_{336}$  744.75 (t<sub>100</sub>17)  $\gamma_{0+}$  1081.05 (t<sub>70</sub>13)  
 1088+x1  $\gamma_{216+x}$  871.89 (t<sub>100</sub>)  
 1105.7+x7  $\gamma_{589+x}$  517.16 (t<sub>100</sub>)  
 1107.24, (7/2<sup>-</sup>, 9/2<sup>-</sup>, 11/2<sup>-</sup>)  $\gamma_{52}$  474.94 (t<sub>19</sub>10) M1+E2:  $\delta$  > 0.4  $\gamma_{378}$  729.34 (t<sub>100</sub>11)  $\gamma_{52}$  1055.64 (t<sub>61</sub>7)  
 1130.8+x8  $\gamma_{265+x}$  865.69 (t<sub>37</sub>17)  $\gamma_{216+x}$  914.97 (t<sub>100</sub>17) M1+E2  
 1133.3+x6  $\gamma_{265+x}$  868.25 (t<sub>32</sub>16)  $\gamma_{216+x}$  917.35 (t<sub>100</sub>16)  $\gamma_{0+}$  1133.35 (t<sub>35</sub>18)  
 1146.55  $\gamma_{52}$  514.25 (t<sub>100</sub>18)  $\gamma_{564}$  583.05 (t<sub>77</sub>38)  
 B 1171.7+x4, (19/2<sup>+</sup>)  $\gamma_{535.2+x}$  636.53 (t<sub>99</sub>20) (E2)  $\gamma_{390+x}$  781.33 (t<sub>100</sub>15) (M1+E2):  $\delta$  = 0.144  
 1178.38  $\gamma_{52}$  1126.78 (t<sub>100</sub>)  
 1193.25  $\gamma_{52}$  501.45 (t<sub>56</sub>10) M1(+E2)  $\gamma_{378}$  815.35 (t<sub>100</sub>21)  
 1199.1  $\gamma_{52}$  1148.1 (t<sub>100</sub>)  
 1208+x1  $\gamma_{216+x}$  992.1 (t<sub>100</sub>)  
 1212.47  $\gamma_{378}$  834.57 (t<sub>100</sub>) (E2)  
 1257+x1  $\gamma_{265+x}$  992.1 (t<sub>100</sub>)  
 1317.69, (5/2<sup>-</sup>, 7/2<sup>-</sup>, 9/2<sup>-</sup>)  $\gamma_{564}$  754.18 (t<sub>100</sub>) M1+E2:  $\delta$  > 1.2  
 1319+x1  $\gamma_{216+x}$  1102.69 (t<sub>100</sub>21)  $\gamma_{0+}$  1318.69 (t<sub>75</sub>25)  
 1320.1, (13/2<sup>-</sup>)  $\gamma_{52}$  687.1 (t<sub>100</sub>)  
 1434+x1  $\gamma_{216+x}$  1218.29 (t<sub>100</sub>)  
 1470.89  $\gamma_{378}$  1092.99 (t<sub>100</sub>)  
 1539.1  $\gamma_{378}$  1161.1 (t<sub>100</sub>)  
 C 1637.8+x4, (21/2<sup>+</sup>)  $\gamma_{1172+x}$  466.13 (t<sub>100</sub>15) (E1)  $\gamma_{1019+x}$  618.63 (t<sub>21</sub>4)  
 1688+x1  $\gamma_{216+x}$  1472.1 (t<sub>100</sub>)  
 A 1769.3+x8, (25/2<sup>+</sup>)  $\gamma_{1019+x}$  750.17 (t<sub>100</sub>) (E2)  
 C 1804.5+x8, (25/2<sup>+</sup>), 0.727 ns  $\gamma_{1638+x}$  166.77 (t<sub>100</sub>) (E2)  
 1844.1  $\gamma_{336}$  1508.1 (t<sub>100</sub>)  
 D 1861.7+x7, (23/2<sup>+</sup>)  $\gamma_{1638+x}$  223.96 (t<sub>25</sub>5)  $\gamma_{1019+x}$  842.56 (t<sub>100</sub>20)  
 D 2064.5+x8, (27/2<sup>+</sup>)  $\gamma_{1862+x}$  202.87 (t<sub>100</sub>20) (E2)  $\gamma_{1805+x}$  260.07 (t<sub>37</sub>7)  $\gamma_{1769+x}$  295.27 (t<sub>26</sub>6)  
 C 2123.4+x8, (29/2<sup>+</sup>)  $\gamma_{1805+x}$  318.93 (t<sub>100</sub>) (E2)  
 2286+x2  $\gamma_{216+x}$  2070.2 (t<sub>100</sub>)  
 2299+x2  $\gamma_{265+x}$  2034.515 (t<sub>100</sub>)  
 2303+x1  $\gamma_{216+x}$  2087.1 (t<sub>100</sub>)  
 2307+x1  $\gamma_{216+x}$  2091.511 (t<sub>100</sub>)  
 2310+x1  $\gamma_{265+x}$  2045.1 (t<sub>100</sub>)  
 2315+x1  $\gamma_{216+x}$  2099.1 (t<sub>100</sub>)  
 2328.9+x8  $\gamma_{743+x}$  1586.37 (t<sub>43</sub>9)  $\gamma_{216+x}$  2113.07 (t<sub>45</sub>9)  $\gamma_{0+}$  2328.97 (t<sub>100</sub>10)  
 2335+x2  $\gamma_{265+x}$  2070.2 (t<sub>100</sub>)  
 2340+x1  $\gamma_{265+x}$  2075.1 (t<sub>100</sub>)  
 2352+x1  $\gamma_{265+x}$  2087.1 (t<sub>100</sub>)  
 2357+x1  $\gamma_{743+x}$  1613.99  $\gamma_{216+x}$  2140.69  
 2358.8+x8  $\gamma_{743+x}$  1616.17 (t<sub>100</sub>10)  $\gamma_{0+}$  2358.77 (t<sub>81</sub>14)  
 2361.6+x8  $\gamma_{743+x}$  1618.97 (t<sub>46</sub>9)  $\gamma_{0+}$  2361.67 (t<sub>100</sub>10)  
 2406+x2  $\gamma_{265+x}$  2141.2 (t<sub>100</sub>)  
 2409+x2  $\gamma_{216+x}$  2193.2 (t<sub>100</sub>)  
 2412.415  $\gamma_{378}$  2034.515 (t<sub>100</sub>)  
 2423.1  $\gamma_{378}$  2045.1 (t<sub>100</sub>)  
 A 2431.4+x8, (29/2<sup>+</sup>)  $\gamma_{1769+x}$  662.13 (t<sub>100</sub>) (E2)  
 2440.29  $\gamma_{852}$  1488.18 (t<sub>100</sub>)  
 2442.2  $\gamma_{336}$  2105.2 (t<sub>100</sub>)  
 2443.1  $\gamma_{378}$  2065.1 (t<sub>100</sub>)  
 2460.1  $\gamma_{1016}$  1443.59 (t<sub>100</sub>)  
 2475+x1  $\gamma_{1019+x}$  1459.1 (t<sub>100</sub>)  
 2476.1  $\gamma_{622}$  1844.1 (t<sub>100</sub>)  
 2477.1  $\gamma_{378}$  2099.1 (t<sub>100</sub>)  
 2543.1  $\gamma_{564}$  1980.1 (t<sub>100</sub>)  
 D 2544+x1, (31/2<sup>+</sup>)  $\gamma_{2065+x}$  479.79 (t<sub>100</sub>) (E2)  
 2589+x1, (29/2<sup>+</sup>)  $\gamma_{1769+x}$  819.48 (t<sub>100</sub>) (E2)  
 A 2598+x1, (33/2<sup>+</sup>), 0.926 ns  $\gamma_{2431+x}$  167.07 (t<sub>100</sub>) (E2)  
 C 2690+x1, (33/2<sup>+</sup>)  $\gamma_{2123+x}$  566.73 (t<sub>100</sub>) (E2)  
 A 3078+x1, (37/2<sup>+</sup>)  $\gamma_{2598+x}$  479.83 (t<sub>100</sub>) (E2)  
 E 3167+x1, (33/2<sup>+</sup>)  $\gamma_{2588+x}$  568.47  $\gamma_{2589+x}$  578.18  
 D 3221+x2, (35/2<sup>+</sup>)  $\gamma_{2544+x}$  677.1 (t<sub>100</sub>) (E2)  
 C 3429+x1, (37/2<sup>+</sup>)  $\gamma_{2590+x}$  738.63 (t<sub>100</sub>) (E2)  
 E 3487+x2, (37/2<sup>+</sup>)  $\gamma_{3167+x}$  320.68 (t<sub>71</sub>14) (E2)  $\gamma_{3078+x}$  409.38 (t<sub>100</sub>20)  
 A 3792.3+x15, (41/2<sup>+</sup>)  $\gamma_{3078+x}$  714.1 (t<sub>100</sub>) (E2)  
 3956+x2, (39/2<sup>+</sup>)  $\gamma_{3221+x}$  735.1 (t<sub>100</sub>) (E2)  
 E 3988+x2, (41/2<sup>+</sup>)  $\gamma_{3487+x}$  501.1 (t<sub>100</sub>) (E2)  
 C 4216+x1, (41/2<sup>+</sup>)  $\gamma_{3429+x}$  787.1 (t<sub>100</sub>)  
 4357+x2, (43/2<sup>+</sup>)  $\gamma_{3956+x}$  400.1 (t<sub>100</sub>) (E2)  
 A 4632+x2, (45/2<sup>+</sup>)  $\gamma_{3792+x}$  840.1 (t<sub>100</sub>) (E2)



**<sup>191</sup>Hg (Continued)**  
**<sup>80</sup>Hg**

- F u, J=(29/2,31/2)  
 F 350.6+u, J+2  $\gamma_{350.6}$  (†, 0.86 s) (E2)  $I^{(1)}=91.3, I^{(2)}=100.3, \hbar\omega=0.185$   
 F 741.1+u, J+4  $\gamma_{351+u}$  390.5 (†, 1.25 s) (E2)  $I^{(1)}=92.2, I^{(2)}=100.5, \hbar\omega=0.205$   
 F 1171.4+u, J+6  $\gamma_{741+u}$  430.3 (†, 1.00 s) (E2)  $I^{(1)}=93.0, I^{(2)}=101.8, \hbar\omega=0.225$   
 F 1641.0+u, J+8  $\gamma_{1171+u}$  469.6 (†, 1.00 s) (E2)  $I^{(1)}=93.7, I^{(2)}=103.9, \hbar\omega=0.244$   
 F 2149.1+u, J+10  $\gamma_{1641+u}$  508.1 (†, 0.81 s) (E2)  $I^{(1)}=94.5, I^{(2)}=107.5, \hbar\omega=0.263$   
 F 2694.4+u, J+12  $\gamma_{2149+u}$  545.3 (†, 0.85 s) (E2)  $I^{(1)}=95.4, I^{(2)}=108.7, \hbar\omega=0.282$   
 F 3276.5+u, J+14  $\gamma_{2694+u}$  582.1 (†, 0.71 s) (E2)  $I^{(1)}=96.2, I^{(2)}=112.0, \hbar\omega=0.300$   
 F 3894.3+u, J+16  $\gamma_{3277+u}$  617.8 (†, 0.65 s) (E2)  $I^{(1)}=97.1, I^{(2)}=113.6, \hbar\omega=0.318$   
 F 4547.3+u, J+18  $\gamma_{3894+u}$  653.0 (†, 0.62 s) (E2)  $I^{(1)}=98.0, I^{(2)}=116.3, \hbar\omega=0.335$   
 F 5234.7+u, J+20  $\gamma_{4547+u}$  687.4 (†, 0.46 s) (E2)  $I^{(1)}=98.9, I^{(2)}=116.3, \hbar\omega=0.352$   
 F 5956.5+u, J+22  $\gamma_{5235+u}$  721.8 (†, 0.30 s) (E2)  $I^{(1)}=99.8, I^{(2)}=123.1, \hbar\omega=0.369$   
 F 6710.8+u, J+24  $\gamma_{5957+u}$  754.3 (†, 0.18 s) (E2)  $I^{(1)}=100.8$   
 G v, J=(25/2)  
 G 292.0+v, J+2  $\gamma_{292.0}$  (†, 0.43 s)  $I^{(1)}=95.9, I^{(2)}=97.8, \hbar\omega=0.156$   
 G 624.9+v, J+4  $\gamma_{292+v}$  332.9 (†, 0.76 s)  $I^{(1)}=96.1, I^{(2)}=101.0, \hbar\omega=0.176$   
 G 997.4+v, J+6  $\gamma_{625+v}$  372.5 (†, 1.07 s)  $I^{(1)}=96.6, I^{(2)}=102.6, \hbar\omega=0.196$   
 G 1408.9+v, J+8  $\gamma_{997+v}$  411.5 (†, 0.87 s)  $I^{(1)}=97.2, I^{(2)}=104.2, \hbar\omega=0.215$   
 G 1858.8+v, J+10  $\gamma_{1409+v}$  449.9 (†, 0.97 s)  $I^{(1)}=97.8, I^{(2)}=104.7, \hbar\omega=0.235$   
 G 2346.9+v, J+12  $\gamma_{1859+v}$  488.1 (†, 0.83 s)  $I^{(1)}=98.3, I^{(2)}=108.1, \hbar\omega=0.253$   
 G 2872.0+v, J+14  $\gamma_{2347+v}$  525.1 (†, 0.57 s)  $I^{(1)}=99.0, I^{(2)}=109.0, \hbar\omega=0.272$   
 G 3433.8+v, J+16  $\gamma_{2872+v}$  561.8 (†, 0.65 s)  $I^{(1)}=99.7, I^{(2)}=114.0, \hbar\omega=0.290$   
 G 4030.7+v, J+18  $\gamma_{3434+v}$  596.9 (†, 0.97 s)  $I^{(1)}=100.5, I^{(2)}=114.3, \hbar\omega=0.307$   
 G 4662.6+v, J+20  $\gamma_{4031+v}$  631.9 (†, 0.55 s)  $I^{(1)}=101.3, I^{(2)}=117.3, \hbar\omega=0.324$   
 G 5328.6+v, J+22  $\gamma_{4663+v}$  666.0 (†, 0.53 s)  $I^{(1)}=102.1, I^{(2)}=120.5, \hbar\omega=0.341$   
 G 6027.8+v, J+24  $\gamma_{5329+v}$  699.2 (†, 0.40 s)  $I^{(1)}=103.0$   
 H w, J=(27/2)  
 H 311.8+w, J+2  $\gamma_{311.8}$  (†, 0.95 s)  $I^{(1)}=96.2, I^{(2)}=100.5, \hbar\omega=0.166$   
 H 663.4+w, J+4  $\gamma_{312+w}$  351.6 (†, 0.96 s)  $I^{(1)}=96.7, I^{(2)}=103.6, \hbar\omega=0.185$   
 H 1053.6+w, J+6  $\gamma_{663+w}$  390.2 (†, 1.44 s)  $I^{(1)}=97.4, I^{(2)}=102.8, \hbar\omega=0.205$   
 H 1482.7+w, J+8  $\gamma_{1054+w}$  429.1  $I^{(1)}=97.9, I^{(2)}=107.0, \hbar\omega=0.224$   
 H 1949.2+w, J+10  $\gamma_{1483+w}$  466.5 (†, 1.07 s)  $I^{(1)}=98.6, I^{(2)}=108.1, \hbar\omega=0.243$   
 H 2452.7+w, J+12  $\gamma_{1949+w}$  503.5 (†, 0.78 s)  $I^{(1)}=99.3, I^{(2)}=111.1, \hbar\omega=0.261$   
 H 2992.2+w, J+14  $\gamma_{2453+w}$  539.5 (†, 0.70 s)  $I^{(1)}=100.1, I^{(2)}=114.9, \hbar\omega=0.278$   
 H 3566.5+w, J+16  $\gamma_{2992+w}$  574.3 (†, 0.71 s)  $I^{(1)}=101.0, I^{(2)}=114.6, \hbar\omega=0.296$   
 H 4175.7+w, J+18  $\gamma_{3567+w}$  609.2 (†, 0.64 s)  $I^{(1)}=101.8, I^{(2)}=119.8, \hbar\omega=0.313$   
 H 4818.3+w, J+20  $\gamma_{4176+w}$  642.6 (†, 0.50 s)  $I^{(1)}=102.7, I^{(2)}=122.7, \hbar\omega=0.329$   
 H 5493.5+w, J+22  $\gamma_{4818+w}$  675.2 (†, 0.40 s)  $I^{(1)}=103.7, I^{(2)}=123.8, \hbar\omega=0.346$   
 H 6201.0+w, J+24  $\gamma_{5494+w}$  707.5 (†, 0.33 s)  $I^{(1)}=104.6$

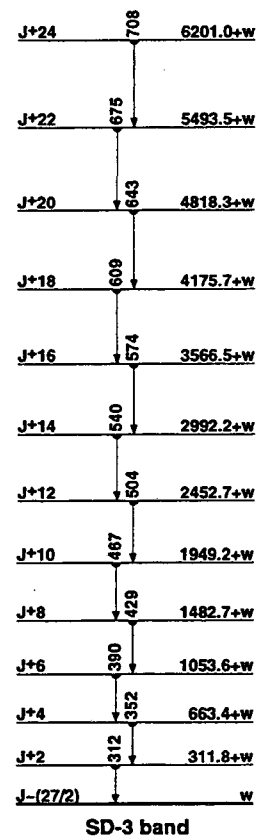
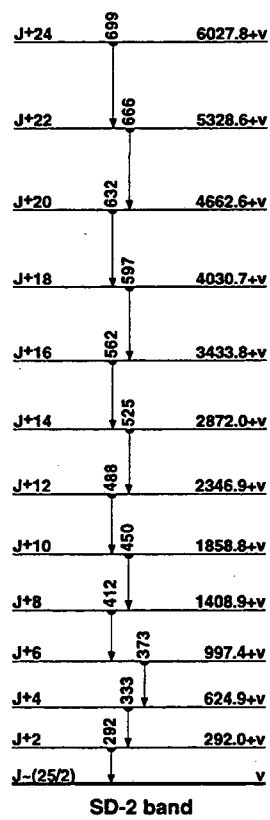
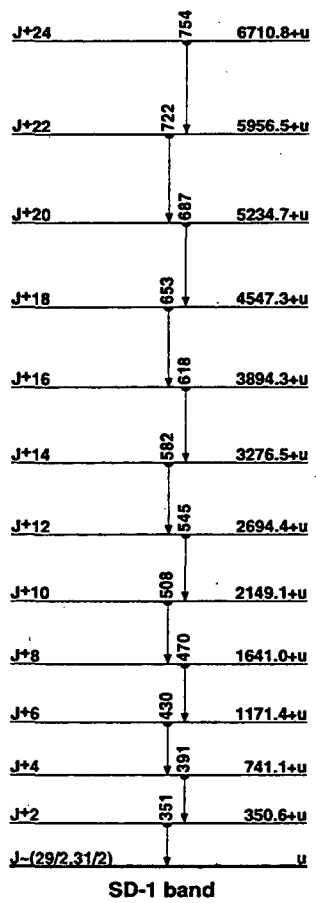

**<sup>191</sup>Hg**  
**<sup>80</sup>Hg**

**192Hg**  
**80**

$\Delta$ : (-32100)  $S_n$ : (9500)  $S_p$ : (5500)

$Q_{EC}$ : (700)  $Q_\alpha$ : (3300)

**Nuclear Bands**

- A GS band,  $(\pi, \alpha)=(+, 0)$
- B  $(\pi, \alpha)=(-, 1)$
- C  $(\pi, \alpha)=(-, 0)$
- D  $(\pi, \alpha)=(+, 0)$
- E Band Structure
- F  $(\pi, \alpha)=(-, 0)$
- G  $(\pi, \alpha)=(-, 1)$
- H  $(\pi, \alpha)=(+, 0)$
- I SD band

**Levels and  $\gamma$ -ray branchings:**

- A 0, 0<sup>+</sup>, 4.85 20 h, %EC=100
- A 422.8 1, 2<sup>+</sup>  $\gamma_{422}$  422.81 (†, 100) E2
- A 1057.6 2, 4<sup>+</sup>  $\gamma_{423}$  634.81 (†, 100) E2
- 1113.6 2, 2<sup>+</sup>  $\gamma_{425}$  690.81 (†, 100) E
- M1+E2:  $\delta=1.7_{-3}$   $\gamma_{1113.0}$  1113.0 (†, 24.3 12) E2
- 1535.6 2, 3<sup>+</sup>  $\gamma_{1058}$  477.63 (†, 12.3 14)
- M1(+E2):  $\delta=0.55$   $\gamma_{423}$  1113.02 (†, 100.5) M1
- 1733.0 2, (4)<sup>+</sup>  $\gamma_{1114}$  619.42 (†, 84.4) E2
- $\gamma_{1058}$  675.41 (†, 100.6) M1+E2:  $\delta=0.7_{-2}$
- A 1803.1 2, 6<sup>+</sup>  $\gamma_{1058}$  745.51 (†, 100) E2
- 1831.6 2, (3, 4)  $\gamma_{1114}$  717.93 (†, 100.0 14)
- $\gamma_{1058}$  774.12 (†, 74.5)
- B 1843.9 2, (5)<sup>-</sup>  $\gamma_{1058}$  786.31 (†, 100) E1
- 1844.6 3, (3, 4)  $\gamma_{423}$  1421.82 (†, 100)
- 1908.6 3, 1, 2<sup>+</sup>  $\gamma_{423}$  1486.14 (†, 76.8)  $\gamma_0$  1908.43 (†, 100.7)
- B 1977.1 2, (7)<sup>-</sup>, 1.04 6 ns  $\gamma_{1844}$  133.11 (†, 42.5 16) E2
- $\gamma_{1803}$  174.01 (†, 100.4) E1
- 2056.3 3, (1, 2<sup>+</sup>)  $\gamma_{423}$  1633.52 (†, 100.7)
- $\gamma_0$  2056.06 (?) (†, <56)
- 2081.7 3, (1, 2<sup>+</sup>)  $\gamma_{423}$  1658.92 (†, 100.8)
- $\gamma_0$  2081.96 (?) (†, 3.5 13)
- 2187.0 3, (6)<sup>-</sup>  $\gamma_{1844}$  343.12 (†, 35 13) M1
- $\gamma_{1803}$  363.92 (†, 100 13) E1
- C 2216.3 3, (8)<sup>-</sup>, 0.92 5 ns  $\gamma_{1977}$  239.22 (†, 100) M1+E2:  $\delta=1.26$
- B 2223.9 3, (9)<sup>-</sup>  $\gamma_{1977}$  246.82 (†, 100) E2
- 2276.9 3, 1, 2<sup>+</sup>  $\gamma_{423}$  1854.04 (†, 100.9)  $\gamma_0$  2277.06 (†, 57.9)
- 2284.7 4  $\gamma_{1114}$  1171.14 (†, 100)
- 2300.8 3, (6, 7, 8)<sup>-</sup>  $\gamma_{1977}$  323.72 (†, 100) M1+E2:  $\delta=0.74$  17
- D 2447.2 3, (8)<sup>+</sup>  $\gamma_{1803}$  644.12 (†, 100) E2
- D 2507.3 3, (10)<sup>+</sup>, 3.6 5 ns  $\gamma_{2447}$  60.13 (†, =2.2) E2
- $\gamma_{224}$  283.42 (†, 100.20) (E1)
- 2534.6 4 (?)  $\gamma_{1536}$  999.03 (?) (†, 100)
- D 2535.6 3, (12)<sup>+</sup>, 11.1 5 ns  $\gamma_{2507}$  28.43 (†, 100) E2
- C 2632.7 3, (10)<sup>-</sup>  $\gamma_{2224}$  408.82 (†, 38)  $\gamma_{2216}$  416.52 (†, 100) E2
- 2657 (?)  $\gamma_{1803}$  854 (?) (†, 100)
- B 2756.8 3, (11)<sup>-</sup>  $\gamma_{2224}$  532.92 (†, 100) E2
- D 2951.8 3, (14)<sup>+</sup>  $\gamma_{2536}$  416.32 (†, 100) E2
- E 3047.0 3, (12<sup>+</sup>)  $\gamma_{2536}$  511.33  $\gamma_{2507}$  539.73 E2
- C 3261.9 3, (12)<sup>-</sup>  $\gamma_{2757}$  505.23 (†, 3.8)  $\gamma_{2633}$  629.22 (†, 100) E2
- B 3449.7 3, (13)<sup>-</sup>  $\gamma_{2757}$  692.92 (†, 100) E2
- D 3608.7 4, (16)<sup>+</sup>  $\gamma_{2952}$  656.82 (†, 100) E2
- E 3669.9 4, (14<sup>+</sup>)  $\gamma_{3047}$  622.73 (†, 100) E2
- $\gamma_{2952}$  718.43 (†, 63)
- 3725.7 4, (14<sup>+</sup>)  $\gamma_{3047}$  678.73 (†, 100) E2
- F 3894.9 3, (14)<sup>-</sup>  $\gamma_{3450}$  445.23 (†, 3.8)  $\gamma_{3262}$  633.02 (†, 100) E2
- G 4010.5 3, (15)<sup>-</sup>  $\gamma_{3450}$  560.92 (†, 100) E2
- $\gamma_{2952}$  1058.73 (†, 24)
- F 4090.0 3, (16)<sup>-</sup>, 0.39 4 ns  $\gamma_{3895}$  195.02 (†, 100) E2
- E 4130.7 4, (16<sup>+</sup>)  $\gamma_{3726}$  405.03 (†, 26) E2

- $\gamma_{3670}$  460.93 (†, 100) E2  $\gamma_{3605}$  521.93 (†, 30)
- G 4216.9 4, (17)<sup>-</sup>  $\gamma_{4090}$  126.93 (†, 33)  $\gamma_{4011}$  206.53 (†, 100) E2
- F 4387.7 4, (18)<sup>-</sup>  $\gamma_{4090}$  297.73 (†, 100) E2
- D 4389.5 4, (18)<sup>+</sup>  $\gamma_{3605}$  780.82 (†, 100) E2
- G 4588.4 4, (19)<sup>-</sup>  $\gamma_{4388}$  200.73 (†, 8.2)  $\gamma_{4217}$  371.52 (†, 100) E2
- E 4741.7 4, (18)<sup>+</sup>  $\gamma_{4131}$  611.02 (†, 100) (E2)
- F 4950.5 5, (20)<sup>-</sup>  $\gamma_{4388}$  562.83 (†, 100) E2
- H 5130.8 5, (20)<sup>+</sup>  $\gamma_{4380}$  741.32 (†, 100) E2
- G 5216.0 4, (21)<sup>-</sup>  $\gamma_{4588}$  627.62 (†, 100) (E2)
- D 5271.7 5, (20)<sup>+</sup>  $\gamma_{4390}$  882.23 (†, 100)
- E 5316.5 5, (20)<sup>+</sup>  $\gamma_{4742}$  574.83 (†, 100) E2
- F 5655.2 6, (22)<sup>-</sup>  $\gamma_{4851}$  704.73 (†, 100) E2
- H 5700.7 5, (22)<sup>+</sup>  $\gamma_{5131}$  569.92 (†, 100) E2
- E 5787.9 6, (22)<sup>+</sup>  $\gamma_{5317}$  471.43 (†, 100) (E2)
- G 6012.2 5, (23)<sup>-</sup>  $\gamma_{5216}$  796.23 (†, 100) E2
- H 6428.2 6, (24)<sup>+</sup>  $\gamma_{5701}$  727.53 (†, 100) E2
- F 6437.5 7, (24)<sup>-</sup>  $\gamma_{5655}$  782.33 (†, 100)
- G 6855.0 6 (?), (25)<sup>-</sup>  $\gamma_{6012}$  842.83 (?) (†, 100)
- I x, J=(8)
- I 214.9+x, J+2  $\gamma_{214.92}$  (†, 0.06 1) (E2)  $I^{(1)}=88.4$ ,  $I^{(2)}=92.4$ ,  $\hbar\omega=0.118$
- I 473.1+x, J+4  $\gamma_{215+x}$  258.21 (†, 0.85 10) (E2)  $I^{(1)}=89.1$ ,  $I^{(2)}=94.8$ ,  $\hbar\omega=0.140$
- I 773.5+x, J+6  $\gamma_{473+x}$  300.41 (†, 0.90 5) (E2)  $I^{(1)}=89.9$ ,  $I^{(2)}=96.9$ ,  $\hbar\omega=0.161$
- I 1115.2+x, J+8  $\gamma_{774+x}$  341.71 (E2)  $I^{(1)}=90.7$ ,  $I^{(2)}=99.3$ ,  $\hbar\omega=0.181$
- I 1497.2+x, J+10  $\gamma_{1115+x}$  382.01 (†, 0.95 5) (E2)  $I^{(1)}=91.6$ ,  $I^{(2)}=102.0$ ,  $\hbar\omega=0.201$
- I 1918.4+x, J+12  $\gamma_{1497+x}$  421.21 (†, 1.00 20) (E2)  $I^{(1)}=92.6$ ,  $I^{(2)}=104.4$ ,  $\hbar\omega=0.220$
- I 2377.9+x, J+14, 0.16 5 ps  $\gamma_{1918+x}$  459.51 (†, 1.00 5) (E2)  $I^{(1)}=93.6$ ,  $I^{(2)}=107.2$ ,  $\hbar\omega=0.239$
- I 2874.7+x, J+16, 0.13 3 ps  $\gamma_{2378+x}$  496.81 (†, 0.80 5) (E2)  $I^{(1)}=94.6$ ,  $I^{(2)}=111.1$ ,  $\hbar\omega=0.257$
- I 3407.5+x, J+18, 0.089 31 ps  $\gamma_{2875+x}$  532.81 (†, 0.70 10) (E2)  $I^{(1)}=95.7$ ,  $I^{(2)}=113.6$ ,  $\hbar\omega=0.275$
- I 3975.5+x, J+20, 0.058 17 ps  $\gamma_{3408+x}$  568.01 (†, 0.60 5) (E2)  $I^{(1)}=96.8$ ,  $I^{(2)}=115.9$ ,  $\hbar\omega=0.293$
- I 4578.0+x, J+22, 0.055 14 ps  $\gamma_{3976+x}$  602.51 (†, 0.50 10) (E2)  $I^{(1)}=97.9$ ,  $I^{(2)}=119.0$ ,  $\hbar\omega=0.310$
- I 5214.1+x, J+24, 0.042 17 ps  $\gamma_{4578+x}$  636.11 (†, 0.45 15) (E2)  $I^{(1)}=99.0$ ,  $I^{(2)}=121.6$ ,  $\hbar\omega=0.326$
- I 5883.1+x, J+26, 0.034 9 ps  $\gamma_{5214+x}$  669.02 (†, 0.40 5) (E2)  $I^{(1)}=100.1$ ,  $I^{(2)}=125.4$ ,  $\hbar\omega=0.342$
- I 6584.0+x, J+28, 0.032 14 ps  $\gamma_{5883+x}$  700.92 (†, 0.30 5) (E2)  $I^{(1)}=101.3$ ,  $I^{(2)}=127.8$ ,  $\hbar\omega=0.358$
- I 7316.2+x, J+30  $\gamma_{6584+x}$  732.21 (†, 0.25 5) (E2)  $I^{(1)}=102.4$ ,  $I^{(2)}=130.7$ ,  $\hbar\omega=0.374$
- I 8079.0+x, J+32, <0.03 ps  $\gamma_{7316+x}$  762.84 (†, 0.15 5) (E2)  $I^{(1)}=103.6$ ,  $I^{(2)}=132.5$ ,  $\hbar\omega=0.389$
- I 8872.0+x, J+34  $\gamma_{8079+x}$  793.03 (†, 0.15 5) (E2)  $I^{(1)}=104.7$ ,  $I^{(2)}=135.6$ ,  $\hbar\omega=0.404$
- I 9694.5+x, J+36  $\gamma_{8872+x}$  822.54 (†, 0.10 2) (E2)  $I^{(1)}=105.8$ ,  $I^{(2)}=135.1$ ,  $\hbar\omega=0.419$
- I 10546.6+x, J+38  $\gamma_{9695+x}$  852.16 (†, 0.05 1)  $I^{(1)}=106.8$ ,  $I^{(2)}=133.8$ ,  $\hbar\omega=0.434$
- I 11428.6+x (?), J+40  $\gamma_{10547+x}$  882 (?) (†, 0.05 1)  $I^{(1)}=107.7$

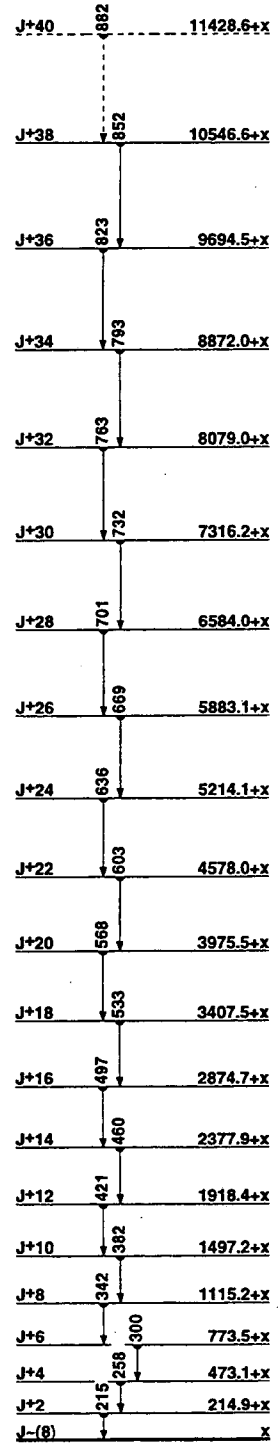

**SD band**  
**192Hg**  
**80**

**193Hg**  
**80Hg**

$\Delta$ : -31071 19  $S_n$ : (7100)  $S_p$ : 5581 25  $Q_{EC}$ : 2340 17  $Q_\alpha$ : 2989 22

**Nuclear Bands**

- A Favored  $i_{132}$  decoupled band
- B Unfavored  $i_{132}$  decoupled band
- C Band Structure
- D Band Structure
- E SD-1 band
- F SD-2 band
- G SD-3 band
- H SD-4 band
- I SD-5 band
- J SD-6 band

**Levels and  $\gamma$ -ray branchings:**

- 0,  $3/2^-$ , 3.80 15 h, %EC+ $\beta^+$ =100,  $\mu$ =-0.62757 18,  $Q_\alpha$ =-0.72 38  
 39.51 3,  $5/2^-$ , 0.63 3 ns  $\gamma_{39.513}$  ( $\dagger_{100}$ ) M1  
 49.96 10,  $(1/2^-)$   $\gamma_{49.9615}$  ( $\dagger_{100}$ )
- A 140.76 5,  $13/2^-$ , 11.82 h, %EC+ $\beta^+$ =92.9, %IT=7.1,  $\mu$ =-1.0584297 26,  $Q_\alpha$ =+0.916 97  $\gamma_{140.765}$  ( $\dagger_{100}$ ) M4  
 207.74 20,  $(7/2^-)$   $\gamma_{207.7420}$  ( $\dagger_{100}$ ) (E2)  
 324.36 7,  $(3/2^-)$   $\gamma_{324.367}$  ( $\dagger_{13.513}$ ) (M1+E2):  $\delta$ =1.8  $\gamma_{40.284.8913}$  ( $\dagger_{21.610}$ ) (M1+E2):  $\delta$ =0.5-5  $\gamma_{324.3710}$  ( $\dagger_{100}$ ) (M1+E2):  $\delta$ =0.4-3  
 344.00 9,  $(3/2^-)$   $\gamma_{344.009}$  ( $\dagger_{10.312}$ ) (M1+E2):  $\delta$ =0.2-8  $\gamma_{343.9910}$  ( $\dagger_{100.4}$ ) (M1+E2):  $\delta$ =1.7-8  
 374.62 9,  $(3/2^-, 5/2^-)$   $\gamma_{374.629}$  ( $\dagger_{40}$ ) (M1+E2):  $\delta$ =0.37-8  $\gamma_{40.335.1110}$  ( $\dagger_{100.4}$ ) (M1+E2):  $\delta$ =0.32-32  $\gamma_{374.5822}$  ( $\dagger_{29.3}$ ) (E2)
- A 522.9 2,  $(17/2^-)$   $\gamma_{522.92}$  ( $\dagger_{100}$ ) (E2)  
 B 747.1 3,  $(15/2^-)$   $\gamma_{747.13}$  ( $\dagger_{100}$ ) (M1+E2)  
 752.6 3,  $(3/2^-, 5/2^-)$   $\gamma_{752.63}$  ( $\dagger_{52.6}$ ) (M1+E2):  $\delta$ =3.2  $\gamma_{752.54}$  ( $\dagger_{100.15}$ ) (M1)  
 1026.6 3,  $(13/2^-, 15/2^-)$   $\gamma_{1026.63}$  ( $\dagger_{100}$ )
- A 1145.4 3,  $(21/2^-)$   $\gamma_{1145.43}$  ( $\dagger_{100}$ ) (E2)  
 B 1380.6 2,  $(19/2^-)$   $\gamma_{1380.62}$  ( $\dagger_{70}$ ) (E2)  $\gamma_{523.857.62}$  ( $\dagger_{100}$ ) (M1+E2)  
 1523.3 3,  $(-)$   $\gamma_{1523.33}$  ( $\dagger_{100.6}$ ) (M1+E2):  $\delta$ =0.9-5  $\gamma_{40.1484.17}$  ( $\dagger_{26.8}$ )  $\gamma_{1523.44}$  ( $\dagger_{62.15}$ )  
 1523.4 3,  $(17/2^-, 19/2^-)$   $\gamma_{1523.43}$  ( $\dagger_{33}$ ) (E2)  $\gamma_{523.1000.53}$  ( $\dagger_{100}$ ) (M1+E2)  
 1580.1 3  $\gamma_{1580.13}$  ( $\dagger_{23.3}$ )  $\gamma_{324.1256.03}$  ( $\dagger_{23.4}$ )  $\gamma_{40.1539.410}$  ( $\dagger_{20.4}$ )  $\gamma_{1579.310}$  ( $\dagger_{100.22}$ )
- C 1756.0 3,  $(21/2^-)$   $\gamma_{1756.03}$  ( $\dagger_{53}$ )  $\gamma_{1381.375.32}$  ( $\dagger_{100}$ ) (E1)  $\gamma_{1146.610.44}$
- A 1884.2 3,  $(25/2^-)$   $\gamma_{1884.23}$  ( $\dagger_{100}$ ) (E2)  
 C 1886.5 3,  $(25/2^-)$ , 1.58 6 ns  $\gamma_{1886.53}$  ( $\dagger_{100}$ ) (E2)  
 D 1890.8 3,  $(23/2^-)$   $\gamma_{1890.83}$  ( $\dagger_{18}$ )  $\gamma_{1145.745.52}$  ( $\dagger_{100}$ ) (E1)  
 2095.9 3,  $(27/2^-)$   $\gamma_{2095.93}$  ( $\dagger_{100}$ ) (E2)  $\gamma_{1887.209.64}$  ( $\dagger_{7.5}$ )  
 C 2189.2 3,  $(29/2^-)$   $\gamma_{2189.23}$  ( $\dagger_{100}$ ) (E2)  $\gamma_{2096.93.05}$  ( $\dagger_{1887}$ )  $\gamma_{302.72}$  (E2)
- A 2502.1 4,  $(29/2^-)$   $\gamma_{2502.14}$  ( $\dagger_{100}$ ) (E2)  
 D 2583.6 4,  $(31/2^-)$   $\gamma_{2583.64}$  ( $\dagger_{100}$ ) (E2)  
 2641.6 4,  $(29/2^-)$   $\gamma_{2641.64}$  ( $\dagger_{100}$ ) (E2)
- A 2695.5 4,  $(33/2^-)$ , 573 30 ps  $\gamma_{2695.54}$  ( $\dagger_{100}$ ) (E2)  
 C 2762.2 4,  $(33/2^-)$   $\gamma_{2762.24}$  ( $\dagger_{100}$ ) (E2)  
 A 3176.1 4,  $(37/2^-)$   $\gamma_{3176.14}$  ( $\dagger_{100}$ ) (E2)  
 3195.9 6,  $(33/2^-)$   $\gamma_{3195.96}$  ( $\dagger_{100}$ ) (E2)  
 D 3223.2 4,  $(35/2^-)$   $\gamma_{3223.24}$  ( $\dagger_{100}$ ) (E2)  
 3260.0 4,  $(33/2^-)$   $\gamma_{3260.04}$  ( $\dagger_{100}$ ) (E2)  $\gamma_{2696.564.54}$   $\gamma_{2502.757.83}$  (E2)
- C 3497.3 4,  $(37/2^-)$   $\gamma_{3497.34}$  ( $\dagger_{100}$ ) (E2)  
 3570.0 5,  $(37/2^-)$   $\gamma_{3570.05}$  ( $\dagger_{70}$ ) (E2)  $\gamma_{5176.393.93}$  ( $\dagger_{100}$ ) (M1+E2)
- A 3880.4 5,  $(41/2^-)$   $\gamma_{3880.45}$  ( $\dagger_{100}$ ) (E2)  
 D 3883.4 5,  $(39/2^-)$   $\gamma_{3883.45}$  ( $\dagger_{100}$ ) (E2)  
 4120.4 6,  $(41/2^-)$   $\gamma_{4120.46}$  ( $\dagger_{100}$ ) (E2)  
 C 4150.6 5,  $(41/2^-)$   $\gamma_{4150.65}$  ( $\dagger_{100}$ ) (E2)  
 4197.7 6  $\gamma_{4197.76}$  ( $\dagger_{100}$ )  $\gamma_{3223.974.54}$  ( $\dagger_{100}$ )
- D 4396.2 6,  $(43/2^-)$   $\gamma_{4396.26}$  ( $\dagger_{100}$ ) (E2)  $\gamma_{3883.512.84}$  ( $\dagger_{100}$ )  
 4412.1 6  $\gamma_{4412.16}$  ( $\dagger_{100}$ )  $\gamma_{3917.914.84}$  ( $\dagger_{100}$ )
- C 4673.8 6,  $(45/2^-)$   $\gamma_{4673.86}$  ( $\dagger_{100}$ ) (E2)  
 A 4688.1 6,  $(45/2^-)$   $\gamma_{4688.16}$  ( $\dagger_{100}$ ) (E2)  
 D 5047.3 7,  $(47/2^-)$   $\gamma_{5047.37}$  ( $\dagger_{100}$ ) (E2)  
 C 5546.9 7,  $(49/2^-)$   $\gamma_{5546.97}$  ( $\dagger_{100}$ ) (E2)  
 A 5556.9 7,  $(49/2^-)$   $\gamma_{5556.97}$  ( $\dagger_{100}$ ) (E2)  
 D 5898.3 8,  $(51/2^-)$   $\gamma_{5898.38}$  ( $\dagger_{100}$ ) (E2)  $\gamma_{5047.851.04}$  ( $\dagger_{100}$ )
- E x, J=(19/2)  
 F 112.1+x, J+1  
 E 233.2+x, J+2  $\gamma_{112.233.2}$  ( $\dagger_{0.373}$ )  $I^{(1)}$ =94.3,  $I^{(2)}$ =97.6,  $\eta_\omega$ =0.127  
 F 366.1+x, J+3  $\gamma_{233.366.1}$  ( $\dagger_{0.125}$ )  $I^{(1)}$ =19.7,  $I^{(2)}$ =98.5,  $\eta_\omega$ =0.137  
 E 507.4+x, J+4  $\gamma_{366.507.4}$  ( $\dagger_{0.483}$ )  $I^{(1)}$ =94.8,  $I^{(2)}$ =99.8,  $\eta_\omega$ =0.147  
 F 660.7+x, J+5  $\gamma_{507.660.7}$  ( $\dagger_{0.388}$ )  $I^{(1)}$ =30.5,  $I^{(2)}$ =99.3,  $\eta_\omega$ =0.157  
 E 821.7+x, J+6  $\gamma_{661.821.7}$  ( $\dagger_{0.755}$ )  $I^{(1)}$ =95.5,  $I^{(2)}$ =102.3,  $\eta_\omega$ =0.167  
 F 995.6+x, J+7  $\gamma_{822.995.6}$  ( $\dagger_{0.619}$ )  $I^{(1)}$ =38.8,  $I^{(2)}$ =101.0,  $\eta_\omega$ =0.177  
 E 1175.1+x, J+8  $\gamma_{996.1175.1}$  ( $\dagger_{0.905}$ )  $I^{(1)}$ =96.2,  $I^{(2)}$ =103.9,  $\eta_\omega$ =0.186  
 F 1370.1+x, J+9  $\gamma_{996.1370.1}$  ( $\dagger_{0.7318}$ )  $I^{(1)}$ =45.4,  $I^{(2)}$ =103.6,  $\eta_\omega$ =0.197  
 E 1567.0+x, J+10  $\gamma_{1370.1567.0}$  ( $\dagger_{0.965}$ )  $I^{(1)}$ =97.0,  $I^{(2)}$ =107.8,  $\eta_\omega$ =0.205  
 F 1783.2+x, J+11  $\gamma_{1370.1783.2}$  ( $\dagger_{1.0012}$ )  $I^{(1)}$ =50.8,  $I^{(2)}$ =105.3,  $\eta_\omega$ =0.216  
 E 1996.0+x, J+12  $\gamma_{1783.1996.0}$  ( $\dagger_{1.005}$ )  $I^{(1)}$ =97.9,  $I^{(2)}$ =113.0,  $\eta_\omega$ =0.223  
 F 2234.3+x, J+13  $\gamma_{1783.2234.3}$  ( $\dagger_{1.0012}$ )  $I^{(1)}$ =55.4,  $I^{(2)}$ =107.5,  $\eta_\omega$ =0.235  
 E 2460.4+x, J+14  $\gamma_{2234.2460.4}$  ( $\dagger_{0.983}$ )  $I^{(1)}$ =99.1,  $I^{(2)}$ =121.2,  $\eta_\omega$ =0.240  
 F 2722.6+x, J+15  $\gamma_{2234.2722.6}$  ( $\dagger_{0.9618}$ )  $I^{(1)}$ =59.4,  $I^{(2)}$ =109.3,  $\eta_\omega$ =0.253  
 E 2957.8+x, J+16  $\gamma_{2460.2957.8}$  ( $\dagger_{1.003}$ )  $I^{(1)}$ =100.5,  $I^{(2)}$ =129.9,  $\eta_\omega$ =0.256  
 F 3247.5+x, J+17  $\gamma_{2722.3247.5}$  ( $\dagger_{0.9820}$ )  $I^{(1)}$ =62.9,  $I^{(2)}$ =114.3,  $\eta_\omega$ =0.271  
 E 3486.0+x, J+18  $\gamma_{2958.3486.0}$  ( $\dagger_{1.1110}$ )  $I^{(1)}$ =102.2,  $I^{(2)}$ =132.0,  $\eta_\omega$ =0.272  
 F 3807.4+x, J+19  $\gamma_{3248.3807.4}$  ( $\dagger_{1.0810}$ )  $I^{(1)}$ =66.1,  $I^{(2)}$ =114.3,  $\eta_\omega$ =0.289  
 E 4044.5+x, J+20  $\gamma_{3486.4044.5}$  ( $\dagger_{0.9414}$ )  $I^{(1)}$ =103.8,  $I^{(2)}$ =127.0,  $\eta_\omega$ =0.287  
 F 4402.3+x, J+21  $\gamma_{3807.4402.3}$  ( $\dagger_{1.0810}$ )  $I^{(1)}$ =68.9,  $I^{(2)}$ =118.0,  $\eta_\omega$ =0.306  
 E 4634.5+x, J+22  $\gamma_{4045.4634.5}$  ( $\dagger_{0.7320}$ )  $I^{(1)}$ =105.1,  $I^{(2)}$ =122.7,  $\eta_\omega$ =0.303  
 F 5031.1+x, J+23  $\gamma_{4402.5031.1}$  ( $\dagger_{0.858}$ )  $I^{(1)}$ =71.6,  $I^{(2)}$ =121.6,  $\eta_\omega$ =0.323  
 E 5257.1+x, J+24  $\gamma_{4635.5257.1}$  ( $\dagger_{1.060}$ )  $I^{(1)}$ =106.0,  $I^{(2)}$ =120.8,  $\eta_\omega$ =0.320  
 F 5692.8+x, J+25  $\gamma_{5031.5692.8}$  ( $\dagger_{0.5212}$ )  $I^{(1)}$ =74.1,  $I^{(2)}$ =123.5,  $\eta_\omega$ =0.339  
 E 5912.8+x, J+26  $\gamma_{5257.5912.8}$  ( $\dagger_{0.4016}$ )  $I^{(1)}$ =106.8,  $I^{(2)}$ =122.0,  $\eta_\omega$ =0.336  
 F 6386.9+x, J+27  $\gamma_{5693.6386.9}$  ( $\dagger_{0.5615}$ )  $I^{(1)}$ =76.4,  $I^{(2)}$ =127.0,  $\eta_\omega$ =0.355  
 E 6601.3+x, J+28  $\gamma_{5913.6601.3}$  ( $\dagger_{0.1810}$ )  $I^{(1)}$ =107.5,  $I^{(2)}$ =122.0,  $\eta_\omega$ =0.352  
 F 7112.5+x, J+29  $\gamma_{6387.7112.5}$  ( $\dagger_{0.4519}$ )  $I^{(1)}$ =78.6,  $I^{(2)}$ =129.0,  $\eta_\omega$ =0.371  
 E 7322.6+x, J+30  $\gamma_{6601.7322.6}$  ( $\dagger_{0.3910}$ )  $I^{(1)}$ =108.1,  $I^{(2)}$ =125.4,  $\eta_\omega$ =0.369  
 F 7869.1+x, J+31  $\gamma_{7113.7869.1}$  ( $\dagger_{0.3810}$ )  $I^{(1)}$ =80.6,  $I^{(2)}$ =130.3,  $\eta_\omega$ =0.386  
 E 8075.8+x, J+32  $\gamma_{7323.8075.8}$  ( $\dagger_{0.5516}$ )  $I^{(1)}$ =108.9,  $I^{(2)}$ =126.2,  $\eta_\omega$ =0.385  
 F 8656.4+x, J+33  $\gamma_{7869.8656.4}$  ( $\dagger_{0.5516}$ )  $I^{(1)}$ =82.6,  $I^{(2)}$ =131.6,  $\eta_\omega$ =0.401  
 E 8860.7+x, J+34  $\gamma_{8076.8860.7}$  ( $\dagger_{0.5516}$ )  $I^{(1)}$ =109.6,  $I^{(2)}$ =126.2,  $\eta_\omega$ =0.400  
 F 9474.1+x, J+35  $\gamma_{8656.9474.1}$  ( $\dagger_{0.5516}$ )  $I^{(1)}$ =84.4,  $I^{(2)}$ =134.2,  $\eta_\omega$ =0.416  
 E 9677.3+x, J+36  $\gamma_{8861.9677.3}$  ( $\dagger_{0.5516}$ )  $I^{(1)}$ =110.2,  $I^{(2)}$ =128.2,  $\eta_\omega$ =0.416  
 F 10321.6+x, J+37  $\gamma_{9474.10321.6}$  ( $\dagger_{0.5516}$ )  $I^{(1)}$ =86.1,  $I^{(2)}$ =139.9,  $\eta_\omega$ =0.431  
 E 10525.1+x, J+38  $\gamma_{9677.10525.1}$  ( $\dagger_{0.5516}$ )  $I^{(1)}$ =110.9,  $I^{(2)}$ =120.8,  $\eta_\omega$ =0.432  
 F 11197.7+x, J+39  $\gamma_{10322.11197.7}$  ( $\dagger_{0.5516}$ )  $I^{(1)}$ =87.9  
 E 11406.0+x, J+40  $\gamma_{10525.11406.0}$  ( $\dagger_{0.5516}$ )  $I^{(1)}$ =111.2
- G y, J=(19/2)  
 H 111.1+y, J+1  
 G 233.5+y, J+2  $\gamma_{111.233.5}$  ( $\dagger_{0.219}$ )  $I^{(1)}$ =94.2,  $I^{(2)}$ =95.9,  $\eta_\omega$ =0.127  
 H 365.1+y, J+3  $\gamma_{234.365.1}$  ( $\dagger_{0.125}$ )  $I^{(1)}$ =19.7,  $I^{(2)}$ =98.5,  $\eta_\omega$ =0.137  
 G 508.7+y, J+4  $\gamma_{365.508.7}$  ( $\dagger_{0.305}$ )  $I^{(1)}$ =94.5,  $I^{(2)}$ =100.0,  $\eta_\omega$ =0.148  
 H 659.7+y, J+5  $\gamma_{509.659.7}$  ( $\dagger_{0.388}$ )  $I^{(1)}$ =30.5,  $I^{(2)}$ =99.3,  $\eta_\omega$ =0.157  
 G 823.9+y, J+6  $\gamma_{660.823.9}$  ( $\dagger_{0.535}$ )  $I^{(1)}$ =95.2,  $I^{(2)}$ =100.8,  $\eta_\omega$ =0.168  
 H 994.6+y, J+7  $\gamma_{824.994.6}$  ( $\dagger_{0.619}$ )  $I^{(1)}$ =38.8,  $I^{(2)}$ =101.0,  $\eta_\omega$ =0.177  
 G 1178.8+y, J+8  $\gamma_{995.1178.8}$  ( $\dagger_{0.785}$ )  $I^{(1)}$ =95.8,  $I^{(2)}$ =102.8,  $\eta_\omega$ =0.187  
 H 1369.1+y, J+9  $\gamma_{1179.1369.1}$  ( $\dagger_{0.7316}$ )  $I^{(1)}$ =45.4,  $I^{(2)}$ =103.6,  $\eta_\omega$ =0.197  
 G 1572.6+y, J+10  $\gamma_{1369.1572.6}$  ( $\dagger_{0.955}$ )  $I^{(1)}$ =96.5,  $I^{(2)}$ =104.4,  $\eta_\omega$ =0.206  
 H 1782.2+y, J+11  $\gamma_{1573.1782.2}$  ( $\dagger_{1.0012}$ )  $I^{(1)}$ =50.8,  $I^{(2)}$ =105.3,  $\eta_\omega$ =0.216

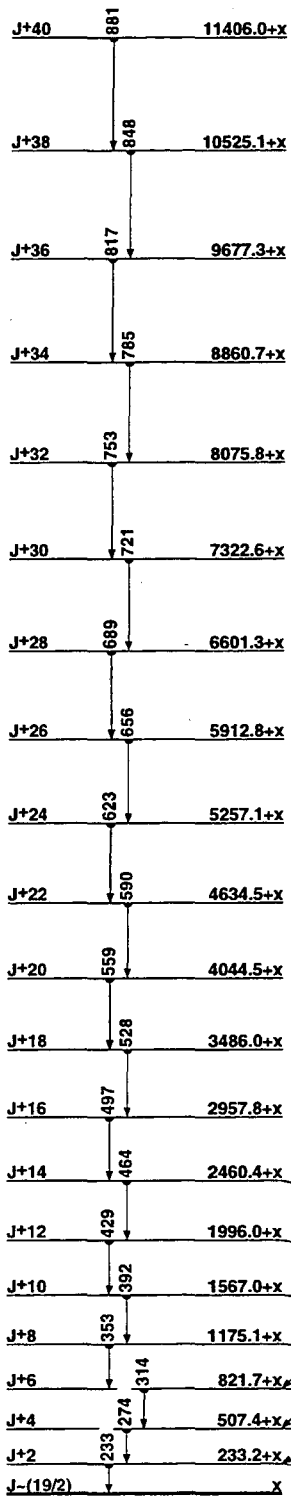

SD-1 band

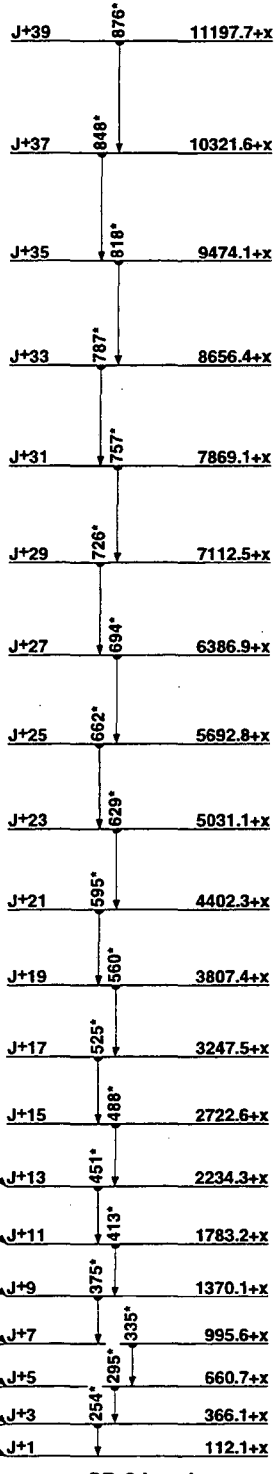

SD-2 band

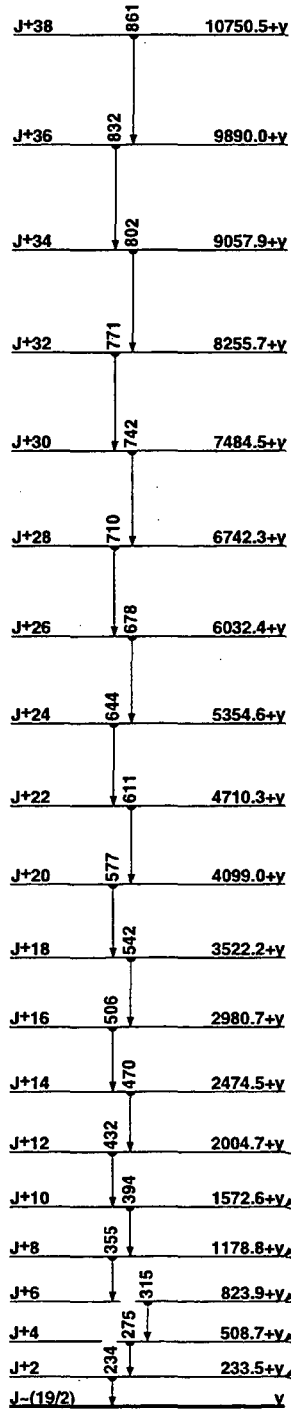

SD-3 band

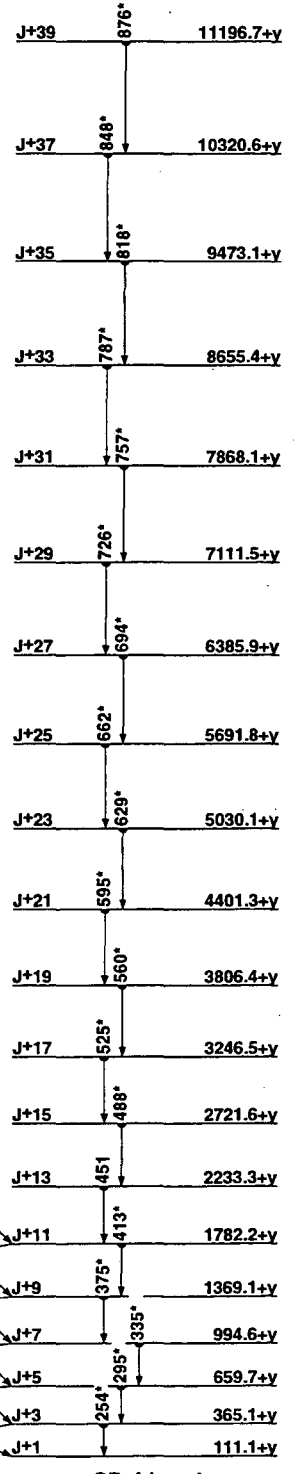

SD-4 band

<sup>193</sup>Hg  
<sub>80</sub>

**<sup>193</sup>Hg (Continued)**

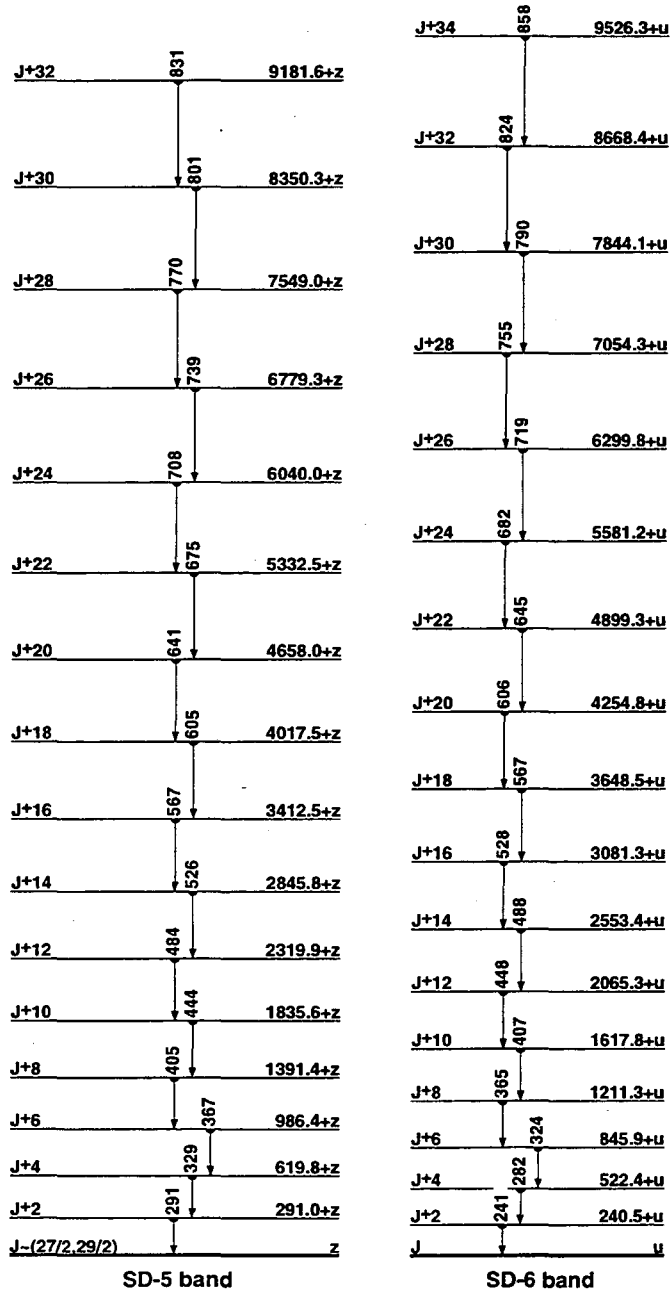

**<sup>193</sup>Hg**  
**<sup>80</sup>Hg**

- G 2004.7+y, J+12  $\gamma_{1782+y} 220.5$   $\gamma_{1573+y} 432.1$  ( $\dagger_{\gamma} 1.02 \theta$ )  $I^{(1)}=97.2$ ,  $I^{(2)}=106.1$ ,  $\eta\omega=0.225$
- H 2233.3+y, J+13  $\gamma_{1782+y} 451.1$  ( $I^{(1)}=55.4$ ,  $I^{(2)}=107.5$ ,  $\eta\omega=0.235$ )
- G 2474.5+y, J+14  $\gamma_{2005+y} 469.8$  ( $\dagger_{\gamma} 1.00 \theta$ )  $I^{(1)}=97.9$ ,  $I^{(2)}=109.9$ ,  $\eta\omega=0.244$
- H 2721.6+y, J+15  $\gamma_{2233+y} 488.3$  ( $\dagger_{\gamma} 0.96 1\theta$ )  $I^{(1)}=59.4$ ,  $I^{(2)}=109.3$ ,  $\eta\omega=0.253$
- G 2980.7+y, J+16  $\gamma_{2475+y} 506.2$  ( $\dagger_{\gamma} 1.00 14$ )  $I^{(1)}=98.8$ ,  $I^{(2)}=113.3$ ,  $\eta\omega=0.262$
- H 3246.5+y, J+17  $\gamma_{2722+y} 524.9$  ( $\dagger_{\gamma} 0.98 2\theta$ )  $I^{(1)}=62.9$ ,  $I^{(2)}=114.3$ ,  $\eta\omega=0.271$
- G 3522.2+y, J+18  $\gamma_{2981+y} 541.5$  ( $\dagger_{\gamma} 0.82 3\theta$ )  $I^{(1)}=99.7$ ,  $I^{(2)}=113.3$ ,  $\eta\omega=0.280$
- H 3806.4+y, J+19  $\gamma_{3247+y} 559.9$  ( $\dagger_{\gamma} 1.08 1\theta$ )  $I^{(1)}=66.1$ ,  $I^{(2)}=114.3$ ,  $\eta\omega=0.289$
- G 4099.0+y, J+20  $\gamma_{3522+y} 576.8$  ( $\dagger_{\gamma} 0.63 24$ )  $I^{(1)}=100.6$ ,  $I^{(2)}=115.9$ ,  $\eta\omega=0.297$
- H 4401.3+y, J+21  $\gamma_{3806+y} 594.9$  ( $I^{(1)}=68.9$ ,  $I^{(2)}=118.0$ ,  $\eta\omega=0.306$ )
- G 4710.3+y, J+22  $\gamma_{4099+y} 611.3$  ( $\dagger_{\gamma} 0.43 2\theta$ )  $I^{(1)}=101.4$ ,  $I^{(2)}=121.2$ ,  $\eta\omega=0.314$
- H 5030.1+y, J+23  $\gamma_{4401+y} 628.8$  ( $\dagger_{\gamma} 0.85 \theta$ )  $I^{(1)}=71.6$ ,  $I^{(2)}=121.6$ ,  $\eta\omega=0.323$
- G 5354.6+y, J+24  $\gamma_{4710+y} 644.3$  ( $I^{(1)}=102.4$ ,  $I^{(2)}=119.4$ ,  $\eta\omega=0.331$ )
- H 5691.8+y, J+25  $\gamma_{5030+y} 661.7$  ( $\dagger_{\gamma} 0.52 12$ )  $I^{(1)}=74.1$ ,  $I^{(2)}=123.5$ ,  $\eta\omega=0.339$
- G 6032.4+y, J+26  $\gamma_{5355+y} 677.8$  ( $I^{(1)}=103.3$ ,  $I^{(2)}=124.6$ ,  $\eta\omega=0.347$ )
- H 6385.9+y, J+27  $\gamma_{5692+y} 694.1$  ( $\dagger_{\gamma} 0.56 15$ )  $I^{(1)}=76.4$ ,  $I^{(2)}=127.0$ ,  $\eta\omega=0.355$
- G 6742.3+y, J+28  $\gamma_{6032+y} 709.9$  ( $I^{(1)}=104.2$ ,  $I^{(2)}=123.8$ ,  $\eta\omega=0.363$ )
- H 7111.5+y, J+29  $\gamma_{6386+y} 725.6$  ( $\dagger_{\gamma} 0.45 19$ )  $I^{(1)}=78.6$ ,  $I^{(2)}=129.0$ ,  $\eta\omega=0.371$
- G 7484.5+y, J+30  $\gamma_{6742+y} 742.2$  ( $I^{(1)}=105.1$ ,  $I^{(2)}=137.9$ ,  $\eta\omega=0.378$ )
- H 7868.1+y, J+31  $\gamma_{7112+y} 756.6$  ( $\dagger_{\gamma} 0.38 1\theta$ )  $I^{(1)}=80.6$ ,  $I^{(2)}=130.3$ ,  $\eta\omega=0.386$
- G 8255.7+y, J+32  $\gamma_{7485+y} 771.2$  ( $I^{(1)}=106.3$ ,  $I^{(2)}=129.0$ ,  $\eta\omega=0.393$ )
- H 8655.4+y, J+33  $\gamma_{7868+y} 787.3$  ( $I^{(1)}=82.6$ ,  $I^{(2)}=131.6$ ,  $\eta\omega=0.401$ )
- G 9057.9+y, J+34  $\gamma_{8256+y} 802.2$  ( $I^{(1)}=107.2$ ,  $I^{(2)}=133.8$ ,  $\eta\omega=0.409$ )
- H 9473.1+y, J+35  $\gamma_{8655+y} 817.7$  ( $I^{(1)}=84.4$ ,  $I^{(2)}=134.2$ ,  $\eta\omega=0.416$ )
- G 9890.0+y, J+36  $\gamma_{9058+y} 832.1$  ( $I^{(1)}=108.2$ ,  $I^{(2)}=140.8$ ,  $\eta\omega=0.423$ )
- H 10320.6+y, J+37  $\gamma_{9473+y} 847.5$  ( $I^{(1)}=86.1$ ,  $I^{(2)}=139.9$ ,  $\eta\omega=0.431$ )
- G 10750.5+y, J+38  $\gamma_{9890+y} 860.5$  ( $I^{(1)}=109.2$ )
- H 11196.7+y, J+39  $\gamma_{10321+y} 876.1$  ( $I^{(1)}=87.9$ )
- I z, J=(27/2, 29/2)
- I 291.0+z, J+2  $\gamma_z 291.0$  ( $I^{(1)}=103.1$ ,  $I^{(2)}=105.8$ ,  $\eta\omega=0.155$ )
- I 619.8+z, J+4  $\gamma_{291+z} 328.8$  ( $I^{(1)}=103.4$ ,  $I^{(2)}=105.8$ ,  $\eta\omega=0.174$ )
- I 986.4+z, J+6  $\gamma_{620+z} 366.6$  ( $\dagger_{\gamma} 1.09 16$ )  $I^{(1)}=103.7$ ,  $I^{(2)}=104.2$ ,  $\eta\omega=0.193$
- I 1391.4+z, J+8  $\gamma_{986+z} 405.0$  ( $I^{(1)}=103.7$ ,  $I^{(2)}=102.0$ ,  $\eta\omega=0.212$ )
- I 1835.6+z, J+10  $\gamma_{1391+z} 444.2$  ( $I^{(1)}=103.6$ ,  $I^{(2)}=99.8$ ,  $\eta\omega=0.232$ )
- I 2319.9+z, J+12  $\gamma_{1836+z} 484.3$  ( $\dagger_{\gamma} 1.09 24$ )  $I^{(1)}=103.2$ ,  $I^{(2)}=96.2$ ,  $\eta\omega=0.253$
- I 2845.8+z, J+14  $\gamma_{2320+z} 525.9$  ( $\dagger_{\gamma} 0.94 12$ )  $I^{(1)}=102.7$ ,  $I^{(2)}=98.0$ ,  $\eta\omega=0.273$
- I 3412.5+z, J+16  $\gamma_{2846+z} 566.7$  ( $\dagger_{\gamma} 0.93 14$ )  $I^{(1)}=102.3$ ,  $I^{(2)}=104.4$ ,  $\eta\omega=0.293$
- I 4017.5+z, J+18  $\gamma_{3413+z} 605.0$  ( $\dagger_{\gamma} 1.10 21$ )  $I^{(1)}=102.5$ ,  $I^{(2)}=112.7$ ,  $\eta\omega=0.311$
- I 4658.0+z, J+20  $\gamma_{4018+z} 640.5$  ( $I^{(1)}=103.0$ ,  $I^{(2)}=117.6$ ,  $\eta\omega=0.329$ )
- I 5332.5+z, J+22  $\gamma_{4658+z} 674.5$  ( $\dagger_{\gamma} 0.37 1\theta$ )  $I^{(1)}=103.8$ ,  $I^{(2)}=121.2$ ,  $\eta\omega=0.346$
- I 6040.0+z, J+24  $\gamma_{5333+z} 707.5$  ( $I^{(1)}=104.6$ ,  $I^{(2)}=125.8$ ,  $\eta\omega=0.362$ )
- I 6779.3+z, J+26  $\gamma_{6040+z} 739.3$  ( $I^{(1)}=105.5$ ,  $I^{(2)}=131.6$ ,  $\eta\omega=0.377$ )
- I 7549.0+z, J+28  $\gamma_{6779+z} 769.7$  ( $I^{(1)}=106.5$ ,  $I^{(2)}=126.6$ ,  $\eta\omega=0.393$ )
- I 8350.3+z, J+30  $\gamma_{7549+z} 801.3$  ( $I^{(1)}=107.3$ ,  $I^{(2)}=133.3$ ,  $\eta\omega=0.408$ )
- I 9181.6+z, J+32  $\gamma_{8350+z} 831.3$  ( $I^{(1)}=108.3$ )
- J u, J
- J 240.5+u, J+2  $\gamma_0 240.5$  ( $\dagger_{\gamma} 0.58 5$ )  $I^{(2)}=96.6$ ,  $\eta\omega=0.131$
- J 522.4+u, J+4  $\gamma_{241+u} 281.9$  ( $\dagger_{\gamma} 0.80 5$ )  $I^{(2)}=96.2$ ,  $\eta\omega=0.151$
- J 845.9+u, J+6  $\gamma_{522+u} 323.5$  ( $\dagger_{\gamma} 0.90 5$ )  $I^{(2)}=95.5$ ,  $\eta\omega=0.172$
- J 1211.3+u, J+8  $\gamma_{846+u} 365.4$  ( $\dagger_{\gamma} 1.00 5$ )  $I^{(2)}=97.3$ ,  $\eta\omega=0.193$
- J 1617.8+u, J+10  $\gamma_{1211+u} 406.5$  ( $\dagger_{\gamma} 1.00 5$ )  $I^{(2)}=97.6$ ,  $\eta\omega=0.213$
- J 2065.3+u, J+12  $\gamma_{1618+u} 447.5$  ( $\dagger_{\gamma} 0.98 5$ )  $I^{(2)}=98.5$ ,  $\eta\omega=0.234$
- J 2553.4+u, J+14  $\gamma_{2065+u} 488.1$  ( $\dagger_{\gamma} 0.95 5$ )  $I^{(2)}=100.5$ ,  $\eta\omega=0.254$
- J 3081.3+u, J+16  $\gamma_{2553+u} 527.9$  ( $\dagger_{\gamma} 1.05 6$ )  $I^{(2)}=101.8$ ,  $\eta\omega=0.274$
- J 3648.5+u, J+18  $\gamma_{3081+u} 567.2$  ( $\dagger_{\gamma} 1.00 6$ )  $I^{(2)}=102.3$ ,  $\eta\omega=0.293$
- J 4254.8+u, J+20  $\gamma_{3649+u} 606.3$  ( $I^{(2)}=104.7$ ,  $\eta\omega=0.313$ )
- J 4899.3+u, J+22  $\gamma_{4255+u} 644.5$  ( $\dagger_{\gamma} 0.90 1\theta$ )  $I^{(2)}=107.0$ ,  $\eta\omega=0.332$
- J 5581.2+u, J+24  $\gamma_{4899+u} 681.9$  ( $\dagger_{\gamma} 0.70 6$ )  $I^{(2)}=109.0$ ,  $\eta\omega=0.350$
- J 6299.8+u, J+26  $\gamma_{5581+u} 718.6$  ( $\dagger_{\gamma} 0.60 6$ )  $I^{(2)}=111.4$ ,  $\eta\omega=0.368$
- J 7054.3+u, J+28  $\gamma_{6300+u} 754.5$  ( $I^{(2)}=113.3$ ,  $\eta\omega=0.386$ )
- J 7844.1+u, J+30  $\gamma_{7054+u} 789.8$  ( $\dagger_{\gamma} 0.42 5$ )  $I^{(2)}=115.9$ ,  $\eta\omega=0.404$
- J 8668.4+u, J+32  $\gamma_{7844+u} 824.3$  ( $\dagger_{\gamma} 0.26 5$ )  $I^{(2)}=119.0$ ,  $\eta\omega=0.421$
- J 9526.3+u, J+34  $\gamma_{8668+u} 857.9$  ( $\dagger_{\gamma} 0.24 5$ )

**194**  
**80** Hg

$\Delta$ : -32247.23  $S_n$ : 9250.30  $S_p$ : 6125.25  $Q_{EC}$ : 40.20  $Q_\alpha$ : 2653.24

**Nuclear Bands**

- A SD-1 band
- B SD-2 band
- C SD-3 band
- D GS band ( $\pi, \alpha$ )=(+, 0)
- E  $(\nu_{1,3/2})^2(\pi h_{1,1/2})^2?$

**Levels and  $\gamma$ -ray branchings:**

- D 0, 0<sup>+</sup>, 520.32 y, %EC=100
- D 428.0.2, 2<sup>+</sup>  $\gamma_{428}$  428.02 (†, 100) E2
- D 1064.5.3, 4<sup>+</sup>  $\gamma_{428}$  636.52 (†, 100) E2
- 1073.2.3, (2<sup>+</sup>)  $\gamma_{428}$  645.20.25 (†, 100.25) E2(+M1):  $\delta > 1$   $\gamma_{1073}$  1073.35 (†, 33.12)
- 1468.5.4, (3<sup>+</sup>)  $\gamma_{1073}$  395.55 (†, 40.8) M1(+E2):  $\delta < 1$   $\gamma_{1065}$  403.97 (†, 48.10)
- M1(+E2):  $\delta < 1$   $\gamma_{428}$  1040.35 (†, 100.30)
- D 1799.4.3, 6<sup>+</sup>  $\gamma_{1065}$  734.92 (†, 100) E2
- 1813.4.3, 5<sup>-</sup>, <0.15 ns  $\gamma_{1065}$  748.92 (†, 100) E1
- 1910.4.3, 7<sup>-</sup>, 3.75 ns  $\gamma_{1813}$  96.95.8 (†, 100.10) E2  $\gamma_{1799}$  110.98.8 (†, 78.8)
- 2138.3.4, 8<sup>-</sup>, 0.91 ns  $\gamma_{1910}$  227.92 (†, 100) E2+M1:  $\delta = 1.2_{-4}^{+8}$
- 2143.5.4, 9<sup>-</sup>, 0.29 ns  $\gamma_{1910}$  233.02 (†, 100) E2
- 2165.8.4, (6<sup>-</sup>)  $\gamma_{1910}$  255.41 (†, 100.17) M1(+E2):  $\delta < 1$   $\gamma_{1813}$  352.20.25 (†, 18.3)
- M1+E2:  $\delta = 1.05$
- 2179.9.4, (5, 6<sup>-</sup>)  $\gamma_{1813}$  366.52 (†, 100.17) M1(+E2):  $\delta < 1$   $\gamma_{1799}$  380.53 (†, 78.13)
- 2259.9.8(?), (4, 5, 6<sup>-</sup>)  $\gamma_{1813}$  446.57 (†, 100) M1(+E2):  $\delta < 1$
- 2264.6.4, (6<sup>-</sup>)  $\gamma_{2166}$  98.91 (†, 12.5)  $\gamma_{1813}$  451.07 (†, 100.23) M1+E2:  $\delta = 1.05$
- 2364.3.4, (8<sup>-</sup>)  $\gamma_{1799}$  565.02 (†, 100)
- 2374.7.4, (6, 7, 8<sup>-</sup>)  $\gamma_{2166}$  208.90.18 (†, 100.25) E2  $\gamma_{1910}$  464.57 (†, 38.13)
- M1(+E2):  $\delta < 1$
- 2423.8.4, (10<sup>-</sup>), 2.9 ns  $\gamma_{2364}$  59.52 (†, 1.5.2) E2  $\gamma_{2144}$  280.22 (†, 100.5) (E1)
- 2463.8.4, 6<sup>-</sup>  $\gamma_{2180}$  284.02 (†, 27.5) M1(+E2):  $\delta < 1$   $\gamma_{2166}$  298.12 (†, 30.3)
- E2(+M1):  $\delta > 1.5$   $\gamma_{1910}$  553.23 (†, 67.17) M1  $\gamma_{1813}$  650.33 (†, 100.22)
- M1+E2:  $\delta = 1.05$   $\gamma_{1799}$  664.27 (†, 17.5)
- 2475.8.5, (12<sup>-</sup>), 8.1 ns,  $g = 0.24$   $\gamma_{2424}$  52.04 (†, 100) E2
- 2562.0.4, (10<sup>-</sup>)  $\gamma_{2144}$  418.53 (†, 28.6)  $\gamma_{2138}$  423.82 (†, 100.6)
- 2688.1.4, (11<sup>-</sup>)  $\gamma_{2144}$  544.62 (†, 100)
- 2888.8.5, (14<sup>-</sup>)  $\gamma_{2476}$  412.92 (†, 100)
- 3173.2.5, (12<sup>-</sup>)  $\gamma_{2688}$  485.04 (†, 30.3)  $\gamma_{2562}$  611.24 (†, 100.6)
- 3394.2.5, (13<sup>-</sup>)  $\gamma_{2688}$  706.22 (†, 100)
- 3531.8.5, (16<sup>-</sup>)  $\gamma_{2889}$  643.02 (†, 100)
- 3747.9.5, (14<sup>-</sup>)  $\gamma_{3394}$  353.64 (†, 2.6.13)  $\gamma_{3173}$  574.72 (†, 100.9)
- 3820.1.6, (15<sup>-</sup>)  $\gamma_{2889}$  931.44 (†, 100)
- 3879.4.5, (15<sup>-</sup>)  $\gamma_{3394}$  485.24 (†, 100)
- 3984.2.5, (16<sup>-</sup>), <0.50 ns  $\gamma_{3748}$  236.34 (†, 100)
- E 4004.6.6(?), (14, 15)  $\gamma_{2889}$  1116.04(?) (†, 100)
- 4015.3.5, (14<sup>+</sup>)  $\gamma_{3748}$  267.34 (†, 100.50)  $\gamma_{3394}$  621.34  $\gamma_{2889}$  1126.54 (†, 67.34)
- 4114.9.5, (17<sup>-</sup>)  $\gamma_{3984}$  130.84  $\gamma_{3879}$  235.54 (†, <540)  $\gamma_{3532}$  583.14 (†, 100.20)
- 4275.4.6, (18<sup>-</sup>)  $\gamma_{3532}$  743.62 (†, 100)
- 4290.1.6, (18<sup>-</sup>)  $\gamma_{3984}$  305.92 (†, 100)
- 4317.8.6, (16<sup>-</sup>)  $\gamma_{4016}$  302.54  $\gamma_{3984}$  333.64(?) (†, 100)
- 4491.4.7, (17<sup>-</sup>)  $\gamma_{3820}$  671.34 (†, 100)
- 4498.1.6, (19<sup>-</sup>)  $\gamma_{4290}$  208.04 (†, 100.20)  $\gamma_{4115}$  383.24 (†, <320)
- E 4521.1.6, (16, 17)  $\gamma_{4005}$  516.24(?)  $\gamma_{3820}$  701.04 (†, 40.15)  $\gamma_{3532}$  989.24 (†, 100.40)
- 4797.7.6, (18<sup>-</sup>)  $\gamma_{4318}$  480.04 (†, 100)  $\gamma_{4290}$  507.54
- 4896.9.7, (20<sup>-</sup>)  $\gamma_{4290}$  606.84 (†, 100)
- 4985.8.6, (20<sup>-</sup>)  $\gamma_{4275}$  710.42 (†, 100)
- E 5103.5.7, (18, 19)  $\gamma_{4521}$  582.44 (†, 12.3)  $\gamma_{4491}$  612.14 (†, 100.6)  $\gamma_{4275}$  828.32(?) (†, 1.8.9)
- 5163.9.7, (21<sup>-</sup>)  $\gamma_{4498}$  665.83 (†, 100)
- 5266.1.7, (20<sup>-</sup>)  $\gamma_{4275}$  990.74 (†, 100)
- 5522.9.7, (20<sup>-</sup>)  $\gamma_{4798}$  725.24 (†, 100)
- 5578.6.7, (22<sup>-</sup>)  $\gamma_{4986}$  592.83 (†, 100)
- E 5610.2.7, (20, 21)  $\gamma_{5104}$  506.73 (†, 100)  $\gamma_{4986}$  624.44(?)
- 5700.5.8, (22<sup>-</sup>)  $\gamma_{4891}$  803.63 (†, 100)
- 6049.7.8, (23<sup>-</sup>)  $\gamma_{5164}$  885.84 (†, 100)
- E 6120.5.9, (22, 23)  $\gamma_{5610}$  510.34  $\gamma_{5579}$  541.64(?) (†, 100)
- 6256.8.8  $\gamma_{5579}$  678.24 (†, 100)
- 6349.5.8(?), (22<sup>+</sup>)  $\gamma_{5523}$  826.64 (†, 100)
- 6411.2.7, (24<sup>+</sup>)  $\gamma_{5579}$  832.63 (†, 100)

- 6645.7.9, (24<sup>-</sup>)  $\gamma_{5701}$  945.24 (†, 100)
- 6676.5.10(?), (22<sup>+</sup>)  $\gamma_{6223}$  1152.04(?) (†, 100)
- E 6815.5.9, (24, 25)  $\gamma_{6121}$  695.03 (†, 100)
- 6834.5.9, (24<sup>+</sup>)  $\gamma_{6877}$  158.04 (†, 57.29)  $\gamma_{6121}$  713.94 (†, 100.40)
- 6941.4.9, (25<sup>-</sup>)  $\gamma_{6050}$  891.74 (†, 100)
- 6989.6.8, (26<sup>+</sup>)  $\gamma_{6835}$  155.14 (†, 71.30)  $\gamma_{6411}$  578.44 (†, 100.41)
- 7304.3.9, (28<sup>+</sup>)  $\gamma_{6990}$  314.74 (†, 100)
- 7767.9.10(?), (27<sup>-</sup>)  $\gamma_{6941}$  826.64(?) (†, 100)
- 7784.6.10, (30<sup>+</sup>)  $\gamma_{7304}$  480.34 (†, 100)
- A x, J=(10)
- A 254.5+x, J+2  $\gamma_x$  254.5.1 (†, 0.56.3)  $I^{(1)}=90.4, I^{(2)}=95.9, \eta\omega=0.138$
- A 550.7+x, J+4  $\gamma_{255+x}$  296.2.1 (†, 1.04.5)  $I^{(1)}=91.2, I^{(2)}=97.1, \eta\omega=0.158$
- A 888.1+x, J+6  $\gamma_{551+x}$  337.4.1 (†, 1.00.4)  $I^{(1)}=91.9, I^{(2)}=99.0, \eta\omega=0.179$
- A 1265.9+x, J+8  $\gamma_{888+x}$  377.8.1 (†, 1.04.4)  $I^{(1)}=92.6, I^{(2)}=102.0, \eta\omega=0.199$
- A 1682.9+x, J+10  $\gamma_{1266+x}$  417.0.1 (†, 1.00.5)  $I^{(1)}=93.5, I^{(2)}=105.5, \eta\omega=0.218$
- A 2137.8+x, J+12, 0.27 ps  $\gamma_{1683+x}$  454.9.1 (†, 1.09.5)  $I^{(1)}=94.5, I^{(2)}=107.8, \eta\omega=0.237$
- A 2629.8+x, J+14, 0.166 ps  $\gamma_{2138+x}$  492.0.1 (†, 1.00.5)  $I^{(1)}=95.5, I^{(2)}=110.5, \eta\omega=0.255$
- A 3158.0+x, J+16, 0.120 ps  $\gamma_{2630+x}$  528.2.1 (†, 1.01.5)  $I^{(1)}=96.6, I^{(2)}=114.3, \eta\omega=0.273$
- A 3721.2+x, J+18, 0.114 ps  $\gamma_{3158+x}$  563.2.1 (†, 0.97.4)  $I^{(1)}=97.7, I^{(2)}=118.0, \eta\omega=0.290$
- A 4318.3+x, J+20, 0.078 ps  $\gamma_{3721+x}$  597.1.1 (†, 0.84.4)  $I^{(1)}=98.8, I^{(2)}=122.0, \eta\omega=0.307$
- A 4948.2+x, J+22, 0.060 ps  $\gamma_{4318+x}$  629.9.1 (†, 0.85.5)  $I^{(1)}=100.0, I^{(2)}=124.6, \eta\omega=0.323$
- A 5610.2+x, J+24, 0.042 ps  $\gamma_{4948+x}$  662.0.5 (†, 0.76.4)  $I^{(1)}=101.2, I^{(2)}=126.2, \eta\omega=0.339$
- A 6303.9+x, J+26, 0.026 ps  $\gamma_{5610+x}$  693.7.5 (†, 0.65.4)  $I^{(1)}=102.3, I^{(2)}=131.6, \eta\omega=0.354$
- A 7028.0+x, J+28  $\gamma_{6304+x}$  724.1.5 (†, 0.51.3)  $I^{(1)}=103.6, I^{(2)}=132.0, \eta\omega=0.370$
- A 7782.4+x, J+30  $\gamma_{7028+x}$  754.4.5 (†, 0.38.3)  $I^{(1)}=104.7, I^{(2)}=137.0, \eta\omega=0.385$
- A 8566.0+x, J+32  $\gamma_{7782+x}$  783.6.5 (†, 0.41.3)  $I^{(1)}=105.9, I^{(2)}=134.2, \eta\omega=0.399$
- A 9379.4+x, J+34  $\gamma_{8566+x}$  813.4.5 (†, 0.34.3)  $I^{(1)}=107.0, I^{(2)}=134.7, \eta\omega=0.414$
- A 10222.5+x, J+36  $\gamma_{9379+x}$  843.1.5 (†, 0.15.5)  $I^{(1)}=107.9$
- B y, J=(11)
- B 262.3+y, J+2  $\gamma_y$  262.3.1 (†, 1.00.14)  $I^{(1)}=95.3, I^{(2)}=99.5, \eta\omega=0.141$
- B 564.6+y, J+4  $\gamma_{262+y}$  302.5.1 (†, 1.00.16)  $I^{(1)}=95.9, I^{(2)}=99.3, \eta\omega=0.161$
- B 907.6+y, J+6  $\gamma_{565+y}$  342.8.1 (†, 1.07.16)  $I^{(1)}=96.3, I^{(2)}=101.8, \eta\omega=0.181$
- B 1289.7+y, J+8  $\gamma_{908+y}$  382.1.1 (†, 1.05.37)  $I^{(1)}=96.8, I^{(2)}=104.4, \eta\omega=0.201$
- B 1710.1+y, J+10  $\gamma_{1290+y}$  420.4.1 (†, 1.11.16)  $I^{(1)}=97.5, I^{(2)}=105.5, \eta\omega=0.220$
- B 2168.4+y, J+12  $\gamma_{1710+y}$  458.3.1 (†, 0.87.16)  $I^{(1)}=98.2, I^{(2)}=110.2, \eta\omega=0.238$
- B 2663.0+y, J+14  $\gamma_{2168+y}$  494.6.5 (†, 1.02.12)  $I^{(1)}=99.1, I^{(2)}=108.1, \eta\omega=0.257$
- B 3194.6+y, J+16  $\gamma_{2663+y}$  531.6.5 (†, 0.93.14)  $I^{(1)}=99.7, I^{(2)}=114.9, \eta\omega=0.275$
- B 3761.0+y, J+18  $\gamma_{3195+y}$  566.4.5 (†, 1.16.14)  $I^{(1)}=100.6, I^{(2)}=115.9, \eta\omega=0.292$
- B 4361.9+y, J+20  $\gamma_{3761+y}$  600.9.5 (†, 0.81.10)  $I^{(1)}=101.5, I^{(2)}=117.0, \eta\omega=0.309$
- B 4997.0+y, J+22  $\gamma_{4362+y}$  635.1.5 (†, 0.93.23)  $I^{(1)}=102.3, I^{(2)}=121.6, \eta\omega=0.326$
- B 5665.0+y, J+24  $\gamma_{4997+y}$  668.0.5 (†, 0.77.16)  $I^{(1)}=103.3, I^{(2)}=123.5, \eta\omega=0.342$
- B 6365.4+y, J+26  $\gamma_{5665+y}$  700.4.5 (†, 0.66.16)  $I^{(1)}=104.2, I^{(2)}=125.8, \eta\omega=0.358$
- B 7097.6+y, J+28  $\gamma_{6365+y}$  732.2.5 (†, 0.50.13)  $I^{(1)}=105.2, I^{(2)}=131.1, \eta\omega=0.374$
- B 7860.3+y, J+30  $\gamma_{7098+y}$  762.7.5  $I^{(1)}=106.2, I^{(2)}=132.0, \eta\omega=0.389$
- B 8653.3+y(?) , J+32  $\gamma_{7860+y}$  793.1(?)  $I^{(1)}=107.2$
- C z, J=(8)
- C 201.3+z, J+2  $\gamma_z$  201.3.1 (†, 0.49.4)  $I^{(1)}=94.4, I^{(2)}=96.6, \eta\omega=0.111$
- C 444.0+z, J+4  $\gamma_{201+z}$  242.7.1 (†, 1.01.5)  $I^{(1)}=94.8, I^{(2)}=98.5, \eta\omega=0.131$
- C 727.3+z, J+6  $\gamma_{444+z}$  283.3.1 (†, 1.11.10)  $I^{(1)}=95.3, I^{(2)}=98.8, \eta\omega=0.152$
- C 1051.1+z, J+8  $\gamma_{727+z}$  323.8.1 (†, 1.25.10)  $I^{(1)}=95.7, I^{(2)}=100.3, \eta\omega=0.172$
- C 1414.8+z, J+10  $\gamma_{1051+z}$  363.7.1 (†, 1.08.14)  $I^{(1)}=96.2, I^{(2)}=104.2, \eta\omega=0.191$
- C 1816.9+z, J+12  $\gamma_{1415+z}$  402.1.1 (†, 1.10.17)  $I^{(1)}=97.0, I^{(2)}=103.6, \eta\omega=0.211$
- C 2257.6+z, J+14, 0.27 ps  $\gamma_{1817+z}$  440.7.1 (†, 0.97.10)  $I^{(1)}=97.6, I^{(2)}=108.1, \eta\omega=0.230$
- C 2735.3+z, J+16, 0.20 ps  $\gamma_{2258+z}$  477.7.1 (†, 0.96.14)  $I^{(1)}=98.4, I^{(2)}=109.3, \eta\omega=0.248$
- C 3249.6+z, J+18, 0.13 ps  $\gamma_{2735+z}$  514.3.1 (†, 1.02.13)  $I^{(1)}=99.2, I^{(2)}=111.1, \eta\omega=0.266$
- C 3799.9+z, J+20, 0.100 ps  $\gamma_{3250+z}$  550.3.1 (†, 0.98.11)  $I^{(1)}=99.9, I^{(2)}=114.6, \eta\omega=0.284$

**$^{194}_{80}\text{Hg}$  (Continued)**

- C 4385.1+z, J+22, 0.089 19 ps  $\gamma_{3800+z}$  585.21 ( $\dagger$ , 0.96 14)  $I^{(1)}=100.8, I^{(2)}=117.3, \hbar\omega=0.301$
- C 5004.4+z, J+24, 0.065 28 ps  $\gamma_{4385+z}$  619.35 ( $\dagger$ , 0.82 14)  $I^{(1)}=101.7, I^{(2)}=121.6, \hbar\omega=0.318$
- C 5656.6+z, J+26  $\gamma_{5004+z}$  652.25 ( $\dagger$ , 0.74 23)  $I^{(1)}=102.7, I^{(2)}=123.8, \hbar\omega=0.334$
- C 6341.1+z, J+28  $\gamma_{5657+z}$  684.55 ( $\dagger$ , 0.65 7)  $I^{(1)}=103.7, I^{(2)}=124.2, \hbar\omega=0.350$
- C 7057.8+z, J+30  $\gamma_{6341+z}$  716.75 ( $\dagger$ , 0.46 10)  $I^{(1)}=104.6, I^{(2)}=129.4, \hbar\omega=0.366$
- C 7805.4+z, J+32  $\gamma_{7058+z}$  747.65 ( $\dagger$ , 0.63 12)  $I^{(1)}=105.7, I^{(2)}=132.9, \hbar\omega=0.381$
- C 8583.1+z(?), J+34  $\gamma_{7805+z}$  777.75(?) ( $\dagger$ , 0.20)  $I^{(1)}=106.7, I^{(2)}=136.5, \hbar\omega=0.396$
- C 9390.1+z(?), J+36  $\gamma_{8583+z}$  807.1(?) ( $\dagger$ , 0.35 12)  $I^{(1)}=107.8$

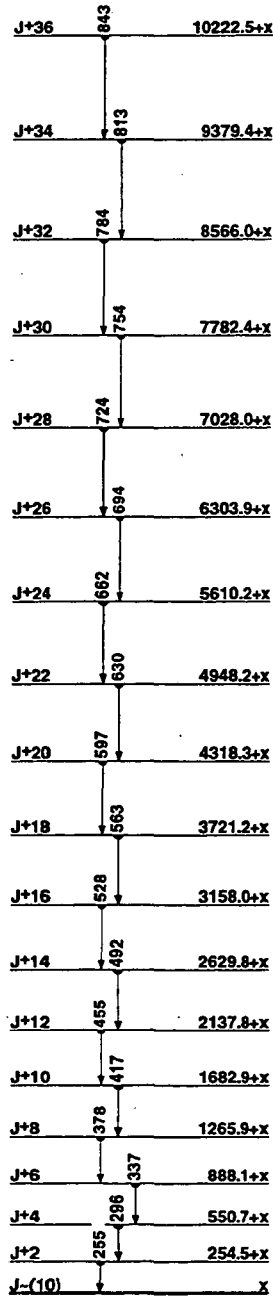

SD-1 band

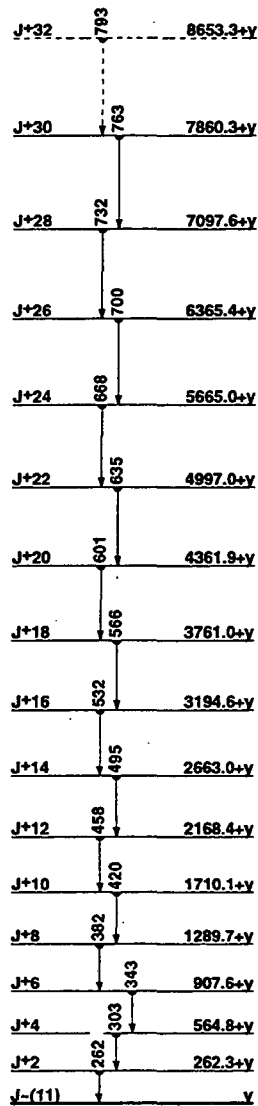

SD-2 band

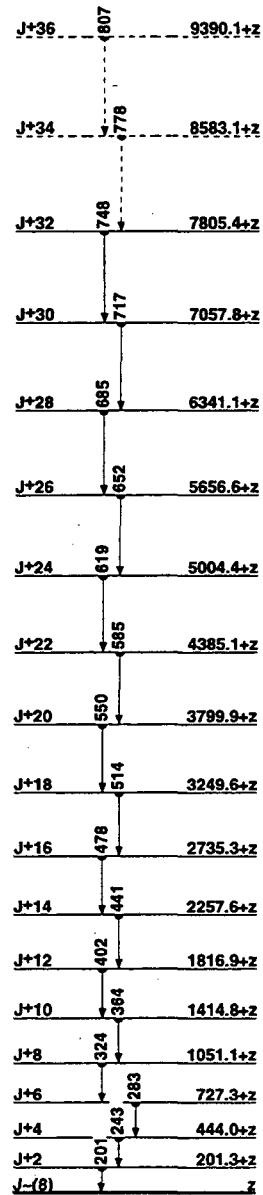

SD-3 band

**$^{194}_{80}\text{Hg}$**

**191**  
**81** **Tl**

$\Delta$ : (-26190)  $S_n$ : (9900)  $S_p$ : (2100)  $Q_{ec}$ : (4490)  $Q_{\alpha}$ : (4400)

**Nuclear Bands**

- A Band Structure
- B 9/2[505]
- C Band Structure
- D 13/2[606]
- E SD-1 band
- F SD-2 band

**Levels and  $\gamma$ -ray branchings:**

0, (1/2<sup>+</sup>)

- B 2997.9(2<sup>-</sup>), 5.22 16 m, %EC+% $\beta^+$ =100
- A 341.22, (3/2<sup>+</sup>)  $\gamma_{341}$  341.22 (†,100)
- B 686.12, (11/2<sup>-</sup>)  $\gamma_{299}$  387.12 (†,100)
- A 745.37(?), (5/2<sup>+</sup>)  $\gamma_{341}$  404.0(?) (†,100)
- C 859.62, (7/2<sup>-</sup>)  $\gamma_{299}$  560.62 (†,100)
- B 1011.22, (13/2<sup>-</sup>)  $\gamma_{686}$  325.02 (†,592)  $\gamma_{299}$  712.22 (†,1007)
- C 1172.82, (9/2<sup>-</sup>)  $\gamma_{860}$  313.02 (†,354)  $\gamma_{299}$  873.92 (†,1004)
- A 1216.67(?), (7/2<sup>+</sup>)  $\gamma_{745}$  471.32 (†,6734)  $\gamma_{341}$  875.5 (†,1007)
- D 1299.82, (13/2<sup>+</sup>)  $\gamma_{686}$  613.52 (†,100)
- 1392.12, (13/2<sup>-</sup>)  $\gamma_{686}$  705.72 (†,10013)  $\gamma_{299}$  1093.32 (†,9413)
- B 1440(?), (15/2<sup>-</sup>)  $\gamma_{1011}$  428(?)  $\gamma_{686}$  753(?)
- D 1706(?), (15/2<sup>+</sup>)  $\gamma_{1300}$  405(?) (†,100)
- B 1761(?), (17/2<sup>-</sup>)  $\gamma_{1440}$  321(?)  $\gamma_{1011}$  749(?)
- B 2232(?), (19/2<sup>-</sup>)  $\gamma_{1761}$  471(?)  $\gamma_{1440}$  792(?)
- B 2600(?), (21/2<sup>-</sup>)  $\gamma_{2232}$  368(?)  $\gamma_{1761}$  389(?)
- B 3018(?), (23/2<sup>-</sup>)  $\gamma_{2600}$  418(?)  $\gamma_{2232}$  786(?)
- E x, J
- E 317.9+x, J+2  $\gamma_x$  317.93(?)  $I^{(2)}=97.6, \eta\omega=0.169$
- E 676.8+x, J+4  $\gamma_{318+x}$  358.93 (†,0.7125)  $I^{(2)}=98.8, \eta\omega=0.190$
- E 1076.2+x, J+6  $\gamma_{677+x}$  399.43 (†,0.7925) (E2)  $I^{(2)}=102.8, \eta\omega=0.209$
- E 1514.5+x, J+8  $\gamma_{1076+x}$  438.33 (†,0.6417) (E2)  $I^{(2)}=103.9, \eta\omega=0.229$
- E 1991.3+x, J+10  $\gamma_{1515+x}$  476.83 (†,0.5720) (E2)  $I^{(2)}=105.0, \eta\omega=0.248$
- E 2506.2+x, J+12  $\gamma_{1991+x}$  514.93 (†,0.5017)  $I^{(2)}=110.8, \eta\omega=0.266$
- E 3057.2+x, J+14  $\gamma_{2506+x}$  551.03 (†,0.3910) (E2)  $I^{(2)}=109.0, \eta\omega=0.285$
- E 3644.9+x, J+16  $\gamma_{3057+x}$  587.73 (†,0.2510) (E2)  $I^{(2)}=113.6, \eta\omega=0.303$
- E 4267.8+x, J+18  $\gamma_{3645+x}$  622.96 (†,0.1810)  $I^{(2)}=122.0, \eta\omega=0.320$
- E 4923.5+x, J+20  $\gamma_{4268+x}$  655.76 (†,0.135)

**F y, J**

- F 377.8+y, J+2  $\gamma_y$  377.86(?) (†,0.4012)  $I^{(2)}=101.5, \eta\omega=0.199$
- F 795.0+y, J+4  $\gamma_{378+y}$  417.23 (†,0.8625) (E2)  $I^{(2)}=104.4, \eta\omega=0.218$
- F 1250.5+y, J+6  $\gamma_{796+y}$  455.53 (†,0.8023) (E2)  $I^{(2)}=105.3, \eta\omega=0.237$
- F 1744.0+y, J+8  $\gamma_{1251+y}$  493.53 (†,0.7120) (E2)  $I^{(2)}=108.7, \eta\omega=0.256$
- F 2274.3+y, J+10  $\gamma_{1744+y}$  530.33 (†,0.6718) (E2)  $I^{(2)}=112.0, \eta\omega=0.274$
- F 2840.3+y, J+12  $\gamma_{2274+y}$  566.03 (†,0.5415) (E2)  $I^{(2)}=119.4, \eta\omega=0.291$
- F 3439.8+y, J+14  $\gamma_{2840+y}$  599.53 (†,0.5415)  $I^{(2)}=120.8, \eta\omega=0.308$
- F 4072.4+y, J+16  $\gamma_{3440+y}$  632.66 (†,0.2710)  $I^{(2)}=119.8, \eta\omega=0.325$
- F 4738.4+y(?), J+18  $\gamma_{4072+y}$  666(?) (†,0.178)

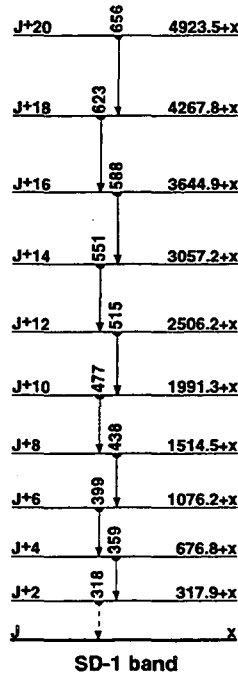

SD-1 band

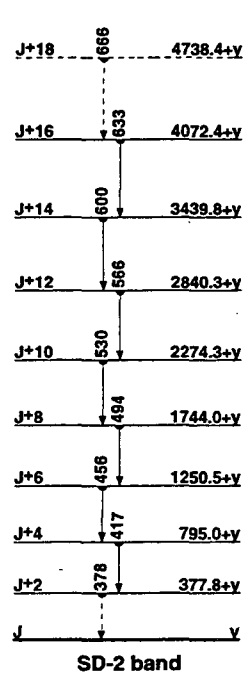

SD-2 band

**191**  
**81** **Tl**



192Tl  
81Tl

$\Delta: (-25900) S_n: (7800) S_p: (2600) Q_{EC}: (6120) Q_{\alpha}: (4200)$

Nuclear Bands

- A SD-1 band
- B SD-2 band
- C SD-3 band
- D SD-4 band
- E SD-5 band
- F SD-6 band

Levels and  $\gamma$ -ray branchings:

- 0+x, (2<sup>-</sup>), 9.64 m, %EC+% $\beta^+$ =100,  $\mu=+0.2003$ ,  $Q=-0.33711$   
 0+y, (7<sup>-</sup>), 10.82 m, %EC+% $\beta^+$ =100,  $\mu=+0.518036$ ,  $Q=+0.47720$   
 167.5+x1, (1<sup>-</sup>)  $\gamma_{0+x} 167.51$  (t<sub>1/2</sub>100) M1(+E2);  $\delta=0.7^{+3}_{-7}$   
 250.6+y2, (8<sup>-</sup>), 296.5 ns,  $\mu=+1.65640$ ,  $Q=0.447$   $\gamma_{0+y} 250.62$  (t<sub>1/2</sub>100) E1  
 250.6+z2(?)  
 333.6+z3  $\gamma_{251+z} 831$  (t<sub>1/2</sub>100) (M1+E2)  
 371.0+x2, (1<sup>-</sup>)  $\gamma_{0+x} 371.02$  (t<sub>1/2</sub>100) M1(+E2);  $\delta=0.6^{+5}_{-6}$   
 414.0+x3, (1<sup>-</sup>, 2<sup>-</sup>)  $\gamma_{0+x} 414.13$  (t<sub>1/2</sub>100) M1  
 609.6+z3  $\gamma_{234+z} 275.82$  (t<sub>1/2</sub>100 15) (M1+E2)  $\gamma_{251+z} 359.02$ (?) (t<sub>1/2</sub>203)  
 775.7+x2, (0<sup>-</sup>, 1<sup>-</sup>)  $\gamma_{371+x} 404.53$  (t<sub>1/2</sub>17.124)  $\gamma_{168+x} 608.21$  (t<sub>1/2</sub>100 8)  
 M1+E2;  $\delta=1.6^{+6}_{-4}$   
 871.6+z3  $\gamma_{610+z} 261.82$  (t<sub>1/2</sub>100 15) (M1+E2)  $\gamma_{334+z} 538.22$  (t<sub>1/2</sub>467) (E2)  
 1195.5+x2, (1<sup>-</sup>)  $\gamma_{414+x} 781.63$  (t<sub>1/2</sub>182)  $\gamma_{0+x} 1195.42$  (t<sub>1/2</sub>100 6) E1  
 1267.9+z3  $\gamma_{672+z} 396.42$  (t<sub>1/2</sub>100 15) (M1+E2)  $\gamma_{610+z} 658.32$  (t<sub>1/2</sub>71 11) (E2)  
 1576.6+z3  $\gamma_{1258+z} 308.72$  (t<sub>1/2</sub>376) (M1+E2)  $\gamma_{672+z} 705.02$  (t<sub>1/2</sub>100 15) (E2)  
 2034.8+z4  $\gamma_{1677+z} 458.22$  (M1+E2)  $\gamma_{1258+z} 767.6$ (?)  
 2255.7+z4(?)  $\gamma_{2035+z} 220.92$ (?) (t<sub>1/2</sub>100) (M1+E2)
- A r, J  
 A 357.8+r, J+2  $\gamma_{0} 357.810 I^{(2)}=99.5, \eta\omega=0.189$   
 A 755.8+r, J+4  $\gamma_{358+r} 398.010 I^{(2)}=101.0, \eta\omega=0.209$   
 A 1193.4+r, J+6  $\gamma_{756+r} 437.65 I^{(2)}=103.4, \eta\omega=0.228$   
 A 1669.7+r, J+8  $\gamma_{1193+r} 476.35 I^{(2)}=101.8, \eta\omega=0.248$   
 A 2185.3+r, J+10  $\gamma_{1670+r} 515.65 I^{(2)}=103.1, \eta\omega=0.268$   
 A 2739.7+r, J+12  $\gamma_{2185+r} 554.45 I^{(2)}=101.8, \eta\omega=0.287$   
 A 3333.4+r, J+14  $\gamma_{2740+r} 593.710 I^{(2)}=112.7, \eta\omega=0.306$   
 A 3962.6+r, J+16  $\gamma_{3333+r} 629.210$
- B s, J  
 B 378+s, J+2  $\gamma_{0} 3781(?) I^{(2)}=103.9, \eta\omega=0.199$   
 B 794.5+s, J+4  $\gamma_{378+s} 416.510 I^{(2)}=102.3, \eta\omega=0.218$   
 B 1250.1+s, J+6  $\gamma_{795+s} 455.610 I^{(2)}=103.1, \eta\omega=0.237$   
 B 1744.5+s, J+8  $\gamma_{1250+s} 494.410 I^{(2)}=113.0, \eta\omega=0.256$   
 B 2274.3+s, J+10  $\gamma_{1745+s} 529.810 I^{(2)}=110.5, \eta\omega=0.274$   
 B 2840.3+s, J+12  $\gamma_{2274+s} 566.010 I^{(2)}=114.3, \eta\omega=0.292$   
 B 3441.3+s, J+14  $\gamma_{2840+s} 601.010 I^{(2)}=112.0, \eta\omega=0.309$   
 B 4078.0+s, J+16  $\gamma_{3441+s} 636.710$

- C t, J  
 C 375.7+t, J+2  $\gamma_{0} 375.710 I^{(2)}=106.1, \eta\omega=0.197$   
 C 789.1+t, J+4  $\gamma_{376+t} 413.45 I^{(2)}=106.1, \eta\omega=0.216$   
 C 1240.2+t, J+6  $\gamma_{789+t} 451.15 I^{(2)}=107.2, \eta\omega=0.235$   
 C 1728.6+t, J+8  $\gamma_{1240+t} 488.45 I^{(2)}=105.8, \eta\omega=0.254$   
 C 2254.8+t, J+10  $\gamma_{1728+t} 526.25 I^{(2)}=101.5, \eta\omega=0.273$   
 C 2820.4+t, J+12  $\gamma_{2255+t} 565.65 I^{(2)}=107.5, \eta\omega=0.292$   
 C 3423.2+t, J+14  $\gamma_{2820+t} 602.85 I^{(2)}=105.8, \eta\omega=0.311$   
 C 4063.8+t, J+16  $\gamma_{3423+t} 640.610$
- D u, J  
 D 357+u, J+2  $\gamma_{0} 3571(?) I^{(2)}=103.4, \eta\omega=0.188$   
 D 752.7+u, J+4  $\gamma_{357+u} 395.710 I^{(2)}=105.5, \eta\omega=0.207$   
 D 1186.3+u, J+6  $\gamma_{753+u} 433.610 I^{(2)}=105.8, \eta\omega=0.226$   
 D 1657.7+u, J+8  $\gamma_{1186+u} 471.410 I^{(2)}=107.2, \eta\omega=0.245$   
 D 2166.4+u, J+10  $\gamma_{1658+u} 508.710 I^{(2)}=104.2, \eta\omega=0.264$   
 D 2713.5+u, J+12  $\gamma_{2166+u} 547.110 I^{(2)}=115.6, \eta\omega=0.282$   
 D 3295.2+u, J+14  $\gamma_{2714+u} 581.710 I^{(2)}=107.2, \eta\omega=0.300$   
 D 3914.2+u, J+16  $\gamma_{3295+u} 6191(?)$
- E v, J  
 E 381.2+v, J+2  $\gamma_{0} 381.210 I^{(2)}=97.8, \eta\omega=0.201$   
 E 803.3+v, J+4  $\gamma_{381+v} 422.110 I^{(2)}=101.8, \eta\omega=0.221$   
 E 1264.7+v, J+6  $\gamma_{803+v} 461.45 I^{(2)}=100.3, \eta\omega=0.241$   
 E 1766.0+v, J+8  $\gamma_{1265+v} 501.35 I^{(2)}=112.0, \eta\omega=0.260$   
 E 2303.0+v, J+10  $\gamma_{1766+v} 537.05 I^{(2)}=110.5, \eta\omega=0.278$   
 E 2876.2+v, J+12  $\gamma_{2303+v} 573.25 I^{(2)}=112.7, \eta\omega=0.295$   
 E 3484.9+v, J+14  $\gamma_{2876+v} 608.710 I^{(2)}=120.5, \eta\omega=0.313$   
 E 4126.8+v, J+16  $\gamma_{3485+v} 641.910$
- F w, J  
 F 406.5+w, J+2  $\gamma_{0} 406.510 I^{(2)}=105.5, \eta\omega=0.213$   
 F 850.9+w, J+4  $\gamma_{407+w} 444.410 I^{(2)}=99.8, \eta\omega=0.232$   
 F 1335.4+w, J+6  $\gamma_{851+w} 484.510 I^{(2)}=102.0, \eta\omega=0.252$   
 F 1859.1+w, J+8  $\gamma_{1335+w} 523.710 I^{(2)}=101.0, \eta\omega=0.272$   
 F 2422.4+w, J+10  $\gamma_{1859+w} 563.310 I^{(2)}=107.0, \eta\omega=0.291$   
 F 3023.1+w, J+12  $\gamma_{2422+w} 600.710 I^{(2)}=122.0, \eta\omega=0.309$   
 F 3656.6+w, J+14  $\gamma_{3023+w} 633.510$

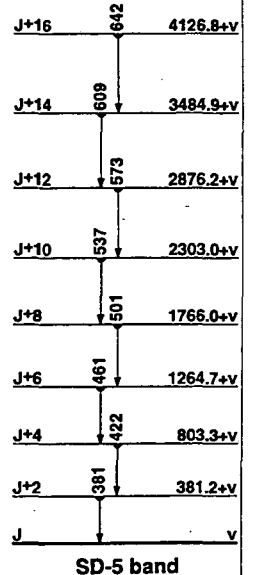
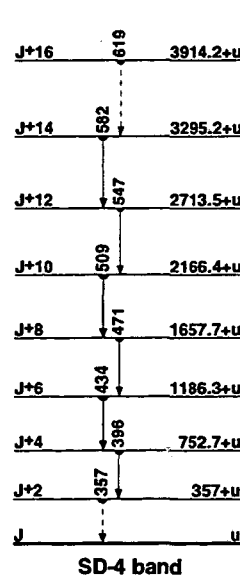
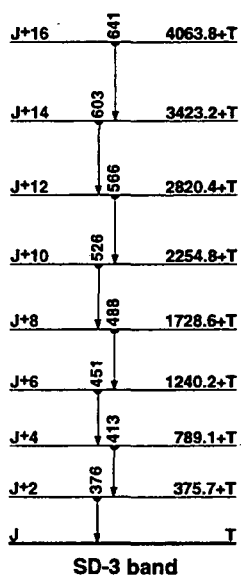
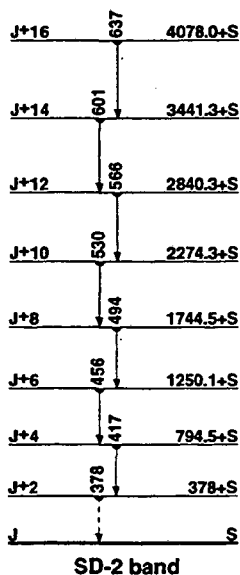
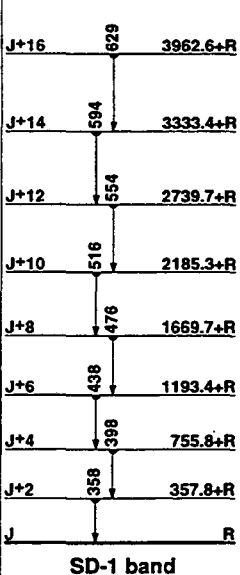
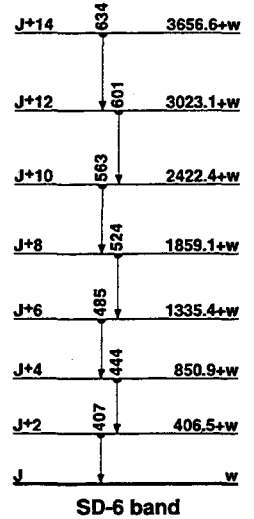

193Tl  
81Tl

$\Delta$ : (-27430)  $S_n$ : (9600)  $S_p$ : (2700)  $Q_{ec}$ : (3640)  $Q_{\alpha}$ : (3800)

Nuclear Bands

- A 9/2[505]
- B 13/2[606]?
- C SD-1 band
- D SD-2 band

Levels and  $\gamma$ -ray branchings:

- 0, 1/2<sup>(+)</sup>, 21.68 m, %EC+% $\beta^+$ =100,  $\mu$ =+1.591222  
 365.2, 3/2<sup>(+)</sup>  $\gamma_{365.2}$  (t<sub>100</sub>) M1+E2:  $\delta$ =1.6<sup>+5</sup><sub>-3</sub>
- A 365.2+x, (9/2<sup>-</sup>), 2.1175 m, %IT=75, %EC+% $\beta^+$ =25,  $\mu$ =+3.948239,  $Q_{\alpha}$ =-2.202  
 $\gamma$ <13
- A 757.4+x, (11/2<sup>-</sup>)  $\gamma_{365.2+x}$  392.2 (t<sub>100</sub>) (M1+E2):  $\delta$ =0.8<sup>+4</sup>  
 1037.7+x  $\gamma_{365.2+x}$  672.5 (t<sub>100</sub>)
- A 1081.5+x, (13/2<sup>-</sup>)  $\gamma_{757.4+x}$  324.0 (t<sub>63.6</sub>)  $\gamma_{365.2+x}$  716.4 (t<sub>100.7</sub>) (E2)  
 1163.9+x  $\gamma_{757.4+x}$  406.4 (t<sub>100</sub>)  
 1350.4+x  $\gamma_{1082.2+x}$  268.9 (t<sub>100</sub>)  
 1423.6+x  $\gamma_{757.4+x}$  666.2 (t<sub>100</sub>)
- B 1493.3+x, (13/2<sup>-</sup>)  $\gamma_{757.4+x}$  735.8 (t<sub>100</sub>) E1+M2:  $\delta$ =0.187
- A 1512.6+x, (15/2<sup>-</sup>)  $\gamma_{1082.2+x}$  431.3 (t<sub>53.4</sub>) (M1+E2):  $\delta$ =0.33  $\gamma_{757.4+x}$  755.1  
 (t<sub>100.11</sub>) (E2)  
 1552.7+x (?)  $\gamma_{1350.4+x}$  202.33 (?) (t<sub>100</sub>)  
 1558.3+x  $\gamma_{1350.4+x}$  207.9 (t<sub>100</sub>)
- A 1833.4+x, (17/2<sup>-</sup>)  $\gamma_{1513.3+x}$  320.93 (t<sub>39.5</sub>) (M1)  $\gamma_{1082.2+x}$  751.7 (t<sub>100.13</sub>) (E2)  
 1870.9+x  $\gamma_{757.4+x}$  1113.5 (t<sub>100</sub>)
- B 1899.6+x (?) (15/2<sup>-</sup>)  $\gamma_{1493.3+x}$  406.4 (?) (t<sub>100</sub>)  
 1960.0+x  $\gamma_{1493.3+x}$  466.8 (t<sub>100</sub>)
- B 2025.5+x (?) (17/2<sup>-</sup>)  $\gamma_{1900.4+x}$  125.9 (?) (t<sub>100</sub>)
- B 2492.3+x (?) (19/2<sup>-</sup>)  $\gamma_{2026.4+x}$  466.8 (?) (t<sub>100</sub>)
- B 2653.9+x (?) (21/2<sup>-</sup>)  $\gamma_{2492.3+x}$  161.6 (?) (t<sub>100</sub>)
- C y, J=(19/2)
- C 228.1+y, J+2  $\gamma_{228.1}$  (t<sub>1.0010</sub>) I<sup>(1)</sup>=96.4, I<sup>(2)</sup>=98.8,  $\eta$  $\omega$ =0.124
- C 496.7+y, J+4  $\gamma_{228.1+y}$  268.64 (t<sub>1.1323</sub>) I<sup>(1)</sup>=96.8, I<sup>(2)</sup>=100.0,  $\eta$  $\omega$ =0.144
- C 805.3+y, J+6  $\gamma_{497.4+y}$  308.63 (t<sub>0.869</sub>) I<sup>(1)</sup>=97.2, I<sup>(2)</sup>=100.5,  $\eta$  $\omega$ =0.164
- C 1153.7+y, J+8  $\gamma_{805.3+y}$  348.43 (t<sub>1.0111</sub>) I<sup>(1)</sup>=97.6, I<sup>(2)</sup>=101.8,  $\eta$  $\omega$ =0.184
- C 1541.4+y, J+10  $\gamma_{1154.4+y}$  387.73 (t<sub>1.44</sub>) I<sup>(1)</sup>=98.0, I<sup>(2)</sup>=104.4,  $\eta$  $\omega$ =0.203
- C 1967.4+y, J+12  $\gamma_{1541.4+y}$  426.03 (t<sub>1.2212</sub>) I<sup>(1)</sup>=98.6, I<sup>(2)</sup>=105.0,  $\eta$  $\omega$ =0.223
- C 2431.5+y, J+14  $\gamma_{1967.4+y}$  464.14 (t<sub>1.6016</sub>) I<sup>(1)</sup>=99.1, I<sup>(2)</sup>=109.3,  $\eta$  $\omega$ =0.241
- C 2932.2+y, J+16  $\gamma_{2432.2+y}$  500.74 I<sup>(1)</sup>=99.9, I<sup>(2)</sup>=108.4,  $\eta$  $\omega$ =0.260
- C 3469.8+y, J+18  $\gamma_{2932.2+y}$  537.66 (t<sub>1.3014</sub>) I<sup>(1)</sup>=100.4, I<sup>(2)</sup>=112.7,  $\eta$  $\omega$ =0.278
- C 4042.9+y, J+20  $\gamma_{3470.4+y}$  573.17 (t<sub>1.0010</sub>) I<sup>(1)</sup>=101.2, I<sup>(2)</sup>=110.5,  $\eta$  $\omega$ =0.296
- C 4652.2+y, J+22  $\gamma_{4043.3+y}$  609.33 (t<sub>0.9610</sub>) I<sup>(1)</sup>=101.8, I<sup>(2)</sup>=118.0,  $\eta$  $\omega$ =0.313
- C 5295.4+y, J+24  $\gamma_{4652.2+y}$  643.26 (t<sub>1.0922</sub>) I<sup>(1)</sup>=102.6, I<sup>(2)</sup>=113.6,  $\eta$  $\omega$ =0.330
- C 5973.8+y, J+26  $\gamma_{5295.4+y}$  678.45 (t<sub>0.7514</sub>) I<sup>(1)</sup>=103.2
- D z, J=(21/2)
- D 248.3+z, J+2  $\gamma_{248.3}$  (t<sub>0.396</sub>) I<sup>(1)</sup>=96.7, I<sup>(2)</sup>=101.8,  $\eta$  $\omega$ =0.134
- D 535.9+z, J+4  $\gamma_{248.3+z}$  287.64 (t<sub>0.455</sub>) I<sup>(1)</sup>=97.4, I<sup>(2)</sup>=99.0,  $\eta$  $\omega$ =0.154
- D 863.9+z, J+6  $\gamma_{536.4+z}$  328.03 (t<sub>0.535</sub>) I<sup>(1)</sup>=97.6, I<sup>(2)</sup>=102.8,  $\eta$  $\omega$ =0.174
- D 1230.8+z, J+8  $\gamma_{864.4+z}$  366.94 (t<sub>1.1523</sub>) I<sup>(1)</sup>=98.1, I<sup>(2)</sup>=102.6,  $\eta$  $\omega$ =0.193
- D 1636.7+z, J+10  $\gamma_{1231.4+z}$  405.95 (t<sub>0.9319</sub>) I<sup>(1)</sup>=98.5, I<sup>(2)</sup>=107.8,  $\eta$  $\omega$ =0.212
- D 2079.7+z, J+12  $\gamma_{1637.4+z}$  443.05 I<sup>(1)</sup>=99.3, I<sup>(2)</sup>=107.8,  $\eta$  $\omega$ =0.231
- D 2559.8+z, J+14  $\gamma_{2080.4+z}$  480.13 (t<sub>0.727</sub>) I<sup>(1)</sup>=100.0, I<sup>(2)</sup>=111.7,  $\eta$  $\omega$ =0.249
- D 3075.7+z, J+16  $\gamma_{2560.4+z}$  515.93 (t<sub>1.1117</sub>) I<sup>(1)</sup>=100.8, I<sup>(2)</sup>=113.0,  $\eta$  $\omega$ =0.267
- D 3627.0+z, J+18  $\gamma_{3076.4+z}$  551.33 (t<sub>1.0014</sub>) I<sup>(1)</sup>=101.6, I<sup>(2)</sup>=112.7,  $\eta$  $\omega$ =0.285
- D 4213.8+z, J+20  $\gamma_{3627.4+z}$  586.83 (t<sub>0.8417</sub>) I<sup>(1)</sup>=102.2, I<sup>(2)</sup>=120.8,  $\eta$  $\omega$ =0.302
- D 4833.7+z, J+22  $\gamma_{4214.4+z}$  619.93 (t<sub>0.8113</sub>) I<sup>(1)</sup>=103.2, I<sup>(2)</sup>=118.7,  $\eta$  $\omega$ =0.318
- D 5487.3+z, J+24  $\gamma_{4834.4+z}$  653.66 (t<sub>0.4211</sub>) I<sup>(1)</sup>=104.0, I<sup>(2)</sup>=127.0,  $\eta$  $\omega$ =0.335
- D 6172.4+z, J+26  $\gamma_{5487.4+z}$  685.16 (t<sub>0.4611</sub>) I<sup>(1)</sup>=105.1

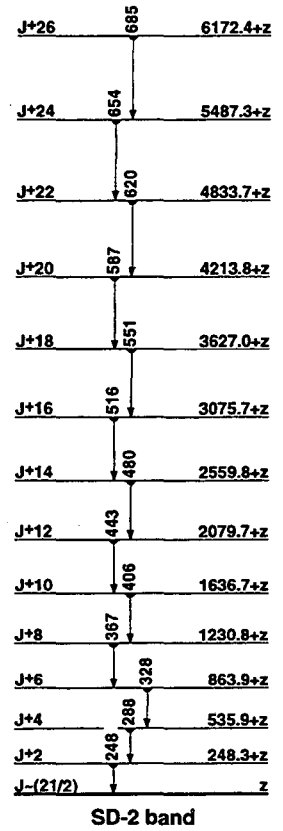
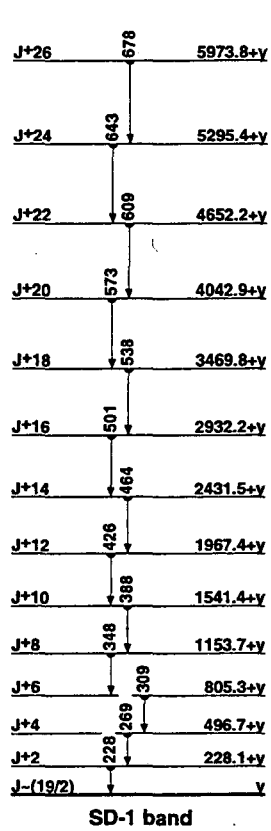

193Tl  
81Tl

194Tl  
81Tl

Δ: (-26970) S<sub>n</sub>: (7610) S<sub>p</sub>: (3180) Q<sub>EC</sub>: (5280) Q<sub>α</sub>: (3490)

Nuclear Bands

- A (πh<sub>9/2</sub>)(νi<sub>13/2</sub>)
- B SD-1 band
- C SD-2 band
- D SD-3 band
- E SD-4 band
- F SD-5 band
- G SD-6 band

Levels and γ-ray branchings:

0, 2<sup>-</sup>, 33.05 m, %EC+%β<sup>+</sup>=100, %α<1×10<sup>-7</sup>, μ=0.141  
192.14 4, (0<sup>-</sup>) γ<sub>0</sub> 192.025 (†, 100) E2  
203.83 3, 1<sup>-</sup> γ<sub>0</sub> 203.826 (†, 100) M1(+E2): δ<0.3  
225.01 4, (2<sup>-</sup>) γ<sub>0</sub> 225.008 (†, 100) M1(+E2): δ<0.3  
270.50 3, (3<sup>-</sup>) γ<sub>225</sub> 45.5 10 (†, 0.23) γ<sub>204</sub> 66.7 10 (†, 0.14) γ<sub>0</sub> 270.524 (†, 100 5) M1(+E2): δ<0.25  
0+s, (7<sup>-</sup>), 32.82 m, %EC+%β<sup>+</sup>=100, μ=0.540 5, Q=0.62  
367.76 4, 1<sup>-</sup> γ<sub>225</sub> 142.94 10 (†, 3.4 4) γ<sub>204</sub> 163.90 10 (†, 5.14 12) M1+E2: δ=1  
γ<sub>192</sub> 175.68 12 (†, 4.2 2) M1 γ<sub>0</sub> 367.80 10 (†, 100 8) M1(+E2): δ<0.1  
459.92 4, (2<sup>-</sup>) γ<sub>368</sub> 92.22 (†, 2.3 3) γ<sub>271</sub> 189.44 5 (†, 50 7) M1(+E2): δ<0.1  
γ<sub>192</sub> 267.92 10(?) (†, 9.1 2) γ<sub>0</sub> 460.05 10 (†, 100 2) M1+E2: δ=0.9 2  
521.52 3, 1<sup>-</sup> γ<sub>368</sub> 153.82 (†, 6.0 6) (M1) γ<sub>225</sub> 296.40 6 (†, 11.9 3) (M1)  
γ<sub>204</sub> 317.70 5 (†, 14.2 3) M1(+E2): δ<0.5 γ<sub>192</sub> 329.48 5 (†, 3.9 4)  
M1(+E2): δ<0.5 γ<sub>0</sub> 521.55 5 (†, 100 2) M1(+E2): δ<0.3  
589.16 4, (2<sup>-</sup>) γ<sub>271</sub> 318.69 5 (†, 100 2) M1(+E2): δ<0.4 γ<sub>204</sub> 385.33 3 (†, 43 4)  
γ<sub>0</sub> 589.12 (†, 59 2) M1(+E2): δ<0.3  
A 292.8+s, (8<sup>-</sup>) γ<sub>0+8</sub> 292.82 (†, 100)  
A 292.8+i, (8<sup>-</sup>, 9<sup>-</sup>, 10<sup>-</sup>)  
A 389.1+t, (9<sup>-</sup>, 10<sup>-</sup>, 11<sup>-</sup>) γ<sub>204+9</sub> 96.32 (†, 100)  
752.94 6, (1<sup>-</sup>) γ<sub>460</sub> 292.98 6(?) (†, <56) γ<sub>225</sub> 527.72 (†, 5.1 8) γ<sub>204</sub> 549.01 (†, 53 1) (M1, E2) γ<sub>0</sub> 752.82 (†, 100 4)  
785.78 5, (1<sup>-</sup>) γ<sub>368</sub> 417.92 6 (†, 12.1 2) M1(+E2): δ<0.3 γ<sub>225</sub> 560.69 10 (†, 7.2 15)  
γ<sub>204</sub> 581.82 10 (†, 100 3) M1(+E2): δ<0.4 γ<sub>0</sub> 785.54 10 (†, 2.1 12)  
833.28 4, (1<sup>-</sup>) γ<sub>225</sub> 311.84 5 (†, 37 3) M1+E2: δ=1.0 3 γ<sub>460</sub> 373.39 4 (†, 43 3)  
M1(+E2): δ<0.5 γ<sub>368</sub> 465.82 (†, 21 2) (M1) γ<sub>204</sub> 629.9 3 (†, 100 11) (M1)  
γ<sub>192</sub> 640.55 8 (†, 90 13) γ<sub>0</sub> 833.4 3 (†, 24 8)  
979.01 11, (1<sup>-</sup>, 2<sup>-</sup>) γ<sub>225</sub> 457.52 (†, 59 15) γ<sub>368</sub> 611.0 3 (†, 39 4) γ<sub>225</sub> 754.42 (†, 100 11) γ<sub>204</sub> 774.9 3 (†, 26 1) (M1) γ<sub>192</sub> 786.71(?) (†, 22 11)  
998.43 8, 1<sup>-</sup> γ<sub>271</sub> 244.93 10 (†, 9.8 6) γ<sub>368</sub> 630.8 3 (†, =10) γ<sub>225</sub> 773.46 20 (†, 20.2 6) M1(+E2): δ<0.7 γ<sub>204</sub> 794.85 7 (†, 54 5) (M1, E2) γ<sub>0</sub> 998.47 10 (†, 100 8) M1(+E2): δ<0.7  
1010.52 5, (1<sup>-</sup>) γ<sub>753</sub> 257.95 10 (†, 23 2) γ<sub>225</sub> 489.02 (†, 25 1) γ<sub>460</sub> 550.6 3 (†, 18 1) γ<sub>368</sub> 642.79 8 (†, 80 9) (M1) γ<sub>225</sub> 785.54 10 (†, 29 18) γ<sub>204</sub> 806.52 7 (†, 91 3) γ<sub>192</sub> 818.02 (†, 7 3) M1 γ<sub>0</sub> 1010.54 10 (†, 100 5)  
A 667.0+t, (10<sup>-</sup>, 11<sup>-</sup>, 12<sup>-</sup>) γ<sub>389+4</sub> 277.92 (†, 100 6) γ<sub>204+4</sub> 373.5(?) (†, 8 4)  
1152.01 7, (1<sup>-</sup>) γ<sub>368</sub> 784.24 (†, 25 12) γ<sub>225</sub> 926.97 9 (†, 100 21) M1(+E2): δ<0.7  
γ<sub>0</sub> 1152.04 9 (†, 38 1)  
1178.81 8, (1<sup>-</sup>) γ<sub>756</sub> 392.63 10 (†, 27 4) E2(+M1): δ>3 γ<sub>271</sub> 811.49 10 (†, 72 3) (M1, E2) γ<sub>0</sub> 1178.62 (†, 100 4)  
1187.56 7, (0, 1<sup>-</sup>) γ<sub>998</sub> 189.04 (†, =5) γ<sub>225</sub> 666.05 8 (†, 74 1) M1(+E2): δ<0.4  
γ<sub>368</sub> 819.50 20 (†, 100 2) γ<sub>225</sub> 962.64 12 (†, 49 1) (E2)  
A 911.7+t, (11<sup>-</sup>, 12<sup>-</sup>, 13<sup>-</sup>) γ<sub>687+4</sub> 244.72 (†, 100 11) γ<sub>389+4</sub> 522.72 (†, 54 9)  
1272.20 8, (0<sup>-</sup>, 1<sup>-</sup>, 2<sup>-</sup>) γ<sub>970</sub> 292.98 6(?) (†, <210) γ<sub>633</sub> 438.83 10 (†, 54 3)  
γ<sub>204</sub> 1068.47 10 (†, 100 9) (M1)  
1519.34 6, 1<sup>+</sup> γ<sub>970</sub> 540.52 (†, 2.61 8) γ<sub>633</sub> 685.93 10 (†, 3.80 7) γ<sub>460</sub> 1059.38 10 (†, 23.6 4) E1 γ<sub>225</sub> 1294.42 (†, 11.6 4) E1 γ<sub>204</sub> 1315.62 (†, 3.4 4)  
γ<sub>0</sub> 1519.45 13 (†, 100 8)  
1553.10 13, (0, 1) γ<sub>368</sub> 1185.35 15 (†, 92 5) γ<sub>204</sub> 1349.25 20 (†, 100 4)  
1602.82, (0<sup>-</sup>, 1<sup>-</sup>, 2<sup>-</sup>) γ<sub>0</sub> 1602.82 (†, 100)  
1639.07 7, (1<sup>-</sup>) γ<sub>1011</sub> 628.13(?) (†, 21 4) γ<sub>756</sub> 852.94 10 (†, 59 2) E2(+M1): δ>2  
γ<sub>368</sub> 1271.98 25 (†, 100 2) γ<sub>225</sub> 1414.35 (†, 30 6) γ<sub>0</sub> 1639.29 10 (†, 68 2)  
A 1314.9+t, (12<sup>-</sup>, 13<sup>-</sup>, 14<sup>-</sup>) γ<sub>912+4</sub> 403.22 (†, 100 10) γ<sub>687+4</sub> 648.52 (†, 43 7)  
1707.61 9, (1<sup>-</sup>) γ<sub>589</sub> 1118.44 10 (†, 100 13) M1, E2 γ<sub>368</sub> 1339.62 (†, 54 18)  
γ<sub>225</sub> 1482.92 (†, 62 5) γ<sub>192</sub> 1515 1 (†, =13)  
1722.97 17, (0<sup>-</sup>, 1) γ<sub>225</sub> 1200.93 (†, 31 4) γ<sub>0</sub> 1723.22 (†, 100 20)  
1753.13 15, (0, 1) γ<sub>225</sub> 1231.52 (†, 53 3) γ<sub>204</sub> 1549.42 (†, 100 4)  
1810.46 12, (1) γ<sub>225</sub> 1585.32 (†, 26 1) γ<sub>192</sub> 1618.52 (†, 35 1) γ<sub>0</sub> 1810.42 (†, 100 2)  
1858.8 10, (0, 1, 2<sup>-</sup>) γ<sub>1639</sub> 220.05 12(?) (†, 160 16) γ<sub>204</sub> 1655 1 (†, 100 20)  
A 1598.2+t, (13<sup>-</sup>, 14<sup>-</sup>, 15<sup>-</sup>) γ<sub>1316+4</sub> 283.32 (†, 60 7) γ<sub>912+4</sub> 686.72 (†, 100 10)

2192.7 3, (1, 2<sup>-</sup>) γ<sub>1639</sub> 553.32(?) (†, 172 10) γ<sub>222</sub> 1671 1 (†, 42 22) γ<sub>192</sub> 2000.6 3 (†, 100 7)  
2343.4 5, (0<sup>-</sup>, 1) γ<sub>0</sub> 2343.45 (†, 100)  
A 2056.8+t, (14<sup>-</sup>, 15<sup>-</sup>, 16<sup>-</sup>) γ<sub>1598+4</sub> 458.62 (†, 100 11) γ<sub>1316+4</sub> 741.92 (†, 46 7)  
A 2346.2+t, (15<sup>-</sup>, 16<sup>-</sup>, 17<sup>-</sup>) γ<sub>2057+4</sub> 289.42 (†, 100 11) γ<sub>1598+4</sub> 748.6(?)  
B u, J=(12)  
B 268.0+u, J+2 γ<sub>0</sub> 268.0 3 I<sup>(1)</sup>=100.7, I<sup>(2)</sup>=102.6, η=0.144  
B 575.0+u, J+4 γ<sub>268+u</sub> 307.0 3 I<sup>(1)</sup>=101.0, I<sup>(2)</sup>=105.0, η=0.163  
B 920.1+u, J+6 γ<sub>575+u</sub> 345.1 3 I<sup>(1)</sup>=101.4, I<sup>(2)</sup>=102.3, η=0.182  
B 1304.3+u, J+8 γ<sub>920+u</sub> 384.2 3 I<sup>(1)</sup>=101.5, I<sup>(2)</sup>=108.7, η=0.201  
B 1725.3+u, J+10 γ<sub>1304+u</sub> 421.0 3 I<sup>(1)</sup>=102.1, I<sup>(2)</sup>=111.1, η=0.220  
B 2182.3+u, J+12 γ<sub>1725+u</sub> 457.0 5 I<sup>(1)</sup>=102.8, I<sup>(2)</sup>=105.5, η=0.238  
B 2677.2+u, J+14 γ<sub>2182+u</sub> 494.9 5 I<sup>(1)</sup>=103.1, I<sup>(2)</sup>=111.1, η=0.256  
B 3208.1+u, J+16 γ<sub>2677+u</sub> 530.9 5 I<sup>(1)</sup>=103.6, I<sup>(2)</sup>=110.8, η=0.274  
B 3775.1+u, J+18 γ<sub>3208+u</sub> 567.0 5 I<sup>(1)</sup>=104.1, I<sup>(2)</sup>=117.0, η=0.292  
B 4376.3+u, J+20 γ<sub>3775+u</sub> 601.2 10 I<sup>(1)</sup>=104.8, I<sup>(2)</sup>=118.7, η=0.309  
B 5011.2+u, J+22 γ<sub>4376+u</sub> 634.9 10 I<sup>(1)</sup>=105.5, I<sup>(2)</sup>=114.6, η=0.326  
B 5681.0+u, J+24 γ<sub>5011+u</sub> 669.8 10 I<sup>(1)</sup>=106.0, I<sup>(2)</sup>=118.3, η=0.343  
B 6384.6+u, J+26 γ<sub>5681+u</sub> 703.6 10 I<sup>(1)</sup>=106.6  
C v, J=(9)  
C 209.3+v, J+2 γ<sub>0</sub> 209.3 3 I<sup>(1)</sup>=100.3, I<sup>(2)</sup>=102.3, η=0.114  
C 457.7+v, J+4 γ<sub>209+u</sub> 248.4 3 I<sup>(1)</sup>=100.6, I<sup>(2)</sup>=102.3, η=0.134  
C 745.2+v, J+6 γ<sub>457+u</sub> 287.5 3 I<sup>(1)</sup>=100.9, I<sup>(2)</sup>=103.9, η=0.153  
C 1071.2+v, J+8 γ<sub>745+u</sub> 326.0 3 I<sup>(1)</sup>=101.2, I<sup>(2)</sup>=104.2, η=0.173  
C 1435.6+v, J+10 γ<sub>1071+u</sub> 364.4 3 I<sup>(1)</sup>=101.5, I<sup>(2)</sup>=107.2, η=0.192  
C 1837.3+v, J+12 γ<sub>1436+u</sub> 401.7 5 I<sup>(1)</sup>=102.1, I<sup>(2)</sup>=106.4, η=0.210  
C 2276.6+v, J+14 γ<sub>1837+u</sub> 439.3 5 I<sup>(1)</sup>=102.4, I<sup>(2)</sup>=109.3, η=0.229  
C 2752.5+v, J+16 γ<sub>2277+u</sub> 475.9 5 I<sup>(1)</sup>=103.0, I<sup>(2)</sup>=110.8, η=0.247  
C 3264.5+v, J+18 γ<sub>2753+u</sub> 512.0 5 I<sup>(1)</sup>=103.5, I<sup>(2)</sup>=111.1, η=0.265  
C 3812.5+v, J+20 γ<sub>3265+u</sub> 548.0 5 I<sup>(1)</sup>=104.0, I<sup>(2)</sup>=112.7, η=0.283  
C 4396.0+v, J+22 γ<sub>3813+u</sub> 583.5 10 I<sup>(1)</sup>=104.5, I<sup>(2)</sup>=117.6, η=0.300  
C 5013.5+v, J+24 γ<sub>4396+u</sub> 617.5 10 I<sup>(1)</sup>=105.3, I<sup>(2)</sup>=115.9, η=0.317  
C 5665.5+v, J+26 γ<sub>5014+u</sub> 652.0 10 I<sup>(1)</sup>=105.8, I<sup>(2)</sup>=118.0, η=0.334  
C 6351.4+v, J+28 γ<sub>5666+u</sub> 685.9 10 I<sup>(1)</sup>=106.4  
D w, J=(10, 11)  
D 240.5+w, J+2 γ<sub>0</sub> 240.5 3 I<sup>(1)</sup>=95.6, I<sup>(2)</sup>=101.3, η=0.130  
D 520.5+w, J+4 γ<sub>241+w</sub> 280.0 3 I<sup>(1)</sup>=96.4, I<sup>(2)</sup>=103.1, η=0.150  
D 839.3+w, J+6 γ<sub>521+w</sub> 318.8 3 I<sup>(1)</sup>=97.2, I<sup>(2)</sup>=101.8, η=0.169  
D 1197.4+w, J+8 γ<sub>839+w</sub> 358.1 3 I<sup>(1)</sup>=97.7, I<sup>(2)</sup>=102.3, η=0.189  
D 1594.6+w, J+10 γ<sub>1197+w</sub> 397.2 3 I<sup>(1)</sup>=98.2, I<sup>(2)</sup>=105.0, η=0.208  
D 2029.9+w, J+12 γ<sub>1595+w</sub> 435.3 3 I<sup>(1)</sup>=98.8, I<sup>(2)</sup>=106.1, η=0.227  
D 2502.9+w, J+14 γ<sub>2030+w</sub> 473.0 3 I<sup>(1)</sup>=99.4, I<sup>(2)</sup>=105.5, η=0.246  
D 3013.8+w, J+16 γ<sub>2503+w</sub> 510.9 5 I<sup>(1)</sup>=99.8, I<sup>(2)</sup>=112.0, η=0.264  
D 3560.4+w, J+18 γ<sub>3014+w</sub> 546.6 5 I<sup>(1)</sup>=100.6, I<sup>(2)</sup>=112.4, η=0.282  
D 4142.6+w, J+20 γ<sub>3560+w</sub> 582.2 5 I<sup>(1)</sup>=101.3, I<sup>(2)</sup>=113.6, η=0.300  
D 4760.0+w, J+22 γ<sub>4143+w</sub> 617.4 5 I<sup>(1)</sup>=102.0, I<sup>(2)</sup>=115.6, η=0.317  
D 5412.0+w, J+24 γ<sub>4760+w</sub> 652.0 10 I<sup>(1)</sup>=105.8, I<sup>(2)</sup>=118.0, η=0.334  
D 6097.5+w, J+26 γ<sub>5412+w</sub> 685.5 10 I<sup>(1)</sup>=103.6, I<sup>(2)</sup>=125.0, η=0.351  
D 6815.0+w(?) J+28 γ<sub>6098+w</sub> 717.5 10(?) I<sup>(1)</sup>=104.5  
E x, J=(9, 10)  
E 220.3+x, J+2 γ<sub>x</sub> 220.3 3 I<sup>(1)</sup>=95.3, I<sup>(2)</sup>=102.3, η=0.120  
E 479.7+x, J+4 γ<sub>220+x</sub> 259.4 3 I<sup>(1)</sup>=96.4, I<sup>(2)</sup>=99.3, η=0.140  
E 779.4+x, J+6 γ<sub>480+x</sub> 299.7 3 I<sup>(1)</sup>=96.8, I<sup>(2)</sup>=102.6, η=0.160  
E 1118.1+x, J+8 γ<sub>770+x</sub> 338.7 3 I<sup>(1)</sup>=97.4, I<sup>(2)</sup>=101.0, η=0.179  
E 1496.8+x, J+10 γ<sub>1118+x</sub> 378.3 3 I<sup>(1)</sup>=97.8, I<sup>(2)</sup>=107.5, η=0.198  
E 1912.3+x, J+12 γ<sub>1497+x</sub> 415.3 5 I<sup>(1)</sup>=98.7, I<sup>(2)</sup>=103.4, η=0.217  
E 2366.5+x, J+14 γ<sub>1912+x</sub> 454.2 5 I<sup>(1)</sup>=99.1, I<sup>(2)</sup>=107.2, η=0.236  
E 2858.0+x, J+16 γ<sub>2367+x</sub> 491.5 5 I<sup>(1)</sup>=99.7, I<sup>(2)</sup>=110.2, η=0.255  
E 3385.8+x, J+18 γ<sub>2858+x</sub> 527.8 5 I<sup>(1)</sup>=100.4, I<sup>(2)</sup>=110.5, η=0.273  
E 3949.8+x, J+20 γ<sub>3386+x</sub> 564.0 5 I<sup>(1)</sup>=101.1, I<sup>(2)</sup>=112.0, η=0.291  
E 4549.5+x(?) J+22 γ<sub>3950+x</sub> 599.7 10(?) I<sup>(1)</sup>=101.7, I<sup>(2)</sup>=117.6, η=0.308  
E 5183.2+x(?) J+24 γ<sub>4550+x</sub> 633.7 10(?) I<sup>(1)</sup>=102.6, I<sup>(2)</sup>=112.7, η=0.326  
E 5852.4+x(?) J+26 γ<sub>5183+x</sub> 669.2 10(?) I<sup>(1)</sup>=103.1, I<sup>(2)</sup>=117.0, η=0.343  
E 6555.8+x(?) J+28 γ<sub>5852+x</sub> 703.4 10(?) I<sup>(1)</sup>=103.8  
F y, J=(8, 9)  
F 187.9+y, J+2 γ<sub>y</sub> 187.9 3 I<sup>(1)</sup>=101.1, I<sup>(2)</sup>=104.2, η=0.104  
F 414.2+y, J+4 γ<sub>188+y</sub> 226.3 3 I<sup>(1)</sup>=101.6, I<sup>(2)</sup>=106.1, η=0.123

194  
81 <sup>TI</sup> (Continued)

- F 678.2+y, J+6  $\gamma_{414+y} 264.03$   $I^{(1)}=102.3, I^{(2)}=105.3, \eta\omega=0.142$
- F 980.2+y, J+8  $\gamma_{678+y} 302.03$   $I^{(1)}=102.6, I^{(2)}=107.5, \eta\omega=0.160$
- F 1319.4+y, J+10  $\gamma_{980+y} 339.23$   $I^{(1)}=103.2, I^{(2)}=107.0, \eta\omega=0.179$
- F 1696.0+y, J+12  $\gamma_{1319+y} 376.63$   $I^{(1)}=103.6, I^{(2)}=107.8, \eta\omega=0.198$
- F 2109.7+y, J+14  $\gamma_{1696+y} 413.75$   $I^{(1)}=103.9, I^{(2)}=110.2, \eta\omega=0.216$
- F 2559.7+y, J+16  $\gamma_{2110+y} 450.05$   $I^{(1)}=104.4, I^{(2)}=110.8, \eta\omega=0.234$
- F 3045.8+y, J+18  $\gamma_{2560+y} 486.15$   $I^{(1)}=104.9, I^{(2)}=112.0, \eta\omega=0.252$
- F 3567.6+y, J+20  $\gamma_{3046+y} 521.85$   $I^{(1)}=105.4, I^{(2)}=109.3, \eta\omega=0.270$
- F 4126.0+y, J+22  $\gamma_{3568+y} 558.410$   $I^{(1)}=105.7, I^{(2)}=113.3, \eta\omega=0.288$
- F 4719.7+y, J+24  $\gamma_{4126+y} 593.710$   $I^{(1)}=106.1, I^{(2)}=117.6, \eta\omega=0.305$
- F 5347.4+y (?), J+26  $\gamma_{4720+y} 627.710$  (?)  $I^{(1)}=106.7$
- G z, J=(9,10)
- G 207.0+z, J+2  $\gamma_z 207.03$   $I^{(1)}=101.4, I^{(2)}=104.2, \eta\omega=0.113$
- G 452.4+z, J+4  $\gamma_{207+z} 245.43$   $I^{(1)}=101.9, I^{(2)}=104.4, \eta\omega=0.132$
- G 736.1+z, J+6  $\gamma_{452+z} 283.73$   $I^{(1)}=102.2, I^{(2)}=105.0, \eta\omega=0.151$
- G 1057.9+z, J+8  $\gamma_{736+z} 321.83$   $I^{(1)}=102.5, I^{(2)}=109.9, \eta\omega=0.170$
- G 1416.1+z, J+10  $\gamma_{1058+z} 358.23$   $I^{(1)}=103.3, I^{(2)}=105.3, \eta\omega=0.189$
- G 1812.3+z, J+12  $\gamma_{1416+z} 396.23$   $I^{(1)}=103.5, I^{(2)}=110.2, \eta\omega=0.207$
- G 2244.8+z, J+14  $\gamma_{1812+z} 432.55$   $I^{(1)}=104.0, I^{(2)}=106.4, \eta\omega=0.226$
- G 2714.9+z, J+16  $\gamma_{2245+z} 470.15$   $I^{(1)}=104.2, I^{(2)}=110.8, \eta\omega=0.244$
- G 3221.1+z, J+18  $\gamma_{2715+z} 503.75$   $I^{(1)}=104.7, I^{(2)}=106.7, \eta\omega=0.262$
- G 3764.8+z, J+20  $\gamma_{3221+z} 543.75$   $I^{(1)}=104.8, I^{(2)}=113.0, \eta\omega=0.281$
- G 4343.9+z, J+22  $\gamma_{3765+z} 579.110$   $I^{(1)}=105.3, I^{(2)}=118.0, \eta\omega=0.298$
- G 4956.9+z, J+24  $\gamma_{4344+z} 613.010$   $I^{(1)}=106.0$

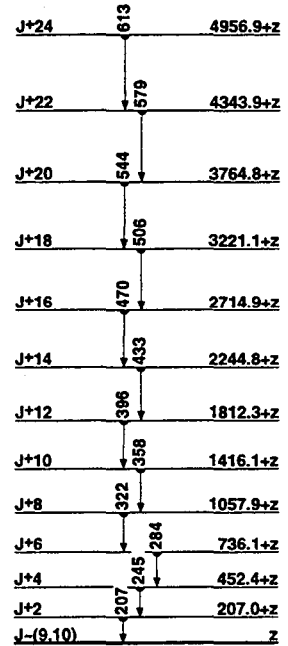
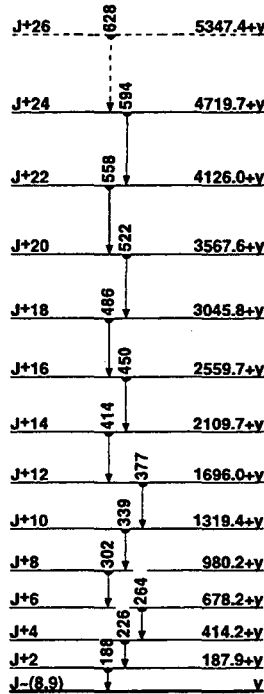

SD-5 band

SD-6 band

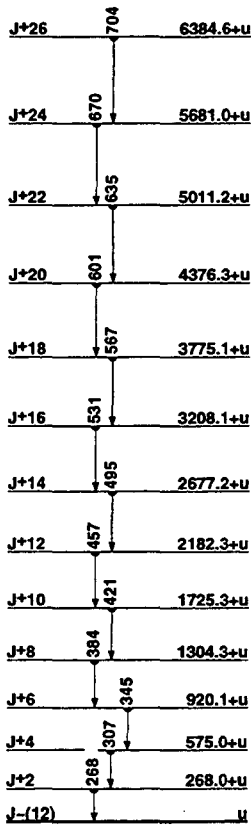

SD-1 band

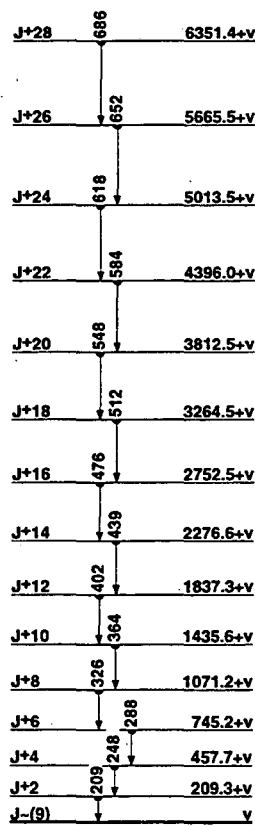

SD-2 band

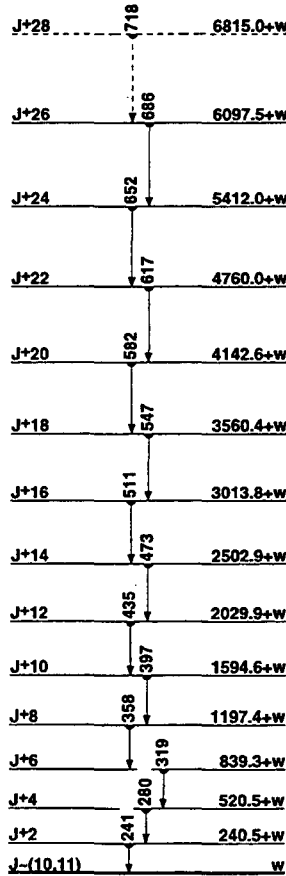

SD-3 band

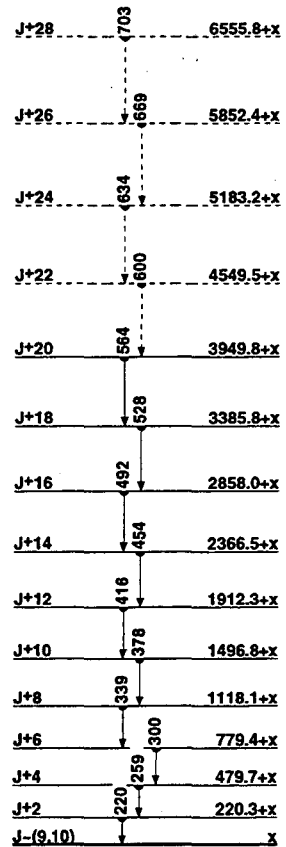

SD-4 band

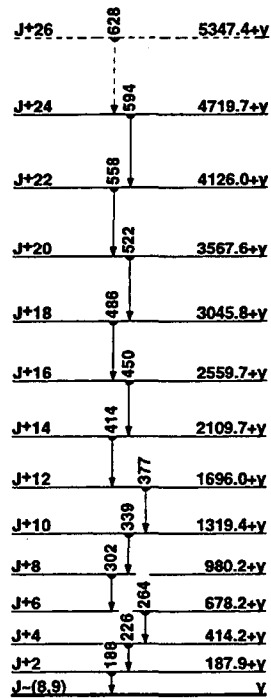

SD-5 band

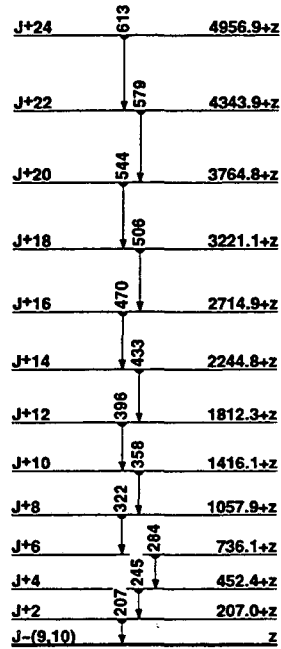

SD-6 band

<sup>194</sup>Tl

81

$\Delta$ : (-28270)  $S_n$ : (9380)  $S_p$ : (3320)  $Q_{EC}$ : (2800)  $Q_\alpha$ : (3160)

Nuclear Bands

- A Band Structure
- B Band Structure
- C SD-1 band
- D SD-2 band

Levels and  $\gamma$ -ray branchings:

- 0, 1/2<sup>+</sup>, 1.165 h, %EC+% $\beta^+$ =100,  $\mu$ =+1.584
- 383.66 12, 3/2<sup>+</sup>  $\gamma_{384}$  383.64 12 (t<sub>100</sub>) M1+E2:  $\delta=1.8_{-3}^{+4}$
- A 482.63 17, 9/2<sup>+</sup>, 3.64 s, %IT=100  $\gamma_{384}$  98.97 12 (t<sub>100</sub>) E3
- 777.55 17, (5/2<sup>+</sup>)  $\gamma_{384}$  393.73 (t<sub>100.089</sub>)  $\gamma_{777}$  6.2 (t<sub>1.189</sub>)
- 811.16  $\gamma_{384}$  427.45 (t<sub>100</sub>)
- A 876.69 19, 11/2<sup>+</sup>  $\gamma_{483}$  394.21 12 (t<sub>100</sub>) M1(+E2):  $\delta=0.42_{13}$
- 1079.78  $\gamma_{384}$  696.08 (t<sub>100</sub>)
- 1173.79 20, 9/2<sup>+</sup>, 11/2<sup>+</sup>  $\gamma_{483}$  691.17 15 (t<sub>100</sub>) M1
- A 1190.12 19, 13/2<sup>+</sup>  $\gamma_{877}$  313.22 12 (t<sub>50.3</sub>) M1+E2:  $\delta=0.38_{10}$   $\gamma_{483}$  707.67 15 (t<sub>100.6</sub>) E2
- 1267.03, (1/2<sup>+</sup>, 3/2<sup>+</sup>, 5/2<sup>+</sup>)  $\gamma_{384}$  883.13 (t<sub>100</sub>) (E2)
- 1285.34  $\gamma_{778}$  507.83 (t<sub>100</sub>)
- 1360.95 22, 11/2<sup>+</sup>  $\gamma_{483}$  878.40 16 (t<sub>100</sub>) M1(+E2)
- 1378(?)  $\gamma_{384}$  994.38(?) (t<sub>100</sub>)
- 1410.68 20, 11/2<sup>+</sup>, 13/2<sup>+</sup>  $\gamma_{1174}$  236.60 23 (t<sub>1.1211</sub>) M1  $\gamma_{877}$  534.11 14 (t<sub>44.9</sub>) M1  $\gamma_{483}$  928.02 16 (t<sub>100.15</sub>) (E2)
- 1434.77  $\gamma_{384}$  1051.08 (t<sub>100</sub>)
- 1484.04 21, 13/2<sup>+</sup>  $\gamma_{1190}$  294.25 (t<sub>65.48</sub>)  $\gamma_{877}$  607.64 15 (t<sub>100.11</sub>) M1+E2:  $\delta=0.66_{19}$   $\gamma_{483}$  1000.92 18 (t<sub>16.614</sub>)
- 1612.79, (3/2<sup>+</sup>, 5/2<sup>+</sup>, 7/2<sup>+</sup>)  $\gamma_{1267}$  346.05(?) (t<sub>18.12</sub>)  $\gamma_{778}$  835.28 (t<sub>100.15</sub>) M1
- 1616.42 21, 9/2<sup>+</sup>, 11/2<sup>+</sup>, 13/2<sup>+</sup>  $\gamma_{1174}$  442.74 14 (t<sub>100.10</sub>) M1  $\gamma_{877}$  739.47 23 (t<sub>47.8</sub>)  $\gamma_{483}$  1133.73 21 (t<sub>98.911</sub>)
- A 1618.74 20, 15/2<sup>+</sup>  $\gamma_{1190}$  428.44 13 (t<sub>100.6</sub>) M1+E2:  $\delta=0.34_6$   $\gamma_{877}$  742.19 15 (t<sub>93.6</sub>) E2
- 1648.65  $\gamma_{778}$  871.05 (t<sub>100</sub>)
- 1687.97  $\gamma_{1435}$  253.25 (t<sub>29.12</sub>)  $\gamma_{384}$  1304.28 (t<sub>100.15</sub>)
- 1725.26 23, (13/2<sup>+</sup>)  $\gamma_{877}$  848.66 16 (t<sub>100.25</sub>) E1(+M2)  $\gamma_{483}$  1242.24 32 (t<sub>11.325</sub>)
- 1843.7 10  $\gamma_{384}$  1461.18 (t<sub>100</sub>)
- 1844.84  $\gamma_{1649}$  196.15 (t<sub>7.314</sub>)  $\gamma_{1267}$  578.05 (t<sub>36.18</sub>)  $\gamma_{778}$  1067.08 (t<sub>100.18</sub>)
- 1924.46 22, 17/2<sup>+</sup>  $\gamma_{1619}$  305.67 15 (t<sub>58.6</sub>) M1+E2:  $\delta=0.11_{-4}^{+3}$   $\gamma_{1190}$  734.43 15 (t<sub>100.25</sub>) E2
- 1944.61 21, 13/2<sup>+</sup>  $\gamma_{1619}$  325.85 14 (t<sub>10.613</sub>) M1+E2  $\gamma_{1411}$  534.1 (t<sub>8.39</sub>)  $\gamma_{1190}$  754.73 32 (t<sub>13.3</sub>) M1  $\gamma_{877}$  1067.88 17 (t<sub>100.6</sub>) M1(+E2)
- 1991.47 22, 11/2<sup>+</sup>, 13/2<sup>+</sup>  $\gamma_{1361}$  630.58 14 (t<sub>100.8</sub>) M1(+E2)  $\gamma_{1190}$  801.26 17 (t<sub>62.6</sub>) M1
- A 2011.53, 17/2<sup>+</sup>  $\gamma_{1619}$  392.85 (t<sub>100.47</sub>) (M1+E2):  $\delta=0.42_{13}$   $\gamma_{1190}$  821.33 (t<sub>82.47</sub>) E2
- 2023.53, 11/2<sup>+</sup>, 13/2<sup>+</sup>, 15/2<sup>+</sup>  $\gamma_{1484}$  539.50 15 (t<sub>100</sub>) M1  $\gamma_{1435}$  549.05(?) (t<sub>65.59</sub>)
- 2033.75(?)  $\gamma_{1190}$  843.25 (t<sub>100</sub>)
- B 2037.13, 15/2<sup>+</sup>  $\gamma_{1619}$  418.53 (t<sub>20.3</sub>) (E1)  $\gamma_{1484}$  552.93 (t<sub>24.4</sub>) (E1)  $\gamma_{1190}$  847.15 (t<sub>100.35</sub>) (E1)  $\gamma_{877}$  1161.65(?)
- 2115.15(?)  $\gamma_{1484}$  630.58 14 (t<sub>100.8</sub>)
- 2145.13, (11/2, 13/2, 15/2)<sup>+</sup>  $\gamma_{1725}$  419.81 16 (t<sub>100</sub>) M1
- B 2212.94, 17/2<sup>+</sup>  $\gamma_{2037}$  175.73 (t<sub>100</sub>) M1+E2:  $\delta=0.13_5$
- 2361.94, (11/2, 13/2, 15/2)  $\gamma_{1484}$  877.93 (t<sub>2.17</sub>)
- 2367.95(?)  $\gamma_{1619}$  748.85 (t<sub>100</sub>)
- A 2470.13, 19/2<sup>+</sup>  $\gamma_{2012}$  458.73 (t<sub>100.13</sub>) M1+E2:  $\delta=0.75_{15}$   $\gamma_{1924}$  545.73 (t<sub>21.5</sub>) M1+E2:  $\delta=0.57_{16}$   $\gamma_{1619}$  851.33 (t<sub>17.8</sub>) E2
- B 2529.64, 19/2<sup>+</sup>  $\gamma_{2213}$  316.83 (t<sub>100.12</sub>) M1+E2:  $\delta=0.21_4$   $\gamma_{2037}$  492.63 (t<sub>1.5</sub>) E2
- 2581.55(?)  $\gamma_{2115}$  466.45 (t<sub>32.14</sub>)  $\gamma_{1190}$  1391.05 (t<sub>100.32</sub>)
- A 2587.43, 21/2<sup>+</sup>  $\gamma_{2470}$  117.35 (t<sub>26.9</sub>) (M1+E2)  $\gamma_{2012}$  575.83 (t<sub>42.6</sub>) E2  $\gamma_{1924}$  663.13 (t<sub>100.11</sub>) E2
- B 2840.75, 21/2<sup>+</sup>  $\gamma_{2630}$  311.45 (t<sub>100.31</sub>) M1+E2:  $\delta=0.23_5$   $\gamma_{2213}$  627.73 (t<sub>1.5</sub>) E2
- A 2861.14, 23/2<sup>+</sup>  $\gamma_{2587}$  273.73 (t<sub>100</sub>) M1(+E2):  $\delta<0.14$
- A 3059.84, 25/2<sup>+</sup>  $\gamma_{2861}$  198.83 (t<sub>100.25</sub>) (M1+E2)  $\gamma_{2587}$  472.33 (t<sub>64.21</sub>) E2
- A 3157.15, 27/2<sup>+</sup>  $\gamma_{3060}$  97.33 (t<sub>100</sub>) (M1+E2)
- B 3201.95, 23/2<sup>+</sup>  $\gamma_{2841}$  361.13 (t<sub>69.8</sub>) M1+E2:  $\delta=0.23_4$   $\gamma_{2530}$  672.35 (t<sub><100</sub>) E2

- B 3513.95, 25/2<sup>+</sup>  $\gamma_{3202}$  312.35 (t<sub>70.22</sub>) M1+E2:  $\delta=0.27_6$   $\gamma_{2841}$  673.25 (t<sub><100</sub>) (E2)
- B 3729.65, 27/2<sup>+</sup>  $\gamma_{3514}$  215.83 (t<sub>100.10</sub>) M1(+E2):  $\delta<0.14$   $\gamma_{3202}$  527.63 (t<sub>60.12</sub>) E2
- B 3885.36, 29/2<sup>+</sup>  $\gamma_{3730}$  155.73 (t<sub>100</sub>) (M1+E2)
- B 4002.88, 31/2<sup>+</sup>  $\gamma_{3885}$  117.55 (t<sub>100</sub>) (M1+E2)
- B 4174.89, 33/2<sup>+</sup>  $\gamma_{4003}$  172.03 (t<sub>100</sub>) (M1+E2)
- B 4393.39, 35/2<sup>+</sup>  $\gamma_{4175}$  218.53 (t<sub>100</sub>) (M1+E2)
- C x, J=(29/2)
- C 330.1+x, J+2  $\gamma_x$  330.1 I<sup>(1)</sup>=96.9, I<sup>(2)</sup>=99.8,  $\eta\omega=0.175$
- C 700.3+x, J+4  $\gamma_{330+x}$  370.2 I<sup>(1)</sup>=97.2, I<sup>(2)</sup>=106.4,  $\eta\omega=0.194$
- C 1107.9+x, J+6  $\gamma_{700+x}$  407.8 I<sup>(1)</sup>=98.1, I<sup>(2)</sup>=106.1,  $\eta\omega=0.213$
- C 1552.4+x, J+8  $\gamma_{1108+x}$  445.5 I<sup>(1)</sup>=98.8, I<sup>(2)</sup>=108.1,  $\eta\omega=0.232$
- C 2034.9+x, J+10  $\gamma_{1552+x}$  482.5 I<sup>(1)</sup>=99.5, I<sup>(2)</sup>=110.2,  $\eta\omega=0.250$
- C 2553.7+x, J+12  $\gamma_{2035+x}$  518.8 I<sup>(1)</sup>=100.2, I<sup>(2)</sup>=111.7,  $\eta\omega=0.268$
- C 3108.3+x, J+14  $\gamma_{2554+x}$  554.6 I<sup>(1)</sup>=101.0, I<sup>(2)</sup>=123.1,  $\eta\omega=0.285$
- C 3695.4+x, J+16  $\gamma_{3108+x}$  587.1 I<sup>(1)</sup>=102.2, I<sup>(2)</sup>=116.6,  $\eta\omega=0.302$
- C 4316.8+x, J+18  $\gamma_{3695+x}$  621.4 I<sup>(1)</sup>=103.0, I<sup>(2)</sup>=126.2,  $\eta\omega=0.319$
- C 4969.9+x, J+20  $\gamma_{4317+x}$  653.1 I<sup>(1)</sup>=104.1, I<sup>(2)</sup>=121.6,  $\eta\omega=0.335$
- C 5655.9+x, J+22  $\gamma_{4970+x}$  686.0 I<sup>(1)</sup>=105.0, I<sup>(2)</sup>=133.3,  $\eta\omega=0.350$
- C 6371.9+x, J+24  $\gamma_{5656+x}$  716.0 I<sup>(1)</sup>=106.1
- D y, J=(31/2)
- D 350.7+y, J+2  $\gamma_y$  350.7 I<sup>(1)</sup>=96.9, I<sup>(2)</sup>=102.0,  $\eta\omega=0.185$
- D 740.6+y, J+4  $\gamma_{351+y}$  389.9 I<sup>(1)</sup>=97.5, I<sup>(2)</sup>=105.0,  $\eta\omega=0.204$
- D 1168.6+y, J+6  $\gamma_{741+y}$  428.0 I<sup>(1)</sup>=98.1, I<sup>(2)</sup>=106.1,  $\eta\omega=0.223$
- D 1634.3+y, J+8  $\gamma_{1169+y}$  465.7 I<sup>(1)</sup>=98.8, I<sup>(2)</sup>=105.8,  $\eta\omega=0.242$
- D 2137.8+y, J+10  $\gamma_{1634+y}$  503.5 I<sup>(1)</sup>=99.3, I<sup>(2)</sup>=108.1,  $\eta\omega=0.261$
- D 2678.3+y, J+12  $\gamma_{2138+y}$  540.5 I<sup>(1)</sup>=99.9, I<sup>(2)</sup>=109.6,  $\eta\omega=0.279$
- D 3255.3+y, J+14  $\gamma_{2678+y}$  577.0 I<sup>(1)</sup>=100.5, I<sup>(2)</sup>=118.0,  $\eta\omega=0.297$
- D 3866.2+y, J+16  $\gamma_{3255+y}$  610.9 I<sup>(1)</sup>=101.5, I<sup>(2)</sup>=119.0,  $\eta\omega=0.314$
- D 4510.7+y, J+18  $\gamma_{3866+y}$  644.5 I<sup>(1)</sup>=102.4, I<sup>(2)</sup>=112.7,  $\eta\omega=0.331$
- D 5190.7+y(?), J+20  $\gamma_{4511+y}$  680.0(?) I<sup>(1)</sup>=102.9

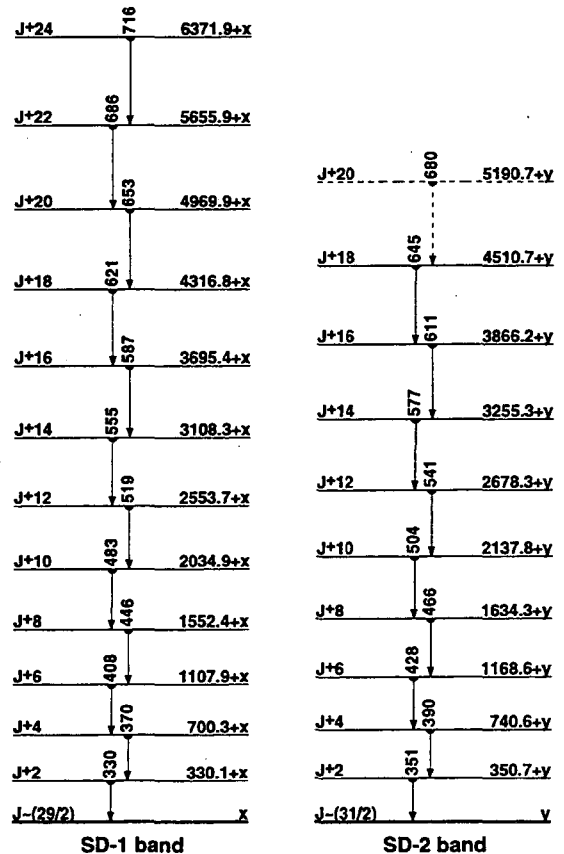

**192Pb**  
**82Pb**

$\Delta: (-22580)$   $S_n: (10300)$   $S_p: (3700)$   $Q_{EC}: (3400)$   $Q_\alpha: 52215$

**Nuclear Bands**

- A GS band
- B Band Structure
- C SD band

**Levels and  $\gamma$ -ray branchings:**

- A 0, 0<sup>+</sup>, 3.51 m, %EC+% $\beta^+$ =99.994310, % $\alpha$ =0.005710
- B 768.84, 0<sup>+</sup>, 0.7510 ns  $\gamma_0$  768.54 E0
- A 853.63, 2<sup>+</sup>  $\gamma_0$  853.82 (t<sub>1/2</sub> 100) E2
- B 1237.93, (2<sup>-</sup>)  $\gamma_{854}$  383.94 (t<sub>1/2</sub> <10)  $\gamma_{768}$  469.43 (t<sub>1/2</sub> 43)  $\gamma_0$  1237.73 (t<sub>1/2</sub> 100  $\theta$ )
- A 1355.54, 4<sup>+</sup>  $\gamma_{854}$  501.82 (t<sub>1/2</sub> 100) E2
- 1430.24  $\gamma_{854}$  576.62 (t<sub>1/2</sub> 100)
- 1544.13, 1, 2<sup>+</sup>  $\gamma_{854}$  690.72 (t<sub>1/2</sub> 100 25)  $\gamma_{768}$  775.02 (t<sub>1/2</sub> 30  $\theta$ )
- 1859.95, (5<sup>-</sup>)  $\gamma_{1356}$  504.32 (t<sub>1/2</sub> 100) E1
- A 1920.75, 6<sup>+</sup>  $\gamma_{1356}$  565.42 (t<sub>1/2</sub> 100) E2
- 1983.36  $\gamma_{1238}$  745.43 (t<sub>1/2</sub> 100)
- 2303.35, (7<sup>-</sup>)  $\gamma_{1921}$  382.82 (t<sub>1/2</sub> 100) E1(+M2)
- 2323.25, (7<sup>-</sup>)  $\gamma_{1921}$  402.42 (t<sub>1/2</sub> 135)  $\gamma_{1860}$  463.42 (t<sub>1/2</sub> 100 10) E2
- 2507.26, (8<sup>-</sup>)  $\gamma_{2323}$  184.02 (t<sub>1/2</sub> 100) M1+E2
- 2514.15, (9<sup>-</sup>)  $\gamma_{2323}$  191.12 (t<sub>1/2</sub> 100 14) E2  $\gamma_{2303}$  210.72 (t<sub>1/2</sub> 17  $\theta$ )
- A 2520.26, (8<sup>+</sup>)  $\gamma_{1921}$  599.52 (t<sub>1/2</sub> 100)
- 2562.36  $\gamma_{1921}$  641.62 (t<sub>1/2</sub> 100)
- A 2581.28, (10<sup>+</sup>), 10015 ns  $\gamma_{2520}$  61.05 (t<sub>1/2</sub> 1.4) (E2)  $\gamma_{2514}$  67.05 (t<sub>1/2</sub> 100) E1
- 2622.45  $\gamma_{1356}$  1266.93 (t<sub>1/2</sub> 979)  $\gamma_{854}$  1768.94 (t<sub>1/2</sub> 100 43)
- A -2626, (12<sup>+</sup>), 1.105  $\mu$ s,  $\mu = -2.07624$   $\gamma_{2581}$  4525 (t<sub>1/2</sub> 100) (E2)
- 2789.15  $\gamma_{2303}$  486.12 (t<sub>1/2</sub> 100 60)  $\gamma_{1860}$  928.73 (t<sub>1/2</sub> 93 33)
- 2894.07  $\gamma_{2323}$  570.83 (t<sub>1/2</sub> 100)
- C x, J=(10,11)
- C 262.6+x, J+2  $\gamma_{262.64}$  (t<sub>1/2</sub> 0.60 10) I<sup>(1)</sup>=87.6, I<sup>(2)</sup>=96.4,  $\eta\omega=0.142$
- C 566.7+x, J+4  $\gamma_{263+x}$  304.14 (t<sub>1/2</sub> 0.85 10) I<sup>(1)</sup>=88.8, I<sup>(2)</sup>=96.4,  $\eta\omega=0.162$
- C 912.3+x, J+6  $\gamma_{567+x}$  345.64 (t<sub>1/2</sub> 0.80 15) I<sup>(1)</sup>=89.7, I<sup>(2)</sup>=100.0,  $\eta\omega=0.183$
- C 1297.9+x, J+8  $\gamma_{912+x}$  385.63 (t<sub>1/2</sub> 1.20 15) I<sup>(1)</sup>=90.8, I<sup>(2)</sup>=103.1,  $\eta\omega=0.202$
- C 1722.3+x, J+10  $\gamma_{1298+x}$  424.44 (t<sub>1/2</sub> 1.00 20) I<sup>(1)</sup>=91.9, I<sup>(2)</sup>=104.2,  $\eta\omega=0.222$
- C 2185.1+x, J+12  $\gamma_{1722+x}$  462.85 (t<sub>1/2</sub> 0.60 15) I<sup>(1)</sup>=92.9, I<sup>(2)</sup>=107.5,  $\eta\omega=0.241$
- C 2685.1+x, J+14  $\gamma_{2185+x}$  500.06 (t<sub>1/2</sub> 0.70 30) I<sup>(1)</sup>=94.0, I<sup>(2)</sup>=114.0,  $\eta\omega=0.259$
- C 3220.2+x, J+16  $\gamma_{2685+x}$  535.18 (t<sub>1/2</sub> 0.65 20) I<sup>(1)</sup>=95.3, I<sup>(2)</sup>=112.7,  $\eta\omega=0.276$
- C 3790.8+x, J+18  $\gamma_{3220+x}$  570.611 (t<sub>1/2</sub> 0.50 25) I<sup>(1)</sup>=96.4, I<sup>(2)</sup>=119.8,  $\eta\omega=0.294$
- C 4394.8+x (?), J+20  $\gamma_{3791+x}$  604(?) I<sup>(1)</sup>=97.7, I<sup>(2)</sup>=125.0,  $\eta\omega=0.310$
- C 5030.8+x (?), J+22  $\gamma_{4395+x}$  636(?) I<sup>(1)</sup>=99.1

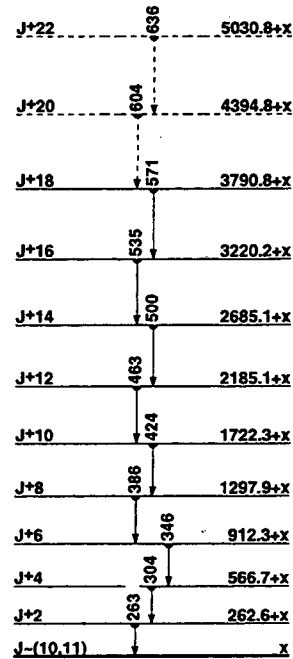

SD band.

**192Pb**  
**82Pb**

194Pb  
82Pb

$\Delta$ : (-24250)  $S_n$ : (10040)  $S_p$ : (4100)  $Q_{EC}$ : (2720)  $Q_\alpha$ : 4738.20

Nuclear Bands

- A SD band
- B GS band
- C Band Structure
- D Band Structure
- E Band Structure
- F Band Structure

Levels and  $\gamma$ -ray branchings:

- B 0, 0<sup>+</sup>, 12.0 s m, %EC+% $\beta^+$ =100, % $\alpha$ =7.3 $\times$ 10<sup>-6</sup> 29  
930.72, 0<sup>+</sup>  $\gamma_{930.64}$  E0
- B 965.41, 2<sup>+</sup>  $\gamma_{965.41}$  (†,100) E2  
1308.24 13, (2<sup>+</sup>)  $\gamma_{965}$  343.22 (†,16.5) (E0+M1+E2)  $\gamma_{991}$  377.53 (†,6.3)  
 $\gamma_0$  1308.32 (†,100.5) (E2)
- B 1540.50 13, (4<sup>+</sup>)  $\gamma_{1308}$  231.92 (†,0.42)  $\gamma_{965}$  575.11 (†,100.2) E2  
1636.82, ( $\leq$ 4)  $\gamma_{965}$  671.82 (†,100)  
1738.72, (1,2<sup>+</sup>)  $\gamma_{965}$  773.53 (†,100.50)  $\gamma_{931}$  808.13 (†,20.15)  $\gamma_0$  1738.93  
(†,30.10)  
1820.62, (5<sup>-</sup>), 1.12 ns  $\gamma_{1541}$  280.11 (†,100) E1  
2019.23, ( $\leq$ 4)  $\gamma_{1308}$  710.92 (†,100)  
2135.94, (6<sup>+</sup>)  $\gamma_{1541}$  595.43 (†,100) E2  
2241.73, (7<sup>-</sup>)  $\gamma_{1821}$  421.12 (†,100) E2  
2407.73, (9<sup>-</sup>), 18.3 ns,  $\mu$ =-0.6336  $\gamma_{2242}$  166.01 (†,100) E2  
2419.83, (8<sup>-</sup>)  $\gamma_{2242}$  178.52 (†,100) (M1+E2);  $\delta$ <0.7  
2438.35, (8<sup>+</sup>), 17.4 ns  $\gamma_{2242}$  196.12 (†,24.2) (E1)  $\gamma_{2136}$  302.43 (†,100.4) E2  
2502.43, (8<sup>-</sup>)  $\gamma_{2242}$  261.12 (†,100) (M1)  
2581.43, (10<sup>+</sup>), 17.25 ns  $\gamma_{2408}$  173.71 (†,100) E1  
2628.54, (12<sup>+</sup>), 350.10 ns,  $\mu$ =-2.00424,  $Q$ =0.493  $\gamma_{2581}$  47.03 (†,100)  
2701.14, (9<sup>-</sup>)  $\gamma_{2242}$  459.43 (†,100) (Q)  
2761.54, (9<sup>-</sup>)  $\gamma_{2242}$  519.83 (†,100) (Q)  
2799.84, (4 to 8)  $\gamma_{2136}$  664.22 (†,100)  
2914.54, (9<sup>-</sup>)  $\gamma_{2242}$  672.83 (†,100) (Q)  
2931.93, (6 to 10)  $\gamma_{2438}$  493.22 (†,100)
- F 2933.64, (11<sup>-</sup>), 124.10 ns  $\gamma_{2628}$  305.01 (†,61.11) E1  $\gamma_{2581}$  352.21 (†,100.12) E1  
3045.85, (10<sup>-</sup>)  $\gamma_{2762}$  284.33 (†,100) (D)  
3189.36, (11<sup>-</sup>)  $\gamma_{3046}$  143.53 (†,100)
- F 3298.34, (12<sup>-</sup>)  $\gamma_{2934}$  364.61 (†,100) M1  
3306.86, (11<sup>-</sup>)  $\gamma_{3046}$  261.03 (†,100) D  
3550.15, (11<sup>-</sup>)  $\gamma_{3189}$  361.53 (†,37.4) (D)  $\gamma_{2762}$  788.63 (†,100.8) (Q)
- C 3561.94, (14<sup>+</sup>)  $\gamma_{2629}$  933.31 (†,100) E2  
3728.86, (12<sup>-</sup>)  $\gamma_{3550}$  178.73 (†,100) (D)
- F 3840.64, (13<sup>-</sup>)  $\gamma_{3298}$  542.21 (†,100.4) M1  $\gamma_{2934}$  907.11 (†,88.2) E2  
4003.74, (15<sup>-</sup>)  $\gamma_{3562}$  441.62 (†,100) E1
- C 4136.84, (16<sup>+</sup>)  $\gamma_{3562}$  575.01 (†,100) (Q)  
F 4367.25, (14<sup>-</sup>)  $\gamma_{3841}$  526.63 (†,100) D  
D 4369.75, (17<sup>+</sup>)  $\gamma_{4137}$  232.93 (†,100) D  
4376.75, (16<sup>-</sup>)  $\gamma_{4004}$  372.73 (†,100) M1  
F 4450.34, (15<sup>-</sup>)  $\gamma_{3841}$  609.71 (†,100) E2  
4454.45, (15<sup>-</sup>)  $\gamma_{3562}$  892.53 (†,100) D  
4601.35, (17<sup>-</sup>)  $\gamma_{4004}$  597.63 (†,100) (Q)  
D 4657.96, (18<sup>+</sup>)  $\gamma_{4370}$  288.23 (†,100) (D)  
4703.15, (18<sup>-</sup>)  $\gamma_{4377}$  326.13 (†,100) (Q)  
4750.75, (17<sup>-</sup>)  $\gamma_{4137}$  613.93 (†,100) D  
C 4796.25, (18<sup>+</sup>)  $\gamma_{4137}$  659.73 (†,100) E2  
4837.16, (18<sup>-</sup>)  $\gamma_{4377}$  460.43 (†,100) (Q)  
F 4965.74, (16<sup>-</sup>)  $\gamma_{4450}$  515.41 (†,100) D  
D 5005.97, (19<sup>+</sup>)  $\gamma_{4658}$  348.03 (†,100) D  
5061.85, (17<sup>-</sup>)  $\gamma_{4004}$  1058.13 (†,100)  
F 5110.85, (17<sup>-</sup>)  $\gamma_{4966}$  145.13 (†,100) (D)  
5168.57, (20<sup>+</sup>)  $\gamma_{5006}$  162.43 (†,100) D  
5236.45, (17<sup>-</sup>)  $\gamma_{4966}$  270.73 (†,100) (D)  
5258.46, (20<sup>+</sup>)  $\gamma_{4796}$  462.23 (†,100)  
F 5307.96, (18<sup>-</sup>)  $\gamma_{5111}$  197.13 (†,100) D  
5329.96, (18<sup>-</sup>)  $\gamma_{4601}$  728.63 (†,100) (D)  
D 5402.77, (20<sup>+</sup>)  $\gamma_{5006}$  396.83 (†,100) D  
5552.17, (19<sup>-</sup>)  $\gamma_{4837}$  715.03 (†,100) (D)  
C 5552.45, (20<sup>+</sup>)  $\gamma_{4796}$  756.53 (†,100.19) (Q)  $\gamma_{4703}$  849.13 (†,28.2)

- 5565.66, (19<sup>+</sup>)  $\gamma_{5236}$  329.23 (†,100) (Q)  
F 5568.27, (19<sup>-</sup>)  $\gamma_{5308}$  260.33 (†,100) (D)  
F 5687.97, (20<sup>-</sup>)  $\gamma_{5568}$  119.73 (†,100) (D)  
5732.96, (20<sup>-</sup>)  $\gamma_{4703}$  1029.83 (†,100) (E2)  
5760.17, (21<sup>+</sup>)  $\gamma_{5169}$  591.33 (†,69.7)  $\gamma_{5006}$  754.43 (†,100.25)  
F 6063.98, (21<sup>-</sup>)  $\gamma_{5688}$  376.03 (†,100) D  
6065.17, (20<sup>-</sup>)  $\gamma_{5568}$  499.53 (†,100) D  
6206.97  $\gamma_{5562.1}$  654.83 (†,100)  
6273.87, (21<sup>+</sup>)  $\gamma_{6065}$  208.73 (†,100) D  
C 6378.76, (22<sup>+</sup>)  $\gamma_{5562.1}$  826.33 (†,100) (Q)  
F 6400.59, (22<sup>-</sup>)  $\gamma_{6064}$  336.63 (†,100) D  
6468.48, (23<sup>+</sup>)  $\gamma_{6274}$  194.63 (†,100) (Q)  
F 6798.39, (23<sup>-</sup>)  $\gamma_{6401}$  397.83 (†,100) (M1)  
6817.29, (23<sup>-</sup>)  $\gamma_{6401}$  416.73 (†,100) D
- E x, J  
E 163.1+x, J+1  $\gamma_{163.13}$  (†,100) D  
E 466.2+x, J+2  $\gamma_{163+x}$  303.13 (†,100) D  
E 596.6+x, J+3  $\gamma_{466+x}$  130.43 (†,100) (D)  
E 994.0+x, J+4  $\gamma_{597+x}$  397.43 (†,100) D  
E 1131.0+x, J+5  $\gamma_{994+x}$  137.03 (†,100) D  
E 1507.7+x, J+6  $\gamma_{1131+x}$  376.73 (†,100) D  
E 1719.9+x, J+7  $\gamma_{1508+x}$  212.23 (†,100) D  
E 1917.0+x, J+8  $\gamma_{1508+x}$  409.33 (†,100) (Q)  
E 2083.6+x, J+9  $\gamma_{1720+x}$  363.73 (†,100) (D)  
E 2344.4+x, J+10  $\gamma_{2084+x}$  260.83 (†,100) (D)  
E 2409.2+x, J+11  $\gamma_{2344+x}$  64.83 (†,100) D  
E 2677.1+x, J+12  $\gamma_{2408+x}$  267.93 (†,100) (D)  
E 2984.9+x, J+13  $\gamma_{2677+x}$  307.83 (†,100) D  
E 3212.9+x, J+14  $\gamma_{2985+x}$  228.03 (†,100) (Q)
- A y, J=(6)  
A 169.6+y, J+2  $\gamma_{169.65}$  (†,0.50.12)  $I^{(1)}$ =88.4,  $I^{(2)}$ =92.0,  $\eta$  $\omega$ =0.096  
A 382.7+y, J+4  $\gamma_{170+y}$  213.15 (†,0.74.15)  $I^{(1)}$ =89.2,  $I^{(2)}$ =92.4,  $\eta$  $\omega$ =0.117  
A 639.1+y, J+6  $\gamma_{383+y}$  256.42 (†,1.03.15)  $I^{(1)}$ =89.7,  $I^{(2)}$ =94.3,  $\eta$  $\omega$ =0.139  
A 937.9+y, J+8  $\gamma_{639+y}$  298.82 (†,1.15.20)  $I^{(1)}$ =90.4,  $I^{(2)}$ =97.8,  $\eta$  $\omega$ =0.160  
A 1277.6+y, J+10  $\gamma_{938+y}$  339.72 (†,1.00.15)  $I^{(1)}$ =91.3,  $I^{(2)}$ =99.3,  $\eta$  $\omega$ =0.180  
A 1657.6+y, J+12, >0.5 ps  $\gamma_{1278+y}$  380.02 (†,1.00.15)  $I^{(1)}$ =92.1,  $I^{(2)}$ =102.3,  $\eta$  $\omega$ =0.200  
A 2076.7+y, J+14, 0.24<sup>+43</sup> ps  $\gamma_{1658+y}$  419.15 (†,0.90.15)  $I^{(1)}$ =93.1,  $I^{(2)}$ =101.8,  $\eta$  $\omega$ =0.219  
A 2535.1+y, J+16, 0.14<sup>+10</sup> ps  $\gamma_{2077+y}$  458.45 (†,0.63.15)  $I^{(1)}$ =93.8,  $I^{(2)}$ =107.5,  $\eta$  $\omega$ =0.239  
A 3030.7+y, J+18, 0.135 ps  $\gamma_{2535+y}$  495.65 (†,0.62.15)  $I^{(1)}$ =94.8,  $I^{(2)}$ =110.2,  $\eta$  $\omega$ =0.257  
A 3562.6+y, J+20, 0.085 ps  $\gamma_{3031+y}$  531.95 (†,0.68.15)  $I^{(1)}$ =95.9,  $I^{(2)}$ =111.1,  $\eta$  $\omega$ =0.275  
A 4130.5+y, J+22, 0.072 ps  $\gamma_{3563+y}$  567.95 (†,0.60.15)  $I^{(1)}$ =96.8,  $I^{(2)}$ =113.0,  $\eta$  $\omega$ =0.293  
A 4733.8+y, J+24  $\gamma_{4131+y}$  603.35 (†,0.50.15)  $I^{(1)}$ =97.8,  $I^{(2)}$ =117.3,  $\eta$  $\omega$ =0.310  
A 5371.2+y, J+26  $\gamma_{4734+y}$  637.45 (†,0.40.15)  $I^{(1)}$ =98.8,  $I^{(2)}$ =112.4,  $\eta$  $\omega$ =0.328  
A 6044.2+y, J+28  $\gamma_{5371+y}$  673.1  $I^{(1)}$ =99.6,  $I^{(2)}$ =125.0,  $\eta$  $\omega$ =0.345  
A 6749+y, J+30  $\gamma_{6044+y}$  705  $I^{(1)}$ =100.7,  $I^{(2)}$ =117.6,  $\eta$  $\omega$ =0.361  
A 7488+y(?), J+32  $\gamma_{6749+y}$  739(?)  $I^{(1)}$ =101.5



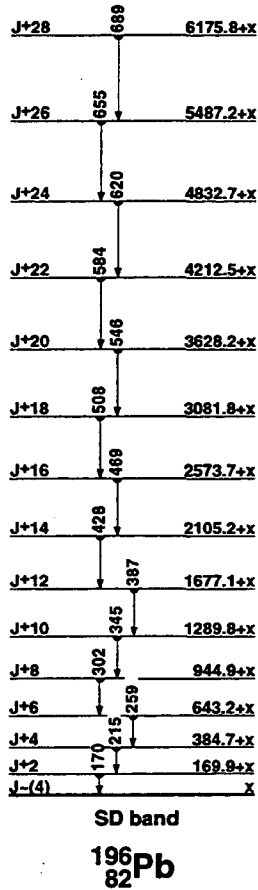
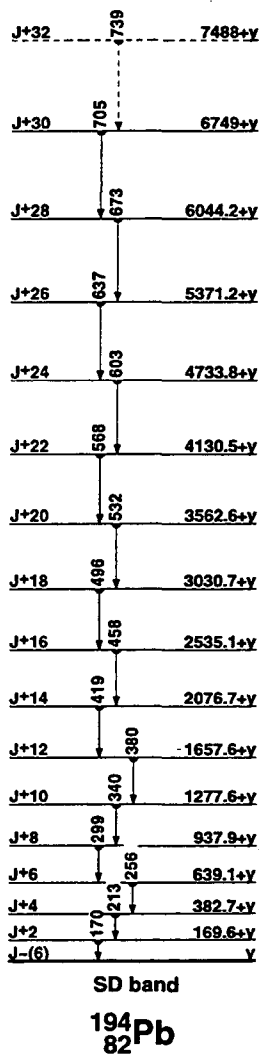

**<sup>196</sup>Pb**  
**<sub>82</sub>**

$\Delta: (-25420) S_n: (9700) S_p: (4440) Q_{Ec}: (2050) Q_{\alpha}: (4200)$

**Nuclear Bands**

- A Band Structure
- B SD band

**Levels and  $\gamma$ -ray branchings:**

- 0, 0<sup>+</sup>, 373 ns, %EC+% $\beta^+$ =100, % $\alpha$ ≤3×10<sup>-5</sup>
- 1049.209, 2<sup>+</sup>, <100 ns  $\gamma_0$  1049.219 (t<sub>1/2</sub> 100) E2
- A 1142.86 17, 0<sup>+</sup>  $\gamma_0$  1142.73 (t<sub>1/2</sub> 2.03) E0
- A 1449.87 13, 2<sup>+</sup>  $\gamma_{1143}$  306.93 (t<sub>1/2</sub> 165)  $\gamma_{1049}$  400.92 (t<sub>1/2</sub> 915) E0+M1+E2
- $\gamma_0$  1449.73 (t<sub>1/2</sub> 1009) E2
- 1697.85, 0<sup>+</sup>  $\gamma_0$  1697.85 (t<sub>1/2</sub> 0.21) E0
- 1738.27 12, 4<sup>+</sup>, <1  $\mu$ s  $\gamma_{1450}$  288.72 (t<sub>1/2</sub> 1.34)  $\gamma_{1049}$  689.009 (t<sub>1/2</sub> 1004) E2
- 1797.51 14, 5<sup>+</sup>, 1338 ns,  $\mu=0.490$  15  $\gamma_{1738}$  59.239 (t<sub>1/2</sub> 10023) E1  $\gamma_{1049}$  748.43 (t<sub>1/2</sub> 101) E3
- 1825.60 16, (3,4)<sup>+</sup>  $\gamma_{1450}$  375.52 (t<sub>1/2</sub> 92)  $\gamma_{1049}$  776.62 (t<sub>1/2</sub> 1007) E2(+M1):  $\delta=2.0$
- A 1861.76, (4<sup>+</sup>)  $\gamma_{1450}$  411.85 (t<sub>1/2</sub> 100)
- 1896.10 17, (2<sup>+</sup>)  $\gamma_{1143}$  753.42 (t<sub>1/2</sub> 5825) (E2)  $\gamma_{1049}$  846.72 (t<sub>1/2</sub> 1008) E2(+M1):  $\delta=1.83$   $\gamma_0$  1896.35 (t<sub>1/2</sub> 3817)
- 1991.61 22, 3<sup>+</sup>  $\gamma_{1049}$  942.42 (t<sub>1/2</sub> 100) E1
- 2060.06 23, (1,2)<sup>+</sup>  $\gamma_{1143}$  916.83 (t<sub>1/2</sub> 3325)  $\gamma_{1049}$  1011.13 (t<sub>1/2</sub> 10017)  $\gamma_0$  2060.97 (t<sub>1/2</sub> 178)
- 2124.41 22, (1,2,3)  $\gamma_{1450}$  674.62 (t<sub>1/2</sub> 10020)  $\gamma_{1049}$  1075.04 (t<sub>1/2</sub> 7050)
- 2169.44 16, 7<sup>+</sup>, <5 ns  $\gamma_{1738}$  371.938 (t<sub>1/2</sub> 100) E2
- 2203.27 24, (4<sup>+</sup>)  $\gamma_{1450}$  753.42 (t<sub>1/2</sub> 100) (E2)
- 2307.83 18, 9<sup>+</sup>, 533 ns  $\gamma_{2169}$  138.417 (t<sub>1/2</sub> 100) E2

- 2333.93, (8<sup>+</sup>)  $\gamma_{2169}$  164.52 (t<sub>1/2</sub> 100)
- 2376.05 20, 6<sup>+</sup>  $\gamma_{1826}$  550.43 (t<sub>1/2</sub> 126)  $\gamma_{1738}$  637.82 (t<sub>1/2</sub> 10018) E2
- A 2423.98, (6<sup>+</sup>)  $\gamma_{1852}$  562.25 (t<sub>1/2</sub> 100)
- 2470.77 23  $\gamma_{1738}$  732.52 (t<sub>1/2</sub> 100)
- 2590.96 19, 8<sup>+</sup>  $\gamma_{2308}$  283.22 (t<sub>1/2</sub> 638)  $\gamma_{2169}$  421.51 (t<sub>1/2</sub> 10013) E1
- A 2621.99, (8<sup>+</sup>), 50 15 ns  $\gamma_{2423}$  198.05 (t<sub>1/2</sub> 100)
- 2645.12 19, 10<sup>+</sup>, <2 ns  $\gamma_{2308}$  337.297 (t<sub>1/2</sub> 100) E1
- 2692.86, 12<sup>+</sup>, 2713 ns,  $\mu=-1.920$  18,  $Q=0.655$   $\gamma_{2645}$  47.75 (t<sub>1/2</sub> 100) (E2)
- 3041.43, 4<sup>+</sup>  $\gamma_{2376}$  665.42 (t<sub>1/2</sub> 100) E2
- 3087.25 25, (9,10)<sup>+</sup>  $\gamma_{2591}$  496.32 (t<sub>1/2</sub> 100) M1(+E2):  $\delta=0.89$
- 3190.56, 11<sup>+</sup>, 723 ns,  $\mu=10.69$   $\gamma_{2693}$  497.72 (t<sub>1/2</sub> 100) (E1)  $\gamma_{2645}$  548.4(?)
- 3394.12 25, (9,10)<sup>+</sup>  $\gamma_{3087}$  306.93 (t<sub>1/2</sub> 7525) (E2)  $\gamma_{2645}$  749.02 (t<sub>1/2</sub> <100)  $\gamma_{2591}$  803.15 (t<sub>1/2</sub> 5025)
- 3652.56, 14<sup>+</sup>  $\gamma_{2693}$  959.699 (t<sub>1/2</sub> 100) E2
- 3737.97, (12,13)<sup>-</sup>  $\gamma_{3191}$  547.44 (t<sub>1/2</sub> 100) (E2+M1)
- 4120.16, 15<sup>-</sup>  $\gamma_{3653}$  467.619 (t<sub>1/2</sub> 100) E1
- 4217.26, 16<sup>+</sup>  $\gamma_{3653}$  564.71 (t<sub>1/2</sub> 7.26) E2
- 4332.16, 16<sup>+</sup>  $\gamma_{3653}$  679.73 (t<sub>1/2</sub> 100) E2
- 4478.06, 15<sup>-</sup>, 5.05 ns  $\gamma_{4120}$  357.91 (t<sub>1/2</sub> 100) M1+E2:  $\delta=1.5$  <sup>+20</sup>
- 4646.07, 16<sup>-</sup>  $\gamma_{4120}$  525.93 (t<sub>1/2</sub> 100) M1+E2:  $\delta=-0.4$  <sup>-30</sup>
- 4675.07, (7<sup>-</sup>)  $\gamma_{4478}$  197.04 (t<sub>1/2</sub> 100) (E2)
- 4722.36, 16<sup>-</sup>  $\gamma_{4478}$  244.31 10 (t<sub>1/2</sub> 100) M1+E2:  $\delta=0.3$  <sup>-1</sup>
- 4962.46, (18<sup>+</sup>)  $\gamma_{4332}$  630.43 (t<sub>1/2</sub> 919) E2  $\gamma_{4217}$  745.22 (t<sub>1/2</sub> 10018) E2
- 5491.57, (20<sup>+</sup>)  $\gamma_{4962}$  529.13 (t<sub>1/2</sub> 100) E2
- 5707.7, (19<sup>-</sup>)  $\gamma_{4962}$  745.22(?) (t<sub>1/2</sub> 100) E1
- B x, J=(4)
- B 169.9+x, J+2  $\gamma_x$  169.93 (t<sub>1/2</sub> 0.193) I<sup>(1)</sup>=64.7, I<sup>(2)</sup>=89.1,  $\eta\omega=0.096$
- B 384.7+x, J+4  $\gamma_{170+x}$  214.82 (t<sub>1/2</sub> 0.496) (E2) I<sup>(1)</sup>=69.8, I<sup>(2)</sup>=91.5,  $\eta\omega=0.118$
- B 643.2+x, J+6  $\gamma_{385+x}$  258.52 (t<sub>1/2</sub> 0.8911) (E2) I<sup>(1)</sup>=73.5, I<sup>(2)</sup>=92.6,  $\eta\omega=0.140$
- B 944.9+x, J+8  $\gamma_{643+x}$  301.72 (t<sub>1/2</sub> 0.9813) (E2) I<sup>(1)</sup>=76.2, I<sup>(2)</sup>=92.6,  $\eta\omega=0.162$
- B 1289.8+x, J+10  $\gamma_{945+x}$  344.92 (t<sub>1/2</sub> 1.008) (E2) I<sup>(1)</sup>=78.3, I<sup>(2)</sup>=94.3,  $\eta\omega=0.183$
- B 1677.1+x, J+12  $\gamma_{1290+x}$  387.32 (t<sub>1/2</sub> 0.948) (E2) I<sup>(1)</sup>=80.0, I<sup>(2)</sup>=98.0,  $\eta\omega=0.204$
- B 2105.2+x, J+14  $\gamma_{1677+x}$  428.12 (t<sub>1/2</sub> 0.9112) (E2) I<sup>(1)</sup>=81.8, I<sup>(2)</sup>=99.0,  $\eta\omega=0.224$
- B 2573.7+x, J+16, 0.23 10 ps  $\gamma_{2105+x}$  468.52 (t<sub>1/2</sub> 0.9010) (E2) I<sup>(1)</sup>=83.2, I<sup>(2)</sup>=101.0,  $\eta\omega=0.244$
- B 3081.8+x, J+18, 0.12 <sup>+3</sup> ps  $\gamma_{2574+x}$  508.12 (t<sub>1/2</sub> 0.768) (E2) I<sup>(1)</sup>=84.6, I<sup>(2)</sup>=104.4,  $\eta\omega=0.264$
- B 3628.2+x, J+20, 0.08 <sup>+5</sup> ps  $\gamma_{3082+x}$  546.42 (t<sub>1/2</sub> 0.539) (E2) I<sup>(1)</sup>=86.0, I<sup>(2)</sup>=105.5,  $\eta\omega=0.283$
- B 4212.5+x, J+22  $\gamma_{3628+x}$  584.32 (t<sub>1/2</sub> 0.416) (E2) I<sup>(1)</sup>=87.3, I<sup>(2)</sup>=111.4,  $\eta\omega=0.301$
- B 4832.7+x, J+24  $\gamma_{4213+x}$  620.22 (t<sub>1/2</sub> 0.368) (E2) I<sup>(1)</sup>=88.7, I<sup>(2)</sup>=116.6,  $\eta\omega=0.319$
- B 5487.2+x, J+26  $\gamma_{4832+x}$  654.53 (t<sub>1/2</sub> 0.153) I<sup>(1)</sup>=90.1, I<sup>(2)</sup>=117.3,  $\eta\omega=0.336$
- B 6175.8+x, J+28  $\gamma_{5487+x}$  688.63 (t<sub>1/2</sub> 0.144) I<sup>(1)</sup>=91.5

**<sup>198</sup>Pb**  
**<sub>82</sub>Pb**

$\Delta$ : (-26100)  $S_n$ : (9380)  $S_p$ : (5020)  $Q_{EC}$ : (1410)  $Q_\alpha$ : (3720)

**Nuclear Bands**

- A Band Structure
- B Band Structure
- C Band Structure
- D Band Structure
- E SD band

**Levels and  $\gamma$ -ray branchings:**

- A 0, 0<sup>+</sup>, 2.40 10 h, %EC+% $\beta$ <sup>+</sup>=100
- A 1063.50 20, 2<sup>+</sup>  $\gamma_0$  1063.52 (†,100) E2
- 1392.1 10, (0<sup>+</sup>)  $\gamma_0$  1392.1 (E0)
- A 1625.9 3, 4<sup>+</sup>  $\gamma_{1064}$  562.42 (†,100) E2
- 1734.7 10, (0<sup>+</sup>)  $\gamma_0$  1734.1 (E0)
- 1823.5 4, 5<sup>-</sup>, 49.5 ns,  $\mu=0.383$   $\gamma_{1625}$  197.62 (†,100) E1
- 2141.4 4, (7<sup>-</sup>), 14.5<sup>+10</sup> ns  $\gamma_{1824}$  317.92 (†,100) E2
- 2141.4+y 4, (8<sup>-</sup>), 4.19 10  $\mu$ s
- 2231.4+y 5, (9<sup>-</sup>)  $\gamma_{2141+y}$  90.02 (†,100) (E2+M1):  $\delta=2.6_{-7}^{+20}$
- A 2772.3+y 5, (10<sup>+</sup>)  $\gamma_{2231+y}$  540.92 (†,100) E1
- A 2772.3+x 5, (12<sup>+</sup>), 212 4 ns
- A 3701.4+x 6, (14<sup>+</sup>)  $\gamma_{2772+x}$  929.12 (†,100) E2
- C 4142.0+x 6, (16<sup>+</sup>)  $\gamma_{3701+x}$  440.62 (†,100) E2
- B 4331.4+x 6, (15<sup>-</sup>)  $\gamma_{3701+x}$  630.02 (†,100) E1
- D 4653.3+x 6, (16<sup>+</sup>)  $\gamma_{4331+x}$  321.92 (†,100) (E1)  $\gamma_{4142+x}$  511.32 (†,47)
- 4724.8+x 6, (16), 6.4 10 ns  $\gamma_{4653+x}$  71.5(?)  $\gamma_{4331+x}$  393.42 (†,100) D
- 4793.6+x 6, (16<sup>+</sup>)  $\gamma_{4331+x}$  462.22 (†,100) (E1)
- C 5022.3+x 7, (18<sup>+</sup>)  $\gamma_{4142+x}$  880.33 (†,100) E2
- B 5092.1+x 6, (17<sup>-</sup>)  $\gamma_{4331+x}$  760.72 (†,100) E2
- D 5601.0+x 6, (18<sup>+</sup>)  $\gamma_{4653+x}$  947.72 (†,100) E2
- B 5789.6+x 7, (19<sup>-</sup>)  $\gamma_{5092+x}$  697.52 (†,100) E2
- C 5852.3+x 6, (20<sup>+</sup>)  $\gamma_{2141}$  630.02 (†,100) (E2)
- D 6418.0+x 7, (20)  $\gamma_{5601+x}$  817.02 (†,100) Q
- C 6450.8+x 6, (22<sup>+</sup>)  $\gamma_{2141}$  798.52 (†,100) E2
- B 6450.9+x 7, (21<sup>-</sup>)  $\gamma_{5790+x}$  661.32 (†,100) E2
- B 6929.9+x 7, (23<sup>-</sup>)  $\gamma_{6450.9+x}$  479.02 (†,100) (E2)
- E z(?), J=(12)
- E 303.8+z(?), J+2  $\gamma_z$  303.84(?) (†,0.45 20)  $I^{(1)}=88.9$ ,  $I^{(2)}=90.3$ ,  $\eta\omega=0.163$
- E 651.9+z(?), J+4  $\gamma_{304+z}$  348.15(?)  $I^{(1)}=89.1$ ,  $I^{(2)}=93.9$ ,  $\eta\omega=0.185$
- E 1042.6+z(?), J+6  $\gamma_{652+z}$  390.74(?) (†,0.85 20)  $I^{(1)}=89.6$ ,  $I^{(2)}=96.6$ ,  $\eta\omega=0.206$
- E 1474.7+z(?), J+8  $\gamma_{1042+z}$  432.15(?) (†,1.00 25)  $I^{(1)}=90.3$ ,  $I^{(2)}=95.9$ ,  $\eta\omega=0.226$
- E 1948.5+z(?), J+10  $\gamma_{1476+z}$  473.85(?) (†,0.80 30)  $I^{(1)}=90.8$ ,  $I^{(2)}=101.8$ ,  $\eta\omega=0.247$
- E 2461.6+z(?), J+12  $\gamma_{1948+z}$  513.17(?) (†,0.95 30)  $I^{(1)}=91.6$ ,  $I^{(2)}=99.3$ ,  $\eta\omega=0.267$
- E 3015.0+z(?), J+14  $\gamma_{2462+z}$  553.47(?) (†,0.45 20)  $I^{(1)}=92.2$

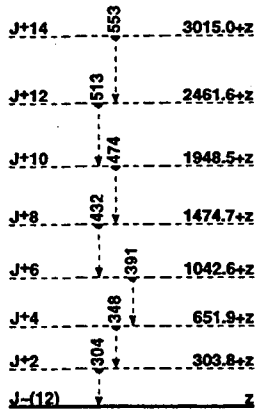

SD band

**<sup>198</sup>Pb**  
**<sub>82</sub>Pb**

**236U**  
**92**

$\Delta$ : 42439.820  $S_n$ : 6544.85  $S_p$ : 7170.50  $Q_\alpha$ : 4572.09  
 $\sigma_p$ : 0 b,  $\sigma_f$ : 5.1121 b

**Nuclear Bands**

- A GS band
- B Band Structure
- C  $\nu$ 7/2[743]- $\nu$ 1/2[631]
- D  $\nu$ 7/2[743]+ $\nu$ 5/2[622]
- E Band Structure
- F Band Structure
- G  $\nu$ 7/2[743]- $\nu$ 5/2[622]
- H  $\nu$ 7/2[743]+ $\nu$ 1/2[631]
- I Band Structure
- J Fission Isomer band

**Levels and  $\gamma$ -ray branchings:**

- A 0, 0<sup>+</sup>, 2.342x10<sup>7</sup> y, % $\alpha$ =100, %SF=9.6x10<sup>-8</sup> 6  
A 45.2423, 2<sup>+</sup>, 234.6 ps  $\gamma_{0,45.2423}$  (t<sub>1/2</sub>) E2  
A 149.476 15, 4<sup>+</sup>, 124.7 ps  $\gamma_{45,149.476}$  (t<sub>1/2</sub>) E2  
A 309.784 8, 6<sup>+</sup>, 58.3 ps  $\gamma_{149,309.784}$  (t<sub>1/2</sub>) E2  
A 522.245, 8<sup>+</sup>, 24.2 ps  $\gamma_{310,522.245}$  (t<sub>1/2</sub>) E2  
B 687.605, 1<sup>-</sup>, 3.78 ns  $\gamma_{149,687.605}$  (t<sub>1/2</sub>) E3  $\gamma_{45,687.605}$  (t<sub>1/2</sub>) E1(+M2+E3)  $\gamma_{0,687.599}$  (t<sub>1/2</sub>) E1  
B 744.15 8, 3<sup>-</sup>  $\gamma_{688,744.15}$  (t<sub>1/2</sub>) E2  $\gamma_{149,744.15}$  (t<sub>1/2</sub>) E2  
A 782.35, 10<sup>+</sup>, 11.6 ns  $\gamma_{522,782.35}$  (t<sub>1/2</sub>) E2  
B 848.3 8, 5<sup>-</sup>  $\gamma_{744,848.3}$  (t<sub>1/2</sub>) E2  
E 919.21 17, 0<sup>+</sup>  $\gamma_{45,919.21}$  (t<sub>1/2</sub>)  $\gamma_{0,919.21}$  (E0)  
F 957.99 17, (2<sup>+</sup>)  $\gamma_{45,957.99}$  (t<sub>1/2</sub>) (M1)  $\gamma_{0,958.02}$  (t<sub>1/2</sub>)  
E 960.33, (2<sup>+</sup>)  $\gamma_{149,960.33}$  (t<sub>1/2</sub>)  $\gamma_{45,960.33}$  (t<sub>1/2</sub>) (M1+E0)  $\gamma_{0,959.9}$  (t<sub>1/2</sub>)  
G 966.63 9, 1<sup>-</sup>  $\gamma_{688,966.63}$  (t<sub>1/2</sub>) (M1,E2)  $\gamma_{45,966.63}$  (t<sub>1/2</sub>) E1  $\gamma_{0,966.92}$  (t<sub>1/2</sub>) E1  
G 987.67 8, 2<sup>-</sup>  $\gamma_{744,987.67}$  (t<sub>1/2</sub>) E2+M1:  $\delta=1.6 \cdot 10^{-15}$   $\gamma_{688,987.67}$  (t<sub>1/2</sub>) (E2)  $\gamma_{45,987.67}$  (t<sub>1/2</sub>) E1  
B 999.8 9, 7<sup>-</sup>  $\gamma_{848,999.8}$  (t<sub>1/2</sub>) E2  
F 1001.53, (3<sup>+</sup>)  $\gamma_{744,1001.53}$  (t<sub>1/2</sub>)  $\gamma_{149,1001.53}$  (t<sub>1/2</sub>) (E0)  $\gamma_{45,1001.53}$  (t<sub>1/2</sub>)  
G 1035.67, (3<sup>-</sup>)  $\gamma_{149,1035.67}$  (t<sub>1/2</sub>)  $\gamma_{45,1035.67}$  (t<sub>1/2</sub>) (E0)  $\gamma_{0,1035.67}$  (t<sub>1/2</sub>)  
E 1050.85 15, (4<sup>+</sup>)  $\gamma_{149,1050.85}$  (t<sub>1/2</sub>)  $\gamma_{45,1050.85}$  (t<sub>1/2</sub>)  
H 1052.89 18, (4<sup>-</sup>), 100.4 ns  $\gamma_{988,1052.89}$  (t<sub>1/2</sub>) (E2)  $\gamma_{688,1052.89}$  (t<sub>1/2</sub>) (E2)  $\gamma_{744,1052.89}$  (t<sub>1/2</sub>) E2+M1:  $\delta=1.47$   $\gamma_{149,1052.89}$  (t<sub>1/2</sub>) E1  
F 1058.61 20, (4<sup>+</sup>)  $\gamma_{149,1058.61}$  (t<sub>1/2</sub>) (M1)  $\gamma_{45,1058.61}$  (t<sub>1/2</sub>)  
1066.1 10, (3<sup>+</sup>, 4<sup>+</sup>)  
G 1070.0 10, (4<sup>-</sup>)  $\gamma_{149,1070.0}$  (t<sub>1/2</sub>)  
A 1085.37, 12<sup>+</sup>, 5.3 ps  $\gamma_{782,1085.37}$  (t<sub>1/2</sub>) E2  
1093.8 10, (2<sup>+</sup>, 5<sup>+</sup>)  
H 1104.4 14, (5<sup>-</sup>)  
I 1110.67 8, (2<sup>-</sup>)  $\gamma_{744,1110.67}$  (t<sub>1/2</sub>)  $\gamma_{688,1110.67}$  (t<sub>1/2</sub>)  $\gamma_{45,1110.67}$  (t<sub>1/2</sub>)  
F 1126.96, (5<sup>+</sup>)  $\gamma_{149,1126.96}$  (t<sub>1/2</sub>)  
1147.0 10, (3<sup>+</sup>, 4<sup>+</sup>)  
I 1149.4 10, (3<sup>-</sup>)  $\gamma_{744,1149.4}$  (t<sub>1/2</sub>)  
G 1164.3, (5<sup>-</sup>)  
H 1164.3, (6<sup>-</sup>)  
1171.8 2  
B 1198.6 10, 9<sup>-</sup>  $\gamma_{1000,1198.6}$  (t<sub>1/2</sub>) E2  
1221.4 10, (2<sup>+</sup>, 5<sup>+</sup>)  
H =1232, (7<sup>-</sup>)  
C 1232.2 10, (4<sup>-</sup>)  
1249.3 10, 2<sup>+</sup>, 5<sup>+</sup>  
1265.2 10, 3<sup>+</sup>, 4<sup>+</sup>  
1271.09 8, (1<sup>-</sup>, 2, 3)  $\gamma_{744,1271.09}$  (t<sub>1/2</sub>)  $\gamma_{45,1271.09}$  (t<sub>1/2</sub>)  
C 1282.2 10, (5<sup>-</sup>)  
H 1320.4, (8<sup>-</sup>)  
1320.4 10, 2<sup>+</sup>, 5<sup>+</sup>  
1329.0 10, 3<sup>+</sup>, 4<sup>+</sup>  
1332.8 10, 3<sup>+</sup>, 4<sup>+</sup>  
C 1342.8 10, (6<sup>-</sup>)  
1347.5 10, (3<sup>+</sup>, 4<sup>+</sup>)  
1351.3 10, 3<sup>+</sup>, 4<sup>+</sup>  
1381.3 10, 3<sup>+</sup>, 4<sup>+</sup>  
1399.8 10, 2<sup>+</sup>, 5<sup>+</sup>  
C 1413.3 19, (7<sup>-</sup>)  
A 1426.39, 14<sup>+</sup>, 2.8 ps  $\gamma_{1085,1426.39}$  (t<sub>1/2</sub>) E2  
B 1443.6 11, 11<sup>-</sup>  $\gamma_{1189,1443.6}$  (t<sub>1/2</sub>) E2  
D 1471.7 10, (6<sup>-</sup>)  
D 1541.8 13, (7<sup>-</sup>)  
1572.2 6  
1580 11(?), (1, 2)  $\gamma_{0,1580}$  11(?)  
1604.80 7, 1<sup>-</sup>, 2<sup>+</sup>  $\gamma_{1271,1604.80}$  (t<sub>1/2</sub>)  $\gamma_{988,1604.80}$  (t<sub>1/2</sub>)  $\gamma_{744,1604.80}$  (t<sub>1/2</sub>)  
(t<sub>1/2</sub>)  $\gamma_{688,1604.80}$  (t<sub>1/2</sub>)  $\gamma_{45,1604.80}$  (t<sub>1/2</sub>)  
D 1621.8 12, (8<sup>-</sup>)  
1642.5 20  
1662.37 8, 1, 2<sup>+</sup>  $\gamma_{988,1662.37}$  (t<sub>1/2</sub>)  $\gamma_{688,1662.37}$  (t<sub>1/2</sub>)  $\gamma_{45,1662.37}$  (t<sub>1/2</sub>)  
B 1732.6 15, 13<sup>-</sup>  $\gamma_{1444,1732.6}$  (t<sub>1/2</sub>) E2  
1791.3 8, 1(\*)  $\gamma_{45,1791.3}$  (t<sub>1/2</sub>) (M1)  $\gamma_{0,1791.3}$  (t<sub>1/2</sub>) (M1)  
A 1800.9 10, 16<sup>+</sup>, 2.1 ps  $\gamma_{1426,1800.9}$  (t<sub>1/2</sub>) E2  
1807.88 7, 1, 2<sup>+</sup>  $\gamma_{45,1807.88}$  (t<sub>1/2</sub>)  $\gamma_{0,1807.88}$  (t<sub>1/2</sub>)  
1865.41 15, 1, 2<sup>+</sup>  $\gamma_{688,1865.41}$  (t<sub>1/2</sub>)  $\gamma_{0,1865.41}$  (t<sub>1/2</sub>)  
1896.97  
1972.62 9, 1, 2<sup>+</sup>  $\gamma_{45,1972.62}$  (t<sub>1/2</sub>)  $\gamma_{0,1972.62}$  (t<sub>1/2</sub>)  
1979.1, 1, 2<sup>+</sup>  $\gamma_{744,1979.1}$  (t<sub>1/2</sub>)  $\gamma_{688,1979.1}$  (t<sub>1/2</sub>)  $\gamma_{45,1979.1}$  (t<sub>1/2</sub>)  
1981.06 16, 1, 2<sup>+</sup>  $\gamma_{1111,1981.06}$  (t<sub>1/2</sub>)  $\gamma_{988,1981.06}$  (t<sub>1/2</sub>)  $\gamma_{0,1981.06}$  (t<sub>1/2</sub>)  
2054.2 8, 1(\*)  $\gamma_{45,2054.2}$  (t<sub>1/2</sub>) (M1)  $\gamma_{0,2054.2}$  (t<sub>1/2</sub>) (M1)  
B 2060.6 18, 15<sup>-</sup>  $\gamma_{1733,2060.6}$  (t<sub>1/2</sub>) E2  
2086.54 9, 1(\*)  $\gamma_{45,2086.54}$  (t<sub>1/2</sub>) (E1)  $\gamma_{0,2086.54}$  (t<sub>1/2</sub>) (E1)  
2095.7 8, 1(\*)  $\gamma_{45,2095.7}$  (t<sub>1/2</sub>) (M1)  $\gamma_{0,2095.7}$  (t<sub>1/2</sub>) (M1)  
2155.40 12, 0, 1, 2  $\gamma_{1605,2155.40}$  (t<sub>1/2</sub>)  
2188.8 8, 1(\*)  $\gamma_{45,2188.8}$  (t<sub>1/2</sub>) (M1)  $\gamma_{0,2188.8}$  (t<sub>1/2</sub>) (M1)  
2190 10, (1, 2<sup>+</sup>)  $\gamma_{0,2190}$  (t<sub>1/2</sub>)  
A 2203.9 12, 18<sup>+</sup>, 1.17 ps  $\gamma_{1801,2203.9}$  (t<sub>1/2</sub>) E2  
2226.93(2), (2)  $\gamma_{45,2226.93}$  (t<sub>1/2</sub>)  
2243.9 10, 1  $\gamma_{0,2243.9}$  (t<sub>1/2</sub>)  
2251.1 8, 1(\*)  $\gamma_{45,2251.1}$  (t<sub>1/2</sub>)  $\gamma_{0,2251.1}$  (t<sub>1/2</sub>)  
2284.7 8, 1(\*)  $\gamma_{45,2284.7}$  (t<sub>1/2</sub>) (M1)  $\gamma_{0,2284.7}$  (t<sub>1/2</sub>) (M1)  
B 2426.6 21, 17<sup>-</sup>  $\gamma_{2061,2426.6}$  (t<sub>1/2</sub>) E2  
2435.6 8, 1(\*)  $\gamma_{45,2435.6}$  (t<sub>1/2</sub>) (M1)  $\gamma_{0,2435.6}$  (t<sub>1/2</sub>) (M1)  
2440.2 8, 1(\*)  $\gamma_{45,2440.2}$  (t<sub>1/2</sub>) (M1)  $\gamma_{0,2440.2}$  (t<sub>1/2</sub>) (M1)  
2457.3 8, 1(\*)  $\gamma_{45,2457.3}$  (t<sub>1/2</sub>) (M1)  $\gamma_{0,2457.3}$  (t<sub>1/2</sub>) (M1)  
2494.5 8, 1(\*)  $\gamma_{45,2494.5}$  (t<sub>1/2</sub>) (M1)  $\gamma_{0,2494.5}$  (t<sub>1/2</sub>) (M1)  
2498.5 8, 1(\*)  $\gamma_{45,2498.5}$  (t<sub>1/2</sub>) (M1)  $\gamma_{0,2498.5}$  (t<sub>1/2</sub>) (M1)  
A 2631.7 13, 20<sup>+</sup>, 0.84 ps  $\gamma_{2204,2631.7}$  (t<sub>1/2</sub>) E2  
2699.0 8, 1(\*)  $\gamma_{45,2699.0}$  (t<sub>1/2</sub>) (M1)  $\gamma_{0,2699.0}$  (t<sub>1/2</sub>) (M1)  
2712.1 8, 1(\*)  $\gamma_{45,2712.1}$  (t<sub>1/2</sub>) (E1)  $\gamma_{0,2712.1}$  (t<sub>1/2</sub>) (E1)  
J 2750 10, (0<sup>+</sup>), 120.2 ns, %SF=13.6, %IT=87.6, % $\alpha$ <10  $\gamma_{2189,2750}$  (t<sub>1/2</sub>)  
 $\gamma_{1580,2750}$  (t<sub>1/2</sub>)  $\gamma_{967,2750}$  (t<sub>1/2</sub>)  $\gamma_{688,2750}$  (t<sub>1/2</sub>)  $\gamma_{45,2750}$  (t<sub>1/2</sub>)  
2756.2 8, 1(\*)  $\gamma_{45,2756.2}$  (t<sub>1/2</sub>) (M1)  $\gamma_{0,2756.2}$  (t<sub>1/2</sub>) (M1)  
J 2770 10, (2<sup>+</sup>)  $\gamma_{2750,2770}$  (t<sub>1/2</sub>)  
J 2817 10, (4<sup>+</sup>)  $\gamma_{2770,2817}$  (t<sub>1/2</sub>) E2  
2823.3 8, 1(\*)  $\gamma_{45,2823.3}$  (t<sub>1/2</sub>) (M1)  $\gamma_{0,2823.3}$  (t<sub>1/2</sub>) (M1)  
B =2825, (19<sup>-</sup>)  $\gamma_{2427,2825}$  (t<sub>1/2</sub>) E2  
2838.3 8, 1(\*)  $\gamma_{45,2838.3}$  (t<sub>1/2</sub>) (M1)  $\gamma_{0,2838.3}$  (t<sub>1/2</sub>) (M1)  
2877.8 8, 1(\*)  $\gamma_{45,2877.8}$  (t<sub>1/2</sub>) (E1)  $\gamma_{0,2877.8}$  (t<sub>1/2</sub>) (E1)  
J 2891 10, (6<sup>+</sup>)  $\gamma_{2817,2891}$  (t<sub>1/2</sub>) E2  
2924.0 8, (2)  $\gamma_{45,2924.0}$  (t<sub>1/2</sub>)  $\gamma_{0,2924.0}$  (t<sub>1/2</sub>)  
2969.0 8, 1(\*)  $\gamma_{45,2969.0}$  (t<sub>1/2</sub>) (M1)  $\gamma_{0,2969.0}$  (t<sub>1/2</sub>) (M1)  
J 2992 10, (8<sup>+</sup>)  $\gamma_{2891,2992}$  100.8  
A 3081.2 14, 22<sup>+</sup>, 0.65 ps  $\gamma_{2632,3081.2}$  (t<sub>1/2</sub>) E2  
3143.8 8, 1(\*)  $\gamma_{45,3143.8}$  (t<sub>1/2</sub>) (M1)  $\gamma_{0,3143.8}$  (t<sub>1/2</sub>) (M1)  
3436 10(?), (0<sup>+</sup>)  $\gamma_{2750,3436}$  (E0)  
A 3550.2, (24<sup>+</sup>), 0.41 ps  $\gamma_{3081,3550.2}$  (t<sub>1/2</sub>) E2  
A 4039.2, (26<sup>+</sup>), 0.33 ps  $\gamma_{3550,4039.2}$  (t<sub>1/2</sub>) E2  
A 4549.2, (28<sup>+</sup>), 0.17 ps  $\gamma_{4039,4549.2}$  (t<sub>1/2</sub>) E2  
A =5077, (30<sup>+</sup>)  $\gamma_{4549,5077}$  (t<sub>1/2</sub>) E2

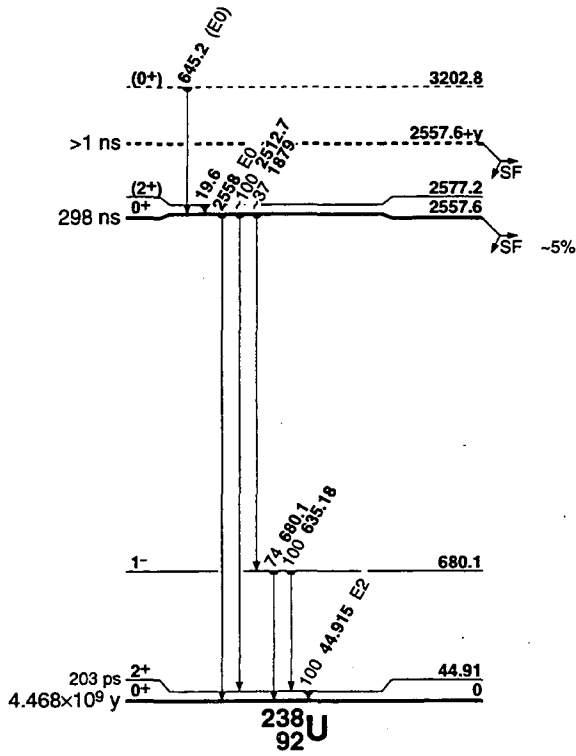
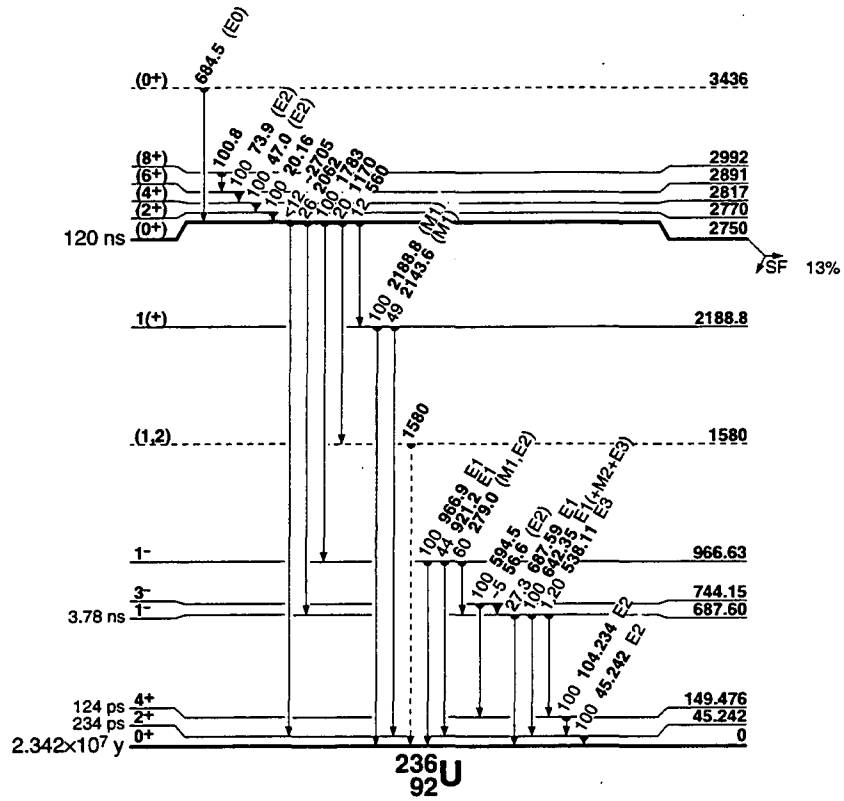

%: 99.2745 60  
 $\Delta$ : 47304.520 S<sub>n</sub>: 6152.014 S<sub>p</sub>: 7620.100 Q<sub>a</sub>: 4270.3  
 $\sigma_T$ : 2.680 19 b,  $\sigma_f$ : 0 mb,  $\sigma_a$ : 0.00136 mb

Nuclear Bands

- A GS band
- B Octupole band
- C Band Structure
- D  $\beta$  band
- E  $\gamma$  band
- F Band Structure
- G Band Structure
- H v1/2[631]+v5/2[622]
- I Band Structure
- J Fission isomer band

Levels and  $\gamma$ -ray branchings:

0, 0<sup>+</sup>, 4.468x10<sup>9</sup> 3y, %SF=5.38x10<sup>-5</sup> 11, % $\alpha$ =100, Q=13.920

- A 44.91 3, 2<sup>+</sup>, 203 7 ps  $\gamma_0$  44.915 13 (t<sub>100</sub>) E2
- A 148.41 5, 4<sup>+</sup>  $\gamma_{45}$  103.50 4 (t<sub>100</sub>)
- A 307.21 10, 6<sup>+</sup>  $\gamma_{148}$  158.80 8 (t<sub>100</sub>)
- A 518.3 3, 8<sup>+</sup>, 23 3 ps  $\gamma_{307}$  211.2 3 (t<sub>100</sub>)
- B 680.1 2, 1<sup>-</sup>  $\gamma_{45}$  635.18 3 (t<sub>100</sub>)  $\gamma_0$  680.1 3 (t<sub>74</sub> 4)
- B 731.9 2, 3<sup>-</sup>  $\gamma_{148}$  583.55 3 (t<sub>83</sub> 2)  $\gamma_{45}$  686.99 3 (t<sub>100</sub> 2)
- A 775.7 4, 10<sup>+</sup>, 9.0 9 ps  $\gamma_{518}$  257.8 4 (t<sub>100</sub>)
- B 826.7 5, 5<sup>-</sup>  $\gamma_{307}$  519.44 8 (t<sub>57</sub> 4)  $\gamma_{148}$  678.4 6 (t<sub>100</sub> 6)
- C 925.7 3, (0<sup>+</sup>)  $\gamma_{45}$  880.8 2 (t<sub>100</sub>)
- F 930.8 3, (1<sup>-</sup>)  $\gamma_{680}$  251.3 10 (t<sub>11</sub> 3)  $\gamma_{45}$  886.2 4 (t<sub>100</sub> 4)  $\gamma_0$  931.5 6 (t<sub>27</sub> 2)
- F 950.2 4, (2<sup>-</sup>)  $\gamma_{732}$  218.0 3 (t<sub>43</sub> 5)  $\gamma_{680}$  270.1 4 (t<sub>37</sub> 6)  $\gamma_{45}$  905.6 6 (t<sub>100</sub> 6)
- B 966.3 5, 7<sup>-</sup>  $\gamma_{518}$  448.4 9  $\gamma_{307}$  659.1 2
- C 967.3 3, 2<sup>+</sup>, 0.6 4 ps  $\gamma_{732}$  234.5 10 (t<sub>16</sub> 2)  $\gamma_{680}$  286.4 10 (t<sub>14</sub> 1)  $\gamma_{148}$  818.4 4 (t<sub>100</sub> 5)  $\gamma_{45}$  922.3 2 (t<sub>59</sub> 3) (t<sub>100</sub> =420) E2+M1+E0  $\gamma_0$  967.3 2 (t<sub>18</sub> 1)
- D 993 (?), (0<sup>+</sup>)
- F 997.5 3, 3<sup>-</sup>  $\gamma_{827}$  171 (t<sub>1</sub> <1.5)  $\gamma_{680}$  318.0 10 (t<sub>7</sub> 6 3)  $\gamma_{148}$  849.1 4 (t<sub>100</sub> 3)  $\gamma_{45}$  952.70 7 (t<sub>61</sub> 3)
- D 1037.3 2, 2<sup>+</sup>, 0.6 7 15 ps  $\gamma_{732}$  305.5 6 (t<sub>10</sub> 5 4)  $\gamma_{680}$  357.7 4 (t<sub>9</sub> 0 4)  $\gamma_{148}$  888.9 3 (t<sub>76</sub> 5 15)  $\gamma_{45}$  993.0 10 (t<sub>73</sub> 8 15) (t<sub>100</sub> =375 35) E2+M1+E0  $\gamma_0$  1037.4 2 (t<sub>100</sub> 3)
- C 1056.6 3, (4<sup>+</sup>)  $\gamma_{307}$  749.3 3 (t<sub>100</sub>)
- H 1059.5, (3<sup>+</sup>)  $\gamma_{148}$  911.1 (t<sub>43</sub>)  $\gamma_{45}$  1014.6 (t<sub>100</sub>)
- E 1060.3 2, 2<sup>+</sup>, 0.6 6 5 ps  $\gamma_{148}$  911.9 4 (t<sub>3</sub> 3 2)  $\gamma_{45}$  1015.3 2 (t<sub>100</sub> 2)  $\gamma_0$  1060.3 2 (t<sub>68</sub> 4 13)
- A 1076.5 5, 12<sup>+</sup>, 4.2 6 ps  $\gamma_{776}$  300.6 9 (t<sub>100</sub>)
- E 1105.7, (3<sup>+</sup>)  $\gamma_{148}$  957.3 3 6 (t<sub>100</sub>)  $\gamma_{45}$  1060.98 3 (?)
- G 1112.6 2, (1<sup>-</sup>)  $\gamma_{680}$  432.5 3  $\gamma_0$  1112.7 3
- D 1127.0 3, (4<sup>+</sup>)  $\gamma_{827}$  300.6 10 (t<sub>57</sub> 4 8)  $\gamma_{148}$  978.5 3 (t<sub>100</sub>)
- G 1128.7 3, (2<sup>-</sup>)  $\gamma_{931}$  198.6 3 (t<sub>12</sub>)  $\gamma_{732}$  396.4 3 (t<sub>25</sub> 5 14)  $\gamma_{680}$  448.3 4 (t<sub>100</sub> 4)  $\gamma_{45}$  1084.0 4 (t<sub>1</sub> <80)
- 1135.8 2  $\gamma_{307}$  828.3 6 (t<sub>25</sub> 8)  $\gamma_{45}$  1090.9 2 (t<sub>100</sub> 8)
- B 1150.3 6, 9<sup>-</sup>  $\gamma_{776}$  374.8 4  $\gamma_{518}$  632.6 4
- E 1168.0 2, (4<sup>+</sup>)  $\gamma_{148}$  1019.6 1 8 (t<sub>100</sub> 7)  $\gamma_{45}$  1123.1 2 (t<sub>40</sub> 4)
- G 1170.4 3, 3<sup>-</sup>  $\gamma_{967}$  203.4 10  $\gamma_{680}$  490.3 2  $\gamma_{148}$  1021 1  $\gamma_{45}$  1123 1
- 1224.2 3, (2<sup>-</sup>), 2.3 14 ps  $\gamma_{1060}$  163.9 5 (?) (t<sub>17</sub> 4 15)  $\gamma_{950}$  274.0 10 (t<sub>11</sub>)  $\gamma_{45}$  1179.4 2 (t<sub>93</sub> 4)  $\gamma_0$  1223.7 4 (t<sub>100</sub> 4)
- 1231
- G 1232.6 5, (4<sup>+</sup>)  $\gamma_{950}$  282.2 6 (t<sub>100</sub> 4 3)  $\gamma_{827}$  405.8 10 (t<sub>57</sub> 2 8)  $\gamma_{732}$  501 1 (t<sub>100</sub> 30)  $\gamma_{148}$  1084.2
- 1260.9 2  $\gamma_{1037}$  223.4 4 (t<sub>100</sub> 2 4)  $\gamma_{148}$  1112.7 3 (t<sub>1</sub> <41)  $\gamma_{45}$  1215.9 2 (t<sub>65</sub> 6)  $\gamma_0$  1262 1 (t<sub>12</sub> 6)
- D 1269.2 10, (6<sup>+</sup>)  $\gamma_{307}$  962.0 10 (t<sub>100</sub>)
- 1278.5 3, (1<sup>-</sup>, 2<sup>-</sup>)  $\gamma_{732}$  547.0 3 (t<sub>80</sub> 20)  $\gamma_{45}$  1233.8 3 (t<sub>80</sub> 20)  $\gamma_0$  1278.8 2 (t<sub>100</sub> 10)
- G 1285.8 3, (5<sup>-</sup>)  $\gamma_{998}$  287.9 4 (t<sub>1</sub> <100)  $\gamma_{307}$  978.5 3 (t<sub>1</sub> <63)  $\gamma_{148}$  1138.0 10 (t<sub>27</sub> 9)
- 1355.2 3, (1, 2<sup>-</sup>)  $\gamma_{45}$  1310.5 4 (t<sub>100</sub> 20)  $\gamma_0$  1354.5 10 (t<sub>60</sub> 20)
- 1375
- B 1378.4 6, 11<sup>-</sup>  $\gamma_{1150}$  228.1 4  $\gamma_{1077}$  302.3  $\gamma_{776}$  602.9 4
- G 1381.7 3, (6<sup>-</sup>)  $\gamma_{827}$  555.3 5 (t<sub>71</sub> 2 8)  $\gamma_{307}$  1074.4 2 (t<sub>100</sub> 14)
- 1413.3 2, (2<sup>+</sup>, 3<sup>-</sup>)  $\gamma_{1113}$  300.6 10  $\gamma_{1059}$  352.3 1 (t<sub>100</sub> 8)  $\gamma_{931}$  482.9 3 (t<sub>28</sub> 8)  $\gamma_{148}$  1265.6 10 (t<sub>12</sub> 4)  $\gamma_{45}$  1368.3 2
- A 1415.3 6, 14<sup>+</sup>, 2.6 2 ps  $\gamma_{1077}$  338.8 4 (t<sub>100</sub>)
- I 1482.0 2, (0<sup>+</sup>)  $\gamma_{1113}$  369.5 2 (t<sub>100</sub> 15)  $\gamma_{1037}$  443.8 10 (t<sub>38</sub> 16)  $\gamma_{931}$  552.5 10
- (t<sub>38</sub> 16)  $\gamma_{45}$  1437.1 2 (t<sub>100</sub> 15)
- 1516.5 2, (4<sup>+</sup>)  $\gamma_{950}$  566.1 3  $\gamma_{307}$  1209.3 3  $\gamma_{148}$  1368.3 2  $\gamma_{45}$  1470 1
- I 1530.7 2, 2<sup>+</sup>  $\gamma_{1129}$  401.6 3 (t<sub>91</sub> 1 8)  $\gamma_{732}$  798.9 2 (t<sub>100</sub> 10)  $\gamma_{148}$  1381.8 5 (t<sub>36</sub> 9)  $\gamma_{45}$  1485 1 (t<sub>18</sub> 9)  $\gamma_0$  1531.6 10 (t<sub>18</sub> 9)
- 1594.9 2, (2<sup>+</sup>, 3, 4<sup>+</sup>)  $\gamma_{827}$  768.3  $\gamma_{732}$  863.5 6 (t<sub>1</sub> <37)  $\gamma_{148}$  1446.2 3 (t<sub>100</sub> 13)  $\gamma_{45}$  1550.0 4 (t<sub>75</sub> 13)
- 1630
- I 1643.2 3, 4<sup>+</sup>  $\gamma_{1355}$  287.9 4 (t<sub>1</sub> <100)  $\gamma_{827}$  816.6  $\gamma_{307}$  1336.2 3 (t<sub>54</sub> 9)  $\gamma_{148}$  1495 1 (t<sub>36</sub> 12)  $\gamma_{45}$  1598.2 4 (t<sub>46</sub> 13)
- B 1648.9 8, 13<sup>-</sup>  $\gamma_{1378}$  270.5 4  $\gamma_{1077}$  572.4 4
- 1665
- 1672.0 2  $\gamma_{1106}$  566.1 3 (t<sub>1</sub> <100)  $\gamma_{148}$  1523.7 3 (t<sub>56</sub> 11)  $\gamma_{45}$  1627.3 6 (t<sub>33</sub> 11)
- 1712
- 1761.2 4, (4<sup>+</sup>)  $\gamma_{1324}$  536.8 4 (t<sub>46</sub> 1 8)  $\gamma_{1336}$  625.2 2 (t<sub>100</sub> 20)  $\gamma_{1106}$  655 1 (t<sub>46</sub> 1 8)  $\gamma_{307}$  1454 1 (t<sub>27</sub> 9)  $\gamma_{45}$  1716.7 6 (t<sub>36</sub> 9)
- 1774.7, (3<sup>+</sup>, 4, 5<sup>-</sup>)  $\gamma_{1168}$  606.6 2 (t<sub>100</sub> 12)  $\gamma_{1127}$  647.7 4 (t<sub>24</sub> 8)  $\gamma_{966}$  808.4 1 (t<sub>56</sub> 8)  $\gamma_{732}$  1043 1 (t<sub>4</sub> 4)  $\gamma_{148}$  1627.3 6 (t<sub>12</sub> 3)
- A 1788.2 8, 16<sup>+</sup>, 1.6 6 7 ps  $\gamma_{1415}$  372.9 4 (t<sub>100</sub>)
- I 1814.3 3, (6<sup>+</sup>)  $\gamma_{1382}$  432.5 3 (t<sub>1</sub> <100)  $\gamma_{518}$  1296 1 (t<sub>37</sub> 12)  $\gamma_{307}$  1507.1 3 (t<sub>100</sub> 12)
- 1892.2 2, (4<sup>+</sup>, 5<sup>-</sup>)  $\gamma_{1643}$  248.6 7 (t<sub>90</sub> 40)  $\gamma_{732}$  1160.4 2 (t<sub>100</sub> 10)  $\gamma_{307}$  1584.9 3 (t<sub>70</sub> 10)
- B 1958.6 8, 15<sup>-</sup>  $\gamma_{1648}$  309.9 4  $\gamma_{1415}$  543.7 4
- 1992.6 3, (3<sup>-</sup>)  $\gamma_{1286}$  706.6 2 (t<sub>100</sub> 13)  $\gamma_{1224}$  768.3 2 (t<sub>1</sub> <69)  $\gamma_{1129}$  863.5 6 (t<sub>1</sub> <19)  $\gamma_{1059}$  932.7 3 (t<sub>50</sub> 6)  $\gamma_{148}$  1844.6 5 (t<sub>25</sub> 6)
- 2163.6 3  $\gamma_{732}$  1431.3 10 (t<sub>67</sub> 15)  $\gamma_{307}$  1856.6 4 (t<sub>100</sub> 15)  $\gamma_{148}$  2014.8 4 (t<sub>84</sub> 15)
- A 2190.7 13, 18<sup>+</sup>, 1.1 8 7 ps  $\gamma_{1788}$  402.6 4 (t<sub>100</sub>)
- B 2305.9 10, 17<sup>-</sup>  $\gamma_{1959}$  347.5 4  $\gamma_{1788}$  518.3 4
- J 2557.6 5, 0<sup>+</sup>, 298 1 8 ns, %IT=95, %SF=5  $\gamma_{680}$  1879 (t<sub>1</sub> =37)  $\gamma_{45}$  2512.7 5 (t<sub>1</sub> =100)  $\gamma_0$  2558 2 (t<sub>0</sub> =0.8) E0
- J 2577.2, (2<sup>-</sup>)  $\gamma_{2558}$  19.6
- 2557.6+y(?), >1 ns
- A 2618.7 16, 20<sup>+</sup>, 0.9 0 7 ps  $\gamma_{2191}$  427.9 4 (t<sub>100</sub>)
- B 2687.2 14, 19<sup>-</sup>  $\gamma_{2306}$  382.7 4  $\gamma_{2191}$  498.3
- 2754, (1),  $\Gamma=8.4 \times 10^{-5}$  eV  $\gamma_{45}$  2709 (t<sub>20</sub> 10)  $\gamma_0$  2754 (t<sub>100</sub>)
- A 3067.2 20, 22<sup>+</sup>, 0.6 9 14 ps  $\gamma_{2619}$  448.9 4 (t<sub>100</sub>)
- B 3104.2 14, 21<sup>-</sup>  $\gamma_{2687}$  415.1 10
- 3202.8 10 (?), (0<sup>+</sup>)  $\gamma_{2558}$  645.2 9 (E0)
- 3253.4, 1<sup>-</sup>,  $\Gamma=5.2 \times 10^{-4}$  19 eV  $\gamma_{1129}$  2125 (t<sub>44</sub>)  $\gamma_{1037}$  2217 (t<sub>9</sub>)  $\gamma_{998}$  2256 (t<sub>8</sub>)  $\gamma_{966}$  2288 (t<sub>91</sub>)  $\gamma_{950}$  2303 (t<sub>16</sub>)  $\gamma_{931}$  2323 (t<sub>32</sub>)  $\gamma_{925}$  2327 (t<sub>33</sub>)  $\gamma_{732}$  2522 (t<sub>14</sub>)  $\gamma_{680}$  2574 (t<sub>28</sub>)  $\gamma_{45}$  3209 (t<sub>22</sub>)  $\gamma_0$  3253 (t<sub>100</sub>)
- A 3534.5 15, 24<sup>+</sup>, 0.5 1 4 ps  $\gamma_{3067}$  467 1 (t<sub>100</sub>)
- B 3547.8 18, 23<sup>-</sup>  $\gamma_{3104}$  443.6 10
- 3809, (1, 2),  $\Gamma>1.6 \times 10^{-3}$  eV  $\gamma_{926}$  2882 (t<sub>55</sub> 22)  $\gamma_{680}$  3128 (t<sub>28</sub> 22)  $\gamma_{45}$  3764 (t<sub>96</sub> 14)  $\gamma_0$  3809 (t<sub>100</sub>)
- A 4017.3 18, 26<sup>+</sup>, 0.4 0 6 ps  $\gamma_{3535}$  482.8 10 (t<sub>100</sub>)
- 4494, (1, 2),  $\Gamma>4.7 \times 10^{-5}$  eV  $\gamma_{45}$  4450 (?) (t<sub>32</sub> 28)  $\gamma_0$  4495 (t<sub>100</sub>)
- A 4516.5 21, 28<sup>+</sup>, 0.3 7 9 ps  $\gamma_{4017}$  499.3 10 (t<sub>100</sub>)
- 4592, (1, 2),  $\Gamma>2.8 \times 10^{-4}$  eV  $\gamma_{45}$  4546 (t<sub>190</sub>)  $\gamma_0$  4592 (t<sub>100</sub>)
- 4806.6, (1),  $\Gamma=2.5 \times 10^{-4}$  eV  $\gamma_{966}$  3840 (t<sub>47</sub> 17)  $\gamma_0$  4807 (t<sub>100</sub>)
- A 5034.3 23, 30<sup>+</sup>  $\gamma_{4517}$  517.7 10
- 5206, (1, 2),  $\Gamma>4.1 \times 10^{-4}$  eV  $\gamma_{1057}$  4148 (?) (t<sub>33</sub> 26)  $\gamma_{45}$  5160 (t<sub>90</sub> 28)  $\gamma_0$  5206 (t<sub>100</sub>)

**237  
93 Np**

$\Delta$ : 44866.7 20  $S_n$ : 6580.50  $S_p$ : 4862.13  $Q_\alpha$ : 4959.1 12  
 $\sigma_\gamma$ : 176.3 b

**Nuclear Bands**

- A 5/2[642]
- B 5/2[523]
- C 1/2[530]
- D 1/2[400]
- E 3/2[521]
- F Band Structure

**Levels and  $\gamma$ -ray branchings:**

- A 0, 5/2<sup>+</sup>, 2.14×10<sup>6</sup> 1 y, % $\alpha$ =100, %SF<2×10<sup>-10</sup>,  $\mu$ =+2.53, Q=+4.17
- A 33.192 2, 7/2<sup>+</sup>, 54.24 ps  $\gamma_{33}$  33.195 11 (†, 100) M1+E2:  $\delta$ =0.133
- B 59.537 1, 5/2<sup>+</sup>, 67.2 ns,  $\mu$ =+1.34 12, Q=+4.17  $\gamma_{33}$  26.345 1 (†, 6.71 14) E1  
 $\gamma_0$  59.537 1 (†, 100) E1
- A 75.89 5, 9/2<sup>+</sup>, = 56 ps  $\gamma_{33}$  42.73 5 (†, 100 15)  $\gamma_0$  75.8 2 (†, 11)
- B 102.96 2, 7/2<sup>+</sup>, 80.40 ps  $\gamma_{76}$  27.03 (?)  $\gamma_{60}$  43.423 10 (†, 100 11) M1+E2:  $\delta$ =0.41 2  
 $\gamma_{33}$  69.76 3 (†, 4.0 6) (E1)  $\gamma_0$  102.98 2 (†, 26.7 2) E1
- A 130.00 6, 11/2<sup>+</sup>  $\gamma_{33}$  96.7 (†, 100)
- B 158.51 2, 9/2<sup>+</sup>  $\gamma_{103}$  55.56 2 (†, 89 9) M1+E2:  $\delta$ =0.46 4  $\gamma_{60}$  98.97 2 (†, 100 2) E2  
 $\gamma_{33}$  125.30 2 (†, 20.1 2)
- A 191.5 2, 13/2<sup>+</sup>  $\gamma_{76}$  115.5 1 (†, 100)
- B 225.96 3, 11/2<sup>+</sup>  $\gamma_{159}$  67.45 5 (†, 42 10) (M1+E2):  $\delta$ =0.46 12  $\gamma_{103}$  123.01 2  
(†, 100 1) E2  $\gamma_{76}$  150.04 3 (†, 7.40 15)
- C 267.54 2, 3/2<sup>+</sup>, 5.2 2 ns  $\gamma_{103}$  164.61 2 (†, 8.6 2) E2  $\gamma_{60}$  208.00 1 (†, 100 1)  
M1+E2:  $\delta$ =+0.156 5  $\gamma_{33}$  234.40 4 (†, 0.097 10) M2  $\gamma_0$  267.54 4 (†, 3.36 10)  
E1+M2:  $\delta$ =0.490 15
- A 269.9, 15/2<sup>+</sup>  $\gamma_{130}$  139.9 (†, 100)
- C 281.35 2, 1/2<sup>+</sup>  $\gamma_{268}$  13.81 2 (†, 21.4 8) M1+E2:  $\delta$ =0.0321 10  $\gamma_{60}$  221.80 4  
(†, 100 4) E2
- B 305.06 4, 13/2<sup>+</sup>  $\gamma_{159}$  146.55 3 (†, 100 2) E2  $\gamma_{130}$  175.07 4 (†, 3.9 3)  
316.8 2 (?)  $\gamma_0$  316.8 2
- C 324.42 5, (7/2<sup>+</sup>)  $\gamma_{159}$  165.81 6 (†, 54.7 24)  $\gamma_{103}$  221.46 3 (†, 100 2)  $\gamma_{76}$  249.00 15  
(†, 1.3)  $\gamma_{60}$  264.89 6 (†, 21.2 10)  $\gamma_{33}$  291.30 20 (†, 7.3 8)
- D 332.36 3, 1/2<sup>+</sup>, <1.0 ns  $\gamma_{281}$  51.01 3 (†, 93.4 16) E1  $\gamma_{268}$  64.83 2 (†, 100 2) E1  
 $\gamma_0$  332.36 4 (†, 26.6 8) E2
- A 348.5, 17/2<sup>+</sup>  $\gamma_{192}$  157.0 (†, 100)
- C 359.7 1, (5/2<sup>+</sup>)  $\gamma_{60}$  300.13 6 (?)
- D 368.59 3, 5/2<sup>+</sup>  $\gamma_{76}$  292.77 6 (†, 2.86 11)  $\gamma_{60}$  309.13 (†, 0.28)  $\gamma_{33}$  335.38 3  
(†, 100 1) M1+E2:  $\delta$ =0.46 17  $\gamma_0$  368.59 4 (†, 43.7 2)
- D 370.93 3, 3/2<sup>+</sup>  $\gamma_{332}$  38.54 3 (M1+E2)  $\gamma_{33}$  337.7 2 (†, 8.3 5) (E2)  $\gamma_0$  370.94 3  
(†, 100 1) M1+E2:  $\delta$ =0.43 21
- B 395.52 5, 15/2<sup>+</sup>  $\gamma_{226}$  169.56 3 (†, 100 2) E2  $\gamma_{192}$  204.06 6 (†, 1.68 11)
- C 434.12 10, (11/2<sup>+</sup>)  $\gamma_{324}$  109.70 7 (†, 7.4)  $\gamma_{305}$  129.2  $\gamma_{159}$  275.77 8 (†, 100 7)  
 $\gamma_{130}$  304.21 20 (†, 15 4)  $\gamma_{76}$  358.25 20 (†, 18 4)
- D 452.53 4, 9/2<sup>+</sup>  $\gamma_{192}$  260.80 15 (†, 0.87 14)  $\gamma_{130}$  322.52 3 (†, 110 1)  
(M1+E2):  $\delta$ =0.6  $\gamma_{76}$  376.65 3 (†, 100 1) (M1)  $\gamma_{33}$  419.33 4 (†, 20.8 5)  
 $\gamma_0$  452.6 2 (†, 1.74 18)
- A 454.4, 19/2<sup>+</sup>  $\gamma_{270}$  184.5
- D 459.68 5, 7/2<sup>+</sup>  $\gamma_{324}$  135.3  $\gamma_{76}$  383.81 3 (†, 100 2)  $\gamma_{33}$  426.47 4 (†, 87.2 18)  
 $\gamma_0$  459.68 (†, 12.8 11)
- C 486.0 2, (9/2<sup>+</sup>)  $\gamma_{324}$  161.54 10 (†, 100)  $\gamma_{226}$  260.8
- B 497.0 1, 17/2<sup>+</sup>  $\gamma_{305}$  191.96 4 (†, 100)
- E 514.20 10, (3/2<sup>+</sup>)  $\gamma_{360}$  154.27 20 (?) (†, 11.7)  $\gamma_{281}$  232.81 5 (†, 100 7)  
 $\gamma_{268}$  246.73 10 (†, 5.2 7)  $\gamma_{60}$  454.66 8 (†, 211 7)  $\gamma_0$  514.0 5 (†, 57 7)
- E 545.6 2, (5/2<sup>+</sup>)  $\gamma_{281}$  264.89  $\gamma_{268}$  278.04 15 (†, 38)  $\gamma_{33}$  512.5 3 (†, 100 20)  
 $\gamma_0$  545.4 3 (†, 64)
- A 546.9, 21/2<sup>+</sup>  $\gamma_{348}$  198.5
- E 590.3 2, (7/2<sup>+</sup>)  $\gamma_{268}$  322.52  $\gamma_{103}$  487.3 3 (†, 15.4)  $\gamma_0$  590.28 15 (†, 100 7)
- D 592.5 10, 13/2<sup>+</sup>  $\gamma_{453}$  139.44 8 (†, 100 21)  $\gamma_{434}$  159.26 20 (†, 26 10)  $\gamma_{396}$  197.0 2  
(†, 9.2)  $\gamma_{192}$  401.3 30 (†, 9.2)  $\gamma_{130}$  463.22 20 (†, 19)
- D 598.0 2, 11/2<sup>+</sup>  $\gamma_{460}$  138.5  $\gamma_{192}$  406.35 15 (†, 50 8)  $\gamma_{130}$  468.12 15 (†, 100 8)  
 $\gamma_{76}$  522.06 15 (†, 31 11)  
618 2
- E 646.1 2, (9/2<sup>+</sup>)  $\gamma_{159}$  487.3  $\gamma_{60}$  586.59 20 (†, 100)
- 666.2 2, (5/2<sup>+</sup>, 7/2<sup>+</sup>)  $\gamma_{268}$  398.64 15 (?) (†, 160)  $\gamma_{76}$  590.28  $\gamma_{33}$  632.93 15 (†, 100)  
 $\gamma_0$  666.5 3 (†, 39)
- A 684.4, 23/2<sup>+</sup>  $\gamma_{547}$  137.6 (?)  $\gamma_{454}$  230.0
- E 709 3, (11/2<sup>+</sup>)
- F 721.94 4, 5/2<sup>+</sup>  $\gamma_{268}$  454.66 (?)  $\gamma_{159}$  563.05 30 (†, 0.20)  $\gamma_{103}$  619.01 2 (†, 16.3 2)  
 $\gamma_{60}$  662.40 2 (†, 100 1) (E0+M1+E2)  $\gamma_{33}$  688.72 4 (†, 8.9 2)  $\gamma_0$  722.01 3

(†, 53.83)

- F 755.98 10, 7/2<sup>+</sup>  $\gamma_{159}$  597.48 8 (†, 19.7 8)  $\gamma_{103}$  653.02 4 (†, 100 3)  $\gamma_{76}$  680.10 10  
(†, 8.3 5)  $\gamma_{60}$  696.60 5 (†, 14.2 5)  $\gamma_{33}$  722.01  $\gamma_0$  755.90 5 (†, 20.2 7)  
758 6
- 770.57 10  $\gamma_{324}$  446.43 15 (†, 6.1 2)  $\gamma_{33}$  737.34 5 (†, 100 3)  $\gamma_0$  770.57 10 (†, 59 3)
- A 787.0, 25/2<sup>+</sup>  $\gamma_{547}$  240.1
- F 800.0 1, 9/2<sup>+</sup>  $\gamma_{226}$  573.94 20 (†, 18 3)  $\gamma_{159}$  641.47 5 (†, 100 5)  $\gamma_{130}$  669.83 20  
(†, 5.4 17)  $\gamma_{103}$  696.6  $\gamma_{33}$  767.00 10 (†, 70.4 22)
- 805.8 2, (7/2<sup>+</sup>, 9/2<sup>+</sup>)  $\gamma_{130}$  676.03 30 (†, 24 5)  $\gamma_{76}$  729.72 15 (†, 50 6)  $\gamma_{33}$  772.4 3  
(†, 100 6)  $\gamma_0$  806.26 30 (†, 11.7)  
823 3
- F 853.36 21, 11/2<sup>+</sup>  $\gamma_{324}$  529.17 20 (†, 82)  $\gamma_{226}$  627.18 20 (†, 100 31)  
861.7 5  $\gamma_{76}$  786.00 15 (?) (†, 46)  $\gamma_{60}$  801.94 20 (†, 100)  $\gamma_{33}$  828.5 (†, 18 5)  
 $\gamma_0$  862.7 5 (†, 39 5)  
906 2  
914 4  
914 4  
920.9 5  $\gamma_{60}$  860.7 5 (†, 37 12)  $\gamma_{33}$  887.3 3 (†, 100 23)  $\gamma_0$  921.5 3 (†, 86 19)  
946 2
- A 959.5, 27/2<sup>+</sup>  $\gamma_{787}$  172.6  $\gamma_{684}$  275.1  
961 3  
963 2  
984 2  
1013 3  
1020 3  
1030 3  
1040 4  
1066 3
- A 1068.2, 29/2<sup>+</sup>  $\gamma_{787}$  281.2  
1072 6  
1112 4
- A 1278.6, 31/2<sup>+</sup>  $\gamma_{1068}$  210.5  $\gamma_{960}$  319
- A 1389, 33/2<sup>+</sup>  $\gamma_{1068}$  321
- A 1639, 35/2<sup>+</sup>  $\gamma_{1389}$  249.4  $\gamma_{1279}$  361
- A 1749, 37/2<sup>+</sup>  $\gamma_{1389}$  360
- A 2041, 39/2<sup>+</sup>  $\gamma_{1749}$  292.7  $\gamma_{1639}$  401.1
- A 2146, 41/2<sup>+</sup>  $\gamma_{1749}$  396.9
- A 2480, 43/2<sup>+</sup>  $\gamma_{2146}$  334.8  $\gamma_{2041}$  439.0
- A 2578, 45/2<sup>+</sup>  $\gamma_{2146}$  431.9  
2800 400, 45 5 ns, %SF>0, %IT>0  $\gamma_0$  2800
- A 2955, 47/2<sup>+</sup>  $\gamma_{2578}$  378.2  $\gamma_{2480}$  475.3
- A 3043, 49/2<sup>+</sup>  $\gamma_{2578}$  465.5
- A 3464, 51/2<sup>+</sup>  $\gamma_{2955}$  508.6
- A 3541, 53/2<sup>+</sup>
- A 4004, 55/2<sup>+</sup>  $\gamma_{3464}$  540.1
- A 4069, 57/2<sup>+</sup>  $\gamma_{3541}$  527.5

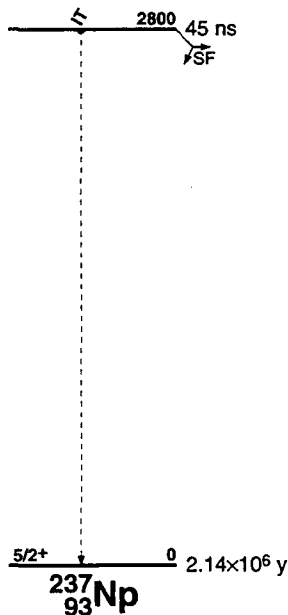

### 235Pu 94

$\Delta$ : (42200)  $S_n$ : (6210)  $S_p$ : (5040)  
 $Q_{EC}$ : (1170)  $Q_\alpha$ : (6000)  
 Nuclear Bands  
 A 5/2[633]  
 Levels:  
 A 0, (5/2<sup>+</sup>), 25.3 10 m, %EC=99.9973 5, % $\alpha$ =0.0027 5  
 3000 200, 25 5 ns  $\gamma_0 IT(?)$

E 438.41 10, 7/2<sup>+</sup>  $\gamma_{280} 158.33$  ( $\dagger_{0.83}$ )  $\gamma_{48} 390.71$   
 ( $\dagger_{6.65}$ ) E1  $\gamma_0 438.41$  ( $\dagger_{100.5}$ ) E1  
 D 453.22, 7/2<sup>+</sup>  $\gamma_{224} 229.13$  ( $\dagger_{100.34}$ )  $\gamma_{201} 252.2$   
 ( $\dagger_{100.34}$ )  $\gamma_0 453.23$  ( $\dagger_{67.14}$ )  
 F 473.50 10, 7/2<sup>+</sup>  $\gamma_{280} 193.43$  ( $\dagger_{2.17}$ )  $\gamma_{48} 425.81$   
 ( $\dagger_{45.3}$ ) E1  $\gamma_0 473.51$  ( $\dagger_{100.7}$ ) E1

884  
 908.92, 7/2<sup>+</sup>  $\gamma_{474} 435.23$  ( $\dagger_{9.616}$ ) M1  
 $\gamma_{453} 455.83$  ( $\dagger_{3.58}$ ) M1  $\gamma_{408} 501.23$  ( $\dagger_{10.816}$ )  
 M1  $\gamma_{404} 504.83$  ( $\dagger_{7.316}$ ) M1  $\gamma_{48} 861.23$   
 ( $\dagger_{14.216}$ )  $\gamma_0 908.82$  ( $\dagger_{100.6}$ )  
 933  
 964  
 998 5  
 1000.6 3, (7/2)  $\gamma_{280} 720.45$  ( $\dagger_{100.21}$ )  $\gamma_0 1000.63$   
 ( $\dagger_{79.21}$ )

### 236Pu 94

$\Delta$ : 42893 3  $S_n$ : (7380)  $S_p$ : 5432.7 2  $Q_\alpha$ : 5867.07 8  
 $\sigma_f$ : 170.35 b  
 Levels and  $\gamma$ -ray branchings:  
 0, 0<sup>+</sup>, 2.858 8 y, % $\alpha$ =100, %SF=1.36x10<sup>-7</sup> 4  
 44.63 10, 2<sup>+</sup>  $\gamma_0 44.63$  10 ( $\dagger_{100}$ ) E2  
 147.45 10, 4<sup>+</sup>  $\gamma_{45} 102.822$  ( $\dagger_{100}$ )  
 305.80 11, 6<sup>+</sup>  $\gamma_{147} 158.352$  ( $\dagger_{100}$ ) E2  
 515.7 2, 8<sup>+</sup>  $\gamma_{306} 209.92$  ( $\dagger_{100}$ ) E2  
 773.5 3, 10<sup>+</sup>  $\gamma_{516} 257.82$  ( $\dagger_{100}$ )  
 1074.3 4, 12<sup>+</sup>  $\gamma_{774} 300.82$  ( $\dagger_{100}$ )  
 1413.6 4, 14<sup>+</sup>  $\gamma_{1074} 339.32$  ( $\dagger_{100}$ )  
 1786.0 5, 16<sup>+</sup>  $\gamma_{1414} 372.43$  ( $\dagger_{100}$ )  
 $\approx 3000$ , (0<sup>+</sup>), 37 4 ps, %SF $\leq$ 100  $\gamma_0 IT(?)$   
 4000 200, 34 8 ns, %SF $\leq$ 100  $\gamma_0 IT(?)$

E 486, (9/2<sup>+</sup>)  
 D 513, 9/2<sup>+</sup>  
 G 545, (1/2<sup>-</sup>)  
 G 582, (5/2<sup>-</sup>)  
 G 591, (3/2<sup>-</sup>)  
 655  
 H 655.32, (5/2<sup>-</sup>)  $\gamma_0 655.32$  ( $\dagger_{100}$ ) M1  
 G 691, (7/2<sup>-</sup>)  
 H 696.23, 7/2<sup>-</sup>  $\gamma_{655.3} 40.748$   $\gamma_{48} 648.53$  ( $\dagger_{100.16}$ )  
 M1  $\gamma_0 696.23$  ( $\dagger_{77.16}$ ) M1  
 716  
 741  
 757  
 775  
 I 800 2, 1/2<sup>+</sup>  
 809  
 840  
 851 5, (3/2<sup>+</sup>, 5/2<sup>+</sup>)  
 852

1014  
 1025 3  
 1053  
 1104  
 1189  
 1216  
 1250  
 1264  
 1348  
 1383  
 1397  
 1463  
 1481  
 1534  
 $\approx 2600$ , 85 15 ns, %SF>0  $\gamma_0 IT(?)$   
 $\approx 2900$ , 1.1 7  $\mu$ s, %SF $\geq$ 0  $\gamma_0 IT(?)$

### 237Pu 94

$\Delta$ : 45087.0 24  $S_n$ : 5877.5 25  $S_p$ : 5580.50  
 $Q_{EC}$ : 220.3 13  $Q_\alpha$ : 5750.3  
 $\sigma_f$ : 2455.295 b  
 Nuclear Bands  
 A 7/2[743]  
 B 1/2[631]  
 C 5/2[622]  
 D 3/2[631]  
 E 5/2[633]  
 F 7/2[624]  
 G 1/2[501]  
 H Band Structure  
 I 1/2[631]+0<sup>+</sup>

Levels and  $\gamma$ -ray branchings:  
 A 0, 7/2<sup>-</sup>, 45.2 1 d, % $\alpha$ =0.0042 4, %EC=99.9958 4  
 A 47.71 4, 9/2<sup>-</sup>  $\gamma_0 47.71$  4 ( $\dagger_{100}$ ) M1+E2:  $\delta=0.24$  8  
 A 106 5, 11/2<sup>-</sup>  
 B 145.544 10, 1/2<sup>+</sup>, 0.182 s  $\gamma_0 145.544$  10 ( $\dagger_{100}$ )  
 E3  
 B 155.452, 3/2<sup>+</sup>  $\gamma_{146} 9.903$  16 ( $\dagger_{100}$ )  
 M1+E2:  $\delta=0.07$  2  
 A 175 7, 13/2<sup>-</sup>  
 B 201.182, 5/2<sup>+</sup>  $\gamma_{155} 45.724$  8 ( $\dagger_{46.12}$ )  
 M1+E2:  $\delta=0.47$  13  $\gamma_{146} 55.638$  11 ( $\dagger_{100.16}$ ) (E2)  
 B 224.25 5, 7/2<sup>+</sup>  $\gamma_{155} 68.8$  1 ( $\dagger_{100}$ ) (E2)  
 A 257, 15/2<sup>-</sup>  
 C 280.222, 5/2<sup>+</sup>  $\gamma_{201} 79.052$  ( $\dagger_{0.427}$ ) (M1)  
 $\gamma_{155} 124.723$  ( $\dagger_{0.5911}$ ) (M1)  $\gamma_0 280.232$   
 ( $\dagger_{100.5}$ ) E1  
 B 304 4, 9/2<sup>+</sup>  
 C 320.97 2, 7/2<sup>+</sup>  $\gamma_{280} 40.748$  6 ( $\dagger_{2.04}$ )  
 M1+E2:  $\delta=0.194$  30  $\gamma_{48} 273.3$  1 ( $\dagger_{54.4}$ )  
 $\gamma_0 321.0$  1 ( $\dagger_{100.8}$ ) E1  
 D 370.40 4, 3/2<sup>+</sup>  $\gamma_{155} 214.92$  ( $\dagger_{100.21}$ ) (M1)  
 $\gamma_{146} 224.86$  4 ( $\dagger_{100.21}$ ) (M1)  
 C 371 5, 9/2<sup>+</sup>  
 D 404.19 5, 5/2<sup>+</sup>  $\gamma_{280} 123.83$  ( $\dagger_{\approx 7}$ )  $\gamma_{224} 179.942$   
 ( $\dagger_{41.9}$ ) (M1+E2):  $\delta=0.77$   $\gamma_{201} 203.035$  ( $\dagger_{71.9}$ )  
 M1+E2:  $\delta=0.44$   $\gamma_{155} 248.72$  ( $\dagger_{100.10}$ )  
 (M1+E2):  $\delta=0.6$  6  
 E 407.83 6, 5/2<sup>+</sup>  $\gamma_{280} 127.52$  ( $\dagger_{17.4}$ )  $\gamma_{224} 183.72$   
 ( $\dagger_{30.8}$ ) M1+E2:  $\delta=0.77$   $\gamma_{201} 206.7$  1 ( $\dagger_{52.7}$ )  
 M1+E2:  $\delta=0.33$   $\gamma_{155} 252.22$  ( $\dagger_{43.12}$ )  
 M1+E2:  $\delta=0.7$   $\gamma_0 407.8$  1 ( $\dagger_{100.8}$ ) (E1)

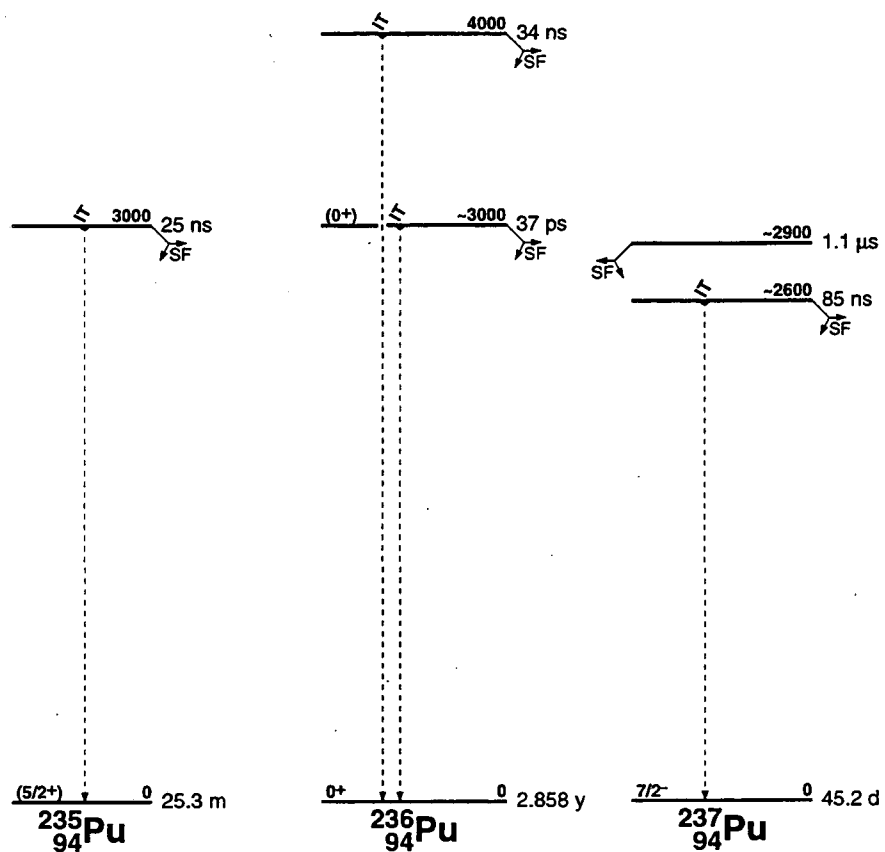

# $^{238}_{94}\text{Pu}$

$\Delta$ : 46157.820  $S_n$ : 7000.515  $S_p$ : 5997.87  $Q_\alpha$ : 5593.2019  
 $\alpha_T$ : 5407 b

## Nuclear Bands

- A GS band
- B Octupole band
- C  $\beta$  band
- D  $v7/2[743]-v5/2[622]$
- E Band Structure
- F Band Structure
- G Band Structure
- H  $v7/2[743]+v1/2[631]$
- I  $v7/2[743]-v1/2[631]$

## Levels:

- 0, 0<sup>+</sup>, 87.73 y, % $\alpha$ =100, %SF=1.9x10<sup>-7</sup>
- A 44.083, 2<sup>+</sup>, 1775 ps  $\gamma_{44}$  44.083 (t<sub>y</sub>100) E2
- A 145.964, 4<sup>+</sup>  $\gamma_{44}$  101.903 (t<sub>y</sub>100) E2
- A 303.407, 6<sup>+</sup>  $\gamma_{146}$  157.425 (t<sub>y</sub>100) E2
- A 513.42, 8<sup>+</sup>  $\gamma_{303}$  210.02 (t<sub>y</sub>100)
- B 605.186, 1<sup>-</sup>, 4.75 ps  $\gamma_{44}$  561.117 (t<sub>y</sub>1002) E1  $\gamma_{605}$  605.139 (t<sub>y</sub>714) E1
- B 661.4310, 3<sup>-</sup>, 3.711 ps  $\gamma_{146}$  515.52 (t<sub>y</sub>663)  $\gamma_{44}$  617.3611 (t<sub>y</sub>1007)
- B 763.23, (5<sup>-</sup>)  $\gamma_{303}$  459.8022  $\gamma_{146}$  617.3611
- A 772.82, 10<sup>+</sup>  $\gamma_{513}$  259.42 (t<sub>y</sub>100)
- C 941.52, 0<sup>+</sup>  $\gamma_{605}$  336.3815 (t<sub>y</sub>3.112)  $\gamma_{44}$  897.3310 (t<sub>y</sub>1007)  $\gamma_{941}$  941.53 (t<sub>0</sub>59) E0
- D 962.773, 1<sup>-</sup>, 6.212 ps  $\gamma_{661}$  301.43 (t<sub>y</sub>1.72) E2  $\gamma_{605}$  357.627 (t<sub>y</sub>7.64) M1+E2  
 $\gamma_{44}$  918.694 (t<sub>y</sub>843) E1  $\gamma_{962}$  962.773 (t<sub>y</sub>1003) E1  
 968.18(?), (2<sup>-</sup>)  $\gamma_{44}$  924(?) (t<sub>y</sub>100)
- C 983.11, 2<sup>+</sup>, 0.53 ps  $\gamma_{661}$  321.7520 (t<sub>y</sub>1.78)  $\gamma_{605}$  378.0513 (t<sub>y</sub>4.48)  
 $\gamma_{146}$  837.1115 (t<sub>y</sub>373)  $\gamma_{44}$  938.9510 (t<sub>y</sub>354) (t<sub>y</sub>190.8) E0+E2  $\gamma_{983}$  983.03 (t<sub>y</sub>10025)
- D 985.465, 2<sup>-</sup>  $\gamma_{661}$  323.989 (t<sub>y</sub>2.92) M1+E2  $\gamma_{605}$  380.2913 (t<sub>y</sub>2.1810)  
 $\gamma_{44}$  941.385 (t<sub>y</sub>1004)
- E 1028.552, 2<sup>+</sup>  $\gamma_{146}$  882.633 (t<sub>y</sub>3.11) E2  $\gamma_{44}$  984.452 (t<sub>y</sub>100) E2  $\gamma_{1028}$  1028.542 (t<sub>y</sub>733) E2
- E 1069.952, 3<sup>+</sup>  $\gamma_{146}$  923.982 (t<sub>y</sub>29.510) E2  $\gamma_{44}$  1025.872 (t<sub>y</sub>1006) E2
- A 1078.52, 12<sup>+</sup>  $\gamma_{773}$  305.72 (t<sub>y</sub>100)
- H 1082.577, (4<sup>+</sup>), 8.55 ns  $\gamma_{968}$  114.44 (t<sub>y</sub>1.52)  $\gamma_{763}$  319.2911 (t<sub>y</sub>2.22) M1+E2  
 $\gamma_{661}$  421.1411 (t<sub>y</sub>5.73)  $\gamma_{146}$  936.616 (t<sub>y</sub>1003)
- E 1125.83, (4<sup>+</sup>)  $\gamma_{146}$  979.82 (t<sub>y</sub>10017)  $\gamma_{44}$  1081.73 (t<sub>y</sub>196)
- 1134.4, (0<sup>+</sup>)
- 1174.44, (2<sup>+</sup>,1)  $\gamma_{44}$  1130.25 (t<sub>y</sub>10016)  $\gamma_{1174}$  1174.55 (t<sub>y</sub>8316)
- I 1202.6610, (3<sup>-</sup>)  $\gamma_{1083}$  119.91 (t<sub>y</sub>1007) (M1)  $\gamma_{1070}$  132.4911 (t<sub>y</sub>2.72)  
 $\gamma_{1028}$  174.02 (t<sub>y</sub>251)
- F 1228.73, 0<sup>+</sup>  $\gamma_{44}$  1184.53 (t<sub>y</sub>100) E2  $\gamma_{1228}$  1228.73 (t<sub>0</sub>9.2) E0  
 12522
- F 1264.23, 2<sup>+</sup>  $\gamma_{146}$  1118.23  $\gamma_{44}$  1220.03 E0+E2+M1  
 1310.33(?), (2<sup>+</sup>)  $\gamma_{44}$  1266.23 (t<sub>y</sub>100) M1
- G 1426.63, 0<sup>+</sup>  $\gamma_{605}$  821.54 (t<sub>y</sub>100) E1  $\gamma_{1426}$  1426.63 (t<sub>0</sub>8.5) E0
- A 1427.23, 14<sup>+</sup>  $\gamma_{1079}$  348.73 (t<sub>y</sub>100)
- 1447.32, 1<sup>-</sup>  $\gamma_{605}$  841.94 (t<sub>0</sub>4.4) E0  $\gamma_{44}$  1403.23 (t<sub>y</sub>1008) E1  $\gamma_{1447}$  1447.33 (t<sub>y</sub>634) E1
- G 1458.33, 2<sup>+</sup>  $\gamma_{44}$  1414.03 (t<sub>y</sub>23)  $\gamma_{1458}$  1458.53 (t<sub>y</sub>10011)
- 1559.92, (1<sup>-</sup>)  $\gamma_{985}$  574.03 (t<sub>y</sub>659) (E2+M1)  $\gamma_{963}$  597.03 (t<sub>y</sub>7910)  $\gamma_{605}$  954.73 (t<sub>y</sub>58)  $\gamma_{44}$  1515.93 (t<sub>y</sub>10012)  $\gamma_{1560}$  1560.03 (t<sub>y</sub>7719)
- 1596.43, (2<sup>+</sup>)  $\gamma_{146}$  1450.45(?) (t<sub>y</sub>77)  $\gamma_{44}$  1552.23 (t<sub>y</sub>10016)  $\gamma_{1596}$  1596.55 (t<sub>y</sub>31)
- 1621.32, 1<sup>-</sup>  $\gamma_{963}$  658.42 (t<sub>y</sub>6.27) E0+E2+M1  $\gamma_{942}$  679.54 (t<sub>y</sub>8.98) E1  
 $\gamma_{605}$  1016.22 (t<sub>y</sub>9.79) E0+E2+M1  $\gamma_{44}$  1577.33 (t<sub>y</sub>1008) E1  $\gamma_{1621}$  1621.44 (t<sub>y</sub>0.6)
- 1636.42, 1<sup>-</sup>  $\gamma_{963}$  653.35 (t<sub>y</sub>4)  $\gamma_{963}$  673.42 (t<sub>y</sub>3.3) E0  $\gamma_{605}$  1031.33 (t<sub>0</sub>4.2) E0  
 $\gamma_{44}$  1592.53 (t<sub>y</sub>384)  $\gamma_{1636}$  1636.63 (t<sub>y</sub>1009) E1
- 1651.24, (1,2<sup>+</sup>)  $\gamma_{44}$  1607.04 (t<sub>y</sub>10015)  $\gamma_{1651}$  1651.45 (t<sub>y</sub>186)
- 1726.43, (1,2<sup>+</sup>)  $\gamma_{44}$  1682.23 (t<sub>y</sub>10010)  $\gamma_{1726}$  1726.43 (t<sub>y</sub>596)
- 1783.63, (1,2<sup>+</sup>)  $\gamma_{44}$  1739.44 (t<sub>y</sub>485)  $\gamma_{1783}$  1783.64 (t<sub>y</sub>10020)
- A 1816.23, 16<sup>+</sup>  $\gamma_{1427}$  389.03 (t<sub>y</sub>100)
- 1898.33, 2<sup>-</sup>  $\gamma_{661}$  1237.03 (t<sub>y</sub>818) M1  $\gamma_{605}$  1293.23 (t<sub>y</sub>10010) M1
- A 2240.54, 18<sup>+</sup>  $\gamma_{1816}$  424.34 (t<sub>y</sub>100)  
 ≈2400, 0.62 ns, %SF≤100  $\gamma_{2240}$  IT(?)  
 ≈3500, (0<sup>+</sup>), 6.015 ns, %SF≤100  $\gamma_{3500}$  IT(?)

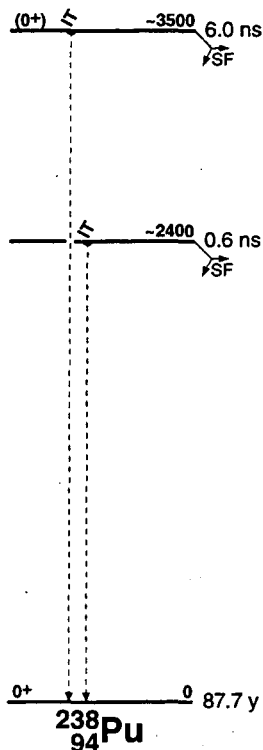



**<sup>239</sup>Pu**  
**<sub>94</sub>**

$\Delta$ : 48582.620  $S_n$ : 5646.53  $S_p$ : 6156.26  $Q_\alpha$ : 5244.5023  
 $\sigma_{abs}$ : 748.120 b,  $\sigma_\gamma$ : 269.3 b

**Nuclear Bands**

- A 1/2[631]
- B 1/2[631]+Octupole
- C 5/2[622]
- D 7/2[743]
- E 7/2[624]
- F 1/2[761]
- G 1/2[620]
- H 7/2[613]?
- I 3/2[622]?
- J 5/2[633]

**Levels and  $\gamma$ -ray branchings:**

- A 0, 1/2<sup>+</sup>, 24110.30 y,  $\mu=+0.2034$ ,  $\% \alpha=100$ ,  $\% SF=3.1 \times 10^{-10} 6$
- A 7.8612, 3/2<sup>+</sup>, 36.3 ps,  $Q=-2.3197$   $\gamma_0$  7.8612 (†,100) M1+E2:  $\delta=0.0552$
- A 57.2762, 5/2<sup>+</sup>, 101.5 ps,  $Q=-3.34513$   $\gamma_8$  49.4152 (†,85.9) M1+E2:  $\delta=0.503$   
 $\gamma_0$  57.2762 (†,100.6) E2
- A 75.7063, 7/2<sup>+</sup>, 83.8 ps,  $Q=-3.82626$   $\gamma_{57}$  18.4302 (†, <20)  $\gamma_8$  67.8462 (†,100.25) E2
- A 163.762, 9/2<sup>+</sup>, 73.4 ps  $\gamma_{76}$  88.052 (†,12.4) M1+E2:  $\delta=0.5010$   $\gamma_{57}$  106.482 (†,100.16) E2
- A 192.8110, 11/2<sup>+</sup>  $\gamma_{76}$  117.11 (†,100) E2
- C 285.4602, 5/2<sup>+</sup>, 1.125 ns,  $\mu=-1.2529$   $\gamma_{76}$  209.7532 (†,23.73) M1(+E2):  $\delta=-0.004_{-24}^{+1}$   $\gamma_{57}$  228.1831 (†,78.013) M1(+E2):  $\delta=+0.001_{-1}^{+9}$   
 $\gamma_8$  277.5991 (†,100.015) M1+E2:  $\delta=+0.1652$   $\gamma_0$  285.4602 (†,5.41) E2
- A 318.11, 13/2<sup>+</sup>  $\gamma_{164}$  154.3510 (†,100) E2
- C 330.1254, 7/2<sup>+</sup>  $\gamma_{285}$  44.6652 (†,100.8) M1+E2:  $\delta=0.203$   $\gamma_{164}$  166.3692 (†,13.6) M1  $\gamma_{76}$  254.4183 (†,85.5) M1+E2:  $\delta=-0.15912$   $\gamma_{57}$  272.8483 (†,60.4) M1+E2:  $\delta=+0.1659$   $\gamma_8$  322.2643 (†,4.012)
- A 358.11, 15/2<sup>+</sup>  $\gamma_{193}$  165.418 E2
- C 387.412, 9/2<sup>+</sup>  $\gamma_{330}$  57.292 (†,100.40) M1(+E2)  $\gamma_{285}$  101.952 (†,=16) E2  
 $\gamma_{76}$  311.702 (†,34.4) (M1+E2)
- D 391.5863, 7/2<sup>+</sup>, 193.4 ns  $\gamma_{330}$  61.4612 (†,4.71) E1  $\gamma_{285}$  106.1252 (†,100.2) E1(+M2):  $\delta=-0.0077$   $\gamma_{76}$  315.8792 (†,5.92) E1(+M2):  $\delta=+0.0087$   
 $\gamma_{57}$  334.3092 (†,7.72) E1(+M2):  $\delta=+0.0064$
- D 434.3, (9/2<sup>-</sup>)
- C 462.3, (11/2<sup>-</sup>)
- B 469.84, (1/2<sup>-</sup>)  $\gamma_8$  461.94 (†,100.15)  $\gamma_0$  469.84 (†,60.15)
- D 487.3, (11/2<sup>-</sup>)
- B 492.13, 3/2<sup>-</sup>  $\gamma_{57}$  434.93 (†,100.15) E1(+M2):  $\delta=-0.0022$   $\gamma_8$  484.33 (†,10.3)  $\gamma_0$  492.13 (†,60.15)
- B 505.52, (5/2<sup>-</sup>)  $\gamma_{76}$  429.82 (†,100.15)  $\gamma_{57}$  448.22 (†,7.2)  $\gamma_8$  497.82 (†,88.18)
- E 511.83813, 7/2<sup>+</sup>  $\gamma_{387}$  124.4348 (†,3.03) M1(+E2):  $\delta=0.26$   $\gamma_{330}$  181.7117 (†,31.2) M1+E2:  $\delta=-0.1507$   $\gamma_{285}$  226.3788 (†,100.7) M1+E2:  $\delta=+0.1336$   
 $\gamma_{76}$  436.13614 (†,0.243)  $\gamma_{57}$  454.56512 (†,0.364)  $\gamma_8$  503.97712 (†,0.424)
- A 519.21, 17/2<sup>+</sup>  $\gamma_{318}$  201.078 (†,100) E2  
538.3
- B 556.15, (7/2<sup>-</sup>)  $\gamma_{164}$  392.45 (†,100.20)  $\gamma_{57}$  498.85 (†,=70)
- E 565, (9/2<sup>-</sup>)
- A 570.11, 19/2<sup>+</sup>  $\gamma_{358}$  212.018 (†,100) E2
- B 583.3, (9/2<sup>-</sup>)
- D 620, (15/2<sup>-</sup>)
- E 634, 11/2<sup>+</sup>
- B 659.3, (11/2<sup>-</sup>)  
716  
752.55, 1/2<sup>+</sup>, 3/2  
756.5  
763.3
- A 764.72, (21/2<sup>+</sup>)  $\gamma_{519}$  245.51 (E2)  
779.3  
798.25, 1/2, 3/2  
805.15, 1/2, 3/2  
813.3  
825.510, 1/2, 3/2
- A 826.92, (23/2<sup>+</sup>)  $\gamma_{570}$  256.81 (E2)  
854.2  
888.05, 1/2, 3/2  
900.2  
915.3  
933.310, 1/2, 3/2  
948.3
- F 990, (3/2<sup>-</sup>)
- F 1017, (1/2<sup>-</sup>)

- 1027.2
- F 1038, (7/2<sup>-</sup>)
- A 1052.93, (25/2<sup>+</sup>)  $\gamma_{765}$  288.21 (†,100) (E2)  
1062.2  
1099.95, 1/2, 3/2
- F 1100, (5/2<sup>-</sup>)
- A 1126.63, (27/2<sup>+</sup>)  $\gamma_{827}$  299.72 (†,100) (E2)
- F 1137, (11/2<sup>-</sup>)  
1174
- G 1214, (1/2<sup>+</sup>)
- G 1233, (3/2<sup>+</sup>)
- H 1233, (9/2<sup>-</sup>)
- G 1261, (5/2<sup>+</sup>)
- I 1261, (3/2<sup>+</sup>)
- I 1289, (5/2<sup>+</sup>)
- G 1311, (7/2<sup>+</sup>)
- I 1342, (7/2<sup>+</sup>)
- G 1359, (9/2<sup>+</sup>)
- A 1381.74, (29/2<sup>+</sup>)  $\gamma_{1053}$  328.83 (†,100)  
1390
- I 1409, (9/2<sup>+</sup>)  
1437  
1465
- A 1466.64, (31/2<sup>+</sup>)  $\gamma_{1127}$  340.02 (†,100) (E2)  
1488
- A 1749.05, (33/2<sup>+</sup>)  $\gamma_{1382}$  367.34 (†,100) (E2)
- A 1845.66, (35/2<sup>+</sup>)  $\gamma_{1467}$  379.04 (†,100) (E2)
- A 2152.57, (37/2<sup>+</sup>)  $\gamma_{1749}$  403.54 (†,100) (E2)
- A 2261.17, (39/2<sup>+</sup>)  $\gamma_{1846}$  415.54 (†,100) (E2)
- A 2590.38, (41/2<sup>+</sup>)  $\gamma_{2153}$  437.84 (†,100) (E2)
- A 2712.08, (43/2<sup>+</sup>)  $\gamma_{2261}$  450.94 (†,100) (E2)
- A 3060.59, (45/2<sup>+</sup>)  $\gamma_{2590}$  470.24 (†,100) E2
- J 3100.200, (5/2<sup>-</sup>), 7.510  $\mu$ s,  $\% SF \leq 100$   $\gamma_0 IT(?)$
- J 3124.3, (7/2<sup>-</sup>)  $\gamma_{3100+6}$  24.3 (†,  $\gamma_{7315}$ )
- J 3156.2, (9/2<sup>-</sup>)  $\gamma_{3124}$  31.9 (†,  $\gamma_{5510}$ ) M1+E2:  $\delta > 0.85$   $\gamma_{3100+6}$  56.2 (†,  $\gamma_{2515}$ ) E2
- A 3199.09, (47/2<sup>+</sup>)  $\gamma_{2712}$  487.04 (†,100) (E2)
- 3303, (9/2<sup>-</sup>), 2.6-12 ns,  $\% SF \leq 100$   $\gamma_{3156}$  146.6 (†,  $\gamma_{9120}$ ) (E1)  $\gamma_{3124}$  178.5 (†,  $\gamma_{4110}$ ) (E1)  $\gamma_{3100+6}$  202.8(?) (†,  $\gamma_{42}$ )
- A 3558.410, (49/2<sup>+</sup>)  $\gamma_{3061}$  497.94 (†,100) (E2)

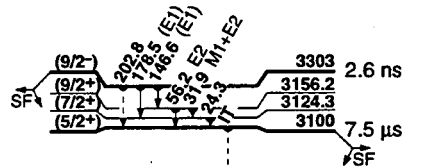

1/2<sup>+</sup> 0 24110 y  
**<sup>239</sup>Pu**  
**<sub>94</sub>**

**240Pu**  
**94**

$\Delta$ : 50120.520  $S_n$ : 6533.55  $S_p$ : 6472.99  $Q_\alpha$ : 5255.78 15  
 $\sigma_\gamma$ : 289.514 b,  $\sigma_p$ : 0.063 b

**Nuclear Bands**

- A Isomer band
- B GS band
- C Band Structure
- D Band Structure
- E Band Structure
- F v1/2[631]+v5/2[622]
- G Band Structure
- H Band Structure
- I Band Structure
- J  $\pi$ 5/2[642]+ $\pi$ 5/2[523]
- K  $\pi$ 5/2[642]- $\pi$ 5/2[523]
- L Band Structure

**Levels and  $\gamma$ -ray branchings:**

- B 0, 0<sup>+</sup>, 6564 11 y, % $\alpha$ =100, %SF=5.7 $\times$ 10<sup>-6</sup>2
- B 42.824 8, 2<sup>+</sup>, 164 5 ps  $\gamma_{42.8248}$  (t<sub>1/2</sub> 100) E2
- B 141.690 15, 4<sup>+</sup>  $\gamma_{43}$  98.860 13 (t<sub>1/2</sub> 100) E2
- B 294.319 24, 6<sup>+</sup>  $\gamma_{142}$  152.630 20 (t<sub>1/2</sub> 100) E2
- B 497.52 21, 8<sup>+</sup>  $\gamma_{294}$  203.22 (t<sub>1/2</sub> 100)
- C 597.34 4, 1<sup>-</sup>  $\gamma_{43}$  554.60 7 (t<sub>1/2</sub> 100) E1  $\gamma_0$  597.40 7 (t<sub>1/2</sub> 62) E1
- C 648.85 4, 3<sup>-</sup>  $\gamma_{142}$  507.20 10 (t<sub>1/2</sub> 100)  $\gamma_{43}$  606.10 7 (t<sub>1/2</sub> 97 5)
- C 742.33 4, 5<sup>-</sup>, <2 ns  $\gamma_{294}$  448.01 6 (t<sub>1/2</sub> 67 3)  $\gamma_{142}$  600.57 6 (t<sub>1/2</sub> 10 5)
- B 747.8 3, (10<sup>+</sup>)  $\gamma_{43}$  250.32 (t<sub>1/2</sub> 100)
- D 860.71 7, 0<sup>+</sup>  $\gamma_{597}$  263.37 7 (t<sub>1/2</sub> 89 2)  $\gamma_{43}$  817.89 10 (t<sub>1/2</sub> 100) E2  $\gamma_0$  860.7 E0
- D 900.32 4, 2<sup>+</sup>  $\gamma_{649}$  251.47 7 (t<sub>1/2</sub> 73 3)  $\gamma_{597}$  302.98 7 (t<sub>1/2</sub> 85 3)  $\gamma_{142}$  758.61 8 (t<sub>1/2</sub> 100 3) E2  $\gamma_{43}$  857.48 10 (t<sub>1/2</sub> 42 2)  $\gamma_0$  900.37 10 (t<sub>1/2</sub> 14 2)
- E 938.06 6, (1<sup>-</sup>)  $\gamma_{649}$  289.21 10 (t<sub>1/2</sub> 1.4 3)  $\gamma_{597}$  340.70 10 (t<sub>1/2</sub> 5.0 5)  $\gamma_{43}$  895.30 10 (t<sub>1/2</sub> 5 1)  $\gamma_0$  938.02 10 (t<sub>1/2</sub> 100 4)
- E 958.85 6, (2<sup>-</sup>)  $\gamma_{649}$  309.99 9 (t<sub>1/2</sub> 4.3 4)  $\gamma_{597}$  361.55 10 (t<sub>1/2</sub> 3.5 6)  $\gamma_{43}$  915.98 9 (t<sub>1/2</sub> 100 3)
- D 992.2 6, (4<sup>+</sup>)  $\gamma_{742}$  249.7 10 (t<sub>1/2</sub> 4.1 15)  $\gamma_{649}$  343.7 10 (t<sub>1/2</sub> 100 10)  $\gamma_{294}$  697.8 (t<sub>1/2</sub> 7 1 16)
- E 1001.93 10, (3<sup>-</sup>)  $\gamma_{43}$  959.11 (t<sub>1/2</sub> 100)
- F 1030.53 5, (3<sup>+</sup>), 1.32 15 ns  $\gamma_{142}$  888.80 5 (t<sub>1/2</sub> 34.3 5) E2  $\gamma_{43}$  987.76 6 (t<sub>1/2</sub> 100 2) E2
- E 1037.52 6, (4<sup>-</sup>)  $\gamma_{742}$  295.20 10 (t<sub>1/2</sub> 3.2 4)  $\gamma_{649}$  388.70 10 (t<sub>1/2</sub> 6.6 5)  $\gamma_{142}$  895.80 10 (t<sub>1/2</sub> 100 5)
- B 1041.8 4, (12<sup>+</sup>)  $\gamma_{748}$  294.00 20 (t<sub>1/2</sub> 100)
- F 1076.22 9, (4<sup>+</sup>)  $\gamma_{142}$  934.50 10 (t<sub>1/2</sub> 100 12)  $\gamma_{43}$  1033.50 20 (t<sub>1/2</sub> 40 4)
- G 1089.45 10, 0<sup>+</sup>  $\gamma_{43}$  1046.62 10 (t<sub>1/2</sub> 100)
- E 1115.53 6, (5<sup>-</sup>)  $\gamma_{649}$  466.70 10 (t<sub>1/2</sub> 4.5 4)  $\gamma_{294}$  821.20 10 (t<sub>1/2</sub> 4.5 4)  $\gamma_{142}$  973.90 10 (t<sub>1/2</sub> 100 5)
- G 1131.95 10, (2<sup>+</sup>)  $\gamma_{142}$  989.20 10 (t<sub>1/2</sub> 100 7)  $\gamma_{43}$  1088.30 20 (t<sub>1/2</sub> 39 4)  $\gamma_0$  1131.00 20 (t<sub>1/2</sub> 75 6)
- H 1136.97 13, (2<sup>+</sup>)  $\gamma_{43}$  1094.20 20 (t<sub>1/2</sub> 100 15)  $\gamma_0$  1137.0 4 (t<sub>1/2</sub> 67 10)
- E 1161.53 7, (6<sup>-</sup>)  $\gamma_{742}$  419.20 10 (t<sub>1/2</sub> 9.8 8)  $\gamma_{294}$  867.20 10 (t<sub>1/2</sub> 100 6)
- H 1177.50 10, (3<sup>+</sup>)  $\gamma_{1038}$  139.90 10  $\gamma_{1002}$  175.40 10(?)  $\gamma_{142}$  1036.13  $\gamma_{43}$  1135.13 1180.4, (2<sup>+</sup>) 1199 2
- 1223.00 20, (2<sup>+</sup>)  $\gamma_{43}$  1180.20 20 (t<sub>1/2</sub> 100 8)  $\gamma_0$  1223.00 20 (t<sub>1/2</sub> 80 12)
- H 1232.46 10, (4<sup>+</sup>)  $\gamma_{294}$  938.20 10 (t<sub>1/2</sub> 100 17)  $\gamma_{142}$  1090.50 20 (t<sub>1/2</sub> 44 9)  $\gamma_{43}$  1190.0 10 (t<sub>1/2</sub> 7 4)
- I 1240.8 3, (2<sup>-</sup>)  $\gamma_{43}$  1198.0 3 (t<sub>1/2</sub> 100)
- 1262.0 3, (3<sup>+</sup>)  $\gamma_{142}$  1120.3 4 (t<sub>1/2</sub> 31 3)  $\gamma_{43}$  1219.2 3 (t<sub>1/2</sub> 100 6)
- I 1282 2, (3<sup>-</sup>)
- J 1308.74 5, (5<sup>-</sup>), 165 10 ns  $\gamma_{1162}$  147.20 10 (t<sub>1/2</sub> 4.0 3) (M1+E2)  $\gamma_{1116}$  193.30 10 (t<sub>1/2</sub> 22.1 11) (M1+E2)  $\gamma_{1038}$  271.30 10 (t<sub>1/2</sub> 22.5 11) (M1+E2)  $\gamma_{1002}$  306.80 10 (t<sub>1/2</sub> 1.6 2) (M1+E2)  $\gamma_{742}$  566.34 6 (t<sub>1/2</sub> 100 5) (M1+E2)  $\gamma_{294}$  1014.40 10 (t<sub>1/2</sub> 0.83 22)  $\gamma_{142}$  1167.10 10 (t<sub>1/2</sub> 17.8 11)
- 1321.10 10(?)  $\gamma_0$  1321.10 10(?) (t<sub>1/2</sub> 100)
- 1337.0 3, (3,4)  $\gamma_{142}$  1195.5 4 (t<sub>1/2</sub> 100 20)  $\gamma_{43}$  1294.0 3 (t<sub>1/2</sub> 35 4)
- B 1375.6 6, (14<sup>+</sup>)  $\gamma_{1042}$  333.8 4 (t<sub>1/2</sub> 100) 1379 4 1407 3
- K 1410.75 15, 0(-)  $\gamma_{597}$  813.41 10 (t<sub>1/2</sub> 100) 1413.0, (1<sup>-</sup>)
- K 1438.45 8, 2(-)  $\gamma_{649}$  789.59 10 (t<sub>1/2</sub> 100 17)  $\gamma_{597}$  841.11 10 (t<sub>1/2</sub> 83 9)  $\gamma_0$  1438.5 (t<sub>1/2</sub> <0.6)
- 1488.17 7, (1<sup>-</sup>)  $\gamma_{43}$  1445.30 10 (t<sub>1/2</sub> 100 3)  $\gamma_0$  1488.20 10 (t<sub>1/2</sub> 53 3)

- L 1525.86 8, (0<sup>+</sup>)  $\gamma_{597}$  928.55 10 (t<sub>1/2</sub> 100 13)  $\gamma_{43}$  1483.00 10 (t<sub>1/2</sub> 18 3) 1539.67 6, (1<sup>-</sup>)  $\gamma_{659}$  580.70 20 (t<sub>1/2</sub> 0.53 15)  $\gamma_{649}$  890.60 20 (t<sub>1/2</sub> 1.3 2)  $\gamma_{597}$  942.39 10 (t<sub>1/2</sub> 7.2 7)  $\gamma_{43}$  1496.90 10 (t<sub>1/2</sub> 100 2)  $\gamma_0$  1539.62 9 (t<sub>1/2</sub> 63.2 15)
- L 1558.87 5, (2<sup>+</sup>)  $\gamma_{649}$  910.10 10 (t<sub>1/2</sub> 100 14)  $\gamma_{597}$  961.62 10 (t<sub>1/2</sub> 93 5)  $\gamma_{142}$  1417.20 10 (t<sub>1/2</sub> 16 3)  $\gamma_{43}$  1515.90 10 (t<sub>1/2</sub> 11 4)  $\gamma_0$  1558.80 10 (t<sub>1/2</sub> 4.3 14) 1574 1580
- 1607.72 15, (1<sup>-</sup>)  $\gamma_{1089}$  518.2 3 (t<sub>1/2</sub> 11 4)  $\gamma_{649}$  959.0 2 (t<sub>1/2</sub> 13 4)  $\gamma_0$  1607.60 20 (t<sub>1/2</sub> 100 9)
- 1626.77 15, (1<sup>-</sup>)  $\gamma_{43}$  1584.10 20 (t<sub>1/2</sub> 100 12)  $\gamma_0$  1626.60 20 (t<sub>1/2</sub> 29 6)
- 1633.37 8, (1<sup>-</sup>)  $\gamma_{1137}$  496.7 3 (t<sub>1/2</sub> 6.5 13)  $\gamma_{597}$  1036.5 3 (t<sub>1/2</sub> 1.9 13)  $\gamma_{43}$  1590.50 10 (t<sub>1/2</sub> 63 3)  $\gamma_0$  1633.33 10 (t<sub>1/2</sub> 100 3)
- 1641 5 1675 2
- 1710.43 8, (2<sup>+</sup>)  $\gamma_{1137}$  573.40 20 (t<sub>1/2</sub> 28 7)  $\gamma_{649}$  1061.60 20 (t<sub>1/2</sub> 100 24)  $\gamma_{597}$  1113.20 20 (t<sub>1/2</sub> 62 10)  $\gamma_{142}$  1568.60 20 (t<sub>1/2</sub> 21 3)  $\gamma_{43}$  1667.60 10 (t<sub>1/2</sub> 66 10)  $\gamma_0$  1711.0 10 (t<sub>1/2</sub> 7 4) 1752 3
- 1775.30 20, (1<sup>-</sup>)  $\gamma_{43}$  1732.40 20 (t<sub>1/2</sub> 67 34)  $\gamma_0$  1775.30 20 (t<sub>1/2</sub> 100 33) 1784 3
- 1796.34 15, (1<sup>-</sup>)  $\gamma_{1321}$  475.0 3 (t<sub>1/2</sub> 100 27)  $\gamma_{1223}$  573.40 20 (t<sub>1/2</sub> 73 18)  $\gamma_{659}$  837.60 20 (t<sub>1/2</sub> 73 27)  $\gamma_0$  1796.2 3 (t<sub>1/2</sub> 27 9)
- 1808.00 20, (1<sup>-</sup>, 2<sup>+</sup>)  $\gamma_{649}$  1159.20 20 (t<sub>1/2</sub> 40 13)  $\gamma_{597}$  1210.5 5 (t<sub>1/2</sub> 100 30)  $\gamma_{43}$  1765.20 20 (t<sub>1/2</sub> 47 7)  $\gamma_0$  1807.9 4 (t<sub>1/2</sub> 13 7) 1861 3 1902 3
- 1917.8 3, (1<sup>-</sup>)  $\gamma_{43}$  1874.9 3 (t<sub>1/2</sub> 100 8)  $\gamma_0$  1918.0 10 (t<sub>1/2</sub> 7 3)
- 1954.50 10, (2<sup>+</sup>)  $\gamma_{649}$  1305.80 20 (t<sub>1/2</sub> 100 26)  $\gamma_{597}$  1357.20 20 (t<sub>1/2</sub> 57 13)  $\gamma_{142}$  1812.80 10 (t<sub>1/2</sub> 22 9)  $\gamma_{43}$  1911.4 3 (t<sub>1/2</sub> 61 4)
- 1996.40 20, (1<sup>-</sup>, 2<sup>+</sup>)  $\gamma_{597}$  1398.5 5 (t<sub>1/2</sub> 100 40)  $\gamma_{43}$  1953.60 20 (t<sub>1/2</sub> 46 10)  $\gamma_0$  1996.7 4 (t<sub>1/2</sub> 20 8)
- 2117.60 20  $\gamma_{43}$  2074.80 20(?) (t<sub>1/2</sub> 100 16)  $\gamma_0$  2117.5 10 (t<sub>1/2</sub> 23 13) 2127.4, (1<sup>-</sup>)
- A =2800, (0<sup>+</sup>), 3.7 3 ns, %SF>0  $\gamma_0$  JT(?)
- A 2820.1, (2<sup>+</sup>)  $\gamma_{2800}$  20.1
- A 2866.8, (4<sup>+</sup>)  $\gamma_{2820}$  46.7 (E2)
- A 2939.9, (6<sup>+</sup>)  $\gamma_{2867}$  73.1 (E2)
- A 3039.2, (8<sup>+</sup>)  $\gamma_{2940}$  99.3 (E2)
- A 3165(?), (10<sup>+</sup>)  $\gamma_{3039}$  =126(?)

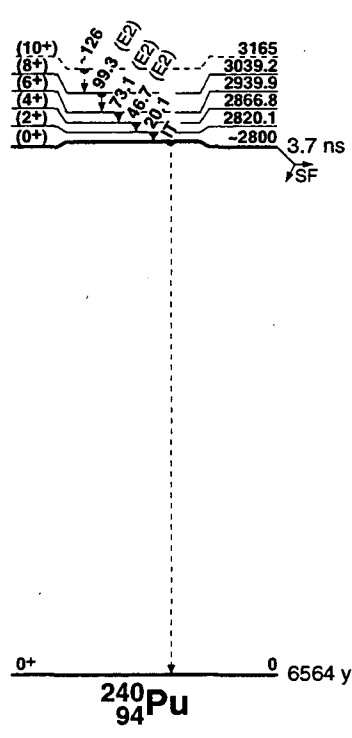

# 241Pu 94

$\Delta$ : 52950.220  $S_n$ : 5241.6019  $S_p$ : 6659.15  $Q_\beta$ : 20.8120  $Q_\alpha$ : 5140.15  
 $\sigma_f$ : 1011.6 b,  $\sigma_{abs}$ : 1017.3 b,  $\sigma_\gamma$ : 358.5 b

### Nuclear Bands

- A 5/2[622]
- B 1/2[631]
- C 7/2[624]
- D 7/2[743]
- E 1/2[620]
- F 1/2[501]?
- G Band Structure

### Levels and $\gamma$ -ray branchings:

- A 0, 5/2<sup>+</sup>, 14.35 10 y,  $\mu = -0.683$  15,  $Q = +5.6$  20,  $\% \beta^- = 99.998$ ,  $\% \alpha = 2.45 \times 10^{-3}$  2,  $\% SF < 2.4 \times 10^{-14}$
- A 41.95 3, 7/2<sup>+</sup>  $\gamma_0$  41.95 3 (M1+E2)
- A 95.69 7, 9/2<sup>+</sup>  $\gamma_{42}$  53.74 6 (M1+E2)
- A 161.05 10, (11/2<sup>+</sup>)  $\gamma_{96}$  65.36 6
- B 161.6 1, 1/2<sup>+</sup>, 0.88 5  $\mu s$   $\gamma_0$  161.6 1
- B 170.9 8, (3/2<sup>+</sup>)
- C 174.94 4, 7/2<sup>+</sup>  $\gamma_{96}$  79.25 6 ( $t_{\gamma}$  1.58 9)  $\gamma_{42}$  132.99 3 ( $t_{\gamma}$  29.2 15)  $\gamma_0$  174.94 4 ( $t_{\gamma}$  100)
- B 223.1 20, (5/2<sup>+</sup>)
- C 231.76 8, 9/2<sup>+</sup>  $\gamma_{175}$  56.81 6 ( $t_{\gamma}$  18.7 10) (M1+E2);  $\delta = 0.59$  8  $\gamma_{96}$  136.06 6 ( $t_{\gamma}$  58 4)  $\gamma_{42}$  189.82 6 ( $t_{\gamma}$  100 7)
- A 235 4, (13/2<sup>+</sup>)
- B 242.7, (7/2<sup>+</sup>)
- C 300.93 8, (11/2<sup>+</sup>)  $\gamma_{232}$  69.17 6 ( $t_{\gamma}$  100 43) (M1+E2)  $\gamma_{161}$  139.81 6 ( $t_{\gamma}$  86 29)
- B 335 2, 9/2<sup>+</sup>
- 337, (1/2, 3/2)
- C 368 4, (13/2<sup>+</sup>)
- $\approx 376$ , (1/2, 3/2)
- $\approx 384$
- 404.4 2, (5/2<sup>+</sup>, 7/2)  $\gamma_{96}$  308.8 2 ( $t_{\gamma}$  37 11)  $\gamma_{42}$  362.4 1 ( $t_{\gamma}$  100 11)  $\gamma_0 = 405$  (?)
- D 444 3, (11/2<sup>-</sup>)
- 473
- 495 10
- B 499 3, (13/2<sup>+</sup>)
- G 518.7 2, (5/2<sup>-</sup>)  $\gamma_{42}$  476.6 2 ( $t_{\gamma}$  100 10)  $\gamma_0$  518.8 1 ( $t_{\gamma} = 400$ )
- G 561.0 3, (7/2<sup>-</sup>)  $\gamma_{42}$  518.8 1 ( $t_{\gamma} = 50$ )  $\gamma_0$  561.1 2 ( $t_{\gamma}$  100 40)
- D 569 3, (15/2<sup>-</sup>)
- 620 10
- 645 9
- 681, (1/2, 3/2)
- E 755.2 10, (1/2<sup>+</sup>)  $\gamma_{171}$  584.3 ( $t_{\gamma}$  5.6)  $\gamma_{162}$  593.6 ( $t_{\gamma}$  100)
- E 769.7 7, (3/2<sup>+</sup>)  $\gamma_{171}$  598.7 ( $t_{\gamma}$  39)  $\gamma_{162}$  608.1 ( $t_{\gamma}$  100)
- 770 3
- 777 4
- 784.4 7, (1/2<sup>+</sup>, 3/2)  $\gamma_{171}$  613.0 ( $t_{\gamma}$  40)  $\gamma_{162}$  622.5 ( $t_{\gamma}$  60)  $\gamma_0$  784.4 ( $t_{\gamma}$  100)
- 797 4, (1/2, 3/2)
- 800 2
- E 800.5, (5/2<sup>+</sup>)
- 808 3
- 834.6 2, 3/2, 5/2<sup>+</sup>  $\gamma_0$  834.6 2
- 841.8 9, 1/2<sup>+</sup>, 3/2  $\gamma_{171}$  671.3 ( $t_{\gamma}$  62.5)  $\gamma_{161}$  680.6 ( $t_{\gamma}$  62.5)  $\gamma_0$  841.0 ( $t_{\gamma}$  100)
- 844 3
- 850.3 10, 1/2, 3/2  $\gamma_{171}$  678.9 ( $t_{\gamma}$  40)  $\gamma_{162}$  688.7 ( $t_{\gamma}$  100)
- 864 3
- 875 (?)
- E 897 4, (9/2<sup>+</sup>)
- 918 3
- 929.7 2, (7/2<sup>+</sup>)  $\gamma_{96}$  834.6 2 (?)  $\gamma_0$  929.7 2
- 936 3
- 942.4 10, 1/2, 3/2  $\gamma_{171}$  772.0 ( $t_{\gamma}$  30)  $\gamma_{161}$  781.3 ( $t_{\gamma}$  100)
- 948 5
- F 965.2 8, (1/2<sup>-</sup>)  $\gamma_{171}$  794.2 ( $t_{\gamma}$  100)  $\gamma_{162}$  803.3 ( $t_{\gamma}$  86)
- 967 3
- 994.4 10, 1/2, 3/2, 5/2<sup>+</sup>
- 995 3
- F 1009 2, (3/2<sup>-</sup> and 5/2<sup>-</sup>)
- 1016 3
- 1049, 1/2, 3/2
- 1063 3
- 1075 3
- 1090.5 8, (1/2, 3/2)
- 1091 3
- 1121 3
- 1173
- 1180 3

- 1196
- 1209 4
- 1219 4
- 1224.1, 1/2, 3/2, 5/2<sup>+</sup>
- 1242 4
- 1253.9, 1/2, 3/2, 5/2<sup>+</sup>
- 1258 4
- 1269.1, 1/2, 3/2, 5/2<sup>+</sup>
- 1277 4
- 1288 4
- 1297.0, 1/2, 3/2, 5/2<sup>+</sup>
- 1299 4
- 1309 4
- 1344 4
- 1356 4
- 1357.8, 1/2, 3/2, 5/2<sup>+</sup>
- 1381 4
- 1399 3
- 1441 5
- 1452 5
- 1474 3
- 1489 5
- 1546 5
- 1594 5
- 1759 3
- 1801 4
- 1826 4
- 1868 5, (15/2<sup>-</sup>)
- 1944 5
- 1991 4
- $\approx 2045$  (?)
- 2199, 1/2, 3/2
- $\approx 2200$ , 21.3  $\mu s$ ,  $\% SF = 100$   $\gamma_0 IT$  (?)
- $\approx 2300$ , 32.5 ns,  $\% SF = 100$   $\gamma_0 IT$  (?)

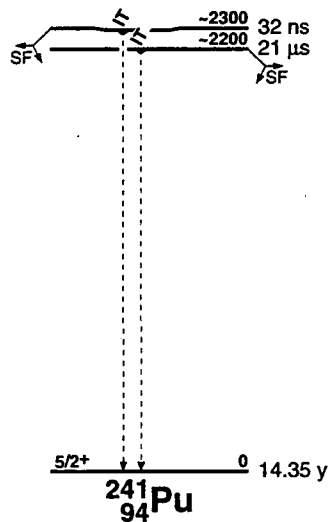

**<sup>242</sup>Pu**  
**<sub>94</sub>Pu**

$\Delta$ : 54712.1 20  $S_n$ : 6309.4 7  $S_p$ : 6830 70  $Q_\alpha$ : 4982.7 12  
 $\sigma_T$ : 18.5 5 b,  $\sigma_f$ : <0.2 b

**Nuclear Bands**

- A GS band
- B Octupole band
- C  $\gamma$  band?
- D Band Structure
- E Band Structure

**Levels and  $\gamma$ -ray branchings:**

- A 0, 0<sup>+</sup>, 3.733×10<sup>5</sup> 12 y, % $\alpha$ =100, %SF=5.50×10<sup>-4</sup> 6
- A 44.54 2, 2<sup>+</sup>, 158 6 ps  $\gamma_0$  44.54 2 (†,100) E2
- A 147.3 2, 4<sup>+</sup>  $\gamma_{45}$  102.8 2 (†,100) E2
- A 306.4 2, 6<sup>+</sup>  $\gamma_{147}$  159.0 1 (†,100) E2
- A 518.1 3, 8<sup>+</sup>  $\gamma_{306}$  211.7 4 (†,100) E2
- A 778.7 6, 10<sup>+</sup>  $\gamma_{518}$  260.5 6 (†,100) E2
- B 780.46 4, (1<sup>-</sup>)  $\gamma_{45}$  735.93 7 (†,100)  $\gamma_0$  780.44 5 (†,53)
- B 832.3 2, 3<sup>-</sup>  $\gamma_{147}$  685.0 1  $\gamma_{45}$  787.8 10
- B 927, (5<sup>-</sup>)
- E 956, (0<sup>+</sup>)
- E 992.5 2, (2<sup>+</sup>)  $\gamma_{45}$  948.0 2 (†,100)
- D 1019.4, 3<sup>-</sup>  $\gamma_{45}$  974.9 (†,100)
- 1039.2 3, (1<sup>+</sup>, 2<sup>+</sup>)  $\gamma_0$  1039.2 3 (?)
- D 1064.0, (4<sup>-</sup>)  $\gamma_{147}$  915.7 (†,100)
- A 1084.0 12, 12<sup>+</sup>  $\gamma_{779}$  305.8 8 (†,100)
- 1092.1 2, (6<sup>+</sup>)  $\gamma_{306}$  785.7 1 (†,100)  $\gamma_{147}$  944.8 1 (†,63)
- C 1102 4, (2<sup>+</sup>)
- D 1122, (5<sup>-</sup>)
- 1150.1, (2<sup>-</sup>)  $\gamma_{45}$  1105.6 (†,100)
- 1154.6 2, (3<sup>-</sup>)  $\gamma_{147}$  1007.3 2 (†,45)  $\gamma_{45}$  1110.0 2 (†,100)
- 1181.6 2, (2<sup>-</sup>)  $\gamma_{147}$  1034.2 2 (†,22)  $\gamma_{45}$  1137.1 1 (†,100)  $\gamma_0$  1181.6 2 (†,12)
- 1357.2 2 (?)  $\gamma_{1084}$  265.1 1 (†,100)
- 1401.0 1 (?), (0, 1<sup>+</sup>)  $\gamma_{780}$  620.6 1 (†,100)
- 1427.96 25, (2<sup>-</sup>)  $\gamma_{780}$  647.4 3 (†,100)  $\gamma_{45}$  1383.6 4 (†,22)
- A 1431.3, 14<sup>+</sup>  $\gamma_{1084}$  347.3 10 (†,100)
- 1517.65 7, (1<sup>-</sup>)  $\gamma_{45}$  1473.1 1 (†,100)  $\gamma_0$  1517.6 1 (†,53)
- 1744.9
- A 1816.3 20, 16<sup>+</sup>  $\gamma_{1431}$  385.0 11 (†,100)
- 1825.0 11, (4<sup>+</sup>, 5<sup>+</sup>)  $\gamma_{306}$  1518.6 (†,100)
- 1871.4 3  $\gamma_{832}$  1039.2 3 (†,96)  $\gamma_{45}$  1826.9 3 (†,100)
- 1874.1 1  $\gamma_{780}$  1093.5 1 (†,100)  $\gamma_0$  1874.5 3 (†,22)
- 1903.6 2  $\gamma_{780}$  1123.1 2 (†,45)  $\gamma_{45}$  1859.2 3 (†,100)
- 1949.8 2, (1, 2<sup>+</sup>)  $\gamma_{45}$  1905.1 2 (†,37)  $\gamma_0$  1949.9 2 (†,100)
- 1969.9 2, (1, 2<sup>+</sup>)  $\gamma_{45}$  1925.4 2 (†,43)  $\gamma_0$  1969.9 2 (†,100)
- 2091.2  $\gamma_{1150}$  941.1 (?)
- ≈2200, 3.5 6 ns, %SF>0  $\gamma_0$  IT(?)
- 2200+y, 28 ns, %SF>0  $\gamma_0$  IT(?)
- A 2235.6 23, 18<sup>+</sup>  $\gamma_{1816}$  419.3 12 (†,100)
- 2246.0 4, (1, 2<sup>+</sup>)  $\gamma_{45}$  2201.6 5 (†,100)  $\gamma_0$  2246.0 5 (†,75)
- 2331.3 1, (2<sup>+</sup>)  $\gamma_{1518}$  813.6 1 (†,100)  $\gamma_{780}$  1550.9 1 (†,28)
- 2437.5
- A 2686 3, 20<sup>+</sup>  $\gamma_{2236}$  450.2 13 (†,100) E2
- A 3163 3, 22<sup>+</sup>  $\gamma_{2686}$  477.2 14 (†,100) E2
- A 3662 4, 24<sup>+</sup>  $\gamma_{3163}$  499.2 15 (†,100) E2
- A 4172 4, 26<sup>+</sup>  $\gamma_{3662}$  510.0 15 (†,100) E2

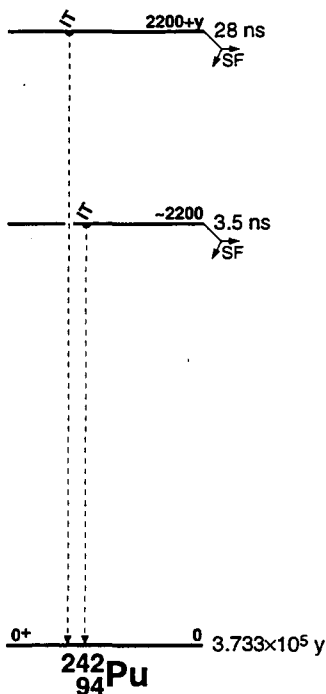

**<sup>243</sup>Pu  
<sub>94</sub>**

$\Delta$ : 57749.3  $S_n$ : 5034.3  $S_p$ : 6950.200  $Q_\beta$ : 582.3  $Q_\alpha$ : 4754.3

$\alpha_T$ : 87.10 b

**Nuclear Bands**

- A 7/2[624]
- B 5/2[622]
- C 1/2[631]
- D 9/2[734]
- E 1/2[620]
- F 7/2[613]
- G Band Structure
- H 1/2[761]
- I 3/2[622]
- J 1/2[501]
- K 3/2[631]

**Levels and  $\gamma$ -ray branchings:**

- A 0, 7/2<sup>+</sup>, 4.956 s h, % $\beta$ =100
- A 58.1 4, 9/2<sup>+</sup>
- A 124.6 10, 11/2<sup>+</sup>
- A 204.4 15, (13/2<sup>+</sup>)
- B 287.4 3, 5/2<sup>+</sup>  $\gamma_{58}$  229.3 2 ( $t_{1/2}$  1.8 4)  $\gamma_0$  287.4 3 ( $t_{1/2}$  100 14) M1
- B 333.2 4, 7/2<sup>+</sup>  $\gamma_{58}$  275.1 2 ( $t_{1/2}$  100 19)  $\gamma_0$  333.0 10 ( $t_{1/2}$  64 28)
- C 383.6 4, (1/2<sup>+</sup>), 0.33 s  $\mu$ s  $\gamma_{287}$  96.2 2
- B  $\approx$ 388 (?), (9/2<sup>+</sup>)
- C 392.0 5, (3/2<sup>+</sup>)
- D 402.6 3, 9/2<sup>+</sup>  $\gamma_{125}$  278.0 8 ( $t_{1/2}$  4.7 10)  $\gamma_{58}$  344.5 5 ( $t_{1/2}$   $\approx$ 1.8)  $\gamma_0$  402.6 3 ( $t_{1/2}$  100 9)
- E1
- C 446.8 4, (5/2<sup>+</sup>)
- C 450.1 15, (7/2<sup>+</sup>)
- D 454.6, 11/2<sup>-</sup>
- B 466.7 15, (11/2<sup>+</sup>)
- B 536.6 15, (13/2<sup>+</sup>)
- C 564.5 15, (9/2<sup>+</sup>)
- D 595.3 15, (15/2<sup>-</sup>)
- E 625.6 4, (1/2<sup>+</sup>)  $\gamma_{392}$  233.9 6 ( $t_{1/2}$  5.0 16)  $\gamma_{384}$  242.0 2 ( $t_{1/2}$  100 19)
- F 626 2, (9/2<sup>+</sup>)
- E 653.8 4, (3/2<sup>+</sup>)  $\gamma_{392}$  261.7 3
- E 677.2 5, (5/2<sup>+</sup>)  $\gamma_{392}$  284.4 3 (?) ( $t_{1/2}$  100 40)  $\gamma_{333}$  343.9 (?)
- G 703.9 4, (3/2<sup>-</sup>)  $\gamma_{287}$  416.5 2
- 734.1 20
- E 741.8 15, (7/2<sup>+</sup>)
- H 790.7 4, (3/2<sup>-</sup>)  $\gamma_{447}$  343.9 2 ( $t_{1/2}$  <158)  $\gamma_{384}$  407.1 3 ( $t_{1/2}$  100 12)
- 809.5 3, (1/2<sup>+</sup>, 3/2<sup>-</sup>)  $\gamma_{384}$  426.0 6 ( $t_{1/2}$  <29)  $\gamma_{287}$  522.1 3 ( $t_{1/2}$  <100)
- I 813.8 2, 3/2<sup>+</sup>  $\gamma_{654}$  159.2 13 ( $t_{1/2}$  27 11)  $\gamma_{333}$  480.6 3 ( $t_{1/2}$  31 4)  $\gamma_{287}$  526.2 3
- ( $t_{1/2}$  100 11)  $\gamma_0$  813.8 2 ( $t_{1/2}$  96 10)
- H 834.4 15, (7/2<sup>-</sup>)
- I 845.4 4, (5/2<sup>+</sup>)  $\gamma_{287}$  558.0 3 ( $t_{1/2}$  100 11)  $\gamma_{58}$  787.5 8 ( $t_{1/2}$  34 17)  $\gamma_0$  844.3 8 (?)
- ( $t_{1/2}$  <26)
- H 873.7 10, (1/2<sup>-</sup>)  $\gamma_{654}$  219.9 3 (?)
- 884 3
- I 895.6 15, (7/2<sup>+</sup>)
- J 905.7 5, (1/2<sup>-</sup>)  $\gamma_{392}$  513.6 3 ( $t_{1/2}$  100 12)  $\gamma_{384}$  522.1 3 ( $t_{1/2}$  <34)
- H 920.6 15, (11/2<sup>-</sup>)
- J 948.0 4, (3/2<sup>-</sup>)  $\gamma_{447}$  501.2 3 ( $t_{1/2}$  59 7)  $\gamma_{392}$  555.7 5 ( $t_{1/2}$  51 17)  $\gamma_{384}$  564.7 4
- ( $t_{1/2}$  100 11)
- I 954 2, (9/2<sup>+</sup>)
- K 981.0 4, (5/2<sup>+</sup>)  $\gamma_{447}$  533.9 4 ( $t_{1/2}$  80 16)  $\gamma_{392}$  589.1 3 ( $t_{1/2}$  100 12)  $\gamma_{333}$  648.8 8 (?)
- ( $t_{1/2}$  <48)  $\gamma_{287}$  693.5 7 ( $t_{1/2}$  32 12)
- 1044 2
- K 1080 2, (9/2<sup>+</sup>)
- 1114 3
- 1130.1 4, (1/2<sup>+</sup>, 3/2<sup>-</sup>)  $\gamma_{704}$  426.0 6 ( $t_{1/2}$  <38)  $\gamma_{447}$  683.4 4 ( $t_{1/2}$  <53)  $\gamma_{392}$  738.2 3
- ( $t_{1/2}$  79 9)  $\gamma_{384}$  746.4 3 ( $t_{1/2}$  100 11)
- 1145 3
- 1176.5 3, 3/2<sup>+</sup>, 5/2<sup>+</sup>  $\gamma_{781}$  385.7 3 ( $t_{1/2}$  13.5 23)  $\gamma_{626.0}$  551.7 5 (?) ( $t_{1/2}$  6.7 18)
- $\gamma_{447}$  730.1 7 ( $t_{1/2}$  5.4 18)  $\gamma_{333}$  844.3 8 (?) ( $t_{1/2}$  <9.9)  $\gamma_{287}$  889.1 6 ( $t_{1/2}$  100 14)
- $\gamma_0$  1176.5 5 ( $t_{1/2}$  52 11)
- 1197 3
- 1213 2  $\gamma_{333}$  879.8 10 (?) ( $t_{1/2}$  75 35)  $\gamma_{287}$  925.3 10 (?) ( $t_{1/2}$  100 50)
- 1233 3
- 1243 3
- 1265 3
- 1286 3
- 1299 2
- 1301.6 5, 1/2, 3/2  $\gamma_{654}$  648.8 8 (?) ( $t_{1/2}$  <37)  $\gamma_{625.6}$  676.0 3 ( $t_{1/2}$  100 10)  $\gamma_{384}$  918.0 10

- ( $t_{1/2}$  43 16)
- 1324 2
- 1354 2
- 1359 3
- 1367.8 6, 1/2, 3/2  $\gamma_{704}$  663.9 6 ( $t_{1/2}$  100 16)  $\gamma_{654}$  714.7 11 (?) ( $t_{1/2}$  31 16)
- $\gamma_{392}$  976.0 12 ( $t_{1/2}$  84 42)
- 1387.4 4, 3/2<sup>+</sup>  $\gamma_{948}$  439.4 3 ( $t_{1/2}$  93 14)  $\gamma_{704}$  683.4 4 ( $t_{1/2}$  <107)  $\gamma_{333}$  1053.8 10
- ( $t_{1/2}$  100 38)
- 1403 3
- 1420.5 6, (3/2<sup>+</sup>)  $\gamma_{704}$  716.9 5 (?) ( $t_{1/2}$  61 13)  $\gamma_{392}$  1028.4 10 (?) ( $t_{1/2}$   $\approx$ 39)
- $\gamma_{333}$  1087.1 8 (?) ( $t_{1/2}$  100 52)
- 1434.7 4, 1/2(\*), 3/2  $\gamma_{810}$  625.2 2 ( $t_{1/2}$  100 11)  $\gamma_{781}$  644.2 4 ( $t_{1/2}$  38 9)  $\gamma_{677}$  757.5 4
- ( $t_{1/2}$  44 8)  $\gamma_{654}$  781.1 12 (?) ( $t_{1/2}$  25 17)  $\gamma_{392}$  1042.1 5 ( $t_{1/2}$  73 11)
- 1444 3
- 1465 3
- 1491.0 10, 1/2, 3/2
- 1516.6 10, 3/2  $\gamma_{677}$  838.7 5 (?)
- 1700 300, 45 15 ns, %SF=100  $\gamma_0$  IT (?)

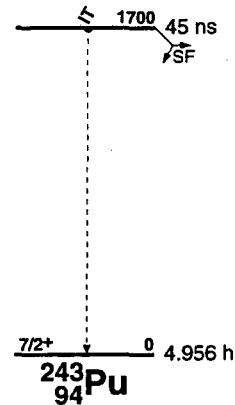

**<sup>244</sup>Pu**  
**<sub>94</sub>**

$\Delta$ : 59799.5  $S_n$ : 6021.4  $S_p$ : 7409.10  $Q_\alpha$ : 4665.510  
 $\sigma_\gamma$ : 1.71 b

**Nuclear Bands**

A GS band

**Levels and  $\gamma$ -ray branchings:**

- A 0, 0<sup>+</sup>, 8.08x10<sup>7</sup> 10 y, %SF=0.1236, % $\alpha$ =99.8776
- A 46.2, 2<sup>+</sup>, 155.2 ps  $\gamma_0$  46.1
- A 153.2, 4<sup>+</sup>  $\gamma_{46}$  106.2
- A 315.4 10, 6<sup>+</sup>  $\gamma_{153}$  162.44
- A 531.8 10, 8<sup>+</sup>  $\gamma_{315}$  216.44
- 708.4, (2<sup>+</sup>, 3<sup>-</sup>)
- A 798.3 10, 10<sup>+</sup>  $\gamma_{532}$  266.56
- 957.2, (3<sup>-</sup>)
- 1015.2, (2<sup>+</sup>)
- 1068.4
- 1108.2, (3<sup>-</sup>)
- A 1110.7 10, 12<sup>+</sup>  $\gamma_{798}$  312.48
- 1194.3, (5<sup>-</sup>)
- 1210.3
- 1353.4
- 1378.3
- 1434.3
- A 1464.4 10, 14<sup>+</sup>  $\gamma_{1111}$  353.710
- 1613.3, (3<sup>-</sup>)
- 1783.3
- 1805.3
- 1847.3
- A 1855.4 20, 16<sup>+</sup>  $\gamma_{1464}$  391.011
- 1896.3
- x(?), 400 100 ps, %SF $\leq$ 100  $\gamma_0$  IT(?)
- A 2279.2 20, 18<sup>+</sup>  $\gamma_{1855}$  423.812
- A 2730.7 20, 20<sup>+</sup>  $\gamma_{2279}$  451.514
- A 3202.7 30(?), 22<sup>+</sup>  $\gamma_{2731}$  472.025
- A 3674.7 30(?), 24<sup>+</sup>  $\gamma_{3203}$  472.025
- A 4132.4 30(?), (26<sup>+</sup>)  $\gamma_{3675}$  457.714

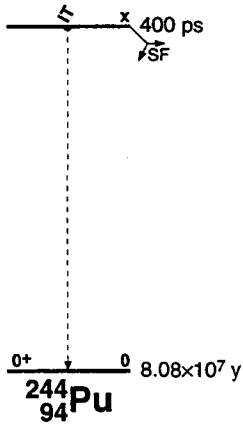

**<sup>245</sup>Pu**  
**<sub>94</sub>**

$\Delta$ : 63097.14  $S_n$ : 4773.13  $Q_\beta$ : 1205.15  
 $\sigma_\gamma$ : 150.30 b

**Nuclear Bands**

A 9/2[734]

B 1/2[620]

C 7/2[613]

D 3/2[622]

E 1/2[761]

**Levels:**

- A 0, (9/2<sup>-</sup>), 10.51 h, % $\beta^-$ =100
- A 217, (15/2<sup>-</sup>)
- 246.4
- B 306.3, (1/2<sup>+</sup>)
- C 325.2, (9/2<sup>+</sup>)
- B 355.3, (5/2<sup>+</sup>)
- B 423.5, (7/2<sup>+</sup>)
- B 459.5, (9/2<sup>+</sup>)
- D 575.4, (3/2<sup>+</sup>)
- D 613.4, (5/2<sup>+</sup>)
- E 637.4, (3/2<sup>-</sup>)
- D 660.3, (7/2<sup>+</sup>)
- E 675.3, (7/2<sup>-</sup>)
- D 723.3, (9/2<sup>+</sup>)
- 738.3
- 758.4
- 802.2
- 1071.3
- 1128.3
- 1279.3
- 1389.4
- 2000 400, 90.30 ns, %SF $\leq$ 100  $\gamma_0$  IT(?)

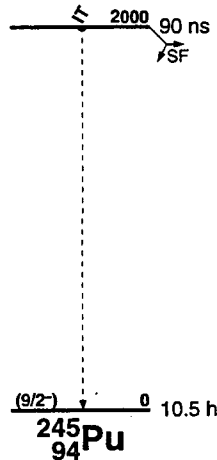

**<sup>237</sup><sub>95</sub>Am**

$\Delta$ : (46820)  $S_n$ : (7430)  
 $Q_{EC}$ : (1730)  $Q_\alpha$ : (6250)

Levels:  
 0, 5/2<sup>-</sup>, 73.0 m, % $\alpha$ =0.0253, %EC=99.9753  
 ≈2400, 5.2 ns, %SF=100  $\gamma_0IT(?)$

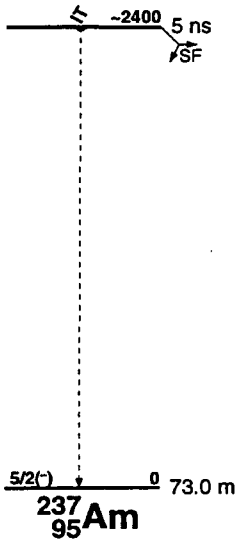

**<sup>238</sup><sub>95</sub>Am**

$S_p$ : (3370)  $\Delta$ : 48420.50  $S_n$ : (6470)  $S_p$ : 3960.50  
 $Q_{EC}$ : 2260.50  $Q_\alpha$ : 6040.50

Levels:  
 0, 1<sup>+</sup>, 98.2 m, % $\alpha$ =1.0×10<sup>-4</sup>, %EC+% $\beta^+$ >99.99  
 ≈2500, 35.10  $\mu$ s, %SF≤100  $\gamma_0IT(?)$

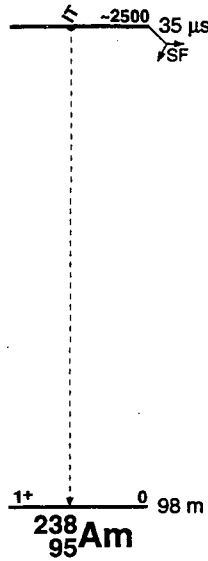

**<sup>239</sup><sub>95</sub>Am**

$\Delta$ : 49386.3  $S_n$ : 7100.50  $S_p$ : 4061.320  
 $Q_{EC}$ : 802.920  $Q_\alpha$ : 5923.718

Nuclear Bands  
 A 5/2[523]  
 B 5/2[642]  
 C 3/2[521]

Levels and  $\gamma$ -ray branchings:

- A 0, (5/2)<sup>-</sup>, 11.91 h, %EC=99.9901, % $\alpha$ =0.0101
- A 40.77, (7/2<sup>-</sup>)
- A 94.6, (9/2<sup>-</sup>)
- A 156.7, (11/2<sup>-</sup>)
- B 187.15, (5/2<sup>+</sup>)  $\gamma_{41}$  146.45 (†, 20.6) (E1)  $\gamma_0$  187.15 (†, 100.25) (E1)
- B 220.6, (7/2<sup>+</sup>)
- B 260.6, (9/2<sup>+</sup>)
- B 317.7, (11/2<sup>+</sup>)
- B ≈370, (13/2<sup>+</sup>)
- C 557.6, (3/2<sup>-</sup>)
- C 586.6, (5/2<sup>-</sup>)
- 2500.200, (7/2<sup>+</sup>), 163.12 ns, %SF≤100,  $\mu$ =(+)-2.5918  $\gamma_0IT(?)$

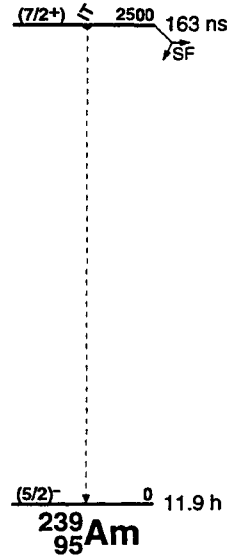

## 240 95Am

$\Delta$ : 51499 14  $S_n$ : 5957 14  $S_p$ : 4372 14

$Q_{EC}$ : 1379 14  $Q_\alpha$ : 5690 50

### Nuclear Bands

- A  $\pi 5/2[523]+v1/2[631]$
- B  $\pi 5/2[523]-v1/2[631]$
- C  $\pi 5/2[523]-v5/2[622]$
- D  $\pi 5/2[523]+v5/2[622]$
- E  $\pi 5/2[523]+v1/2[501]$
- F  $\pi 5/2[523]-v1/2[501]$

### Levels:

- A 0, (3<sup>-</sup>), 50.8 s h, %EC=100, % $\alpha$ =1.9 $\times 10^{-4}$
- A 41, (4<sup>-</sup>)
- B 53, (2<sup>-</sup>)
- B 87, (3<sup>-</sup>)
- A 96, (5<sup>-</sup>)
- B 130, (4<sup>-</sup>)
- A 158, (6<sup>-</sup>)
- B 186, (5<sup>-</sup>)
- 213
- A 233, (7<sup>-</sup>)
- B 252, (6<sup>-</sup>)
- 281

- A 316, (8<sup>-</sup>)
- B 329, (7<sup>-</sup>)
- C 346, (1<sup>-</sup>)
- C 398, (3<sup>-</sup>)
- D 398, (5<sup>-</sup>)
- C 423, (2<sup>-</sup>)
- D 458, (6<sup>-</sup>)
- 474
- C 498, (4<sup>-</sup>)
- C 498, (5<sup>-</sup>)
- D 534, (7<sup>-</sup>)
- 551
- C 616, (6<sup>-</sup>)
- C 640, (7<sup>-</sup>)
- 660
- 757
- 777
- 809
- 819
- 845
- 856
- 877
- 898
- 917
- 932

- 956
- E 973, (3<sup>-</sup>)
- 997
- F 1016, (2<sup>-</sup>)
- E 1016, (4<sup>-</sup>)
- F 1052, (3<sup>-</sup>)
- 1066
- 1079
- 1194
- 1218
- 1235
- 1248
- 1305
- 1318
- 1335
- 1349
- 1372
- 1386
- 1407
- 1437
- 1495
- 1515
- 1545
- 3000<sup>200</sup>, 0.94 s ms, %SF $\leq$ 100  $\gamma_0 IT(?)$

## 241 95Am

$\Delta$ : 52929.4 20  $S_n$ : 6641 14  $S_p$ : 4480.13  $Q_\alpha$ : 5637.81 12

$\sigma_T$ (to 0): 533 13 b,  $\sigma_T$ (to 48.6): 54 5 b

### Nuclear Bands

- A 5/2[523]
- B 5/2[642]
- C 3/2[521]
- D 1/2[400]
- E 1/2[530]
- F 3/2[651]

### Levels and $\gamma$ -ray branchings:

- A 0, 5/2<sup>-</sup>, 432.2 5 y, %SF=3.77 $\times 10^{-10}$  s, % $\alpha$ =100,  $\mu$ =+1.59 13,  $Q$ =+4.9
- A 41.176 3, 7/2<sup>-</sup>  $\gamma_{41}$  41.176 3 (t<sub>y</sub> 100) M1+E2:  $\delta$ =0.48 5
- A 93.65 10, 9/2<sup>-</sup>
- A 158.0 15, 11/2<sup>-</sup>
- B 205.883 10, 5/2<sup>+</sup>  $\gamma_{41}$  164.82 (t<sub>y</sub> 16 3)  $\gamma_0$  205.879 13 (t<sub>y</sub> 100 6) E1
- A 234.0 13, (13/2<sup>-</sup>)
- B 235 1, (7/2<sup>-</sup>)  $\gamma_{41}$  195 1 (t<sub>y</sub> 100)
- 239 2(?)
- B 272 2, (9/2<sup>-</sup>)
- 273 2(?)
- B 320 2, (11/2<sup>-</sup>)
- B 380 1, (13/2<sup>-</sup>)
- 459 (?)
- C 471.810 9, 3/2<sup>-</sup>  $\gamma_{206}$  265.922 12 (t<sub>y</sub> 0.56 6) (E1)  $\gamma_{41}$  430.634 20 (t<sub>y</sub> 5.7 3) E2
- $\gamma_0$  471.805 20 (t<sub>y</sub> 100 5) M1+E2
- 495 2
- C 504.448 9, 5/2<sup>-</sup>  $\gamma_{472}$  32.639 3 (t<sub>y</sub> 17 3) M1+E2:  $\delta$ =0.125 10  $\gamma_{206}$  298.57 5
- (t<sub>y</sub> 6.4 17)  $\gamma_{94}$  410.8 1 (t<sub>y</sub> 7.0 7)  $\gamma_{41}$  463.273 20 (t<sub>y</sub> 100 7) M1+E2  $\gamma_0$  504.45 3
- (t<sub>y</sub> 48 4) (M1+E2)
- 543 (?)
- C 549 1, 7/2<sup>-</sup>
- D 623.10 4, (1/2<sup>+</sup>)  $\gamma_{472}$  151.44 (t<sub>y</sub>  $\approx$  3)  $\gamma_{206}$  417.24 4 (t<sub>y</sub> 100 7) (E2)  $\gamma_0$  623.13
- (t<sub>y</sub> 1.8 5)
- E 636.861 10, 3/2<sup>-</sup>  $\gamma_{504}$  132.413 7 (t<sub>y</sub> 100 6) M1+E2:  $\delta$ =0.060 20  $\gamma_{472}$  165.049 8
- (t<sub>y</sub> 77 6) M1+E2:  $\delta$ =0.22 3  $\gamma_{206}$  430 1 (t<sub>y</sub>  $\approx$  1.0)  $\gamma_{41}$  595.8 3 (t<sub>y</sub> 0.38 8)
- $\gamma_0$  636.88 3 (t<sub>y</sub> 40 3) M1+E2:  $\delta$ =0.57 20
- E 652.089 10, (1/2<sup>-</sup>)  $\gamma_{637}$  15.228 2 (t<sub>y</sub> 11.5 7) M1+E2:  $\delta$ =0.032 7  $\gamma_{623}$  29.02 5
- (t<sub>y</sub> 6.3 13)  $\gamma_{504}$  147.67 3 (t<sub>y</sub> 4.2 17)  $\gamma_{472}$  180.277 8 (t<sub>y</sub> 100 9) M1(+E2)
- $\gamma_0$  652.1 4 (t<sub>y</sub> 8.3 21)
- D 653.23 4, (3/2<sup>+</sup>)  $\gamma_{206}$  447.35 4 (t<sub>y</sub> 80 10) (M1+E2):  $\delta$ =0.36<sup>+50</sup><sub>-36</sub>  $\gamma_0$  653.22
- (t<sub>y</sub> 100 7)
- F 670.24 8, (3/2<sup>+</sup>)  $\gamma_{206}$  464.36 8 (t<sub>y</sub> 15 3) (M1+E2):  $\delta$ =1.5<sup>+20</sup><sub>-7</sub>  $\gamma_0$  670.22 (t<sub>y</sub> 100 7)
- C 682 3, (11/2<sup>-</sup>)
- 732 4 1106 4
- 822 4 1132 5
- 884 4 1136 3
- 952 1, 5/2<sup>-</sup> 1163 3
- 982 2 1227 3
- 1020 4 1550 4, (5/2<sup>-</sup>)
- 1064 4  $\approx$ 2200, 1.0 3  $\mu$ s, %SF=100  $\gamma_0 IT(?)$

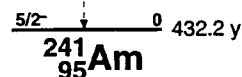
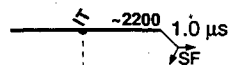
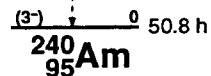
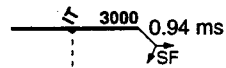



**242Am**  
**95**

$\Delta$ : 55463.1 20  $S_n$ : 5537.57 10  $S_p$ : 4776.03 22

$Q_\beta$ : 664.8 7  $Q_{EC}$ : 751.0 7  $Q_\alpha$ : 5588.33 25

$\sigma_f$ (to 0): 2100 200 b,  $\sigma_f$ (to 48.6): 2000 600 b

**Nuclear Bands**

- A  $\pi 5/2[523]-\nu 5/2[622]$
- B  $\pi 5/2[523]+\nu 5/2[622]$
- C  $\pi 5/2[523]+\nu 1/2[631]$
- D  $\pi 5/2[523]-\nu 1/2[631]$
- E  $\pi 5/2[523]+\nu 1/2[501]$
- F  $\pi 5/2[523]-\nu 1/2[501]$

**Levels and  $\gamma$ -ray branchings:**

- A 0, 1<sup>-</sup>, 16.02 2 h,  $\mu=+0.382$  2,  $Q=-2.76$ ,  
% $\beta^-$ =82.7 3, %EC=17.3 3
- A 44.1 (?), (0<sup>-</sup>)  $\gamma_0$  44.1 (?)
- B 48.63 5, 5<sup>-</sup>, 141 2 y, % $\alpha$ =0.459 12, %IT=99.541 12,  
%SF=1.5 $\times 10^{-8}$  6  $\gamma_0$  48.63 5 E4
- A 52.9, (3<sup>-</sup>)  $\gamma_0$  52.9 (?)
- A 75.8, (2<sup>-</sup>)  $\gamma_0$  75.8 (?)
- 99
- B 114, (6<sup>-</sup>)
- A 148, (5<sup>-</sup>)
- A 149.9, (4<sup>-</sup>)  $\gamma_{53}$  96.9 (?)
- 171
- B 190, (7<sup>-</sup>)
- 197.6, (3<sup>-</sup>)
- 230.5, (1<sup>+</sup>)  $\gamma_{76}$  154.7 (?)  $\gamma_{44}$  186.4 (?)
- C 244.1 3, (3<sup>-</sup>)
- A 263, (6<sup>-</sup>)
- A 263, (7<sup>-</sup>)
- 270.1 3, (2<sup>+</sup>)
- 283.3 3, (3<sup>+</sup>)
- C 288.4, (4<sup>-</sup>)
- D 291.8, (2<sup>-</sup>)
- D 306.9 4, (3<sup>-</sup>)
- D 326.0 6, (3<sup>-</sup>)
- C 341.4 29, (5<sup>-</sup>)
- 363.5 3, (2<sup>+</sup>)
- D 370.2 3, (4<sup>-</sup>)
- 377.0, (2<sup>+</sup>)
- 400.2 4, (3<sup>+</sup>)
- C 410.0 12, (6<sup>-</sup>)
- 417.9 3, (2<sup>+</sup>)
- D 428.7 4, (5<sup>-</sup>)
- 463.7, (3<sup>+</sup>)
- C 488, (7<sup>-</sup>)
- D 500, (6<sup>-</sup>)
- D 581, (7<sup>-</sup>)
- 608
- 626
- 658
- D 679, (8<sup>-</sup>)
- 697
- D 792 (?), (9<sup>-</sup>)
- 821
- 833
- 846
- 873, (2<sup>-</sup>)
- 899, (3<sup>-</sup>)
- 915
- 936
- 951
- E 975, (3<sup>+</sup>)
- 995
- F 1011, (2<sup>+</sup>)
- E 1031, (4<sup>+</sup>)
- F 1051, (3<sup>+</sup>)
- E 1065, (5<sup>+</sup>)
- 1077
- 1088
- F 1098, (4<sup>+</sup>)
- 1118
- 1140
- 1151
- 1162
- 1167
- 1171
- 1187

- 1192
- 1199
- 1210
- 1230
- 1243
- 1263
- 1290
- 1300
- 1310
- 1325
- 1343
- 1362
- 1380
- 1406
- 1417
- 1443
- 1455
- 1467
- 1482
- 1507
- 1519
- 1562
- 2200 80, 14.0 10 ms, %SF $\leq$ 100  $\gamma_0$  2200 80 (?)

**243Am**  
**95**

$\Delta$ : 57167.4 22  $S_n$ : 6367.0 11  $S_p$ : 4833.6 12

$Q_\alpha$ : 5438.1 9

$\sigma_f$ : 75.1 18 b,  $\sigma_f$ : 0.198 4 b,  $\sigma_f$ (to 0): 3.8 4 b

**Nuclear Bands**

- A 5/2[523]
- B 5/2[642]
- C 3/2[521]
- D 7/2[633]

**Levels and  $\gamma$ -ray branchings:**

- A 0, 5/2<sup>-</sup>, 7370 40 y,  $\mu=1.53$  3,  $Q=+4.30$  3, % $\alpha$ =100,  
%SF=3.7 $\times 10^{-9}$  2
- A 42.2 3, 7/2<sup>-</sup>, = 40 ps  $\gamma_0$  42.2 5 M1+E2:  $\delta=0.29$
- B 84.0 2, 5/2<sup>+</sup>, 2.34 7 ns,  $\mu=+2.74$  14,  $Q=4.20$  3  
 $\gamma_{42}$  41.8 2 ( $t_{1/2}$  3.3 3)  $\gamma_0$  84.0 2 ( $t_{1/2}$  100) E1
- A 96.4 4, 9/2<sup>-</sup>  $\gamma_{42}$  54 1 ( $t_{1/2}$  <100)  $\gamma_0$  96.4 4 ( $t_{1/2}$  60 10)  
(E2)
- B 109.2 2, 7/2<sup>+</sup>  $\gamma_{42}$  67 1 ( $t_{1/2}$  100 50)  $\gamma_0$  109.2 2  
( $t_{1/2}$  70 7)
- B 143.5 5, (9/2<sup>+</sup>)  $\gamma_{109}$  = 34  $\gamma_{42}$  101.3
- A 162.3 10, 11/2<sup>-</sup>
- B 189.3 7, (11/2<sup>+</sup>)
- A 238 1, 13/2<sup>-</sup>
- B 244 2, (13/2<sup>+</sup>)
- C 266 2, (3/2<sup>-</sup>)  $\gamma_0$  265 10 (M1+E2)
- C 300 2, (5/2<sup>-</sup>)
- C 345 1, (7/2<sup>-</sup>)
- 383 2
- 407.1 5 (?)  $\gamma_0$  407.1 5 (?)
- 423 5
- 445 3
- D 465.7 3, 7/2<sup>+</sup>  $\gamma_{144}$  322.2 3 ( $t_{1/2}$  5.0 5)  $\gamma_{109}$  356.4 3  
( $t_{1/2}$  24 2) (M1+E2):  $\delta=0.44$   $\gamma_{84}$  381.7 3 ( $t_{1/2}$  100 9)  
M1  $\gamma_{42}$  423.2 (?)  $\gamma_0$  465.7 5 ( $t_{1/2}$  <0.04)
- C 466 5, (11/2<sup>-</sup>)
- D 532.5 4, (9/2<sup>+</sup>)  $\gamma_{189}$  343.2 5 ( $t_{1/2}$  = 11)  $\gamma_{144}$  388.9 3  
( $t_{1/2}$  38 6)  $\gamma_{109}$  423.2 3 ( $t_{1/2}$  100 12)  $\gamma_{84}$  448.7 5  
( $t_{1/2}$  = 1.9)
- 586 5
- D 704 2, (13/2<sup>+</sup>)
- 724 4
- 933 4
- 977 3
- 1053 3
- 1123 3
- 1174 3
- 1222 3
- 2300 200, 5.5 5  $\mu$ s, %SF $\leq$ 100  $\gamma_0$  IT (?)

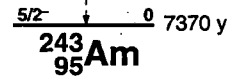
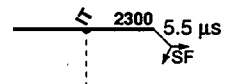
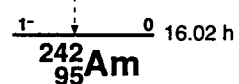
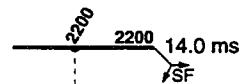

244  
95Am

$\Delta$ : 59875.022  $S_n$ : 5363.79  $S_p$ : 5163.3  $Q_{\beta^-}$ : 1428.19  $Q_{EC}$ : 76.5  $Q_{\alpha}$ : 5130.15  
 $\sigma$ (to 0): 2300.300 b,  $\sigma$ (to 70): 1600.300 b

Nuclear Bands

- A  $\pi$ 5/2[523] $^+$ -v7/2[624]
- B  $\pi$ 5/2[642] $^-$ -v7/2[624]
- C  $\pi$ 5/2[523] $^-$ -v7/2[624]
- D  $\pi$ 3/2[521] $^-$ -v7/2[624]
- E  $\pi$ 5/2[523] $^-$ -v5/2[622]
- F  $\pi$ 1/2[400] $^-$ -v7/2[624]
- G  $\pi$ 7/2[633] $^-$ -v7/2[624]
- H  $\pi$ 5/2[642] $^-$ -v1/2[631] $^?$
- I  $\pi$ 5/2[523] $^-$ -v9/2[734]
- J  $\pi$ 5/2[523] $^+$ -v1/2[631]
- K  $\pi$ 5/2[523] $^-$ -v1/2[631]
- L  $\pi$ 5/2[642] $^-$ -v9/2[734]
- M  $\pi$ 3/2[651] $^-$ -v7/2[624]
- N  $\pi$ 3/2[521] $^-$ -v5/2[622]

Levels and  $\gamma$ -ray branchings:

- A 0, (6 $^-$ ), 10.11 h,  $\% \beta^- = 100$
- B 88.030, 1 $^+$ , = 26 m,  $\% \beta^- = 99.9639$  13,  $\% EC = 0.0361$  13
- B 100.3092 11, (2) $^+$
- B 123.2811 11, (3) $^+$   $\gamma_{100}$  22.975 10 ( $\dagger$ , 100.20) M1  $\gamma_{88}$  35.313 ( $\dagger$ , 0.102) E2
- B 148.2831 16, (4) $^+$   $\gamma_{123}$  25.034 20 ( $\dagger$ , 100) M1
- C 175.6573 10, (1) $^-$   $\gamma_{100}$  75.3475 13 ( $\dagger$ , 67.10) E1+M2:  $\delta = 0.0256$   $\gamma_{88}$  87.6553 15 ( $\dagger$ , 100.17) E1+M2:  $\delta = 0.0206$
- B 183.511 5, (5) $^+$   $\gamma_{148}$  35.233 ( $\dagger$ , 100) M1
- C 197.2947 11, (2) $^-$   $\gamma_{176}$  21.636 10 ( $\dagger$ , 49.10) M1  $\gamma_{123}$  74.01447 ( $\dagger$ , 100.14) E1(+M2):  $\delta = 0.05220$   $\gamma_{100}$  96.9851 10 ( $\dagger$ , 63.10) E1
- C 228.2990 12, (3) $^-$   $\gamma_{197}$  31.001 ( $\dagger$ , 30.6) M1  $\gamma_{176}$  52.641 ( $\dagger$ , 2.96) E2  $\gamma_{148}$  80.0156 11 ( $\dagger$ , 41.2) E1(+M2):  $\delta = 0.12325$   $\gamma_{123}$  105.0116 ( $\dagger$ , 3.34)  $\gamma_{100}$  127.9891 24 ( $\dagger$ , 100.8) E1(+M2):  $\delta = 0.125$
- D 261.6962 11, (2) $^-$   $\gamma_{228}$  33.396 10 ( $\dagger$ , 8.516) M1  $\gamma_{197}$  64.4013 20 ( $\dagger$ , 60.9) M1+E2:  $\delta = 0.01510$   $\gamma_{176}$  86.0376 10 ( $\dagger$ , 100.14) M1+E2:  $\delta = 0.32$   $\gamma_{123}$  138.4157 17 ( $\dagger$ , 22.4)  $\gamma_{100}$  161.3914 ( $\dagger$ , 6.416)  $\gamma_{88}$  173.6984 ( $\dagger$ , 68.11)
- C 272.2018 17, (4) $^-$   $\gamma_{228}$  43.904 10 ( $\dagger$ , 77.15) M1  $\gamma_{197}$  74.918 10 ( $\dagger$ , 29.5) E2  $\gamma_{123}$  148.9208 19 ( $\dagger$ , 100.20) E1
- E 289.2119 12, (1) $^-$   $\gamma_{197}$  91.9252 13 ( $\dagger$ , 55.10) M1  $\gamma_{176}$  113.5625 12 ( $\dagger$ , 100.17) M1+E2:  $\delta = 0.32$   $\gamma_{100}$  188.9105 ( $\dagger$ , 35.5) E1  $\gamma_{88}$  201.2194 ( $\dagger$ , 20.4) E1
- D 296.6583 26, (3) $^-$   $\gamma_{262}$  34.975 15 ( $\dagger$ , 100) E2
- C 322.7506 24, (5) $^-$   $\gamma_{272}$  50.550 10 ( $\dagger$ , 54.12) M1  $\gamma_{228}$  94.4544 ( $\dagger$ , 31.7)  $\gamma_{148}$  174.4665 ( $\dagger$ , 100.17)
- E 335.575 4, (0) $^-$   $\gamma_{289}$  46.375 20 ( $\dagger$ , 100) M1
- E 342.6498 13, (3) $^-$   $\gamma_{289}$  53.431 ( $\dagger$ , 14.3) E2  $\gamma_{272}$  70.4522 24 ( $\dagger$ , 8.936) M1  $\gamma_{262}$  81.3663 10 ( $\dagger$ , 29.5) M1  $\gamma_{228}$  114.3510 17 ( $\dagger$ , 100.15) M1  $\gamma_{197}$  145.3564 ( $\dagger$ , 26.4) M1  $\gamma_{148}$  194.3638 ( $\dagger$ , 28.7)  $\gamma_{123}$  219.365 13 ( $\dagger$ , 25.10)
- D 343.658 3, (4) $^-$   $\gamma_{228}$  115.3624 ( $\dagger$ , 70.14) M1  $\gamma_{123}$  220.3805 ( $\dagger$ , 100.20) E1
- F 348.4047 16, (3) $^+$   $\gamma_{148}$  200.1173 ( $\dagger$ , 17.4) M1+E2:  $\delta = 1.13$   $\gamma_{123}$  225.1205 ( $\dagger$ , 60.11) M1+E2:  $\delta = 0.7620$   $\gamma_{100}$  248.0975 ( $\dagger$ , 100.17) M1+E2:  $\delta = 0.6622$   $\gamma_{88}$  260.394 ( $\dagger$ , 2.07)
- E 361.8376 20, (2) $^-$   $\gamma_{289}$  72.6184 12 ( $\dagger$ , 100) M1 367.6 10(?)
- G 377.0566 22, (0) $^+$   $\gamma_{176}$  201.393 9 ( $\dagger$ , 11.4)  $\gamma_{88}$  289.0570 22 ( $\dagger$ , 100.25) M1
- F 390.028 7, (4) $^+$   $\gamma_{348}$  41.632 ( $\dagger$ , 24.12) M1  $\gamma_{184}$  206.559 20 ( $\dagger$ , 100.25)  $\gamma_{148}$  241.721 13 ( $\dagger$ , 30.10) (M1)  $\gamma_{123}$  266.7324 ( $\dagger$ , 91.14) (M1)
- D 398.743 4, (5) $^-$   $\gamma_{272}$  126.5415 ( $\dagger$ , 43.13)  $\gamma_{148}$  250.435 ( $\dagger$ , 100.25)
- G 414.6889 14, (2) $^+$   $\gamma_{148}$  266.373 ( $\dagger$ , 1.55)  $\gamma_{123}$  291.4059 19 ( $\dagger$ , 73.18) M1  $\gamma_{100}$  314.3823 ( $\dagger$ , 100.17) M1  $\gamma_{88}$  326.6902 22 ( $\dagger$ , 37.7) M1
- H 418.957 2, (2) $^+$   $\gamma_{297}$  122.2993 ( $\dagger$ , 22.4) E1  $\gamma_{100}$  318.6478 24 ( $\dagger$ , 100.20) M1  $\gamma_{88}$  330.9556 23 ( $\dagger$ , 84.14) M1
- I 420.1309 14, (2) $^+$   $\gamma_{262}$  158.4352 10 ( $\dagger$ , 7.10) E1  $\gamma_{228}$  191.8294 ( $\dagger$ , 1.02)  $\gamma_{197}$  222.8343 ( $\dagger$ , 28.5) E1  $\gamma_{176}$  244.4713 ( $\dagger$ , 100.20) E1(+M2):  $\delta = 0.103$   $\gamma_{123}$  296.8483 ( $\dagger$ , 29.5) M1  $\gamma_{100}$  319.8213 ( $\dagger$ , 5.819) M1+E2:  $\delta = 1.55$   $\gamma_{88}$  332.1343 ( $\dagger$ , 5.19) M1
- J 421.2035 16, (3) $^-$   $\gamma_{348}$  72.79927 ( $\dagger$ , 100.17) E1(+M2):  $\delta = 0.042$   $\gamma_{262}$  159.506 10 ( $\dagger$ , 6.513)  $\gamma_{228}$  192.9074 ( $\dagger$ , 5.411)  $\gamma_{123}$  297.9206 ( $\dagger$ , 5.316)  $\gamma_{100}$  320.8874 ( $\dagger$ , 6.522) 431.03
- E 435.036 3, (4) $^-$   $\gamma_{323}$  112.2853 ( $\dagger$ , 80.19) M1  $\gamma_{272}$  162.8196 ( $\dagger$ , <130)  $\gamma_{228}$  206.718 18 ( $\dagger$ , 100.19)  $\gamma_{184}$  251.509 13 ( $\dagger$ , 54.12)  $\gamma_{148}$  286.743 ( $\dagger$ , <54)
- E 437.310 3, (5) $^-$   $\gamma_{343}$  94.6665 ( $\dagger$ , 54.13)  $\gamma_{323}$  114.5573 ( $\dagger$ , 100.17)  $\gamma_{272}$  165.1106 ( $\dagger$ , 61.15)
- I 444.381 3, (3) $^+$   $\gamma_{228}$  216.0875 ( $\dagger$ , 80.16)  $\gamma_{148}$  296.1035 ( $\dagger$ , 100.18) M1

- $\gamma_{123}$  321.0989 ( $\dagger$ , 23.6)  $\gamma_{100}$  344.0549 ( $\dagger$ , 86.40) M1
- G 454.002 3, (1) $^+$   $\gamma_{420}$  33.888 10 ( $\dagger$ , 6.812) M1  $\gamma_{100}$  353.6934 ( $\dagger$ , 54.10) M1  $\gamma_{88}$  365.9998 24 ( $\dagger$ , 100.17) M1
- H 456.8632 23, (4) $^+$   $\gamma_{148}$  308.5818 21 ( $\dagger$ , 100.15) M1  $\gamma_{123}$  333.5853 ( $\dagger$ , 33.6) M1
- J 466.263 5, (4) $^-$   $\gamma_{421}$  45.074 10 ( $\dagger$ , 100.30) M1  $\gamma_{297}$  169.5977 ( $\dagger$ , <80) M1  $\gamma_{272}$  194.079 13 ( $\dagger$ , 24.6)
- 478.0960 18, (2) $^-$   $\gamma_{419}$  59.139 10 ( $\dagger$ , 8.2) M1  $\gamma_{123}$  354.8132 24 ( $\dagger$ , 80.20) M1  $\gamma_{100}$  377.7903 ( $\dagger$ , 100.20) M1  $\gamma_{88}$  390.1003 ( $\dagger$ , 24.5)
- I 478.3491 26, (4) $^+$   $\gamma_{272}$  206.147 10 ( $\dagger$ , 37.8)  $\gamma_{228}$  250.0444 ( $\dagger$ , 100.20)  $\gamma_{148}$  330.0677 ( $\dagger$ , 17.4)  $\gamma_{123}$  355.0684 ( $\dagger$ , 90.20) M1  $\gamma_{100}$  378.0517 ( $\dagger$ , <33)
- K 484.7911 20, (2) $^-$   $\gamma_{348}$  136.3836 15 ( $\dagger$ , 100.16) E1  $\gamma_{197}$  287.5004 19 ( $\dagger$ , 85.15) M1  $\gamma_{176}$  309.1387 ( $\dagger$ , 4.08)
- G 495.394 3, (4) $^+$   $\gamma_{184}$  311.899 11 ( $\dagger$ , 11.3)  $\gamma_{148}$  347.1103 ( $\dagger$ , 92.23) M1  $\gamma_{123}$  372.1133 ( $\dagger$ , 100.20) M1
- G 514.1423 22, (3) $^+$   $\gamma_{148}$  365.859 3 ( $\dagger$ , 100.24) M1  $\gamma_{123}$  390.8584 ( $\dagger$ , 64.13) M1  $\gamma_{100}$  413.8364 ( $\dagger$ , 24.8) (M1)
- I 516.267 8, (5) $^-$   $\gamma_{323}$  193.5226 ( $\dagger$ , 100.20)  $\gamma_{272}$  244.115 ( $\dagger$ , <51)  $\gamma_{184}$  332.738 13 ( $\dagger$ , 49.12)  $\gamma_{148}$  367.934 ( $\dagger$ , 40.20)
- L 516.8230 13, (2) $^-$   $\gamma_{420}$  96.6925 19 ( $\dagger$ , 2.45)  $\gamma_{262}$  255.1276 ( $\dagger$ , 57.11) M1  $\gamma_{228}$  288.5229 19 ( $\dagger$ , 26.7) M1  $\gamma_{197}$  319.5279 21 ( $\dagger$ , 70.13) M1  $\gamma_{176}$  341.1649 22 ( $\dagger$ , 100.20) M1  $\gamma_{123}$  393.549 14 ( $\dagger$ , 0.84)  $\gamma_{100}$  416.5204 ( $\dagger$ , 5.012)  $\gamma_{88}$  428.8255 ( $\dagger$ , 14.3)
- K 524.2516 24, (3) $^-$   $\gamma_{348}$  175.840 8 ( $\dagger$ , 4.214)  $\gamma_{272}$  252.0523 ( $\dagger$ , 100.16) M1(+E2):  $\delta = 0.43$   $\gamma_{228}$  295.9533 ( $\dagger$ , 19.4)
- L 535.7558 17, (3) $^-$   $\gamma_{444}$  91.3695 ( $\dagger$ , 1.54) (E1)  $\gamma_{420}$  115.6262 20 ( $\dagger$ , 3.26)  $\gamma_{419}$  116.8017 ( $\dagger$ , 0.72)  $\gamma_{297}$  239.092 ( $\dagger$ , 3.68)  $\gamma_{272}$  263.5544 ( $\dagger$ , 50.10) M1  $\gamma_{262}$  274.0543 ( $\dagger$ , 3.59)  $\gamma_{228}$  307.4552 ( $\dagger$ , 100.15) M1  $\gamma_{197}$  338.4603 ( $\dagger$ , 59.10) M1  $\gamma_{100}$  435.4507 ( $\dagger$ , 13.4)
- L 561.5594 26, (4) $^-$   $\gamma_{444}$  117.1853 ( $\dagger$ , 8.016)  $\gamma_{399}$  162.8196 ( $\dagger$ , <11)  $\gamma_{423}$  238.784 12 ( $\dagger$ , 80.16) M1  $\gamma_{272}$  289.3540 22 ( $\dagger$ , 58.15) M1  $\gamma_{228}$  333.2566 ( $\dagger$ , 25.6) M1  $\gamma_{184}$  378.0517 ( $\dagger$ , <17)  $\gamma_{148}$  413.2824(?) ( $\dagger$ , 100.20) (M1)  $\gamma_{123}$  438.282 13 ( $\dagger$ , 15.4)
- K 578.842 6, (4) $^-$   $\gamma_{348}$  230.497 ( $\dagger$ , <20)  $\gamma_{343}$  236.2036 ( $\dagger$ , 100.20)  $\gamma_{323}$  256.064 ( $\dagger$ , <36)  $\gamma_{272}$  306.646 11 ( $\dagger$ , 30.14)  $\gamma_{123}$  455.5242 ( $\dagger$ , 86.22)
- 584.041 3, (2) $^-$   $\gamma_{485}$  99.2465 ( $\dagger$ , 3.211)  $\gamma_{362}$  222.2059 ( $\dagger$ , 9.321) M1  $\gamma_{289}$  294.8242 22 ( $\dagger$ , 100.25)  $\gamma_{197}$  386.7463 ( $\dagger$ , 39.9)  $\gamma_{176}$  408.3866 ( $\dagger$ , 30.6)  $\gamma_{123}$  460.7332 ( $\dagger$ , 9.321)  $\gamma_{100}$  483.708 12 ( $\dagger$ , 60.20)  $\gamma_{88}$  496.0296 ( $\dagger$ , 93.24) 608.43
- G 610.887 4, (5) $^+$   $\gamma_{344}$  267.230 6 ( $\dagger$ , 28.10)  $\gamma_{184}$  427.3719 ( $\dagger$ , 50.15) (M1)  $\gamma_{148}$  462.6046 ( $\dagger$ , 100.25) M1
- M 615.243 4, (2) $^+$   $\gamma_{524}$  90.9923(?) ( $\dagger$ , 3.28) M1  $\gamma_{100}$  514.9254 ( $\dagger$ , 39.13) M1  $\gamma_{88}$  527.2524 ( $\dagger$ , 100.25) M1
- 643.114 5, (3) $^+$   $\gamma_{419}$  224.213 ( $\dagger$ , 4.015)  $\gamma_{184}$  459.603 15 ( $\dagger$ , 12.3)  $\gamma_{148}$  494.870 15 ( $\dagger$ , 21.8)  $\gamma_{123}$  519.8317 ( $\dagger$ , 100.25) M1  $\gamma_{100}$  542.8097 ( $\dagger$ , 40.16) (M1)
- M 650.187 4, (3) $^+$   $\gamma_{485}$  165.422 16 ( $\dagger$ , 1.69)  $\gamma_{262}$  388.4816 ( $\dagger$ , 12.3)  $\gamma_{148}$  501.893 10 ( $\dagger$ , 14.6)  $\gamma_{123}$  526.9105 ( $\dagger$ , 100.25) M1  $\gamma_{100}$  549.8805 ( $\dagger$ , 61.20) M1
- 670.758 5, (2) $^+$   $\gamma_{457}$  213.9524 ( $\dagger$ , 6.718)  $\gamma_{420}$  250.6155 ( $\dagger$ , 51.8) M1  $\gamma_{415}$  256.064 ( $\dagger$ , <12)  $\gamma_{176}$  495.121 10 ( $\dagger$ , 29.9)  $\gamma_{100}$  570.4689 ( $\dagger$ , 100.30) (M1)  $\gamma_{88}$  582.743 14 ( $\dagger$ , 41.4)
- N 680.5726 23, (1) $^-$   $\gamma_{517}$  163.743 5 ( $\dagger$ , 26.6) M1  $\gamma_{420}$  260.394 ( $\dagger$ , <9.6)  $\gamma_{336}$  345.0006 ( $\dagger$ , <13)  $\gamma_{289}$  391.360 4 ( $\dagger$ , 33.8) M1  $\gamma_{197}$  483.276 5 ( $\dagger$ , 100.24) M1  $\gamma_{176}$  504.915 4 ( $\dagger$ , 100.25) M1
- M 696.825 6, (4) $^+$   $\gamma_{184}$  513.34 8 ( $\dagger$ , <42)  $\gamma_{148}$  548.560 9 ( $\dagger$ , 100.30) (M1)  $\gamma_{123}$  573.522 17 ( $\dagger$ , 80.28) (M1)
- N 699.7788 21, (2) $^-$   $\gamma_{536}$  164.0203 ( $\dagger$ , 14.3) M1(+E2):  $\delta = 1.1550$   $\gamma_{517}$  182.9604 ( $\dagger$ , 7.212)  $\gamma_{289}$  410.561 8 ( $\dagger$ , 28.7)  $\gamma_{228}$  471.482 6 ( $\dagger$ , 46.15) M1  $\gamma_{176}$  524.1204 ( $\dagger$ , 100.30) M1
- N 731.141 4, (3) $^-$   $\gamma_{562}$  169.5977 ( $\dagger$ , <17)  $\gamma_{444}$  286.743 ( $\dagger$ , <5.3)  $\gamma_{435}$  296.1035 ( $\dagger$ , 61.12) M1  $\gamma_{343}$  388.4816 ( $\dagger$ , 26.5)  $\gamma_{272}$  458.9335 ( $\dagger$ , 51.11) M1  $\gamma_{197}$  533.8556 ( $\dagger$ , 100.25) M1
- M 756.705 6, (5) $^-$   $\gamma_{611}$  145.8166 ( $\dagger$ , 20.5)  $\gamma_{184}$  573.187 18 ( $\dagger$ , 79.26) (M1)  $\gamma_{148}$  608.437 15 ( $\dagger$ , 100.30)
- 774.914 6, (1) $^+$   $\gamma_{336}$  439.3477 ( $\dagger$ , 5.416)  $\gamma_{262}$  513.34 8 ( $\dagger$ , <17)  $\gamma_{100}$  674.596 7 ( $\dagger$ , 78.23) (M1)  $\gamma_{88}$  686.9227 ( $\dagger$ , 100.25) M1
- N 779.914 5, (4) $^-$   $\gamma_{662}$  218.332 16 ( $\dagger$ , 32.8)  $\gamma_{536}$  244.115 ( $\dagger$ , <22)  $\gamma_{421}$  358.703 ( $\dagger$ , 11.6)  $\gamma_{380}$  389.873 5 ( $\dagger$ , 74.13)  $\gamma_{344}$  436.269 7 ( $\dagger$ , 70.18)  $\gamma_{272}$  507.731 7 ( $\dagger$ , 100.32) (M1)

**244Am** (Continued)

780.1524, (2)<sup>-</sup>  $\gamma_{514}$  266.02516 (†, <22) (M1)  $\gamma_{478.1}$  302.0696 (†, 12.4)  $\gamma_{454}$  326.16516 (†, 7.520)  $\gamma_{420}$  360.05312 (†, 6.520)  $\gamma_{419}$  361.1873 (†, 26.6) (M1)  $\gamma_{297}$  483.4925 (†, 100.30) M1  $\gamma_{100}$  679.866 (†, 41.14)  $\gamma_{88}$  692.187 (†, 38.17)

782.8755, (2)<sup>-</sup>  $\gamma_{579}$  204.0528 (†, 8.512)  $\gamma_{536}$  247.1075 (†, 100.25) (M1+E2):  $\delta=1.7535$   $\gamma_{524}$  258.703 (†, 36.12) M1  $\gamma_{517}$  266.02516 (†, <13) (M1)  $\gamma_{485}$  347.8366 (†, 9.3) (M1)  $\gamma_{343}$  440.23310 (†, 7.921)  $\gamma_{336}$  447.2858 (†, 6.721)  $\gamma_{228}$  554.523 (†, 12.4)  $\gamma_{123}$  659.62013(?) (†, 40.12) (M1)

795.0067, (4)<sup>-</sup>  $\gamma_{536}$  259.164 (†, 18.13)  $\gamma_{517}$  278.20516 (†, 30.10)  $\gamma_{399}$  396.2624 (†, 100.25) M1  $\gamma_{344}$  451.36011 (†, 19.7)  $\gamma_{323}$  472.27213 (†, 75.50)  $\gamma_{197}$  597.663 (†, 30.10)  $\gamma_{184}$  611.48910 (†, <92)

799.0065, (2)<sup>-</sup>  $\gamma_{454}$  345.0006 (†, <12.5)  $\gamma_{297}$  502.3587 (†, 79.24) M1  $\gamma_{289}$  509.77512 (†, 25.13) (M1)  $\gamma_{197}$  601.733 (†, 18.8)  $\gamma_{123}$  675.71619 (†, 100.33)

808.8004, (3)<sup>-</sup>  $\gamma_{650}$  158.6167 (†, 16.8)  $\gamma_{457}$  351.9425 (†, 57.9)  $\gamma_{435}$  373.7606 (†, 100.20) M1  $\gamma_{382}$  446.94417 (†, 23.7)  $\gamma_{348}$  460.3799 (†, 23.7)  $\gamma_{289}$  519.59313 (†, 67.22)  $\gamma_{263}$  547.163 (†, 17.8)  $\gamma_{197}$  611.48910 (†, <89)

825.5264, (2)<sup>-</sup>  $\gamma_{466}$  359.2653 (†, 43.13) (M1)  $\gamma_{421}$  404.3185 (†, 34.8) (M1)  $\gamma_{336}$  489.9525 (†, 77.18)  $\gamma_{297}$  528.903 (†, 46.18)  $\gamma_{262}$  563.884 (†, 100.33) M1  $\gamma_{123}$  702.185 (†, 46.18)

832.23

840.6486, (2)<sup>+</sup>  $\gamma_{457}$  383.7864 (†, 37.9)  $\gamma_{444}$  396.2624 (†, 100.25) M1  $\gamma_{197}$  643.435 (†, 67.28)  $\gamma_{176}$  665.105 (†, 28.12)  $\gamma_{100}$  740.413 (†, 100.33)  $\gamma_{88}$  752.666 (†, 51.20)

842.7544, (3)<sup>+</sup>  $\gamma_{584}$  258.703(?) (†, 70.23) M1  $\gamma_{457}$  385.8964 (†, 48.11) M1  $\gamma_{454}$  388.73512 (†, 11.6)  $\gamma_{444}$  398.37111 (†, 13.6)  $\gamma_{420}$  422.6183 (†, 100.17) M1  $\gamma_{419}$  423.8116 (†, 65.14) M1  $\gamma_{289}$  553.613(?) (†, 15.5)

859.1954, (3)<sup>+</sup>  $\gamma_{697}$  162.3745 (†, 6.815)  $\gamma_{643}$  216.0875 (†, 30.6)  $\gamma_{495}$  363.8013 (†, 100.33) (M1)  $\gamma_{478.3}$  380.83615 (†, 11.4)  $\gamma_{390}$  469.1458 (†, 22.5) (M1)  $\gamma_{362}$  497.353 (†, 7.525)  $\gamma_{123}$  735.933 (†, 27.9)  $\gamma_{100}$  758.895 (†, 36.12)

875.0595, (2)<sup>-</sup>  $\gamma_{783}$  92.1813 (†, 7.320)  $\gamma_{615}$  259.883 (†, 16.6)  $\gamma_{536}$  339.3198 (†, 5.320)  $\gamma_{420}$  454.87924 (†, 14.3)  $\gamma_{415}$  460.3799 (†, 19.5)  $\gamma_{176}$  699.444 (†, 33.12)  $\gamma_{148}$  726.79323 (†, 87.27)  $\gamma_{123}$  751.80420 (†, 100.33) (M1)  $\gamma_{100}$  774.755 (†, 87.29)

880.7864, (2)<sup>-</sup>  $\gamma_{779.9}$  100.8723 (†, 10.4) M1  $\gamma_{650}$  230.497 (†, <9.0)  $\gamma_{524}$  356.5366 (†, 75.13)  $\gamma_{421}$  459.60315 (†, 31.7)  $\gamma_{419}$  461.81915 (†, 44.14)  $\gamma_{263}$  619.094 (†, 100.30)  $\gamma_{197}$  683.49517 (†, 82.28)  $\gamma_{88}$  792.7513 (†, 27.11)

893.73  
901.43  
914.23  
933.24  
951.33  
999.63  
1015.89  
1030.53  
1046.15  
1052.43  
1063.25  
1071.314(?)  
1151.33  
2800 400, 0.90 15 ms, %SF≤100  $\gamma_0IT(?)$   
2800+x, = 6.5 μs, %SF≤100  $\gamma_0IT(?)$

C 395.872, 9/2<sup>+</sup>  $\gamma_{88}$  308.222(?)  $\gamma_{47}$  348.7829 (†, 30.5)  $\gamma_{19}$  376.6763 (†, 100) (M1)  $\gamma_0$  395.8720 (†, 3.1)

C 475.523, 11/2<sup>+</sup>  $\gamma_{135}$  341.0020 (†, 19.4)  $\gamma_{88}$  387.884 (†, 55.14)  $\gamma_{47}$  428.43822 (†, 100)

C 563.13, (13/2<sup>+</sup>)  $\gamma_{135}$  428.438(?)  $\gamma_{88}$  475.16

D 887.4710, (7/2<sup>+</sup>)  $\gamma_{476}$  411.935 (†, 9.113)  $\gamma_{396}$  491.5919 (†, 50.8) (E2)  $\gamma_{327}$  560.135 (†, 100) (E2)  $\gamma_{125}$  762.7320 (†, 13.118)  $\gamma_{88}$  799.8720 (†, 29.5)  $\gamma_{70}$  817.0420 (†, 16.3)  $\gamma_{47}$  840.5620 (†, 24.4)  $\gamma_{28}$  859.5320 (†, 9.414)  $\gamma_{19}$  868.84 (†, 2.27)  $\gamma_0$  887.14(?)

921.0120, (9/2<sup>+</sup>, 11/2<sup>+</sup>)  $\gamma_{563}$  357.9020 (†, 17.6)  $\gamma_{476}$  445.3420 (†, 82.18)  $\gamma_{396}$  525.0820 (†, 73.14)  $\gamma_{327}$  593.76 (†, 9.5)  $\gamma_{181}$  730.4020 (†, 50.12)  $\gamma_{135}$  786.5420 (†, 100)  $\gamma_{125}$  796.3720 (†, 68.21)  $\gamma_{88}$  833.1420 (†, <141)  $\gamma_{47}$  874.1620 (†, 36.11)  $\gamma_{19}$  901.98 (†, 14.8)

D 957.532, (9/2<sup>+</sup>)  $\gamma_{476}$  481.910 (†, 0.5026)  $\gamma_{396}$  560.13(?)  $\gamma_{327}$  630.10214 (†, 100) M1+(E2)  $\gamma_{191}$  766.5915 (†, 13.3)  $\gamma_{135}$  824(?) (†, <1.3)  $\gamma_{125}$  833.1420 (†, <19)  $\gamma_{88}$  870.55 (†, 2.513)  $\gamma_{70}$  887.1420 (†, 26.5)  $\gamma_{47}$  910.4620 (†, 51.8)  $\gamma_{19}$  938.42 (†, 37.8)  $\gamma_0$  957.5920 (†, 36.6)

987.515, (7/2<sup>+</sup>, 9/2<sup>+</sup>)  $\gamma_{476}$  511.510 (†, 2.613)  $\gamma_{396}$  591.63 (†, 13.3)  $\gamma_{327}$  660.085 (†, 64.12)  $\gamma_{70}$  917.05 (†, 6.3)  $\gamma_{47}$  941.010 (†, 19.13)  $\gamma_{19}$  968.57 (†, 2.613)  $\gamma_0$  987.6020 (†, 100)

1024.2220, (7/2<sup>+</sup>, 9/2<sup>+</sup>)  $\gamma_{476}$  549.26 (†, 12.8)  $\gamma_{396}$  630.102(?)  $\gamma_{327}$  696.84 (†, 31.17)  $\gamma_{125}$  899.310 (†, 12.8)  $\gamma_{70}$  953.2 (†, 6.4)  $\gamma_{47}$  977.22 (†, <144)  $\gamma_{28}$  996.03 (†, 75.31)  $\gamma_{19}$  1005.13 (†, 100)

1065.3020  $\gamma_{396}$  669.2820 (†, 33.7)  $\gamma_{327}$  737.9620 (†, 21.6)  $\gamma_{135}$  930.36 (†, 5.3)  $\gamma_{88}$  977.2(?)  $\gamma_{47}$  1018.3320 (†, 100)

1111.23  $\gamma_{88}$  1023.3220 (†, 100)  $\gamma_{70}$  1040.212 (†, 1.37)  $\gamma_{28}$  1083.95 (†, 6.318)  $\gamma_0$  1111.95 (†, 10.3)

1185.65  $\gamma_{135}$  1051.38 (†, 10.4)  $\gamma_{88}$  1097.97 (†, 33.11)  $\gamma_{47}$  1138.55 (†, 83.18)  $\gamma_{19}$  1166.35 (†, 100)

2400 400, 0.64 6 μs, %SF≤100  $\gamma_0IT(?)$

**246Am**

$\Delta$ : 64988 18  $S_n$ : 4976 18  $S_p$ : 5398 23  $Q_\beta$ : 2376 18  $Q_\alpha$ : 5150 200

Levels and  $\gamma$ -ray branchings:

0, (7<sup>-</sup>), 39.3 m, % $\beta^-$ =100

x, 2(7<sup>-</sup>), 25.02 m, % $\beta^-$ =100, %IT<0.01

16.233, (0<sup>-</sup>, 1<sup>-</sup>, 2<sup>-</sup>)  $\gamma_0$  16.233 (†, 100)

43.812, (1<sup>+</sup>), 4.33 ns  $\gamma_{16}$  27.582 (†, 14.115) (E1)  $\gamma_x$  43.812 (†, 100.5) (E1) 74.335

223.752, (1<sup>+</sup>)  $\gamma_{74}$  149.423 (†, 0.2420)  $\gamma_{44}$  179.942 (†, 41.320) (M1)  $\gamma_x$  223.752 (†, 100.7) (E1)

232.763  $\gamma_{74}$  158.423 (†, 31.7)  $\gamma_{44}$  189.004 (†, 42.7)  $\gamma_{16}$  216.554 (†, 100.16)  $\gamma_x$  223.752 (†, 71.11)

299.354, 0<sup>-</sup>, 1  $\gamma_{233}$  66.602 (†, 100.7)  $\gamma_{224}$  75.642 (†, 71.10)  $\gamma_{44}$  255.543 (†, 90.7)  $\gamma_0$  299.346 (†, 12.3)

=2000, 73 10 μs, %SF≤100  $\gamma_0IT(?)$

**245Am**

$\Delta$ : 61893 3  $S_n$ : 6054 3  $S_p$ : 5195 5  $Q_\beta$ : 894.0 18  $Q_\alpha$ : 5210 70

Nuclear Bands

- A 5/2[642]
- B 5/2[523]
- C 7/2[633]

D Band Structure

Levels and  $\gamma$ -ray branchings:

- A 0, (5/2)<sup>+</sup>, 2.05 h, % $\beta^-$ =100
- A 19.202, (7/2<sup>+</sup>)
- B 27.9320, (5/2<sup>-</sup>)  $\gamma_0$  28.1 (E1)
- A 47.072, (9/2<sup>+</sup>)
- B 70.4320, (7/2<sup>-</sup>)
- A 87.6510, (11/2<sup>+</sup>)
- B 124.5920, (9/2<sup>-</sup>)
- A 134.5120, (13/2<sup>+</sup>)
- B 190.8220, (11/2<sup>-</sup>)
- C 327.4288, 7/2<sup>+</sup>  $\gamma_{47}$  280.38513 (†, 5.18) (M1+E2):  $\delta=0.7525$   $\gamma_{28}$  299.87 (†, 0.074)  $\gamma_{19}$  308.2228 (†, 19.3) M1+E2:  $\delta=0.6$   $\gamma_0$  327.4288 (†, 100.15) M1+E2:  $\delta=0.55$

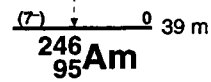
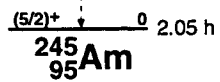
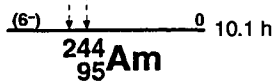
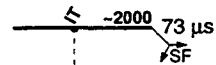
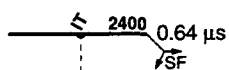
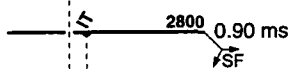
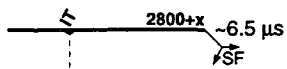

**<sup>240</sup><sub>96</sub>Cm**

$\Delta$ : 51715.3  $S_n$ : (7440)  $S_p$ : 4959.3  $Q_{EC}$ : 216.14  $Q_\alpha$ : 6397.26

Levels:

- 0, 0<sup>+</sup>, 27.1 d, % $\alpha$ >99.5, %EC<0.5, %SF=3.9×10<sup>-6</sup>
- 38.5, 2<sup>+</sup>
- ≈2000, 10.3 ps, %SF≤100  $\gamma_0IT(?)$
- ≈3000, 55.12 ns, %SF=100  $\gamma_0IT(?)$

**<sup>241</sup><sub>96</sub>Cm**

$\Delta$ : 53696.923  $S_n$ : 6089.825  $S_p$ : 5092.14  $Q_{EC}$ : 767.512  $Q_\alpha$ : 6185.06

Levels:

- 0, 1/2<sup>+</sup>, 32.82 d, % $\alpha$ =1.01, %EC=99.01
- 53
- 103
- 157
- 255
- ≈2300, 15.310 ns, %SF=100  $\gamma_0IT(?)$

**<sup>242</sup><sub>96</sub>Cm**

$\Delta$ : 54798.320  $S_n$ : 6969.914  $S_p$ : 5420.07  $Q_\alpha$ : 6215.568

$\sigma_f$ : <5 b,  $\sigma_\gamma$ : 16.5 b,  $\sigma_f$ : <5 b

Nuclear Bands

A GS band

Levels and  $\gamma$ -ray branchings:

- A 0, 0<sup>+</sup>, 162.82 d, % $\alpha$ =100, %SF=6.2×10<sup>-6</sup>
- A 42.131, 2<sup>+</sup>  $\gamma_{42.131} E2$
- A 138.4, 4<sup>+</sup>  $\gamma_{138.4} 963$
- A 284.7, 6<sup>+</sup>  $\gamma_{284.7} 1465$
- 1900.200, 40.15 ps, %SF≤100  $\gamma_0IT(?)$
- ≈2800, 180.70 ns, %SF=100  $\gamma_0IT(?)$

**<sup>243</sup><sub>96</sub>Cm**

$\Delta$ : 57176.322  $S_n$ : 5693.310  $S_p$ : 5575.812  $Q_{EC}$ : 8.914  $Q_\alpha$ : 6168.810

$\sigma_{abs}$ : 747.23 b,  $\sigma_\gamma$ : 130.10 b

Nuclear Bands

- A 5/2[622]
- B 1/2[631]
- C 7/2[624]
- D 1/2[501]

Levels and  $\gamma$ -ray branchings:

- A 0, 5/2<sup>+</sup>, 29.11 y, % $\alpha$ =99.713, %EC=0.293, %SF=5.3×10<sup>-9</sup>,  $\mu$ =0.41
- A 42.2, 7/2<sup>+</sup>
- B 87.41, 1/2<sup>+</sup>, 1.083  $\mu$ s  $\gamma_{87.41} (t_\gamma 100) E2$
- A 94.2, 9/2<sup>+</sup>
- B 94.2, (3/2<sup>+</sup>)
- C 128.4, (7/2<sup>+</sup>)
- 153.2
- 164.2
- C 187.9, (9/2<sup>+</sup>)
- 219.3
- 228.3
- B 260.2, (9/2<sup>+</sup>)
- 530.3
- D 729.2, (1/2<sup>+</sup>)
- 769.2
- 798.2
- 842.2
- 860.4(?)
- 892.2
- 904.3
- 930.4
- 973.2
- 1015.3
- 1023.2
- 1046.4
- 1136.2
- 1217.3
- 1222.4
- 1359.3
- 1367.4
- 1900.300, 42.6 ns, %SF≤100  $\gamma_0IT(?)$

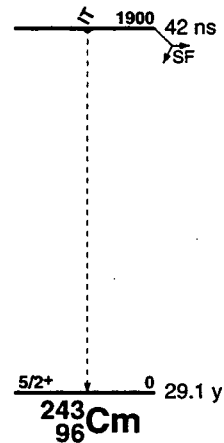
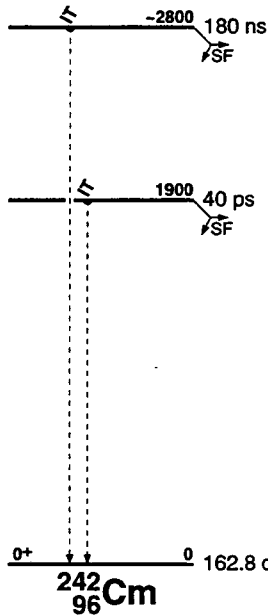
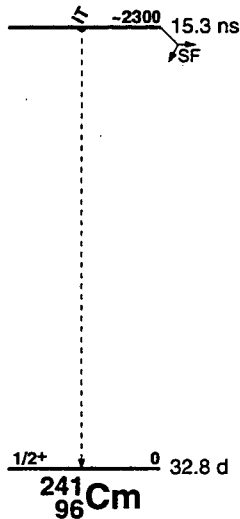
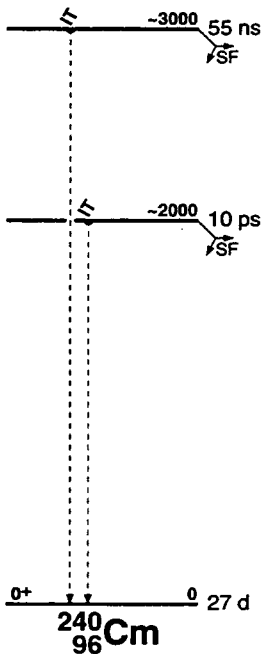

## 244 96 Cm

$\Delta$ : 58447.0 20  $S_n$ : 6800.7 11  $S_p$ : 6009.4 10  $Q_\alpha$ : 5901.61 5  
 $\sigma_f$ : 1.04 20 b,  $\sigma_{\gamma}$ : 15.2 12 b

### Nuclear Bands

A GS band

### Levels and $\gamma$ -ray branchings:

- A 0, 0<sup>+</sup>, 18.10 2 y, %SF=1.347×10<sup>-4</sup> s, % $\alpha$ =100  
 A 42.965 10, 2<sup>+</sup>, 97 5 ps  $\gamma_0$  42.965 10 (†,100) E2  
 A 142.348 4, 4<sup>+</sup>  $\gamma_{43}$  99.383 4 (†,100) E2  
 A 296.211 11, 6<sup>+</sup>  $\gamma_{142}$  153.863 2 (†,100) E2  
 A 501.787 12, 8<sup>+</sup>  $\gamma_{296}$  205.575 4 (†,100)  
 970 4, (2<sup>+</sup>,3<sup>-</sup>)  
 984.915 15, 0<sup>+</sup>  $\gamma_{43}$  941.95 2  $\gamma_0$  984.919 20 E0  
 1020.759 22(?), (2<sup>+</sup>)  $\gamma_{43}$  977.80 2 (†,100) E0(+M1)  
 1038 6, (2<sup>+</sup>,3<sup>-</sup>)  
 1040.181 11, 6<sup>+</sup>, 34 2 ms  $\gamma_{502}$  538.400 16 (†,1.0 2)  $\gamma_{296}$  743.971 5 (†,100 30)  
 M1+E2:  $\delta$ =-0.92 8  $\gamma_{142}$  897.848 7 (†,42 12) E2  
 1084.199 12(?), (1,2<sup>+</sup>)  $\gamma_{43}$  1041.278 22 (†,53 18)  $\gamma_0$  1084.181 14 (†,100 30)  
 1105.908 20(?), (1,2<sup>+</sup>)  $\gamma_{43}$  1062.953 18 (†,100 30) (M1),(E1)  $\gamma_0$  1105.43 19  
 (†,15 8)  
 1187 4, (2<sup>+</sup>,3<sup>-</sup>)  
 ≈2200(?), <5 ps, %SF≤100  $\gamma_0$  IT(?)  
 ≈3500, >100 ns, %SF≤100  $\gamma_0$  IT(?)

## 245 96 Cm

$\Delta$ : 60999 3  $S_n$ : 5519.8 19  $S_p$ : 6165.5 21  $Q_\alpha$ : 5623.5 19  
 $\sigma_f$ : 369 17 b,  $\sigma_{abs}$ : 2514 60 b

### Nuclear Bands

- A 7/2[624]  
 B 5/2[622]  
 C 1/2[631]  
 D 9/2[734]  
 E Band Structure  
 F 7/2[743]  
 G 7/2[613]  
 H 1/2[620]  
 I 1/2[501]

### Levels and $\gamma$ -ray branchings:

- A 0, 7/2<sup>+</sup>, 8500 100 y,  $\mu$ =0.5 1, % $\alpha$ =100, %SF=6.1×10<sup>-7</sup> s  
 A 54.81 5, 9/2<sup>+</sup>, <0.10 ns  $\gamma_0$  54.81 5 M1+E2:  $\delta$ =1.3 2  
 A 121.60 4, 11/2<sup>+</sup>  $\gamma_{55}$  66.80 2 (†,64 4) M1+E2:  $\delta$ =0.86 30  $\gamma_0$  121.60 4 (†,100 10)  
 A 197.4 20, 13/2<sup>+</sup>  $\gamma_{122}$  75.8 20(?)  
 B 252.80 2, 5/2<sup>+</sup>  $\gamma_{55}$  198.0 1 (†,0.54 7) E2  $\gamma_0$  252.80 2 (†,100 7) M1+E2:  $\delta$ =0.16 3  
 B 295.72 2, 7/2<sup>+</sup>  $\gamma_{253}$  42.88 2 (†,17.5 10)  $\gamma_{55}$  240.86 2 (†,100 4) M1(+E2):  $\delta$ <0.7  
 $\gamma_0$  295.72 2 (†,65 3) M1+E2:  $\delta$ =0.22 22  
 B 350.64 4, 9/2<sup>+</sup>  $\gamma_{296}$  54.8 (†,20 15)  $\gamma_{122}$  229.50 10 (†,100 5)  
 C 355.90 10, 1/2<sup>+</sup>, 0.29 2  $\mu$ s  $\gamma_{253}$  103.1 1 E2  
 C 361.4 4, (3/2<sup>+</sup>)  
 D 388.18 5, 9/2<sup>+</sup>, 0.450 20 ns  $\gamma_{351}$  37.54 3 (†,0.0224 11)  $\gamma_{296}$  92.51 2 (†,0.494 16)  
 $\gamma_{122}$  266.62 2 (†,1.05 4) (E1)  $\gamma_{55}$  333.37 2 (†,21.1 6) E1  $\gamma_0$  388.16 2 (†,100 3)  
 E1  
 B 416.60 5, 11/2<sup>+</sup>  $\gamma_{351}$  65.96 2  
 C 418.7 5, (5/2<sup>+</sup>)  
 C 431 2, (7/2<sup>+</sup>)  
 D 442.84 5, 11/2<sup>-</sup>  $\gamma_{388}$  54.8 (†,56 13) M1+E2:  $\delta$ =0.68 17  $\gamma_{122}$  321.24 3 (†,100 6)  
 B 498 2, 13/2<sup>+</sup>  
 D 509.0 2, 13/2<sup>-</sup>  $\gamma_{443}$  65.96  $\gamma_{388}$  120.80 10  
 C 532 2, (9/2<sup>+</sup>)  
 545 3  
 C 555 5, (11/2<sup>+</sup>)  
 558 3  
 D 588 3, (15/2<sup>-</sup>)  
 B 598 3, (15/2<sup>+</sup>)  
 E 633.60 11, (3/2<sup>-</sup>)  $\gamma_{361}$  272.2 3 (†,0.50,73)  $\gamma_{253}$  380.8 1 (†,100) E1  
 ≈638(?)  
 F 643.65 6, (7/2<sup>-</sup>)  $\gamma_{388}$  255.45 3 (†,100 13)  $\gamma_{253}$  390.85 5 (†,67 8)  $\gamma_{55}$  589.00 10  
 (†,9.2 15)  $\gamma_0$  643.2 3 (†,49 18)  
 660 5(?)  
 E 661.52 10, 5/2<sup>-</sup>  $\gamma_{296}$  365.8 1 (†,100) E1  $\gamma_{253}$  408.7 1 (†,51 9)  
 D 672 3, (17/2<sup>-</sup>)  
 F 701.72 11, (9/2<sup>-</sup>)  $\gamma_{296}$  406.00 10 (†,100 8)  $\gamma_0$  =700(?) (†,≈55)

- G 722 3, (7/2<sup>+</sup>)  
 735 3(?)  
 H 740.9 2, (1/2<sup>+</sup>)  $\gamma_{356}$  385.0 1 (†,100) M1  $\gamma_{253}$  488.2 2 (†,2.5 6)  
 H 769.2 5, (3/2<sup>+</sup>)  $\gamma_{418}$  350.5 1 (†,100) M1  $\gamma_{361}$  407.8 2 (†,≈37) (M1)  
 772 3  
 F 773 4, (11/2<sup>-</sup>)  
 G 782 4, (9/2<sup>+</sup>)  
 H 791 4, (5/2<sup>+</sup>)  
 ≈838  
 ≈848  
 G ≈853, (11/2<sup>+</sup>)  
 H 856 3, (7/2<sup>+</sup>)  
 F ≈866, (13/2<sup>-</sup>)  
 H 891 4, (9/2<sup>+</sup>)  
 ≈901  
 908 5  
 I 913 3, (1/2<sup>-</sup>)  
 ≈936  
 942 3  
 I 956 2, (3/2<sup>-</sup>,5/2<sup>-</sup>)  
 ≈972  
 980 5  
 995 5  
 ≈1009  
 1017 4  
 1042 5  
 1050 5  
 1056 3  
 1083 3  
 1103 3  
 1259 5  
 1271 2  
 1473 3  
 2100 300, 13.2 18 ns, %SF≤100  $\gamma_0$  IT(?)

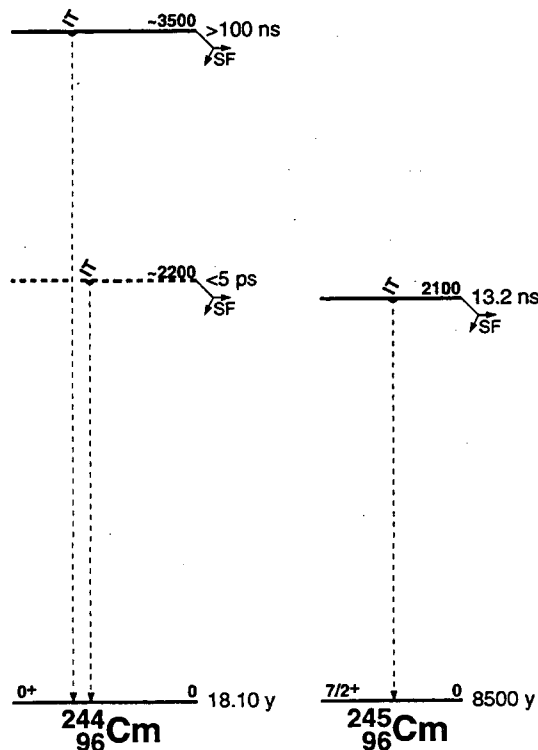

### $^{242}_{97}\text{Bk}$

$\Delta$ : (57800)  $S_n$ : (6400)  $S_p$ : (3190)  $Q_{EC}$ : (3000)  $Q_\alpha$ : (6960)

Levels:

0, 7.0 13 m, %EC+% $\beta^+$ =100

$\approx 330$

x, 9.5 20 ns, %SF>0  $\gamma_0 \Pi$ (?)

y, 0.60 10  $\mu$ s, %SF>0  $\gamma_0 \Pi$ (?)

### $^{243}_{97}\text{Bk}$

$\Delta$ : 58685.5  $S_n$ : (7190)  $S_p$ : 3403.5  $Q_{EC}$ : 1508.5  $Q_\alpha$ : 6874.4

Nuclear Bands

A 7/2[633]

Levels:

0, (3/2<sup>-</sup>), 4.5 2 h, % $\alpha$ =0.15, %EC=99.85

A 0+x, (7/2<sup>+</sup>)

A 49+x 4, (9/2<sup>+</sup>)

A 112+x 6, (11/2<sup>+</sup>)

$\approx 2200$ (?), 5 ns, %SF $\leq$ 100  $\gamma_0 \Pi$ (?)

### $^{244}_{97}\text{Bk}$

$\Delta$ : 60700.50  $S_n$ : 6050.50  $S_p$ : 3760.50  $Q_{EC}$ : 2260.50  $Q_\alpha$ : 6780.50

Levels:

0, (1<sup>-</sup>), 4.35 15 h, % $\alpha$ =0.006 2, %EC=99.994 2

$\approx 170$

x, 0.82 6  $\mu$ s, %SF $\leq$ 100  $\gamma_0 \Pi$ (?)

### $^{245}_{97}\text{Bk}$

$\Delta$ : 61808.825  $S_n$ : 6970.50  $S_p$ : 3927.215  $Q_{EC}$ : 810.224  $Q_\alpha$ : 6454.515

Nuclear Bands

A 3/2[521]

B 7/2[633]

Levels:

A 0, 3/2<sup>-</sup>, 4.94 3 d, % $\alpha$ =0.12 1, %EC=99.88 1

B 0+x, 7/2(\*)

B 61+x 13, (9/2<sup>+</sup>)

$\approx 1560$ , 2 1 ns, %SF=100  $\gamma_0 \Pi$ (?)

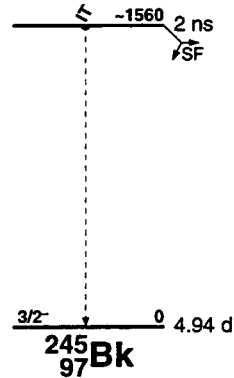
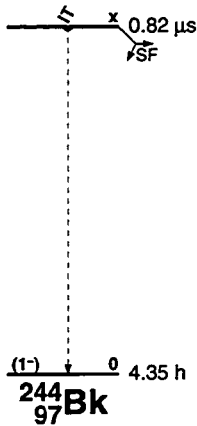
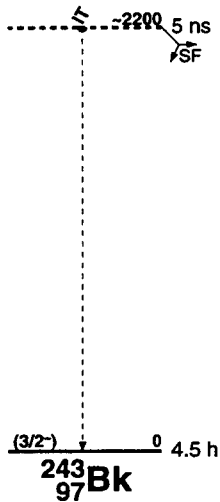
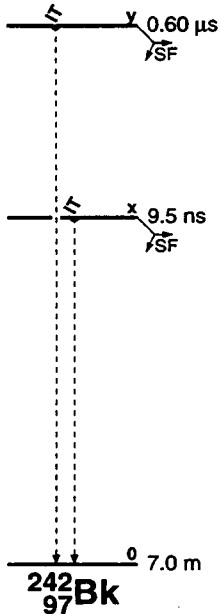

## References for Superdeformed Bands (Experimental)

### 82Sc07 Search for Collective Effects in Very High Spin States of $^{152}\text{Dy}$

Y. Schutz, J. P. Vivien, F. A. Beck, T. Byrski, C. Gehringer, J. C. Merdinger, J. Dudek, W. Nazarewicz, Z. Szymanski, Phys. Rev. Lett. 48, 1534 (1982).

**Nuclear Reactions:**  $+123\text{Sn}(^{28}\text{S},\text{xn})$ ,  $E=160$  MeV; measured  $\gamma(\theta)$  ratio,  $\gamma\gamma(E)$ .  $^{152}\text{Dy}$  deduced high spin collective effects, superdeformed configuration parameters, moments of inertia. Rotating Woods-Saxon potential.

### 83Ku16 Suppression of Neutron Emission after Heavy-Ion Fusion: Is shape relaxation affected by a superdeformed minimum (question)

W. Kuhn, P. Chowdhury, R. V. F. Janssens, T. L. Khoo, F. Haas, J. Kasagi, R. M. Ronningen, Phys. Rev. Lett. 51, 1858 (1983).

**Nuclear Reactions:**  $+92\text{Zr}(^{44}\text{Ni},\text{xn})$ ,  $E=233$  MeV; measured neutron yield,  $n_{\gamma}$ ,  $\gamma\gamma$ -coin, neutron multiplicity,  $E_{\gamma}$ ,  $l_{\gamma}$ ; deduced temperature vs entry state spin, two-neutron emission dominance.  $^{169}\text{Er}$  deduced level density, possible superdeformation at high-spin.

### 84Ny01 Observation of Superdeformation in $^{152}\text{Dy}$

B. M. Nyako, J. R. Cresswell, P. D. Forsyth, D. Howe, P. J. Nolan, M. A. Riley, J. F. Sharpey-Schafer, J. Simpson, N. J. Ward, P. J. Twin, Phys. Rev. Lett. 52, 507 (1984).

**Nuclear Reactions:**  $+108\text{Pd}(^{40}\text{Ca},4\text{n})$ ,  $E=205$  MeV; measured  $\gamma\gamma$ -energy correlation.  $^{152}\text{Dy}$  deduced dynamical moment of inertia, rotational behavior, deformation, superdeformation characteristics. Bismuth germanate, escape suppressed Ge detectors.

### 85Be40 Comparison of Cross Sections for C + O Reactions in the Second Regime of Complete Fusion

C. Beck, F. Haas, R. M. Freeman, B. Heusch, J. P. Coffin, G. Guillaume, F. Rami, P. Wagner, Nucl. Phys. A442, 320 (1985).

**Nuclear Reactions:** CPND  $^{12}\text{C}(^{16}\text{O},\text{X})$ ,  $E=32-140$  MeV;  $^{13}\text{C}(^{17}\text{O},\text{X})$ ,  $E=54-140$  MeV;  $^{12}\text{C}(^{18}\text{O},\text{X})$ ,  $E=62-150$  MeV;  $^{16}\text{O}(^{12}\text{C},\text{X})$ ,  $E=46.5-112.5$  MeV; measured  $\sigma(\text{fragment } \theta, E)$  for fragment  $Z=3-14$ , fusion  $\sigma(E)$ ; deduced critical, grazing angular momenta.  $^{28}\text{Si}$  deduced possible superdeformation. Statistical, complete fusion model predictions.

### 85Tw01 Collectivity of the Superdeformed Bands in $^{152}\text{Dy}$

P. J. Twin, A. H. Nelson, B. M. Nyako, D. Howe, H. W. Cranmer-Gordon, D. Elenkov, P. D. Forsyth, J. K. Jabber, J. F. Sharpey-Schafer, J. Simpson, G. Sletten, Phys. Rev. Lett. 55, 1380 (1985).

**Nuclear Reactions:**  $+108\text{Pd}(^{40}\text{Ca},4\text{n})$ ,  $E=210$  MeV; measured  $\gamma\gamma$ -energy correlation.  $^{152}\text{Dy}$  deduced rotational band transition  $T_{1/2}$ , collectivity, superdeformed prolate shape.

### 86Tw01 Observation of Discrete-Line Superdeformed Band up to $60(\hbar\text{-bar})$ in $^{152}\text{Dy}$

P. J. Twin, B. M. Nyako, A. H. Nelson, J. Simpson, M. A. Bentley, H. W. Cranmer-Gordon, P. D. Forsyth, D. Howe, A. R. Mokhtar, J. D. Morrison, J. F. Sharpey-Schafer, G. Sletten, Phys. Rev. Lett. 57, 811 (1986).

**Nuclear Reactions:**  $+108\text{Pd}(^{40}\text{Ca},4\text{n})$ ,  $E=205$  MeV; measured  $E_{\gamma}$ ,  $l_{\gamma}$ ,  $\gamma\gamma$ -energy correlation,  $\gamma\gamma$ -coin.  $^{152}\text{Dy}$  deduced levels,  $J, \pi, \gamma$ -branching, yrast sequence, band structure, deformation, superdeformation characteristics.

### 86Vi05 Search for Superdeformation Effects in $^{144}\text{Gd}$

J. P. Vivien, A. Nourredine, F. A. Beck, T. Byrski, C. Gehringer, B. Haas, J. C. Merdinger, D. C. Radford, Y. Schutz, J. Dudek, W. Nazarewicz, Phys. Rev. C33, 2007 (1986).

**Nuclear Structure:**  $+144\text{Gd}$ ; calculated Routhians, superdeformed configuration temperature, pairing effects. Cranking model, Woods-Saxon fields.

**Nuclear Reactions:**  $+120\text{Sn}(^{28}\text{Si},4\text{n})$ ,  $E=125, 135, 145, 155$  MeV; measured  $\gamma$ -spectra,  $\gamma(\theta)$ , multiplicity distribution, anisotropy.  $^{144}\text{Gd}$  level deduced isomer  $T_{1/2}$ , superdeformation effects.

### 87Be32 Superdeformed Bands in Nd Nuclei

E. M. Beck, R. J. McDonald, A. O. Macchiavelli, J. C. Bacelar, M. A. Deleplanque, R. M. Diamond, J. E. Draper, F. S. Stephens, Phys. Lett. 195B, 531 (1987).

**Nuclear Reactions:**  $+98\text{Mo}(^{40}\text{Ar},4\text{n})$ ,  $E=173$  MeV;  $^{100}\text{Mo}(^{40}\text{Ar}, 4\text{n})$ ,  $E=176$  MeV; measured  $E_{\gamma}$ ,  $l_{\gamma}$ ,  $\gamma\gamma$ -energy correlations.  $^{134}, ^{136}\text{Nd}$  deduced levels,  $J, \pi$ , superdeformed bands, dynamic moments of inertia.

### 87Be41 Intrinsic Quadrupole Moment of the Superdeformed Band in $^{152}\text{Dy}$

M. A. Bentley, G. C. Ball, H. W. Cranmer-Gordon, P. D. Forsyth, D. Howe, A. R. Mokhtar, J. D. Morrison, J. F. Sharpey-Schafer, P. J. Twin, B. Fant, C. A. Kalfas, A. H. Nelson, J. Simpson, G. Sletten, Phys. Rev. Lett. 59, 2141 (1987).

**Nuclear Reactions:**  $+108\text{Pd}(^{40}\text{Ca},4\text{n})$ ,  $E=205$  MeV; measured  $E_{\gamma}$ ,  $l_{\gamma}$ , DSA.  $^{152}\text{Dy}$  deduced levels,  $J$ , effective  $T_{1/2}$ , band characteristics, superdeformed quadrupole moment, moment of inertia.

### 87Be57 Superdeformed Band in $^{152}\text{Nd}$

E. M. Beck, F. S. Stephens, J. C. Bacelar, M. A. Deleplanque, R. M. Diamond, J. E. Draper, C. Duyar, R. J. McDonald, Phys. Rev. Lett. 58, 2182 (1987).

**Nuclear Reactions:**  $+100\text{Mo}(^{40}\text{Ar},5\text{n})$ ,  $E=173, 177$  MeV; measured  $\gamma\gamma$ -coin.  $^{152}\text{Nd}$  deduced levels,  $J, \pi$ , superdeformed band, moment of inertia.

### 87BeYB Superdeformed Bands in Nd Nuclei

E. M. Beck, R. J. McDonald, A. O. Macchiavelli, J. C. Bacelar, M. A. Deleplanque, R. M. Diamond, J. E. Draper, F. S. Stephens, Proc. Intern. Conf. Nuclear Structure Through Static and Dynamic Moments, Melbourne, Australia, Vol. 1, p. 48 (1987).

**Nuclear Reactions:**  $+98\text{Mo}(^{40}\text{Ar},4\text{n})$ ,  $E=173$  MeV;  $^{100}\text{Mo}(^{40}\text{Ar}, \text{xn})$ ,  $E=176$  MeV; measured  $\gamma$ -spectra.  $^{134}, ^{136}, ^{138}\text{Nd}$  deduced levels,  $J, \pi$ , superdeformed bands.

### 87De17 Superdeformed Bands at High Spin in $Z=66$ and $68$ Isotopes

M. J. A. de Voigt, J. C. Bacelar, E. M. Beck, M. A. Deleplanque, R. M. Diamond, J. E. Draper, H. J. Riezebos, F. S. Stephens, Phys. Rev. Lett. 59, 270 (1987).

**Nuclear Reactions:**  $+114$ ,  $^{116}\text{Cd}$ ,  $^{118}, ^{120}\text{Sn}(^{40}\text{Ar}, \text{xn})$ ,  $E=180$  MeV; measured  $\gamma\gamma$ -coin,  $\gamma\gamma$ -energy correlation spectra.  $^{150}, ^{152}\text{Dy}$ ,  $^{154}, ^{156}\text{Er}$  deduced superdeformed bands. Compton suppressed Ge detectors.

**Radioactivity:**  $^{150}, ^{152}\text{Dy}$ ,  $^{154}, ^{156}\text{Er}(EC)$ , ( $\beta^+$ ); measured  $\gamma\gamma$ -energy correlations,  $\gamma\gamma$ -coin spectra.  $^{150}, ^{152}\text{Dy}$ ,  $^{154}, ^{156}\text{Er}$  deduced superdeformed bands. Compton suppressed Ge detectors.

### 87DeZT The $\beta^+$ and EC Decay of $^{66}\text{Se}$ Possible Shape-Coexistence and Superdeformation Effects in $^{66}\text{As}$

Ph. Dessagne, Ch. Miede, P. Baumann, A. Huck, J. M. Maison, G. Klotz, M. Ramdane, G. Walter, J. Dudek, Contrib. Proc. 5th Int. Conf. Nuclei Far from Stability, Rosseau Lake, Canada, K10 (1987).

**Radioactivity:**  $^{66}\text{Se}(\beta^+)$ , (EC) [from  $^{66}\text{Ca}(^{28}\text{S}, n2p)$ ,  $E=100$  MeV]; measured  $\gamma\gamma$ -coin; deduced log ft.  $^{66}\text{As}$  deduced levels, shape characteristics,  $\gamma$ -branching ratios, superdeformed band.

**Nuclear Reactions:**  $+40\text{Ca}(^{28}\text{S},n2p)$ ,  $E=100$  MeV; measured p(X-ray)- $\gamma\gamma$ -coin,  $\sigma(\text{Ep})$ .

### 87He16 Observation of Superdeformation in the Doubly Closed-Shell Nucleus $^{146}\text{Gd}$

G. Hobbingshaus, T. Rzaca-Urban, C. Senff, R. M. Lieder, W. Gast, A. Kramer-Flecken, H. Schnare, W. Urban, G. de Angelis, P. Kleinheinz, W. Starzecki, J. Styczen, P. von Brentano, A. Dewald, J. Eberth, W. Lieberz, T. Mylaeus, A. v. d. Werth, H. Wolters, K. O. Zell, S. Heppner, H. Hubel, M. Murzel, H. Grawe, H. Kluge, Phys. Rev. Lett. 59, 2024 (1987).

**Nuclear Reactions:**  $+110\text{Pd}(^{40}\text{Ar},\text{X})$ ,  $E=180$  MeV; measured  $\gamma\gamma$ -energy



correlation, DSA.  $^{146}\text{Gd}$  deduced levels, moment of inertia, deformation, superdeformation characteristics, quadrupole moment, stretched E2 transitions.

**87He23 Population and Decay of the Superdeformed Rotational Band of  $^{152}\text{Dy}$**

B. Herskind, B. Lauritzen, K. Schiffer, R. A. Broglia, F. Barranco, M. Gallardo, J. Dudek, E. Vigezzi, *Phys. Rev. Lett.* 59, 2416 (1987).

**Nuclear Structure:**  $+152]\text{Dy}$ ; calculated E1 transition probabilities, superdeformed yrast band.

**87HeZJ Observation of Superdeformation in  $^{148}\text{Gd}$**

G. Hebbinghaus, T. Rzaca-Urban, C. Senff, R. M. Lieder, W. Gast, A. Kramer-Flecken, H. Schnare, W. Urban, G. de Angelis, P. Kleinheinz, W. Starzecki, J. Styczen, P. von Brentano, J. Eberth, W. Lieberz, T. Mytaeus, A. von der Werth, H. Wolters, K. O. Zell, S. Heppner, H. Hubel, M. Murzel, H. Grawe, H. Kluge, *Proc. Intern. Conf. Nuclear Structure Through Static and Dynamic Moments*, Melbourne, Australia, Vol. 1, p. 3 (1987).

**Nuclear Reactions:**  $+110]\text{Pd}(^{20}\text{Ar},4n)$ ,  $E=180$  MeV; measured  $\gamma$  energy correlations, DSA.  $^{146}\text{Gd}$  deduced levels,  $T_{1/2}$ , superdeformed bands.

**87KI02 Mean-Lifetime Measurements within the Superdeformed Second Minimum in  $^{132}\text{Ce}$**

A. J. Kirwan, G. C. Ball, P. J. Bishop, M. J. Godfrey, P. J. Nolan, D. J. Thornley, D. J. G. Love, A. H. Nelson, *Phys. Rev. Lett.* 58, 467 (1987).

**Nuclear Reactions:**  $+100]\text{Mo}(^{26}\text{S},4n)$ ,  $E=150$  MeV; measured  $E_\gamma$ ,  $I_\gamma$ , DSA.  $^{132}\text{Ce}$  deduced levels,  $J, \pi$ , rotational band structure,  $T_{1/2}$ , deformation, superdeformation. Bismuth germanate detectors.

**Radioactivity:**  $^{132}\text{Ce}(\text{EC})$  [from  $^{100}\text{Mo}(^{26}\text{S},4n)$ ,  $E=150$  MeV]; measured  $E_\gamma$ ,  $I_\gamma$ , DSA.  $^{132}\text{Ce}$  deduced levels,  $J, \pi$ , rotational band structure,  $T_{1/2}$ , deformation, superdeformation. Bismuth germanate detectors.

**87Ma54 Search for Entrance-Channel Effects in the Production of Superdeformed Nuclei**

A. O. Macchiavelli, M. A. Deleplanque, R. M. Diamond, R. J. McDonald, F. S. Stephens, J. E. Draper, *Phys. Rev.* C36, 2177 (1987).

**Nuclear Reactions:**  $+82]\text{Se}(^{76}\text{Ge},4n)$ ,  $E=4.6$  MeV/nucleon; measured  $\gamma\gamma$ -coin.  $^{152}\text{Dy}$  deduced levels, superdeformed band excitation mechanism.

**87Rz01 Search for Superdeformation in  $^{160}\text{Os}$**

T. Rzaca-Urban, R. M. Lieder, W. Gast, W. Urban, J. Bacelar, J. D. Garrett, G. Sletten, R. Chapman, J. C. Lisle, J. N. Mo, *Z. Phys.* A328, 379 (1987).

**Nuclear Reactions:**  $+150]\text{Nd}(^{24}\text{S},4n)$ ,  $E=158$  MeV; measured  $\gamma\gamma$ -energy correlation spectra.  $^{160}\text{Os}$  deduced levels,  $J, \pi$ , band structure, moments of inertia, superdeformation axis ratio.

**87Sc01 Search for Superdeformed Shapes in  $^{144}\text{Gd}$**

Y. Schutz, C. Baktash, I. Y. Lee, M. L. Halbert, D. C. Hensley, N. R. Johnson, M. Oshima, R. Ribas, J. C. Lisle, L. Adler, K. Honkanen, D. G. Sarantites, A. J. Larabee, J. X. Saladin, *Phys. Rev.* C35, 348 (1987).

**Radioactivity:**  $^{144}\text{Gd}(\text{EC})$ , (IT) [from  $^{120}\text{Sn}(^{28}\text{Si}, 4n)$ ,  $E=145$  MeV]; measured  $\gamma\gamma$ -transition energy correlation; deduced moment of inertia, shape characteristics, no evidence for superdeformation. Germanium detectors.

**87St15  $\gamma$ -Rays Draining the Superdeformed Band in  $^{152}\text{Dy}$**

J. Styczen, R. Menegazzo, W. Starzecki, P. Kleinheinz, *Z. Phys.* A327, 481 (1987).

**Nuclear Reactions:**  $+152]\text{Gd}(\alpha,4n)$ ,  $E=60$  MeV; measured  $E_\gamma$ ,  $I_\gamma$ ,  $\chi(\theta)$ ,  $\gamma\gamma$ -coin.  $^{152}\text{Dy}$  deduced levels,  $J, \pi$ ,  $\gamma$ -branching,  $\gamma$  multipolarity, superdeformed band.

**87Wa18 The New Spectroscopy of Superdeformed States: Systematics in the light rare earths and unexpected feeding patterns**

R. Wadsworth, A. Kirwan, D. J. G. Love, Y. -X. Luo, J. -Q. Zhong, P. J. Nolan, P. J. Bishop, M. J. Godfrey, R. Hughes, A. N. James, I. Jenkins, S. M. Mullins, J. Simpson, D. J. Thornley, K. L. Ying, *J. Phys. (London)* G13, L207 (1987).

**Nuclear Reactions:**  $+104]\text{Pd}(^{28}\text{S},2n,2p)$ , ( $^{28}\text{S},n,2p$ ),  $E=152$  MeV;  $^{104}\text{Ru}(^{24}\text{S},4n)$ , ( $^{24}\text{S},3n$ ),  $E=155$  MeV;  $^{104}\text{Ru}(^{28}\text{S},4n)$ , ( $^{28}\text{S},3n$ ),  $E=150$  MeV;  $^{104}\text{Ru}(^{24}\text{S},4np)$ ,  $E=162$  MeV;  $^{100}\text{Pd}(^{24}\text{S}, 4np)$ , ( $^{24}\text{S},4n$ ),  $E=152$  MeV;  $^{100}\text{Mo}(^{28}\text{S}, 4n)$ ,  $E=150$  MeV; measured  $E_\gamma$ ,  $I_\gamma$ ,  $\gamma\gamma$ -coin.  $^{132}\text{Ce}$ ,  $^{133}$ ,  $^{134}$ ,  $^{135}$ ,  $^{137}\text{Nd}$  deduced transitions, feeding level  $J, \pi$ , dynamical moments of inertia, superdeformed bands.

**88BaZP Search for Superdeformed Bands in  $^{82}\text{Sr}$**

C. Baktash, G. Garcia-Bermudez, M. L. Halbert, D. C. Hensley, N. R. Johnson, I. Y. Lee, F. K. McGowan, M. A. Riley, A. Virtanen, V. Abenante, D. G. Sarantites, T. M. Semkow, H. C. Griffin, X. T. Liu, *Bull. Am. Phys. Soc.* 33, No. 8, 1574, BD7 (1988)

**Nuclear Reactions:**  $+52]\text{Cr}(^{34}\text{S},2n,2p)$ ,  $E=130$  MeV; measured not given.  $^{82}\text{Sr}$  deduced levels,  $J, \pi$ , band structure, no strong evidence for superdeformation.

**88BeZG Lifetimes of the Superdeformed Band in  $^{106}\text{Pd}$**

C. W. Beausang, J. Burde, R. M. Diamond, M. A. Deleplanque, A. O. Macchiavelli, R. J. McDonald, F. S. Stephens, J. E. Draper, *Bull. Am. Phys. Soc.* 33, No. 8, 1584, CD3 (1988)

**Nuclear Reactions:**  $+64]\text{Ni}(^{48}\text{Ca},X)$ ,  $E=190$  MeV; measured  $\gamma$ -spectra.  $^{106}\text{Pd}$  deduced superdeformed band, level  $T_{1/2}$ .

**88Bu19 Unusual Rotational Behavior in  $^{178}\text{Os}$**

J. Burde, A. O. Macchiavelli, M. A. Deleplanque, R. M. Diamond, F. S. Stephens, C. W. Beausang, R. J. McDonald, J. E. Draper, *Phys. Rev.* C38, 2470 (1988).

**Nuclear Reactions:**  $+154]\text{Sm}(^{28}\text{Si},5n)$ ,  $E=150, 155$  MeV; measured  $\gamma\gamma$ -coin.  $^{178}\text{Os}$  deduced levels,  $J, \pi$ ,  $I_\gamma$ , band features.

**88De10 Superdeformed Band in  $^{148}\text{Gd}$ : A test of shell effects in the mass-150 region**

M. A. Deleplanque, C. Beausang, J. Burde, R. M. Diamond, J. E. Draper, C. Duyar, A. O. Macchiavelli, R. J. McDonald, F. S. Stephens, *Phys. Rev. Lett.* 60, 1626 (1988).

**Nuclear Reactions:**  $+104]\text{Ru}(^{48}\text{Ca},4n)$ ,  $E=202, 215$  MeV;  $^{124}\text{Sn}(^{28}\text{Si}, 5n)$ ,  $E=157, 150$  MeV; measured  $\gamma$ -spectra,  $\gamma\gamma$ -coin.  $^{148}\text{Gd}$  deduced levels,  $J, \pi$ , band structure, deformation, superdeformation.

**88DeZX Superdeformation in  $^{150}\text{Tb}$**

M. A. Deleplanque, C. Beausang, J. Burde, R. M. Diamond, R. J. McDonald, F. S. Stephens, J. E. Draper, *Bull. Am. Phys. Soc.* 33, No. 8, 1585, CD9 (1988)

**Radioactivity:**  $^{150}\text{Tb}$ ; measured  $\gamma$ -spectra; deduced superdeformation.

**88DIzV Quadrupole Moment of Superdeformed Band in  $^{126}\text{Nd}$**

R. M. Diamond, M. -A. Deleplanque, R. J. McDonald, F. S. Stephens, A. O. Macchiavelli, J. Bacelar, J. Burde, J. L. Draper, C. Duyar, *Proc. of the Conf. on High-Spin Nuclear Structure and Novel Nuclear Shapes*, April 13-15, 1988, Argonne National Laboratory, Argonne, Illinois; ANL-PHY-88-2, p. 58 (1988).

**Nuclear Reactions:**  $+100]\text{Mo}(^{40}\text{Ar},5n)$ ,  $E=175$  MeV; measured Doppler shifted  $E(\gamma)$ ,  $I(\gamma)$ , DSA.  $^{126}\text{Nd}$  deduced levels,  $J, \pi$ , band structure, dynamic moment of inertia, superdeformed band quadrupole moment.

**88Dr01 Evidence for Superdeformation in  $^{148}\text{Gd}$**

M. W. Drigert, R. V. F. Janssens, R. Holzmann, R. R. Chasman, I. Ahmad, J. Borggreen, P. J. Daly, B. K. Dichter, H. Emling, U. Garg, Z. W. Grabowski, T. L. Khoo, W. C. Ma, M. Piliarinen, M. Quader, D. C. Radford, W. Trzaska, *Phys. Lett.* 201B, 223 (1988).

**Radioactivity:**  $^{148}\text{Gd}(\alpha)$  [from  $^{116}\text{Cd}(^{28}\text{S},4n)$ ,  $E=170$  MeV]; measured  $E_\gamma$ ,

ly,  $\gamma\gamma$ -coin, energy correlations.  $^{148}\text{Gd}$  deduced moment of inertia superdeformation. Compton suppressed Ge detectors. Cranked Strutinsky calculations.

**Nuclear Structure:** +146)  $^{147, 148, 150, 151, 152, 153, 154, 155, 156}\text{Er}$ ,  $^{145, 147, 148, 149, 150, 151, 152, 153, 154, 155}\text{Ho}$ ,  $^{144, 145, 146, 147, 148, 149, 150, 151, 152, 153}\text{Dy}$ ,  $^{143, 144, 145, 146, 147, 148, 149, 150, 151, 152, 153}\text{Tb}$ ,  $^{142, 143, 144, 145, 146, 147, 148, 149, 150, 151, 152}\text{Gd}$ ,  $^{141, 142, 143, 144, 145, 146, 147, 148, 149, 150, 151}\text{Eu}$ ,  $^{140, 141, 142, 143, 144, 145, 146, 147, 148, 149, 150}\text{Sm}$ ,  $^{139, 140, 141, 142, 143, 144, 145, 146, 147, 148, 149}\text{Pm}$ ,  $^{142, 143, 144, 145, 146, 147, 148}\text{Pr}$ ,  $^{138, 139, 140, 141, 142, 143, 144, 145, 146, 147, 148}\text{Nd}$ ; calculated moments of inertia.  $^{148}\text{Gd}$  deduced superdeformation evidence. Cranked Strutinsky model.

**88FIZX Spins and Average Quadrupole Moment of the Superdeformed Band in  $^{148}\text{Gd}$  and Evidence for a Superdeformed Band in  $^{146}\text{Gd}$**

S. Flibotte, S. Pilotte, F. Banville, S. Coumoyer, J. Gascon, B. Haas, S. Monaro, N. Nadon, D. Prevost, P. Taras, D. Thibault, J. K. Johansson, D. Tucker, J. C. Waddington, H. R. Andrews, G. C. Ball, D. Horn, D. C. Radford, D. Ward, Proc. of the Conf. on High-Spin Nuclear Structure and Novel Nuclear Shapes, April 13-15, 1988, Argonne National Laboratory, Argonne, Illinois; ANL-PHY-88-2, p. 21 (1988).

**Nuclear Reactions:** +124)Sn( $^{30}\text{Si},5n$ ), E=150 MeV;  $^{124}\text{Sn}$ ( $^{30}\text{Si}, 6n$ ), E=160 MeV;  $^{124}\text{Sn}$ ( $^{30}\text{Si},5n$ ), E=147 MeV; measured  $\gamma\gamma$ -coin,  $\gamma\gamma(\theta)$ .  $^{148}\text{Gd}$  deduced levels, J,  $\pi$ , superdeformed band.  $^{146}\text{Gd}$  deduced levels, J,  $\pi$ , superdeformed band, quadrupole moment.

**88Ha02 Superdeformed Band up to Spin (127/2) in  $^{146}\text{Gd}$**

B. Haas, P. Taras, S. Flibotte, F. Banville, J. Gascon, S. Coumoyer, S. Monaro, N. Nadon, D. Prevost, D. Thibault, J. K. Johansson, D. M. Tucker, J. C. Waddington, H. R. Andrews, G. C. Ball, D. Horn, D. C. Radford, D. Ward, C. St. Pierre, J. Dudek, Phys. Rev. Lett. 60, 503 (1988).

**Nuclear Reactions:** +124)Sn( $^{30}\text{Si},5n$ ), E=150 MeV; measured E $\gamma$ , I( $\gamma$ ), Doppler shift fraction.  $^{146}\text{Gd}$  deduced levels, J,  $\pi$ , moment of inertia superdeformed band quadrupole moment.

**88HeZO Superdeformation in  $^{146}\text{Gd}$  und Gestaltkoexistenz in  $^{186}\text{Pt}$**

G. Hebbinghaus, JUL-2208 (1988).

**Nuclear Reactions:** +102)Ru( $^{48}\text{Ca},4n$ ), E=205 MeV; measured  $\gamma\gamma$ -coin, energy correlations, DSA.  $^{146}\text{Gd}$  deduced levels, deformation, superdeformation features, static quadrupole moment.  $^{186}\text{Os}$ ( $\alpha,6n$ ), E=70-90 MeV; measured  $\gamma\gamma$ -coin, energy correlation,  $\gamma\gamma(\theta)$ , oriented nuclei.  $^{186}\text{Pt}$  deduced levels, I( $\gamma$ ), J,  $\pi$ , deformation.

**88HeZV Study of Superdeformed Shapes in  $^{146}\text{Gd}$**

G. Hebbinghaus, T. Rzaca-Urban, C. Senff, G. de Angelis, E. M. Beck, P. von Brentano, J. Eberth, W. Gast, H. Grawe, S. Heppner, D. Howe, H. Hubel, P. Kleinheinz, H. Kluge, A. Kramer-Flecken, W. Lieberz, R. M. Lieder, M. Murzel, T. Mylaeus, B. Nyako, H. Schnare, W. Starzecki, J. Styczen, W. Urban, A. v. d. Werth, R. Wirowski, H. Wolters, K. O. Zell, JUL-Spez-422, p. 32 (1988).

**Nuclear Reactions:** +102)Ru( $^{48}\text{Ca},xn$ ), E=205 MeV; measured  $\gamma$ -spectra, energy correlation.  $^{146}\text{Gd}$  deduced superdeformed structures.

**88JaZT A Superdeformed Band in  $^{151}\text{Dy}$**

R. V. F. Janssens, G. -E. Rathke, M. W. Drigert, I. Ahmad, K. Beard, R. R. Chasman, U. Garg, M. Hass, T. L. Khoo, H. -J. Komer, W. C. Ma, S. Pilotte, P. Taras, F. L. H. Wolfs, Proc. of the Conf. on High-Spin Nuclear Structure and Novel Nuclear Shapes, April 13-15, 1988, Argonne National Laboratory, Argonne, Illinois; ANL-PHY-88-2, p. 31 (1988).

**Nuclear Reactions:** +122)Sn( $^{28}\text{S},5n$ ), E=174. 5 MeV; measured  $\gamma$ -multiplicity, summed  $\gamma\gamma$ -coin, I( $\gamma$ ).  $^{151}\text{Dy}$  deduced levels, J,  $\pi$ , rotational superdeformed band, dynamic moment of inertia.

**88Ko17 Neutron-Emission Spectra and Superdeformation in Light Nuclei**

J. J. Kolata, R. A. Kryger, P. A. DeYoung, F. W. Prosser, Phys. Rev. Lett. 61, 1178 (1988).

**Nuclear Reactions:** +12)C( $^{16}\text{O},xnyp$ ), E=56 MeV; measured np-coin.  $^{28}\text{Si}$  deduced shape transitions, superdeformation.

**88Lu01 A Superdeformed Band in  $^{151}\text{Ce}$**

Y. -X. Luo, J. -Q. Zhong, D. J. G. Love, A. Kirwan, P. J. Bishop, M. J. Godfrey, I. Jenkins, P. J. Nolan, S. M. Mullins, R. Wadsworth, Z. Phys. A329, 125 (1988).

**Nuclear Reactions:** +100)Mo( $^{36}\text{S},5n$ ),  $^{88}\text{Mo}$ ( $^{36}\text{S},3n$ ), E=155 MeV; measured E $\gamma$ , I $\gamma$ ,  $\gamma\gamma$ -coin.  $^{151}\text{Ce}$  deduced levels, rotational band, superdeformed band, moment of inertia.

**88Ma38 Superdeformation in  $^{104}, ^{106}\text{Pd}$**

A. O. Macchiavelli, J. Burde, R. M. Diamond, C. W. Beausang, M. A. Deleplanque, R. J. McDonald, F. S. Stephens, J. E. Draper, Phys. Rev. C38, 1088 (1988).

**Nuclear Reactions:** +64)Ni( $^{40}\text{Ca},4n\alpha$ ), ( $^{44}\text{Ca},3n\alpha$ ), E=200 MeV; measured  $\gamma\gamma$ -coin,  $\gamma\gamma(\theta)$ , E $\gamma$ , I $\gamma$ .  $^{104}, ^{106}\text{Pd}$  deduced levels, J,  $\pi$ , moments of inertia, superdeformation evidence.

**88NoAA**

Ann. Rev. Nucl. Part. Sci. 38, 533(1988) (review article) abstract unavailable.

**88NoZY Superdeformation in the A = 130-140 Region**

P. J. Nolan, P. J. Bishop, Y. He, M. J. Godfrey, I. Jenkins, A. Kirwan, R. Wadsworth, R. Hughes, S. M. Mullins, D. J. G. Love, Y. -X. Luo, J. -Q. Zhong, J. Simpson, Proc. of the Conf. on High-Spin Nuclear Structure and Novel Nuclear Shapes, April 13-15, 1988, Argonne National Laboratory, Argonne, Illinois; ANL-PHY-88-2, p. 63 (1988).

**Nuclear Reactions:** +100)Mo( $^{36}\text{S},4n$ ), E=150 MeV; measured E( $\gamma$ ), I( $\gamma$ ),  $\gamma\gamma$ -coin.  $^{106}\text{Pd}$ ( $^{32}\text{S}, 2n2p$ ), E=152 MeV; measured  $\gamma\gamma$ -coin, DSA.  $^{64}\text{Zn}$ ( $^{76}\text{Se}, n2p$ ), E=300 MeV; measured  $\gamma$ -spectra.  $^{132}\text{Ce}$ ,  $^{133}\text{Nd}$ ,  $^{137}\text{Sm}$  deduced levels, J,  $\pi$ , band structure, superdeformed bands.

**88PiZW Search for Superdeformed States in the Continuum of  $^{146}\text{Gd}$**

S. Pilotte, P. Taras, F. Banville, S. Flibotte, J. Gascon, B. Haas, H. R. Andrews, D. C. Radford, D. Ward, AECL-9758, p. 3-9 (1988).

**Nuclear Reactions:** +124)Sn( $^{30}\text{Si},6n$ ), ( $^{30}\text{Si},4n$ ), ( $^{30}\text{Si}, 5n$ ), E=150 MeV; measured  $\gamma$ -energy correlation; deduced residuals relative yields.  $^{146}\text{Gd}$  deduced superdeformed states.

**88Ra19 A Superdeformed Band in  $^{151}\text{Dy}$**

G. -E. Rathke, R. V. F. Janssens, M. W. Drigert, I. Ahmad, K. Beard, R. R. Chasman, U. Garg, M. Hass, T. L. Khoo, H. -J. Komer, W. C. Ma, S. Pilotte, P. Taras, F. L. H. Wolfs, Phys. Lett. 209B, 177 (1988).

**Nuclear Reactions:** +122)Sn( $^{28}\text{S},5n$ ), E=174. 5 MeV; measured  $\gamma\gamma$ -coin,  $\gamma$  multiplicity, E $\gamma$ , I $\gamma$ .  $^{151}\text{Dy}$  deduced levels, J,  $\pi$ ,  $\gamma$ -branching, deformation, superdeformation features.

**88RzZY Search for Superdeformation in  $^{146}\text{Gd}$  and  $^{186}\text{Os}$**

T. Rzaca-Urban, W. Gast, G. Hebbinghaus, A. Kramer-Flecken, R. M. Lieder, H. Schnare, C. Senff, M. Thoms, W. Urban, G. de Angelis, P. Kleinheinz, W. Starzecki, J. Styczen, P. von Brentano, A. Dewald, J. Eberth, W. Lieberz, T. Mylaeus, A. v. d. Werth, H. Wolters, K. O. Zell, S. Heppner, H. Hubel, M. Murzel, H. Grawe, H. Kluge, K. H. Maier, R. Chapman, J. C. Lisle, J. N. Mo, J. D. Garrett, G. Sletten, J. Bacelar, Proc. of the Conf. on High-Spin Nuclear Structure and Novel Nuclear Shapes, April 13-15, 1988, Argonne National Laboratory, Argonne, Illinois; ANL-PHY-88-2, p. 46 (1988).

**Nuclear Reactions:** +110)Pd( $^{40}\text{Ar},4n$ ), E=180 MeV;  $^{186}\text{Os}$ ( $^{28}\text{S}, 4n$ ), E=157 MeV;  $^{102}\text{Ru}$ ( $^{48}\text{Ca},4n$ ), E=205 MeV; measured  $\gamma\gamma(\theta)$ ,  $\gamma$ -energy correlation,  $\gamma\gamma$ -coin.  $^{146}\text{Gd}$ ,  $^{186}\text{Os}$  deduced levels, band structure, superdeformation evidence.

**88RzZZ Search of Superdeformation in  $^{186}\text{Os}$**

T. Rzaca-Urban, R. M. Lieder, W. Gast, W. Urban, J. Bacelar, J. D. Garrett, G. Sletten, R. Chapman, J. C. Lisle, J. N. Mo, JUL-Spez-442, p. 30 (1988).

**Nuclear Reactions:** +150)Nd( $^{28}\text{S},4n$ ), E=158 MeV; measured  $\gamma\gamma$ -coin, energy correlation.  $^{186}\text{Os}$  deduced superdeformation possibility.

**88ShAA**

Prog. Part. Nucl. Phys. 21, 293(1988) (review article) abstract unavailable.

**88StZW** *Some Results on  $\gamma$ -Rays Draining the Superdeformed Band in  $^{152}\text{Dy}$*

J. Styczen, H. Guven, W. Urban, G. Hebbinghaus, W. Gast, R. Menezz, P. Kleinheinz, JUL-Spez-442, p. 52 (1988).

**Nuclear Reactions:**  $+152\text{Gd}(\alpha,4n)$ ,  $E=60$  MeV; measured  $\gamma\gamma$ -coin,  $\gamma(\theta)$ , oriented nuclei.  $^{152}\text{Dy}$  deduced levels,  $J$ ,  $\pi$ ,  $\gamma$ -branching, superdeformed band.

**88Ta20** *Feeding of Discrete-Line Superdeformed Bands at Very High Spin*

P. Taras, S. Flibotte, J. Gascon, B. Haas, S. Pilotte, D. C. Radford, D. Ward, H. R. Andrews, G. C. Ball, F. Banville, S. Courmoyer, D. Horn, J. K. Johansson, S. Monaro, N. Nadon, D. Prevost, C. Pruneau, D. Thibault, D. M. Tucker, J. C. Waddington, Phys. Rev. Lett. 61, 1348 (1988).

**Nuclear Reactions:**  $+124\text{Sn}(\alpha,4n)$ ,  $(^{28}\text{Si},5n)$ ,  $(^{28}\text{Si},6n)$ ,  $(^{28}\text{Si},xn)$ ,  $E=140-160$  MeV; measured  $\gamma$  yields,  $\gamma$  sum spectra, multiplicities.  $^{140}\text{Gd}$  deduced superdeformed band features.

**88TwZZ** *Superdeformation - Perspectives*

P. J. Twin, Proc. of the Conf. on High-Spin Nuclear Structure and Novel Nuclear Shapes, April 13-15, 1988, Argonne National Laboratory, Argonne, Illinois; ANL-PHY-88-2, p. 83 (1988).

**Nuclear Reactions:**  $+130\text{Te}(\alpha,6n)$ ,  $E=145$  MeV;  $^{100}\text{Pd}(\alpha,4n)$ ,  $E=205$  MeV; measured not given.  $^{100}\text{Gd}$ ,  $^{152}\text{Dy}$  deduced band structure, superdeformation.

**88WaZR** *A Search for Discrete Line Superdeformed Bands in  $^{120}\text{Ba}$  and  $^{164}\text{Pt}$*

J. C. Waddington, J. K. Johansson, D. Rajnauth, D. Tucker, H. R. Andrews, G. C. Ball, D. Horn, D. C. Radford, D. Ward, M. P. Carpenter, V. P. Janzan, L. L. Riedinger, F. Banville, J. Gascon, S. Monaro, N. Nadon, S. Pilotte, D. Prevost, P. Taras, D. Thibault, Proc. of the Conf. on High-Spin Nuclear Structure and Novel Nuclear Shapes, April 13-15, 1988, Argonne National Laboratory, Argonne, Illinois; ANL-PHY-88-2, p. 41 (1988).

**Nuclear Reactions:**  $+96\text{Zr}(\alpha,4n)$ ,  $E=155$  MeV;  $^{100}\text{Gd}(\alpha,5n)$ ,  $E=151$  MeV; measured  $\gamma\gamma$ -coin,  $\gamma$ -energy correlations.  $^{120}\text{Ba}$ ,  $^{164}\text{Pt}$  deduced levels,  $J$ ,  $\pi$ , band structure, possible superdeformation.

**89AKZY** *Search for Low-Spin Superdeformed States in  $^{160}\text{Hg}$*

Y. A. Akovali, E. A. Henry, J. A. Becker, J. Kormicki, C. R. Bingham, R. Meyer, H. K. Carter, W. Schmidt-Ott, I. C. Girit, Y. -S. Xu, H. Carmichael, ORNL-6508, p. 90 (1989).

**Radioactivity:**  $^{160}\text{Tl}$ ; measured  $E_\gamma$ ,  $I_\gamma$ ,  $E_\alpha$ ,  $I_\alpha$ ,  $\alpha\gamma$ ,  $\gamma\gamma$ -coin,  $\gamma(\theta)$ .  $^{160}\text{Au}$ ,  $^{160}\text{Pt}$ ,  $^{160}\text{Ir}$ ,  $^{160}\text{Hg}$  deduced transitions, possible superdeformation.

**89AkZZ** *Search for Low-Spin Superdeformed States in  $^{160}\text{Hg}$  and  $^{160}\text{Hg}$*

Y. A. Akovali, H. K. Carter, W. D. Hamilton, I. C. Girit, J. Breitenbach, C. R. Bingham, W. Schmidt-Ott, R. L. Knight, J. M. Bauer, J. A. Becker, E. A. Henry, R. A. Meyer, N. Roy, J. Kormicki, Bull. Am. Phys. Soc. 34, No. 8, 1816, CC4 (1989).

**Radioactivity:**  $^{160}\text{Tl}$ ; measured not given.  $^{160}\text{Au}$ ,  $^{160}\text{Hg}$  deduced levels,  $J$ , shape characteristics, possible superdeformation.

**89AIZS** *The De-Excitation of the Superdeformed Band in  $^{152}\text{Dy}$*

A. Alderson, P. J. Twin, M. A. Bentley, A. M. Bruce, P. Fallon, P. D. Forsyth, D. Howe, J. W. Roberts, J. F. Sharpey-Schafer, Daresbury Lab., 1988-1989 Ann. Rept., Appendix, p. 50 (1989).

**Nuclear Reactions:**  $+108\text{Pd}(\alpha,4n)$ ,  $E=197$  MeV; measured  $\gamma\gamma$ -coin, energy correlations.  $^{152}\text{Dy}$  deduced levels,  $J$ ,  $\pi$ , superdeformed band.

**89BaZC** *Search for Superdeformed Bands in  $^{82}\text{Sr}$*

C. Baktash, M. A. Riley, G. Garcia-Bermudez, A. Virtanen, M. L. Halbert, V. Abenante, D. C. Hensley, D. G. Sarantites, N. R. Johnson, T. M. Semkow, I. Y. Lee, H. C. Griffin, F. K. McGowan, X. T. Liu, ORNL-6508, p. 75 (1989).

**Nuclear Reactions:**  $+52\text{Cr}(\alpha,2n2p)$ ,  $E=130$  MeV; measured  $\gamma\gamma$ -coin.  $^{82}\text{Sr}$  deduced levels,  $J$ ,  $\pi$ , moments of inertia, band structure, possible superdeformation.

**89BeYO** *Lifetimes and Line-Shapes in the Superdeformed Band of  $^{152}\text{Dy}$*

M. A. Bentley, N. Rowley, K. Schiffer, P. D. Forsyth, H. W. Crammer-Gordon, D. Howe, A. R. Mokhtar, J. D. Morrison, J. F. Sharpey-Schafer, P. J. Twin, Daresbury Lab., 1988-1989 Ann. Rept., Appendix, p. 55 (1989).

**Nuclear Reactions:**  $+108\text{Pd}(\alpha,4n)$ ,  $E=205$  MeV; analyzed data.  $^{152}\text{Dy}$  deduced superdeformed band features.

**89BeYP** *The Population Mechanism of the Superdeformed Band in  $^{152}\text{Dy}$*

M. A. Bentley, A. Alderson, P. Fallon, P. D. Forsyth, J. D. Morrison, J. W. Roberts, J. F. Sharpey-Schafer, P. J. Twin, B. M. Nyako, C. A. Kafas, Daresbury Lab., 1988-1989 Ann. Rept., Appendix, p. 52 (1989).

**Nuclear Reactions:**  $+108\text{Pd}(\alpha,4n)$ ,  $E=195-212$  MeV; measured  $\gamma\gamma$ -coin.  $^{152}\text{Dy}$  deduced levels,  $J$ ,  $\pi$ , superdeformed band, level population intensity. Comparison with other data.

**89BeZD** *Evidence for Superdeformation at  $N=80$ ,  $Z=64$*

Ph. Benet, P. J. Daly, I. Ahmad, P. Fernandez, T. Happ, R. V. F. Janssens, T. L. Khoo, E. F. Moore, F. L. H. Wolfs, M. W. Drigert, K. B. Beard, D. Ye, Bull. Am. Phys. Soc. 34, No. 8, 1824, DC2 (1989).

**Nuclear Reactions:**  $+98\text{Mo}(\alpha,4n)$ ,  $E=219$  MeV; measured  $\gamma(\theta)$ ; deduced  $N=80$ ,  $Z=64$  superdeformation.

**89De10** *Superdeformation in the Odd-Odd Nucleus  $^{160}\text{Tb}$ : Experimental search for superdeformed configurations*

M. A. Deleplanque, C. W. Beausang, J. Burde, R. M. Diamond, F. S. Stephens, R. J. McDonald, J. E. Draper, Phys. Rev. C39, 1651 (1989).

**Nuclear Reactions:**  $+124\text{Sn}(\alpha,4n)$ ,  $E=160$  MeV; measured  $E(\gamma)$ ,  $I(\gamma)$ ,  $\gamma(\theta)$ ,  $\gamma\gamma$ -coin.  $^{160}\text{Tb}$  deduced levels,  $J$ ,  $\pi$ , deformation, band structure, superdeformed band.

**89Fa02** *Superdeformed Bands in  $^{160}\text{Gd}$  and  $^{161}\text{Tb}$ : Evidence for the influence of high- $N$  intruder states at large deformations*

P. Fallon, P. Alderson, M. A. Bentley, A. M. Bruce, P. D. Forsyth, D. Howe, J. W. Roberts, J. F. Sharpey-Schafer, P. J. Twin, F. A. Beck, T. Byrski, D. Curien, C. Schuck, Phys. Lett. 218B, 137 (1989).

**Nuclear Reactions:**  $+130\text{Te}(\alpha,6n)$ ,  $E=145$  MeV;  $^{130}\text{Te}(\alpha,6n)$ ,  $E=150$  MeV; measured  $\gamma\gamma$ -coin,  $\gamma(\theta)$ .  $^{160}\text{Gd}$ ,  $^{161}\text{Tb}$  deduced levels,  $J$ ,  $\pi$ , superdeformed band structure, shapes, moments of inertia.

**89Go13** *The Proton Structure of the Superdeformed Bands in the  $N=73$  Isotones  $^{120}\text{La}$ ,  $^{121}\text{Ce}$  and  $^{123}\text{Nd}$*

M. J. Godfrey, Y. He, I. Jenkins, A. Kirwan, P. J. Nolan, R. Wadsworth, S. M. Mullins, J. Phys. (London) G15, L163 (1989).

**Nuclear Reactions:**  $+51\text{V}(\alpha,3n)$ ,  $E=290$  MeV; measured  $\gamma\gamma$ -coin.  $^{120}\text{La}$  deduced levels, superdeformed band structure, shape features, moments of inertia.

**89GoZR** *A Superdeformed Band in  $^{120}\text{La}$*

M. J. Godfrey, Y. He, I. Jenkins, A. Kirwan, P. J. Nolan, R. Wadsworth, S. M. Mullins, Daresbury Lab., 1988-1989 Ann. Rept., Appendix, p. 30 (1989).

**Nuclear Reactions:**  $+51\text{V}(\alpha,3n)$ ,  $E=290$  MeV; measured  $\gamma\gamma$ -coin.  $^{120}\text{La}$  deduced levels,  $J$ ,  $\pi$ , superdeformed band structure.

**89HeYZ** *Search for Low-Spin Superdeformed States in  $^{164}\text{Hg}$*

E. A. Henry, C. R. Bingham, Y. A. Akovali, W. D. Schmidt-Ott, J. A. Becker, R. A. Meyer, H. K. Carter, Y. S. Xu, J. Kormicki, H. V. Carmichael, ORNL-6508, p. 150 (1989).

**Radioactivity:**  $^{164}\text{Tl}$ ; measured  $E_\gamma$ ,  $I_\gamma$ ,  $\gamma\gamma$ ,  $\alpha\gamma$ -coin,  $E_\alpha$ ,  $I_\alpha$ .  $^{164}\text{Hg}$  deduced levels, possible superdeformation.

**89HeZl Mean Lifetime Measurements in the Superdeformed Band in  $^{151}\text{Ce}$** 

Y. He, M. J. Godfrey, I. Jenkins, P. J. Nolan, R. Wadsworth, S. M. Mullins, J. R. Hughes, Daresbury Lab., 1988-1989 Ann. Rept., Appendix, p. 32 (1989).

**Nuclear Reactions:**  $+100\text{Mo}(^{86}\text{S},5\text{n})$ ,  $E=155$  MeV; measured centroid shifts.  $^{151}\text{Ce}$  deduced levels, superdeformed quadrupole moment.

**89HeZR Discovery of a Discrete Superdeformed Band in  $^{146}\text{Gd}$** 

G. Hebbinghaus, K. Strahle, T. Rzaca-Urban, D. Alber, D. Balabanski, E. M. Beck, P. von Brentano, W. Gast, J. Eberth, H. Hubel, H. Kluge, A. Kramer-Flecken, R. M. Lieder, H. Maier, W. Schmitz, M. Thoms, W. Urban, H. Wolters, K. O. Zell, JUL-Spez-499, p. 28 (1989).

**Nuclear Structure:**  $+146\text{Gd}$ ; analyzed data; deduced discrete superdeformed band in  $^{146}\text{Gd}$ .

**89Jo04 Multiple Superdeformed Bands in  $^{152}\text{Dy}$** 

J. K. Johansson, H. R. Andrews, T. Bengtsson, A. Djaafri, T. E. Drake, S. Flibotte, A. Galindo-Uribarri, D. Horn, V. P. Janzen, J. A. Kuehner, S. Monaro, N. Nadon, S. Pilotte, D. Prevost, D. C. Radford, I. Ragnarsen, P. Taras, A. Tehami, J. C. Waddington, D. Ward, S. Aberg, Phys. Rev. Lett. 63, 2200 (1989).

**Nuclear Reactions:**  $+124\text{Sn}(^{86}\text{S},5\text{n})$ ,  $E$  not given; measured  $\gamma\gamma$ -coin, sum spectra.  $^{152}\text{Dy}$  deduced levels,  $J$ ,  $\pi$ , moment of inertia, band structure, deformation, superdeformation features.

**89KoZL Superdeformation a Spin Nul dans  $^{160}\text{Pt}$** 

A. Korichi, Ch. Bourgeois, N. Perrin, H. Sergolle, M. G. Porquet, F. Hannachi, G. Bastin, N. Redon, M. Meyer, R. Beraud, Ph. Quentin, H. Hubel, Univ. Paris, Inst. Phys. Nucl., 1989 Ann. Rept., p. E33 (1989).

**Nuclear Reactions:**  $+176\text{Yb}(^{14}\text{O},5\text{n})$ ,  $E=145$  MeV; measured  $\gamma$ -spectra.  $^{160}\text{Pt}$  deduced levels,  $J$ ,  $\pi$ .

**89LiZV A Search for Superdeformation in  $^{86}\text{Zr}$** 

C. J. Lister, P. Chowdhury, P. Ennis, B. Crowell, H. R. Andrews, D. Horn, D. C. Radford, D. Ward, S. Pilotte, J. C. Waddington, J. K. Johansson, AECL-9859, p. 3-5 (1989).

**Nuclear Reactions:**  $+60\text{Ni}(^{28}\text{Si},2\text{n}2\text{p})$ ,  $E=135$  MeV; measured  $\gamma$ -multiplicities.  $8\pi$  spectrometer; deduced possible superdeformation effects.

**89Mo08 Observation of Superdeformation in  $^{181}\text{Hg}$** 

E. F. Moore, R. V. F. Janssens, R. R. Chasman, I. Ahmad, T. L. Khoo, F. L. H. Wolfs, D. Ye, K. B. Beard, U. Garg, M. W. Drigert, Ph. Benet, Z. W. Grabowski, J. A. Cizewski, Phys. Rev. Lett. 63, 360 (1989).

**Nuclear Reactions:**  $+160\text{Gd}(^{86}\text{S},5\text{n})$ ,  $E=172$  MeV; measured  $\gamma\gamma$ -coin.  $^{181}\text{Hg}$  deduced superdeformed band structure, shape characteristics.

**89MoZS Feeding of the Superdeformed Band in  $^{181}\text{Hg}$** 

E. F. Moore, R. V. F. Janssens, D. Ye, M. P. Carpenter, P. Fernandez, I. Ahmad, K. B. Beard, Ph. Benet, R. R. Chasman, M. D. Drigert, T. L. Khoo, F. L. H. Wolfs, Bull. Am. Phys. Soc. 34, No. 8, 1816, CC5 (1989).

**Nuclear Structure:**  $+191\text{Hg}$ ; measured not given; deduced superdeformed band feeding features.

**89MoZX Feeding of the Superdeformed Band in  $^{182}\text{Dy}$** 

E. F. Moore, I. Ahmad, M. Hass, R. V. F. Janssens, T. L. Khoo, H. J. Komer, W. C. Ma, G. -E. Rathke, F. L. H. Wolfs, U. Garg, D. Ye, K. Beard, Z. Grabowski, M. W. Drigert, Bull. Am. Phys. Soc. 34, No. 4, 1234, J8 6 (1989).

**Nuclear Reactions:**  $+120\text{Sn}(^{86}\text{S},4\text{n})$ ,  $E=172$  MeV; measured not given.  $^{182}\text{Dy}$  deduced levels, band structure, deformation, superdeformation features.

**89MuZR Normal and Highly Deformed Rotational Bands in  $^{150}\text{Sm}$  and  $^{152}\text{Nd}$** 

S. M. Mullins, Thesis, Univ. York (1989).

**Nuclear Reactions:**  $+64\text{Zn}(^{74}\text{Se},\text{n}2\text{p})$ ,  $E=290$  MeV;  $^{82}\text{Mo}(^{46}\text{Ti}, \text{n}2\text{p})$ ,  $E=210$  MeV;  $^{104}\text{Pd}(^{28}\text{S},\text{n}2\text{p})$ ,  $E=152$  MeV; measured  $\gamma\gamma$ -coin, DSA.  $^{150}\text{Sm}$  deduced levels, band structure, configuration.  $^{152}\text{Nd}$  deduced levels,  $J$ ,  $\pi$ , superdeformed band, quadrupole moment. Cranked shell model, total Routhian surface calculations.

**89NyZX Search for Superdeformation in  $^{129}\text{La}$** 

B. M. Nyako, S. Andre, D. Barneoud, F. A. Beck, H. El-Samman, C. Foin, J. Genevey, A. Gizon, J. Gizon, M. Jozsa, J. C. Merdinger, L. Zolnai, ATOMKI 1988 Ann. Rept., p. 16 (1989).

**Nuclear Reactions:**  $+100\text{Mo}(^{84}\text{S},4\text{n})$ ,  $E=165$  MeV; measured  $\gamma\gamma$ -coin.  $^{129}\text{La}$  deduced levels, band structure, possible superdeformation.

**89RaZX Search for a Second Superdeformed Band in  $^{132}\text{Nd}$** 

D. C. Radford, H. R. Andrews, B. Herskind, J. F. Sharpey-Schafer, S. Pilotte, S. Flibotte, D. Prevost, J. K. Johansson, J. C. Waddington, AECL-9859, p. 3-8 (1989).

**Nuclear Reactions:**  $+110\text{Pd}(^{28}\text{Si},5\text{n})$ ,  $E=151, 155$  MeV; measured  $\gamma\gamma$ -coin,  $\gamma$ -multiplicity, sum spectra.  $^{132}\text{Nd}$  deduced levels,  $J$ ,  $\pi$ , band structure, shape, no evidence for second superdeformed band.

**89RoZS Search for a Superdeformed Band in  $^{182}\text{Hg}$** 

N. Roy, J. A. Becker, E. A. Henry, J. A. Cizewski, M. J. Brinkman, C. Beausang, M. A. Deleplanque, R. M. Diamond, F. S. Stephens, J. E. Draper, Bull. Am. Phys. Soc. 34, No. 8, 1816, CC7 (1989).

**Nuclear Reactions:**  $+176\text{Yb}(^{22}\text{Ne},6\text{n})$ ,  $E=122$  MeV; measured  $\gamma$ -spectra.  $^{182}\text{Hg}$  deduced levels, superdeformed band structure, moment of inertia.

**89Sc02 Lifetimes and Lineshapes in Superdeformed Bands**

K. Schiffer, B. Herskind, J. Gascon, Z. Phys. A332, 17 (1989).

**Nuclear Structure:**  $+152\text{Dy}$ ; calculated levels,  $T_{1/2}$ ,  $B(\lambda)$ ,  $I(\gamma)$ ; deduced normal, superdeformed state mixing. Statistical model, Monte Carlo simulation.

**89Sc30  $\gamma$  Decay of the Superdeformed Shape Isomer in  $^{226}\text{U}$** 

J. Schirmer, J. Gerl, D. Habs, D. Schwalm, Phys. Rev. Lett. 63, 2196 (1989).

**Nuclear Reactions:**  $+235\text{U}(d,p)$ ,  $E=11$  MeV; measured  $\gamma$  time spectra, missing energy vs delayed sum energy.  $^{226}\text{U}$  deduced isomer, decay, superdeformation features,  $\gamma$ -decay to fission branching ratio.

**89ScZS Search for Superdeformation in  $^{180}\text{Os}$** 

H. Schnare, T. Rzaca-Urban, D. Balabanski, W. Gast, G. Hebbinghaus, A. Kramer-Flecken, R. M. Lieder, W. Urban, K. H. Maier, G. Sletten, JUL-Spez-499, p. 41 (1989).

**Nuclear Reactions:**  $+150\text{Nd}(^{86}\text{S},4\text{n})$ ,  $E=158$  MeV; measured  $E_\gamma$ ,  $\gamma\gamma$ -coin,  $\gamma$ -multiplicities,  $\gamma\gamma$ -energy correlation.  $^{180}\text{Os}$  deduced levels, band deformation, superdeformation features.

**89Ta12 Additional Superdeformed States in the Continuum of  $^{146}\text{Gd}$** 

P. Taras, S. Flibotte, J. Gascon, B. Haas, S. Pilotte, D. C. Radford, D. Ward, H. R. Andrews, F. Banville, J. K. Johansson, J. C. Waddington, Phys. Lett. 222B, 357 (1989).

**Nuclear Reactions:**  $+124\text{Sn}(^{28}\text{Si},5\text{n})$ ,  $E=150$  MeV; analyzed data.  $^{146}\text{Gd}$  deduced levels,  $J$ ,  $\pi$ , superdeformation.

**89W119 High Spin States in  $^{76}\text{Kr}$ : Approaching superdeformation in the  $A = 80$  Region**

D. F. Winchell, M. S. Kaplan, J. X. Saladin, H. Takai, J. J. Kolata, J. Dudek, Phys. Rev. C40, 2672 (1989).

**Nuclear Reactions:**  $+46\text{Ti}(^{32}\text{S},\text{n}2\text{p})$ ,  $E=97$  MeV; measured  $\gamma\gamma$ -coin.  $^{76}\text{Kr}$  deduced levels,  $J$ ,  $\pi$ , moment of inertia, possible superdeformation. Cranked HFB calculations.

- Nuclear Structure:** +75)Kr; calculated Routhians, moments of inertia; deduced possible superdeformation. Cranked HFB.
- 89Zu01 Non-Yrast States in  $^{152}\text{Dy}$  Around  $22(\hbar\text{-bar})$ , the Region into which the Discrete Superdeformed Band Drains**
- K. Zuber, E. Bozek, F. A. Beck, P. Benet, T. Byrski, D. Curien, G. Duchene, C. Gehringer, B. Haas, A. Kreiner, J. C. Merdinger, P. Romain, J. P. Vivien, *Z. Phys.* A332, 231 (1989).
- Nuclear Reactions:** +124)Sn( $^{28}\text{S},4n$ ),  $E=132$  MeV; measured  $\gamma\gamma$ -coin.  $^{152}\text{Dy}$  deduced levels, J,  $\pi$ , superdeformed band drainage.
- 90AaZZ Superdeformed Band in  $^{146}\text{Gd}$ : First observation of band crossing**
- S. Aaberg, D. Alber, D. Balabanski, E. M. Beck, T. Bengtsson, P. von Brentano, J. Eberth, W. Gast, G. Hebbinghaus, H. Hubel, R. M. Lieder, K. H. Maier, E. Ott, I. Ragnarsson, T. Rzaca-Urban, W. Schmitz, H. Schnare, K. Strahle, J. Theuerkauf, W. Urban, H. Wolters, K. O. Zell, *JUL-Spez-562*, p. 55 (1990).
- Nuclear Reactions:** +110)Pd( $^{46}\text{Ar},4n$ ),  $E=175$  MeV; measured  $E_\gamma$ ,  $I_\gamma$ ,  $\gamma(t)$ ,  $\gamma\gamma$  correlation matrix.  $^{146}\text{Gd}$  deduced levels, J,  $\pi$ , superdeformed band structure.
- 90AIZY Population of the Superdeformed Continuum in  $^{152}\text{Dy}$**
- A. Alderson, P. Fallon, P. D. Forsyth, D. Howe, J. W. Roberts, J. F. Sharpey-Schafer, P. J. Twin, M. A. Bentley, A. M. Bruce, Daresbury Labs., 1989-1990 Ann. Rept., Appendix, p. 49 (1990).
- Nuclear Reactions:** +108)Pd( $^{46}\text{Ca},xn$ ),  $E=197$  MeV; measured  $\gamma\gamma$ -coin.  $^{152}\text{Dy}$  deduced superdeformed continuum features.
- 90AIZZ The Collectivity of the Superdeformed Band in  $^{152}\text{Dy}$  at the Point of De-Excitation**
- A. Alderson, I. Ali, D. M. Cullen, P. Fallon, P. D. Forsyth, M. A. Riley, J. W. Roberts, J. F. Sharpey-Schafer, P. J. Twin, M. A. Bentley, A. M. Bruce, Daresbury Labs., 1989-1990 Ann. Rept., Appendix, p. 47 (1990).
- Nuclear Reactions:** +108)Pd( $^{46}\text{Ca},xn$ ),  $E=197$  MeV; measured DSA,  $\gamma$ -multiplicity, transition fractional Doppler shifts.  $^{152}\text{Dy}$  deduced superdeformed band quadrupole moment.
- 90Az03 Superdeformed Bands in  $^{164}\text{Tl}$**
- F. Azaiez, W. H. Kelly, W. Korten, M. A. Deleplanque, F. S. Stephens, R. M. Diamond, C. W. Beausang, J. A. Becker, E. A. Henry, J. E. Draper, M. J. Brinkman, S. W. Yates, A. Kuhnert, E. Rubel, *Z. Phys.* A336, 243 (1990).
- Nuclear Reactions:** +176)Yb( $^{28}\text{Na},5n$ ), ( $^{28}\text{Na},4n$ ), ( $^{28}\text{Na},6n$ ),  $E=116, 122$  MeV;  $^{181}\text{Ta}(^{16}\text{O},6n)$ , ( $^{16}\text{O},5n$ ), ( $^{16}\text{O},4n$ ),  $E=95-104$  MeV; measured  $\gamma\gamma$ -coin.  $^{164}\text{Tl}$  deduced levels, J,  $\pi$ , superdeformed band structure.
- 90Az06 Superdeformed Bands in  $^{164}\text{Tl}$**
- F. Azaiez, W. H. Kelly, W. Korten, M. A. Deleplanque, F. S. Stephens, R. M. Diamond, C. W. Beausang, J. A. Becker, E. A. Henry, J. E. Draper, M. J. Brinkman, S. W. Yates, A. Kuhnert, E. Rubel, *Nucl. Phys.* A520, 121c (1990).
- Nuclear Reactions:** +176)Yb( $^{28}\text{Na},4n$ ), ( $^{28}\text{Na},5n$ ), ( $^{28}\text{Na},6n$ ),  $E=116, 122$  MeV;  $^{181}\text{Ta}(^{16}\text{O},X)$ ,  $E=95-104$  MeV; measured  $\gamma\gamma$ -coin.  $^{164}\text{Tl}$  deduced levels, superdeformed band structure.
- 90Be01 Observation of Superdeformation in  $^{182}\text{Hg}$**
- J. A. Becker, N. Roy, E. A. Henry, M. A. Deleplanque, C. W. Beausang, R. M. Diamond, J. E. Draper, F. S. Stephens, J. A. Cizewski, M. J. Brinkman, *Phys. Rev.* C41, R9 (1990).
- Nuclear Reactions:** +176)Yb( $^{28}\text{Ne},6n$ ),  $E=122$  MeV; measured  $\gamma\gamma$ -coin.  $^{182}\text{Hg}$  deduced levels, J,  $\pi$ , superdeformed band structure. HERA detector array.
- 90Be11 Observation of Superdeformed Bands in  $^{184}\text{Hg}$**
- C. W. Beausang, E. A. Henry, J. A. Becker, N. Roy, S. W. Yates, M. A. Deleplanque, R. M. Diamond, F. S. Stephens, J. E. Draper, W. H. Kelly, J. Burde, R. J. McDonald, E. Rubel, M. J. Brinkman, J. A. Cizewski, Y. A. Akovali, *Z. Phys.* A335, 325 (1990).
- Nuclear Reactions:** +150)Nd( $^{46}\text{Ca},4n$ ), ( $^{46}\text{Ca},5n$ ),  $E=195-210$  MeV; measured  $\gamma\gamma$ ,  $\gamma\gamma$ -coin.  $^{184}\text{Hg}$  deduced levels, J,  $\pi$ , superdeformed band structure.
- 90Br10 Superdeformation in Lead Nuclei**
- M. J. Brinkman, A. Kuhnert, E. A. Henry, J. A. Becker, S. W. Yates, R. M. Diamond, M. A. Deleplanque, F. S. Stephens, W. Korten, F. Azaiez, W. H. Kelly, J. E. Draper, C. W. Beausang, E. Rubel, J. A. Cizewski, *Z. Phys.* A336, 115 (1990).
- Nuclear Reactions:** +176)Yb( $^{24}\text{Mg},xn$ ),  $E=122-132$  MeV; measured  $\gamma\gamma$ -coin.  $^{184}, ^{186}\text{Pb}$  deduced levels, J,  $\pi$ , superdeformed band structure.
- 90BrZN Superdeformed Bands in  $^{182}\text{Hg}$**
- M. J. Brinkman, E. A. Henry, C. W. Beausang, J. A. Becker, N. Roy, S. W. Yates, R. M. Diamond, M. A. Deleplanque, F. S. Stephens, J. E. Draper, W. H. Kelly, R. J. McDonald, J. Burde, A. Kuhnert, W. Korten, E. Rubel, J. A. Cizewski, Y. A. Akovali, *Proc. Inter. Conf. Nuclear Structure of the Nineties*, Oak Ridge, Tennessee, Vol. 1, p. 5 (1990).
- Nuclear Reactions:** +176)Yb( $^{24}\text{Ne},5n$ ),  $^{150}\text{Nd}(^{46}\text{Ca},5n)$ ,  $E$  not given; measured  $\gamma$ -spectra.  $^{182}\text{Hg}$  deduced levels, J,  $\pi$ , superdeformed band structure.
- 90BrZQ Search for Superdeformed Bands in Lead**
- M. J. Brinkman, J. A. Cizewski, A. Kuhnert, E. A. Henry, J. A. Becker, S. W. Yates, R. M. Diamond, M. A. Deleplanque, F. S. Stephens, R. J. McDonald, W. Korten, F. Azaiez, W. H. Kelly, C. W. Beausang, J. E. Draper, E. Rubel, *Bull. Am. Phys. Soc.* 35, No. 6, 1398, H6 14 (1990).
- Nuclear Reactions:** +176)Yb( $^{24}\text{Mg},xn$ ),  $E=122, 127, 132$  MeV; measured  $E_\gamma$ .  $^{184}, ^{186}\text{Pb}$  deduced superdeformed band structure.
- 90BrZX Search for Superdeformed Bands in  $^{182}\text{Hg}$**
- M. J. Brinkman, J. A. Cizewski, E. A. Henry, J. A. Becker, N. Roy, S. W. Yates, A. Kuhnert, C. W. Beausang, R. M. Diamond, M. A. Deleplanque, F. S. Stephens, R. J. McDonald, J. Burde, W. Korten, J. E. Draper, E. Rubel, W. H. Kelly, Y. A. Akovali, *Bull. Am. Phys. Soc.* 35, No. 4, 1017, H6 11 (1990).
- Nuclear Reactions:** +176)Yb( $^{28}\text{Ne},5n$ ),  $^{150}\text{Nd}(^{46}\text{Ca},5n)$ ,  $E$  not given; measured  $E_\gamma$ .  $^{182}\text{Hg}$  deduced levels, J,  $\pi$ , superdeformed band structure.
- 90By01 Observation of Identical Superdeformed Bands in  $N = 86$  Nuclei**
- T. Byrski, F. A. Beck, D. Curien, C. Schuck, P. Fallon, A. Alderson, I. Ali, M. A. Bentley, A. M. Bruce, P. D. Forsyth, D. Howe, J. W. Roberts, J. F. Sharpey-Schafer, G. Smith, P. J. Twin, *Phys. Rev. Lett.* 64, 1650 (1990).
- Nuclear Reactions:** +130)Te( $^{26}\text{Mg},6n$ ),  $E=145$  MeV;  $^{150}\text{Te}(^{27}\text{Al},6n)$ ,  $E=150$  MeV; measured  $\gamma\gamma$ -coin, sum spectra.  $^{150}\text{Gd}$ ,  $^{151}\text{Tb}$  deduced levels, J,  $\pi$ , superdeformed band structure.
- 90Ca18 Excited Superdeformed Bands in  $^{181}\text{Hg}$**
- M. P. Carpenter, R. V. F. Janssens, E. F. Moore, I. Ahmad, P. B. Fernandez, T. L. Khoo, F. L. H. Wolfs, D. Ye, K. B. Beard, U. Garg, M. W. Drigart, Ph. Benet, R. Wyss, W. Satula, W. Nazarewicz, M. A. Riley, *Phys. Lett.* 240B, 44 (1990).
- Nuclear Reactions:** +160)Gd( $^{26}\text{S},5n$ ),  $E=167, 172$  MeV; measured  $\gamma\gamma$ -coin.  $^{181}\text{Hg}$  deduced levels, J,  $\pi$ , superdeformed band structure.
- 90Ca37 Evidence of Time Delay in the Decay of the Superdeformed Bands of  $^{191}, ^{192}\text{Hg}$**
- M. P. Carpenter, D. Ye, R. V. F. Janssens, T. L. Khoo, I. Ahmad, K. B. Beard, Ph. Benet, J. A. Cizewski, M. W. Drigart, P. Fernandez, U. Garg, E. F. Moore, F. L. H. Wolfs, *Nucl. Phys.* A520, 133c (1990).
- Nuclear Reactions:** +160)Gd( $^{26}\text{S},4n$ ), ( $^{26}\text{S},5n$ ),  $E=167$  MeV; measured  $\gamma\gamma$ -coin.  $^{191}, ^{192}\text{Hg}$  deduced levels, J,  $\pi$ , superdeformed band decay time delay.
- 90Cu05 Landau-Zener Crossing in Superdeformed  $^{182}\text{Hg}$ : Evidence for octupole**

*correlations in superdeformed nuclei*

D. M. Cullen, M. A. Riley, A. Alderson, I. Ali, C. W. Beausang, T. Bengtsson, M. A. Bentley, P. Fallon, P. D. Forsyth, F. Hanna, S. M. Mullins, W. Nazarewicz, R. J. Poynter, P. H. Regan, J. W. Roberts, W. Satula, J. F. Sharpey-Schafer, J. Simpson, G. Sletten, P. J. Twin, R. Wadsworth, R. Wyss, Phys. Rev. Lett. 65, 1547 (1990).

**Nuclear Reactions:** +150Nd(<sup>48</sup>Ca,5n), E=205, 213 MeV; measured E<sub>γ</sub>, I<sub>γ</sub>, γγ-coin. <sup>150</sup>Hg deduced levels, J, π, superdeformed band structure, shape features.

**90Cu06 Evidence for Octupole Softness of the Superdeformed Shape from Band Interactions in <sup>150, 154</sup>Hg**

D. M. Cullen, M. A. Riley, A. Alderson, I. Ali, T. Bengtsson, M. A. Bentley, A. M. Bruce, P. Fallon, P. D. Forsyth, F. Hanna, S. M. Mullins, W. Nazarewicz, R. Poynter, P. Regan, J. W. Roberts, W. Satula, J. F. Sharpey-Schafer, J. Simpson, G. Sletten, P. J. Twin, R. Wadsworth, R. Wyss, Nucl. Phys. A520, 105c (1990).

**Nuclear Reactions:** +150Nd(<sup>48</sup>Ca,4n), E=205 MeV; <sup>150</sup>Nd(<sup>48</sup>Ca, 5n), E=213 MeV; measured γγ-coin. <sup>150, 154</sup>Hg deduced levels, J, π, superdeformed band structure.

**90D101 Line Shape and Lifetimes in the <sup>150</sup>Nd Superdeformed Band**

R. M. Diamond, C. W. Beausang, A. O. Macchiavelli, J. C. Bacelar, J. Burde, M. A. Deleplanque, J. E. Draper, C. Duyar, R. J. McDonald, F. S. Stephens, Phys. Rev. C41, R1327 (1990).

**Nuclear Reactions:** +100Mo(<sup>40</sup>Ar,5n), E=175 MeV; measured γγ-coin, DSA. <sup>150</sup>Nd deduced levels, J, π, superdeformed band features, transition quadrupole moment.

**90DrZZ Search for Superdeformation in <sup>160</sup>Hg**

M. W. Drigert, I. Ahmad, M. P. Carpenter, P. Fernandez, R. V. F. Janssens, T. L. Khoo, E. F. Moore, F. L. H. Wolfs, D. Ye, K. Beard, U. Garg, Ph. Benet, Bull. Am. Phys. Soc. 35, No. 4, 1016, H6 8 (1990)

**Nuclear Reactions:** +160Gd(<sup>28</sup>S,4n), E=159 MeV; measured γ-spectra. <sup>160</sup>Hg deduced levels, superdeformed band features.

**90Fe07 Proton Excitations in the Superdeformed Well of <sup>182</sup>Tl**

P. B. Fernandez, M. P. Carpenter, R. V. F. Janssens, I. Ahmad, E. F. Moore, T. L. Khoo, F. Scarlassara, I. G. Bearden, Ph. Benet, P. J. Daly, M. W. Drigert, U. Garg, W. Reviol, D. Ye, S. Pilotte, Nucl. Phys. A517, 386 (1990).

**Nuclear Reactions:** +160Gd(<sup>27</sup>Cl,4n), E=167 MeV; measured E<sub>γ</sub>, I<sub>γ</sub>, γγ-coin. <sup>182</sup>Tl deduced levels, J, π, rotational, superdeformed bands characteristics. Enriched targets, Ge detectors, array of Compton suppressed spectrometers, 4π bismuth germanate array. Cranked Woods-Saxon calculations.

**90GaZO The Role of Charged Particles in the Population of the <sup>152</sup>Nd Superdeformed Band**

A. Galindo-Uribarri, T. K. Alexander, H. R. Andrews, G. C. Ball, T. E. Drake, S. Filibotte, J. S. Forster, V. P. Janzen, J. K. Johansson, S. Pilotte, D. Prevost, D. C. Radford, P. Taras, J. Waddington, D. Ward, G. Zwart, Proc. Inter. Conf. Nuclear Structure of the Nineties, Oak Ridge, Tennessee, Vol. 1, p. 14 (1990).

**Nuclear Reactions:** +105Pd(<sup>28</sup>S,X), E=155 MeV; measured (charged particle)γγ-coin, pγγ-coin. <sup>152</sup>Nd deduced superdeformed band.

**90Ha25 Feeding of the Superdeformed Yrast Band in <sup>140</sup>Gd**

B. Haas, J. P. Vivien, S. K. Basu, F. A. Beck, Ph. Benet, T. Byrski, D. Curien, G. Duchene, C. Gehringer, H. Kluge, J. C. Merdinger, P. Romain, D. Santos, S. Filibotte, J. Gascon, P. Taras, E. Bozek, K. Zuber, Phys. Lett. 245B, 13 (1990).

**Nuclear Reactions:** +124Sn(<sup>20</sup>Si,5n), E=150-160 MeV; measured γ-spectra. <sup>140</sup>Gd deduced superdeformed yrast band relative I<sub>γ</sub>.

**90Ha31 Observation of Excited Proton and Neutron Configurations in the Superdeformed <sup>140</sup>Gd Nucleus**

B. Haas, D. Ward, H. R. Andrews, G. C. Ball, T. E. Drake, S. Filibotte, A. Galindo-Uribarri, V. P. Janzen, J. K. Johansson, H. Kluge, J. Kuehner, A. Omar, S. Pilotte, D. Prevost, J. Rodriguez, D. C. Radford, P. Taras, J. P. Vivien, J. C. Waddington, S. Aberg, Phys. Rev. C42, R1817 (1990).

**Nuclear Reactions:** +124Sn(<sup>20</sup>Si,5n), E=155 MeV; <sup>124</sup>Sn(<sup>21</sup>P, 5n), E=156 MeV; measured γ-spectra, γγ-coin. <sup>140</sup>Gd deduced levels, J, π, superdeformed band structure.

**90He09 Superdeformed Bands in <sup>180</sup>Hg and <sup>184</sup>Hg**

E. A. Henry, M. J. Brinkman, C. W. Beausang, J. A. Becker, N. Roy, S. W. Yates, J. A. Cizewski, R. M. Diamond, M. A. Deleplanque, F. S. Stephens, J. E. Draper, W. H. Kelly, R. J. McDonald, J. Burde, A. Kuhnert, W. Korten, E. Rubel, Y. A. Akovall, Z. Phys. A335, 361 (1990).

**Nuclear Reactions:** +176Yb(<sup>22</sup>Ne,5n), (<sup>22</sup>Ne,6n), E=116, 122 MeV; <sup>180</sup>Nd(<sup>48</sup>Ca,5n), (<sup>48</sup>Ca,4n), E=195-210 MeV; measured γγ-coin. <sup>180, 184</sup>Hg deduced levels, J, π, superdeformed band structure.

**90He12 Quadrupole Moment of the Superdeformed Band in <sup>131</sup>Ce**

Y. He, M. J. Godfrey, I. Jenkins, A. J. Kirwan, P. J. Nolan, S. M. Mullins, R. Wadsworth, D. J. G. Love, J. Phys. (London) G16, 657 (1990).

**Nuclear Reactions:** +100Mo(<sup>28</sup>S,5n), E=155 MeV; measured γγ-coin, DSA. <sup>131</sup>Ce deduced levels, J, π, mean T<sub>v2</sub>, β<sub>2</sub>, superdeformed intrinsic quadrupole moment, band structure.

**90He23 Properties of Superdeformed Bands in the A = 194 Region**

E. A. Henry, J. A. Becker, M. J. Brinkman, A. Kuhnert, S. W. Yates, M. A. Deleplanque, R. M. Diamond, F. S. Stephens, C. W. Beausang, W. H. Kelly, W. Korten, F. Azaiez, J. E. Draper, E. Rubel, J. A. Cizewski, Y. A. Akovall, Nucl. Phys. A520, 115c (1990).

**Nuclear Reactions:** +150Nd(<sup>48</sup>Ca,5n), E=200, 205, 210 MeV; <sup>176</sup>Yb(<sup>22</sup>Ne, 5n), E=110, 116, 122 MeV; measured γγ-coin, relative I<sub>γ</sub>. <sup>180</sup>Hg deduced levels, superdeformed band structure.

**90Hu10 Superdeformation in <sup>184</sup>Pb**

H. Hubel, K. Theine, D. Mehta, W. Schmitz, P. Willsau, C. X. Yang, F. Hannachi, D. B. Fossan, H. Grawe, H. Kluge, K. H. Maier, Nucl. Phys. A520, 125c (1990).

**Nuclear Reactions:** +158Gd(<sup>40</sup>Ar,4n), E=178-188 MeV; measured γγ-coin, I<sub>γ</sub>. <sup>184</sup>Pb deduced superdeformed band structure, moments of inertia vs rotational frequency.

**90Kh06 Population of Superdeformed Bands, the Competition with Fission, and the Barrier between Normal and Superdeformed States**

T. L. Khoo, R. V. F. Janssens, E. F. Moore, K. B. Beard, Ph. Benet, I. Ahmad, M. P. Carpenter, R. R. Chasman, P. J. Daly, M. W. Drigert, U. Garg, Z. W. Grabowski, F. L. H. Wolfs, D. Ye, Nucl. Phys. A520, 169c (1990).

**Nuclear Reactions:** +160Gd(<sup>28</sup>S,4n), E=154-172 MeV; <sup>130</sup>Sn(<sup>28</sup>S, 4n), E=170 MeV; measured γγ-coin, γ-multiplicity. <sup>162</sup>Dy, <sup>162</sup>Hg deduced superdeformed band level entry, feeding spin features.

**90L132 Band Crossing in the Superdeformed Band of <sup>140</sup>Gd**

R. M. Lieder, Nucl. Phys. A520, 59c (1990).

**Nuclear Reactions:** +110Pd(<sup>40</sup>Ar,4n), E=175 MeV; measured γ-multiplicity, DSA, I<sub>γ</sub>. <sup>140</sup>Gd deduced levels, superdeformed band structure, Nilsson assignments.

**90Mo16 Lifetime Measurements in the Superdeformed Band of <sup>182</sup>Hg**

E. F. Moore, R. V. F. Janssens, I. Ahmad, M. P. Carpenter, P. B. Fernandez, T. L. Khoo, S. L. Ridley, F. L. H. Wolfs, D. Ye, K. B. Beard, U. Garg, M. W. Drigert, Ph. Benet, P. J. Daly, R. Wyss, W. Nazarewicz, Phys. Rev. Lett. 64, 3127 (1990).

**Nuclear Reactions:** +160Gd(<sup>28</sup>S,4n), E=159 MeV; measured γγ-coin, DSA. <sup>182</sup>Hg deduced levels, T<sub>v2</sub>, B(E2), transition quadrupole moment, J, π, superdeformed band structure.

## 90MoZS Population of Superdeformed States and Competition with Fission

E. F. Moore, R. V. F. Janssens, T. L. Khoo, I. Ahmad, M. P. Carpenter, R. R. Chasman, F. L. H. Wolfs, K. B. Beard, D. Ye, U. Garg, Ph. Benet, P. J. Daly, Z. W. Grabowski, M. W. Drigert, *Bull. Am. Phys. Soc.* 35, No. 8, 1657, BC 9 (1990)

**Nuclear Reactions:** +160]Gd(<sup>28</sup>S,4n), E=154-172 MeV; measured not given. <sup>192</sup>Hg deduced normal level, superdeformed states entry point comparison.

90MuZY A Superdeformed Band in <sup>142</sup>Eu

S. M. Mullins, P. Fallon, S. A. Forbes, Y. J. He, M. S. Metcalfe, P. J. Nolan, E. S. Paul, P. H. Regan, R. Wadsworth, Daresbury Lab., 1989-1990 Ann. Rept., Appendix, p. 37 (1990).

**Nuclear Reactions:** +110]Pd(<sup>27</sup>Cl,5n), E=160 MeV; measured  $\gamma\gamma$ -coin. <sup>142</sup>Eu deduced superdeformed band structure.

90RI05 Multiple Superdeformed Bands in <sup>194</sup>Hg and Their Dynamical Moments of Inertia

M. A. Riley, D. M. Cullen, A. Alderson, I. Ali, P. Fallon, P. D. Forsyth, F. Hanna, S. M. Mullins, J. W. Roberts, J. F. Sharpey-Schafer, P. J. Twin, R. Poynter, R. Wadsworth, M. A. Bentley, A. M. Bruce, J. Simpson, G. Sletten, W. Nazarewicz, T. Bengtsson, R. Wyss, *Nucl. Phys.* A512, 178 (1990).

**Nuclear Reactions:** +150]Nd(<sup>44</sup>Ca,4n), E=205 MeV; measured  $E\gamma$ ,  $I\gamma$ ,  $\gamma\gamma$ -coin. <sup>194</sup>Hg deduced levels, J,  $\pi$ , rotational, superdeformed band characteristics. Enriched targets, Ge detectors, array of anti-Compton spectrometers, 4 $\pi$  bismuth germanate ball. Cranked Woods-Saxon and Nilsson model calculations.

## 90Sc31 The Population of Superdeformed Bands in the A = 150 Region by Compound Reactions

K. Schiffer, B. Herskind, *Nucl. Phys.* A520, 521c (1990).

**Nuclear Reactions:** +124]Sn(<sup>28</sup>Si,4n), <sup>120</sup>Sn(<sup>28</sup>S,4n), E not given; <sup>108</sup>Pd(<sup>44</sup>Ca,4n), E=185-205 MeV; analyzed data; deduced superdeformed band population mechanism.

## 90St12 Spin Alignment in Superdeformed Hg Nuclei

F. S. Stephens, M. A. Deleplanque, J. E. Draper, R. M. Diamond, C. W. Beausang, W. Korten, W. H. Kelly, F. Azaiez, J. A. Becker, E. A. Henry, N. Roy, M. J. Brinkman, J. A. Cizewski, S. W. Yates, A. Kuhnert, *Phys. Rev. Lett.* 64, 2623 (1990).

**Radioactivity:** <sup>192</sup>, <sup>194</sup>Hg; analyzed spectra; deduced superdeformed band spin alignment.

90Th01 Superdeformation in <sup>184</sup>Pb

K. Theine, F. Hannachi, P. Willsau, H. Hubel, D. Mehta, W. Schmitz, C. X. Yang, D. B. Fossan, H. Grawe, H. Kluge, K. H. Maier, *Z. Phys.* A336, 113 (1990).

**Nuclear Reactions:** +158]Gd(<sup>40</sup>Ar,4n), E=180, 188 MeV; measured  $\gamma\gamma$ -coin. <sup>184</sup>Pb deduced levels, J,  $\pi$ , superdeformed band structure, dynamic moment of inertia.

## 90Tw02 Superdeformation - An Experimental Overview

P. J. Twin, *Nucl. Phys.* A520, 17c (1990).

**Compilation:** A=152; compiled, reviewed data on superdeformation.

## 90Wa24 Studies in Superdeformation at Chalk River

D. Ward, *Nucl. Phys.* A520, 139c (1990).

**Nuclear Reactions:** +124]Sn(<sup>28</sup>Si,5n), E=155 MeV; <sup>124</sup>Sn(<sup>21</sup>P, 5n), E=156 MeV; <sup>108</sup>Pd(<sup>28</sup>S,2p), (<sup>28</sup>S, 2n), E=155 MeV; compiled  $\gamma\gamma$ -coin data. <sup>142</sup>Gd, <sup>138</sup>Tb deduced band structure, deformation, superdeformation features. 8 $\pi$  spectrometer.

90Ye01 Superdeformed Band in <sup>192</sup>Hg

D. Ye, R. V. F. Janssens, M. P. Carpenter, E. F. Moore, R. R. Chasman, I. Ahmad, K. B. Beard, Ph. Benet, M. W. Drigert, P. B.

Fernandez, U. Garg, T. L. Khoo, S. L. Ridley, F. L. H. Wolfs, *Phys. Rev.* C41, R13 (1990).

**Nuclear Reactions:** +160]Gd(<sup>28</sup>S,4n), E=162 MeV; measured  $\gamma\gamma$ -coin. <sup>192</sup>Hg deduced levels, J,  $\pi$ , superdeformed band structure.

90Zu02 Superdeformed Bands in <sup>147</sup>Gd, a Possible Test of the Existence of Octupole Correlations in Superdeformed Bands

K. Zuber, D. Balouka, F. A. Beck, Th. Byrski, D. Curien, G. Duchene, C. Gehringer, B. Haas, J. C. Merdinger, P. Romain, D. Santos, J. Styczen, J. P. Vivien, J. Dudek, Z. Szymanski, T. Werner, *Nucl. Phys.* A520, 195c (1990).

**Nuclear Reactions:** +122]Sn(<sup>28</sup>Si,5n), E=155 MeV; measured  $E\gamma$ ,  $I\gamma$ . <sup>147</sup>Gd deduced levels, superdeformed band structure.

91Az03 Six 'Identical' Superdeformed Bands in <sup>184</sup>Tl

F. Azaiez, W. H. Kelly, W. Korten, F. S. Stephens, M. A. Deleplanque, R. M. Diamond, A. O. Macchiavelli, J. E. Draper, E. C. Rubel, C. W. Beausang, J. Burde, J. A. Becker, E. A. Henry, S. W. Yates, M. J. Brinkman, A. Kuhnert, T. F. Wang, *Phys. Rev. Lett.* 66, 1030 (1991).

**Nuclear Reactions:** +181]Ta(<sup>18</sup>O,4n), (<sup>18</sup>O,5n), (<sup>18</sup>O, 6n), E=95, 100, 104 MeV; measured  $\gamma\gamma\gamma$ -coin. <sup>184</sup>Tl deduced levels, superdeformed bands.

91Az04 Superdeformed Bands in <sup>187</sup>Tl

F. Azaiez, W. H. Kelly, W. Korten, M. A. Deleplanque, F. S. Stephens, R. M. Diamond, J. E. Draper, A. O. Macchiavelli, E. Rubel, J. de Boer, M. Rohn, J. A. Becker, E. A. Henry, M. J. Brinkman, S. W. Yates, A. Kuhnert, T. F. Wang, *Z. Phys.* A338, 471 (1991).

**Nuclear Reactions:** +181]Ta(<sup>18</sup>O,xn), E=95-104 MeV; <sup>186</sup>W(<sup>15</sup>N, 5n), (<sup>15</sup>N,6n), E=90, 95 MeV; measured  $\gamma\gamma$ -coin. <sup>187</sup>Tl deduced superdeformed bands.

91Be12 Gamma-Ray Spectroscopy of Superdeformed States in the Nucleus <sup>152</sup>Dy

M. A. Bentley, A. Alderson, G. C. Ball, H. W. Cranmer-Gordon, P. Fallon, B. Fant, P. D. Forsyth, B. Herskind, D. Howe, C. A. Kalfas, A. R. Mokhtar, J. D. Morrison, A. H. Nelson, B. M. Nyako, K. Schiffer, J. F. Sharpey-Schafer, J. Simpson, G. Sletten, P. J. Twin, *J. Phys. (London)* G17, 481 (1991).

**Nuclear Reactions:** +108]Pd(<sup>44</sup>Ca,4n), E=205 MeV; measured  $E\gamma$ ,  $I\gamma$ ,  $\gamma\gamma$ -coin,  $\gamma\gamma(\theta)$ , DSA. <sup>152</sup>Dy deduced levels, J,  $\pi$ , superdeformed band, intrinsic T<sub>22</sub>, quadrupole moment. Microscopic structure, Nilsson, Woods-Saxon models comparison, Monte Carlo simulations.

## 91Be48 Very Elongated Nuclei Near A = 194

J. A. Becker, E. A. Henry, S. W. Yates, T. F. Wang, A. Kuhnert, M. J. Brinkman, J. A. Cizewski, M. A. Deleplanque, R. M. Diamond, F. S. Stephens, F. Azaiez, W. Korten, J. E. Draper, *Nucl. Instrum. Methods Phys. Res.* B56/57, 500 (1991)

**Nuclear Structure:** =194; <sup>192</sup>, <sup>194</sup>Hg; compiled, reviewed data; deduced new superdeformation region.

91BeZM Entry Spin Distributions for Superdeformed and Normal States in <sup>192</sup>Hg

Ph. Benet, T. L. Khoo, K. Beard, E. F. Moore, I. Ahmad, M. P. Carpenter, P. J. Daly, M. W. Drigert, P. B. Fernandez, U. Garg, Z. W. Grabowski, R. V. F. Janssens, S. L. Ridley, J. Winn, F. L. H. Wolfs, D. Ye, *Bull. Am. Phys. Soc.* 36, No. 4, 1387, M10 3 (1991)

**Nuclear Reactions:** +160]Gd(<sup>28</sup>S,4n), E=154-172 MeV; measured not given. <sup>192</sup>Hg deduced normal, superdeformed states spin distribution.

91BrZX A Search for Superdeformed Oblate States in <sup>24</sup>Mg

J. D. Brown, A. Martinez-Davalos, K. Ioannides, W. D. M. Rae, A. E. Smith, S. J. Bennett, M. Freer, B. R. Fulton, J. T. Murgatroyd, G. J. Gyapong, N. S. Jarvis, C. D. Jones, D. L. Watson, Daresbury Lab., 1990-1991 Ann. Rept., Appendix, p. 67 (1991).

**Nuclear Reactions:** +10]B(<sup>28</sup>Si,<sup>24</sup>Mg), E not given; measured (particle)(particle)-coin total energy spectra following ejectile breakup, search for superdeformation evidence.

**91CuZY  $^{192}$ ,  $^{193}$ Hg Superdeformation Population with Light Ion Beams**

D. M. Cullen, M. A. Riley, I. Ali, C. W. Beausang, P. Fallon, P. D. Forsyth, F. Hanna, S. M. Mullins, J. F. Sharpey-Schafer, G. Smith, R. J. Poynter, R. Wadsworth, Daresbury Lab., 1990-1991 Ann. Rept., Appendix, p. 41 (1991).

**Nuclear Reactions:**  $+186$ W( $^{13}$ C,6n), E=92 MeV;  $^{186}$ W( $^{13}$ C, 7n), E=105 MeV; measured  $\gamma$ -energy correlations.  $^{192}$ Gd( $^{28}$ S,4n), E=162 MeV; measured not given.  $^{192}$ ,  $^{193}$ Hg deduced levels, J,  $\pi$ , superdeformed bands.

**91Dr04 Superdeformed Bands in  $^{180}$ ,  $^{180}$ Hg**

M. W. Drigert, M. P. Carpenter, R. V. F. Janssens, E. F. Moore, I. Ahmad, P. B. Fernandez, T. L. Khoo, F. L. H. Wolfs, I. G. Bearden, Ph. Benet, P. J. Daly, U. Garg, W. Reviol, D. Ye, R. Wyss, Nucl. Phys. A530, 452 (1991).

**Nuclear Reactions:**  $+160$ Gd( $^{28}$ S,xn), E=159, 162 MeV; measured E $\gamma$ , I $\gamma$ ,  $\gamma$ -coin, DSA.  $^{180}$ ,  $^{180}$ Hg deduced levels, J,  $\pi$ , T $_{1/2}$ , superdeformed band characteristics. Enriched targets, Ge detectors, array of anti-Compton spectrometers, 4 $\pi$  bismuth germanate ball. Cranked Woods-Saxon model calculations.

**91Fa07 The Collectivity and the De-Excitation of the Yrast Superdeformed Band in  $^{160}$ Gd**

P. Fallon, A. Alderson, I. Ali, D. M. Cullen, P. D. Forsyth, M. A. Riley, J. W. Roberts, J. F. Sharpey-Schafer, P. J. Twin, M. A. Bentley, A. M. Bruce, Phys. Lett. 257B, 269 (1991).

**Nuclear Reactions:**  $+130$ Te( $^{26}$ Mg,6n), E=145 MeV; measured  $\gamma$ -coin spectra, DSA.  $^{160}$ Gd deduced levels, J,  $\pi$ , deformation, superdeformation, band structure, quadrupole moment.

**91FaZY An Experiment to Search for Superdeformation in  $^{162}$ Pb**

P. Fallon, C. W. Beausang, P. Butler, N. Clarkson, D. M. Cullen, F. Hanna, T. Hoare, S. M. Mullins, M. A. Riley, J. W. Roberts, G. Smith, R. Wadsworth, R. J. Poynter, M. A. Bentley, A. M. Bruce, J. Simpson, B. Cederwall, B. Fant, L. O. Norlin, Daresbury Lab., 1990-1991 Ann. Rept., Appendix, p. 45 (1991).

**Nuclear Reactions:**  $+164$ Dy( $^{28}$ S,5n), E=165 MeV; measured  $\gamma$ -energy correlation.  $^{162}$ Pb deduced no superdeformation evidence.

**91HaZY Rotational Bands in the Odd-Odd  $^{132}$ Pr Nucleus**

C. V. Hampton, A. Rios, R. M. Ronningen, W. A. Olivier, Wm. C. McHarris, Bull. Am. Phys. Soc. 36, No. 4, 1361, K10 6 (1991)

**Nuclear Reactions:**  $+100$ Mo( $^{27}$ Cl,5n), E=160 MeV; measured  $\gamma$ -coin spectra.  $^{132}$ Pr deduced transitions, possible superdeformation.

**91He11 Observation of Superdeformed Band in  $^{182}$ Pb**

E. A. Henry, A. Kuhnert, J. A. Becker, M. J. Brinkman, T. F. Wang, J. A. Cizewski, W. Korten, F. Azaiez, M. A. Deleplanque, R. M. Diamond, J. E. Draper, W. H. Kelly, A. O. Macchiavelli, F. S. Stephens, Z. Phys. A338, 469 (1991).

**Nuclear Reactions:**  $+173$ Yb( $^{24}$ Mg,5n), E=128, 132 MeV; measured  $\gamma$ -coin.  $^{182}$ Pb deduced levels, J,  $\pi$ , superdeformed band dynamic moment of inertia.

**91JaAA**

Ann. Rev. Nucl. Part. Sci. 41, 321(1991) (review article) abstract unavailable.

**91KuZT Superdeformed Band in  $^{196}$ Pb**

A. Kuhnert, J. A. Becker, E. A. Henry, S. W. Yates, T. F. Wang, M. J. Brinkman, J. A. Cizewski, R. M. Diamond, M. A. Deleplanque, F. S. Stephens, C. W. Beausang, A. O. Macchiavelli, W. H. Kelly, W. Korten, F. Azaiez, J. E. Draper, E. Rubel, Bull. Am. Phys. Soc. 36, No. 4, 1388, M10 6 (1991)

**Nuclear Reactions:**  $+176$ Yb( $^{24}$ Mg,4n), ( $^{26}$ Mg,6n), E not given; measured not given.  $^{196}$ Pb deduced levels, superdeformed band structure.

**91Mo11 K X-Ray Yields Associated with the Superdeformed Band of  $^{192}$ Hg**

E. F. Moore, R. V. F. Janssens, I. Ahmad, M. P. Carpenter, A. M. Baxter, M. E. Bleich, P. B. Fernandez, T. Lauritsen, T. L. Khoo, I. G. Bearden, Ph. Benet, P. J. Daly, U. Garg, W. Reviol, D. Ye, Phys. Lett. 258B, 284 (1991).

**Nuclear Reactions:**  $+160$ Gd( $^{28}$ S,4n), E=159 MeV; measured  $\gamma$ , X-ray spectra,  $\gamma$ (X-ray)-coin, X-ray yields.  $^{192}$ Hg; deduced no strong superdeformed band E0 decay.

**91Mu08 Superdeformation and Double Blocking in  $^{142}$ Eu**

S. M. Mullins, R. A. Wyss, P. Fallon, T. Byrski, D. Curien, S. A. Forbes, Y. -J. He, M. S. Metcalfe, P. J. Nolan, E. S. Paul, R. J. Poynter, P. H. Regan, R. Wadsworth, Phys. Rev. Lett. 66, 1677 (1991).

**Nuclear Reactions:**  $+110$ Pd( $^{27}$ Cl,5n), E=160 MeV; measured  $\gamma$ -coin sum spectra.  $^{142}$ Eu deduced levels, superdeformed band.

**91Rz01 Excited Superdeformed Band in  $^{146}$ Gd**

T. Rzaca-Urban, K. Strahle, G. Hebbinghaus, D. Balabanski, W. Gast, R. M. Lieder, H. Schnare, W. Urban, P. von Brentano, A. Dewald, J. Eberth, E. Ott, J. Theuerkauf, H. Wolters, K. O. Zell, D. Alber, K. H. Maier, E. M. Beck, H. Hubel, W. Schmitz, Z. Phys. A339, 421 (1991).

**Nuclear Reactions:**  $+110$ Pd( $^{40}$ Ar,4n), E=175 MeV; measured  $\gamma$ -coin, summed spectra.  $^{146}$ Gd deduced superdeformed band.

**91RzZZ Search for Superdeformation in  $^{146}$ Gd**

T. Rzaca-Urban, R. M. Lieder, K. Strahle, D. Balabanski, W. Gast, A. Georgiev, H. Schnare, M. Binderberger, M. Eschenauer, S. Freund, E. Ott, J. Theuerkauf, H. Wolters, K. O. Zell, J. Eberth, P. von Brentano, K. H. Maier, H. Grawe, C. Bach, R. Schubart, KFA-IKP Ann. Rept., 1990, p. 23 (1991).

**Nuclear Reactions:**  $+110$ Pd( $^{40}$ Ar,4n), ( $^{40}$ Ar,5n), E=189, 200 MeV; measured E $\gamma$ , I $\gamma$ ,  $\gamma$ -multiplicity, DSA.  $^{146}$ ,  $^{146}$ Gd deduced superdeformed bands.

**91ThZY Nuclear Dissipation and the Feeding of Superdeformed Bands**

M. Thoennessen, J. R. Beene, F. E. Bertrand, C. Baktash, M. L. Halbert, D. J. Horen, D. C. Hensley, R. L. Varner, D. G. Sarantites, D. W. Stracener, W. Spang, Bull. Am. Phys. Soc. 36, No. 4, 1271, C11 9 (1991)

**Nuclear Reactions:**  $+159$ Tb( $^{16}$ O,X), E not given; measured  $\gamma$ (fission fragment)-coin following fusion.  $^{173}$ Ta deduced GDR decay features, feeding of superdeformed bands.

**91Tw01 Superdeformed Nuclei at High Spin**

P. J. Twin, Nucl. Phys. A522, 13c (1991).

**Nuclear Structures:**  $+152$ Dy,  $^{151}$ Tb,  $^{150}$ Gd,  $^{152}$ Eu; analyzed data; deduced superdeformed band evidence. Other data reviewed.

**91Wa14 Superdeformation in  $^{190}$ ,  $^{190}$ Pb**

T. F. Wang, A. Kuhnert, J. A. Becker, E. A. Henry, S. W. Yates, M. J. Brinkman, J. A. Cizewski, F. A. Azaiez, M. A. Deleplanque, R. M. Diamond, J. E. Draper, W. H. Kelly, W. Korten, A. O. Macchiavelli, E. Rubel, F. S. Stephens, Phys. Rev. C43, R2465 (1991).

**Nuclear Reactions:**  $+154$ Sm( $^{44}$ Ca,xn), E=205 MeV;  $^{190}$ Yb( $^{26}$ Mg, xn), E=135 MeV; measured  $\gamma$ -coin.  $^{190}$ ,  $^{190}$ Pb deduced levels, superdeformed band features. Other isotopes discussed.

**91Wa24 Comment on 'Landau-Zener Crossing in Superdeformed  $^{190}$ Hg: Evidence for octupole correlations in superdeformed nuclei'**

P. M. Walker, Phys. Rev. Lett. 67, 1174 (1991).

**Nuclear Structure:**  $+193$ Hg; analyzed data; deduced octupole correlations role in superdeformed states.

**91WaZV A Superdeformed (SD) Band in  $^{196}$ Pb**

T. F. Wang, J. A. Becker, E. A. Henry, A. Kuhnert, S. W. Yates, M. J.



Brinkman, J. A. Cizewski, F. A. Azalez, M. A. Deleplanque, R. M. Diamond, J. E. Draper, W. H. Kelly, W. Kortan, A. O. Macchiavelli, E. Rubel, F. S. Stephens, *Bull. Am. Phys. Soc.* 36, No. 4, 1388, M10 8 (1991)

**Nuclear Reactions:** +148}Sm(<sup>48</sup>Ca,xn), E=205 MeV; measured not given. <sup>196</sup>Pb deduced superdeformed band.

**91Zu01 A Comparative Study of Superdeformation in <sup>146</sup>, <sup>147</sup>, <sup>148</sup>Gd. Possible Manifestations of the Pseudo-SU<sub>3</sub> Symmetry, Octupole Shape Susceptibility and Superdeformed Deep-Hole Excitations**

K. Zuber, D. Balouka, F. A. Beck, Th. Byrski, D. Curien, G. De France, G. Duchene, C. Gehringer, B. Haas, J. C. Merdinger, P. Romain, D. Santos, J. Styczen, J. P. Vivien, J. Dudek, Z. Szymanski, T. R. Werner, *Phys. Lett.* 254B, 308 (1991).

**Nuclear Reactions:** +122}Sn(<sup>28</sup>Si,5n), E=155 MeV; measured E<sub>γ</sub>, I<sub>γ</sub>, sum spectra. <sup>147</sup>Gd deduced levels, J, π, superdeformed band features. Model comparison.

**92AtZW Observation of the Decay Out of the Superdeformed Band in <sup>140</sup>Eu**

A. Atac, M. Piiparinen, B. Herskind, J. Nyberg, G. Sletten, G. de Angelis, R. M. Clark, S. A. Forbes, N. Gjorup, G. B. Hagemann, F. Ingebråsen, H. J. Jensen, D. Jørestam, H. Kusakari, R. M. Lieder, G. V. Marti, S. Mullins, P. J. Nolan, E. S. Paul, P. H. Regan, D. Santonocito, H. Schnare, K. Strahle, M. Sugawara, P. O. Tjøm, A. Virtanen, R. Wadsworth, *Priv. Comm.* (1992).

**Nuclear Reactions:** +110}Pd(<sup>28</sup>Cl,4n), E=160 MeV; measured γγ-coin. <sup>142</sup>Eu deduced levels, J, π, γ-branching, superdeformed to normal band transitions.

**92Be18 Characterization of the Superdeformed Band in <sup>180</sup>Hg**

I. G. Bearden, R. V. F. Janssens, M. P. Carpenter, E. F. Moore, I. Ahmad, A. M. Baxter, Ph. Benet, P. J. Daly, M. W. Drigert, P. B. Fernandez, U. Garg, Z. W. Grabowski, T. L. Khoo, T. Lauritsen, W. Reviol, D. Ye, *Z. Phys.* A341, 491 (1992).

**Nuclear Reactions:** +160}Gd(<sup>28</sup>S,5n), E=165 MeV; measured γγ-coin. <sup>180</sup>Hg deduced superdeformed band, levels, J, π.

**92BeZL Higher Superdeformed Band Members in <sup>180</sup>Hg: Evidence for a band interaction (Question)**

I. G. Bearden, R. V. F. Janssens, M. P. Carpenter, I. Ahmad, P. J. Daly, M. W. Drigert, U. Garg, T. L. Khoo, T. Lauritsen, Y. Liang, W. Reviol, R. Wyss, *Proc. Int. Conf. Nuclear Structure at High Angular Momentum, Ottawa*, p. 10 (1992); AECL-10613 (1992)

**Nuclear Reactions:** +160}Gd(<sup>28</sup>S,4n), E=159-165 MeV; measured γγ-coin, γ-multiplicity. <sup>180</sup>Hg deduced superdeformed band, dynamic moment of inertia, band interaction evidence.

**92BeZR Entrance Channel Effects and the Superdeformed Band in <sup>162</sup>Dy**

C. W. Beausang, A. Alderson, I. Ali, M. A. Bentley, P. J. Dagnall, G. de France, P. Fallon, S. Flibotte, P. D. Forsyth, B. Haas, P. Romain, G. Smith, P. J. Twin, J. P. Vivien, *Contrib. Int. Conf. Nuclear Structure at High Angular Momentum, Ottawa*, p. 66 (1992); AECL-10613 (1992)

**92BeZT Feeding of the Superdeformed Band in <sup>182</sup>Hg: The mechanism and Constraints on the superdeformed band energies and well depth**

Ph. Benet, T. Lauritsen, T. L. Khoo, I. Ahmad, K. Beard, I. G. Bearden, M. P. Carpenter, P. Daly, M. W. Drigert, P. B. Fernandez, U. Garg, R. V. F. Janssens, Y. Liang, E. F. Moore, W. Reviol, D. Ye, *Contrib. Int. Conf. Nuclear Structure at High Angular Momentum, Ottawa*, p. 54 (1992); AECL-10613 (1992)

**Nuclear Reactions:** +160}Gd(<sup>28</sup>S,4n), E=154, 167 MeV; measured transition I<sub>γ</sub>, quasicontinuum γ-spectra. <sup>182</sup>Hg deduced superdeformed band, feeding mechanism. Model comparison.

**92BeZV Shape Coexistence to High Spin in <sup>180</sup>Hg**

I. G. Bearden, M. P. Carpenter, A. M. Baxter, R. V. F. Janssens, I. Ahmad, Ph. Benet, P. J. Daly, M. W. Drigert, P. B. Fernandez, B.

Fornal, U. Garg, Z. W. Grabowski, T. L. Khoo, R. M. Mayer, E. F. Moore, W. Reviol, D. Ye, *Contrib. Int. Conf. Nuclear Structure at High Angular Momentum, Ottawa*, p. 18 (1992); AECL-10613 (1992)

**Nuclear Reactions:** +156}Gd(<sup>28</sup>S,4n), E=167 MeV; measured γγ-coin. <sup>188</sup>Hg deduced levels, J, π, band structure, shape features, no superdeformation evidence.

**92BIZZ Search for Low Spin Superdeformed States by Transfer Reaction**

J. Blons, D. Goutte, A. Lepretre, R. Lucas, V. Meot, D. Paya, X. H. Phan, G. Barreau, T. Doan, G. Pedemey, *Contrib. Int. Conf. Nuclear Structure at High Angular Momentum, Ottawa*, p. 57 (1992); AECL-10613 (1992)

**Nuclear Reactions:** +236}U(<sup>16</sup>O,<sup>16</sup>O), E=9 MeV/nucleon; <sup>182</sup>Pt (<sup>16</sup>O,<sup>14</sup>C), E not given; measured γ sum spectra, γ(particle)-coin. <sup>184</sup>Hg deduced superdeformed band population.

**92BrZY Shape Coexistence in <sup>184</sup>Pb**

M. J. Brinkman, A. Kuhnert, M. A. Stoyer, J. A. Becker, E. A. Henry, T. F. Wang, J. A. Cizewski, R. M. Diamond, F. S. Stephens, M. A. Deleplanque, J. E. Draper, *Contrib. Int. Conf. Nuclear Structure at High Angular Momentum, Ottawa*, p. 71 (1992); AECL-10613 (1992)

**Nuclear Reactions:** +176}Yb(<sup>24</sup>Mg,6n), E=132, 134 MeV; <sup>180</sup>Sm(<sup>48</sup>Ca, 4n), E=205 MeV; <sup>124</sup>Sn(<sup>72</sup>Ge,3n), E=305 MeV; analyzed data. <sup>184</sup>Pb deduced superdeformed, near-oblate collective states interplay.

**92CiZZ Identical Bands and Quantized Alignment in Superdeformed A = 194 Nuclei: Evidence for a new kind of rotor**

J. A. Cizewski, J. A. Becker, E. A. Henry, M. J. Brinkman, T. F. Wang, A. Kuhnert, F. S. Stephens, M. A. Deleplanque, R. M. Diamond, F. Azalez, A. O. Macchiavelli, J. E. Draper, *Contrib. Int. Conf. Nuclear Structure at High Angular Momentum, Ottawa*, p. 68 (1992); AECL-10613 (1992)

**Nuclear Structure:** =194; analyzed data; deduced superdeformed, identical band features. Spin-rotor framework.

**92DeZV Search for Transitions Deexciting the Superdeformed Band in <sup>182</sup>Hg**

M. A. Deleplanque, F. S. Stephens, R. M. Diamond, J. R. B. Oliveira, J. Burde, J. E. Draper, E. Rubel, C. Duyar, J. A. Becker, E. A. Henry, M. J. Brinkman, A. Kuhnert, T. F. Wang, M. A. Stoyer, *Contrib. Int. Conf. Nuclear Structure at High Angular Momentum, Ottawa*, p. 79 (1992); AECL-10613 (1992)

**Nuclear Reactions:** +176}Yb(<sup>22</sup>Ne,6n), E=125, 130 MeV; measured γγ-coin. <sup>182</sup>Hg deduced superdeformed band transition intensity features.

**92Fi02 Entrance-Channel Effects in the Population of Superdeformed Bands in <sup>147</sup>, <sup>148</sup>Gd**

S. Flibotte, H. R. Andrews, T. E. Drake, A. Galindo-Uribarri, B. Haas, V. J. Janzen, D. Prevost, D. C. Radford, J. Rodriguez, P. Romain, J. P. Vivien, J. C. Waddington, D. Ward, G. Zwart, *Phys. Rev.* C45, R889 (1992).

**Nuclear Reactions:** +124}Sn(<sup>28</sup>Si,xn), <sup>122</sup>Sn(<sup>28</sup>Si,xn), E=155 MeV; <sup>76</sup>Ge(<sup>76</sup>Ge,xn), E=319 MeV; measured E<sub>γ</sub>, I<sub>γ</sub>, γγ-coin. <sup>147</sup>, <sup>148</sup>Gd deduced superdeformed bands population intensity. Enriched targets, Compton-suppressed hyperpure Ge array.

**92Fi03 Multidimensional Analysis of High Resolution γ-Ray Data**

S. Flibotte, U. J. Huttmeier, P. Bednarczyk, G. de France, B. Haas, P. Romain, Ch. Theisen, J. P. Vivien, J. Zen, *Nucl. Instrum. Methods Phys. Res.* A320, 325 (1992)

**Nuclear Structure:** +149}Gd; analyzed superdeformed band γ-transition data; deduced transitions for use in Monte Carlo simulation. Multi-dimensional analysis, algorithm development.

**92FoZX Lifetime Measurements on Superdeformed Bands in <sup>152</sup>Nd and <sup>140</sup>Eu**

S. A. Forbes, S. M. Mullins, P. J. Nolan, E. S. Paul, R. M. Clarke, P.

H. Regan, R. Wadsworth, A. Atac, G. B. Hagemann, B. Herskind, J. Nyberg, M. J. Piiparinen, A. Dewald, G. Boehm, R. Kruecken, Contrib. Int. Conf. Nuclear Structure at High Angular Momentum, Ottawa, p. 65 (1992); AECL-10613 (1992)

**Nuclear Reactions:** +110)Pd( $^{27}\text{Cl},4n$ ), E=160 MeV; measured  $\gamma\gamma$ -coin, DSA.  $^{105}\text{Pd}$ ( $^{28}\text{S},2n2p$ ), E=150 MeV; measured  $\gamma\gamma$ -coin.  $^{145}\text{Eu}$  deduced superdeformed band states  $T_{1/2}$ , deformation.  $^{129}\text{Nd}$  deduced superdeformed band states  $T_{1/2}$ .

**92GaZX New Features in the Spectrum of  $^{162}\text{Dy}$ : Evidence for hyperdeformation (Question)**

A. Galindo-Uribarri, H. R. Andrews, G. C. Ball, T. E. Drake, G. Hackmann, V. P. Janzen, S. M. Mullins, L. Persson, D. C. Radford, J. C. Waddington, D. Ward, R. Wyss, Contrib. Int. Conf. Nuclear Structure at High Angular Momentum, Ottawa, p. 16 (1992); AECL-10613 (1992)

**Nuclear Reactions:** +120)Sn( $^{27}\text{Cl},4np$ ), E not given; measured  $\gamma$ (particle)-coin, proton gated  $E_{\gamma}$ - $E_{\gamma}$  correlation.  $^{162}\text{Dy}$  deduced superdeformed ridge, other ridges. Discussion of hyperdeformation evidence.

**92Ha35 Nuclear Superdeformation Data Tables**

X. -L. Han, C. -L. Wu, At. Data Nucl. Data Tables 52, 43 (1992).

**Compilation:** A=130, 150, 190; compiled by for transitions in superdeformed bands.

**92HaZR Studies of Superdeformation in the A = 150 Region**

B. Haas, V. P. Janzen, D. Ward, H. R. Andrews, D. C. Radford, D. Prevost, J. A. Kuehner, A. Omar, J. C. Waddington, T. E. Drake, A. Galindo-Uribarri, G. Zwart, S. Filibotte, P. Taras, I. Ragnarsson, TASSC-P-92-11 (1992).

**Nuclear Reactions:** +124),  $^{122}$ ,  $^{120}\text{Sn}$ ( $^{28}\text{Si},xn$ ), ( $^{28}\text{Si}, xn$ ), ( $^{28}\text{Si},xn$ ), E=155 MeV; measured  $E_{\gamma}$ ,  $I_{\gamma}$ ,  $\gamma\gamma$ -coin, DCO ratios.  $^{140}$ ,  $^{148}$ ,  $^{147}$ ,  $^{146}$ ,  $^{145}\text{Gd}$  deduced levels, J,  $\pi$ , superdeformed bands,  $\gamma$ -ray multiplicities, total  $\gamma$ -ray sum energy. Compton-suppressed hyperpure Ge detector array, 4 $\pi$ -bismuth germanate ball. Cranked shell-model-Strutinski calculations.

**92HaZT Recent Results and Future Prospects Along the N = Z Line with Radioactive Nuclear Beams and RMS**

J. H. Hamilton, A. V. Ramayya, Contrib. 6th Intern. Conf. on Nuclei Far from Stability + 9th Intern. Conf. on Atomic Masses and Fundamental Constants, Bernkastel-Kues, Germany, PE10 (1992)

**Nuclear Structure:** +72),  $^{74}$ ,  $^{76}\text{Kr}$ ; reviewed, analyzed data.  $^{88}\text{Ru}$ ; analyzed band structure; deduced low spin superdeformation. Nuclei along N=Z line.

**92HaZX A Superdeformed Rotational Band in  $^{142}\text{Sm}$**

G. S. Hackman, A. Galindo-Uribarri, V. P. Janzen, S. M. Mullins, D. Prevost, D. C. Radford, J. C. Waddington, D. Ward, Contrib. Int. Conf. Nuclear Structure at High Angular Momentum, Ottawa, p. 81 (1992); AECL-10613 (1992)

**Nuclear Reactions:** +124)Sn( $^{24}\text{Mg},6n$ ), E=145 MeV; measured  $\gamma$ -multiplicity, total sum energy.  $^{142}\text{Sm}$  deduced levels, J,  $\pi$ , dynamical moment of inertia, superdeformed rotational band.

**92HaZY Study of the Superdeformed Band in  $^{194}\text{Pb}$  with Eurogam**

F. Hannachi, Contrib. Int. Conf. Nuclear Structure at High Angular Momentum, Ottawa, p. 67 (1992); AECL-10613 (1992)

**Nuclear Reactions:** +164),  $^{162}\text{Dy}$ ( $^{28}\text{S},X$ ), ( $^{28}\text{S},X$ ), E=157-162 MeV; measured  $\gamma\gamma\gamma$ -coin, DSA.  $^{194}\text{Pb}$  deduced superdeformed band states  $T_{1/2}$ , decay features.

**92HeZM Superdeformation in the A = 190 Region: The lead nuclei**

E. A. Henry, J. A. Becker, M. J. Brinkman, A. Kuhnert, M. A. Stoyer, T. F. Wang, S. W. Yates, F. A. Azalaz, C. W. Beausang, J. Burde, M. A. Deleplanque, R. M. Diamond, J. E. Draper, W. H. Kelly, W. Korten, A. O. Macchiavelli, J. Oliveira, E. Rubel, F. S. Stephens, J. A. Cizewski,

Proc. Int. Conf. Nuclear Structure at High Angular Momentum, Ottawa, p. 15 (1992); AECL-10613 (1992)

**Nuclear Reactions:** +176)Yb( $^{26}\text{Mg},6n$ ), E=138 MeV; measured  $\gamma\gamma$ -coin.  $^{198}\text{Pb}$  deduced new levels in superdeformed band.  $^{184}\text{Sm}$ ( $^{28}\text{Ca},X$ ), E=205, 210 MeV;  $^{178}\text{Yb}$ ( $^{24}\text{Mg}, xn$ ), E=129-134 MeV;  $^{176}\text{Yb}$ ( $^{26}\text{Mg},xn$ ), E=130, 135 MeV; measured not given.  $^{197}$ ,  $^{195}$ ,  $^{193}\text{Pb}$  deduced no superdeformed bands.

**Nuclear Structure:** +192),  $^{194}$ ,  $^{196}\text{Pb}$ ; analyzed superdeformed band data.

**92KoZX New Results on the Superdeformed Band in  $^{194}\text{Pb}$**

W. Korten, M. J. Piiparinen, A. Atac, R. A. Bark, B. Herskind, T. Ramsøy, G. Sletten, J. Gerl, H. Hubel, P. Willsau, B. Cederwall, L. O. Norlin, B. Fant, Contrib. Int. Conf. Nuclear Structure at High Angular Momentum, Ottawa, p. 58 (1992); AECL-10613 (1992)

**Nuclear Reactions:** +164)Dy( $^{24}\text{S},4n$ ), E=160 MeV; measured  $\gamma\gamma$ -coin.  $^{194}\text{Pb}$  deduced superdeformed band origin uncertainties.

**92La07 Dynamic Moment of Inertia of the  $^{192}\text{Hg}$  Superdeformed Band at High Rotational Frequencies**

T. Lauritsen, R. V. F. Janssens, M. P. Carpenter, E. F. Moore, I. Ahmad, P. B. Fernandez, T. L. Khoo, J. A. Kuehner, D. Prevost, J. C. Waddington, U. Garg, W. Reviol, D. Ye, M. W. Drigert, Phys. Lett. 279B, 239 (1992).

**Nuclear Reactions:** +160)Gd( $^{28}\text{S},4n$ ), E=154-167 MeV; measured  $\gamma\gamma$ -coin.  $^{192}\text{Hg}$  deduced superdeformed states, relative  $I_{\gamma}$ , increasing dynamic moment of inertia.

**92La19 Feeding of Superdeformed Bands: The mechanism and constraints on band energies and the well depth**

T. Lauritsen, Ph. Benet, T. L. Khoo, K. B. Beard, I. Ahmad, M. P. Carpenter, P. J. Daly, M. W. Drigert, U. Garg, P. B. Fernandez, R. V. F. Janssens, E. F. Moore, F. L. H. Wolfs, D. Ye, Phys. Rev. Lett. 69, 2479 (1992).

**Nuclear Reactions:** +160)Gd( $^{28}\text{S},4n$ ), E=159 MeV; measured  $\gamma\gamma$ -coin.  $^{192}\text{Hg}$  deduced superdeformed band feeding, entry distribution features.

**92LaZS Search for Long-Lived Fissioning Isomers in Superdeformed High-Spin Nuclei Around  $^{162}\text{Dy}$  and  $^{190}\text{Hg}$**

Yu. A. Lazarev, Yu. Ts. Oganessian, I. V. Shirokovsky, S. P. Tretyakova, V. K. Utyonkov, Contrib. 6th Intern. Conf. on Nuclei Far from Stability + 9th Intern. Conf. on Atomic Masses and Fundamental Constants, Bernkastel-Kues, Germany, PE48 (1992)

**Nuclear Reactions:** +116)Cd( $^{40}\text{Ar},X$ ), E=203 MeV; measured not given; deduced no fragment delayed fission evidence,  $\sigma$  upper limit.  $^{162}\text{Dy}$  deduced superdeformed rotational band population.  $^{164}\text{Sm}$ ( $^{40}\text{Ar},X$ ), E=219 MeV; measured not given; deduced no fragment delayed fission evidence,  $\sigma$  upper limit.

**92LaZT Calculations of the Decay of Superdeformed Bands and Search for the  $\gamma$  Rays Connecting Superdeformed and Normal States**

T. Lauritsen, T. L. Khoo, E. F. Moore, I. Ahmad, M. P. Carpenter, P. Fernandez, R. V. F. Janssens, Y. Liang, M. Freer, A. Wuosmaa, P. Benet, I. Bearden, P. J. Daly, B. Fornal, D. Ye, U. Garg, M. W. Drigert, Contrib. Int. Conf. Nuclear Structure at High Angular Momentum, Ottawa, p. 53 (1992); AECL-10613 (1992)

**Nuclear Structure:** =150, 190; analyzed superdeformed bands decay; deduced mixing into normal states role.

**92LaZS Lifetimes of the Low Spin States in the Superdeformed Band of  $^{192}\text{Hg}$**

I. Y. Lee, C. Baktash, D. Cullen, J. D. Garrett, N. R. Johnson, F. K. McGowan, D. F. Winchell, C. H. Yu, Proc. Int. Conf. Nuclear Structure at High Angular Momentum, Ottawa, p. 21 (1992); AECL-10613 (1992)

**Nuclear Reactions:** +160)Gd( $^{28}\text{S},4n$ ), E=159 MeV; measured  $\gamma\gamma$ -coin, recoil distance.  $^{192}\text{Hg}$  deduced superdeformed band levels  $T_{1/2}$ .

**92LI21 Double Blocking in the Superdeformed  $^{162}\text{Tl}$  Nucleus**

Y. Liang, M. P. Carpenter, R. V. F. Janssens, I. Ahmad, R. G. Henry, T. L. Khoo, T. Lauritsen, F. Soramel, S. Pilotte, J. M. Lewis, L. L. Riedinger, C. -H. Yu, U. Garg, W. Reviol, I. G. Bearden, Phys. Rev. C46, R2136 (1992).

**Nuclear Reactions:**  $+160\text{Gd}(^{77}\text{Cl},5n)$ ,  $E=178, 181$  MeV; measured  $E_\gamma$ ,  $I_\gamma$ ,  $\gamma\gamma(\theta)$ .  $^{162}\text{Tl}$  deduced levels, J,  $\pi$ , band structures, moments of inertia. Cranked shell model.

**92LIZU**

Y. Liang, M. P. Carpenter, R. V. F. Janssens, I. Ahmad, R. Henry, T. L. Khoo, T. Lauritsen, S. Pilotte, J. M. Lewis, L. L. Riedinger, C. -H. Yu, U. Garg, W. Reviol, I. G. Bearden, Contrib. Int. Conf. Nuclear Structure at High Angular Momentum, Ottawa, p. 56 (1992); AECL-10613 (1992)

**Nuclear Reactions:**  $+160\text{Gd}(^{77}\text{Cl},5n)$ ,  $E=187$  MeV; measured  $\gamma$  spectra.  $^{162}\text{Tl}$  deduced several superdeformed band pairs.

**92MaZP Search for Superdeformation in  $^{180}\text{Au}$** 

G. Marti, W. Gast, A. Georgiev, D. Kutchin, R. M. Lieder, K. Strahle, H. Maier, J. Heese, KFA-IKP Ann. Rept., 1991, p. 100 (1992).

**Nuclear Reactions:**  $+176\text{Yb}(^{19}\text{F},4n)$ ,  $(^{19}\text{F},5n)$ ,  $(^{19}\text{F},6n)$ ,  $E=107$  MeV; measured  $E_\gamma$ ,  $\gamma\gamma$ -energy correlation.  $^{180}\text{Au}$  deduced weak ridge structure. Discussed superdeformation aspects.

**92Mu10 Study of Superdeformed Bands in Nuclei with  $A \approx 150$  by Heavy-Ion- $\gamma$  Coincidences**

L. Muller, F. Soramel, E. Adamides, S. Beghini, L. Corradi, G. LoBianco, B. Million, N. Molho, H. Moreno, D. R. Napoli, G. F. Prete, F. Scarassara, G. F. Segato, S. Signorelli, C. Signorini, P. Spolaore, A. M. Stefanini, Z. Phys. A341, 131 (1992).

**Nuclear Reactions:** CPND  $^{124}\text{Sn}(^{35}\text{S},5n)$ ,  $(^{35}\text{S},4np)$ ,  $(^{35}\text{S},6n)$ ,  $(^{35}\text{S},5np)$ ,  $(^{35}\text{S},7n)$ ,  $(^{35}\text{S},6np)$ ,  $(^{35}\text{S},5n2p)$ ,  $(^{35}\text{S},7n2p)$ ,  $(^{35}\text{S},5n\alpha)$ ,  $E=160, 170$  MeV; measured  $\gamma$ (evaporation residue)-coin; deduced residue relative production  $\sigma$ .  $^{152}$ ,  $^{151}\text{Dy}$ ,  $^{151}\text{Tb}$  deduced superdeformed bands.

**92PaZW Highly-Deformed Bands in the Mass 130 Region**

E. S. Paul, Proc. Int. Conf. Future Directions in Nuclear Physics with 4 $\pi$  Gamma Detection Systems of the New Generation, Strasbourg, France (1991), J. Dudek, B. Haas, Eds., American Institute of Physics, New York, p. 165 (1992).

**Compilation:**  $^{133}$ ,  $^{135}$ ,  $^{137}\text{Sm}$ ,  $^{136}\text{Gd}$ ,  $^{142}\text{Eu}$ ,  $^{133}$ ,  $^{134}$ ,  $^{135}$ ,  $^{136}$ ,  $^{137}\text{Nd}$ ,  $^{134}\text{Pr}$ ,  $^{131}$ ,  $^{132}$ ,  $^{133}$ ,  $^{135}\text{Ce}$ ,  $^{132}\text{La}$ ; compiled, reviewed superdeformed, intruder bands,  $T_{1/2}$  data; deduced dominated configuration.

**92PaZX Intensity of K X-Rays in Coincidence with Superdeformed Band in  $^{142}\text{Eu}$** 

M. Palacz, Z. Sujkowski, J. Bacelar, A. Atac, B. Herskind, J. Nyberg, M. Piiparinen, G. de Angelis, S. Forbes, N. Gjørup, G. Hagemann, F. Ingebretsen, H. Jensen, D. Jerrestam, H. Kusakari, R. Lieder, G. M. Marti, S. Mullins, D. Santonocito, H. Schnare, G. Sletten, K. Strahle, M. Sugawara, P. O. Tjøm, A. Virtanen, R. Wadsworth, KVI 1991 Ann. Rept., p. 31 (1992).

**Nuclear Structure:**  $+142\text{J}$ ,  $^{142}\text{Eu}$ ; analyzed data; deduced evidence for enhanced X-ray yields for coincidence with superdeformed band transitions.

**92PIZR Superdeformation in  $^{171}\text{Tl}$** 

S. Pilotte, J. M. Lewis, L. L. Riedinger, C. -H. Yu, M. P. Carpenter, R. V. F. Janssens, T. L. Khoo, T. Lauritsen, Y. Liang, F. Soramel, I. G. Bearden, Proc. Int. Conf. Nuclear Structure at High Angular Momentum, Ottawa, p. 2 (1992); AECL-10613 (1992)

**Nuclear Reactions:**  $+159\text{Tb}(^{36}\text{S},4n)$ ,  $E=165$  MeV; measured  $E_\gamma$ ,  $I_\gamma$ ,  $\gamma\gamma$ -coin.  $^{171}\text{Tl}$  deduced levels, J,  $\pi$ , band structure, superdeformation. Enriched target, Compton-suppressed Ge detector array, BGO array. Cranked shell model.

**92Re05 Measurement of the Intrinsic Quadrupole Moments in the  $\nu_{1,2}$  Bands of  $^{135}$ ,  $^{137}\text{Sm}$** 

P. H. Regan, R. Wadsworth, S. M. Mullins, J. Nyberg, A. Atac, S. A. Forbes, D. B. Fossan, Y. -J. He, J. R. Hughes, I. Jenkins, R. Ma, M. S. Metcalfe, P. J. Nolan, E. S. Paul, R. J. Poynter, D. Santonocito, A. Virtanen, N. Xu, J. Phys. (London) G18, 847 (1992).

**Nuclear Reactions:**  $+92\text{Mo}(^{40}\text{Ti},n2p)$ ,  $E=210$  MeV;  $^{104}\text{Pd}(^{77}\text{Cl},3np)$ ,  $E=168$  MeV; measured  $\gamma\gamma$ -coin, DSA.  $^{137}\text{Sm}$  deduced levels, J,  $\pi$ ,  $T_{1/2}$ , deformation parameter  $\beta_2$ , quadrupole moments, band structure.  $^{135}\text{Sm}$  deduced levels, J,  $\pi$ ,  $T_{1/2}$ , deformation parameter  $\beta_2$ , quadrupole moments, band structure, superdeformation features.

**92RzZZ Excited Superdeformed Band in  $^{140}\text{Gd}$** 

T. Rzaca-Urban, K. Strahle, G. Hebbinghaus, D. Balabanski, W. Gast, R. M. Lieder, H. Schnare, W. Urban, P. von Brentano, H. Wolters, K. O. Zell, D. Alber, K. H. Maier, E. M. Beck, H. Hubel, W. Schmitz, KFA-IKP Ann. Rept., 1991, p. 92 (1992).

**Nuclear Reactions:**  $+110\text{Pd}(^{40}\text{Ar},4n)$ ,  $E=175$  MeV; measured  $\gamma\gamma$ -coin, sum spectra.  $^{140}\text{Gd}$  deduced levels, J,  $\pi$ , excited superdeformed band.

**92ShAA**

Prog. Part. Nucl. Phys. 28, 187(1992) (review article) abstract unavailable.

**92ShZR Octupole Correlations, Spin Assignments and Identical Bands in  $^{193}\text{Hg}$** 

J. F. Sharpey-Schafer, D. M. Cullen, M. A. Riley, A. Alderson, I. Ali, T. Bengtsson, M. A. Bentley, A. M. Bruce, P. Fallon, P. D. Forsyth, F. Hanna, S. M. Mullins, W. Nazarewicz, R. Poynter, P. Regan, J. W. Roberts, W. Satula, J. Simpson, G. Sletten, P. J. Twin, R. Wadsworth, R. Wyss, Proc. Int. Conf. Future Directions in Nuclear Physics with 4 $\pi$  Gamma Detection Systems of the New Generation, Strasbourg, France (1991), J. Dudek, B. Haas, Eds., American Institute of Physics, New York, p. 64 (1992).

**Nuclear Reactions:**  $+150\text{Nd}(^{40}\text{Ca},5n)$ ,  $E=213$  MeV; measured  $E_\gamma$ ,  $I_\gamma$ ,  $\gamma\gamma$ -coin,  $\gamma\gamma(\theta)$ .  $^{193}\text{Hg}$  deduced levels, J,  $\pi$ , superdeformed band. Also discussed data on  $^{191}$ ,  $^{194}\text{Hg}$ .

**92Sm01 Entrance-Channel Effects in the Population of Superdeformed Bands**

G. Smith, B. Haas, A. Alderson, I. Ali, C. W. Beausang, M. A. Bentley, P. Dagnall, P. Fallon, G. de France, P. D. Forsyth, U. Huttmeier, P. Romain, D. Santos, P. J. Twin, J. P. Vivien, Phys. Rev. Lett. 68, 158 (1992).

**Nuclear Reactions:**  $+74\text{Ge}(^{62}\text{Se},4n)$ ,  $E=324-346$  MeV;  $^{106}\text{Pd}(^{40}\text{Ca},4n)$ ,  $E=205$  MeV;  $^{120}\text{Sn}(^{36}\text{S},4n)$ ,  $E=175$  MeV; measured  $\gamma\gamma$ -coin.  $^{152}\text{Dy}$  deduced superdeformed band population entrance channel effects.

**92SoZZ Entrance-Channel Dependence in the Population of the Superdeformed Bands in  $^{191}\text{Hg}$  (Question)**

F. Soramel, T. L. Khoo, R. V. F. Janssens, I. Ahmad, M. P. Carpenter, T. Lauritsen, Y. Liang, B. Fomal, I. Bearden, Ph. Benet, P. J. Daly, Z. W. Grabowski, R. Maier, D. Ye, U. Garg, W. Reviol, M. W. Drigert, Contrib. Int. Conf. Nuclear Structure at High Angular Momentum, Ottawa, p. 52 (1992); AECL-10613 (1992)

**Nuclear Reactions:**  $+130\text{Te}(^{60}\text{Ni},3n)$ ,  $E=259$  MeV;  $^{106}\text{Gd}(^{36}\text{S},5n)$ ,  $E=169$  MeV; measured not given.  $^{191}\text{Hg}$  deduced superdeformed band entrance channel dependence effects.

**92StZQ Search for Superdeformation in  $^{144}$ ,  $^{146}\text{Gd}$** 

K. Strahle, T. Rzaca-Urban, R. M. Lieder, S. Utzelmann, D. Balabanski, B. Bochev, W. Gast, A. Georgiev, D. Kutchin, G. Marti, H. Schnare, K. Spohr, M. Binderberger, M. Eschenauer, S. Freund, E. Ott, J. Theuerkauf, H. Wolters, K. O. Zell, J. Eberth, P. von Brentano, K. H. Maier, H. Grawe, C. Bach, J. Heese, H. Kluge, M. Schramm, R. Schubarth, KFA-IKP Ann. Rept., 1991, p. 90 (1992).

**Nuclear Reactions:**  $+110\text{Pd}(^{40}\text{Ar},4n)$ ,  $(^{40}\text{Ar},5n)$ ,  $E=189$  MeV;  $^{106}\text{Pd}(^{40}\text{Ar},3n)$ ,  $(^{40}\text{Ar},4n)$ ,  $E=200$  MeV; measured  $\gamma\gamma$ -energy correlation, DSA.  $^{144}$ ,  $^{146}\text{Gd}$  deduced evidence for superdeformed states.

**92StZS Superdeformation in  $^{183}\text{Pb}$  (Question)**

M. A. Stoyer, E. A. Henry, J. A. Becker, M. J. Brinkman, A. Kuhnert, T. F. Wang, J. Burde, M. A. Deleplanque, R. M. Diamond, J. Draper, J.

Oliveira, E. Rubel, F. Stephens, Contrib. Int. Conf. Nuclear Structure at High Angular Momentum, Ottawa, p. 72 (1992); AECL-10613 (1992)

**Nuclear Reactions:**  $+174\text{Yb}(^{24}\text{Mg},5n)$ ,  $(^{24}\text{Mg},4n)$ ,  $(^{24}\text{Mg},6n)$ ,  $E=129, 134$  MeV; measured relative  $\sigma$ ,  $\gamma\gamma$ -coin.  $^{193}\text{Pb}$  deduced transitions, band structure, superdeformed band evidence.

**92StZT Search for Population of Superdeformed States in  $^{194}\text{Pb}$  using  $^{194}\text{Bi}$   $\beta^-$ -Decay**

M. A. Stoyer, E. A. Henry, J. A. Becker, R. W. Hoff, A. Kuhnert, T. F. Wang, J. Breitenbach, M. Jamio, J. L. Wood, Y. A. Akovali, C. R. Bingham, M. Zhang, P. Joshi, H. K. Carter, J. Kornicki, P. Mantica, Contrib. Int. Conf. Nuclear Structure at High Angular Momentum, Ottawa, p. 69 (1992); AECL-10613 (1992)

**Nuclear Structure:**  $+194\text{Bi}(\beta^-)$ ; measured  $E_\gamma$ ,  $I_\gamma$ ,  $I(\text{ce})$ ,  $\gamma\gamma$ ,  $\gamma(\text{ce})$ -coin.  $^{194}\text{Pb}$  deduced no evidence of superdeformed states. Analyzed actinide data. Deformed liquid drop model.

**92StZU Quadrupole Moment of the Excited SD Band in  $^{146}\text{Gd}$**

K. Strahle, T. Rzaca-Urban, G. Hebbinghaus, R. M. Lieder, D. Balabanski, W. Gast, H. Schnare, W. Urban, P. von Brentano, A. Dewald, J. Eberth, E. Ott, J. Theuerkauf, H. Wolters, K. O. Zell, D. Alber, K. H. Maier, E. M. Beck, H. Hubel, W. Schmitz, Contrib. Int. Conf. Nuclear Structure at High Angular Momentum, Ottawa, p. 64 (1992); AECL-10613 (1992)

**Nuclear Structure:**  $+146\text{Gd}$ ; analyzed data; deduced excited superdeformed band quadrupole moment.

**92StZV Search for Superdeformation in  $^{144}$ ,  $^{146}\text{Gd}$**

K. Strahle, T. Rzaca-Urban, R. M. Lieder, S. Utzelmann, D. Balabanski, B. Bochev, W. Gast, A. Georgiev, D. Kutchin, G. Marti, H. Schnare, K. Spohr, M. Binderberger, M. Eschenauer, S. Freund, E. Ott, J. Theuerkauf, H. Wolters, K. O. Zell, J. Eberth, P. von Brentano, K. H. Maier, H. Grawe, C. Bach, J. Heese, H. Kluge, M. Schramm, R. Schubarth, Contrib. Int. Conf. Nuclear Structure at High Angular Momentum, Ottawa, p. 63 (1992); AECL-10613 (1992)

**Nuclear Reactions:**  $+110\text{Pd}(^{40}\text{Ar},xn)$ ,  $E=189$  MeV;  $^{109}\text{Pd}(^{40}\text{Ar}, xn)$ ,  $E=182$  MeV; measured  $\gamma$ -spectra, sum coincidences.  $^{146}\text{Gd}$  deduced superdeformed band.

**92Vi03 Radiation Originating from Unresolved Superdeformed States in  $^{146}\text{Gd}$**

J. P. Vivien, D. Balouka, B. Haas, H. R. Andrews, D. C. Radford, D. Ward, V. P. Janzen, D. Prevost, J. C. Waddington, S. Flibotte, S. Pilotte, P. Taras, A. Galindo-Uribarri, H. Kluge, S. Aberg, Phys. Lett. 278B, 407 (1992).

**Nuclear Reactions:**  $+124\text{Sn}(^{28}\text{Si},xn)$ ,  $E=155$  MeV; measured correlated  $\gamma\gamma$ -coincidence matrix,  $I_\gamma$ .  $^{146}\text{Gd}$  deduced unresolved superdeformed states.

**92WaZW Topological Excitations and Identical Superdeformed Bands**

J. C. Waddington, R. K. Bhaduri, Contrib. Int. Conf. Nuclear Structure at High Angular Momentum, Ottawa, p. 80 (1992); AECL-10613 (1992)

**Nuclear Structure:**  $+192\text{Hg}$ ; analyzed identical superdeformed band features; deduced vortices role. Topological excitations,  $^{192}\text{Dy}$  core.

**92WaZX Feeding of the Yrast Superdeformed Band through the Superdeformed Continuum**

J. C. Waddington, J. A. Kuehner, H. R. Andrews, D. Balouka, T. Drake, S. Flibotte, A. Galindo-Uribarri, B. Haas, V. P. Janzen, J. Kluge, S. M. Mullins, S. Pilotte, D. Prevost, D. C. Radford, J. P. Vivien, D. Ward, S. Aberg, Contrib. Int. Conf. Nuclear Structure at High Angular Momentum, Ottawa, p. 62 (1992); AECL-10613 (1992)

**Nuclear Reactions:**  $+124\text{Sn}(^{28}\text{Si},xn)$ ,  $E=155$  MeV; measured  $\gamma\gamma$ -coin.  $^{146}\text{Gd}$  deduced superdeformed continuum feeding of yrast superdeformed band.

**92WIZS Lifetimes of Superdeformed States in  $^{194}\text{Pb}$**

P. Willsau, H. Hubel, F. Azaiez, M. A. Deleplanque, R. M. Diamond, A. Macchiavelli, F. S. Stephens, H. Kluge, F. Hannachi, J. C. Bachejar, J. A. Becker, M. J. Brinkman, E. A. Henry, A. Kuhnert, T. F. Wang, J. A. Draper, E. Rubel, KVI 1991 Ann. Rept., p. 32 (1992).

**Nuclear Reactions:**  $+150\text{Sm}(^{48}\text{Ca},4n)$ ,  $E=205$  MeV; measured DSA,  $\gamma$ -spectra.  $^{194}\text{Pb}$  deduced superdeformed state  $T_{1/2}$ , transition quadrupole moment.

**92WIZU Lifetimes of Superdeformed States in  $^{194}\text{Pb}$**

P. Willsau, H. Hubel, F. Azaiez, M. A. Deleplanque, R. M. Diamond, W. Korten, A. O. Macchiavelli, F. S. Stephens, H. Kluge, F. Hannachi, J. C. Bachejar, J. A. Becker, M. J. Brinkman, E. A. Henry, A. Kuhnert, T. F. Wang, J. A. Draper, E. Rubel, Contrib. Int. Conf. Nuclear Structure at High Angular Momentum, Ottawa, p. 82 (1992); AECL-10613 (1992)

**Nuclear Reactions:**  $+150\text{Sm}(^{48}\text{Ca},4n)$ ,  $E=205$  MeV; measured  $\gamma\gamma$ -coin, DSA.  $^{194}\text{Pb}$  deduced superdeformed states  $T_{1/2}$ .

**92YuZY Observation of Superdeformation in  $^{191}\text{Tl}$**

C. -H. Yu, S. Pilotte, J. M. Lewis, L. L. Riedinger, I. Bearden, M. P. Carpenter, R. V. F. Janssens, T. L. Khoo, Y. Liang, T. Lauritsen, F. Soramel, Bull. Am. Phys. Soc. 37, No. 2, 1029, Q7 4 (1992)

**Nuclear Reactions:**  $+159\text{Tb}(^{88}\text{Sr},4n)$ ,  $E=165$  MeV; measured  $\gamma$  multiplicity.  $^{191}\text{Tl}$  deduced superdeformation, band structure.

**92ZwZZ Search for Superdeformed Nucl in the  $A = 190$  Region**

G. Zwart, H. Andrews, M. Cromaz, T. Drake, A. Galindo-Uribarri, F. Ingebretsen, V. Janzen, S. Mullins, L. Persson, T. Porcelli, D. Prevost, D. Radford, J. Waddington, D. Ward, Contrib. Int. Conf. Nuclear Structure at High Angular Momentum, Ottawa, p. 76 (1992); AECL-10613 (1992)

**Nuclear Reactions:**  $+176\text{Yb}(^{19}\text{F},xn)$ ,  $E=105, 110$  MeV;  $^{184}\text{W}(^{19}\text{F}, xn)$ ,  $E=107$  MeV; measured  $\gamma\gamma$ -coin.  $^{180}\text{W}(^{18}\text{O}, xn)$ ,  $(^{18}\text{O},xn\alpha)$ ,  $E=105, 110$  MeV; measured  $\gamma\alpha$ ,  $\gamma\gamma$ -coin.  $^{180}$ ,  $^{182}\text{Au}$ ,  $^{180}$ ,  $^{182}\text{Hg}$ ,  $^{187}$ ,  $^{188}\text{Pb}$  deduced levels,  $J, \pi$ , no superdeformed band evidence.

**93At01 Linking Transitions from the Superdeformed Band in  $^{148}\text{Eu}$**

A. Atac, M. Piiparinen, B. Herskind, J. Nyberg, G. Sletten, G. de Angelis, S. Forbes, N. Gjorup, G. Hagemann, F. Ingebretsen, H. Jensen, D. Jerrestam, H. Kusakari, R. M. Lieder, G. V. Marti, S. Mullins, D. Santonocito, H. Schnare, K. Strahle, M. Sugawara, P. O. Tjom, A. Virtanen, R. Wadsworth, Phys. Rev. Lett. 70, 1069 (1993).

**Nuclear Reactions:**  $+110\text{Pd}(^{37}\text{Cl},4n)$ ,  $E=160$  MeV; measured  $\gamma\gamma$ , higher fold-coin,  $E_\gamma$ ,  $I_\gamma$ .  $^{148}\text{Eu}$  deduced levels,  $J, \pi$ ,  $I_\gamma$ , normal deformed superdeformed states connection.

**93At02 Superdeformed Band in the  $^{148}\text{Eu}$  Nucleus: Study of the decay out**

A. Atac, M. Piiparinen, B. Herskind, J. Nyberg, G. Sletten, G. de Angelis, S. Forbes, N. Gjorup, G. Hagemann, F. Ingebretsen, H. Jensen, D. Jerrestam, H. Kusakari, R. Lieder, G. M. Marti, S. Mullins, D. Santonocito, H. Schnare, K. Strahle, M. Sugawara, P. O. Tjom, A. Virtanen, R. Wadsworth, Acta Phys. Pol. B24, 395 (1993).

**Nuclear Reactions:**  $+110\text{Pd}(^{37}\text{Cl},4n)$ ,  $E=160$  MeV; measured  $\gamma\gamma$ -coin sum spectra.  $^{148}\text{Eu}$  deduced superdeformed band decay features.

**93At03 Observation of the Decay Out of the Superdeformed Band in  $^{148}\text{Eu}$**

A. Atac, M. Piiparinen, B. Herskind, J. Nyberg, G. Sletten, G. de Angelis, R. M. Clark, S. A. Forbes, N. Gjorup, G. B. Hagemann, F. Ingebretsen, H. J. Jensen, D. Jerrestam, H. Kusakari, R. M. Lieder, G. V. Marti, S. Mullins, P. J. Nolan, E. S. Paul, P. H. Regan, D. Santonocito, H. Schnare, K. Strahle, M. Sugawara, P. O. Tjom, A. Virtanen, R. Wadsworth, Nucl. Phys. A557, 109c (1993).

**Nuclear Reactions:**  $+110\text{Pd}(^{37}\text{Cl},4n)$ ,  $E=160$  MeV; measured  $\gamma\gamma$ -coin,  $E_\gamma$ ,  $I_\gamma$ .  $^{148}\text{Eu}$  deduced levels,  $J, \pi$ , superdeformed band decay features.

**93Ba20 Linking Transitions between the Highly Deformed States and the Yrast States of Normal Deformation in  $^{152}\text{Nd}$**

D. Bazzacco, F. Brandolini, R. Burch, A. Buscemi, C. Cavedon, D. De Acuna, S. Lunardi, R. Menegazzo, P. Pavan, C. Rossi-Alvarez, M. Sferrazza, R. Zanon, G. de Angelis, P. Bezzon, M. A. Cardona, M. De Poli, G. Maron, M. L. Mazza, D. Napoli, J. Rico, P. Spolaora, X. N. Tang, G. Vedovato, N. Blasi, I. Castiglioni, G. Falconi, G. LoBianco, P. G. Bizzeti, R. Wyss, Phys. Lett. 309B, 235 (1993).

**Nuclear Reactions:** +105}Pd(<sup>28</sup>S,2n2p), E=155 MeV; measured  $\gamma\gamma$ -coin,  $\gamma\gamma(\theta)$ . <sup>153</sup>Nd deduced levels, J,  $\pi$ , moments of inertia, intra-band transition features, deformed intruder band.

**93Be29 The First Results from EUROGAM: Superdeformed structures in <sup>161</sup>Tb**

F. A. Beck, Th. Byrski, D. Curien, G. Duchene, S. Flibotte, G. de France, B. Haas, B. Kharraja, J. C. Merdinger, C. Theisen, J. P. Vivien, J. C. Lisle, C. W. Beausang, P. Dagnall, P. Fallon, J. Simpson, P. Twin, F. Hannachi, C. Schuck, Z. Fulop, M. Jozsa, A. Kiss, B. M. Nyako, C. M. Petrache, Nucl. Phys. A557, 67c (1993).

**Nuclear Reactions:** +124}Sn(<sup>21</sup>P,4n), E=145 MeV; <sup>152</sup>Te(<sup>27</sup>Al, 6n), E=150 MeV; measured  $\gamma\gamma$ -coin. <sup>151</sup>Tb deduced superdeformed bands.

**93Be37 Degenerate Superdeformed States in <sup>160</sup>Gd**

C. W. Beausang, P. Fallon, S. Clarke, F. A. Beck, Th. Byrski, D. Curien, P. J. Dagnall, G. de France, G. Duchene, P. D. Forsyth, B. Haas, M. J. Joyce, A. O. Macchiavelli, E. S. Paul, J. F. Sharpey-Schafer, J. Simpson, P. J. Twin, J. P. Vivien, Phys. Rev. Lett. 71, 1800 (1993).

**Nuclear Reactions:** +130}Te(<sup>28</sup>Mg,6n), E=149 MeV; measured  $\gamma\gamma\gamma$ -coin. <sup>158</sup>Gd deduced levels, J,  $\pi$ , superdeformed state degeneracy features.

**93Ca23 New Results on Superdeformed Bands in Hg and Tl Nuclei**

M. P. Carpenter, R. V. F. Janssens, Y. Liang, I. G. Bearden, I. Ahmad, M. W. Drigert, U. Garg, R. G. Henry, J. M. Lewis, T. L. Khoo, T. Lauritsen, S. Pilotte, W. Reviol, L. L. Riedinger, F. Soramel, C. -H. Yu, Nucl. Phys. A557, 57c (1993).

**Nuclear Reactions:** +159}Tb(<sup>28</sup>S,4n), E=165 MeV; <sup>160</sup>Gd(<sup>27</sup>Cl, 5n), E=178, 181 MeV; analyzed data. <sup>161</sup>, <sup>162</sup>Tl, <sup>160</sup>Hg deduced levels, J,  $\pi$ , superdeformed bands. Other data input.

**93Cu02 X-Ray Yields of Superdeformed States in <sup>160</sup>Hg**

D. M. Cullen, I. Y. Lee, C. Baktash, J. D. Garrett, N. R. Johnson, F. K. McGowan, D. F. Winchell, Phys. Rev. C47, 1298 (1993).

**Nuclear Reactions:** +150}Nd(<sup>48</sup>Ca,5n), E=213 MeV; measured  $E_\gamma$ ,  $I_\gamma$ , X-ray spectra,  $\gamma(X\text{-ray})$ ,  $\gamma\gamma$ -coin. <sup>160</sup>Hg deduced superdeformed, normal deformed bands X-ray yields.

**93Cu06 Deexcitation from Superdeformed Bands in <sup>161</sup>Tb and Neighboring A 150 Nuclei**

D. Curien, G. de France, C. W. Beausang, F. A. Beck, T. Byrski, S. Clark, P. Dagnall, G. Duchene, S. Flibotte, S. Forbes, P. D. Forsyth, B. Haas, M. A. Joyce, B. Kharraja, B. M. Nyako, C. Schuck, J. Simpson, C. Theisen, P. J. Twin, J. P. Vivien, L. Zolnai, Phys. Rev. Lett. 71, 2559 (1993).

**Nuclear Reactions:** +130}Te(<sup>27</sup>Al,6n), E=154 MeV; measured  $E_\gamma$ ,  $I_\gamma$ ,  $\gamma\gamma$ -coin. <sup>151</sup>Tb deduced superdeformed band transition energies, relative  $I_\gamma$  decay mechanism features.

**93Da04 Coexistence of Collective Oblate and Superdeformed Prolate Shapes in <sup>160</sup>Pb**

P. J. Dagnall, C. W. Beausang, P. Fallon, P. D. Forsyth, E. S. Paul, J. F. Sharpey-Schafer, P. J. Twin, I. All, D. M. Cullen, M. J. Joyce, G. Smith, R. Wadsworth, R. M. Clark, P. H. Regan, A. Astier, M. Meyer, N. Redon, J. Phys. (London) G19, 465 (1993).

**Nuclear Reactions:** +184}W(<sup>16</sup>O,4n), E=98 MeV; <sup>160</sup>W(<sup>16</sup>O, 6n), E=120 MeV; measured  $\gamma\gamma$ -coin. <sup>160</sup>Pb deduced levels, J,  $\pi$ , collective oblate, superdeformed prolate band coexistence.

**93DaZV Excited Superdeformed Bands in <sup>162</sup>Dy**

P. J. Dagnall, C. W. Beausang, S. Clarke, S. A. Forbes, P. D. Forsyth, E. S. Paul, P. J. Twin, J. Simpson, M. A. Bentley, F. Beck, D. Curien, G. De France, G. Duchene, S. Flibotte, B. Haas, A. Atac, J. Nyberg, B. Herskind, J. Styczen, K. Zuber, B. Nyako, Daresbury Lab., 1992-

1993 Ann. Rept., Appendix, p. 31 (1993).

**Nuclear Reactions:** +108}Pd(<sup>48</sup>Ca,4n), E=200 MeV; measured  $\gamma\gamma$ -coin. <sup>152</sup>Dy deduced levels J,  $\pi$ , superdeformed band features.

**93Es01 Evidence for Superdeformed Shape Isomeric States in <sup>28</sup>Si at Excitations Above 40 MeV Through Observations of Selective Particle Decays of <sup>16</sup>O + <sup>12</sup>C Resonances in <sup>4</sup>Be and Alpha Channels**

M. A. Eswaran, S. Kumar, E. T. Mirgule, D. R. Chakrabarty, V. M. Datar, N. L. Ragoowansi, U. K. Pal, Phys. Rev. C47, 1418 (1993).

**Nuclear Reactions:** +12}C(<sup>16</sup>O,<sup>4</sup>Be), <sup>16</sup>O,  $\alpha$ ), E(cm)=25. 7-38. 6 MeV; measured spectra,  $\sigma(\theta)$  vs E. <sup>28</sup>Si deduced resonances, J,  $\pi$ , configuration, superdeformed isomeric states.

**93Fa07 Evidence for M1 Transitions between Superdeformed States in <sup>183</sup>Hg**

P. Fallon, J. Burde, B. Cederwall, M. A. Deleplanque, R. M. Diamond, I. Y. Lee, J. R. B. Oliveira, F. S. Stephens, J. A. Becker, M. J. Brinkman, E. A. Henry, A. Kuhnert, M. A. Stoyer, J. E. Draper, C. Duyar, E. Rubel, Phys. Rev. Lett. 70, 2690 (1993).

**Nuclear Reactions:** +176}Yb(<sup>22</sup>Ne,5n), E=116 MeV; measured  $\gamma\gamma$ -energy correlation,  $\gamma\gamma$ -coin. <sup>183</sup>Hg deduced superdeformed bands two-way decay.

**93Fl03 Multiparticle Excitations and Identical Bands in Superdeformed <sup>140</sup>Gd Nucleus**

S. Flibotte, G. Hackman, Ch. Theisen, H. R. Andrews, G. C. Ball, C. W. Beausang, F. A. Beck, G. Belier, M. A. Bentley, T. Byrski, D. Curien, G. de France, D. Disdier, G. Duchene, P. Fallon, B. Haas, V. P. Janzen, P. M. Jones, B. Kharraja, J. A. Kuehner, J. C. Lisle, J. C. Merdinger, S. M. Mullins, E. S. Paul, D. Prevost, D. C. Radford, V. Rauch, J. F. Smith, J. Styczen, P. J. Twin, J. P. Vivien, J. C. Waddington, D. Ward, K. Zuber, Phys. Rev. Lett. 71, 688 (1993).

**Nuclear Reactions:** +124}Sn(<sup>28</sup>Si,5n), E=158 MeV; measured  $\gamma\gamma$ -coin. <sup>140</sup>Gd deduced levels, J,  $\pi$ , superdeformed bands.

**93Fl07  $\Delta I = 4$  Bifurcation in a Superdeformed Band: Evidence for a  $C_4$  symmetry**

S. Flibotte, H. R. Andrews, G. C. Ball, C. W. Beausang, F. A. Beck, G. Belier, T. Byrski, D. Curien, P. J. Dagnall, G. de France, D. Disdier, G. Duchene, Ch. Finck, B. Haas, G. Hackman, D. S. Haslip, V. P. Janzen, B. Kharraja, J. C. Lisle, J. C. Merdinger, S. M. Mullins, W. Nazarewicz, D. C. Radford, V. Rauch, H. Savajols, J. Styczen, Ch. Theisen, P. J. Twin, J. P. Vivien, J. C. Waddington, D. Ward, K. Zuber, S. Aberg, Phys. Rev. Lett. 71, 4299 (1993).

**Nuclear Reactions:** +124}Sn(<sup>28</sup>Si,5n), E=158 MeV; measured  $E_\gamma$ ,  $I_\gamma$ ,  $\gamma\gamma$ -coin. <sup>140</sup>Gd deduced yrast superdeformed band moment of inertia, evidence for fourfold rotational symmetry.

**93Ga10 First Evidence for the Hyperdeformed Nuclear Shape at High Angular Momentum**

A. Galindo-Uribarri, H. R. Andrews, G. C. Ball, T. E. Drake, V. P. Janzen, J. A. Kuehner, S. M. Mullins, L. Persson, D. Prevost, D. C. Radford, J. C. Waddington, D. Ward, R. Wyss, Phys. Rev. Lett. 71, 231 (1993).

**Nuclear Reactions:** +120}Sn(<sup>27</sup>Cl,xnp), E=187 MeV; measured  $\gamma\gamma$ ,  $\gamma\gamma(\text{particle})$ -coin. <sup>152</sup>, <sup>153</sup>Dy deduced levels,  $\gamma$ -multipolarity, band structure, moment of inertia, hyperdeformation evidence.

**93Ha03 Superdeformed Band in <sup>142</sup>Sm**

G. Hackman, S. M. Mullins, J. A. Kuehner, D. Prevost, J. C. Waddington, A. Galindo-Uribarri, V. P. Janzen, D. C. Radford, N. Schmeing, D. Ward, Phys. Rev. C47, R433 (1993).

**Nuclear Reactions:** +124}Sn(<sup>24</sup>Mg,xn), E=145 MeV; measured  $\gamma\gamma$ -coin,  $E_\gamma$ ,  $I_\gamma$ . <sup>142</sup>Sm deduced superdeformed rotational band, continuum, dynamic moment of inertia.

**93Ha19 Studies of Superdeformation in the Gadolinium Nuclei**

B. Haas, V. P. Janzen, D. Ward, H. R. Andrews, D. C. Radford, D. Prevost, J. A. Kuehner, A. Omar, J. C. Waddington, T. E. Drake, A. Galindo-Uribarri, G. Zwart, S. Flibotte, P. Taras, I. Ragnarsson, Nucl. Phys. A561, 251 (1993).

- Nuclear Reactions:** +120),  $^{122}, ^{124}\text{Sn}(^{28}\text{Si}, xn)$ , ( $^{28}\text{Si}, xn$ ), ( $^{30}\text{Si}, xn$ ),  $E=155$  MeV; measured  $E_\gamma$ ,  $I_\gamma$ ,  $\gamma\gamma$ -coin, DCO ratios.  $^{146}, ^{148}, ^{147}, ^{149}, ^{140}\text{Gd}$  deduced,  $\gamma$ -multiplicities,  $J$ ,  $\pi$ , levels, superdeformed bands. Compton-suppressed hyperpure Ge detector array,  $4\pi$ -bismuth germanate ball. Cranked shell-model-Strutinsky calculations.
- 93Ha20 Study of the Superdeformed Band in  $^{184}\text{Pb}$  and  $^{182}\text{Hg}$  with EUROGAM**  
F. Hannachi, C. Schuck, G. Bastin, I. Deloncle, B. Gall, M. G. Porquet, A. G. Smith, F. Azaiez, C. Bourgeois, J. Duprat, A. Korichi, N. Perrin, N. Poffe, H. Sergolle, A. Astier, Y. Le Coz, M. Meyer, N. Redon, M. Bentley, J. Simpson, J. F. Sharpey-Schafer, M. J. Joyce, C. W. Beausang, P. Fallon, E. S. Paul, P. J. Dagnall, S. A. Forbes, S. Gale, P. M. Jones, R. Wadsworth, R. M. Clark, M. M. Leonard, D. Cunien, G. De France, M. Carpenter, R. Henry, T. Lauritsen, P. Willsau, Nucl. Phys. A557, 75c (1993).  
**Nuclear Reactions:** +162)Dy( $^{32}\text{S}, 4n$ ),  $E=162$  MeV; measured  $E_\gamma$ ,  $I_\gamma$ ,  $\gamma\gamma$ -coin, DSA.  $^{160}\text{Gd}(^{32}\text{S}, 4n)$ ,  $E=159$  MeV; measured  $\gamma\gamma$ -coin.  $^{164}\text{Pb}$  deduced decay out of superdeformed band.
- 93HaZZ**  
G. S. Hackman, Priv. Comm. (1993).  
**Nuclear Structure:** +149)Gd; measured not given; deduced superdeformed band.
- 93Je02 A 'Superdeformed' Band in  $^{102}\text{Pd}$**   
D. Jerrestam, S. Mitarai, E. Ideguchi, B. Fogelberg, A. Gizon, J. Gizon, W. Klamra, Th. Lindblad, R. Bark, J. Nyberg, M. Piiparinen, G. Sletten, Nucl. Phys. A557, 411c (1993).  
**Nuclear Reactions:** CPND  $^{76}\text{Ge}(^{24}\text{S}, 3n\alpha)$ ,  $E=130-153$  MeV; measured  $\gamma$  yields,  $\gamma\gamma$ -coin,  $\gamma(\theta)$ .  $^{100}\text{Pd}$  deduced levels,  $J$ ,  $\pi$ , superdeformed band, configurations.
- 93JoZY First Measurement of a g-Factor in a Superdeformed Nucleus:  $^{182}\text{Hg}$**   
M. J. Joyce, J. F. Sharpey-Schafer, P. J. Twin, C. W. Beausang, D. M. Cullen, M. A. Riley, R. M. Clark, P. J. Dagnall, I. Deloncle, J. Duprat, P. Fallon, P. D. Forsyth, N. Fotiades, S. J. Gale, B. Gall, F. Hannachi, S. Harissopoulos, K. Hauschild, P. M. Jones, C. A. Kalfas, A. Korichi, I. Le Coz, M. Meyer, E. S. Paul, M. G. Porquet, N. Redon, C. Schuck, J. Simpson, R. Vlastou, R. Wadsworth, Priv. Comm. (1993).  
**Nuclear Reactions:** +150)Nd( $^{40}\text{Ca}, 5n$ ),  $E=213$  MeV; measured  $E_\gamma$ ,  $\gamma\gamma$ -coin.  $^{152}\text{Hg}$  deduced superdeformed bands transition  $\gamma$ -multipolarity, g-factors,  $\gamma$ -branching ratio, configurations. Cranked Woods-Saxon calculations.
- 93Jo09 First Measurement of Magnetic Properties in a Superdeformed Nucleus:  $^{182}\text{Hg}$**   
M. J. Joyce, J. F. Sharpey-Schafer, P. J. Twin, C. W. Beausang, D. M. Cullen, M. A. Riley, R. M. Clark, P. J. Dagnall, I. Deloncle, J. Duprat, P. Fallon, P. D. Forsyth, N. Fotiades, S. J. Gale, B. Gall, F. Hannachi, S. Harissopoulos, K. Hauschild, P. M. Jones, C. A. Kalfas, A. Korichi, Y. Le Coz, M. Meyer, E. S. Paul, M. G. Porquet, N. Redon, C. Schuck, J. Simpson, R. Vlastou, R. Wadsworth, Phys. Rev. Lett. 71, 2176 (1993).  
**Nuclear Reactions:** +150)Nd( $^{40}\text{Ca}, 5n$ ),  $E=213$  MeV; measured  $\gamma\gamma$ -coin.  $^{182}\text{Hg}$  deduced levels,  $J$ ,  $\pi$ ,  $B(\lambda)$ , M1/E2 branching ratios, superdeformed bands linking, g factor. Strong coupling model.
- 93Ko08 On the Decay of the Superdeformed Band in  $^{184}\text{Pb}$**   
W. Korten, M. J. Piiparinen, A. Atac, R. A. Bark, B. Herskind, T. Ramsoy, G. Sletten, J. Gerl, H. Hubel, P. Willsau, B. Cederwall, L. O. Norlin, B. Fant, Z. Phys. A344, 475 (1993).  
**Nuclear Reactions:** +164)Dy( $^{32}\text{S}, 4n$ ),  $E=160$  MeV; measured  $\gamma\gamma$ -coin.  $^{164}\text{Pb}$  deduced levels,  $J$ ,  $\pi$ , superdeformed band decay features.
- 93LIZV Investigation of Superdeformation in Doubly-Magic  $^{146}\text{Gd}$**   
R. M. Lieder, W. Gast, A. Georgiev, S. Utzelmann, T. Rzaca-Urban, P. von Brentano, A. Dewald, Chr. Schuhmacher, F. Linden, J. Lisle, W. Urban, F. Hannachi, Daresbury Lab., 1992-1993 Ann. Rept., Appendix, p. 23 (1993).  
**Nuclear Reactions:** +102)Ru( $^{48}\text{Ca}, 4n$ ),  $E=203$  MeV; measured not given.  $^{146}\text{Gd}$  deduced superdeformed band levels.
- 93Lu02 First Results from Ga. Sp. Experiments**  
S. Lunardi, Acta Phys. Pol. B24, 31 (1993).  
**Nuclear Reactions:** +105)Pd( $^{32}\text{S}, 2n2p$ ),  $E=155$  MeV; measured  $\gamma\gamma$ -coin.  $^{133}\text{Nd}$  deduced levels,  $J$ ,  $\pi$ , superdeformed band states decay features.
- 93Lu04 First Results from Ga. Sp. Experiments: The decay out of the superdeformed band in  $^{133}\text{Nd}$**   
S. Lunardi, and the Ga. Sp. Collaboration, Nucl. Phys. A557, 331c (1993).  
**Nuclear Reactions:** +105)Pd( $^{32}\text{S}, 2n2p$ ),  $E=155$  MeV; measured  $\gamma\gamma$ ,  $\gamma\gamma$ -coin.  $^{133}\text{Nd}$  deduced levels,  $J$ ,  $\pi$ , decay out of superdeformed band.
- 93Ma02 First Evidence for States in Hg Nuclei with Deformations between Normal and Super Deformation**  
W. C. Ma, J. H. Hamilton, A. V. Ramayya, L. Chaturvedi, J. K. Deng, W. B. Gao, Y. R. Jiang, J. Kormicki, X. W. Zhao, N. R. Johnson, J. D. Garrett, I. Y. Lee, C. Baktash, F. K. McGowan, W. Nazarewicz, R. Wyss, Phys. Rev. C47, R5 (1993).  
**Nuclear Reactions:** +154)Gd( $^{32}\text{S}, 4n$ ),  $E=159-175$  MeV; measured  $\gamma\gamma$ -coin.  $^{186}\text{Hg}$  deduced levels,  $J$ ,  $\pi$ ,  $T_{1/2}$ , deformation between normal and superdeformed, configuration,  $I_\gamma$ , quadrupole moments.
- 93Mo19 Spectroscopy of the Superdeformed Band in  $^{182}\text{Pb}$**   
E. F. Moore, Y. Liang, R. V. F. Janssens, M. P. Carpenter, I. Ahmad, I. G. Bearden, P. J. Daly, M. W. Drigert, B. Fornal, U. Garg, Z. W. Grabowski, H. L. Harrington, R. G. Henry, T. L. Khoo, T. Lauritsen, R. H. Mayer, D. Nissius, W. Reviol, M. Sferrazza, Phys. Rev. C48, 2261 (1993).  
**Nuclear Reactions:** +170)Er( $^{28}\text{Si}, 4n$ ),  $E=142-151$  MeV; measured  $E_\gamma$ ,  $I_\gamma$ ,  $\gamma\gamma$ -coin, DSA.  $^{180}\text{Pb}$  deduced superdeformed band transitions, intrinsic quadrupole moment, dynamic moment of inertia. Model comparison.
- 93Mu09 Population Effects in the Highly-Deformed Bands of  $^{151}\text{Ce}$  and  $^{152}\text{Nd}$  from  $^{18}\text{O}$ -Induced Reactions**  
S. M. Mullins, J. Nyberg, A. Maj, M. S. Metcalfe, P. J. Nolan, P. H. Regan, R. Wadsworth, R. A. Wyss, Phys. Lett. 312B, 272 (1993).  
**Nuclear Reactions:** +117)Sn( $^{16}\text{O}, 4n$ ),  $E=85$  MeV; measured  $E_\gamma$ ,  $I_\gamma$ ,  $\gamma\gamma$ -coin, DSA.  $^{122}\text{Te}(^{16}\text{O}, 3n)$ ,  $E=85$  MeV; measured  $E_\gamma$ ,  $I_\gamma$ ,  $\gamma\gamma$ -coin.  $^{151}\text{Ce}$ ,  $^{152}\text{Nd}$  deduced levels,  $J$ ,  $\pi$ , highly deformed band structure.
- 93Mu16 Superdeformation in  $^{144}\text{Eu}$**   
S. M. Mullins, G. Hackman, A. Galindo-Uribarri, D. C. Radford, J. C. Waddington, D. Ward, Z. Phys. A346, 327 (1993).  
**Nuclear Reactions:** +122)Sn( $^{27}\text{Al}, 5n$ ),  $E=142$  MeV; measured  $\gamma\gamma$ -coin.  $^{144}\text{Eu}$  deduced superdeformed band evidence.
- 93No04 Superdeformation and High Spin States**  
P. J. Nolan, Nucl. Phys. A553, 107c (1993).  
**Nuclear Structure:** =130-140; A 150; A 190; compiled, reviewed superdeformation, other data features.
- 93Pa05 E0 Transitions and the Depopulation of SD Bands**  
M. Palacz, Z. Sujkowski, J. Bacelar, A. Atac, B. Herskind, J. Nyberg, M. Piiparinen, G. de Angelis, S. Forbes, N. Gjurup, G. Hagemann, F. Ingebretsen, H. Jensen, D. Jerrestam, H. Kusakari, R. Lieder, G. M. Marti, S. Mullins, D. Santonocito, H. Schnare, G. Sletten, K. Strahle, M. Sugawara, P. O. Tjom, A. Virtanen, R. Wadsworth, Acta Phys. Pol. B24, 399 (1993).  
**Nuclear Structure:** +132)Ce,  $^{143}\text{Eu}$ ,  $^{152}\text{Dy}$ ,  $^{182}\text{Hg}$ ; calculated transition probability vs excitation energy for superdeformed states.  $^{146}\text{Eu}$ ; analyzed  $\gamma(\text{K X-ray})$ -coin following superdeformed states decay.
- 93PI01 Lack of Evidence for a Superdeformed Band in  $^{182}\text{Pb}$**   
A. J. M. Plompen, M. N. Harakeh, W. H. A. Hesselink, G. van't Hof, N.

Kalantar-Nayestanaki, J. P. S. van Schagen, R. V. F. Janssens, I. Ahmad, I. G. Bearden, M. P. Carpenter, T. L. Khoo, T. Lauritsen, Y. Liang, U. Garg, W. Reviol, D. Ye, *Phys. Rev. C* **47**, 2378 (1993).

**Nuclear Reactions:** +173)Yb(<sup>24</sup>Mg,5n), E=132 MeV; measured  $\gamma\gamma$ -coin, DSA. <sup>182</sup>Pb deduced no superdeformed band.

**93Ra08 High-Spin Studies: Recent results from the 8 $\pi$  spectrometer**

D. C. Radford, A. Galindo-Uribarri, G. Hackman, V. P. Janzen, and the 8 $\pi$  Collaboration, *Nucl. Phys. A* **557**, 311c (1993).

**Nuclear Reactions:** +54)Fe(<sup>58</sup>Ni,3p), E=243 MeV; <sup>66</sup>Ru(<sup>19</sup>F, 2n2p), E=90 MeV; <sup>82</sup>Mo(<sup>23</sup>Na,2n2p), E=120 MeV; <sup>84</sup>Mo(<sup>23</sup>Na,2n2p), E=117 MeV; <sup>88</sup>Zr(<sup>23</sup>Na, 5n), E=102 MeV; <sup>88</sup>Zr(<sup>23</sup>Na,4n), E=102 MeV; <sup>102</sup>Pd(<sup>11</sup>B,4n), E=47 MeV; <sup>110</sup>Pd(<sup>11</sup>B, 4n), E=45 MeV; <sup>116</sup>Cd(<sup>11</sup>Li,4n), E=39 MeV; <sup>54</sup>Fe(<sup>58</sup>Ni,2p $\alpha$ ), E=243 MeV; <sup>44</sup>Fe(<sup>58</sup>Ni, 4p), E=243 MeV; <sup>84</sup>Mo(<sup>19</sup>F,2np), E=83 MeV; <sup>84</sup>Mo(<sup>23</sup>Na,2np $\alpha$ ), E=117 MeV; <sup>76</sup>Ge(<sup>27</sup>Cl, 4n), E=138 MeV; <sup>88</sup>Zr(<sup>19</sup>F,5n), E=95 MeV; <sup>88</sup>Zr(<sup>19</sup>F,4n), E=85 MeV; <sup>88</sup>Zr(<sup>19</sup>F, 4n), E=70 MeV; deduced band structure for Sb, Sn, In isotopes, A 100. <sup>142</sup>Sm deduced superdeformed band. Other data input. <sup>129</sup>Sn(<sup>27</sup>Cl,xnp), E=187 MeV; measured  $\gamma\gamma$ ,  $\gamma\gamma$ -coin. <sup>152</sup>, <sup>153</sup>Dy deduced hyperdeformation evidence. 8 $\pi$   $\gamma$ -ray spectrometer.

**93RI02 Highly Deformed Band in <sup>138</sup>Pm and the Anomalous Dynamical Moment of Inertia Behavior in the A 135 Superdeformed Region**

M. A. Riley, T. Petters, J. Shick, D. E. Archer, J. Doring, J. W. Holcomb, G. D. Johns, T. D. Johnson, O. N. Tekiy-Mensah, S. L. Tabor, P. C. Womble, V. A. Wood, C. Baktash, M. L. Halbert, D. C. Hensley, I. Y. Lee, R. J. Charity, D. G. Sarantites, L. L. Wittmer, J. Simpson, *Phys. Rev. C* **47**, R441 (1993).

**Nuclear Reactions:** +106)Pd(<sup>62</sup>S,xp $\alpha$ ), <sup>106</sup>Pd(<sup>62</sup>S, xp $\alpha$ ), E=165 MeV; measured  $\gamma\gamma$ -coin sum spectra. <sup>138</sup>Pm deduced deformed rotational band, dynamical moment of inertia. Other nuclei considered.

**93SaZZ Observation of Excited Superdeformed Bands in <sup>132</sup>Ce**

D. Santos, J. Gizon, C. Foin, J. Genevey, A. Gizon, M. Jozsa, J. A. Pinston, C. W. Beausang, S. A. Forbes, P. J. Nolan, E. S. Paul, A. T. Semple, J. N. Wilson, R. M. Clark, K. Hauschild, R. Wadsworth, J. Simpson, B. M. Nyako, L. Zolnai, W. Klamra, J. Dudek, N. El Aouad, Daresbury Lab., 1992-1993 Ann. Rept., Appendix, p. 15 (1993).

**Nuclear Reactions:** +100)Mo(<sup>26</sup>S,4n), E=155 MeV; measured  $\gamma\gamma$ -coin. <sup>132</sup>Ce deduced levels, J,  $\pi$ , superdeformed bands.

**93SeZZ A Search for a Superdeformed Band in <sup>144</sup>Gd**

A. T. Semple, C. W. Beausang, S. A. Forbes, P. J. Nolan, E. S. Paul, J. N. Wilson, R. M. Clark, K. Hauschild, I. M. Hibbert, R. Wadsworth, J. Simpson, A. Gizon, J. Gizon, D. Santos, Daresbury Lab., 1992-1993 Ann. Rept., Appendix, p. 22 (1993).

**Nuclear Reactions:** +118)Sn(<sup>26</sup>Si,4n), E=155 MeV; measured  $\gamma\gamma$ -coin. <sup>144</sup>Gd deduced no definite superdeformed band.

**93St01 Search for Population of Superdeformed States in <sup>184</sup>Pb Using <sup>184</sup>Bi  $\beta^+$  Decay**

M. A. Stoyer, E. A. Henry, Y. A. Akovali, J. A. Becker, C. R. Bingham, J. Breitenbach, H. K. Carter, R. W. Hoff, M. Jarrio, P. Joshi, J. Kornicki, A. Kuhnert, P. F. Mantica, T. F. Wang, J. L. Wood, M. Zhang, *Phys. Rev. C* **47**, 76 (1993).

**Radioactivity:** <sup>184</sup>Bi( $\beta^+$ ), (EC) [from Re(<sup>18</sup>O, xn), E=170 MeV]; measured E $\gamma$ ,  $\gamma$ ,  $\gamma\gamma$ ,  $\gamma$ (ce)-coin, I(ce). <sup>184</sup>Pb deduced levels, J,  $\pi$  upper limit for superdeformed states population.

**93Vo04 Superdeformation in <sup>191</sup>Au**

D. T. Vo, W. H. Kelly, F. K. Wahn, J. C. Hill, M. A. Deleplanque, R. M. Diamond, F. S. Stephens, J. R. B. Oliveira, J. Burde, A. O. Macchiavelli, J. deBoer, B. Cederwall, I. Y. Lee, P. Fallon, J. A. Becker, E. A. Henry, M. J. Brinkman, A. Kuhnert, M. A. Stoyer, J. R. Hughes, J. E. Draper, C. Duyar, E. Rubel, *Phys. Rev. Lett.* **71**, 340 (1993).

**Nuclear Reactions:** +186)W(<sup>11</sup>B,7n), (<sup>11</sup>B,6n), (<sup>11</sup>B,5n), E=84, 86 MeV; <sup>176</sup>Yb(<sup>19</sup>F,xn), E=100, 105 MeV; measured  $\gamma\gamma$ -coin. <sup>191</sup>Au deduced levels, J,  $\pi$ , superdeformed band, dynamic moments of inertia.

**93Wi02 Transition Quadrupole Moments of Superdeformed States in <sup>184</sup>Pb**

P. Willsau, H. Hubel, W. Korten, F. Azaiez, M. A. Deleplanque, R. M. Diamond, A. O. Macchiavelli, F. S. Stephens, H. Kluge, F. Hannachi, J. C. Bacelar, J. A. Becker, M. J. Brinkman, E. A. Henry, A. Kuhnert, T. F. Wang, J. A. Draper, E. Rubel, *Z. Phys. A* **344**, 351 (1993).

**Nuclear Reactions:** +150)Sm(<sup>28</sup>Ca,4n), E=205 MeV; measured  $\gamma\gamma$ -coin, DSA. <sup>184</sup>Pb levels deduced T<sub>1/2</sub>, superdeformed states transition quadrupole moments.

**93W109 Lifetimes of the Decay from Superdeformed to Normal Deformed in <sup>152</sup>Nd**

P. Willsau, H. Hubel, R. M. Diamond, M. A. Deleplanque, A. O. Macchiavelli, J. R. Oliveira, F. S. Stephens, H. Kluge, J. A. Becker, E. A. Henry, A. Kuhnert, M. Stoyer, *Phys. Rev. C* **48**, R494 (1993).

**Nuclear Reactions:** +100)Mo(<sup>40</sup>Ar,5n), E=175 MeV; measured  $\gamma\gamma$ -coin, Doppler shift recoil distance. <sup>152</sup>Nd deduced superdeformed states T<sub>1/2</sub>, transition probabilities, quadrupole moments.

**93WIZX Multiple, Excited Superdeformed Bands in <sup>133</sup>Pr**

J. N. Wilson, P. J. Nolan, E. S. Paul, A. T. Semple, C. W. Beausang, S. A. Forbes, R. Wadsworth, K. Hauschild, I. M. Hibbert, R. M. Clark, J. Gizon, A. Gizon, D. Santos, B. Nyako, J. Simpson, Daresbury Lab., 1992-1993 Ann. Rept., Appendix, p. 17 (1993).

**Nuclear Reactions:** +100)Mo(<sup>27</sup>Cl,4n), E=155 MeV; measured  $\gamma\gamma$ -coin. <sup>133</sup>Pr deduced levels, J,  $\pi$ , superdeformed band.

**93WIZZ Highly Deformed Bands in <sup>132</sup>Ce and <sup>133</sup>Pr**

J. N. Wilson, C. W. Beausang, S. A. Forbes, P. J. Nolan, E. S. Paul, A. T. Semple, A. Gizon, J. Gizon, D. Santos, B. M. Nyako, R. M. Clark, I. M. Hibbert, K. Hauschild, R. Wadsworth, J. Simpson, *Bull. Am. Phys. Soc.* **38**, No. 2, 981, 169 (1993)

**Nuclear Reactions:** +100)Mo(<sup>26</sup>S,4n), (<sup>27</sup>Cl,4n), E not given; measured  $\gamma\gamma$ -coin. <sup>132</sup>Ce, <sup>133</sup>Pr deduced levels, J,  $\pi$ , superdeformed bands.

**94GaAA**

*Z. Phys.* **A347**, 223(1994) abstract unavailable

**94HuAA**

*Phys. Rev. Lett.* **72**, 824(1994) abstract unavailable

**94LuAA**

*Phys. Rev. Lett.* **72**, 1427(1994) abstract unavailable

**94PIAA**

*Phys. Rev. C* **49**, 718(1994) abstract unavailable

## References for Superdeformed Bands (Theoretical)

- 67StAA  
Nucl. Phys. A95, 420(1967) abstract unavailable
- 70Ts01 *Shape Isomeric States in Heavy Nuclei*  
C. F. Tsang, S. G. Nilsson, Nucl. Phys. A140, 275 (1970).  
**Nuclear Structure:** =174-256; calculated potential energy surface, two-peaked fission barriers, total potential energy,  $T_{1/2}$ .
- 74Co41 *Equilibrium Configurations of Rotating Charged or Gravitating Liquid Masses with Surface Tensor. II.*  
S. Cohen, F. Plasll, W. J. Swiatecki, Ann. Phys. (New York) 82, 557 (1974).  
**Nuclear Reactions:** +107}Ag( $^{20}$ Ne,X),  $E(\text{cm})=25-205$  MeV; calculated impact parameter.  $^{86}$ Rb( $^{20}$ Ne,X),  $^{66}$ Cu( $^{40}$ Ar, X),  $^{46}$ Ti( $^{16}$ O,X),  $^{27}$ Al( $^{16}$ O, X),  $^{12}$ C( $^{12}$ C,X), E not given; calculated fission barrier, neutron binding energy, excitation energy.  $^{106}$ Ag,  $^{66}$ Zn,  $^{46}$ Sc,  $^{27}$ Mg; deduced possible superdeformation. Rotating liquid masses.  
**Nuclear Structure:** =1-300; calculated angular momentum where fission barrier would vanish. A=1-200; calculated fission barrier. Rotating liquid masses.
- 75Be35 *Yrast Bands and High-Spin Potential-Energy Surfaces*  
R. Bengtsson, S. E. Larsson, G. Leander, P. Moller, S. G. Nilsson, S. Aberg, Z. Szymanski, Phys. Lett. 57B, 301 (1975).  
**Nuclear Structure:** +146}Sm,  $^{160}$ Yb; calculated yrast bands, energy surfaces.
- 79BI09 *Alpha Decay Amplification in Superdeformed Nuclei: An Important New Mechanism of Nuclear de-Excitation at High Angular Momenta*  
M. Blann, Phys. Lett. 88B, 5 (1979).  
**Nuclear Reactions:** +109}Ag( $^{40}$ Ar, $\alpha$ ),  $E=169-337$  MeV; calculated transmission coefficients for n, p,  $\alpha$ .  $^{149}$ Tb deduced decay probabilities for n, p,  $\alpha$ , fission channels, evidence for superdeformation. Statistical model for deformed nuclei.
- 80BI04 *Decay of Deformed and Superdeformed Nuclei Formed in Heavy Ion Reactions*  
M. Blann, Phys. Rev. C21, 1770 (1980).  
**Nuclear Reactions:** +109}Ag( $^{40}$ Ar,X),  $E=236$  MeV;  $^{40}$ Ca( $^{16}$ O, X),  $E=214$  MeV; calculated transmission coefficients for spherical, deformed, superdeformed nuclei.  $^{149}$ Tb,  $^{86}$ Ni deduced fraction of  $\alpha$  decay vs spin,  $\alpha$ , n, p branching ratios, superdeformation effects. Rotating liquid drop model, Hauser-Feshbach calculation.
- 80RaAA  
Nucl. Phys. A347, 287(1980) abstract unavailable
- 81Be41 *Some Properties of Superdeformed Nuclei*  
T. Bengtsson, M. E. Faber, G. Leander, P. Moller, M. Ploszajczak, I. Ragnarsson, S. Aberg, Phys. Scr. 24, 200 (1981).  
**Nuclear Structure:** +152}Dy; calculated potential, shell energy surfaces;  $^{80}$ ,  $^{82}$ Zr,  $^{84}$ Ru; calculated potential energy vs deformation;  $^{86}$ Ru; calculated liquid drop model energy. Anisotropic harmonic oscillator potential. A 100; deduced superdeformed properties. A 150; deduced superdeformed properties.
- 81Fa05 *Shell Structure in Superdeformed Light Nuclei (A < 40) at High Rotational Frequencies*  
M. E. Faber, M. Ploszajczak, Phys. Scr. 24, 189 (1981).  
**Nuclear Structure:** +24}Mg,  $^{26}$ ,  $^{27}$ Al,  $^{28}$ ,  $^{30}$ Si; calculated deformation, superdeformation energy surfaces. Cranking Strutinsky model, Saxon-Woods potential.
- 82Ab01 *High-Spin Potential-Energy Surfaces*  
S. Aberg, Phys. Scr. 25, 23 (1982).  
**Nuclear Structure:** =66-218; calculated high-spin potential energy surfaces. Cranked Nilsson-Strutinsky model.
- 85Be12 *Study of the Decay Schemes of  $^{90}$ Mo and  $^{92}$ Tc Nuclei*  
V. S. Belyavenko, G. P. Borozhenets, I. N. Vishnevsky, V. A. Zheltonozhsky, Izv. Akad. Nauk SSSR, Ser. Fiz. 49, 103 (1985).  
**Radioactivity:**  $^{90}$ Mo;  $^{92}$ Tc( $\beta^+$ ), (EC) [from  $^{92}$ ,  $^{94}$ ,  $^{96}$ Mo(p,xn),  $E=70$  MeV]; measured  $E_{\gamma}$ ,  $\eta$ ,  $\gamma\gamma$ -coin; deduced log ft.  $^{92}$ Mo deduced transition, level energies.  $^{90}$ Nb deduced levels,  $\gamma$ -branching, possible J,  $\pi$ , configuration.
- 85Du01 *Shape Evolution in the Transitional Gadolinium, Dysprosium, Erbium, and Ytterbium Nuclei*  
J. Dudek, W. Nazarewicz, Phys. Rev. C31, 298 (1985).  
**Nuclear Structure:** +144},  $^{146}$ ,  $^{148}$ ,  $^{150}$ Gd,  $^{150}$ ,  $^{152}$ ,  $^{154}$ ,  $^{156}$ Dy,  $^{152}$ ,  $^{154}$ ,  $^{156}$ ,  $^{158}$ Er,  $^{154}$ ,  $^{156}$ ,  $^{158}$ ,  $^{160}$ Yb; calculated levels; deduced shape evolution at high J. Cranking approximation, generalized Strutinsky method.
- 86ChZE *High Energy Dipole Bump in the Continuum as a Probe for Super-Deformation*  
Y. S. Chen, C. Baktash, Proc. Intern. Nuclear Physics Conference, Harrogate, U. K., p. 49 (1986).  
**Nuclear Structure:** +158}Yb; calculated E2, M1 transition strength; deduced superdeformation features. Cranked shell model.
- 87Ch07 *Superdeformation in the Rare-Earth Region*  
R. R. Chasman, Phys. Lett. 187B, 219 (1987).  
**Nuclear Structure:** +132}Ce,  $^{146}$ Pm,  $^{141}$ ,  $^{142}$ ,  $^{147}$ ,  $^{149}$ Sm,  $^{142}$ ,  $^{143}$ ,  $^{144}$ ,  $^{145}$ ,  $^{146}$ ,  $^{147}$ ,  $^{148}$ ,  $^{149}$ Eu,  $^{144}$ ,  $^{147}$ ,  $^{148}$ ,  $^{149}$ ,  $^{150}$ Gd,  $^{149}$ ,  $^{150}$ ,  $^{151}$ ,  $^{152}$ Tb,  $^{151}$ ,  $^{152}$ ,  $^{153}$ Dy,  $^{152}$ Ho; calculated well depths, deformation, superdeformation parameters, excitation energies, proton, neutron unoccupied levels. Strutinsky method.
- 87Du02 *Shape Coexistence Effects and Superdeformation in  $^{84}$ Zr*  
J. Dudek, W. Nazarewicz, N. Rowley, Phys. Rev. C35, 1489 (1987).  
**Nuclear Structure:** +78},  $^{80}$ ,  $^{82}$ ,  $^{84}$ ,  $^{86}$ Zr; calculated total energy surfaces, Routhians.  $^{84}$ Zr; calculated levels, yrast scheme, band structure; deduced shape coexistences, superdeformation. Woods-Saxon potential, cranking, Hartree-Fock-Bogolyubov method, Strutinsky generalizations, particle number projection.
- 87Du04 *Abundance and Systematics of Nuclear Superdeformed States; Relation to the pseudospin and pseudo-SU(3) symmetries*  
J. Dudek, W. Nazarewicz, Z. Szymanski, G. A. Leander, Phys. Rev. Lett. 59, 1405 (1987).  
**Nuclear Structure:** +148},  $^{152}$ ,  $^{154}$ Dy,  $^{136}$ ,  $^{144}$ ,  $^{150}$ Sm,  $^{152}$ ,  $^{154}$ ,  $^{144}$ Nd,  $^{128}$ ,  $^{132}$ ,  $^{142}$ Ce; calculated potential energy surfaces; deduced super elongation particle number dependence, superdeformation effects.
- 87He23 *Population and Decay of the Superdeformed Rotational Band of  $^{152}$ Dy*  
B. Herskind, B. Lauritzen, K. Schiffer, R. A. Broglia, F. Barranco, M. Gallardo, J. Dudek, E. Vigezzi, Phys. Rev. Lett. 59, 2416 (1987).  
**Nuclear Structure:** +152}Dy; calculated E1 transition probabilities, superdeformed yrast band.
- 87Na21 *Pairing Correlations in the Superdeformed Rotational Bands: The frequency-deformation scaling*  
W. Nazarewicz, Z. Szymanski, J. Dudek, Phys. Lett. 196B, 404 (1987).  
**Nuclear Structure:** +152}Dy; calculated routhians vs deformation parameter, pairing correlation energy, associated dealignment in superdeformed states.



**87Sh25** *Role of Static and Dynamic Pairing Correlations in the Superdeformed Band of  $^{152}\text{Dy}$*

Y. R. Shimizu, E. Vigezzi, R. A. Broglia, Phys. Lett. 198B, 33 (1987).

**Nuclear Structure:**  $+152\text{Dy}$ ; calculated superdeformed configuration kinetic, dynamic moments of inertia, correlation energy; deduced pairing correlations role.

**87St08** *Superdeformed States in Rotating  $^{152}\text{Dy}$*

V. M. Strutinsky, Z. Phys. A326, 261 (1987).

**Nuclear Structure:**  $+152\text{Dy}$ ; analyzed level data; calculated deformation energy; deduced angular momentum minimum, stability against rotation criteria for superdeformation. Liquid drop, Nilsson models.

**87Sw01** *Superdeformed Band in  $^{152}\text{Dy}$  as Evidence for the Centrifugal Solidification of a Rotating Nucleus*

W. J. Swiatecki, Phys. Rev. Lett. 58, 1184 (1987).

**Nuclear Structure:**  $+152\text{Dy}$ ; analyzed superdeformed rotational spectrum; deduced centrifugal solidification evidence. Macroscopic model.

**88Be22** *The Role of High-N Orbits in Superdeformed States*

T. Bengtsson, I. Ragnarsson, S. Aberg, Phys. Lett. 208B, 39 (1988).

**Nuclear Structure:**  $+152\text{Dy}$ ,  $^{146}\text{Gd}$ ,  $^{146}\text{Eu}$ ,  $^{146}\text{Sm}$ ; calculated superdeformed quadrupole moment, moment of inertia vs spin.

**88Du13** *Pairing, Temperature, and Deformed-Shell Effects on the Properties of Superdeformed  $^{152}\text{Dy}$  Nucleus*

J. Dudek, B. Herskind, W. Nazarewicz, Z. Szymanski, T. R. Werner, Phys. Rev. C38, 940 (1988).

**Nuclear Structure:**  $+152\text{Dy}$ ; calculated barrier heights, potential energy surfaces, high spin behaviour, deformation, superdeformation properties. Strutinsky model.

**88Du16** *Dependence of the First Saddle-Point Energy on Temperature and Spin in Superdeformed Rare-Earth Nuclei*

J. Dudek, T. Werner, L. L. Riedinger, Phys. Lett. 213B, 120 (1988).

**Nuclear Structure:**  $+146\text{Gd}$ ,  $^{152, 150, 152}\text{Dy}$ ,  $^{152, 154, 156, 158, 160, 162}\text{Er}$ ,  $^{148, 150, 152, 154, 156, 158}\text{Gd}$ ,  $^{146, 148, 150, 152, 154, 156}\text{Sm}$ ; calculated saddle point energy vs temperature, spin, superdeformation.

**88FiZW** *Microscopic Description of the Ground-State and High-Spin Properties of the Light Strontiums*

H. C. Flocard, Proc. Intern. Workshop Nucl. Struct. of the Zirconium Region, Bad Honnef, Germany, p. 143 (1988).

**Nuclear Structure:**  $+76\text{Sr}$ ,  $^{78, 82, 84, 86, 88}\text{Sr}$ ; calculated deformation energy surfaces, rms radii.  $^{80}\text{Sr}$  calculated superdeformed band level energies, deformation energy surfaces, rms radii, fission barriers. Constrained Hartree-Fock with Skyrme interactions.

**88KIZQ** *Moments of Inertia of Superdeformed Nuclei*

S. -I. Kinouchi, T. Kishimoto, Univ. Tsukuba, Tandem Accel. Center, Ann. Rept., 1987, p. 54 (1988); UTTAC-54 (1988).

**Nuclear Structure:**  $+152\text{Dy}$ ; calculated superdeformed moments of inertia. Microscopic calculation with improved effective interactions.

**88Sh37** *Superdeformation and Other Phases at Very High Spin*

J. F. Sharpey-Schafer, Nucl. Phys. A488, 127c (1988).

**Nuclear Structure:**  $+151\text{Dy}$ ,  $^{152}\text{Dy}$ ,  $^{148, 150}\text{Gd}$ ,  $^{151}\text{Tb}$ ,  $^{150, 160}\text{Er}$ ; analyzed level systematics; deduced superdeformation role.

**88Si18** *Nuclear Shapes and Phases at Very High Spin*

J. Simpson, Phys. Scr. T23, 37 (1988).

**Nuclear Reactions:**  $+114\text{Cd}$ ,  $^{106}\text{Pd}(^{48}\text{Ca}, 4n)$ ,  $E=205$  MeV; analyzed data.  $^{152}\text{Dy}$ ,  $^{150}\text{Er}$  deduced levels, superdeformed band features.

**Nuclear Structure:**  $+133\text{Nd}$ ,  $^{135, 137}\text{Nd}$ ,  $^{131}\text{Ce}$ ; analyzed data; deduced

superdeformed band features.

**88TaZU** *Intrinsic Structure of the Superdeformed Band in  $^{132}\text{Ce}$*

K. Tanabe, K. Sugawara-Tanabe, Proc. of the Conf. on High-Spin Nuclear Structure and Novel Nuclear Shapes, April 13-15, 1988, Argonne National Laboratory, Argonne, Illinois; ANL-PHY-88-2, p. 53 (1988).

**Nuclear Structure:**  $+132\text{Ce}$ ; calculated levels, proton, neutron pairing gaps; deduced superdeformation parameters. Cranked HFB.

**89Bo24** *Superdeformation and Shape Isomerism at Zero Spin*

P. Bonche, S. J. Krieger, P. Quentin, M. S. Weiss, J. Meyer, M. Meyer, N. Redon, H. Flocard, P. -H. Heenen, Nucl. Phys. A500, 308 (1989).

**Nuclear Structure:**  $+186\text{Os}$ ,  $^{186, 194, 192, 190, 188, 186, 202, 210}\text{Os}$ ,  $^{200, 198, 196, 194, 192, 190, 188, 186}\text{Pt}$ ,  $^{194, 202, 210, 218}\text{Hg}$ ; calculated Hartree-Fock energies, energy surfaces.  $^{192, 194, 196, 198, 200, 202, 204, 206, 208, 210, 212, 214, 216, 218}\text{Hg}$ ; calculated secondary minima deformations.  $^{194, 196, 198}\text{Pt}$ ; calculated axial deformation energies.  $^{60, 68}\text{Ni}$ ,  $^{190, 182}\text{Pt}$ ,  $^{206, 208, 210}\text{Os}$ ,  $^{194, 186, 214}\text{Hg}$ ; deduced possible superdeformation effects. Microscopic Hartree-Fock plus BCS.

**89Ch06** *Superdeformation Near  $A = 190$*

R. R. Chasman, Phys. Lett. 219B, 227 (1989).

**Nuclear Structure:**  $+178\text{W}$ ,  $^{191, 192, 183}\text{Re}$ ,  $^{178, 180, 182, 183, 194}\text{Os}$ ,  $^{191, 192, 193, 194, 195}\text{Ir}$ ,  $^{190, 191, 192, 193, 194, 195, 196}\text{Pt}$ ,  $^{190, 191, 192, 193, 194, 195, 196}\text{Au}$ ,  $^{187, 190, 191, 192, 193, 194, 195, 196}\text{Hg}$ ,  $^{189}\text{Tl}$ ,  $^{191}\text{Al}$ ,  $^{192, 203, 204}\text{Rn}$ ,  $^{183}\text{Fr}$ ; calculated level energies; deduced superdeformation features. Cranked Strutinsky method.

**89Ch41** *On the Formation of Superdeformed Nuclear States*

Y. Chen, Chin. J. Nucl. Phys. 11, No. 1, 53 (1989).

**Nuclear Structure:**  $+130\text{Pr}$ ,  $^{131}\text{Ce}$ ,  $^{131}\text{Pr}$ ; calculated yrast configuration potential energy surfaces; deduced superdeformation features.

**89Na07** *Shape Variations, Influence of Pairing and Alignment of Angular Momentum in Superdeformed Bands in the  $A = 150$  Region*

W. Nazarewicz, R. Wyss, A. Johnson, Phys. Lett. 225B, 208 (1989).

**Nuclear Structure:**  $+152\text{Dy}$ ,  $^{150}\text{Gd}$ ,  $^{151}\text{Tb}$ ; calculated levels, equilibrium deformations, dynamical moments of inertia. Deformation-self-consistent pairing average model and variants.  $^{152}\text{Dy}$ ,  $^{150}\text{Gd}$ ; deduced superdeformation character.

**89Na17** *Structure of Superdeformed Bands in the  $A = 150$  Mass Region*

W. Nazarewicz, R. Wyss, A. Johnson, Nucl. Phys. A503, 285 (1989).

**Nuclear Structure:**  $+144\text{Nd}$ ,  $^{140, 150, 148, 146}\text{Gd}$ ,  $^{150, 152, 153}\text{Dy}$ ,  $^{150, 151}\text{Tb}$ ,  $^{153}\text{Ho}$ ,  $^{148, 149}\text{Eu}$ ; calculated levels, rotational band moments of inertia, quadrupole moments.  $^{143, 148}\text{Eu}$ ,  $^{144, 146, 148, 149}\text{Gd}$ ,  $^{150, 152, 153}\text{Dy}$ ,  $^{153}\text{Ho}$ ,  $^{154}\text{Er}$ ; analyzed superdeformed moments of inertia.  $^{146}\text{Gd}$ ; analyzed superdeformed moments of inertia; deduced  $\pi$ .  $^{150}\text{Gd}$ ; analyzed superdeformed moments of inertia, quadrupole moments.  $^{150}\text{Tb}$ ; analyzed superdeformed moments of inertia; deduced configuration.  $^{151}\text{Tb}$ ; analyzed superdeformed moments of inertia; deduced  $\pi$  and signature.  $^{151}\text{Dy}$ ; analyzed superdeformed moments of inertia; deduced possible band crossings. Deformed shell model. Comparison with other data.

**89Ok01** *Fission Stability of Superdeformed Nuclei*

J. Okolowicz, J. M. Irvine, J. Phys. (London) G15, 823 (1989).

**Nuclear Structure:**  $+144\text{Nd}$ ; calculated free energy vs mass quadrupole moment; deduced superdeformation shapes. Constrained Hartree-Fock.

**89Sc02** *Lifetimes and Lineshapes in Superdeformed Bands*

K. Schiffer, B. Herskind, J. Gascon, Z. Phys. A332, 17 (1989).

**Nuclear Structure:**  $+152\text{Dy}$ ; calculated levels,  $T_{1/2}$ ,  $B(\lambda)$ ,  $I(\gamma)$ ; deduced normal, superdeformed state mixing. Statistical model, Monte Carlo simulation.

89ShZZ *Semi-Empirical Fits for Superdeformed Band Energies*

Y. Y. Sharon, R. A. Naumann, G. Loring, *Bull. Am. Phys. Soc.* 34, No. 4, 1169, D6 7 (1989)

**Nuclear Structure:** =100-180; analyzed superdeformed band in 11 nuclei. Semi-empirical fits.

90Ab08 *Superdeformations - A Theoretical Overview*

S. Aberg, *Nucl. Phys.* A520, 35c (1990).

**Nuclear Structure:** =66-218; compiled superdeformed state calculations, data analyses.

## 90AbAA

*Ann. Rev. Nucl. Part. Sci.* 40, 439(1990) abstract unavailable.

90Be37 *Level Spin and Moments of Inertia in Superdeformed Nuclei Near A = 194*

J. A. Becker, N. Roy, E. A. Henry, S. W. Yates, A. Kuhnert, J. E. Draper, W. Korten, C. W. Beausang, M. A. Deleplanque, R. M. Diamond, F. S. Stephens, W. H. Kelly, F. Azalez, J. A. Cizewski, M. J. Brinkman, *Nucl. Phys.* A520, 187c (1990).

**Nuclear Structure:** +190, <sup>191</sup>, <sup>192</sup>, <sup>193</sup>, <sup>194</sup>Hg, <sup>194</sup>, <sup>195</sup>Pb, <sup>193</sup>, <sup>194</sup>Tl; analyzed data; deduced levels, J, superdeformed band parameters. Least-squares fit to rotational formulas.

90BeZK *Spin Determination in Superdeformed <sup>192</sup>Hg and <sup>194</sup>Hg*

J. A. Becker, N. Roy, E. A. Henry, S. W. Yates, J. E. Draper, C. W. Beausang, M. A. Deleplanque, R. M. Diamond, F. S. Stephens, W. Korten, J. A. Cizewski, M. J. Brinkman, *Proc. Inter. Conf. Nuclear Structure of the Nineties*, Oak Ridge, Tennessee, Vol. 1, p. 2 (1990).

**Nuclear Structure:** +192, <sup>194</sup>Hg; analyzed data; deduced superdeformed band exit spin.

90Bo40 *Quadrupole Collective Correlations and the Depopulation of the Superdeformed Bands in Mercury*

P. Bonche, J. Dobaczewski, H. Flocard, P. H. Heenen, S. J. Krieger, J. Meyer, M. S. Weiss, *Nucl. Phys.* A519, 509 (1990).

**Nuclear Structure:** +190, <sup>192</sup>, <sup>194</sup>, <sup>196</sup>, <sup>198</sup>Hg; calculated deformation energy, wave functions, proton quadrupole moments, superdeformed band decay  $\lambda$ . Self-consistent generator coordinate method, Hartree-Fock plus BCS wave functions.

90Ch24 *The Effects of Pairing on Superdeformed Rotational Bands Near A = 190*

R. R. Chasman, *Phys. Lett.* 242B, 317 (1990).

**Nuclear Structure:** +190, <sup>191</sup>, <sup>192</sup>, <sup>193</sup>, <sup>194</sup>Hg, <sup>193</sup>, <sup>194</sup>Tl; calculated superdeformed level second moments of inertia.

90ChZI *The Criterion for the Observation of the GDR Built on Superdeformed States*

Y. S. Chen, *Proc. Inter. Conf. Nuclear Structure of the Nineties*, Oak Ridge, Tennessee, Vol. 1, p. 200 (1990).

**Nuclear Structure:** +146, <sup>146</sup>, <sup>150</sup>, <sup>152</sup>Dy, <sup>132</sup>, <sup>134</sup>, <sup>136</sup>Nd, <sup>80</sup>, <sup>82</sup> Sr; calculated levels,  $\sigma(\gamma, X)$ ; deduced superdeformed state based GDR excitation criterion. Linear response theory.

90Do05 *The Superdeformed Isotope Chains in the Rare-Earth Region*

B. Dong, Y. Chen, X. Jin, *Chin. J. Nucl. Phys.* 12, No 1, 1 (1990).

**Nuclear Structure:** +144, <sup>145</sup>, <sup>146</sup>, <sup>147</sup>, <sup>148</sup>, <sup>149</sup>, <sup>150</sup>, <sup>151</sup>, <sup>152</sup>Gd, <sup>145</sup>, <sup>148</sup>, <sup>150</sup>, <sup>152</sup>, <sup>154</sup>Dy; calculated total equipotential energy surfaces; deduced superdeformation features. Cranked Nilsson model.

90DoZY *A Model for the Decay of Superdeformed Bands*

T. Dossing, E. Vigezzi, *Proc. Inter. Conf. Nuclear Structure of the Nineties*, Oak Ridge, Tennessee, Vol. 1, p. 12 (1990).

**Nuclear Structure:** +152Dy; calculated superdeformed band decay features.

90Dr08 *Spins in Superdeformed Bands in the Mass 190 Region*

J. E. Draper, F. S. Stephens, M. A. Deleplanque, W. Korten, R. M. Diamond, W. H. Kelly, F. Azalez, A. O. Macchiavelli, C. W. Beausang, E. C. Rubel, J. A. Becker, N. Roy, E. A. Henry, M. J. Brinkman, A. Kuhnert, S. W. Yates, *Phys. Rev.* C42, R1791 (1990).

**Nuclear Structure:** +192, <sup>194</sup>Hf, <sup>233</sup>U; analyzed superdeformed band structure; deduced level J. Pseudospin formalism.

90Du10 *Prediction of Octupole-Deformation Effects in Superdeformed Nuclei of A 150 and A 190 Mass Regions and Possible Interrelation with Pseudo-Spin Symmetry*

J. Dudek, T. R. Werner, Z. Szymanski, *Phys. Lett.* 248B, 235 (1990).

**Nuclear Structure:** +146Nd, <sup>148</sup>Sm, <sup>150</sup>Gd, <sup>152</sup>Dy, <sup>154</sup>Er, <sup>156</sup>Yb, <sup>185</sup>, <sup>188</sup>, <sup>190</sup>, <sup>192</sup>, <sup>194</sup>, <sup>196</sup>, <sup>198</sup>, <sup>200</sup>, <sup>202</sup>Hg; calculated potential energy vs deformation parameter; deduced pronounced octupole effects, superdeformed nuclei.

90Ge06 *On a Possible Supersymmetry in Superdeformed Bands*

A. Gelberg, P. von Brentano, R. F. Casten, *J. Phys. (London)* G16, L143 (1990).

**Nuclear Structure:** +152Dy, <sup>151</sup>Tb; analyzed level data; deduced supersymmetry role in superdeformation.

90Ho13 *Octupole Instability of Super- and Hyperdeformed Nuclei*

J. Holler, S. Aberg, *Z. Phys.* A336, 363 (1990).

**Nuclear Structure:** +152Dy, <sup>190</sup>, <sup>194</sup>Hg, <sup>200</sup>Rn; calculated potential energy surfaces; deduced possible superdeformation, hyperdeformation. <sup>146</sup>Gd, <sup>152</sup>Dy, <sup>194</sup>, <sup>190</sup>Hg, <sup>196</sup>Pb, <sup>198</sup>Po, <sup>200</sup>Rn; calculated octupole softness; deduced possible superdeformation. Cranked Nilsson-Strutinsky model.

90Ja13 *Superdeformation in the Mercury Nuclei*

R. V. F. Janssens, M. P. Carpenter, M. W. Drigert, P. B. Fernandez, E. F. Moore, D. Ye, I. Ahmad, K. B. Beard, I. G. Bearden, Ph. Benet, P. J. Daly, U. Garg, Z. W. Grabowski, T. L. Khoo, W. Reviol, F. L. H. Wolfs, *Nucl. Phys.* A520, 75c (1990).

**Nuclear Structure:** +194, <sup>190</sup>Pb, <sup>193</sup>, <sup>194</sup>Tl, <sup>190</sup>, <sup>191</sup>, <sup>192</sup>, <sup>193</sup>, <sup>194</sup>Hg; compiled, analyzed superdeformed band data.

90Ko12 *A Relativistic Theory of Superdeformations in Rapidly Rotating Nuclei*

W. Koepf, P. Ring, *Nucl. Phys.* A511, 279 (1990).

**Nuclear Structure:** +152Dy, <sup>80</sup>Sr; calculated superdeformed band structure, quadrupole moments. Cranked relativistic mean field theory.

90Kr10 *Coupling Schemes in Doubly Odd Nuclei and Identical Superdeformed Bands*

A. J. Kreiner, A. O. Macchiavelli, *Phys. Rev.* C42, R1822 (1990).

**Nuclear Structure:** +150, <sup>146</sup>, <sup>148</sup>, <sup>147</sup>Gd; analyzed band structure, superdeformation features. Coupling schemes from pseudospin symmetry.

90Mi13 *Octupole Vibrations Built on Superdeformed Rotational Bands*

S. Mizutori, Y. R. Shimizu, K. Matsuyanagi, *Prog. Theor. Phys. (Kyoto)* 83, 666 (1990).

**Nuclear Structure:** +152Dy; calculated giant octupole resonance strength functions; deduced resonances built on superdeformed band states. Cranking model based RPA.

90Na08 *Natural-Parity States in Superdeformed Bands and Pseudo SU(3) Symmetry at Extreme Conditions*

W. Nazarewicz, P. J. Twin, P. Fallon, J. D. Garrett, *Phys. Rev. Lett.* 64, 1654 (1990).

**Nuclear Structure:** +151Tb, <sup>152</sup>Dy, <sup>150</sup>Gd; analyzed level schemes, superdeformed bands; deduced pseudo SU(3) symmetry features.

90Ra27 *Transition Energies in Superdeformed Bands. Dependence on Orbital and Deformation*

I. Ragnarsson, *Nucl. Phys.* A520, 67c (1990).

**Nuclear Structure:** +152Dy; calculated superdeformed band transition energy differences; deduced orbital, deformation dependence.

**90RaZW Transition Energies in Superdeformed Bands - Dependence on Orbital and Deformation**

I. Ragnarsson, Proc. Inter. Conf. Nuclear Structure of the Nineties, Oak Ridge, Tennessee, Vol. 1, p. 32 (1990).

**Nuclear Structure:** +151), <sup>152</sup>, <sup>153</sup>Dy; calculated superdeformed band transition energies. Pure single particle model.

**90Sh05 Effects of Pairing Correlations on Superdeformed Bands in the A 150 Region**

Y. R. Shimizu, E. Vigezzi, R. A. Broglia, Nucl. Phys. A509, 80 (1990).

**Nuclear Structure:** +150), <sup>146</sup>, <sup>148</sup>Gd, <sup>150</sup>, <sup>151</sup>, <sup>152</sup>Tb, <sup>151</sup>, <sup>152</sup>, <sup>153</sup>Dy; calculated deformation, superdeformation band structure, moments of inertia. Pair correlations, different models.

**90Sh07 Inertias of Superdeformed Bands**

Y. R. Shimizu, E. Vigezzi, R. A. Broglia, Phys. Rev. C41, 1861 (1990).

**Nuclear Structure:** +149), <sup>150</sup>Gd, <sup>152</sup>Dy; calculated superdeformed moment of inertia. Self-consistent treatment of nuclear deformation, pairing correlations.

**90Sh08 Quantum Size Effects in Rapidly Rotating Nuclei**

Y. R. Shimizu, R. A. Broglia, Phys. Rev. C41, 1865 (1990).

**Nuclear Structure:** +166)Yb; calculated effective pairing gap. <sup>150</sup>Gd; calculated superdeformed band moments of inertia. RPA, strongly rotating nuclei.

**90Sh21 A Comparison of the RPA and Number Projection Approaches for Calculations of Pairing Fluctuations in Fast Rotating Nuclei**

Y. R. Shimizu, R. A. Broglia, Nucl. Phys. A515, 38 (1990).

**Nuclear Structure:** +166)Yb; calculated correlation energy vs rotational frequency, pairing force strength. <sup>150</sup>Gd; calculated superdeformed band two moments of inertia. RPA, number projection methods.

**90ShZS Effects of Pairing Correlations on the Depopulation of Superdeformed Bands**

Y. R. Shimizu, E. Vigezzi, T. Dossing, R. A. Broglia, Proc. Inter. Conf. Nuclear Structure of the Nineties, Oak Ridge, Tennessee, Vol. 1, p. 184 (1990).

**Nuclear Structure:** +151), <sup>152</sup>Dy; calculated potential energy surfaces vs spin; deduced pairing correlations role in superdeformed band decay. Cranked HFB plus RPA.

**90ShZT Effects of Particle Correlations on the Moment of Inertia of Superdeformed Bands**

Y. R. Shimizu, E. Vigezzi, R. A. Broglia, Proc. Inter. Conf. Nuclear Structure of the Nineties, Oak Ridge, Tennessee, Vol. 1, p. 182 (1990).

**Nuclear Structure:** +151), <sup>152</sup>, <sup>153</sup>Dy, <sup>150</sup>, <sup>151</sup>, <sup>152</sup>Tb, <sup>146</sup>, <sup>148</sup>, <sup>150</sup>Gd; calculated superdeformed band moments of inertia; deduced pairing correlations role. Cranked HFB plus RPA.

**90St22 Spin Alignment in Superdeformed Rotational Bands**

F. S. Stephens, Nucl. Phys. A520, 91c (1990).

**Nuclear Structure:** =151-194; calculated incremental, total alignment for bands; deduced pairing vibrations role in superdeformation. Plausibility arguments.

**90Su05 The Nuclear Meissner Effect and Superdeformation in the Number-Projected Constrained-Cranked HFB Approach**

K. Sugawara-Tanabe, K. Tanabe, Phys. Lett. 238B, 15 (1990).

**Nuclear Structure:** +132)Ce; calculated levels, superdeformed band structure. Self-consistent constrained-cranked HFB approach.

**90SuZU Mottelson-Valatin Effect in the Number-Projected Constrained-Cranked HFB Solution and the Superdeformation**

K. Sugawara-Tanabe, K. Tanabe, Proc. Inter. Conf. Nuclear Structure of the Nineties, Oak Ridge, Tennessee, Vol. 1, p. 34 (1990).

**Nuclear Structure:** +132)Ce; calculated levels, alignments; deduced superdeformed band structure. Constrained-cranked HFB, number projection.

**90Ta29 Microscopic Structure of the Superdeformed Rotational Band in <sup>132</sup>Ce**

K. Tanabe, K. Sugawara-Tanabe, Prog. Theor. Phys. (Kyoto) 83, 1148 (1990).

**Nuclear Structure:** +132)Ce; calculated levels, average pairing gaps, g, intrinsic quadrupole moments; deduced superdeformed band structure. Self-consistent cranked HFB.

**90TaZY Microscopic Structure of the Superdeformed Bands in A = 130 Region**

K. Tanabe, K. Sugawara-Tanabe, Proc. Inter. Conf. Nuclear Structure of the Nineties, Oak Ridge, Tennessee, Vol. 1, p. 36 (1990).

**Nuclear Structure:** +132)Ce, <sup>136</sup>, <sup>138</sup>Nd; calculated levels, alignments; deduced superdeformed band structure. Angular momentum constrained HFB.

**90Tw02 Superdeformation - An Experimental Overview**

P. J. Twin, Nucl. Phys. A520, 17c (1990).

**Compilation:** A=152; compiled, reviewed data on superdeformation.

**90Vi06 A Model for the Decay Out of Superdeformed Bands**

E. Vigezzi, R. A. Broglia, T. Dossing, Nucl. Phys. A520, 179c (1990).

**Nuclear Structure:** +146), <sup>148</sup>Gd, <sup>150</sup>, <sup>151</sup>Tb, <sup>151</sup>, <sup>152</sup>Dy; analyzed rotational, superdeformed band decay features. Admixture considerations.

**90Vi08 The Decay Out of Superdeformed Rotational Bands**

E. Vigezzi, R. A. Broglia, T. Dossing, Phys. Lett. 249B, 163 (1990).

**Nuclear Structure:** +146), <sup>148</sup>, <sup>150</sup>Gd, <sup>150</sup>, <sup>151</sup>Tb, <sup>151</sup>, <sup>152</sup>Dy; analyzed superdeformed states decay data; deduced superdeformed, normal states barrier transmission coefficient. Statistical model.

**90Za05 Variable Volume Parameters for the Radii and Kinetic Energies of Superdeformed States**

L. Zamick, E. Moya de Guerra, J. Caballero, D. Berdichevsky, D. C. Zheng, Phys. Lett. 242B, 7 (1990).

**Nuclear Structure:** +40)Ca; calculated level kinetic energy, radii differences, superdeformation. Hartree-Fock calculations, Skyrme interactions.

**90Zh05 Superdeformed Many-Particle - Many-Hole States in N = Z Nuclei: Beyond the 8p-8h state in <sup>42</sup>Ca**

D. C. Zheng, L. Zamick, D. Berdichevsky, Phys. Rev. C42, 1004 (1990).

**Nuclear Structure:** +40)Ca, <sup>44</sup>Ti, <sup>48</sup>Cr, <sup>52</sup>Fe, <sup>56</sup>Ni; calculated multi-particle, multi-hole bands, shapes; deduced possible superdeformation. Fixed configuration, deformed Hartree-Fock.

**91Am03 Supersymmetric Quantum Mechanics and Superdeformed Nuclei**

R. D. Amado, R. Båker, F. Cannata, J. P. Dedonder, Phys. Rev. Lett. 67, 2777 (1991).

**Nuclear Structure:** =146-198; deduced supersymmetry role in superdeformation.

**91Be48 Very Elongated Nuclei Near A = 194**

J. A. Becker, E. A. Henry, S. W. Yates, T. F. Wang, A. Kuhnert, M. J. Brinkman, J. A. Cizewski, M. A. Deleplanque, R. M. Diamond, F. S. Stephens, F. Azaiez, W. Kortan, J. E. Draper, Nucl. Instrum. Methods Phys. Res. B56/57, 500 (1991)

**Nuclear Structure:** =194; <sup>192</sup>, <sup>194</sup>Hg; compiled, reviewed data; deduced new superdeformation region.

**91Bo07 Cranked Hartree-Fock Study of the Yrast Line of <sup>80</sup>Sr**

P. Bonche, H. Flocard, P.-H. Heenen, Nucl. Phys. A523, 300 (1991).

- Nuclear Structure:** +80}Sr; calculated levels, quadrupole moments, superdeformed bands. Cranked Hartree-Fock.
- 91Bo11 Description of Superdeformed Bands by the Quantum Algebra SU(q)(2)**  
D. Bonatsos, S. B. Drenska, P. P. Raychev, R. P. Roussev, Yu. F. Smirnov, J. Phys. (London) G17, L67 (1991).  
**Nuclear Structure:** +134}, <sup>136</sup>Nd, <sup>150</sup>Gd, <sup>162</sup>, <sup>182</sup>Dy, <sup>182</sup>, <sup>194</sup>Hg, <sup>174</sup>Yb, <sup>244</sup>Cm; analyzed level data; deduced superdeformed band features. Quantum SU(q)(2) algebra.
- 91Bo19 Octupole Softness of Superdeformed <sup>184</sup>Pb**  
P. Bonche, S. J. Krieger, M. S. Weiss, J. Dobaczewski, H. Flocard, P. -H. Heenen, Phys. Rev. Lett. 66, 876 (1991).  
**Nuclear Structure:** +194}Pb; analyzed data; deduced band structure, superdeformed softness features. Generator coordinate method, pairing projection.
- 91Ch01 Giant Dipole Resonance Built on Superdeformed Rotational States**  
Y. S. Chen, Phys. Rev. C43, 173 (1991).  
**Nuclear Structure:** +146}, <sup>148</sup>, <sup>180</sup>, <sup>182</sup>Dy, <sup>132</sup>, <sup>134</sup>, <sup>136</sup>Nd, <sup>82</sup>Sr, <sup>82</sup>Sr, <sup>84</sup>Sr; calculated superdeformed states based GDR,  $\gamma$ -anisotropy following decay. Linear response theory, superdeformed mean field, self-consistent approach.  
**Nuclear Reactions:** +150}Dy, <sup>134</sup>Nd, <sup>82</sup>Sr( $\gamma$ ,X), E  $\leq$  20 MeV; calculated total absorption  $\sigma(E)$ . Linear response theory, superdeformed mean field, self-consistent approach.
- 91Ch36 Superdeformed and Hyperdeformed Banana Shaped Nuclei Near A = 190**  
R. R. Chasman, Phys. Lett. 266B, 243 (1991).  
**Nuclear Structure:** +190}Pt, <sup>180</sup>, <sup>190</sup>, <sup>191</sup>, <sup>182</sup>Au, <sup>188</sup>, <sup>189</sup>, <sup>190</sup>, <sup>191</sup>, <sup>192</sup>, <sup>193</sup>, <sup>194</sup>, <sup>195</sup>Hg, <sup>180</sup>, <sup>190</sup>, <sup>191</sup>, <sup>192</sup>, <sup>193</sup>, <sup>194</sup>, <sup>195</sup>Tl, <sup>180</sup>, <sup>191</sup>, <sup>192</sup>, <sup>193</sup>Pb, <sup>183</sup>, <sup>194</sup>, <sup>195</sup>, <sup>196</sup>Bi, <sup>194</sup>Po; calculated level energy relative to prolate minimum, barrier heights, reflection symmetric shapes; deduced superdeformed, hyperdeformed minima, deformation features.
- 91Cu01 Cullen et al. Reply:**  
D. M. Cullen, M. A. Riley, A. Alderson, I. Ali, C. W. Beausang, T. Bengtsson, M. A. Bentley, P. Fallon, P. D. Forsyth, F. Hanna, S. M. Mullins, W. Nazarewicz, R. J. Poynter, P. H. Regan, J. W. Roberts, W. Satula, J. F. Sharpey-Schafer, J. Simpson, G. Sletten, P. J. Twin, R. Wadsworth, R. Wyss, Phys. Rev. Lett. 67, 1175 (1991).  
**Nuclear Structure:** +193}Hg; analyzed data; deduced superdeformed states features.
- 91Gu03 Stability of the Superdeformed Z = 38 Shell Against Exotic Cluster Decays: Reinforcing and switching of shell gaps in nuclei**  
R. K. Gupta, W. Scheid, W. Greiner, J. Phys. (London) G17, 1731 (1991).  
**Nuclear Structure:** +78}Sr, <sup>82</sup>Zr; calculated cluster-decay T<sub>v2</sub>; deduced superdeformed Z=38 stability against exotic decay. Cluster <sup>16</sup>O-<sup>40</sup>Ca nuclei.
- 91Ia02 Physics of High-Spin States in the Interacting Boson Model**  
F. Iachello, Nucl. Phys. A522, 83c (1991).  
**Nuclear Structure:** +192}Hg; analyzed data; deduced superdeformed band features. Other nuclei discussed. Interacting boson model.
- 91Ji05 Symmetries of the Nuclear Average Field Hamiltonian and a Search for Possible Exotic Equilibrium Deformations in Superdeformed Nuclei**  
X. Ji, J. Dudek, P. Romain, Phys. Lett. 271B, 281 (1991).  
**Nuclear Structure:** =54-78; N=86-122; calculated proton, neutron shell energies vs deformation. <sup>189</sup>Hf; calculated total energy surface vs deformations, superdeformed configurations. Nuclear average field hamiltonian.
- 91Ko18 The Spin-Orbit Field in Superdeformed Nuclei: A relativistic investigation**  
W. Koepf, P. Ring, Z. Phys. A339, 81 (1991).  
**Nuclear Structure:** +208}Pb, <sup>16</sup>O; calculated nucleon single particle levels. <sup>182</sup>Dy; calculated potential parameters; analyzed superdeformation. Relativistic mean field theory.
- 91Me07 Pairing Vibrations and Stability of Superdeformed States**  
J. Meyer, P. Bonche, J. Dobaczewski, H. Flocard, P. H. Heenen, Nucl. Phys. A533, 307 (1991).  
**Nuclear Structure:** +194}Hg; calculated levels, quadrupole moments; deduced pairing vibrations role in superdeformed state stability.
- 91Mi07 Octupole Vibrations with K = 1 and 2 in Superconducting, Superdeformed Nuclei**  
S. Mizutori, Y. R. Shimizu, K. Matsuyanagi, Prog. Theor. Phys. (Kyoto) 85, 559 (1991).  
**Nuclear Structure:** +192}Hg, <sup>144</sup>Gd; calculated octupole strength functions, superdeformed nuclei. RPA.
- 91Ot02 Interacting Boson Model for Superdeformation**  
T. Otsuka, M. Honma, Phys. Lett. 268B, 305 (1991).  
**Nuclear Structure:** +194}Hg; calculated neutron, proton occupation probabilities,  $\gamma$ , levels; deduced possible superdeformed  $\beta$ ,  $\gamma$  bands features, boson charge, interaction strength. Super interacting boson model.
- 91Ra20 Additivity in Superdeformed Bands**  
I. Ragnarsson, Phys. Lett. 264B, 5 (1991).  
**Nuclear Structure:** +146}, <sup>147</sup>, <sup>148</sup>Gd; analyzed superdeformed bands transition energies; deduced stability, two-orbitals role.
- 91Sa12 Structure of Superdeformed States in Au-Ra Nuclei**  
W. Satula, S. Cwiok, W. Nazarewicz, R. Wyss, A. Johnson, Nucl. Phys. A529, 289 (1991).  
**Nuclear Structure:** +190}, <sup>192</sup>, <sup>194</sup>, <sup>196</sup>Hg, <sup>192</sup>, <sup>194</sup>, <sup>196</sup>, <sup>198</sup>Pb, <sup>194</sup>, <sup>196</sup>, <sup>198</sup>, <sup>200</sup>, <sup>202</sup>Po, <sup>188</sup>, <sup>200</sup>, <sup>202</sup>, <sup>204</sup>, <sup>206</sup>Rn, <sup>204</sup>, <sup>206</sup>, <sup>208</sup>, <sup>210</sup>, <sup>212</sup>Ra; calculated superdeformed state energies, equilibrium deformations, band head energies, barrier heights, potential energy surfaces. <sup>180</sup>, <sup>191</sup>, <sup>193</sup>, <sup>195</sup>, <sup>196</sup>, <sup>197</sup>, <sup>198</sup>, <sup>199</sup>, <sup>200</sup>, <sup>201</sup>, <sup>202</sup>, <sup>203</sup>, <sup>204</sup>, <sup>205</sup>, <sup>206</sup>, <sup>207</sup>, <sup>208</sup>, <sup>209</sup>, <sup>210</sup>, <sup>211</sup>, <sup>212</sup>Ac; calculated equilibrium deformations. Strutinsky shell correction method.
- 91Sc09 The Population of the Superdeformed Continuum**  
K. Schiffer, B. Herskind, Phys. Lett. 255B, 508 (1991).  
**Nuclear Structure:** +152}Dy; analyzed superdeformed level data; deduced continuum features.
- 91St05 Stephens et al. Reply:**  
F. S. Stephens, M. A. Deleplanque, W. Korten, R. M. Diamond, F. Azaiez, A. O. Macchiavelli, J. A. Becker, E. A. Henry, A. Kuhnt, J. E. Draper, J. A. Cizewski, M. J. Brinkman, Phys. Rev. Lett. 66, 1378 (1991).  
**Nuclear Structure:** +192}, <sup>194</sup>Hg; analyzed superdeformed band data, spin assignments.
- 91Ta14 Microscopic Properties of the Superdeformed Rotational States in Light Rare-Earth Nuclei <sup>132</sup>Ce and <sup>134</sup>, <sup>136</sup>Nd**  
K. Tanabe, K. Sugawara-Tanabe, Phys. Lett. 259B, 12 (1991).  
**Nuclear Structure:** +132}Ce, <sup>134</sup>, <sup>136</sup>Nd; calculated levels, g-factors, yrast sequence electric quadrupole moment, dynamical moments of inertia; deduced superdeformed to yrast transition. Particle number, angular momentum constrained HFB.
- 91Tw01 Superdeformed Nuclei at High Spin**  
P. J. Twin, Nucl. Phys. A522, 13c (1991).  
**Nuclear Structure:** +152}Dy, <sup>161</sup>Tb, <sup>160</sup>Gd, <sup>162</sup>Eu; analyzed data; deduced superdeformed band evidence. Other data reviewed.
- 91Wa24 Comment on 'Landau-Zener Crossing in Superdeformed <sup>182</sup>Hg: Evidence for octupole correlations in superdeformed nuclei'**

- P. M. Walker, Phys. Rev. Lett. 67, 1174 (1991).
- Nuclear Structure:** +193]Hg; analyzed data; deduced octupole correlations role in superdeformed states.
- 91We12 *Superdeformation in the Quasicontinuum: Microscopic view of the excited superdeformed bands and the corresponding level densities*  
T. R. Werner, J. Dudek, Phys. Rev. C44, R948 (1991).
- Nuclear Structure:** +152]Dy, <sup>149</sup>Gd; calculated rotational, superdeformed bands. Microscopic approach, Woods-Saxon potential, extended Strutinsky method.
- 91Wu01 *Superdeformations and Fermion Dynamical Symmetries*  
C. -L. Wu, Nucl. Phys. A522, 31c (1991).
- Nuclear Structure:** +150]Gd, <sup>164</sup>Hg; calculated levels, band features, decay characteristics, superdeformation effects. Other nuclei discussed. Fermion dynamical symmetry model.
- 91Wu04 *Comment on 'Spin Alignment in Superdeformed Hg Nuclei'*  
C. -L. Wu, D. H. Feng, M. W. Guidry, Phys. Rev. Lett. 66, 1377 (1991).
- Nuclear Structure:** +192], <sup>184</sup>Hg; analyzed superdeformed band data; deduced spin alignment features.
- 91Wy01 *Integer Alignment and Strong Coupling Limit in Superdeformed Nuclei*  
R. Wyss, S. Pilotte, Phys. Rev. C44, R602 (1991).
- Nuclear Structure:** +191], <sup>192</sup>, <sup>193</sup>, <sup>194</sup>Hg; analyzed levels, superdeformed band spin, alignment data; deduced strong coupling limit role.
- 91Ze01 *Spin Determination and Quantized Alignment in the Superdeformed Bands in <sup>152</sup>Dy, <sup>151</sup>Tb, and <sup>150</sup>Gd*  
J. Y. Zeng, J. Meng, C. S. Wu, E. G. Zhao, Z. Xing, X. Q. Chen, Phys. Rev. C44, R1745 (1991).
- Nuclear Structure:** +152]Dy, <sup>151</sup>Tb, <sup>150</sup>Gd; analyzed data. <sup>152</sup>Dy deduced superdeformed band lowest level J. <sup>152</sup>Dy, <sup>151</sup>Tb, <sup>150</sup>Gd deduced superdeformed band quantized alignment.
- 91Zh23 *An Excited Superdeformed band of <sup>60</sup>Zr in Skyrme Hartree-Fock Calculations*  
D. C. Zheng, L. Zamick, Phys. Lett. 266, 5 (1991).
- Nuclear Structure:** +80]Zr; calculated levels; deduced superdeformed band features. Skyrme Hartree-Fock approach.
- 92Ba42 *Low-Spin Identical Bands in Neighboring Odd-A and Even-Even Nuclei: A possible challenge to mean-field theories*  
C. Baktash, J. D. Garrett, D. F. Winchell, A. Smith, Phys. Rev. Lett. 69, 1500 (1992).
- Nuclear Structure:** +157], <sup>161</sup>, <sup>163</sup>Ho, <sup>166</sup>, <sup>161</sup>, <sup>163</sup>, <sup>167</sup>, <sup>169</sup>Tm, <sup>163</sup>, <sup>165</sup>, <sup>167</sup>, <sup>169</sup>, <sup>171</sup>, <sup>173</sup>, <sup>175</sup>, <sup>177</sup>, <sup>179</sup>, <sup>181</sup>Ta, <sup>177</sup>, <sup>181</sup>, <sup>183</sup>, <sup>185</sup>Re, <sup>175</sup>, <sup>177</sup>, <sup>180</sup>Ir; analyzed band structure; deduced identical bands at deformations between normal, superdeformed values.
- 92Be25 *Level Spin for Superdeformed Nuclei Near A = 194*  
J. A. Becker, E. A. Henry, A. Kuhnert, T. F. Wang, S. W. Yates, R. M. Diamond, F. S. Stephens, J. E. Draper, W. Korten, M. A. Deleplanque, A. O. Macchiavelli, F. Azaiez, W. H. Kelly, J. A. Cizewski, M. J. Brinkman, Phys. Rev. C46, 889 (1992).
- Nuclear Structure:** +189], <sup>190</sup>, <sup>191</sup>, <sup>192</sup>, <sup>193</sup>, <sup>194</sup>Hg, <sup>192</sup>, <sup>194</sup>, <sup>196</sup>, <sup>198</sup>Pb, <sup>193</sup>, <sup>194</sup>, <sup>199</sup>Tl; analyzed superdeformed band transition E<sub>γ</sub>; deduced J, π. Power series expansion approach.
- 92Ch20 *The Fermion Dynamic Symmetry Model and Superdeformation Near A = 220*  
R. R. Chasman, Phys. Lett. 280B, 187 (1992).
- Nuclear Structure:** +222], <sup>223</sup>, <sup>224</sup>Fr, <sup>222</sup>, <sup>223</sup>, <sup>224</sup>, <sup>225</sup>Ra, <sup>222</sup>, <sup>223</sup>, <sup>224</sup>, <sup>225</sup>, <sup>226</sup>Ac, <sup>224</sup>, <sup>224</sup>, <sup>225</sup>, <sup>226</sup>, <sup>227</sup>Th, <sup>223</sup>, <sup>224</sup>, <sup>225</sup>, <sup>226</sup>, <sup>227</sup>, <sup>228</sup>Pa, <sup>224</sup>, <sup>225</sup>, <sup>226</sup>, <sup>227</sup>, <sup>228</sup>, <sup>229</sup>U; calculated well depths, quadrupole, hexadecapole deformation, level energies, static moments of inertia; deduced oblate superdeformed minima, prolate superdeformation features. Fermion dynamic symmetry model.
- 92Ch32 *Observation of Identical Bands in Superdeformed Nuclei with the Cranked Hartree-Fock Method*  
B. -Q. Chen, P. -H. Heenen, P. Bonche, M. S. Weiss, H. Flocard, Phys. Rev. C46, R1582 (1992).
- Nuclear Structure:** +194], <sup>192</sup>Hg, <sup>194</sup>Pb; calculated superdeformed band level energies, quadrupole moments, dynamical, rigid moments of inertia; deduced twinning characteristics. Cranked Hartree-Fock, Skyrme effective interaction.
- 92CIZZ *Identical Bands and Quantized Alignment in Superdeformed A = 194 Nuclei: Evidence for a new kind of rotor*  
J. A. Cizewski, J. A. Becker, E. A. Henry, M. J. Brinkman, T. F. Wang, A. Kuhnert, F. S. Stephens, M. A. Deleplanque, R. M. Diamond, F. Azaiez, A. O. Macchiavelli, J. E. Draper, Contrib. Int. Conf. Nuclear Structure at High Angular Momentum, Ottawa, p. 68 (1992); AECL-10613 (1992).
- Nuclear Structure:** =194; analyzed data; deduced superdeformed, identical band features. Spin-rotor framework.
- 92CI06 *On the DSAM and Lifetime Measurements for Superdeformed States*  
R. Clark, N. Rowley, J. Phys. (London) G18, 1515 (1992).
- Nuclear Structure:** +152]Dy, <sup>153</sup>Nd; analyzed DSA, T<sub>1/2</sub> data procedures; deduced improved results possibility with inverse reactions; calculated superdeformed bands quadrupole moments. Bateman equations equivalent formalism.
- 92Cs03 *On the Relation between Cluster and Superdeformed States of Light Nuclei*  
J. Cseh, W. Scheid, J. Phys. (London) G18, 1419 (1992).
- Nuclear Structure:** +12]C, <sup>16</sup>O, <sup>20</sup>Ne, <sup>24</sup>Mg, <sup>28</sup>Si, <sup>32</sup>S, <sup>36</sup>Ar, <sup>40</sup>Ca, <sup>44</sup>Ti; analyzed levels; deduced superdeformed states clusterization features.
- 92DeZW *Microscopic Description of Superdeformed Bands in <sup>190</sup>, <sup>192</sup>, <sup>194</sup>Hg and <sup>152</sup>Dy*  
J. P. Delaroche, M. Girod, J. F. Berger, J. Libert, Contrib. Int. Conf. Nuclear Structure at High Angular Momentum, Ottawa, p. 77 (1992); AECL-10613 (1992).
- Nuclear Structure:** +190], <sup>192</sup>, <sup>194</sup>Hg, <sup>152</sup>Dy; calculated potential energy surfaces, inertia tensors; deduced band structure, superdeformed band characteristics. Constrained HFB, Gogny force.
- 92DuAA  
Prog. Part. Nucl. Phys. 28, 131(1992) abstract unavailable.
- 92Fa02 *The Influence of Pairing on the Properties of 'Identical' Superdeformed Bands in Hg Nuclei*  
P. Fallon, W. Nazarewicz, M. A. Riley, R. Wyss, Phys. Lett. 276B, 427 (1992).
- Nuclear Structure:** +190], <sup>191</sup>, <sup>192</sup>, <sup>193</sup>, <sup>194</sup>Hg; analyzed band structure data; deduced good reference for superdeformed bands, neutron pairing relative magnitude.
- 92FaZY *Differences in 'Identical' Superdeformed Bands*  
P. Fallon, W. Nazarewicz, M. A. Riley, R. Wyss, Contrib. Int. Conf. Nuclear Structure at High Angular Momentum, Ottawa, p. 74 (1992); AECL-10613 (1992).
- Nuclear Structure:** +194]Hg; analyzed superdeformed band low spin state transition energies; deduced low spin deviations qualitative picture. Blocking arguments.
- 92Gi01 *Ab Initio Calculation of Superdeformed Bands in <sup>192</sup>Hg*  
M. Girod, J. P. Delaroche, J. Libert, I. Deloncle, Phys. Rev. C45, R1420 (1992).

- Nuclear Structure:** +192]Hg; calculated levels, kinematic moment of inertia,  $B(\lambda)$ ; deduced superdeformed bands. Griffin-Hill-Wheeler equation, Gaussian overlap approximation, constrained Hartree-Fock-Bogoliubov calculation based potential, tensor of inertia, Gogny's force.
- 92Ha32 Magnetic Dipole Strength in Superdeformed Nuclei**  
I. Hamamoto, W. Nazarewicz, Phys. Lett. 297B, 25 (1992).  
**Nuclear Structure:** +192]Hg,  $^{152}\text{Dy}$ ; calculated  $B(M1)$ , superdeformed nuclei; deduced isovector GQR, scissors mode overlap.
- 92Ha35 Nuclear Superdeformation Data Tables**  
X.-L. Han, C.-L. Wu, At. Data Nucl. Data Tables 52, 43 (1992).  
**Compilation:** A=130, 150, 190; compiled by for transitions in superdeformed bands.
- 92HaZT Recent Results and Future Prospects Along the  $N = Z$  Line with Radioactive Nuclear Beams and RMS**  
J. H. Hamilton, A. V. Ramayya, Contrib. 6th Intern. Conf. on Nuclei Far from Stability + 9th Intern. Conf. on Atomic Masses and Fundamental Constants, Bernkastel-Kues, Germany, PE10 (1992).  
**Nuclear Structure:** +72],  $^{74}\text{Kr}$ ,  $^{76}\text{Kr}$ ; reviewed, analyzed data.  $^{86}\text{Ru}$ ; analyzed band structure; deduced low spin superdeformation. Nuclei along  $N=Z$  line.
- 92Kr07 Super-Deformation and Shape Isomerism: Mapping the isthmus**  
S. J. Krieger, P. Bonche, M. S. Weiss, J. Meyer, H. Flocard, P.-H. Heenen, Nucl. Phys. A542, 43 (1992).  
**Nuclear Structure:** =108-152; calculated excitation energy, rigid moment of inertia.  $^{190}\text{, }^{182}\text{, }^{184}\text{, }^{186}\text{, }^{198}\text{, }^{200}\text{, }^{202}\text{, }^{204}\text{, }^{206}\text{, }^{210}\text{, }^{212}\text{, }^{214}\text{, }^{216}\text{, }^{218}\text{, }^{220}\text{, }^{222}\text{, }^{224}\text{, }^{226}\text{, }^{228}\text{, }^{230}\text{Pb}$  calculated rigid moment of inertia, quadrupole moment, superdeformed isomers; deduced shape isomerism isthmus superdeformation region. Microscopic Hartree-Fock-BCS formalism.
- 92Me01 Superdeformed Single-Particle Orbitals in the  $A = 190$  Region from Hartree-Fock Plus BCS Calculations**  
M. Meyer, N. Redon, P. Quentin, J. Libert, Phys. Rev. C45, 233 (1992).  
**Nuclear Structure:** +192],  $^{184}\text{, }^{186}\text{, }^{198}\text{, }^{200}\text{Pb}$ ,  $^{184}\text{, }^{182}\text{, }^{180}\text{Hg}$ ; calculated superdeformed nucleon state components, spectra; deduced particle number symmetry restoration role. Self-consistent axial Hartree-Fock plus BCS.
- 92Na03 Dynamical Symmetries, Multiclustering, and Octupole Susceptibility in Superdeformed and Hyperdeformed Nuclei**  
W. Nazarewicz, J. Dobaczewski, Phys. Rev. Lett. 68, 154 (1992).  
**Nuclear Structure:** =66-230; calculated minimum shell correction energy; deduced new superdeformation and hyperdeformation classification schemes.
- 92Na12 Quadrupole Splitting of Octupole Vibrational States**  
R. Nazmitdinov, S. Aberg, Phys. Lett. 289B, 238 (1992).  
**Nuclear Structure:** =150; calculated giant octupole, dipole, quadrupole resonance K-component splittings; deduced analytical RPA solutions at spherical, superdeformed, hyperdeformed shells.
- 92Na15 Octupole Vibrations in the Harmonic-Oscillator-Potential Model with Axis Ratio Two to One**  
T. Nakatsukasa, S. Mizutori, K. Matsuyanagi, Prog. Theor. Phys. (Kyoto) 87, 607 (1992).  
**Nuclear Structure:** =80; N=80; calculated RPA octupole transition strength functions; deduced open shell superdeformed configurations octupole vibrations evidence. Harmonic oscillator potential model, axis ratio two to one, RPA solutions.
- 92NaZZ Couplings between Octupole-Vibrational and Quasiparticle Modes of Excitation in Rotating, Superconducting, Superdeformed Nuclei**  
T. Nakatsukasa, S. Mizutori, K.-I. Arita, Y. R. Shimizu, K. Matsuyanagi, Contrib. Int. Conf. Nuclear Structure at High Angular Momentum, Ottawa, p. 87 (1992); AECL-10613 (1992).  
**Nuclear Structure:** +193]Hg; calculated intraband coupling effects, superdeformed states. Microscopic particle-vibration couplings.
- 92NaZS New Vistas in Superdeformation**  
W. Nazarewicz, Proc. Int. Conf. Nuclear Structure at High Angular Momentum, Ottawa, p. 32 (1992); AECL-10613 (1992).  
**Nuclear Structure:** +170],  $^{180}\text{, }^{190}\text{, }^{200}\text{Hg}$ ; analyzed total potential energies.  $^{166}\text{, }^{168}\text{, }^{170}\text{, }^{172}\text{, }^{174}\text{, }^{176}\text{, }^{178}\text{, }^{180}\text{, }^{182}\text{, }^{184}\text{, }^{186}\text{, }^{188}\text{, }^{190}\text{, }^{192}\text{, }^{194}\text{, }^{196}\text{, }^{198}\text{, }^{200}\text{Hg}$ ; analyzed shape-coexisting states energies; deduced superdeformation related features. Other nuclei discussed.
- 92Pa22 On a Possible Origin of Identical Superdeformed and Normally Deformed Bands and Absence of Polarization in Interacting Boson-Fermion Model**  
V. Paar, D. K. Sunko, D. Vretenar, J. Phys. (London) G18, L191 (1992).
- 92PaZW Highly-Deformed Bands in the Mass 130 Region**  
E. S. Paul, Proc. Int. Conf. Future Directions in Nuclear Physics with 4 $\pi$  Gamma Detection Systems of the New Generation, Strasbourg, France (1991), J. Dudek, B. Haas, Eds., American Institute of Physics, New York, p. 165 (1992).  
**Compilation:**  $^{133}\text{, }^{135}\text{, }^{137}\text{Sm}$ ,  $^{139}\text{Gd}$ ,  $^{142}\text{Eu}$ ,  $^{133}\text{, }^{134}\text{, }^{135}\text{, }^{136}\text{, }^{137}\text{Nd}$ ,  $^{134}\text{Pr}$ ,  $^{131}\text{, }^{132}\text{, }^{133}\text{, }^{138}\text{Ce}$ ,  $^{130}\text{La}$ ; compiled, reviewed superdeformed, intruder bands,  $T_{1/2}$  data; deduced dominated configuration.
- 92RaZV Assignment of Nilsson Orbitals at Superdeformation - Identical Bands**  
I. Ragnarsson, Proc. Int. Conf. Nuclear Structure at High Angular Momentum, Ottawa, p. 187 (1992); AECL-10613 (1992).  
**Nuclear Structure:** +146],  $^{147}\text{, }^{148}\text{, }^{149}\text{Gd}$ ; analyzed superdeformed bands data; deduced effective alignments direct imaging of Nilsson orbitals, other features.
- 92Se01**  
P. B. Semmes, I. Ragnarsson, S. Aberg, Phys. Rev. Lett. 68, 460 (1992).  
**Nuclear Structure:** +193],  $^{194}\text{Hg}$ ; calculated transition by in superdeformed bands.  $^{193}\text{Hg}$  deduced internal conversion dominated M1 cross talk evidence.
- 92Sh04 Superfluid Tunneling in Superdeformed Nuclei**  
Y. R. Shimizu, F. Barranco, R. A. Broglia, T. Dossing, E. Vigezzi, Phys. Lett. 274B, 253 (1992).  
**Nuclear Structure:** +152]Dy; calculated potential energy vs adiabatic path.  $^{148}\text{, }^{150}\text{Gd}$ ,  $^{150}\text{, }^{151}\text{Tb}$ ,  $^{151}\text{, }^{152}\text{Dy}$ ; calculated invariant adiabatic action vs angular momentum, superdeformed band decay related parameter. Superfluid tunneling model.
- 92ShZX On the Mechanism of Decay Out of Superdeformed Bands**  
Y. R. Shimizu, T. Dossing, E. Vigezzi, R. A. Broglia, Contrib. Int. Conf. Nuclear Structure at High Angular Momentum, Ottawa, p. 70 (1992); AECL-10613 (1992).  
**Nuclear Structure:** 150, 190; analyzed superdeformed decay characteristics; deduced possible mechanism plausibility.
- 92Sk01 Octupole Correlations at Superdeformed Shape in the Hg-Pb Region - Including Nonaxial Components**  
J. Skalski, Phys. Lett. 274B, 1 (1992).  
**Nuclear Structure:** +192],  $^{184}\text{Hg}$ ,  $^{182}\text{, }^{184}\text{, }^{186}\text{, }^{188}\text{Pb}$ ; calculated routhian stiffness vs octupole deformation components; deduced octupole vibration frequencies at superdeformed minima.
- 92So10 Intrinsic Structures and Associated Rotational Bands in Deformed Even-Even Nuclei of the Actinide Region**

- P. C. Sood, D. M. Headly, R. K. Sheline, *At. Data Nucl. Data Tables* 51, 273 (1992).
- Nuclear Structure:**  $\geq 88$ ;  $N \geq 134$ ;  $^{230, 232, 234, 236, 238}\text{U}$ ,  $^{220, 222, 224, 226, 228, 230}\text{Th}$ ,  $^{218, 220, 222, 224, 226, 228, 230}\text{Ra}$ ; analyzed levels; deduced band structure, fission isomers superdeformation, hyperdeformation evidence.
- 92TaZX The Anisotropy Coefficient of Gamma-Rays from Thermal High-Spin Giant-Dipole-Resonances**
- K. Tanabe, K. Sugawara-Tanabe, *Contrib. Int. Conf. Nuclear Structure at High Angular Momentum, Ottawa*, p. 94 (1992); AECL-10613 (1992)
- Nuclear Structure:** +132]Ce; calculated  $\gamma$ -ray anisotropy coefficients,  $\alpha(\gamma, X)$ ; deduced behavior for superdeformed states. Thermal RPA, GDR, high spin.
- 92TaZY The Thermal Energy-Weighted Sum Rule for Giant-Dipole-Resonances in Hot Nuclei**
- K. Tanabe, K. Sugawara-Tanabe, *Contrib. Int. Conf. Nuclear Structure at High Angular Momentum, Ottawa*, p. 93 (1992); AECL-10613 (1992)
- Nuclear Structure:** +132]Ce; calculated GDR resonance thermal energy-weighted sum rule; deduced  $\gamma(\theta)$  asymmetry behavior for superdeformed band. Thermal RPA.
- 92Th01 Nuclear Dissipation and the Feeding of Superdeformed Bands**
- M. Thoennessen, J. R. Beene, *Phys. Rev. C* 45, 873 (1992).
- Nuclear Reactions:** +159]Tb( $^{16}\text{O}, X$ ),  $E=160$  MeV; calculated fusion, fission, evaporation residue  $\sigma$  vs spin, high energy  $\gamma$ -spectra; deduced dissipation role, enhanced superdeformed band feeding features. Statistical model.
- 92WaZW Topological Excitations and Identical Superdeformed Bands**
- J. C. Waddington, R. K. Bhaduri, *Contrib. Int. Conf. Nuclear Structure at High Angular Momentum, Ottawa*, p. 80 (1992); AECL-10613 (1992)
- Nuclear Structure:** +192]Hg; analyzed identical superdeformed band features; deduced vortices role. Topological excitations,  $^{152}\text{Dy}$  core.
- 92Wu01 Spin Determination and Calculation of Nuclear Superdeformed Bands in A 190 Region**
- C. S. Wu, J. Y. Zeng, Z. Xing, X. Q. Chen, J. Meng, *Phys. Rev. C* 45, 261 (1992).
- Nuclear Structure:** +190],  $^{191, 192, 193, 194}\text{Hg}$ ,  $^{193, 194}\text{Tl}$ ,  $^{194, 195}\text{Pb}$ ; calculated superdeformed bands, transition energies. Two-parameter approach.
- 92Wu05 Relation between the Kinematic and Dynamic Moments of Inertia in Superdeformed Nuclei**
- C. S. Wu, L. Cheng, C. Z. Lin, J. Y. Zeng, *Phys. Rev. C* 45, 2507 (1992).
- Nuclear Structure:** +164],  $^{190}\text{Er}$ ,  $^{168, 170, 172, 174, 176}\text{Yb}$ ,  $^{170, 172, 174, 176, 178}\text{Hf}$ ,  $^{238}\text{U}$ ,  $^{242}\text{Pu}$ ,  $^{244}\text{Cm}$ ; analyzed ground state bands data.  $^{191, 192, 193, 194}\text{Hg}$ ,  $^{193, 194}\text{Tl}$ ,  $^{194, 195}\text{Pb}$ ,  $^{151, 152}\text{Dy}$ ,  $^{160}\text{Tb}$ ,  $^{162}\text{Gd}$ ; analyzed superdeformed band level data; deduced R-parameter remains independent of spin.
- 92Wu06 Is There Objective Evidence for Quantized Spin Alignment in Superdeformed Nuclei (Question)**
- C.-L. Wu, D. H. Feng, M. Guidry, *Phys. Rev. C* 46, 1339 (1992).
- Nuclear Structure:** +192],  $^{191, 193, 194}\text{Hg}$ ,  $^{194}\text{Pb}$ ,  $^{194}\text{Tl}$ ; analyzed superdeformed band  $\gamma$ -transition energy analyses for spin determination; deduced quantized spin alignment related characteristics.
- 93Ab08 Superdeformed Nuclei**
- S. Aberg, *Nucl. Phys. A* 557, 17c (1993).
- Nuclear Structure:** +146],  $^{150}\text{Gd}$ ,  $^{151}\text{Tb}$ ,  $^{152}\text{Dy}$ ,  $^{188, 190, 191, 192, 193, 194}\text{Hg}$ ; compiled, reviewed superdeformed band related data.  $^{146}\text{Gd}$  deduced hyperdeformation evidence. Other nuclei included.
- 93Ba17 On the Question of Spin Fitting and Quantized Alignment in Rotational Bands**
- C. Baktash, W. Nazarewicz, R. Wyss, *Nucl. Phys. A* 555, 375 (1993).
- Nuclear Structure:** +76],  $^{79}\text{Kr}$ ; analyzed level energy rms deviation vs spin.  $^{150}\text{Gd}$ ,  $^{151, 152}\text{Dy}$ ,  $^{151}\text{Tb}$ ,  $^{192, 194}\text{Hg}$ ; analyzed superdeformed states data, level energy rms deviation vs spin.  $^{190}\text{Pt}$ ,  $^{179}\text{Ir}$ ,  $^{179}\text{Re}$ ,  $^{177}\text{Pt}$ ,  $^{182}\text{Os}$ ,  $^{235}\text{U}$ ,  $^{172, 166}\text{Yb}$ ,  $^{166}\text{Lu}$ ,  $^{174, 178}\text{Hf}$ ,  $^{180, 182}\text{Os}$ ,  $^{186}\text{Hg}$ ; calculated superdeformed, rotational bands. Harris expansion formula.
- 93Ba36 High-Spin States and Superdeformation in the Proton-Neutron Interacting Boson Model**
- A. F. Barfield, B. R. Barrett, *Nucl. Phys. A* 557, 551c (1993).
- Nuclear Structure:** +192]Hg,  $^{238}\text{U}$ ; calculated levels, moment of inertia for bands.  $^{192}\text{Hg}$  deduced possible new superdeformed band candidate. Neutron-proton interacting boson model.
- 93F104 Hartree-Fock and Hartree-Fock-Bogoliubov Calculations of Superdeformed Bands**
- H. Flocard, B. Q. Chen, B. Gall, P. Bonche, J. Dobaczewski, P. H. Heenen, M. S. Weiss, *Nucl. Phys. A* 557, 559c (1993).
- Nuclear Structure:** +192],  $^{194}\text{Hg}$ ,  $^{194}\text{Pb}$ ; calculated superdeformed bands quadrupole moments, dynamical, rigid body moments of inertia. Hartree-Fock, HFB calculations, limitations discussed.
- 93Gu08 Some General Constraints on Identical Band Symmetries**
- M. W. Guidry, M. R. Strayer, C.-L. Wu, D. H. Feng, *Phys. Rev. C* 48, 1739 (1993).
- Nuclear Structure:** +192],  $^{194, 196}\text{Hg}$ ,  $^{234, 236, 238}\text{U}$ ,  $^{238, 240, 242, 244}\text{Pu}$ ,  $^{248, 244}\text{Cm}$ ,  $^{248, 252}\text{Cf}$ ; analyzed band structure; deduced normal, superdeformed identical bands related features.
- 93Ho17 E2 Contribution to the Decay Out of a Superdeformed Band**
- M. Honma, T. Otsuka, *Phys. Lett.* 314B, 1 (1993).
- Nuclear Structure:** +199]Hg; calculated superdeformed band  $B(\lambda)$ ,  $I_\gamma$ ; deduced superdeformed band sudden termination reason. Nilsson+particle number conserving BCS model.
- 93Hu06 Spin Determination of Superdeformed Bands, A - 190 and A - 150 Regions**
- J. Hu, C. Zheng, *Chin. J. Nucl. Phys.* 15, No 1, 45 (1993).
- Nuclear Structure:** +190],  $^{191, 192, 193, 194}\text{Hg}$ ,  $^{193, 194}\text{Tl}$ ,  $^{194, 196, 198}\text{Pb}$ ,  $^{146, 147, 148, 149, 150}\text{Gd}$ ,  $^{150, 151}\text{Tb}$ ,  $^{151, 152, 153}\text{Dy}$ ; analyzed level spectra,  $E_\gamma$ ; deduced superdeformed band states spin. Different methods.
- 93Kh06 Feeding and Decay of Superdeformed States**
- T. L. Khoo, T. Lauritsen, I. Ahmad, M. P. Carpenter, P. B. Fernandez, R. V. F. Janssens, E. F. Moore, F. L. H. Wolfs, Ph. Benet, P. J. Daly, K. B. Beard, U. Garg, D. Ye, M. W. Drigert, *Nucl. Phys. A* 557, 83c (1993).
- Nuclear Structure:** +192]Hg; analyzed superdeformed band feeding, decay data; deduced mechanisms.
- 93Ko41 Identical Bands in Superdeformed Nuclei: A relativistic description**
- J. Konig, P. Ring, *Phys. Rev. Lett.* 71, 3079 (1993).
- Nuclear Structure:** +152]Dy,  $^{151}\text{Tb}$ ; calculated binding energy, mass quadrupole moment, static, rigid body moment of inertia, transitional energy differences for superdeformed band. Relativistic mean field theory, rotating frame.
- 93Lu09 Microscopic Description of Superdeformed Bands in  $^{180, 182, 184}\text{Hg}$**
- J. Libert, J. F. Berger, J. P. Delaroche, M. Girod, *Nucl. Phys. A* 553, 523c (1993).
- Nuclear Structure:** +190],  $^{192, 194}\text{Hg}$ ; calculated levels, normal, superdeformation bands. Microscopic model.
- 93Lu08 On the Fits to the Superdeformed Bands**

- W. Luo, Y. Chen, Chin. J. Nucl. Phys. 15, No 1, 50 (1993).
- Nuclear Structure:** +146), <sup>147</sup>, <sup>148</sup>, <sup>149</sup>, <sup>150</sup>Gd, <sup>150</sup>, <sup>151</sup>Tb, <sup>151</sup>, <sup>152</sup>, <sup>153</sup>Dy; analyzed level spectra, E<sub>γ</sub>, deduced superdeformed band states spin. Different methods.
- 93Mi10 Octupole Correlations in Superdeformed High-Spin States**
- S. Mizutori, T. Nakatsukasa, K. Arita, Y. R. Shimizu, K. Matsuyanagi, Nucl. Phys. A557, 125c (1993).
- Nuclear Structure:** +158), <sup>156</sup>, <sup>154</sup>, <sup>152</sup>, <sup>150</sup>, <sup>148</sup>, <sup>146</sup>, <sup>144</sup>, <sup>142</sup>Gd, <sup>164</sup>, <sup>166</sup>, <sup>168</sup>, <sup>170</sup>, <sup>172</sup>, <sup>174</sup>, <sup>176</sup>, <sup>178</sup>, <sup>180</sup>Hg; calculated curvature against octupole deformation, stretched octupole strengths; deduced octupole instability, superdeformed shape relationship.
- 93No04 Superdeformation and High Spin States**
- P. J. Nolan, Nucl. Phys. A553, 107c (1993).
- Nuclear Structure:** =130-140; A 150; A 190; compiled, reviewed superdeformation, other data features.
- 93Pa05 E0 Transitions and the Depopulation of SD Bands**
- M. Palacz, Z. Sujkowski, J. Bacelar, A. Atac, B. Herskind, J. Nyberg, M. Piipariinen, G. de Angelis, S. Forbes, N. Gjørup, G. Hagemann, F. Ingebretsen, H. Jensen, D. Jerrestam, H. Kusakari, R. Lieder, G. M. Marti, S. Mullins, D. Santonocito, H. Schnare, G. Sletten, K. Strahle, M. Sugawara, P. O. Tjorn, A. Virtanen, R. Wadsworth, Acta Phys. Pol. B24, 399 (1993).
- Nuclear Structure:** +132}Ce, <sup>142</sup>Eu, <sup>152</sup>Dy, <sup>162</sup>Hg; calculated transition probability vs excitation energy for superdeformed states. <sup>142</sup>Eu; analyzed γ(K X-ray)-coin following superdeformed states decay.
- 93Pa10 Shapes of Exotic Nuclei in the Mass A = 70 Region**
- S. K. Patra, C. R. Praharaj, Phys. Rev. C47, 2978 (1993).
- Nuclear Structure:** +64}Ge, <sup>66</sup>Se, <sup>72</sup>Kr, <sup>76</sup>Sr, <sup>80</sup>Zr; calculated ground state deformation parameters. <sup>76</sup>Se; calculated occupation probability vs neutron single particle energies for normal deformation, superdeformation. Deformed relativistic mean field theory.
- 93Pi03 Model of Superfluid Liquid with Triplet Pairing, Cranking Model and Model of Variable Moment of Inertia in Superdeformed Bands in A 190 Region**
- R. Piepenbring, K. V. Protasov, Z. Phys. A345, 7 (1993).
- Nuclear Structure:** +189), <sup>190</sup>, <sup>191</sup>, <sup>193</sup>, <sup>194</sup>Hg, <sup>194</sup>, <sup>196</sup>Pb, <sup>192</sup>, <sup>194</sup>Tl; calculated superdeformed band states transition energies; deduced spin assignments. Triplet pairing model.
- 93Pr01 Rotational Spectra of Nuclei: Equivalence of a superfluid liquid model, the cranking model and a model with a variable moment of inertia**
- K. V. Protasov, R. Piepenbring, J. Phys. (London) G19, 597 (1993).
- Nuclear Structure:** +194}Tl; calculated superdeformed band transition energies; deduced model equivalences. Superfluid liquid, cranking, variable moment of inertia models.
- 93Ra07 Orbital and Spin Assignment of SD Bands in the Dy/ Gd Region - Identical Bands**
- I. Ragnarsson, Nucl. Phys. A557, 167c (1993).
- Nuclear Structure:** +146), <sup>147</sup>, <sup>148</sup>, <sup>149</sup>, <sup>150</sup>Gd, <sup>151</sup>Tb, <sup>151</sup>, <sup>152</sup>, <sup>153</sup>Dy; analyzed superdeformed band transition E<sub>γ</sub>, other data; deduced J, π assignments.
- 93Ro04 Hyperdeformation in <sup>152</sup>Dy at Very High Spins**
- G. Royer, F. Haddad, Phys. Rev. C47, 1302 (1993).
- Nuclear Structure:** +152}Dy; calculated macroscopic, rotational energies, rigid moment of inertia, electric quadrupole moment vs deformation. <sup>58</sup>Ni; calculated macroscopic, rotational energies vs deformation. <sup>152</sup>Dy deduced hyperdeformed states evidence. Rotational liquid drop model.
- 93Sh18 Tunneling Probability for Decays Out of Superdeformed Bands**
- Y. R. Shimizu, E. Vigezzi, T. Dossing, R. A. Broglia, Nucl. Phys. A557, 99c (1993).
- Nuclear Structure:** +151}, <sup>152</sup>Dy, <sup>162</sup>Hg; <sup>142</sup>Eu, <sup>146</sup>, <sup>147</sup>, <sup>148</sup>, <sup>149</sup>, <sup>150</sup>Gd, <sup>150</sup>, <sup>151</sup>Tb; analyzed data; deduced tunneling probability for decays out of superdeformed bands.
- 93Sk01 Octupole Correlations in Superdeformed Mercury and Lead Nuclei: A generator-coordinate method analysis**
- J. Skalski, P. -H. Heenen, P. Bonche, H. Flocard, J. Meyer, Nucl. Phys. A551, 109 (1993).
- Nuclear Structure:** +194}Pb, <sup>164</sup>, <sup>162</sup>Hg; calculated axial, nonaxial octupole level energies built on superdeformed states, B(λ); deduced weak coupling. Generator coordinate method, self-consistent Hartree-Fock BCS basis.
- 93Su10 The Angular Distribution of Gamma-Rays from Thermal High-Spin Giant-Dipole-Resonances on Superdeformed States**
- K. Sugawara-Tanabe, K. Tanabe, Nucl. Phys. A559, 42 (1993).
- Nuclear Structure:** +132}Ce; calculated levels, transition γ(θ), absorption σ(E<sub>γ</sub>), thermal high spin GDR, superdeformed states. Microscopic approach, thermal RPA, thermal cranked HFB ensemble.
- 93Su14 Quantization of Alignment and Different Parity Pair Levels with Omega = 1/2**
- K. Sugawara-Tanabe, A. Arima, Nucl. Phys. A557, 157c (1993).
- Nuclear Structure:** +192}Hg, <sup>152</sup>Dy; calculated l-s operator matrix element for parity doublet levels; deduced degeneracy features at superdeformation.
- 93Su23 Parity Doublet Levels in Superdeformation**
- K. Sugawara-Tanabe, A. Arima, Phys. Lett. 317B, 1 (1993).
- Nuclear Structure:** +192}Hg, <sup>152</sup>Dy; calculated parity-doublet levels; deduced degeneracy features at Fermi surface in superdeformed shape.
- 93Zh21 Comment on 'Evidence for Superdeformed Shape Isomeric States in <sup>28</sup>Si at Excitations Above 40 MeV Through Observations of Selective Particle Decays of <sup>16</sup>O + <sup>12</sup>C Resonances in <sup>8</sup>Be and Alpha Channels'**
- J. Zhang, A. C. Merchant, W. D. M. Rae, Phys. Rev. C48, 2117 (1993).
- Nuclear Reactions:** +12}C(<sup>16</sup>O, <sup>8</sup>Be), (<sup>16</sup>O, α), E(cm)=25. 7-38. 6 MeV; analyzed previous data analyses. <sup>28</sup>Si deduced superdeformed shape isomeric states structure.





## References for Fission Isomers

- 62Po09 Spontaneous Fission with an Anomalously Short Period. I.**  
S. M. Polikanov, V. A. Druin, V. A. Karnaukhov, V. L. Mikheev, A. A. Pleve, N. K. Skobelev, G. M. Ter-Akopyan, V. A. Fomichev, Zhur. Eksptl. i Teoret. Fiz. 42, 1464 (1962); Soviet Phys. JETP 15, 1016 (1962).  
**Nuclear Structure:** isson  $^{242}\text{Am}$ ; measured not abstracted; deduced nuclear properties.
- 62Pe26 Spontaneous Fission with an Anomalously Short Period. II**  
V. P. Pereygin, S. P. Almazova, B. A. Gvozdev, Y. T. Chuburkov, Zhur. Eksptl. i Teoret. Fiz. 42, 1472 (1962); Soviet Phys. JETP 15, 1022 (1962).
- 63Fi08 Formation of a Spontaneously Fissioning Isomer in Reactions Involving  $\alpha$  Particles and Deuterons**  
G. N. Flerov, S. M. Polikanov, K. A. Gavrilov, V. L. Mikheev, V. P. Pereygin, A. A. Pleve, Zh. Eksperim. i Teor. Fiz. 45, 1396 (1963); Soviet Phys. JETP 18, 964 (1964).
- 63Pe27 Half-Life of a Spontaneously Fissioning Isomer**  
V. G. Pereygin, S. P. Tretyakova, Zh. Eksperim. i Teor. Fiz. 45, 863 (1963); Soviet Phys. JETP 18, 592 (1964).  
**Nuclear Structure:** isson  $^{238}\text{U}$ ; measured not abstracted; deduced nuclear properties.
- 65Fi04 The Excitation Function and the Isomeric Yield Ratio for the 14 msec Fissioning Isomer from Deuteron Irradiation of Plutonium**  
G. N. Flerov, A. A. Pleve, S. M. Polikanov, E. Ivanov, N. Martalogu, D. Poenaru, N. Vilcov, Rev. Roumaine Phys. 10, 217 (1965).  
**Nuclear Structure:**  $+242\text{Am}$ ; measured not abstracted; deduced nuclear properties.
- 65Le22 Decay of the  $\text{Am}^{242m}$  14-msec Isomer**  
R. B. Leachman, B. H. Erkkila, Bull. Am. Phys. Soc. 10, No. 9, 1204, P12 (1965).  
**Nuclear Structure:**  $+242\text{Am}$ ; measured not abstracted; deduced nuclear properties.
- 65Li05 The Formation of a Spontaneously Fissioning Isomer in the Capture of Neutrons by Am**  
A. F. Linev, B. N. Markov, A. A. Pleve, S. M. Polikanov, Nucl. Phys. 63, 173 (1965).  
**Radioactivity:**  $^{242}\text{Am}$ ; measured  $T_{1/2}$ , SF.  $^{242}\text{Am}(n, 2n)$ ,  $E=14$  MeV; measured  $\sigma$ .
- 66Br23 A Study of Nuclear Isomers Which Decay by Spontaneous Fission**  
D. S. Brenner, L. Westgaard, S. Bjornholm, Nucl. Phys. 89, 267 (1966).  
**Radioactivity:**  $^{242}\text{Am}$  isomer [from  $^{242}\text{Pu}(d,2n)$ ]; measured  $T_{1/2}$ (SF),  $E(\text{fragment})$ -spectrum. Enriched target.  $^{242}\text{Pu}(d,2n)$ ,  $(d,F)$ ,  $E = 12$  MeV; measured  $\sigma(F)(\text{delayed})/\sigma(F)(\text{prompt})$ . Enriched target.  $^{232}\text{Th}$ ,  $^{235}\text{U}$ ,  $^{238}\text{Pu}$ ,  $^{241}\text{Am}$ ,  $^{243}\text{Am}(d, xn)(d,F)$ ,  $E = 12$  MeV;  $^{243}\text{Am}(p, xn)(p,F)$ ,  $E = 13$  MeV; measured upper limits  $\sigma(F)(\text{delayed})/\sigma(F)(\text{prompt})$ . Enriched targets.
- 66Ma48 Structure of Spontaneously Fissionable Isomers**  
L. A. Malov, S. M. Polikanov, V. G. Solovov, Yadern. Fiz. 4, 528 (1966); Soviet J. Nucl. Phys. 4, 376 (1967).
- 67Bj03 Excitation Energy of the Spontaneously Fissioning Isomeric State in  $^{240}\text{Am}$**   
S. Bjornholm, J. Borggreen, L. Westgaard, V. A. Karnaukhov, Nucl. Phys. A95, 513 (1967).  
**Nuclear Reactions:**  $+240\text{Pu}(d,2n)$ ,  $E = 12.1$  MeV;  $^{240}\text{Pu}(p,n)$ ,  $E = 10.3-11.3$  MeV; measured  $\sigma$  (delayed fission).  $^{241}\text{Pu}(p,2n)$ ,  $E = 9.6-13.6$  MeV; measured  $\sigma$  (delayed fission); deduced threshold. Enriched target.  $^{240m}\text{Am}$  measured  $T_{1/2}$  for spontaneous fission.
- 67Bo23 A New Spontaneously Fissioning Isomer:  $^{238}\text{Am}$**   
J. Borggreen, Y. P. Gangrsky, G. Sletten, S. Bjornholm, Phys. Letters 25B, 402 (1967).  
**Nuclear Structure:**  $+238\text{Am}$ ; measured not abstracted; deduced nuclear properties.
- 67Fi03 Excitation Energy of Spontaneously Fissioning Isomer  $242m\text{-Am}$**   
G. N. Flerov, A. A. Pleve, S. M. Polikanov, S. P. Tretyakova, N. Martalogu, D. Poenaru, M. Sezon, I. Vilcov, N. Vilcov, Nucl. Phys. A97, 444 (1967).  
**Nuclear Reactions:**  $+243\text{Am}(n,2nF)$ ,  $E = 8-14.4$  MeV; measured  $\sigma(E)$ ,  $n$ ,  $F$ -delay.  $^{242}\text{Am}$  deduced level,  $T_{1/2}$ . Enriched target.
- 67Fi08 A Study of the Spontaneously-Fissioning Isomer of  $^{242}\text{Am}$  Through the  $^{241}\text{Am}(n,\gamma)$  Reaction**  
G. N. Flerov, A. A. Pleve, S. M. Polikanov, S. P. Tretyakova, I. Boca, M. Sezon, I. Vilcov, N. Vilcov, Nucl. Phys. A102, 443 (1967).  
**Nuclear Reactions:** isson  $^{241}\text{Am}(n,\gamma)$ ;  $E=0-6.5$  MeV; measured  $\sigma(E)$ .  
**Radioactivity:** Fission  $^{244m}\text{Am}$  [from  $^{242}\text{Am}(n,\gamma)$ ]; measured  $T_{1/2}$  (SF).
- 67Ga04 Investigation of the Reaction  $\text{U}^{238}+\text{B}^{11}$ , Which Leads to the Spontaneously-Fissioning Isomer  $\text{Am}^{242}$**   
Y. P. Gangrskii, B. N. Markov, S. M. Polikanov, G. Jungclaussen, Yadern. Fiz. 5, 22 (1967); Soviet J. Nucl. Phys. 5, 16 (1967).  
**Nuclear Structure:**  $+242\text{Am}$ ; measured not abstracted; deduced nuclear properties.
- 67Vi01 On the Spin Value of the 14-msec Spontaneously Fissioning Isomer of  $\text{Am}^{242}$**   
N. Vilcov, Rev. Roumaine Phys. 12, 487 (1967).  
**Nuclear Structure:**  $+242\text{Am}$ ; measured not abstracted; deduced nuclear properties.
- 68Bj04 Investigation of  $(d,p)$  and  $(d,t)$  Reactions Leading to Spontaneously Fissile Isomeric States**  
S. Bjornholm, I. Borggreen, Y. P. Gangrskii, G. Sletten, Yadern. Fiz. 8, 459 (1968); Soviet J. Nucl. Phys. 8, 267 (1969).  
**Nuclear Reactions:**  $+241$ ,  $^{243}\text{Am}(d,p)$ ,  $(d,t)$ ,  $E=9-13$  MeV; measured  $\sigma(E)$ ; deduced isomeric ratio.
- 68Ca23 Autocorrelation Effects in the Neutron Induced Fission Cross Section of  $^{235}\text{U}$**   
M. G. Cao, E. Migneco, J. P. Theobald, Phys. Lett. 27B, 409 (1968).  
**Nuclear Reactions:** isson  $^{235}\text{U}(n,F)$ ,  $E=0.006-3$  keV; measured  $\sigma(E)$ .  $^{235}\text{U}$  deduced resonance, autocorrelation, intermediate state, shape isomer. Reanalysis of data.
- 68Er01 Energy of  $^{242}\text{Am}$  and  $^{242m}\text{Am}$  Fission Fragments**  
B. H. Erkkila, R. B. Leachman, Nucl. Phys. A108, 689 (1968).  
**Radioactivity:** Fission  $^{242m}\text{Am}$ (SF) [from  $^{242}\text{Pu}(d,2n)$ ]; measured  $T_{1/2}$ ,  $E(\text{fragment})$ .  $^{232}\text{Cf}$  measured  $E(\text{fragment})$ .  
**Nuclear Reactions:** isson  $^{240}\text{Pu}(d,F)$ ,  $E=7.6-14$  MeV; measured  $\sigma(E)$ ;  $E(\text{fragment})$   $^{230}\text{Th}$ ,  $^{235}\text{U}$ ,  $^{240}\text{Pu}(d, F)$ ,  $E=14$  MeV; measured  $\sigma(E(\text{fragment}))$ .
- 68Mi14 Resonance Grouping Structure in Neutron Induced Subthreshold Fission of  $^{240}\text{Pu}$**   
E. Migneco, J. P. Theobald, Nucl. Phys. A112, 603 (1968).

- Nuclear Reactions:** +240jPu(n,F), E=0. 2 to 8 keV; measured  $\sigma$ (nF)(E).  $^{241}\text{Pu}$  resonances deduced F-width.
- 68WoZZ Short-Lived Spontaneous Fission Isomers**
- K. L. Wolf, R. Vandenbosch, Bull. Am. Phys. Soc. 13, No. 11, 1407, CF4(1968)
- Nuclear Reactions:** +238jU( $\alpha$ ,2n), E=21-42 MeV; measured isomer ratio,  $\sigma$ (E $\alpha$ ).  $^{240}\text{Pu}$  deduced  $T_{1/2}$ , spontaneous fission.
- 69Bj02 Intermediate States in Fission**
- S. Bjornholm, V. M. Strutinsky, Nucl. Phys. A136, 1 (1969).
- 69Bo25 Population of the Spontaneously Fissioning Isomer  $^{244}\text{m}f\text{-Am}$  Through the (n, $\gamma$ ) Reaction**
- I. Boca, N. Martalogu, M. Sezon, I. Vilcov, N. Vilcov, G. N. Flerov, A. A. Pleve, S. M. Polikanov, S. P. Tretyakova, Nucl. Phys. A134, 541 (1969).
- Nuclear Reactions:** +243jAm(n, $\gamma$ ), (n,F), E = 0. 3-4 MeV; measured  $\sigma$ (E).  $^{244}\text{Am}$  deduced  $T_{1/2}$ , spontaneous fission. Enriched target.
- 69EI06 Discussion on Papers SM 122/110 and SM 122/29**
- A. J. Elwyn, A. T. G. Ferguson, 2nd Symp. Phys. Chem. of Fission, Vienna, Intern. At. Energy Agency, Vienna, p. 457 (1969).
- 69Ja01 Fission Components in  $^{242}\text{Pu}$  Resonances**
- G. D. James, Nucl. Phys. A123, 24 (1969).
- Nuclear Reactions:** +242jPu(n,F), E=16 eV-35 keV; measured  $\sigma$ (E).  $^{242}\text{Pu}$  deduced resonances, resonance parameters. Enriched target.
- 69JoZU**
- A. B. Jorgensen, S. M. Polikanov, G. Sletten, Priv. Comm., quoted by 70PO01, unpublished (1969)
- 69Ka27 Photofission of Even-Even Nuclei and Structure of the Fission Barrier**
- S. P. Kapitza, N. S. Rabotnov, G. N. Smirenkin, A. S. Soldatov, L. N. Usachev, Y. M. Tsipenyuk, ZhETF Pisma v Redaktsiyu 9, 128 (1969); JETP Letters 9, 73 (1969).
- Nuclear Reactions:** +232jTh,  $^{238}\text{U}$ ,  $^{240}\text{Pu}$ ,  $^{242}\text{Pu}$ ,  $^{242}\text{Pu}$ ( $\gamma$ , F), E < 5-8 MeV; measured  $\sigma$ (E;E(fragment), $\theta$ (fragment)).  $^{232}\text{Th}$ ,  $^{238}\text{U}$ ,  $^{240}\text{Pu}$ ,  $^{242}\text{Pu}$  deduced fission barrier structure.
- 69Kr12 The Moment of Inertia of the Fission Isomer**
- J. Krumlinde, Phys. Letters 30B, 221 (1969).
- Nuclear Structure:** isomer  $^{238}\text{U}$ ,  $^{242}\text{Pu}$ ,  $^{242}\text{Pu}$ ,  $^{242}\text{Pu}$ ,  $^{242}\text{Pu}$ (SF); calculated moments of inertia. Cranking model.
- 69La14 Spontaneously Fissioning Isomers in U, Np, Pu and Am Isotopes**
- N. L. Lark, G. Sletten, J. Pedersen, S. Bjornholm, Nucl. Phys. A139, 481 (1969).
- Radioactivity:** Fission  $^{238}\text{U}$ ,  $^{238}\text{Np}$ ,  $^{238}\text{Pu}$ ,  $^{237}\text{Pu}$ ,  $^{240}\text{Pu}$ ,  $^{241}\text{Pu}$ ,  $^{242}\text{Pu}$ ,  $^{243}\text{Pu}$ ,  $^{243}\text{Pu}$ ,  $^{243}\text{Pu}$ ,  $^{243}\text{Pu}$ (SF); measured  $T_{1/2}$ .
- Nuclear Reactions:** +235jU,  $^{238}\text{U}$ ,  $^{241}\text{Pu}$ ,  $^{242}\text{Pu}$ (d,p),  $^{240}\text{Pu}$ (d,X), E=11-13 MeV; measured  $\sigma$  delayed fission.  $^{237}\text{Np}$ (p,2n), E=9-14 MeV;  $^{240}\text{Pu}$ (p, 2n), E=10-13 MeV;  $^{242}\text{Pu}$ (p,2n), E=8-13 MeV; measured  $\sigma$  delayed fission; deduced thresholds.  $^{238}\text{U}$ ,  $^{237}\text{Np}$ (d,X),  $^{238}\text{Pu}$ ,  $^{241}\text{Pu}$ (d, 2n), E=13 MeV; measured  $\sigma$  delayed fission.  $^{237}\text{Np}$ (p, 2n), E=13 MeV; measured  $\sigma$  ground state. Enriched targets.
- 69Na20 On the Detection of Spontaneously Fissioning Isomer States**
- L. Nagy, T. Nagy, I. Vinnay, KFKI Közlemeny. 17, 165 (1969).
- 69Me11 Fission Isomerism Induced by Helium Ions**
- V. Metag, R. Repnow, P. Von Brentano, J. D. Fox, Z. Physik 226, 1 (1969).
- Nuclear Reactions:** +233j,  $^{235}\text{U}$ ,  $^{236}\text{U}$ ,  $^{238}\text{U}$ ,  $^{237}\text{Np}$ ,  $^{238}\text{Pu}$ ( $\alpha$ ,2n), E=26. 1 MeV; measured  $\alpha$ .  $^{235}\text{U}$ ,  $^{237}\text{U}$ ,  $^{238}\text{U}$ ,  $^{240}\text{Pu}$ ,  $^{238}\text{Am}$ ,  $^{241}\text{Cm}$  deduced  $T_{1/2}$  (SF-isomer).  $^{238}\text{Pu}$ ( $^3\text{He}$ , 2np), E=30 MeV; measured  $\sigma$ .  $^{238}\text{Am}$  deduced  $T_{1/2}$  (SF-isomer).  $^{238}\text{U}$ ( $\alpha$ ,n), E=26 MeV; measured  $\sigma$ .  $^{238}\text{Pu}$  deduced  $T_{1/2}$  (SF-isomer).  $^{237}\text{Np}$ ( $^3\text{He}$ ,p)( $^3\text{He}$ ,np), ( $^3\text{He}$ , 2np), E=26, 30 MeV; measured  $\sigma$ .  $^{237}\text{U}$ ,  $^{238}\text{U}$ ,  $^{238}\text{Pu}$  deduced  $T_{1/2}$  (SF-isomer).
- 69MeZX Charged-Particle Studies of Isomeric Fission**
- V. Metag, R. Repnow, P. von Brentano, J. D. Fox, Proc. Symp. Phys. Chem. Fission, 2nd, Vienna, Intern. At. En. Agency, p. 449 (1969).
- 69Ni13 On the Nuclear Structure and Stability of Heavy and Superheavy Elements**
- S. G. Nilsson, C. F. Tsang, A. Sobiczewski, Z. Szymanski, S. Wycech, C. Gustafson, I. -L. Lamm, P. Moller, B. Nilsson, Nucl. Phys. A131, 1 (1969).
- 69SIZZ Discussion on Papers SM-122/110 and SM-122/29**
- G. Sletten, S. M. Polikanov, Symp. Phys. Chem. Of Fission, 2nd, Vienna, Intern. At. Energy Agency, Vienna, p. 461 (1969).
- Radioactivity:** Fission  $^{237}\text{Am}$ ,  $^{238}\text{Am}$ ,  $^{240}\text{Am}$ ,  $^{241}\text{Cm}$ ,  $^{243}\text{Cm}$ ,  $^{244}\text{Am}$ ; measured  $T_{1/2}$ .
- 69VaZX Spontaneous Fission Isomers with Very Short Half-Lives**
- R. Vandenbosch, K. L. Wolf, Proc. Symp. Phys. Chem. Fission, 2nd, Vienna, Intern. At. En. Agency, Vienna, p. 439 (1969).
- Radioactivity:** Fission  $^{236}\text{U}$ ,  $^{237}\text{U}$ ,  $^{238}\text{U}$ ,  $^{240}\text{Pu}$ (SF); measured  $T_{1/2}$ .
- Nuclear Reactions:** +236j,  $^{238}\text{U}$ ( $\alpha$ ,3n),  $^{238}\text{U}$ ( $\alpha$ ,2n), E=21-42 MeV; measured  $\sigma$ (E); deduced isomer ratios.
- 69Vo18 Analysis of Neutron Fission of the Odd-Even Nuclei Pa $^{231}$ , Np $^{237}$ , and Am $^{241}$**
- P. E. Vorotnikov, Yadern. Fiz. 9, 538 (1969); Soviet J. Nucl. Phys. 9, 308 (1969).
- Nuclear Reactions:** +231jPa,  $^{237}\text{Np}$ ,  $^{241}\text{Am}$ (n, $\gamma$ ), (n,F), E=0-1 MeV; calculated  $\sigma$ (E).  $^{232}\text{Pa}$ ,  $^{238}\text{Np}$ ,  $^{242}\text{Am}$  calculated level-width, fission barrier penetrability.
- 70AIZT On Vibrational Type Resonances in Fission**
- J. Aimberger, S. Jagare, Ann. Rept., Research Inst. Phys., Stockholm, p. 217 (1970).
- Nuclear Structure:** isomer  $^{238}\text{U}$ ,  $^{242}\text{Pu}$ ,  $^{242}\text{Pu}$ ; calculated fission branching ratios. Vibrational-type resonances.
- 70Be44 Search for a Long-Lived Spontaneous Fission Isomer of  $^{241}\text{Pu}$**
- C. E. Bemis, Jr., R. J. Silva, J. E. Bigelow, A. M. Friedman, Inorg. Nucl. Chem. Lett. 6, 747 (1970); ORNL-4581, p. 36 (1970).
- Nuclear Reactions:** +240jPu(n, $\gamma$ ), E=thermal, > 1 MeV;  $^{242}\text{Pu}$ (n, 2n), E > 6. 2 MeV;  $^{238}\text{U}$ ( $\alpha$ ,n), E=40 MeV; measured  $\sigma$ .  $^{241}\text{Pu}$  deduced no 0. 3-yr SF-isomer.
- 70Bj02 Search for New Islands of Fission Isomerism**
- S. Bjornholm, J. Borggreen, E. K. Hyde, Nucl. Phys. A156, 561 (1970).
- Nuclear Reactions:** +197jAu(HI,X), E=5-10 MeV/nucleon for HI= $^{11}\text{B}$ ,  $^{12}\text{C}$ ,  $^{14}\text{N}$ ,  $^{16}\text{O}$ ; measured  $\sigma$ (E) for SF-isomers.  $^{200}\text{Po}$ ,  $^{201}\text{Po}$ ,  $^{202}\text{Po}$ ,  $^{203}\text{Po}$ ,  $^{204}\text{Po}$ ,  $^{201}\text{Po}$ ,  $^{202}\text{Po}$ ,  $^{203}\text{Po}$ ,  $^{204}\text{Po}$ ,  $^{205}\text{Po}$ ,  $^{206}\text{Po}$ ,  $^{207}\text{Po}$ ,  $^{208}\text{Po}$ ,  $^{209}\text{Po}$ ,  $^{210}\text{Po}$ ; deduced no SF-isomer ( $\sigma < 0.1 \mu\text{b}$ ) with  $2\text{ns} < T_{1/2} < 2000\text{s}$ .
- 70Br32 Fission of Odd-A Uranium and Plutonium Isotopes Excited by (d,p), (t,d), and (t,p) Reactions**
- H. C. Britt, J. D. Cramer, Phys. Rev. C2, 1758 (1970).
- Nuclear Reactions:** +234j,  $^{236}\text{U}$ ,  $^{238}\text{U}$ ,  $^{242}\text{Pu}$ (d,pF),  $^{235}\text{U}$ ,  $^{238}\text{U}$ ,  $^{238}\text{Pu}$ (t,pF),  $^{238}\text{U}$ ,  $^{240}\text{Pu}$ ,  $^{242}\text{Pu}$ (t,dF), E=18 MeV; measured (p)(fragment)( $\theta$ ), (d)(fragment)( $\theta$ ).  $^{235}\text{U}$ ,  $^{237}\text{U}$ ,  $^{238}\text{U}$ ,  $^{241}\text{Pu}$ ,  $^{242}\text{Pu}$  deduced fission probabilities.

**70Bu02 Systematics of Plutonium Fission Isomers**

S. C. Burnett, H. C. Britt, B. H. Erkkila, W. E. Stein, Phys. Lett. 31B, 523 (1970).

**Radioactivity:** Fission  $^{233m}\text{Pu}$ ,  $^{237m}\text{Pu}$ ,  $^{238m}\text{Pu}$ ,  $^{239m}\text{Pu}$ ,  $^{240m}\text{Pu}$ (SF); measured  $T_{1/2}$ .

**Nuclear Reactions:** +233),  $^{235}$ ,  $^{236}$ ,  $^{238}\text{U}(\alpha, 2n)$ ,  $E=20-28$  MeV;  $^{234}\text{U}(\alpha, xn)$ ,  $^{238}\text{U}(\alpha, n)$ ,  $^{238}\text{U}(\alpha, n)$ ,  $(\alpha, 3n)$ ,  $E=20-29$  MeV; measured isomeric  $\sigma$  ratios( $E$ ); deduced thresholds for SF-isomer production.

**70Da05 Production of Spontaneously Fissioning Isomers  $^{242}\text{Am}$  and  $^{244}\text{Am}$  by Slow Neutron Capture**

B. Dalhsuren, G. N. Flerov, Y. P. Gangrsky, Y. A. Lazarev, B. N. Markov, Nguyen Cong Khanh, Nucl. Phys. A148, 492 (1970).

**Nuclear Reactions:** +241),  $^{243}\text{Am}(n, \gamma)$ ,  $(n, F)$ ,  $E=0.2-20$  eV; measured delayed, prompt fission  $\sigma$  ratios,  $(n)$ (fission fragment)-delay.  $^{242}$ ,  $^{244}\text{Am}$  [SF-isomers] deduced  $T_{1/2}$ .

**70EI03 Short-Lived Fission Isomers from Neutron Studies**

A. J. Elwyn, A. T. G. Ferguson, Nucl. Phys. A148, 337 (1970).

**Nuclear Reactions:** +233),  $^{234}$ ,  $^{235}$ ,  $^{238}\text{U}$ ,  $^{239}\text{Pu}(n, \gamma)$ ,  $E=0.55, 2.2$  MeV; measured  $\sigma$  for SF-isomer production; deduced isomeric  $\sigma$  ratios.  $^{234}$ ,  $^{235}$ ,  $^{238}$ ,  $^{239}\text{U}$ ,  $^{240}\text{Pu}$  deduced SF-isomers,  $T_{1/2}$ .

**70Ga04 Study of  $(\gamma, n)$  Reactions Leading to Formation of Spontaneously Fissile Isomers of Am**

Y. P. Gangrskii, B. N. Markov, Y. M. Tsipenyuk, Yad. Fiz. 11, 54 (1970); Sov. J. Nucl. Phys. 11, 30 (1970).

**Nuclear Reactions:** +241),  $^{243}\text{Am}(\gamma, n)$ ,  $E < 9.5-13.5$  MeV; measured  $\sigma(E)$  for producing SF-isomers.  $^{240}$ ,  $^{242}\text{Am}$  deduced energy of SF isomeric state.

**70Ga10 Investigation of the Properties of the Spontaneously Fissioning Isomer  $^{241}\text{Pu}$  in the Reaction  $(\gamma, n)$** 

Y. P. Gangrsky, B. N. Markov, Y. M. Tsipenyuk, Phys. Lett. 32B, 182 (1970).

**Nuclear Reactions:** +242)Pu( $\gamma, nF$ ),  $E < 8-13$  MeV; measured  $\sigma(E)$ ,  $(\gamma)$ (fragment)-delay.  $^{241}\text{Pu}$  deduced SF-isomer  $T_{1/2}$ .

**70Ga34 Production of Spontaneously Fissioning Isomers of Uranium, Plutonium, and Americium in the Neutron Reactions**

Y. P. Gangrsky, T. Nagy, I. Vinnay, I. Kovacs, JINR-P3-5528 (1970).

**Nuclear Reactions:** +232)Th,  $^{235}$ ,  $^{238}\text{U}$ ,  $^{239}\text{Pu}$ ,  $^{243}\text{Am}(n, 2n)$ ,  $^{238}\text{U}$ ,  $^{242}\text{Pu}$ ,  $^{243}\text{Am}(n, n')$ ,  $E$  not given; measured SF-isomer production  $\sigma$ .

**70Ja16 Excitation Energies of Fissioning Shape Isomers**

S. Jagare, Phys. Lett. 32B, 571 (1970).

**Nuclear Reactions:** +239),  $^{240}$ ,  $^{241}$ ,  $^{242}\text{Pu}(p, 2n)$ ,  $E=10.9-13.5$  MeV; calculated  $\sigma$  for SF-isomer production.  $^{238}$ ,  $^{239}$ ,  $^{240}$ ,  $^{241}$ ,  $^{242}\text{Am}$  calculated SF-isomer excitation energies.

**70KrZT**

Report: IN-1407 P151

**Radioactivity:**  $^{241}\text{Pu}$ ; measured activity; deduced no SF-isomer.

**70Ot02 Fragment Angular Distributions from Neutron-Induced Fission of  $^{242}\text{Pu}$** 

K. Otozai, J. W. Meadows, A. N. Behkami, J. R. Huizenga, Nucl. Phys. A144, 502 (1970).

**Nuclear Reactions:** fission  $^{242}\text{Pu}(n, F)$ ,  $E_n=500, 620, 730, 990, 1230$  keV; measured  $\sigma(E_n, \theta(\text{fragment}))$ .  $^{242}\text{Pu}$  deduced information on transition states.

**70PaZU**

Report: CEA-N-1339, D Paya, 7/12/71

**Nuclear Reactions:** fission  $^{237}\text{Np}(n, F)$ ,  $E$  not given; measured(fragment)(fragment)-coin, (fragment)(fragment)-delay.  $^{238}\text{Np}$  deduced no SF-isomer.

**70Po01 Spontaneously Fissioning Isomers in U, Pu, Am and Cm Isotopes**

S. M. Poikanov, G. Sletten, Nucl. Phys. A151, 656 (1970).

**Nuclear Reactions:** +233)U( $d, p$ ),  $^{238}\text{U}(d, pn)$ ,  $^{237}\text{Np}(d, 2n)$ ,  $^{238}$ ,  $^{244}\text{Pu}(p, 2n)$ ,  $^{238}$ ,  $^{240}\text{Pu}(d, p)$ ,  $^{239}$ ,  $^{241}\text{Pu}(d, pn)$ ,  $^{241}$ ,  $^{243}\text{Am}(p, 2n)$ ,  $^{241}$ ,  $^{243}\text{Am}(d, 2n)$ ,  $^{243}\text{Am}(d, pn)$ ;  $E=9-14.2$  MeV; measured  $\sigma(E)$  delayed fission.  $^{238}\text{Pu}(p, 2n)$ ,  $E=12.1-14.0$  MeV; measured  $\sigma(E)$ ; deduced threshold. Enriched targets.

**Radioactivity:** Fission  $^{237m}$ ,  $^{238m}$ ,  $^{240m}$ ,  $^{241m}$ ,  $^{243m}\text{Pu}$ (SF),  $^{243m}$ ,  $^{237m}\text{Am}$ (SF),  $^{240m}$ ,  $^{241m}$ ,  $^{242m}$ ,  $^{243m}\text{Cm}$ (SF),  $^{239m}\text{U}$ (SF); measured  $T_{1/2}$ .  $^{237m}$ ,  $^{242m}$ ,  $^{243m}\text{Pu}$ (SF); analyzed data, reevaluated  $T_{1/2}$ .  $^{239}\text{Np}$  deduced misassignment of (SF) isomer.  $^{238m}\text{U}$ (SF) deduced  $T_{1/2}$ .

**70Re05 Evidence for a Direct Reaction Mechanism in the Production of Fission Isomers**

R. Repnow, V. Metag, J. D. Fox, P. von Brentano, Nucl. Phys. A147, 183 (1970).

**Nuclear Reactions:** +235)U( $d, p$ ),  $E=13-20$  MeV; measured  $\sigma$  delayed fission. Enriched target.  $^{238}\text{U}(d, pn)$ ,  $E=11-20$  MeV; measured  $\sigma$  delayed fission. Enriched target.  $^{238}\text{U}(d, pn)$ ,  $E=11-20$  MeV; measured  $\sigma$  delayed fission. Natural target.  $^{239}\text{U}(d, X)$ ,  $^{239}\text{U}(p, X)$ ,  $E=14, 20$  MeV;  $E$  upper limits  $\sigma$  delayed fission. Enriched targets.  $^{239}\text{U}(p, X)$ ,  $E=14-20$  MeV; measured upper limits  $\sigma$  delayed fission. Natural target.

**Radioactivity:** Fission  $^{238}$ ,  $^{239}\text{U}$  deduced  $T_{1/2}$  (SF-isomer).  $^{234}$ ,  $^{237}\text{U}$  deduced no SF-isomer.

**70So06 Intermediate Structure Effects in the Fission of Some Actinide Nuclei**

D. K. Sood, N. Sarma, Nucl. Phys. A151, 532 (1970).

**Nuclear Reactions:** fission  $^{233}$ ,  $^{236}\text{U}$ ,  $^{238}$ ,  $^{240}$ ,  $^{241}\text{Pu}$ ,  $^{242}\text{Am}(n, F)$ ,  $E < 1$  MeV; measured nothing; analyzed  $\sigma(E)$  data; deduced spacing of second minimum levels.

**70Vi05 Izomeri Spontan Fisionabili Ai Nucleelor Transuraniene**

N. Vilcov, Stud. Cercet. Fiz. 22, 795 (1970).

**Radioactivity:** Fission  $^{238}\text{U}$ ,  $^{238}\text{Np}$ ,  $^{238}$ ,  $^{240}$ ,  $^{241}$ ,  $^{242}$ ,  $^{243}\text{Pu}$ ,  $^{239}$ ,  $^{241}\text{Am}$ (SF); measured  $T_{1/2}$ .

**70Wo06 Spontaneous Fission Isomerism in Uranium Isotopes**

K. L. Wolf, R. Vandenbosch, P. A. Russo, M. K. Mehta, C. R. Rudy, Phys. Rev. C1, 2096 (1970).

**Radioactivity:** Fission  $^{238m}\text{U}$ ,  $^{238m}\text{U}$ (SF); measured  $T_{1/2}$ .

**Nuclear Reactions:** +236),  $^{238}\text{U}(d, X)$ ,  $(d, pn)$ ,  $E=13-22$  MeV; measured  $\sigma(E; Ep)$ .  $^{238}$ ,  $^{239}\text{U}$  deduced isomer ratios.

**71Au06 Neutron-Induced Fission Cross Sections of  $^{242}\text{Pu}$  and  $^{244}\text{Pu}$** 

G. F. Auchampaugh, J. A. Farrell, D. W. Bergen, Nucl. Phys. A171, 31 (1971).

**Nuclear Reactions:** fission  $^{242}$ ,  $^{244}\text{Pu}(n, F)$ ,  $E=20$  eV-10 MeV; measured  $\sigma(E)$ .  $^{242}$ ,  $^{244}\text{Pu}$  deduced level spacings, resonance parameters, second barrier widths.

**71Ba30 Fission of U, Np, Pu and Am Isotopes Excited in the  $(d, p)$  Reaction**

B. B. Back, J. P. Bondorf, G. A. Otroschenko, J. Pedersen, B. Rasmussen, Nucl. Phys. A165, 449 (1971).

**Nuclear Reactions:** fission  $^{233}$ ,  $^{235}\text{U}$ ,  $^{237}\text{Np}$ ,  $^{238}$ ,  $^{240}$ ,  $^{241}\text{Pu}$ ,  $^{241}$ ,  $^{243}\text{Am}(d, pF)$ ,  $E=13.0$  MeV; measured  $\sigma(E, p, E(\text{fragment}))$ .  $^{234}$ ,  $^{236}\text{U}$ ,  $^{239}\text{Np}$ ,  $^{238}$ ,  $^{240}$ ,  $^{242}\text{Pu}$ ,  $^{242}$ ,  $^{244}\text{Am}$  deduced fission probability, fission barrier heights, transparencies.

**71Be12 Neutron-Induced Fission Cross Section of  $^{242}\text{Pu}$** 

D. W. Bergen, R. R. Fullwood, Nucl. Phys. A163, 577 (1971).

- Nuclear Reactions:** fission  $^{242}\text{Pu}(n,F)$ ,  $E=50$  eV-5 keV, 0. 1-3 MeV; measured  $\sigma(E)$ .  $^{243}\text{Pu}$  deduced resonances, F-width, fission barrier.
- 71Be62 Production of the Spontaneously Fissioning  $U^{230}$  Isomer in Thermal Neutron Radiative Capture**  
A. G. Belov, Y. P. Gangrskii, B. Dalkhsuren, A. M. Kucher, *Yad. Fiz.* 14, 685 (1971); *Sov. J. Nucl. Phys.* 14, 385 (1972).  
**Nuclear Reactions:** fission  $^{230}\text{U}(n,\gamma F)$ ,  $E=\text{thermal}$ ; measured  $\sigma$ , (fragment)(ce)-delay.  $^{230m}\text{U}$  deduced  $T_{1/2}$ .
- 71Bo61 Study of the  $^{230m}\text{U}$  Isomeric Fission Through the  $^{230}\text{U}(n,\gamma)$  Reaction in the Energy Range 0. 25 - 4 MeV**  
I. Boca, M. Sezon, I. Vilcov, N. Vilcov, *Rev. Roum. Phys.* 16, 473 (1971).  
**Radioactivity:**  $^{230m}\text{U}(\text{SF})$ ; measured  $T_{1/2}$ .  
**Nuclear Reactions:** fission  $^{230}\text{U}(n,\gamma F)$ ,  $E=0. 25-4$  MeV; measured  $\sigma(E)$  for  $^{230m}\text{U}(\text{SF})$  production.
- 71Br38 Population of Fission Isomers in  $^{230}\text{U}$  by the (d,p) Reaction**  
H. C. Britt, B. H. Erkkila, *Phys. Rev. C* 4, 1441 (1971).  
**Nuclear Reactions:** fission  $^{230}\text{U}(d,pf)$ , (d,p),  $E=12$  MeV; measured  $\sigma$  ratios,  $\sigma(\text{Ep})$ , (d)(fragment)-delay.  $^{230m}\text{U}$  deduced  $T_{1/2}$ .  
**Radioactivity:** Fission  $^{230m}\text{U}$ ; measured  $T_{1/2}$ .
- 71Br39 Systematics of Spontaneously Fissioning Isomers**  
H. C. Britt, S. C. Burnett, B. H. Erkkila, J. E. Lynn, W. E. Stein, *Phys. Rev. C* 4, 1444 (1971).  
**Radioactivity:** Fission  $^{235m}$ ,  $^{237m}$ ,  $^{238m}$ ,  $^{239m}$ ,  $^{240m}$ ,  $^{241m}\text{Pu}(\text{SF})$ ,  $^{241m}$ ,  $^{242m}$ ,  $^{243m}$ ,  $^{244m}$ ,  $^{245m}\text{Cm}(\text{SF})$ ,  $^{238m}\text{U}(\text{SF})$ ,  $^{239m}$ ,  $^{240m}$ ,  $^{242m}$ ,  $^{243m}$ ,  $^{244m}\text{Am}(\text{SF})$ ; measured  $T_{1/2}$ ,  $T_{1/2}$  lower limits.
- 71Ga19 Excitation of the Spontaneously Fissioning Isomeric States of  $^{230}\text{Pu}$  and  $^{243}\text{Am}$  at Inelastic  $\gamma$ -Quantum Scattering**  
Y. P. Gangrsky, B. N. Markov, I. F. Kharisov, Y. M. Tsipenyuk, *JINR-P15-5959* (1971).  
**Nuclear Reactions:** +239)Pu,  $^{243}\text{Am}(\gamma,\gamma)$ ,  $E=7-11$  MeV; measured  $\sigma(E;\gamma)$ , ( $\gamma$ )(fragment)-delay.  $^{230}\text{Pu}$ ,  $^{243}\text{Am}$  deduced SF-isomer excitation.  $^{230m}\text{Pu}$  deduced  $T_{1/2}$ .
- 71Ga35 Spontaneously Fissioning Isomers of Uranium, Plutonium, and Americium from Neutron Reactions**  
Y. P. Gangrskii, T. Nad, I. Vinnai, I. Kovach, *At. Energ.* 31, 156 (1971); *Sov. At. Energy* 31, 874 (1972).  
**Nuclear Reactions:** +232)Th,  $^{235}$ ,  $^{238}\text{U}$ ,  $^{239}\text{Pu}$ ,  $^{243}\text{Am}(n, 2n)$ ,  $E=14. 7$  MeV;  $^{236}\text{U}$ ,  $^{242}\text{Pu}$ ,  $^{243}\text{Am}(n, n')$ ,  $E=2-7$  MeV; measured  $\sigma(\text{SF isomers})$ .  $^{231}\text{Th}$ ,  $^{234}$ ,  $^{237}\text{U}$ ,  $^{239}\text{Pu}$  deduced no SF-isomer yield.  $^{238}\text{U}$ ,  $^{242}\text{U}$ ,  $^{242}$ ,  $^{243}\text{Am}$  deduced SF isomer yield.
- 71Ga39 Excitation of Spontaneously Fissioning Isomer States  $^{230}\text{Pu}$  and  $^{243}\text{Am}$  in Inelastic Scattering of  $\gamma$  Quanta**  
Y. P. Gangrskii, B. N. Markov, I. F. Kharisov, Y. M. Tsipenyuk, *Pisma Zh. Eksp. Teor. Fiz.* 14, 370 (1971); *JETP Lett. (USSR)* 14, 249 (1971).  
**Nuclear Reactions:** fission  $^{230}\text{Pu}$ ,  $^{243}\text{Am}(\gamma,\gamma F)$ ,  $E < 11$  MeV; measured ( $\gamma$ )(fragment)-delay.  $^{230m}\text{Pu}$  deduced  $T_{1/2}$ .  $^{239}\text{Pu}$ ,  $^{243}\text{Am}$  deduced isomer yields.
- 71MaZE**  
Thesis: , Univ Kansas, D E Mahary, DABBB 32B 5981\_5/5/72  
**Nuclear Reactions:** +92)Mo(d,p $\gamma$ ), measured  $\sigma(\text{Ep}, E\gamma)$ .  $^{93}\text{Mo}$  deduced levels.  
**Nuclear Structure:** =230-256;  $^{230}\text{U}$ ; calculated fission barriers, shape isomer excitation energies, equilibrium deformations, total energy surfaces.
- 71Me03 Correlation between Fission Isomer Half-Lives and Liquid-Drop Model Parameters**  
V. Metag, R. Repnow, P. von Brentano, *Nucl. Phys.* A165, 289 (1971).
- 71Mo11 Analysis of the Fission and Capture Cross Sections of the Curium Isotopes**  
M. S. Moore, G. A. Keyworth, *Phys. Rev. C* 3, 1656 (1971).  
**Nuclear Reactions:** +244),  $^{245}$ ,  $^{246}$ ,  $^{247}$ ,  $^{248}\text{Cm}(n, F)$ ,  $^{244}$ ,  $^{246}\text{Cm}(n,\gamma)$ ,  $E=20$  eV-3 MeV; measured  $\sigma(E)$ .  $^{245}$ ,  $^{246}$ ,  $^{247}$ ,  $^{248}$ ,  $^{249}\text{Cm}$  deduced resonances, level-width.
- 71Na26 Investigations of the Radiative Capture of Fast Neutrons Producing the Spontaneously Decaying Isomers  $^{242}\text{Am}$  and  $^{244}\text{Am}$**   
T. Nagy, A. G. Belov, Y. P. Gangrsky, B. N. Markov, I. V. Sizov, I. F. Harisov, *Acta Phys.* 30, 293 (1971).  
**Nuclear Reactions:** +241),  $^{243}\text{Am}(n,\gamma)$ ,  $E < 16$  MeV; measured  $\sigma$  ratios for  $^{242}$ ,  $^{244}\text{Am}$  SF-isomer production.
- 71Pa33 Fission Threshold Energies in the Actinide Region**  
H. C. Pauli, T. Ledergerber, *Nucl. Phys.* A175, 545 (1971).  
**Nuclear Structure:** fission  $^{232}$ ,  $^{234}\text{Th}$ ,  $^{234}$ ,  $^{236}$ ,  $^{238}$ ,  $^{240}\text{U}$ ,  $^{236}$ ,  $^{238}$ ,  $^{240}$ ,  $^{242}$ ,  $^{244}\text{Pu}$ ; calculated liquid-drop barriers, first, second saddle point energies.
- 71Re11 Fission Isomers in Cm and Bk Isotopes**  
R. Repnow, V. Metag, P. von Brentano, *Z. Phys.* 243, 418 (1971).  
**Radioactivity:** Fission  $^{245m}\text{Bk}$ ,  $^{242m}\text{Cm}$ ,  $^{241m}\text{Cm}$ ,  $^{243m}\text{Am}$ ,  $^{243m}\text{Cm}$ ,  $^{237m}\text{Pu}$ ; measured  $T_{1/2}$ .  $^{243}\text{Am}(\alpha, 2m)$ ,  $E=26$  MeV;  $^{243}\text{Am}(p, 2m)$ , (p,3m),  $E=14, 20$  MeV;  $^{243}\text{Am}(d,pn)$ , (d,2m),  $E=13-20$  MeV;  $^{237}\text{Np}(d, 2m)$ ,  $E=12-18$  MeV; measured delays,  $\sigma(E)$ .
- 71Ru03 Spin Isomers of the Shape Isomer  $^{237m}\text{Pu}$**   
P. A. Russo, R. Vandenbosch, M. Mehta, J. R. Tesmer, K. L. Wolf, *Phys. Rev. C* 3, 1595 (1971).  
**Radioactivity:** Fission  $^{237m}\text{Pu}(\text{SF})$ ; measured  $T_{1/2}$ ; deduced shape isomerism.
- 71Ta17 Search for Bremsstrahlung-Induced Fission Isomers of  $^{238}\text{U}$  and  $^{239}\text{Pu}$**   
B. Tamain, B. Pfeiffer, H. Wolnik, E. Konecny, *Nucl. Phys.* A173, 465 (1971).  
**Radioactivity:** Fission  $^{238}\text{U}$ ,  $^{239}\text{Pu}(\text{SF})$ ; measured  $T_{1/2}$ .  
**Nuclear Reactions:** fission  $^{238}\text{U}$ ,  $^{239}\text{Pu}(\gamma F)$ ,  $E < 53$  MeV; measured ( $\gamma$ )(fragment)-delay.  $^{238}\text{U}$ ,  $^{239}\text{Pu}$  deduced fission isomers,  $T_{1/2}$ .
- 71Te07 Spontaneously Fissioning Isomers in  $^{237}\text{Pu}$**   
J. K. Temperley, J. A. Morrissey, S. L. Bacharach, *Nucl. Phys.* A175, 433 (1971).  
**Radioactivity:** Fission  $^{237m}\text{Pu}(\text{SF})$  [from  $^{237}\text{Np}(d, 2n)$ ]; measured  $T_{1/2}$ ,  $E(\text{fragment})$ .  $^{237}\text{Np}(d, 2n)$ ,  $E=8. 5-14. 5$  MeV; measured delayed, prompt fission  $\sigma$  ratios, (d)(fission-fragment)-delay;  $E=13. 0$  MeV, measured  $E(\text{fragment})$ .
- 72Bo48 Search for Spontaneously Fissioning Isomers Produced with 600 MeV Protons**  
A. H. Boos, R. Brandt, D. Molzahn, D. M. Montgomery, *J. Inorg. Nucl. Chem.* 34, 3309 (1972).  
**Nuclear Reactions:** , Th, Bi, Pb(p,X),  $E=600$  MeV; measured fission activities; deduced  $\sigma$  for SF-isomer production.
- 72Br04 Investigation of  $\gamma$ -Ray Emission Preceding Isomeric Fission of  $^{230}\text{U}$**   
J. C. Browne, C. D. Bowman, *Phys. Rev. Lett.* 28, 617 (1972).

- Nuclear Reactions:** ission  $^{235}\text{U}(n,\gamma f)$ ,  $E=1-100$  eV; measured  $(\gamma)$ (fragment)-delay; deduced limit on pre-fission  $\gamma$ -emission.  $^{235}\text{U}$  deduced relative double barrier penetrabilities.
- 72Br35 Excitation Functions for the Production of Fission Isomers in Various Am Isotopes**  
H. C. Britt, B. H. Erkkila, B. B. Back, Phys. Rev. C6, 1090 (1972).  
**Radioactivity:** Fission  $^{235}\text{mAm}$ ,  $^{240}\text{mAm}$ ; measured  $T_{1/2}$ .  
**Nuclear Reactions:**  $+239$ ,  $^{240}$ ,  $^{242}$ ,  $^{244}\text{Pu}(p,2n)$ ,  $(t, 2n)$ ,  $(t,3n)$ ,  $E=10-16$  MeV; measured  $\sigma$  for SF-isomer production.
- 72Ga04 Measurement of the Excitation Energy of the Spontaneously Fissioning Isomer  $\text{Pu}^{239}(\gamma,n)$**   
Y. P. Gangrskii, V. N. Maykov, I. F. Kharisov, Y. M. Tsipenyuk, Yad. Fiz. 16, 271 (1972); Sov. J. Nucl. Phys. 16, 151 (1973).  
**Nuclear Reactions:**  $+240$ Pu( $\gamma,n$ ),  $E < 15$  MeV; measured  $\sigma(E)$  for  $^{239}\text{mPu}$ (SF) production.  $^{239}\text{mPu}$ (SF) deduced excitation energy.
- 72Ga42 Production of Spontaneously Fissioning Isomers with Nanosecond Lifetimes in  $\alpha$ -Particle Reactions**  
Y. P. Gangrskii, Nguen Kong Khan, D. D. Pulatov, At. Energ. 33, 829 (1972); Sov. At. Energy 33, 948 (1973).  
**Nuclear Reactions:**  $+233$ ,  $^{235}$ ,  $^{238}\text{U}$ ,  $^{239}$ ,  $^{242}\text{Pu}$ ,  $^{241}$ ,  $^{243}\text{Am}(\alpha,xn)$ ,  $E=20-36$  MeV; measured  $\sigma(E)$  for SF-isomers.  $^{235}$ ,  $^{237}$ ,  $^{240}\text{Pu}$ ,  $^{241}$ ,  $^{243}\text{Cm}$ ,  $^{242}$ ,  $^{243}$ ,  $^{244}$ ,  $^{245}\text{Bk}$  deduced SF-isomers,  $T_{1/2}$ .
- 72Ho11 Total Spontaneous and Isomer Fission Half-Lives of  $^{234}\text{U}$ ,  $^{236}\text{U}$  and  $^{240}\text{Pu}$**   
M. A. Hooshyar, F. B. Malik, Phys. Lett. 38B, 495 (1972).  
**Nuclear Structure:** ission  $^{234}$ ,  $^{236}\text{U}$ ,  $^{240}\text{Pu}$ (SF); calculated total  $T_{1/2}$ ,  $T_{1/2}$ (SF), average fragment kinetic energies. Coupled-channel decay theory.
- 72Ho48 A Coupled Channel Approach to the Isomer Fission State**  
M. A. Hooshyar, F. B. Malik, Helv. Phys. Acta 45, 567 (1972).
- 72HoXQ Suche nach  $\gamma$ -Übergängen im Spaltungs-Isomer  $^{236}\text{U}$**   
F. Horsch, E. Konecny, K. E. G. Lobner, H. J. Specht, Univ., Tech. Univ. Munchen, Jahresbericht 1972, p. 104 (1973).  
**Nuclear Reactions:**  $+235$ U( $n,F\gamma$ ); measured  $E_\gamma$ ,  $\gamma$ .  $^{236}\text{U}$  deduced isomer.
- 72Ka59 Search for  $\gamma$ -Branch in the  $^{239}\text{mU}$  Fission Isomer Decay**  
E. Kashy, J. Hattula, J. Borggreen, V. Maarbjerg, Comment. Phys. -Math. 42, 266 (1972).  
**Radioactivity:**  $^{239}\text{mU}$ ; measured upper limit for  $\gamma$ -ray decay.
- 72Ko10 Search for Conversion Electrons Populating the  $^{238}\text{U}$  Fission Isomer**  
E. Konecny, H. J. Specht, J. Weber, H. Weigmann, R. L. Ferguson, P. Osterman, M. Waldschmidt, G. Siegert, Nucl. Phys. A187, 426 (1972).  
**Nuclear Reactions:** ission  $^{238}\text{U}(n,\gamma f)$ ,  $E=\text{thermal}$ ; measured (fragment)(ce)-coin, -delay; deduced upper limit for isomeric/prompt fission ratio.
- 72Ku26 Search for Fission Isomers in the Radium Region**  
I. M. Kuks, V. I. Matvienko, Y. A. Nemilov, Y. A. Selitskii, V. B. Funshstein, Yad. Fiz. 16, 438 (1972); Sov. J. Nucl. Phys. 16, 244 (1973).  
**Nuclear Reactions:**  $+226$ Ra( $d,X$ ),  $E=6, 11, 3$  MeV;  $^{226}\text{Ra}(n,X)$ ,  $E=0, 7-10, 14, 5$  MeV; measured  $\sigma(F)$ .  $^{224}$ ,  $^{225}$ ,  $^{226}$ ,  $^{227}\text{Ra}$ ,  $^{225}$ ,  $^{226}$ ,  $^{227}\text{Ac}$  deduced no SF-isomer.
- 72La05 Fission Barriers and the Inclusion of Axial Asymmetry**  
S. E. Larson, I. Ragnarsson, S. G. Nilsson, Phys. Lett. 38B, 269 (1972).  
**Nuclear Structure:** ission  $^{186}$ ,  $^{188}$ ,  $^{190}$ ,  $^{192}\text{W}$ ,  $^{196}\text{Pt}$ ,  $^{196}\text{Hg}$ ,  $^{196}$ ,  $^{204}\text{Pb}$ ,  $^{242}\text{Pu}$ ,  $^{240}\text{Cm}$ ,  $^{252}\text{Fm}$ ,  $^{258}104$ , superheavy; calculated potential energy surfaces vs deformation parameters, fission barriers. Modified oscillator model, axial symmetry.
- 72Ma11 A Single-Particle Model Calculation of Total Energy Surfaces in Heavy Nuclei**  
D. E. Maharry, J. P. Davidson, Nucl. Phys. A183, 371 (1972).  
**Nuclear Structure:** ission  $^{236}\text{U}$ ,  $^{238}$ ,  $^{232}\text{Th}$ ,  $^{234}$ ,  $^{235}$ ,  $^{238}\text{U}$ ,  $^{246}$ ,  $^{248}$ ,  $^{250}$ ,  $^{252}\text{Cf}$ ,  $^{238}$ ,  $^{240}$ ,  $^{242}$ ,  $^{244}\text{Am}$ ,  $^{236}$ ,  $^{238}$ ,  $^{240}$ ,  $^{242}$ ,  $^{244}\text{Pu}$ ,  $^{240}$ ,  $^{242}$ ,  $^{244}$ ,  $^{246}$ ,  $^{248}$ ,  $^{250}\text{Cm}$ ; calculated total energy surfaces, fission barriers. Single-particle model.
- 72Mo27 Odd-Multipole Shape Distortions and the Fission Barriers of Elements in the Region  $84 < Z < 120$**   
P. Moller, Nucl. Phys. A192, 529 (1972).  
**Nuclear Structure:** ission  $Z=84-120$ ;  $^{210}\text{Po}$ ,  $^{230}\text{U}$ ,  $^{258}\text{Fm}$ ,  $^{252}\text{Fm}$ ; calculated potential energy surfaces, fission barriers.
- 72NaYU**  
Thesis: T Nagy, Dubna  
**Nuclear Reactions:**  $+241$ ,  $^{243}\text{Am}(n,\gamma)$ ,  $E=0, 8-16$  MeV;  $^{235}\text{U}$ ,  $^{239}\text{Pu}(n,\gamma)$ ,  $E=\text{th}$ ;  $^{238}\text{U}$ ,  $^{239}$ ,  $^{242}\text{Pu}$ ,  $^{243}\text{Am}(n,n')$ ,  $E=3-7$  MeV,  $14, 7$  MeV;  $^{240}$ ,  $^{242}\text{Pu}$ ,  $^{243}\text{Am}(n,2n)$ ,  $E=14, 7$  MeV; measured  $\sigma(E)$  for SF isomers.  $^{232}\text{Th}$ ,  $^{233}$ ,  $^{235}$ ,  $^{238}\text{U}$ ,  $^{237}\text{Np}$ ,  $^{239}\text{Pu}(n, 2n)$ ,  $E=14, 7$  MeV; measured no SF isomer.
- 72Pe01 An Investigation of the Population of the Shape Isomer  $^{238m}\text{U}$  Through the  $(d,p)$  Reaction**  
J. Pedersen, B. Rasmussen, Nucl. Phys. A178, 449 (1972).  
**Nuclear Reactions:**  $+235$ U( $d,pF$ ),  $E=11$  MeV; measured  $(p)$ (fragment)-delay.  $^{238m}\text{U}$  deduced  $T_{1/2}$ , fission barrier parameters.
- 72PIZR Fission Isomer in Uranium-236**  
J. V. Pilcher, F. D. Brooks, W. R. McMurray, INDC(SEC)-28/L, p. 249 (1972).  
**Radioactivity:** Fission  $^{236m}\text{U}$ (SF); measured  $T_{1/2}$ .
- 72Sp06 Identification of a Rotational Band in the  $^{240}\text{Pu}$  Fission Isomer**  
H. J. Specht, J. Weber, E. Konecny, D. Heunemann, Phys. Lett. 41B, 43 (1972).  
**Radioactivity:** Fission  $^{240}\text{Pu}$ (SF) [from  $^{238}\text{U}(\alpha,2m\gamma)$ ;  $E=25$  MeV]; measured  $I(\text{ce})$ ,  $(\alpha)$ (fragment)-delay,  $E(\text{ce})$ .  $^{240m}\text{Pu}$  deduced levels, rotational band structure.
- 72Va08 Spontaneous-Fission-Isomer Excitation Energies from Threshold Measurements**  
R. Vandenbosch, Phys. Rev. C5, 1428 (1972).
- 72Va44 Searches for the Spontaneously Fissioning Isomer  $\text{Pu}^{240m}$  in the Thermal-Neutron Capture Reaction**  
G. V. Vaiskii, O. M. Mrachkovskii, G. A. Petrov, Y. S. Pleva, Yad. Fiz. 16, 667 (1972); Sov. J. Nucl. Phys. 16, 374 (1973).  
**Nuclear Reactions:** ission  $^{240}\text{Pu}(n,F)$ ;  $E=\text{thermal}$ ; measured  $\sigma$  production for  $^{240m}\text{Pu}$ .
- 72Vi10  $^{239m}\text{Pu}(f)$  Double Fission Isomer Study Through the  $^{237}\text{Np}(d,2n)$  Reaction in the  $E = 9-12$  MeV Energy Range**  
N. Vilcov, G. Griffith, I. Vilcov, R. B. Leachman, Rev. Roum. Phys. 17, 1031 (1972).  
**Nuclear Reactions:**  $+237$ Np( $d,2n$ ),  $E=9, 1-12, 1$  MeV; measured  $\sigma(E)$  ratio for two isomers.  $^{237}\text{Pu}$  deduced levels,  $T_{1/2}$ .
- 72Vy07 Excitation Energies of the Spontaneously Fissioning Isomers of  $\text{Pu}^{240}$ ,  $\text{Cm}^{241}$ , and  $\text{Bk}^{240}$  in Reactions with  $\alpha$ -Particles**  
I. Vylkov, N. Vylkov, Y. P. Gangrskii, M. Marinescu, A. A. Pleva, D. Poenaru, I. F. Kharisov, Yad. Fiz. 16, 454 (1972); Sov. J. Nucl. Phys.

16, 253 (1973).

**Nuclear Reactions:** +238]U,  $^{239}\text{Pu}$ ,  $^{241}\text{Am}(\alpha,2n)$ ,  $E=20-26$  MeV; measured  $\sigma$  for SF-isomer production.  $^{240}\text{Pu}$ ,  $^{241}\text{Cm}$ ,  $^{243}\text{Bk}$  deduced SF isomer excitation energies.

**72We09 Evaluation of Fission Barrier Parameters from Near-Barrier Fission and Isomeric Half-Life Data**

H. Weigmann, J. P. Theobald, Nucl. Phys. A187, 305 (1972).

**Nuclear Structure:** isson  $^{234}$ ,  $^{235}$ ,  $^{236}$ ,  $^{237}$ ,  $^{238}$ ,  $^{239}\text{U}$ ,  $^{237}$ ,  $^{238}$ ,  $^{239}$ ,  $^{240}\text{Np}$ ,  $^{235}$ ,  $^{236}$ ,  $^{237}$ ,  $^{238}$ ,  $^{239}$ ,  $^{240}$ ,  $^{241}$ ,  $^{242}$ ,  $^{243}$ ,  $^{244}$ ,  $^{245}\text{Pu}$ ,  $^{237}$ ,  $^{238}$ ,  $^{239}$ ,  $^{240}$ ,  $^{241}$ ,  $^{242}$ ,  $^{243}$ ,  $^{244}\text{Am}$ ,  $^{241}$ ,  $^{242}$ ,  $^{243}$ ,  $^{244}$ ,  $^{245}\text{Cm}$ ,  $^{246}$ ,  $^{247}\text{Cm}$ ,  $^{244}$ ,  $^{245}$ ,  $^{246}\text{Bk}$ ; calculated fission barriers,  $T_{1/2}$ .

**72Wo07 Fissioning Isomers of Americium, Curium and Berkelium Isotopes**

K. L. Wolf, J. P. Unik, Phys. Lett. 38B, 405 (1972).

**Radioactivity:** Fission  $^{240m}\text{Am}$ ,  $^{243m}\text{Am}$ ,  $^{245m}\text{Am}$ ,  $^{246m}\text{Am}$ ,  $^{244m}\text{Am}$ ,  $^{236m}\text{Pu}$ ,  $^{242m}\text{Bk}$ ,  $^{244m}\text{Bk}$ ,  $^{243m}\text{Cm}$ ,  $^{245m}\text{Cm}$ ; measured  $T_{1/2}$ .

**Nuclear Reactions:** +242],  $^{244}\text{Pu}$ ,  $^{241}$ ,  $^{243}\text{Am}(\alpha,xF)$ ,  $E=25-46$  MeV; measured  $\sigma(E)$  for SF-isomer production.

**73AI08 A New Two-Center Shell Model for Nuclear Fission**

K. Albrecht, Nucl. Phys. A207, 225 (1973).

**Nuclear Structure:** +226]Ra,  $^{232}\text{Th}$ ,  $^{236}$ ,  $^{238}\text{U}$ ,  $^{240}$ ,  $^{242}\text{Pu}$ ,  $^{244}\text{Cm}$ ,  $^{248}$ ,  $^{252}\text{Cf}$ ,  $^{252}\text{Fm}$ ; calculated deformation energies, isomer energies.

**73Ba19 Fission and Decay of Excited Nuclei**

V. S. Barashenkov, A. S. Ilijinov, V. D. Toneev, F. G. Gereghi, Nucl. Phys. A206, 131 (1973).

**Nuclear Structure:** +149]Eu,  $^{187}\text{Ho}$ ,  $^{179}\text{Ta}$ ,  $^{186}\text{Os}$ ,  $^{187}\text{Os}$ ,  $^{188}\text{Os}$ ,  $^{189}\text{Ir}$ ,  $^{190}\text{Ir}$ ,  $^{191}\text{Ir}$ ,  $^{194}\text{Hg}$ ,  $^{198}\text{Hg}$ ,  $^{210}\text{Po}$ ,  $^{211}\text{Po}$ ,  $^{212}\text{Po}$ ,  $^{213}\text{At}$ ,  $^{227}\text{Ra}$ ,  $^{233}\text{U}$ ,  $^{234}\text{U}$ ,  $^{235}\text{U}$ ,  $^{237}\text{U}$ ,  $^{238}\text{U}$ ,  $^{239}\text{U}$ ,  $^{237}\text{Np}$ ,  $^{238}\text{Np}$ ,  $^{241}\text{Am}$ ,  $^{242}\text{Am}$ ,  $^{244}\text{Am}$ ,  $^{240}\text{Cm}$ ,  $^{242}\text{Cm}$ ,  $^{244}\text{Cm}$ ,  $^{250}\text{Cm}$ ,  $^{246}\text{Cf}$ ,  $^{248}\text{Cf}$ ,  $^{250}\text{Cf}$ ,  $^{252}\text{Cf}$ ,  $^{251}\text{No}$ ,  $^{252}\text{No}$ ,  $^{253}\text{No}$ ,  $^{254}\text{No}$ ,  $^{255}\text{No}$ ,  $^{256}\text{No}$ ,  $^{257}\text{No}$ ,  $^{259}\text{No}$ ; calculated fission barrier, level-width(n)/level-width(F).

**73Be04 Production of Spontaneously Fissioning Isomers in Th, U, Np, Pu and Am Isotopes in Reactions Induced by 14.7 MeV Neutrons**

A. G. Belov, Y. P. Gangrsky, B. Dalkhsuren, A. M. Kucher, T. Nagy, D. M. Nadkarni, Indian J. Phys. 47, 232 (1973).

**Nuclear Reactions:** +232]Th,  $^{235}$ ,  $^{238}\text{U}$ ,  $^{237}\text{Np}$ ,  $^{240}$ ,  $^{242}\text{Pu}$ ,  $^{241}$ ,  $^{243}\text{Am}(n,2n)$ ,  $^{238}\text{Pu}$ ,  $^{241}$ ,  $^{243}\text{Am}(n,n')$ ,  $E=14.7$  MeV; measured production  $\sigma$  for SF isomers,  $nF(t)$ .  $^{238m}$ ,  $^{241m}\text{Pu}$ ,  $^{240m}$ ,  $^{241m}$ ,  $^{242m}$ ,  $^{243m}\text{Am}$  deduced  $T_{1/2}$ .

**73Be05 Search for  $\alpha$  Emission in the Decay of Spontaneously Fissionable Isomers**

A. G. Belov, Y. P. Gangrskii, B. Dalkhsuren, A. M. Kucher, Nguen Kong Khan, Yad. Fiz. 17, 942 (1973); Sov. J. Nucl. Phys. 17, 493 (1974).

**Radioactivity:** Fission  $^{240m}$ ,  $^{242m}\text{Am}$ ,  $^{241m}\text{Pu}(\text{SF})$ ; measured  $E_{\alpha}$ ,  $I_{\alpha}$ . Deduced no  $\alpha$ -emission.

**73Be10 Search for  $\gamma$ -Rays Emitted in the Formation of a Fission Isomer**

D. Benson, Jr., C. M. Lederer, E. Cheifetz, Nucl. Phys. A201, 445 (1973).

**Nuclear Reactions:** +238]U( $\alpha,\gamma F$ ); measured  $af(t)$ ,  $\gamma(t)$ ,  $E_{\gamma}$ .  $^{240m}\text{Pu}(\text{SF})$ ; deduced limits on pre-fission  $\gamma$ -ray photons.

**73Br04 Fission Barriers Deduced from the Analysis of Fission Isomer Results**

H. C. Britt, M. Boisterli, J. R. Nix, J. L. Norton, Phys. Rev. C7, 801 (1973).

**73Br38 Properties of Fission Isomers**

H. C. Britt, At. Data Nucl. Data Tables 12, 407 (1973).

**73BRWU**

Report: USNDC-7 P106

**Nuclear Reactions:** +243]Pu(n,F); measured  $\sigma(E_{\gamma})$ .  $^{243}\text{Pu}$  deduced fission isomer.

**73FI03 Excitation Functions for Spallation Products and Fission Isomers in  $^{237}\text{Np}(\text{He},xn)^{241-x}\text{Am}$  Reactions**

A. Fleury, F. H. Ruddy, M. N. Namboodiri, J. M. Alexander, Phys. Rev. C7, 1231 (1973).

**Nuclear Reactions:** +237]Np( $\alpha,2n$ ), ( $\alpha,3n$ ), ( $\alpha,4n$ ),  $E=19-45$  MeV; measured  $\sigma(E)$ ,  $\sigma$ , isomer  $\sigma$  ratio.  $^{236m}\text{Am}$  deduced  $T_{1/2}$ .

**73HeYN Search for Conversion Electrons from the Decay of Excited States in the Secondary Minimum of  $^{238}\text{U}$**

R. Heffner, J. Pedersen, P. A. Russo, H. Swanson, RLO-1388-221, p. 123 (1973).

**Radioactivity:**  $^{238}\text{U}$ ; measured  $I(\text{ce})$ .

**73Kh06 Angular Distribution of Fragments of Spontaneously Fissioning Isomers**

Fam Zui Khien, Yad. Fiz. 17, 489 (1973); Sov. J. Nucl. Phys. 17, 251 (1974).

**Nuclear Reactions:** +235]U( $\alpha,3n$ ); calculated  $^{236}\text{Pu}$  fission isomer angular distribution.

**73Li01 A Subnanosecond and a Nanosecond Fission Isomer in  $^{238}\text{Pu}$**

P. Limkilde, G. Sletten, Nucl. Phys. A199, 504 (1973).

**Radioactivity:** Fission  $^{238m}\text{Pu}$ ,  $^{240m}\text{Pu}$ ; measured  $T_{1/2}$ .

**Nuclear Reactions:** +236]U( $\alpha,2n$ ),  $E=21.0-27.0$  MeV; measured  $\sigma(1)(E)$ ,  $\sigma(2)(E)$  delayed fission; deduced thresholds;  $^{236}\text{U}(\alpha,F)$ ,  $E=20.0-28.0$  MeV; measured  $\sigma(E)$  prompt fission;  $^{238}\text{U}(\alpha,2n)$ ,  $E$  approx 25 MeV; measured  $\sigma$  delayed fission.

**73Me23 Neutron-Fission Competition Near Threshold; The Influence of Shells and Pairing on the Decay of the  $^{241}\text{Cm}$  Compound Nucleus**

V. Metag, S. M. Lee, E. Liukkonen, G. Sletten, S. Bjornholm, A. S. Jensen, Nucl. Phys. A213, 397 (1973).

**Nuclear Reactions:** +238]Pu( $\alpha,n$ ),  $E=19.9-23$  MeV;  $^{238}\text{Pu}(\alpha,2n)$ ,  $E=19.9-27$  MeV;  $^{241}\text{Am}(p,2n)$ ,  $E=8.2-16$  MeV; measured  $\sigma(^{241}\text{Cm})$ ,  $\sigma(^{242}\text{Cm})$ ,  $\sigma(\text{fission})$ .  $^{241}$ ,  $^{242}\text{Cm}$  deduced  $n$ -width,  $F$ -width.

**73Na03 Excitation Functions for the Fission Isomers  $^{240m}\text{Pu}$  and  $^{238m}\text{Pu}$  from  $^{238}\text{U}(\text{He},xn)$  Reactions**

M. N. Namboodiri, F. H. Ruddy, J. M. Alexander, Phys. Rev. C7, 1222 (1973).

**Nuclear Reactions:** +238]U( $\alpha,2n$ ), ( $\alpha,3n$ ),  $E < 28$  MeV; measured  $\sigma(E)$ ,  $\sigma$ .  $^{240m}\text{Pu}$  deduced  $T_{1/2}$ .

**73Na35 Neutronokkal Letrehozott, Izomer Allapotbol Spontan Hasado Magok Keletkezesere Vezeto Reakciok Vizsgalata**

T. Nagy, Magy. Fiz. Foly. 21, 555 (1973).

**Radioactivity:** Fission  $^{238}\text{U}$ ,  $^{239}$ ,  $^{241}$ ,  $^{242}\text{Pu}$ ,  $^{242}$ ,  $^{243}$ ,  $^{244}\text{Am}$ ,  $^{238}\text{Np}(\text{SF})$ ; measured  $T_{1/2}$ .  $^{238}\text{Pu}$ ,  $^{232}$ ,  $^{234}$ ,  $^{237}\text{U}$ ,  $^{231}\text{Th}$  measured  $T_{1/2}$  limits.

**Nuclear Reactions:** +241],  $^{243}\text{Am}(n,\gamma)$ ,  $E=0.8-16$  mev;  $^{235}$ ,  $^{236}$ ,  $^{238}\text{U}$ ,  $^{239}\text{Pu}(n,\gamma)$ ,  $E=\text{thermal}$ ;  $^{238}\text{U}$ ,  $^{239}$ ,  $^{242}\text{Pu}$ ,  $^{243}\text{Am}(n,n')$ ,  $E=3-7, 14.7$  MeV;  $^{237}\text{Np}$ ,  $^{235}$ ,  $^{236}$ ,  $^{238}\text{U}$ ,  $^{232}\text{Th}$ ,  $^{238}$ ,  $^{240}$ ,  $^{242}\text{Pu}$ ,  $^{243}\text{Am}(n,2n)$ ,  $E=14.7$  MeV; measured  $\sigma(E)$  for production of SF isomers.

**73OIZX**

Report: RCN-203 P169

**Nuclear Reactions:** +235]U(n,F),  $E=1$  MeV; measured fission isomer yield.

**73Po05 Spontaneously Fissioning Isomer  $U^{236m}$  Excited by Capture of Thermal Neutrons**

L. A. Popeko, G. A. Petrov, E. F. Kochubei, T. K. Zvezdkina, Yad. Fiz. 17, 234 (1973); Sov. J. Nucl. Phys. 17, 120 (1974).

- Nuclear Reactions:** +235U(n,F), E=thermal; measured (fragment)(ce, $\gamma$ , X)-delay.  $^{235m}\text{U}$  deduced yield.
- 73Po08 Neutron Resonance Parameters of  $^{242}\text{Pu}$**   
F. Poortmans, G. Rohr, J. P. Theobald, H. Weigmann, G. J. Vanpraet, Nucl. Phys. A207, 342 (1973).  
**Nuclear Reactions:** +242Pu(n,n),  $^{242}\text{Pu}$ (n, $\gamma$ ), E=20-1300 eV; measured  $\sigma$ .  $^{242}\text{Pu}$  resonances deduced resonance parameters n-width,  $\gamma$ -width. Enriched target.
- 73PoZA Fission Isomers, Eleven Years of Experimental Work**  
D. N. Poenaru, IFA-CRD-54-1973 (1973).  
**Compilation:** Fission  $^{234m}$ ,  $^{235m}$ ,  $^{236m}$ ,  $^{238m}$ U(SF),  $^{237m}$ Np(SF),  $^{235m}$ ,  $^{236m}$ ,  $^{237m}$ ,  $^{238m}$ ,  $^{239m}$ ,  $^{240m}$ ,  $^{241m}$ ,  $^{242m}$ Pu(SF),  $^{237m}$ ,  $^{238m}$ ,  $^{239m}$ ,  $^{240m}$ ,  $^{241m}$ ,  $^{242m}$ ,  $^{243m}$ ,  $^{244m}$ ,  $^{245m}$ ,  $^{246m}$ Am,  $^{240m}$ ,  $^{241m}$ ,  $^{242m}$ ,  $^{243m}$ ,  $^{245m}$ Cm,  $^{240m}$ ,  $^{243m}$ ,  $^{244m}$ ,  $^{246m}$ Bk; compiled experimental  $T_{1/2}$ .
- 73Sp04 Statistical Theory of Isomer Ratios for Shape (Fission) Isomers in (n, $\gamma$ ) Reactions**  
D. Sperber, Nuovo Cim. 13A, 373 (1973).  
**Nuclear Reactions:** +233),  $^{235}\text{U}$ ,  $^{238}\text{Pu}$ ,  $^{241}\text{Am}$ (n, $\gamma$ ); calculated isomer ratios.
- 73Va16 Relative Excitations of the  $^{237}\text{Pu}$  Shape Isomers**  
R. Vandenbosch, P. A. Russo, G. Sletten, M. Mehta, Phys. Rev. C8, 1080 (1973).  
**Radioactivity:** Fission  $^{237m}\text{Pu}$ (SF),  $^{237}\text{Pu}$ ; measured delayed yields.  $^{237}\text{Pu}$  deduced levels, J,  $\pi$ ,  $T_{1/2}$ .
- 73Va30 Probability of Formation of Spontaneously Fissioning Isomer States Following Thermal Neutron Capture by  $\text{U}^{235}$  and  $\text{Pu}^{239}$**   
G. V. Valskii, O. M. Mrachkovskii, G. A. Petrov, Y. S. Pleva, Yad. Fiz. 18, 492 (1973); Sov. J. Nucl. Phys. 18, 253 (1974).  
**Nuclear Reactions:** +235U,  $^{239}\text{Pu}$ (n, $\gamma$ ); measured  $\sigma$ (isomer).
- 73Wo03 The Fissioning Isomer  $^{237m}\text{Np}$**   
K. L. Wolf, J. P. Unik, Phys. Lett. 43B, 25 (1973).  
**Radioactivity:** Fission  $^{237m}\text{Np}$ (SF); measured  $T_{1/2}$ , excitation energy.
- 73Ze05 Search for a Spontaneously Fissioning Isomer Nucleus  $\text{U}^{236}$  in the Reaction  $\text{U}^{235}$ (n, $\gamma$ )**  
Zen Chang Bom, A. Lajtai, A. A. Omelyanenko, T. T. Pantaleev, S. M. Polikanov, Y. V. Ryabov, Tang San Khak, Yad. Fiz. 18, 34 (1973); Sov. J. Nucl. Phys. 18, 18 (1974).  
**Nuclear Reactions:** +235U(n, $\gamma$ ), E approx 60 keV; measured  $\sigma$  for SF isomer.  $^{236}\text{U}$  deduced no SF isomer.
- 74Ba73 Fission of Odd-A and Doubly Odd Actinide Nuclei Induced by Direct Reactions**  
B. B. Back, H. C. Britt, O. Hansen, B. Leroux, J. D. Garrett, Phys. Rev. C10, 1948 (1974).  
**Nuclear Reactions:** +230),  $^{232}\text{Th}$ ( $^3\text{He}$ , $\alpha$ F),  $^{230}$ ,  $^{232}\text{Th}$ ,  $^{233}$ ,  $^{234}$ ,  $^{235}$ ,  $^{236}$ ,  $^{238}\text{U}$ ,  $^{238}$ ,  $^{240}$ ,  $^{242}\text{Pu}$ ,  $^{248}\text{Cm}$ ( $^3\text{He}$ , dF), E=24 MeV;  $^{232}\text{Th}$ ,  $^{231}\text{Pa}$ ,  $^{237}\text{Np}$ ,  $^{248}\text{Cm}$ (d,pF), E=15 MeV;  $^{243}\text{Am}$ ,  $^{239}\text{Pu}$ (t, pF), E=15 MeV;  $^{248}\text{Cm}$ (t, $\alpha$ F), E=16 MeV; measured fission probabilities.  $^{229}$ ,  $^{231}\text{Th}$ ,  $^{231}$ ,  $^{232}$ ,  $^{233}\text{Pa}$ ,  $^{234}$ ,  $^{235}$ ,  $^{236}$ ,  $^{237}$ ,  $^{238}$ ,  $^{239}\text{Np}$ ,  $^{241}\text{Pu}$ ,  $^{240}$ ,  $^{241}$ ,  $^{243}$ ,  $^{245}$ ,  $^{247}\text{Am}$ ,  $^{249}\text{Cm}$ ,  $^{249}\text{Bk}$  deduced barrier heights.
- 74Ba28 Fission of Doubly Even Actinide Nuclei Induced by Direct Reactions**  
B. B. Back, O. Hansen, H. C. Britt, J. D. Garrett, Phys. Rev. C9, 1924 (1974).  
**Nuclear Reactions:** +230),  $^{232}\text{Th}$ ,  $^{234}$ ,  $^{235}$ ,  $^{238}\text{U}$ ,  $^{238}$ ,  $^{240}$ ,  $^{242}\text{Pu}$ ,  $^{248}\text{Cm}$ (t,pF), E=15 MeV;  $^{231}\text{Pa}$ (t, $\alpha$ F), E=16 MeV;  $^{231}\text{Pa}$ ,  $^{237}\text{Np}$ ,  $^{243}\text{Am}$ ( $^3\text{He}$ ,dF), E=24 MeV;  $^{239}\text{U}$ (d,pF), E=13 MeV;  $^{248}\text{Cm}$ (p,p'F), E=22.5 MeV; measured E(fragment), I(fragment).  $^{230}$ ,  $^{232}$ ,  $^{234}\text{Th}$ ,  $^{232}$ ,  $^{234}$ ,  $^{235}$ ,  $^{236}$ ,  $^{238}$ ,  $^{240}\text{U}$ ,  $^{238}$ ,  $^{240}$ ,  $^{242}$ ,  $^{244}\text{Pu}$ ,  $^{244}$ ,  $^{246}\text{Cm}$  deduced fission probability.
- 74Ba82 Comparison of Fragment Kinetic Energies from Two  $^{237}\text{Pu}$  Fission Isomers**  
S. L. Bacharach, P. S. Hoepfer, J. A. Morrissey, J. K. Temperley, Phys. Rev. C10, 2636 (1974).  
**Radioactivity:** Fission  $^{237m}\text{Pu}$ (SF); measured  $T_{1/2}$ .
- 74Be52 Attempted Coulomb Excitation of the Spontaneous-Fission Isomeric State in  $^{230}\text{Pu}$**   
C. E. Bemis, Jr., F. Plasil, R. L. Ferguson, E. E. Gross, A. Zucker, Phys. Rev. C10, 1590 (1974).  
**Nuclear Reactions:** +239Pu( $^{20}\text{Ne}$ , $^{20}\text{Ne}$ '), E=100, 117 MeV; measured fission fragments.  $^{239m}\text{Pu}$  deduced upper limit on yield.
- 74BeYO**  
Report: ORNL-4937 P26  
**Nuclear Reactions:** +239Pu( $^{20}\text{Ne}$ , $^{20}\text{Ne}$ '), E=100, 117 MeV; measured  $\sigma$ (fragment mass, $\theta$ ).  $^{239}\text{Pu}$  deduced fission isomer.
- 74Bo02 Search for a  $\gamma$ -Branch from Shape Isomers in  $^{236}\text{U}$  and  $^{238}\text{Np}$**   
J. Borggreen, J. Hattula, E. Kashy, V. Maarbjerg, Nucl. Phys. A218, 621 (1974).  
**Nuclear Reactions:** +235U(d,p), E=11 MeV;  $^{236}\text{U}$ (p,n), E=8 MeV; measured  $\sigma$ (delayed  $\gamma$ ),  $T_{1/2}$ =130 ns,  $2 \mu\text{s} < T_{1/2} < 20 \text{ms}$ .  $^{236m}\text{U}$ ,  $^{238m}\text{Np}$  deduced limits on  $\sigma$  for delayed  $\gamma$  from shape isomer.
- 74Br05 Investigation of the  $\gamma$  Decay of Subthreshold-Fission Resonances of  $^{242}\text{Pu}$  to a Fission Isomeric State**  
J. C. Browne, C. D. Bowman, Phys. Rev. C9, 1177 (1974).  
**Nuclear Reactions:** +242Pu(n,F $\gamma$ ), E=400-3000 eV; measured  $\sigma$ (E),  $\gamma$ (t).  $^{242}\text{Pu}$  resonance deduced  $\gamma$ -branching.
- 74BrYE**  
Conference proceedings: Rochester(Phys, Chem of Fission),Vol2 P493  
**Nuclear Reactions:** +242Pu(n,F), E=subthreshold; measured E $\gamma$ .  $^{242}\text{Pu}$  deduced no fission isomer.
- 74Ga41 Investigation of Photoneuclear Reactions Leading to Spontaneously Fissioning Isomers**  
Y. P. Gangrsky, B. N. Markov, Y. M. Tsypenyuk, Fortschr. Phys. 22, 199 (1974).  
**Nuclear Reactions:** +239Pu,  $^{243}\text{Am}$ ( $\gamma$ , $\gamma$ ),  $^{240}$ ,  $^{242}\text{Pu}$ ,  $^{241}$ ,  $^{243}\text{Am}$ ( $\gamma$ ,n), E=7-16 MeV; measured  $\sigma$ (E) for the production of spontaneously fissioning isomers; deduced barrier parameters.
- 74GaZD Delayed Fission Fragment Angular Distributions in Some Alpha-Particle-Induced Reactions**  
D. Galeriu, M. Marinescu, D. Poenaru, I. Vilcov, N. Vilcov, Y. P. Gangrsky, P. Z. Hien, N. C. Khan, Proc. Symp. Phys. Chem. Fission, 3rd, Rochester, N. Y. (1973), Int. At. En. Agency, Vienna, Vol. 1, p. 297 (1974).  
**Nuclear Reactions:** +235),  $^{238}\text{U}$ ,  $^{239}\text{Pu}$ ,  $^{241}\text{Am}$ ( $\alpha$ ,2n),  $^{238}\text{U}$ ,  $^{242}\text{Pu}$ ( $\alpha$ ,3n), E=26-33 MeV; measured  $\sigma$ (fragment mass, $\theta$ ), fragment(t).  $^{238m}$ ,  $^{237m}$ ,  $^{240m}\text{Pu}$ ,  $^{241m}$ ,  $^{243m}\text{Cm}$  deduced anisotropies.
- 74HeZE Experimental Study of the Deformation of the Fission Isomer in  $^{236}\text{U}$**   
R. H. Heffner, Thesis, Univ. Washington (1973); Diss. Abstr. Int. B35, 435 (1974).  
**Radioactivity:** Fission  $^{236m}\text{U}$ (SF); measured  $\gamma$ ce(t); deduced  $T_{1/2}$ ,  $\beta$ .
- 74LoZN Gamma-Ray Transitions Preceding Isomeric Fission in  $^{236}\text{U}$**   
K. E. G. Lobner, D. Harrach, E. Konecny, N. Nenoff, H. J. Specht, J. Weber, Contrib. Int. Symp. Neutron Capture Gamma Ray Spectroscopy



and Related Topics, 2nd, Petten, p. 409 (1974)

**Nuclear Reactions:** +235U(n,F); measured (fragment) $\gamma$ (t). <sup>235</sup>U deduced transitions.

**74Me10** *Detection of Fission Isomers with Half-Lives in the Picosecond Range by the Recoil-Distance Technique*

V. Metag, E. Liukkonen, G. Sletten, O. Glomset, S. Bjornholm, Nucl. Instrum. Methods 114, 445 (1974).

**Nuclear Reactions:** +237Np(p,F), <sup>242</sup>Pu(d,pnF); measured recoil distance. <sup>242</sup>Pu level deduced T<sub>1/2</sub>.

**74MeYP** *Half-Life Systematics of Fission Isomers in Even-Even Pu Isotopes*

V. Metag, E. Liukkonen, O. Glomset, A. Bergman, Proc. Symp. Phys. Chem. Fission, 3rd, Rochester, N. Y. (1973), Int. At. En. Agency, Vienna, Vol. 1, p. 317 (1974).

**Nuclear Reactions:** +238U, <sup>240</sup>, <sup>242</sup>, <sup>244</sup>Pu(d,pn), <sup>237</sup>Np(p, 2n), <sup>234</sup>U( $\alpha$ ,2n); measured delayed fission. <sup>235</sup>, <sup>238</sup>, <sup>242</sup>, <sup>244</sup>Pu deduced fission isomers, T<sub>1/2</sub>.

**74MoYC** *Calculation of Fission Barriers*

P. Moller, J. R. Nix, Proc. Symp. Phys. Chem. Fission, 3rd, Rochester, N. Y. (1973), Int. At. En. Agency, Vienna, Vol. 1, p. 103 (1974).

**Nuclear Structure:** +244U, <sup>248</sup>, <sup>252</sup>, <sup>256</sup>, <sup>260</sup>No, <sup>240</sup>, <sup>244</sup>, <sup>248</sup>, <sup>252</sup>, <sup>256</sup>Cf, <sup>235</sup>, <sup>240</sup>, <sup>244</sup>, <sup>248</sup>, <sup>252</sup>Pu, <sup>232</sup>, <sup>235</sup>, <sup>240</sup>, <sup>244</sup>, <sup>248</sup>Th; calculated fission barriers. A=242; calculated single particle energies.

**74SpZS** *Fragment Anisotropy in Isomeric Fission*

H. J. Specht, E. Konecny, J. Weber, C. Kozuharov, Proc. Symp. Phys. and Chem. Fission, Rochester, N. Y., 3rd, (1973), IAEA, Vienna, Vol. 1, p. 285 (1974).

**Nuclear Reactions:** +235U, <sup>238</sup>U, <sup>239</sup>Pu( $\alpha$ ,2n), E=25 MeV; measured  $\sigma$ (fragment mass, $\theta$ ), fragment(t). <sup>237m</sup>, <sup>238m</sup>Pu, <sup>241m</sup>Cm deduced anisotropies, J.

**74WoZW** *Measurements on the Fissioning Isomer <sup>238m</sup>U with the (n,n') and (d,pn) Reactions*

K. L. Wolf, J. W. Meadows, Bull. Am. Phys. Soc. 19, No. 4, 595, KH1 (1974)

**Nuclear Reactions:** fission <sup>238</sup>U(n,n'F), (d,pnF); measured  $\sigma$ (E;E(fragment), t). <sup>238m</sup>U deduced T<sub>1/2</sub>.

**75Ch09** *Investigation of Delayed Fission in <sup>238</sup>U*

J. Christiansen, G. Hempel, H. Ingwersen, W. Klinger, G. Schatz, W. Witthuhn, Nucl. Phys. A239, 253 (1975).

**Nuclear Reactions:** +235U(d,pF), E=11 MeV; measured prompt, delayed fission. <sup>238m</sup>U(SF) deduced T<sub>1/2</sub>, isomeric to prompt fission ratio. <sup>232</sup>Th(d,F), E=11 MeV; measured prompt fission.

**75Gr16** *Feasibility of Experimental Verification of the Shape-Isomerism Hypothesis in Heavy Nuclei*

D. P. Grachukhin, Yad. Fiz. 21, 956 (1975); Sov. J. Nucl. Phys. 21, 491 (1976).

**Nuclear Structure:** +242U, <sup>242m</sup>Am; calculated isomeric shift.

**75Ha09** *An Investigation of the Properties of Single-Particle-States in the Second Minimum of <sup>237</sup>Pu*

I. Hamamoto, W. Ogle, Nucl. Phys. A240, 54 (1975).

**Nuclear Reactions:** +235U( $\alpha$ ,2n), E=22-25 MeV; analyzed data. <sup>237</sup>Pu levels deduced g, J,  $\pi$ , K.

**75Kh06** *Determination of the Spins of Spontaneously-Fissioning Isomers*

P. Z. Hien, Yad. Fiz. 22, 938 (1975); Sov. J. Nucl. Phys. 22, 489 (1976).

**Radioactivity:** Fission <sup>241</sup>Cm(SF), <sup>235</sup>, <sup>237</sup>, <sup>238</sup>Pu (SF); calculated spins of

SF isomers.

**75LoZT** *Gamma-Ray Transitions Preceding Isomeric Fission in <sup>238</sup>U*

K. E. G. Lobner, D. Harrach, E. Konecny, N. Nenoff, H. J. Specht, J. Weber, Proc. Int. Symp. Neutron Capture Gamma Ray Spectroscopy and Related Topics, 2nd, Petten, The Netherlands (1974), K. Abrahams, F. Stecher-Rasmussen, P. Van Assche, Eds., Reactor Centrum Nederland, p. 665 (1975).

**Nuclear Reactions:** +235U(n, $\gamma$ ), E=thermal; measured fragment  $\gamma$ (t). <sup>238</sup>U deduced levels.

**75Me28** *Systematics of Fission Isomer Halfives*

V. Metag, Nukleonika 20, 789 (1975).

**Nuclear Structure:** +236U, <sup>238</sup>, <sup>242</sup>, <sup>244</sup>Pu, <sup>242</sup>, <sup>244</sup>Cm; analyzed, reviewed fission isomer T<sub>1/2</sub>, Systematics.

**75Ru03** *Gamma Decay of the <sup>238</sup>U Shape Isomer*

P. A. Russo, J. Pedersen, R. Vandenbosch, Nucl. Phys. A240, 13 (1975).

**Nuclear Reactions:** +238U(d,n $\gamma$ ), E=13, 18 MeV; <sup>238</sup>U(p,p' $\gamma$ ), E=13 MeV; measured  $\sigma$ (E, $\gamma$ ,t). <sup>238</sup>U deduced levels, J,  $\pi$ , T<sub>1/2</sub>, barrier parameters.

**75Va21** *Formation of the Spontaneously Fissile Isomer <sup>242m</sup>Am in Thermal-Neutron Capture*

G. V. Valsky, V. L. Varentsov, G. A. Petrov, Y. S. Pleva, B. M. Aleksandrov, A. S. Krivokhatsky, Yad. Fiz. 22, 701 (1975); Sov. J. Nucl. Phys. 22, 363 (1976).

**Nuclear Reactions:** +241Am(n, $\gamma$ ), E=thermal; measured  $\sigma$  for production of <sup>242</sup>Am(SF) isomer. <sup>242m</sup>Am deduced T<sub>1/2</sub>.

**76An11** *The Shape Isomer in <sup>238</sup>U Populated by Thermal Neutron Capture*

V. Andersen, C. J. Christensen, J. Borggreen, Nucl. Phys. A269, 338 (1976).

**Nuclear Reactions:** +235U(n, $\gamma$ ), E=th; measured ce X-coin, fragment delay; obtained isomeric/prompt fission ratio. <sup>238m</sup>U shape isomer deduced  $\gamma$ F branching ratio.

**76Be55** *Search for Conversion Electrons Emitted during the Decay of Spontaneously Fissile Isomers*

A. G. Belov, Y. P. Gangrskii, B. Dalkhsuren, M. B. Miller, Izv. Akad. Nauk SSSR, Ser. Fiz. 40, 1109 (1976); Bull. Acad. Sci. USSR, Phys. Ser. 40, No. 6, 10 (1976).

**Nuclear Reactions:** +238U, <sup>239</sup>, <sup>242</sup>Pu, <sup>241</sup>, <sup>243</sup>Am(n, X), E=14. 7 MeV; <sup>238</sup>U, <sup>239</sup>, <sup>242</sup>Pu, <sup>241</sup>, <sup>243</sup>Am( $\gamma$ ,X), E=9, 15 MeV; measured E(ce), I(ce). <sup>238</sup>U deduced  $\gamma$ -decay for SF isomer.

**76BeZM** *Search for the Conversion Electrons Emitted in the Decay of Spontaneously Fissioning Isomers*

A. G. Belov, Y. P. Gangrsky, B. Dalkhsuren, M. B. Miller, JINR-P6-9397 (1976).

**Radioactivity:** Fission <sup>238</sup>U, <sup>239</sup>, <sup>241</sup>Pu, <sup>240</sup>, <sup>241</sup>, <sup>242</sup>, <sup>243</sup>Am(SF); measured ce spectra.

**76Br38** *Search for Fissile Isomers in the (n,2n)-Reaction*

J. S. Browne, R. E. Houve, At. Energ. 40, 491(1976); Sov. At. Energy 40, 587 (1976).

**Nuclear Reactions:** +238U, <sup>242</sup>, <sup>244</sup>Pu(n,2n), E=14 MeV; measured  $\sigma$  for production of SF isomers. <sup>237</sup>U, <sup>241</sup>, <sup>243</sup>Pu deduced no SF isomers.

**76Ga11** *TnTf for Actinide Nuclei Using (<sup>3</sup>He,df) and (<sup>3</sup>He,tf) Reactions*

A. Gavron, H. C. Britt, E. Konecny, J. Weber, J. B. Wilhelm, Phys. Rev. C13, 2374 (1976).

**Nuclear Structure:** +230U, <sup>231</sup>, <sup>232</sup>, <sup>233</sup>Pa, <sup>231</sup>, <sup>232</sup>U, <sup>233</sup>, <sup>234</sup>, <sup>235</sup>, <sup>236</sup>, <sup>237</sup>, <sup>238</sup>, <sup>239</sup>Np, <sup>237</sup>, <sup>238</sup>Pu, <sup>239</sup>, <sup>240</sup>, <sup>241</sup>, <sup>242</sup>, <sup>243</sup>Am, <sup>241</sup>, <sup>242</sup>, <sup>243</sup>, <sup>244</sup>Cm; measured fission probability in <sup>3</sup>He induced reactions; deduced barrier heights, average

Tn/Tl.

**Nuclear Reactions:** +230<sup>232</sup>Th, <sup>231</sup>Pa, <sup>234</sup>, <sup>235</sup>, <sup>238</sup>U, <sup>237</sup>Np, <sup>239</sup>, <sup>241</sup>Pu, <sup>241</sup>, <sup>243</sup>Am(<sup>2</sup>He,df), (<sup>2</sup>He,t); <sup>232</sup>U, <sup>242</sup>Pu(<sup>2</sup>He,df); E=25 MeV; measured fission spectra; deduced barrier heights, average neutron-, fission-widths. <sup>230</sup>, <sup>231</sup>, <sup>232</sup>, <sup>233</sup>Pa, <sup>231</sup>, <sup>232</sup>U, <sup>233</sup>, <sup>234</sup>, <sup>235</sup>, <sup>236</sup>, <sup>237</sup>, <sup>238</sup>, <sup>239</sup>Np, <sup>237</sup>, <sup>238</sup>Pu, <sup>239</sup>, <sup>240</sup>, <sup>241</sup>, <sup>242</sup>, <sup>243</sup>Am, <sup>241</sup>, <sup>242</sup>, <sup>243</sup>, <sup>244</sup>Cm deduced fission probability.

**76Ga29 Study of the  $\gamma$ -Ray Spectra Emitted in Formation of the Spontaneously Fissile Isomer <sup>236</sup>U in the (n, $\gamma$ ) Reaction**

Y. P. Gangrskii, A. Lajtai, B. N. Markov, Yad. Fiz. 24, 880 (1976); Sov. J. Nucl. Phys. 24, 460 (1976).

**Nuclear Reactions:** +235<sup>235</sup>U(n, $\gamma$ ), E=th; measured  $\gamma$ -spectrum from <sup>236m</sup>U(SF), fragment  $\gamma$ -coin.

**76Si01 Picosecond Fission Isomers in Even-Even Cm Isotopes**

G. Sletten, V. Metag, E. Liukkonen, Phys. Lett. 60B, 153 (1976).

**Radioactivity:** Fission <sup>240</sup>, <sup>242</sup>Cm(SF); measured  $T_{1/2}$ , <sup>244</sup>Cm(SF); measured  $T_{1/2}$  upper limit.

**76We03 Mass and Kinetic Energy Measurements of Fragments from the Isomeric and Excited State Fission of <sup>242</sup>Am**

J. Weber, B. R. Erdal, A. Gavron, J. B. Wilhelmy, Phys. Rev. C13, 189 (1976).

**Radioactivity:** Fission <sup>242m</sup>Am(SF); measured  $T_{1/2}$ ,  $\sigma$ (E(fragment mass)).

**Nuclear Reactions:** +241<sup>241</sup>Am(d,pF), E=15 MeV; measured  $\sigma$ (E(fragment mass)).

**77ArZZ Excitation and Spontaneous Fission of <sup>238m</sup>U Isomer by Neutrons with 14 MeV Energy**

R. Art, G. Muziol, D. Hoffman, Proc. Conf. Neutron Physics, Kiev, Part 3, p. 247 (1977).

**Nuclear Reactions:** +238<sup>238</sup>U(n,n'), E=14 MeV; measured isomer excitation,  $\sigma$ (ratio).

**Radioactivity:** Fission <sup>238m</sup>U(SF); measured  $\sigma$ (fragment) vs t.

**77BoZO On the Spontaneous Fission of <sup>238</sup>U Isomer**

A. P. Bordulya, S. N. Ezhov, Proc. Conf. Neutron Physics, Kiev, Part 3, p. 244 (1977).

**Radioactivity:** <sup>238</sup>Pa [from <sup>238</sup>U(n,p), E=14.7 MeV]; measured  $\beta$ -delayed  $\gamma$ -decay. <sup>238</sup>U deduced isomer fission probability.

**77Bo09 The Rotational Band of the <sup>236</sup>U Shape Isomer**

J. Borggreen, J. Pedersen, G. Sletten, R. Heffner, E. Swanson, Nucl. Phys. A279, 189 (1977).

**Nuclear Reactions:** +235<sup>235</sup>U(d,p), E=12 MeV; measured ce-delayed fission coin, pce-coin. <sup>236m</sup>U deduced rotational constant.

**77DI09 Near Threshold Neutron-Fission Cross Section**

M. Di Toro, G. Russo, Nucl. Phys. A284, 177 (1977).

**Nuclear Structure:** +235<sup>235</sup>U, <sup>238</sup>Np, <sup>242</sup>Pu; calculated fission parameters. <sup>238</sup>Np; calculated, predicted isomer.

**77Ga09 Tn/Tl in Heavy Actinides**

A. Gavron, H. C. Britt, P. D. Goldstone, R. Schoenmackers, J. Weber, J. B. Wilhelmy, Phys. Rev. C15, 2238 (1977).

**Nuclear Reactions:** +244<sup>244</sup>Pu, <sup>245</sup>, <sup>246</sup>, <sup>248</sup>Cm, <sup>249</sup>, <sup>250</sup>Cf(<sup>2</sup>He,d), (<sup>2</sup>He,t), E=8, 11 MeV; measured fission probability of compound systems <sup>244</sup>, <sup>245</sup>Am, <sup>246</sup>, <sup>247</sup>, <sup>248</sup>, <sup>249</sup>Bk, <sup>249</sup>, <sup>250</sup>, <sup>251</sup>Es.

**77Go03 Cross Section for Fission of <sup>244</sup>Pu by Fast Neutrons**

B. M. Gokhberg, S. M. Dubrovina, V. A. Shigin, Yad. Fiz. 25, 21 (1977); Sov. J. Nucl. Phys. 25, 11 (1977).

**Nuclear Reactions:** +244<sup>244</sup>Pu(n,F), E=fast; measured  $\sigma$ (E); deduced fission threshold. <sup>245</sup>Pu deduced fission barrier height.

**77GoZH Transmissionresonanzen und Winkelverteilungen der prompten Spaltung in der <sup>239</sup>Pu(d,pf) Reaktion**

U. Goerlach, D. Habs, M. Just, V. Metag, E. Mosler, B. Neumann, P. Paul, J. Schukraft, P. Singer, H. J. Specht, G. Ulfert, C. O. Wene, Max-Planck Institut fur Keimphysik (Heidelberg), Jahresbericht 1976, p. 49 (1977).

**Nuclear Reactions:** +239<sup>239</sup>Pu(d,p), E=11 MeV; measured fission yields; deduced transmission resonance. <sup>239</sup>U( $\alpha$ ,3n); measured  $\gamma$ ( $\theta$ ,H,t). <sup>239m</sup>Pu deduced g.

**77GoYZ Messung der Energie- und Massenverteilung bei der Spaltung des <sup>239m</sup>Pu mit Hilfe des Magnetischen Ruckstossionenseparator**

U. Goerlach, D. Habs, M. Just, V. Metag, E. Mosler, J. Pedersen, J. Schukraft, P. Singer, H. J. Specht, G. Ulfert, C. O. Wene, Max-Planck Institut fur Keimphysik (Heidelberg), Jahresbericht 1977, p. 51 (1977).

**Radioactivity:** Fission <sup>239</sup>Pu(SF) [from <sup>239</sup>U( $\alpha$ ,3n)]; measured fragment mass, kinetic energy distribution. Compared with neutron induced fission.

**77Ha01 Quadrupole Moment of the 8- $\mu$ s Fission Isomer in <sup>239</sup>Pu**

D. Habs, V. Metag, H. J. Specht, G. Ulfert, Phys. Rev. Lett. 38, 387 (1977).

**Nuclear Reactions:** +238<sup>238</sup>U( $\alpha$ ,3n), E=33 MeV; measured charge distribution, activity by charge-plunger technique. <sup>239</sup>Pu fission isomer deduced quadrupole moment.

**77KeZI Investigation of (n, $\gamma$ F) Reaction**

J. Kecskemeti, Gy. Kluge, A. Lajtai, INDC(SEC)-61/LN, p. 44 (1977).

**Nuclear Reactions:** +235<sup>235</sup>U(n,F), E=th; measured  $\gamma\gamma$ (t). <sup>235m</sup>U(SF) deduced transitions.

**77Me08 The Quadrupole Moment of the 40 ps Fission Isomer in <sup>239</sup>Pu**

V. Metag, G. Sletten, Nucl. Phys. A282, 77 (1977).

**Nuclear Reactions:** +234<sup>234</sup>U( $\alpha$ ,2n), E=25 MeV; measured delayed fission fragment( $\theta$ ). <sup>236</sup>Pu shape isomer deduced  $T_{1/2}$ ,  $Q_0$ .

**77MI09 Fission Isomer of <sup>237m</sup>Np**

E. Migneco, G. Russo, R. De Leo, A. Pantaleo, Phys. Rev. C16, 1919 (1977).

**Nuclear Reactions:** +238<sup>238</sup>U(n,2n), E=9.75, 11.6, 12.5 MeV; measured delayed/prompt fission ratios. <sup>237m</sup>Np deduced partial  $T_{1/2}$  for  $\gamma$ , fission, branching ratio.

**77Ta05 <sup>239</sup>Pu Fission Isomer in the Reaction with 3-5 MeV Neutrons**

E. Takekoshi, Y. Tsukihashi, J. Phys. Soc. Jap. 42, 1773 (1977).

**Nuclear Reactions:** +239<sup>239</sup>Pu(n,n'), (n,F), E=3-5 MeV; measured  $\sigma$  for isomer production/ $\sigma$  prompt fission; deduced  $\sigma$  for isomer production/ $\sigma$  ground state.

**77VaYN Spontaneously Fissioning Isomers**

R. Vandenbosch, Ann. Rev. Nucl. Sci. 27, 1 (1977).

**Nuclear Structure:** +236<sup>236</sup>U, <sup>237</sup>Np, <sup>235</sup>, <sup>237</sup>, <sup>239</sup>, <sup>241</sup>, <sup>243</sup>Pu, <sup>237</sup>, <sup>238</sup>, <sup>239</sup>, <sup>240</sup>, <sup>241</sup>, <sup>242</sup>, <sup>243</sup>, <sup>244</sup>, <sup>245</sup>Am, <sup>240</sup>, <sup>241</sup>, <sup>242</sup>, <sup>243</sup>, <sup>244</sup>Cm, <sup>232</sup>, <sup>234</sup>, <sup>235</sup>, <sup>236</sup>Bk; compiled, reviewed isomer SF-decay  $T_{1/2}$  data.

**77VoZU Production of Fission Isomers in the Reaction <sup>238</sup>U(n, n')**

P. E. Vorotnikov, V. A. Vukolov, E. A. Koltypin, Yu. D. Molchanov, G. A. Oroschenko, Proc. Conf. Neutron Physics, Kiev, Part 3, p. 239 (1977).

**Nuclear Reactions:** +238<sup>238</sup>U(n,n'), E=2.5-4.7 MeV; measured fission isomer yield,  $T_{1/2}$ , reaction threshold.

**78Ba47 Search for a  $\gamma$ -Decay of the <sup>236</sup>U Shape Isomer**

- H. Bartsch, W. Gunther, K. Huber, U. Kneissl, H. Krieger, H. J. Maier, Nucl. Phys. A306, 29 (1978).
- Radioactivity:**  $^{238m}\text{U}$  shape isomer [from  $^{238}\text{U}(\gamma, 2n)$ ,  $E=45$  MeV bremsstrahlung]; measured  $E_\gamma$ ,  $I_\gamma$ ; deduced  $\Gamma\gamma/\Gamma$ .
- 78De07 Fission-Evaporation Competition in Pu Isotopes of Mass 235-239**
- H. Delagrangé, A. Fleury, J. M. Alexander, Phys. Rev. C17, 1706 (1978).
- Nuclear Reactions:**  $+233$ ,  $^{234}$ ,  $^{235}\text{U}(\alpha, xn)$ ,  $X=1-4$ ,  $E \leq 46$  MeV; measured fusion  $\sigma(E)$ .
- 78FI05 Statistical-Model Analysis of Fission Isomer Production for  $^{237}$ ,  $^{238}\text{Pu}$  and  $^{239}\text{Am}$**
- A. Fleury, H. Delagrangé, J. M. Alexander, Phys. Rev. C17, 1721 (1978).
- Nuclear Reactions:**  $+235$ ,  $^{235}\text{U}$ ,  $^{237}\text{Np}(\alpha, 2n)$ ,  $E=22-28$  MeV; calculated  $\sigma(E)$ , isomer production  $\sigma(E)$ . Statistical model analysis.
- 78Go10 Resonances in the Isomeric and Prompt Fission Probabilities of  $^{240}\text{Pu}$**
- U. Goerlach, D. Habs, M. Just, V. Metag, P. Paul, H. J. Specht, H. J. Maier, Z. Phys. A287, 171 (1978).
- Nuclear Reactions:**  $+239$ Pu(d,p),  $E=11$  MeV; measured proton-fragment time distributions, prompt, delayed fission  $\sigma$ ; deduced fission probability.
- 78Gu02 Population of the  $^{238}\text{U}$  Shape Isomer in a Photonuclear Reaction**
- W. Gunther, K. Huber, U. Kneissl, H. Krieger, Nucl. Phys. A297, 254 (1978).
- Nuclear Reactions:**  $+238$ U( $\gamma, 2n$ ),  $E=45$  MeV bremsstrahlung; measured isomer/prompt yields; deduced  $\sigma$  for isomer production.  $^{238m}\text{U}$  shape isomer deduced  $T_{1/2}$ ,  $\Gamma\gamma/\Gamma$ . Natural target.
- 78Po01 Properties of Fission Isomers**
- K. Pomorski, A. Sobiczewski, Acta Phys. Pol. B9, 61 (1978).
- Nuclear Structure:**  $+226$ Ra,  $^{230}$ ,  $^{232}\text{Th}$ ,  $^{234}$ ,  $^{236}$ ,  $^{238}\text{U}$ ,  $^{238}$ ,  $^{239}$ ,  $^{240}$ ,  $^{242}$ ,  $^{244}\text{Pu}$ ,  $^{240}$ ,  $^{242}$ ,  $^{244}$ ,  $^{246}$ ,  $^{250}\text{Cm}$ ; calculated fission isomer properties: moment of inertia, pairing energy gap, g. Nilsson potential.
- 78SoZP Production of  $^{235m}\text{U}$  Fission Isomer and  $^{234}\text{Pu}$  in the Reactions  $\alpha + ^{233}\text{U}$  and  $^3\text{He} + ^{234}\text{U}$**
- L. P. Somerville, M. J. Nurmi, A. Ghiorso, G. T. Seaborg, LBL-8151, p. 39 (1978).
- Nuclear Reactions:**  $+234$ U( $^3\text{He}, 2n$ ),  $E=21.5-31.4$  MeV;  $^{238}\text{U}(\alpha, 2n)$ ,  $E=36.1$  MeV; measured production  $\sigma(E)$ .  $^{235m}\text{U}$  level deduced  $T_{1/2}$ . Mica spontaneous fission detector.
- 78UI01 Lifetime Measurements of Nuclear Levels with the Charge Plunger Technique**
- G. Ulfert, D. Habs, V. Metag, H. J. Specht, Nucl. Instrum. Methods 148, 369 (1978).
- Nuclear Reactions:**  $+239$ Pu( $\alpha, 3n$ ),  $E=27, 33$  MeV; measured recoil distance.  $^{240}\text{Cm}$  levels deduced  $T_{1/2}$ , Q.
- 79Ba02 Spectroscopy in the Second Minimum of the Potential Energy Surface of  $^{239}\text{Pu}$**
- H. Backe, L. Richter, D. Habs, V. Metag, J. Pedersen, P. Singer, H. J. Specht, Phys. Rev. Lett. 42, 490 (1979).
- Radioactivity:**  $^{239m}\text{Pu}$  [from  $^{239}\text{U}(\alpha, 3n)$ ,  $E=33$  MeV]; measured  $E(\text{ce})$ ,  $I(\text{ce})$ .  $^{239}\text{Pu}$  deduced levels in second minimum, J,  $\pi$ ,  $\delta$ , rotational parameters. Nilsson assignments.
- 79Be33 Deep Subthreshold Photofission Yields Analysis**
- G. Bellia, A. Del Zoppo, E. Migneco, R. C. Barna, D. De Pasquale, Phys. Rev. C20, 1059 (1979).
- Nuclear Reactions:**  $+232$ Th,  $^{235}$ ,  $^{236}$ ,  $^{238}\text{U}(\gamma, f)$ ,  $E=3.6, 4.1, 4.6, 5.1$  MeV (bremsstrahlung); measured  $\sigma$ .  $^{232}\text{Th}$  deduced three-humped fission barrier.  $^{232}\text{Th}$ ,  $^{235}$ ,  $^{236}$ ,  $^{238}\text{U}$  deduced energies, fission branching ratios for shape isomers. Double-humped fission barrier model.
- 79Be46 Optical Isomer Shift for the Spontaneous-Fission Isomer  $^{240}\text{Am-m}$**
- C. E. Bemis, Jr., J. R. Beene, J. P. Young, S. D. Kramer, Phys. Rev. Lett. 43, 1854 (1979); Erratum Phys. Rev. Lett. 44, 500 (1980).
- Radioactivity:**  $^{240m}\text{Am}$ ; measured  $T_{1/2}$ , optical isomer shift.  $^{240m}\text{Am}$ ,  $^{240}\text{Am}$  deduced difference in rms radii.
- Atomic Physics:**  $+240$ Am(SF); measured optical isomer shift.  $^{240m}$ ,  $^{240}\text{Am}$  deduced difference in rms radii.
- 79Gr04 Excitation of a Spontaneously Fissile Isomer in Positron Annihilation in the K Shell of an Atom**
- D. P. Grechukhin, A. A. Soldatov, Yad. Fiz. 29, 296 (1979); Sov. J. Nucl. Phys. 29, 146 (1979).
- Radioactivity:** Fission  $^{238}$ ,  $^{239}\text{U}$ ; calculated  $T_{1/2}$  (SF).
- 79Gu03 Photonuclear Yields of the  $^{237}\text{Pu}$  Fission Isomers**
- W. Gunther, K. Huber, U. Kneissl, H. Krieger, H. J. Maier, Phys. Rev. C19, 433 (1979).
- Nuclear Reactions:**  $+239$ Pu( $\gamma, 2n$ ),  $E=45$  MeV bremsstrahlung; measured  $T_{1/2}$ , isomeric yield ratio.  $^{237m}\text{Pu}$  levels deduced isomeric ratio, spin. Nilsson assignments.
- 79UI01 Quadrupole Moment of the 200-ns Fission Isomer in  $^{237}\text{U}$**
- G. Ulfert, V. Metag, D. Habs, H. J. Specht, Phys. Rev. Lett. 42, 1596 (1979).
- Nuclear Reactions:**  $+238$ U(d,pn),  $E=20$  MeV; measured yield of fission-isomeric recoil.  $^{237m}\text{U}$  level deduced quadrupole moment.
- 79Va25 On Gamma-Rays in the Population of the Spontaneously Fissioning Isomer in the Reaction  $^{241}\text{Am}(n, \gamma)^{240m}\text{Am}$**
- G. V. Valskii, V. L. Varentsov, G. A. Petrov, Y. S. Pleva, Y. A. Otchik, Pisma Zh. Eksp. Teor. Fiz. 29, 92 (1979); JETP Lett. 29, 84 (1979).
- Nuclear Reactions:**  $+241$ Am( $n, \gamma$ ),  $E=\text{thermal}$ ; measured  $\gamma(t)$ .  $^{242}\text{Am}$  deduced transition, E(SF) isomer.
- 80Bj02 The Double-Humped Fission Barrier**
- S. Bjornholm, J. E. Lynn, Rev. Mod. Phys. 52, 725 (1980).
- Nuclear Structure:**  $=231-245$ ; analyzed resonance structure, fission data; deduced fission features. Double-humped fission barrier concept.
- 80Bu13 Experimental Upper Limit for a  $\gamma$  Branch from the  $^{238}\text{U}$  Shape Isomer**
- P. A. Butler, R. Daniel, A. D. Irving, T. P. Morrison, P. J. Nolan, V. Metag, J. Phys. (London) G6, 1165 (1980).
- Nuclear Reactions:**  $+235$ U(d,p),  $E=11$  MeV; measured  $\sigma(E_\gamma)$ ,  $\gamma p(t)$ .  $^{238}\text{U}$  level deduced limit on  $\Gamma\gamma/\Gamma$ .
- 80BuZL Experimental Upper Limit for a  $\gamma$ -Branch from the  $^{238}\text{U}$  Shape Isomer**
- P. A. Butler, R. Daniels, A. D. Irving, T. P. Morrison, P. J. Nolan, V. Metag, R. Wadsworth, Univ. Liverpool, 1979-1980 Ann. Rept., p. 52 (1980).
- Nuclear Reactions:**  $+235$ U(d,p),  $E=11$  MeV; measured  $E_\gamma$ ,  $I_\gamma$ ,  $\gamma p(t)$ .  $^{238}\text{U}$  deduced shape isomer  $\Gamma\gamma/\Gamma$  upper limit.
- 80Gu20 Systematics of Photonuclear Yields and Cross Sections for Plutonium and Uranium Fission Isomers**
- W. Gunther, K. Huber, U. Kneissl, H. Krieger, H. Ries, H. Stroher, W. Wilke, H. J. Maier, Nucl. Phys. A350, 1 (1980).
- Nuclear Reactions:** fission  $^{240}\text{Pu}$ ,  $^{239}\text{U}(\gamma, xn)$ ,  $^{239}\text{Pu}(\gamma, 2n)$ ,  $^{240}\text{Pu}(\gamma, n)$ ,  $E=45$  MeV bremsstrahlung; measured  $T_{1/2}$ , isomeric to prompt yield ratios.  $^{239}\text{U}$ ,  $^{237}$ ,  $^{238}$ ,  $^{241}\text{Pu}$  levels deduced  $\sigma(\text{fission})$ . Natural, enriched tar-



J. Drexler, R. Heil, K. Huber, U. Kneissl, G. Mank, R. Ratzek, H. Ries, H. Stroher, T. Weber, W. Wilke, Nucl. Phys. A411, 17 (1983).

**Nuclear Reactions:** +238]U( $\gamma$ , $\gamma$ ), E=12 MeV bremsstrahlung; measured isomer  $T_{1/2}$ ; isomeric to prompt yield ratio; deduced isomeric fission cross section.  $^{238}\text{U}$  deduced isomer decay branching ratio. Natural target.

**83Ka11 Observation of an E0 Isomeric Transition from the  $^{238}\text{U}$  Shape Isomer**

J. Kantale, W. Stoffl, L. E. Ussery, D. J. Decman, E. A. Henry, R. W. Hoff, L. G. Mann, G. L. Struble, Phys. Rev. Lett. 51, 91 (1983).

**Radioactivity:**  $^{238\text{m}}\text{U}$  [from  $^{238}\text{U}(\text{d},\text{pn})$ , E=18 MeV]; measured I(ce); deduced shape isomer E0 transition, J,  $\pi$ ,  $T_{1/2}$  assignment consistency. Reevaluation of  $\text{I}\gamma$  data, superconducting, solenoid type electron spectrometer.

**83Po14 Identification of  $^{246}\text{Pu}$ ,  $^{247}\text{Pu}$ ,  $^{246\text{m}}\text{Am}$ , and  $^{247}\text{Am}$  and Determination of Their Half-Lives**

Yu. S. Popov, P. A. Privalova, G. A. Timofeev, V. B. Mishenev, A. V. Marmelin, B. I. Levakov, V. M. Prokopev, Radiokhimiya 25, 482 (1983); Sov. Radiochemistry 25, 458 (1983).

**Radioactivity:**  $^{246}$ ,  $^{247}\text{Pu}$ ,  $^{246\text{m}}$ ,  $^{247}\text{Am}(\beta^-)$  [from Pu neutron irradiation]; measured  $E\gamma$ ,  $\text{I}\gamma$ , E(X-ray), I(X-ray); deduced  $T_{1/2}$ ,  $^{246}\text{Pu}$  burnout  $\sigma$ . Isotope identification by  $\alpha$ -,  $\beta$ -,  $\gamma$ -spectroscopy techniques.

**83Ra36 g-Factor Measurements of Fission Isomers**

M. H. Rafailovich, E. Dafni, G. Schatz, S. Y. Zhu, K. Dybdal, S. Vajda, C. Alonso-Arias, S. Rolston, G. D. Sprouse, Hyperfine Interactions 15/16, 43 (1983).

**Radioactivity:**  $^{236\text{m}}\text{Am}$ ,  $^{237}\text{Pu}(\text{SF})$  [from  $^{235}\text{U}$ ,  $^{237}\text{Np}(\alpha, 2\text{n})$ , E=25 MeV]; measured fission fragment anisotropy, isomer  $T_{1/2}$ , g.

**Nuclear Reactions:** +235]U,  $^{237}\text{Np}(\alpha, 2\text{n})$ , E=25 MeV; measured  $\gamma(\theta, \text{H}, \text{I})$ .  $^{236\text{m}}\text{Am}$ ,  $^{237}\text{Pu}$  deduced fission isomer g,  $T_{1/2}$ .

**83WeZT Search for Alpha Particle Emission from the 14-ms  $^{240\text{m}}\text{Am}$  Shape Isomer**

J. Weber, H. C. Britt, C. Fontenla, M. M. Fowler, Z. Fraenkel, A. Gavron, K. Rudolph, J. Van der Plicht, J. B. Wilhelm, LA-9797-PR, p. 151 (1983); Isotope and Nucl. Chem. Div. Ann. Rept., 1981-1982, H. A. Lindberg Ed., Los Alamos Nat. Lab., p. 151 (1983).

**Radioactivity:**  $^{240\text{m}}\text{Am}(\alpha)(\text{SF})$  [from  $^{240}\text{Pu}(\text{t}, 3\text{n})$ , E=17 MeV]; measured  $E\alpha$ ,  $\text{I}\alpha$ ; deduced deexcitation shape dependence,  $T_{1/2}$ , long range  $\alpha$ -particle to SF branching ratio.

**83WeZU Messungen zum  $\alpha$ -Zerfall des Formisomers  $^{240\text{m}}\text{Am}$**

J. Weber, K. Rudolph, C. Ley, K. E. G. Lobner, S. J. Skorka, J. B. Wilhelm, H. C. Britt, A. Gavron, Z. Fraenkel, Univ., Tech. Univ. Munich, Jahresbericht 1982, p. 16 (1983).

**Radioactivity:**  $^{240\text{m}}\text{Am}(\alpha)$  [from  $^{240}\text{Pu}(\text{t}, 3\text{n})$ , (d,2n)]; measured  $E\alpha$ ,  $\text{I}\alpha$ .

**84Bo33 Alpha Decay of Fission Isomers**

N. M. Borstnik, ATOMKI Koziem. 26, 100 (1984).

**Nuclear Structure:** +242m]Am; calculated  $\alpha$ -decay characteristics. Vibrational degrees,  $\alpha$ -particle motion dynamical coupling.

**84Du03 Theoretical Analysis of the Single-Particle States in the Secondary Minima of Fissioning Nuclei**

J. Dudek, W. Nazarewicz, A. Faessler, Nucl. Phys. A412, 61 (1984).

**Nuclear Structure:** +239m],  $^{237\text{m}}\text{Pu}$ ,  $^{236\text{m}}\text{Am}$ ,  $^{231}$ ,  $^{232}\text{Th}$ ; calculated g, single particle resonances, deformations near fission second minima. Deformed Woods-Saxon potential.

**84Ka10 Reinvestigation of the Gamma Branch from the  $^{238}\text{U}$  Shape Isomer**

J. Kantale, W. Stoffl, L. E. Ussery, D. J. Decman, E. A. Henry, R. J. Estep, R. W. Hoff, L. G. Mann, Phys. Rev. C29, 1693 (1984).

**Nuclear Reactions:** CPND  $^{238}\text{U}(\text{d},\text{np})$ , E=18.1 MeV; measured  $E\gamma$ ,  $\text{I}\gamma$ ; deduced (isomeric/ground state)  $\sigma$ .  $^{238}\text{U}$  deduced shape isomer SF, conversion decay characteristics, levels.

**Radioactivity:**  $^{238\text{m}}\text{U}(\text{SF})$ , (IT) [from  $^{238}\text{U}(\text{d},\text{np})$ , E=18.1 MeV]; measured  $E\gamma$ ,  $\text{I}\gamma$ ; deduced isomer decay process relative probabilities.

**84Ku05 Systematics of Neutron Cross Sections and Other Characteristics of Fission Probabilities of Transuranium Nuclei**

V. M. Kupriyanov, G. N. Smirenkin, B. I. Fursov, Yad. Fiz. 39, 281 (1984).

**Nuclear Structure:** +228],  $^{229}$ ,  $^{230}$ ,  $^{231}$ ,  $^{232}$ ,  $^{233}$ ,  $^{234}$ ,  $^{235}$ ,  $^{236}$ ,  $^{237}$ ,  $^{238}$ ,  $^{239}$ ,  $^{240}$ ,  $^{241}$ ,  $^{242}\text{U}$ ,  $^{230}$ ,  $^{231}$ ,  $^{232}$ ,  $^{233}$ ,  $^{234}$ ,  $^{235}$ ,  $^{236}$ ,  $^{237}$ ,  $^{238}$ ,  $^{239}$ ,  $^{240}$ ,  $^{241}$ ,  $^{242}\text{Np}$ ,  $^{234}$ ,  $^{235}$ ,  $^{236}$ ,  $^{237}$ ,  $^{238}$ ,  $^{239}$ ,  $^{240}$ ,  $^{241}$ ,  $^{242}$ ,  $^{243}$ ,  $^{244}$ ,  $^{245}$ ,  $^{246}\text{Pu}$ ,  $^{236}$ ,  $^{237}$ ,  $^{238}$ ,  $^{239}$ ,  $^{240}$ ,  $^{241}$ ,  $^{242}$ ,  $^{243}$ ,  $^{244}$ ,  $^{245}$ ,  $^{246}$ ,  $^{247}\text{Am}$ ,  $^{238}$ ,  $^{239}$ ,  $^{240}$ ,  $^{241}$ ,  $^{242}$ ,  $^{243}$ ,  $^{244}$ ,  $^{245}$ ,  $^{246}$ ,  $^{247}$ ,  $^{248}$ ,  $^{249}$ ,  $^{250}\text{Cm}$ ,  $^{242}$ ,  $^{243}$ ,  $^{244}$ ,  $^{245}$ ,  $^{246}$ ,  $^{247}$ ,  $^{248}$ ,  $^{249}$ ,  $^{250}$ ,  $^{251}$ ,  $^{252}$ ,  $^{253}\text{Bk}$ ,  $^{245}$ ,  $^{246}$ ,  $^{247}$ ,  $^{248}$ ,  $^{249}$ ,  $^{250}$ ,  $^{251}$ ,  $^{252}$ ,  $^{253}$ ,  $^{254}$ ,  $^{255}$ ,  $^{256}\text{Cf}$ ,  $^{244}$ ,  $^{245}$ ,  $^{246}$ ,  $^{247}$ ,  $^{248}$ ,  $^{249}$ ,  $^{250}$ ,  $^{251}$ ,  $^{252}$ ,  $^{253}$ ,  $^{254}$ ,  $^{255}\text{Es}$ ,  $^{250}$ ,  $^{251}$ ,  $^{252}$ ,  $^{253}$ ,  $^{254}$ ,  $^{255}$ ,  $^{256}$ ,  $^{257}\text{Fm}$ ; calculated fast neutron induced fission  $\sigma$ ; analyzed fission data systematics; deduced fission barrier heights,  $(\Gamma(n)/\Gamma(f))$ . Statistical approach, two-hump fission barrier model.

**84Ma44  $\alpha$  Decay of Fission Isomers**

N. Mankoc-Borstnik, J. Phys. (London) G10, 1371 (1984).

**Radioactivity:**  $^{242}\text{Am}(\text{EC})$ , ( $\beta^-$ ), ( $\alpha$ ),  $^{242\text{m}}\text{Am}(\text{SF})$ , ( $\alpha$ ); calculated  $\alpha$ -decay constant. First-order perturbation theory.

**84Ni04 On Connection between  $\alpha$  Decay and Ternary Fission of Heavy Nuclei**

A. M. Nikitin, Yad. Fiz. 39, 380 (1984).

**Nuclear Structure:** +252]Cf,  $^{253}$ ,  $^{254}$ ,  $^{255}$ ,  $^{256}\text{U}$ ,  $^{243}$ ,  $^{242\text{m}}\text{Am}$ ; analyzed ternary fission light fragment emission,  $\alpha$ -decay characteristics systematics; deduced initial nucleus quasistationary  $\alpha$ -particle state role.

**84Oh09 Systematic Analysis of Fission Cross Sections of Actinides by Means of Double-Humped Barrier Model**

T. Ohsawa, Y. Shigemitsu, M. Ohta, K. Kudo, J. Nucl. Sci. Technol. (Tokyo) 21, 887 (1984).

**Nuclear Reactions:** +231]Pa,  $^{232}$ ,  $^{234}$ ,  $^{235}$ ,  $^{236}$ ,  $^{238}\text{U}$ ,  $^{237}\text{Np}$ ,  $^{238}$ ,  $^{239}$ ,  $^{240}$ ,  $^{241}$ ,  $^{242}$ ,  $^{244}\text{Pu}$ ,  $^{241}$ ,  $^{242}$ ,  $^{243}\text{Am}$ ,  $^{243}$ ,  $^{244}$ ,  $^{245}$ ,  $^{246}$ ,  $^{247}$ ,  $^{248}\text{Cm}$ ,  $^{246}\text{Bk}$ ,  $^{252}\text{Cf}(\text{n}, \text{f})$ , E 0.5-6 MeV; calculated  $\sigma(\text{E})$ ; deduced optical model parameters.  $^{232}\text{Pa}$ ,  $^{233}$ ,  $^{235}$ ,  $^{236}$ ,  $^{237}$ ,  $^{238}\text{U}$ ,  $^{238}\text{Np}$ ,  $^{238}$ ,  $^{240}$ ,  $^{241}$ ,  $^{242}$ ,  $^{243}$ ,  $^{245}\text{Pu}$ ,  $^{242}$ ,  $^{243}$ ,  $^{244}\text{Am}$ ,  $^{244}$ ,  $^{245}$ ,  $^{246}$ ,  $^{247}$ ,  $^{248}$ ,  $^{249}\text{Cm}$ ,  $^{246}\text{Bk}$ ,  $^{252}\text{Cf}$  deduced fission barriers. Double-humped barrier model.

**84Vo18 Energy Dependence of Yield of Fission Isomers in the Reactions  $^{241}\text{Am}(\text{n}, \gamma)$  and  $^{242}\text{Am}(\text{n}, \gamma)$**

P. E. Vorotnikov, G. A. Otroshchenko, Yad. Fiz. 40, 1135 (1984).

**Nuclear Reactions:** +241],  $^{242}\text{Am}(\text{n}, \gamma)$ , E=0.2-1.3 MeV; measured fission isomer, prompt fission product yield ratios.

**85Ba20 On Measurement of the Angular Momenta of Fission Isomer**

A. L. Barabanov, D. P. Grechukhin, Yad. Fiz. 41, 582 (1985).

**Nuclear Reactions:** +238]U( $^7\text{Li}, 5\text{n}$ ), E=46.1 MeV; analyzed data.  $^{240\text{m}}\text{Am}$  deduced fission isomer J estimate. Residual orientation in laser radiation field.

**85Be58 Laser Optical Pumping in Nuclear Physics: Fission Isomers, oriented targets, and hyperfine pumping in single-electron atoms**

C. E. Bemis, Jr., Hyperfine Interactions 24, 139 (1985).

**Radioactivity:**  $^{240\text{m}}\text{Am}(\text{SF})$ ; measured optical isomer shift. Oriented targets, anisotropic fission decay from resonant laser optical pumping.

**85Dr01 The 'Isomeric Shelf' in the Deep Subbarrier Photofission of  $^{238}\text{U}$**

J. Drexler, R. D. Heil, K. Huber, U. Kneissl, G. Mank, R. Ratzek, H. Ries, T. Weber, W. Wilke, B. Fischer, H. Hollick, Nucl. Phys. A437, 253 (1985).

**Nuclear Reactions:** +238]U( $\gamma, \text{f}$ ), E=3.9-4.3 MeV bremsstrahlung; measured  $T_{1/2}$ ; isomeric to prompt yield ratio. Depleted targets.

**85Ig01 Analysis of Cross Sections of U and Pu Isotope Fission Induced by Neutrons in the Range of the First 'Plateau'**

A. V. Ignatyuk, A. B. Klepatsky, V. M. Maslov, E. Sh. Sukhovitsky, Yad.

Fiz. 42, 569 (1985).

**Nuclear Reactions:** +239), <sup>240</sup>, <sup>241</sup>, <sup>242</sup>, <sup>244</sup>, <sup>245</sup>Pu, <sup>234</sup>, <sup>235</sup>, <sup>236</sup>, <sup>237</sup>, <sup>238</sup>, <sup>239</sup>, <sup>240</sup>U(n,F), E=1-5. 5 MeV; analyzed fission  $\sigma(E)$ . <sup>240</sup>, <sup>241</sup>, <sup>242</sup>, <sup>243</sup>, <sup>245</sup>, <sup>246</sup>Pu, <sup>235</sup>, <sup>236</sup>, <sup>237</sup>, <sup>238</sup>, <sup>239</sup>, <sup>240</sup>, <sup>241</sup>U deduced fission barriers, transitional states statistical characteristics.

**85Jo04 <sup>241</sup>Am and <sup>243</sup>Am Charge Distributions from Muonic X-Ray Spectroscopy and the Quadrupole Moment of the <sup>240</sup>Am Fission Isomer**

M. W. Johnson, E. B. Shera, M. V. Hoehn, R. A. Naumann, J. D. Zumbr, C. E. Bemis, Jr., Phys. Lett. 161B, 75 (1985).

**Nuclear Reactions:** +241), <sup>243</sup>Am( $\mu$ ,X), E at rest; measured muonic E X-ray, I X-ray. <sup>241</sup>, <sup>243</sup>Am deduced intrinsic quadrupole moment, Barrett radii. <sup>240</sup>Am deduced fission isomer quadrupole moment. Optical isotope shift data input.

**Atomic Physics:** esic-Atoms <sup>241</sup>, <sup>243</sup>Am( $\mu$ ,X), E at rest; measured muonic X-rays.

**85Ku18 Excitation of Fission Isomer <sup>242m</sup>Am, <sup>242</sup>Am(f) by Electrons in the Energy Region 17. 5-78 MeV**

V. L. Kuznetsov, L. E. Lazareva, V. G. Nedorezov, N. V. Nikitina, A. S. Sudov, Yad. Fiz. 42, 29 (1985).

**Nuclear Reactions:** +243)Am(e,n), ( $\gamma$ ,n), E=17. 5-78 MeV; measured residual fission isomer production  $\sigma(E)$ ; <sup>240</sup>Am(e,F), ( $\gamma$ ,F), E=17. 5-78 MeV; measured fission  $\sigma(E)$ ; deduced fission isomer production mechanism. Virtual photon theory.

**85Ra28 A g-Factor Measurement of the <sup>239</sup>Am Fission Isomer**

M. H. Rafailovich, S. Vajda, E. Dafni, G. Schatz, S. Rolston, S. Y. Zhu, G. D. Sprouse, Phys. Lett. 163B, 327 (1985).

**Nuclear Reactions:** +237)Np( $\alpha$ ,2n), E=tandem; measured  $\gamma(\theta, H, t)$ . <sup>239</sup>Am deduced fission isomer g.

**85Vo17 Anisotropy of Fission of <sup>242m</sup>Am by Fast Neutrons**

P. E. Vorotnikov, B. M. Gokhberg, V. A. Shigin, E. F. Formushkin, G. F. Novoselov, Yad. Fiz. 42, 1038 (1985); Sov. J. Nucl. Phys. 42, 656 (1985).

**Radioactivity:** <sup>242m</sup>Am(SF); measured fission fragment decay  $\sigma(\theta_n=0^\circ)/\sigma(\theta_n=90^\circ)$ , anisotropy.

**86B110 Intermediate Structure in the Fission Cross Sections of the Even Curium Isotopes**

R. C. Block, D. R. Harris, H. T. Maguire, Jr., C. R. S. Stopa, R. E. Slovacek, J. W. T. Dabbs, R. J. Dougan, R. W. Hoff, R. W. Loughheed, Radiat. Eff. 92, 305 (1986).

**Nuclear Reactions:** +244), <sup>246</sup>, <sup>248</sup>Cm(n,F), E  $\leq$  100 keV; analyzed fission  $\sigma(E)$ ; deduced structure. <sup>245</sup>, <sup>247</sup>, <sup>248</sup>Cm deduced barrier parameter differences.

**86De04 Excitation Function and Half-Life for the Fission Isomer <sup>240m</sup>Pu from the <sup>238</sup>U( $\alpha$ ,2n)<sup>240m</sup>Pu Reaction**

S. de Barros, S. D. de Magalhaes, H. Wolf, J. Barreto, J. Eichler, N. Lisbona, I. O. de Souza, D. M. Vianna, Z. Phys. A323, 101 (1986).

**Radioactivity:** <sup>240m</sup>Pu(SF) [from <sup>238</sup>U( $\alpha$ ,2n), E=20. 1-27. 3 MeV]; measured  $T_{1/2}$ .

**Nuclear Reactions:** CPND <sup>238</sup>U( $\alpha$ ,2n), E=20. 1-27. 3 MeV; measured residual fission isomer production  $\sigma(E)$ . <sup>240m</sup>Pu deduced delayed fission  $\sigma$ , isomeric  $\sigma$  ratio.

**87Ah07 Search for the Shape-Isomeric Gamma Decay in Muonic Uranium**

S. Ahmad, G. A. Beer, B. H. Olaniyi, A. Olin, S. N. Kaplan, A. Mirashghi, J. A. Macdonald, O. Hausser, Can. J. Phys. 65, 753 (1987).

**Nuclear Reactions:** +236), <sup>238</sup>, <sup>239</sup>U( $\mu$ , $\gamma$ ), E at rest; measured  $E_\gamma$ ,  $I_\gamma$ , E X-ray, I X-ray,  $\gamma(t)$ ; deduced no shape isomer excitation evidence. <sup>235</sup>, <sup>238</sup>, <sup>239</sup>U deduced  $\mu$ -capture  $T_{1/2}$ .

**Atomic Physics:** esic-Atoms <sup>236</sup>, <sup>238</sup>, <sup>239</sup>U( $\mu$ ,  $\gamma$ ), E at rest; measured  $E_\gamma$ ,  $I_\gamma$ , E X-ray, I X-ray,  $\gamma(t)$ .

**87Gu03 A New Macroscopic-Microscopic Description of the Double-Humped Fission Barriers**

S. K. Gupta, L. Satpathy, Z. Phys. A326, 221 (1987).

**Nuclear Structures:** +228)Ra, <sup>228</sup>Ac, <sup>228</sup>Th, <sup>229</sup>Pa, <sup>234</sup>U, <sup>236</sup>Np, <sup>238</sup>Pu, <sup>241</sup>Am, <sup>243</sup>Cm, <sup>244</sup>Bk, <sup>250</sup>Cf, <sup>254</sup>Es, <sup>255</sup>Fm, <sup>256</sup>Md, <sup>257</sup>No, <sup>260</sup>Lr, <sup>261</sup>104; calculated binding energies; Z=90-98; calculated doubled-humped fission barriers, shell energies. New mass relation.

**87ScZP On the  $\gamma$ -Decay of the Shape Isomer in <sup>238</sup>U**

J. Schirmer, D. Habs, D. Schwalm, H. J. Maier, GSI-87-1, p. 32 (1987).

**Nuclear Reactions:** +235)U(d,p), E=11 MeV; measured  $\gamma$ -spectra,  $\gamma(t)$ . <sup>238</sup>U deduced shape isomer decay characteristics.

**88Ma43  $\alpha$ -Decay Probability of Spontaneously Fissioning Isomer and Deformation Hindrance Factor**

V. E. Makarenko, V. G. Nosov, Yad. Fiz. 48, 73 (1988).

**Radioactivity:** <sup>238m</sup>U( $\alpha$ ); calculated  $\alpha$ -decay probability; deduced deformation hindrance factor.

**88Ma52 Triple Fission of the Spontaneously Fissioning Isomer <sup>238</sup>U**

V. E. Makarenko, Yu. D. Molchanov, G. A. Otroshchenko, G. B. Yankov, Pisma Zh. Eksp. Teor. Fiz. 47, 489 (1988); JETP Lett. (USSR) 47, 573 (1988).

**Radioactivity:** <sup>238m</sup>U( $\alpha$ ), (SF) [from <sup>238</sup>U(n,n'), E=4. 5 MeV]; measured decay  $T_{1/2}$ , triple fission branching ratio.

**Nuclear Reactions:** +238)U(n,n'), E=4. 5 MeV; measured isomer production yield.

**89Eg01 Actinide Nuclei Fission Cross-Section Irregularities**

S. A. Egorov, V. A. Rubchenya, S. V. Khlebnikov, Nucl. Phys. A494, 75 (1989).

**Nuclear Reactions:** +227)Ac(n,F), E 2-16 MeV; <sup>228</sup>Ra(n,F), E 3-16 MeV; <sup>244</sup>Cm(n,F), E 1-3 MeV; <sup>242</sup>, <sup>246</sup>, <sup>248</sup>Cm(n,F), E 0. 5-5 MeV; calculated fission  $\sigma(E)$ . <sup>243</sup>, <sup>245</sup>, <sup>247</sup>, <sup>248</sup>Cm, <sup>226</sup>, <sup>228</sup>, <sup>227</sup>Ra, <sup>228</sup>, <sup>227</sup>Ac deduced fission barrier parameters.

**89Ha40 Spectroscopy of the Second Minimum**

D. Habs, Nucl. Phys. A502, 105c (1989).

**Nuclear Structure:** 150; analyzed high spin level systematics; deduced comparison with fission second minimum in actinide region.

**89HoZP Second Minimum Spectroscopy Using Heavy Ion Transfer Reactions**

T. H. Hoare, P. A. Butler, G. D. Jones, R. J. Poynter, C. A. White, Daresbury Lab., 1988-1989 Ann. Rept., Appendix, p. 92 (1989).

**Nuclear Reactions:** +238)U(<sup>60</sup>Ni,<sup>60</sup>Ni), E=325 MeV; measured  $\gamma\gamma$ -coin,  $\gamma(t)$ ; deduced residue fission isomer  $\sigma$ .

**89Ma54 Ternary Fission of Neutron Induced Uranium Fissioning Isomers**

V. E. Makarenko, Yu. D. Molchanov, G. A. Otroshchenko, G. B. Yankov, Nucl. Phys. A502, 363c (1989).

**Radioactivity:** <sup>238m</sup>, <sup>238m</sup>U(SF) [from <sup>238</sup>, <sup>239</sup>U(n, n'), E=4. 5 MeV]; measured  $T_{1/2}$ , fission fragment; deduced relative fission probabilities.

**89Ma64 Spontaneous Fission Isomers  $\alpha$ -Decay Hindrance Factor**

V. E. Makarenko, V. G. Nosov, Izv. Akad. Nauk SSSR, Ser. Fiz. 53, 933 (1989); Bull. Acad. Sci. USSR, Phys. Ser. 53, No. 5, 105 (1989).

**Radioactivity:** <sup>238m</sup>U(SF); calculated  $\alpha$ -decay hindrance factor.

**89Ma57 Ternary Fission of Uranium Fissioning Isomers Excited by Neutrons**

V. E. Makarenko, Yu. D. Molchanov, G. A. Otroshchenko, G. B. Yankov

, Yad. Fiz. 50, 928 (1989).

**Radioactivity:**  $^{236m}\text{U}$ ,  $^{238m}\text{U}$ (SF) [from  $^{235}\text{U}$ ,  $^{238}\text{U}$ (n, n'), E=4. 5 MeV]; measured fission fragment spectra; deduced  $T_{1/2}$ , decay probability, fission mechanism.

**89Sc30  $\gamma$  Decay of the Superdeformed Shape Isomer in  $^{236}\text{U}$**

J. Schirmer, J. Gerl, D. Habs, D. Schwalm, Phys. Rev. Lett. 63, 2196 (1989).

**Nuclear Reactions:** +235U(d,p), E=11 MeV; measured  $\gamma$  time spectra, missing energy vs delayed sum energy.  $^{236}\text{U}$  deduced isomer, decay, superdeformation features,  $\gamma$ -decay to fission branching ratio.

**89SoZZ Production of the Fission Isomer  $^{236m}\text{Pu}$  and  $^{234}\text{Pu}$  in the Reactions  $\alpha + ^{232}\text{U}$  and  $^3\text{He} + ^{234}\text{U}$**

L. P. Somerville, M. J. Nurmia, A. Ghiorso, J. M. Nitschke, G. T. Seaborg, Bull. Am. Phys. Soc. 34, No. 1, 69, EG7 (1989)

**Nuclear Reactions:** CPND  $^{234}\text{U}$ ( $^3\text{He}, 2n$ ), ( $^3\text{He}, 3n$ ), E not given; measured  $\sigma$ (E).  $^{232}\text{U}$ ( $\alpha, 3n$ ), E=36 MeV; measured E( $\alpha$ ), I( $\alpha$ ); deduced reaction  $\sigma$ ,  $^{235}\text{Pu}$ ,  $^{234}\text{Pu}$  production.

**90Bh02 Test of the Adequacy of Using Smoothly Joined Parabolic Segments to Parametrize the Multihumped Fission Barriers in Actinides**

B. S. Bhandari, Phys. Rev. C42, 1443 (1990).

**Nuclear Structure:** +236),  $^{236}\text{U}$ ,  $^{237}\text{Np}$ ,  $^{235}$ ,  $^{237}$ ,  $^{238}$ ,  $^{239}$ ,  $^{240}$ ,  $^{241}$ ,  $^{242}$ ,  $^{243}$ ,  $^{244}$ ,  $^{245}\text{Pu}$ ,  $^{239}$ ,  $^{240}$ ,  $^{241}$ ,  $^{242}$ ,  $^{243}$ ,  $^{244}$ ,  $^{245}\text{Am}$ ,  $^{241}$ ,  $^{242}$ ,  $^{243}$ ,  $^{244}$ ,  $^{245}\text{Cm}$ ; calculated fission  $T_{1/2}$ ; deduced fission barrier parametrization.

**90HoZU Second Minimum Spectroscopy Using Heavy Ion Reactions**

T. H. Hoare, P. A. Butler, N. Clarkson, G. D. Jones, C. A. White, R. J. Poynter, R. A. Cunningham, Daresbury Labs., 1989-1990 Ann. Rept., Appendix, p. 84 (1990).

**Nuclear Reactions:** CPND  $^{238}\text{U}$ ( $^{28}\text{Ni}, ^{26}\text{Ni}$ ), E=325 MeV;  $^{238}\text{U}$ ( $^{28}\text{Ni}, ^{24}\text{Ni}$ ), E=332 MeV; measured fission isomer production  $\sigma$  upper limit.

**90Ku17 Energy of Alpha Particles in Triple Fission of the Fissile Isomer Uranium-238**

I. A. Kukushkin, V. E. Makarenko, Yu. D. Molchanov, G. A. Otroshchenko, G. B. Yankov, Pisma Zh. Eksp. Teor. Fiz. 51, 611 (1990); JETP Lett. (USSR) 51, 693 (1990).

**Radioactivity:**  $^{238m}\text{U}$  [from  $^{238}\text{U}$ (n,n'), E=4. 5 MeV]; measured fission fragment,  $\alpha$ -spectra; deduced  $T_{1/2}$ , triple fission  $\alpha$ -distribution features, branching ratio relative to SF-decay.

**90Ma59 Method of Half-Life Determination**

V. E. Makarenko, G. A. Otroshchenko, Yad. Fiz. 51, 1201 (1990); Sov. J. Nucl. Phys. 51, 765 (1990).

**Radioactivity:**  $^{236m}\text{U}$ ,  $^{238m}\text{U}$ ; calculated  $T_{1/2}$ . Time spectrum processing method proposed.

**91Ku23 Energies of Long-Range Particles in Ternary Fission of the  $^{238}\text{U}$  Spontaneously Fissioning Isomer**

I. A. Kukushkin, V. E. Makarenko, Yu. D. Molchanov, G. A. Otroshchenko, G. B. Yankov, Yad. Fiz. 54, 8 (1991); Sov. J. Nucl. Phys. 54, 4 (1991).

**Nuclear Reactions:** +238U(n,n'), E=4. 5 MeV; measured (fragment)(fragment)-coin following SF-decay, ternary fission.  $^{238m}\text{U}$  deduced  $T_{1/2}$ , fission branching ratio.

**92Ba67 First Observation of a Resonance Ionization Signal on  $^{242m}\text{Am}$  Fission Isomers**

H. Backe, Th. Blonnigen, M. Dahlinger, U. Doppler, P. Graffe, D. Habs, M. Hies, Ch. Illgner, H. Kunz, W. Lauth, H. Schope, P. Schwamb, W. Theobald, R. Zahn, Hyperfine Interactions 74, 47 (1992).

**Radioactivity:**  $^{242m}\text{Am}$ (SF) [from  $^{242}\text{Pu}$ (d,2n), E=12 MeV]; measured resonance ionization followed by isomer fission decay. Buffer gas cell,

two-step resonance ionization, excimer dye laser combination.

**92Bh03 Systematics of the Deduced Fission Barriers for the Doubly Even Transactinium Nuclei**

B. S. Bhandari, Y. B. Bendaraf, Phys. Rev. C45, 2803 (1992).

**Nuclear Structure:** +236),  $^{238}$ ,  $^{240}$ ,  $^{242}$ ,  $^{244}\text{Pu}$ ,  $^{240}$ ,  $^{242}$ ,  $^{244}$ ,  $^{246}$ ,  $^{248}$ ,  $^{250}\text{Cm}$ ; calculated isomer energies,  $T_{1/2}$ , SF-decay  $T_{1/2}$ , outer barrier heights.  $^{230}$ ,  $^{232}\text{Th}$ ,  $^{230}$ ,  $^{232}$ ,  $^{234}$ ,  $^{236}$ ,  $^{238}\text{U}$ ,  $^{240}$ ,  $^{242}$ ,  $^{244}$ ,  $^{246}$ ,  $^{248}$ ,  $^{250}$ ,  $^{252}$ ,  $^{254}\text{Cf}$ ,  $^{242}$ ,  $^{244}$ ,  $^{246}$ ,  $^{248}$ ,  $^{250}$ ,  $^{252}$ ,  $^{254}$ ,  $^{256}\text{Fm}$ ,  $^{250}$ ,  $^{252}$ ,  $^{254}$ ,  $^{256}$ ,  $^{258}$ ,  $^{260}\text{No}$ ,  $^{250}\text{104}$ ,  $^{252}\text{104}$ ,  $^{254}\text{104}$ ,  $^{256}\text{104}$ ,  $^{260}\text{104}$ ; calculated SF-decay  $T_{1/2}$ , outer barrier height. Double humped fission barrier model. Other nuclei, other aspects discussed.

**92BIZZ Search for Low Spin Superdeformed States by Transfer Reaction**

J. Blons, D. Goutte, A. Lepretre, R. Lucas, V. Meot, D. Paya, X. H. Phan, G. Barreau, T. Doan, G. Pedemey, Contrib. Int. Conf. Nuclear Structure at High Angular Momentum, Ottawa, p. 57 (1992); AECL-10613 (1992)

**Nuclear Reactions:** +236U( $^{16}\text{O}, ^{16}\text{O}$ ), E=9 MeV/nucleon;  $^{192}\text{Pt}$  ( $^{16}\text{O}, ^{14}\text{C}$ ), E not given; measured  $\gamma$  sum spectra,  $\gamma$ (particle)-coin.  $^{194}\text{Hg}$  deduced superdeformed band population.

**92Ch08 Limits on the Lifetime of the Shape Isomer of  $^{238}\text{U}$**

C. R. Chinn, J. -F. Berger, D. Gogny, M. S. Weiss, Phys. Rev. C45, 1700 (1992).

**Radioactivity:**  $^{238}\text{U}$ ; calculated fission isomer partial  $T_{1/2}$ . Constrained Hartree-Fock-Bogoliubov.

**92DeZZ Population of the 0. 5ns Fission Isomer and Excited States in  $^{230}\text{Pu}$  by Heavy-Ion Induced 1n-Transfer**

M. Devlin, D. Cline, K. G. Helmer, R. Ibbotson, C. Y. Wu, A. Cresswell, P. A. Butler, G. D. Jones, M. A. Stoyer, J. O. Rasmussen, Bull. Am. Phys. Soc. 37, No. 2, 870, A8 1 (1992)

**Nuclear Reactions:** +239Pu( $^{117}\text{Sn}, ^{118}\text{Sn}$ ), E=630 MeV; measured E $\gamma$ ,  $\gamma$ -multiplicity, particle spectra, (fragment)(fragment)-coin.  $^{239}\text{Pu}$  deduced levels, J,  $\pi$ .  $^{239}\text{Pu}$  deduced levels, J,  $\pi$ , fission isomer population.

**92Er01 Quasi-Stationary State Population Probability of the Actinide Nuclei Second Well**

D. O. Eremenko, S. Yu. Platonov, O. A. Yuminov, Bull. Rus. Acad. Sci. Phys. 56, 70 (1992).

**Nuclear Structure:** +239),  $^{238}$ ,  $^{236}$ ,  $^{235}\text{Np}$ ,  $^{240}$ ,  $^{238}$ ,  $^{237}\text{Pu}$ ,  $^{238}$ ,  $^{236}\text{Pa}$ ; calculated quasistationary states population probability under induced fission, second potential. Fluctuation dissipation dynamics.

**92Ma34  $\alpha$  and  $\gamma$  Spectroscopy of Spontaneous-Fission Isomers**

V. E. Makarenko, Yad. Fiz. 55, 1759 (1992); Sov. J. Nucl. Phys. 55, 973 (1992).

**Nuclear Structure:** +238)U,  $^{238}$ ,  $^{241}\text{Pu}$ ,  $^{240}$ ,  $^{241}$ ,  $^{242}$ ,  $^{242}\text{Am}$ ; compiled, reviewed fission isomer decay by  $\alpha$ -,  $\gamma$ -emission.

**92So10 Intrinsic Structures and Associated Rotational Bands in Deformed Even-Even Nuclei of the Actinide Region**

P. C. Sood, D. M. Headly, R. K. Sheline, At. Data Nucl. Data Tables 51, 273 (1992).

**Nuclear Structure:**  $\geq 88$ ;  $N \geq 134$ ;  $^{230}$ ,  $^{232}$ ,  $^{234}$ ,  $^{236}$ ,  $^{238}\text{U}$ ,  $^{220}$ ,  $^{222}$ ,  $^{224}$ ,  $^{226}$ ,  $^{228}$ ,  $^{230}$ ,  $^{232}$ ,  $^{234}\text{Th}$ ,  $^{218}$ ,  $^{220}$ ,  $^{222}$ ,  $^{224}$ ,  $^{226}$ ,  $^{228}$ ,  $^{230}\text{Ra}$ ; analyzed levels; deduced band structure, fission isomers superdeformation, hyperdeformation evidence.

**92St05 Fission and Gamma-Ray Decay of the  $^{236}\text{U}$  Shape Isomer**

M. Steinmayer, K. E. G. Lobner, L. Corradi, U. Lenz, U. Quade, P. R. Pascholati, K. Rudolph, W. Schomburg, Z. Phys. A341, 145 (1992).

**Radioactivity:**  $^{236m}\text{U}$  [from  $^{236}\text{U}$ (d,np), E=18 MeV]; measured  $\gamma$ (ce)-coin; deduced delayed fission  $T_{1/2}$ .  $^{236}\text{U}$  deduced transitions.

**93Ar03 Fission of Heavy Hypernuclei Formed in Antiproton Annihilation**

T. A. Armstrong, J. P. Bocquet, G. Ericsson, T. Johansson, T. Kro-gulski, R. A. Lewis, F. Malek, M. Maurel, E. Monnard, J. Mougey, H. Nifenecker, J. Passaneau, P. Perrin, S. M. Polikanov, M. Rey-Campagnolle, C. Ristori, G. A. Smith, G. Tibell, Phys. Rev. C47, 1957 (1993).

**Nuclear Reactions:**  $+238\text{U}(\bar{p},X)$ , E at 105 MeV/c; measured hypernuclei yield, fission (fragment)(fragment)-coin; deduced fission hypernuclei  $T_{1/2}$ .

**93Ku16 Yield of the Fissioning Isomer in the Reaction  $^{241}\text{Am}(n, n')$**

I. A. Kukushkin, V. E. Makarenko, Yu. D. Molchanov, G. A. Otroshchenko, Yad. Fiz. 56, No 9, 13 (1993); Phys. Atomic Nuclei 56, 1157 (1993).

**Nuclear Reactions:**  $+241\text{Am}(n, n')$ ,  $(n, \gamma)$ , E=4. 5 MeV; measured fission isomer yields; deduced reaction dependence.

**Radioactivity:**  $^{242m}$ ,  $^{241m}\text{Am}(\text{SF})$  [from  $^{241}\text{Am}(n, n')$ ,  $(n, \gamma)$ , E=4. 5 MeV]; measured fission fragment spectra.  $^{241}\text{Am}$  deduced isomeric state fission probability,  $T_{1/2}$ .

**93Ro07 The Study of Prompt and Delayed Muon Induced Fission III. The Ratios of Prompt to Delayed Fission Yields**

Ch. Rosel, H. Hanscheid, J. Hartfiel, R. von Mutius, J. F. M. d'Achard van Enschut, P. David, H. Janszen, T. Johansson, J. Konijn, T. Kro-gulski, C. T. A. M. de Laat, H. Paganetti, C. Petitjean, S. M. Polikanov, H. W. Reist, F. Risse, L. A. Schaller, L. Schellenberg, W. Schrieder, A. K. Sinha, A. Taal, J. P. Theobald, G. Tibell, N. Trautmann, Z. Phys. A345, 89 (1993).

**Nuclear Reactions:**  $+233$ ,  $^{234}$ ,  $^{235}$ ,  $^{236}$ ,  $^{238}\text{U}$ ,  $^{237}\text{Np}$ ,  $^{242}$ ,  $^{244}\text{Pu}(\mu, F)$ , E not given; measured prompt to delayed fission yields, absolute probabilities; deduced fission probabilities per muon capture.



LAWRENCE BERKELEY LABORATORY  
UNIVERSITY OF CALIFORNIA  
TECHNICAL INFORMATION DEPARTMENT  
BERKELEY, CALIFORNIA 94720