

Projector

CP-AW100N

User's Manual (detailed) Operating Guide

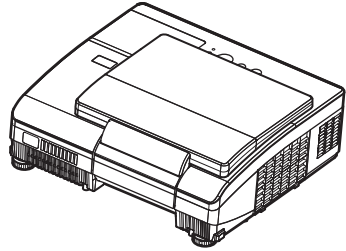

Thank you for purchasing this projector.

⚠ WARNING ▶ Before using this product, please read all manuals for this product. Be sure to read “**Safety Guide**” first. After reading them, store them in a safe place for future reference.

About this manual

Various symbols are used in this manual. The meanings of these symbols are described below.

⚠ WARNING This symbol indicates information that, if ignored, could possibly result in personal injury or even death due to incorrect handling.

⚠ CAUTION This symbol indicates information that, if ignored, could possibly result in personal injury or physical damage due to incorrect handling.

NOTICE This entry notices of fear of causing trouble.



Please refer to the pages written following this symbol.

NOTE • The information in this manual is subject to change without notice.
• The manufacturer assumes no responsibility for any errors that may appear in this manual.
• The reproduction, transfer or copy of all or any part of this document is not permitted without express written consent.

Trademark acknowledgment

- Mac® is a registered trademark of Apple Inc.
- Windows® is a registered trademark of Microsoft Corporation in the U.S. and/or other countries.
- VESA and DDC are trademarks of the Video Electronics Standard Association.
- HDMI, the HDMI logo and High-Definition Multimedia Interface are trademarks or registered trademarks of HDMI Licensing LLC.
- DVI is a trademark of Digital Display Working Group.
- Trademark PJLink is a trademark applied for trademark rights in Japan, the United States of America and other countries and areas.
- "Blu-ray Disc" is a trademark.

PJLink™

All other trademarks are the properties of their respective owners.

Projector

User's Manual - Safety Guide



Thank you for purchasing this projector.

⚠ WARNING • Before using, read these user's manuals of this projector to ensure correct usage through understanding. After reading, store them in a safe place for future reference. Incorrect handling of this product could possibly result in personal injury or physical damage. The manufacturer assumes no responsibility for any damage caused by mishandling that is beyond normal usage defined in these manuals of this projector.

- NOTE** • The information in this manual is subject to change without notice.
- The manufacturer assumes no responsibility for any errors that may appear in this manual.
 - The reproduction, transmission or use of this document or contents is not permitted without express written authority.

About The Symbols

Various symbols are used in this manual, the user's manual and on the product itself to ensure correct usage, to prevent danger to the user and others, and to prevent property damage. The meanings of these symbols are described below. It is important that you read these descriptions thoroughly and fully understand the contents.

 WARNING	This symbol indicates information that, if ignored, could possibly result in personal injury or even death due to incorrect handling.
 CAUTION	This symbol indicates information that, if ignored, could result possibly in personal injury or physical damage due to incorrect handling.

Typical Symbols



This symbol indicates an additional warning (including cautions). An illustration is provided to clarify the contents.



This symbol indicates a prohibited action. The contents will be clearly indicated in an illustration or nearby (the symbol to the left indicates that disassembly is prohibited).



This symbol indicates a compulsory action. The contents will be clearly indicated in an illustration or nearby (the symbol to the left indicates that the power plug should be disconnected from the power outlet).

Safety Precautions

WARNING

Never use the projector if a problem should occur.

Abnormal operations such as smoke, strange odor, no image, no sound, excessive sound, damaged casing or elements or cables, penetration of liquids or foreign matter, etc. can cause a fire or electrical shock.

In such case, immediately turn off the power switch and then disconnect the power plug from the power outlet. After making sure that the smoke or odor has stopped, contact your dealer. Never attempt to make repairs yourself because this could be dangerous.

- The power outlet should be close to the projector and easily accessible.

Use special caution for children and pets.

Incorrect handling could result in fire, electrical shock, injury, burn or vision problem.

Use special caution in households where children and pets are present.

Do not insert liquids or foreign object.

Penetration of liquids or foreign objects could result in fire or electrical shock.

Use special caution in households where children are present.

If liquids or foreign object should enter the projector, immediately turn off the power switch, disconnect the power plug from the power outlet and contact your dealer.

- Do not place the projector near water (ex. a bathroom, a beach, etc.).
- Do not expose the projector to rain or moisture. Do not place the projector outdoors.
- Do not place flower vases, pots, cups, cosmetics, liquids such as water, etc on or around the projector.
- Do not place metals, combustibles, etc on or around the projector.
- To avoid penetration of foreign objects, do not put the projector into a case or bag together with any thing except the accessories of the projector, signal cables and connectors.

Never disassemble and modify.

The projector contains high voltage components. Modification and/or disassembly of the projector or accessories could result in fire or electrical shock.

- Never open the cabinet.
- Ask your dealer to repair and clean insider.

Do not give the projector any shock or impact.

If the projector should be shocked and/or broken, it could result in an injury, and continued use could result in fire or electrical shock.

If the projector is shocked, immediately turn off the power switch, disconnect the power plug from the power outlet and contact your dealer.

Do not place the projector on an unstable surface.

If the projector should be dropped and/or broken, it could result in an injury, and continued use could result in fire or electrical shock.

- Do not place the projector on an unstable, slant or vibrant surface such as a wobbly or inclined stand.
- Use the caster brakes placing the projector on a stand with casters.
- Do not place the projector in the side up position, the lens up position or the lens down position.
- In the case of a ceiling installation or the like, contact your dealer before installation.



Disconnect the plug from the power outlet.



Do not disassemble.



Safety Precautions (continued)

WARNING

Be cautious of High temperatures of the projector.

High temperatures are generated when the lamp is lit. It could result in fire or burn. Use special caution in households where children are present.

Do not touch about the lens, air fans and ventilation openings during use or immediately after use, to prevent a burn. Take care of ventilation.

- Keep a space of 30 cm or more between the sides and other objects such as walls.
- Do not place the projector on a metallic table or anything weak in heat.
- Do not place anything about the lens, air fans and ventilation openings of the projector.
- Never block the air fan and ventilation openings.
- Do not cover the projector with a tablecloth, etc.
- Do not place the projector on a carpet or bedding.



Never look through the lens or openings when the lamp is on.

The powerful light could adversely affect vision.

Use special caution in households where children are present.



Use only the correct power cord and the correct power outlet.

Incorrect power supply could result in fire or electrical shock.

- Use only the correct power outlet depending on the indication on the projector and the safety standard.
- The enclosed power cord must be used depending on the power outlet to be used.



Be cautious of the power cord connection.

Incorrect connection of the power cord could result in fire or electrical shock.

- Do not touch the power cord with a wet hand.
- Check that the connecting portion of the power cord is clean (with no dust), before using. Use a soft and dry cloth to clean the power plug.
- Insert the power plug into a power outlet firmly. Avoid using a loose, unsound outlet or contact failure.



Be sure to connect with ground wire.

Connect the ground terminal of AC inlet of this unit with the ground terminal provided at the building using the correct power cord; otherwise, fire or electric shock can result.

- Don't take the core of power cord away.



Surely connect the ground wire.

Safety Precautions (continued)

WARNING

Be careful in handling the light source lamp.

The projector uses a high-pressure mercury glass lamp made of glass. The lamp can break with a loud bang, or burn out. When the bulb bursts, it is possible for shards of glass to fly into the lamp housing, and for gas containing mercury to escape from the projector's vent holes.

Please carefully read the section "Lamp".

Be careful in handling the power cord and external connection cables.

If you keep using a damaged the power cord or cables, it can cause a fire or electrical shock. Do not apply too much heat, pressure or tension to the power cord and cables.

If the power cord or cables is damaged (exposed or broken core wires, etc.), contact your dealer.

- Do not place the projector or heavy objects on the power cord and cables. Also, do not place a spread, cover, etc, over them because this could result in the inadvertent placing of heavy objects on the concealed power cord or cables.

- Do not pull the power cord and cables. When connecting and disconnecting the power cord or cables, do it with your hand holding the plug or connector.

- Do not place the cord near the heater.

- Avoid bending the power cord sharply.

- Do not attempt to work on the power cord.

Be careful in handling the battery of the remote control.

Incorrect handling of the battery could result in fire or personal injury. The battery may explode if not handled properly.

- Keep the battery away from children and pets. If swallowed consult a physician immediately for emergency treatment.

- Do not allow the battery in a fire or water.

- Avoid fire or high-temperature environment.

- Do not hold the battery with the metallic tweezers.

- Keep the battery in a dark, cool and dry place.

- Do not short circuit the battery.

- Do not recharge, disassemble or solder the battery.

- Do not give the battery a physical impact.

- Use only the battery specified in the other manual of this projector.

- Make sure the plus and minus terminals are correctly aligned when loading the battery.

- If you observe a leakage of the battery, wipe out the flower and then replace the battery. If the flower adheres your body or clothes, rinse well with water.

- Obey the local laws on disposing the battery.



Safety Precautions (continued)

CAUTION

Be careful in moving the projector.

Neglect could result in an injury or damage.

- Do not move the projector during use. Before moving, disconnect the power cord and all external connections, and close the slide lens door or attach the lens cap.
- Avoid any impact or shock to the projector.
- Do not drag the projector.
- For moving the projector, use the enclosed case or bag if provided.



Do not put anything on top of the projector.

Placing anything on the projector could result in loss of balance or falling, and cause an injury or damage. Use special caution in households where children are present.



Do not attach anything other than specified things to the projector.

Neglect could result in an injury or damage.

- Some projector has a screw thread in a lens part. Do not attach anything other than specified options (such as conversion lens) to the screw thread.



Avoid a smoky, humid or dusty place.

Placing the projector in a smoke, a highly humid, dusty place, oily soot or corrosive gas could result in fire or electrical shock.

- Do not place the projector near a smoky, humid or dusty place (ex. a smoking space, a kitchen, a beach, etc.). Do not place the projector outdoors.
- Do not use a humidifier near the projector.



Take care of the air filter to normal ventilate.

The air filter should be cleaned periodically. If the air filter becomes clogged by dust or the like, internal temperature rises and could cause malfunction. The projector may display the message such as "CHECK THE AIR FLOW" or turn off the projector, to prevent the internal heat level rising.

- When the indicators or a message prompts you to clean the air filter, clean the air filter as soon as possible.
- If the soiling will not come off the air filter, or it becomes damaged, replace the air filter.
- Use the air filter of the specified type only. Please order the air filter specified in the other manual of this projector to your dealer.
- When you replace the lamp, replace also the air filter. The air filter may be attached when you buy a replacement lamp for this projector.
- Do not turn on the projector without air filter.



Avoid a high temperature environment.

The heat could have adverse influence on the cabinet of the projector and other parts. Do not place the projector, the remote control and other parts in direct sunlight or near a hot object such as heater, etc.



Avoid Magnetism.

Manufacture strongly recommends to avoid any magnetic contact that is not shielded or protected on or near the projector itself. (ie., Magnetic Security Devices, or other projector accessory that contains magnetic material that has not been provided by the manufacture etc.) Magnetic objects may cause interruption of the projector's internal mechanical performance which may interfere with cooling fans speed or stopping, and may cause the projector to completely shut down.



Safety Precautions (continued)

CAUTION

Remove the power cord for complete separation.

- For safety purposes, disconnect the power cord if the projector is not to be used for prolonged periods of time.
- Before cleaning, turn off and unplug the projector. Neglect could result in fire or electrical shock.



Disconnect the plug from the power outlet.

Ask your dealer to cleaning inside of the projector about every year.

Accumulations of dust inside the projector cause result in fire or malfunction. Cleaning inside is more effective if performed before every humid periods such as rainy season.



- Do not clean inside yourself because it is dangerous.

NOTE

Do not give the remote control any physical impact.

A physical impact could cause damage or malfunction of the remote control.

- Take care not to drop the remote control.
- Do not place the projector or heavy objects on the remote control.

Take care of the lens.

- Close the slide lens door or attach the lens cap to prevent the lens surface being scratched when the projector is not used.
- Do not touch the lens to prevent fog or dirt of the lens that cause deterioration of display quality.
- Use commercially available lens tissue to clean the lens (used to clean cameras, eyeglasses, etc.). Be careful not to scratch the lens with hard objects.

Take care of the cabinet and the remote control.

Incorrect care could have adverse influence such as discoloration, peeling paint, etc.

- Use a soft cloth to clean the cabinet and control panel of the projector and the remote control. When excessively soiled dilute a neutral detergent in water, wet and wring out the soft cloth and afterward wipe with a dry soft cloth. Do not use undiluted detergent directly.
- Do not use an aerosol sprays, solvents, volatile substances or abrasive cleaner.
- Before using chemical wipes, be sure to read and observe the instructions.
- Do not allow long-term close contact with rubber or vinyl.

About bright spots or dark spots.

Although bright spots or dark spots may appear on the screen, this is a unique characteristic of liquid crystal displays, and such do not constitute or imply a machine defect.

Be careful of printing of the LCD panel.

If the projector continues projecting a still image, inactive images or 16:9 aspect images in case of 4:3 panel, etc., for long time, the LCD panel might possibly be printed.

Safety Precautions (continued)

NOTE

About consumables.

Lamp, LCD panels, polarizers and other optical components, and air filter and cooling fans have a different lifetime in each. These parts may need to be replaced after a long usage time.

- This product isn't designed for continuous use of long time. In the case of continuous use for 6 hours or more, or use for 6 hours or more every day (even if it isn't continuous), or repetitious use, the lifetime may be shortened, and these parts may need to be replaced even if one year has not passed since the beginning of using.
- Any inclining use beyond the adjustment range explained in these user's manuals may shorten the lifetimes of the consumables.

Before turning on the power, make the projector cool down adequately.

After turning the projector off, pushing the restart switch or interrupting of the power supply, make the projector cool down adequately. Operation in a high temperature state of the projector causes a damage of the electrode and un-lighting of the lamp.

Avoid strong rays.

Any strong ray (such as direct rays of the sun or room lighting) onto the remote control sensors could invalidate the remote control.

Avoid radio interference.

Any interfering radiation could cause disordered image or noises.

- Avoid radio generator such as a mobile telephone, transceiver, etc. around the projector.

About displaying characteristic.

The display condition of the projector (such as color, contrast, etc.) depends on characteristic of the screen, because the projector uses a liquid crystal display panel. The display condition can differ from the display of CRT.

- Do not use a polarized screen. It can cause red image.

Turn the power on/off in right order.

To prevent any trouble, turn on/off the projector in right order mentioned below unless specifying.

- Power on the projector before the computer or video tape recorder.
- Power off the projector after the computer or video tape recorder.

Take care not to fatigue your eyes.

Rest the eyes periodically.

Set the sound volume at a suitable level to avoid bothering other people.

- It is better to keep the volume level low and close the windows at night to protect the neighborhood environment.

Connecting with notebook computer

When connecting with notebook computer, set to valid the RGB external image output (setting CRT display or simultaneous display of LCD and CRT).

Please read instruction manual of the notebook for more information.

Lamp

WARNING



HIGH VOLTAGE



HIGH TEMPERATURE



HIGH PRESSURE

The projector uses a high-pressure mercury glass lamp. The lamp can **break with a loud bang, or burn out**, if jolted or scratched, handled while hot, or worn over time. Note that each lamp has a different lifetime, and some may burst or burn out soon after you start using them. In addition, when the bulb bursts, it is possible for **shards of glass** to fly into the lamp housing, and for **gas containing mercury** to escape from the projector's vent holes.

About disposal of a lamp • This product contains a mercury lamp; do not put in trash. Dispose of in accord with environmental laws.

For lamp recycling, go to www.lamprecycle.org. (in USA)

For product disposal, contact your local government agency or www.eiae.org (in the US) or www.epsc.ca (in Canada).

For more information, call your dealer.



Disconnect
the plug from
the power
outlet

- If the lamp should break (it will make a loud bang when it does), unplug the power cord from the outlet, and make sure to request a replacement lamp from your local dealer. Note that shards of glass could damage the projector's internals, or cause injury during handling, so please do not try to clean the projector or replace the lamp yourself.
- If the lamp should break (it will make a loud bang when it does), ventilate the room well, and make sure not to breathe the gas that comes out of the projector vents, or get it in your eyes or mouth.
- Before replacing the lamp, make sure the power switch is off and the power cable is not plugged in, then wait at least 45 minutes for the lamp to cool sufficiently. Handling the lamp while hot can cause burns, as well as damaging the lamp.



- Do not open the lamp cover while the projector is suspended from above. This is dangerous, since if the lamp's bulb has broken, the shards will fall out when the cover is opened. In addition, working in high places is dangerous, so ask your local dealer to have the lamp replaced even if the bulb is not broken.
- Do not use the projector with the lamp cover removed. At the lamp replacing, make sure that the screws are screwed in firmly. Loose screws could result in damage or injury.



- Use the lamp of the specified type only.
- If the lamp breaks soon after the first time it is used, it is possible that there are electrical problems elsewhere besides the lamp. If this happens, contact your local dealer or a service representative.
- Handle with care: jolting or scratching could cause the lamp bulb to burst during use.
- Using the lamp for long periods of time, could cause it dark, not to light up or to burst. When the pictures appear dark, or when the color tone is poor, please replace the lamp as soon as possible. Do not use old (used) lamps; this is a cause of breakage.

Regulatory Notices

FCC Statement Warning

This device complies with part 15 of the FCC Rules. Operation is subject to the following two conditions: (1) This device may not cause harmful interference, and (2) this device must accept any interference received, including interference that may cause undesired operation.

WARNING: This equipment has been tested and found to comply with the limits for a Class B digital device, pursuant to Part 15 of the FCC Rules. These limits are designed to provide reasonable protection against harmful interference in a residential installation. This equipment generates, uses, and can radiate radio frequency energy and, if not installed and used in accordance with the instructions, may cause harmful interference to radio communications. However, there is no guarantee that interference will not occur in a particular installation. If this equipment does cause harmful interference to radio or television reception, which can be determined by turning the equipment off and on, the user is encouraged to try to correct the interference by one or more of the following measures:

- Reorient or relocate the receiving antenna.
- Increase the separation between the equipment and receiver.
- Connect the equipment into an outlet on a circuit different from that to which the receiver is connected.
- Consult the dealer or an experienced radio/TV technician for help.

INSTRUCTIONS TO USERS: This equipment complies with the requirements of FCC (Federal Communication Commission) equipment provided that the following conditions are met. Some cables have to be used with the core set. Use the accessory cable or a designated-type cable for the connection. For cables that have a core only at one end, connect the core to the projector.

CAUTION: Changes or modifications not expressly approved by the party responsible for compliance could void the user's authority to operate the equipment.

For the Customers in CANADA

NOTICE: This Class B digital apparatus complies with Canadian ICES-003.

Warranty And After-Service

Unless seen any abnormal operations (mentioned with the first paragraph of WARNING in this manual), when a problem occurs with the equipment, first refer to the "Troubleshooting" section of the "Operating Guide", and run through the suggested checks. If this does not resolve the problem contact your dealer or service company. They will tell you what warranty condition is applied.



About this manual	1	MY MEMORY	
Contents	2	IMAGE menu	34
Projector features	3	ASPECT, OVER SCAN, V POSITION, H POSITION, H PHASE, H SIZE, AUTO ADJUST EXECUTE	
Preparations	3	INPUT menu	36
Checking the contents of package	3	PROGRESSIVE, VIDEO NR, COLOR SPACE, VIDEO FORMAT, HDMI FORMAT, HDMI RANGE, COMPUTER IN, FRAME LOCK, RESOLUTION	
Part names	4	SETUP menu	40
Projector	4	D-ZOOM, D-SHIFT V, D-SHIFT H, PICT. POSIT. H, KEYSTONE, ECO MODE, MIRROR, STANDBY MODE, MONITOR OUT	
Control panel	5	AUDIO menu	42
Rear panel	5	VOLUME, SPEAKER, AUDIO SOURCE, HDMI AUDIO	
Remote control	6	SCREEN menu	43
Setting up	7	LANGUAGE, MENU POSITION, BLANK, START UP, MyScreen, MyScreen Lock, MESSAGE, SOURCE NAME, TEMPLATE, C.C.	
Arrangement	7	OPTION menu	49
Connecting your devices	9	AUTO SEARCH, DIRECT POWER ON, AUTO POWER OFF, LAMP TIME, FILTER TIME, MY BUTTON, MY SOURCE, SERVICE	
Using the security bar and slot	13	NETWORK menu	58
Using the cable cover	14	SETUP, PROJECTOR NAME, MY IMAGE, AMX D.D., INFORMATION, SERVICE	
Remote control	15	SECURITY menu	63
Installing the batteries	15	SECURITY PASSWORD CHANGE, MyScreen PASSWORD, PIN LOCK, TRANSITION DETECTOR, MY TEXT PASSWORD, MY TEXT DISPLAY, MY TEXT WRITING	
Changing the frequency of remote control signal	16	Maintenance	69
Starting the projector	17	Replacing the lamp	69
Connecting power supply	18	Cleaning and replacing the air filter	72
Turning on the power	18	Replacing the internal clock battery	73
Turning off the power	19	Caring for the mirror and lens	74
Operating	20	Other care	75
Adjusting the volume	20	Troubleshooting	76
Temporarily muting the sound	20	Related messages	77
Selecting an input signal	20	Regarding the indicator lamps	78
Searching an input signal	22	Shutting the projector down	80
Selecting an aspect ratio	22	Resetting all settings	80
Adjusting the projector's elevator	23	Phenomena that may be easy to be mistaken for machine defects	81
Adjusting the focus	23	Specifications	86
Using the automatic adjustment feature	24		
Adjusting the position	24		
Correcting the keystone distortions	25		
Using the magnify feature	25		
Temporarily freezing the screen	26		
Temporarily blanking the screen	26		
Using the menu function	27		
EASY MENU	29		
ASPECT, D-ZOOM, KEYSTONE, PICTURE MODE, ECO MODE, MIRROR, RESET, FILTER TIME, LANGUAGE, ADVANCED MENU, EXIT			
PICTURE menu	31		
BRIGHTNESS, CONTRAST, GAMMA, COLOR TEMP, COLOR, TINT, SHARPNESS,			

Projector features

The projector provides you with the broad use by the following features.

- ✓ The unique lens and mirror system realizes ultra short distance projection, which gives you more various way of use.
- ✓ The motorized lens door offers you very simple use of the projector.
- ✓ The double layer filter system is expected to function longer and offers you less maintenance frequency.
- ✓ The HDMI port can support various image equipment which have digital interface to get clearer pictures on a screen.
- ✓ This projector can be controlled and monitored via LAN connection.
- ✓ This projector's network supports the PJLink™ standard.
- ✓ PJLink™ is a unified standard for operating and controlling data projectors. PJLink™ enables central control of projectors manufactured by different vendors and projectors can be operated by a controller. PJLink™ compliant equipment can be managed and controlled at any time and in any place, regardless of manufacturer.

For the command of PJLink™, see "Technical".

For specifications of PJLink™, see the web site of the Japan Business Machine and Information System Industries Association.

URL: <http://pjlink.jbmia.or.jp>

Preparations

Checking the contents of package

Your projector should come with the items shown below. Check that all the items are included. Require of your dealer immediately if any items are missing.

- (1) Remote control with two AA batteries
- (2) Power cord
- (3) Computer cable
- (4) Cable cover
- (5) User's manuals (Book x1, CD x1)
- (6) Security label

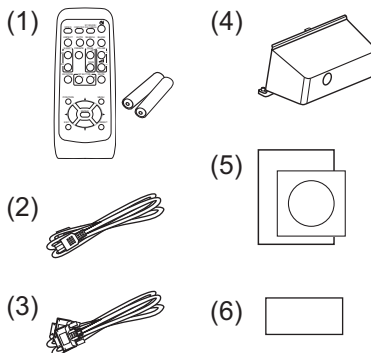

NOTE • Keep the original packing materials, for future reshipment. Be sure to use the original packing materials when moving the projector. Use special caution for the lens.

Part names

Projector

- (1) Lamp cover (📖69)
The lamp unit is inside.
- (2) Focus ring (📖23)
- (3) Control panel (📖5)
- (4) Elevator buttons (x 2) (📖17)
- (5) Elevator feet (x 2) (📖17)
- (6) Remote sensors (📖15)
- (7) Lens (📖74)
- (8) Intake vents
- (9) Filter cover (📖72)
The air filter and intake vent are inside.
- (10) Speaker (📖42)
- (11) Exhaust vent
- (12) **AC IN** (AC inlet) (📖18)
- (13) Rear panel (📖5)
- (14) Security bar (📖13)
- (15) Security slot (📖13)
- (16) Lens door (📖74)
- (17) Battery cover (📖73)
- (18) Mirror (📖74)

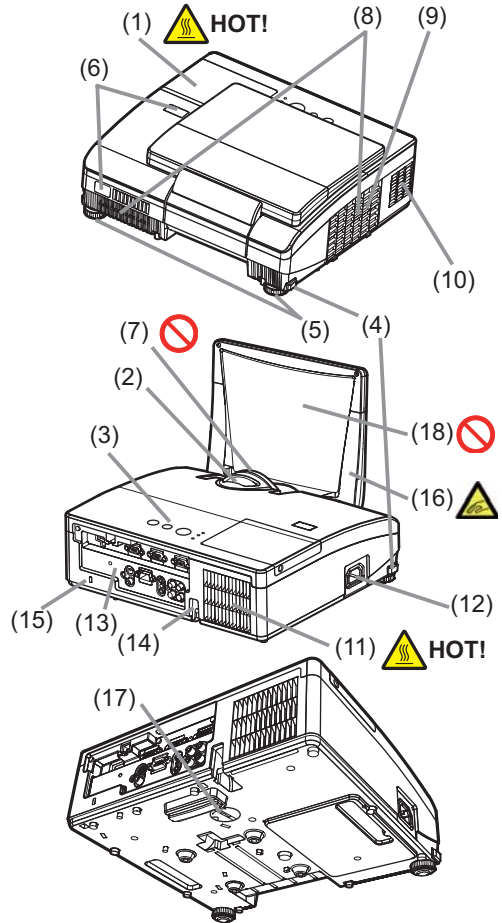

⚠ WARNING ▶HOT! : Do not touch around the lamp cover and the exhaust vent during use or just after use, since it is too hot.

- ▶ Be careful not to pinch your finger with the lens door, to prevent an injury.
- ▶ Never look into the projection lens or mirror while the projection lamp lights, since the projection lamp ray may cause a trouble on your eyes.
- ▶ Do not handle the elevator buttons without holding the projector, since the projector may drop down.

⚠ CAUTION ▶ Maintain normal ventilation to prevent the projector from heating up. Do not cover, block or plug up the vents. Do not place anything that can stick or be sucked to the vents, around the intake vents. Clean the air filter periodically.

- ▶ Do not use the security bar and slot to prevent the projector from falling down, since it is not designed for it.

Control panel

- (1) **STANDBY/ON** button (📖18)
- (2) **INPUT** button (📖20, 27)
- (3) **MENU** button (📖27)
It consists of four cursor buttons.
- (4) **POWER** indicator (📖18, 78)
- (5) **TEMP** indicator (📖78)
- (6) **LAMP** indicator (📖78)

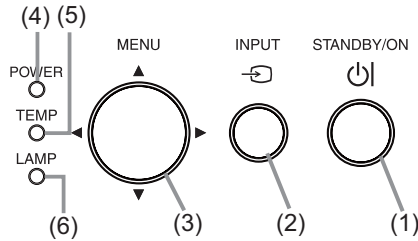

Rear panel (📖9)

- (1) **AUDIO IN1** port
- (2) **AUDIO IN2** port
- (3) **COMPUTER IN1** port
- (4) **COMPUTER IN2** port
- (5) **MONITOR OUT** port
- (6) Shutdown switch (📖80)
- (7) **CONTROL** port
- (8) **VIDEO** port
- (9) **S-VIDEO** port
- (10) **AUDIO IN3 (R, L)** ports
- (11) **AUDIO OUT (R, L)** ports
- (12) **HDMI** port
- (13) **LAN** port

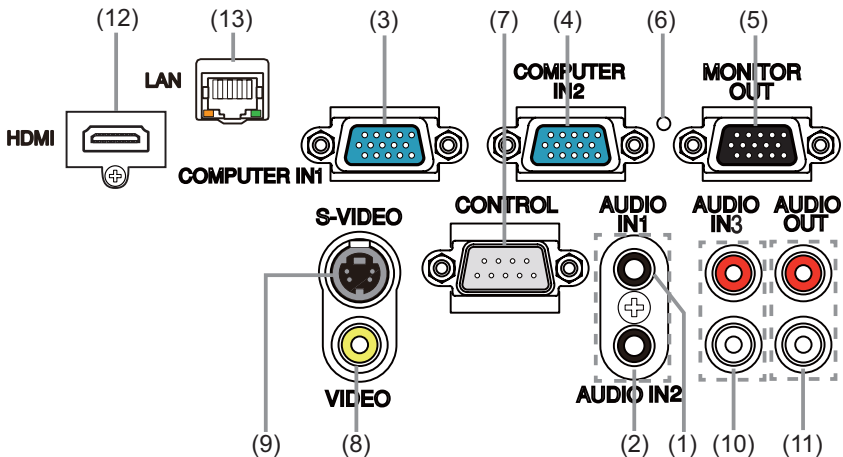

⚠ CAUTION ► Use the shutdown switch only when the projector is not turned off by normal procedure, since pushing this switch stops operation of the projector without cooling it down.

Remote control

- (1) **VIDEO** button (📖21)
- (2) **COMPUTER** button (📖21)
- (3) **SEARCH** button (📖22)
- (4) **STANDBY/ON** button (📖19)
- (5) **ASPECT** button (📖22)
- (6) **AUTO** button (📖24)
- (7) **BLANK** button (📖26)
- (8) **MAGNIFY - ON** button (📖25)
- (9) **MAGNIFY - OFF** button (📖16, 25)
- (10) **MY SOURCE/DOC.CAMERA** button (📖21, 51)
- (11) **VOLUME -** button (📖16, 20)
- (12) **PAGE UP** button *
- (13) **PAGE DOWN** button *
- (14) **VOLUME +** button (📖20)
- (15) **MUTE** button (📖20)
- (16) **FREEZE** button (📖26)
- (17) **MY BUTTON - 1** button (📖51)
- (18) **MY BUTTON - 2** button (📖51)
- (19) **KEYSTONE** button (📖25)
- (20) **POSITION** button (📖24, 28)
- (21) **MENU** button (📖27)
- (22) **▲/▼/◀/▶** cursor buttons (📖27)
- (23) **ENTER** button (📖27)
- (24) **ESC** button (📖16, 27)
- (25) **RESET** button (📖16, 27)
- (26) Battery cover (📖15)

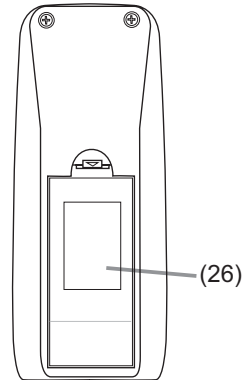
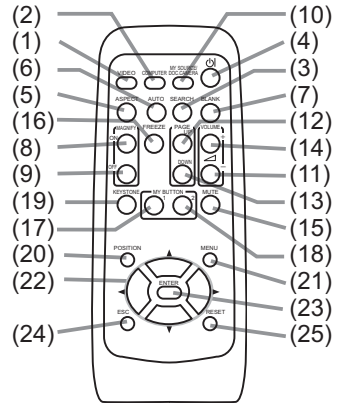

Back of
the remote control

NOTE • Any button marked with “*” is not supported on this projector (📖77).

Setting up

Install the projector according to the environment and manner the projector will be used in.

Arrangement

Refer to the illustrations and tables below to determine screen size and projection distance.

The values shown in the table are calculated for a full size screen: 1280 x 800

- (a) Screen size (diagonal) (b) Projection distance ($\pm 8\%$)
 (c1), (c2) Screen height

- On a horizontal surface

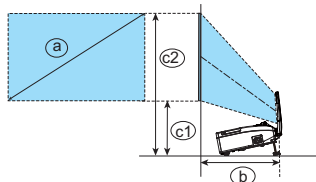

- Suspended from the ceiling

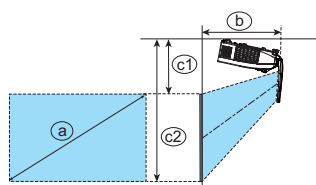

(a) Screen size (diagonal)		(b) Projection distance		(c1) Screen height		(c2) Screen height	
type(inch)	m	m	inch	m	inch	m	inch
60	1.5	0.592	23	0.316	12	1.124	44
70	1.8	0.705	28	0.349	14	1.292	51
80	2.0	0.819	32	0.383	15	1.460	57
90	2.3	0.933	37	0.416	16	1.627	64
100	2.5	1.046	41	0.449	18	1.795	71

- Keep a space of 30 cm or more between the sides of the projector and other objects such as walls. Do not place or attach anything that would block the lens or vent holes.
- For the case of installation in a special state such as ceiling mount, the specified mounting accessories ([86](#)) and service may be required. Before installing the projector, consult your dealer about your installation.
- The screen position may shift after installation if the projector is suspended from the ceiling or other location due to the flexibility of the plastic projector body. If readjustment is necessary, consult with your dealer or service personnel.
- The projected image position and/or focus may change during warm-up (approx. 30 minutes after the lamp is turned on) or when the ambient conditions change. Readjust the image position and/or focus as necessary.
- Since the projector features an ultra short throw, be aware that it is required to select a screen carefully to have better performance.
 - A soft screen such as a pull-down screen may cause serious distortion of a projected image. A hard screen such as a board screen is recommended for use with this projector.
 - A high-gain screen such as a bead screen that has narrow viewing angle is not suitable for this projector. A low-gain screen (around 1.0) such as a matte screen that has wide viewing angle is recommended for use with this projector.
 - A screen with a weave pattern may cause moiré on the projected image, which is not a failure of the projector. A screen that has less moiré effects is recommended for use with this projector.

Arrangement (continued)

- ⚠ WARNING** ▶ Place the projector in a stable horizontal position. If the projector falls or is knocked over, it could cause injury and/or damage to the projector. Using a damaged projector could then result in fire and/or electric shock.
- Do not place the projector on an unstable, slanted or vibrational surface such as a wobbly or inclined stand.
 - Do not place the projector on its side, front or rear position.
 - Consult with your dealer before a special installation such as suspending from a ceiling or somewhere else.
- ▶ Place the projector in a cool place, and ensure that there is sufficient ventilation. The high temperature of the projector could cause fire, burns and/or malfunction of the projector.
- Do not place or attach anything that would block the lens or vent holes.
 - Keep a space of 30 cm or more between the sides of the projector and other objects such as walls.
 - Do not place the projector on metallic thing or anything weak in heat.
 - Do not place the projector on carpet, cushions or bedding.
 - Do not place the projector in direct sunlight or near hot objects such as heaters. Do not place the projector where the air from an air conditioner or similar unit will blow on it directly.
 - Do not place anything near the projector lens or vents, or on top of the projector.
 - Do not place anything that may be sucked into or stick to the vents on the bottom of the projector. This projector has some intake vents also on the bottom.
- ▶ Do not place the projector anyplace where it may get wet. Getting the projector wet or inserting liquid into the projector could cause fire, electric shock and/or malfunction of the projector.
- Do not place the projector in a bathroom or the outdoors.
 - Do not place anything containing liquid near the projector.
- ▶ Use only the mounting accessories the manufacturer specified, and leave installing and removing the projector with the mounting accessories to the service personnel.
- Read and keep the user's manual of the mounting accessories used.
- ⚠ CAUTION** ▶ Avoid placing the projector in smoky, humid or dusty place. Placing the projector in such places could cause fire, electric shock and/or malfunction of the projector.
- Do not place the projector near humidifiers, smoking spaces or a kitchen.
- ▶ Position the projector to prevent light from directly hitting the projector's remote sensor.
- ▶ Do not place the product in a place where radio interference may be caused.
- ▶ Do not place this product in a magnetic field.

NOTE • The projector may make a rattling sound when tilted, moved or shaken, since a flap to control the air flow inside of the projector has moved. Be aware that this is not a failure or malfunction.

Connecting your devices

Be sure to read the manuals for devices before connecting them to the projector. Make sure that all the devices are suitable to be connected with this product, and prepare the cables required to connect. Please refer to the following illustrations to connect them.

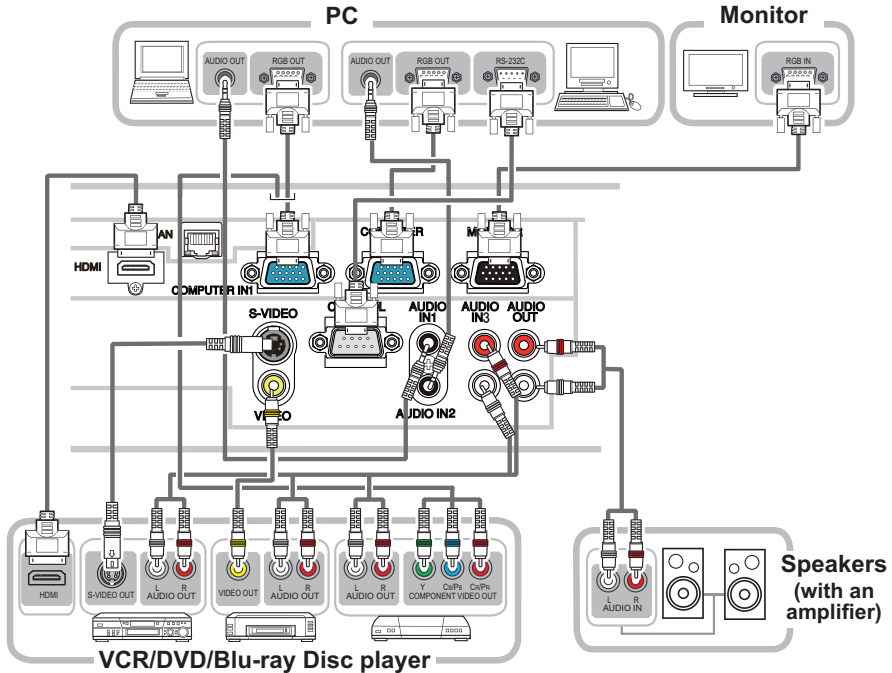

Connecting your devices (continued)

To use network functions of the projector, connect the LAN port to the computer's LAN port.

To use NETWORK BRIDGE function, also connect the CONTROL port and an RS-232C port of the external device to communicate as a network terminal. See the User's Manual - Network Guide for details of network functions.

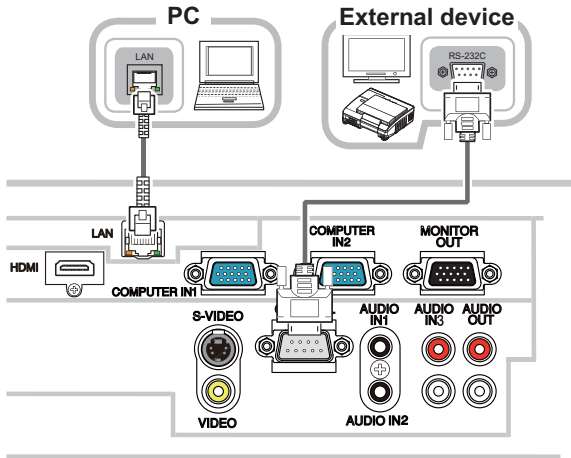

⚠ WARNING ▶ Do not disassemble or modify the projector and accessories.

▶ Be careful not to damage the cables, and do not use damaged cables.

⚠ CAUTION ▶ Turn off all devices and unplug their power cords prior to connecting them to projector. Connecting a live device to the projector may generate extremely loud noises or other abnormalities that may result in malfunction or damage to the device and the projector.

▶ Use appropriate accessory or designated cables. Ask your dealer about non-accessory cables which may be required a specific length or a ferrite core by the regulations. For cables with a core only at one end, connect the end with the core to the projector.

▶ Make sure that devices are connected to the correct ports. An incorrect connection may result in malfunction or damage to the device and the projector.

▶ Be sure to consult the administrator of the network. Do not connect LAN port to any network that might have the excessive voltage.

NOTICE ▶ Use the cables with straight plugs, not L-shaped ones, as the input ports of the projector are recessed.

NOTE • The **COMPUTER IN1/2** port can support a component signal also. The specific adapter or the specific cable is required for a component video input to the projector.

Connecting your devices (continued)

- NOTE** • Be sure to read the manuals for devices before connecting them to the projector, and make sure that all the devices are suitable to be connected with this product. Before connecting to a PC, check the signal level, the signal timing, and the resolution.
- Some signal may need an adapter to input this projector.
 - Some PCs have multiple screen display modes that may include some signals which are not supported by this projector.
 - Although the projector can display signals with resolution up to UXGA (1600X1200), the signal will be converted to the projector's panel resolution before being displayed. The best display performance will be achieved if the resolutions of the input signal and the projector panel are identical.
 - While connecting, make sure that the shape of the cable's connector fits the port to connect with. And be sure to tighten the screws on connectors with screws.
 - When connecting a laptop PC to the projector, be sure to activate the PC's external RGB output. (Set the laptop PC to CRT display or to simultaneous LCD and CRT display.) For details on how this is done, please refer to the instruction manual of the corresponding laptop PC.
 - When the picture resolution is changed on a PC depending on an input, automatic adjustment function may take some time and may not be completed. In this case, you may not be able to see a check box to select "Yes/No" for the new resolution on Windows. Then the resolution will go back to the original. It might be recommended to use other CRT or LCD monitors to change the resolution.
 - In some cases, this projector may not display a proper picture or display any picture on screen. For example, automatic adjustment may not function correctly with some input signals. An input signal of composite sync or sync on G may confuse this projector, so the projector may not display a proper picture.
 - The **HDMI** port of this model is compatible with HDCP (High-bandwidth Digital Content Protection) and therefore capable of displaying a video signal from HDCP compatible DVD players or the like.

Connecting your devices (continued)

About Plug-and-Play capability

Plug-and-Play is a system composed of a PC, its operating system and peripheral equipment (i.e. display devices). This projector is VESA DDC 2B compatible. Plug-and-Play can be used by connecting this projector to a PC that is VESA DDC (display data channel) compatible.

- Take advantage of this feature by connecting a computer cable to the **COMPUTER IN1** port (DDC 2B compatible). Plug-and-Play may not work properly if any other type of connection is attempted.
- Please use the standard drivers in your PC as this projector is a Plug-and-Play monitor.

NOTE for HDMI

- The **HDMI** supports the following signals.
 - Video signal : 480i@60,480p@60,576i@50,576p@50,720p@50/60,1080i@50/60,1080p@50/60
 - PC signals : See **User's Manual(detailed) - Technical**
- This projector can be connected with another equipment that has HDMI connector, but with some equipment the projector may not work properly, something like no video.
- Be sure to use an HDMI cable that has the HDMI logo.
- When the projector is connected with a device having DVI connector, use a DVI to HDMI cable to connect with the **HDMI** input.

Using the security bar and slot

A commercial anti-theft chain or wire up to 10 mm in diameter can be attached to the security bar on the projector.

Also this product has the security slot for the Kensington lock.

For details, see the manual of the security tool.

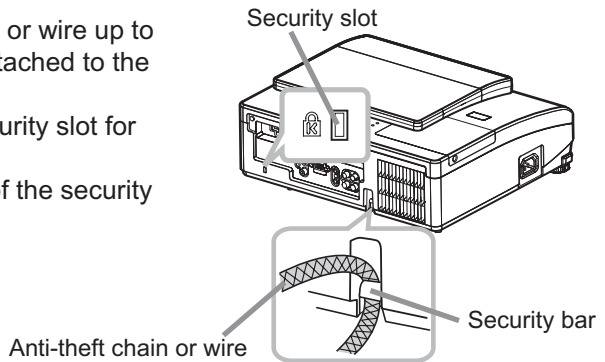

⚠ WARNING ▶ Do not use the security bar and slot to prevent the projector from falling down, since it is not designed for it.

⚠ CAUTION ▶ Do not place anti-theft chain or wire near the exhaust vent. It may become too hot.

NOTE • The security bar and slot is not comprehensive theft prevention measures. It is intended to be used as supplemental theft prevention measure.

Using the cable cover

Utilize the cable cover as the guard and blind for the connecting parts.

1. Connect the signal cables to the projector first.
2. Insert the two knobs on the cable cover into the two holes on the bottom of the projector as shown in the figure. Pass the cables through the holes on the bottom of the cable cover. Place the cable cover on the back of the projector by rotating the cover in the direction of the arrow.

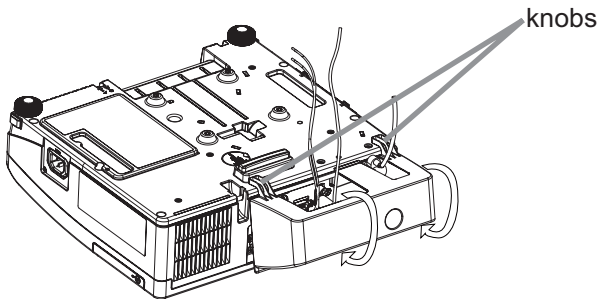

3. Tighten the screw to fix the cable cover.

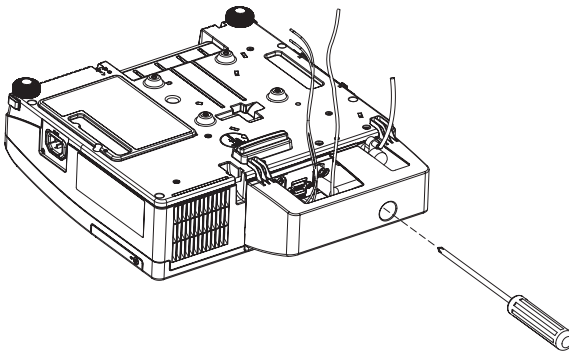

- ⚠ CAUTION** ▶ Be careful not to pinch the cables in the cable cover, to prevent damage to the cables.
- ▶ Install the cable cover firmly. The cable cover will drop if the screw is loosened, and it may cause injury.
- ▶ Use the cable cover that is supplied with the projector. Do not attempt any modifications to the cable cover.

Remote control

Installing the batteries

Please insert the batteries into the remote control before using it. If the remote control starts to malfunction, try to replace the batteries. If you will not use the remote control for long period, remove the batteries from the remote control and store them in a safe place.

1. Holding the hook part of the battery cover, remove it.
2. Align and insert the two AA batteries (HITACHI MAXELL, Part No.LR6 or R6P) according to their plus and minus terminals as indicated in the remote control.
3. Replace the battery cover in the direction of the arrow and snap it back into place.

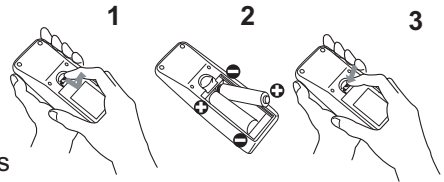
**NOTE**

- Try changing the batteries when the remote control malfunctions.
- This remote control works with the remote sensors on the projector using infrared light (Class 1 LED). The active sensor senses the remote control signal assigned within 60 degrees to right and left, and within 3 meters.
- Prevent the remote sensors from being hit by a strong ray. It may cause malfunction of the projector and remote control.

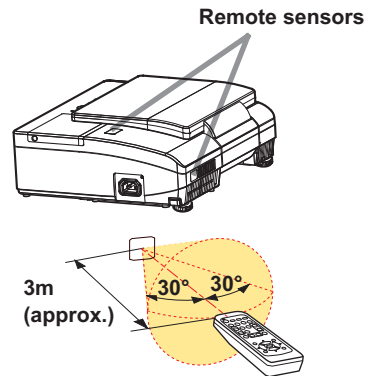

- ⚠WARNING** ▶ Always handle the batteries with care and use them only as directed. Improper use may result in battery explosion, cracking or leakage, which could result in fire, injury and/or pollution of the surrounding environment.
- Be sure to use only the batteries specified. Do not use batteries of different types at the same time. Do not mix a new battery with used one.
 - Make sure the plus and minus terminals are correctly aligned when loading a battery.
 - Keep a battery away from children and pets.
 - Do not recharge, short circuit, solder or disassemble a battery.
 - Do not place a battery in a fire or water. Keep batteries in a dark, cool and dry place.
 - If you observe battery leakage, wipe out the leakage and then replace a battery. If the leakage adheres to your body or clothes, rinse well with water immediately.
 - Obey the local laws on disposing the battery.

Changing the frequency of remote control signal

The accessory remote control has the two choices on signal frequency, Mode 1:NORMAL and Mode 2:HIGH. If the remote control does not function properly, attempt to change the signal frequency.

In order to set the Mode, please keep pressing the combination of the two buttons listed below simultaneously for about 3 seconds.

- (1) Set to Mode 1:NORMAL... the **VOLUME -** and the **RESET** buttons
- (2) Set to Mode 2:HIGH... the **MAGNIFY OFF** and the **ESC** buttons

Please remember that the REMOTE FREQ. in the SERVICE item of the OPTION menu (📖53) of the projector to be controlled should be set to the same mode as the remote control.

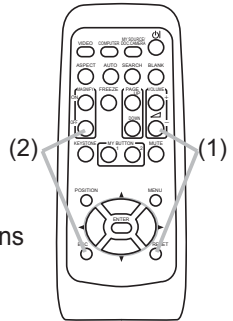

Starting the projector

For this projector, follow the procedure below.

This projector needs to be tilted slightly as shown in the figure to project the image properly. Follow the procedure below for set up.

- (1) Hold both sides of the projector, and tilt the projector.
- (2) Push the elevator buttons to release the elevator feet while you hold the projector tilted.
- (3) Release the elevator button to lock the elevator feet and put the projector down gently.

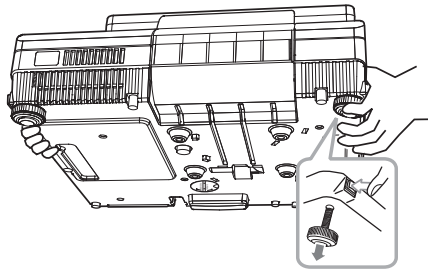

⚠ CAUTION ► Do not handle the elevator buttons without holding the projector, since the projector may drop down.

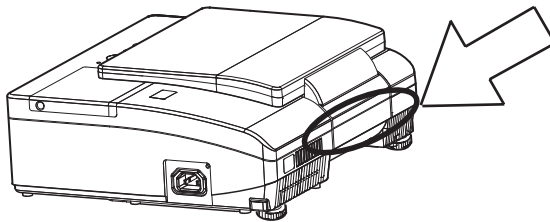

⚠ WARNING ► The mirror of this machine is made of glass. It can be damaged by excessive force or an impact. Safety film is attached to the back surface of the mirror. However, small pieces of broken glass could fall from the surface of the mirror and scatter. Read the following important warnings carefully, and follow them for your own safety.

- Do not apply excessive force on or allow impact to the lens door, as it incorporates a mirror.
- Keep the projector out of the reach of children.
- Do not stand under a ceiling mounted projector when its lens door is opening or closing. Moreover, do not look at the mirror when the lens door is opening or closing.
- If the mirror is broken, the projected image will be distorted. Never touch a broken mirror. Close the lens door, and contact your dealer.

► Do not handle the portion on the projector shown by the arrow in the figure above when you carry the projector. It could cause malfunction or injury.

► When the lens door is opening or closing, keep your fingers away from the portion shown by the arrow in the figure above to avoid pinching your fingers.

Connecting power supply

1. Put the connector of the power cord into the **AC IN** (AC inlet) of the projector.
2. Firmly plug the power cord's plug into the outlet. In a couple of seconds after the power supply connection, the **POWER** indicator will light up in steady orange.

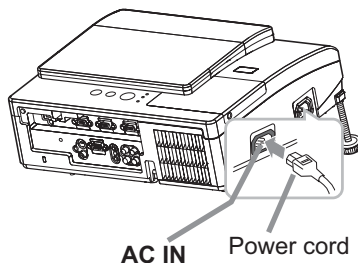

Please remember that when the DIRECT POWER ON function activated, the connection of the power supply make the projector turn on.

⚠WARNING ► Please use extra caution when connecting the power cord, as incorrect or faulty connections may result in fire and/or electrical shock.

- Only use the power cord that came with the projector. If it is damaged, consult your dealer to get a new one.
- Only plug the power cord into an outlet whose voltage is matched to the power cord. The power outlet should be close to the projector and easily accessible. Remove the power cord for complete separation.
- Never modify the power cord.

Turning on the power

1. Make sure that the power cord is firmly and correctly connected to the projector and the outlet.
2. Make sure that the **POWER** indicator is steady orange.
3. Confirm that there is nothing that the lens door hits while opening. Press the **STANDBY/ON** button on the projector or the remote control. The lens door opens, the projection lamp lights up, and the **POWER** indicator begins to blink green. When the power is completely on, the indicator will stop blinking and light in steady green.

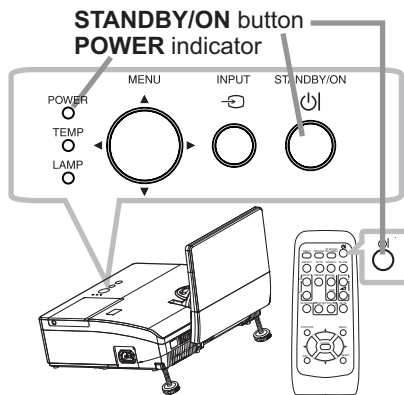

⚠WARNING ► Never look into the projection lens or mirror while the projection lamp lights, since the projection lamp ray may cause a trouble on your eyes.

- Be careful not to pinch your finger with the lens door, to prevent an injury.
- Do not place the projector vertically with the lens door open as shown in the figure on the right. It could cause malfunction or injury.



Turning off the power

1. Press the **STANDBY/ON** button on the projector or the remote control.
The message “Power off?” will appear on the screen for about 5 seconds.
2. Confirm that there is nothing that the lens door hits while closing. Press the **STANDBY/ON** button again while the message appears.
The projector lamp will go off, and the **POWER** indicator will begin blinking in orange. Then the **POWER** indicator will stop blinking and light in steady orange when the lamp cooling is complete.

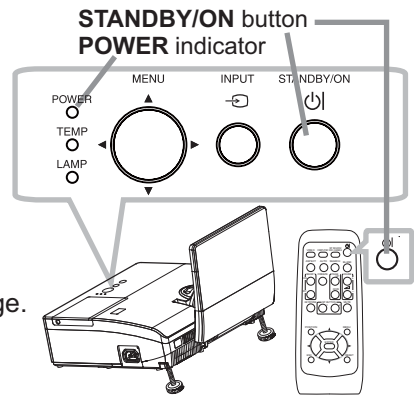

Do not turn the projector on for about 10 minutes or more after turning it off. Turning the projector on again too soon could shorten the lifetime of some consumable parts of the projector.

- ⚠ WARNING** ▶ Be careful not to pinch your finger with the lens door, to prevent an injury.
- ▶ Do not touch around the lamp cover and the exhaust vents during use or just after use, since it is too hot.
 - ▶ Remove the power cord for complete separation. The power outlet should be close to the projector and easily accessible.

- NOTE** • Turn the power on/off in right order. Please power on the projector prior to the connected devices.
- This projector has the function that can make the projector automatically turn on/off. Please refer to the **DIRECT POWER ON (P.49)** and the **AUTO POWER OFF (P.50)** items of the **OPTION** menu.
 - Use the shutdown switch (**P.80**) only when the projector is not turned off by normal procedure.

Operating

Adjusting the volume

VOLUME +/- buttons

- Use the **VOLUME +/-** buttons to adjust the volume.
 - A dialog will appear on the screen to aid you in adjusting the volume. If you do not do anything, the dialog will automatically disappear after a few seconds.
 - When \times is selected for current picture input port, the volume adjustment is disabled. Please see the **AUDIO SOURCE** item of the **AUDIO** menu (42).
 - When the projector is in the standby state, the volume can be adjusted if \times is not selected for the **AUDIO OUT STANDBY** and the **NORMAL** is selected to the **STANDBY MODE** in the **SETUP** menu (41).

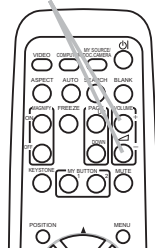

Temporarily muting the sound

- Press the **MUTE** button on the remote control.
 - A dialog will appear on the screen indicating that you have muted the sound. To restore the sound, press the **MUTE**, **VOLUME +** or **VOLUME -** button. Even if you do not do anything, the dialog will automatically disappear after a few seconds.
 - When \times is selected for current picture input port, the sound is always muted. Please see the **AUDIO SOURCE** item of the **AUDIO** menu (42).
 - The C.C. (Closed Caption) is automatically activated when sound is muted and an input signal containing C.C. is received. This function is available only when the signal is NTSC for the **VIDEO** or **S-VIDEO**, or 480i@60 for the **COMPUTER IN1** or **COMPUTER IN2**, and when the **AUTO** is selected for the **DISPLAY** in the C.C. menu under the **SCREEN** menu (48).

MUTE button

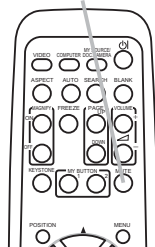

Selecting an input signal

- Press the **INPUT** button on the projector.
 - Each time you press the button, the projector switches its input port from the current port as below.

```

                    ┌───> COMPUTER IN1 ──> COMPUTER IN2 ──┐
                    │                               │
                    └── VIDEO ← S-VIDEO ← HDMI ←──┘
                    
```
 - While the **ON** is selected for the **AUTO SEARCH** item in the **OPTION** menu (49), the projector will keep checking the ports in above order repeatedly till an input signal is detected.

INPUT button

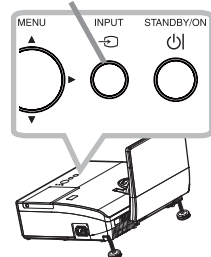

(continued on next page)

Selecting an input signal (continued)

1. Press the **COMPUTER** button on the remote control.
 - Each time you press the button, the projector switches its input port from the current port as below.



- While the ON is selected for the AUTO SEARCH item in the OPTION menu, the projector will keep checking every port sequentially till an input signal is detected (49). If the **COMPUTER** button is pressed when the **VIDEO** or **S-VIDEO** port is selected, the projector will check the **COMPUTER IN1** port first.

COMPUTER button

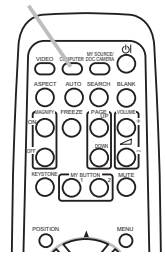

1. Press the **VIDEO** button on the remote control.
 - Each time you press the button, the projector switches its input port from the current port as below.



- While ON is selected for AUTO SEARCH item in OPTION menu, the projector will keep checking every port sequentially till an input signal is detected (49). If the **VIDEO** button is pressed when the **COMPUTER IN1** or the **COMPUTER IN2** port is selected, the projector will check the **S-VIDEO** port first.

VIDEO button

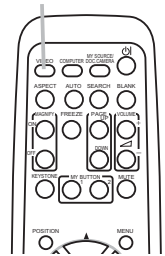

1. Press the **MY SOURCE / DOC. CAMERA** button on the remote control. The input signal will be changed into the signal you set as the MY SOURCE (51).

- This function also can use for document camera. Select the input port that connected the document camera.

MY SOURCE / DOC. CAMERA button

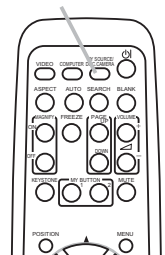

Searching an input signal

SEARCH button

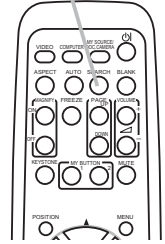

- Press the **SEARCH** button on the remote control.
 - The projector will start to check its input ports as below in order to find any input signals. When an input is found, the projector will stop searching and display the image. If no signal is found, the projector will return to the state selected before the operation.



- While the ON is selected for the AUTO SEARCH item in the OPTION menu (49), the projector will keep checking the ports in above order repeatedly till an input signal is detected.

Selecting an aspect ratio

ASPECT button

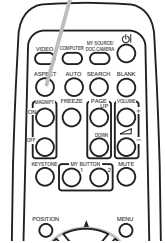

- Press the **ASPECT** button on the remote control.
 - Each time you press the button, the projector switches the mode for aspect ratio in turn.

○ For a computer signal

NORMAL → 4:3 → 16:9 → 16:10 → NATIVE

○ For an HDMI signal

NORMAL → 4:3 → 16:9 → 16:10 → 14:9 → NATIVE

○ For a video signal, s-video signal or component video signal

4:3 → 16:9 → 16:10 → 14:9 → NATIVE

○ For no signal

16:10 (fixed)

- The **ASPECT** button does not work when no proper signal is inputted.
- The NORMAL mode keeps the original aspect ratio setting.
- The on-screen menu might be displayed outside of the image display area depending on the adjustment value of the ASPECT, D-ZOOM and KEYSTONE. Changing the values of ASPECT, D-ZOOM and KEYSTONE may fix the symptom.

Adjusting the projector's elevator

If necessary, the elevator feet can be manually twisted to make more precise adjustments. Hold the projector when twisting the feet.

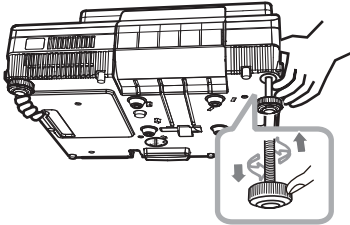

To finely adjust, twist the foot.

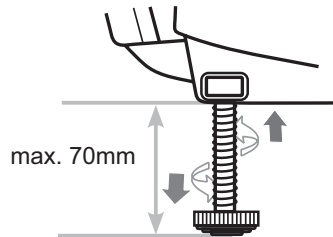

- ⚠ CAUTION** ▶ Do not handle the elevator buttons without holding the projector, since the projector may drop down.
 ▶ Do not lengthen the elevator feet to 70 mm or more. The foot lengthened exceeding the limit may come off from the projector, and result in an injury.

Adjusting the focus

Use the focus ring to focus the picture.

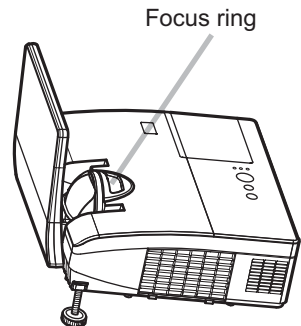

Using the automatic adjustment feature

1. Press the **AUTO** button on the remote control.
 - Pressing this button performs the following.
 - **For a computer signal**
The vertical position, the horizontal position and the horizontal phase will be automatically adjusted. Make sure that the application window is set to its maximum size prior to attempting to use this feature. A dark picture may still be incorrectly adjusted. Use a bright picture when adjusting.
 - **For a video signal and s-video signal**
The video format best suited for the respective input signal will be selected automatically. This function is available only when the AUTO is selected for the VIDEO FORMAT item in the INPUT menu (📖37). The vertical position and horizontal position will be automatically set to the default.
 - **For a component video signal**
The vertical position and horizontal position will be automatically set to the default. The horizontal phase will be automatically adjusted.
 - The automatic adjustment operation requires approx. 10 seconds. Also please note that it may not function correctly with some input.
 - When this function is performed for a video signal, a certain extra such as a line may appear outside a picture.
 - When this function is performed for a computer signal, a black frame may be displayed on the edge of the screen, depending on the PC model.
 - The items adjusted by this function may vary when the FINE or DISABLE is selected for the AUTO ADJUST item of the SERVICE item in the OPTION menu (📖52).

AUTO button

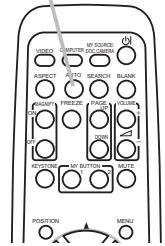

Adjusting the position

1. Press the **POSITION** button on the remote control while no menu is on screen, to display the D-SHIFT (📖40) dialog on screen.
2. Use the ▲, ▼, ◀ and ▶ buttons to adjust the picture position. Press the **POSITION** button again to finish this operation.

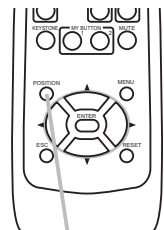

POSITION button

- This is a function to shift the position of the shrunken picture by the D-ZOOM (📖40) function.
- When an OSD (On Screen Display) menu is displayed, this operation moves the position of the OSD menu, but the picture position is not (📖28).
- The D-SHIFT adjustment values are not valid when the D-ZOOM is set to 320 (full screen).

Correcting the keystone distortions

KEYSTONE button

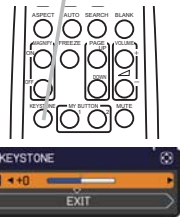

1. Press the **KEYSTONE** button on the remote control.
 - A dialog will appear on the screen to aid you in correcting the distortion.
2. Use the **◀/▶** cursor buttons for adjustment.
 - To close the dialog and complete this operation, press the **KEYSTONE** button again. Even if you do not do anything, the dialog will automatically disappear after a few seconds.
 - The adjustable range of this function varies for each input signal. For some input, this function may not work well.
 - When the projector is inclined to near ± 6 degrees or over, this function may not work well.
 - This function will be unavailable when the Transition Detector is activated (66).
 - The OSD menu might be displayed outside of the image display area depending on the adjustment value of the **ASPECT**, **D-ZOOM** and **KEYSTONE**. Changing the values of **ASPECT**, **D-ZOOM** and **KEYSTONE** may fix the symptom.

Using the magnify feature

MAGNIFY ON/OFF buttons

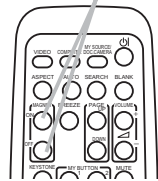

1. Press the **MAGNIFY ON** button on the remote control. The picture will be magnified, and the **MAGNIFY** dialog will appear on the screen. When the **MAGNIFY ON** button is pressed for the first time after the projector is turned on, the picture will be zoomed by 1.5 times. On the dialog, triangle marks to show each direction will be displayed.
2. While the triangles are displayed on the dialog, use the **▲/▼/◀/▶** cursor buttons to shift the magnifying area.
3. A magnifying glass icon will be displayed on the dialog when the **MAGNIFY ON** button is pressed while the dialog with the triangles is displayed.
4. While the magnifying glass icon is displayed on the dialog, use the **▲/▼** cursor buttons to adjust the magnification ratio. The magnification ratio will be adjusted with fine steps. And changes in the ratio in single steps are subtle so they may be hard to recognize.
5. Press the **MAGNIFY OFF** button on the remote control to exit magnification.

NOTE • The **MAGNIFY** dialog will automatically disappear in several seconds with no operation. The dialog will appear again if the **MAGNIFY ON** button is pressed when the dialog has automatically disappeared.

- While the **MAGNIFY** dialog is displayed, press the **MAGNIFY ON** button to switch the dialog between magnifying area shifting (with the triangles) and magnification ratio adjustment (with the magnifying glass icon).
- The magnification is automatically disabled when the displaying signal or its display condition is changed.
- While the magnification is active, the keystone distortion condition may vary. It will be restored when the magnification is disabled.
- Some horizontal stripes might be visible on the image while magnification is active.

Temporarily freezing the screen

1. Press the **FREEZE** button on the remote control.
 - The “FREEZE” indication will appear on the screen (however, the indication will not appear when the OFF is selected for the MESSAGE item in the SCREEN menu (45)), and the projector will go into the FREEZE mode, which the picture is frozen.

To exit the FREEZE mode and restore the screen to normal, press the **FREEZE** button again.

- The projector automatically exits from the FREEZE mode when some control buttons are pressed.
- If the projector continues projecting a still image for a long time, the LCD panel might possibly be burned in. Do not leave the projector in the FREEZE mode for too long.
- Images might appear degraded when this function is operated, but it is not a malfunction.

FREEZE button

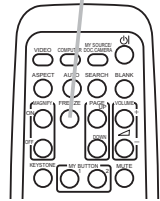

Temporarily blanking the screen

1. Press the **BLANK** button on the remote control.
 - The BLANK screen will be displayed instead of the screen of input signal. Please refer to the BLANK item in the SCREEN menu (43).

To exit from the BLANK screen and return to the input signal screen, press the **BLANK** button again.

- The projector automatically exits from the BLANK mode when some control buttons are pressed.

BLANK button

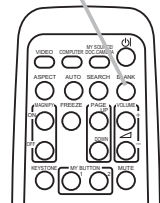

CAUTION ► If you wish to have a blank screen while the projector's lamp is on, use the BLANK function above. Any other method of blocking the projection light, such as attaching something to the lens or placing something in front of the lens, may cause the damage to the projector.

NOTE • The sound is not connected with the BLANK screen function. If necessary, set the volume or mute first. To display the BLANK screen and mute the sound at one time, use the AV MUTE function (51).

Using the menu function

This projector has the following menus:

PICTURE, IMAGE, INPUT, SETUP, AUDIO, SCREEN, OPTION, NETWORK, SECURITY and EASY MENU.

The EASY MENU consists of functions often used, and the other menus are classified into each purpose and brought together as the ADVANCED MENU. Each of these menus is operated using the same methods. While the projector is displaying any menu, the **MENU** button on the projector works as the cursor buttons. The basic operations of these menus are as follows.

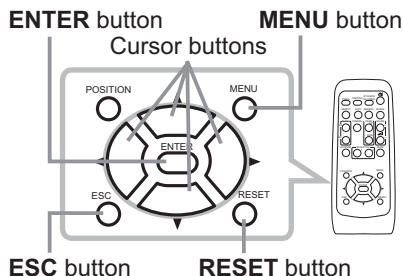
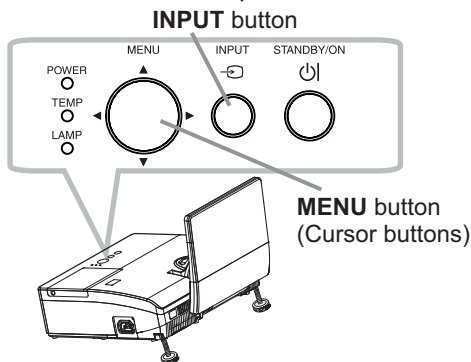

1. To start the MENU, press the **MENU** button. The MENU you last used (EASY or ADVANCED) will appear. The EASY MENU has priority to appear just after powered on.

2. In the EASY MENU

- (1) Use the ▲/▼ cursor buttons to select an item to operate. If you want to change it to the ADVANCED MENU, select the ADVANCED MENU.
- (2) Use the ◀/▶ cursor buttons to operate the item.



In the ADVANCED MENU

- (1) Use the ▲/▼ cursor buttons to select a menu. The items in the menu appear on the right side. If you want to change it to the EASY MENU, select the EASY MENU.
- (2) Press the ▶ cursor (or the **ENTER**) button to move the cursor to the right side. Then use the ▲/▼ cursor buttons to select an item to operate and press the ▶ cursor (or the **ENTER**) button to progress. The operation menu or dialog of the selected item will appear.
- (3) Use the buttons as instructed in the OSD to operate the item.



(continued on next page)

Using the menu function (continued)

3. To close the MENU, press the **MENU** button again or select the EXIT and press the ◀ cursor (or the **ENTER**) button. Even if you do not do anything, the dialog will automatically disappear after about 30 seconds.
 - If you want to move the menu position, use the cursor buttons after pressing the **POSITION** button.
 - Some functions cannot be performed when a certain input port is selected, or when a certain input signal is displayed.
 - When you want to reset the operation, press the **RESET** button on the remote control during the operation. Note that some items (ex. LANGUAGE, VOLUME) cannot be reset.
 - In the ADVANCED MENU, when you want to return to the previous display, press the ◀ cursor (or the **ESC**) button on the remote control.

Indication in OSD (On Screen Display)

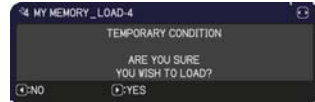
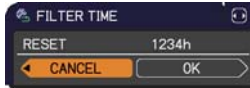

The meanings of the general words on the OSD are as follows.

Indication	Meaning
EXIT	Selecting this word finishes the OSD menu. It's the same as pressing the MENU button on the remote control.
RETURN	Selecting this word returns the menu to the previous menu.
CANCEL or NO	Selecting this word cancels the operation in the present menu and returns to the previous menu.
OK or YES	Selecting this word executes the prepared function or shifts the menu to the next menu.

EASY MENU

From the EASY MENU, items shown in the table below can be performed.

Select an item using the ▲/▼ cursor buttons. Then perform it according to the following table.



Item	Description																								
ASPECT	<p>Using the ◀/▶ cursor buttons switches the mode for aspect ratio. See the ASPECT item in the IMAGE menu (📖34).</p> <ul style="list-style-type: none"> The on-screen menu might be displayed outside of the image display area depending on the adjustment value of the ASPECT, D-ZOOM and KEYSTONE. Changing the values of ASPECT, D-ZOOM and KEYSTONE may fix the symptom. 																								
D-ZOOM	<p>Using the ◀/▶ cursor buttons adjusts the magnification ratio. Small ⇔ Large</p> <p>See the D-ZOOM item in the SETUP menu (📖40).</p> <ul style="list-style-type: none"> The on-screen menu might be displayed outside of the image display area depending on the adjustment value of the ASPECT, D-ZOOM and KEYSTONE. Changing the values of ASPECT, D-ZOOM and KEYSTONE may fix the symptom. 																								
KEYSTONE	<p>Using the ◀/▶ cursor buttons corrects the vertical keystone distortion. See the KEYSTONE item in the SETUP menu (📖40).</p> <ul style="list-style-type: none"> The on-screen menu might be displayed outside of the image display area depending on the adjustment value of the ASPECT, D-ZOOM and KEYSTONE. Changing the values of ASPECT, D-ZOOM and KEYSTONE may fix the symptom. 																								
PICTURE MODE	<p>Using the ◀/▶ cursor buttons switches the picture mode. The picture modes are combinations of the GAMMA and the COLOR TEMP settings. Choose a suitable mode according to the projected source.</p> <p> </p> <table border="1"> <thead> <tr> <th></th> <th>GAMMA</th> <th>COLOR TEMP</th> </tr> </thead> <tbody> <tr> <td>NORMAL</td> <td>1 DEFAULT</td> <td>2 MID</td> </tr> <tr> <td>CINEMA</td> <td>2 DEFAULT</td> <td>3 LOW</td> </tr> <tr> <td>DYNAMIC</td> <td>3 DEFAULT</td> <td>1 HIGH</td> </tr> <tr> <td>BOARD(BLACK)</td> <td>4 DEFAULT</td> <td>4 HI-BRIGHT-1</td> </tr> <tr> <td>BOARD(GREEN)</td> <td>4 DEFAULT</td> <td>5 HI-BRIGHT-2</td> </tr> <tr> <td>WHITEBOARD</td> <td>5 DEFAULT</td> <td>2 MID</td> </tr> <tr> <td>DAYTIME</td> <td>6 DEFAULT</td> <td>6 HI-BRIGHT-3</td> </tr> </tbody> </table> <ul style="list-style-type: none"> When the combination of the GAMMA and the COLOR TEMP differs from pre-assigned modes above, the display on the menu for the PICTURE MODE is “CUSTOM”. Please refer to the GAMMA and the COLOR TEMP (📖31, 32) items in the PICTURE menu. Lines or other noise might appear on the screen when this function is operated, but it is not a malfunction. 		GAMMA	COLOR TEMP	NORMAL	1 DEFAULT	2 MID	CINEMA	2 DEFAULT	3 LOW	DYNAMIC	3 DEFAULT	1 HIGH	BOARD(BLACK)	4 DEFAULT	4 HI-BRIGHT-1	BOARD(GREEN)	4 DEFAULT	5 HI-BRIGHT-2	WHITEBOARD	5 DEFAULT	2 MID	DAYTIME	6 DEFAULT	6 HI-BRIGHT-3
	GAMMA	COLOR TEMP																							
NORMAL	1 DEFAULT	2 MID																							
CINEMA	2 DEFAULT	3 LOW																							
DYNAMIC	3 DEFAULT	1 HIGH																							
BOARD(BLACK)	4 DEFAULT	4 HI-BRIGHT-1																							
BOARD(GREEN)	4 DEFAULT	5 HI-BRIGHT-2																							
WHITEBOARD	5 DEFAULT	2 MID																							
DAYTIME	6 DEFAULT	6 HI-BRIGHT-3																							

EASY MENU

Item	Description
ECO MODE	Using the ◀/▶ cursor buttons turns off/on the eco mode. See the ECO MODE item in the SETUP menu (📖40).
MIRROR	Using the ◀/▶ cursor buttons switches the mode for mirror status. See the MIRROR item in the SETUP menu (📖41).
RESET	Performing this item resets all of the EASY MENU items except the FILTER TIME and the LANGUAGE. A dialog is displayed for confirmation. Selecting the OK using the ▶ cursor button performs resetting.
FILTER TIME	The usage time of the air filter is shown in the menu. Performing this item resets the filter time which counts usage time of the air filter. A dialog is displayed for confirmation. Selecting the OK using the ▶ cursor button performs resetting. See the FILTER TIME item in the OPTION menu (📖50).
LANGUAGE	Using the ◀/▶ cursor buttons changes the display language. See the LANGUAGE item in the SCREEN menu (📖43).
ADVANCED MENU	Press the ▶ cursor (or the ENTER) button to use the ADVANCED MENU.
EXIT	Press the ◀ cursor (or the ENTER) button to finish the OSD menu.

PICTURE menu

From the PICTURE menu, items shown in the table below can be performed.



Select an item using the ▲/▼ cursor buttons, and press the ► cursor (or the **ENTER**) button to execute the item. Then perform it according to the following table.



Item	Description
BRIGHTNESS	Using the ◀/▶ cursor buttons adjusts the brightness. Dark ⇄ Light
CONTRAST	Using the ◀/▶ cursor buttons adjusts the contrast. Weak ⇄ Strong
GAMMA	<p>Using the ▲/▼ cursor buttons switches the gamma mode.</p> <p>1 DEFAULT ⇄ 1 CUSTOM ⇄ 2 DEFAULT ⇄ 2 CUSTOM ⇄ 3 DEFAULT ⇄ 6 CUSTOM ⇄ 3 CUSTOM ⇄ 6 DEFAULT ⇄ 5 CUSTOM ⇄ 5 DEFAULT ⇄ 4 CUSTOM ⇄ 4 DEFAULT</p> <p>To adjust CUSTOM</p> <p>Selecting a mode whose name includes the CUSTOM and then pressing the ► cursor (or the ENTER) button displays a dialog to aid you in adjusting the mode.</p> <p>This function is useful when you want to change the brightness of particular tones.</p> <p>Choose an item using the ◀/▶ cursor buttons, and adjust the level using the ▲/▼ cursor buttons.</p> <p>You can display a test pattern for checking the effect of your adjustment by pressing the ENTER (or the INPUT) button.</p> <p>Each time you press the ENTER (or the INPUT) button, the pattern changes as below.</p> <p>No pattern ⇄ Gray scale of 9 steps ⇄ ⇄ Ramp ⇄ Gray scale of 15 steps</p> <p>The eight equalizing bars correspond to eight tone levels of the test pattern (Gray scale of 9 steps) except the darkest in the left end. If you want to adjust the 2nd tone from left end on the test pattern, use the equalizing adjustment bar "1". The darkest tone at the left end of the test pattern cannot be controlled with any of equalizing adjustment bar.</p> <ul style="list-style-type: none"> • Lines or other noise might appear on the screen when this function is operated, but it is not a malfunction.



(continued on next page)

Item	Description
<p>COLOR TEMP</p>	<p>Using the ▲/▼ cursor buttons switches the color temperature mode.</p> <p style="text-align: center;"> 1 HIGH ⇄ 1 CUSTOM ⇄ 2 MID ⇄ 2 CUSTOM ⇕ ⇕ 6 CUSTOM ⇄ 3 LOW ⇕ ⇕ 6 Hi-BRIGHT-3 ⇄ 3 CUSTOM ⇕ ⇕ 5 CUSTOM ⇄ 5 Hi-BRIGHT-2 ⇄ 4 CUSTOM ⇄ 4 Hi-BRIGHT-1 </p> <p style="text-align: center;">To adjust CUSTOM</p> <p>Selecting a mode whose name includes the CUSTOM and then pressing the ► cursor (or the ENTER) button displays a dialog to aid you in adjusting the OFFSET and GAIN of the selected mode.</p>  <p>The OFFSET adjustments change the color intensity on the whole tones of the test pattern. GAIN adjustments mainly affect color intensity on the brighter tones of the test pattern.</p> <p>Choose an item using the ◀/▶ cursor buttons, and adjust the level using the ▲/▼ cursor buttons. You can display a test pattern for checking the effect of your adjustment by pressing the ENTER (or the INPUT) button. Each time you press the ENTER (or the INPUT) button, the pattern changes as below.</p> <p style="text-align: center;"> No pattern ⇄ Gray scale of 9 steps ⇐ ⇑ ⇐ Ramp ⇄ Gray scale of 15 steps </p> <ul style="list-style-type: none"> • Lines or other noise might appear on the screen when this function is operated, but it is not a malfunction. 
<p>COLOR</p>	<p>Using the ◀/▶ cursor buttons adjusts the strength of whole color.</p> <p style="text-align: center;">Weak ⇄ Strong</p> <ul style="list-style-type: none"> • This item can be selected when input signals are video, s-video or component video signals. • When input signals is HDMI, this item can also be selected if either 1) or 2) applies. <ol style="list-style-type: none"> 1) HDMI FORMAT is set to VIDEO. 2) HDMI FORMAT is set to AUTO, and the projector recognizes that it receives video signals.

(continued on next page)

Item	Description
TINT	<p>Using the ◀/▶ cursor buttons adjusts the tint. Reddish ⇔ Greenish</p> <ul style="list-style-type: none"> • This item can be selected when input signals are video, s-video or component video signals. • When input signals is HDMI, this item can also be selected if either 1) or 2) applies. <ol style="list-style-type: none"> 1) HDMI FORMAT is set to VIDEO. 2) HDMI FORMAT is set to AUTO, and the projector recognizes that it receives video signals.
SHARPNESS	<p>Using the ◀/▶ cursor buttons adjusts the sharpness. Weak ⇔ Strong</p> <ul style="list-style-type: none"> • There may be some noise and/or the screen may flicker for a moment when an adjustment is made. This is not a malfunction.
MY MEMORY	<p>This projector has 4 memories for adjustment data (for all the items of the PICTURE menu). Selecting a function using the ▲/▼ cursor buttons and pressing the ▶ cursor (or the ENTER) button performs each function.</p> <p style="text-align: center;"> ↻ SAVE-1 ⇔ SAVE-2 ⇔ SAVE-3 ⇔ SAVE-4 ↻ ↻ LOAD-4 ⇔ LOAD-3 ⇔ LOAD-2 ⇔ LOAD-1 ↻ </p> <p><u>SAVE-1, SAVE-2, SAVE-3, SAVE-4</u> Performing a SAVE function saves the current adjustment data into the memory linked in the number included in the function's name.</p> <ul style="list-style-type: none"> • Remember that the current data being stored of a memory will be lost by saving new data into the memory. <p><u>LOAD-1, LOAD-2, LOAD-3, LOAD-4</u> Performing a LOAD function loads the data from the memory linked in the number included in the function's name, and adjusts the picture automatically depending on the data.</p> <ul style="list-style-type: none"> • The LOAD functions whose linked memory has no data are skipped. • Remember that the current adjusted condition will be lost by loading data. If you want to keep the current adjustment, please save it before performing a LOAD function. • There may be some noise and the screen may flicker for a moment when loading data. This is not malfunction. • You can perform the LOAD function using the MY BUTTONS. <p>Please see the MY BUTTON item in the OPTION menu (📖51).</p>

IMAGE menu

From the IMAGE menu, items shown in the table below can be performed.

Select an item using the ▲/▼ cursor buttons, and press the ► cursor (or the ENTER) button to execute the item. Then perform it according to the following table.

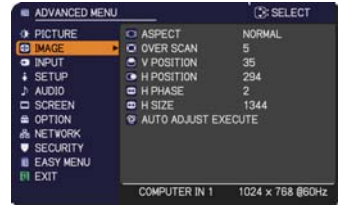

Item	Description
<p>ASPECT</p>	<p>Using the ▲/▼ cursor buttons switches the mode for aspect ratio.</p> <p>For a computer signal NORMAL ⇄ 4:3 ⇄ 16:9 ⇄ 16:10 ⇄ NATIVE</p> <p>For an HDMI signal NORMAL ⇄ 4:3 ⇄ 16:9 ⇄ 16:10 ⇄ 14:9 ⇄ NATIVE</p> <p>For a video signal, s-video signal or component video signal 4:3 ⇄ 16:9 ⇄ 16:10 ⇄ 14:9 ⇄ NATIVE</p> <p>For no signal 16:10 (fixed)</p> <ul style="list-style-type: none"> • The NORMAL mode keeps the original aspect ratio of the signal. • The on-screen menu might be displayed outside of the image display area depending on the adjustment value of the ASPECT, D-ZOOM and KEYSTONE. Changing the values of ASPECT, D-ZOOM and KEYSTONE may fix the symptom.
<p>OVER SCAN</p>	<p>Using the ◀/▶ cursor buttons adjusts the over-scan ratio. Small (It magnifies picture) ⇄ Large (It reduces picture)</p> <ul style="list-style-type: none"> • This item can be selected when input signals are video, s-video or component video signals. • When input signals is HDMI, this item can also be selected if either 1) or 2) applies. 1) HDMI FORMAT is set to VIDEO. 2) HDMI FORMAT is set to AUTO, and the projector recognizes that it receives video signals. • When this adjustment is too large, certain degradation may appear at the frame area of the picture. In such a case, please adjust small.
<p>V POSITION</p>	<p>Using the ◀/▶ cursor buttons adjusts the vertical position. Down ⇄ Up</p> <ul style="list-style-type: none"> • Over-adjusting the vertical position may cause noise to appear on the screen. If this occurs, please reset the vertical position to the default setting. Pressing the RESET button on the remote control when the V POSITION is selected will reset the V POSITION to the default setting. • When this function is performed on a video signal or s-video signal, the range of this adjustment depends on the OVER SCAN (above) setting. It is not possible to adjust when the OVER SCAN is set to 10. • This item cannot be selected for an HDMI signal.

(continued on next page)

Item	Description
H POSITION	<p>Using the ◀/▶ cursor buttons adjusts the horizontal position. Right ⇔ Left</p> <ul style="list-style-type: none"> • Over-adjusting the horizontal position may cause noise to appear on the screen. If this occurs, please reset the horizontal position to the default setting. Pressing the RESET button on the remote control when the H POSITION is selected will reset the H POSITION to the default setting. • When this function is performed on a video signal or s-video signal, the range of this adjustment depends on the OVER SCAN (📖34) setting. It is not possible to adjust when the OVER SCAN is set to 10. • This item cannot be selected for an HDMI signal.
H PHASE	<p>Using the ◀/▶ cursor buttons adjusts the horizontal phase to eliminate flicker. Right ⇔ Left</p> <ul style="list-style-type: none"> • This item can be selected only for a computer signal or a component video signal.
H SIZE	<p>Using the ◀/▶ cursor buttons adjusts the horizontal size. Small ⇔ Large</p> <ul style="list-style-type: none"> • This item can be selected only for a computer signal. • When this adjustment is excessive, the picture may not be displayed correctly. In such a case, please reset the adjustment by pressing the RESET button on the remote control during this operation. • Images might appear degraded when this function is operated, but it is not a malfunction.
AUTO ADJUST EXECUTE	<p>Selecting this item performs the automatic adjustment feature.</p> <p>For a computer signal The vertical position, the horizontal position and the horizontal phase will be automatically adjusted. Make sure that the application window is set to its maximum size prior to attempting to use this feature. A dark picture may still be incorrectly adjusted. Use a bright picture when adjusting.</p> <p>For a video signal and s-video signal The video format best suited for the respective input signal will be selected automatically. This function is available only when the AUTO is selected for the VIDEO FORMAT item in the INPUT menu (📖37). The vertical position and horizontal position will be automatically set to the default.</p> <p>For a component video signal The vertical position and horizontal position will be automatically set to the default. The horizontal phase will be automatically adjusted.</p> <ul style="list-style-type: none"> • The automatic adjustment operation requires approx. 10 seconds. Also please note that it may not function correctly with some input. • When this function is performed for a video signal, a certain extra such as a line may appear outside a picture. • When this function is performed for a computer signal, a black frame may be displayed on the edge of the screen, depending on the PC model. • The items adjusted by this function may vary when the FINE or the DISABLE is selected for the AUTO ADJUST item of the SERVICE item in the OPTION menu (📖52).

INPUT menu

From the INPUT menu, items shown in the table below can be performed.

Select an item using the ▲/▼ cursor buttons, and press the ► cursor (or the **ENTER**) button to execute the item. Then perform it according to the following table.



Item	Description
PROGRESSIVE	<p>Using the ▲/▼ cursor buttons switches the progress mode. TV ⇄ FILM ⇄ OFF ↑—————↑</p> <ul style="list-style-type: none"> • This function works only for a video signal, s-video signal, component video signal or HDMI signal of 480i@60 or 576i@50. • When the TV or the FILM is selected, the screen image will be sharp. The FILM adapts to the 2-3 Pull-Down conversion system. But these may cause a certain defect (for example, jagged line) of the picture for a quick moving object. In such a case, please select the OFF, even though the screen image may lose sharpness.
VIDEO NR	<p>Using the ▲/▼ cursor buttons switches the noise reduction mode. HIGH ⇄ MID ⇄ LOW ↑—————↑</p> <ul style="list-style-type: none"> • This function works only for a video signal, s-video signal, component video signal or HDMI signal of 480i@60 or 576i@50. • When this function is excessive, it may cause a certain degradation of the picture.
COLOR SPACE	<p>Using the ▲/▼ cursor buttons switches the mode for color space. AUTO ⇄ RGB ⇄ SMPTE240 ⇄ REC709 ⇄ REC601 ↑—————↑</p> <ul style="list-style-type: none"> • This item can be selected only for a computer signal or a component video signal. • The AUTO mode automatically selects the optimum mode. • The AUTO operation may not work well at some signals. In such a case, it might be good to select a suitable mode except the AUTO.

(continued on next page)

Item	Description								
<p>VIDEO FORMAT</p>	<p>The video format for the S-VIDEO port and the VIDEO port can be set.</p> <p>(1) Use the ▲/▼ cursor buttons to select the input port. S-VIDEO ⇄ VIDEO</p> <p>(2) Using the ◀/▶ cursor buttons switches the mode for video format. AUTO ⇄ NTSC ⇄ PAL ⇄ SECAM ⤴ N-PAL ⇄ M-PAL ⇄ NTSC4.43 ⤴</p>  <ul style="list-style-type: none"> • This item is performed only for a video signal from the VIDEO port or the S-VIDEO port. • The AUTO mode automatically selects the optimum mode. • The AUTO operation may not work well for some signals. If the picture becomes unstable (e.g. an irregular picture, lack of color), please select the mode according to the input signal. 								
<p>HDMI FORMAT</p>	<p>Set the video format for the HDMI port. Using the ▲/▼ cursor buttons switches the digital signal format. AUTO ⇄ VIDEO ⇄ COMPUTER</p> <table border="1" data-bbox="311 770 1024 911"> <thead> <tr> <th></th> <th>Feature</th> </tr> </thead> <tbody> <tr> <td>AUTO</td> <td>Selecting the optimum mode automatically.</td> </tr> <tr> <td>VIDEO</td> <td>Suitable for DVD signals.</td> </tr> <tr> <td>COMPUTER</td> <td>Suitable for computer signals.</td> </tr> </tbody> </table> <ul style="list-style-type: none"> • If the COMPUTER is selected, COLOR, TINT, OVERSCAN can not be selected. 		Feature	AUTO	Selecting the optimum mode automatically.	VIDEO	Suitable for DVD signals.	COMPUTER	Suitable for computer signals.
	Feature								
AUTO	Selecting the optimum mode automatically.								
VIDEO	Suitable for DVD signals.								
COMPUTER	Suitable for computer signals.								
<p>HDMI RANGE</p>	<p>Set the digital range for HDMI port. Using the ▲/▼ cursor buttons changes the digital signal mode. AUTO ⇄ NORMAL ⇄ ENHANCED</p> <table border="1" data-bbox="311 1114 1024 1254"> <thead> <tr> <th></th> <th>Feature</th> </tr> </thead> <tbody> <tr> <td>AUTO</td> <td>Selecting the optimum mode automatically.</td> </tr> <tr> <td>NORMAL</td> <td>Suitable for DVD signals (16-235)</td> </tr> <tr> <td>ENHANCED</td> <td>Suitable for computer signals (0-255)</td> </tr> </tbody> </table> <ul style="list-style-type: none"> • If the contrast of the screen image is too strong or too weak, try finding a more suitable mode. 		Feature	AUTO	Selecting the optimum mode automatically.	NORMAL	Suitable for DVD signals (16-235)	ENHANCED	Suitable for computer signals (0-255)
	Feature								
AUTO	Selecting the optimum mode automatically.								
NORMAL	Suitable for DVD signals (16-235)								
ENHANCED	Suitable for computer signals (0-255)								

(continued on next page)

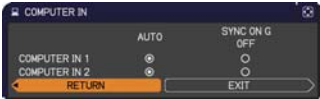
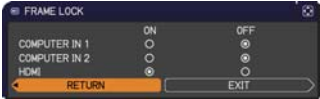
Item	Description
<p>COMPUTER IN</p>	<p>The computer input signal type for the COMPUTER IN1 and IN2 ports can be set.</p> <p>(1) Use the ▲/▼ cursor buttons to select the COMPUTER IN port to be set. COMPUTER IN1 ⇔ COMPUTER IN2</p> <p>(2) Use the ◀/▶ cursor buttons to select the computer input signal type. AUTO ⇔ SYNC ON G OFF</p>  <ul style="list-style-type: none"> • Selecting the AUTO mode allows you to input a sync on G signal or component video from the port. • In the AUTO mode, the picture may be distorted with certain input signals. In such a case, remove the signal connector so that no signal is received and select the SYNC ON G OFF, and then reconnect the signal. • The COMPUTER IN1/2 port can support a component signal also (p.9).
<p>FRAME LOCK</p>	<p>Set the frame lock function on/off for each port.</p> <p>(1) Use the ▲/▼ cursor buttons to select the input ports.</p> <p>(2) Use the ◀/▶ cursor buttons to turn the frame lock function on/off. ON ⇔ OFF</p>  <ul style="list-style-type: none"> • This item can be performed only on a signal with a vertical frequency of 50 to 60 Hz. • When the ON is selected, moving pictures are displayed more smoothly. • This function may cause a certain degradation of the picture. In such a case, please select the OFF.

(continued on next page)

Item	Description
<p>RESOLUTION</p>	<p>The resolution for the COMPUTER IN1 and the COMPUTER IN2 input signals can be set on this projector.</p> <p>In the RESOLUTION menu select the resolution you wish to display using the ▲/▼ cursor buttons.</p> <p>■ AUTO Selecting AUTO will set a resolution appropriate to the input signal.</p> <p>■ STANDARD Pressing the ► cursor (or the ENTER) button when selecting a STANDARD resolution will automatically adjust the horizontal and vertical positions, clock phase and horizontal size. The INPUT_INFORMATION dialog will be displayed.</p> <p>■ CUSTOM (1) To set a custom resolution use the ▲/▼ cursor buttons to select the CUSTOM and the RESOLUTION_CUSTOM box will be displayed. Set the horizontal (HORZ) and vertical (VERT) resolutions using the ▲/▼/◀/▶ cursor buttons. This function is may not support all resolutions.</p> <p>(2) Move the cursor to the OK on screen and press the ► cursor (or the ENTER) button. The message "ARE YOU SURE YOU WISH TO CHANGE RESOLUTION?" appears. To save the setting, press the ► cursor button. The horizontal and vertical positions, clock phase and horizontal size will be automatically adjusted.</p> <p>To revert back to the previous resolution without saving changes, move the cursor to the CANCEL on screen and press the ◀ cursor (or the ENTER) button. The screen will then return to the RESOLUTION menu displaying the previous resolution.</p> <ul style="list-style-type: none"> • For some pictures, this function may not work well.



SETUP menu



From the SETUP menu, items shown in the table below can be performed.

Select an item using the ▲/▼ cursor buttons, and press the ► cursor (or the **ENTER**) button to execute the item. Then perform it according to the following table.



Item	Description
D-ZOOM	Using the ◀/▶ cursor buttons adjusts the magnification ratio. Small ⇔ Large <ul style="list-style-type: none"> The on-screen menu might be displayed outside of the image display area depending on the adjustment value of the ASPECT, D-ZOOM and KEYSTONE. Changing the values of ASPECT, D-ZOOM and KEYSTONE may fix the symptom.
D-SHIFT V	Using the ◀/▶ cursor buttons adjusts the vertical picture position. Down ⇔ Up <ul style="list-style-type: none"> The D-SHIFT adjustment values are not valid when the D-ZOOM is set to 320 (full screen).
D-SHIFT H	Using the ◀/▶ cursor buttons adjusts the horizontal picture position. Left ⇔ Right <ul style="list-style-type: none"> The D-SHIFT adjustment values are not valid when the D-ZOOM is set to 320 (full screen).
PICT. POSIT. H	Using the ▲/▼ cursor buttons selects the horizontal picture position. LEFT ⇔ MID ⇔ RIGHT The PICTURE POSITION is not changed if any of the following cases apply. <ul style="list-style-type: none"> The ASPECT is set to 16:9 or 16:10. The input signal has an aspect ratio of 16:9, 16:10 or vertically smaller than 16:10, while ASPECT is set to NORMAL. Horizontal size of the displayed image is full on the effective display area, while the ASPECT is set to NATIVE. One of the following messages is displayed on the screen: "NO INPUT IS DETECTED" "SYNC IS OUT OF RANGE" "INVALID SCAN FREQ." The BLANK or TEMPLATE function is selected.
KEYSTONE	Using the ◀/▶ cursor buttons corrects the vertical keystone distortion. Shrink the bottom of the image ⇔ Shrink the top of the image <ul style="list-style-type: none"> The adjustable range of this function will vary among inputs. For some input, this function may not work well. This function will be unavailable when the Transition Detector is on (66). The on-screen menu might be displayed outside of the image display area depending on the adjustment value of the ASPECT, D-ZOOM and KEYSTONE. Changing the values of ASPECT, D-ZOOM and KEYSTONE may fix the symptom.
ECO MODE	Using the ▲/▼ cursor buttons turns off/on the eco mode. NORMAL ⇔ ECO <ul style="list-style-type: none"> When the ECO is selected, acoustic noise and screen brightness are reduced.

(continued on next page)

Item	Description
<p>MIRROR</p>	<p>Using the ▲/▼ cursor buttons switches the mode for mirror status.</p> <div style="text-align: center;">  <p>NORMAL ⇔ H:INVERT ⇔ V:INVERT ⇔ H&V:INVERT</p> </div> <p>If the Transition Detector is on and the MIRROR status is changed, the TRANSITION DETECTOR ON alarm (🔊66) will be displayed when projector is restarted after the AC power is turned off.</p>
<p>STANDBY MODE</p>	<p>Using ▲/▼ cursor buttons switches the standby mode setting between the NORMAL and the SAVING.</p> <p>NORMAL ⇔ SAVING</p> <ul style="list-style-type: none"> • When SAVING is selected and the projector is in the standby state, the power consumption is lowered with some functional restriction as below. <ul style="list-style-type: none"> - The RS-232C communication control is disabled except turning the projector on and changing the STANDBY MODE setting. - The STANDBY of the MONITOR OUT (🔊below) is invalid, and no signal is output from the MONITOR OUT port. - The AUDIO OUT STANDBY of the AUDIO SOURCE (🔊42) is invalid, and no signal is output from the AUDIO OUT ports (🔊20). • If the COMMUNICATION TYPE in the COMMUNICATION menu is set to NETWORK BRIDGE, all of the RS-232C commands are disabled (🔊55).
<p>MONITOR OUT</p>	<p>The combination of a picture shown on screen and output from the MONITOR OUT port can be arranged in the menu.</p> <p>The picture coming into the port selected in the (2) is output to the MONITOR OUT port while an image from the port chosen in the (1) is on screen.</p> <p>(1) Choose a picture input port using ▲/▼ cursor buttons.</p> <ul style="list-style-type: none"> • Select STANDBY to specify the output from the MONITOR OUT port in the standby state. This selection is available only when NORMAL is selected for the STANDBY MODE (🔊above). <p>(2) Select one of the COMPUTER IN ports using the ◀/▶ cursor buttons.</p> <p>Choosing the COMPUTER IN1 allows the following choice.</p> <p>COMPUTER IN1 ⇔ OFF</p> <p>Choosing the COMPUTER IN2 allows the following choice.</p> <p>COMPUTER IN2 ⇔ OFF</p> <p>Choosing other input or the STANDBY allows the following choice.</p> <p>COMPUTER IN1 ⇔ COMPUTER IN2 ⇔ OFF</p> <div style="text-align: center;">  </div> <ul style="list-style-type: none"> • The OFF disables the MONITOR OUT port.

AUDIO menu

From the AUDIO menu, items shown in the table below can be performed. Select an item using the ▲/▼ cursor buttons, and press the ► cursor (or the **ENTER**) button to execute the item. Then perform it according to the following table.



Item	Description
VOLUME	Using the ◀/▶ cursor buttons adjusts the volume. Low ⇔ High
SPEAKER	Using the ▲/▼ cursor buttons turns on/off the built-in speaker. ON ⇔ OFF When the OFF is selected, the built-in speaker does not work.
AUDIO SOURCE	<p>The combination of a picture and audio input port can be arranged in the menu. The audio coming into the port selected in the (2) is output while an image from the port chosen in the (1) is on screen.</p> <p>(1) Choose a picture input port using the ▲/▼ cursor buttons.</p> <ul style="list-style-type: none"> Choose the AUDIO OUT STANDBY, to select the audio output to the AUDIO OUT ports in the standby state. The built-in speaker does not work in the standby state. While the RETURN is selected, pressing the ◀ cursor (or the ENTER) button returns to the previous menu. <p>(2) Select one of the AUDIO IN ports using the ◀/▶ cursor buttons. AUDIO IN1 ⇔ AUDIO IN2 ⇔ AUDIO IN3 ⇔ ⓧ ⇔ H</p> <p style="text-align: center;">↑—————↑</p> <ul style="list-style-type: none"> "H" is abbreviation of HDMI. H can be selected for HDMI port only. When H is selected, the audio signal to HDMI port will be output if HDMI is chosen as a picture source. ⓧ disables the audio output. The C.C. (Closed Caption) is automatically activated when ⓧ is selected and an input signal containing C.C. is received. This function is available only when the signal is NTSC for the VIDEO or the S-VIDEO, or 480i@60 for the COMPUTER IN1 or the COMPUTER IN2, and when the AUTO is selected for the DISPLAY in the C.C. menu under the SCREEN menu (48).
HDMI AUDIO	The HDMI AUDIO is set to 1 as default. In case the HDMI audio does not work well, try 2. 1 ⇔ 2



SCREEN menu



From the SCREEN menu, items shown in the table below can be performed.

Select an item using the ▲/▼ cursor buttons, and press the ► cursor (or the **ENTER**) button to execute the item. Then perform it according to the following table.

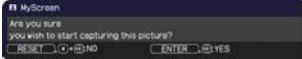

Item	Description
LANGUAGE	<p>Using the ▲/▼/◀/▶ cursor buttons switches the OSD (On Screen Display) language. ENGLISH, FRANÇAIS, DEUTSCH, ESPAÑOL... (shown in the LANGUAGE dialog)</p> <p>Press the ENTER (or the INPUT) button to save the language setting.</p>
MENU POSITION	<p>Using the ▲/▼/◀/▶ cursor buttons adjusts the menu position. To quit the operation, press the MENU button on the remote control or keep no operation for about 10 seconds.</p>
BLANK	<p>Using the ▲/▼ cursor buttons switches the mode for the blank screen. The blank screen is a screen for the temporarily blanking feature (0026). It is displayed by pressing the BLANK button on the remote control.</p> <p>MyScreen ⇔ ORIGINAL ⇔ BLUE ⇔ WHITE ⇔ BLACK ↑—————↑</p> <p><u>MyScreen</u> : Screen can be registered by the MyScreen item (0044). <u>ORIGINAL</u> : Screen preset as the standard screen. <u>BLUE, WHITE, BLACK</u> : Plain screens in each color.</p> <ul style="list-style-type: none"> • To avoid remaining as an afterimage, the MyScreen or the ORIGINAL screen will change to the plain black screen after several minutes.
START UP	<p>Using the ▲/▼ cursor buttons switches the mode for the start-up screen. The start-up screen is a screen displayed when no signal or an unsuitable signal is detected.</p> <p>MyScreen ⇔ ORIGINAL ⇔ OFF ↑—————↑</p> <p><u>MyScreen</u> : The screen can be registered by the MyScreen item (0044). <u>ORIGINAL</u> : The screen preset as the standard screen. <u>OFF</u> : Plain black screen.</p> <ul style="list-style-type: none"> • To avoid remaining as an afterimage, the MyScreen or the ORIGINAL screen will change to the BLANK screen (0026) after several minutes. If also the BLANK screen is the MyScreen or the ORIGINAL, the plain black screen is instead used. • When the ON is selected to the MyScreen PASSWORD item in the SECURITY menu (0064), the START UP is fixed to the MyScreen.

(continued on next page)

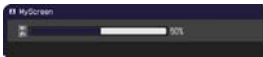
Item	Description
<p>MyScreen</p>	<p>This item allows you to capture an image for use as a MyScreen image which can be used as the BLANK screen and the START UP screen. Display the image you want to capture before executing the following procedure.</p> <ol style="list-style-type: none"> <p>1. Selecting this item displays a dialog titled "MyScreen". It will ask you if you start capturing an image from the current screen.</p>  <p>Please wait for the target image to be displayed, and press the ENTER (or the INPUT) button when the image is displayed. The image will freeze and the frame for capturing will appear.</p> <p>To stop performing, press the RESET (or press the ◀ cursor and the INPUT buttons at the same time) button.</p> <p>2. Using the ▲/▼/◀/▶ cursor buttons adjusts the frame position.</p> <p>Please move the frame to the position of the image which you want to use. The frame may not be able to be moved for some input signals.</p>  <p>To start registration, press the ENTER (or the INPUT) button on the remote control.</p>  <p>To restore the screen and return to the previous dialog, press the RESET (or press the ◀ cursor and the INPUT buttons at the same time) button.</p> <p>Registration takes several minutes.</p> <p>When the registration is completed, the registered screen and the following message is displayed for several seconds:</p> <p>"MyScreen registration is finished."</p> <p>If the registration failed, the following message is displayed:</p> <p>"A capturing error has occurred. Please try again."</p> <ul style="list-style-type: none"> • This function cannot be selected when the ON is selected to the MyScreen Lock item (📖45). • This function cannot be selected when the ON is selected to the MyScreen PASSWORD item in the SECURITY menu (📖64). • This item cannot be selected for an HDMI signal.

(continued on next page)

Item	Description
MyScreen Lock	<p>Using the ▲/▼ cursor buttons turns on/off the MyScreen lock function. ON ⇔ OFF</p> <p>When the ON is selected, the item MyScreen is locked. Use this function for protecting the current MyScreen.</p> <ul style="list-style-type: none"> • This function cannot be selected when the ON is selected to the MyScreen PASSWORD item in the SECURITY menu (📖64).
MESSAGE	<p>Using the ▲/▼ cursor buttons turns on/off the message function. ON ⇔ OFF</p> <p>When the ON is selected, the following message function works.</p> <p>“AUTO IN PROGRESS” while automatically adjusting “NO INPUT IS DETECTED” “SYNC IS OUT OF RANGE” “INVALID SCAN FREQ.” “NOT AVAILABLE” “Searching....” while searching for the input “Detecting....” while an input signal is detected</p> <p>The indication of the input signal displayed by changing The indication of the aspect ratio displayed by changing The indication of the PICTURE MODE displayed by changing The indication of the MY MEMORY displayed by changing The indication of “FREEZE” and “II” while freezing the screen by pressing the FREEZE button. The indication of the TEMPLATE displayed by changing.</p> <ul style="list-style-type: none"> • When the OFF is selected, please remember if the picture is frozen. Do not mistake freezing for a malfunction (📖26).

(continued on next page)

Item	Description
<p>SOURCE NAME</p>	<p>Each input port for this projector can have a name applied to it.</p> <ol style="list-style-type: none"> Use the ▲/▼ cursor buttons on the SCREEN menu to select the SOURCE NAME and press the ► cursor (or the ENTER) button. The SOURCE NAME menu will be displayed. Use the ▲/▼ cursor buttons on the SOURCE NAME menu to select the port to be named and press the ► cursor button. Right side of the menu is blank until a name is specified. The SOURCE NAME dialog will be displayed. The current name will be displayed on the first line. Use the ▲/▼/◀/▶ cursor buttons and the ENTER (or the INPUT) button to select and enter characters. To erase 1 character at one time, press the RESET (or press the ◀ cursor and the INPUT buttons at the same time) button. Also if you move the cursor to the DELETE or the ALL CLEAR on screen and press the ENTER (or the INPUT) button, 1 character or all characters will be erased. The name can be a maximum of 16 characters. To change an already inserted character, press the ▲ cursor button to move the cursor to the first line, and use the ◀/▶ cursor buttons to move the cursor on the character to be changed. After pressing the ENTER (or the INPUT) button, the character is selected. Then, follow the same procedure as described at the item (3) above. To finish entering text, move the cursor to the OK on screen and press the ► cursor (or the ENTER / the INPUT) button. To revert to the previous name without saving changes, move the cursor to the CANCEL on screen and press the ◀ cursor (or the ENTER / the INPUT) button.



(continued on next page)

Item	Description
TEMPLATE	<p>Using the ▲/▼ cursor buttons switches the mode for the template screen.</p> <p>Press the ► cursor (or the ENTER) button to display the selected template, and press the ◀ cursor button to close the displayed screen.</p> <p>The last selected template is displayed when the MY BUTTON allocated to the TEMPLATE function is pressed (51).</p> <p>TEST PATTERN ⇄ DOT-LINE1 ⇄ DOT-LINE2 ⇄ DOT-LINE3 ⇄ ⇄ ⇄</p> <p>MAP2 ⇄ MAP1 ⇄ CIRCLE2 ⇄ CIRCLE1 ⇄ DOT-LINE4</p> <p>You can turn a map upside down and scroll it horizontally when MAP1 or MAP2 is selected. To invert or scroll the map, display the guidance by pressing the RESET button on the remote three seconds or more when MAP1 or MAP2 appears.</p> <p>While the guidance is displayed:</p> <ul style="list-style-type: none"> • Press the ▲ cursor button and then press the ENTER or INPUT button to place the Northern Hemisphere on the top. • Press the ▼ cursor button and then press the ENTER or INPUT button to place the Southern Hemisphere on the top. • Press the ◀/▶ cursor button and then press the ENTER or INPUT button to scroll the map horizontally.

(continued on next page)

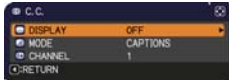
Item	Description
<p>C.C. (Closed Caption)</p>	<p>The C.C. is the function that displays a transcript or dialog of the audio portion of a video, files or other presentation or other relevant sounds. It is required to have NTSC format video or 480i@60 format component video source supporting C.C. feature to utilize this function.</p> <p>It may not work properly, depending on equipment or signal source. In this case, please turn off the Closed Caption.</p> 
	<p>DISPLAY</p> <p>Select the Closed Caption DISPLAY setting from following options using the ▲/▼ cursor buttons.</p> <p>AUTO ⇔ ON ⇔ OFF</p> <p style="text-align: center;">↑—————↓</p> <p><u>AUTO</u> : Closed Caption automatically displays when the volume is muted.</p> <p><u>ON</u> : The Closed Caption is on.</p> <p><u>OFF</u> : The Closed Caption is off.</p> <ul style="list-style-type: none"> • The caption is not displayed when the OSD menu is active. • The Closed Caption is the function to display the dialogue, narration, and / or sound effects of a television program or other video sources. The Closed Caption availability is depending upon broadcaster and/or content.
	<p>MODE</p> <p>Select the Closed Caption MODE setting from following options using the ▲/▼ cursor buttons.</p> <p>CAPTIONS ⇔ TEXT</p> <p><u>CAPTIONS</u> : Display Closed Caption.</p> <p><u>TEXT</u> : Display Text data, which is for additional information such as news reports or a TV program guide. The information covers the entire screen. Not all of the C.C. program has Text information.</p>
	<p>CHANNEL</p> <p>Select the Closed Caption CHANNEL from following options using the ▲/▼ cursor buttons.</p> <p>1 ⇔ 2 ⇔ 3 ⇔ 4</p> <p style="text-align: center;">↑—————↓</p> <p><u>1</u>: Channel 1, primary channel / language <u>2</u>: Channel 2 <u>3</u>: Channel 3 <u>4</u>: Channel 4</p> <p>The channel data may vary, depending on the content. Some channel might be used for secondary language or empty.</p>

OPTION menu

From the OPTION menu, items shown in the table below can be performed.

Select an item using the ▲/▼ cursor buttons, and press the ► cursor (or the **ENTER**) button to execute the item, except for the items LAMP TIME and FILTER TIME. Then perform it according to the following table.







Item	Description
AUTO SEARCH	<p>Using the ▲/▼ cursor buttons turns on/off the automatic signal search function.</p> <p>ON ⇄ OFF</p> <p>When the ON is selected, detecting no signal automatically cycles through input ports in the following order. The search is started from the current port. Then when an input is found, the projector will stop searching and display the image.</p> <p>COMPUTER IN1 ⇄ COMPUTER IN2 ⇄ HDMI VIDEO ⇄ S-VIDEO</p>
DIRECT POWER ON	<p>Using the ▲/▼ cursor buttons turns on/off the DIRECT POWER ON function.</p> <p>ON ⇄ OFF</p> <p>When set to the ON, the lamp in projector will be automatically turned on without the usual procedure (18), only when the projector is supplied with the power after the power was cut while the lamp was on.</p> <ul style="list-style-type: none"> • This function does not work as long as the power has been supplied to the projector while the lamp is off. • After turning the lamp on by the DIRECT POWER ON function, if neither input nor operation is detected for about 30 minutes, the projector is turned off, even though the AUTO POWER OFF function (50) is disabled.

(continued on next page)

Item	Description
<p>AUTO POWER OFF</p>	<p>Using the ▲/▼ cursor buttons adjusts the time to count down to automatically turn the projector off. Long (max. 99 minutes) ⇔ Short (min. 0 minute = DISABLE)</p>  <p>When the time is set to 0, the projector is not turned off automatically. When the time is set to 1 to 99, and when the passed time with no-signal or an unsuitable signal reaches at the set time, the projector lamp will be turned off. If one of the projector's buttons or the remote control buttons is pressed or one of the commands (except get commands) is transmitted to the CONTROL port during the corresponding time, projector will not be turned off. Please refer to the section the "Turning off the power" (19).</p>
<p>LAMP TIME</p>	<p>The lamp time is the usage time of the lamp, counted after the last resetting. It is shown in the OPTION menu. Pressing the ► cursor (or the ENTER / the RESET) button displays a dialog. To reset the lamp time, select the OK using the ► cursor button. CANCEL ⇔ OK</p> <ul style="list-style-type: none"> • Please reset the lamp time only when you have replaced the lamp, for a suitable indication about the lamp. • For the lamp replacement, see the section the "Replacing the lamp" (69, 70, 71).
<p>FILTER TIME</p>	<p>The filter time is the usage time of the air filter, counted after the last resetting. It is shown in the OPTION menu. Pressing the ► cursor (or the ENTER / the RESET) button displays a dialog. To reset the filter time, select the OK using the ► cursor button. CANCEL ⇔ OK</p> <ul style="list-style-type: none"> • Please reset the filter time only when you have cleaned or replaced the air filter, for a suitable indication about the air filter. • For the air filter cleaning, see the section the "Cleaning and replacing the air filter" (72).

(continued on next page)

Item	Description
<p>MY BUTTON</p>	<p>This item is to assign one of the following functions to the MY BUTTON 1/2 on the remote control (6).</p> <p>(1) Use the ▲/▼ cursor buttons on the MY BUTTON menu to select a MY BUTTON - (1/2) and press the ► cursor (or the ENTER) button to display the MY BUTTON setup dialog.</p> <p>(2) Then using the ▲/▼/◀/▶ cursor buttons sets one of the following functions to the chosen button. Press the ENTER (or the INPUT) button to save the setting.</p> <ul style="list-style-type: none"> • COMPUTER IN1: Sets port to the COMPUTER IN1. • COMPUTER IN2: Sets port to the COMPUTER IN2. • HDMI: Sets port to HDMI. • S-VIDEO: Sets port to the S-VIDEO. • VIDEO: Sets port to the VIDEO. • MY IMAGE: Displays the MY IMAGE menu (61). • MESSENGER: Turns the messenger text displayed on the screen on/off (6 Messenger Function of the User's Manual - Network Guide). When there is no transferred text data to display, the message "NO MESSENGER DATA" appears. • INFORMATION: Displays the SYSTEM_INFORMATION, INPUT_INFORMATION (57), NETWORK_INFORMATION(62) or nothing. • MY MEMORY: Loads one of adjustment data stored (33). When more than one data are saved, the adjustment changes every time the MY BUTTON is pressed. When no data is saved in memory, the dialog "No saved data" appears. When the current adjustment is not saved to memory, the dialog as shown in the right appears.   <p>If you want to keep the current adjustment, please press the ► cursor button to exit. Otherwise loading a data will overwrite the current adjusted condition.</p> <ul style="list-style-type: none"> • PICTURE MODE: Changes the PICTURE MODE (29). • FILTER RESET: Displays the filter time reset confirmation dialogue (50). • TEMPLATE: Makes the template pattern selected to the TEMPLATE item (47) appear or disappear. • AV MUTE: Turns the picture and audio on/off. • D-ZOOM: Turns the D-ZOOM mode on/off. When the D-ZOOM mode is on, use the ▲/▼ cursor buttons to adjust the magnification ratio. • D-SHIFT: Turns the D-SHIFT mode on/off. When the D-SHIFT mode is on, use the ▲/▼/◀/▶ cursor buttons to move the magnifying area. • RESOLUTION: Turns the RESOLUTION menu on/off (39).
<p>MY SOURCE</p>	<p>Using the ▲/▼ cursor buttons selects the picture input port to be selected with pressing the MY SOURCE/DOC.CAMERA button on the remote control.</p> <p>Select the picture input that is connected with a document camera.</p> 

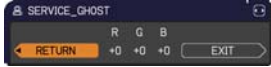
Item	Description
SERVICE	<p>Selecting this item displays the SERVICE menu.</p> <p>Select an item using the ▲/▼ cursor buttons, and press the ► cursor (or the ENTER) button on the remote control to execute the item.</p> 
	<p>FAN SPEED</p> <p>Using the ▲/▼ cursor buttons switches the rotation speed of the cooling fans. The HIGH is the mode for use at highlands etc. Note that the projector is noisier when the HIGH is selected.</p> <p>HIGH ⇄ NORMAL</p>
	<p>AUTO ADJUST</p> <p>Using the ▲/▼ cursor buttons to select one of the mode. When the DISABLE is selected, the automatic adjustment feature is disabled.</p> <p>FINE ⇄ FAST ⇄ DISABLE</p> <p style="text-align: center;">↑—————↑</p> <p><u>FINE</u>: Finer tuning including the H.SIZE adjustment. <u>FAST</u>: Faster tuning, setting the H.SIZE to prearranged data for the input signal.</p> <ul style="list-style-type: none"> Depending on conditions, such as input image, signal cable to the projector, environment around the projector, etc., the automatic adjustment may not work correctly. In such a case, please choose the DISABLE to disable the automatic adjustment, and make adjustment manually.
	<p>GHOST</p> <ol style="list-style-type: none"> Select a color element of ghost using the ◀/▶ cursor buttons. Adjust the selected element using the ▲/▼ cursor buttons to disappear ghost. 
	<p>FILTER MESSAGE</p> <p>Use the ▲/▼ cursor button to set the timer for notifying by the message when to replace the filter unit</p> <p>500h ⇄ 1000h ⇄ 2000h ⇄ 3000h ⇄ 4000h ⇄ 5000h ⇄ OFF</p> <p>After choosing an item except the OFF, the message the “REMINDER ***HRS PASSED” will appear after the timer reaches the interval time set by this feature (p.77).</p> <p>When the OFF is chosen, the message will not appear. Utilize this feature to keep the air filter clean, setting the suitable time according to your environment of this projector.</p> <ul style="list-style-type: none"> Please take care of the filter unit periodically, even if there is no message. If the air filter becomes to be blocked by dust or other matter, the internal temperature will rise, which could cause malfunction, or reduce the lifetime of the projector. Please be careful with the operating environment of the projector and the condition of the filter unit.

(continued on next page)

Item	Description
SERVICE (continued)	<p>KEY LOCK Using the ▲/▼ buttons turns on/off the key lock feature. When ON is selected, the buttons on the projector except the STANDBY/ON button are locked.</p> <p>ON ⇔ OFF</p> <ul style="list-style-type: none"> • Please use this function to prevent tampering or accidental operation. This function does not have any effect on the remote control.
	<p>LENS DOOR LOCK Use the ▲/▼ cursor buttons to turn on/off the LENS DOOR LOCK function. Set LENS DOOR LOCK to ON to keep the lens door open even when power is turned off. Follow cautions below when you set LENS DOOR LOCK to ON and keep the lens door open all the time.</p> <ul style="list-style-type: none"> • Do not apply excessive force on or allow impact to the lens door, as it incorporates a mirror. • Keep the projector out of the reach of children. • If the mirror is broken, the projected image will be distorted. Never touch a broken mirror. Close the lens door, and contact your dealer. <p>When the LENS DOOR LOCK is set to ON and the lens door is not open completely for some reason, the image may shift or have keystone distortion. In that case use the LENS DOOR OPEN function (📖 below) to open the lens door completely.</p>
	<p>LENS DOOR OPEN Use the LENS DOOR OPEN function to open the lens door if not open completely for some reason such as cleaning.</p>
	<p>LENS DOOR CLOSE Use the LENS DOOR CLOSE function to temporarily close the lens door when LENS DOOR LOCK is set to ON. Note that the lamp will be turned off when the lens door is closed. Press the STANDBY/ON button on the projector or the remote control to open the lens door and start the projector again.</p>
	<p>REMOTE RECEIV. (1) Select a remote sensor using ▲/▼ buttons. FRONT ⇔ TOP</p> <p>(2) Use the ◀/▶ button to change the projector's remote sensor on or off. ON ⇔ OFF</p> <ul style="list-style-type: none"> • A sensor cannot be turned off when the other one is off. Always at least one sensor is on.
	<p>REMOTE FREQ. (1) Use the ▲/▼ button to change the projector's remote sensor frequency setting. 1:NORMAL ⇔ 2:HIGH</p> <p>(2) Use the ◀/▶ button to change the projector's remote sensor on or off. ON ⇔ OFF</p> <p>The factory default setting is for both 1:NORMAL and 2:HIGH to be on. If the remote control does not function correctly, disable either of them (📖 16). It's not possible to disable both options at the same time.</p>

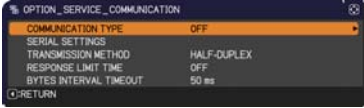

(continued on next page)

Item	Description	
<p>SERVICE (continued)</p>	<p>COMMUNICATION (continued)</p>	<p>Selecting this item displays COMMUNICATION menu. In this menu, you can configure the serial communication settings of the projector using the CONTROL port.</p>  <p>The screenshot shows a menu titled 'OPTION_SERVICE_COMMUNICATION' with a sub-menu 'COMMUNICATION TYPE' set to 'OFF'. Below it are 'SERIAL SETTINGS', 'TRANSMISSION METHOD' (set to 'HALF-DUPLEX'), 'RESPONSE LIMIT TIME' (set to 'OFF'), and 'BYTES INTERVAL TIMEOUT' (set to '50 ms'). A 'RETURN' button is at the bottom.</p> <ul style="list-style-type: none"> • Select an item using the cursor buttons ▲/▼. Then pressing the ► button opens the submenu for the setting item you selected. Or, pressing the ◀ button instead of the ► button makes the menu back to the previous one without changing the setup. Each submenu can be operated as described above. • When COMMUNICATION TYPE (📖55) is set to OFF, the other items in COMMUNICATION menu are invalid. • For the function of serial communication, refer to the User's Manual - Network Guide.



(continued on next page)

Item	Description
SERVICE (continued)	<p style="text-align: center; vertical-align: middle;"> COMMUNICATION (continued) </p> <p>COMMUNICATION TYPE Select the communication type for transmission via the CONTROL port.</p> <p style="padding-left: 40px;">NETWORK BRIDGE ⇔ OFF</p> <p><u>NETWORK BRIDGE</u>: Select this type, if it is required to control an external device as a network terminal, via this projector from the computer. The CONTROL port doesn't accept RS-232C commands. (☞ Controlling the external device via the projector (using the NETWORK BRIDGE function) of the User's Manual - Network Guide)</p> <p><u>OFF</u>: Select this mode to receive RS-232C commands using the CONTROL port.</p> <ul style="list-style-type: none"> • OFF is selected as the default setting. • When you select the NETWORK BRIDGE, check the item, TRANSMISSION METHOD (☞ <i>below</i>). <p>SERIAL SETTINGS Select the serial communication condition for the CONTROL port.</p> <p>BAUD RATE 4800bps ⇔ 9600bps ⇔ 19200bps ⇔ 38400bps ↑—————↑</p> <p>PARITY NONE ⇔ ODD ⇔ EVEN ↑—————↑</p> <ul style="list-style-type: none"> • The BAUD RATE is fixed to 19200bps and PARITY is fixed NONE when the COMMUNICATION TYPE is set to OFF (☞ <i>above</i>). <p>TRANSMISSION METHOD Select the transmission method for communication by the NETWORK BRIDGE from the CONTROL port.</p> <p style="padding-left: 40px;">HALF-DUPLEX ⇔ FULL-DUPLEX</p> <p><u>HALF-DUPLEX</u>: This method lets the projector make two way communication, but only one direction, either transmitting or receiving data, is allowed at a time.</p> <p><u>FULL-DUPLEX</u>: This method lets the projector make two way communication, transmitting and receiving data at the same time.</p> <ul style="list-style-type: none"> • HALF-DUPLEX is selected as the default setting. • When you select HALF-DUPLEX, check the items, RESPONSE LIMIT TIME and BYTES INTERVAL TIMEOUT (☞ 56).

(continued on next page)

Item	Description	
<p>SERVICE (continued)</p>	<p>COMMUNICATION (continued)</p>	<p>RESPONSE LIMIT TIME Select the time period to wait for receiving response data from other device communicating by the NETWORK BRIDGE and the HALF-DUPLEX through the CONTROL port.</p> <p>OFF ⇔ 1s ⇔ 2s ⇔ 3s ↑—————↑</p> <p><u>OFF</u>: Select this mode if it is not required to check the responses from the device that the projector sends data to. In this mode, the projector can send out data from the computer continuously.</p> <p><u>1s /2s /3s</u>: Select the time period to keep the projector waiting for response from the device that the projector sends data to. While waiting the response, the projector does not send out any data from the CONTROL port.</p> <ul style="list-style-type: none"> • This menu is available only when the NETWORK BRIDGE is selected for the COMMUNICATION TYPE and the HALF-DUPLEX is selected for the TRANSMISSION METHOD (p55). • OFF is selected as the default setting.
		<p>BYTES INTERVAL TIMEOUT Select the blank time length to judge that the response data has finished in the communicating in the condition of the NETWORK BRIDGE and the HALF-DUPLEX through the CONTROL port.</p> <p>50ms ⇔ 100ms ⇔ 150ms ⇔ 200ms ↑—————↑</p> <ul style="list-style-type: none"> • This menu is available only when NETWORK BRIDGE is selected for the COMMUNICATION TYPE and HALF-DUPLEX is selected for the TRANSMISSION METHOD (p55). • 50ms is selected as the default setting.

(continued on next page)

Item	Description
SERVICE (continued)	<p>INFORMATION</p> <p>Selecting this item displays a dialog titled “INPUT_INFORMATION”. It shows the information about the current input.</p> <div style="display: flex; justify-content: space-around; align-items: center;">    </div> <ul style="list-style-type: none"> • The “FRAME LOCK” message on the dialog means the frame lock function is working. • This item can't be selected for no signal and sync out. • When the MY TEXT DISPLAY is set to ON, the MY TEXT is displayed together with the input information in the INPUT_INFORMATION box (📖68).
	<p>FACTORY RESET</p> <p>Selecting OK using the ► cursor button performs this function. By this function, all the items in all of menus will collectively return to the initial setting. Note that the LAMP TIME, FILTER TIME, LANGUAGE, FILTER MESSAGE, NETWORK, STANDBY MODE, SECURITY settings, and others are not reset.</p> <p>CANCEL ⇨ OK</p>

NETWORK menu

Remember that incorrect network settings on this projector may cause trouble on the network. Be sure to consult with your network administrator before connecting to an existing access point on your network.

Select "NETWORK" from the main menu to access the following functions.

Select an item using the ▲/▼ cursor buttons on the projector or remote control, and press the ► cursor button on the projector or remote control, or **ENTER** button on the remote control to execute the item. Then perform it according to the following table.

See the **User's Manual - Network Guide** for details of NETWORK operation.



NOTE • If you are not utilizing SNTP ([Date/Time Settings of the User's Manual - Network Guide](#)), then you must set the DATE AND TIME during the initial installation.

• The network communication control is disabled while the projector is in standby mode if the STANDBY MODE item of SETUP menu is set to SAVING. Please connect the network communication to the projector after setting the STANDBY MODE to NORMAL ([41](#)).

Item	Description	
<p>SETUP</p>	<p>Selecting this item displays the SETUP Menu for the network. Use the ▲/▼ buttons to select an item, and the ► or ENTER button on the remote control to perform the item.</p> 	
	<p>DHCP (Dynamic Host Configuration Protocol)</p>	<p>Use the ▲/▼ buttons to turn DHCP on/off. ON ⇔ OFF</p> <p>Select OFF when the network does not have DHCP enabled.</p> <ul style="list-style-type: none"> • When the "DHCP" setting changes to "ON", it takes a little time to obtain IP address from DHCP server. • Auto IP function will be assigned an IP address if the projector could not obtain an IP address from server even if DHCP is "ON".

(continued on next page)



Item	Description	
SETUP (continued)	IP ADDRESS	<p>Use the ▲/▼/◀/▶ buttons to enter the IP ADDRESS.</p> <p>This function can only be used when DHCP is set to OFF.</p> <ul style="list-style-type: none"> • The IP ADDRESS is the number that identifies this projector on the network. You cannot have two devices with the same IP ADDRESS on the same network. • The IP ADDRESS “0.0.0.0” is prohibited.
	SUBNET MASK	<p>Use the ▲/▼/◀/▶ buttons to enter the same SUBNET MASK used by your computer.</p> <p>This function can only be used when DHCP is set to OFF.</p> <ul style="list-style-type: none"> • The SUBNET MASK “0.0.0.0” is prohibited.
	DEFAULT GATEWAY	<p>Use the ▲/▼/◀/▶ buttons to enter the DEFAULT GATEWAY (a node on a computer network that serves as an access point to another network) address.</p> <p>This function can only be used when DHCP is set to OFF.</p>
	DNS SERVER	<p>Use the ▲/▼/◀/▶ buttons to input the DNS server address.</p> <p>The DNS server is a system to control domain names and IP addresses on the Network.</p>
	TIME DIFFERENCE	<p>Use the ▲/▼ buttons to enter the TIME DIFFERENCE.</p> <p>Set the same TIME DIFFERENCE as the one set on your computer. If unsure, consult your IT manager.</p> <p>Use the ▶ button to return to the menu after setting the TIME DIFFERENCE.</p>
	DATE AND TIME	<p>Use the ▲/▼/◀/▶ buttons to enter the Year (last two digits), Month, Date, Hour and Minute.</p> <ul style="list-style-type: none"> • The projector will override this setting and retrieve DATE AND TIME information from the Time server when SNTP is enabled. (📖 Date/Time Settings of the User’s Manual - Network Guide)

(continued on next page)

Item	Description
<p>PROJECTOR NAME</p>	<p>(1) Use the ▲/▼ buttons on the NETWORK menu to select the PROJECTOR NAME and press the ► button. The PROJECTOR NAME dialog will be displayed.</p> <p>(2) The current PROJECTOR NAME will be displayed on the first 3 lines. If not yet written, the lines will be blank.</p> <p>Use the ▲/▼/◀/► buttons and the ENTER or INPUT button to select and enter characters.</p> <p>To erase 1 character at one time, press the RESET button or press the ◀ and INPUT button at the same time. Also if you move the cursor to DELETE or ALL CLEAR on screen and push the ENTER or INPUT button, 1 character or all characters will be erased. The PROJECTOR NAME can be input up to 64 characters.</p> <p>(3) To change an already inserted character, press the ▲/▼ button to move the cursor to one of the first 3 lines, and use the ◀/► buttons to move the cursor on the character to be changed. After pressing the ENTER or INPUT button, the character is selected. Then, follow the same procedure as described at the item (2) above.</p> <p>(4) To finish entering text, move the cursor to the OK on screen and press the ►, ENTER or INPUT button. To revert to the previous PROJECTOR NAME without saving changes, move the cursor to the CANCEL on screen and press the ◀, ENTER or INPUT button.</p>

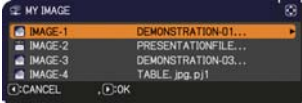

(continued on next page)

Item	Description
<p>MY IMAGE</p>	<p>Selecting this item displays the MY IMAGE menu.</p> <p>The application software “PJImage” is required to store image(s) into the projector.</p> <p>Use the ▲/▼ buttons to select an item which is a still image by the MY IMAGE ( MY IMAGE (Still Image Transfer) Display of the User’s Manual - Network Guide) and the ► or ENTER button to display the image.</p> <ul style="list-style-type: none"> • The item without image stored cannot be selected. • The image names are each displayed in 16 characters or less. <p>To switch the image displayed Use the ▲/▼ buttons.</p> <p>To return to the menu Press the ◀ button on the remote control.</p> <p>To erase the image displayed and its source file in the projector.</p> <p>(1) Press the RESET button on the remote control while displaying an image to display the MY IMAGE DELETE menu.</p>  <p>(2) Press the ► button to perform to erase. To stop erasing, press the ◀ button.</p> 
<p>AMX D.D. (AMX Device Discovery)</p>	<p>Use the ▲/▼ buttons to turn the AMX Device Discovery on/off. ON ⇔ OFF</p> <p>When ON is selected, the projector can be detected by controllers of AMX connected to the same network. For the details of AMX Device Discovery, visit the AMX web site. <u>URL: http://www.amx.com/</u></p>

(continued on next page)

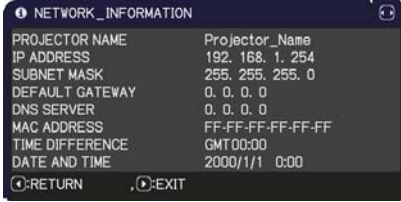
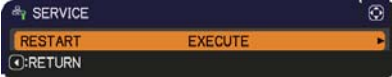
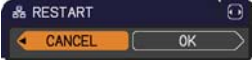
Item	Description
<p>INFORMATION</p>	<p>Selecting this item displays the NETWORK_INFORMATION dialog for confirming the network settings.</p>  <ul style="list-style-type: none"> • Only the first 16 characters of the projector name are displayed. • Nothing (blank) is shown in the “PROJECTOR NAME” field until you setup the item (☞60). • When the voltage level of the battery for the built in clock decreases, the set time may become incorrect even though accurate date and time are input. Replace the battery suitably (☞73). • IP ADDRESS, SUBNET MASK and DEFAULT GATEWAY indicate “0.0.0.0” when DHCP is ON and the projector has not gotten address from DHCP server.
<p>SERVICE</p>	<p>Executing this item restarts and initializes the network functions. Choose the RESTART EXECUTE using the button ►.</p>  <p>Then use the button ► to execute.</p>  <p>Network will be once cut off when choose restart. If DHCP is selected on, IP address may be changed. After selecting RESTART EXECUTE, NETWORK menu may not be controlled approx. 30 seconds.</p>

SECURITY menu

This projector is equipped with security functions. From the SECURITY menu, items shown in the table below can be performed.

To use SECURITY menu: User registration is required before using the security functions.



Enter the SECURITY menu

- Use the ▲/▼ cursor buttons on the SECURITY menu to select ENTER PASSWORD and press the ► cursor (or the **ENTER**) button. The ENTER PASSWORD box will be displayed.
- Use the ▲/▼/◀/▶ cursor buttons to enter the registered password. The factory default password is **3410**. This password can be changed (see **below**). Move the cursor to the right side of the ENTER PASSWORD box and press the ► cursor (or the **ENTER**) button to display the SECURITY menu.
 - It is strongly recommended the factory default password to be changed as soon as possible.
 - If an incorrect password is input, the ENTER PASSWORD box will be displayed again. If incorrect password is input 3 times, the projector will turn off. Afterwards the projector will turn off every time an incorrect password is input.
- Items shown in the table below can be performed.



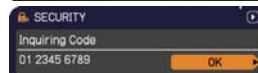

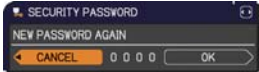
If you have forgotten your password

- While the ENTER PASSWORD box is displayed, press and hold the **RESET** (or press the ◀ cursor and the **INPUT** buttons at the same time) button for about 3 seconds.
- The 10 digit Inquiring Code will be displayed. Contact your dealer with the 10 digit Inquiring Code. Your password will be sent after your user registration information is confirmed.
 - If there is no key input for about 55 seconds while the Inquiring Code is displayed, the menu will close. If necessary, repeat the process from (1).



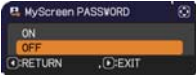

Item	Description
<p>SECURITY PASSWORD CHANGE</p>	<ol style="list-style-type: none"> Use the ▲/▼ cursor buttons on the SECURITY menu to select SECURITY PASSWORD CHANGE and press the ► cursor (or the ENTER) button to display the ENTER NEW PASSWORD box.  Use the ▲/▼/◀/▶ cursor buttons to enter the new password. Move the cursor to the right side of the ENTER NEW PASSWORD box and press the ► cursor (or the ENTER) button to display the NEW PASSWORD AGAIN box, enter the same password again.  Move the cursor to the right side of the NEW PASSWORD AGAIN box and press the ► cursor (or the ENTER) button and the NOTE NEW PASSWORD box will be displayed for about 30 seconds, please make note of the password during this time. Pressing the ► cursor (or the ENTER) button will close the NOTE NEW PASSWORD box.  <ul style="list-style-type: none"> Please do not forget your password.

(continued on next page)

Item	Description
<p>MyScreen PASSWORD</p>	<p>The MyScreen PASSWORD function can be used to prohibit access to the MyScreen function and prevent the currently registered MyScreen image from being overwritten.</p> <p>1 Turning on the MyScreen PASSWORD</p> <p>1-1 Use the ▲/▼ cursor buttons on the SECURITY menu to select MyScreen PASSWORD and press the ► cursor (or the ENTER) button to display the MyScreen PASSWORD on/off menu.</p>  <p>1-2 Use the ▲/▼ cursor buttons on the MyScreen PASSWORD on/off menu to select ON. The ENTER NEW PASSWORD box (small) will be displayed.</p>  <p>1-3 Use the ▲/▼/◀/▶ cursor buttons to enter the password. Move the cursor to the right side of the ENTER NEW PASSWORD box (small) and press the ► cursor (or the ENTER) button to display the NEW PASSWORD AGAIN box, enter the same PASSWORD again.</p>  <p>1-4 Move the cursor to the right side of the NEW PASSWORD AGAIN box and press the ► cursor (or the ENTER) button to display the NOTE NEW PASSWORD box for about 30 seconds, please make note of the password during this time.</p>  <p>Pressing the ► cursor (or the ENTER) button will return to the MyScreen PASSWORD on/off menu.</p> <p>When a password is set for the MyScreen:</p> <ul style="list-style-type: none"> • The MyScreen registration function (and menu) will be unavailable. • The MyScreen Lock menu will be unavailable. • The START UP setting will be locked on MyScreen (and the menu will be unavailable). <p>Turning the MyScreen PASSWORD off will allow normal operation of these functions.</p> <ul style="list-style-type: none"> • Please do not forget your MyScreen PASSWORD. <p>2 Turning off the MyScreen PASSWORD</p> <p>2-1 Follow the procedure in 1-1 to display the MyScreen PASSWORD on/off menu.</p> <p>2-2 Select the OFF to display the ENTER PASSWORD box (large). Enter the registered password and the screen will return to the MyScreen PASSWORD on/off menu.</p>  <p>If an incorrect PASSWORD is input, the menu will close. If necessary, repeat the process from 2-1.</p> <p>3 If you have forgotten your password</p> <p>3-1 Follow the procedure in 1-1 to display the MyScreen PASSWORD on/off menu.</p> <p>3-2 Select the OFF to display the ENTER PASSWORD box (large). The 10 digit Inquiring Code will be displayed inside the box.</p> <p>3-3 Contact your dealer with the 10 digit Inquiring Code. Your password will be sent after your user registration information is confirmed.</p>

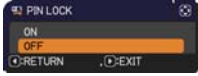

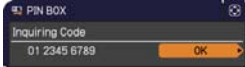

(continued on next page)

Item	Description
PIN LOCK	<p>The PIN LOCK is a function which prevents the projector from being used unless a registered Code is input.</p> <p>1 Turning on the PIN LOCK</p> <p>1-1 Use the ▲/▼ cursor buttons on the SECURITY menu to select PIN LOCK and press the ► cursor (or the ENTER) button to display the PIN LOCK on/off menu.</p>  <p>1-2 Use the ▲/▼ cursor buttons on the PIN LOCK on/off menu to select ON and the Enter PIN Code box will be displayed.</p>  <p>1-3 Input a 4 part PIN code using the ▲/▼/◀/▶ cursor and the COMPUTER (or the INPUT) button.</p> <p>The PIN Code again box will appear. Reenter the same PIN code. This will complete the PIN code registration.</p>  <ul style="list-style-type: none"> • If there is no key input for about 55 seconds while the Enter PIN Code box or the PIN Code again box is displayed, the menu will close. If necessary, repeat the process from 1-1. <p>Afterwards, anytime the projector is restarted after AC power is turned off the Enter PIN Code box will be displayed. Enter the registered PIN code. The projector can be used after entering the registered PIN code. If an incorrect PIN code is input, the Enter PIN code box will be displayed again. If an incorrect PIN Code is input 3 times, the projector will turn off. Afterwards the projector will turn off every time an incorrect PIN code is input. The projector will also turn off if there is no key input for about 5 minutes while the Enter PIN code box is displayed. This function will activate only when the projector is started after AC power is turned off.</p> <ul style="list-style-type: none"> • Please do not forget your PIN code. <p>2 Turning off the PIN LOCK</p> <p>2-1 Follow the procedure in 1-1 to display the PIN LOCK on/off menu.</p> <p>2-2 Use the ▲/▼ cursor buttons to select the OFF and the Enter PIN Code box will be displayed.</p> <p>Enter the registered the PIN code to turn the PIN LOCK function off.</p> <p>If an incorrect the PIN Code is input 3 times, the menu will close.</p> <p>3 If you have forgotten your PIN Code</p> <p>3-1 While the Enter PIN Code box is displayed, press and hold the RESET (or press the ◀ cursor and the INPUT buttons at the same time) button for 3 seconds.</p> <p>The 10 digit Inquiring Code will be displayed.</p>  <ul style="list-style-type: none"> • If there is no key input for about 5 minutes while the Inquiring Code is displayed, the projector will turn off. <p>3-2 Contact your dealer with the 10 digit Inquiring Code. Your PIN Code will be sent after your user registration information is confirmed.</p>

(continued on next page)

Item	Description
<p>TRANSITION DETECTOR</p>	<ul style="list-style-type: none"> • Transition Detector alarm shown below might appear on screen, if the projector has been moved or re-installed. • Transition Detector alarm might appear on screen, if the MIRROR setting has been changed. • To display the signal again, set this function to the OFF. • After about 5 minutes of displaying the TRANSITION DETECTOR ON alarm, the lamp will turn off. • Keystone adjustment feature has been prohibited as long as the Transition Detector function is on. <div data-bbox="848 178 1032 300" style="border: 1px solid gray; padding: 5px; margin-bottom: 10px;"> <p><<TRANSITION DETECTOR On>> The projector has been transferred from previously installed position. If you wish to have a square image on screen again, disable Transition Detector on Menu.</p> </div> <p>1 Turning on the TRANSITION DETECTOR</p> <p>1-1 Use the ▲/▼ cursor buttons on the SECURITY menu to select the TRANSITION DETECTOR and press the ► cursor (or the ENTER) button to display the TRANSITION DETECTOR on/off menu.</p> <div data-bbox="837 466 1032 539" style="border: 1px solid gray; padding: 5px; margin-bottom: 10px;"> <p>TRANSITION DETECTOR</p> <p>ON</p> <p>OFF</p> <p>◀ RETURN ▶ EXIT</p> </div> <p>1-2 Use the ▲/▼ cursor buttons on the TRANSITION DETECTOR on/off menu to select the ON. Select the ON and the current angle and the MIRROR setting will be recorded. The ENTER NEW PASSWORD box (small) will be displayed.</p> <div data-bbox="792 587 1032 660" style="border: 1px solid gray; padding: 5px; margin-bottom: 10px;"> <p>TRANSITION DETECTOR</p> <p>ENTER NEW PASSWORD</p> <p>< CANCEL 0 0 0 0 OK ></p> </div> <p style="text-align: center;">ENTER NEW PASSWORD box (small)</p> <p>1-3 Use the ▲/▼/◀/▶ cursor buttons to enter a password. Move the cursor to the right side of the ENTER NEW PASSWORD box (small) and press the ► cursor (or the ENTER) button to display the NEW PASSWORD AGAIN box, enter the same password again.</p> <div data-bbox="792 737 1032 810" style="border: 1px solid gray; padding: 5px; margin-bottom: 10px;"> <p>TRANSITION DETECTOR</p> <p>NEW PASSWORD AGAIN</p> <p>< CANCEL 0 0 0 0 OK ></p> </div> <p>1-4 Move the cursor to the right side of the NEW PASSWORD AGAIN box and press the ► cursor (or the ENTER) button to display the NOTE NEW PASSWORD box for about 30 seconds, please make note of the password during this time.</p> <div data-bbox="792 858 1032 932" style="border: 1px solid gray; padding: 5px; margin-bottom: 10px;"> <p>TRANSITION DETECTOR</p> <p>NOTE NEW PASSWORD</p> <p>0 0 0 0 OK ></p> </div> <p>Pressing the ► cursor (or the ENTER) button will return to the TRANSITION DETECTOR on/off menu.</p> <ul style="list-style-type: none"> • Please do not forget your TRANSITION DETECTOR password. • This function will activate only when the projector is started after turning off the AC power. • This feature may not function properly if the projector is not in a stable position when the ON is selected. <p>2 Turning off the TRANSITION DETECTOR</p> <p>2-1 Follow the procedure in 1-1 to display the TRANSITION DETECTOR on/off menu.</p> <p>2-2 Select the OFF to display the ENTER PASSWORD box (large). Enter the registered password and the screen will return to the TRANSITION DETECTOR on/off menu.</p> <div data-bbox="792 1216 1032 1289" style="border: 1px solid gray; padding: 5px; margin-bottom: 10px;"> <p>TRANSITION DETECTOR</p> <p>ENTER PASSWORD</p> <p>Inquiring Code 01 2345 5789</p> <p>< CANCEL 0 0 0 0 OK ></p> </div> <p style="text-align: center;">ENTER PASSWORD box (large)</p> <p>If an incorrect password is input, the menu will close. If necessary, repeat the process from 2-1.</p> <p>3 If you have forgotten your password</p> <p>3-1 Follow the procedure in 1-1 to display the TRANSITION DETECTOR on/off menu.</p> <p>3-2 Select the OFF to display the ENTER PASSWORD box (large). The 10 digit Inquiring Code will be displayed inside the box.</p> <p>3-3 Contact your dealer with the 10 digit Inquiring Code. Your password will be sent after your user registration information is confirmed.</p>

(continued on next page)

Item	Description
<p>MY TEXT PASSWORD</p>	<p>The MY TEXT PASSWORD function can prevent the MY TEXT from being overwritten. When the password is set for the MY TEXT;</p> <ul style="list-style-type: none"> • The MY TEXT DISPLAY menu will be unavailable, which can prohibit changing the DISPLAY setting. • The MY TEXT WRITING menu will be unavailable, which can prevent the MY TEXT from being overwritten. <p>1 Turning on the MY TEXT PASSWORD</p> <p>1-1 Use the ▲/▼ cursor buttons on the SECURITY menu to select the MY TEXT PASSWORD and press the ► cursor (or the ENTER) button to display the MY TEXT PASSWORD on/off menu.</p>  <p>1-2 Use the ▲/▼ cursor buttons on the MY TEXT PASSWORD on/off menu to select the ON. The ENTER NEW PASSWORD box (small) will be displayed.</p>  <p>1-3 Use the ▲/▼/◀/▶ cursor buttons to enter the password. Move the cursor to the right side of the ENTER NEW PASSWORD box (small) and press the ► cursor (or the ENTER) button to display the NEW PASSWORD AGAIN box, and then enter the same password again.</p>  <p>1-4 Move the cursor to the right side of the NEW PASSWORD AGAIN box and press the ► cursor (or the ENTER) button to display the NOTE NEW PASSWORD box for about 30 seconds, then please make note of the password during this time.</p>  <p>Pressing the ► cursor (or the ENTER) button will return to the MY TEXT PASSWORD on/off menu.</p> <p>2 Turning off the MY TEXT PASSWORD</p> <p>2-1 Follow the procedure in 1-1 to display the MY TEXT PASSWORD on/off menu.</p> <p>2-2 Select the OFF to display the ENTER PASSWORD box (large). Enter the registered password and the screen will return to the MY TEXT PASSWORD on/off menu.</p>  <p>If an incorrect password is input, the menu will close. If necessary, repeat the process from 2-1.</p> <p>3 If you have forgotten your password</p> <p>3-1 Follow the procedure in 1-1 to display the MY TEXT PASSWORD on/off menu.</p> <p>3-2 Select the OFF to display the ENTER PASSWORD box (large). The 10 digit inquiring code will be displayed inside the box.</p> <p>3-3 Contact your dealer with the 10 digit inquiring code. Your password will be sent after your user registration information is confirmed.</p>

(continued on next page)

Item	Description
<p>MY TEXT DISPLAY</p>	<p>(1) Use the ▲/▼ cursor buttons on the SECURITY menu to select the MY TEXT DISPLAY and press the ► cursor (or the ENTER) button to display the MY TEXT DISPLAY on/off menu.</p> <p>(2) Use the ▲/▼ cursor buttons on the MY TEXT DISPLAY on/off menu to select on or off. ON ⇔ OFF</p> <p>When it is set to the ON, the MY TEXT will be displayed on the START UP screen and the INPUT_INFORMATION when the INFORMATION on the SERVICE menu is chosen.</p> <ul style="list-style-type: none"> • This function is available only when the MY TEXT PASSWORD function is set to the OFF.
<p>MY TEXT WRITING</p>	<p>(1) Use the ▲/▼ cursor buttons on the SECURITY menu to select the MY TEXT WRITING and press the ► cursor (or the ENTER) button. The MY TEXT WRITING dialog will be displayed.</p> <p>(2) The current the MY TEXT will be displayed on the first 3 lines. If not yet written, the lines will be blank. Use the ▲/▼/◀/▶ cursor buttons and the ENTER (or the INPUT) button to select and enter characters. To erase 1 character at one time, press the RESET (or press the ◀ cursor and the INPUT buttons at the same time) button. Also if you move the cursor to the DELETE or the ALL CLEAR on screen and press the ENTER (or the INPUT) button, 1 character or all characters will be erased. The MY TEXT can be input up to 24 characters on each line.</p> <p>(3) To change an already inserted character, press the ▲/▼ cursor button to move the cursor to one of the first 3 lines, and use the ◀/▶ cursor buttons to move the cursor on the character to be changed. After pressing the ENTER (or the INPUT) button, the character is selected. Then, follow the same procedure as described at the item (2) above.</p> <p>(4) To finish entering text, move the cursor to the OK on screen and press the ► cursor (or the ENTER/the INPUT) button. To revert to the previous MY TEXT without saving changes, move the cursor to the CANCEL on screen and press the ◀ cursor (or the ENTER/the INPUT) button.</p> <ul style="list-style-type: none"> • The MY TEXT WRITING function is available only when the MY TEXT PASSWORD function is set to the OFF.



Maintenance

Replacing the lamp

A lamp has finite product life. Using the lamp for long periods of time could cause the pictures darker or the color tone poor. Note that each lamp has a different lifetime, and some may burst or burn out soon after you start using them.

Preparation of a new lamp and early replacement are recommended. To prepare a new lamp, make contact with your dealer and tell the lamp type number.

Type number : DT01091

1. Turn the projector off, and unplug the power cord.
Allow the projector to cool for at least 45 minutes.
2. Prepare a new lamp. If the projector is mounted on a ceiling, or if the lamp has broken, also ask the dealer to replace the lamp.

In case of replacement by yourself, follow the following procedure.

3. You can open the lens door by hand. Hold both sides of the lens door as shown in the figure. Open the lens door slowly in the direction of the arrow till it clicks. Do not touch the surface of the mirror when you open the lens door.

4. Loosen the screw (marked by arrow) of the lamp cover and then slide and lift the lamp cover to the side to remove it.

5. Loosen the 2 screws (marked by arrow) of the lamp, and slowly pick up the lamp by the handles. **Never** loosen any other screws.

6. Insert the new lamp, and retighten firmly the 2 screws of the lamp that are loosened in the previous process to lock it in place.

7. While putting the interlocking parts of the lamp cover and the projector together, slide the lamp cover back in place. Then firmly fasten the screw of the lamp cover.

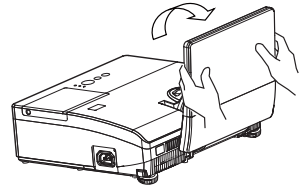
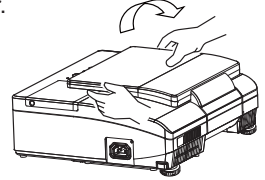

lamp cover

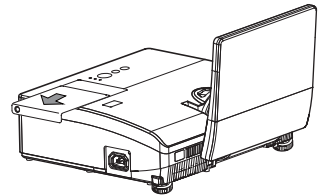
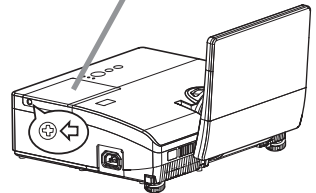

Handles

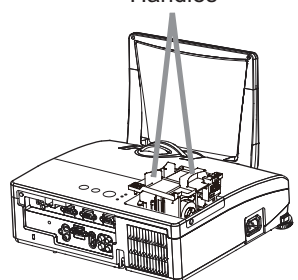
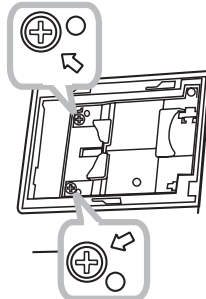

8. Follow the procedure below to close the lens door properly.

- (1) Insert the power cord with the lens door opened.
- (2) The power indicator will light in orange, and the lens door closes automatically. Do not touch the lens door when the door is closing. Do not allow anything to obstruct the lens door.

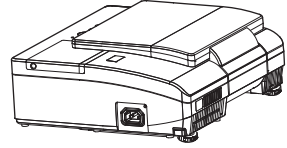

9. Turn the projector on and reset the lamp time using the LAMP TIME item in the OPTION menu.

- (1) Press the **MENU** button to display a menu.
- (2) Point at the **ADVANCED MENU** in the menu using the ▲/▼ cursor buttons, then press the ► cursor (or the **ENTER**) button.
- (3) Point at the **OPTION** in the left column of the menu using the ▲/▼ cursor buttons, then press the ► cursor (or the **ENTER**) button.
- (4) Point at the **LAMP TIME** using the ▲/▼ cursor buttons, then press the ► cursor (or the **ENTER** / the **RESET**) button. A dialog will appear.
- (5) Press the ► cursor button to select the “OK” on the dialog. It performs resetting the lamp time.

⚠ WARNING ► Be careful not to pinch your finger with the lens door, to prevent an injury.

⚠ CAUTION ► Do not touch any inner space of the projector, while the lamp is taken out.

NOTE • Please reset the lamp time only when you have replaced the lamp, for a suitable indication about the lamp.

- When the lens door is closed manually, it may not shut properly.
- The lens door may not close when the **LENS DOOR LOCK** function of the **SERVICE** item in the **OPTION** menu is set to **ON**. Refer to the **LENS DOOR LOCK** function of the **SERVICE** item in the **OPTION** menu ([p.53](#)).

Replacing the lamp (continued)

Lamp warning

 **HIGH VOLTAGE**  **HIGH TEMPERATURE**  **HIGH PRESSURE**

⚠ WARNING ▶ The projector uses a high-pressure mercury glass lamp. The lamp can break with a loud bang, or burn out, if jolted or scratched, handled while hot, or worn over time. Note that each lamp has a different lifetime, and some may burst or burn out soon after you start using them. In addition, if the bulb bursts, it is possible for shards of glass to fly into the lamp housing, and for gas containing mercury and dust containing fine particles of glass to escape from the projector's vent holes.

▶ **About disposal of a lamp:** This product contains a mercury lamp; do not put it in a trash. Dispose of it in accordance with environmental laws.

- For lamp recycling, go to www.lamprecycle.org (in the US).
- For product disposal, consult your local government agency or www.eiae.org (in the US) or www.epsc.ca (in Canada).

For more information, call your dealer.



Disconnect
the plug
from the
power
outlet

- If the lamp should break (it will make a loud bang when it does), unplug the power cord from the outlet, and make sure to request a replacement lamp from your local dealer. Note that shards of glass could damage the projector's internals, or cause injury during handling, so please do not try to clean the projector or replace the lamp yourself.
- If the lamp should break (it will make a loud bang when it does), ventilate the room well, and make sure not to inhale the gas or fine particles that come out from the projector's vent holes, and not to get them into your eyes or mouth.
- Before replacing the lamp, turn the projector off and unplug the power cord, then wait at least 45 minutes for the lamp to cool sufficiently. Handling the lamp while hot can cause burns, as well as damaging the lamp.



- Never unscrew except the appointed (marked by an arrow) screws.
- Do not open the lamp cover while the projector is suspended from a ceiling. This is dangerous, since if the lamp's bulb has broken, the shards will fall out when the cover is opened. In addition, working in high places is dangerous, so ask your local dealer to have the lamp replaced even if the bulb is not broken.
- Do not use the projector with the lamp cover removed. At the lamp replacing, make sure that the screws are screwed in firmly. Loose screws could result in damage or injury.



- Use only the lamp of the specified type. Use of a lamp that does not meet the lamp specifications for this model could damage or shorten the life of this product.
- If the lamp breaks soon after the first time it is used, it is possible that there are electrical problems elsewhere besides the lamp. If this happens, consult your local dealer or a service representative.
- Handle with care: jolting or scratching could cause the lamp bulb to burst during use.
- Using the lamp for long periods of time, could cause it dark, not to light up or to burst. When the pictures appear dark, or when the color tone is poor, please replace the lamp as soon as possible. Do not use old (used) lamps; this is a cause of breakage.

Cleaning and replacing the air filter

The air filter has two kinds of filters inside. Please check and clean the air filter periodically. When the indicators or a message prompts you to clean the air filter, comply with it as soon as possible. If the filters are damaged or heavily soiled, replace them with the new ones. To prepare the new filters, make contact with your dealer and tell the following type number.

Type number : UX35971 (Filter unit)

When you replace the lamp, please replace the air filter. An air filter of specified type will come together with a replacement lamp for this projector.

1. Turn the projector off, and unplug the power cord.
Allow the projector to sufficiently cool down.
2. Use a vacuum cleaner on and around the filter cover.
3. Pick and pull up the filter cover knobs to take it off.
4. Use a vacuum cleaner for the filter vent of the projector.
5. Take the fine meshed filter out while holding the filter cover. It is recommended to leave the coarse meshed filter in the filter cover as it is.
6. Use a vacuum cleaner on both sides of the fine meshed filter while holding it so it will not be sucked in. Use a vacuum cleaner for the inside of the filter cover to clean up the coarse meshed filter. If the filters are damaged or heavily soiled, replace them with new ones.
7. Put the fine meshed filter on the coarse meshed one, turning its stitched side up.
8. Put the filter unit back into the projector.
9. Turn the projector on and reset the filter time using the FILTER TIME item in the EASY MENU.
 - (1) Press the **MENU** button to display a menu.
 - (2) Point at the FILTER TIME using the ▲/▼ cursor buttons, then press the ► cursor (or the **ENTER** / the **RESET**) button. A dialog will appear.
 - (3) Press the ► cursor button to select the "OK" on the dialog. It performs resetting the filter time.

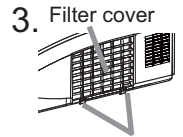
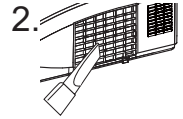

Filter cover knobs

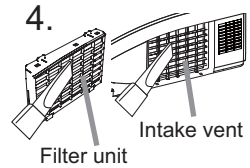

Filter unit

Intake vent

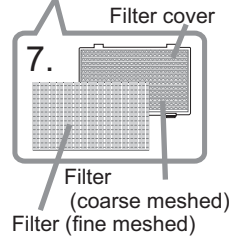

Filter (coarse meshed)
Filter (fine meshed)

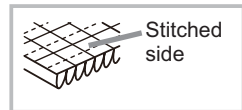

Stitched side

⚠ WARNING ▶ Before taking care of the air filter, make sure the power cable is not plugged in, then allow the projector to cool sufficiently.
 ▶ Use only the air filter of the specified type. Do not use the projector without the air filter or the filter cover. It could result in a fire or malfunction to the projector.
 ▶ Clean the air filter periodically. If the air filter becomes clogged by dust or the like, internal temperatures rise and could cause a fire, a burn or malfunction to the projector.

NOTE • Please reset the filter time only when you have cleaned or replaced the air filter, for a suitable indication about the air filter.
 • The projector may display the message such as the "CHECK THE AIR FLOW" or turn off the projector, to prevent the internal heat level rising.

Replacing the internal clock battery

Consumption of the battery makes the clock not to work correctly. When the clock is wrong or it has stopped, please replace the battery according to the following procedures..

1. Turn the projector off, and unplug the power cord. Allow the projector to cool sufficiently.
2. After making sure that the projector has cooled adequately, slowly turn over the projector, so that the bottom is facing.
3. Turn the battery cover fully in the direction indicated "OPEN" using a coin or the like, and pick the cover up to remove it.
4. Pry up the battery using a flathead screwdriver or the like to take it out. While prying it up, put a finger lightly on the battery since it may pop out of the holder.
5. Replace the battery with a new **HITACHI MAXELL**, Part No. **CR2032** or **CR2032H**. Slide the battery in under the plastic claw, and push it into the holder until it clicks.
6. Replace the battery cover in place, then turn it in the direction indicated "CLOSE" using such as coins, to fix.

Battery Cover

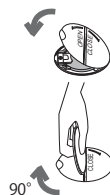
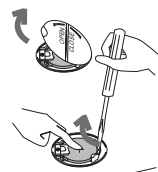
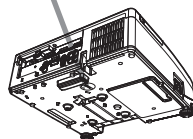

⚠ WARNING ▶ Always handle the batteries with care and use them only as directed. Battery may explode if mistreated. Do not recharge, disassemble or dispose of in fire.

And also improper use may result in cracking or leakage, which could result in fire, injury and/or pollution of the surrounding environment.

- Be sure to use only the batteries specified.
- Make sure the plus and minus terminals are correctly aligned when loading a battery.
- Keep a battery away from children and pets. If swallowed consult a physician immediately for emergency treatment.
- Do not short circuit or solder a battery.
- Do not allow a battery in a fire or water. Keep batteries in a dark, cool and dry place.
- If you observe battery leakage, wipe out the leakage and then replace a battery. If the leakage adheres to your body or clothes, rinse well with water immediately.
- Obey the local laws on disposing a battery.

Caring for the mirror and lens

If the projection mirror or lens is flawed, soiled or fogged, it could cause deterioration of display quality. Please take care of the mirror and lens, being cautious of handling.

1. Turn the projector off and unplug the power cord from the power outlet. And cool the projector down by leaving it for a while as it is.
2. The lens door can be opened manually. Please hold both side of the lens door and slowly open it until it is locked with clicking sound.
3. Wipe softly the mirror and lens with a cleaning cloth for lens on the market, being careful not to give any damage on the mirror and lens. For around edge of the mirror and lens where might be difficult to be wiped out, please use an air blower for cameras on the market to clean up.
4. To close the lens door properly, please take the following procedure.
 - (1) Insert the power cord with the lens door opened.
 - (2) The power indicator will light in orange, and the lens door closes automatically. Do not touch the lens door when the door is closing. Do not allow anything to obstruct the lens door.

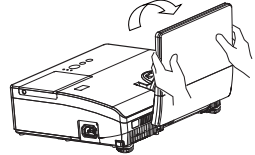
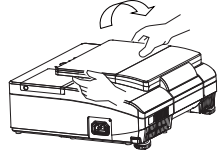

Cleaning cloth

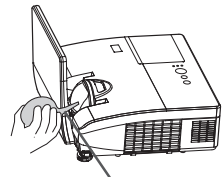
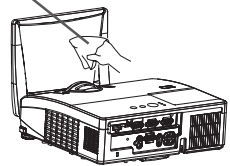

Blower

NOTE

- When the lens door is closed manually, it may not shut properly.
- The lens door may not close when the LENS DOOR LOCK function of the SERVICE item in the OPTION menu is set to ON. Refer to the LENS DOOR LOCK function of the SERVICE item in the OPTION menu ( 53).

⚠ WARNING ▶ Before caring for the projection mirror and lens, turn the projector off and unplug the power cord, then cool the projector sufficiently.
 ▶ Do not use a vacuum cleaner to clean the projection mirror or lens, since it might give some damage.
 ▶ Do not use cleaners or chemicals other than those specified in this manual. Pay special attention to the mirror and lens as these materials could cause serious damage to either.

⚠ CAUTION ▶ Be careful not to pinch your finger with the lens door, to prevent an injury.

Other care

Inside of the projector

In order to ensure the safe use of your projector, please have it cleaned and inspected by your dealer about once every year.

Caring for the cabinet and remote control

Incorrect care could have adverse influence such as discoloration, peeling paint, etc.

1. Turn the projector off, and unplug the power cord. Allow the projector to cool sufficiently.
2. After making sure that the projector is cool adequately, lightly wipe with gauze or a soft cloth.
If the projector is extremely dirty, dip soft cloth in water or a neutral cleaner diluted in water, and wipe lightly after wringing well. Then, wipe lightly with a soft, dry cloth.

⚠ WARNING ▶ Before caring, make sure the power cord is not plugged in, and then allow the projector to cool sufficiently. The care in a high temperature state of the projector could cause a burn and/or malfunction to the projector.

▶ Never try to care for the inside of the projector personally. Doing is so dangerous.

▶ Avoid wetting the projector or inserting liquids in the projector. It could result in a fire, an electric shock, and/or malfunction to the projector.

- Do not put anything containing water, cleaners or chemicals near the projector.
- Do not use aerosols or sprays.

⚠ CAUTION ▶ Please take right care of the projector according to the following. Incorrect care could cause not only an injury but adverse influence such as discoloration, peeling paint, etc.

▶ Do not use cleaners or chemicals other than those specified in this manual.

▶ Do not polish or wipe with hard objects.

Troubleshooting

If an abnormal operation should occur, stop using the projector immediately.





⚠ WARNING ▶ Never use the projector if abnormal operations such as smoke, strange odor, excessive sound, damaged casing or elements or cables, penetration of liquids or foreign matter, etc. should occur. In such cases, immediately disconnect the power plug from the power outlet. After making sure that the smoke or odor has stopped, contact to your dealer or service company.

Otherwise if a problem occurs with the projector, the following checks and measures are recommended before requesting repair. If this does not resolve the problem, please contact your dealer or service company. They will tell you what warranty condition is applied.

(continued on next page)

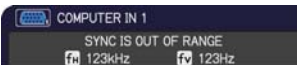
Related messages

When some message appears, check and cope with it according to the following table. Although these messages will be automatically disappeared around several minutes, it will be reappeared every time the power is turned on.

Message	Description
	<p>There is no input signal. Please confirm the signal input connection, and the status of the signal source.</p>
	<p>The horizontal or vertical frequency of the input signal is not within the specified range. Please confirm the specs for your projector or the signal source specs.</p>
	<p>An improper signal is input. Please confirm the specs for your projector or the signal source specs.</p>
	<p>The interior temperature is too high, or has increased or decreased in a short term. Please turn the power off, and allow the projector to cool down at least 20 minutes. After having confirmed the following items, please turn the power on again.</p> <ul style="list-style-type: none"> • Is there blockage of the air passage aperture? • Is the air filter dirty? • Does the peripheral temperature exceed 35°C? • Does warm or cool air from an air conditioner or similar unit blow on the projector directly? <p>If the same indication is displayed after the remedy, please set FAN SPEED of the SERVICE item in the OPTION menu to HIGH.</p>
	<p>A note of precaution when cleaning the air filter. Please immediately turn the power off, and clean or change the air filter referring to the “Cleaning and replacing the air filter” section of this manual. After you have cleaned or changed the air filter, please be sure to reset the filter time (📖50).</p>
	<p>The button operation is not available (📖6).</p>

Regarding the indicator lamps

When operation of the **POWER**, **TEMP** and **LAMP** indicators differs from usual, check and cope with it according to the following table.

POWER	TEMP	LAMP	Description
Lighting In Orange	Turned off	Turned off	The projector is in a standby state. Please refer to the section "Power on/off".
<i>Blinking</i> In Green	Turned off	Turned off	The projector is warming up. Please wait.
Lighting In Green	Turned off	Turned off	The projector is in an on state. Ordinary operations may be performed.
<i>Blinking</i> In Orange	Turned off	Turned off	The projector is cooling down. Please wait.
<i>Blinking</i> In Red	(discre- tionary)	(discre- tionary)	The projector is cooling down. A certain error has been detected. Please wait until POWER indicator finishes blinking, and then perform the proper measure using the item descriptions below.
<i>Blinking</i> In Red or Lighting In Red	Turned off	Lighting In Red	The lamp does not light, and there is a possibility that interior portion has become heated. Please turn the power off, and allow the projector to cool down at least 20 minutes. After the projector has sufficiently cooled down, please make confirmation of the following items, and then turn the power on again. <ul style="list-style-type: none"> • Is there blockage of the air passage aperture? • Is the air filter dirty? • Does the peripheral temperature exceed 35°C? If the same indication is displayed after the remedy, please change the lamp referring to the section "Replacing the lamp".
<i>Blinking</i> In Red or Lighting In Red	Turned off	<i>Blinking</i> In Red	The lamp cover has not been properly fixed. Please turn the power off, and allow the projector to cool down at least 45 minutes. After the projector has sufficiently cooled down, please make confirmation of the attachment state of the lamp cover. After performing any needed maintenance, turn the power on again. If the same indication is displayed after the remedy, please contact your dealer or service company.

(Continued on next page)

Regarding the indicator lamps (continued)

POWER	TEMP	LAMP	Description
Blinking In Red or Lighting In Red	Blinking In Red	Turned off	The cooling fan is not operating. Please turn the power off, and allow the projector to cool down at least 20 minutes. After the projector has sufficiently cooled down, please make confirmation that no foreign matter has become caught in the fan, etc., and then turn the power on again. If the same indication is displayed after the remedy, please contact your dealer or service company.
Blinking In Red or Lighting In Red	Lighting In Red	Turned off	There is a possibility that the interior portion has become heated. Please turn the power off, and allow the projector to cool down at least 20 minutes. After the projector has sufficiently cooled down, please make confirmation of the following items, and then turn the power on again. <ul style="list-style-type: none"> • Is there blockage of the air passage aperture? • Is the air filter dirty? • Does the peripheral temperature exceed 35°C? • Does air from an air conditioner or similar unit blow on the projector directly? If the same indication is displayed after the remedy, please set FAN SPEED of SERVICE item in OPTION menu to HIGH (52).
Lighting In Red	Turned off	Turned off	The lens door is not opened properly. One of the followings has been happened. <ul style="list-style-type: none"> • The lens door is not opened properly, when the projector is turned on. • The lens door position is shifted, while the projector is working. Restart the projector, after confirming that there is nothing that the lens door hits while opening or closing.
Lighting In Green	Simultaneous blinking in Red		It is time to clean the air filter. Please immediately turn the power off, and clean or change the air filter referring to the section “Cleaning and replacing the air filter”. After cleaning or changing the air filter, please be sure to reset the filter timer. After the remedy, reset the power to ON.
Lighting In Green	Alternative blinking in Red		There is a possibility that the interior portion has become overcooled. Please use the unit within the usage temperature parameters (5°C to 35°C). After the treatment, reset the power to ON.

(Continued on next page)

Regarding the indicator lamps (continued)

POWER	TEMP	LAMP	Description
Blinking In Green for approx. 3 seconds	Turned off	Turned off	At least 1 Power ON schedule is saved to the projector. Please refer to "Schedule Settings" section of User's Manual - Network Guide .

NOTE • When the interior portion has become overheated, for safety purposes, the projector is automatically shut down, and the indicator lamps may also be turned off. In such a case, disconnect the power cord, and wait at least 45 minutes. After the projector has sufficiently cooled down, please make confirmation of the attachment state of the lamp and lamp cover, and then turn the power on again.

Shutting the projector down

Only when the projector can not be turned off by usual procedure (19), please push the shutdown switch using a pin or similar, and disconnect the power plug from the power outlet. Before turning it on again, wait at least 10 minutes to make the projector cool down enough.

Shutdown switch

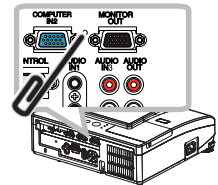

Resetting all settings

If it is hard to correct some wrong settings, the FACTORY RESET function of SERVICE item in OPTION menu (57) can reset all settings (except LANGUAGE, FILTER TIME, LAMP TIME, FILTER MESSAGE, NETWORK, STANDBY MODE, SECURITY settings, and others) to the factory default.

Phenomena that may be easy to be mistaken for machine defects

About the phenomenon confused with a machine defect, check and cope with it according to the following table.

Phenomenon	Cases not involving a machine defect	Reference page
Power does not come on.	The electrical power cord is not plugged in. Correctly connect the power cord.	18
	The main power source has been interrupted during operation such as by a power outage (blackout), etc. Please disconnect the power plug from the power outlet, and allow the projector to cool down at least 10 minutes, then turn the power on again.	18
	Either there is no lamp and/or lamp cover, or either of these has not been properly fixed. Please turn the power off and disconnect the power plug from the power outlet, and allow the projector to cool down at least 45 minutes. After the projector has sufficiently cooled down, please make confirmation of the attachment state of the lamp and lamp cover, and then turn the power on again.	69, 70, 71
Neither sounds nor pictures are outputted.	The signal cables are not correctly connected. Correctly connect the connection cables.	9
	Signal source does not correctly work. Correctly set up the signal source device by referring to the manual of the source device.	–
	The input changeover settings are mismatched. Select the input signal, and correct the settings.	20, 21
	The BLANK function for pictures and the MUTE function for sounds are working. AV MUTE may be active. Refer to the item “Sound does not come out” and “No pictures are displayed” on the next page to turn off the MUTE and BLANK functions.	20, 26, 51
Sound does not come out.	The signal cables are not correctly connected. Correctly connect the audio cables.	9
	The MUTE function is working. Restore the sound pressing MUTE or VOLUME +/- button on the remote control.	20
	The volume is adjusted to an extremely low level. Adjust the volume to a higher level using the menu function or the remote control.	20

(Continued on next page)

Phenomena that may be easy to be mistaken for machine defects (continued)

Phenomenon	Cases not involving a machine defect	Reference page
Sound does not come out.	The AUDIO SOURCE/SPEAKER setting is not correct. Correctly set the AUDIO SOURCE/SPEAKER in AUDIO menu.	42
	The audio on your HDMI equipment is not set to Linear PCM. The HDMI input on this projector supports Linear PCM audio only. Check the audio setting on your HDMI equipment.	12
	The audio on the HDMI input is muted. Change the HDMI AUDIO setting in the AUDIO menu.	42
	The digital audio in HDMI signal does not work well. Use the analogue audio, connecting either an RCA audio cable or stereo mini cable.	9
No pictures are displayed.	The lens door is not fully opened. Turn the projector off, and then turn it on again to make sure that the door is opened correctly. Use the LENS DOOR OPEN function.	18,53
	The signal cables are not correctly connected. Correctly connect the connection cables.	9
	The brightness is adjusted to an extremely low level. Adjust BRIGHTNESS to a higher level using the menu function.	31
	The computer cannot detect the projector as a plug and play monitor. Make sure that the computer can detect a plug and play monitor using another plug and play monitor.	12
	The BLANK screen is displayed. Press the BLANK button on the remote control.	26
No pictures or disturbed pictures are displayed on HDMI input.	The HDMI cable is not correctly connected. Correctly connect the HDMI cable.	9
	Your HDMI equipment is not compatible with the projector. This projector can be connected with another equipment that has HDMI or DVI connector, but with some equipment the projector may not work properly.	12
	Your HDMI equipment and the projector are not harmonized. Turn off the both equipment, and turn on them again.	-
	The signal format on the HDMI is not supported. Check the video setting on your HDMI equipment.	12

(Continued on next page)

Phenomena that may be easy to be mistaken for machine defects (continued)

Phenomenon	Cases not involving a machine defect	Reference page
Video screen display freezes.	<p>The FREEZE function is working. Press the FREEZE button to restore the screen to normal.</p>	26
Colors have a faded- out appearance, or Color tone is poor.	<p>Color settings are not correctly adjusted. Perform picture adjustments by changing the COLOR TEMP, COLOR, TINT and/or COLOR SPACE settings, using the menu functions.</p>	32, 33, 36
	<p>COLOR SPACE setting is not suitable. Change the COLOR SPACE setting to AUTO, RGB, SMPTE240, REC709 or REC601.</p>	36
Pictures appear dark.	<p>The brightness and/or contrast are adjusted to an extremely low level. Adjust the BRIGHTNESS and/or the CONTRAST settings to a higher level using the menu function.</p>	31
	<p>The ECO MODE function is working. Select the NORMAL for the ECO MODE item in the SETUP menu.</p>	40
	<p>The lamp is approaching the end of its product lifetime. Replace the lamp.</p>	69, 70, 71
Pictures appear blurry.	<p>Either the focus and/or horizontal phase settings are not properly adjusted. Adjust the focus using the focus ring, and/or the H PHASE using the menu function.</p>	23, 35
	<p>The lens or mirror is dirty or fogged. Clean the lens or mirror referring to the section “Caring for the mirror and lens”.</p>	74
When the ASPECT is set to NATIVE, PICTURE POSITION does not work even if the vertical size of the displayed image does not fit visually on the effective display area.	<p>Vertical resolution of the input signal is equal to or more than the vertical resolution of display area that is determined by D-ZOOM adjustment value. Change input signal resolution or/and D-ZOOM adjustment value so that vertical resolution of the input signal is less than D-ZOOM adjustment value (40).</p>	40



(Continued on next page)

Phenomena that may be easy to be mistaken for machine defects (continued)

Phenomenon	Cases not involving a machine defect	Reference page
The picture is distorted or shifted.	Projector is tilted inappropriately. Adjust the projector's elevator feet.	17, 23
	Keystone is not corrected appropriately. Correct the keystone distortion.	25, 29, 40
	Lens door is not completely open. Use the LENS DOOR OPEN function.	53
No signal is output from the MONITOR OUT and AUDIO OUT ports.	The SAVING function is working in the standby state. Select the NORMAL for the STANDBY MODE item in the SETUP menu.	41
RS-232C does not work.		
RS-232C does not work.	The COMMUNICATION TYPE for the CONTROL port is set to NETWORK BRIDGE. Select OFF for COMMUNICATION TYPE item in the OPTION - SERVICE - COMMUNICATION menu.	55
Network does not work.	The SAVING function is working. Select the NORMAL for the STANDBY MODE item in the SETUP menu.	41
NETWORK BRIDGE function does not work.	The NETWORK BRIDGE function is turned off. Select NETWORK BRIDGE for COMMUNICATION TYPE item in the OPTION - SERVICE - COMMUNICATION menu.	55
Schedule function does not work.	The SAVING function is working. Select the NORMAL for the STANDBY MODE item in the SETUP menu.	41
Scheduled Power command does not work.	Some specific kinds of errors have been detected. Check the status of the POWER, TEMP, LAMP indicators on the control panel of the projector and take countermeasures referring to the table on page 78,79 and 80.	78, 79, 80
Scheduled Input Source command function does not work.	Security features are activated and the projector is locked. Please release the security lock.	63

(Continued on next page)

Phenomena that may be easy to be mistaken for machine defects (continued)

Phenomenon	Cases not involving a machine defect	Reference page
<p>Scheduled Display Image command does not work.</p>	<p>The lamp is turned off. If the projector is in the standby state, please press the STANDBY/ON button on the projector or the remote control to turn on the lamp. If the POWER, TEMP, LAMP indicators on the control panel of the projector represent some errors (such as temperature error, lamp error), take countermeasures referring to the table on page 78, 79 and 80 and then turn on the lamp.</p>	<p>18, 78, 79, 80</p>
	<p>Security features are activated and the projector is locked. Please release the security lock.</p>	<p>63</p>
	<p>Image data for display is not stored in the projector. No image data for display is registered in the specified data store number. Store image data for display in the projector. ( please refer to "3.5 MY IMAGE (Still Image Transfer) Display" in the Network guide.)</p>	<p>-</p>
<p>Scheduled Display Text command does not work.</p>	<p>The lamp is turned off. If the projector is in the standby state, please press the STANDBY/ON button on the projector or the remote control to turn on the lamp. If the POWER, TEMP, LAMP indicators on the control panel of the projector represent some errors (such as temperature error, lamp error), take countermeasures referring to the table on page 78, 79 and 80 and then turn on the lamp.</p>	<p>18, 78, 79, 80</p>
	<p>No text data for display is registered. No text data for display is registered in the specified data store number. Store the text data for display. ( please refer to "3.6 Messenger Function" in the Network guide.)</p>	<p>-</p>
	<p>High-priority text data is being displayed. ( please refer to "3.6 Messenger Function" in the Network guide and the application manual for the Messenger function.) The projector is forced to turn the lamp on and displayed the high-priority text data. Text display by the scheduling function will not start until the projector completes the display of high-priority text data.</p>	<p>-</p>

NOTE • Although bright spots or dark spots may appear on the screen, this is a unique characteristic of liquid crystal displays, and it does not constitute or imply a machine defect.

Specifications

Specifications

Item	Specification
Product name	Liquid crystal projector
Liquid Crystal Panel	1,024,000 pixels (1280 horizontal x 800 vertical)
Lamp	180 W UHB
Speaker	10 W
Power supply	AC 100-120V/3.1A, AC220-240V/1.5A
Power consumption	270 W
Temperature range	5 ~ 35°C (Operating)
Size	333 (W) x 118 (H) x 303 (D) mm * Not including protruding parts. Please refer to the following figure.
Weight (mass)	approx. 4.7 kg
Ports	<p>Computer input port COMPUTER IN1D-sub 15 pin mini x1 COMPUTER IN2D-sub 15 pin mini x1</p> <p>Computer output port MONITOR OUTD-sub 15 pin mini x1</p> <p>Video input port S-VIDEO..... mini DIN 4 pin x1 VIDEO RCA x1</p> <p>HDMI input port HDMIHDMI connector x1</p> <p>Audio input/output port AUDIO IN1..... Stereo mini x1 AUDIO IN2..... Stereo mini x1 AUDIO IN3 (R, L)..... RCA x2 AUDIO OUT (R, L)..... RCA x2</p> <p>Others CONTROL..... D-sub 9 pin x1 LAN..... RJ45 x1</p>
Optional parts	<p>Lamp: DT01091 Filter set: UX35971 Mounting accessory: HAS-AW100 (Bracket for ceiling mount) HAS-203L (Fixing adaptor for low ceilings) HAS-P100 (Fixing adaptor for high ceilings)</p> <p>Laser remote control: RC-R008 * For more information, please consult your dealer.</p>

Specifications (continued)

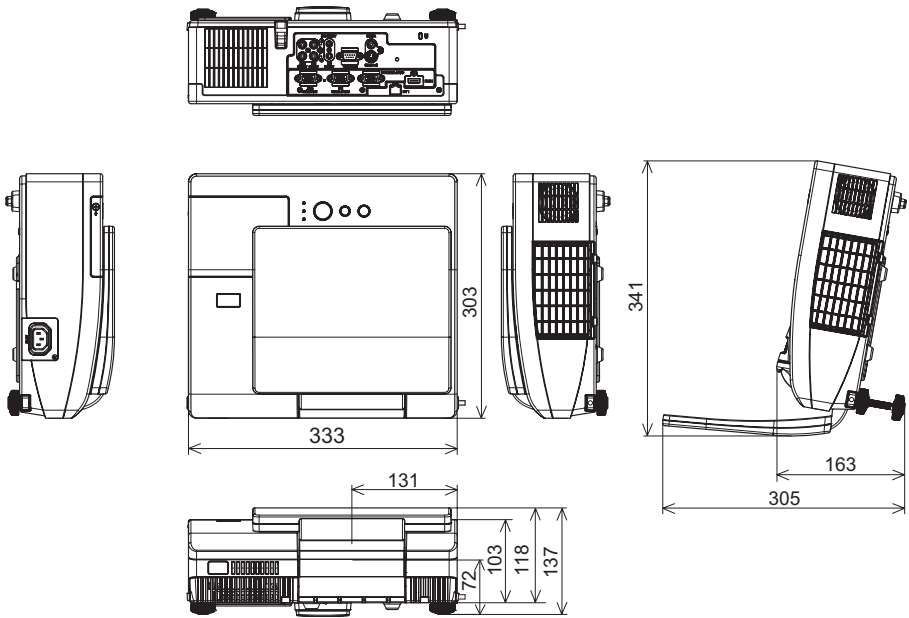

[unit: mm]

Projector

CP-AW100N

User's Manual (detailed) Network Guide

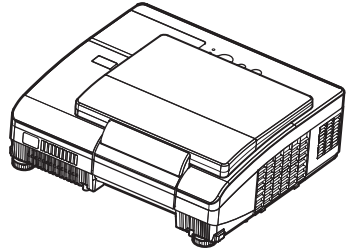

Thank you for purchasing this projector.

This projector has the network function that brings you the following main features.

✓ **Web control**

The projector can be controlled and monitored by a web browser software on your computer, which can help you to setup and maintain the projector.

✓ **MY IMAGE (Still Image Transfer) Display**

The projector can display still images that are transferred via the network.

✓ **Messenger Function**

The projector can display the text data transferred via the network on the screen.

This manual is only intended to explain Network function only.

For safety, operations or any other issues, refer to the Safety Guide and User's Manual (concise and detailed).

⚠ WARNING ► Before using this product, be sure to read all manuals for this product.

After reading them, store them in a safe place for future reference.

NOTE • The information in this manual is subject to change without notice.

- The manufacturer assumes no responsibility for any errors that may appear in this manual.
- The reproduction, transfer or copy of all or any part of this document is not permitted without express written consent.

Trademark acknowledgment

- Microsoft® and Internet Explorer®, Windows®, Windows Vista® are registered trademark of Microsoft Corporation in the U.S. and/or other countries.
- JavaScript® is a registered trademark of Sun microsystems, Inc.
- Trademark PJLink is a trademark applied for trademark rights in Japan, the United States of America and other countries and areas.

PJLink™

All other trademarks are the properties of their respective owners.



Content	2
1. Main functions	3
1.1 Configuring and controlling via a web browser	3
1.2 MY IMAGE (Still image Transfer) Display	3
1.3 Messenger Function	4
2. Equipment connection and network setting	5
2.1 Required equipment preparation	5
2.2 Manual network connection setting.....	6
2.2.1 Equipments connection	6
2.2.2 Network settings.....	6
2.2.3 “Internet Option” setting.....	9
2.2.4 Check connection.....	10
3. Network Functions	11
3.1 Configuring and controlling the projector via a web browser	12
3.1.1 Logon	14
3.1.2 Network Information	15
3.1.3 Network Settings	16
3.1.4 Port Settings.....	17
3.1.5 Mail Settings.....	19
3.1.6 Alert Settings	20
3.1.7 Schedule Settings	22
3.1.8 Date/Time Settings	24
3.1.9 Security Settings	26
3.1.10 Projector Control	28
3.1.11 Projector Status	32
3.1.12 Network Restart.....	33
3.1.13 Logoff	33
3.2 E-mail Alerts.....	34
3.3 Projector Management using SNMP.....	36
3.4 Event Scheduling	37
3.5 MY IMAGE (Still Image Transfer) Display.....	40
3.6 Messenger Function	42
3.7 Command Control via the Network.....	44
3.8 Controlling the external device via the projector (using the NETWORK BRIDGE function)	49

1. Main functions

1.1 Configuring and controlling via a web browser

You can adjust or control the projector via a network from a web browser on a computer that is connected to the same network. Logon the network from the web browser and it offers the menus to configure the network settings, monitor the projector and so on.



1.2 MY IMAGE (Still image Transfer) Display

Image files can be sent via the network, and up to 4 image data can be stored in the projector and displayed on screen one by one (📖40).

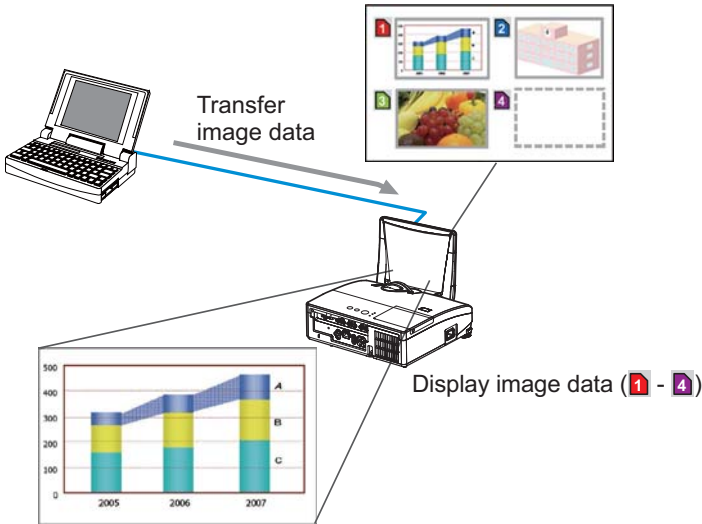

1.3 Messenger Function

The text data can be sent via the network and displayed on the screen. You can display the transferred text on real time or choose one from ones once stored in the projector and display it (📖42).

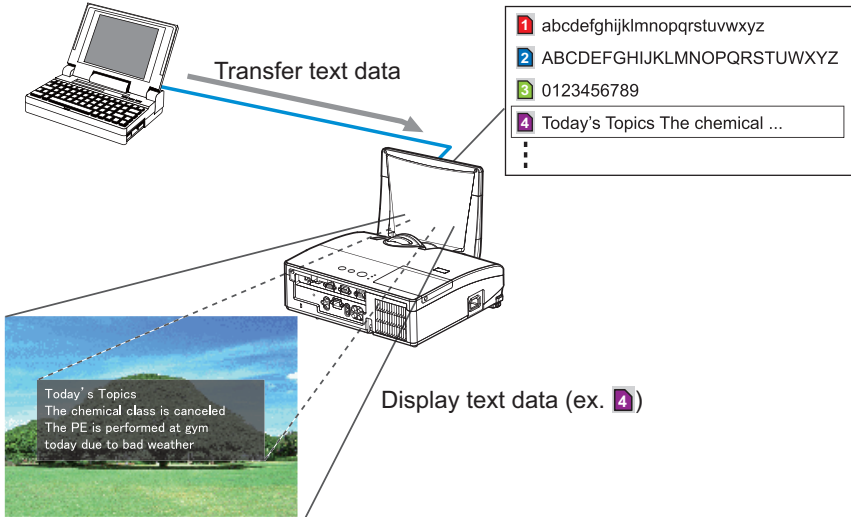

2. Equipment connection and network setting

2.1 Required equipment preparation

The following equipments are required to connect the projector to your computer through the network.

Computer : 1) equipped with the network feature
2) installed a web browser software ( 12)

LAN cable : CAT-5 or greater

NOTE • The system for using the network function of the projector requires communication environment conforming 100Base-TX or 10Base-T.
• The network communication control is disabled while the projector is in standby mode if the STANBY MODE item is set to SAVING. Please connect the network communication to the projector after setting the STANDBY MODE to NORMAL.
( **SETUP menu in the User's Manual – Operating Guide**)

2.2 Manual network connection setting

2.2.1 Equipments connection

Connect the projector and computer with a LAN cable.

* Before connecting with an existing network, contact the network administrator.

Next, please check the computer setting as explained below.

2.2.2 Network settings

This is the explanation of network connection settings for Windows® XP and Internet Explorer®.

- 1) Log on to Windows® XP as administrator authority. (*)
- 2) Open “Control Panel” from “Start” menu.
- 3) Open “Network and Internet Connections” in “Control Panel”. (Fig. 2.2.2.a)

* Administrator authority is the account, which can access to all functions.

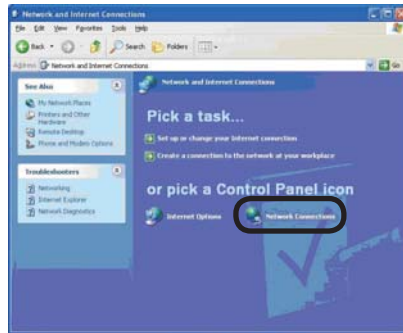

Fig. 2.2.2.a “Network and Internet Connections” window

- 4) Open “Network Connections”. (Fig.2.2.2.b)

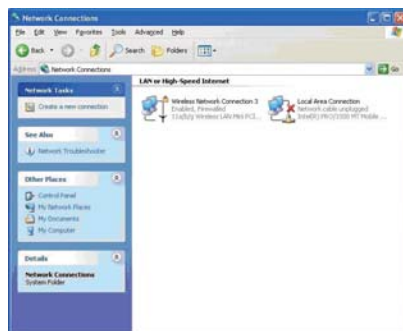

Fig. 2.2.2.b “Network Connections” window

2.2 Manual network connection setting (continued)

- 5) Open “Local Area Connection Properties” window you use for network device.
(Fig. 2.2.2.c)

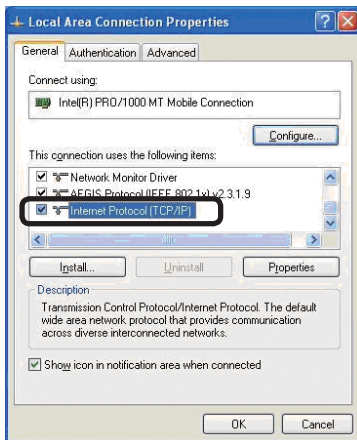

Fig. 2.2.2.c “Local Area Connection Properties” window

- 6) Set used protocol as “TCP/IP” and open “Internet Protocol (TCP/IP) Properties” window.

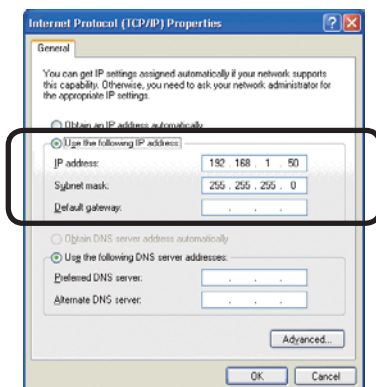

Fig. 2.2.2.d “Internet Protocol (TCP/IP) Properties” window

- 7) Set IP address, subnet mask and default gateway for computer.

2.2 Manual network connection setting (continued)

[About IP address]

■ Setting manually

The Network address portion included in the IP address set into your computer should be common with projector's one. And the entire IP address in the computer should not be overlapped with other equipments in the same network, including the projector.

For example

The projector's initial settings are as follows.

IP address: 192.168.1.10

Subnet mask: 255.255.255.0

(Network address: 192.168.1 in this case)

Therefore, specify computer's IP address as follows.

IP address: 192.168.1.xxx (xxx shows decimal number.)

Subnet mask: 255.255.255.0

(Network address: 192.168.1 in this case)

Select from 1 to 254 for "xxx" not duplicating with any other equipments.

In this case, projector has "192.168.1.10" IP address, specify from 1 to 254 except 10 for computer.

NOTE • "0.0.0.0" cannot be set to the IP address.

- The projector's IP address can be changed by using the configuration utility via a web browser ( 12).
- If the projector and computer exist in the same network (i.e. network address is common), default gateway can be blank.
- When the projector and computer exist in different networks, default gateway setting is necessary. Contact the network administrator in detail.

■ Setting automatically

When DHCP server exists in network, it is possible to assign IP address to the projector and computer automatically.

* DHCP is abbreviation for "Dynamic Host Configuration Protocol" and has the function to provide necessary setting for network like IP address from server to client. A server that has DHCP function is called DHCP server.

2.2 Manual network connection setting (continued)

2.2.3 “Internet Option” setting

- 1) Click “Internet Options” in “Network and Internet Connections” window (Fig. 2.2.3.a) to open “Internet Properties” window. (Fig.2.2.3.b)

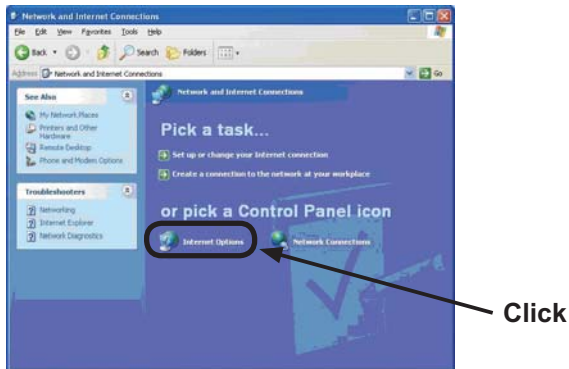

Fig. 2.2.3.a “Network and Internet Connections” window

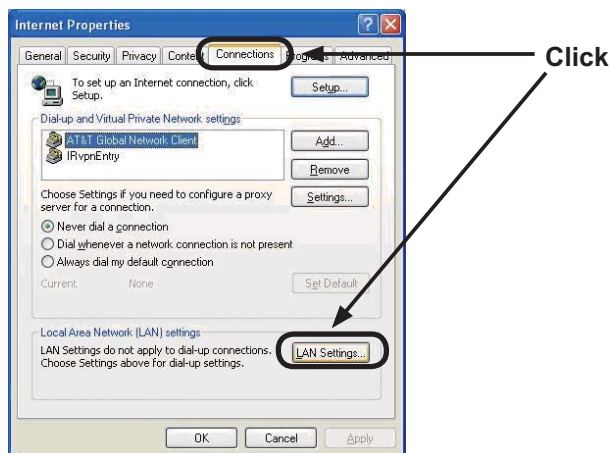

Fig. 2.2.3.b “Internet Properties” window

- 2) Click “Connections” tab and then click [LAN Settings] button to open “Local Area Network (LAN) settings”. (Fig. 2.2.3.c)

2.2 Manual network connection setting (continued)

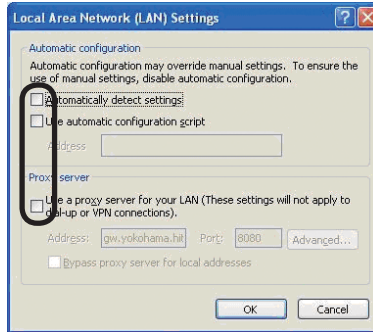

Fig. 2.2.3.c “Local Area Network (LAN) Settings” window

3) Uncheck all boxes in “Local Area Network (LAN) Settings” window. (Fig. 2.2.3.c)

2.2.4 Check connection

Check computer and projector are connected properly here. If it is not connected, check cable connections and settings are properly or not.

1) Start browser in computer and specify following URL, then click “→” button.

URL: `http://(Projector IP address)/`

For example, if projector IP address is 192.168.1.10, specify

URL: `http://192.168.1.10/`

2) If Fig. 2.2.4 appears, it succeeds.



Fig. 2.2.4 “Logon Menu”

3. Network Functions

This projector is equipped with the following network functions by using a web browser software.

3.1 Configuring and Controlling the Projector via a Web Browser

You can change the settings of or control the projector via a network by using a web browser from a computer that is connected to the same network.

 12)

3.2 E-mail Alerts

The projector can automatically send an alert to specified e-mail addresses when the projector requires maintenance or has encountered an error.

 34)

3.3 Projector Management using SNMP

This projector is SNMP (Simple Network Management Protocol) compliant, allowing you to monitor it from a remote location using SNMP software. In addition, the projector is able to send failure & warning alerts to a specified computer.

 36)

3.4 Event Scheduling

You can schedule the projector to perform various functions according to the date and time.

 37)

3.5 MY IMAGE (Still Image Transfer) Display

The projector can display still images that are transferred via the network.

 40)

3.6 Messenger Function

The projector can display the text data transferred via the network on the screen.

 42)

3.7 Command Control via the Network

The projector can be controlled using RS-232C commands over a network.

 44)

3.8 Controlling the external device via the projector (using the NETWORK BRIDGE function)

Using the NETWORK BRIDGE function can control an external device as a network terminal, via this projector from the computer.

 49)

3.1 Configuring and controlling the projector via a web browser

You can adjust or control the projector via a network from a web browser on a computer that is connected to the same network.

- NOTE** • Internet Explorer® 5.5 or later is required.
- If JavaScript® is disabled in your web browser configuration, you must enable JavaScript® in order to use the projector web pages properly. See the Help files for your web browser for details on how to enable JavaScript®.
 - It is recommended that all web browser updates are installed.

3.1 Configuring and controlling the projector via a web browser (continued)

When configuring or controlling the projector via a web browser, an ID and password are required. There are two types of IDs, Administrator ID and User ID. The following chart describes the differences between Administrator and User IDs.

Item	Description	Administrator	User
Network Information	Displays the projector's current network configuration settings.	√	√
Network Settings	Displays and configures network settings.	√	N/A
Port Settings	Displays and configures communication port settings.	√	N/A
Mail Settings	Displays and configures e-mail addressing settings.	√	N/A
Alert Settings	Displays and configures failure & warning alerts.	√	N/A
Schedule Settings	Displays and configures schedule settings.	√	N/A
Date/Time Settings	Displays and configures the date and time settings.	√	N/A
Security Settings	Displays and configures passwords and other security settings.	√	N/A
Projector Control	Controls the projector.	√	√
Projector Status	Displays the current projector status.	√	√
Network Restart	Restarts the projector's network connection.	√	N/A

3. Network Functions

3.1 Configuring and controlling the projector via a web browser (continued)

3.1.1 Logon

Refer to the following for configuring or controlling the projector via a web browser.

Example: If the IP address of the projector is set to **192.168.1.10**:

- 1) Enter “**http://192.168.1.10**” into the address bar of the web browser and press “Enter” key or click “**→**” button. The screen in Fig. 3.1.1a will be displayed.
- 2) Enter your ID and password and click [**Logon**].



Fig. 3.1.1 a “Logon Menu”

Below are the factory default settings for Administrator ID, User ID and passwords.

Item	ID	Password
Administrator	Administrator	<blank>
User	User	<blank>

If the logon is successful, either the Fig. 3.1.1 b or Fig. 3.1.1 c screen will be displayed.

Main menu

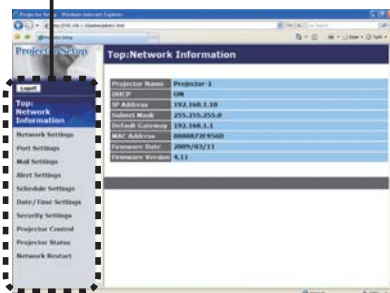

Fig. 3.1.1 b “Logon with Administrator ID”

Main menu

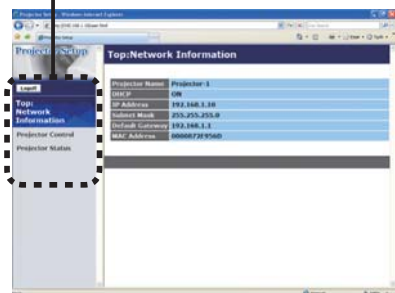

Fig. 3.1.1 c “Logon with User ID”

- 3) Click the desired operation or configuration item on the main menu located on the left-hand side of the screen.

3.1 Configuring and controlling the projector via a web browser (continued)

3.1.2 Network Information



All screen drawings in this manual are shown when you logon with the Administrator ID. Any functions that are available only for the Administrator will not be shown when you logon with the User ID. Refer to the table. (📖13,14)

Displays the projector's current network configuration settings.

Item	Description
Projector Name	Displays the projector name settings.
DHCP	Displays the DHCP configuration settings.
IP Address	Displays the current IP address.
Subnet Mask	Displays the subnet mask.
Default Gateway	Displays the default gateway.
MAC Address	Displays the ethernet MAC address.
Firmware Date	Displays the network firmware time stamp. This information is only displayed when logged on using an Administrator ID.
Firmware Version	Displays the network firmware version number. This information is only displayed when logged on using an Administrator ID.

3.1 Configuring and controlling the projector via a web browser (continued)

3.1.3 Network Settings



Displays and configures network settings.

Item	Description
IP Configuration	Configures network settings.
DHCP ON	Enables DHCP.
DHCP OFF	Disables DHCP.
IP Address	Configures the IP address when DHCP is disabled.
Subnet Mask	Configures the subnet mask when DHCP is disabled.
Default Gateway	Configures the default gateway when DHCP is disabled.
Projector Name	Configures the name of the projector. The length of the Projector Name can be up to 64 alphanumeric characters. Only alphabets, numbers and following symbols can be used. !"#%\$&'()*+,-./:;<=>?@[\\]^_`{ }~ and space
sysLocation (SNMP)	Configures the location to be referred to when using SNMP. The length of the sysLocation can be up to 255 alphanumeric characters. Only numbers '0-9' and alphabet 'a-z', 'A-Z' can be used.
sysContact (SNMP)	Configures the contact information to be referred to when using SNMP. The length of the sysContact can be up to 255 alphanumeric characters. Only numbers '0-9' and alphabet 'a-z', 'A-Z' can be used.
DNS Server Address	Configures the DNS server address.
AMX D.D. (AMX Device Discovery)	Configures the AMX Device Discovery setting to detect the projector from the controllers of AMX connected to the same network. For the details of AMX Device Discovery, visit the AMX web site. <u>URL: http://www.amx.com</u>

Click **[Apply]** button to save the settings.

NOTE • The new configuration settings are activated after restarting the network connection. When the configuration settings are changed, you must restart the network connection. You can restart the network connection by clicking **[Network Restart]** on the main menu.

- If you connect the projector to an existing network, consult a network administrator before setting server addresses.

3.1 Configuring and controlling the projector via a web browser (continued)

3.1.4 Port Settings

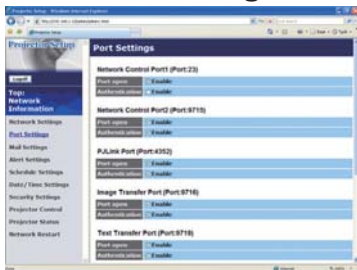

Displays and configures communication port settings.

Item	Description
Network Control Port1 (Port:23)	Configures command control port 1 (Port:23).
Port open	Click the [Enable] check box to use port 23.
Authentication	Click the [Enable] check box when authentication is required for this port.
Network Control Port2 (Port:9715)	Configures command control port 2 (Port:9715).
Port open	Click the [Enable] check box to use port 9715.
Authentication	Click the [Enable] check box when authentication is required for this port.
PJLink™ Port (Port:4352)	Configures the PJLink™ port (Port:4352).
Port open	Click the [Enable] check box to use port 4352.
Authentication	Click the [Enable] check box when authentication is required for this port.
Image Transfer Port (Port:9716)	Configures the image transfer port (Port:9716).
Port open	Click the [Enable] check box to use port 9716.
Authentication	Click the [Enable] check box when authentication is required for this port.
Text Transfer Port (Port:9719)	Configures the text transfer port (Port:9719).
Port open	Click the [Enable] check box to use port 9719.
Authentication	Click the [Enable] check box when authentication is required for this port.

3.1 Configuring and controlling the projector via a web browser (continued)

Item	Description
SNMP Port	Configures the SNMP port.
Port open	Click the [Enable] check box to use SNMP.
Trap address	Configures the destination of the SNMP Trap in IP format. • The address allows not only IP address but also domain name if the valid DNS server is setup in the Network Settings . The maximum length of host or domain name is up to 255 characters.
SMTP Port	Configures the SMTP port.
Port open	Click the [Enable] check box to use the e-mail function.
Network Bridge Port	Configures the Bridge port number.
Port Number	Input the port number. Except for 9715, 9716, 9719, 4352 between 1024 and 65535 can be set up. It is set to 9717 as the default setting.

Click **[Apply]** button to save the settings.

NOTE • The new configuration settings are activated after restarting the network connection. When the configuration settings are changed, you must restart the network connection. You can restart the network connection by clicking **[Network Restart]** on the main menu.

3.1 Configuring and controlling the projector via a web browser (continued)

3.1.5 Mail Settings

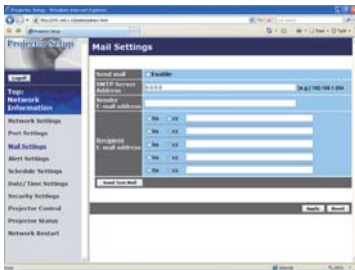

Displays and configures e-mail addressing settings.

Item	Description
Send mail	Click [Enable] check box to use the e-mail function. Configure the conditions for sending e-mail under the Alert Settings.
SMTP Server Address	Configures the address of the mail server in IP format. • The address allows not only IP address but also domain name if the valid DNS server is setup in the Network Settings . The maximum length of host or domain name is up to 255 characters.
Sender E-mail address	Configures the sender e-mail address. The length of the sender e-mail address can be up to 255 alphanumeric characters.
Recipient E-mail address	Configures the e-mail address of up to five recipients. You can also specify [TO] or [CC] for each address. The length of the recipient e-mail address can be up to 255 alphanumeric characters.

Click **[Apply]** button to save the settings.

NOTE • You can confirm whether the mail settings work correctly using **[Send Test Mail]** button. Please enable Send mail setting before clicking **[Send Test Mail]**.

• If you connect the projector to an existing network, consult a network administrator before setting server addresses.

3.1 Configuring and controlling the projector via a web browser (continued)

3.1.6 Alert Settings

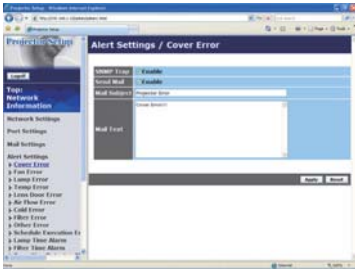

Displays and configures failure & alert settings.

Alert Item	Description
Cover Error	The lamp cover has not been properly fixed.
Fan Error	The cooling fan is not operating.
Lamp Error	The lamp does not light, and there is a possibility that interior portion has become heated.
Temp Error	There is a possibility that the interior portion has become heated.
Lens Door Error	The lens door is not opened or closed properly.
Air Flow Error	The internal temperature is rising.
Cold Error	There is a possibility that the interior portion has become overcooled.
Filter Error	Filter time over.
Other Error	Other error. If displaying this error, please contact your dealer.
Schedule Execution Error	Schedule Execution error. (📖22)
Lamp Time Alarm	Lamp time over Alarm Time setting.
Filter Time Alarm	Filter time over Alarm Time setting.
Transition Detector Alarm	Transition Detector Alarm. (📖OPTION menu in the User's Manual – Operating Guide)
Cold Start	<ul style="list-style-type: none"> •If the STANDBY MODE is set to the NORMAL : the projector's power status changes from "OFF" to "Standby state". •If the STANDBY MODE is set to the SAVING : the projector's power status changes from "Standby state" to "ON(lamp is turned on)". (📖SETUP menu in the User's Manual – Operating Guide)
Authentication Failure	The SNMP access is detected from the invalid SNMP community.

Refer to 📖“**Troubleshooting**” in the *User's Manual – Operating Guide* for further detailed explanation of Error except Other Error and Schedule Execution Error.

3.1 Configuring and controlling the projector via a web browser (continued)

The Alert Items are shown below.

Setting Item	Description
Alarm Time	Configures the time to alert. (Only Lamp Time Alarm and Filter Time Alarm .)
SNMP Trap	Click [Enable] check box to enable SNMP Trap alerts.
Send Mail	Click [Enable] check box to enable e-mail alerts. (Except Cold Start and Authentication Failure .)
Mail Subject	Configures the subject line of the e-mail to be sent. The length of the subject line can be up to 100 alphanumeric characters. (Except Cold Start and Authentication Failure .)
Mail Text	Configures the text of the e-mail to be sent. The length of the text can be up to 1024 alphanumeric characters. (Except Cold Start and Authentication Failure .)

Click **[Apply]** button to save the settings.

NOTE • The trigger of **Filter Error** e-mail is depending on the FILTER MESSAGE setting in the SERVICE item of the OPTION menu which defines the period until the filter message is displayed on the projector screen. The e-mail will be sent when the filter time exceeds 500, 1000, 2000, 3000, 4000 or 5000 hours based on the configuration. No notification e-mail will be sent if the FILTER MESSAGE is set to OFF. ( **OPTION menu in the User's Manual – Operating Guide**)

- **Lamp Time Alarm** is defined as a threshold for e-mail notification (reminder) of the lamp time. When the lamp hour exceeds this threshold that is configured through the Web page, the e-mail will be sent out.

- **Filter Time Alarm** is defined as a threshold for e-mail notification (reminder) of the filter time. When the filter hour exceeds this threshold that is configured in the web page, the e-mail will be sent out.

3. Network Functions

3.1 Configuring and controlling the projector via a web browser (continued)

3.1.7 Schedule Settings

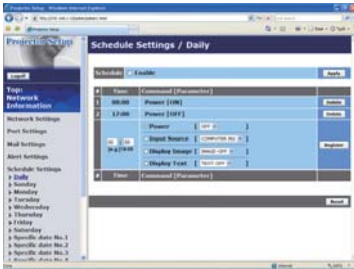

Displays and configures schedule settings.

Item	Description
Daily	Configures the daily schedule.
Sunday	Configures the Sunday schedule.
Monday	Configures the Monday schedule.
Tuesday	Configures the Tuesday schedule.
Wednesday	Configures the Wednesday schedule.
Thursday	Configures the Thursday schedule.
Friday	Configures the Friday schedule.
Saturday	Configures the Saturday schedule.
Specific date No.1	Configures the specific date (No.1) schedule.
Specific date No.2	Configures the specific date (No.2) schedule.
Specific date No.3	Configures the specific date (No.3) schedule.
Specific date No.4	Configures the specific date (No.4) schedule.
Specific date No.5	Configures the specific date (No.5) schedule.

3.1 Configuring and controlling the projector via a web browser (continued)

The schedule settings are shown below.

Item	Description
Schedule	Click [Enable] check box to enable the schedule.
Date (Month/Day)	Configures the month and date. This item appears only when Specific date (No. 1-5) is selected.

Click **[Apply]** button to save the settings.

The current event settings are displayed on the schedule list. To add additional functions and events, set the following items.

Item	Description
Time	Configures the time to execute commands.
Command [Parameter]	Configures the commands to be executed.
Power	Configures the parameters for power control.
Input Source	Configures the parameters for input switching.
Display Image	Configures the parameters for display of transfered image data (📖40).
Display Text	Configures the parameters for display of transfered text data (📖42).

Click **[Register]** button to add new commands to the schedule list.

Click **[Delete]** button to delete commands from the schedule list.

Click **[Reset]** button to delete all commands and reset the schedule settings from the schedule list.

NOTE • After the projector is moved, check the date and time set for the projector before configuring the schedules. Strong shock may make the date and time settings (📖24) get out of tune.

- Events "Display Image" and "Display Text" will not be executed appropriately but result in "schedule execution error" status in case lamp does not light or/and display data are not stored in the projector at the scheduled event execution time.
- Events "Input Source" and "Display Image" will not be executed if security feature is enabled and the projector is locked due to the feature.
- Certain error state in the projector (such as temperature error, lamp error) will prevent the projector from appropriate execution of scheduled functions/events.
- Please refer to the Troubleshooting in the User's Manual – Operating Guide in case scheduled functions/events are not executed appropriately as you've set.

3.1 Configuring and controlling the projector via a web browser (continued)

3.1.8 Date/Time Settings

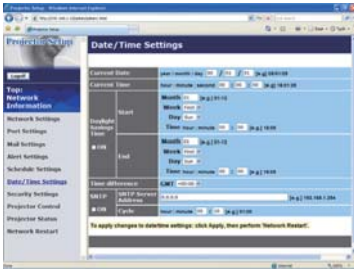

Displays and configures the date and time settings.

Item	Description				
Current Date	Configures the current date in year/month/day format.				
Current Time	Configures the current time in hour:minute:second format.				
Daylight Savings Time	Click [ON] check box to enable daylight savings time and set the following items.				
Start	Configures the date and time daylight savings time begins.				
Month	Configures the month daylight savings time begins (1~12).				
Week	Configures the week of the month daylight savings time begins (First, 2, 3, 4, Last).				
Day	Configures the day of the week daylight savings time begins (Sun, Mon, Tue, Wed, Thu, Fri, Sat).				
Time	<table border="1"> <tr> <td>hour</td> <td>Configures the hour daylight savings time begins (0 ~ 23).</td> </tr> <tr> <td>minute</td> <td>Configures the minute daylight savings time begins (0 ~ 59).</td> </tr> </table>	hour	Configures the hour daylight savings time begins (0 ~ 23).	minute	Configures the minute daylight savings time begins (0 ~ 59).
hour	Configures the hour daylight savings time begins (0 ~ 23).				
minute	Configures the minute daylight savings time begins (0 ~ 59).				
End	Configures the date and time daylight savings time ends.				
Month	Configures the month daylight savings time ends (1 ~ 12).				
Week	Configures the week of the month daylight savings time ends (First, 2, 3, 4, Last).				
Day	Configures the day of the week daylight savings time ends (Sun, Mon, Tue, Wed, Thu, Fri, Sat).				
Time	<table border="1"> <tr> <td>hour</td> <td>Configures the hour daylight savings time ends (0 ~ 23).</td> </tr> <tr> <td>minute</td> <td>Configures the minute daylight savings time ends (0 ~ 59).</td> </tr> </table>	hour	Configures the hour daylight savings time ends (0 ~ 23).	minute	Configures the minute daylight savings time ends (0 ~ 59).
hour	Configures the hour daylight savings time ends (0 ~ 23).				
minute	Configures the minute daylight savings time ends (0 ~ 59).				

3.1 Configuring and controlling the projector via a web browser (continued)

Item	Description
Time difference	Configures the time difference. Set the same time difference as the one set on your computer. If unsure, consult your IT manager.
SNTP	Click the [ON] check box to retrieve Date and Time information from the SNTP server and set the following items.
SNTP Server Address	Configures the SNTP server address in IP format. <ul style="list-style-type: none"> The address allows not only IP address but also domain name if the valid DNS server is setup in the Network Settings. The maximum length of host or domain name is up to 255 characters.
Cycle	Configures the interval at which to retrieve Date and Time information from the SNTP server (hour:minute).

Click **[Apply]** button to save the settings.

NOTE • The new configuration settings are activated after restarting the network connection. When the configuration settings are changed, you must restart the network connection. You can restart the network connection by clicking **[Network Restart]** on the main menu.

- If you connect the projector to an existing network, consult a network administrator before setting server addresses.
- To enable the SNTP function, the time difference must be set.
- The projector will retrieve Date and Time information from the time server and override time settings when SNTP is enabled.
- The internal clock's time may not remain accurate. Using SNTP is recommended to maintain accurate time.

3.1 Configuring and controlling the projector via a web browser (continued)

3.1.9 Security Settings



Displays and configures passwords and other security settings.

Item	Description
Administrator authority	Configures the Administrator ID and password.
Administrator ID	Configures the Administrator ID. The length of the text can be up to 32 alphanumeric characters.
Administrator Password	Configures the Administrator password. The length of the text can be up to 255 alphanumeric characters.
Re-enter Administrator Password	Reenter the above password for verification.
User authority	Configures the User ID and password.
User ID	Configures the User ID. The length of the text can be up to 32 alphanumeric characters.
User Password	Configures the User password. The length of the text can be up to 255 alphanumeric characters.
Re-enter User Password	Reenter the above password for verification.

3.1 Configuring and controlling the projector via a web browser (continued)

Item	Description
Network Control	Configures the Authentication password for the command control.
Authentication Password	Configures the Authentication password. The length of the text can be up to 32 alphanumeric characters.
Re-enter Authentication Password	Reenter the above password for verification.
SNMP	Configures the community name if SNMP is used.
Community name	Configures the community name. The length of the text can be up to 64 alphanumeric characters.

Click **[Apply]** button to save the settings.

NOTE • The new configuration settings are activated after restarting the network connection. When the configuration settings are changed, you must restart the network connection. You can restart the network connection by clicking **[Network Restart]** on the main menu.

- Only numbers '0-9' and alphabet 'a-z', 'A-Z' can be used.

3.1 Configuring and controlling the projector via a web browser (continued)

3.1.10 Projector Control

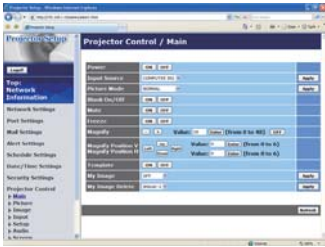

The items shown in the table below can be performed using the Projector Control menu. Select an item using the up and down arrow keys on the computer. Most of the items have a submenu. Refer to the table below for details.

NOTE • The setting value may not match with the actual value if the user changes the value manually. In that case, please refresh the page by clicking [Refresh] button.

Controls the projector.

Item	Description
Main	
Power	Turns the power on/off.
Input Source	Selects the input source.
Picture Mode	Selects the picture mode setting.
Blank On/Off	Turns Blank on/off.
Mute	Turns Mute on/off.
Freeze	Turns Freeze on/off.
Magnify	Controls the magnify setting. In some input signal sources, it might stop “Magnify” even though it does not reach to maximum setting value.
Magnify Position V	Adjusts the vertical magnify position.
Magnify Position H	Adjusts the horizontal magnify position.
Template	Turns template on/off.
My Image	Select MY IMAGE data.
My Image Delete	Delete MY IMAGE data.
Picture	
Brightness	Adjusts the brightness setting.
Contrast	Adjusts the contrast setting.
Gamma	Selects the gamma setting.
Color Temp	Selects the color temperature setting.
Color	Adjusts the color setting.
Tint	Adjusts the tint setting.
Sharpness	Adjusts the sharpness setting.
My Memory Save	Saves the My Memory data.
My Memory Recall	Recalls the My Memory data.

3.1 Configuring and controlling the projector via a web browser (continued)

Item	Description
Image	
Aspect	Selects the aspect setting.
Over Scan	Adjusts the over scan setting.
V Position	Adjusts the vertical position.
H Position	Adjusts the horizontal position.
H Phase	Adjusts the horizontal phase.
H Size	Adjusts the horizontal size.
Auto Adjust Execute	Performs the automatic adjustment.
Input	
Progressive	Selects the progressive setting.
Video NR	Selects the video noise reduction setting.
Color Space	Selects the color space.
S-Video Format	Selects the s-video format setting.
C-Video Format	Selects the video format setting.
HDMI Format	Selects the HDMI format setting.
HDMI Range	Selects the HDMI range setting.
Computer in1	Selects the COMPUTER IN1 input signal type.
Computer in2	Selects the COMPUTER IN2 input signal type.
Frame Lock - Computer in1	Turns the FRAME LOCK-COMPUTER IN1 function on/off.
Frame Lock - Computer in2	Turns the FRAME LOCK-COMPUTER IN2 function on/off.
Frame Lock - HDMI	Turns the FRAME LOCK-HDMI function on/off.
Setup	
D-Zoom	Adjusts the zoom.
D-SHIFT V	Adjusts the vertical picture position.
D-SHIFT H	Adjusts the horizontal picture position.
Pict. Posit. H	Selects the horizontal picture position.
Keystone V	Adjusts the vertical keystone distortion setting.
Eco Mode	Selects the eco mode.
Mirror	Selects the mirror status.
Standby Mode	Selects the Standby mode.
Monitor Out - Computer in1	Assigns the MONITOR OUT when the COMPUTER IN1 input port is selected.
Monitor Out - Computer in2	Assigns the MONITOR OUT when the COMPUTER IN2 input port is selected.
Monitor Out - HDMI	Assigns the MONITOR OUT when the HDMI input port is selected.
Monitor Out - S-Video	Assigns the MONITOR OUT when the S-VIDEO input port is selected.
Monitor Out - Video	Assigns the MONITOR OUT when the VIDEO input port is selected.
Monitor Out - Standby	Assigns the MONITOR OUT in the standby mode.

3.1 Configuring and controlling the projector via a web browser (continued)

Item	Description
Audio	
Volume	Adjusts the volume setting.
Speaker	Turns the built-in speaker on/off.
Audio Source - Computer in1	Assigns the AUDIO SOURCE- COMPUTER IN1 input port.
Audio Source - Computer in2	Assigns the AUDIO SOURCE- COMPUTER IN2 input port.
Audio Source - HDMI	Assigns the AUDIO SOURCE- HDMI input port.
Audio Source - S-Video	Assigns the AUDIO SOURCE- S-VIDEO input port.
Audio Source - Video	Assigns the AUDIO SOURCE- VIDEO input port.
Audio Out Standby	Assigns the AUDIO OUT in the standby mode.
HDMI Audio	Selects the HDMI audio setting.
Screen	
Language	Selects the language for the OSD.
Menu Position V	Adjusts the vertical Menu position.
Menu Position H	Adjusts the horizontal Menu position.
Blank	Selects the Blank mode.
Startup	Selects the startup screen mode.
MyScreen Lock	Turns MyScreen lock function on/off.
Message	Turns the message function on/off.
Template	Selects the template setting.
C.C. - Display	Selects Closed Caption DISPLAY setting.
C.C. - Mode	Selects Closed Caption MODE setting.
C.C. - Channel	Selects Closed Caption CHANNEL setting.

3.1 Configuring and controlling the projector via a web browser (continued)

Item	Description
Option	
Auto Search	Turns the automatic signal search function on/off.
Direct Power On	Turns the direct power on function on/off.
Auto Power Off	Configures the timer to shut off the projector when no signal is detected.
My Button-1	Assigns the functions for the MY BUTTON1 button on the included remote control.
My Button-2	Assigns the functions for the MY BUTTON2 button on the included remote control.
My Source	Selects the My Source setting.
Remote Receiv. Front	Turns the remote receiv. front function on/off.
Remote Receiv. Top	Turns the remote receiv. top function on/off.
Remote Freq. Normal	Turns the remote control signal frequency normal function on/off.
Remote Freq. High	Turns the remote control signal frequency high function on/off.

3.1 Configuring and controlling the projector via a web browser (continued)

3.1.11 Projector Status



Displays the current projector status.

Item	Description
Error Status	Displays the current error status
Lamp Time	Displays the usage time for the current lamp.
Filter Time	Displays the usage time for the current filter.
Power Status	Displays the current power status.
Input Status	Displays the current input signal source.
Blank On/Off	Displays the current Blank on/off status.
Mute	Displays the current Mute on/off status.
Freeze	Displays the current Freeze status.

3.1 Configuring and controlling the projector via a web browser (continued)

3.1.12 Network Restart

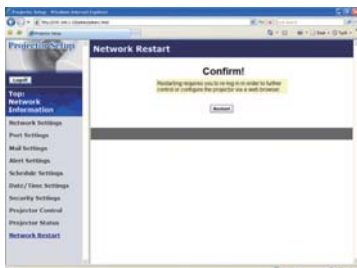

Restarts the projector's network connection.

Item	Description
Restart	Restarts the projector's network connection in order to activate new configuration settings.

NOTE • Restarting requires you to re-log on in order to further control or configure the projector via a web browser. Wait 1 minute or more after clicking **[Restart]** button to log on again.

3.1.13 Logoff

When **[Logoff]** is clicked, the Logon menu is displayed (📖14).

3.2 E-mail Alerts

The projector can automatically send an alert message to the specified e-mail addresses when the projector detects a certain condition that is requiring maintenance or detected an error.

NOTE • Up to five e-mail addresses can be specified.
• The projector may be not able to send e-mail if the projector suddenly loses power.

Mail Settings (📖19)

To use the projector's e-mail alert function, please configure the following items through a web browser.

Example: If the IP address of the projector is set to **192.168.1.10**:

- 1) Enter “**http://192.168.1.10/**” into the address bar of the web browser.
- 2) Enter the Administrator ID and password and click **[Logon]**.
- 3) Click **[Port Settings]** on the main menu.
- 4) Click **[Enable]** check box to open the **SMTP Port**.
- 5) Click **[Apply]** button to save the settings.

NOTE • A Network Restart is required after the **SMTP Port** configuration settings have changed. Click **[Network Restart]** and configure the following items.

- 6) Click **[Mail Settings]** and configure each item. Refer to the item **3.1.5 Mail Settings (📖19)** for further information.
- 7) Click **[Apply]** button to save the settings.

NOTE • Click **[Send Test Mail]** button in **[Mail Settings]** to confirm that the e-mail settings are correct. The following mail will be delivered to the specified addresses.

Subject line	:Test Mail	<Projector name>
Text	:Send Test Mail	
	Date	<Testing date>
	Time	<Testing time>
	IP Address	<Projector IP address>
	MAC Address	<Projector MAC address>

3.2 E-mail Alerts (continued)

- 8) Click **[Alert Settings]** on the main menu to configure the E-mail Alerts settings.
- 9) Select and configure each alert item. Refer to the item **3.1.6 Alert Settings** () for further information.
- 10) Click **[Apply]** button to save the settings.

Failure/Warning e-mails are formatted as follows:

Subject line	: <Mail title>	<Projector name>
Text	: <Mail text>	
	Date	<Failure/Warning date>
	Time	<Failure/Warning time>
	IP Address	<Projector IP address>
	MAC Address	<Projector MAC address>

3.3 Projector Management using SNMP

The SNMP (Simple Network Management Protocol) enables to manage the projector information, which is a failure or warning status, from the computer on the network. The SNMP management software will be required on the computer to use this function.

NOTE • It is recommended that SNMP functions be carried out by a network administrator.
• SNMP management software must be installed on the computer to monitor the projector via SNMP.

SNMP Settings (📖 17)

Configure the following items via a web browser to use SNMP.

Example: If the IP address of the projector is set to **192.168.1.10**:

- 1) Enter “**http://192.168.1.10/**” into the address bar of the web browser.
- 2) Enter the Administrator ID and Password and click **[Logon]**.
- 3) Click **[Port Settings]** on the main menu.
- 4) Click **[Enable]** check box to open the **SNMP Port**. Set the IP address to send the SNMP trap to when a Failure/Warning occurs.

NOTE • A Network Restart is required after the **SNMP Port** configuration settings have been changed. Click **[Network Restart]** and configure the following items.

- 5) Click **[Security Settings]** on the main menu.
- 6) Click **[SNMP]** and set the community name on the screen that is displayed.

NOTE • A Network Restart is required after the **Community name** has been changed. Click **[Network Restart]** and configure the following items.

- 7) Configure the settings for Trap transmission of Failures/Warnings. Click **[Alert Settings]** on the main menu and select the Failure/Warning item to be configured.
- 8) Click **[Enable]** check box to send out the SNMP trap for Failures/Warnings. Clear **[Enable]** check box when SNMP trap transmission is not required.
- 9) Click **[Apply]** button to save the settings.

3.4 Event Scheduling

The scheduling function enables to setup scheduled events including power on / power off. It enables to be “self-management” projector.

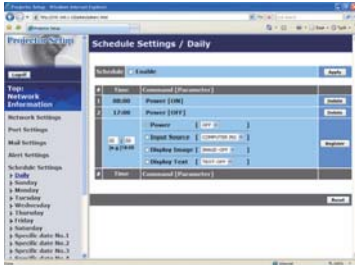

- NOTE** • You can schedule the following control events: Power ON/OFF, Input Source, Transferred Image Display and Transferred Text Display.
- The power on / off event has the lowest priority among the all events that are defined at the same time.
 - There are 3 types of Scheduling, 1) daily 2) weekly 3) specific date. (📖22)
 - The priority for scheduled events is as follows 1) specific date 2) weekly 3) daily.
 - Up to five specific dates are available for scheduled events. Priority is given to those with the lower numbers when more than one event has been scheduled for the same date and time (e.g., ‘Specific date No. 1’ has priority over ‘Specific date No. 2’ and so on).
 - Be sure to set the date and time before enabling scheduled events. (📖24)

3.4 Event Scheduling (continued)

Schedule Settings (📖22)

Schedule settings can be configured from a web browser.

Example: If the IP address of the projector is set to **192.168.1.10**:

- 1) Enter “**http://192.168.1.10/**” into the address bar of the web browser.
- 2) Enter the Administrator ID and password and click [**Logon**].
- 3) Click [**Schedule Settings**] on the main menu and select the required schedule item. For example, if you want to perform the command every Sunday, please select [**Sunday**].
- 4) Click [**Enable**] check box to enable scheduling.
- 5) Enter the date (month/day) for specific date scheduling.
- 6) Click [**Apply**] button to save the settings.
- 7) After configure the time, command and parameters, click [**Register**] to add the new event.
- 8) Click [**Delete**] button when you want to delete a schedule.

There are three types of scheduling.

- 1) Daily: Perform the specified operation at a specified time every day.
- 2) Sunday ~ Saturday: Perform the specified operation at the specified time on a specified day of the week.
- 3) Specific date: Perform the specified operation on the specified date and time.

NOTE • In Standby mode the power indicator will flash green for approx. 3 seconds when at least 1 “Power ON” schedule is saved.
• When the schedule function is used, the power cord must be connected to the projector and the outlet. The schedule function does not work when the breaker in a room is tripped. The power indicator will lights orange or green when the projector is receiving AC power.

3.4 Event Scheduling (continued)

Date/Time Settings (📖24)

The Date/Time setting can be adjusted via a web browser.

Example: If the IP address of the projector is set to **192.168.1.10**:

- 1) Enter “**http://192.168.1.10/**” into the address bar of the web browser. Enter the Administrator ID and Password and click [**Logon**].
- 2) Click [**Date/Time Settings**] on the main menu and configure each item. Refer to the item **3.1.8 Data/Time Settings** for further information.
- 3) Click [**Apply**] button to save the settings.

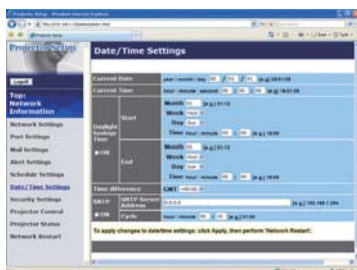

NOTE • A Network Restart is required after the **Daylight Savings Time** or **SNTP** configuration settings have been changed.

- The battery for the built in clock may be dead if the clock loses time even when the date and time have been set correctly. Replace the battery by following “**Replacing the internal clock battery**” section of the **User's Manual (concise)**.
- The internal clock's time may not remain accurate. Using SNTP is recommended to maintain accurate time.

3.5 MY IMAGE (Still Image Transfer) Display

The projector can display still images that are transferred via the network.

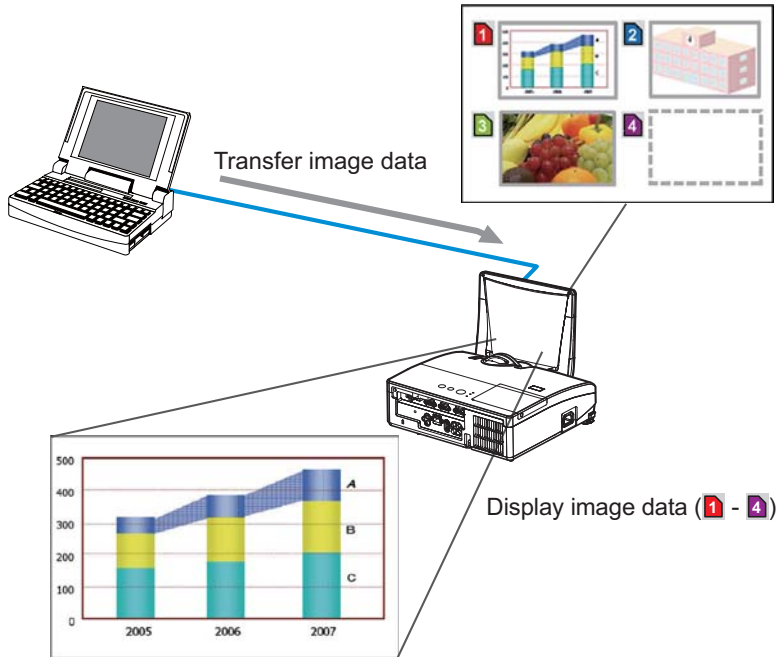

Fig. 3.5 Still Image Transfer

MY IMAGE transmission requires an exclusive application for your computer. You can download it from the Hitachi web site (<http://hitachi.us/digitalmedia> or <http://www.hitachidigitalmedia.com>). Refer to the manual for the details and the application for instructions.

To display the transferred image, select the MY IMAGE item in the NETWORK menu. For more information, please see the description of the MY IMAGE item of the NETWORK menu. ([NETWORK menu in the User's Manual – Operating Guide](#))

- NOTE** • It is possible to allocate the image file up to 4 in the maximum.
- Using **MY BUTTON** that registered MY IMAGE can display transferred image. ([OPTION menu in the User's Manual – Operating Guide](#))
 - The image file also can be displayed by using schedule function via the web browser. Refer to the item **3.4 Event Scheduling** ([37](#)) for the detail.

3.5 MY IMAGE (Still Image Transfer) Display (continued)

Configure the following items from a web browser when MY IMAGE is used.

Example: If the IP address of the projector is set to **192.168.1.10**:

- 1) Enter "**http://192.168.1.10/**" into the address bar of the web browser.
- 2) Enter the Administrator ID and password and click **[Logon]**.
- 3) Click **[Port Settings]** on the main menu.
- 4) Click the **[Enable]** check box to open the **Image Transfer Port (Port: 9716)**. Click the **[Enable]** check box for the **[Authentication]** setting when authentication is required, otherwise clear the check box.
- 5) Click the **[Apply]** button to save the settings.

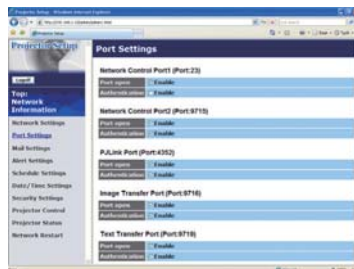

When the authentication setting is enabled, the following settings are required.

- 6) Click **[Security Settings]** on the main menu.
- 7) Select **[Network Control]** and enter the desired authentication password.
- 8) Click the **[Apply]** button to save the settings.

NOTE • The Authentication Password will be the same for **Network Control Port1 (Port: 23)**, **Network Control Port2 (Port: 9715)**, **PjLink™ Port (Port: 4352)**, **Image Transfer Port (Port: 9716)** and **Text Transfer Port (Port: 9719)**.
 • The new configuration settings are activated after restarting the network connection. When the configuration settings are changed, you must restart the network connection. You can restart the network connection by clicking **[Network Restart]** on the main menu.

3.6 Messenger Function

The projector can display the text data transferred via the network on the screen. The text data can be displayed on the screen in two ways that displays the text transferred from the computer on real time, and the other chooses and displays the text data from the ones once stored in the projector.

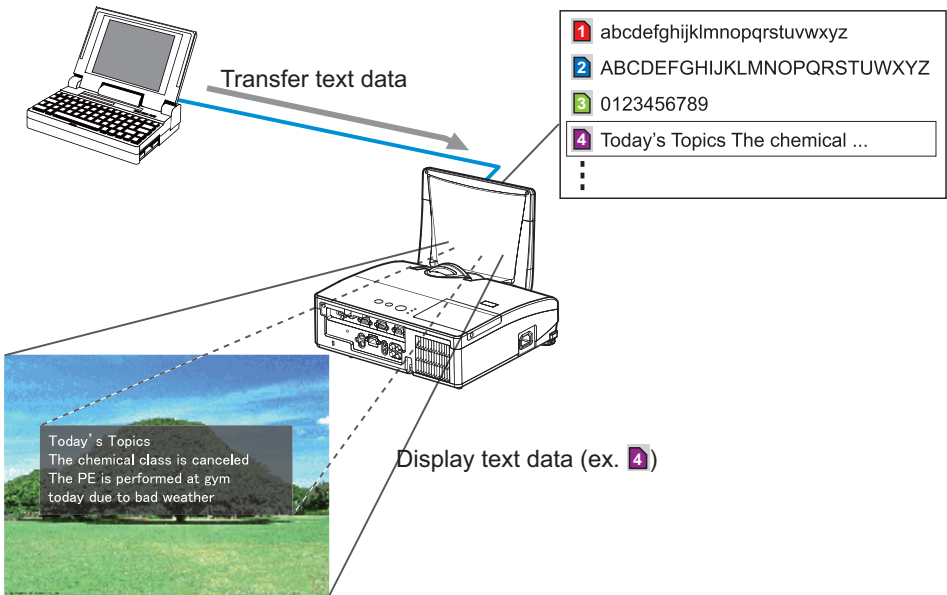

Fig. 3.6 Messenger function

Messenger function requires an exclusive application for your computer. To edit, transfer and display the text data, use the application. You can download it from the Hitachi web site (<http://hitachi.us/digitalmedia> or <http://www.hitachidigitalmedia.com>). Refer to the manual for the application for the details of Messenger function and instructions of the application.

- NOTE**
- It is possible to store the text data up to 12 in the maximum.
 - Using **MY BUTTON** that registered MESSENGER can turn the displaying messenger text on/off. (**OPTION menu in the User's Manual – Operating Guide**)
 - The text file also can be displayed by using schedule function via the web browser. Refer to the item 3.4 Event Scheduling(37) for the detail.

3.6 Messenger Function (continued)

Configure the following items from a web browser when Messenger function is used.

Example: If the IP address of the projector is set to **192.168.1.10**:

- 1) Enter "**http://192.168.1.10/**" into the address bar of the web browser.
- 2) Enter the Administrator ID and password and click **[Logon]**.
- 3) Click **[Port Settings]** on the main menu.
- 4) Click the **[Enable]** check box to open the **Text Transfer Port (Port: 9719)**. Click the **[Enable]** check box for the **[Authentication]** setting when authentication is required, otherwise clear the check box.
- 5) Click the **[Apply]** button to save the settings.

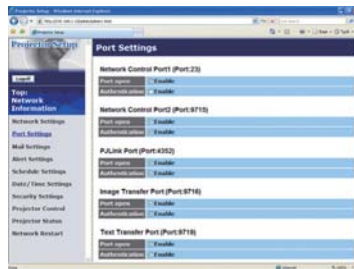

When the authentication setting is enabled, the following settings are required.

- 6) Click **[Security Settings]** on the main menu.
- 7) Select **[Network Control]** and enter the desired authentication password.
- 8) Click the **[Apply]** button to save the settings.

NOTE • The Authentication Password will be the same for **Network Control Port1 (Port: 23)**, **Network Control Port2 (Port: 9715)**, **P.J.LINK™ Port (Port: 4352)**, **Image Transfer Port (Port: 9716)** and **Text Transfer Port (Port: 9719)**.
 • The new configuration settings are activated after restarting the network connection. When the configuration settings are changed, you must restart the network connection. You can restart the network connection by clicking **[Network Restart]** on the main menu.

3.7 Command Control via the Network

You can configure and control the projector via the network using RS-232C commands.

Communication Port

The following two ports are assigned for the command control.

TCP #23(**Network Control Port1 (Port: 23)**)

TCP #9715(**Network Control Port2 (Port: 9715)**)

NOTE • Command control is available only via the specified port above.

Command Control Settings (17)

Configure the following items from a web browser when command control is used.

Example: If the IP address of the projector is set to **192.168.1.10**:

- 1) Enter “**http://192.168.1.10/**” into the address bar of the web browser.
- 2) Enter the Administrator ID and password and click [**Logon**].
- 3) Click [**Port Settings**] on the main menu.

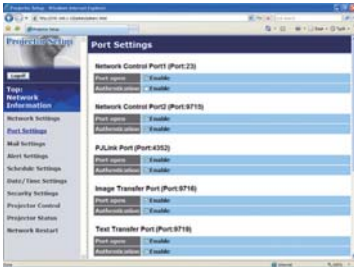

- 4) Click [**Enable**] check box to open **Network Control Port1 (Port: 23)** to use TCP #23. Click [**Enable**] check box for [**Authentication**] setting when authentication is required, otherwise clear the check box.
- 5) Click [**Enable**] check box to open **Network Control Port2 (Port: 9715)** to use TCP #9715. Click [**Enable**] check box for [**Authentication**] setting when authentication is required, otherwise clear the check box.
- 6) Click [**Apply**] button to save the settings.

3.7 Command Control via the Network (continued)

When the authentication setting is enabled, the following settings are required.

( 26)

- 7) Click [**Security Settings**] on the main menu.
- 8) Click [**Network Control**] and enter the desired authentication password.
 - * See NOTE.
- 9) Click [**Apply**] button to save the settings.

NOTE • The Authentication Password will be the same for **Network Control Port1 (Port: 23)**, **Network Control Port2 (Port: 9715)**, **PJLink™ Port (Port: 4352)**, **Image Transfer Port (Port: 9716)** and **Text Transfer Port (Port: 9719)**.
• The new configuration settings are activated after restarting the network connection. When the configuration settings are changed, you must restart the network connection. You can restart the network connection by clicking [**Network Restart**] on the main menu.

3.7 Command Control via the Network (continued)

Command Format

Command formats differ among the different communication ports.

- TCP #23

You can use the RS-232C commands without any changes. The reply data format is the same as the RS-232C commands. ([📖“RS-232C Communication” in the User’s Manual – Operating Guide \(Technical\)](#)) However, the following reply will be sent back in the event of authentication failure when authentication is enabled.

<Reply in the event of an authentication error>

Reply	Error code	
0x1F	0x04	0x00

- TCP #9715

Send Data format

The following formatting is added to the header (0x02), Data length (0x0D), Checksum (1 byte) and Connection ID (1 byte) of the RS-232C commands. ([📖“RS-232C Communication” in the User’s Manual – Operating Guide \(Technical\)](#))

Header	Data length	RS-232C command	Check Sum	Connection ID
0x02	0x0D	13 bytes	1 byte	1 byte

- Header → 0x02, Fixed
- Data length → RS-232C commands byte length (0x0D, Fixed)
- RS-232C commands → RS-232C commands that start with 0xBE 0xEF (13 bytes)
- Check Sum → This is the value to make zero on the addition of the lower 8 bits from the header to the checksum.
- Connection ID → Random value from 0 to 255 (This value is attached to the reply data)

3.7 Command Control via the Network (continued)

Reply Data format

The connection ID (the data is same as the connection ID data on the sending data format) is attached to the RS-232C commands reply data.

<ACK reply>

Reply	Connection ID
0x06	1 byte

<NAK reply>

Reply	Connection ID
0x15	1 byte

<Error reply>

Reply	Error code	Connection ID
0x1C	2 bytes	1 byte

<Data reply>

Reply	Data	Connection ID
0x1D	2 bytes	1 byte

<Projector busy reply>

Reply	Status code	Connection ID
0x1F	2 bytes	1 byte

<Authentication error reply>

Reply	Authentication Error code		Connection ID
0x1F	0x04	0x00	1 byte

3.7 Command Control via the Network (continued)

Automatic Connection Break

The TCP connection will be automatically disconnected after there is no communication for 30 seconds after being established.

Authentication

The projector does not accept commands without authentication success when authentication is enabled. The projector uses a challenge response type authentication with an MD5 (Message Digest 5) algorithm.

When the projector is using a LAN, a random 8 bytes will be returned if authentication is enabled. Bind this received 8 bytes and the Authentication Password and digest this data with the MD5 algorithm and add this in front of the commands to send.

Following is a sample if the Authentication Password is set to “password” and the random 8 bytes are “a572f60c”.

- 1) Select the projector.
- 2) Receive the random 8 bytes “a572f60c” from the projector.
- 3) Bind the random 8 bytes “a572f60c” and the Authentication Password “password” and it becomes “a572f60cpassword”.
- 4) Digest this bind “a572f60cpassword” with MD5 algorithm.
It will be “e3d97429adffa11bce1f7275813d4bde”.
- 5) Add this “e3d97429adffa11bce1f7275813d4bde” in front of the commands and send the data.
Send “e3d97429adffa11bce1f7275813d4bde”+command.
- 6) When the sending data is correct, the command will be performed and the reply data will be returned. Otherwise, an authentication error will be returned.

NOTE • As for the transmission of the second or subsequent commands, the authentication data can be omitted when the same connection.

3.8 Controlling the external device via the projector (using the NETWORK BRIDGE function)

This projector is equipped with the NETWORK BRIDGE function to perform mutual conversion of a network protocol and a serial interface.

Using the NETWORK BRIDGE function, a computer that is connected with this projector by Ethernet communication can control an external device that is connected with this projector by RS-232C communication as a network terminal.

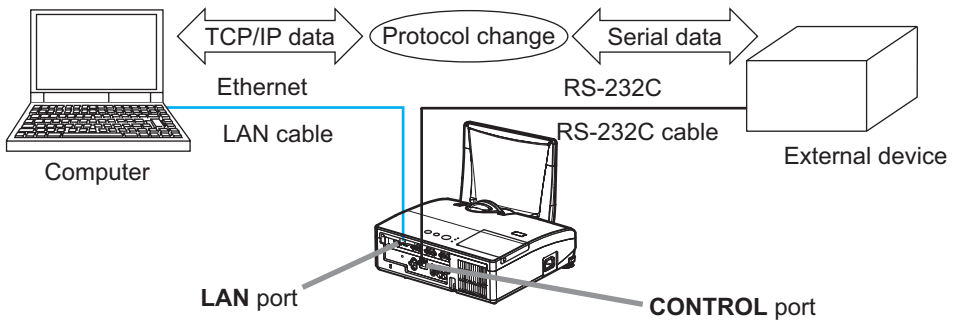

3.8.1 Connecting devices

- 1) Connect the projector's **LAN** port and the computer's LAN port with a LAN cable, for Ethernet communication.
- 2) Connect the projector's **CONTROL** port and the device's RS-232C port with an RS-232C cable, for RS-232C communication.

NOTE • Before connecting the devices, read the manuals for the devices to ensure the connection.

For RS-232C connection, check the specifications of each port and use the suitable cable. (📖 **"Connection to the ports" in the User's Manual - Operating Guide (Technical)**)

3.8.2 Communication setup

To configure the setup of the communication using NETWORK BRIDGE for the projector, use items in the COMMUNICATION menu. Open the menu of the projector and select the OPTION - SERVICE - COMMUNICATION menu.

(📖 **OPTION menu - SERVICE – COMMUNICATION in the User's Manual - Operating Guide**)

- 1) Using the COMMUNICATION TYPE menu, select the NETWORK BRIDGE for the **CONTROL** port.
- 2) Using the SERIAL SETTINGS menu, select the proper baud rate and parity for the **CONTROL** port, according to the specification of the RS-232C port of the connected device.

Item	Condition
BAUD RATE	4800bps/9600bps/19200bps/38400bps
PARITY	NONE/ODD/EVEN
Data length	8 bit (fixed)
Start bit	1 bit (fixed)
Stop bit	1 bit (fixed)

- 3) Using the TRANSMISSION METHOD menu, set up the proper method for the **CONTROL** port according to your use.

NOTE • The OFF is selected for the COMMUNICATION TYPE as the default setting.

- Using the COMMUNICATION menu, set up the communication. Remember that an unsuitable setup could cause malfunction of communication.
- When COMMUNICATION TYPE is set to NETWORK BRIDGE, the **CONTROL** port doesn't accept RS-232C commands.

3.8.3 Communication port

For the NETWORK BRIDGE function, send the data from the computer to the projector with using the **Network Bridge Port** that is configured in the “Port Settings” of web browser. (📖18)

NOTE • Except for 9715, 9716, 9719, 4352 between 1024 and 65535 can be set up as the **Network Bridge Port** number. It is set to 9717 as the default setting.

3.8.4 Transmission method

The transmission method can be selected from the menus, only when the NETWORK BRIDGE is selected for the COMMUNICATION TYPE.

( **OPTION menu - SERVICE - COMMUNICATION in the User's Manual - Operating Guide**)

HALF-DUPLEX ↔ FULL-DUPLEX

3.8.4.1 HALF-DUPLEX

This method lets the projector make two way communication, but only one direction, either transmitting or receiving data, is allowed at a time. The method does not allow the projector to receive the data from the computer while waiting for response data from an external device. After the projector receives the response data from an external device or the response limit time is past, the projector can receive the data from the computer. That means that the projector controls transmitting and receiving the data to synchronize the communication.

To use the HALF-DUPLEX method, set up the RESPONSE LIMIT TIME and BYTES INTERVAL TIMEOUT, following the instruction below.

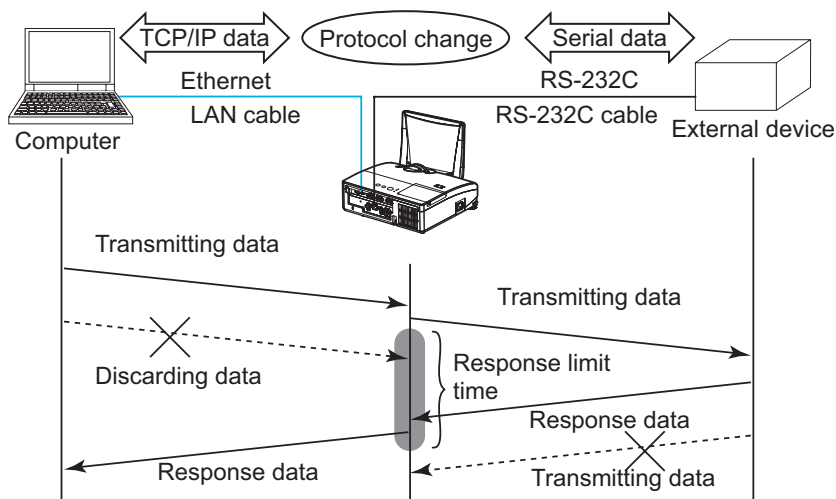

- Using the RESPONSE LIMIT TIME menu, set the waiting time for response data from an external device. ( **OPTION menu - SERVICE - COMMUNICATION in the User's Manual - Operating Guide**)

OFF ↔ 1s ↔ 2s ↔ 3s (↔ OFF)

3.8.4.1 HALF-DUPLEX (continued)

2) If the response data from an external device is blank in a certain time period (BYTES INTERVAL TIMEOUT), the projector judges that the response data is finished, and starts to send data again.

If a blank time in the response data is longer than the BYTES INTERVAL TIMEOUT, the projector cannot receive all data, then the computer may not be able to control an external device well.

Using the BYTES INTERVAL TIMEOUT menu, set the waiting time for response data to match your system. ( **OPTION menu - SERVICE - COMMUNICATION in the User's Manual - Operating Guide**)

50ms ↔ 100ms ↔ 150ms ↔ 200ms (↔ 50ms)

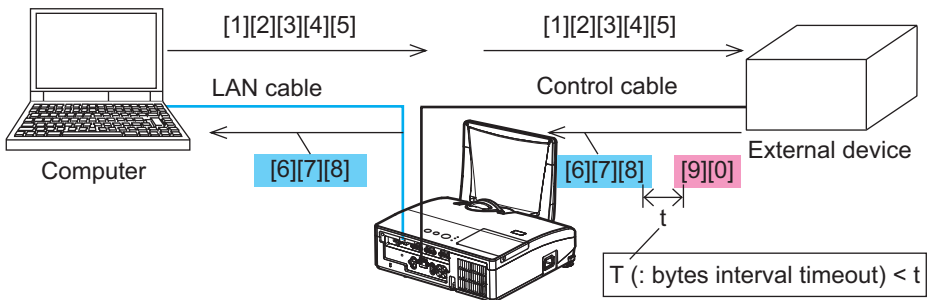

NOTE • With using the HALF-DUPLEX method, the projector can send out 254 byte data as maximum at once.

- If it is not required to monitor the response data from an external device and the RESPONSE LIMIT TIME is set to OFF, the projector can receive the data from the computer and send it out to an external device continuously. The OFF is selected as the default setting.

3.8.4.2 FULL-DUPLEX

This method lets the projector make two way communication, transmitting and receiving data at the same time, without monitoring response data from an external device.

With using this method, the computer and an external device will send the data out of synchronization. If it is required to synchronize them, set the computer to make the synchronization.

NOTE • In case that the computer controls to synchronize transmitting and receiving the data, it may not be able to control an external device well depending on the processing status of the projector.

Projector

CP-AW100N

User's Manual (concise)

Thank you for purchasing this projector.

Please read through this manual before using this product, in order to use safely and utilize well the product.

⚠ WARNING ▶ Before using this product, be sure to read all manuals for this product. See the “Using the CD manual” (📖22) to read the manuals in the CD. After reading them, store them in a safe place for future reference.

- ▶ Heed all the warnings and cautions in the manuals or on the product.
- ▶ Follow all the instructions in the manuals or on the product.

NOTE • In this manual, unless any comments are accompanied, “the manuals” means all the documents provided with this product, and “the product” means this projector and all the accessories came with the projector.

Contents

First of all..... 2	📖	Connecting power supply 12	📖
Entries and graphical symbols explanation2		Turning on the power..... 12	
Important safety instruction2		Adjusting the projector's elevator 13	
Regulatory notices..... 3		Displaying the picture 14	
About Electro-Magnetic Interference3		Turning off the power..... 15	
About Waste Electrical and Electronic Equipment...4		Replacing the lamp..... 16	
Contents of package..... 5		Cleaning and replacing the air filter .. 19	
Arrangement..... 6		Caring for the mirror and lens..... 20	
Connecting your devices 7		Replacing the internal clock battery.. 21	
Using the cable cover 9		Using the CD manual 22	
Preparing for the remote control..... 10		Specifications 23	
Starting the projector 11		Troubleshooting	
		- Warranty and after-service 24	

First of all

Entries and graphical symbols explanation

The following entries and graphical symbols are used for the manuals and the product as follows, for safety purpose. Please know their meanings beforehand, and heed them.

- ⚠ **WARNING** This entry warns of a risk of serious personal injury or even death.
- ⚠ **CAUTION** This entry warns of a risk of personal injury or physical damage.
- NOTICE** This entry notices of fear of causing trouble.

Important safety instruction

The followings are important instructions for safely using the product. Be sure to follow them always when handling the product. The manufacturer assumes no responsibility for any damage caused by mishandling that is beyond normal usage defined in these manuals of this projector.

- ⚠ **WARNING** ▶ Never use the product in or after an abnormality (ex. giving off smoke, smelling strange, took a liquid or an object inside, broken, etc.). If an abnormality should occur, unplug the projector urgently.
 - ▶ Situate the product away from children and pets.
 - ▶ Do not use the product when there is fear of a thunderbolt.
 - ▶ Unplug the projector from the power outlet if the projector is not used for the time being.
 - ▶ Do not open or remove any portion of the product, unless the manuals direct it. For internal maintenance, leave it to your dealer or their service personnel.
 - ▶ Use only the accessories specified or recommended by the manufacturer.
 - ▶ Modify neither the projector nor accessories.
 - ▶ Let neither any things nor any liquids enter to the inside of the product.
 - ▶ Do not wet the product.
 - ▶ Apply neither a shock nor pressure to this product.
- Do not place the product on an unstable place such as the uneven surface or the leaned table.
- Do not place the product unstably. Place the projector so that it does not protrude from the surface where the projector is placed on.
- Remove all the attachments including the power cord and cables, from the projector when carrying the projector.
- ▶ Do not look into the lens and the openings on the projector, while the lamp is on.
- ▶ Do not approach the lamp cover and the exhaust vents, while the projection lamp is on. Also after the lamp goes out, do not approach them for a while, since too hot.

Regulatory notices

About Electro-Magnetic Interference

In CANADA

This Class B digital apparatus complies with Canadian ICES-003.

In the US, and other places where the FCC regulations are applicable

Declaration of Conformity

Trade name	HITACHI
Model Number	CP-AW100N
Responsible Party	Hitachi America, Ltd.
Address	900 Hitachi way, Chula Vista, CA 91914-3556 U.S.A.
Telephone Number	+1 -800-225-1741

This device complies with part 15 of the FCC Rules. Operation is subject to the following two conditions: (1) This device may not cause harmful interference, and (2) this device must accept any interference received, including interference that may cause undesired operation. This equipment has been tested and found to comply with the limits for a Class B digital device, pursuant to Part 15 of the FCC Rules.

These limits are designed to provide reasonable protection against harmful interference in a residential installation. This equipment generates, uses, and can radiate radio frequency energy and, if not installed and used in accordance with the instructions, may cause harmful interference to radio communications. However, there is no guarantee that interference will not occur in a particular installation. If this equipment does cause harmful interference to radio or television reception, which can be determined by turning the equipment off and on, the user is encouraged to try to correct the interference by one or more of the following measures:

- Reorient or relocate the receiving antenna.
- Increase the separation between the equipment and receiver.
- Connect the equipment into an outlet on a circuit different from that to which the receiver is connected.
- Consult the dealer or an experienced radio/TV technician for help.

INSTRUCTIONS TO USERS: This equipment complies with the requirements of the FCC (Federal Communication Commission) equipment provided that the following conditions are met. Some cables have to be used with the core set. Use the accessory cable or a designated-type cable for the connection. For cables that have a core only at one end, connect the core to the projector.

CAUTION: Changes or modifications not expressly approved by the party responsible for compliance could void the user's authority to operate the equipment.

Regulatory notices (continued)

About Waste Electrical and Electronic Equipment



The mark is in compliance with the Waste Electrical and Electronic Equipment Directive 2002/96/EC (WEEE).

The mark indicates the requirement NOT to dispose the equipment including any spent or discarded batteries or accumulators as unsorted municipal waste, but use the return and collection systems available. If the batteries or accumulators included with this equipment, display the chemical symbol Hg, Cd, or Pb, then it means that the battery has a heavy metal content of more than 0.0005% Mercury or more than, 0.002% Cadmium, or more than 0.004% Lead.

Contents of package

Your projector should come with the items shown below. Check that all the items are included. Require of your dealer immediately if any items are missing.

- (1) Remote control with the two AA batteries
- (2) Power cord
- (3) Computer cable
- (4) Cable cover
- (5) User's manuals (Book x1, CD x1)
- (6) Security label

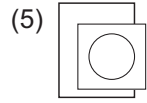
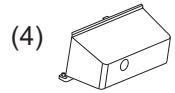
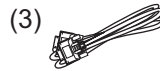
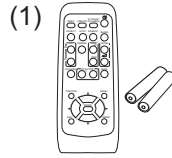

ENGLISH

NOTE • Keep the original packing materials for future reshipment. Be sure to use the original packing materials when moving the projector. Use special caution for the lens.

Arrangement

Refer to the illustrations and tables below to determine screen size and projection distance.

The values shown in the table are calculated for a full size screen: 1280 x 800

Ⓐ Screen size (diagonal) Ⓑ Projection distance (±8%) Ⓒ1, Ⓒ2 Screen height

• On a horizontal surface

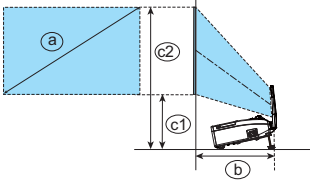

Screen size Ⓐ (diagonal)		Ⓑ Projection distance		Ⓒ1 Screen height		Ⓒ2 Screen height	
type(inch)	m	m	inch	m	inch	m	inch
60	1.5	0.592	23	0.316	12	1.124	44
70	1.8	0.705	28	0.349	14	1.292	51
80	2.0	0.819	32	0.383	15	1.460	57
90	2.3	0.933	37	0.416	16	1.627	64
100	2.5	1.046	41	0.449	18	1.795	71

• Suspended from the ceiling

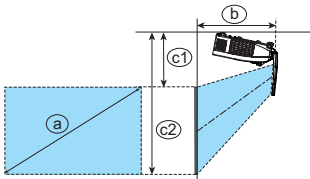

- Keep a space of 30 cm or more between the sides of the projector and other objects such as walls. Do not place or attach anything that would block the lens or vent holes.
- For the case of installation in a special state such as ceiling mount, the specified mounting accessories (Ⓔ23) and service may be required. Before installing the projector, consult your dealer about your installation.

- The screen position may shift after installation if the projector is suspended from the ceiling or other location due to the flexibility of the plastic projector body. If readjustment is necessary, consult with your dealer or service personnel.
- The projected image position and/or focus may change during warm-up (approx. 30 minutes after the lamp is turned on) or when the ambient conditions change. Readjust the image position and/or focus as necessary.
- Since the projector features an ultra short throw, be aware that it is required to select a screen carefully to have better performance.
 - A soft screen such as a pull-down screen may cause serious distortion of a projected image. A hard screen such as a board screen is recommended for use with this projector.
 - A high-gain screen such as a bead screen that has narrow viewing angle is not suitable for this projector. A low-gain screen (around 1.0) such as a matte screen that has wide viewing angle is recommended for use with this projector.
 - A screen with a weave pattern may cause moiré on the projected image, which is not a failure of the projector. A screen that has less moiré effects is recommended for use with this projector.

- ⚠WARNING** ▶ Install the projector in a stable horizontal position.
- ▶ Place the projector in a cool place, and ensure that there is sufficient ventilation. Do not place the projector where the air from an air conditioner or similar unit will blow on it directly.
 - ▶ Do not place the projector anywhere where it may get wet.
 - ▶ Use only the mounting accessories the manufacturer specified, and leave installing and removing the projector with the mounting accessories to the service personnel.
 - ▶ Read and keep the user's manual of the mounting accessories used.
- ⚠CAUTION** ▶ Avoid placing the projector in smoky, humid or dusty place.
- ▶ Position the projector to prevent light from directly hitting the projector's remote sensor.

NOTE • The projector may make a rattling sound when tilted, moved or shaken, since a flap to control the air flow inside of the projector has moved. Be aware that this is not a failure or malfunction.

Connecting your devices

Be sure to read the manuals for devices before connecting them to the projector. Make sure that all the devices are suitable to be connected with this product, and prepare the cables required to connect. Please refer to the following illustrations to connect them.

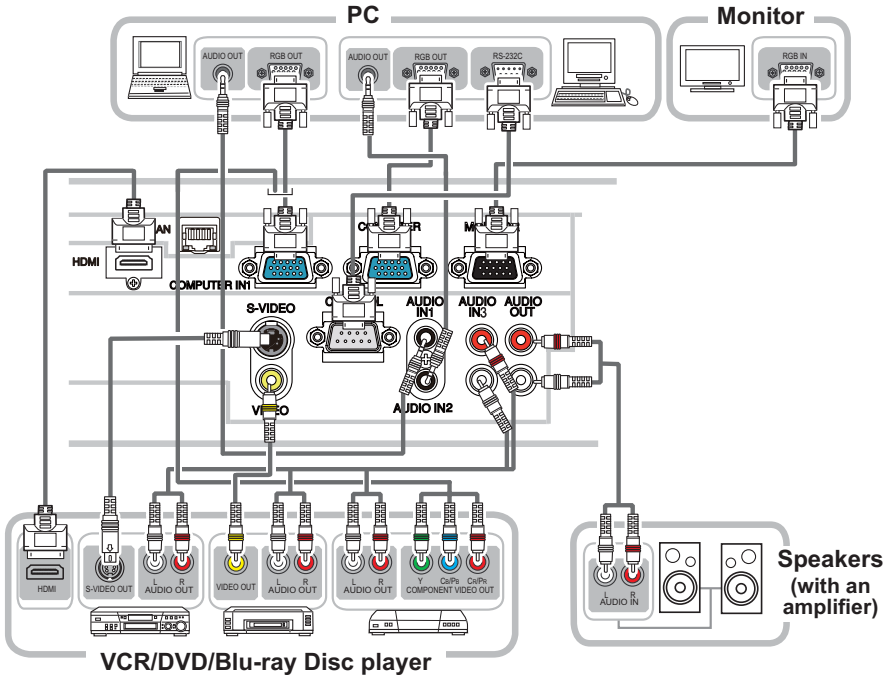

Connecting your devices (continued)

To use network functions of the projector, connect the **LAN** port to the computer's LAN port.

To use NETWORK BRIDGE function, also connect the **CONTROL** port and an RS-232C port of the external device to communicate as a network terminal. See the "Network Guide" in the CD for details of network functions.

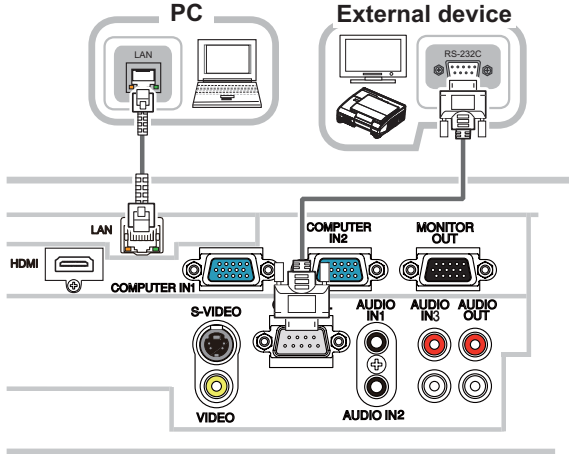

- ⚠ **WARNING** ▶ Do not disassemble or modify the projector and accessories.
- ▶ Be careful not to damage the cables, and do not use damaged cables.
- ⚠ **CAUTION** ▶ Turn off all devices and unplug their power cords prior to connecting them to projector. Connecting a live device to the projector may generate extremely loud noises or other abnormalities that may result in malfunction or damage to the device and the projector.
- ▶ Use appropriate accessory or designated cables. Ask your dealer about non-accessory cables which may be required a specific length or a ferrite core by the regulations. For cables with a core only at one end, connect the end with the core to the projector.
- ▶ Make sure that devices are connected to the correct ports. An incorrect connection may result in malfunction or damage to the device and the projector.
- ▶ Be sure to consult the administrator of the network. Do not connect LAN port to any network that might have the excessive voltage.
- NOTICE** ▶ Use the cables with straight plugs, not L-shaped ones, as the input ports of the projector are recessed.

NOTE • The **COMPUTER IN1/2** port can support a component signal also. The specific adapter or the specific cable is required for a component video input to the projector.

Using the cable cover

Utilize the cable cover as the guard and blind for the connecting parts.

1. Connect the signal cables to the projector first.
2. Insert the two knobs on the cable cover into the two holes on the bottom of the projector as shown in the figure. Pass the cables through the holes on the bottom of the cable cover. Place the cable cover on the back of the projector by rotating the cover in the direction of the arrow.

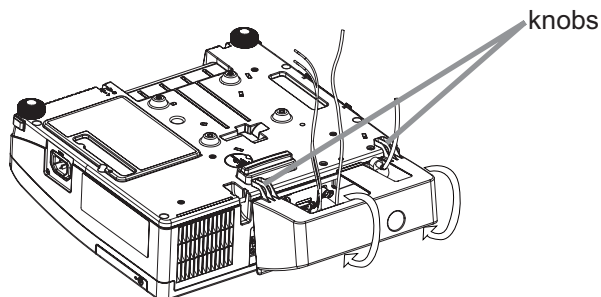

3. Tighten the screw to fix the cable cover.

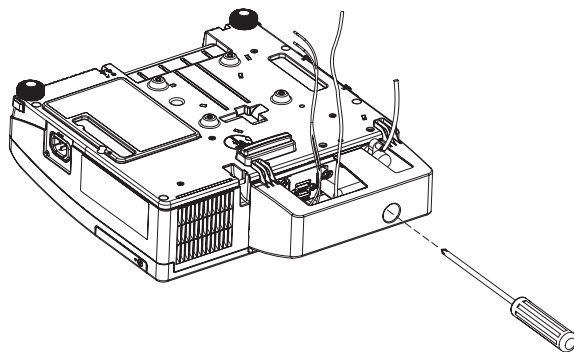

⚠ CAUTION ► Be careful not to pinch the cables in the cable cover, to prevent damage to the cables.

► Install the cable cover firmly. The cable cover will drop if the screw is loosened, and it may cause injury.

► Use the cable cover that is supplied with the projector. Do not attempt any modifications to the cable cover.

Preparing for the remote control

Please insert the batteries into the remote control before using it. If the remote control starts to malfunction, try to replace the batteries. If you will not use the remote control for long period, remove the batteries from the remote control and store them in a safe place.

1. Holding the hook part of the battery cover, remove it.
2. Align and insert the two AA batteries (**HITACHI MAXELL, Part No.LR6 or R6P**) according to their plus and minus terminals as indicated in the remote control.
3. Replace the battery cover in the direction of the arrow and snap it back into place.

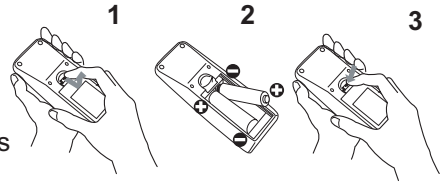

NOTE

- Try changing the batteries when the remote control malfunctions.
- This remote control works with the remote sensors on the projector using infrared light (Class 1 LED). The active sensor senses the remote control signal assigned within 60 degrees to right and left, and within 3 meters. For details, see the Operating Guide in the CD.
- Prevent the remote sensors from being hit by a strong ray. It may cause malfunction of the projector and remote control.

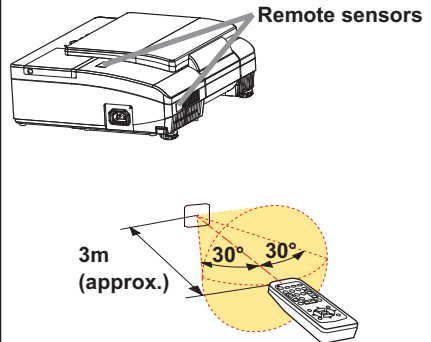

- ⚠WARNING** ► Always handle the batteries with care and use them only as directed. Improper use may result in battery explosion, cracking or leakage, which could result in fire, injury and/or pollution of the surrounding environment.
- Be sure to use only the batteries specified. Do not use batteries of different types at the same time. Do not mix a new battery with used one.
 - Make sure the plus and minus terminals are correctly aligned when loading a battery.
 - Keep a battery away from children and pets.
 - Do not recharge, short circuit, solder or disassemble a battery.
 - Do not place a battery in a fire or water. Keep batteries in a dark, cool and dry place.
 - If you observe battery leakage, wipe out the leakage and then replace a battery. If the leakage adheres to your body or clothes, rinse well with water immediately.
 - Obey the local laws on disposing the battery.

Starting the projector

For this projector, follow the procedure below.

This projector needs to be tilted slightly as shown in the figure to project the image properly. Follow the procedure below for set up.

- (1) Hold both sides of the projector, and tilt the projector.
- (2) Push the elevator buttons to release the elevator feet while you hold the projector tilted.
- (3) Release the elevator button to lock the elevator feet and put the projector down gently.

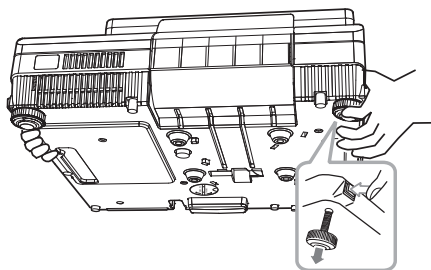

⚠ CAUTION ► Do not handle the elevator buttons without holding the projector, since the projector may drop down.

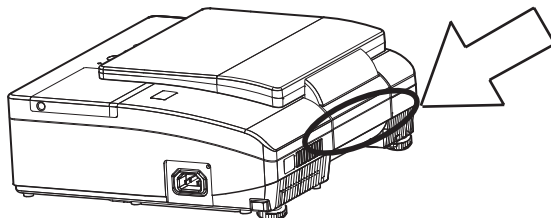

⚠ WARNING ► The mirror of this machine is made of glass. It can be damaged by excessive force or an impact. Safety film is attached to the back surface of the mirror. However, small pieces of broken glass could fall from the surface of the mirror and scatter. Read the following important warnings carefully, and follow them for your own safety.

- Do not apply excessive force on or allow impact to the lens door, as it incorporates a mirror.
- Keep the projector out of the reach of children.
- Do not stand under a ceiling mounted projector when its lens door is opening or closing. Moreover, do not look at the mirror when the lens door is opening or closing.
- If the mirror is broken, the projected image will be distorted. Never touch a broken mirror. Close the lens door, and contact your dealer.

► Do not handle the portion on the projector shown by the arrow in the figure above when you carry the projector. It could cause malfunction or injury.

► When the lens door is opening or closing, keep your fingers away from the portion shown by the arrow in the figure above to avoid pinching your fingers.

Connecting power supply

1. Put the connector of the power cord into the **AC IN** (AC inlet) of the projector.
2. Firmly plug the power cord's plug into the outlet. In a couple of seconds after the power supply connection, the **POWER** indicator will light up in steady orange.

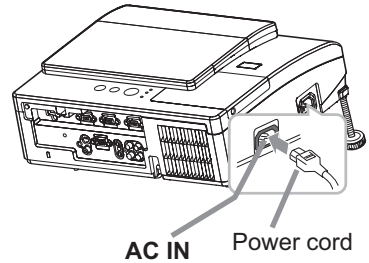

Please remember that when the DIRECT POWER ON function activated, the connection of the power supply make the projector turn on.

- ⚠WARNING** ▶ Please use extra caution when connecting the power cord, as incorrect or faulty connections may result in fire and/or electrical shock.
- Only use the power cord that came with the projector. If it is damaged, consult your dealer to get a new one.
 - Only plug the power cord into an outlet whose voltage is matched to the power cord. The power outlet should be close to the projector and easily accessible. Remove the power cord for complete separation.
 - Never modify the power cord.

Turning on the power

1. Make sure that the power cord is firmly and correctly connected to the projector and the outlet.
2. Make sure that the **POWER** indicator is steady orange.
3. Confirm that there is nothing that the lens door hits while opening. Press the **STANDBY/ON** button on the projector or the remote control. The lens door opens, the projection lamp lights up, and the **POWER** indicator begins to blink green. When the power is completely on, the indicator will stop blinking and light in steady green.

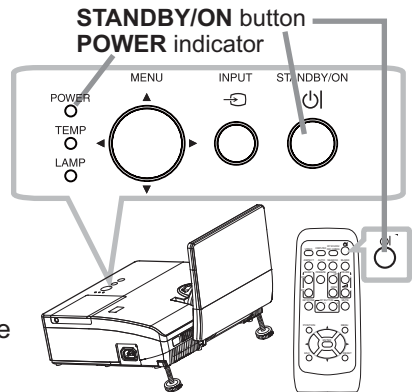

- ⚠WARNING** ▶ Never look into the projection lens or mirror while the projection lamp lights, since the projection lamp ray may cause a trouble on your eyes.
- ▶ Be careful not to pinch your finger with the lens door, to prevent an injury.
 - ▶ Do not place the projector vertically with the lens door open as shown in the figure on the right. It could cause malfunction or injury.

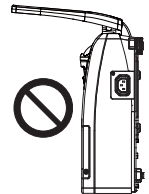

- NOTE** • Please power on the projector prior to the connected devices.
- The projector has the DIRECT POWER ON function, which can make the projector automatically turn on. For more information, please see the "Operating Guide" in the CD.

Adjusting the projector's elevator

If necessary, the elevator feet can be manually twisted to make more precise adjustments. Hold the projector when twisting the feet.

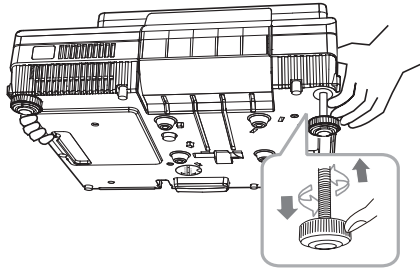

To finely adjust, twist the foot.

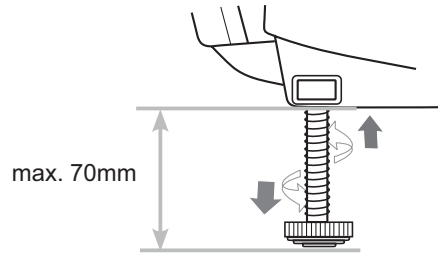

- ⚠ CAUTION** ► Do not handle the elevator buttons without holding the projector, since the projector may drop down.
- Do not lengthen the elevator feet to 70 mm or more. The foot lengthened exceeding the limit may come off from the projector, and result in an injury.

Displaying the picture

1. Activate your signal source. Turn the signal source on, and make it send the signal to the projector.
2. Use the **VOLUME + / VOLUME -** buttons to adjust the volume.
To have the projector silent, press the **MUTE** button on the remote control.
3. Press the **INPUT** button on the projector. Each time you press the button, the projector switches its input port in turn. You can also use the remote control to select an input signal. Press the **VIDEO** button for selecting an input signal from the **S-VIDEO** or **VIDEO** port, or the **COMPUTER** button for selecting an input signal from the **COMPUTER IN1**, **COMPUTER IN2** or **HDMI** port.
4. Press the **ASPECT** button on the remote control. Each time you press the button, the projector switches the mode for aspect ratio in turn.
5. Use the focus ring to focus the picture.

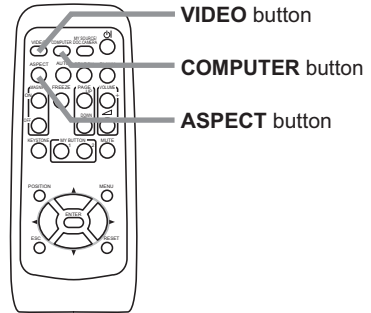
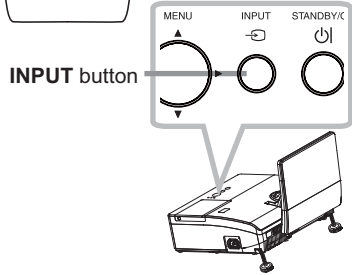
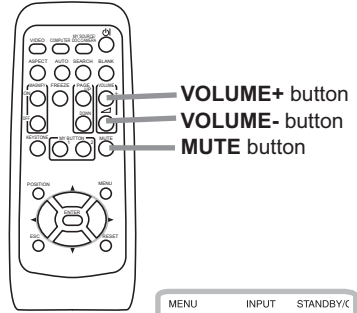

CAUTION ▶ If you wish to have a blank screen while the projector's lamp is on, use the BLANK function (see the Operating Guide). Any other method of blocking the projection light, such as attaching something to the lens or placing something in front of the lens, may cause the damage to the projector.

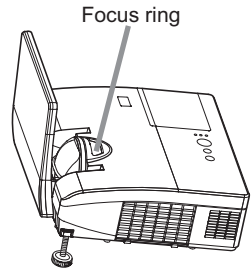

NOTE • The **ASPECT** button does not work when no proper signal is inputted.
• For the details of how to adjust the picture, please see the "Operating Guide" in the CD.

Turning off the power

1. Press the **STANDBY/ON** button on the projector or the remote control.
The message “Power off?” will appear on the screen for about 5 seconds.
2. Confirm that there is nothing that the lens door hits while closing. Press the **STANDBY/ON** button again while the message appears.
The projector lamp will go off, and the **POWER** indicator will begin blinking in orange. Then the **POWER** indicator will stop blinking and light in steady orange when the lamp cooling is complete.

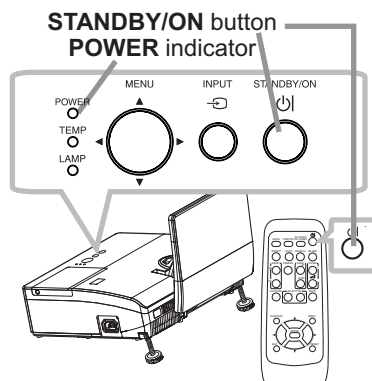

Do not turn the projector on for about 10 minutes or more after turning it off. Turning the projector on again too soon could shorten the lifetime of some consumable parts of the projector.

⚠ WARNING ▶ Be careful not to pinch your finger with the lens door, to prevent an injury.

▶ Do not touch around the lamp cover and the exhaust vents during use or just after use, since it is too hot.

▶ Remove the power cord for complete separation. The power outlet should be close to the projector and easily accessible.

NOTE • Please power off the projector after any connected devices are powered off.

• This projector has the AUTO POWER OFF function that can make the projector turn off automatically. For more information, please see the “Operating Guide” in the CD.

Replacing the lamp

A lamp has finite product life. Using the lamp for long periods of time could cause the pictures darker or the color tone poor. Note that each lamp has a different lifetime, and some may burst or burn out soon after you start using them. Preparation of a new lamp and early replacement are recommended. To prepare a new lamp, make contact with your dealer and tell the lamp type number.

Type number : DT01091

1. Turn the projector off, and unplug the power cord.
Allow the projector to cool for at least 45 minutes.
2. Prepare a new lamp. If the projector is mounted on a ceiling, or if the lamp has broken, also ask the dealer to replace the lamp.

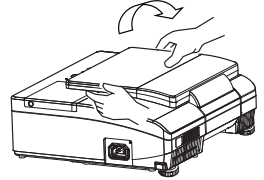

In case of replacement by yourself, follow the following procedure.

3. You can open the lens door by hand. Hold both sides of the lens door as shown in the figure. Open the lens door slowly in the direction of the arrow till it clicks. Do not touch the surface of the mirror when you open the lens door.

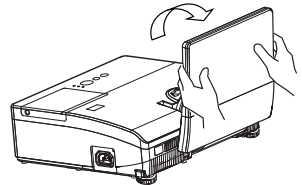

4. Loosen the screw (marked by arrow) of the lamp cover and then slide and lift the lamp cover to the side to remove it.

lamp cover

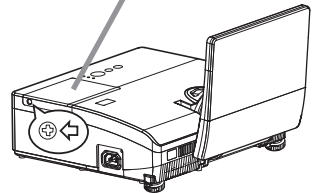

5. Loosen the 2 screws (marked by arrow) of the lamp, and slowly pick up the lamp by the handles. **Never** loosen any other screws.

6. Insert the new lamp, and retighten firmly the 2 screws of the lamp that are loosened in the previous process to lock it in place.

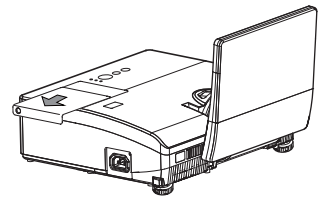

7. While putting the interlocking parts of the lamp cover and the projector together, slide the lamp cover back in place. Then firmly fasten the screw of the lamp cover.

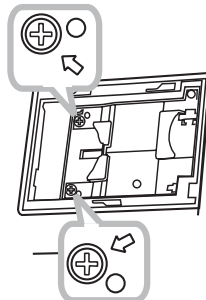

Handles

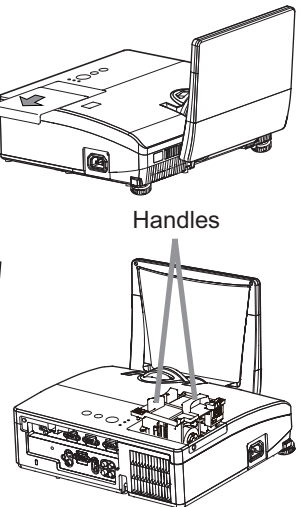

8. Follow the procedure below to close the lens door properly.

- (1) Insert the power cord with the lens door opened.
- (2) The power indicator will light in orange, and the lens door closes automatically. Do not touch the lens door when the door is closing. Do not allow anything to obstruct the lens door.

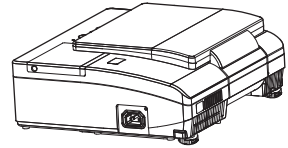

9. Turn the projector on and reset the lamp time using the LAMP TIME item in the OPTION menu.

- (1) Press the **MENU** button to display a menu.
- (2) Point at the **ADVANCED MENU** in the menu using the **▲/▼** cursor buttons, then press the **▶** cursor (or the **ENTER**) button.
- (3) Point at the **OPTION** in the left column of the menu using the **▲/▼** cursor buttons, then press the **▶** cursor (or the **ENTER**) button.
- (4) Point at the **LAMP TIME** using the **▲/▼** cursor buttons, then press the **▶** cursor (or the **ENTER** / the **RESET**) button. A dialog will appear.
- (5) Press the **▶** cursor button to select the "OK" on the dialog. It performs resetting the lamp time.

⚠ WARNING ▶ Be careful not to pinch your finger with the lens door, to prevent an injury.

⚠ CAUTION ▶ Do not touch any inner space of the projector, while the lamp is taken out.

NOTE • Please reset the lamp time only when you have replaced the lamp, for a suitable indication about the lamp.

- When the lens door is closed manually, it may not shut properly.
- The lens door may not close when the **LENS DOOR LOCK** function of the **SERVICE** item in the **OPTION** menu is set to **ON**. For more information, please see the "Operating Guide" on the CD.

Replacing the lamp (continued)



HIGH VOLTAGE



HIGH TEMPERATURE



HIGH PRESSURE

⚠️WARNING ► The projector uses a high-pressure mercury glass lamp. The lamp can break with a loud bang, or burn out, if jolted or scratched, handled while hot, or worn over time. Note that each lamp has a different lifetime, and some may burst or burn out soon after you start using them. In addition, if the bulb bursts, it is possible for shards of glass to fly into the lamp housing, and for gas containing mercury and dust containing fine particles of glass to escape from the projector's vent holes.

► **About disposal of a lamp:** This product contains a mercury lamp; do not put it in a trash. Dispose of it in accordance with environmental laws.

- For lamp recycling, go to www.lamprecycle.org (in the US).
- For product disposal, consult your local government agency or www.eiae.org (in the US) or www.epsc.ca (in Canada).

For more information, ask your dealer.



Disconnect the plug from the power outlet

- If the lamp should break (it will make a loud bang when it does), unplug the power cord from the outlet, and make sure to request a replacement lamp from your local dealer. Note that shards of glass could damage the projector's internals, or cause injury during handling, so please do not try to clean the projector or replace the lamp yourself.

- If the lamp should break (it will make a loud bang when it does), ventilate the room well, and make sure not to inhale the gas or fine particles that come out from the projector's vent holes, and not to get them into your eyes or mouth.

- Before replacing the lamp, turn the projector off and unplug the power cord, then wait at least 45 minutes for the lamp to cool sufficiently. Handling the lamp while hot can cause burns, as well as damaging the lamp.



- Never unscrew except the appointed (marked by an arrow) screws.
- Do not open the lamp cover while the projector is suspended from a ceiling. This is dangerous, since if the lamp's bulb has broken, the shards will fall out when the cover is opened. In addition, working in high places is dangerous, so ask your local dealer to have the lamp replaced even if the bulb is not broken.

- Do not use the projector with the lamp cover removed. At the lamp replacing, make sure that the screws are screwed in firmly. Loose screws could result in damage or injury.



- Use only the lamp of the specified type. Use of a lamp that does not meet the lamp specifications for this model could damage or shorten the life of this product.

- If the lamp breaks soon after the first time it is used, it is possible that there are electrical problems elsewhere besides the lamp. If this happens, consult your local dealer or a service representative.

- Handle with care: jolting or scratching could cause the lamp bulb to burst during use.
- Using the lamp for long periods of time, could cause it dark, not to light up or to burst. When the pictures appear dark, or when the color tone is poor, please replace the lamp as soon as possible. Do not use old (used) lamps; this is a cause of breakage.

Cleaning and replacing the air filter

The air filter has two kinds of filters inside. Please check and clean the air filter periodically. When the indicators or a message prompts you to clean the air filter, comply with it as soon as possible. If the filters are damaged or heavily soiled, replace them with the new ones. To prepare the new filters, make contact with your dealer and tell the following type number.

Type number : UX35971 (Filter unit)

When you replace the lamp, please replace the air filter. An air filter of specified type will come together with a replacement lamp for this projector.

1. Turn the projector off, and unplug the power cord. Allow the projector to sufficiently cool down.
2. Use a vacuum cleaner on and around the filter cover.
3. Pick and pull up the filter cover knobs to take it off.
4. Use a vacuum cleaner for the filter vent of the projector.
5. Take the fine meshed filter out while holding the filter cover. It is recommended to leave the coarse meshed filter in the filter cover as it is.
6. Use a vacuum cleaner on both sides of the fine meshed filter while holding it so it will not be sucked in. Use a vacuum cleaner for the inside of the filter cover to clean up the coarse meshed filter. If the filters are damaged or heavily soiled, replace them with new ones.
7. Put the fine meshed filter on the coarse meshed one, turning its stitched side up.
8. Put the filter unit back into the projector.
9. Turn the projector on and reset the filter time using the FILTER TIME item in the EASY MENU.
 - (1) Press the **MENU** button to display a menu.
 - (2) Point at the FILTER TIME using the **▲/▼** cursor buttons, then press the **▶** cursor (or the **ENTER** / the **RESET**) button. A dialog will appear.
 - (3) Press the **▶** cursor button to select the "OK" on the dialog. It performs resetting the filter time.

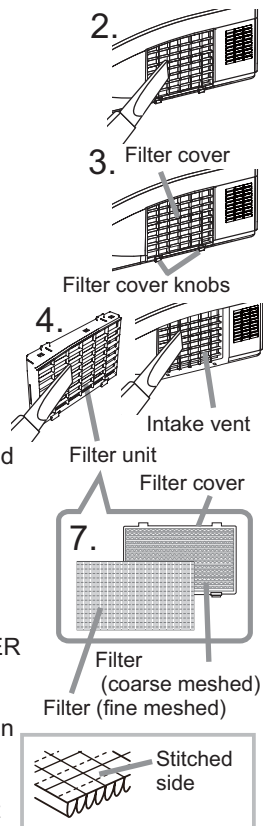

⚠ WARNING ▶ Before taking care of the air filter, make sure the power cable is not plugged in, then allow the projector to cool sufficiently.

▶ Use only the air filter of the specified type. Do not use the projector without the air filter or the filter cover. It could result in a fire or malfunction to the projector.

▶ Clean the air filter periodically. If the air filter becomes clogged by dust or the like, internal temperatures rise and could cause a fire, a burn or malfunction to the projector.

NOTE • Please reset the filter time only when you have cleaned or replaced the air filter, for a suitable indication about the air filter.

• The projector may display the message such as the "CHECK THE AIR FLOW" or turn off the projector, to prevent the internal heat level rising.

Caring for the mirror and lens

If the projection mirror or lens is flawed, soiled or fogged, it could cause deterioration of display quality. Please take care of the mirror and lens, being cautious of handling.

1. Turn the projector off and unplug the power cord from the power outlet. And cool the projector down by leaving it for a while as it is.
2. The lens door can be opened manually. Please hold both side of the lens door and slowly open it until it is locked with clicking sound.
3. Wipe softly the mirror and lens with a cleaning cloth for lens on the market, being careful not to give any damage on the mirror and lens.
For around edge of the mirror and lens where might be difficult to be wiped out, please use an air blower for cameras on the market to clean up.
4. To close the lens door properly, please take the following procedure.
 - (1) Insert the power cord with the lens door opened.
 - (2) The power indicator will light in orange, and the lens door closes automatically. Do not touch the lens door when the door is closing. Do not allow anything to obstruct the lens door.

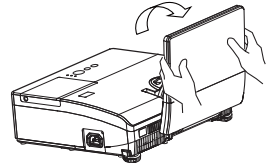
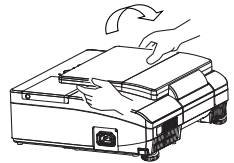

Cleaning cloth

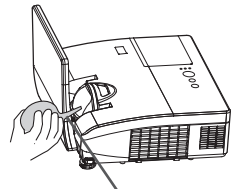
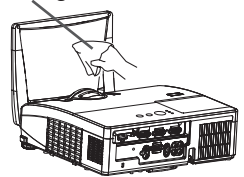

Blower

NOTE

- When the lens door is closed manually, it may not shut properly.
- The lens door may not close when the LENS DOOR LOCK function of the SERVICE item in the OPTION menu is set to ON. For more information, please see the "Operating Guide" on the CD.

⚠ WARNING ▶ Before caring for the projection mirror and lens, turn the projector off and unplug the power cord, then cool the projector sufficiently.
▶ Do not use a vacuum cleaner to clean the projection mirror or lens, since it might give some damage.
▶ Do not use cleaners or chemicals other than those specified in this manual. Pay special attention to the mirror and lens as these materials could cause serious damage to either.

⚠ CAUTION ▶ Be careful not to pinch your finger with the lens door, to prevent an injury.

Replacing the internal clock battery

Consumption of the battery makes the clock not to work correctly. When the clock is wrong or it has stopped, please replace the battery according to the following procedures.

1. Turn the projector off, and unplug the power cord. Allow the projector to cool sufficiently.
2. After making sure that the projector has cooled adequately, slowly turn over the projector, so that the bottom is facing.
3. Turn the battery cover fully in the direction indicated "OPEN" using a coin or the like, and pick the cover up to remove it.
4. Pry up the battery using a flathead screwdriver or the like to take it out. While prying it up, put a finger lightly on the battery since it may pop out of the holder.
5. Replace the battery with a new **HITACHI MAXELL**, Part No. **CR2032** or **CR2032H**. Slide the battery in under the plastic claw, and push it into the holder until it clicks.
6. Replace the battery cover in place, then turn it in the direction indicated "CLOSE" using such as coins, to fix.

Battery Cover

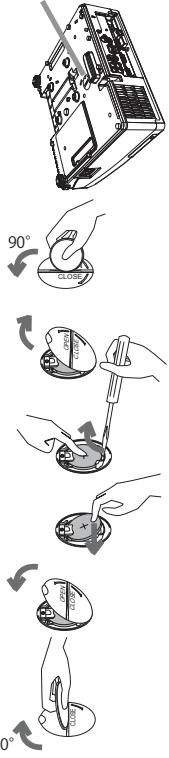

ENGLISH

⚠WARNING ► Always handle the batteries with care and use them only as directed. Battery may explode if mistreated. Do not recharge, disassemble or dispose of in fire. And also improper use may result in cracking or leakage, which could result in fire, injury and/or pollution of the surrounding environment.

- Be sure to use only the batteries specified.
- Make sure the plus and minus terminals are correctly aligned when loading a battery.
- Keep a battery away from children and pets. If swallowed consult a physician immediately for emergency treatment.
- Do not short circuit or solder a battery.
- Do not allow a battery in a fire or water. Keep batteries in a dark, cool and dry place.
- If you observe battery leakage, wipe out the leakage and then replace a battery. If the leakage adheres to your body or clothes, rinse well with water immediately.
- Obey the local laws on disposing a battery.

Using the CD manual

The other manuals for this product are written into the included CD-ROM titled "User's Manual (detailed)". Before using the CD-ROM, please read the following to ensure the proper use.

■ System requirements

The system for using the CD-ROM requires the following.

- Windows®:** OS:Microsoft® Windows® 98, Windows® 98SE, Windows NT®4.0, Windows® Me, Windows® 2000/Windows® XP or later
CPU:Pentium® processor 133MHz / Memory:32MB or more
- Macintosh®:** OS:Mac OS® 10.2 or later
CPU:PowerPC® / Memory:32MB or more
- CD-ROM drive:** 4x CD-ROM drive
- Display:** 256 color / 640x480 dots resolution
- Applications:** Microsoft® Internet Explorer®4.0 and Adobe® Acrobat® Reader® 4.0 or later

■ How to use the CD

1. Insert CD into PC's CD-ROM drive.

- Windows®:** In a while, Web browser automatically starts. Start up window comes up.
- Macintosh®:** (1) Double-click on the "Projectors" icon appeared on the desktop screen.
(2) When "main.html" file is clicked, Web browser will start and Initial window will appear.

2. Click the model name of your projector first, and then click language you want from the displayed list. The User's manual (detailed) will open.

⚠ CAUTION ▶ Only use the CD-ROM in a computer CD drive. The CD-ROM is designed for PC use only. NEVER INSERT THE CD-ROM INTO A NON-COMPUTER CD PLAYER! Inserting the CD-ROM into an incompatible CD drive may produce a loud noise, which in turn MAY RESULT IN EAR AND SPEAKER DAMAGE!

- After using CD-ROM, please put it into CD case and keep it. Please keep the CD neither in direct sunlight nor in a high temperature and high humidity environment.

NOTE • The information in the CD-ROM is subject to change without notice.
• No responsibility is taken for any obstacle and defect to hardware and software of your PC as a result of the use of the CD-ROM.
• All or Any part of the information in the CD-ROM must not be copied, reproduced or republished without notice to our company.

Specifications

Item	Specification
Product name	Liquid crystal projector
Liquid Crystal Panel	1,024,000 pixels (1280 horizontal x 800 vertical)
Lamp	180W UHB
Speaker	10W
Power supply	AC 100-120V / 3.1A, AC220-240V / 1.5A
Power consumption	270 W
Temperature range	5 ~ 35°C (Operating)
Size	333 (W) x 118 (H) x 303 (D) mm * Not including protruding parts. Please refer to the following figure.
Weight (mass)	approx. 4.7 kg
Ports	<p>Computer input port COMPUTER IN1 D-sub 15 pin mini x1 COMPUTER IN2 D-sub 15 pin mini x1</p> <p>Computer output port MONITOR OUT D-sub 15 pin mini x1</p> <p>Video input port S-VIDEO mini DIN 4 pin x1 VIDEO RCA x1</p> <p>HDMI input port HDMI HDMI connector x1</p> <p>Audio input/output port AUDIO IN1 Stereo mini x1 AUDIO IN2 Stereo mini x1 AUDIO IN3 (R, L) RCA x2 AUDIO OUT (R, L) RCA x2</p> <p>Others CONTROL D-sub 9 pin x1 LAN RJ45 x1</p>
Optional parts	<p>Lamp: DT01091 Filter set: UX35971 Mounting accessory: HAS-AW100 (Bracket for ceiling mount) HAS-203L (Fixing adaptor for low ceilings) HAS-P100 (Fixing adaptor for high ceilings) Laser remote control: RC-R008 * For more information, please consult your dealer.</p>

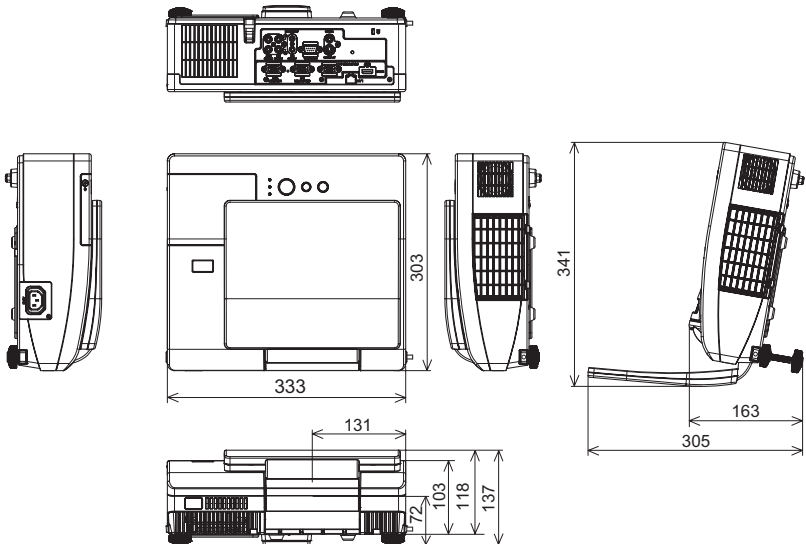

Troubleshooting - Warranty and after-service

If an abnormal operation (such as smoke, strange odor or excessive sound) should occur, stop using the projector immediately. Otherwise if a problem occurs with the projector, first refer to the "Troubleshooting" of the "Operating Guide" in the CD and run through the suggested checks.

If this does not resolve the problem, please consult your dealer or service company. They will tell you what warranty condition is applied.

Please check the following web address where you may find the latest information for this projector.

<http://www.hitachi.us/digitalmedia>

or

<http://www.hitachidigitalmedia.com>

- NOTE** • The information in this manual is subject to change without notice.
- The manufacturer assumes no responsibility for any errors that may appear in this manual.
 - The reproduction, transfer or copy of all or any part of this document is not permitted without express written consent.

Trademark acknowledgment

- Mac[®], Macintosh[®] and Mac OS[®] are registered trademarks of Apple Inc.
- Pentium[®] is a registered trademark of Intel Corp.
- Adobe[®] and Acrobat[®], Reader[®] are registered trademarks of Adobe Systems Incorporated.
- Microsoft[®] and Internet explorer[®], Windows[®], Windows NT[®], Windows Vista[®] are registered trademarks of Microsoft Corporation.
- PowerPC[®] is a registered trademark of International Business Machines Corporation.
- HDMI, the HDMI logo and High-Definition Multimedia Interface are trademarks or registered trademarks of HDMI Licensing LLC.
- "Blu-ray Disc" is a trademark.

All other trademarks are the properties of their respective owners.

Projector

CP-AW100N

User's Manual (detailed) Operating Guide – Technical

Example of PC signal

Resolution (H x V)	H. frequency (kHz)	V. frequency (Hz)	Rating	Signal mode
720 x 400	37.9	85.0	VESA	TEXT
640 x 480	31.5	59.9	VESA	VGA (60Hz)
640 x 480	37.9	72.8	VESA	VGA (72Hz)
640 x 480	37.5	75.0	VESA	VGA (75Hz)
640 x 480	43.3	85.0	VESA	VGA (85Hz)
800 x 600	35.2	56.3	VESA	SVGA (56Hz)
800 x 600	37.9	60.3	VESA	SVGA (60Hz)
800 x 600	48.1	72.2	VESA	SVGA (72Hz)
800 x 600	46.9	75.0	VESA	SVGA (75Hz)
800 x 600	53.7	85.1	VESA	SVGA (85Hz)
832 x 624	49.7	74.5		Mac 16" mode
1024 x 768	48.4	60.0	VESA	XGA (60Hz)
1024 x 768	56.5	70.1	VESA	XGA (70Hz)
1024 x 768	60.0	75.0	VESA	XGA (75Hz)
1024 x 768	68.7	85.0	VESA	XGA (85Hz)
1152 x 864	67.5	75.0	VESA	1152 x 864 (75Hz)
1280 x 768	47.7	60.0	VESA	W-XGA (60Hz)
1280 x 800	49.7	60.0	VESA	1280 x 800 (60Hz)
1280 x 960	60.0	60.0	VESA	1280 x 960 (60Hz)
1280 x 1024	64.0	60.0	VESA	SXGA (60Hz)
1280 x 1024	80.0	75.0	VESA	SXGA (75Hz)
1280 x 1024	91.1	85.0	VESA	SXGA (85Hz)
1400 x 1050	65.2	60.0	VESA	SXGA+ (60Hz)
1600 x 1200	75.0	60.0	VESA	UXGA (60Hz)

- NOTE** • Be sure to check jack type, signal level, timing and resolution before connecting this projector to a PC.
- Some PCs may have multiple display screen modes. Use of some of these modes will not be possible with this projector.
 - Depending on the input signal, full-size display may not be possible in some cases. Refer to the number of display pixels above.
 - Although the projector can display signals with resolution up to UXGA (1600x1200), the signal will be converted to the projector's panel resolution before being displayed. The best display performance will be achieved if the resolutions of the input signal and projector panel are identical.
 - Automatic adjustment may not function correctly with some input signals.
 - The image may not be displayed correctly when the input sync signal is a composite sync or a sync on G.

Initial set signals

The following signals are used for the initial settings. The signal timing of some PC models may be different. In such case, adjust the items V POSITION and H POSITION in IMAGE menu.

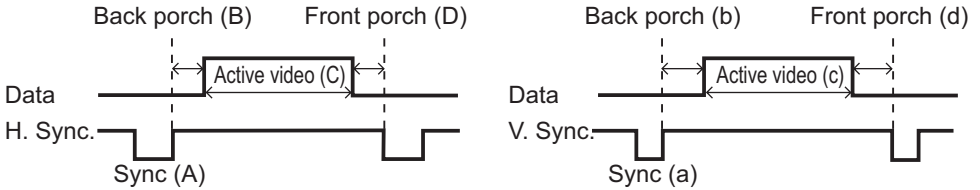

Computer signal	Horizontal signal timing (μs)				Vertical signal timing (lines)			
	(A)	(B)	(C)	(D)	(a)	(b)	(c)	(d)
720 x 400 / TEXT	2.0	3.0	20.3	1.0	3	42	400	1
640 x 480 / VGA (60Hz)	3.8	1.9	25.4	0.6	2	33	480	10
640 x 480 / VGA (72Hz)	1.3	4.1	20.3	0.8	3	28	480	9
640 x 480 / VGA (75Hz)	2.0	3.8	20.3	0.5	3	16	480	1
640 x 480 / VGA (85Hz)	1.6	2.2	17.8	1.6	3	25	480	1
800 x 600 / SVGA (56Hz)	2.0	3.6	22.2	0.7	2	22	600	1
800 x 600 / SVGA (60Hz)	3.2	2.2	20.0	1.0	4	23	600	1
800 x 600 / SVGA (72Hz)	2.4	1.3	16.0	1.1	6	23	600	37
800 x 600 / SVGA (75Hz)	1.6	3.2	16.2	0.3	3	21	600	1
800 x 600 / SVGA (85Hz)	1.1	2.7	14.2	0.6	3	27	600	1
832 x 624 / Mac 16" mode	1.1	3.9	14.5	0.6	3	39	624	1
1024 x 768 / XGA (60Hz)	2.1	2.5	15.8	0.4	6	29	768	3
1024 x 768 / XGA (70Hz)	1.8	1.9	13.7	0.3	6	29	768	3
1024 x 768 / XGA (75Hz)	1.2	2.2	13.0	0.2	3	28	768	1
1024 x 768 / XGA (85Hz)	1.0	2.2	10.8	0.5	3	36	768	1
1152 x 864 (75Hz)	1.2	2.4	10.7	0.6	3	32	864	1
1280 x 768 / W-XGA (60Hz)	1.7	2.5	16.0	0.8	3	23	768	1
1280 x 800 (60Hz)	1.6	2.4	15.3	0.8	3	24	800	1
1280 x 960 (60Hz)	1.0	2.9	11.9	0.9	3	36	960	1
1280 x 1024 / SXGA (60Hz)	1.0	2.3	11.9	0.4	3	38	1024	1
1280 x 1024 / SXGA (75Hz)	1.1	1.8	9.5	0.1	3	38	1024	1
1280 x 1024 / SXGA (85Hz)	1.0	1.4	8.1	0.4	3	44	1024	1
1400 x 1050 / SXGA+ (60Hz)	1.2	2.0	11.4	0.7	3	33	1050	1
1600 x 1200 / UXGA (60Hz)	1.2	1.9	9.9	0.4	3	46	1200	1

Connection to the ports

NOTICE ▶ Use the cables with straight plugs, not L-shaped ones, as the input ports of the projector are recessed.

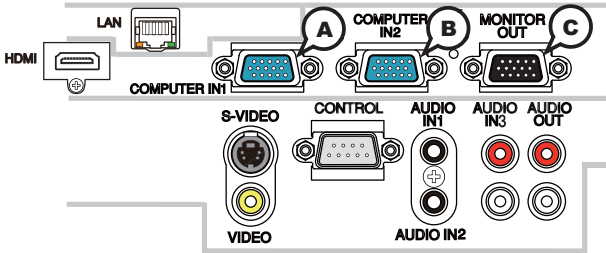

ⒶCOMPUTER IN1, ⒷCOMPUTER IN2, ⒸMONITOR OUT

D-sub 15pin mini shrink jack

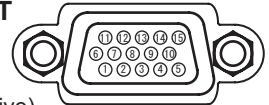

(1) for PC signal

- Video signal: RGB separate, Analog, 0.7Vp-p, 75Ω terminated (positive)
- H/V. sync. Signal: TTL level (positive/negative)
- Composite sync. Signal: TTL level

Pin	Signal	Pin	Signal
1	Video Red	10	Ground
2	Video Green	11	(No connection)
3	Video Blue	12	Ⓐ: SDA (DDC data) Ⓑ, Ⓒ: (No connection)
4	(No connection)	13	H. sync / Composite sync.
5	Ground	14	V. sync.
6	Ground Red	15	Ⓐ: SCL (DDC clock) Ⓑ, Ⓒ: (No connection)
7	Ground Green		
8	Ground Blue		
9	(No connection)	-	-

(2) for Component signal

- Y : Component video Y with composite sync, 1.0±0.1 Vp-p, 75 Ω terminator
 - Cr/Pr : Component video Cr/Pr, 0.7±0.1 Vp-p, 75 Ω terminator
 - Cb/Pb : Component video Cb/Pb, 0.7±0.1 Vp-p, 75 Ω terminator
- System:480i@60,480p@60,576i@50,576p@50,720p@50/60,1080i@50/60,1080p@50/60

Pin	Signal	Pin	Signal
1	Cr/Pr	9	(No connection)
2	Y	10	Ground
3	Cb/Pb	11	(No connection)
4	(No connection)	12	(No connection)
5	Ground	13	(No connection)
6	Ground Cr/Pr	14	(No connection)
7	Ground Y	15	(No connection)
8	Ground Cb/Pb	-	-

To input component video signal to **COMPUTER IN** ports

ex.

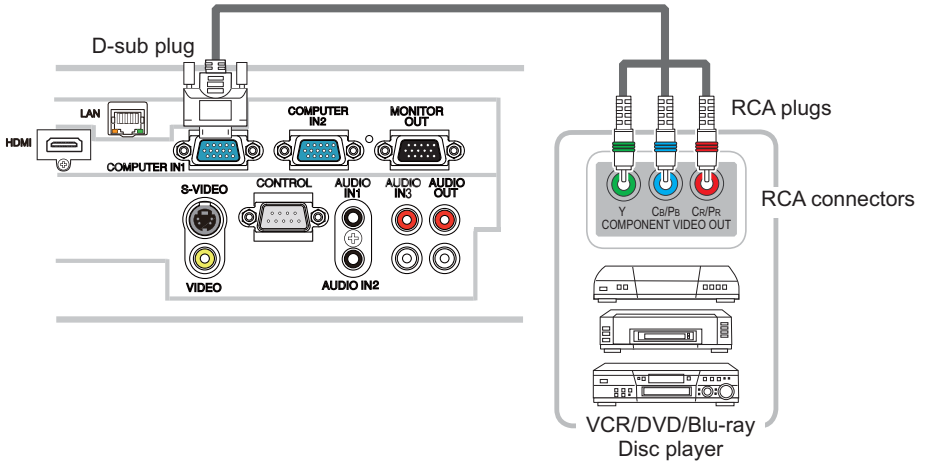

To input component video signal to the **COMPUTER IN1** or **IN2** port of the projector, use a RCA to D-sub cable or adapter.
For about the pin description of the required cable or adapter, refer to the descriptions about **COMPUTER IN1** and **IN2** port ([📖3](#)).

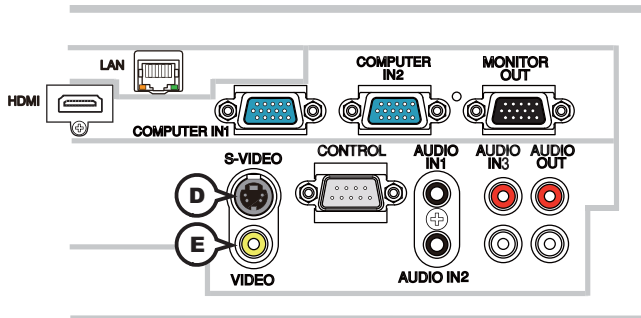

ⓓ S-VIDEO

Mini DIN 4pin jack

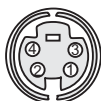

- System: NTSC, PAL, SECAM, PAL-M, PAL-N, NTSC4.43, PAL (60Hz)

Pin	Signal
1	Color signal 0.286Vp-p (NTSC, burst), 75Ω terminator Color signal 0.300Vp-p (PAL/SECAM, burst) 75Ω terminator
2	Brightness signal, 1.0Vp-p, 75Ω terminator
3	Ground
4	Ground

ⓔ VIDEO

RCA jack

- System: NTSC, PAL, SECAM, PAL-M, PAL-N, NTSC4.43, PAL (60Hz)
- 1.0±0.1Vp-p, 75Ω terminator

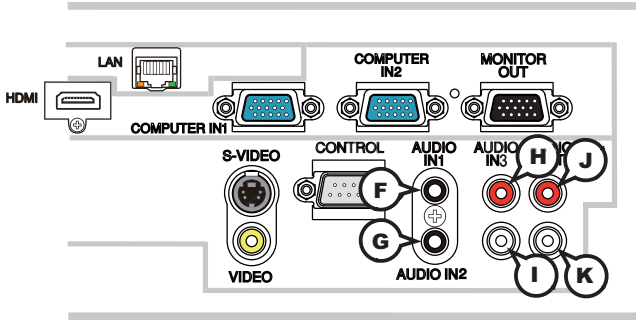

F AUDIO IN1, **G** AUDIO IN2

Ø3.5 stereo mini jack

- 200 mVrms 47kΩ terminator

AUDIO IN3 **H**, **R**, **I**, **L**

RCA jack x2

- 200 mVrms 47kΩ terminator

AUDIO OUT **J**, **R**, **K**, **L**

RCA jack x2

- 200 mVrms 1kΩ output impedance

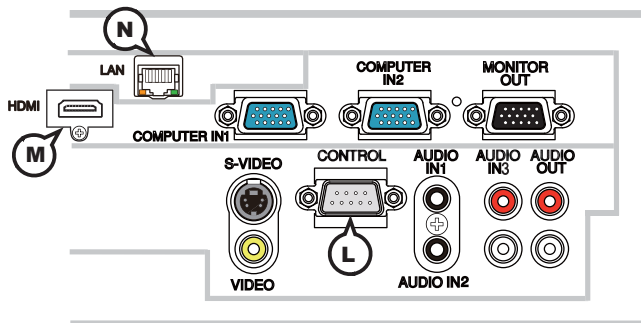

L CONTROL

D-sub 9pin plug

• About the details of RS-232C communication, please refer to the following page.

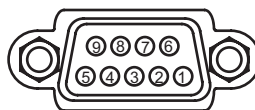

Pin	Signal	Pin	Signal	Pin	Signal
1	(No connection)	4	(No connection)	7	RTS
2	RD	5	Ground	8	CTS
3	TD	6	(No connection)	9	(No connection)

M HDMI

• Type :Digital video connector

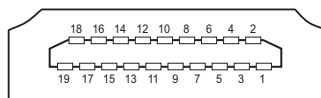

Pin	Signal	Pin	Signal	Pin	Signal
1	T.M.D.S. Data2 +	8	T.M.D.S. Data0 Shield	15	SCL
2	T.M.D.S. Data2 Shield	9	T.M.D.S. Data0 -	16	SDA
3	T.M.D.S. Data2 -	10	T.M.D.S. Clock +	17	DDC/CEC Ground
4	T.M.D.S. Data1 +	11	T.M.D.S. Clock Shield	18	+5V Power
5	T.M.D.S. Data1 Shield	12	T.M.D.S. Clock -	19	Hot Plug Detect
6	T.M.D.S. Data1 -	13	CEC		
7	T.M.D.S. Data0 +	14	Reserved(N.C. on device)		

N LAN

RJ-45 jack

Pin	Signal	Pin	Signal	Pin	Signal
1	TX+	4	-	7	-
2	TX-	5	-	8	-
3	RX+	6	RX-		

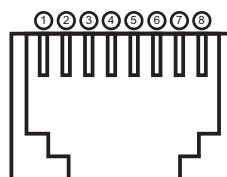

PJLink command

This projector is equipped with the PJLink™ Class 1.

See the following table for the commands for controlling the projector using the PJLink™ protocol are as given in the table below.

Commands	Control Description	Parameter or Response
POWER	Power Control	0 = Standby 1 = Power On
POWER ?	Power Status inquiry	0 = Standby 1 = Power On 2 = Cool Down
INPT	Input Source selection	11 = COMPUTER IN 1 12 = COMPUTER IN 2 22 = S-VIDEO 23 = VIDEO 31 = HDMI
INPT ?	Input Source inquiry	11 = COMPUTER IN 1 12 = COMPUTER IN 2 22 = S-VIDEO 23 = VIDEO 31 = HDMI
AVMT	AV Mute	10 = BLANK off 11 = BLANK on 20 = MUTE off 21 = MUTE on 30 = AV MUTE off 31 = AV MUTE on
AVMT ?	AV Mute inquiry	10 = BLANK off 11 = BLANK on 20 = MUTE off 21 = MUTE on 30 = AV MUTE off 31 = AV MUTE on
ERST ?	Error Status inquiry	1st byte: Refers to Fan error; one of 0 to 2 2nd byte: Refers to Lamp error; one of 0 to 2 3rd byte: Refers to Temperature error; one of 0 to 2 4th byte: Refers to Cover error; one of 0 to 2 5th byte: Refers to Filter error; one of 0 to 2 6th byte: Refers to Other error; one of 0 to 2 The meaning of 0 to 2 is as given below 0 = Error is not detected; 1 = Warning; 2 = Error

Commands	Control Description	Parameter or Response
LAMP ?	Lamp Status inquiry	1st number (digits 1 to 5): Lamp Time 2nd number : 0 = Lamp off, 1 = Lamp on
INST ?	Input Source List inquiry	11 12 22 23 31
NAME ?	Projector Name inquiry	Responds with the name set in "PROJECTOR NAME" of "NETWORK"
INF1 ?	Manufacturer's Name inquiry	HITACHI
INF2 ?	Model Name inquiry	CP-AW100N
INFO ?	Other Information inquiry	Responds with the factory information and so on
CLSS ?	Class Information inquiry	1

NOTE • The password used in PJLink™ is the same as the password set in the Web Browser Control. To use PJLink™ without authentication, do not set any password in Web Browser Control.

- For specifications of PJLink™, see the web site of the Japan Business Machine and Information System Industries Association.
URL: <http://pjlink.jbmia.or.jp/>

RS-232C Communication

When the projector connects to the computer by RS-232C communication, the projector can be controlled with RS-232C commands from the computer.

For details of RS-232C commands, refer to RS-232C Communication / Network command table (📖19).

Connection

1. Turn off the projector and the computer.
2. Connect the projector's **CONTROL** port and the computer's RS-232C port with a RS-232C cable (cross). Use the cable that fulfills the specification shown in figure
3. Turn the computer on, and after the computer has started up turn the projector on.

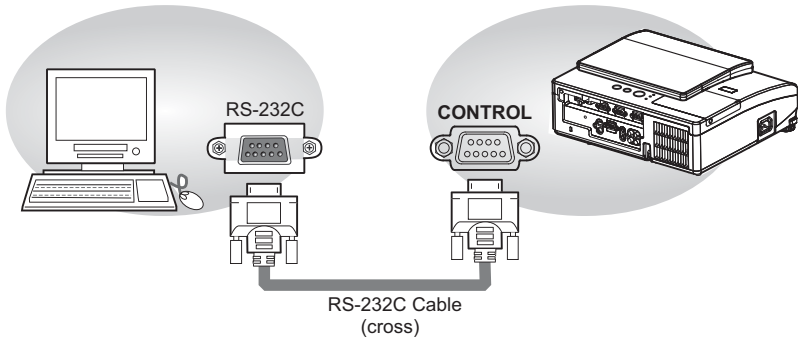

RS-232C port
of the computer

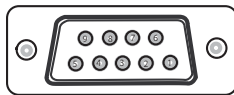

CONTROL port
of the projector

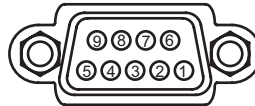

CD (1)	(1) —
RD(2)	(2) RD
TD (3)	(3) TD
DTR (4)	(4) —
GND (5)	(5) GND
DSR (6)	(6) —
RTS (7)	(7) RTS
DTS (8)	(8) CTS
RI (9)	(9) —

Communication settings

1. Protocol

19200bps,8N1

2. Command format ("h" shows hexadecimal)

Byte Number	0	1	2	3	4	5	6	7	8	9	10	11	12
Command Action	Header						Data						
	Header code		Packet	Data size		CRC flag		Action		Type		Setting code	
	L	H		L	H	L	H	L	H	L	H	L	H
<SET>Change setting to desired value [(cL)(cH)].						(aL)	(aH)	01h	00h	(bL)	(bH)	(cL)	(cH)
<GET>Read projector internal setup value [(bL)(bH)].						(aL)	(aH)	02h	00h	(bL)	(bH)	00h	00h
<INCREMENT> Increment setup value [(bL)(bH)] by 1.	BEh	EFh	03h	06h	00h	(aL)	(aH)	04h	00h	(bL)	(bH)	00h	00h
<DECREMENT> Decrement setup value [(bL)(bH)] by 1.						(aL)	(aH)	05h	00h	(bL)	(bH)	00h	00h
<EXECUTE> Run a command [(bL)(bH)].						(aL)	(aH)	06h	00h	(bL)	(bH)	00h	00h

[Header code] [Packet] [Data size]

Set [BEh, EFh, 03h, 06h, 00h] to byte number 0~4.

[CRC flag]

For byte number 5, 6, refer to RS-232C Communication / Network command table ([19](#)).

[Action]

Set functional code to byte number 7, 8.

<SET> = [01h, 00h], <GET> = [02h, 00h], <INCREMENT> = [04h, 00h]

<DECREMENT> = [05h, 00h], <EXECUTE> = [06h, 00h]

Refer to the Communication command table ([above](#)).

[Type] [Setting code]

For byte number 9~12, refer to RS-232C Communication / Network command table ([19](#)).

3. Response code / Error code ("h" shows hexadecimal)

(1) ACK reply : 06h

When the projector receives the Set, Increment, Decrement or Execute command correctly, the projector changes the setting data for the specified item by [Type], and it returns the code.

(2) NAK reply : 15h

When the projector cannot understand the received command, the projector returns the error code.

In such a case, check the sending code and send the same command again.

(3) Error reply : 1Ch + 0000h

When the projector cannot execute the received command for any reasons, the projector returns the error code.

In such a case, check the sending code and the setting status of the projector.

(4) Data reply : 1Dh + xxxxh

When the projector receives the GET command correctly, the projector returns the response code and 2 bytes of data.

- NOTE** • Operation cannot be guaranteed when the projector receives an undefined command or data.
- Provide an interval of at least 40ms between the response code and any other code.
 - The projector outputs test data when the power supply is switched ON, and when the lamp is lit. Ignore this data.
 - Commands are not accepted during warm-up.

Command Control via the Network

When the projector connects network, the projector can be controlled with RS-232C commands from the computer with web browser.

For details of RS-232C commands, refer to RS-232C Communication / Network command table (19).

Connection

1. Turn off the projector and the computer.
2. Connect the projector's **LAN** port and the computer's LAN port with a LAN cable. Use the cable that fulfills the specification shown in figure (Use CAT-5 or greater LAN Cable when LAN ports are used)
3. Turn the computer on, and after the computer has started up turn the projector on.

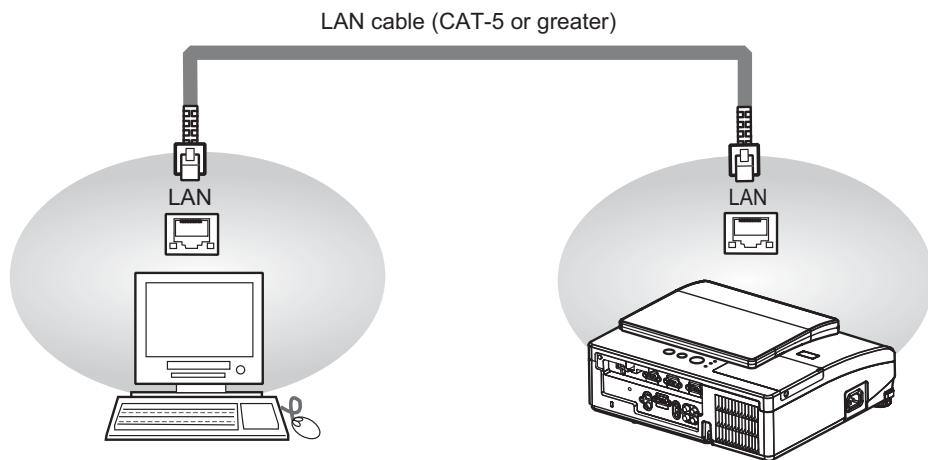

Communicaion Port

The following two ports are assigned for the command control.

TCP #23

TCP #9715

Configure the following items form a web browser when command control is used.

Port Settings		
Network Control Port1 (Port: 23)	Port open	Click the [Enable] check box to open [Network Control Port1 (Port: 23)] to use TCP #23. Default setting is "Enable".
	Authentication	Click the [Enable] check box for the [Authentication] setting when authentication is required. Default setting is "Disable".
Network Control Port2 (Port: 9715)	Port open	Click the [Enable] check box to open [Network Control Port2 (Port: 9715)] to use TCP #9715. Default setting is "Enable".
	Authentication	Click the [Enable] check box for the [Authentication] setting when authentication is required. Default setting is "Enable".

When the authentication setting is enabled, the following settings are required.

Security Settings		
Network Control	Authentication Password	Enter the desired authentication password. This setting will be the same for [Network Control Port1 (Port: 23)] and [Network Control Port2 (Port: 9715)] . Default setting is blank.
	Re-enter Authentication Password	

Command control settings

[TCP #23]

1. Command format

Same as RS-232C communication, refer to RS-232C Communication command format.

2. Response code / Error code ("h" shows hexadecimal)

Four of the response / error code used for TCP#23 are the same as RS-232C Communication (1)~(4). One authentication error reply (5) is added.

(1) ACK reply : 06h

Refer to RS-232C communication (11).

(2) NAK reply : 15h

Refer to RS-232C communication (11).

(3) Error reply : 1Ch + 0000h

Refer to RS-232C communication (11).

(4) Data reply : 1Dh + xxxxh

Refer to RS-232C communication (11).

(5) Authentication error reply : 1Fh + 0400h

When authentication error occurred, the projector returns the error code.

[TCP #9715]

1. Command format

The commands some datum are added to the head and the end of the ones of TCP#9715 are used.

Header	Data length	RS-232C command	Check sum	Connection ID
0×02	0×0D	13 bytes	1 byte	1 byte

[Header]

02, Fixed

[Data Length]

RS-232C commands byte length (0×0D, Fixed)

[RS-232C commands]

Refer to RS-232C Communication command format (11).

[Check Sum]

This is the value to make zero on the addition of the lower 8 bits from the header to the checksum.

[Connection ID]

Random value from 0 to 255 (This value is attached to the reply data).

NOTE • Operation cannot be guaranteed when the projector receives an undefined command or data.

- Provide an interval of at least 40ms between the response code and any other code.
- Commands are not accepted during warm-up.

2. Response code / Error code ("h" shows hexadecimal)

The connection ID is attached for the TCP#23's response / error codes are used. The connection ID is same as the sending command format.

- (1) ACK reply : 06h + xxh (xxh : connection ID)
- (2) NAK reoly : 15h + xxh
- (3) Error reply : 1Ch + 0000h + xxh
- (4) Data reply : 1Dh + xxxhx + xxh
- (5) Authentication error reply : 1Fh + 0400h + xxh
- (6) Projector busy reply: 1Fh + xxxxxh + xxh

When the projector is too busy to receives the command ,the projector returens the error code.

In such a case, check the sending code and send the same command again.

Automatic Connection Break

The TCP connection will be automatically disconnected after there is no communication for 30 seconds after being established.

Authentication

The projector does not accept commands without authentication success when authentication is enabled. The projector uses a challenge response type authentication with an MD5 (Message Digest 5) algorithm. When the projector is using a LAN, a random 8 bytes will be returned if authentication is enabled. Bind this received 8 bytes and the authentication password and digest this data with the MD5 algorithm and add this in front of the commands to send.

Following is a sample if the authentication password is set to "password" and the random 8 bytes are "a572f60c".

- 1) Select the projector.
- 2) Receive the random 8 bytes "a572f60c" from the projector.
- 3) Bind the random 8 bytes "a572f60c" and the authentication password "password" and it becomes "a572f60cpassword".
- 4) Digest this bind "a572f60cpassword" with MD5 algorithm.
It will be "e3d97429adffa11bce1f7275813d4bde".
- 5) Add this "e3d97429adffa11bce1f7275813d4bde" in front of the commands and send the data.
Send "e3d97429adffa11bce1f7275813d4bde"+command.
- 6) When the sending data is correct, the command will be performed and the reply data will be returned. Otherwise, an authentication error will be returned.

NOTE • As for the transmission of the second or subsequent commands, the authentication data can be omitted when the same connection.

Network Bridge Communication

This projector is equipped with NETWORK BRIDGE function.

When the projector connects to the computer by LAN communication, an external device that is connected with this projector by RS-232C communication can be controlled from the computer as a network terminal.

For details, see the **3.7 Controlling the external device via the projector(using the NETWORK BRIDGE function) - Network Guide.**

Connection

1. Connect the computer's LAN port and the projector's **LAN** port with a LAN cable.
2. Connect the projector's **CONTROL** port and the RS-232C port of the devices that you want to control with a RS-232C cable.
3. Turn the computer on, and after the computer has started up turn the projector on.
4. Set the COMMUNICATION TYPE to NETWORK BRIDGE. (**OPTION menu - SERVICE - COMMUNICATION in the User's Manual - Operating Guide**)

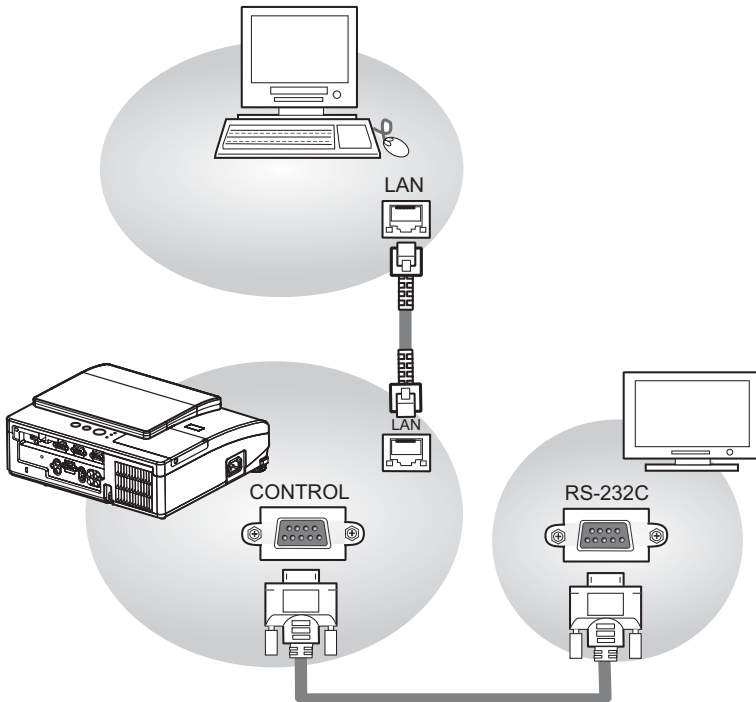

Communication settings

For communication setting, use the OPTION - SERVICE - COMMUNICATION menu. ( **OPTION menu - SERVICE - COMMUNICATION in the User's Manual - Operating Guide**)

Item	Condition
BAUD RATE	4800bps / 9600bps / 19200bps / 38400bps
Data length	8 bit (fixed)
PARITY	NONE/ODD/EVEN
Start bit	1 bit (fixed)
Stop bit	1 bit (fixed)
Transmission method	HALF-DUPLEX/FULL-DUPLEX

- NOTE** • For connecting the projector to your devices, please read the manual for each devices, and connect them correctly with suitable cables.
- Turn off (the power of) both the projector and other devices and unplug , before connecting them.
 - For details of Transmission method, refer to **3.8.4 Transmission method-Network Guide**.

RS-232C Communication / Network command table

Names	Operation Type	Header				Command Data			
						CRC	Action	Type	Setting Code
Power	Set	OFF	BE EF	03	06 00	2A D3	01 00	00 60	00 00
		ON	BE EF	03	06 00	BA D2	01 00	00 60	01 00
	Get		BE EF	03	06 00	19 D3	02 00	00 60	00 00
		[Example return]				00 00 [Off]	01 00 [On]	02 00 [Cool down]	
Input Source	Set	COMPUTER IN1	BE EF	03	06 00	FE D2	01 00	00 20	00 00
		COMPUTER IN2	BE EF	03	06 00	3E D0	01 00	00 20	04 00
		HDMI	BE EF	03	06 00	0E D2	01 00	00 20	03 00
		S-VIDEO	BE EF	03	06 00	9E D3	01 00	00 20	02 00
		VIDEO	BE EF	03	06 00	6E D3	01 00	00 20	01 00
	Get	BE EF	03	06 00	CD D2	02 00	00 20	00 00	
Error Status	Get		BE EF	03	06 00	D9 D8	02 00	20 60	00 00
		[Example return]				00 00 [Normal]	01 00 [Cover error]	02 00 [Fan error]	03 00 [Lamp error]
MAGNIFY	Get		BE EF	03	06 00	7C D2	02 00	07 30	00 00
		Increment	BE EF	03	06 00	1A D2	04 00	07 30	00 00
		Decrement	BE EF	03	06 00	CB D3	05 00	07 30	00 00
Magnify Position H	Get		BE EF	03	06 00	C8 D7	02 00	10 30	00 00
		Increment	BE EF	03	06 00	AE D7	04 00	10 30	00 00
		Decrement	BE EF	03	06 00	7F D6	05 00	10 30	00 00
Magnify Position V	Get		BE EF	03	06 00	34 D6	02 00	11 30	00 00
		Increment	BE EF	03	06 00	52 D6	04 00	11 30	00 00
		Decrement	BE EF	03	06 00	83 D7	05 00	11 30	00 00
FREEZE	Set	NORMAL	BE EF	03	06 00	83 D2	01 00	02 30	00 00
		FREEZE	BE EF	03	06 00	13 D3	01 00	02 30	01 00
	Get	BE EF	03	06 00	B0 D2	02 00	02 30	00 00	
BRIGHTNESS	Get		BE EF	03	06 00	89 D2	02 00	03 20	00 00
		Increment	BE EF	03	06 00	EF D2	04 00	03 20	00 00
		Decrement	BE EF	03	06 00	3E D3	05 00	03 20	00 00
BRIGHTNESS Reset	Execute	BE EF	03	06 00	58 D3	06 00	00 70	00 00	
CONTRAST	Get		BE EF	03	06 00	FD D3	02 00	04 20	00 00
		Increment	BE EF	03	06 00	9B D3	04 00	04 20	00 00
		Decrement	BE EF	03	06 00	4A D2	05 00	04 20	00 00
CONTRAST Reset	Execute	BE EF	03	06 00	A4 D2	06 00	01 70	00 00	
PICTURE MODE	Set	NORMAL	BE EF	03	06 00	23 F6	01 00	BA 30	00 00
		CINEMA	BE EF	03	06 00	B3 F7	01 00	BA 30	01 00
		DYNAMIC	BE EF	03	06 00	E3 F4	01 00	BA 30	04 00
		BOARD(BLACK)	BE EF	03	06 00	E3 EF	01 00	BA 30	20 00
		BOARD(GREEN)	BE EF	03	06 00	73 EE	01 00	BA 30	21 00
		WHITEBOARD	BE EF	03	06 00	83 EE	01 00	BA 30	22 00
		DAYTIME	BE EF	03	06 00	E3 C7	01 00	BA 30	40 00
		CUSTOM	BE EF	03	06 00	E3 FB	01 00	BA 30	10 00
	Get	BE EF	03	06 00	10 F6	02 00	BA 30	00 00	

(continued on next page)

RS-232C Communication / Network command table (continued)

Names	Operation Type	Header				Command Data			
						CRC	Action	Type	Setting Code
GAMMA	Set	#1 DEFAULT	BE EF	03	06 00	07 E9	01 00	A1 30	20 00
		#2 DEFAULT	BE EF	03	06 00	97 E8	01 00	A1 30	21 00
		#3 DEFAULT	BE EF	03	06 00	67 E8	01 00	A1 30	22 00
		#4 DEFAULT	BE EF	03	06 00	F7 E9	01 00	A1 30	23 00
		#5 DEFAULT	BE EF	03	06 00	C7 EB	01 00	A1 30	24 00
		#6 DEFAULT	BE EF	03	06 00	57 EA	01 00	A1 30	25 00
		#1 CUSTOM	BE EF	03	06 00	07 FD	01 00	A1 30	10 00
		#2 CUSTOM	BE EF	03	06 00	97 FC	01 00	A1 30	11 00
		#3 CUSTOM	BE EF	03	06 00	67 FC	01 00	A1 30	12 00
		#4 CUSTOM	BE EF	03	06 00	F7 FD	01 00	A1 30	13 00
		#5 CUSTOM	BE EF	03	06 00	C7 FF	01 00	A1 30	14 00
		#6 CUSTOM	BE EF	03	06 00	57 FE	01 00	A1 30	15 00
	Get		BE EF	03	06 00	F4 F0	02 00	A1 30	00 00
User Gamma Pattern	Set	Off	BE EF	03	06 00	FB FA	01 00	80 30	00 00
		9 steps gray scale	BE EF	03	06 00	6B FB	01 00	80 30	01 00
		15 steps gray scale	BE EF	03	06 00	9B FB	01 00	80 30	02 00
		Ramp	BE EF	03	06 00	0B FA	01 00	80 30	03 00
		Get		BE EF	03	06 00	C8 FA	02 00	80 30
User Gamma Point 1	Get		BE EF	03	06 00	08 FE	02 00	90 30	00 00
	Increment		BE EF	03	06 00	6E FE	04 00	90 30	00 00
	Decrement		BE EF	03	06 00	BF FF	05 00	90 30	00 00
User Gamma Point 1 Reset	Execute		BE EF	03	06 00	58 C2	06 00	50 70	00 00
User Gamma Point 2	Get		BE EF	03	06 00	F4 FF	02 00	91 30	00 00
	Increment		BE EF	03	06 00	92 FF	04 00	91 30	00 00
	Decrement		BE EF	03	06 00	43 FE	05 00	91 30	00 00
User Gamma Point 2 Reset	Execute		BE EF	03	06 00	A4 C3	06 00	51 70	00 00
User Gamma Point 3	Get		BE EF	03	06 00	B0 FF	02 00	92 30	00 00
	Increment		BE EF	03	06 00	D6 FF	04 00	92 30	00 00
	Decrement		BE EF	03	06 00	07 FE	05 00	92 30	00 00
User Gamma Point 3 Reset	Execute		BE EF	03	06 00	E0 C3	06 00	52 70	00 00
User Gamma Point 4	Get		BE EF	03	06 00	4C FE	02 00	93 30	00 00
	Increment		BE EF	03	06 00	2A FE	04 00	93 30	00 00
	Decrement		BE EF	03	06 00	FB FF	05 00	93 30	00 00
User Gamma Point 4 Reset	Execute		BE EF	03	06 00	1C C2	06 00	53 70	00 00
User Gamma Point 5	Get		BE EF	03	06 00	38 FF	02 00	94 30	00 00
	Increment		BE EF	03	06 00	5E FF	04 00	94 30	00 00
	Decrement		BE EF	03	06 00	8F FE	05 00	94 30	00 00
User Gamma Point 5 Reset	Execute		BE EF	03	06 00	68 C3	06 00	54 70	00 00
User Gamma Point 6	Get		BE EF	03	06 00	C4 FE	02 00	95 30	00 00
	Increment		BE EF	03	06 00	A2 FE	04 00	95 30	00 00
	Decrement		BE EF	03	06 00	73 FF	05 00	95 30	00 00
User Gamma Point 6 Reset	Execute		BE EF	03	06 00	94 C2	06 00	55 70	00 00
User Gamma Point 7	Get		BE EF	03	06 00	80 FE	02 00	96 30	00 00
	Increment		BE EF	03	06 00	E6 FE	04 00	96 30	00 00
	Decrement		BE EF	03	06 00	37 FF	05 00	96 30	00 00
User Gamma Point 7 Reset	Execute		BE EF	03	06 00	D0 C2	06 00	56 70	00 00

(continued on next page)

RS-232C Communication / Network command table (continued)

Names	Operation Type	Header			Command Data				
					CRC	Action	Type	Setting Code	
User Gamma Point 8	Get	BE EF	03	06 00	7C FF	02 00	97 30	00 00	
	Increment	BE EF	03	06 00	1A FF	04 00	97 30	00 00	
	Decrement	BE EF	03	06 00	CB FE	05 00	97 30	00 00	
User Gamma Point 8 Reset	Execute	BE EF	03	06 00	2C C3	06 00	57 70	00 00	
COLOR TEMP	Set	#1 HIGH	BE EF	03	06 00	0B F5	01 00	B0 30	03 00
		#2 MID	BE EF	03	06 00	9B F4	01 00	B0 30	02 00
		#3 LOW	BE EF	03	06 00	6B F4	01 00	B0 30	01 00
		#4 Hi-BRIGHT-1	BE EF	03	06 00	3B F2	01 00	B0 30	08 00
		#5 Hi-BRIGHT-2	BE EF	03	06 00	AB F3	01 00	B0 30	09 00
		#6 Hi-BRIGHT-3	BE EF	03	06 00	5B F3	01 00	B0 30	0A 00
		#1 CUSTOM (HIGH)	BE EF	03	06 00	CB F8	01 00	B0 30	13 00
		#2 CUSTOM (MID)	BE EF	03	06 00	5B F9	01 00	B0 30	12 00
		#3 CUSTOM (LOW)	BE EF	03	06 00	AB F9	01 00	B0 30	11 00
		#4 CUSTOM (Hi-BRIGHT-1)	BE EF	03	06 00	FB FF	01 00	B0 30	18 00
		#5 CUSTOM (Hi-BRIGHT-2)	BE EF	03	06 00	6B FE	01 00	B0 30	19 00
		#6 CUSTOM (Hi-BRIGHT-3)	BE EF	03	06 00	9B FE	01 00	B0 30	1A 00
		Get	BE EF	03	06 00	C8 F5	02 00	B0 30	00 00
COLOR TEMP GAIN R	Get	BE EF	03	06 00	34 F4	02 00	B1 30	00 00	
	Increment	BE EF	03	06 00	52 F4	04 00	B1 30	00 00	
	Decrement	BE EF	03	06 00	83 F5	05 00	B1 30	00 00	
COLOR TEMP GAIN R Reset	Execute	BE EF	03	06 00	10 C6	06 00	46 70	00 00	
COLOR TEMP GAIN G	Get	BE EF	03	06 00	70 F4	02 00	B2 30	00 00	
	Increment	BE EF	03	06 00	16 F4	04 00	B2 30	00 00	
	Decrement	BE EF	03	06 00	C7 F5	05 00	B2 30	00 00	
COLOR TEMP GAIN G Reset	Execute	BE EF	03	06 00	EC C7	06 00	47 70	00 00	
COLOR TEMP GAIN B	Get	BE EF	03	06 00	8C F5	02 00	B3 30	00 00	
	Increment	BE EF	03	06 00	EA F5	04 00	B3 30	00 00	
	Decrement	BE EF	03	06 00	3B F4	05 00	B3 30	00 00	
COLOR TEMP GAIN B Reset	Execute	BE EF	03	06 00	F8 C4	06 00	48 70	00 00	
COLOR TEMP OFFSET R	Get	BE EF	03	06 00	04 F5	02 00	B5 30	00 00	
	Increment	BE EF	03	06 00	62 F5	04 00	B5 30	00 00	
	Decrement	BE EF	03	06 00	B3 F4	05 00	B5 30	00 00	
COLOR TEMP OFFSET R Reset	Execute	BE EF	03	06 00	40 C5	06 00	4A 70	00 00	
COLOR TEMP OFFSET G	Get	BE EF	03	06 00	40 F5	02 00	B6 30	00 00	
	Increment	BE EF	03	06 00	26 F5	04 00	B6 30	00 00	
	Decrement	BE EF	03	06 00	F7 F4	05 00	B6 30	00 00	
COLOR TEMP OFFSET G Reset	Execute	BE EF	03	06 00	BC C4	06 00	4B 70	00 00	
COLOR TEMP OFFSET B	Get	BE EF	03	06 00	BC F4	02 00	B7 30	00 00	
	Increment	BE EF	03	06 00	DA F4	04 00	B7 30	00 00	
	Decrement	BE EF	03	06 00	0B F5	05 00	B7 30	00 00	
COLOR TEMP OFFSET B Reset	Execute	BE EF	03	06 00	C8 C5	06 00	4C 70	00 00	

(continued on next page)

RS-232C Communication / Network command table (continued)

Names	Operation Type	Header			Command Data				
					CRC	Action	Type	Setting Code	
COLOR	Get	BE EF	03	06 00	B5 72	02 00	02 22	00 00	
	Increment	BE EF	03	06 00	D3 72	04 00	02 22	00 00	
	Decrement	BE EF	03	06 00	02 73	05 00	02 22	00 00	
COLOR Reset	Execute	BE EF	03	06 00	80 D0	06 00	0A 70	00 00	
TINT	Get	BE EF	03	06 00	49 73	02 00	03 22	00 00	
	Increment	BE EF	03	06 00	2F 73	04 00	03 22	00 00	
	Decrement	BE EF	03	06 00	FE 72	05 00	03 22	00 00	
TINT Reset	Execute	BE EF	03	06 00	7C D1	06 00	0B 70	00 00	
SHARPNESS	Get	BE EF	03	06 00	F1 72	02 00	01 22	00 00	
	Increment	BE EF	03	06 00	97 72	04 00	01 22	00 00	
	Decrement	BE EF	03	06 00	46 73	05 00	01 22	00 00	
SHARPNESS Reset	Execute	BE EF	03	06 00	C4 D0	06 00	09 70	00 00	
MY MEMORY Load	Set	1	BE EF	03	06 00	0E D7	01 00	14 20	00 00
		2	BE EF	03	06 00	9E D6	01 00	14 20	01 00
		3	BE EF	03	06 00	6E D6	01 00	14 20	02 00
		4	BE EF	03	06 00	FE D7	01 00	14 20	03 00
MY MEMORY Save	Set	1	BE EF	03	06 00	F2 D6	01 00	15 20	00 00
		2	BE EF	03	06 00	62 D7	01 00	15 20	01 00
		3	BE EF	03	06 00	92 D7	01 00	15 20	02 00
		4	BE EF	03	06 00	02 D6	01 00	15 20	03 00
ASPECT	Set	4:3	BE EF	03	06 00	9E D0	01 00	08 20	00 00
		16:9	BE EF	03	06 00	0E D1	01 00	08 20	01 00
		NATIVE	BE EF	03	06 00	5E D7	01 00	08 20	08 00
		14:9	BE EF	03	06 00	CE D6	01 00	08 20	09 00
		16:10	BE EF	03	06 00	3E D6	01 00	08 20	0A 00
		NORMAL	BE EF	03	06 00	5E DD	01 00	08 20	10 00
OVER SCAN	Get	BE EF	03	06 00	AD D0	02 00	08 20	00 00	
	Increment	BE EF	03	06 00	91 70	02 00	09 22	00 00	
	Decrement	BE EF	03	06 00	26 71	05 00	09 22	00 00	
OVER SCAN Reset	Execute	BE EF	03	06 00	EC D9	06 00	27 70	00 00	
V POSITION	Get	BE EF	03	06 00	0D 83	02 00	00 21	00 00	
	Increment	BE EF	03	06 00	6B 83	04 00	00 21	00 00	
	Decrement	BE EF	03	06 00	BA 82	05 00	00 21	00 00	
V POSITION Reset	Execute	BE EF	03	06 00	E0 D2	06 00	02 70	00 00	
H POSITION	Get	BE EF	03	06 00	F1 82	02 00	01 21	00 00	
	Increment	BE EF	03	06 00	97 82	04 00	01 21	00 00	
	Decrement	BE EF	03	06 00	46 83	05 00	01 21	00 00	
H POSITION Reset	Execute	BE EF	03	06 00	1C D3	06 00	03 70	00 00	
H PHASE	Get	BE EF	03	06 00	49 83	02 00	03 21	00 00	
	Increment	BE EF	03	06 00	2F 83	04 00	03 21	00 00	
	Decrement	BE EF	03	06 00	FE 82	05 00	03 21	00 00	

(continued on next page)

RS-232C Communication / Network command table (continued)

Names	Operation Type	Header				Command Data			
						CRC	Action	Type	Setting Code
H SIZE	Get	BE EF	03	06 00	B5 82	02 00	02 21	00 00	
	Increment	BE EF	03	06 00	D3 82	04 00	02 21	00 00	
	Decrement	BE EF	03	06 00	02 83	05 00	02 21	00 00	
H SIZE Reset	Execute	BE EF	03	06 00	68 D2	06 00	04 70	00 00	
AUTO ADJUST	Execute	BE EF	03	06 00	91 D0	06 00	0A 20	00 00	
PROGRESSIVE	Set	OFF	BE EF	03	06 00	4A 72	01 00	07 22	00 00
		TV	BE EF	03	06 00	DA 73	01 00	07 22	01 00
		FILM	BE EF	03	06 00	2A 73	01 00	07 22	02 00
	Get	BE EF	03	06 00	79 72	02 00	07 22	00 00	
VIDEO NR	Set	LOW	BE EF	03	06 00	26 72	01 00	06 22	01 00
		MID	BE EF	03	06 00	D6 72	01 00	06 22	02 00
		HIGH	BE EF	03	06 00	46 73	01 00	06 22	03 00
	Get	BE EF	03	06 00	85 73	02 00	06 22	00 00	
COLOR SPACE	Set	AUTO	BE EF	03	06 00	0E 72	01 00	04 22	00 00
		RGB	BE EF	03	06 00	9E 73	01 00	04 22	01 00
		SMPTE240	BE EF	03	06 00	6E 73	01 00	04 22	02 00
		REC709	BE EF	03	06 00	FE 72	01 00	04 22	03 00
		REC601	BE EF	03	06 00	CE 70	01 00	04 22	04 00
	Get	BE EF	03	06 00	3D 72	02 00	04 22	00 00	
S-VIDEO FORMAT	Set	AUTO	BE EF	03	06 00	E6 70	01 00	12 22	0A 00
		NTSC	BE EF	03	06 00	86 74	01 00	12 22	04 00
		PAL	BE EF	03	06 00	16 75	01 00	12 22	05 00
		SECAM	BE EF	03	06 00	16 70	01 00	12 22	09 00
		NTSC4.43	BE EF	03	06 00	26 77	01 00	12 22	02 00
		M-PAL	BE EF	03	06 00	86 71	01 00	12 22	08 00
		N-PAL	BE EF	03	06 00	76 74	01 00	12 22	07 00
	Get	BE EF	03	06 00	75 76	02 00	12 22	00 00	
C-VIDEO FORMAT	Set	AUTO	BE EF	03	06 00	A2 70	01 00	11 22	0A 00
		NTSC	BE EF	03	06 00	C2 74	01 00	11 22	04 00
		PAL	BE EF	03	06 00	52 75	01 00	11 22	05 00
		SECAM	BE EF	03	06 00	52 70	01 00	11 22	09 00
		NTSC4.43	BE EF	03	06 00	62 77	01 00	11 22	02 00
		M-PAL	BE EF	03	06 00	C2 71	01 00	11 22	08 00
		N-PAL	BE EF	03	06 00	32 74	01 00	11 22	07 00
	Get	BE EF	03	06 00	31 76	02 00	11 22	00 00	
HDMI FORMAT	Set	AUTO	BE EF	03	06 00	BA 77	01 00	13 22	00 00
		VIDEO	BE EF	03	06 00	2A 76	01 00	13 22	01 00
		COMPUTER	BE EF	03	06 00	DA 76	01 00	13 22	02 00
	Get	BE EF	03	06 00	89 77	02 00	13 22	00 00	
HDMI RANGE	Set	AUTO	BE EF	03	06 00	86 D8	01 00	22 20	00 00
		NORMAL	BE EF	03	06 00	16 D9	01 00	22 20	01 00
		ENHANCED	BE EF	03	06 00	E6 D9	01 00	22 20	02 00
	Get	BE EF	03	06 00	B5 D8	02 00	22 20	00 00	
COMPUTER IN1	Set	AUTO	BE EF	03	06 00	CE D6	01 00	10 20	03 00
		SYNC ON G OFF	BE EF	03	06 00	5E D7	01 00	10 20	02 00
	Get	BE EF	03	06 00	0D D6	02 00	10 20	00 00	
COMPUTER IN2	Set	AUTO	BE EF	03	06 00	32 D7	01 00	11 20	03 00
		SYNC ON G OFF	BE EF	03	06 00	A2 D6	01 00	11 20	02 00
	Get	BE EF	03	06 00	F1 D7	02 00	11 20	00 00	

(continued on next page)

RS-232C Communication / Network command table (continued)

Names	Operation Type	Header				Command Data			
						CRC	Action	Type	Setting Code
FRAME LOCK – COMPUTER IN1	Set	OFF	BE EF	03	06 00	3B C2	01 00	50 30	00 00
		ON	BE EF	03	06 00	AB C3	01 00	50 30	01 00
	Get	BE EF	03	06 00	08 C2	02 00	50 30	00 00	
FRAME LOCK – COMPUTER IN2	Set	OFF	BE EF	03	06 00	0B C3	01 00	54 30	00 00
		ON	BE EF	03	06 00	9B C2	01 00	54 30	01 00
	Get	BE EF	03	06 00	38 C3	02 00	54 30	00 00	
FRAME LOCK - HDMI	Set	OFF	BE EF	03	06 00	7F C2	01 00	53 30	00 00
		ON	BE EF	03	06 00	EF C3	01 00	53 30	01 00
	Get	BE EF	03	06 00	4C C2	02 00	53 30	00 00	
KEYSTONE V	Get	BE EF	03	06 00	B9 D3	02 00	07 20	00 00	
	Increment	BE EF	03	06 00	DF D3	04 00	07 20	00 00	
	Decrement	BE EF	03	06 00	0E D2	05 00	07 20	00 00	
KEYSTONE V Reset	Execute	BE EF	03	06 00	08 D0	06 00	0C 70	00 00	
ECO MODE	Set	NORMAL	BE EF	03	06 00	3B 23	01 00	00 33	00 00
		ECO	BE EF	03	06 00	AB 22	01 00	00 33	01 00
	Get	BE EF	03	06 00	08 23	02 00	00 33	00 00	
MIRROR	Set	NORMAL	BE EF	03	06 00	C7 D2	01 00	01 30	00 00
		H:INVERT	BE EF	03	06 00	57 D3	01 00	01 30	01 00
		V:INVERT	BE EF	03	06 00	A7 D3	01 00	01 30	02 00
		H&V:INVERT	BE EF	03	06 00	37 D2	01 00	01 30	03 00
	Get	BE EF	03	06 00	F4 D2	02 00	01 30	00 00	
STANDBY MODE	Set	NORMAL	BE EF	03	06 00	D6 D2	01 00	01 60	00 00
		SAVING	BE EF	03	06 00	46 D3	01 00	01 60	01 00
	Get	BE EF	03	06 00	E5 D2	02 00	01 60	00 00	
MONITOR OUT - COMPUTER IN1	Set	COMPUTER IN1	BE EF	03	06 00	3E F4	01 00	B0 20	00 00
		OFF	BE EF	03	06 00	CE B5	01 00	B0 20	FF 00
	Get	BE EF	03	06 00	0D F4	02 00	B0 20	00 00	
MONITOR OUT - COMPUTER IN2	Set	COMPUTER IN2	BE EF	03	06 00	CE F7	01 00	B4 20	04 00
		OFF	BE EF	03	06 00	FE B4	01 00	B4 20	FF 00
	Get	BE EF	03	06 00	3D F5	02 00	B4 20	00 00	
MONITOR OUT - S-VIDEO	Set	COMPUTER IN1	BE EF	03	06 00	86 F5	01 00	B2 20	00 00
		COMPUTER IN2	BE EF	03	06 00	46 F7	01 00	B2 20	04 00
		OFF	BE EF	03	06 00	76 B4	01 00	B2 20	FF 00
	Get	BE EF	03	06 00	B5 F5	02 00	B2 20	00 00	
MONITOR OUT - VIDEO	Set	COMPUTER IN1	BE EF	03	06 00	C2 F5	01 00	B1 20	00 00
		COMPUTER IN2	BE EF	03	06 00	02 F7	01 00	B1 20	04 00
		OFF	BE EF	03	06 00	32 B4	01 00	B1 20	FF 00
	Get	BE EF	03	06 00	F1 F5	02 00	B1 20	00 00	
MONITOR OUT - HDMI	Set	COMPUTER IN1	BE EF	03	06 00	7A F4	01 00	B3 20	00 00
		COMPUTER IN2	BE EF	03	06 00	BA F6	01 00	B3 20	04 00
		OFF	BE EF	03	06 00	8A B5	01 00	B3 20	FF 00
	Get	BE EF	03	06 00	49 F4	02 00	B3 20	00 00	
MONITOR OUT - STANDBY	Set	COMPUTER IN1	BE EF	03	06 00	2A F7	01 00	BF 20	00 00
		COMPUTER IN2	BE EF	03	06 00	EA F5	01 00	BF 20	04 00
		OFF	BE EF	03	06 00	DA B6	01 00	BF 20	FF 00
	Get	BE EF	03	06 00	19 F7	02 00	BF 20	00 00	
VOLUME - COMPUTER IN1	Get	BE EF	03	06 00	CD CC	02 00	60 20	00 00	
	Increment	BE EF	03	06 00	AB CC	04 00	60 20	00 00	
	Decrement	BE EF	03	06 00	7A CD	05 00	60 20	00 00	

RS-232C Communication / Network command table (continued)

Names	Operation Type	Header			Command Data				
					CRC	Action	Type	Setting Code	
VOLUME - COMPUTER IN2	Get	BE EF	03	06 00	FD CD	02 00	64 20	00 00	
	Increment	BE EF	03	06 00	9B CD	04 00	64 20	00 00	
	Decrement	BE EF	03	06 00	4A CC	05 00	64 20	00 00	
VOLUME - S-VIDEO	Get	BE EF	03	06 00	75 CD	02 00	62 20	00 00	
	Increment	BE EF	03	06 00	13 CD	04 00	62 20	00 00	
	Decrement	BE EF	03	06 00	C2 CC	05 00	62 20	00 00	
VOLUME - VIDEO	Get	BE EF	03	06 00	31 CD	02 00	61 20	00 00	
	Increment	BE EF	03	06 00	57 CD	04 00	61 20	00 00	
	Decrement	BE EF	03	06 00	86 CC	05 00	61 20	00 00	
VOLUME - HDMI	Get	BE EF	03	06 00	89 CC	02 00	63 20	00 00	
	Increment	BE EF	03	06 00	EF CC	04 00	63 20	00 00	
	Decrement	BE EF	03	06 00	3E CD	05 00	63 20	00 00	
VOLUME - AUDIO OUT STANDBY	Get	BE EF	03	06 00	D9 CF	02 00	6F 20	00 00	
	Increment	BE EF	03	06 00	BF CF	04 00	6F 20	00 00	
	Decrement	BE EF	03	06 00	6E CE	05 00	6F 20	00 00	
MUTE	Set	OFF	BE EF	03	06 00	46 D3	01 00	02 20	00 00
		ON	BE EF	03	06 00	D6 D2	01 00	02 20	01 00
	Get	BE EF	03	06 00	75 D3	02 00	02 20	00 00	
SPEAKER	Set	OFF	BE EF	03	06 00	6E D5	01 00	1C 20	00 00
		ON	BE EF	03	06 00	FE D4	01 00	1C 20	01 00
	Get	BE EF	03	06 00	5D D5	02 00	1C 20	00 00	
AUDIO - COMPUTER IN1	Set	OFF	BE EF	03	06 00	FE DD	01 00	30 20	00 00
		AUDIO1	BE EF	03	06 00	6E DC	01 00	30 20	01 00
		AUDIO2	BE EF	03	06 00	9E DC	01 00	30 20	02 00
		AUDIO3	BE EF	03	06 00	0E DD	01 00	30 20	03 00
	Get	BE EF	03	06 00	CD DD	02 00	30 20	00 00	
AUDIO - COMPUTER IN2	Set	OFF	BE EF	03	06 00	CE DC	01 00	34 20	00 00
		AUDIO1	BE EF	03	06 00	5E DD	01 00	34 20	01 00
		AUDIO2	BE EF	03	06 00	AE DD	01 00	34 20	02 00
		AUDIO3	BE EF	03	06 00	3E DC	01 00	34 20	03 00
	Get	BE EF	03	06 00	FD DC	02 00	34 20	00 00	
AUDIO - HDMI	Set	OFF	BE EF	03	06 00	BA DD	01 00	33 20	00 00
		AUDIO1	BE EF	03	06 00	2A DC	01 00	33 20	01 00
		AUDIO2	BE EF	03	06 00	DA DC	01 00	33 20	02 00
		AUDIO3	BE EF	03	06 00	4A DD	01 00	33 20	03 00
	AUDIO_HDMI	BE EF	03	06 00	7A C4	01 00	33 20	20 00	
Get	BE EF	03	06 00	89 DD	02 00	33 20	00 00		
AUDIO - S-VIDEO	Set	OFF	BE EF	03	06 00	46 DC	01 00	32 20	00 00
		AUDIO1	BE EF	03	06 00	D6 DD	01 00	32 20	01 00
		AUDIO2	BE EF	03	06 00	26 DD	01 00	32 20	02 00
		AUDIO3	BE EF	03	06 00	B6 DC	01 00	32 20	03 00
	Get	BE EF	03	06 00	75 DC	02 00	32 20	00 00	
AUDIO - VIDEO	Set	OFF	BE EF	03	06 00	02 DC	01 00	31 20	00 00
		AUDIO1	BE EF	03	06 00	92 DD	01 00	31 20	01 00
		AUDIO2	BE EF	03	06 00	62 DD	01 00	31 20	02 00
		AUDIO3	BE EF	03	06 00	F2 DC	01 00	31 20	03 00
	Get	BE EF	03	06 00	31 DC	02 00	31 20	00 00	

(continued on next page)

RS-232C Communication / Network command table (continued)

Names	Operation Type	Header				Command Data			
						CRC	Action	Type	Setting Code
AUDIO OUT STANDBY	Set	OFF	BE EF	03	06 00	EA DE	01 00	3F 20	00 00
		AUDIO1	BE EF	03	06 00	7A DF	01 00	3F 20	01 00
		AUDIO2	BE EF	03	06 00	8A DF	01 00	3F 20	02 00
	AUDIO3	BE EF	03	06 00	1A DE	01 00	3F 20	03 00	
	Get	BE EF	03	06 00	D9 DE	02 00	3F 20	00 00	
HDMI AUDIO	Set	1	BE EF	03	06 00	AE C6	01 00	40 20	01 00
		2	BE EF	03	06 00	5E C6	01 00	40 20	02 00
	Get	BE EF	03	06 00	0D C7	02 00	40 20	00 00	
REMOTE FRONT	Set	OFF	BE EF	03	06 00	FF 32	01 00	00 26	00 00
		ON	BE EF	03	06 00	6F 33	01 00	00 26	01 00
	Get	BE EF	03	06 00	CC 32	02 00	00 26	00 00	
REMOTE TOP	Set	OFF	BE EF	03	06 00	47 33	01 00	00 26	00 00
		ON	BE EF	03	06 00	D7 32	01 00	00 26	01 00
	Get	BE EF	03	06 00	74 33	02 00	00 26	00 00	
LANGUAGE *	Set	ENGLISH	BE EF	03	06 00	F7 D3	01 00	05 30	00 00
		FRANÇAIS	BE EF	03	06 00	67 D2	01 00	05 30	01 00
		DEUTSCH	BE EF	03	06 00	97 D2	01 00	05 30	02 00
		ESPAÑOL	BE EF	03	06 00	07 D3	01 00	05 30	03 00
		ITALIANO	BE EF	03	06 00	37 D1	01 00	05 30	04 00
		NORSK	BE EF	03	06 00	A7 D0	01 00	05 30	05 00
		NEDERLANDS	BE EF	03	06 00	57 D0	01 00	05 30	06 00
		PORTUGUÊS	BE EF	03	06 00	C7 D1	01 00	05 30	07 00
		日本語	BE EF	03	06 00	37 D4	01 00	05 30	08 00
		简体中文	BE EF	03	06 00	A7 D5	01 00	05 30	09 00
		한글	BE EF	03	06 00	57 D5	01 00	05 30	0A 00
		SVENSKA	BE EF	03	06 00	C7 D4	01 00	05 30	0B 00
		РУССКИЙ	BE EF	03	06 00	F7 D6	01 00	05 30	0C 00
		SUOMI	BE EF	03	06 00	67 D7	01 00	05 30	0D 00
		POLSKI	BE EF	03	06 00	97 D7	01 00	05 30	0E 00
		TÜRKÇE	BE EF	03	06 00	07 D6	01 00	05 30	0F 00
		繁體中文	BE EF	03	06 00	37 DE	01 00	05 30	10 00
		DANSK	BE EF	03	06 00	A7 DF	01 00	05 30	11 00
		ČESKY	BE EF	03	06 00	57 DF	01 00	05 30	12 00
		MAGYAR	BE EF	03	06 00	C7 DE	01 00	05 30	13 00
		ROMÂNĂ	BE EF	03	06 00	F7 DC	01 00	05 30	14 00
		SLOVENSKI	BE EF	03	06 00	67 DD	01 00	05 30	15 00
		HRVATSKI	BE EF	03	06 00	97 DD	01 00	05 30	16 00
		ΕΛΛΗΝΙΚΑ	BE EF	03	06 00	07 DC	01 00	05 30	17 00
		LIETUVIŲ	BE EF	03	06 00	F7 D9	01 00	05 30	18 00
		EESTI	BE EF	03	06 00	67 D8	01 00	05 30	19 00
		LATVIEŠU	BE EF	03	06 00	97 D8	01 00	05 30	1A 00
		ไทย	BE EF	03	06 00	07 D9	01 00	05 30	1B 00
		عبرية	BE EF	03	06 00	37 DB	01 00	05 30	1C 00
		کسراف	BE EF	03	06 00	A7 DA	01 00	05 30	1D 00
		PORTUGUÊS BRA	BE EF	03	06 00	57 DA	01 00	05 30	1E 00
			Get	BE EF	03	06 00	C4 D3	02 00	05 30
MENU POSITION H	Get	BE EF	03	06 00	04 D7	02 00	15 30	00 00	
	Increment	BE EF	03	06 00	62 D7	04 00	15 30	00 00	
	Decrement	BE EF	03	06 00	B3 D6	05 00	15 30	00 00	
MENU POSITION H Reset	Execute	BE EF	03	06 00	DC C6	06 00	43 70	00 00	

RS-232C Communication / Network command table (continued)

Names	Operation Type	Header				Command Data			
						CRC	Action	Type	Setting Code
MENU POSITION V	Get	BE EF	03	06 00	40 D7	02 00	16 30	00 00	
	Increment	BE EF	03	06 00	26 D7	04 00	16 30	00 00	
	Decrement	BE EF	03	06 00	F7 D6	05 00	16 30	00 00	
MENU POSITION V Reset	Execute	BE EF	03	06 00	A8 C7	06 00	44 70	00 00	
BLANK	Set	MyScreen	BE EF	03	06 00	FB CA	01 00	00 30	20 00
		ORIGINAL	BE EF	03	06 00	FB E2	01 00	00 30	40 00
		BLUE	BE EF	03	06 00	CB D3	01 00	00 30	03 00
		WHITE	BE EF	03	06 00	6B D0	01 00	00 30	05 00
	BLACK	BE EF	03	06 00	9B D0	01 00	00 30	06 00	
	Get	BE EF	03	06 00	08 D3	02 00	00 30	00 00	
BLANK On/Off	Set	OFF	BE EF	03	06 00	FB D8	01 00	20 30	00 00
		ON	BE EF	03	06 00	6B D9	01 00	20 30	01 00
	Get	BE EF	03	06 00	C8 D8	02 00	20 30	00 00	
START UP	Set	MyScreen	BE EF	03	06 00	CB CB	01 00	04 30	20 00
		ORIGINAL	BE EF	03	06 00	0B D2	01 00	04 30	00 00
		OFF	BE EF	03	06 00	9B D3	01 00	04 30	01 00
	Get	BE EF	03	06 00	38 D2	02 00	04 30	00 00	
MyScreen Lock	Set	OFF	BE EF	03	06 00	3B EF	01 00	C0 30	00 00
		ON	BE EF	03	06 00	AB EE	01 00	C0 30	01 00
	Get	BE EF	03	06 00	08 EF	02 00	C0 30	00 00	
MESSAGE	Set	OFF	BE EF	03	06 00	8F D6	01 00	17 30	00 00
		ON	BE EF	03	06 00	1F D7	01 00	17 30	01 00
	Get	BE EF	03	06 00	BC D6	02 00	17 30	00 00	
TEMPLATE	Set	TEST PATTERN	BE EF	03	06 00	43 D9	01 00	22 30	00 00
		DOT-LINE1	BE EF	03	06 00	D3 D8	01 00	22 30	01 00
		DOT-LINE2	BE EF	03	06 00	23 D8	01 00	22 30	02 00
		DOT-LINE3	BE EF	03	06 00	B3 D9	01 00	22 30	03 00
		DOT-LINE4	BE EF	03	06 00	83 DB	01 00	22 30	04 00
		CIRCLE 1	BE EF	03	06 00	13 DA	01 00	22 30	05 00
		CIRCLE 2	BE EF	03	06 00	E3 DA	01 00	22 30	06 00
		MAP 1	BE EF	03	06 00	83 D4	01 00	22 30	10 00
	MAP 2	BE EF	03	06 00	13 D5	01 00	22 30	11 00	
Get	BE EF	03	06 00	70 D9	02 00	22 30	00 00		
TEMPLATE On/Off	Set	OFF	BE EF	03	06 00	BF D8	01 00	23 30	00 00
		ON	BE EF	03	06 00	2F D9	01 00	23 30	01 00
	Get	BE EF	03	06 00	8C D8	02 00	23 30	00 00	
AUTO SEARCH	Set	OFF	BE EF	03	06 00	B6 D6	01 00	16 20	00 00
		ON	BE EF	03	06 00	26 D7	01 00	16 20	01 00
	Get	BE EF	03	06 00	85 D6	02 00	16 20	00 00	
DIRECT POWER ON	Set	OFF	BE EF	03	06 00	3B 89	01 00	20 31	00 00
		ON	BE EF	03	06 00	AB 88	01 00	20 31	01 00
	Get	BE EF	03	06 00	08 89	02 00	20 31	00 00	

(continued on next page)

RS-232C Communication / Network command table (continued)

Names	Operation Type	Header				Command Data			
						CRC	Action	Type	Setting Code
AUTO POWER OFF	Get	BE EF	03	06 00	08 86	02 00	10 31	00 00	
	Increment	BE EF	03	06 00	6E 86	04 00	10 31	00 00	
	Decrement	BE EF	03	06 00	BF 87	05 00	10 31	00 00	
LAMP TIME	Get	BE EF	03	06 00	C2 FF	02 00	90 10	00 00	
LAMP TIME Reset	Execute	BE EF	03	06 00	58 DC	06 00	30 70	00 00	
FILTER TIME	Get	BE EF	03	06 00	C2 F0	02 00	A0 10	00 00	
FILTER TIME Reset	Execute	BE EF	03	06 00	98 C6	06 00	40 70	00 00	
MY BUTTON-1	Set	COMPUTER IN1	BE EF	03	06 00	3A 33	01 00	00 36	00 00
		COMPUTER IN2	BE EF	03	06 00	FA 31	01 00	00 36	04 00
		HDMI	BE EF	03	06 00	CA 33	01 00	00 36	03 00
		S-VIDEO	BE EF	03	06 00	5A 32	01 00	00 36	02 00
		VIDEO	BE EF	03	06 00	AA 32	01 00	00 36	01 00
		INFORMATION	BE EF	03	06 00	FA 3E	01 00	00 36	10 00
		MY MEMORY	BE EF	03	06 00	9A 3F	01 00	00 36	12 00
		PICTURE MODE	BE EF	03	06 00	0A 3E	01 00	00 36	13 00
		FILTER RESET	BE EF	03	06 00	3A 3C	01 00	00 36	14 00
		MY IMAGE	BE EF	03	06 00	5A 3D	01 00	00 36	16 00
		AV MUTE	BE EF	03	06 00	AA 38	01 00	00 36	19 00
		TEMPLATE	BE EF	03	06 00	CA 39	01 00	00 36	1B 00
		D-ZOOM	BE EF	03	06 00	FA 3B	01 00	00 36	1C 00
		D-SHIFT	BE EF	03	06 00	6A 3A	01 00	00 36	1D 00
		RESOLUTION	BE EF	03	06 00	9A 3A	01 00	00 36	1E 00
MESSENGER	BE EF	03	06 00	AA 29	01 00	00 36	25 00		
	Get	BE EF	03	06 00	09 33	02 00	00 36	00 00	
MY BUTTON-2	Set	COMPUTER IN1	BE EF	03	06 00	C6 32	01 00	01 36	00 00
		COMPUTER IN2	BE EF	03	06 00	06 30	01 00	01 36	04 00
		HDMI	BE EF	03	06 00	36 32	01 00	01 36	03 00
		S-VIDEO	BE EF	03	06 00	A6 33	01 00	01 36	02 00
		VIDEO	BE EF	03	06 00	56 33	01 00	01 36	01 00
		INFORMATION	BE EF	03	06 00	06 3F	01 00	01 36	10 00
		MY MEMORY	BE EF	03	06 00	66 3E	01 00	01 36	12 00
		PICTURE MODE	BE EF	03	06 00	F6 3F	01 00	01 36	13 00
		FILTER RESET	BE EF	03	06 00	C6 3D	01 00	01 36	14 00
		MY IMAGE	BE EF	03	06 00	A6 3C	01 00	01 36	16 00
		AV MUTE	BE EF	03	06 00	56 39	01 00	01 36	19 00
		TEMPLATE	BE EF	03	06 00	36 38	01 00	01 36	1B 00
		D-ZOOM	BE EF	03	06 00	06 3A	01 00	01 36	1C 00
		D-SHIFT	BE EF	03	06 00	96 3B	01 00	01 36	1D 00
		RESOLUTION	BE EF	03	06 00	66 3B	01 00	01 36	1E 00
MESSENGER	BE EF	03	06 00	56 28	01 00	01 36	25 00		
	Get	BE EF	03	06 00	F5 32	02 00	01 36	00 00	
MY SOURCE	Set	COMPUTER IN1	BE EF	03	06 00	FA 38	01 00	20 36	00 00
		COMPUTER IN2	BE EF	03	06 00	3A 3A	01 00	20 36	04 00
		HDMI	BE EF	03	06 00	0A 38	01 00	20 36	03 00
		S-VIDEO	BE EF	03	06 00	9A 39	01 00	20 36	02 00
		VIDEO	BE EF	03	06 00	6A 39	01 00	20 36	01 00
	Get	BE EF	03	06 00	C9 38	02 00	20 36	00 00	

(continued on next page)

RS-232C Communication / Network command table (continued)

Names	Operation Type	Header				Command Data			
						CRC	Action	Type	Setting Code
REMOTE FREQ. NORMAL	Set	Disable	BE EF	03	06 00	FF 3D	01 00	30 26	00 00
		Enable	BE EF	03	06 00	6F 3C	01 00	30 26	01 00
	Get	BE EF	03	06 00	CC 3D	02 00	30 26	00 00	
REMOTE FREQ. HIGH	Set	Disable	BE EF	03	06 00	03 3C	01 00	31 26	00 00
		Enable	BE EF	03	06 00	93 3D	01 00	31 26	01 00
	Get	BE EF	03	06 00	30 3C	02 00	31 26	00 00	
D-ZOOM	Get	BE EF	03	06 00	D0 D0	02 00	0A 30	00 00	
	Increment	BE EF	03	06 00	B6 D0	04 00	0A 30	00 00	
	Decrement	BE EF	03	06 00	67 D1	05 00	0A 30	00 00	
D-ZOOM Reset	Execute	BE EF	03	06 00	98 C9	06 00	70 70	00 00	
D-SHIFT V	Get	BE EF	03	06 00	2C D1	02 00	0B 30	00 00	
	Increment	BE EF	03	06 00	4A D1	04 00	0B 30	00 00	
	Decrement	BE EF	03	06 00	9B D0	05 00	0B 30	00 00	
D-SHIFT V Reset	Execute	BE EF	03	06 00	A8 C8	06 00	74 70	00 00	
D-SHIFT H	Get	BE EF	03	06 00	58 D0	02 00	0C 30	00 00	
	Increment	BE EF	03	06 00	3E D0	04 00	0C 30	00 00	
	Decrement	BE EF	03	06 00	EF D1	05 00	0C 30	00 00	
D-SHIFT H Reset	Execute	BE EF	03	06 00	54 C9	06 00	75 70	00 00	
PICT. POSIT. H	Set	RIGHT	BE EF	03	06 00	46 D5	01 00	1E 20	01 00
		MID	BE EF	03	06 00	D6 D4	01 00	1E 20	00 00
		LEFT	BE EF	03	06 00	B6 D5	01 00	1E 20	02 00
	Get	BE EF	03	06 00	E5 D4	02 00	1E 20	00 00	
C.C. DISPLAY	Set	OFF	BE EF	03	06 00	FA 62	01 00	00 37	00 00
		ON	BE EF	03	06 00	6A 63	01 00	00 37	01 00
		AUTO	BE EF	03	06 00	9A 63	01 00	00 37	02 00
	Get	BE EF	03	06 00	C9 62	02 00	00 37	00 00	
C.C. MODE	set	CAPTIONS	BE EF	03	06 00	06 63	01 00	01 37	00 00
		TEXT	BE EF	03	06 00	96 62	01 00	01 37	01 00
	Get	BE EF	03	06 00	35 63	02 00	01 37	00 00	
C.C. CHANNEL	Set	1	BE EF	03	06 00	D2 62	01 00	02 37	01 00
		2	BE EF	03	06 00	22 62	01 00	02 37	02 00
		3	BE EF	03	06 00	B2 63	01 00	02 37	03 00
		4	BE EF	03	06 00	82 61	01 00	02 37	04 00
	Get	BE EF	03	06 00	71 63	02 00	02 37	00 00	
MY IMAGE	Set	OFF	BE EF	03	06 00	3A C3	01 00	00 35	00 00
		IMAGE-1	BE EF	03	06 00	AA C2	01 00	00 35	01 00
		IMAGE-2	BE EF	03	06 00	5A C2	01 00	00 35	02 00
		IMAGE-3	BE EF	03	06 00	CA C3	01 00	00 35	03 00
	IMAGE-4	BE EF	03	06 00	FA C1	01 00	00 35	04 00	
Get	BE EF	03	06 00	09 C3	02 00	00 35	00 00		
MY IMAGE IMAGE-1 Delete	Execute	BE EF	03	06 00	71 C3	06 00	01 35	00 00	
MY IMAGE IMAGE-2 Delete	Execute	BE EF	03	06 00	35 C3	06 00	02 35	00 00	
MY IMAGE IMAGE-3 Delete	Execute	BE EF	03	06 00	C9 C2	06 00	03 35	00 00	
MY IMAGE IMAGE-4 Delete	Execute	BE EF	03	06 00	BD C3	06 00	04 35	00 00	

HITACHI

Inspire the Next

Hitachi Consumer Electronics Co. Ltd.,
Shin-Otemachi Bldg 5f, 2-1, Otemachi 2-Chome,
Chiyoda-Ku, Tokyo 100-0004 Japan

HITACHI EUROPE LTD.

Consumer Affairs Department
PO Box 3007
Maidenhead
Berkshire SL6 8ZE

UNITED KINGDOM

Tel: 0844 481 0297
Email: consumer.mail@hitachi-eu.com

HITACHI EUROPE S.A.

364, Kifissias Ave. & 1, Delfon Str.
152 33 Chalandri
Athens

GREECE

Tel: 210 6837200
Fax: 210 6835694
Email: dmgservice.gr@hitachi-eu.com

HITACHI EUROPE GmbH

Am Seestern 18
40547 Düsseldorf

GERMANY

Tel: 211-5283-808
Fax: 211-5283-809
Hotline: 0180 - 551 25 51 (12ct/min.)
Email: Service.germany@hitachi-eu.com

HITACHI EUROPE S.A.

Gran Via Carles III, 86 Planta 5ª
Edificios Trade - Torre Este
08028 Barcelona

SPAIN

Tel: 0034 934 092 5 50
Email: garantias@ltr-hitachi.es

HITACHI EUROPE S.r.l.

Via T. Gulli, 39
20147 MILANO

ITALY

Tel. +39 02 2570094
Fax +39 02 25712029
E.mail: aerta_sas@iol.it

HITACHI EUROPE AB

Frösundaviks Alle 15
169 29 Solna

SWEDEN

Sweden Tel: +46 856 27 1100
Finland Tel: +358 10 8503 085
Norway Tel: +47 9847 3898
Denmark Tel: +45 43 43 6050
Email: rma.nordic@hitachi-eu.com

HITACHI EUROPE S.A.S

Digital Media Group
77 Rue Alexandre Dumas
69120 Vaulx en Velin

FRANCE

Tel: 04 37 42 84 30
Email: france.consommateur@hitachi-eu.com

www.hitachidigitalmedia.com