

Phytochemical studies of *Helichrysum patulum*

Vuyiswa Gladys Swartz



**Thesis submitted in partial fulfilment of the requirements for the degree of
Masters of Science in the
Department of Chemistry, University of the Western Cape**

Supervisor: Dr W.T. Mabusela

May 2006

Abstract

The extractives from the medicinal plant *Helichrysum patulum* were isolated in the crude form and compounds comprised thereof identified using standard techniques.

The types of compounds isolated included : glucosides e.g. arbutin and sitosterol glycoside, monoterpenes e.g. pinene, terpineol and limonene, sesquiterpenes e.g. viridiflorol, β -caryophyllene, (-)-alloaromadendrene, muurolol, γ -gurjunene and long chain carboxylic acids e.g. hexadecanoic acid and tetradecanoic acid.

Soxhlet extraction , flash chromatography , thin layer chromatography and column chromatography techniques were central to the isolation of the compounds. Structural elucidation included the use of 1D and 2D NMR spectroscopy such as ^1H , ^{13}C , COSY, HMQC and HMBC spectroscopy.



Declaration

I declare that Phytochemical studies of *Helichrysum patulum* is my own work, that it has not been submitted for any degree or examination in any other university, and that all the sources I have used have been indicated and acknowledged by complete references.

Full name: Vuyiswa Gladys Swartz

Date: May 2006

Signed:



Acknowledgements

I would like to thank Dr W.T. Mabusela for his guidance, mentorship and encouragement throughout.

Thanks to Professor Q. J. Johnson for organizing the funding for the project and Professor I.R. Green for his assistance with NMR data interpretation.

Huge level of gratitude to the following institutions :

The National Research Foundation (NRF) for funding the project.

Cape Peninsula University of Technology for providing running costs.

Synexa Life Sciences for a portion of financial assistance.

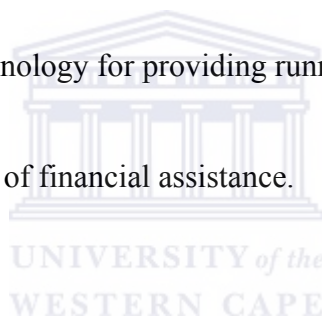

Thanks also to Ming-Yi Lee and Thalma Corbett for their support and valuable suggestions.

Thanks to my husband for his support throughout, I know it should not have been easy at times.

To my parents for their support, understanding and prayers. Also to my sister for all her support.

Special thanks to my God for His guidance and source of strength.

List of Tables and Figures

List of Tables		Page
Table 1	Relation of stress-related ailment to chemical nature of active constituents	3
Table 2	^1H and ^{13}C data for compound 1	34
Table 3	^1H and ^{13}C data for compound 3b	37
Table 4	^1H and ^{13}C data for compound 4	39
Table 5	GC-MS of the essential oils of <i>Helichrysum patulum</i>	41
List of Figures		Page
Figure 1	Isoprene units	10
Figure 2	Examples of terpene structures of each group	10
Figure 3a	The first postulated method of uniting C_5 units	12
Figure 3b	The real active forms of the C_5 units	12
Figure 4	Biosynthesis of S-3-hydroxy-3-methylglutaryl- Co A	14
Figure 5	Origin of the IPP and DMAPP units	15
Figure 6	Biosynthesis of γ -bisabolene	18
Figure 7	Biogenetic relationships between some of the phytosterols	21
Figure 8	Some aglcones of cardiotonic sterols	22

CONTENTS

	Page
Abstract	i
Declaration	ii
Acknowledgements	iii
List of Tables and Figures	iv

CHAPTER 1: INTRODUCTION AND LITERATURE REVIEW

1. Introduction	1
1.1 Historical review of health care practices	3
1.2 Overview of International health	4
2. Traditional pharmacology and medicine	5
2.1 Ethnopharmacological themes in sub-Saharan art objects and utensils	5
2.2 Ethnopharmacological information of the <i>Helichrysum</i> genus	6
3. An overview of the chemistry of the <i>Helichrysum</i> genus	7
3.1 Terpenes	9
3.1.1 Biosynthesis of terpenes	12
3.1.2 Sesquiterpenes and their biosynthesis	16
3.1.2.1 Sesquiterpenes of particular biological importance	19
3.1.3 Phytosterols	19
3.1.3.1 Biosynthesis of steroids	19
3.1.4 Glycosides	23
4. Aim of this thesis	25

CHAPTER 2 : EXPERIMENTAL

2. Materials and methods	27
2.1 Plant material	27
2.2 General experimental methods	27
2.3 Preparation of extracts	28

<u>CHAPTER 3 : RESULTS AND DISCUSSION</u>	30
3. Results and Discussion	31
3.1 Structural elucidation of compound 1 (<i>Arbutin</i> : 4-hydroxyphenyl-D-glucopyranoside)	33
3.2 Compound 2 : Decane	36
3.3 Compound 3 : β -sitosterol glucoside tetraacetate	36
3.3.1 Structural elucidation of compound 3	37
3.4 Compound 4 : Viridiflorol	39
3.4.1 Structural elucidation of compound 4	39
3.5 Isolation of essential oil of <i>Helichrysum patulum</i>	41
3.5.1 Discussion	42
3.5.2 General discussion on essential oils	42
4. Conclusion	44
References	45



CHAPTER 1

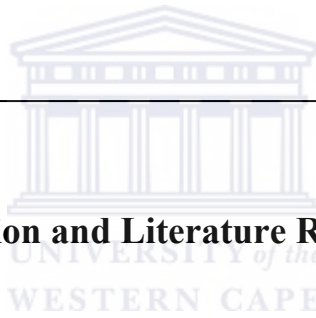

Introduction and Literature Review

1. Introduction

Medicinal plants have always played an important role in therapy within the traditional health care system in South Africa, as practised by izangoma (traditional healers), herbalists and home users. The most common applications are liquid concoctions for drinking to heal ailments, burning of a certain plant organ like the leaves or stems for the healing aroma, as well as liquid washes and dressings with the leaves, for wounds.

Helichrysum, “impepho” in isiXhosa, the Everlastings in English, from the families Asteraceae and Compositae, is a large genus of about 500 species with 246 growing in South Africa (Afolayan and Meyer, 1997). The species are used according to their availability by geographical area and they go under the names, to name a few, *Helichrysum aureonitens*, *Helichrysum caespitium*, *Helichrysum coriaceum*, *Helichrysum tenuifolium*, *Helichrysum kraussii*, *Helichrysum rugosolum*, etc.

Helichrysum patulum (Asteraceae) has been well recognised for its medicinal properties by the indigenous people of Africa for ages, and indeed, there is a large number of other species in this genus which enjoy similar recognition in different parts of the world. The antimicrobial activity of the genus has always been there since most of the species are used topically by the indigenous people of South Africa against infections (Afolayan and Meyer, 1997). The antimicrobial activities of extracts from *Helichrysum* species have been widely reported (Afolayan and Meyer, 1997; Bougatsos *et al.*, 2003; Cosar and Cubukcu, 1990; Eloff, 1999; Grierson and Afolayan, 1999; Mathekga *et al.*, 2000; Meyer and Dilika, 1996; Meyer *et al.*, 1997; Rios *et al.*, 1991; Rios *et al.*, 1987; Salie, 1998; Salie *et al.*, 1996; Tomas-Barberan *et al.*, 1990; Tomas-Barberan, 1988). All the above authors acknowledged that the compounds responsible for these activities have been identified in only a few cases. As long as there is no modern scientific evidence to support the medicinal applications of these types of herbs, as practised in the traditional context, practitioners of the Western medicine will continue to be sceptical about the validity of such medicinal applications, and thus make it difficult for their acceptance in the role of complementary medicine.

The need for scientific research on medicinal plants increases almost daily in the African continent as well as other continents. About five years ago a need was realized for TB drugs with improved efficacy. Recently pharmaceutical practitioners have discovered that antibiotics are becoming less effective on certain ailments and conditions, due to increased resistance from various microorganisms and as a result more effective drugs must be

manufactured as a matter of urgency. The last drugs to be discovered from higher plants were vinblastine and vincristine, marketed in 1961 and 1963 respectively, with the addition of taxol in late sixties, and the research and development budget for efforts to find new drugs in higher plants has been miniscule for the past 49 years. Since there are 250 000 species of higher plants on earth it is logical to presume that many more useful drugs will be discovered in the plant kingdom if the search for these entities is carried out in a logical and systematic manner. It has been estimated that 80% of people living in developing countries are almost completely dependent on traditional medical practices for their primary health care needs, and higher plants are known to be the main source of drug therapy in traditional medicine. About 15 years ago, approximately 64% of the total population of the world was reported as utilizing plants as drugs i.e. 3.2 billion people (Ciba Foundation, 1990). On the global survey data it has been found that about 119 plant – derived chemical compounds of known structures are currently used as drugs or as biodynamic agents that affect human health. Many of the plant – derived drugs currently in use are prototypes. The most important of the plant – derived drugs in addition to vinblastine and vincristine are, to name a few: atropine, bromelain, caffeine, morphine, papaverine, quinidine, quinine, reserpine and tubocurarine (Ciba Foundation, 1990). Since the knowledge of traditional herbs is gradually being lost due to the older generation who have mostly used them, passing away, scientific research needs to be conducted whereby:

1. Detailed documentation on traditional medicines is established and preserved.
2. The therapeutically active constituents are identified.
3. The safety and quality of the medicines are investigated.
4. The toxicity of these traditional medicines is studied.
5. The clinical efficacy of these medicines is well established.
6. Valuable collaboration with traditional healers exists.

In the Spanish Mediterranean area antimicrobial herbs have great prestige among inhabitants of the little towns and rural villages, because their efficacy is sometimes spectacular in cases where conventional chemotherapy has failed (Ivancheva and Stantcheva, 2000). The South African *Helichrysum* species (Asteracea) are used extensively for stress-related ailments and as dressings for wounds normally encountered in circumcision rites, bruises, cuts and sores (Grierson and Afolayan, 1999; Lourens *et al.*, 2004). They are used for menstrual and abdominal pains in East Africa. The route of administration for stress- related ailments is by inhalation of smoke from burned plant material. Assumptions made in relating the type of

possible stress-related ailment activity with the chemical nature of active constituents (Hutchings and Van Staden, 1994) are listed in Table 1 :

Activity	Chemical nature
Analgesic (relieving pain)	Morphine –like
Decongestant (nasal and sinuses)	Aromatic
Antispasmodic (relaxing muscles and blood vessels)	Flavonoids
Anti-inflammatory (reduce inflammation and relieve pain)	Flavonoids
Sedative (relieving anxiety states)	Morphine-like narcotic

Table 1 (Hutchings and Van Staden, 1994)

The importance of ethnopharmacological investigations in the discovery of new therapeutic agents from plants has been discussed extensively (Meyer *et al.*, 1997). Acute, recurrent and chronic viral infections occur worldwide and several antiviral compounds have been introduced into therapeutic use during the past decades (Meyer *et al.*, 1997). The variability in efficacy of these antiviral compounds in recurrent and chronic infections and in immunodeficient patients as well as the problem of prohibitive costs in developing countries have necessitated the search for alternative drugs (Meyer *et al.*, 1997). The use of drugs prepared from medicinal plants in Bulgarian traditional medicine dates from centuries ago (Ivancheva and Stantcheva, 2000). The healing effects of medicinal plants are mentioned in Hexaameron of John the Exarch, kept at the British museum (De Smet, 1998). In spite of the progress of pharmacological technology, the memory of popular medicine still survives and remains as a common heritage to be used when necessary.

1.1 HISTORICAL REVIEW OF HEALTH CARE PRACTICES

People have always been concerned with the events surrounding birth, death and illness. Early people tried to understand disease so that they could cope with disease-producing agents.

However, their success was limited since their health practices were largely based on magic and superstition rather than on facts about the cause and effect of actions and the subsequent health consequences (Stanhope, 1996). The health care system has undergone transformations from the times of the Ancient Babylonians who believed that disease was a punishment for sinning and the Egyptians of about 1 000 BC who used principles based on observation and empirical knowledge rather than on magic. Egyptians developed and systematized a variety of pharmaceutical preparations. The early Greeks viewed people as part of nature and believed health resulted from a harmonious relationship with nature and, therefore, saw health care delivery as a responsibility of a civilized society paying attention to personal cleanliness, exercise, diet and sanitation. The first notation of women being associated with healing is found in connection with the Greek mythological character of *Aesculapius*, who eventually became deified as the god of healing. During the Middle Ages the early Christian church believed that the Roman and Greek ways pampered the body at the expense of the soul. Then, religious persecution of those who tried to introduce new ideas occurred and thus communicable diseases such as measles, smallpox, diphtheria and bubonic plague became prevalent. Advances in development of health care led to the Renaissance, a period of history during which community health as it is currently known was begun. However, the colonialists in the developed areas lacked a continuing and organized mechanism for ensuring that community health efforts would be supported and enforced (Stanhope, 1996).

1.2 OVERVIEW OF INTERNATIONAL HEALTH

All countries of the world experience health problems of one kind or another. However, those countries that are lesser developed are often faced with a multiplicity of health care problems and concerns that often sound exotic and far removed to people in more developed nations. Some of the more exotic-sounding problems include such diseases as leishmaniasis, schistosomiasis, pediculosis, typhus, yellow fever and malaria. Health problems that are still ongoing and in need of control in lesser developed countries include measles, mumps, rubella and polio, while current health concerns of more developed countries reflect ongoing struggles with hepatitis, the appearance of new viral strains such as *hantavirus*, and larger social issues such as violence and substance abuse. Two examples of diseases from recent years that were once fairly isolated and rare, but are now spread throughout the world are acquired immunodeficiency syndrome (AIDS) and drug – resistant tuberculosis (TB). In 1977, attendees at the annual meeting of the World Health Assembly maintained that a major social goal for all of its member agencies should be “the attainment by all citizens of the

world by the year 2000 of a level of health that will permit them to lead a socially and economically productive life” (World Health Organization, 1986a : 65).

The goal of health for all by the year 2000 (HFA 2000) continued to be promoted by numerous health-related conferences that were held around the world and was reinforced at the International Conference on Primary Health Care that was held in Alma Ata, Kazakhstan, in 1978, which was sponsored by WHO and UNICEF (United Nations Children’s Fund). The participants in the conference, which represented 143 countries and 67 organisations, adopted a resolution that proclaimed that the major key to attaining HFA 2000 was the worldwide implementation of primary health care. Current problems and realities in the health care delivery system are reflected on increasingly limited resources, limited growth and a reorganization of methods of financing and care delivery. Health providers are being forced to be more introspective and to look at alternatives and options to the limited resources, growth and services of previous decades. Scientists are also challenged to look at alternatives to present methods of developing and manufacturing drugs with enhanced therapeutic activity.

2. Traditional pharmacology and medicine.

2.1 Ethnopharmacological themes in sub-Saharan art objects and utensils.

Ethnopharmacological themes in native art can be defined as themes visualizing different features of traditional medicines and poisons, such as natural sources, methods of preparation, containers, usage and implementations, target diseases and effects. These themes are drawn from the general description that ethnopharmacology studies the human use of crude drugs and poisons in a traditional context. The front of the Journal of Ethnopharmacology is embellished with the head of a large terracotta statue of 77 cm which was excavated at Gazi in Crete, and which is presently in the museum of Herakleoin. This figure is said to date from the second millennium BC and represents a goddess or a female worshipper, whose head is adorned with poppy capsules. The capsules are incised in a manner, which is typical of the way in which opium is obtained. The statue that is an indisputable example of an art object with an ethnopharmacological theme may then be an archaeological piece of evidence that the blissful effects of opium were already known more than 3 000 years ago. The concept of ethnopharmacological themes in native art is, in its essence, just as ethnopharmacology itself, a Western approach that does not revolve around the principle, that the meaning of objects is culturally bound. It has been pointed out in a fascinating book about the commodifications of African objects in the international art market, that the very same Western collections of

native art, which have incited a previous generation of anthropologists to increase their knowledge about the native significance of these objects, are nowadays prompting some anthropologists to explore the question, which means these objects have come to rest in Western hands. Part of these native objects convey an ethnopharmacological message by embodying the diversified and indigenous ways in which mankind has applied natural religious experiences. In this context the objects can do much to inform and please spectators, inside as well as outside the ethnopharmacological community.

2.2 Ethnopharmacological information on the *Helichrysum* genus.

The Rwandan people use *Helichrysum odoratissimum* (L) Less (Asteraceae) to treat female sterility, menstrual pain and eczema, and is known under the names of Umutamatama, Manayeze, Umunyarugabo, Umutaranuka and Rukanjabyuna. This species is a wide spread herb throughout intertropical and southern Africa where it is used to relieve abdominal pains, heartburn, coughs, colds and wounds. In the course of systematic studies on biologically active substances from medicinal plants of Rwanda, antimicrobial activity was found in the methanol extract of the flowers of *Helichrysum odoratissimum* (Puyvelde *et al.*, 1989). The roots of *Helichrysum davyi* S. Moore and *Helichrysum arenarium* L . (Moench) have been found to contain compounds with biological activity. The genus of *Helichrysum* (Asteraceae), widely represented in European flora consists of a taxonomically complex group of plants used in folk medicine. In Europe today, infusions are prepared from inflorescences of *Helichrysum arenarium* and *H. italicum* because of their bile regulatory and diuretic effects (Cosar and Cubukcu, 1989). The choleric, hepatoprotective and detoxifying activities of the inflorescence of *H. arenarium* (L.) Moench (everlasting; immortelle : Asteraceae – *Helichrysi flos* syn. *Stoechados flos*) have been known for a long time from herbal medicine in Hungary. While the first therapeutic uses of the plant were based on folk medicine, recent *in vitro* and *in vivo* studies also proved its choleric (Czinner *et al.*, 2000) and hepatoprotective (Skakun and Stepanov, 1988) properties. *H. aureonitens* Sch.Bip is a hairy perennial herb, which grows in the kwaZulu – Natal province of South Africa. Extracts from the plant are used topically by the indigenous people of South Africa against infections especially herpes zoster and infections associated with herpes simplex virus. The antimicrobial activities of extracts from *Helichrysum* species have been widely reported (Cosar and Cubukcu, 1990; Rios *et al.*, 1991; Skakun and Stepanov, 1988; Tomas-Barberan *et al.*, 1990; Tomas-Barberan *et al.*, 1988). The antiherpes and antibacterial activities of extracts of *H. aureonitens* were reported by Meyer and Afolayan (1995; Meyer and Dilika, 1996). The aerial parts of *H. italicum* and *H. stoechas*

are employed in the Spanish Mediterranean area in therapy for their antifever, anticold, wound healing and antiinfectious qualities. In addition, *H.italicum* is recognised for its ability to heal skin problems, as well as its diuretic and disinfectant qualities. *H.stoechas* (L.) Moench is a shrub with yellow flowers. *H. nitens* Oliv. and Hiern is a plant that is found in the Zomba Plateau of Malawi. The rinses obtained by soaking the aerial parts help with fungal diseases. In the Eastern Cape province of South Africa the indigenous people of this province have a long history of traditional plant usage for the treatment of various diseases and ailments including the uses for the treatment of wounds (Afolayan and Meyer, 1995; Grierson and Afolayan, 1999; Meyer and Dilika, 1996; Van Wyk,1997). In this province the leaves of *H. foetidum* (L.) Moench are warmed and applied as a poultice for infected sores, the tea from dried leaves of *H. appendiculatum* and the sap of *H. pedunculare* DC are applied to circumcision wounds. Dried and ground plant is used for bacterial infections.

3. An overview of the chemistry of the *Helichrysum* genus

Different compounds like phenolics e.g. flavonoids and chalcones, phthalides, α -pyron derivatives, terpenoids, essential oils, volatiles and fatty acids have been found in the genus (Czinner *et al.*, 2000) and antimicrobial activities of extracts from *Helichrysum* species have been widely reported (Cosar and Cubukcu, 1990; Rios *et al.*, 1991; Tomas-Barberan *et al.*, 1988). However the compounds responsible for these activities have been identified in only a few cases. From the flowers and leaves of *H. odoratissimum* the flavonoids namely; 3,5 dihydroxy-6, 7,8-trimethoxyflavone and 3-O-methylquercitin with antimicrobial activity and a chalcone namely helichrysetin were obtained (Cosar and Cubukcu, 1990). Antifungal epicuticular methylated flavonoids have been isolated from the aerial parts of *H.nitens* (Tomas-Barberan,1988). Prenylflavanones and chalcones with antibiotic activity have been isolated from the aerial parts and roots of *H. rugosolum* (Bohlmann and Misra, 1984).

Generic structures of a flavanone and a chalcone :

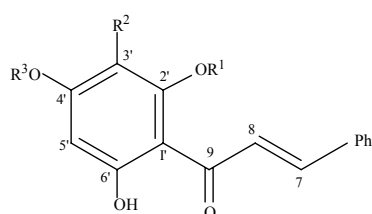

Chalcone

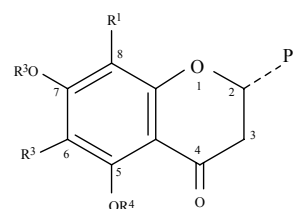

Flavanoid

where R^1 , R^2 , R^3 and R^4 can be H, Me, DMA, *DMA; *DMA = 3,3'-dimethylallyl.

Galangin (3, 5, 7 – trihydroxyflavone) was isolated from the aerial parts excluding the flowers of *H.aureonitens* (Afolayan and Meyer, 1997) and has been studied for its antibacterial , antifungal and antiviral activities (Meyer *et al.*,1997) .

A sesquiterpene was isolated from the roots of *H.davyi* (Jakupovic *et al.*,1987),

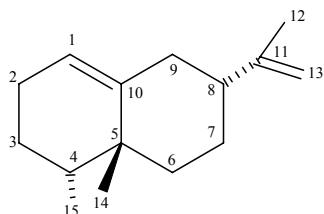

and a diterpene was isolated from the aerial parts of *H.refluxum*. The carbon skeleton resembles that of some rare diterpenes which have been isolated from an *Erythroxyton* species; the proposed name for the C-skeleton is erythropane and hence the proposed structure is erythroxa-3,15-dien-18-oic acid. The literature reveals that sesquiterpenes have been isolated from the *Helichrysum* genus. A lot of diterpenes have been isolated from other *Helichrysum* species including *H. ambiguum* , *H. bilobum* , *H. davenportii* , *H. leucopsideum* and *H. lindleyi* (Jakupovic *et al.*,1989). Establishing the biological activity of these diterpenes presents a challenge on on-going phytochemical studies.

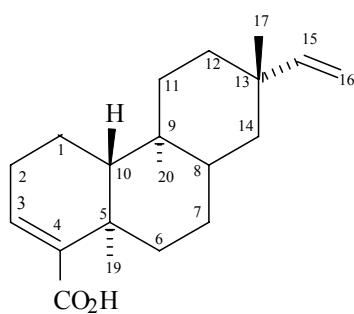

erythroxa-3,15-dien-18-oic acid

A phloroglucinol derivative, **caespit** with chemical formula $C_{17}H_{14}O_4$, and with interesting antimicrobial activities was isolated from the whole plant of the *H.caespitium* (Dekker *et al.*, 1983; Mathekgga *et al.*, 2000) . More phloroglucinols were found from the aerial parts of *H. platypterum* DC, *H.nudifolium* , *H.oreophilum* Klatt , *H.stenopterum* and were discovered together with diterpenes from the roots of *H.cephaloideum* DC and

H. mixtum. α -Pyrone derivatives were isolated from the roots of *H. zeyheri* (Jakupovic *et al.*, 1986; Jakupovic *et al.*, 1989) . Intensive investigation of compounds in the *Helichrysum* genus that afforded phloroglucinols also yielded the likes of bicyclogermacrene, cadinene derivatives, guaianolides, xanthanolides, dimeric sesquiterpene lactones aliphatic lactones and glycerol angelate derivatives from the species: *H. asperum* (Thumb) Hilliard et Burtt. var *albidulum* (DC) Hilliard, *H. monticola* Hilliard, *H. cerastroides* DC subsp. *Aurosicum* Merxm. et. A. Schreiber, *H. cymosum* (L.) D. Don, *H. lepidissimum* S. Moore, *H. argyrophyllum* DC , *H. petiolare* Hilliard et Burtt. , *H. dasyanthum* (Willd) Sweet and *H. splendidum*.

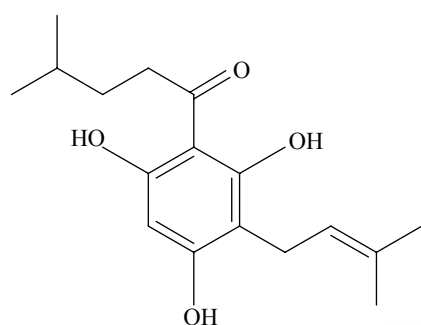

Caespitin

The whole plant of *H. stoechas* yielded a sterol that on acetylation was resolved into two phytosterols namely: β -sitosterol and stigmasterol (De Quesada *et al.*, 1972).

As reflected in the foregoing discussion, the scope of natural products that have been isolated from the *Helichrysum* genus is quite broad, covering nearly all the known fundamental classes with the obvious exception of alkaloids. Hence no justice can be done in attempting to provide a detailed review of all such classes in a thesis of this type and size. Consequently, for the purposes of this thesis further detailed discussion will be confined only to the two topics, namely: terpenes and glycosides.

3.1 Terpenes

These are natural products that often possess a carbon framework comprised of units of the five-carbon arrangement as shown in Fig 1.1. This monomeric unit is referred to as 'isoprenic' because of its relationship to the diene isoprene (Fig 1.2) and is commonly indicated by the symbol, C_5 . Most terpenes possess a carbon content in multiples of this five-carbon arrangement.

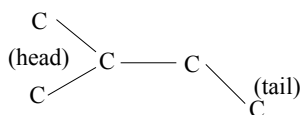

Fig 1.1

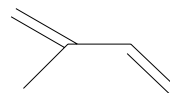

Fig 1.2

Figure 1 : **Isoprene units**

The term terpene was introduced for those compounds containing ten carbon atoms and this basis is still used for the modern classification of such natural products. This classification divides terpenes into *hemiterpenes* (1 x C₅), *monoterpenes* (2 x C₅ = 10), *sesquiterpenes* (3 x C₅ = 15), *diterpenes* (4 x C₅ = 20), *sesterpenes* (5 x C₅ = 25), and *triterpenes* (6 x C₅ = 30). The C₅ units are joined by 'head to tail' bonds as well as supplementary bonds. These structural features are a consequence of the common biosynthetic origin of the terpenes. Related structures possessing irregularities as a result of subsequent bond rearrangements are often found. For example, one or more head-to-tail bonds may be missing or part of the carbon skeleton may not possess isoprenic character. The terpenes may in some cases, because of subsequent loss or gain of carbon atoms, not contain a simple multiple of five carbon atoms. The family of regular and irregular terpenoids is very large and of great importance.

The examples of terpene structures of each group are shown below;

HEMITERPENES

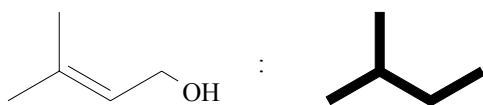

γ,γ - Dimethylallyl alcohol

MONOTERPENES

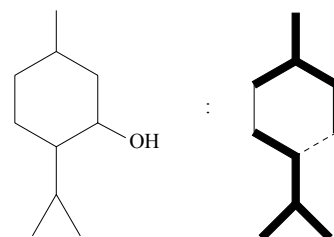

Menthol

SESQUITERPENES

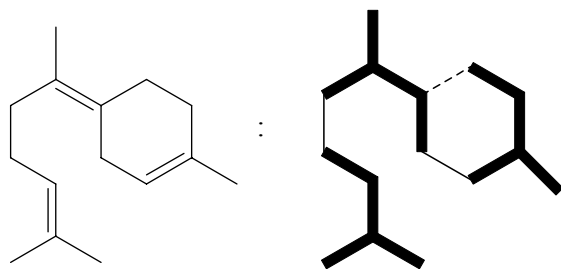

γ -Bisabolene

DITERPENES

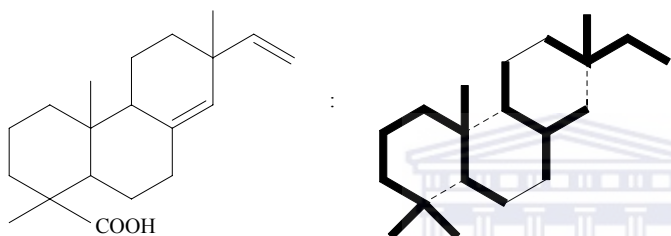

Pimaric acid

UNIVERSITY of the
WESTERN CAPE

SESTERTERPENES

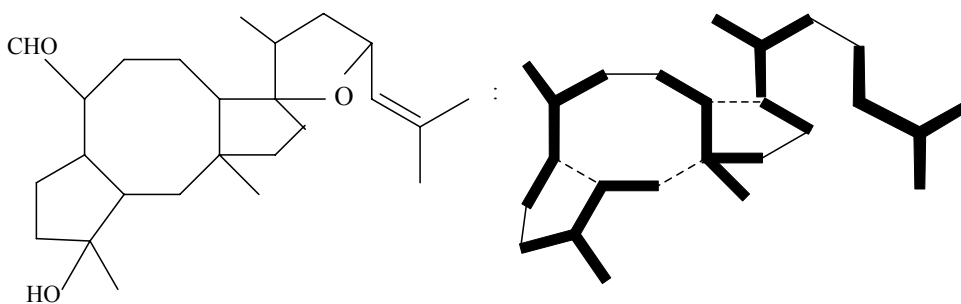

Ophiobolin-A

TRITERPENES

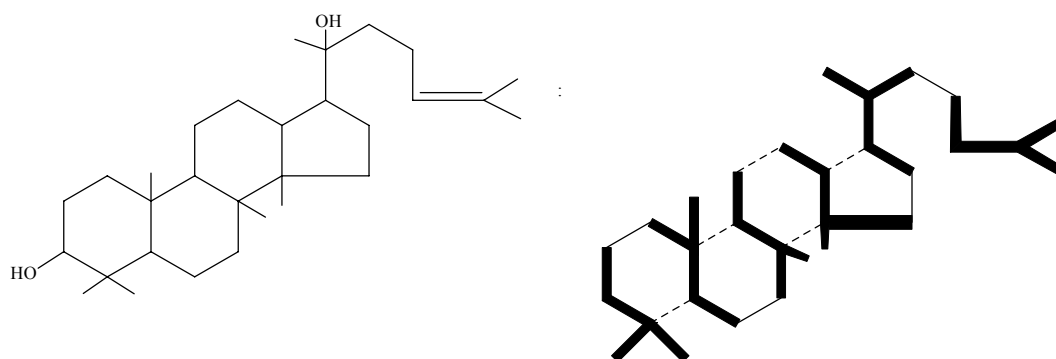

Dammarenediol

Figure 2: Examples of terpene structures of each group

3.1.1 Biosynthesis of terpenes

Earlier chemists hypothesised the direct participation of isoprene in the *in vivo* synthesis of terpenes. An illustration of this is the possible formation of ‘dipentene’ from two isoprenic units by a Diels-Alder process (Fig.3) and by the wide occurrence, amongst essential oils of compounds with the dipentene structure;

(a)

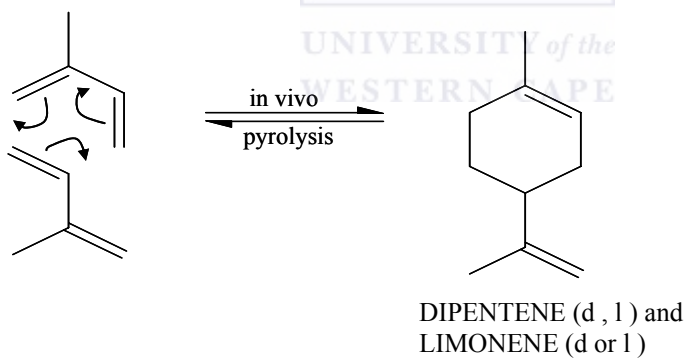

(b)

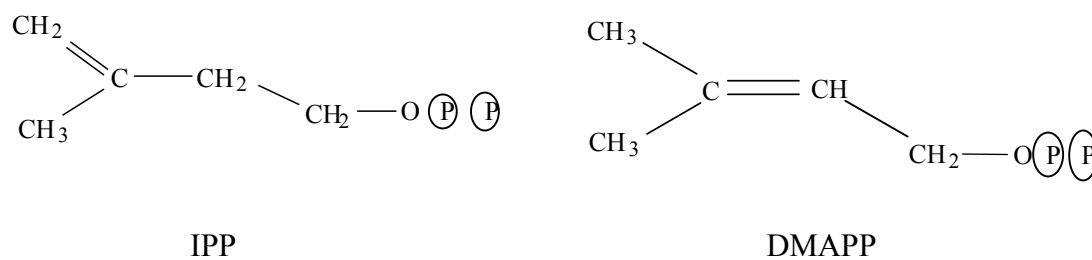

Figure 3: (a) The first postulated method for uniting C₅ units; (b) the real active forms of the C₅ units.

Research into the biosynthesis of the terpenoids may be divided into three parts, namely:

- (i) Studying the structure and origin of the parent isoprenic units.
- (ii) The study of the enzymatic process by which the C₅ units are assembled, and the fundamental skeletons are formed.
- (iii) The study of the sequences and nature of processes by which modified terpenic skeletons are built and the introduction of functional groups occur.

Such studies have not as yet revealed a complete picture of all *in vivo* terpenic syntheses. Nevertheless, a general pattern of the key biosynthetic process has emerged. This pattern, based on solid experimental data, has led to formulation of the biogenetic isoprene rule. Since the isoprene rule was originally proposed by Ruzicka it has been successively improved and extended to cover the increasing number of terpenic compounds discovered in nature. The isoprene rule was a rationalisation, through plausible chemical reactions and probable biological intermediates of the old structural isoprenic rule of Wallach and Robinson, based upon the frequency and regularity of isoprenic features in the terpenes. The dipentene obtained in the way shown (Fig 3a) is particularly abundant in turpentine oil. Its two optically active forms, (+) – limonene and (-)-limonene are found respectively, in citrus fruit oil found in oranges, lemons and peppermint oil. Isoprene itself did not appear to be present in nature and can only be obtained by the pyrolysis of certain monoterpenes. Elucidation of the structure of the real, natural C₅ precursor unit utilised by organisms for the synthesis of terpenes, was achieved by J.W. Cornforth in 1959. In his work on the biosynthesis of steroids he characterised two active forms of isoprene, isopentenyl pyrophosphate (IPP) and dimethylallylpyrophosphate (DMAPP) (Fig 3). Such intermediates are obligatory for the synthesis of plant terpenes. Various enzymes catalyse the incorporation of these intermediates into terpenes. The enzymes catalysing the reactions illustrated in Figures 4, 5 and 6 have been identified and isolated from a variety of vegetable sources. The intermediates IPP and DMAPP arise from (+)-mevalonic acid (MVA) and an enzyme complex that effects this conversion in high yields has been isolated from the latex of the rubber plant. Acetic acid or its derivative acetyl CoA, is the only carbon atom source of mevalonic acid and hence the two intermediates. In the process leading to these intermediates a key intermediate is S-3-hydroxy – 3-methylglutaryl CoA. This can be formed from either acetic acid (major route) or L-leucine (Fig 4). Thereafter, a unique pathway leads to IPP and DMAPP, Fig 5). The enzymes involved in the biosynthesis of the active forms of the C₅ unit are highly specific, they have

been isolated from many different sources and the reactions they catalyse have been studied in detail.

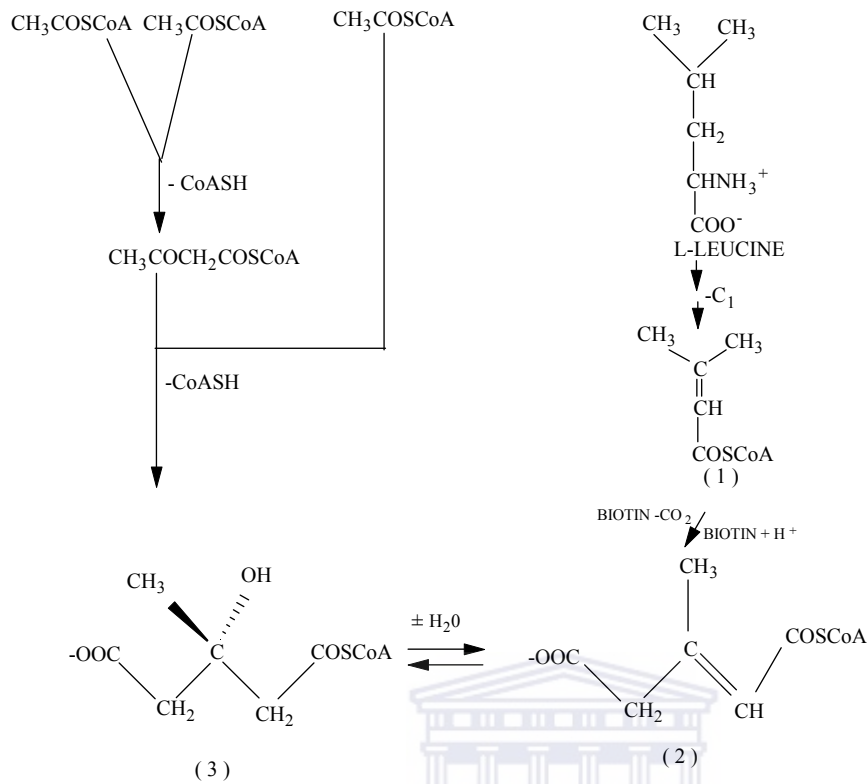

Figure 4: Biosynthesis of S-3-hydroxy-3-ethylglutaryl-coenzyme A.

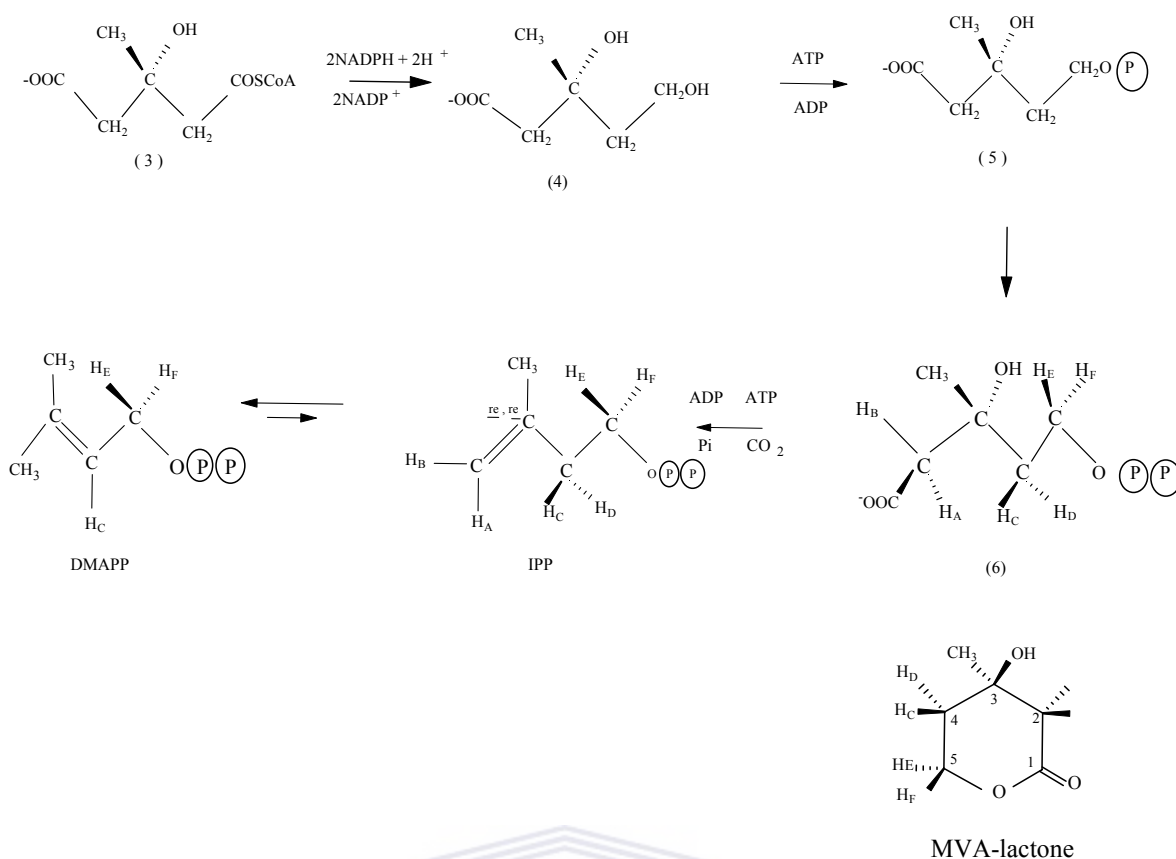
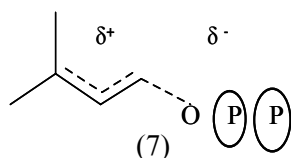

Figure 5: Origin of the isopentyl-pyrophosphate (IPP) and dimethylallylpyrophosphate (DMAPP) units.

Compound 6 is the biological equivalent of R-(+)-mevalonic acid lactone. MVA-lactone is a crystalline substance, chemically stable, which is easily converted into compound 6 *in vivo*, by opening of the lactone ring and esterifying its primary alcoholic group with pyrophosphoric acid. MVA-lactone is by far the most used precursor for selective incorporation experiments on biosynthesis of the terpenes and is commercially available in many different ³H- and ¹⁴C specifically labelled forms. Only the R form is utilised by organisms for producing terpenes whilst the S form is metabolically inert. After formation of the 3-phosphate ester the 5-pyrophosphate of mevalonic acid (6) undergoes decarboxylation, induced by the incipient formation of a tertiary carbocation at position 3 formed by loss of the phosphate group. The last step of the reaction schematised in Fig 5 can be considered as an E2 elimination reaction with antiperiplanar leaving groups. IPP can undergo an isomerisation into DMAPP, the consequence thereof being to transform a relatively unreactive substance into a reactive molecule, i.e. Formula 7, capable of attacking nucleophilic species such as a double bond. This reactivity is fully exploited in combining with other C₅ units and prenylation reactions. The isomerisation of IPP into DMAPP is one of the few reversible reactions observed in terpene biosynthesis. As far as the two enantiotopic hydrogens at these positions

are concerned the enzyme involved selectively removes H_D . The reprotonation takes place from the *re, re* face of IPP. DMAPP formation is subject to steric influences.



A DMAPP molecule can condense in a head-to-tail manner with IPP to produce geranyl pyrophosphate (GPP). This type of reaction can be repeated by further reaction of the product with IPP and a series of pyrophosphate esters of aliphatic alcohols is obtained. Such systems are called prenylogues, since the dimethylallyl radical is known as the prenyl group. DMAPP thus acts as the foundation stone upon which are added the building bricks of IPP units. Such additions are possible since the product obtained from each prior C_5 -addition has the same tail structure and thus the same reactivity as DMAPP. In nature, various types of transferases exist, each of them able to catalyse one or more of the reactions mentioned. By the use of such enzymes cells can discriminate between the synthesis of pyrophosphate esters with different numbers of carbon atoms. For example, one prenyl transferase, isolated from the liver of animals could promote the formation of either geranylpyrophosphate (GPP) or farnesylpyrophosphate (FPP) but not of higher prenylogues, probably because its active site could not accept allylic reagents larger than GPP. The names of the free pyrophosphate esters formed from the isoprene units are geranyl pyrophosphate, farnesyl pyrophosphate, geranyl geranyl pyrophosphate (GGPP) and geranyl farnesyl pyrophosphate (GFPP) and are obligatory intermediates for synthesis of all triterpenes and carotenes. The structural variety of the mono to sesterterpenes arises from elaborations such as cyclisation of these five open-chain intermediates (Manitto, 1981).

3.1.2 Sesquiterpenes and their biosynthesis

The sesquiterpene family of compounds provide a seemingly inexhaustible supply of biogenetic variations. A rich range of sophisticated reaction processes are utilised by nature, including the use of non-classical cations, molecular rearrangements, hydride ion or methyl group shifts and anti-Markownikoff additions (Manitto, 1981). About 1 000 sesquiterpenes are known that possess over 100 different carbon skeletons and arise mainly from plants, although the lower animals such as the coelenterates, molluscs and arthropods as well as

certain fungi, also contain this group of terpenes. Progress in the growth of experimental knowledge of their biogenesis has been rather slow and one reason for the rather slow elucidation of biogenetic patterns in this family of compounds is the difficulty encountered in incorporating labelled precursors when working with plants. The carbon atom skeleton of almost all the known sesquiterpenoids can be derived from *trans*-farnesylpyrophosphate (**9**) and the *cis*- isomer (**8**) through appropriate cyclisations and rearrangements. The schemes for sesquiterpene biogenesis have many similarities to those for the cyclohexane monoterpenes. The departure of the pyrophosphate anion from (**8**) and (**9**) leads to six possible monocyclic cations through such classical cations as (**11**). The stabilisation of such classical carbocations, either through loss of a proton from the adjacent carbon atoms, or attack of hydroxide ion, produces compounds referred to as primary skeletal sesquiterpenes. Compounds of this group as well as those modified by further functionalisation of the skeleton but not in the sequence of the carbon atoms or the configuration of the endocyclic bonds form from the cations of the bisabolene group e.g γ -bisabolene (**14**). The cations and their primary skeletal compounds can give rise to the other classes of sesquiterpenes (the secondary skeletal sesquiterpenes). γ -Bisabolene is considered to be the precursor to a number of sesquiterpene systems, often all present in the same plant (Manitto, 1981).

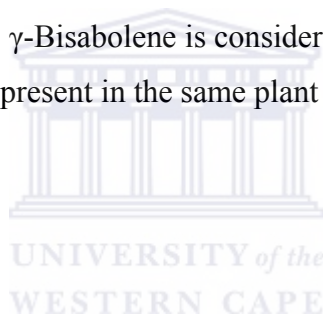

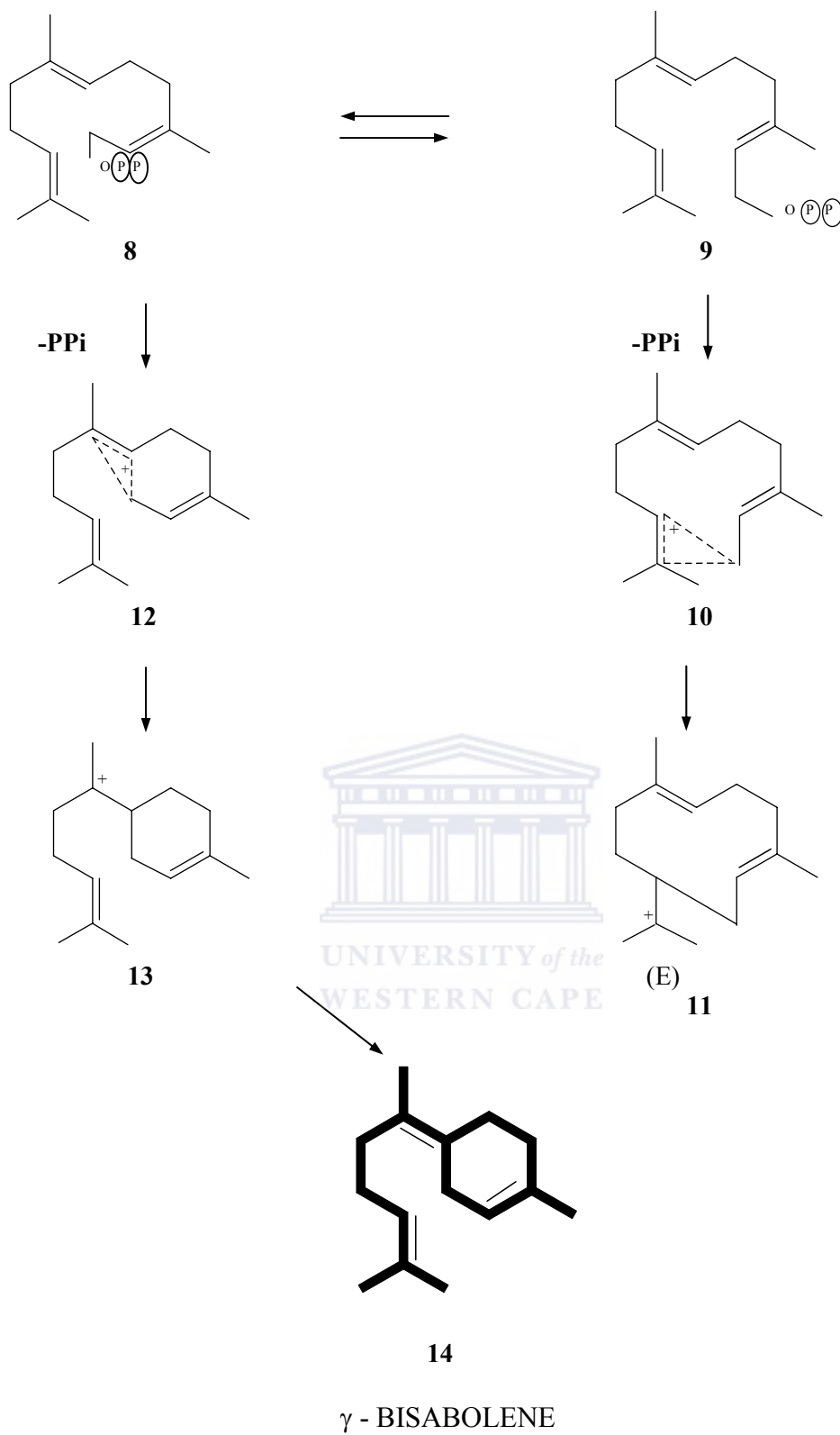

Figure 6 : Biosynthesis of γ - bisabolene

3.1.2.1 Sesquiterpenes of Particular Biological Importance.

There are many sesquiterpenes, which, besides compounds which are toxic to mammals (such as poicrotoxin and its derivatives) or which have antibiotic or phytotoxic power (such as trichothecin), are extremely interesting from a physiological point of view (Manitto, 1981 and Moreau *et al.*, 2002). Phytohormones of plants and the juvenile hormones of insects are the two groups to be exemplified. The hormone regulated growth of the higher plants takes place through the balanced action of stimulating and inhibitory hormones. Such hormones are often terpenoids. The gibberellins stimulate such growth, whilst abscisic acid (ABA) and its derivatives (typical sesquiterpenes) are inhibitors. Recent experimental results show that ABA is biosynthesised from farnesyl pyrophosphate. The physiological role of the insect juvenile hormones, the first such hormone to be isolated, which came from tens of thousands of male *Hyalophora cecrepia* L. butterflies, was neotenin, which is the methyl ester of 10,11-epoxy-7-ethyl-3,11-dimethyl-10,11-cis,2-trans,6-trans-tridecadienoic acid (also known as JH). A second juvenile hormone was also extracted from *H.acropia* and this had a methyl group instead of an ethyl group, at C-7. This discovery, together with the remarkable structural analogies between neotenin and farnesol, leads to the suggestion that JH is derived from FPP through the epoxidation of the terminal double bond, oxidation of the primary alcoholic group followed by addition of a C₁-unit to each methyl group at positions 7 and 11.

UNIVERSITY of the
WESTERN CAPE

3.1.3 Phytosterols

Phytosterols (plant sterols) are triterpenes that are important structural components of plant membranes, and free phytosterols serve to stabilize phospholipid bilayers in plant cell membranes just as cholesterol does in animal cell membranes. Most phytosterols contain 28 or 29 carbons and one or two carbon-carbon double bonds, typically one in the sterol nucleus and sometimes a second in the alkyl side chain (Moreau *et al.*, 2002).

3.1.3.1 Biosynthesis of Steroids

The natural steroids are derived by a series of chemical transformations, from the two parent triterpenes, lanosterol and cycloartenol. The steroid nucleus (**15**) is shown, where R¹, R² and R³ differentiate various steroid families. The earlier steps of biosynthesis are common to all the natural steroids and proceed from acetic acid to lanosterol (or cycloartenol) through

mevalonic acid and squalene. It is generally recognised that all steroids in animals originate from lanosterol, whilst cycloartenol is the precursor of the steroids in plants.

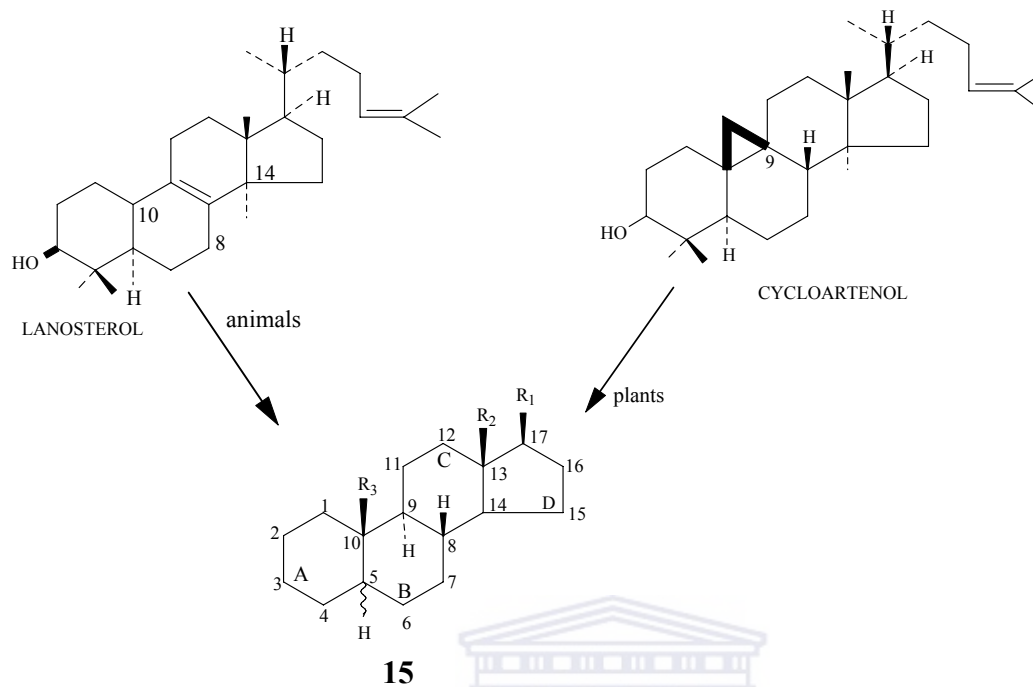

The natural sterols possess the cholestane, ergostane or stigmasterane frameworks. They usually bear a hydroxyl group at position 3 and a double bond at position 5(6). Examples of sterols are illustrated in Fig 7.

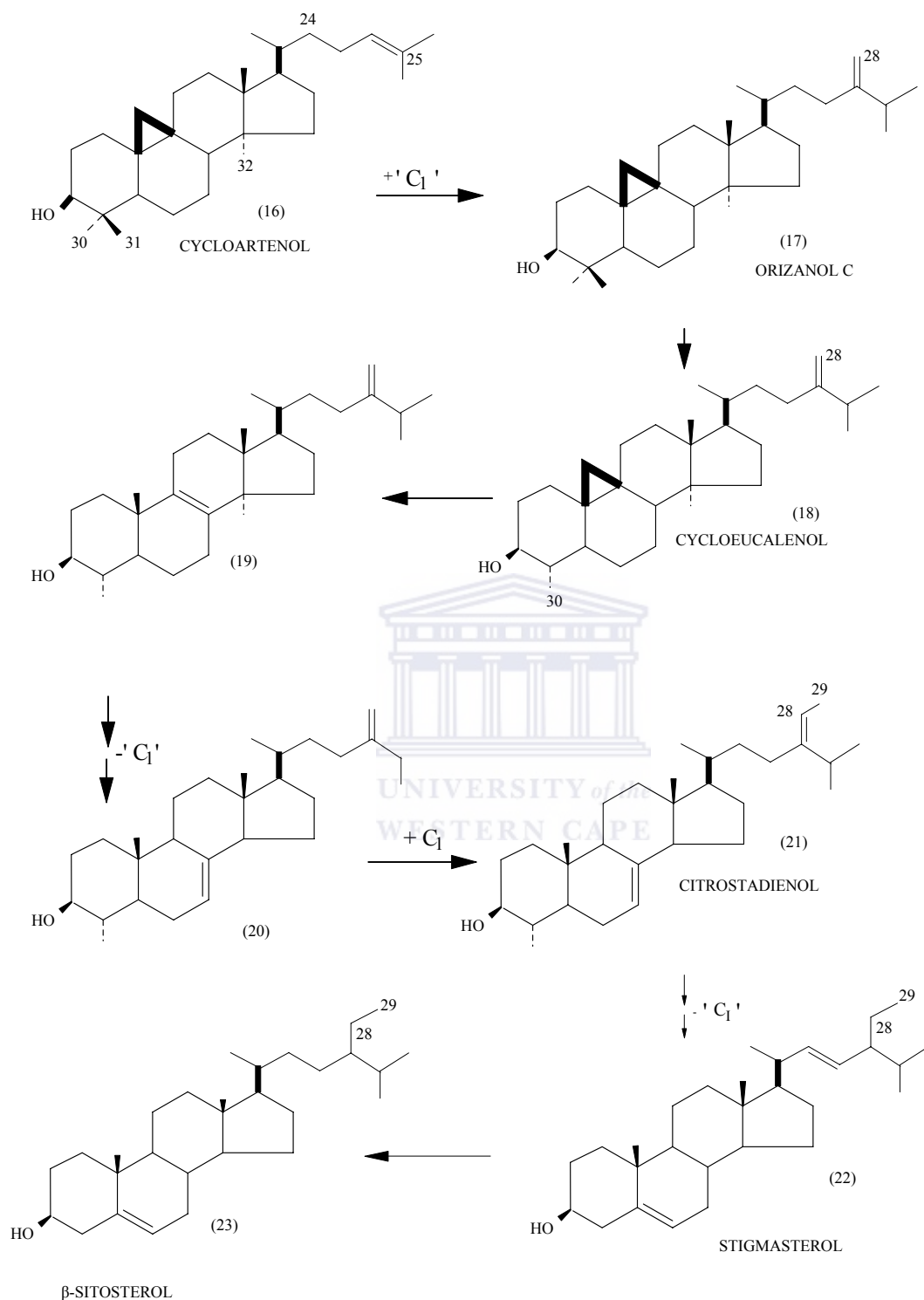
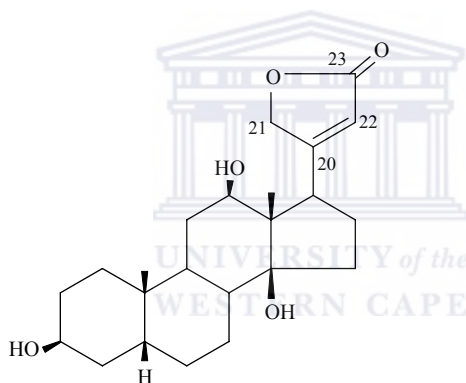

Figure 7 : Biogenetic relationships between some of the phytosterols.

The most common of phytosterols is stigmasterol (22), which is particularly abundant in soya beans and in calabar seeds. The opening of the cyclopropane ring (from cycloartenol)

probably occurs after loss of the 4α - methyl group and before loss of the 14α - methyl group. The 4α - methyl group is eliminated before the 4β - methyl group, in the same order found for the biosynthesis of cholesterol. The phytosterol can also be synthesised in plants through sequences varying in timing from those shown in Fig 7. Thus compounds such as stigmasta-8,14,(Z)-24(28)-trien-3 β - ol, and 31-norcycloartenol have been isolated from various tissues. Phytosterols can undergo a variety of structural transformations in plants, especially those involving the side chains. The resulting products are classified into two families; the *cardiotonic glycosides* and *steroidal saponins*. Cardiotonic glycosides are so called because of their powerful heart stimulating activity. On acidic or enzymatic hydrolysis they afford aglycones, sometimes called genins. These genins possess the usual steroidal nucleus and a characteristic side chain, in a form of a butenolide ring for the *cardenolide aglycones*, such as digoxigenin, a 2-pyrone ring for the *scilladienolide*, or *bufadienolide aglycones*, such as scillarenin.

(a)



DIGOXIGENIN

(b)

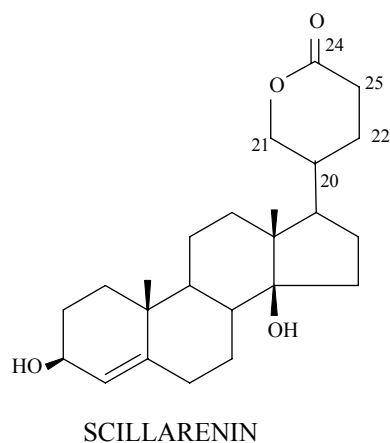

**Figure 8 : Some aglcones of cardiotonic sterols, (a) cardenolide type;
(b) bufadienolide type**

3.1.4 Glycosides

Glycosides are compounds containing a **carbohydrate** and a **noncarbohydrate** residue in the same molecule. The carbohydrate residue is attached by an acetal linkage to a noncarbohydrate residue or **Aglycone**. The non-sugar component is known as an **Aglycone** and the sugar component is called a **Glycone**. If the carbohydrate portion is glucose, for example, the resulting compound is a **GLUCOSIDE**. The aglycone may be methyl alcohol, glycerol, a sterol, a phenol etc. An acetal has two ether functions at a single carbon atom, as demonstrated:

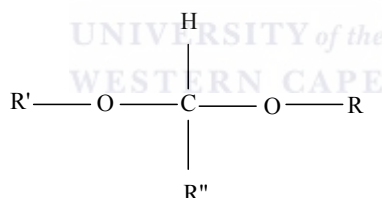

Phenolic and triterpene glycosides found from different plants especially from the stems of *Ilex litseaefolia* distributed widely in the People's Republic of China, are used extensively in folk medicine, for example, rotunda, an antipyretic and antidote rich in glycosides, is used for treatment of the common cold, tonsillitis, stomach and intestinal ulcers (Zhang *et al.*, 2005). *Ilex pubescens*, reported to contain glycosides, is used for treatment of coronary disease, myocardial infarction, dysentery and erysipelas (Zhang *et al.*, 2005). *Ilex cornuta* and *Ilex latifolia* are used for treatment of headache, bloodshot eyes and tinnitus (Glycosides. Online., 2004).

Classification of Glycosides.

The chemical nature of the aglycone group is used as the basis of systematisation, hence the classification takes the forms: tannin, cardioactive group, aldehyde, anthraquinone alcohol, and saponin, cyanophore, isothiocyanate, phenol and flavonol glycosides.

Saponin glycosides

Saponin glycosides are divided into two types based on the chemical structure of their aglycones (sapogenins). Saponins, on hydrolysis yield an aglycone known as “sapogenin.” The so-called **neutral** saponins are derivatives of **steroids** with *spiroketal* side chains. The **acid** saponins possess a triterpenoid structure. The main pathway leading to both types of sapogenins is similar and involves the head – to- tail coupling of acetate units. However, a branch occurs, after the formation of the triterpenoid hydrocarbon, **squalene** that leads to steroids in one direction and to acyclic triterpenoids in the other;

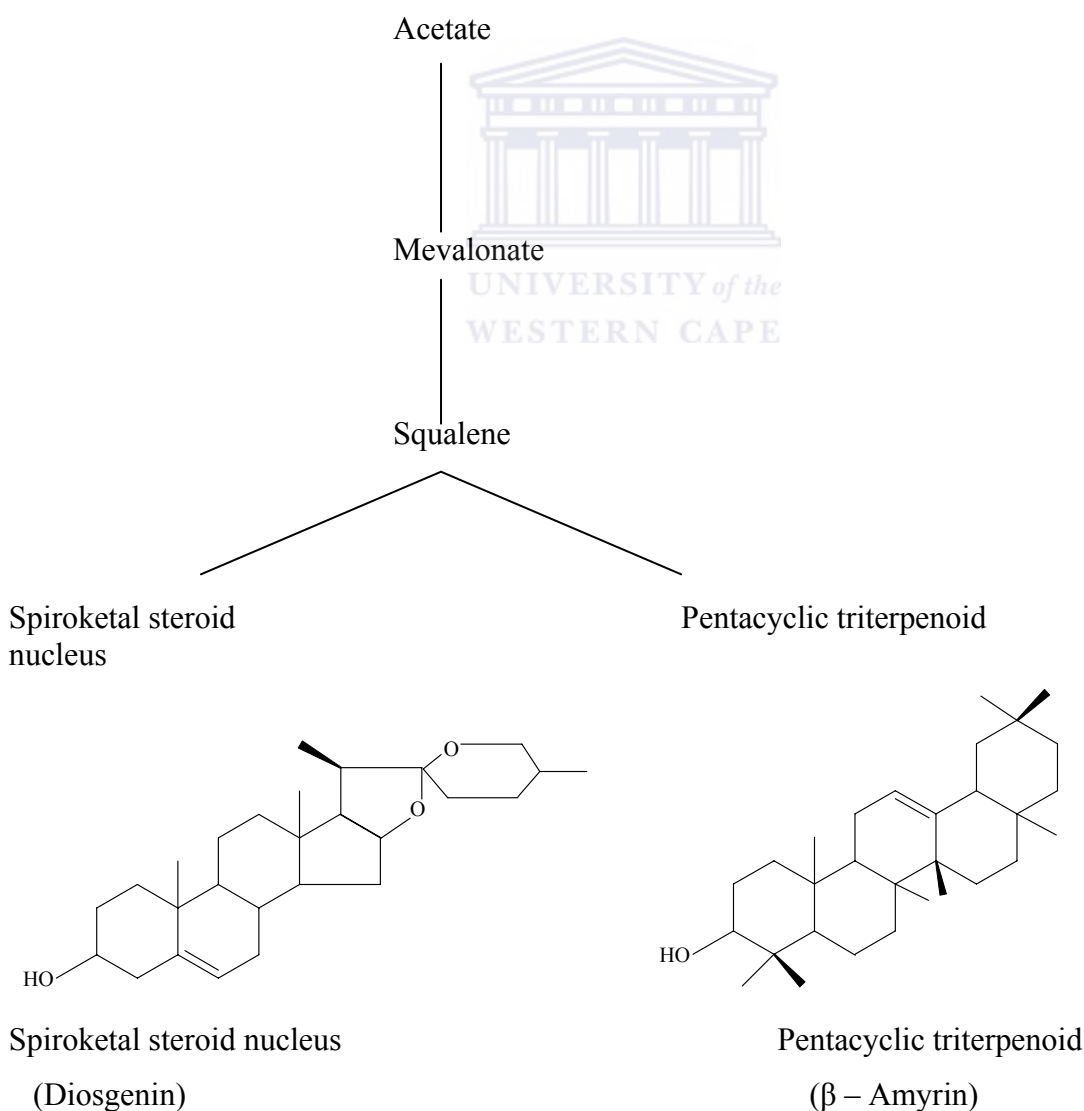

An example of saponin glycoside is Glycyrrhizin, where the glycone is glucuronic acid and the aglycone is glycyrrhetinic acid. Glycyrrhizin is found in glycyrrhiza. Glycyrrhiza is the dried rhizome and roots of *Glycyrrhiza glabra* (licorice).

Glycoside = Glycyrrhizimic acid

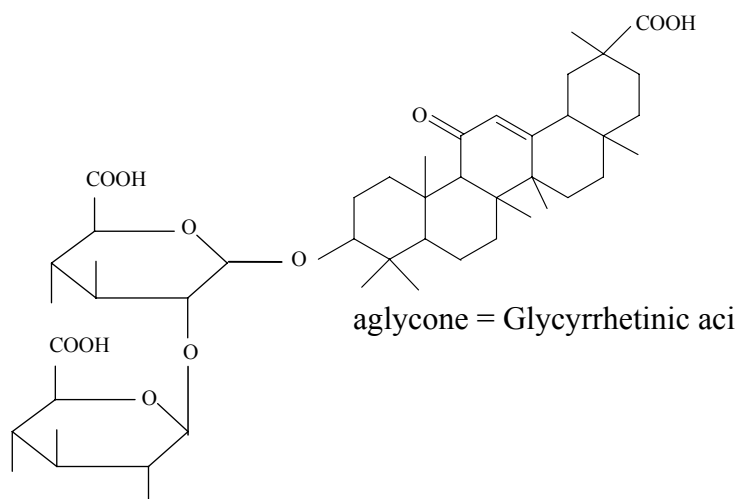

2 molecules of glycone = glucuronic acid

Glycyrrhizimic acid is 50 times sweeter than sugar (sucrose). Upon hydrolysis the glycoside loses its sweet taste and is converted to the aglycone, glycyrrhetinic acid plus two molecules of glucuronic acid. Glycyrrhetinic acid is a pentacyclic triterpenoid derivative of the beta-amyrin type. The acid has expectorant and antitussive properties (Glycosides .Online., 2004). Expectorants are used to decrease the viscosity of tenacious mucus, or to increase the secretion of mucus in dry irritant unproductive cough, thereby lubricating the air passages and making coughing more productive. It is used considerably as a flavouring agent and is frequently employed to mask the taste of bitter drugs such as aloe, quinine etc.

4. Aim of this thesis

Since *Helichrysum* is known by the indigenous people of Africa for therapeutic properties, such as against colds, flu and wounds, the aim of this study is to focus on the *patulum* species found predominantly in the Western Cape region of South Africa and by means of isolation and identification of the plant constituents, be able to relate the therapeutic activity on the basis of literature precedents, to the compounds extracted.

CHAPTER 2



Materials and Methods

2.1 Plant material

Fresh aerial parts of *Helichrysum patulum* were harvested alongside Polkadraai road, close to Vorentoe farm, next to the road: 33°57.3' S; 18°42.7' E, one batch in October 2002, a second one in July 2004 and a third in September 2005. Mr F. Weitz, of the Botany Department at the University of Western Cape verified the identity of the species and a voucher specimen was deposited in the herbarium of the Department of Biodiversity and Conservation Biology, University of the Western Cape, South Africa.

2.2 General experimental methods

The experimental methods employed included; NMR Spectroscopy, FTIR Spectroscopy, Mass Spectrometry, UV-VIS Spectroscopy, VLC, Chromatography, Hot Extraction, Acetylation and Hydro Distillation.

Nuclear Magnetic Resonance Spectroscopy (NMR Spectroscopy)

NMR spectra were recorded in CDCl₃ and CH₃OD on a Varian Gemini 2000 200 MHz and on a 600 MHz spectrometer. The NMR data chemical shifts are expressed in δ (ppm) from tetramethylsilane as an internal standard and coupling constants (*J*) are given in Hz.

Fourier Transform -Infrared Spectroscopy (FT-IR Spectroscopy)

IR spectra were recorded on a Perkin – Elmer paragon 1000 spectrometer that was corrected against an air background. Spectra were recorded using NaCl windows with CHCl₃ as a solvent.

Mass Spectrometry

GC-MS spectra were recorded using a Finnigan Matt GCQ Mass Spectrometer. Analysis of the *Helichrysum* essential oil was performed at the Department of Ecological Chemistry, University of Stellenbosch, South Africa.

Ultra – violet/ Visible Spectroscopy (UV-VIS Spectroscopy)

UV absorption spectra were obtained on a Unicam Helios v2.03 UV-VIS Spectrometer using methanol as a solvent.

Vacuum Liquid Chromatography (VLC)

The technique adapted was that of Pelletier, Chokshi and Desai (1986) :

The column was then developed under gentle vacuum with appropriate solvent mixtures for gradient elution, namely; 10%, 20%, 30%, 40%, 50%, 60%, 70%, 80%, 90% and 100% ethyl acetate in petroleum ether, pulling the column dry between each fraction collected. The fractions were collected in 100ml beakers. After each fraction was collected, an appropriate solvent was added to the top of the column without vacuum until the surface was well covered. The vacuum was gently reapplied.

Chromatography

Silica gel 60 (Merck) 230-400 mesh particle size was used for column chromatography (CC) and silica gel 60 F₂₅₄ plates (Merck) were used for thin layer chromatography (TLC). Detection was carried out by spraying with anisaldehyde:H₂SO₄: acetic acid (0.5:1:50) and vanillin (10% w/v in EtOH), from which 25:1 mixture v/v vanillin solution: concentrated H₂SO₄ was prepared on the day of experiment as it deteriorated relatively fast once the acid was added. The TLC plates, after spraying, were then heated. In both cases H₂SO₄ was added slowly and with stirring. Gravity column chromatography with the gradient elution was employed. The column was run slowly over six days, changing to a different solvent each day. The eluents used from day 2 - 6 were 5:1:0.5 EtOAc : MeOH : pet. ether; 5:1 EtOAc: MeOH; 20: 5, 10: 3 and 10: 4 EtOAc: MeOH respectively. The column fractions were identified by TLC. The consecutive fractions that showed similar profiles were combined and rechromatographed.

2.3 Preparation of extracts

Whole fresh plant material was subjected to Soxhlet extraction, the first batch (827g) with 80% methanol/water and the second batch (13g) with methanol . Both extracts were concentrated to dryness under reduced pressure at 40°C with a rotary evaporator. After determining the yields, extracts were stored at 4°C until further use.

Hot extraction

The crude 80% methanol extract (19g) was heated under reflux successively with 200ml of petroleum ether for 1hr, followed by 150ml of chloroform for 1 hr, 150ml of ethyl acetate for 1 hr, 100ml of butanol for 1 hr and then with 100ml of water for 1 hr , collecting the specific solvent soluble portions in between. The ethyl acetate, chloroform and petroleum ether fractions were combined and chromatographed by column chromatography on silica gel 60 (Merck) onto a 65 x 25 mm glass column.

Acetylation

Acetylation was achieved by dissolution of compound (2 –50mg) in 6ml of 2:1 v/v mixture of dried pyridine and acetic anhydride, followed by stirring at room temperature, until the reaction was complete (TLC). The reaction mixture was worked up by adding it into an excess amount of ice-water mixture, whilst the latter was being stirred. The resulting mixture, after vigorous stirring for 0.5 - 1.0 hr, was extracted with diethyl ether, and the extract was washed five times with water until free of pyridine and acetic acid. Drying of the ethereal layer over anhydrous sodium sulphate, followed by evaporation of solvent, gave the acetylated product.

Hydro distillation

Fresh leaves from the September 2005 harvest were subjected to hydro distillation in a Clavenger apparatus for 3hr. The essential oils were collected in hexane, dried over anhydrous sodium sulphate and stored in the dark in a glass bottle at 0 – 4°C until analysis.



CHAPTER 3



Results and Discussion

UNIVERSITY of the
WESTERN CAPE

3. RESULTS AND DISCUSSION

The fractionation process leading to the isolation of products is summarised in the following flow diagram,



**FRACTIONATION
FLOW DIAGRAM**

Helichrysum patulum

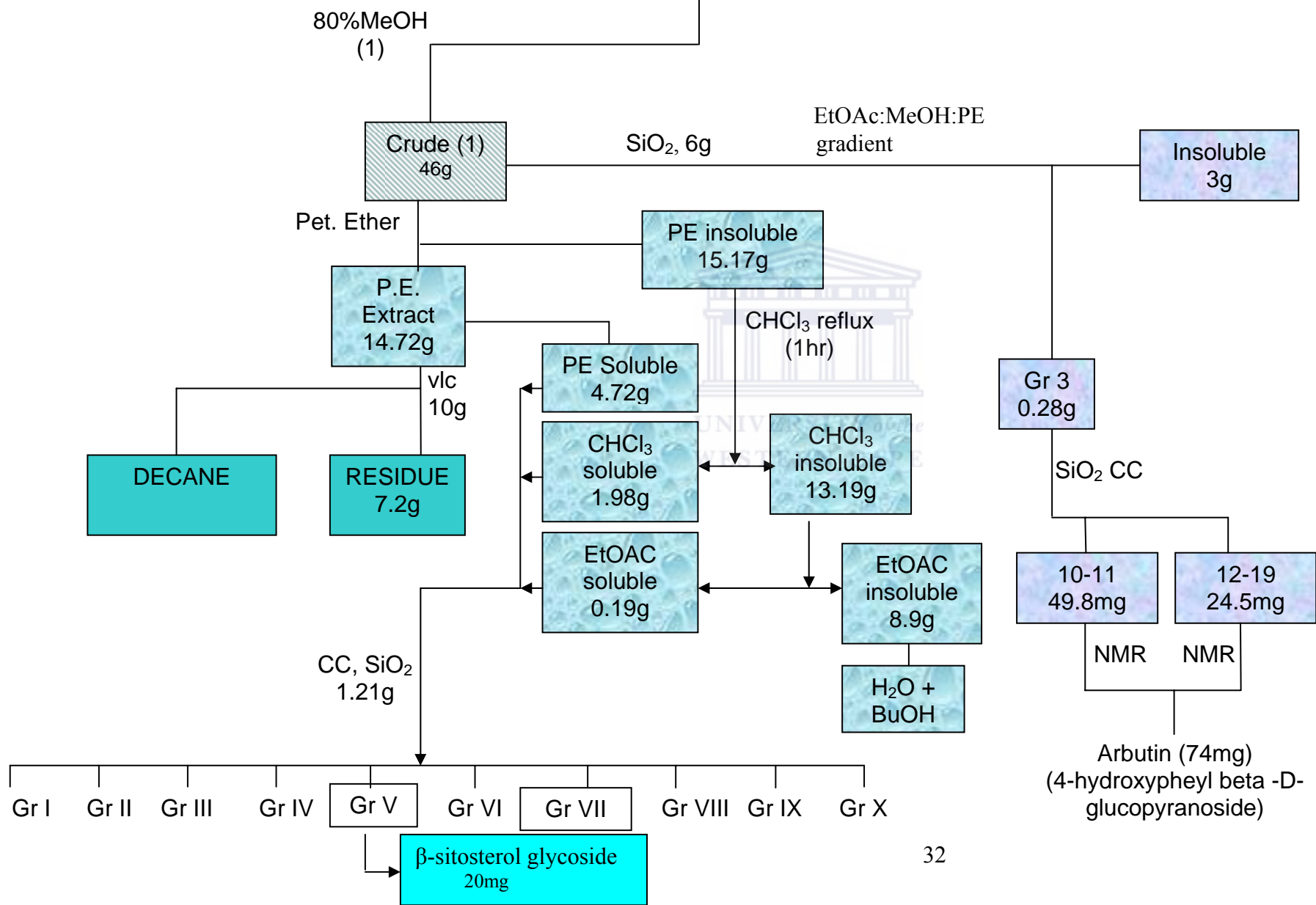

Compound I : (Arbutin ; 4-hydroxyphenyl- β -D-glucopyranoside)

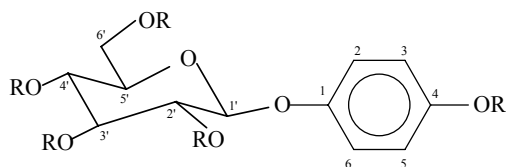

R

1 H

1a Ac

3.1 Structural elucidation of compound 1

Column chromatography using 6g of the crude extract (80 % MeOH) of the October 2002 batch led to the isolation of Compound **1** (74mg) that was identified as a phenyl glycoside by its ^1H NMR, UV and FTIR spectra. It was isolated as a white crystalline material and had a molecular formula of 272,26g/mol. Compound **1** gave UV absorption maxima at $\lambda_{\text{max}}^{\text{MeOH}}$ 190nm, 232nm and 287nm. These absorption maxima are characteristic of a benzene ring attached to oxygen. The IR of compound **1** showed absorptions at 2921 and 1375 cm^{-1} , due to the saturated C-H bond, and at 1513 cm^{-1} , due to the aromatic ring C = C.

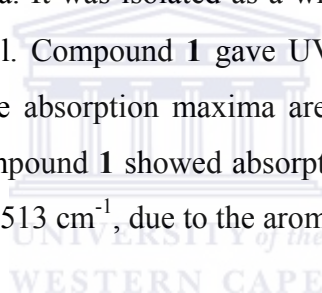

Table 2: ¹H and ¹³C data for compound 1, arbutin.

Pos	δ_{H} , 200 MHz, CD ₃ OD	δ_{C} , 200 MHz, CD ₃ OD
1		152.5
2/6	6.95, d (9.0)	116.7
3/5	6.68, d (9.0)	119.5
4		153.9
1'	4.72, d (7.6)	103.8
2'	3.68, m	71.5
3'	3.68, m	75.1
4'	3.68, m	78.1
5'	3.68, m	78.1
6'	3.68-3.88, d (11.8)	62.7

The ¹H NMR spectrum of compound **1** showed the presence of a para-disubstituted aromatic ring with the appearance of a 2-proton doublet at δ_{H} 6.68 ($J = 9.0$ Hz), attributed to H-3 and H-5 and a 2-proton doublet at δ_{H} 6.95 ($J = 9.0$ Hz), attributed to H-2 and H-6. H-2 and H-6 are close to the slightly electron-deficient environment as a result of the proximity of the sugar ring oxygen to the glycoside bond oxygen and hence are more deshielded than H-3 and H-5, which occupy a slightly electron-rich environment. The sugar moiety resonances were shown by the appearance of a 4-proton multiplet at δ_{H} 3.68 ($J = 11.8$ Hz), attributed to H-2', H-3', H-4' and H-5', a 1-proton doublet at δ_{H} 3.88 ($J = 11.8$ Hz), attributed to H-6', and a 1-proton doublet at δ_{H} 4.72 ($J = 7.6$), attributed to H-1'. H-1' is attached to a carbon that is bonded to two oxygen atoms, thus representing a highly electron-deficient environment and is therefore more deshielded than the rest of the sugar moiety protons. The ¹H and ¹³C NMR spectral assignments are in agreement with those reported in the literature (Hisatomi et al., 2000).

The ¹H NMR spectrum of the acetylated product showed the chemical shift due to the four monosaccharide acetyl groups' hydrogens as singlets at 2.03, 2.05, 2.06 and 2.08 ppm. The chemical shift due to the phenyl acetyl group was shown at 2.29 ppm. It can be observed from these results that acetylation of arbutin resulted in downward shift of the affected proton signals due to the acetyl group being more electron-withdrawing and, therefore, more deshielded. The ¹³C NMR spectrum showed the chemical shift due to the methyl carbon of

the four acetyl groups of the monosaccharide at 20.7 ppm and the chemical shift due to the acetyl group of the phenyl at 21.1 ppm.

To our knowledge this is the first time that arbutin has been isolated from a species of the *Helichrysum* genus.

Arbutin is a hydroquinone derivative, used mostly in cosmetics, as a skin lightener, anti-aging and anti-acne treatment, as well as a food supplement. A lot of research on arbutin cosmetic use had been done by the Japanese (Fujinuma *et al.*, 1986). The whitening effect of arbutin has resulted in it being used for making a milky lotion (Gohar *et al.*, 2000; Gohar *et al.*, 2002; Fujinuma *et al.*, 1986; Kinomura and Sakakibara, 1987; Kuroda *et al.*, 1985; Seno and Uehara, 1988 and Yokoyama, 1991). It is an active ingredient of the crude drug *Uvea Ursi Folium* traditionally used in Japan and is contained in leaves of pear trees and certain herbs (Maeda and Fukuda, 1996). Arbutin is known as an effective inhibitor of the production of melanin. The melanin pigment is produced in animal tissues through reactions catalysed by tyrosinase enzyme. Deregulation of this enzymatic reaction due to disease, age, or environmental factors can lead to hyperpigmentation and various skin conditions including melasma, age spots and vitiligo (Simonot *et al.*, 2002). It reduces spore germination of decay fungi as well as exhibits other biological effects. Its use as an indicator reagent in the assay of yeasts is well known (Jahodar *et al.*, 1999). Arbutin has been found in leaves of the *Ericaceae* family, for example blueberry, cranberry and bearberry intact plant. With other *Ericaceae*, it is biosynthesised from tyrosine (Hisatomi *et al.*, 2000). Isolation of arbutin from intact plants is reported as rather time-consuming and economically inexpedient. The laboratory synthesis thereof is a multistep process. Hence the obvious interest from pharmaceutical chemists in the biotechnological production of arbutin from appropriate simple precursors in plant tissue cultures (Jahodar *et al.*, 1999). Plant cultures of other plants that normally do not produce arbutin in an intact state are capable of glucosylating hydroquinone. Examples of other plant cultures that have been experimented with for the biosynthesis of arbutin include *Datura*, *Catharanthus*, *Rauwolfia*, *Rhodiola rosea* and *Datura meteloides*.

Antioxidative activity of Japanese pepper was evaluated and linked to, among other compounds, arbutin (Hisatomi *et al.*, 2000). Arbutin is an antimicrobial agent in the treatment of urinary tract infections, is also a powerful antitussive agent, possesses antiinflammatory effect and is known as an effective inhibitor in the production of melanin. Arbutin has been reported to have antibacterial activity (Xu, 1989 and Xu, 1987) and therefore can be used clinically to treat infections. Recent studies have extended the understanding of the antimicrobial activity of phenolics and their glucosides, and it was observed that free phenolic

compounds and their glycosides generally exhibit low activities. Thus, Jin and Sato (2003) could through a quantitative bioassay study prove that arbutin is not an active substance but rather a precursor of the active substances, hydroquinone which is further oxidized to benzoquinone, the most active substance (Jin and Sato, 2003). Since *H. patulum* is used extensively by the indigenous people of the Western Cape Province of South Africa it is clear that there is an explanation regarding antimicrobial studies *in vitro* and the effect of *in vivo* metabolism. One explanation may be that, in this species and other plants where it has been isolated, arbutin exists as an inactive substance which through a metabolic process involving the enzyme, β -glucosidase, is converted to the active substance benzoquinone and hence the antibacterial activities described by Xu and Si (1987).

3.2 Compound 2 : Decane

Compound 2, from the October 2002 harvest, was isolated using VLC and was identified as decane by GC-MS. It was isolated as a green oily material. Decane is an aliphatic hydrocarbon of primary metabolism, found in most plants and is known to contribute to the structural rigidity of all plants (Grison-Pige et al., 2002; Jiang and Kubota, 2002; Ozel and Kaymaz, 2004).

3.3 Compound 3: β -sitosterol glucoside and its tetraacetate

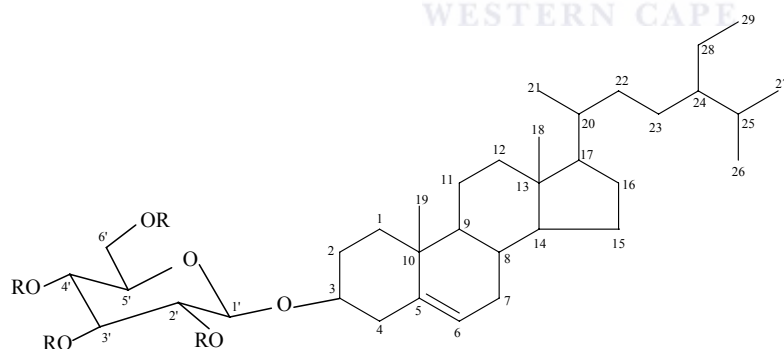

R

3a H

3b Ac

3.3.1 Structural elucidation of compound 3.

Compound 3a was isolated by CC of the CHCl_3 / EtOAc / petrol ether extract mixture and its purification was achieved by conversion into its acetylated form, 3b. The ^1H and ^{13}C NMR confirmed the structure.

This compound gave problems with solubility upon evaporation of the solvent in that it would not dissolve in any other solvent, a phenomenon typical of compounds containing hydroxyl groups and therefore was acetylated with the expectation that it would dissolve in ethyl acetate thereafter, and that indeed happened. Acetylation of compound **3** was carried out in the same manner as that of compound **1**.

Table 3: ¹H and ¹³C data for compound 3b, β-sitosterol glycoside.

Pos.	δ _H , 200 MHz, CDCl ₃	δ _C , 200 MHz, CDCl ₃
1		37.2
2		29.4
3	3.49, m	
4		38.9
5		140.5
6	5.35, m	122.0
7		32.0
8		32.0
9		50.1
10		36.3
11		21.1
12		39.7
13		42.5
14		56.9
15		24.2
16		28.1
17		56.9
18	0.67, s	12.1
19	0.98, s	
20		36.3
21	0.91, d (6.5)	18.8
22		33.9
23		26.0
24		

25		29.8
26	0.81, d (6.6)	19.2
27		
28		22.7
29	0.82, t (6.4)	
1'	4.59, d (8.0)	99.8
2'	5.10, m	
3'	5.10, m	
4'	5.10, m	68.5
5'	3.68, m	
6'	4.10, dd (12.44; 2.6)	61.9
CO		169.5; 170; 170.5
AcO	2.00; 2.02; 2.05; 2.08	19.9 – 20.1

Comparisons of ^1H and ^{13}C NMR spectra of the isolated glucoside to the spectra of *longiside A* (Ali *et al.*, 2002) facilitated the identification of the structure. The isobutyl ester side chain of *longiside A* was not detected in the ^{13}C NMR spectrum of the isolated compound. The isolated compound differs in another clear aspect which is that there are four acetate signals at 2.00, 2.02, 2.05 and 2.08 ppm instead of three and thus leads to the conclusion that the OH groups on the sugar moiety at C-2, C-3, C-4 and C-6 are acetylated. Four C = O signals in the ^{13}C NMR spectrum at 169.5 (x 2), 170.4 and 170.5 confirms the presence of four acetyl groups. The ^1H NMR spectrum displayed H-6 at δ 5.35 as a multiplet. The same spectrum showed signals for H-3 at δ 3.49(m), H-18 at δ 0.67 (s), H-19 at δ 0.98(s), C-21 at δ 0.91(d, J = 6.5 Hz), C-26 & 27 at δ 0.81 (d, J = 6.6 Hz) and C-29 at δ 0.82 (t, J = 6.4 Hz). The presence of a sugar moiety in the molecule was evident from the appearance of an anomeric proton signal at δ 4.59 (8.0 Hz), other sugar protons appeared around δ 5.10, methylene – 6' protons at δ 4.18 (d) and an anomeric carbon at δ 99.6 (^{13}C NMR data).

This compound has been reported from the genus *Mentha*, family *Lamiaceae* found mostly in temperate regions of Eurasia, Australia and South Africa (Ali *et al.*, 2002). This glucoside has in most cases been reported to have been isolated together with sitosterol (Gohar *et al.*, 2002 and Gohar *et al.*, 2000). In this study sitosterol was not detected as a constituent, either because it was absent or it was present in very low concentrations. It is not yet clear whether the antimicrobial activities described for β -sitosterol are similar to those of its glucoside,

isolated in this study, or if there are synergistic effects between the two compounds. β -sitosterol from the genus *Senecio* (*Asteracea*) has been reported to have antifungal and antibacterial activities (Kiprono *et al.*, 2002). From the genus *Mentha* where the glucoside is also found, the members of the genus are used as herbal teas and condiments in both fresh and dried form due to their distinct aroma.

3.4 Compound 4 : Viridiflorol

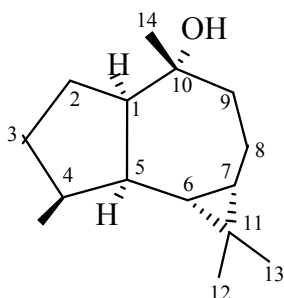

Column chromatography of the methanol extract from the July 2004 batch afforded compound 4, identified as viridiflorol, an aromadendrane type sesquiterpene alcohol. Viridiflorol was isolated as a colourless oil. COSY, HMQC and HMBC confirmed the structure.

3.4.1 Structural elucidation of compound 4

Table 4: ^1H , ^{13}C and COSY data for compound 4, viridiflorol.

Pos.	δ_{H} , 200 MHz, CDCl_3	δ_{C} , 200 MHz, CDCl_3
1	0.80, m	58.6
2	1.85, m	29.5
3	1.85, m	30.1
4	2.00, m	38.9
5	1.85, m	40.1
6	0.13, t (9.2)	22.7
7	0.62, m	29.0
8	1.85, m	19.2
9	1.85, m	38.2

10		75.0
11		18.8
12	1.02, s	16.5
13		16.7
14	1.17, s	29.1
15	0.94, d (6.6)	32.5

Assignments were based on a comparison with *ledol* (Kaplan, 2000).

Volatile constituents have been studied extensively from other species particularly monoterpenes, and it has been reported that the monoterpene composition is dependant upon the plant's genotype and can be used for taxonomical purposes even in spite of environmental variabilities (Cane, 1990; Harborne, 1977; Poulouse, 1978). Very little is known about the chemistry of volatile metabolites of *Helichrysum* species; even though significant ecological and pharmacological properties have been attributed to the essential oils of *Helichrysum* (Kavatas, 1965; Meyer *et al.*, 1997; Tomas-Barberan, 1990), few reports have been published on volatile chemistry of the genus. In some cases mostly from other genera the oils are dominated by sesquiterpenes and linear chain aliphatic hydrocarbons. Viridiflorol has been isolated from different plant species such as *Hypericum perforatum* L., niaouli and the liverworts. Viridiflorol was isolated from the *Helichrysum* genus as a constituent of the essential oil of *Helichrysum cymosum* (Van Vuuren *et al.*, 2006) as well as a constituent of two species from the *Helichrysum* genus, *H. kraussii* and *H. rugosolum* (Bougatsos *et al.*, 2003). Its identification and that of its isomers ledol and globulol was rather difficult since their spectral data are very similar, as a result their NMR assignments were reported as quite confusing and contradictory (Bombarda *et al.*, 2001). Following the contradictory results on ledol and viridiflorol, Bombarda, Raharivelomanana, Ramanoelina, Faure, Bianchini and Gaydou (2001) decided to reinvestigate the structure determination of the main sesquiterpene alcohol contained in *niaouli* essential oil, in that they synthesised sesquiterpenols with an aromadendrene skeleton and have characterized aldehydic and epoxydic intermediates. In this way they were able to establish unambiguously the chemical composition of *niaouli* essential oil rich in viridiflorol. Terpenes in general have been implicated in antimicrobial activity, as can be gathered from the chapter covering the terpenoids in the review of this paper and since viridiflorol belongs to a class of sesquiterpenes, viridiflorol can thus be linked to the antimicrobial activity of the plant.

3.5 Isolation of essential oils of *Helichrysum patulum*

The September 2005 batch of *Helichrysum patulum* was subjected to hydro distillation using the Clavenger apparatus and an essential oil was isolated in hexane. The essential oil was analysed by GC-MS. Listed in the **table 5** is the essential oil components of *Helichrysum patulum* and their characteristics :

Compound	t _R (min)	MW	MS diagnostic peaks
α-pinene	10.6	136	121 , 105 , 94 , 93
β-pinene	12.2	136	121 , 107 , 94 , 93
β-myrcene	12.8	136	121, 107, 94, 93, 91
(+)-Limonene	14.3	154	136, 121, 111, 107, 93
Trans ocimene	14.7	136	121, 105, 93
α-terpineol	20.7	154	136, 121, 115, 59
β-caryophyllene	29.5	204	189, 162, 161, 134, 93
*1,5 bis – hexan-2-one	30.9	236	221, 205, 193, 180
γ-gurjunene	31.3	204	189, 175, 161, 147
Eremophilene	31.7	204	189, 175, 161, 147
**1--indene	32.2	222	207, 189, 179, 164
β-cadinene	32.9	204	189, 162, 161, 145
Patchouli alcohol	34.2	222	207, 179, 162, 161
Palustrol	34.5	222	204, 189, 179, 161
(-)-alloaromandrene	35.2	204	189, 175, 161
α-muurolol	36.4	204	189, 164, 161 , 121
β- eudesmene	37.1	204	189, 175, 161, 107
***Octahydro..MeOH naph	37.6	222	207, 179, 162, 98
Tetradecanoic acid	40.3	228	219, 199, 191, 129
Hexadecanoic acid	46.0	256	227, 213, 199, 73
17-chloro-7-heptadecene	50.6	272	135, 123, 111, 69
Stearic acid	51.2	284	241, 208, 57, 55, 43

* 1,5-bis(1,1-dimethylethyl)-3,3-dimethyl- bicyclo 3.1.0 hexan-2-one

** 1-ethylidene octahydro-7A-methyl-(1E,3A,α,7A.β)-1H-indene

*** Octahydro-4,8A,9,9-Tetramethyl,1R-(1A)-1,6-Methanonaphthalen-1(2H)-ol

Table 5 : GC-MS analysis of the essential oil of *Helichrysum patulum*

3.5.1 Discussion

Four of the constituents of the essential oil of *Helichrysum patulum*, namely β -pinene, α -pinene, (-)-alloaromadendrene and hexadecanoic acid displayed prominent peaks on the GC-MS spectra. Comparison of these results of the essential oil obtained from the GC-MS to those obtained from the essential oil of other *Helichrysum* species, e.g. *H. bracteiferum*, *H. italicum*, *H. amorginum* shows to have yielded common compounds, namely; β -caryophyllene, α -pinene, α -terpineol, γ -terpinene, β -pinene, limonene, allo-aromadendrene, α -muurolol (Bianchini *et al.*, 2001; Chimou *et al.*, 1996; Gundidza and Zwaring, 1993; Jakupovic *et al.*, 1989; Lourens *et al.*, 2004; Puerta *et al.*, 1993; Ramanoelina *et al.*, 1992). Hexadecanoic acid has been quoted as a source of new therapeutic activity against psoriasis (Roussis *et al.*, 2000).

Stearic acid has been reported from *Helichrysum* seed oil (Powell *et al.*, 1965; Ulchenko, 2000).

It is very interesting that viridiflorol, a well-known regular abundant constituent of essential oils was isolated as an abundant constituent of the July 2004 batch of *Helichrysum* but was surprisingly undetected from the September 2005 batch which was specifically analysed for essential oils. This phenomenon could possibly be attributed to seasonal differences or to the fact that 2004 was relatively dry while 2005 had fairly good rains.

3.5.2 General discussion on essential oils

Essential oils as volatile oils with aroma and flavor are used in a variety of products such as incense, aromatherapy oils, perfumes, cosmetics, pharmaceuticals, beverages and foods. The market for these oils demands high quality and reliable supplies at competitive prices (Haworth, 2002). Antimicrobial, antioxidant, anti-inflammatory, antispasmodic and relaxing properties of essential oils have been described both in animals and humans (Tognolini *et al.*, 2006). Lavender oil has recently proven interesting *in vitro* antiplatelet properties and a remarkable *in vivo* ability to reduce thromboembolic events with no effect on bleeding time in mice (Tognolini *et al.*, 2006). It was proven that the best overall results in inhibiting platelet aggregation were characterized by the abundance of phenylpropanoids and phenols, thus suggesting the existence of a relationship between these chemical components of essential oils and the antiplatelet activity. Traditional Chinese medicine identified *Angelica sinensis*, *Asarum forbesii* and *Rhodiola crenulata* species as remedies to prevent blood stasis and

thrombus formation and recognized isoeugenol, ferulic acid, elemicin, myristicin, ethyl gallate, dihydroacetophenone and virolongin as effective antiplatelet compounds (Tognolini *et al.*, 2006). Essential oils demonstrate potential applications in foods due to their antibacterial properties (Burt, 2004). This has come about during modern improvements in slaughter hygiene and food production techniques since food safety is an increasingly important public health issue. It has been estimated that about 30% of people in industrialised countries suffer from a food borne disease each year and in 2000 at least two million people died from diarrhoeal disease worldwide (Burt, 2004). There is therefore still a need for new methods of reducing or eliminating food borne pathogens, possibly in combination with existing methods. The World Health Organisation has, about two years ago, called for a worldwide reduction in the consumption of salt (WHO, 2002). If the level of salt in processed foods is reduced , it is possible that other additives will be needed to maintain the safety of foods. There is therefore a scope for new methods of making food safe with natural compounds and one such possibility is the use of essential oils as antibacterial additives (Burt, 2004). *In vitro* studies have demonstrated antibacterial activity of essential oils against *Listeria monocytogenes*, *Salmonella tryphimurium*, *Escherichia coli* 0157 : H7, *Shigella dysenteria*, *Bacillus cereus*, and *Staphylococcus aureus* at levels between 0.2 and 10 µl / ml (Burt, 2004). Growing uses of essential oils have extended to them being used in pesticides (Hink and Duffey, 2006). Use of synthetic pesticides or insecticides has become undesirable in many instances. Synthetic insecticides can be toxic not only to the pest but also to animals or humans to be protected from the pest. Furthermore, the Federal Insecticide, Fungicide and Rodenticide Act has made registration and use of synthetic insecticides somewhat difficult (Hink and Duffey, 2006). Compliance with regulations requires among other things, Environmental Protection Agency approval. Use of naturally occurring organic insecticides is desirable in many other respects. Many of these insecticides have proven to be safe to humans and the animals whom they are to benefit (Hink and Duffey, 2006). Essential oils comprised of α -terpineol, amyl cinnamic aldehyde, amyl salicylate, anisic aldehyde, benzyl acetate, cinnamaldehyde, carvacrol, carveol and citral have been reported to display synergistic and residual pesticidal inhibition with pyrethrum (Bessette and Beigler, 2006). As is well known, ticks and fleas are more difficult to control than other insects and so the ability of organic insecticides to satisfactory control ticks and fleas is extremely limited. Linalool, a naturally occurring acyclic terpene alcohol is a candidate as the essential pesticide for ticks and fleas (Hink and Duffey, 2006). A few terpenes have been found to have some insecticidal activity. Those terpenes such as borneol and α -terpineol were found to have toxicity for cockchafer mealworm larvae. Terpeneol, cyclic terpene alcohols ,their acetates, chacetate and bornyl acetate were discussed as

exhibiting toxicity for the pine bugs (Hink and Duffey, 2006). From the foregoing discussion on essential oils *Helichrysum patulum* shows potential in being used as an insecticide, since it contains terpenes and since these compounds have been found to have insecticidal activity. It is, however, notable that the compounds detected in the essential oils from the plants studied for antiplatelet activity (Tognolini et al., 2006), included a lot of compounds that have been detected from the essential oil of *Helichrysum patulum* and hence suggests *H. patulum* to be a possible candidate for antiplatelet activity. The compounds referred to include α -pinene, β -pinene, myrcene, limonene, trans-ocimene and α -terpineol.

4. **Conclusion**

Isolation of chemical compounds of secondary metabolism from *Helichrysum patulum* was done successfully. The compounds isolated included glucosides e.g. arbutin and sitosterol glycoside, monoterpenes e.g. pinene, terpineol and limonene, sesquiterpenes e.g. viridiflorol, β -caryophyllene, (-)-alloaromadendrene, γ -gurjunene and long chain carboxylic acids e.g. hexadecanoic acid and tetradecanoic acid. With the abundance of terpenoids it may be expected of *Helichrysum patulum* to have antimicrobial activity. Antioxidant activity is to be expected due to the presence of the phenolic constituent, arbutin. Jin and Sato (2003) provide evidence for arbutin acting as a source of quinone, an antimicrobial compound. When conducting biological tests for secondary metabolites extracted from plants such as *Helichrysum* it is always necessary to take into account the synergistic inhibition effects that these metabolites might have on microorganisms against which they are tested.

References

1. Afolayan AJ and Meyer JJM. Antibacterial activity of *Helichrysum aureonitens* (Asteraceae). *Journal of Ethnopharmacology* 1995; **47**: 109-111.
2. Afolayan AJ and Meyer JJM. The antimicrobial activity of 3,5,7-trihydroflavone isolated from the shoots of *Helichrysum aureonitens*. *Journal of Ethnopharmacology* 1997; **57**: 177-181.
3. Ali MS, Saleem M, Ahmad W, Parvez M, Yamdagni R. A chlorinated monoterpene ketone , acylated B-sitosterol glycosides and a flavanone glycoside from *Mentha longifolia* (Lamiaceae). *Phytochemistry* 2002; **59**: 889-895.
4. Bessette SM, Beigler MA. Synergistic and residual pesticidal compositions containing plant essential oils. [EP 1 634 500 A3]. 2006.
5. Bianchini A, Pierre T, Costa J, Bernardini AF. Composition of *Helichrysum italicum* (Roth)G.Don fil.subsp.italicum essential oils from Corsica (France). *Flavour and Fragrance Journal* 2001; **16**: 30-34.
6. Bohlmann F, Knauf W, Misra LN. Structure and synthesis of chlorophenol derivatives from *Helichrysum* species. *Tetrahedron* 1984; **40**: 4987-4989.
7. Bohlmann F, Misra LN. New Prenylflavanones and chalcones from *Helichrysum rugosolum*. *Planta Medica* 1984; 271-272.
8. Bombarda I, Raharivelomanana P, Ramanoelina PAR, Faure M, Bianchini JP, Gaydou EM. Spectrometric identifications of sesquiterpene alcohols from niaouli (*Melaleuca quinquenervia*) essential oil. *Analytica Chimica Acta* 2001; **447**: 113-123.

9. Bougatsos C, Meyer JJM, Magiatis P, Vagias C, Chinou IB. Composition and antimicrobial activity of the essential oils of *Helichrysum kraussii* Sch.Bip. and *H.rugulosum* Less. from South Africa. *Flavour and Fragrance Journal* 2003; **18**: 48-51.
10. Burt S. Essential oils : their antibacterial properties and potential applications in foods-a review. *International Journal of Food Microbiology* 2004; **94**: 223-253.
11. Cane ED. Enzymatic formation of sesquiterpenes. *Chemical Reviews* 1990; **90**: 1089-1103.
12. Chinou IB, Roussis V, Perdetzoglou D, Loukis A. Chemical and biological studies on two *Helichrysum* species of Greek origin. *Planta Medica* 1996; **62**: 377-379.
13. Ciba Foundation. Introduction. Bioactive compounds from plants. England: Wiley Interscience 1990: 1-15.
14. Cosar G, Cubukcu B. Antibacterial activity of *Helichrysum* species growing in Turkey. *Fitoterapia* 1990; **101**: 161-164.
15. Czinner E, Hagymasi K, Blazovics AK, Kery A, Szoke E, Lemberkovics E. In vitro antioxidant properties of *Helichrysum arenarium* (L.) Moench. *Journal of Ethnopharmacology* 2000; **73**: 437-443.
16. de Quesada TG, Rodriguez B, Valverde S. The constituents of *Helichrysum stoechas*. *Phytochemistry* 1972; **11**: 446-449.
17. De Smet PAGM. Traditional pharmacology and medicine. *Journal of Ethnopharmacology* 1998; **63**: 1-179.

18. Dekker TG, Fourie TG, Snyckers FO, Van der Schyf. Studies of South African medicinal plants. Part 2. Caespitin, a new phloroglucinol derivative with antimicrobial properties from *Helichrysum caespitium*. *South African Journal of Chemistry*. 1983; **36** : 114-116.
19. Eloff JN. It is possible to use herbarium specimens to screen for antibacterial components in some plants. *Journal of Ethnopharmacology* 1999; **67**: 355-360.
20. Fujinuma Y, Toyoda H, Tamaoki S. Skin preparations containing placental extracts and hydroquinone glycosides. [Japanese Patent]. 1986.
21. Gohar AA, El-Olemy M, Abdel-Sattar E, El-Said M, Niwa M. Cardenolides and α -sitosterol glucoside from *Pergularia tomentosa*. *Natural Product Science* 2000; **6**: 142-146.
22. (2004). Glycosides: [Online]. Available www.friedli.com/herbs/phytochem/glycosides.html
23. Gohar AA, Maatooq GT, Niwa M, Yoshiaki T. A New Triterpene Saponin from *Chenopodium ficifolium*. *Natural Product Science* 2002; **57c**: 597-602.
24. Goun EA, Petrichenko VM, Solodnikov SU, Suhinina TV, Kline MA, Cunningham G, Nguyen C, Miles H. Antithrombin and anticancer activity of some Russian plants. *Journal of Ethnopharmacology* 2002; **81**: 337-342.
25. Grierson DS, Afolayan AJ. An ethnobotanical study of plants used for the treatment of wounds in the Eastern Cape, South Africa. *Journal of Ethnopharmacology* 1999; **67**: 327-332.

26. Grierson DS, Afolayan AJ. Antibacterial activity of some indigenous plants used for the treatment of wounds in the Eastern Cape, South Africa. *Journal of Ethnopharmacology* 1999 ; **66** : 103-106.
27. Grison-Pige L, Hossaert-McKey M, Greeff J, Bessiere JM. Fig volatile compounds-a first comparative study. *Phytochemistry* 2002; **61**: 61-71.
28. Gundidza M, Zwaring, J.H. The chemical composition of the essential leaf oil of *Helichrysum oforatissimum* sweet from Zimbabwe. *Journal of Essential Oil Research* 1993; **5**: 341-343.
29. Harborne JB. Chemosystematics and coevolution. *Pure Applied Chemistry* 1977; **49**: 1403-1421.
30. Harworth JE. Method for removing oils and antioxidants from extract products of lamiaceae species using rolled film evaporation. [United States Patent 6 450 935]. 2002.
31. Hink WF, Duffey TE. Controlling ticks and fleas with linalool. [United States Patent 1 634 500 A3]. 2006.
32. Hisatomi E, Matsui M, Kobayashi A, Kubota K. Antioxidative Activity in the Pericarp and Seed of Japanese Pepper (*Xanthoxylum piperitum* DC). *Journal of Agricultural and Food Chemistry* 2000; **48**: 4924-4928.
33. Hutchings A, Van Staden J. Plants used for stress-related ailments in traditional Zulu, Xhosa and Sotho medicine. Part 1. Plants used for headaches. *Journal of Ethnopharmacology* 1994 ; **43** : 89-124.
34. Ivancheva S, Stantcheva B. Ethnobotanical inventory of medicinal plants in Bulgaria. *Journal of Ethnopharmacology* 2000; **69**: 165-167.

35. Jahodar L, Duskova J, Polasek M, Papugova P. Different kinetics of hydroquinone depletion in various medicinal plant tissue cultures producing arbutin. *Pharmazie* 1999; **54**: 234-235.
36. Jakupovic J, Kuhnke J, Schuster A, Metwally MA, Bohlmann F. Phloroglucinol derivatives and other constituents from South African *Helichrysum* species. *Phytochemistry* 1986; **25**: 1133-1142.
37. Jakupovic J, Schuster A, Bohlmann F, Ganzer U, King RM, Robinson H. Diterpenes and other constituents from Australian *Helichrysum* and related species. *Phytochemistry* 1989; **28**: 543-551.
38. Jakupovic J, Teetz T, Bohlmann F. An anomalous sesquiterpene from *Helichrysum davyi*. *Phytochemistry* 1987; **26**: 1841-1842.
39. Jakupovic J, Zdero C, Grenz M *et al.* Enty-one acylphloroglucinol derivatives and further constituents from South African *Helichrysum* species. *Phytochemistry* 1989; **28**: 1119-1131.
40. Jiang L, Kubota K. Differences in the volatile components and their odor characteristics of green and ripe fruits and dried pericarp of Japanese Pepper (*Xanthoxylum piperitum* DC). *Journal of Agricultural and Food Chemistry* 2004; **52**: 4197-4203.
41. Jin S, Sato N. Benzoquinone, the substance essential for antibacterial activity in aqueous extracts from succulent young shoots of the pear *Pyrus* spp. *Phytochemistry* 2003; **62**: 101-107.
42. Kagan BM. Introduction . Antimicrobial Therapy. California: 1974: 2-17.

43. Kaplan MAC, Pugialli HRL, Lopez D, Gottlieb HE. The stereochemistry of ledol from *Renalmia chrysotrycha* : an NMR study. *Phytochemistry* 2000; **55**: 749-753.
44. Kavatas D. *Botanical Plant Dictionary* 1965; **5**: 1422-1426.
45. Kinomura K, Sakakibara T. A process for preparing tetraacetylarbutin. [Japanese Patent].1987.
46. Kiprono PC, Kaberia F, Keriko JM, Karanja JN. The *in vitro* Anti-Fungal and Anti-Bacterial Activities of β -Sitosterol from *Senecio lyratus* (Asteraceae). 2000.
47. Krivenko VV, Potebnia GP, Loiko VV. Experience in treating digestive organ diseases with medicinal plants. *Vracebnoe Delo* 1989; **3**: 76-78.
48. Kuroda H, Suzuki M, Kato S. Cosmetics containing arbutin for he prevention of skin darkening. [Japanese Patent].1985.
49. Litvinenko VI, Popova TP, Popova NV, Bubenchikova VN. Medicinal plants and preparations derived from them. *Pharmazie* 1992; **3**: 83-84.
50. Lourens AC, Reddy D, Baser KH, Viljoen AM, Van Vuuren SF. *In vitro* biological activity and essential oil composition of four indigenous South African *Helichrysum* species. *Journal of Ethnopharmacology* 2004; **95**: 253-258.
51. Maeda M, Fukuda M. Arbutin : Mechanism of its depigmentation action in human melanocyte culture. *Pharmacology and Experimental Therapeutics* 76[2], 765-769. 1996.
52. Manitto P. The Isoprenoids. Biosynthesis of natural products. England: Ellis Horwood 1981: 213-326.

53. Mathekga ADM, Meyer JJM, Horn MM, Drewes SE. An acylated phloroglucinol with antimicrobial properties from *Helichrysum caespititium*. *Phytochemistry* 2000; **53**: 93-96.
54. Meyer JJM, Afolayan AJ, Taylor MB, Erasmus D. Antiviral activity of galangin isolated from the aerial parts of *Helichrysum aureonitens*. *Journal of Ethnopharmacology* 1997; **56**: 165-169.
55. Meyer JJM, Dilika F. Antibacterial activity of *Helichrysum pedunculatum* used in circumcision rites. *Journal of Ethnopharmacology* 1996; **53**: 51-54.
56. Moreau RA, Whitaker BD, Hicks KB. Phytosterols, phytostanols, and their conjugates in foods : structural diversity , quantitative analysis , and health-promoting uses. *Progress in Lipid Research* 2002; **41**: 457-500.
57. Ozel MZ, Kaymaz H. Superheated water extraction, steam distillation and Soxhlet extraction of essential oils of *Origanum onites*. *Journal of Analytical and Bioanalytical Chemistry* 2004; **379**: 1127-1133.
58. Pelletier SW, Chokshi HP, and, Desai HK. Separation of diterpenoid alkaloid mixtures using vacuum liquid chromatography. *Journal of Natural Products* 1986; **49**: 892-900.
59. Poulouse AJ. Biosynthesis of aromatic monoterpenes. *Arch.Biochem.Biophys.* 1978; **187**: 307-314.
60. Powell RG, Smith.C.R.Jr, Wolff I. Helichrysum seed oil.Separation and characterisation of individual acids. *Journal of the American Oil Chemists Society* 1965; **42**: 165-169.
61. Puerta R, Garcia MDA, Saenz MT, Gil AM. Analysis of the essential oil from *Helichrysum picardii*. *Planta Medica* 1993; **59**: 194-195.

62. Puyvelde L, De Kimpe N, Costa J *et al.* Isolation of flavonoids and a chalcone from *Helichrysum odoratissimum* and synthesis of helichrysetin. *Journal of Natural Products* 1989; **52**: 629-633.
63. Ramanoelina PAR, Bianchini JP, Gaydou EM, Emile M. Chemical composition of essential oil of *Helichrysum bracteiferum*. *Journal of Essential Oil Research* 1992; **4**: 531-532.
64. Rios JL, Recio MC, Villar A. Isolation and purification of the antibacterial compounds from *Helichrysum stoechas*. *Journal of Ethnopharmacology* 1991; **33** : 51-55.
65. Rios JL, Recio MC, Villar A. Antimicrobial activity of selected plants employed in the Spanish Mediterranean area. *Journal of Ethnopharmacology* 1987; **21**: 139-152.
66. Roussis V, Tsoukatou M, Petrakis PV, Chinou I, Skoula M, Harborne JB. Volatile constituents of four *Helichrysum* species growing in Greece. *Biochemical Systematics and Ecology* 2000; **28**: 163-175.
67. Salie F. (1998). The antimicrobial screening of four South African Asteracea species and the preliminary structural investigation of an antipseudomonal compound from *Arctotis auriculata*. Master's thesis. University of the Western Cape.
68. Salie F, Eagles PFK, Leng HMJ. Preliminary antimicrobial screening of four South African Asteraceae species. *Journal of Ethnopharmacology* 1996; **52**: 27-33.
69. Senoo K, Uehara K. Hydroquinone glycosides as antioxidants for pharmaceuticals, cosmetics, and foods. [Japanese Patent]. 1988.

70. Simonot D, McColl J, Thome D. Tyrosinase inhibitors : Activity of a Rumex Extract in combination with Kojic acid and Arbutin. *Cosmetics and Toiletries* 2002; **117**: 51-56.
71. Skakun NP, Stepanov NY. Comparative evaluation of the hepatoprotective , antioxidant and choleric evaluation of flavonoid drugs. *Vrachebnoe Delo* 1988; **12**: 52-54.
72. Stanhope M and Lancaster J. (1996). *Community Health Nursing*. Mosby : USA: 3-187.
73. Tognolini M, Barocelli E, Ballabeni V, Bruni R, Bianchi A, Chiavarini M, Impicciatore M. Comparative screening of plant essential oils : Phenylpropanoid moiety as basic core for antiplatelet activity. *Life Sciences* 2006; **78**: 1419-1432.
74. Tomas-Barberan FA, Iniesta-Sanmartin E, Tomas-Lorente F, Rumbero A. Antimicrobial phenolic compounds from three Spanish *Helichrysum* species. *Phytochemistry* 1990; **29**: 1093-1095.
75. Tomas-Barberan FA, Msonthi JD, Hostettmann K. Antifungal Epicuticular Methylated Flavonoids from *Helichrysum nitens* . *Phytochemistry* 1988; **27**: 753-755.
76. Ulchenko NT, Mukhamedova KS, Glushenkova A. Lipids of *Helichrysum maracandicum* flowers. *Chemistry of Natural compounds* 2000; **36**: 93-94.
77. Van Vuuren SF, Viljoen AM, Van Zyl RL, Van Heerden FR, Baser KH. The antimicrobial, antimalarial and toxicity profiles of helihumulone, leaf essential oil and extracts of *Helichrysum cymosum* (L.) D. Don subsp. *cymosum*. *South African Journal of Botany* 2006; **72**: 287-290.

78. Van Wyk BE, Van Oudshoorn B, Gericke N. (1997). *Medicinal plants of South Africa*. Briza : Pretoria : 75-159.
79. Vlietinck AJ, Van Hoof L, Totte J *et al.* Screening of hundred Rwandese medicinal plants for antimicrobial and antiviral activities. *Journal of Ethnopharmacology* 1995; **46**: 31-47.
80. Vrkoc J, Budesinsky M, Dolejs L, Vasickova S. Arenophthalide A : A new phthalide glycoside from *Helichrysum arenarium* roots. *Phytochemistry* 1975; **14**: 1848.
81. WHO. 1989:65.
82. WHO. 2002.
83. Xu GJ. Coloured Illustrations of Chinese Traditional and Herbal Drugs. *Fujian Science and Technology Press* 1989.
84. Xu GJ, Si DW. Pharmacognosy. *People's Health Press* 1987.
85. Yokoyama M. Manufacture of phenol glycosides by plant tissue culture with antioxidants. [Japanese Patent]. 1991.