

# CSL Elite Wheel Base +



**Manual**

**EN**



“PS”, PlayStation, “PS4” and “△×□○” are registered trademarks of Sony Interactive Entertainment Inc. All rights reserved.  
All other trademarks are the property of their respective owners.



**Thank you for choosing**  
***FANATEC***<sup>®</sup>

To get the most out of your CSL Elite Wheel Base+, please read this manual before use. It contains important health and safety information and should be retained for future reference.

# INDEX

1. General .....	5-6
2. Introduction .....	7
3. Compatibility .....	7
4. Preparation .....	8-9
4.1 Package contents .....	8-9
5. Assembly .....	10-19
5.1 Plan your configuration .....	10
5.2 Mounting the CSL Elite Wheel Base+ using the Table Clamp .....	10-11
5.3 Hard mounting the CSL Elite Wheel Base+ .....	12
5.4 Attaching a CSL Elite Steering Wheel with simplified Quick Release ....	13-14
5.5 Detaching a CSL Elite Steering Wheel with simplified Quick Release ...	14
5.6 Attaching a ClubSport Steering Wheel .....	15
5.7 Detaching a ClubSport Steering Wheel .....	16
5.8 ClubSport Static Shifter Paddles (CS SSP) .....	17
5.9 Connections .....	17-19
5.10 Drilling Template .....	19
6. Functions & Features .....	20-35
6.1 Firmware and driver update .....	20-28
6.2 Start-Up procedure .....	29
6.3 Tuning Menu .....	30-33
6.4 RPM Lights (RevLEDs) .....	34
6.5 Cooling system .....	34-35
7. Electronic operation .....	36-39
7.1 Hotkeys .....	36-39
8. Cleaning .....	40
9. Troubleshooting .....	40-41
10. Serial number .....	42
11. Trademarks .....	42
12. End of life product recycling .....	43-46
13. FCC Compliance .....	47
14. CE Compliance .....	47
15. Warranty .....	48-49

 **WARNING!** Photosensitive Seizures

A very small percentage of people may experience a seizure when exposed to certain visual images, including flashing lights or patterns that may appear in video games. Even people who have no history of seizures or epilepsy may have an undiagnosed condition that can cause these „photosensitive epileptic seizures” while watching video games. These seizures may have a variety of symptoms, including light-headedness, altered vision, eye or face twitching, jerking or shaking of arms or legs, disorientation, confusion, or momentary loss of awareness. Seizures may also cause loss of consciousness or convulsions that can lead to injury from falling down or striking nearby objects. Immediately stop playing and consult a doctor if you experience any of these symptoms. Parents should watch for or ask their children about the above symptoms – children and teenagers are more likely than adults to experience these seizures.

The risk of photosensitive epileptic seizures may be reduced by taking the following precautions:

- Sit farther from the TV screen.
- Use a smaller TV screen.
- Play in a well-lit room.
- Do not play when you are drowsy or fatigued.

If you or any of your relatives have a history of seizures or epilepsy, consult a doctor before playing.

 **WARNING!** Musculoskeletal disorders

Use of game controllers, keyboards, mice, or other electronic input devices may be linked to serious injuries or disorders. When playing video games, as with many activities, you may experience occasional discomfort in your hands, arms, shoulders, neck, or other parts of your body. However, if you experience symptoms such as persistent or recurring discomfort, pain, throbbing, aching, tingling, numbness, burning sensation, or stiffness, **DO NOT IGNORE THESE WARNING SIGNS. PROMPTLY SEE A QUALIFIED HEALTH PROFESSIONAL**, even if symptoms occur when you are not playing a video game. Symptoms such as these can be associated with painful and sometimes permanently disabling injuries or disorders of the nerves, muscles, tendons, blood vessels, and other parts of the body. These musculoskeletal disorders (MSDs) include carpal tunnel syndrome, tendonitis, tenosynovitis, vibration syndromes, and other conditions.

While researchers are not yet able to answer many questions about MSDs, there is general agreement that many factors may be linked to their occurrence, including medical and physical conditions, stress and how one copes with it, overall health, and how a person positions and uses their body during work and other activities (including playing a video game). Some studies suggest that the amount of time a person performs an activity may also be a factor. If you have questions about how your own lifestyle, activities, or medical or physical condition may be related to MSDs, see a qualified health professional.

## 1

## GENERAL

 **ATTENTION**

- The device must not be exposed to rain or humidity in order to avoid risk of fire and or electric shock.
- Operating room temperature: 15°C – 35°C
- The recommended operation time of the wheel with continuous force feedback activity is 1 hour. Let the wheel cool down for a few minutes before you continue.
- Excessive use may cause health risks. Take a break of 5 minutes every 20 minutes, and do not drive for more than 2 hours per day.
- We strongly advise you to not drive a vehicle immediately after using a video game.
- Utilisation of the vibration and Force Feedback function may cause damage to your health.
- In case of interference with other wireless 2.4 GHz devices, the interfering devices must be removed or switched off.
- Not intended for children under the age of 6 years old. Contains small pieces which pose a choking hazard!
- Do not open the casing of the device.
- This device contains components that cannot be repaired by the user, opening will void the warranty.



 **WARNING!** Electrical Safety

The CSL Elite Wheel Base+ must be connected to an appropriate power source:

- Use only the power supply and power cord that came with your CSL Elite Wheel Base+. Replacements may only be issued from an authorized repair centre.
- Do not use non-standard power sources, such as generators or inverters, even if the voltage and frequency appear acceptable. Only use AC power provided by a standard wall outlet.
- To avoid damage, do not expose your CSL Elite Wheel Base+ to sources of heat.
- When connecting and / or disconnecting any Steering Wheel (e.g. Porsche 918 RSR or Universal Hub) to / from CSL Elite Wheel Base+ take care of the pins inside the quick release.
- Only use Fanatec® Steering Wheels with the CSL Elite Wheel Base+.
- Do not try to use the CSL Elite Wheel Base+ with an external power source different from the power supply packaged with the CSL Elite Wheel Base+ or received from an authorised repair centre.
- Unplug the power cord of your CSL Elite Wheel Base+ during storms or when unused for long periods of time.
- If the CSL Elite Wheel Base+ becomes damaged in any way, stop using it immediately and contact Fanatec® Customer Support.



## GENERAL NOTES

- This product contains no steering wheels, all Fanatec® steering wheels which might be mentioned in this manual are not included within the CSL Elite Wheel Base+ package and sold separately.
- Additional peripheral devices like shifters, pedals, LED displays and others which might be mentioned in this manual are not included within the CSL Elite Wheel Base+ package and are sold separately.
- This manual discusses assembly, connections, and functions related to Fanatec® steering wheels and other additional devices (e.g. PlayStation®4 and PC.) This is not a replacement manual for the other corresponding products! Read the quick guides or user manuals for the other products as well!
- All specifications in this document are subject to change. The CSL Elite Wheel Base+ firmware and/or PC driver may be updated to implement new features or general improvements.
- The warranty does not include defects that are due to commercial use of the product. See chapter “Warranty” at the end of this user manual as well as the terms & conditions at [www.fanatec.com](http://www.fanatec.com) for more details.
- “”, “PlayStation” and “” are registered trademarks of Sony Interactive Entertainment Inc. All rights reserved. All other trademarks are the property of their respective owners.
- Licensed for sale in Europe and Australia and for use exclusively with PlayStation®4.
- Compatibility with other platforms not tested nor endorsed by Sony Interactive Entertainment Europe.

## 2

## INTRODUCTION

Thank you for purchasing the CSL Elite Wheel Base+. This innovative product offers precise steering, strong force feedback through a brushless servo motor, smooth belt drive, and 1080° rotation built into a solid wheel base using an automotive-grade quick release.

Choose from a wide variety of compatible Fanatec steering wheels, such as the CSL Elite P1, BMW M3 GT2, Formula V2, Porsche 918 RSR, and the Universal Hub for Xbox One. Pick a wheel that best suits the car you're driving - it's up to you!

## 3

## COMPATIBILITY

The CSL Elite Wheel Base+ can be used with many Fanatec steering wheels, including the CSL Elite Steering Wheel P1 for Xbox One, and many ClubSport wheels like the BMW M3 GT2, Formula V2, Porsche 918 RSR, as well as many other Fanatec peripheral devices such as pedals, shifters, and handbrake. Always check the individual product pages for compatibility information.

The CSL Elite Wheel Base+ can be used on PlayStation®4 and other platforms\*.

 **IMPORTANT:** Before first use the CSL Elite Wheel Base+ must be updated to the latest firmware version which is available on our website [www.fanatec.com](http://www.fanatec.com). See chapter 'Firmware and driver update' for more details!

\*Compatibility with other platforms not tested nor endorsed by Sony Interactive Entertainment Europe.

**4 PREPARATION**

**4.1 Package contents**

CSL Elite Wheel Base+



Table clamp



Table clamp screw with handle



Power supply unit



Power supply



USB connection cable with straight plug





O-Ring (O1)



Allen key 5 mm



Black washers



PS4™ button caps for ClubSport steering wheels



Quick Guide

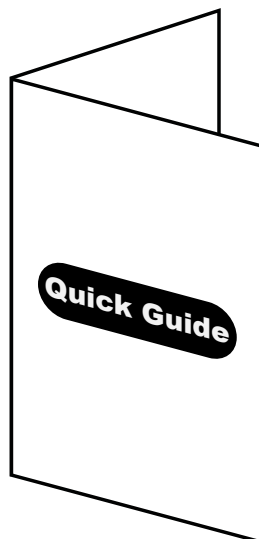

## 5

## ASSEMBLY

### 5.1 Plan your configuration

To operate the CSL Elite Wheel Base+, connect your steering wheel onto the base quick release shaft and get started. Connect the CSL Elite Wheel Base+ to your PlayStation®4 system or other platforms\* by using the USB cable.

**⚠ IMPORTANT:** Use only the supplied USB cable with your CSL Elite Wheel Base+. Failure to do this may cause damage to the CSL Elite Wheel Base+ or PlayStation®4 electronics!

Please check the “5.9 Connections” chapter to see which kind of peripheral devices must be connected to which socket on the CSL Elite Wheel Base+. All devices have to be connected to the CSL Elite Wheel Base+ before powering ON to allow proper detection and operation.

Additional peripheral devices like pedals or shifters are not strictly required but will give the user a more similar feeling to driving a race car. We recommend using shifters and pedals from the Fanatec® ClubSport platform like the ClubSport Shifter SQ, the ClubSport Static Shifter Paddles or the ClubSport Pedals and more. Visit our Webshop at [www.fanatec.com](http://www.fanatec.com) for more compatible products.

### 5.2 Mounting the CSL Elite Wheel Base+ using the Table Clamp

Insert the threaded rod with handles into the table clamp.

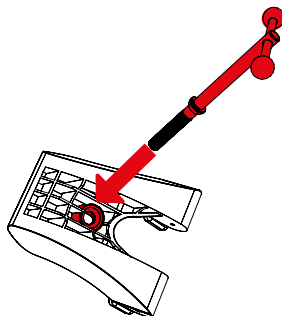

\*Compatibility with other platforms not tested nor endorsed by Sony Interactive Entertainment Europe.

Turn the table clamp screw into the bottom centre of the CSL Elite Wheel Base+.

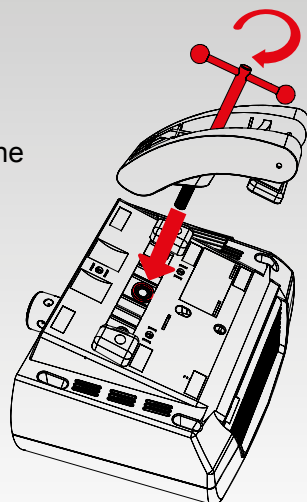

Slide the CSL Elite Wheel Base+ Slide the CSL Elite Racing Wheel onto the table plate until the limiter blocks are flush with the table edge. The table clamp must be below the table top.

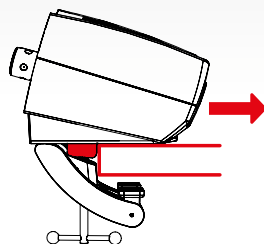

Tighten the table clamp by turning the table clamp bolt. Ensure that the table clamp feet remain well aligned with the underside of the table.

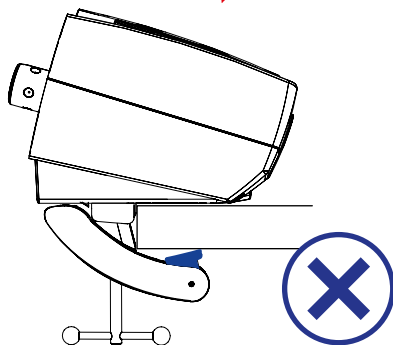
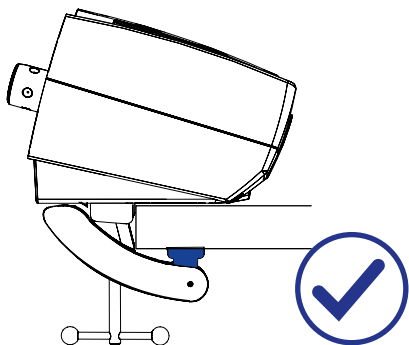
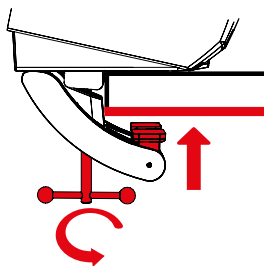

### 5.3 Hard-mounting the CSL Elite Wheel Base+

The CSL Elite Wheel Base+ offers a three-point hard-mount location on the bottom side of the CSL Elite Wheel Base (see the right hand side picture below.) To hard-mount the wheel base, first disassemble the two blocks from the bottom side with a 3mm Allen key (not included), see highlighted on the left hand picture below:

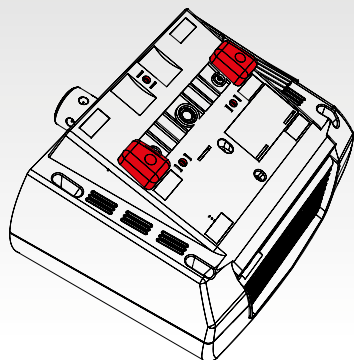

**⚠ IMPORTANT:** Use only good quality M6 screws. Choose the screw length so that the thread does not reach more than 16 mm into the wheel base. Example: If your table thickness is 20 mm the screw must not exceed a total thread length of 36 mm! Always use all three hard-mount points, this allows a proper and stable installation and avoids damage!

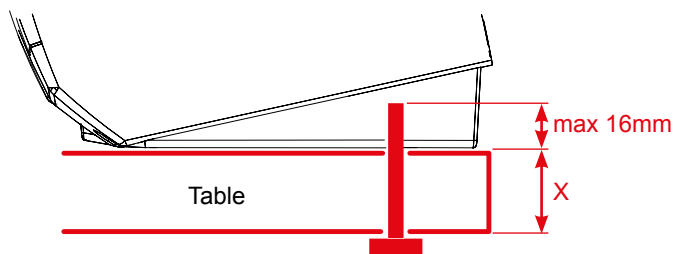

To hard-mount the CSL Elite Wheel Base+ to a table or rig by screws please find the printable drilling template in the download area of our website [www.fanatec.com](http://www.fanatec.com).

### 5.4 Attaching a CSL Elite Steering Wheel with simplified Quick Release

Use clamp ring screw (M6 x 18mm flat head) and Allen key from box contents.



Align CSL Elite Wheel Base.

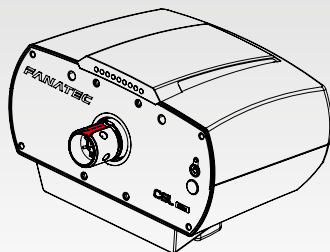

Slide Steering Wheel onto wheel base axle.

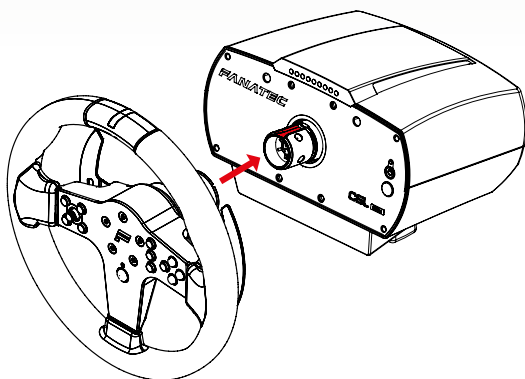

Turn the Steering Wheel top side down to see the bottom side of the clamp ring to follow next step below.

Push the Steering Wheel until the screw hole matches with hole on CSL Elite Wheel Base+ axle.

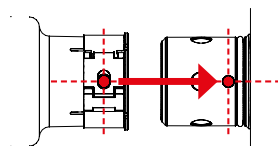

Tighten the screw to fix clamp ring mechanism, use only the Allen key which comes with the CSL Elite Wheel Base+!

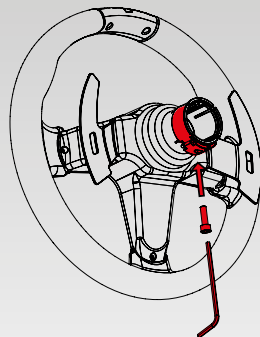

**⚠ IMPORTANT:** Tighten only by using the short lever of Allen key!

### 5.5 Detaching a CSL Elite Steering Wheel with simplified Quick Release

Loosen the fixing screw and open clamp ring mechanism. Use only the Allen key which comes with the CSL Elite Wheel Base+!

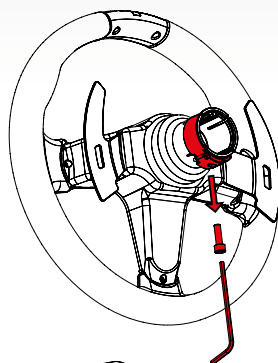

Slide the Steering Wheel off CSL Elite Wheel Base axle.

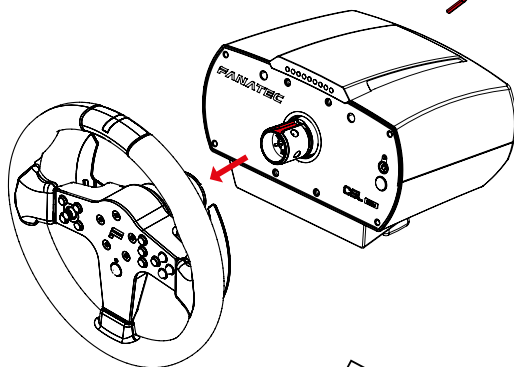

Store clamp ring screw and Allen key safely for later use.

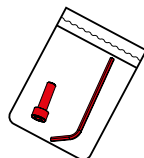

## 5.6 Attaching a ClubSport Steering Wheel

Remove storage pin.

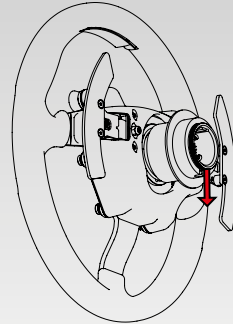

Align CSL Elite Wheel Base axle to correct position.

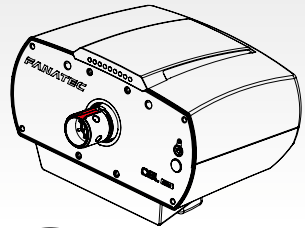

Slide and hold quick release mechanism

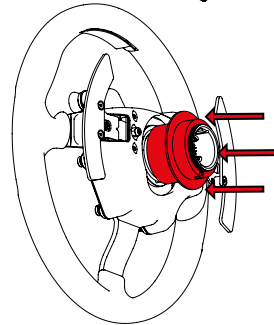

Slide steering wheel onto CSL Elite Wheel Base+ axle.

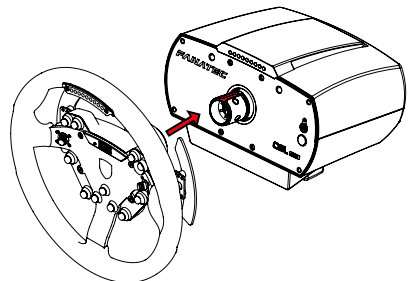

Now release the sleeve of the quick release mechanism.

**⚠ IMPORTANT:** Take care not to use too much force while attaching the steering wheel to avoid damage! You may need to push the steering wheel with a slightly higher force onto the wheel base axis, particularly on the last 8 mm due to the O-ring on the wheel base axis.

## 5.7 Detaching a ClubSport Steering Wheel

Slide and hold quick release mechanism.

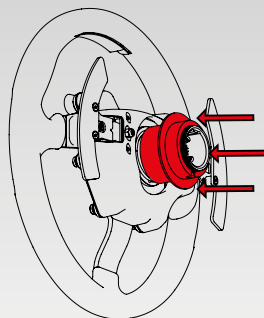

Slide steering wheel off CSL Elite Wheel Base axle.

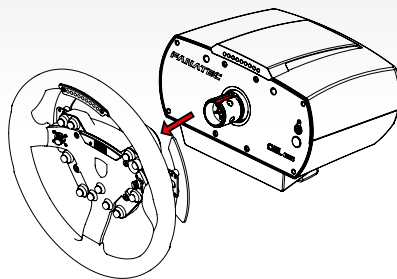

Place steering wheel face down on table.

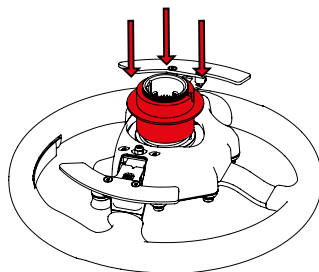

Insert storage pin.

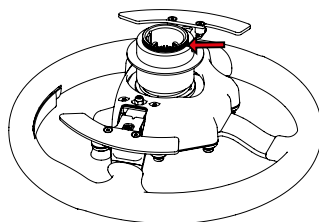

Now release the sleeve of the quick release mechanism.



### 5.8 ClubSport Static Shifter Paddles

At the front plate of the CSL Elite Wheel Base+ there are four threaded holes with gears which are used for mounting the ClubSport Static Shifter Paddles as shown in the picture below:

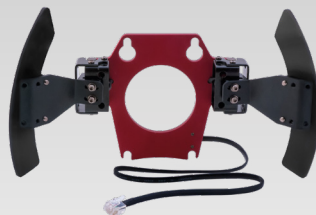

For assembly of the ClubSport Static Shifter Paddles please put one of the black washers included with the CSL Elite Wheel Base+ between wheel base front-plate and the static shifter paddles plate to ensure proper fitting.

**⚠ IMPORTANT:** ClubSport Static Shifter Paddles are sold separately and not included within the CSL Elite Wheel Base+ package contents. Mounting screws for the ClubSport Static Shifter Paddles are included within the package contents of the ClubSport Static Shifter Paddles.

### 5.9 Connections

To connect additional peripheral devices like shifters, pedals or handbrake to the CSL Elite Wheel Base+ there is a row of connector sockets at the lower back-side of the CSL Elite Wheel Base+:

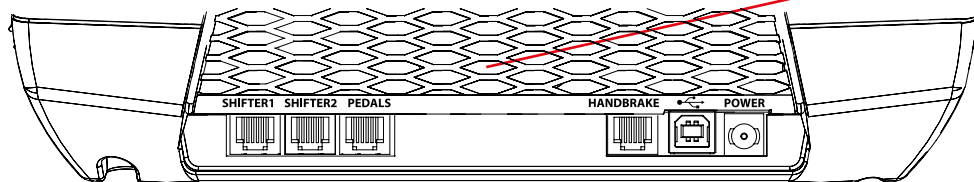

**⚠ IMPORTANT:** Use only the connection cables which are packaged with the peripheral devices! Peripheral devices are not included and sold separately!

### 5.9.1 USB

The USB port is used to connect the CSL Elite Wheel Base+ to PlayStation®4 or other platforms\*.

 **IMPORTANT:** Use only the USB cable with the straight plug which is packaged with your CSL Elite Wheel Base+ to avoid damage to the CSL Elite Wheel Base+ or PlayStation®4 electronics!

### 5.9.2 SHIFTER1

The SHIFTER1 port is used to connect H-pattern shifters to the CSL Elite Wheel Base+ (e.g. the ClubSport Shifter or the ClubSport Shifter SQ in H-pattern mode.) Sequential shifters can also be connected to this port. Note: Sequential shifters connected to this port can be mapped identically to the shifter paddles at the CSL Elite Steering Wheel (PS4™ version) or any other Fanatec® steering wheels by PC\* driver settings (see chapter 'PC\* driver' of this user manual).

### 5.9.3 SHIFTER2

The SHIFTER2 port is used to connect sequential shifters to the CSL Elite Wheel Base+ (e.g. the ClubSport Shifter SQ in SQ mode or the ClubSport Static Shifter Paddles.) Note: Sequential shifters connected to this port can be mapped identically to the shifter paddles at the CSL Elite Steering Wheel (PS4™ version) or any other Fanatec® steering wheels by PC\* driver settings (see chapter 'PC\* driver' of this user manual).

**Attention: H-pattern shifters will not work on SHIFTER2 port!**

### 5.9.4 PEDAL

The PEDAL port is used to connect pedals to the CSL Elite Wheel Base+ (e.g. the CSL Elite Pedals and CSL Elite Pedals LC.)

### 5.9.5 HANDBRAKE

The HANDBRAKE port is used to connect an analogue handbrake device to the CSL Elite Wheel Base+.

\*Compatibility with other platforms not tested nor endorsed by Sony Interactive Entertainment Europe.

### 5.9.6 POWER

The POWER connector is used to connect the power supply to the CSL Elite Wheel Base+.

**⚠ IMPORTANT:** Please use only the power supply and power cord that came with your CSL Elite Wheel Base+. Replacements may only be issued from an authorized repair centre. See ‘Electrical Safety’ in Chapter 1 ‘General’ for more details!

### 5.10 Drilling Template

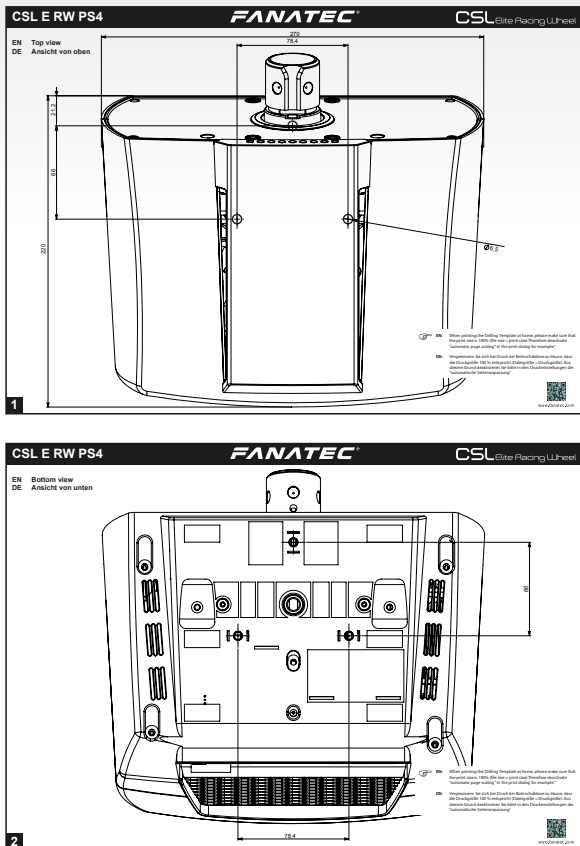

**⚠ ATTENTION:** Please download and print the drilling template for hard-mounting the CSL Elite Wheel Base+ from the download area of our website [www.fanatec.com](http://www.fanatec.com).

## 6 FUNCTIONS & FEATURES

The CSL Elite Wheel Base+ has specific firmware handling the device communication to PlayStation®4 and other platforms\* as well as to other hardware peripheral devices like shifters and pedals. This firmware provides different functions for the user.

### 6.1 Firmware and driver update



The firmware and the PC\* driver can be updated to newer versions from Fanatec®. These updates may include bug fixes or introduction of new features and compatibilities.

Before first use the CSL Elite Wheel Base+ has to be updated to the latest firmware version which is available in the Downloads section of our website [www.fanatec.com](http://www.fanatec.com).

You also have to use the latest PC\* driver version in order to use the CSL Elite Wheel Base+ on a PC\*.

Run the downloaded file(s) and follow the instructions shown on the screen. See more detailed description later in this user manual chapter.

 **IMPORTANT:** The CSL Elite Wheel Base+ is secured by firmware and by driver so that usually it is not possible to install wrong firmwares on the CSL Elite Wheel Base+! Do not try to force installation of any wrong firmware to the CSL Elite Wheel Base+ to avoid damages.

 **IMPORTANT:** After firmware update the centre position of the CSL Elite Wheel Base+ has to be manually calibrated again. This is also indicated by the display of the attached steering wheel showing 'CAL'. This appearance will be gone after manual calibration of the wheel centre. See chapter 'Hotkeys'  'Wheel centre calibration' for more details.

 **IMPORTANT:** After firmware update the H-pattern shifters connected to the CSL Elite Wheel Base+ has to be manually calibrated again. See

chapter 'Hotkeys'  'Shifter calibration mode' for more details.

\*Compatibility with other platforms not tested nor endorsed by Sony Interactive Entertainment Europe.

### 6.1.1 PC\* driver

The PC\* driver is a very helpful tool as it can assist the user to do functional tests, adjustments and update procedure on the CSL Elite Wheel Base+.

When you start the driver this window as shown on the right hand side will appear and show all connected USB devices:

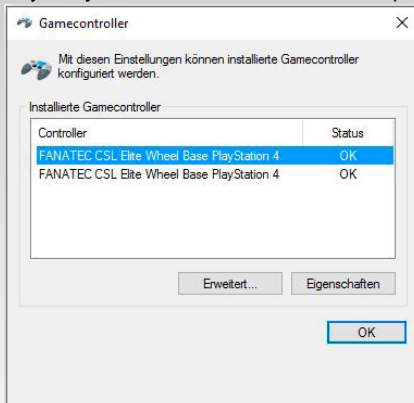

Double-click on the detected device to proceed to the various menu tabs.

The 'Function Test' tab will display the attached Fanatec® Steering Wheel. In this example a CSL Elite Steering Wheel (PS4™ version) is shown below:

This window provides a lot of diagnostic information and gives the option to test the hardware and peripherals:

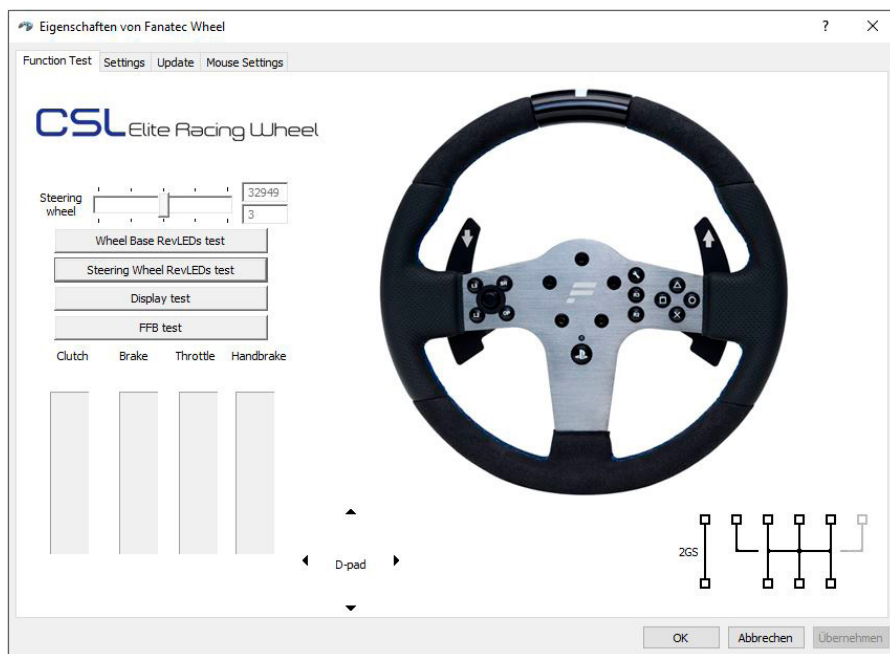

\*Compatibility with other platforms not tested nor endorsed by Sony Interactive Entertainment Europe.

The indicator bar shows the current steering wheel position, the upper box shows the position in digits, the lower box shows the position as an angle (positive and negative angle related to the calibrated wheel centre position).

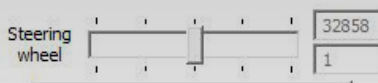

The **“Display test”** button activates a signal flow on the LED display of the attached Fanatec® steering wheel and activates all LED display segments so you can check if all LED display segments work properly.

The **“FFB test”** button starts a force feedback test and activates the motor of the CSL Elite Wheel Base+ to check proper functionality.

The **“Wheel Base RevLEDs test”** button starts a signal flow on the LED bar on the upper front side of the CSL Elite Wheel Base and activates them to test proper functionality of each single LED.

The **“Steering Wheel RevLEDs test”** button starts a signal flow on the LED bar on the steering wheel top side and activates them to test proper functionality of each single LED. This is only available for steering wheels which have RevLEDs, refer to the product description of the used steering wheel. The CSL Elite Steering Wheel has RevLEDs integrated in the rim centre stripe.

The **“Vibration test”** button starts a vibration signal to activate the vibration motors inside the Fanatec® steering wheels. This is only available for steering wheels which have vibration motors inside, refer to the product description of the used steering wheel. Not applicable for the CSL Elite Steering Wheel.

Clutch Brake Throttle Handbrake



The **“Clutch”**, **“Brake”**, and **“Throttle”** indicators show the current activation and position of these single pedals by a blue bar moving up and down. Therefore the pedals must be connected to the CSL Elite Wheel Base+.

**Note:** Every pedal lever must be pressed down completely to auto-calibrate the lever movement distance each time when power resumes.



The **“D-pad”** arrows (up, down, left, right) change their colour from black to blue when the corresponding direction is pressed on the attached Fanatec® steering wheel.

Rotary Encoder

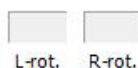

The **“Rotary Encoder”** boxes flash blue when turning the FunkySwitch™ left or right. Not applicable for the CSL Elite Steering Wheel. Not applicable for the CSL Elite Steering Wheel P1/P1X.

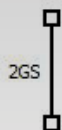

The “**2GS**” indicator shows the activation of the 2GS (two gears shifter, sequential shifter, SQ) with a blue square, depending on the activated shifting position (up or down). This can be for example the ClubSport Static Shifter Paddles or the ClubSport Shifter SQ in sequential mode if these are not mapped to the steering wheel shifter paddles.

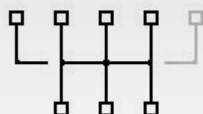

The “**H-pattern**” indicator shows the activation of the 6GS, 7GS or 8GS (six gears shifter, seven gears shifter or eight gears shifter) with a blue square, depending on the activated shifting position. This can be for example the ClubSport Shifter or ClubSport Shifter SQ. Therefore, the H-pattern shifter must be calibrated. See chapter ‘Hotkeys’ → ‘Shifter calibration mode’ for more details

The biggest area in this window is the upper right section, showing a scheme of the attached Fanatec® steering wheel with all buttons. If you press one of the buttons on the attached steering wheel the corresponding button will be highlighted with a blue spot as long as the button is physically activated. Please note that this view is depending by the attached Fanatec® steering wheel. See example picture for the CSL Elite Steering Wheel (PS4™ version) on the right hand below:



If you go to the PC\* driver **Settings** page, you will see this window:

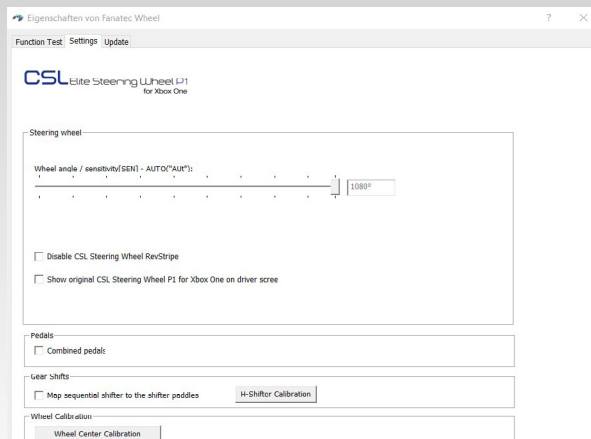

There are two different slider bars in the section “**Steering Wheel**”:

There are up to two different options in the section, “**Wheel angle / sensitivity**” depending on the Steering Wheel you have attached to the CSL Elite Wheel Base+:

- A Checkbox to disable the LED Center Stripe on your CSL Elite P1 Steering Wheel.
- An option to change the picture from CSL Elite P1 Steering Wheel to the CSL P1 Steering Wheel.
- To change the picture on the Universal Hub for Xbox One to show the internal wiring.

In the “**Pedals**” section there is only the one checkbox called ‘**Combined pedals**’. Activate this checkbox if the game or software uses only one input (I/O) for brake and throttle pedal signals (negative signal for brake, positive signal for throttle). This might solve problems especially with older games.

In the “**Gear shifts**” section there is only one checkbox called ‘Map sequential shifter to the shifter paddles’. Usually shifters connected to the SHIFTER2 port are mapped to different inputs (I/Os) than the shifter paddles on Fanatec® steering wheels. If you want to change the mapping so that the inputs for these shifters are mapped identically to the Fanatec® steering wheel shifter paddles, activate this checkbox. With the H-Shifter Calibration button it’s possible to force a shifter calibration if you have, for example, a Podium Hub without any mounted buttons. This works with any other Fanatec Steering Wheel as well.

The Tuning Menu will be explained later in this user manual ([Chapter 6.3](#)).

\*Compatibility with other platforms not tested nor endorsed by Sony Interactive Entertainment Europe.



If you go to the PC\* driver page **Update** you will see this window:

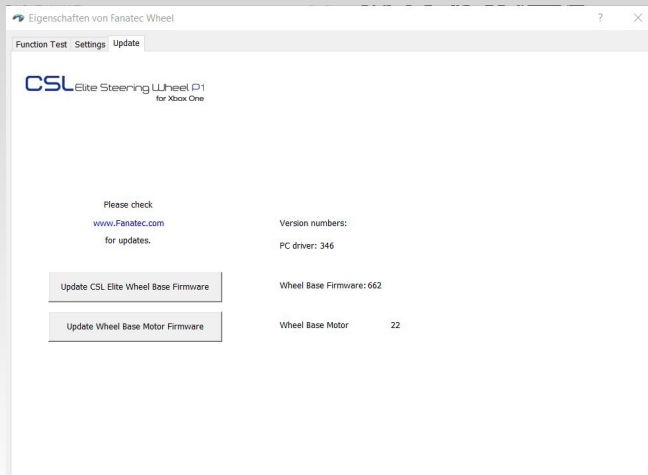

In this window you can see the following informations:

- Currently installed and used PC\* driver version
- Currently installed and used firmware version on the CSL Elite Wheel Base+
- Quick link to the Fanatec® homepage [www.fanatec.com](http://www.fanatec.com)

Below the shown information there is the button “**Update CSL Elite Wheel Base Firmware**”. When pressing this button the firmware update process for the CSL Elite Wheel Base+ will start (see more detailed description in chapter “Firmware update procedure” below in this user manual).

### 6.1.2 Firmware update procedure

To initiate the firmware update, the CSL Elite Wheel Base+ first has to be connected to the PC\* by USB cable and then it has to be switched to Bootloader mode. You can switch to Bootloader mode in two different ways:

- by PC\* driver, on page “**Update**” press the button “**Update CSL Elite Wheel Base Firmware**” when the CSL Elite Wheel Base+ is switched ON, see previous chapter ‘PC\* driver’
- by pressing the ON/OFF button “” on the front plate of the CSL Elite Wheel Base+ for about 8 seconds when the CSL Elite Wheel Base+ is switched OFF.

\*Compatibility with other platforms not tested nor endorsed by Sony Interactive Entertainment Europe.

When the Bootloader mode is active the LED above the ON/OFF button “” will be flashing blue. The cooling fan will also switch off. On the PC\* screen this window will appear automatically as shown on the right hand side:

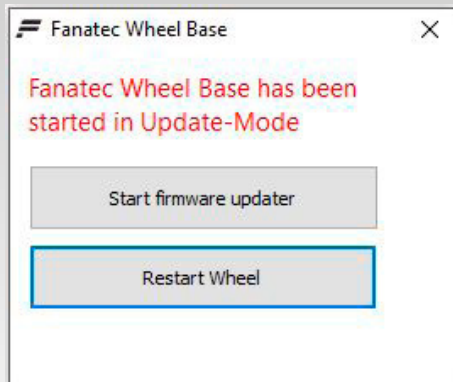

Click on the upper button ‘Start firmware updater’.

Then a new window will appear as shown on the right hand side:

Connect to your CSL Elite Wheel Base+ by pressing the button ‘Connect’.

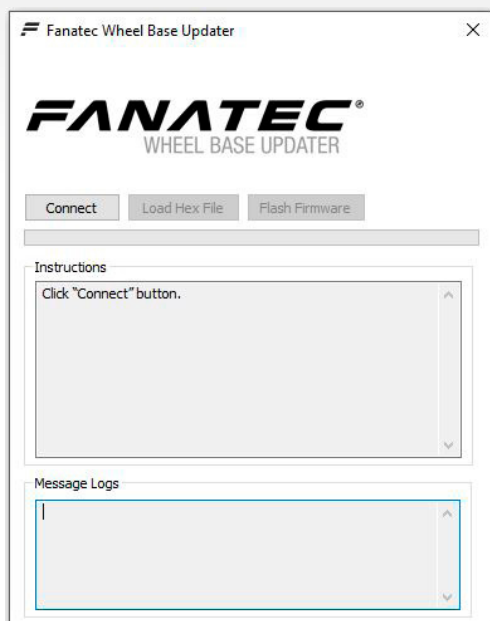

\*Compatibility with other platforms not tested nor endorsed by Sony Interactive Entertainment Europe.

When the Wheel Base Updater is connected to the CSL Elite Wheel Base+ the buttons 'Load Hex File' and 'Flash Firmware' are available as shown on the right hand side:

Use button 'Load Hex File' to browse and select the wanted firmware file (.hex). Usually the latest available firmware found is already pre-selected and this step can be skipped.

When the pre-selected firmware file (.hex) is ok or the wanted firmware file (.hex) is chosen press button 'Flash Firmware' to execute the firmware update.



The firmware update is proceeding. You can see the progress bar becoming green as shown on the right hand side:

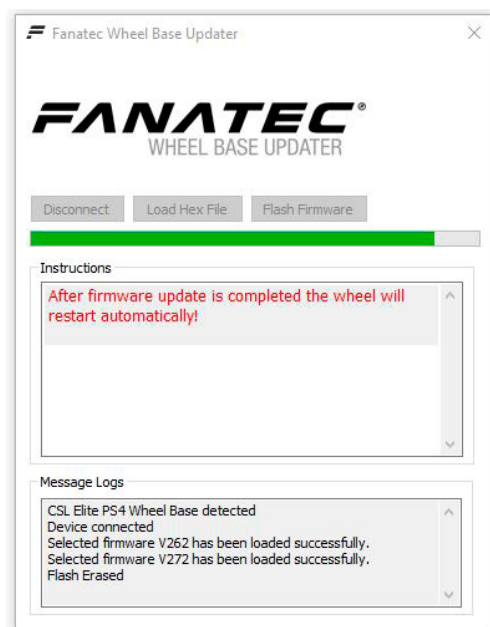

When the update is done the CSL Elite Wheel Base+ will restart automatically after firmware update is completely finished as shown on the right hand side:

The CSL Elite Wheel Base+ switches off and automatically on again and then will execute the calibration run.

**⚠ IMPORTANT:** Do not touch the attached steering wheel while the CSL Elite Wheel Base+ restarts and performs the initial calibration run to avoid injuries and/or miscalibration!



**⚠ IMPORTANT:** The CSL Elite Wheel Base+ is secured by firmware and by driver so that usually it is not possible to install wrong firmwares on the CSL Elite Wheel Base+! Do not try to force installation of any wrong firmware to the CSL Elite Wheel Base+ to avoid damages.

**⚠ IMPORTANT:** After a firmware update the centre position of the CSL Elite Wheel Base+ has to be manually calibrated again. This is also indicated by the display of the steering wheel showing 'CAL'. This warning will stop after manual calibration of the wheel centre. See chapter 'Hot-keys' 🖱 'Wheel centre calibration' for more details.

**⚠ IMPORTANT:** After a firmware update the H-pattern shifters connected to the CSL Elite Wheel Base+ has to be manually calibrated again. See chapter 'Hotkeys' 🖱 'Shifter calibration mode' for more details.

## 6.2 Start-Up procedure

The CSL Elite Wheel Base+ has an improved and faster start-up procedure:

**⚠ ATTENTION:** When initialisation and auto calibration of the CSL Elite Wheel Base+ is in progress never touch the attached steering wheel in order to avoid injuries or incorrect calibration!

- **Step1:** Press the ON/OFF button “⏻” at the front plate of the CSL Elite Wheel Base+, marked in the picture above:
- **Step2:** The fans start working, the LED above the ON/OFF Button “⏻” is lit red.
- **Step3:** The CSL Elite Wheel Base+ starts turning to the right side (clockwise) until mechanical limit is reached. Then it runs back to the the left side (counter clockwise) and stops.
  - at the centre position (0°) if wheel centre was manually calibrated before. **Note:** If SPR is set to low values or ‘000’ the CSL Elite Wheel Base+ will stop in a different position after calibration run.
  - at about -60° on the left hand side if wheel centre was not yet calibrated (e.g. after firmware update; see description above in this chapter).
- **Step4:** The currently installed firmware version is shown on the LED display of the Fanatec® steering wheel for a moment as shown on the picture on the right hand side:
- **Step5:** If the wheel centre was not yet calibrated ‘CAL’ will blink on the LED display of the steering wheel as shown on the picture on the right hand side:
  - Proceed with a manual wheel centre calibration as described in chapter ‘Hotkeys’ of this manual.
  - The CSL Elite Wheel Base+ is ready to use after manual wheel centre calibration.
- **Step6:** Your CSL Elite Wheel Base+ is ready to use. If the wheel centre was previously calibrated, step 5 can be skipped and the CSL Elite Wheel Base+ is ready to use immediately. If you use a H-pattern shifter the wheel base firmware will request to calibrate the gears automatically now. Refer to chapter ‘Shifter calibration mode later in this user manual’.



## 6.3 Tuning Menu

Activate the Tuning Menu by pressing the Tuning Menu button  (see the 'Hotkeys' chapter of this user manual). The menu will be shown on the tuning display of the Fanatec® steering wheel. To navigate through the Tuning Menu, use the directional stick of the Fanatec® steering wheel.

**Note:** Tuning functions are subject to change and may be altered in future firmware versions.

### 6.3.1 S\_1 ... S\_5 (Setups)

**Setups range: S\_1 ... S\_5**                      **Setups default: S\_1**

The CSL Elite Wheel Base+ provides five different setups to store your adjusted values independently from each other. To change which setup is active, move the directional stick of the Fanatec® steering wheel up or down.

### 6.3.2 SEN (Sensitivity)

**SEN range: 009 ... 108 → Aut**                      **SEN default: Aut**

The sensitivity defines the steering angle. If SEN is set to 009 the steering wheel can only be turned 90° (45° to left and 45° to right side direction from calibrated centre position). If SEN is set to 108 the steering wheel can be turned the mechanical maximum way of 1080° (540° to left and 540° to right side direction from calibrated centre position). If SEN is set to OFF/Aut the sensitivity is controlled by the PC\* driver (see chapter PC\* driver for more details). Some games support this feature. To change the active value, move the directional stick of the Fanatec® steering wheel up or down.

### 6.3.3 FF (Force Feedback)

**FF range: OFF → 001 ... 100**                      **FF default: 100**

The Force Feedback defines the maximum strength of the motor when force feedback effects from software / games are sent to the CSL Elite Wheel Base+. If FF is set to OFF, there will be no force feedback effect executed by the CSL Elite Wheel Base+ motor. If FF is set to 001, the motor will execute only 1% of the maximum motor power. If FF is set to 100, the motor will execute 100% of the maximum motor power. To change the active value, move the directional stick of the Fanatec® steering wheel up or down. It is recommended to leave this setting at 100 and reduce the strength using the in-game setting to avoid force feedback signal clipping.

\*Compatibility with other platforms not tested nor endorsed by Sony Interactive Entertainment Europe.

### 6.3.4 SHO (Shock)

**SHO range: OFF → 010 ... 100      SHO default: 100**

The strength of the shock / vibration motors inside some Fanatec steering wheels can be adjusted from 100% to 0%. These vibration motors can be used by a game directly (Fanatec® SDK) or by the ABS function.

**Note:** The CSL Elite Steering Wheel has no vibration motors.

### 6.3.5 ABS

**ABS range: 000 ... 100 → OFF      ABS default: OFF**

This feature gives you a direct feedback based on your brake inputs. If you set the value to 100 the vibration will start as soon as you give 100% brake input to the game. If you set it to 95% the vibration will start if you push the brake to 95% or more. The ABS feature uses the vibration within your wheel rim (can be turned off by setting SHO to “0”) AND the vibration motor on a CSP (V2 or V3) pedal set if it is connected directly to the wheel base, not individually by USB. ABS can also be simulated dynamically by the game if the developer makes use of the Fanatec® SDK. To change the active value, move the directional stick of the Fanatec® steering wheel up or down.

### 6.3.6 DRI (Drift mode)

**DRI range: -05 ... -01 → OFF → 001 ... 005      DRI default: -05**

The drift mode reduces overall resistance of the wheel and lets you turn the wheel more easily. It almost works like power steering. It reduces the basic dampening of the wheel in the range of -05 to -01 and makes the wheel turn faster in the range of 001 to 005. If the value is set to values beyond -05 (or if the games FFB interferes with this feature) you might experience some oscillation. If that happens - reduce the value or turn DRI “-05”.

To change the active value, move the directional stick of the Fanatec® steering wheel in the up or down direction. “-05” to “-01” is a damper effect (natural damper), “OFF” is without damper effect and “001” or higher values are with motor assistance to accelerate the steering wheel.

### 6.3.7 FOR (force), SPR (spring), DPR (damper)

FOR range: OFF → 010 ... 120      FOR default: 100 (%)

SPR range: OFF → 010 ... 120      SPR default: 100 (%)

DPR range: OFF → 010 ... 120      DPR default: 100 (%)

These force feedback modifiers give you the ability to change the force feedback signals of a game (only applicable if game uses these effects). In theory there are three types of signals which a game can send: Force (pushes the wheel in a specific direction), spring (pulls the wheel towards the dynamic centre) and damper (creates friction). Not every game uses all types of effects and some games even use only one type to create all different feelings. Using your Tuning Menu in the CSL Elite Wheel Base+ you can increase or reduce these different effects individually. To change the active value, move the directional stick of the Fanatec® steering wheel up or down.

**Note:** If SPR is set to low values or 'OFF' the CSL Elite Wheel Base+ will not be able to move the attached steering wheel to the correct centre position after calibration run.

 **IMPORTANT:** Only set these values higher than 100% if the force feedback effects are clearly not strong enough and weaker in comparison to other games. When the game sends full effects and the wheel is set to 100% then the device will work on its power limit. Pushing up one value to a very high number or even raising multiple values will result in higher load on the motor and increased heat generation.

For further information check the FAQ section on our website [www.fanatec.com/support](http://www.fanatec.com/support).



### 6.3.8 FEI (Force Effect Intensity)

**FEI range: OFF ... 100**

**FEI default: 050**

This parameter adjusts the intensity of force effects and can make effects more smooth: OFF is very smooth and low noise while 100 is very sharp and direct. Tuning this parameter can improve the feeling of the wheel depending on the game. This can be helpful to reduce the noise level especially for bases assembled to tables or rigs.

### 6.3.9 BRF (brake force)

**BRF range: Lo/Min → Hi/Max**

**BRF default: 050**

Increasing BRF value to Hi/Max means the user needs to press the brake pedal with maximum force to achieve 100% brake input. Reducing the BRF value to Lo/Min means the user needs to press the brake with minimum force to achieve 100% brake input.

You can either check the brake signal level on the PC\* driver or you can see it on the RevLEDs of the CSL Elite Wheel Base+ and/or the attached steering wheel (depending on steering wheel type). To change the active value, move the directional stick of the Fanatec® steering wheel up or down.

 **NOTE:** The BRF parameter is only available when a supported pedal set is connected to the PEDAL port of the CSL Elite Wheel Base+. Please read the description and/or manuals of your pedals to verify if the BRF feature is supported. For reference, the CSL Elite Pedals LC (i.e. CSL Elite Pedals with Loadcell Kit) support this feature.

### 6.3.10 MPS (Function of Multi Position Switch)

**MPS: Auto; Encoder; Constant; Pulse**

**MPS default: AUTO**

In AUTO mode the steering wheel decides which mode is appropriate for the game being played.

In Encoder mode the MPS simulates two buttons, one when you turn the MPS left and one when you turn the MPS right.

In Constant mode, the MPS outputs a constant button signal for each position. In PULSE Mode, the MPS outputs a specific button signal for each position which is only sent as a single pulse when you move the switch.

\*Compatibility with other platforms not tested nor endorsed by Sony Interactive Entertainment Europe.

## 6.4 Revolution Lights (RevLEDs)

The CSL Elite Wheel Base+ offers the RevLEDs feature integrated directly into the wheel base. This RevLEDs are usually mirrored with the RevLEDs of the steering wheel. Games supporting the steering wheel RevLEDs by default will also support the wheel base RevLEDs.



Further, if games make use of it, the RevLEDs of the wheel base can indicate a different function than the Steering Wheel RevLEDs. Example: Wheel Base RevLEDs show the fuel level while the steering wheel RevLEDs indicate engine RPM and help the driver shift up at the best moment.

Beyond this in-game feature, the RevLEDs are also a helpful indicator in case of any unexpected behaviour: While the wheel calibration runs after power ON is proceeding, the RevLEDs of the wheel base show the current status. For example, if no steering wheel is attached or is attached but cannot be detected and identified, the three blue RevLEDs will not be lit.

After calibration run is completed the RevLEDs turn off automatically and the game or software takes control.

## 6.5 Cooling system

To avoid damage to the CSL Elite Wheel Base+ there is an effective cooling system integrated to the hardware, controlled by firmware.



### 6.5.1 Hardware measures

The CSL Elite Wheel Base+ has a fan inside which carries out the hot air from the inside.

Make sure that there is nothing blocking the air intake at the back of the wheel base.

### 6.5.2 Automatic fan adjustment

The firmware provides different stages of fan control which are clearly defined after intensive testing in a R&D lab.

When switching ON, the CSL Elite Wheel Base+ fan operates at maximum speed until calibration run is completed.

The operation speed of the fan is adjusted according to the currently detected temperature of the motor inside the CSL Elite Wheel Base+ and could even stop, depending on your firmware version.

The temperature control and fan behaviour is subject to change by firmware updates.

## 7 ELECTRICAL OPERATION

### 7.1 Hotkeys

#### 7.1.1 Tuning Menu

To enter the Tuning Menu, use the Tuning Menu button (usually the button with the wrench symbol or the small black button close to the LED display of your Fanatec® steering wheel; see corresponding Quick Guide of your Fanatec® steering wheel). The picture (right) shows the Tuning Menu button of the CSL Elite Steering Wheel (PS4™ version) as an example:



#### 7.1.2 Restore original Tuning Menu settings

To restore the original Tuning Menu settings, open the Tuning Menu. S\_1 will be shown on the tuning display. Then press and hold the Tuning Menu button for about five seconds until 'rSt' is displayed.

#### 7.1.3 Wheel centre calibration

If a centre calibration is needed (e.g. after updating the firmware of the CSL Elite Wheel Base+) first you need to enter the Tuning Menu as described above.

When you use the CSL Elite Steering Wheel (PS4™ version) you must press the buttons **OP** + **X** at the same time.

When you use a Fanatec® steering wheel from the ClubSport Series you must press the left and right stick at the same time. Please see corresponding quick guide of the Fanatec® steering wheel you decide to use with the CSL Elite Wheel Base+ (PS4™ version).

The picture on the right hand side just shows the Fanatec® steering wheel Porsche 918 RSR as an example:



**⚠ ATTENTION:** When initialisation and auto calibration of the CSL Elite Wheel Base+ is in progress never touch the attached steering wheel in order to avoid injuries or incorrect calibration!

#### 7.1.4 Switching modes

The CSL Elite Wheel Base+ will start in “PlayStation®4 Mode” by default. To switch to other modes press the ‘Mode’ button once. The LED above the “” button will indicate the current operation mode (more colours can be shown with other compatible platforms):

- Blue indicates “PlayStation®4 mode“
- Red indicates “PC\* mode“
- Purple indicates “ClubSport Wheel Base V2 compatibility mode“



**⚠ NOTE:** Once the mode was changed manually the CSL Elite Wheel Base+ will remember the last active mode and will boot in the same mode next time. Exception: After firmware update was done.

\*Compatibility with other platforms not tested nor endorsed by Sony Interactive Entertainment Europe.

### 7.1.5 Shifter calibration mode

To enter the H-pattern shifter calibration mode press buttons **OP** + **🔧** of the CSL Elite Steering Wheel (PS4™ version) at the same time while H-pattern shifter is connected, see picture on the right:



For ClubSport steering wheels press buttons **START (10)** + **Tuning Menu button** at the same time while H-pattern shifter is connected.

The **START** button is usually the black button on the lower right centre of the ClubSport steering wheel, the picture on the right hand side shows the Porsche 918 RSR as an example:



Please refer to the Quick Guides of your Fanatec® steering wheel for more detailed information.

**⚠️ NOTE:** After firmware update the CSL Elite Wheel Base+ will request the shifter calibration automatically as soon as a non-calibrated H-pattern shifter is connected and detected. The menu will guide you through the calibration steps as described next below.

Put the H-pattern shifter lever into the position shown on the LED display and acknowledge each single position by pressing **OP / START (10)** to proceed to the next step.

The following pictures show the instructions on the LED display of the CSL Elite Steering Wheel (PS4™ version) but are similar on other Fanatec® steering wheels:

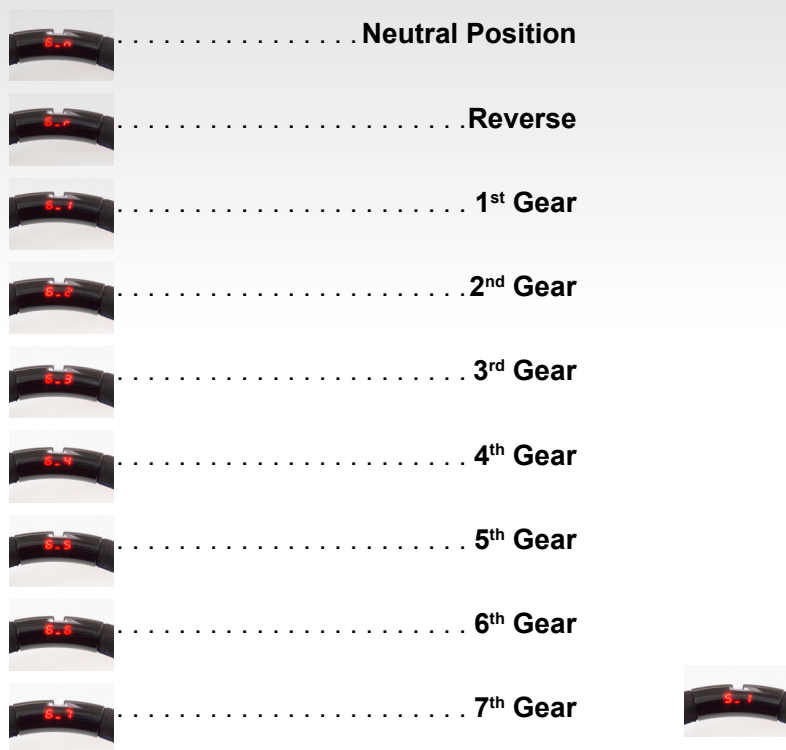

If your shifter has no 7th gear, acknowledge it by pressing **OP / START (10)** when the shifter lever is physically in the 6th gear position. After all gears are calibrated the LED display shows S\_1 and the shifter is ready for use.

**⚠ NOTE:** If you did not intend to enter the shifter calibration mode simply complete the calibration process either without a connected shifter or without moving the shifter lever. You may then leave the shifter calibration mode at the end of the process. This has no impact on the CSL Elite Wheel Base+ original calibration itself and you can continue without a shifter.

8

CLEANING

Clean only with a dry or slightly damp cloth. Using cleaning solutions may damage your CSL Elite Wheel Base+.

9

TROUBLESHOOTING

The CSL Elite Wheel Base+ must not be modified differently than described in this manual. Endor® AG expressly prohibits analysis and utilisation of the electronics, hardware, software and firmware contained in the controller. In case difficulties occur in connection with utilisation of the CSL Elite Wheel Base+, please use the following guide for elimination of errors which is available in the Downloads tab of the product page on [www.fanatec.com](http://www.fanatec.com).

If the CSL Elite Wheel Base+ is not working properly:

Problem description	Solution
After firmware update of the CSL Elite Wheel Base+ the steering wheel is not properly centred.	After performing a firmware update on the CSL Elite Wheel Base+ the wheel centre position must be manually calibrated. See chapter 'CSL Racing Wheel Functions' → 'Firmware and driver update' of this manual for more details.
After firmware update of the CSL Elite Wheel Base+ the H-pattern shifter is not working properly.	After performing a firmware update on the CSL Elite Wheel Base+ the H-pattern shifter must be manually calibrated. See chapter 'CSL Elite Wheel Base+ Functions' → 'Firmware and driver update' of this manual for more details.
The driver window does not show the attached steering wheel.	Make sure that you have updated your CSL Elite Wheel Base+ to the latest firmware which can be downloaded from the Downloads section of the Fanatec website <a href="http://www.fanatec.com">www.fanatec.com</a> .
	Check the pins inside the quick release of the steering wheel, these must not be bent or damaged.
	Try to use another steering wheel. If this is also not detected the CSL Elite Wheel Base+ might be damaged.



Problem description	Solution
<p>The tuning display does not show anything or is not working properly.</p>	<p>Try to use another steering wheel. If this is also not working properly the CSL Elite Wheel Base+ might be damaged.</p> <p>Check the pins inside the quick release of the steering wheel, these must not be bent or damaged.</p>
<p>After switching on the CSL Elite Wheel Base+ the auto calibration is not working properly.</p>	<p>Make sure that you have updated your CSL Elite Wheel Base+ to the latest firmware version which can be downloaded from the Downloads section of the Fanatec website <a href="http://www.fanatec.com">www.fanatec.com</a>.</p>
<p>After playing a while the CSL Elite Wheel Base+ seems to become weaker or is fading.</p>	<p>When the motor temperature is close to the upper limit the Tuning Menu values will be overwritten to regular maximum values (not higher than 100%).</p> <p>Additionally, the motor power level is controlled by firmware so that the FFB strength may fade in this high temperature range but the motor will not be damaged. This allows extending the duration of driving before the motor has to completely stop operating.</p> <p>Let your CSL Elite Wheel Base+ cool down before continuing use.</p>
<p>After playing a while the CSL Elite Wheel Base+ motor has switched OFF.</p>	<p>When the temperature is exceeding the upper limit the motor will be deactivated for a while until the temperature is low enough (to protect the hardware from damages).</p> <p>Let your CSL Elite Wheel Base+ cool down before continuing use. Contact our customer support if this happens consecutively.</p>
<p>Fan is always working in full speed even though the CSL Elite Wheel Base+ was just powered ON and did not heat up due to driving yet.</p>	<p>In case of malfunctioning temperature sensor the fans will work at maximum speed to protect the hardware from overheating. Please contact our customer support. Note: The room temperature should be above 20°C.</p>
<p>After calibration run at startup of CSL Elite Wheel Base+ the attached steering wheel doesn't go to correct centre position.</p>	<p>Please check your Tuning Menu settings, the value for SPR (spring) must be higher than '000' as this effect is required to make correct centring. Default value is '100'.</p>

10

**SERIAL NUMBER**

Before contacting the Fanatec® Customer Support please note the serial number of your CSL Elite Wheel Base+:



- CSL Elite Wheel Base+: .....

You can find the serial number on a sticker on the bottom side of your CSL Elite Wheel Base+.

The serial number of the CSL Elite Wheel Base (PS4™ version) starts with letters 'PV' and has additional 8 numbers, for example: **PV12704023**.

11

**TRADEMARKS**

“”, “PlayStation“ and ““ are registered trademarks of Sony Interactive Entertainment Inc. All rights reserved.

“Fanatec®” and “Endor®” are registered trademarks of Endor® AG/Germany. All rights reserved.

All other trademarks are the property of their respective owners.

## 12 END OF LIFE PRODUCT RECYCLING

Please follow your local regulations when disposing of this product as e-waste.

**English:** The European Union's WEEE directive requires that products sold into EU countries must have the crossed out trash bin label on the product (or the package in some cases). As defined by the WEEE directive, this cross-out trash bin label means that customers and end-users in EU countries should not dispose of electronic and electrical equipment or accessories in household waste. Customers or end-users in EU countries should contact their local equipment supplier representative or service centre for information about the waste collection system in their country.



**German:** Gemäß der WEEE-Richtlinie der Europäischen Union müssen Produkte, die in EU-Länder verkauft werden, auf dem Produkt (oder in manchen Fällen auf der Verpackung) ein durchgestrichenes Müllleimer-Etikett enthalten. Im Sinne der WEEE-Richtlinie bedeutet diese durchgestrichene Mülltonne, dass Kunden und Endbenutzer in EU-Ländern elektronische und elektrische Geräte oder Zubehör nicht mit dem Hausmüll entsorgen dürfen. Kunden oder Endbenutzer in EU-Ländern sollten sich an ihren örtlichen Lieferanten oder Servicecentre wenden, um Informationen über das Abfallsammelsystem in ihrem Land zu erhalten.

**Dutch:** De Europese Unie WEEE-richtlijn vereist dat producten die worden verkocht in EU-landen, dat het doorgekruiste prullenbak-etiket op het product (of het pakket in sommige gevallen) moeten hebben. Zoals gedefinieerd door de WEEE-richtlijn, betekent dit doorgekruiste prullenbak-etiket dat klanten en eindgebruikers in EU-landen geen elektrische en elektronische apparatuur of accessoires mogen weggooien bij huishoudelijk afval. Klanten of eindgebruikers in EU-landen moeten contact opnemen met de vertegenwoordiger van hun lokale leverancier of het servicecentrum voor informatie over het afval verzamelsysteem in hun land.

**French:** La directive de l'Union européenne sur les DEEE exige que les produits vendus dans les pays de l'UE portent une étiquette de poubelle barrée sur le produit (ou l'emballage dans certains cas). Tel que défini par la directive WEEE, cette étiquette rayée de poubelle signifie que les clients et les utilisateurs finaux des pays de l'UE ne doivent pas éliminer leurs équipements et accessoires électroniques et électriques avec leurs ordures ménagères. Les clients ou les utilisateurs finaux dans les pays de l'UE doivent contacter leur représentant du fournisseur d'équipement ou leur centre de service local pour obtenir des informations sur le système de collecte des déchets de leur pays.

**Italian:** La direttiva WEEE dei sindacati europei richiede che i prodotti venduti nei paesi dell'EU debbano avere l'etichetta del bidone dei rifiuti barrata (o del cestino in alcuni casi). Come definita dalla direttiva WEEE, questa etichetta del bidone dei rifiuti barrata significa che i clienti e gli utenti finali nei paesi dell'EU non devono smaltire apparecchiature elettriche ed elettroniche o accessori, nei rifiuti domestici. I clienti o gli utenti finali nei paesi dell'EU devono contattare il proprio rappresentante del fornitore di apparecchiature locali o il centro di assistenza per informazioni sul sistema di raccolta dei rifiuti nel loro paese.

**Spanish:** La directiva WEEE de la Unión Europea requiere que los productos vendidos en países de la UE

tengan la etiqueta de un contenedor de basura tachado en el producto (o el paquete en algunos casos). Según lo define la directiva WEEE, esta etiqueta de contenedor de basura tachado significa que los clientes y usuarios finales en los países de la UE no deben desechar equipos electrónicos y eléctricos o sus accesorios en la basura doméstica. Los clientes o usuarios finales en los países de la UE deben consultar con el representante de su proveedor de equipos local o centro de servicio para obtener información sobre el sistema de recolección de residuos en su país.

**Portuguese:** A diretiva WEEE da União Europeia exige que os produtos vendidos nos países da UE tenham o rótulo de lixeira riscada no produto (ou o pacote em alguns casos). Conforme definido pela diretiva WEEE, esse rótulo de lixeira de vedação significa que os clientes e usuários finais nos países da UE não devem descartar equipamentos eletrônicos ou elétricos ou acessórios em lixo doméstico. Os clientes ou usuários finais dos países da UE devem entrar em contato com o representante local de fornecedores de equipamentos ou o centro de serviços para obter informações sobre o sistema de coleta de lixo em seu país.

**Swedish:** EU:s WEEE-direktiv kräver att produkter som säljs till EU-länder måste ha etiketten över korsfacket på produkten (eller i vissa fall paketet). I enlighet med WEEE-direktivet innebär detta märkningssmärke för kryssrutor att kunder och slutanvändare i EU-länder inte ska använda elektronisk och elektrisk utrustning eller tillbehör i hushållsavfall. Kunder eller slutanvändare i EU-länderna bör kontakta sin lokala leverantörsleverantör eller servicecentre för information om avfallssamlingssystemet i sitt land.

**Danish:** EU's WEEE-direktiv kræver, at produkter, der sælges i EU-lande, skal have den krydsede affaldsseddel på produktet (eller pakken i nogle tilfælde). Som defineret i WEEE-direktivet betyder denne kryds-etiket for krydsning af affald, at kunder og slutbrugere i EU-lande ikke må bortskaffe elektronisk og elektrisk udstyr eller tilbehør i husholdningsaffald. Kunder eller slutbrugere i EU-lande skal kontakte deres lokale udstyrsleverandør eller servicecentre for oplysninger om affaldsindsamlingsystemet i deres land.

**Finnish:** Euroopan unionin sähkö- ja elektroniikkalaiteromua koskevassa direktiivissä edellytetään, että EU-maihin myydyissä tuotteissa on oltava tuotteen (tai joissakin tapauksissa pakkauksen) roskakorin etiketti. Kuten sähkö- ja elektroniikkalaiteromua koskevassa direktiivissä määritellään, tämä roskakorin merkintä tarkoittaa, että EU-maiden asiakkaat ja loppukäyttäjät eivät saa hävittää elektronia ja sähköisiä laitteita tai asusteita kotitalousjätteeseen. EU-maiden asiakkaiden tai loppukäyttäjien tulee ottaa yhteyttä paikalliseen laitetoimittajan edustajaan tai huoltokeskukseen saadakseen tietoa maansa jätehuoltojärjestelmästä.

**Irish:** Éilíonn Treoir WEEE na gCeardchumainn Eorpacha go gcaithfidh lipéad bruscair bruscair a thrasnú amach ar an táirge (nó an pacáiste i gcásanna áirithe) go dtiocfaidh táirgí a dhíoltar i dtíortha an AE. Mar atá sainmhíneithe ag an treoir WEEE, ciallaíonn an lipéad bruscair bruscair seo trasna nár cheart do chustaiméirí agus d'úsáideoirí deiridh i dtíortha an AE trealamh leictreonach agus leictreachais nó gabhálaís leictreacha a dhiúscairt i ndramháil tí. Ba cheart do chustaiméirí nó d'úsáideoirí deiridh i dtíortha an AE dul i dteagmháil lena n-ionadaí nó a n-ionad seirbhísí soláthraithe trealaimh áitiúil le haghaidh faisnéise faoin gcóras bailithe dramháila ina dtír féin.

**Greek:** Η οδηγία για τα ΑΗΗΕ της Ευρωπαϊκής Ένωσης απαιτεί τα προϊόντα που πωλούνται σε χώρες της ΕΕ να φέρουν στο προϊόν (ή σε ορισμένες περιπτώσεις) τη διαγραμμένη ετικέτα απορριμμάτων. Όπως ορίζεται στην οδηγία για τα ΑΗΗΕ, αυτή η ετικέτα διαχωριστικών απορριμμάτων απορριμμάτων σημαίνει ότι οι πελάτες και οι τελικοί χρήστες στις χώρες της ΕΕ δεν πρέπει να διαθέτουν ηλεκτρονικό και ηλεκτρικό εξοπλισμό ή εξαρτήματα στα οικιακά απορρίμματα. Οι πελάτες ή οι τελικοί χρήστες στις χώρες

της ΕΕ πρέπει να επικοινωνήσουν με τον τοπικό αντιπρόσωπο προμηθευτών εξοπλισμού ή το κέντρο εξυπηρέτησης πελατών για πληροφορίες σχετικά με το σύστημα συλλογής αποβλήτων στη χώρα τους.

**Maltese:** Id-direttiva tal-WEEE tal-Unjoni Ewropea tirrikjedi li l-prodotti mibjugha fil-pajjiżi tal-UE jrid ikollhom it-tikketta tal-kontenitur tal-iskart maqsuma fuq il-prodott (jew il-pakkett f'xi każijiet). Kif iddefinit mid-direttiva WEEE, din it-tikketta tal-kontenitur tal-iskart tfisser li l-konsumaturi u l-utenti finali fil-pajjiżi tal-UE m'għandhomx jiddisponu minn tagħmir jew aċċessorji elettronici u elettrici fi skart domestiku. Kliġenti jew utenti finali fil-pajjiżi tal-UE għandhom jikkuntattjaw ir-rappreżentant tal-fornitur tat-tagħmir lokali tagħhom jew iċ-ċentru tas-servizz għal informazzjoni dwar is-sistema tal-gbir tal-iskart f'pajjiżhom.

**Bulgarian:** Директивата на ЕС относно ОЕЕО изисква продуктите, продавани в страните от ЕС да имат символа със зачертания контейнер за отпадъци върху тях (или в определени случаи върху опаковката). Както е отредено от директивата относно ОЕЕО, символът със зачертания контейнер означава, че клиентите и крайните потребители в страните от ЕС не трябва да изхвърлят електронно и електрическо оборудване или електронни принадлежности в битовите отпадъци. Клиентите или крайните потребители в страните от ЕС трябва да се свържат с представителя на местния доставчик на оборудване или с центъра за информация относно системата за събиране на отпадъци в съответната страна.

**Polish:** Dyrektywa WEEE (ang. Waste of Electrical and Electronic Equipment / pol. zużyty sprzęt elektryczny i elektroniczny – utylizacja odpadów elektrycznych i elektronicznych) dotycząca Unii Europejskiej wymaga, aby produkty sprzedawane do krajów UE musiały mieć na każdym opakowaniu symbol przekreślonego kosza na śmieci, który oznacza selektywną zbiórkę urządzeń elektrycznych i elektronicznych. Informuje ona o tym, że dany sprzęt nie może zostać wyrzucony do zwykłego pojemnika na odpady. Elektroodpady należy pozostawiać wyłącznie w miejscach do tego przeznaczonych. W razie pytań klienci w krajach UE powinni skontaktować się z lokalnym przedstawicielem dostawcy sprzętu lub centrum serwisowym, aby uzyskać informacje na temat systemu zbiórki odpadów w ich kraju.

**Czech:** Směrnice WEEE Evropských unií vyžaduje, aby výrobky prodávané v zemích EU obsahovaly štítek s přeškrtnutým odpadním košem na výrobku (nebo v některých případech balení). Jak je definováno směrnici o OEEZ, tento štítek odpadkového koše znamená, že zákazníci a koncoví uživatelé v zemích EU by neměli likvidovat elektronická a elektrická zařízení nebo příslušenství domácího odpadu. Zákazníci nebo koncoví uživatelé v zemích EU by měli kontaktovat svého zástupce místního dodavatele zařízení nebo servisního střediska o informacích o systému sběru odpadu ve své zemi.

**Slovak:** Smernica o odpade z elektrických a elektronických zariadení v Európskej únii vyžaduje, aby výrobky predávané v krajinách EÚ obsahovali na výrobku (alebo v niektorých prípadoch) označenie přeškrtnutého odpadkového koša. Ako je definované v smernici o OEEZ, tento štítok s priečnym odpadom znamená, že zákazníci a koncoví užívatelia v krajinách EÚ by nemali likvidovať elektronické a elektrické zariadenia alebo príslušenstvo v domácom odpade. Zákazníci alebo koncoví užívatelia v krajinách EÚ by mali kontaktovať svojho zástupcu dodávateľa zariadenia alebo servisného strediska ohľadom informácií o systéme zberu odpadu vo svojej krajine.

**Slovenian:** Direktiva WEEE o evropskih unijah zahteva, da morajo imeti izdelki, prodani v državi EU, na izdelku označeno prečrtano oznako za smeti (ali pakiranje v nekaterih primerih). Kot določa direktiva WEEE, ta oznaka za smeti za smeti pomeni, da kupci in končni uporabniki v državah EU ne bi smeli odlagati elektronske in električne opreme ali dodatkov v gospodinjске odpadke. Stranke ali končni uporabniki v državah EU se morajo za informacije o sistemu zbiranja odpadkov v svoji državi obrniti na predstavnike

lokalnih dobaviteljev opreme ali na servisne centre.

**Hungarian:** Az Európai Unió WEEE-irányelv előírja, hogy az EU-ba értékesített termékeknek a terméken (vagy bizonyos esetekben a csomagoláson) meg kell jelölniük az áthúzott szemetet. Az elektromos és elektronikus berendezések hulladékairól szóló irányelvben meghatározottak szerint ez az áthúzódozó szemetgyűjtő címke azt jelenti, hogy az EU-országokban az ügyfelek és a végfelhasználók nem dobhatják el a háztartási hulladék elektronikus és elektromos berendezéseit vagy tartozékait. Az EU-országokban az ügyfelek vagy a végfelhasználók kapcsolatba kell lépniük a helyi berendezések beszállító képviselőjével vagy szervizközpontjával, hogy tájékozódjanak az országuk hulladékgyűjtő rendszeréről.

**Romanian:** Directiva Uniunii WEEE privind DEEE impune ca produsele vândute în țările UE să aibă eticheta trasată a coșului de gunoi pe produs (sau ambalajul în unele cazuri). Așa cum este definită de directiva WEEE, această etichetă de coș de gunoi înseamnă că clienții și utilizatorii finali din țările UE nu ar trebui să dispună de echipamente și accesorii electronice și electrice în deșeurile menajere. Clienții sau utilizatorii finali din țările UE ar trebui să contacteze reprezentantul local al furnizorului de echipamente sau centrul de service pentru informații despre sistemul de colectare a deșeurilor din țara lor.

**Estonian:** Euroopa Liidu WEEE direktiiviga nõutakse, et ELi riikidesse müüdatavatel toodetel peab olema toote (või mõnel juhul pakendi) läbimõeldud prügikasti märgis. Vastavalt elektri- ja elektroonikaseadmete jäätmete direktiivis määratletule tähendab see, et see prügikasti märgis tähendab, et ELi liikmesriikide kliendid ja lõppkasutajad ei tohi elektroonikaseadmeid ega elektriseadmeid ega majapidamisjäätmete tarvikuid kõrvaldada. ELi riikide kliendid või lõppkasutajad peaksid võtma ühendust oma kohaliku varustuse esindaja või teeninduskeskusega, et saada teavet oma riigi jäätmekogumissüsteemi kohta.

**Lithuanian:** Europos Sąjungos WEEE direktyvoje reikalaujama, kad į ES šalis parduodami produktai turėtų būti paženklinti šiukšliadėžės etiketė ant gaminio (arba kai kuriais atvejais pakuotės). Kaip apibrėžta EEĮ atliekų direktyvoje, ši kryžminė šiukšlių dėžės etiketė reiškia, kad klientai ir galutiniai vartotojai ES šalyse neturėtų šalinti buitinių atliekų elektronikos ir elektros įrangos ar priedų. Klientai ar galutiniai vartotojai ES šalyse turėtų kreiptis į savo vietinį įrangos tiekėją arba paslaugų centrą, kad gautų informacijos apie atliekų surinkimo sistemą savo šalyje.

**Latvian:** Eiropas Savienības WEEE direktīvā ir noteikts, ka ES valstīs pārdotajiem izstrādājumiem (vai dažos gadījumos iepakojumam) jābūt marķējumam, kas ir šķērsojis atkritumu tvertni. Kā noteikts EEI A direktīvā, šis šķērsošanas atkritumu tvertnes marķējums nozīmē, ka klienti un galalietotāji ES valstīs nedrīkst atbrīvoties no elektroniskajām un elektriskajām iekārtām vai piederumiem sadzīves atkritumos. Klientiem vai galalietotājiem ES valstīs jāsazinās ar vietējo iekārtu piegādātāju pārstāvi vai pakalpojumu centru, lai iegūtu informāciju par atkritumu savākšanas sistēmu savā valstī.

**Turkish:** Avrupa Birliği Sendikaları WEEE yönergesi, AB ülkelerine satılan ürünlerin, ürün üzerinde (veya bazı durumlarda paketin üzerinde çarpı işareti bulunan çöp kutusu etiketi) bulunmasını gerektirir. WEEE yönergesinde tanımlandığı gibi, bu çarpı işaretli çöp kutusu etiketi, AB ülkelerindeki müşterilerin ve son kullanıcıların elektronik ve elektrikli ekipmanı veya aksesuarları evsel atıklarla birlikte atmaması gerektiği anlamına gelir. AB ülkelerindeki müşteriler veya son kullanıcılar, ülkelerindeki atık toplama sistemi hakkında bilgi için yerel ekipman tedarikçisi temsilcisine veya servis merkezine başvurmalıdır.

For all other countries: Please adhere to local recycling laws for packaging materials.

13

**FCC COMPLIANCE**

This device complies with part 15 of the FCC rules. The operation of this device is subject to the following two conditions:



- This device may not cause harmful interference, and must accept any interference received, including interference that may cause undesired operation.
- This device was not modified different than described explicitly in this user manual.

**Note:** This device was tested and approved to the limitations for class B of digital devices according to part 15 of the FCC rules. This limitations should ensure an adequate protection against harming interferences in residential areas. However, a warranty for not-occurring of interferences is not assumed.

Do not modify the device different than described explicitly in this user manual. Nevertheless, if you do modifications different from the described in this manual you can be determined to stop the operation of the device.

14

**CE COMPLIANCE**

This device complies with the European product regulations according to CE regulations.



The CE regulations contain basic requirements for safe usage of technical products.

## 15

## WARRANTY

Endor® AG („Endor“) warrants to the original purchaser that the Fanatec® product, which includes components contained in the retail box with this product will be free from material defects in material and workmanship for a period of one year from the original date of purchase (the “Warranty Period”). This warranty is valid in the country where the product was purchased. **If this product is determined to be materially defective during the warranty period, your sole remedy and Endor’s sole and exclusive liability is limited to the repair or replacement of this product with a factory-recertified product, at Endor’s option.** For purposes of this Limited Hardware Warranty and Liability, “factory recertified” means a product that has been returned to its original specifications.

**This warranty does not apply if this product**

- a) **is used with products that are not expressly declared in the product descriptions as compatible with this product;**
- b) **is used with peripherals Endor does not license, expressly approve or sell. This includes non-licensed hardware enhancement devices, controllers, adaptors, and power supply devices (“non-licensed/non-approved peripherals”);**
- c) **is used for any commercial purpose, including rental or arcade purposes;**
- d) **is modified or tampered with contrary to the operating and maintenance instructions;**
- e) **is damaged by the acts of God (natural disasters), negligence, accidents, wear and tear, unreasonable use, or by causes unrelated to defective materials or workmanship;**
- f) **has the serial number altered, defaced or removed (where applicable);**
- g) **has the warranty seal altered, defaced or removed (where applicable).**

**This warranty does not cover consumables (such as batteries) or products sold and clearly marked “AS IS” or with faults. Endor may void this warranty if:**

- 1) **Endor reasonably believes that the product has been used in a manner that violates the terms of a separate end user agreement for firmware, system software or game software;**
- 2) **the product is used with non-licensed/non-approved peripherals. Consumer assume all risks and liabilities associated with use of third-party products.**



This warranty is provided to you in lieu of all other express or implied warranties. This includes warranties of merchantability and fitness for a particular purpose for this product, which Endor disclaims under these terms. However, if applicable law requires any of these warranties, then they are limited in duration to the warranty period.

Except as expressly stated above, Endor excludes all liability for loss of data, loss of profit, or any loss or damage suffered by you or any third party, whether those damages are direct, indirect, consequential, special, or incidental and however arising under any theory of law, as a result of using this product. Some states or provinces do not allow limitations on how long an implied warranty lasts and some states do not allow the exclusion or limitations of consequential or incidental damages, so these limitations or exclusions may not apply to you. This warranty gives you specific legal rights. You may also have other rights which vary from state to state or province to province. The warranty offered by Endor on this product is the same whether or not you register your product.

This warranty does not apply to any system software / firmware that is pre-installed in the purchased product, or is subsequently provided via update or upgrade releases. In case of issues apparently related to system software / firmware as well as any other product related issues, Endor recommends checking the FAQ database at [www.fanatec.com](http://www.fanatec.com) to see if your problem can be solved there.

Manufactured by



Fanatec® is a registered trademark of Endor AG  
Designed and developed by Endor AG in Germany  
Seligenthaler Straße 16 a - 84034 Landshut - Germany  
Telephone: +49 (871) 9221-122 Fax: +49 (871) 9221-221  
Email: [info.webshop@fanatec.com](mailto:info.webshop@fanatec.com)  
Website: [www.fanatec.com](http://www.fanatec.com) - [www.endor.ag](http://www.endor.ag)



Made in China

Contact | Запитати:  
Endor AG  
Seligenthaler Straße 16 a - 84034 Landshut - Germany  
Telephone | Телефон: +49 (871) 9221-122  
Email | Електронна пошта: [info.webshop@fanatec.com](mailto:info.webshop@fanatec.com)  
Цей продукт відповідає вимогам RoHS  
(Директива ЄС 2011/65 / ЄС).

05/2020