

Table of Contents

1. Introduction	2
1.1 Preface.....	2
1.2 Packing List.....	3
1.3 Cautions.....	3
1.4 Connection.....	5
1.5 Power On / Off.....	10
1.6 Menu Language.....	10
1.7 HDD Format.....	10
2. About AC Ryan PLAYON!HD	12
2.1 Remote Control.....	12
2.2 Front Panel.....	14
2.3 Rear Panel.....	14
2.4 Side Panel.....	14
3. Setup Menu	16
3.1 Changing Audio Settings.....	16
3.2 Changing Video Settings.....	17
3.3 Changing Network Settings.....	17
3.4 Changing System Settings.....	21
3.5 Miscellaneous.....	22
4. Browser Menu	24
4.1 Browsing All.....	24
4.2 Browsing Music.....	25
4.3 Browsing Photos.....	25
4.4 Browsing Movies.....	26
4.5 A/V Streaming via Network.....	27
4.6 A/V Streaming via UPnP-server.....	28
4.7 Renaming / Deleting Files.....	30
4.8 Managing the Playlist.....	31
5. File Copy Menu	33
6. Internet Radio	34
7. Web Server & BitTorrent	35
7.1 Web Server (unicgi).....	35
7.2 Account Management.....	35
7.3 Visit Neighbor (samba).....	36
7.4 BitTorrent Download (btpd).....	36
8. Upgrading the Firmware	39
9. Appendixes	40
9.1 Specifications.....	40
9.2 Frequently Asked Questions.....	40
9.3 Copyrights and Trademarks.....	43
9.4 Warranty.....	43
9.5 GPL Statement.....	43

1. Introduction

1.1 Preface

Thank you very much for purchasing our AC Ryan ACR-PV73100 Playon!HD media player. We hope you will enjoy using it as a great home entertainment device. This player has the following functionality.

A/V Output

- HDMI V1.3 for high-definition video and digital audio
- Composite & component video and stereo audio for analog audio-visual connection
- S/PDIF coaxial & optical interface for high-fidelity digital audio
- Adjustable video output resolution (NTSC, PAL, 480p, 576p, 720p, 1080i, 1080p)

Multimedia Playback

- Supports major audio, video and image file formats (1080p HD video decoding)
- Movie format: AVI/MKV/TS/TP/TRP/M2TS/MPG/MP4/M4V/MOV/VOB/ISO/IFO/DAT/WMV/ASF/RM/RMVB/FLV
- Music format: MP3/OGG/WMA/WAV/AAC/FLAC
- Photo format: HD JPEG/BMP/GIF/TIF/PNG
- Photo slide show with background music

Network Feature

- A/V streaming/transmission via Ethernet (10M/100M) & Wi-Fi (802.11b/g/n, optional)
- File sharing via Samba server
- A/V streaming via UPnP Media Server
- BitTorrent download (controlled and managed via web server)
- Digital Radio (SHOUTcast)

File Copy

- Supports copying & moving files among Card, USB, HDD, and Network

USB 2.0 Support

- USB DEVICE port (for computer connection)
- USB HOST port x 2 (for USB storage devices)

Note: All the information contained in this manual was correct at the time of publication. However, as our engineers are always updating and improving the product, your device's software may have a slightly different appearance or modified functionality than presented in this manual.

1.2 Packing List

Part	Quantity
Player	1
A/V cable	1
Y/Pb/Pr cable	1
USB cable	1
Remote Control	1
Remote Control Battery	2
AC/DC adaptor	1
AC/DC adaptor Power Cord	1
Quick Installation Guide	1
User Manual (printed)	1
HDMI cable	1 (optional)
802.11b/g/n Wireless LAN USB adapter	1 (optional)

Note:

The actual contents in the package might be different from the packing list in this manual.

1.3 Cautions

This player's design and manufacture has your safety in mind. In order to safely and effectively use this player, please read the following before usage.

1.3.1 Usage Cautions

User should not modify this player. If commercial hard disk is being used, the environmental temperature should be within +5°C ~ +35°C.

1.3.2 Power

The player's power voltage: DC 12V.

When using this player, please connect the supplied AC adapter or AC adapter cable to the player's power jack. When placing the adapter cable, make sure it can not get damaged or be subject to pressure. To reduce the risk of electric shock, unplug the adapter first before cleaning it. Never connect the adapter to the player in a humid or dusty area. Do not replace the adapter or cable's wire or connector.

1.3.3 Radio Interference

- If not properly shielded, almost all electronic devices will get radio interference. Under some conditions, your player might get interference.

- The design of this player has followed the FCC/CE standard, and has followed the following rules:

- (1) This player may not cause harmful interference;
- (2) This player could accept some interference received including interference that may cause undesired operation.

1.3.4 Repair

If the player has a problem, you should take it to an appointed repair center and let the specialists do the repair, never repair the player yourself, you might damage the player or endanger yourself or your data.

1.3.5 Disposing of the Player

When you dispose of the player, be sure to dispose it appropriately. Some countries may regulate disposal of electrical device, please consult with your local authority.

1.3.6 Hard Disk Cautions

The player uses an internal hard disk for data storage, in normal case, format or repair is not required.

You should carefully read the < Frequently Asked Questions > chapter, and check our website for latest information before formatting the hard disk.

- Physical impact may create bad sector in the hard disk, you can use CHKDSK to fix the problem.
- All data stored in the player may be lost due to physical impact, electrical shock, power lost, HDD format etc. Please backup your data.
- It is suggested to do defragment after a long period of usage.
- Regularly backup the data in the hard disk so that it can be recovered in the event of data corruption or loss. Our company takes no responsibility for loss of data stored on the hard disk.

1.3.7 Others

When using this player, please do not let the player come into contact with water or other liquid, if water is accidentally spilled on the player, please use a dry cloth to absorb the spillage.

Electronic products are vulnerable, when using please avoid shaking or hitting the player, and do not press the buttons too hard.

- ✧ Do not let the player come into contact with water or other liquid.
- ✧ Do not disassemble the player, repair the player or change the design of the player, any damage done will not be included in the repair policy.
- ✧ Do not press the buttons of the player too hard.
- ✧ Avoid hitting the player with hard object, avoid shaking the player, and stay away from magnetic fields.
- ✧ During electrostatic discharge and the strong electromagnetic field, the product will malfunction, then unplug the power cable and the product will return to normal

performance next time it is powered on.

1.4 Connection

1.4.1 Connecting the Power Supply

- (1) Follow the picture and connect the AC adaptor to the player's DC IN jack;
- (2) Follow the picture and plug in the AC adaptor to the power outlet.

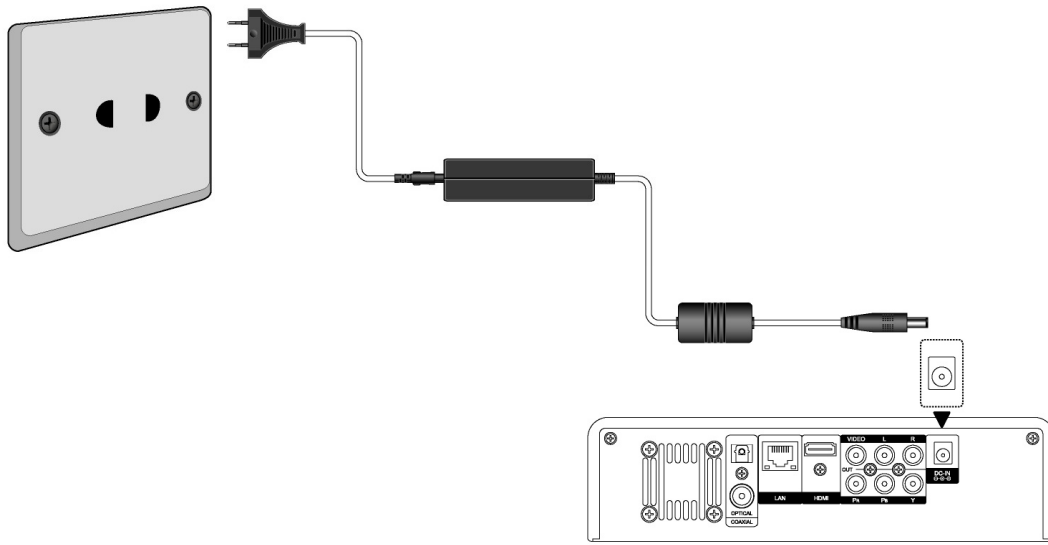

1.4.2 Connecting to a PC

- (1) Make sure the player is powered on;
- (2) Plug in the squarish connector (B-Male) USB cable to this player's USB DEVICE port;
- (3) Plug in the rectangular connector (A-Male) of the USB cable to computer.

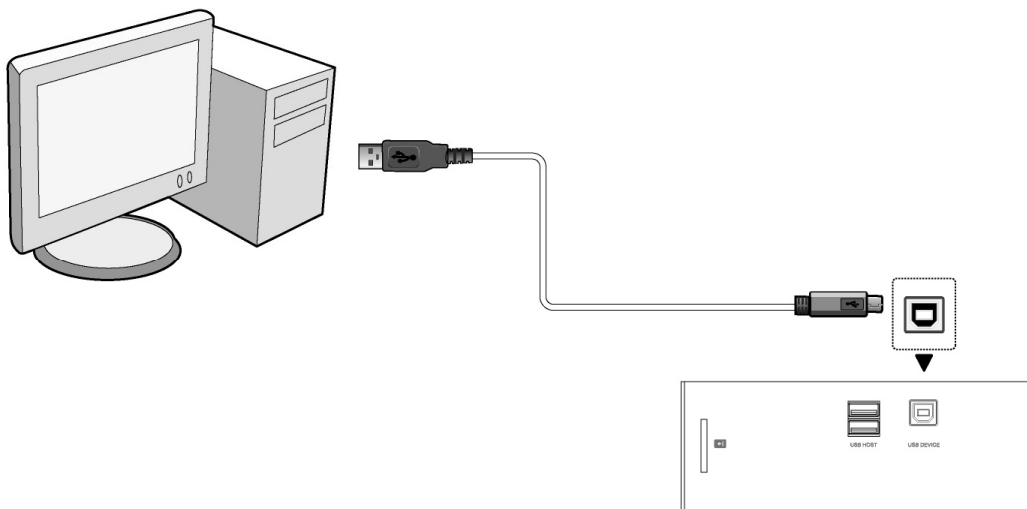

In this way, you can manage content on the built-in HDD of the player on your local PC.

1.4.3 Connecting a USB Device

- (1) Make sure the player is powered on;
- (2) Plug in the USB stick or USB HDD etc. to the USB HOST port of this player.

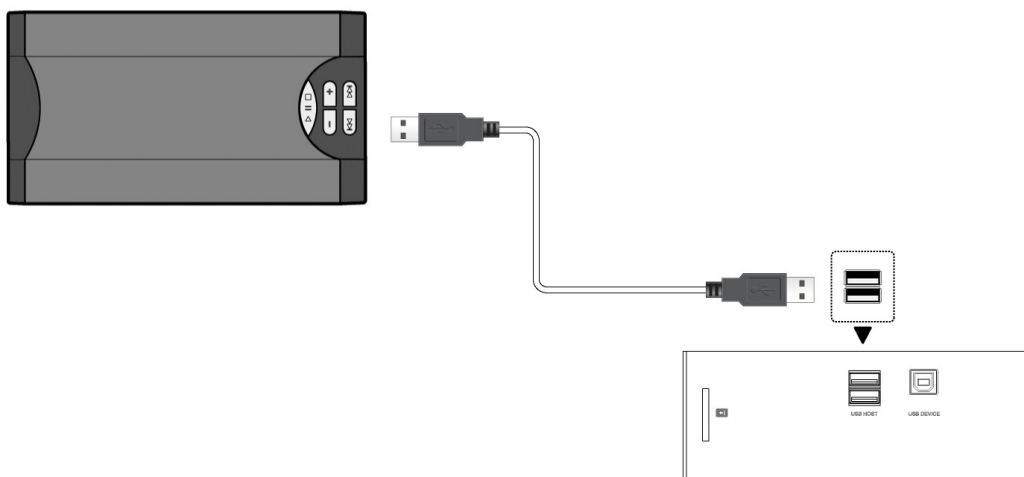

In this way, you can browse contents on the USB device.

1.4.4 Connecting a Memory Card

Memory card can be used by inserting to the card slot

- (1) Follow the picture to insert the memory card to the card slot properly;
- (2) Insert the card by following the arrow pointer in the picture.

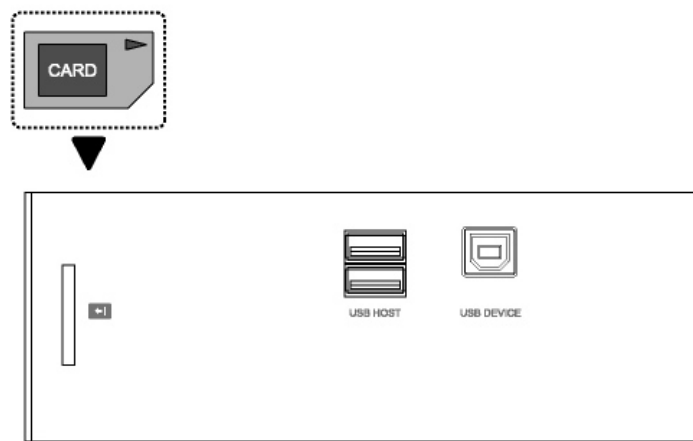

In this way, you can browse contents on the memory card.

1.4.5 Connecting to a TV

1.4.5.1 A/V OUT

- (1) Follow the picture and plug in the 3 color connector to the player's A/V OUT jack;

- (2) Follow the picture and plug in the 3 color connector to the TV's A/V IN jack.
- In this way, you can enjoy the content in the player on TV or other display devices.

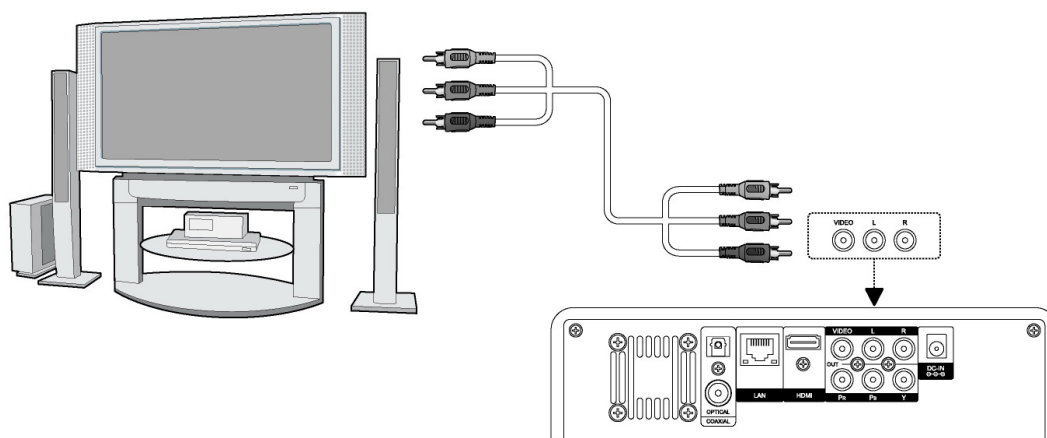

1.4.5.2 Y/Pb/Pr Component OUT

- (1) Follow the picture and plug in the 3 color connector to the player's Y/Pb/Pr jack;
- (2) Follow the picture and plug in the 3 color connector to the TV's Y/Pb/Pr jack.

Audio Connection while using Y/Pb/Pr Video out:

First method: use the audio output from the A/V OUT jack;

Second method: use the audio output from the S/PDIF Coaxial or Optical jack.

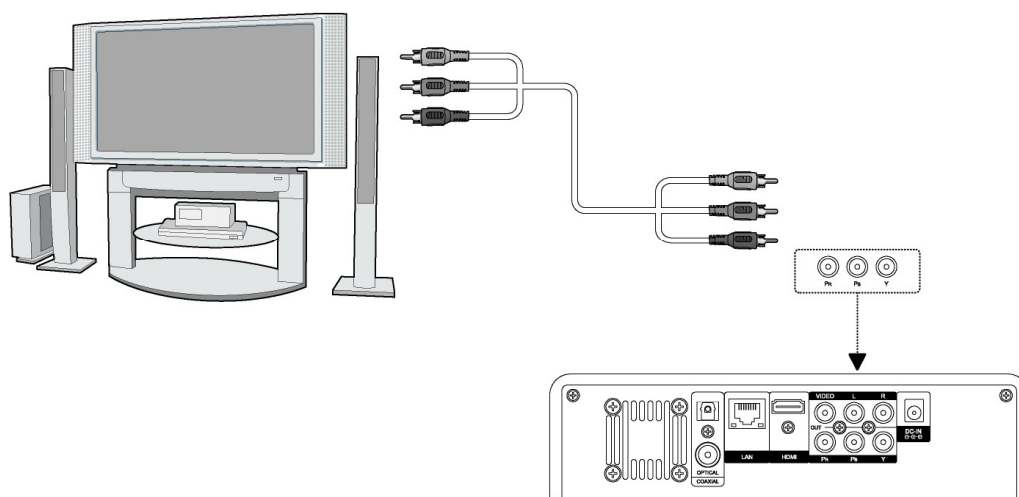

In this way, you can also enjoy videos, music, and photos in the player on TV.

1.4.5.3 HDMI OUT

- (1) Follow the picture and plug one connector on your HDMI cable to the player's HDMI jack;
- (2) Follow the picture and plug the other connector on your HDMI cable to the TV's HDMI jack.

Note: The HDMI cable is an optional accessory sold separately.

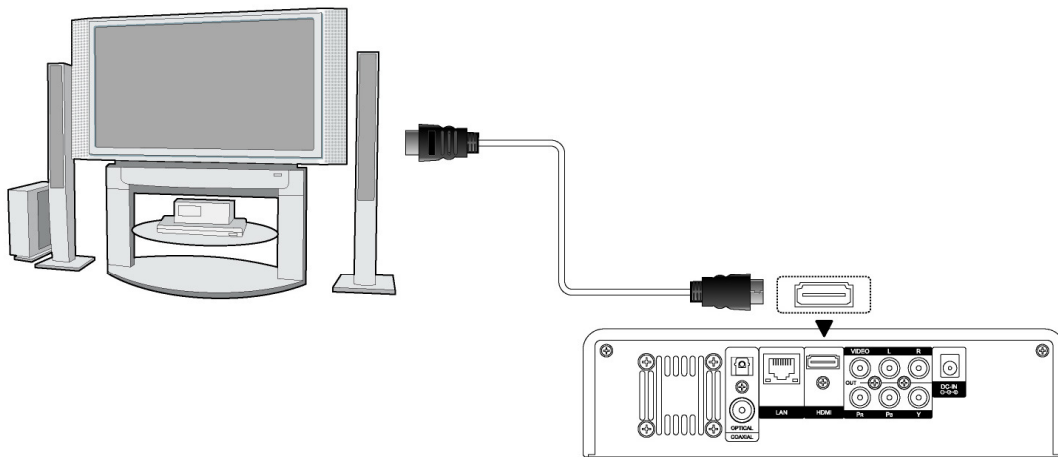

In this way, you can have the highest quality video and audio via a single cable.

1.4.6 Connecting to an Digital Amplifier

- (1) Follow the picture and plug in the RCA connector on your coaxial cable to the player's S/PDIF Coaxial jack. Or if you use optical fiber, please plug in the Toslink connector on your optical fiber to the player's S/PDIF Optical jack;
- (2) Follow the picture and plug in the other connector on your coaxial cable or optical fiber to the digital audio device (digital amplifier or decoder).

Note: Optical fiber and coaxial cable are not supplied.

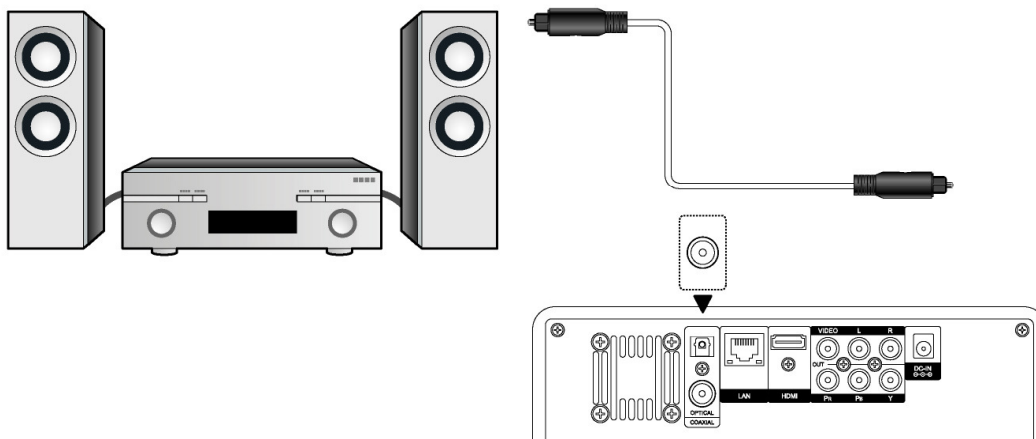

In this way, you can enjoy powerful Dolby Digital, DTS, or MPEG sound. (Please refer to '**3.1 Changing Audio Settings**' for configuration)

1.4.7 Connecting to a LAN

To connect to a LAN (Local Area Network) you require a cat5, cat5e or cat6 network cable (not supplied).

- (1) Connect one of the crystal plugs on the cable to the player's RJ45 LAN socket;
- (2) Connect the other crystal plug on the cable to a RJ45 LAN port on your router, switch, or hub devices.

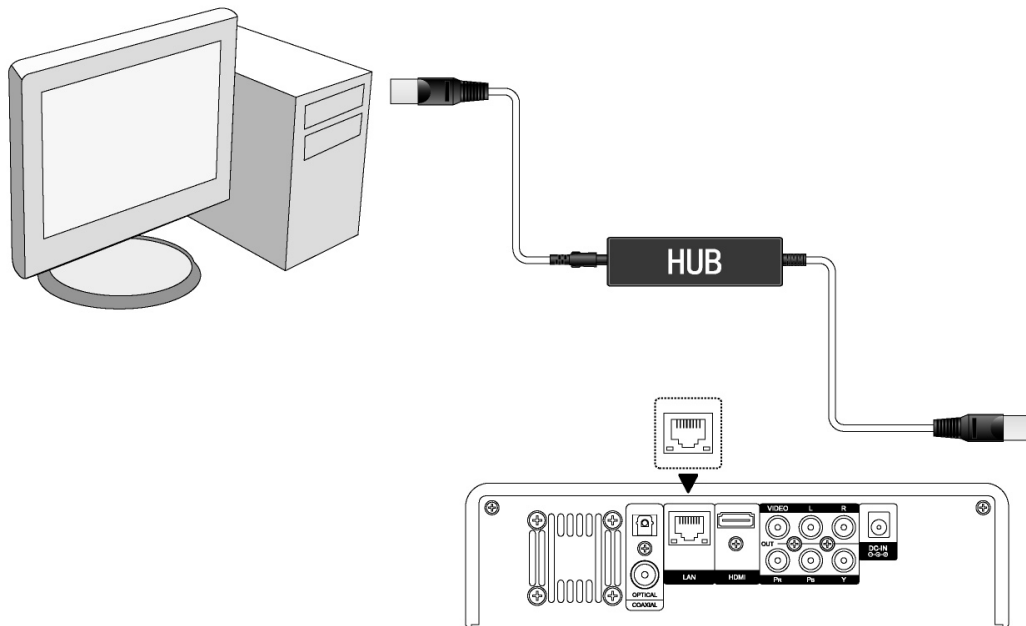

1.4.8 Connecting to a WLAN

- (1) Make sure the player is powered on;
- (2) Plug the Wireless LAN USB Adapter (i.e. Wi-Fi USB Dongle) to the USB HOST port of the player.

Note: The Wi-Fi Dongle is an optional accessory sold separately. (Please refer to '3.3 *Changing Network Settings*' for more details about wireless setup)

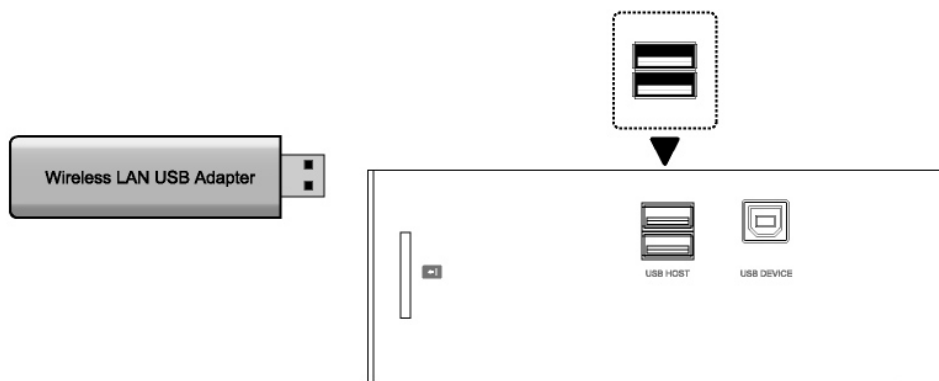

1.5 Power On / Off

Power On

After connecting the DC IN jack and press the power button on the front panel, the player will soon enter the home screen, and the power indicator will turn blue.

Power Off

Press the power button on the front panel, the player will soon enter standby mode, and the power indicator will turn red. Then unplug the power cord to cut off the power supply.

1.6 Menu Language

The system language of this player can be set to English or other languages. Change the language you wish in the setup menu, the selected language will take effect immediately.



1.7 HDD Format

For users who wish to install a new SATA HDD into the player, please refer to the following procedures to format the hard disk on the player before usage.

- Step 1: Select **OK** on the **Warning** page, press **ENTER** to confirm.

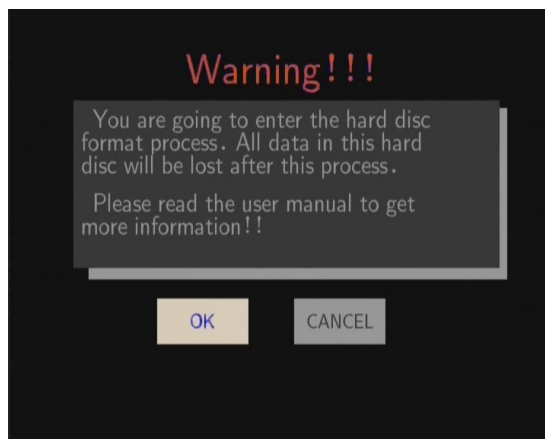

Note: This page can be also accessed via **Setup->System->HDD Format** menu.

- Step 2: Select **Format**, press **ENTER**, and then hard disk format will start.

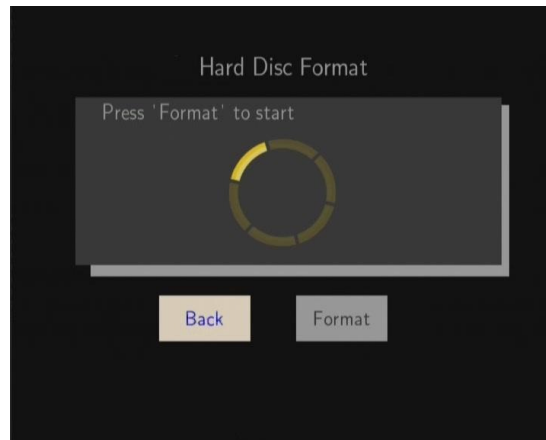

The formatting procedure will be finished within a few minutes. And then you can use the hard disk properly on the player.

Note: HDD format will remove all data stored on the hard disk drive. Please take care and backup your data in advance!

2. About AC Ryan PLAYON!HD

2.1 Remote Control

All procedures in this manual can be carried out using the remote control buttons. See the following for details on each button and its function:

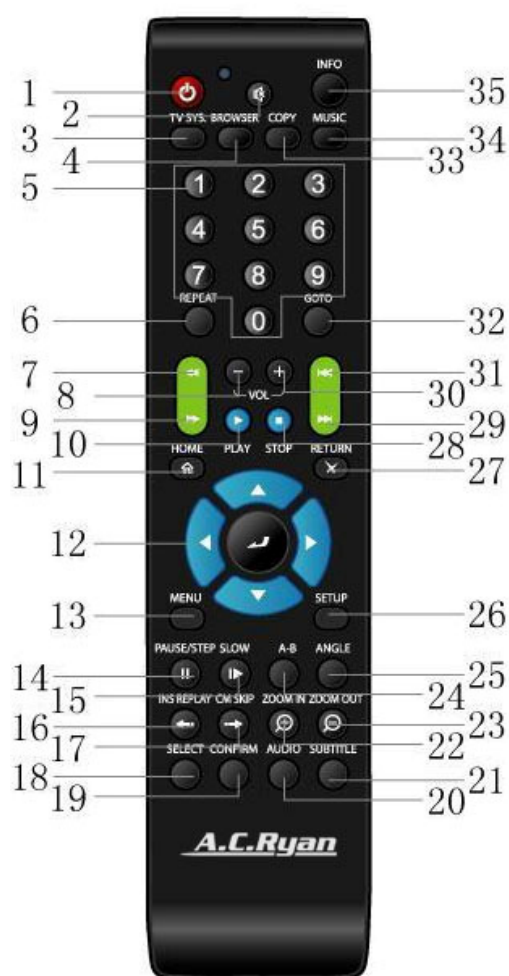

- | | |
|--------------------|--------------------------|
| 1. STANDBY | 2. MUTE |
| 3. TV SYSTEM | 4. BROWSER |
| 5. Numeric buttons | 6. REPEAT |
| 7. FR | 8. VOL- |
| 9. FF | 10. PLAY |
| 11. HOME | 12. Navigational buttons |
| 13. MENU | 14. PAUSE/STEP |
| 15. SLOW | 16. INS REPLAY |
| 17. CM SKIP | 18. SELECT |
| 19. CONFIRM | 20. AUDIO |
| 21. SUBTITLE | 22. ZOOM IN |
| 23. ZOOM OUT | 24. A-B |
| 25. ANGLE | 26. SETUP |
| 27. RETURN | 28. STOP |
| 29. NEXT | 30. VOL+ |
| 31. PREV | 32. GOTO |
| 33. COPY | 34. MUSIC |
| 35. INFO | |

No.	Button	Function
1	STANDBY	Press to enter standby mode or wake up.
2	MUTE	Press to mute audio output, and press again to resume.
3	TV SYSTEM	Press to switch between NTSC, PAL, 480P, 576P, 720P, 1080I, and 1080P.
4	BROWSER	Press to enter the browser menu.

5	Numeric buttons	Press to enter numeric input when changing settings.
6	REPEAT	Press to set repeat option: One, All, (and Shuffle).
7	FR	Press to fast rewind the current playback. Press repeatedly to select speeds.
8	VOL-	Press to decrease the volume.
9	FF	Press to fast forward the current playback. Press repeatedly to select speeds.
10	PLAY	Press to begin playback.
11	HOME	Press to enter the home screen.
12	Navigational buttons	Press the arrow buttons to select menu options, and the ENTER button to confirm.
13	MENU	Press to activate tools menus: <ul style="list-style-type: none"> ● Press in the browser menu to rename and delete files. ● Press in My_Shortcuts in NET of the browser menu to add shortcuts for network access.
14	PAUSE/STEP	Press to pause the current playback. Press again to step to the next frame. Press the PLAY button to resume playback.
15	SLOW	Press to play back in slow motion. Press the PLAY button to resume regular playback.
16	INS REPLAY	Press to backward 10 seconds of the current playback, which suitable for sport programs.
17	CM SKIP	Press to advance 30 seconds of the current playback.
18	SELECT	Press to select files in browser and file copy menu.
19	CONFIRM	Press to confirm and add the selects to the playlist.
20	AUDIO	Press to select an audio track.
21	SUBTITLE	Press to set subtitle options.
22	ZOOM IN	Press to zoom in the image (photo or video).
23	ZOOM OUT	Press to zoom out the image (photo or video).
24	A-B	Press to set the beginning and end points of a section to repeat.
25	ANGLE	Press to change the view angle during DVD (with multi-angle) playback.
26	SETUP	Press to enter the setup menu.
27	RETURN	Press to return to the previous screen while navigating menus.
28	STOP	Press to stop playback.
29	NEXT	Press to view the next file / page down.

30	VOL+	Press to increase the volume.
31	PREV	Press to view the previous file / page up.
32	GOTO	Press to jump to a specific point on a title. Specify the point using Title, Chapter and Time.
33	COPY	Press to enter the file copy menu.
34	MUSIC	Press to start playing music in the music playlist.
35	INFO	Press to hide or display the information bar during playback.

2.2 Front Panel

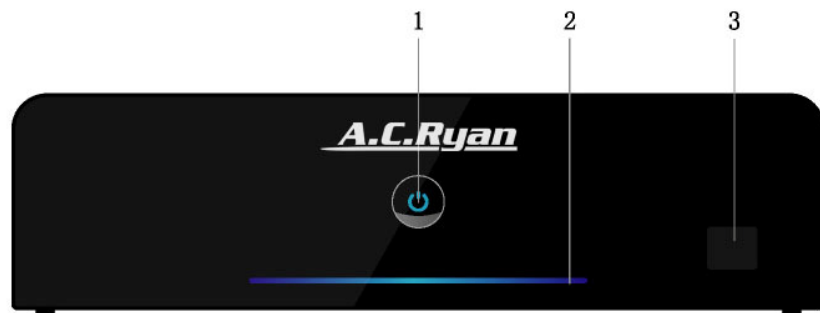

- 1. Power button & indicator
- 2. Working indicator
- 3. Infrared receiver window

2.3 Rear Panel

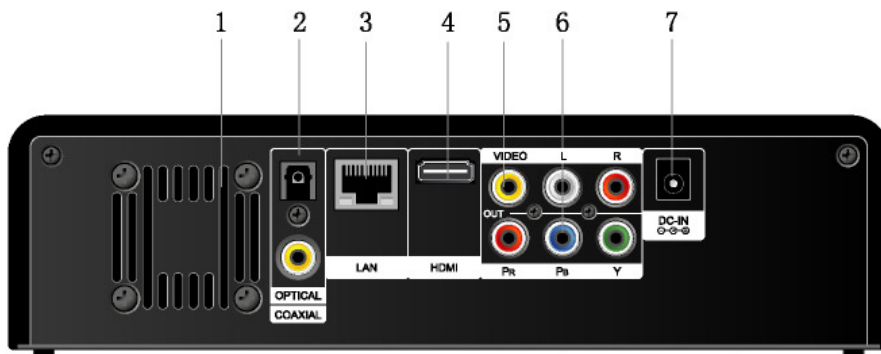

- 1. Air Flow hole
- 2. S/PDIF OPTICAL / COAXIAL jack
- 3. RJ45 LAN socket
- 4. HDMI jack
- 5. A/V OUT jack
- 6. Y/Pb/Pr OUT jack
- 7. DC IN jack

2.4 Side Panel

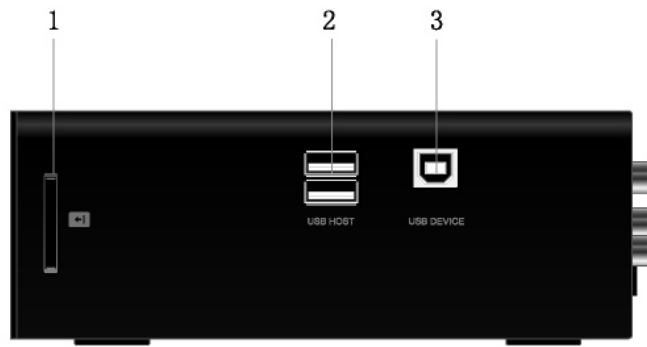

- 1. Memory Card slot
- 3. USB DEVICE port (B-Type)

- 2. USB HOST port (A-Type) x 2

3. Setup Menu

The Setup menu allows you to personalize and configure the preferences for your player.

To select a Setup option:

- Select the **Setup** icon on the home screen, or press the **SETUP** button on the remote control.



- Use the **LEFT/RIGHT** navigational buttons to select an option, and then press **ENTER**.

There are five Setup options, including **Audio**, **Video**, **Network**, **System**, and **MISC**. Use the **UP/DOWN** navigational buttons to select a menu. Press **ENTER** to confirm. Press **RETURN** to cancel and display the previous menu screen.

3.1 Changing Audio Settings

Use this menu to configure audio settings.

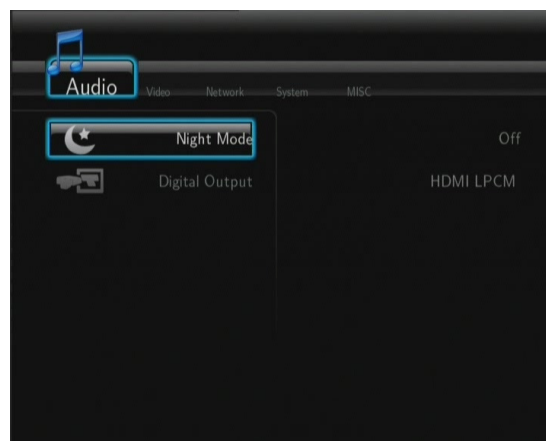

Night Mode

- Choose between **Off** / **On** / **Comfort**. If the option is turned on, the audio output volume

will be decreased to make you more comfortable.

Digital Output

- Choose between **HDMI LPCM / HDMI RAW / SPDIF LPCM / SPDIF RAW**. In raw mode, Dolby Digital, DTS, or MPEG sound can be bypassed to the HDMI TV or Digital amplifier.

3.2 Changing Video Settings

Use this menu to configure video settings.

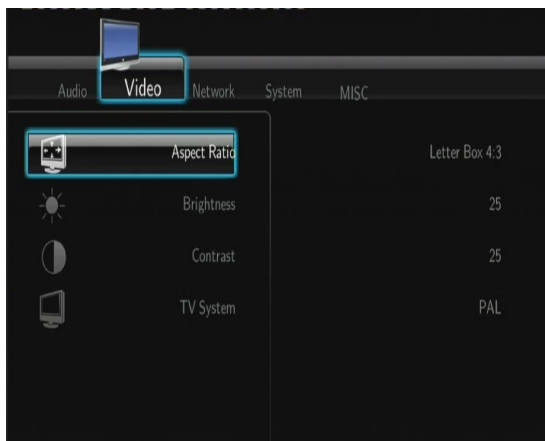

Aspect Ratio

- **Pan Scan 4:3**: Display a wide picture on the entire screen and cuts off the redundant portions. Select when a standard 4:3 TV is connected.
- **Letter Box 4:3**: Display a wide picture with two black borders on the top and bottom of 4:3 screen. Select when a standard 4:3 TV is connected.
- **16:9**: Compress the image to convert the whole image. Select when a 16:9 TV is connected.

Brightness

- Adjust the level of brightness.

Contrast

- Adjust the level of contrast.

TV SYSTEM

- Select to adjust video output resolution: **NTSC / PAL / 480P / 576P / 720P 50HZ / 720P 60HZ / 1080I 50HZ / 1080I 60HZ / 1080P 50HZ / 1080P 60HZ**.

3.3 Changing Network Settings

Use this menu to configure Ethernet and WLAN (Wireless Local Area Network) settings.

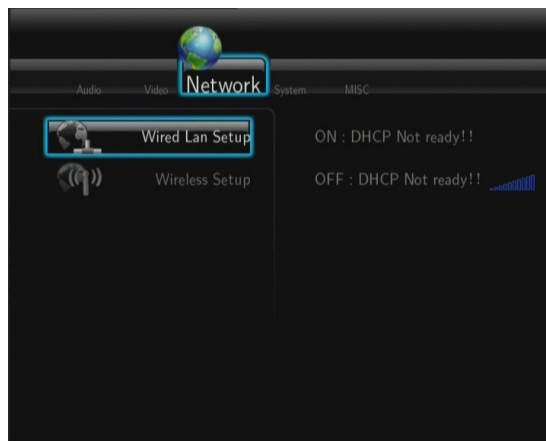

Wired LAN Setup

- **DHCP IP (AUTO)**
Select to obtain IP address automatically.
- **FIX IP (MANUAL)**
Select to manually input the IP Address, Subnet Mask, Default Gateway, and DNS Server IP Address.

Wireless Setup

- **Selecting a connection profile**

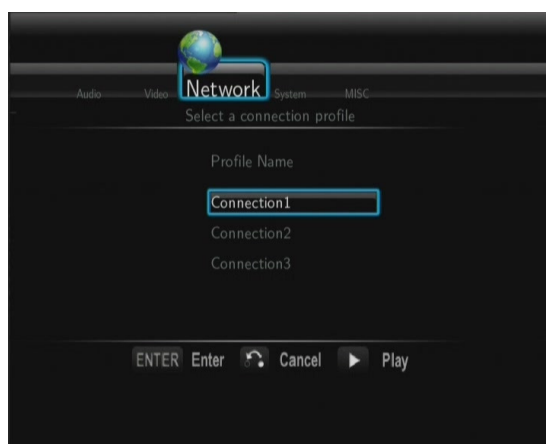

This player can store up to three wireless network connections. Press **ENTER** to go to next step, press **RETURN** to cancel, and press **PLAY** to connect.

- **Get Connection Mode**



Choose between **Infrastructure (AP)** and **Peer to Peer (Ad Hoc)**. Press **ENTER** to go to next step, and press **RETURN** to cancel.

- **Infrastructure (AP)**

Infrastructure mode is used to connect computers with wireless network adapters, also known as wireless clients, to an existing wired network with the help from wireless router or access point.

Get SSID Name



Press **ENTER** to go to next step, press **RETURN** to cancel, and press **SELECT** to refresh the SSID list.

Note: In the Security list, **WEP** (Wired Equivalent Privacy) and **WPA** (Wi-Fi Protected Access) means the network is encrypted, i.e. an encryption key is needed to access the network. **NONE** means it is an open system network.

Input WEP / WPA Key

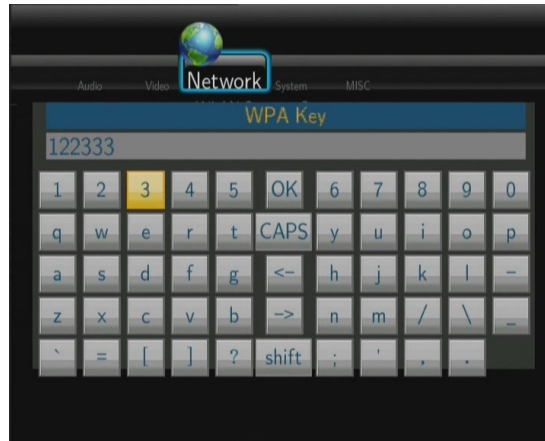

Encryption keys can be inputted via the virtual keyboard. Press the navigational buttons to select, **ENTER** to input, **CAPS** to switch between uppercase and lowercase, **<-** to delete a character, **->** to insert a space, **shift** to make more symbols available, and **OK** to confirm.

Test connection

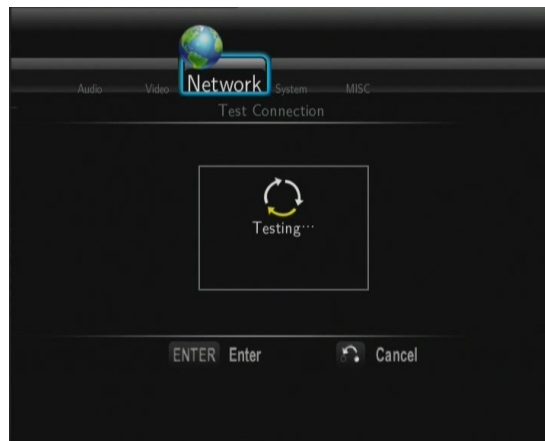

The testing process will take for a while, please be patient to wait. If the test is ok, the network information (Profile Name, IP address, Subnet Mask, Gateway, etc.) will be displayed on the screen.

- Peer to Peer (Ad Hoc)

Peer to Peer mode, which is also called Ad Hoc mode or computer-to-computer mode, is used to connect wireless clients directly together, without the need for a wireless router or access point.

Ad-Hoc Setup



Press **ENTER** to go to next step, press **RETURN** to cancel, and press **PLAY** to connect.

3.4 Changing System Settings

Use this menu to configure system settings.

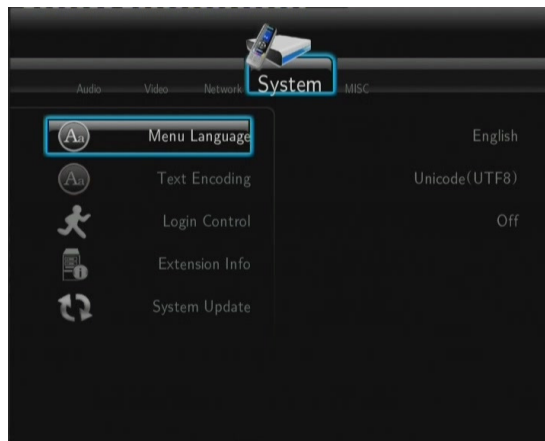

Menu Language

- Select to choose the OSD (On-Screen Display) language.

Text Encoding

- Select to set the text encoding option (subtitle display).

Login Control

- Select to turn on / off password protect for the Web server (Neighbor Web).

Extension Info

- Select to install / upgrade / uninstall extended packages: btpd (BitTorrent Protocol Daemon), samba (file sharing), and unicgi (Web server).
- **Install / Upgrade**

- 1) Copy the .ipk files (e.g., btpd_0.0.1_mipsel.ipk, samba_3.0.23c_mipsel.ipk, and unicgi_0.0.1_mipsel.ipk) to the root directory of a USB stick, and insert it to the USB HOST port on the player.
- 2) Select **Install / Upgrade** and press **ENTER** to confirm.

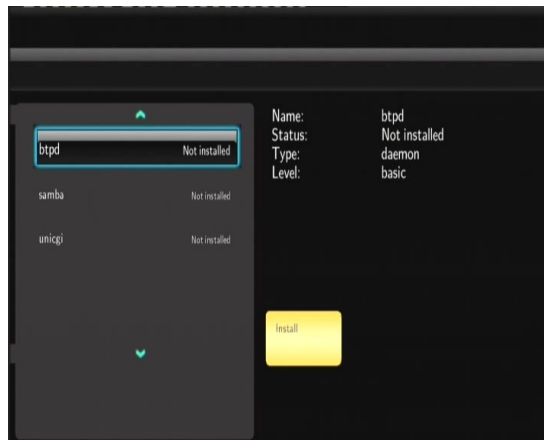

- **Uninstall**

Select **Uninstall** and press **ENTER** to confirm.

Note: When the packages are installed properly, you can click **Run / Stop** to control the BitTorrent, samba, and Web server services.

System Update

- Select to update the firmware or extension package via a USB stick.
 - 1) Copy 'install.img' or extension files to the root directory of a USB stick, and connect it to the USB HOST port of the player.
 - 2) Press **ENTER** to confirm.

HDD Format

- Select to format the built-in HDD.

Note: Please take care that all data on the hard disk will be removed after formatting.

System Info

- Select to view system information (firmware version, HDD info, Mac address, etc.)

Restore Default

- Select to restore factory defaults.

3.5 Miscellaneous

Use this menu to adjust miscellaneous settings.

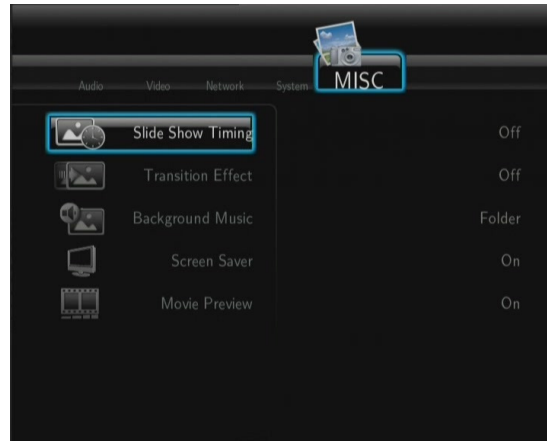

Slide Show Timing

- Select to set the interval time for photo slide show.

Transition Effect

- Select to set the transition effect for photo slide show.

Background Music

- Select to set the background music options while view pictures: **Off / Folder / Playlist**.

Screen Saver

- Select to turn on / off screen saver.

Movie Preview

- Select to turn on / off movie preview in the browser menu.

Resume Playback

- Select to turn on / off resume playback (auto-bookmarking) feature for movies.

4. Browser Menu

The browser menu allows you to browse and play media files stored on Removable Devices (USB, Card), HDD, Network, UPnP-server, and Playlist. To enter the menu, select the **Browser** icon on the home screen, or press the **BROWSER** button on the remote control.

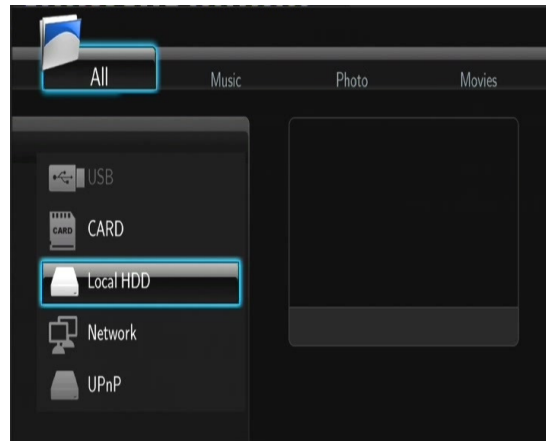

The following buttons can be used while navigating the browser menu.

Button	Function
UP / DOWN	Move cursor up / down to select devices, folders, or files.
LEFT / RIGHT	Select filter options: All , Music , Photos , and Movies .
PREV / NEXT	Go to previous / next page.
ENTER	Enter or confirm the selected item.
SELECT	Select files under Browser -> HDD menu.
CONFIRM	Add the selected files to the playlist.
RETURN	Return to the previous menu.

4.1 Browsing All

In this mode, all folders and supported contents (music, photos, and movies) will be displayed.

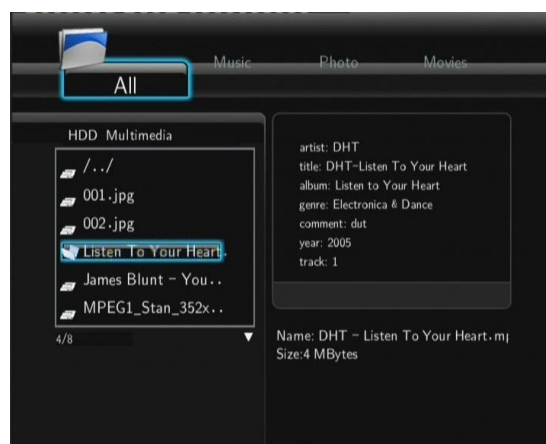

Note:

- Please refer to chapter '**9.1 Specifications**' for more about the supported content formats.
- Music tracks might not be able to be played continuously under **All** filter, please switch to the

Music filter instead.

4.2 Browsing Music

In this mode, all folders and supported audio files in current directory will be displayed.



The following buttons can be used to control music playback.

Button	Function
PLAY	Begin playback.
PAUSE / STEP	Pause playback.
FR / FF	Fast rewind or fast forward. Press repeatedly to select the speed.
REPEAT	Set repeat options: One , All , (and Shuffle).
INFO	Hide or display the information bar during playback.
STOP	Stop playback.

4.3 Browsing Photos

In this mode, all folders and supported image files in current directory will be displayed.

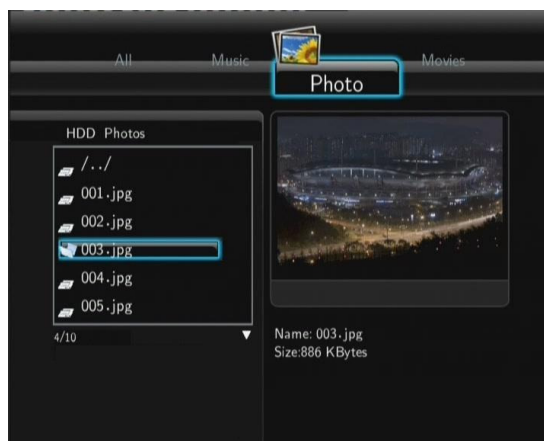

The following buttons can be used to control music playback.

Button	Function
PLAY	Begin playback.
PREV / NEXT	View the previous or next photo.
LEFT / RIGHT	Rotate a photo in any angle.

REPEAT	Set repeat options: One , All , (and Shuffle).
ZOOM IN / OUT	Zoom in / out the image.
INFO	Hide or display the information bar during playback.
STOP	Stop playback.

You can view photos in slide show mode with background music. When it is enabled, the slide show starts automatically once you press **PLAY** button. (Please refer to **Slide Show Timing**, **Transition Effect**, and **Background Music** in chapter '**3.5 Miscellaneous**' for more details)

4.4 Browsing Movies

In this mode, all folders and supported video files in current directory will be displayed.

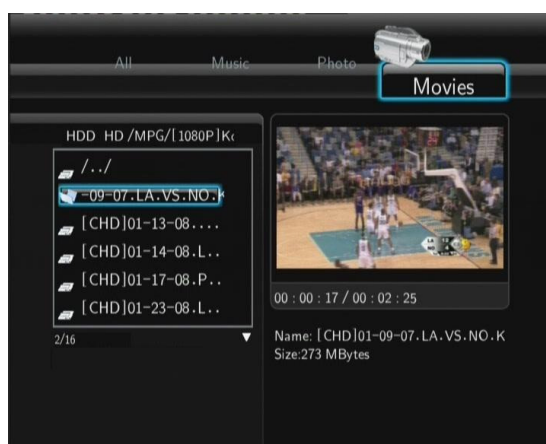

The following buttons can be used to control video playback.

Button	Function
PLAY	Begin playback.
PAUSE / STEP	Pause playback; Press again to step to next frame.
SLOW	Play video in slow motion. Press repeatedly to select the speed.
FR / FF	Fast rewind or fast forward. Press repeatedly to select the speed.
PREV / NEXT	View the previous or next movie.
REPEAT	Set repeat options: One , All , (and Shuffle).
ZOOM IN / OUT	Zoom in / out the image.
INFO	Hide or display the information bar during playback.
GOTO	Display playback search menu.
A-B	Set the beginning and end points of a section to repeat.
ANGLE	Change the view angle during DVD (with multi-angle) playback.
MENU	Return to the root menu during DVD playback.
INS REPLAY	Backward 10 seconds of the current playback
CM SKIP	Advance 30 seconds of the current playback.
AUDIO	Select an audio track while watching BivX video or DVD with multiple audio tracks.
SUBTITLE	Set subtitle options.
STOP	Stop playback.

4.5 A/V Streaming via Network

You can stream the media files shared on the home network (Ethernet or WLAN). Please refer to '**3.3 Changing Network Settings**' for details about network settings.

There are two ways to locate media files shared on your local network in the **Network** menu. One is to browse through workgroup; the other way is to browse through '**My_Shortcuts**'.

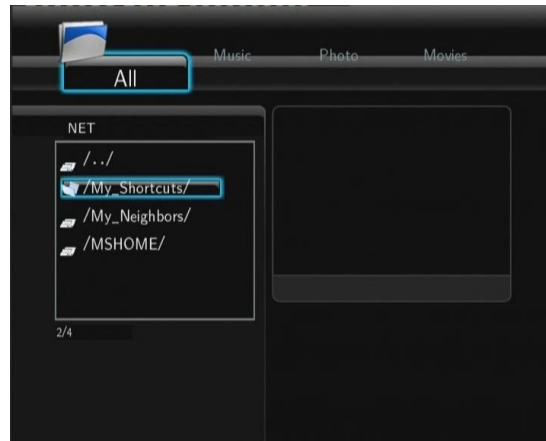

4.5.1 Browsing through Workgroup

You can choose the workgroup which your PC belongs to from the workgroup list, find your PC name, and press the **ENTER** button to confirm. Then you can select and play the shared media files that you want to browse.

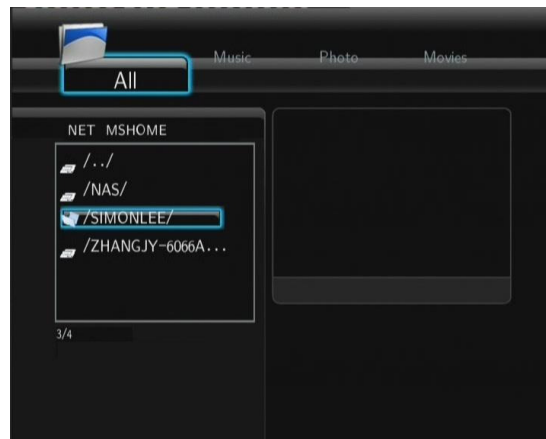

Note:

- While browsing high definition video files (resolution up to 720p / 1080i / 1080p) via Ethernet or WLAN, the video might be buffering. It is normal due to the limit of network speed or signal strength.
- Due to different network conditions, sometimes the workgroup might not be accessed or shown in the list. And then you need to use '**My_Shortcuts**' to browse shared files.

4.5.2 Browsing through 'My_Shortcuts'

You can also set '**Specific File Server IP**' and access it from '**My_Shortcuts**' in the menu.

- Press the **MENU** button and a popup menu appears.

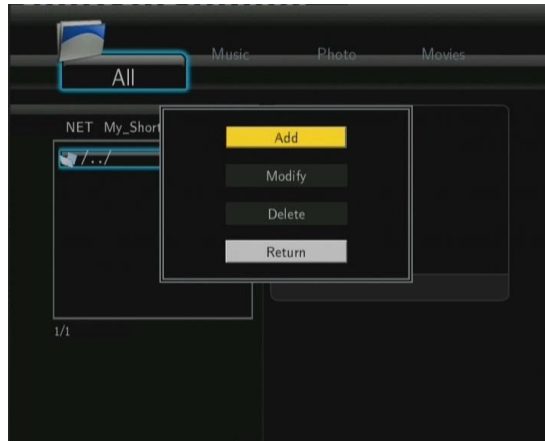

- Select **Add** to open a popup menu where you can input **Label**, **Net User ID**, **Net Password**, **Domain**, **Host Name**, and **Specific File Server IP**. Select **OK** to confirm, **Cancel** to cancel, and **Simple / Detail** to switch between simple and advanced options.

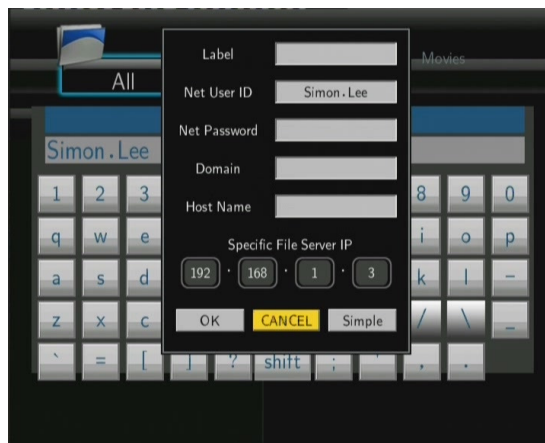

- Select the shortcut you added and press the **ENTER** button to confirm. Then you can select and play the shared media files on the destination computer.

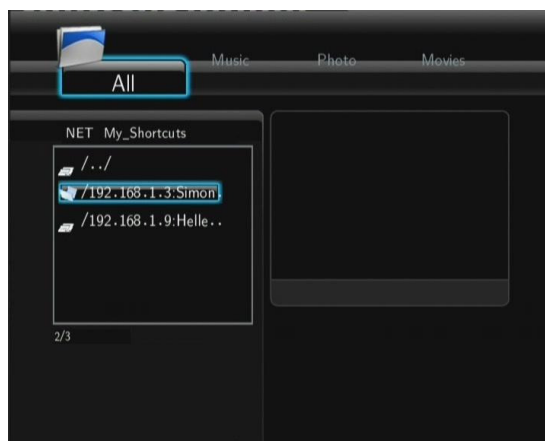

4.6 A/V Streaming via UPnP-server

A built-in UPnP (Universal Plug and Play) client has been integrated on the system, which enables the player to auto-detect UPnP Media Servers on the network to browse and stream media files from them.

4.6.1 Installing UPnP Media Server on your PC

There're a lot of free and commercial UPnP Media Server software, such as Windows Media Connect, Windows Media Player 11, XBMC Media Center (Linux/Mac/Windows), MediaTomb (Linux), etc. Please install one of them on you computer. In the following chapters, we will take Windows Media Player 11 on Microsoft Windows XP SP2 for an example.

4.6.2 Sharing Media on your PC

The Media Sharing feature of Windows Media Player 11 lets you enjoy the contents of your Windows Media Player library from anywhere in your home.

- Open Windows Media Player 11, click **Library** -> **Add Library** -> **Advanced Options** to add or remove media files from the library.

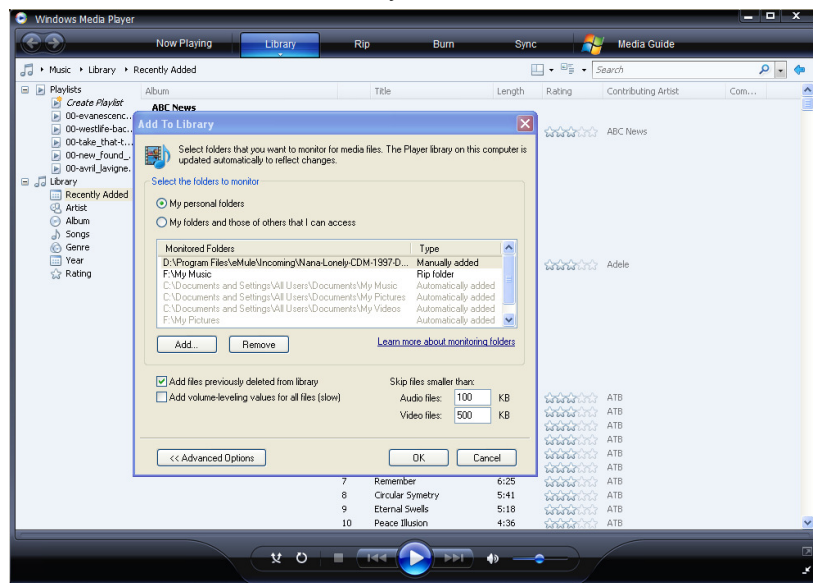

- Click **Library** -> **Media Sharing**, then you can allow or deny devices to access the media library. Click **Allow** to authorize your player.

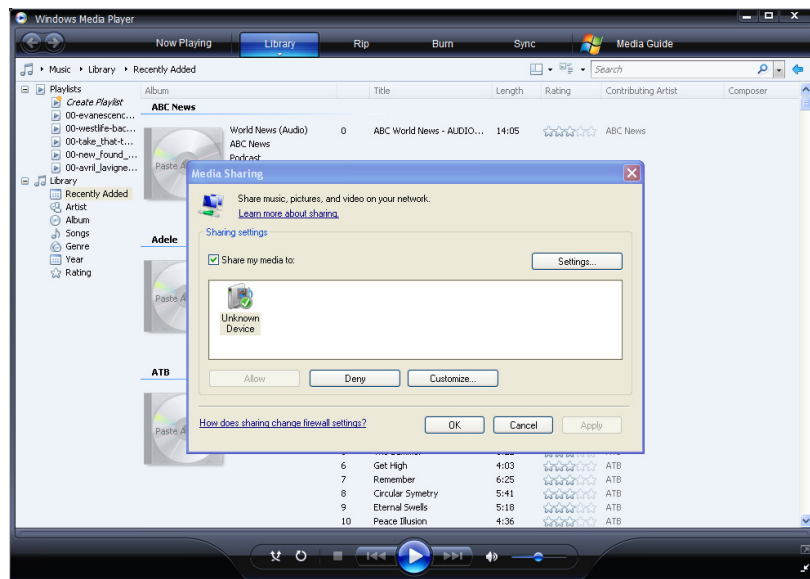

4.6.2 Streaming Media on your Player

- Connect your player to the home network (LAN or WLAN).
- Visit **Browser** - > **UPnP** menu on the player, select the UPnP-server, and press **ENTER**.

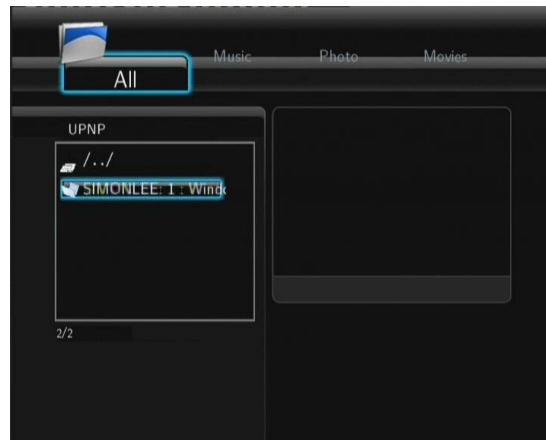

- Then you can browse the media library shared by Windows Media Player 11.

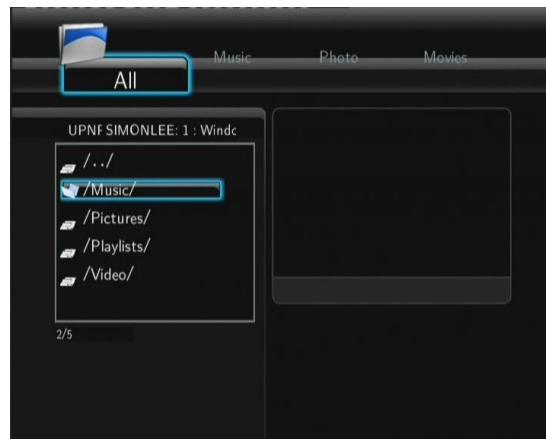

Note:

- Make sure your player and your computer are on the same local area network and subnet.
- Firewalls may prevent your player to communicating with your computer. Please open the ports manually and add your player to the 'trusted' list, or disable the firewall temporarily.

4.7 Renaming / Deleting Files

When navigating in the browser menu, you can press the **MENU** button to activate a popup menu where you can rename and delete files or folders.

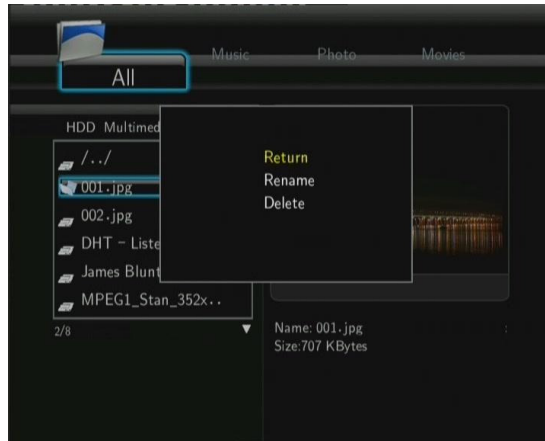

Press the **UP** / **DOWN** buttons to select from **Return**, **Rename**, and **Delete**. And press **ENTER** to confirm.

4.8 Managing the Playlist

This player supports the playlist function, which allows you to add your favorite contents on local HDD to the playlists (All, Music, Photos, and Movies), and enjoy them at any time.

4.8.1 Adding files to the playlist

Select the favorite file you wish to add, press the **SELECT** button, and the file will be ticked. Press the **CONFIRM** button to confirm, and then an on-screen message 'Add selects to list' will be shown. Multiple selections are allowed. See photo below.

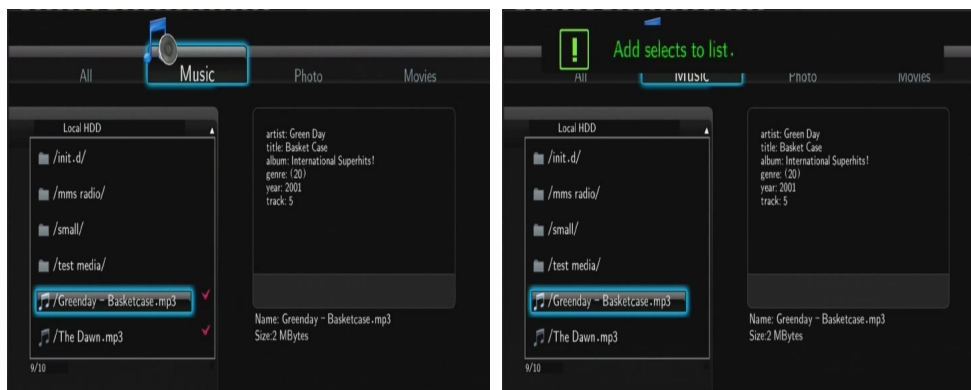

4.8.2 Browsing the playlist

Press the **UP** / **DOWN** buttons to select **Play List** in the browser menu. Press the **LEFT** / **RIGHT** buttons to select between **All**, **Music**, **Photos**, and **Movies**. And press the **ENTER** button to confirm. Then you will enter the playlist.

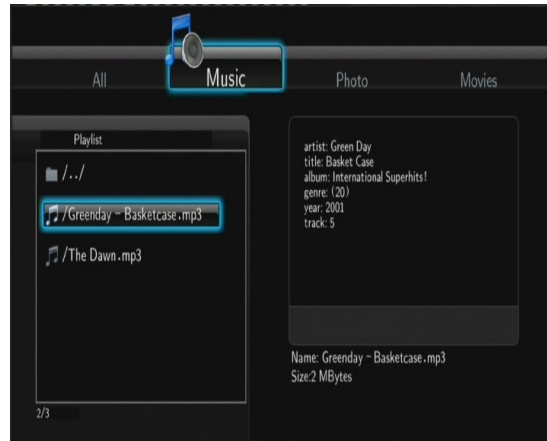

If you wish to delete a file from the playlist, press the **SELECT** button to select, and then press the **CONFIRM** button to confirm.

5. File Copy Menu

Select the **File Copy** icon from the home screen to enter the **File Copy** menu, which allows you to copy files between Removable Devices (Card, USB), HDD, and Network.



The following buttons can be used under the file copy menu.

Button	Function
UP / DOWN	Move cursor up / down to select devices, folders
RIGHT	Go to the next step.
SELECT	Select (or cancel) folders or files (The selected items will be ticked).
STOP	Cancel all selections.
ENTER	Confirm the selected options.

Please refer to the following operations to copy / move folders / files between devices.

- Step 1: Select the source device and destination device.
- Step 2: Select the source files you want to copy.
- Step 3: Select the destination folder to store the above files.
- Step 4: Select **Copy** or **Move** to proceed.

6. Internet Radio

This player integrates the SHOUTcast free Internet radio function. Select the **Internet Radio** icon on the main interface to enter this menu.

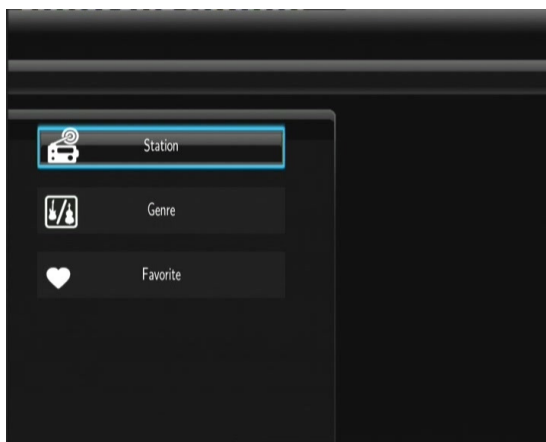

Note:

- Make sure the player is connected properly to a LAN or WLAN with Internet access, please refer to '**3.3 Changing Network Settings**' for more details;
- When you enter the Digital Radio menu at the first time, it will take several seconds to download data from the Internet, please be patient to wait;
- For more about SHOUTcast, please refer to the website: www.shoutcast.com

The following buttons can be used under this menu.

Button	Function
UP / DOWN	Move cursor up / down to select station, channel, and genre.
PREV / NEXT	Page up / down.
ENTER	Confirm and enter the selected menu.
MENU	Add / delete a station to / from Favorite while it is highlighted.
PLAY	Begin playback after a channel has been selected.
STOP	Stop playback.
RETURN	Return to the previous menu.

Station

- All downloaded stations will be listed under this menu.

Genre

- You can search for stations by genre (pop, rock, jazz, etc.) under this menu.

Favorite

- Your favorite stations can be kept under this menu.

7. Web Server & BitTorrent

7.1 Web Server (unicgi)

A Web server called 'Neighbor Web' has been integrated into the player.

- Connect the player to your home network (LAN or WLAN).
- Get the IP address of the player under **SETUP** -> **NETWORK** menu.
- Type the IP address (e.g., 192.168.3.15) in the address bar of Internet Explorer on your PC.

Then you can access the Web server on your PC.

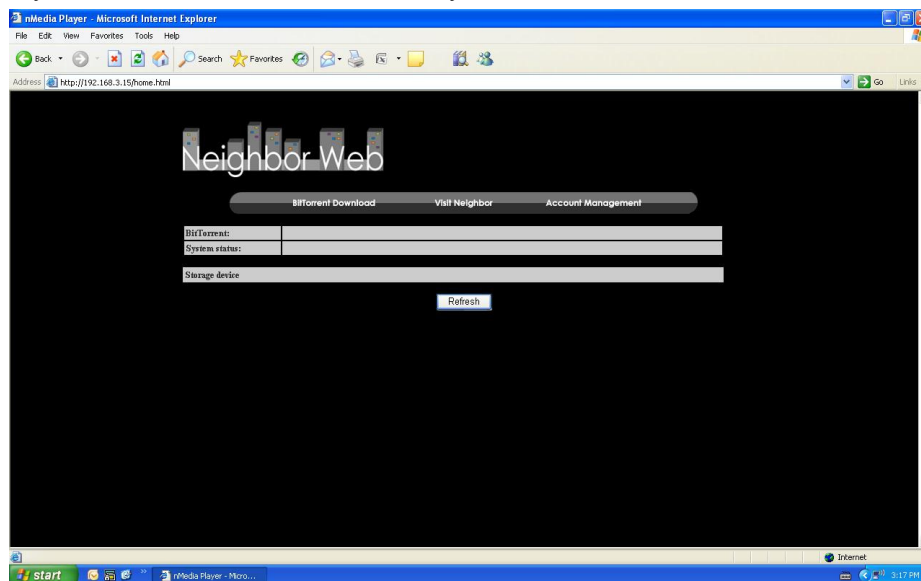

Note: Please refer to **Extension Info** in chapter '**3.4 Changing System Settings**', and make sure all related packages 'btpd', 'samba', and 'unicgi' are installed and run properly in advance.

7.2 Account Management

- Click **Account Management** on the home page of Neighbor Web.

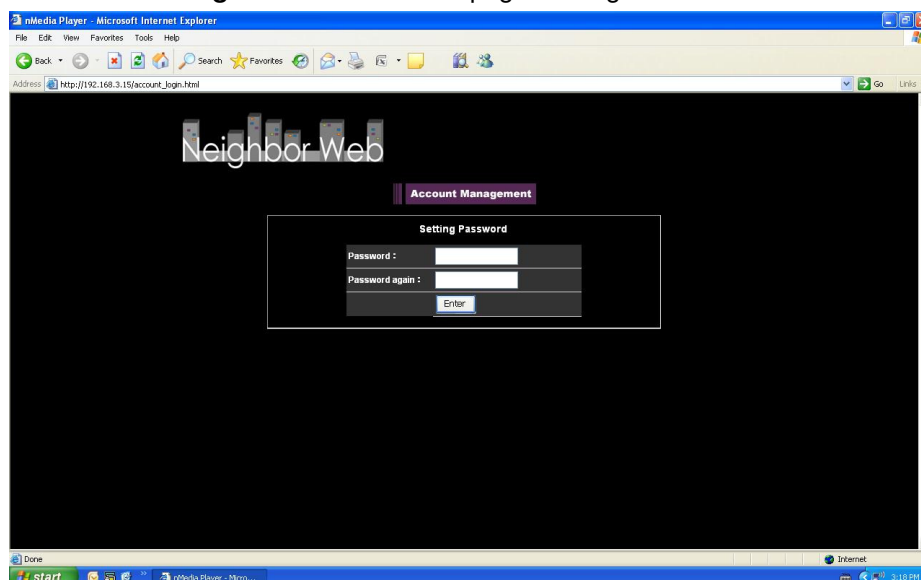

- This page allows you to set a password for accessing Neighbor Web.

Note:

- Password will become effective when Login Control is turned on. (Please refer to **Login Control** in chapter '**3.4 Changing System Settings**' for more details)
- The default user name is 'admin', and the default password is '123'.

7.3 Visit Neighbor (samba)

- Click **Visit Neighbor** on the home page of Neighbor Web.
- Then you will be able to browse, edit, and copy files to / from the local HDD of the player.

7.4 BitTorrent Download (btpd)

BitTorrent is a peer-to-peer file sharing protocol used for distributing large amounts of data on the Internet. A BitTorrent utility (btpd – BitTorrent Protocol Daemon) has been integrated into the player (Please refer to **Extension Info** in chapter '**3.4 Changing System Settings**' for more details about installing and uninstalling btpd).

The BitTorrent client btpd is running in daemon (a process running in the background) mode and you can manipulate the process via the Web server.

- Click **BitTorrent Download** on the home page of Neighbor Web, then you will enter the BitTorrent Download page.

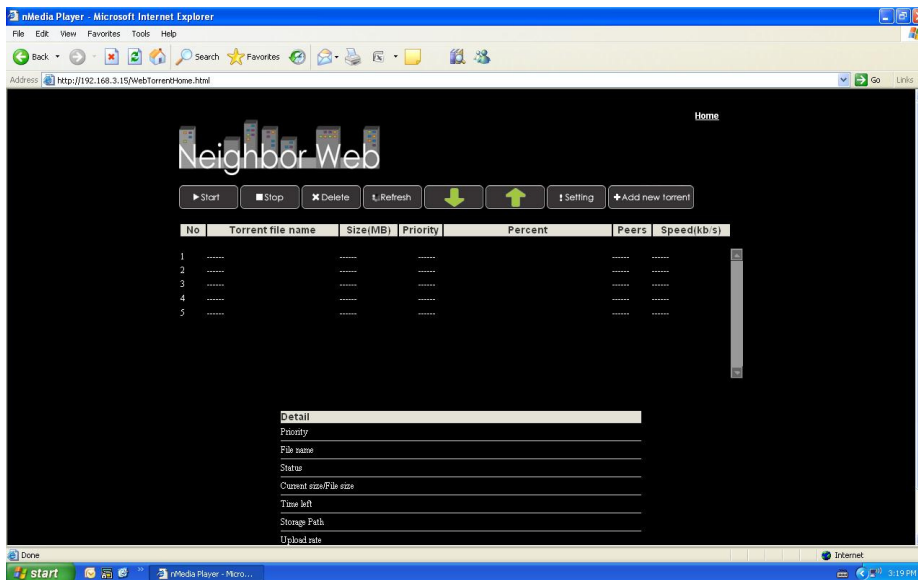

7.4.1 Add new torrent

- Click **Add new torrent** on the BitTorrent Download page.

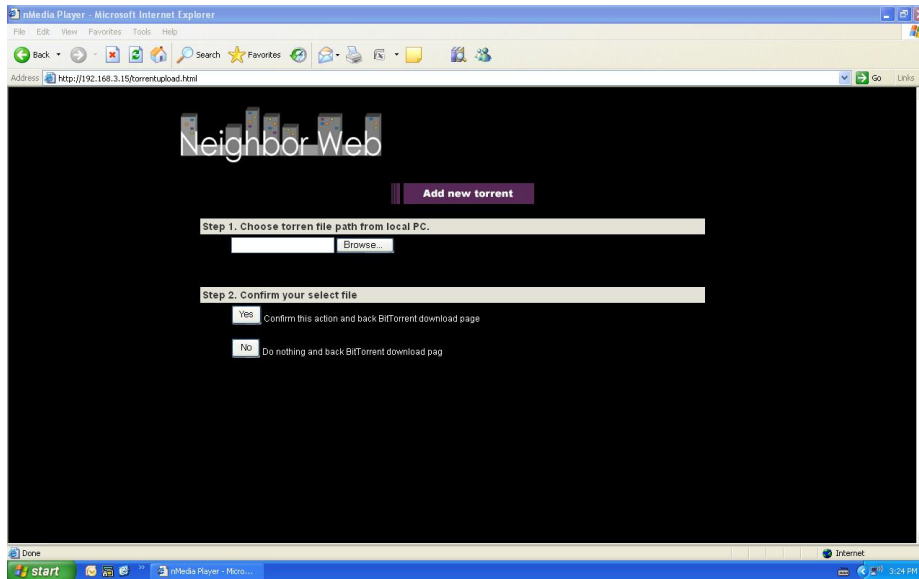

- Click **Browse** to upload a torrent file, and click **Yes** to confirm.

7.4.2 Managing the downloads

The BitTorrent Download page also allows you to start, stop, delete torrents, and set priorities for torrents, as well as view the status of current torrents.

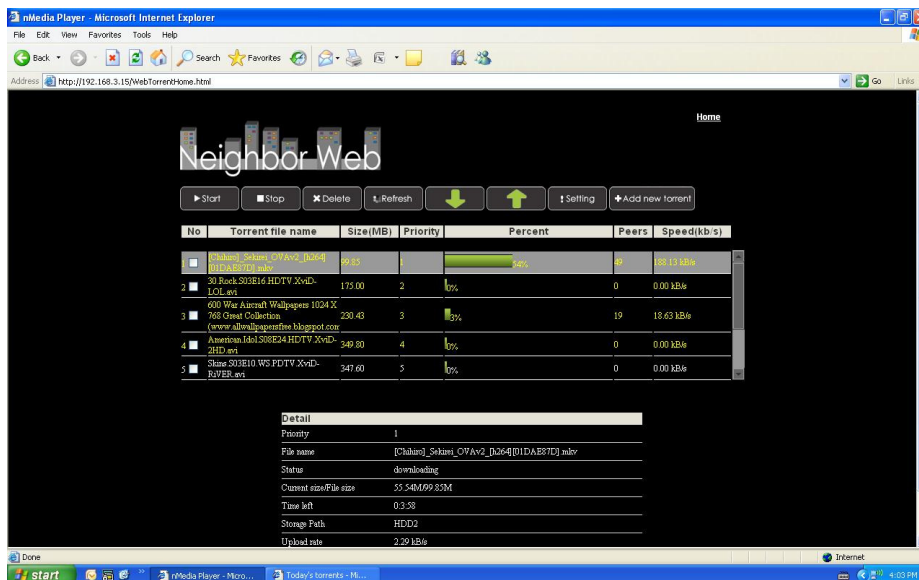

- Click **Start** to begin download.
- Click **Stop** to stop download.
- Click **Delete** to delete the selected torrent.
- Click **Refresh** to refresh the current status.
- Click **Down** arrow to decrease the priority for the selected torrent.
- Click **Up** arrow to increase the priority for the selected torrent.

7.4.3 Settings

- Click **Setting** on the BitTorrent Download page to enter the BitTorrent Setting page.

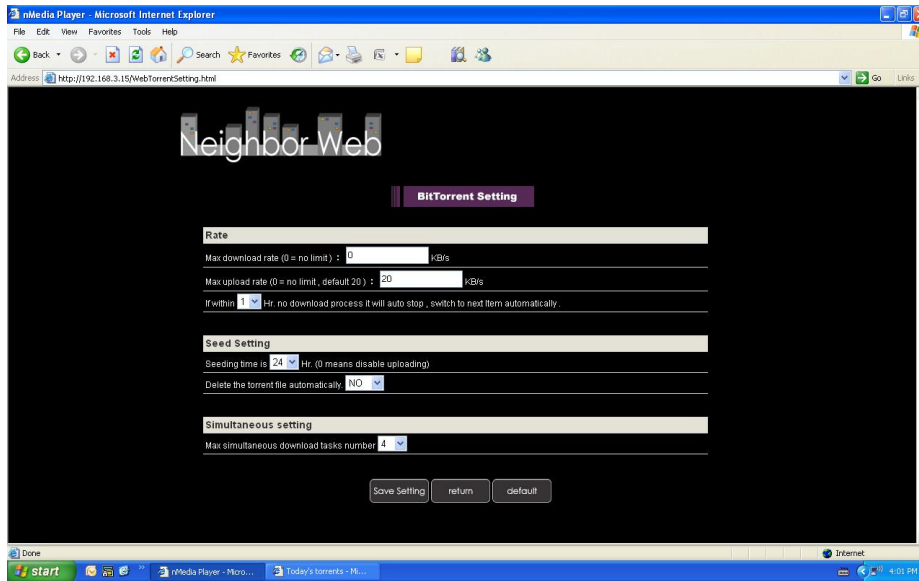

In the BitTorrent Setting page, you can configure the following settings.

- Set the maximum download rate.
- Set the maximum upload rate.
- Set the idle hours to start the next download automatically.
- Set the seeding hours.
- Set to delete the finished torrent files automatically or not.
- Set the maximum number of simultaneous download tasks.

8. Upgrading the Firmware

The firmware is the operating system (OS) installed on the device. Firmware upgrades can bring new features, improvements and bug fixes.

Please refer to **System Update** and **Extension Info** in chapter '**3.4 Changing System Settings**' for more details.

9. Appendixes

9.1 Specifications

I/O INTERFACES SUPPORTED:

- 3.5" SATA HDD
 - USB 2.0 HOST port x 2 (compatible to USB 1.1)
 - Memory Card slot (supports SD/MMC/MS/MS Pro)
 - USB 2.0 DEVICE port (connecting to PC)
 - Composite (CVBS) A/V jack
 - Component Y/Pb/Pr jack
 - HDMI V1.3 interface
 - S/PDIF coaxial & optical jack
 - DC-IN 12V
-

FILE SYSTEM SUPPORTED:

- FAT/FAT32/NTFS/EXT3
-

CONTENT FORMATS SUPPORTED:

- AVI/MKV/TS/TP/TRP/M2TS/MPG/MP4/MOV/M4V/VOB/ISO/IFO/DAT/WMV/ASF/RM/RMVB/FLV, resolution up to 720p/1080i/1080p
 - MP3/OGG/WMA/WAV/AAC/FLAC
 - HD JPEG/BMP/GIF/TIF/PNG
-

VIDEO CODECS SUPPORTED:

- MPEG-1
 - HD MPEG-2
 - HD MPEG-4 SP/ASP/AVC (H.264)
 - WMV9 (VC-1)
 - RealNetworks (RM/RMVB) 8/9/10, up to 720p
-

AUDIO CODECS SUPPORTED:

- MP2/3, OGG Vorbis, WMA (DRM, and Advanced Profile not supported), PCM, LPCM, MS-ADPCM, LC-AAC, HE-AAC, COOK, RA-Lossless
-

SUBTITLE FORMATS SUPPORTED:

- SRT, SMI, SSA, ASS, IDX/SUB, SUB
-

NETWORK FEATURE

- 10/100Mbps Auto-Negotiation Ethernet
 - 802.11b/g/n WLAN, up to 300Mbps (supported by optional WLAN USB Adapter)
-

Note: The specifications and design of this product are subject to change without notice.

9.2 Frequently Asked Questions

Question 1. When I try to disconnect the USB device, I keep on getting “The device ‘Generic volume’ cannot be stopped right now. Try stopping the device again later.” message, what should I do?

Answer:

Close any program that might be accessing data on the player, including Windows® Explorer. If it does not work, close all programs and wait for another 20 seconds, then try the green arrow icon again. If it still does not work, you should shut down the player and disconnect the USB cable.

Question 2. I find new file names and folder names that I never created before or they have strange gibberish names.

Answer:

Most likely, the player’s file allocation table (FAT) has been corrupted. This might be due to the player shutting down (due to low battery power) while reading or writing to your computer by the USB connection. Windows and Macintosh often write extra files to the hard disk such as finder.def or System volume info. These are normal and will not do any harm to the player.

Question 3. I used my player to transfer files back and forth between different computers. Will defragmenting the player hard disk do any harm to it?

Answer:

Defragmenting the player hard disk may be useful after having transferred many files to and from the player. It is never harmful to use the defragment on the player. Make sure no other programs are running while using the Windows® defragment utility. Make sure you have connected the player with the external power adapter during this procedure.

Question 4. My files have disappeared from the player.

Answer:

Make sure that you browse your files via the correct browser mode which means correct filtered views such as Photos, Music, or Movies.

Question 5. During power on, why does the TV will have a short flashing, blue screen or screensaver?

Answer:

This is normal, when the system initializes, it will setup the corresponding parameters so it can output the correct video signal to the TV, during the initializing time, the TV will receive incorrect signals or the signals will not be stable and will cause the TV screen to flash, some TV’s will treat this as no signal, and will display a blue screen or screensaver.

Question 6. Why when I switch to Y/Pb/Pr 480p, 576p, 720p, 1080i, and 1080p, does the TV screen display an unwatchable picture?

Answer:

Please check if your TV supports Y/Pb/Pr 480p, 576p, 720p, 1080i, and 1080p output, if your TV does not support, please use the A/V signal display instead, press the TV SYSEEM button on the remote control, then switch the TV’s video input to NTSC or PAL.

Question 7. Why is there no sound on movie or music playback when using Y/Pb/Pr component output?

Answer:

Y/Pb/Pr output is a video output only, and does not include sound signals. When using Y/Pb/Pr output, please plug the A/V OUT or the S/PDIF jack to output sound.

Question 8. I cannot get SSID name, the screen always displays: 'Can't get any SSID!!'

Answer:

When the WLAN USB Adapter is connected to the player, it needs some time to get initialized. Please wait for about 1~2 minutes and try refreshing the SSID list again.

Question 9. I cannot see files shared on my computer via Browser->Network menu.

Answer:

Please check following items:

- 1) Connect the player to network and obtain an IP address first;
- 2) Please enable NetBIOS of TCP/IP on computer;
- 3) Please check your PC's firewall settings;
- 4) Please enable your PC's 'Guest' account;
- 5) Please share the folders which you wish to browse on your PC, and make sure that 'Everyone' or 'Guest' has the right to access.

Question 10. I configured everything correctly, but still cannot get the wireless network or UPnP function to work.

Answer:

Are you using a firewall such as Norton Internet Security, McAfee Personal Firewall, Zone Alarm, etc. or even the built-in firewall of Windows XP? (Don't forget that Service Pack 2 for Windows XP automatically upgrades your firewall and turn it on by default)

If you have a firewall, it may need to be configured or have exceptions created to allow you to see and communicate with the player on the network. To test if your firewall is preventing network communication (including PING and access shared folders), try disabling it to see if you can connect. If you can connect with the firewall disabled, you may need to add the player to the 'Trusted' list or configure the firewall for local intranet access. Worst-case, disable your firewall long enough to use the player, then enable it again when done.

Question 11. I am using the 802.11n Wi-Fi dongle with an 802.11n wireless router, why the speed is still 802.11g 54Mbps rather than 300Mbps?

Answer:

The IEEE 802.11n Draft standard prohibits using high throughput with WEP or TKIP as the unicast cipher. If you use these encryption methods (e.g. WEP, WPA-TKIP), your data rate will drop to 54 Mbps. You may contact the Access Point or router manufacturer to download the latest firmware, or try other encryption methods (WPA2-AES or WPA2-TKIP), or choose to configure an unsecured profile, but this option is not recommended.

Question 12. Where can I find .torrent files for BitTorrent download?

Answer:

A lot of torrent sites can be found on the Internet, such as The Pirate Bay, Isohunt.com, TorrentPortal.com, Mininova.org, etc. Please take care of the contents you're downloading and their usage, which might cause copyright infringements and violate the local laws.

9.3 Copyrights and Trademarks

Copyrights

All rights reserved. No part of this manual may be reproduced, or transmitted in any form or by any means, whether by electronically or mechanically, without the express written permission from the copyright holder.

Copyrighted materials, such as software, music files, or movies, are protected by local law, and may not be illegally copied or used without permission from the copyright owner.

Trademarks

Microsoft and Windows are registered trademarks of Microsoft Corporation.

All other trademarks are property of their respective holders.

9.4 Warranty

What your warranty *does not* cover:

- Acts of nature, such as fire, static discharge.
- Damage from unauthorized repair, alteration or accident.
- Damage from misuse or neglect.
- A unit that has been modified or incorporated into other products or is used for institutional or other commercial purposes.
- Loss of customer's software, firmware, information, or memory data.
- Improper handling or installation.

9.5 GPL Statement

This product contains free software which is licensed under the GNU General Public License. After you purchase this product, you may procure, modify or distribute the source code of the GPL/LGPL software that is used in this product.

To obtain a copy of our open source software, please contact our support center and we will provide you with a CD-ROM of the source code that is used, charging only the actual expense involved. However, please be noted that we can not provide guarantee with the source code, and there is also no technical support for the source code from us.