

ENGLISH

Canon

DIGITAL
IXUS 860 IS

Camera User Guide



Getting Started

Learning More

Components Guide

Basic Operations

Commonly Used Shooting Functions

Various Shooting Methods

Playback/Erasing

Print Settings/Transfer Settings

Connecting to a TV

Customizing the Camera

Troubleshooting

List of Messages

Appendix

Ensure that you read the Safety Precautions (pp. 201–209).

DiGiC III



Exif Print



Workflow and Reference Guides

The following guides are available. Refer to them as necessary according to the flowchart below.

 : Contents of This Guide

Check the package contents

Getting Started (p. 7)

Explains how to complete tasks ranging from charging batteries and installing memory cards to setting the date and time, shooting, playing and erasing images, and performing simple printing tasks.

Learning More (p. 37)

Names camera components and provides more detailed instructions for shooting and playback. Lists information for more advanced use of your camera.

Connect the camera to other devices

- Connecting to a printer
- Connecting to a TV set
- Connecting to a computer



Camera User Guide
(This guide)



Direct Print User
Guide



Software Starter
Guide

Checking the Package Contents

The following items are included in the package. If something is missing, please contact the retail outlet at which you purchased the product.

1 Camera



2 Battery Pack NB-5L (with Terminal Cover)



3 Battery Charger CB-2LX/CB-2LXE

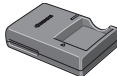

4 Memory Card (32MB)



5 Interface Cable IFC-400PCU

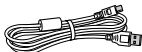

6 AV Cable AVC-DC300



7 Wrist Strap WS-DC2



8 Canon Digital Camera Solution Disk



9 User Guides



- Getting Started Guide
- "Use of Genuine Canon Accessories Recommended" Leaflet



- Canon Digital Camera Manuals Disk

10 "European Warranty System" Booklet



You may not be able to achieve the full performance of this camera with the included memory card.





You can use SD memory cards, SDHC (SD High Capacity) memory cards, MultiMediaCards, MMCplus cards and HC MMCplus cards in this camera. These cards are collectively referred to as memory cards in this guide.

Table of Contents

Items marked with a ☆ are lists or charts that summarize camera functions or procedures.

Please Read

6

Getting Started	7
Preparations	8
Shooting Still Images ( Auto Mode)	14
Viewing Still Images	17
Shooting Movies ( Standard Mode)	18
Viewing Movies	20
Erasing	21
Printing	22
Downloading Images to a Computer	24
System Map	32

Learning More

37

Components Guide











38

Using the Touch Control Dial	41
Using the  Button	43
How to Use the Mode Switch	44
Indicator	45
Power Saving Function	45

Basic Operations

47

☆ Menus and Settings	47
☆ Menus and Default Settings	49
Using the LCD Monitor	54
Information Displayed on the LCD Monitor	55
Resetting Settings to Their Default Values	64
Formatting Memory Cards	65

Commonly Used Shooting Functions	66
  Shooting with the Optical Zoom	66
Using the Digital Zoom/Digital Tele-Converter	67
Magnified Close-Up Shooting (Digital Macro)	70
 Using the Flash	71
  Shooting Close-Ups/Infinity Shot	72
 Using the Self-Timer	73
Changing the Recording Pixels/ Compression (Still Images)	75
Configuring the Postcard Mode	77
Embedding the Date in the Image Data	78
Setting the Image Stabilizer Function	79
Various Shooting Methods	81
Shooting in Modes for Special Conditions	81
Shooting in Manual Mode	84
 Continuous Shooting	85
Setting the Red-Eye Reduction Function	86
Setting the Slow Synchro Function	87
 Movie Shooting	88
Shooting Panoramic Images (Stitch Assist)	93
Checking the Focus and Peoples' Expressions (Focus Check)	95
Switching between Focusing Modes	97
Shooting Hard-to-Focus Subjects (Focus Lock, AF Lock)	100
Locking the Exposure Setting (AE Lock)	102
Locking the Flash Exposure Setting (FE Lock)	103
 Adjusting the ISO Speed	104
 Reducing the Effects of Camera Shake (Auto ISO Shift)	105
Adjusting the Exposure Compensation	107
Switching between Metering Modes	108
Setting the Shutter Speed (Long Shutter Mode)	109
Adjusting the Tone (White Balance)	111
Shooting in a My Colors Mode	114
Changing Colors	116
Categorizing Images Automatically (Auto Category)	121
 Registering Settings to the Print/Share Button	122
Setting the Display Overlays	124

Setting the Auto Rotate Function	125
Creating an Image Destination (Folder).	126
Resetting the File Number	128
Playback/Erasing	130
<hr/>	
🔍 Magnifying Images	130
🖼️ Viewing Images in Sets of Nine (Index Playback)	131
Checking the Focus and Peoples' Expressions (Focus Check display)	132
🏠 Jumping to Images	134
Organizing Images by Category (My Category).	136
Viewing Movies (Operating the Movie Control Panel)	140
Editing Movies	142
Rotating Images in the Display	144
Playback with Transition Effects	145
Automated Playback (Slide Shows).	146
Red-Eye Correction Function.	151
Adding Effects with the My Colors Function	155
Resizing Images	158
Attaching Sound Memos to Images.	160
Sound-Only Recording (Sound Recorder).	162
Protecting Images	164
Erasing Images	168
Registering Functions to the Playback Button	172
Print Settings/Transfer Settings	174
<hr/>	
Setting the DPOF Print Settings	174
Setting the DPOF Transfer Settings	181
Connecting to a TV	183
<hr/>	
Shooting/Playback Using a TV	183
Customizing the Camera (My Camera Settings)	184
<hr/>	
Changing My Camera Settings	184
Registering My Camera Settings.	185
Troubleshooting	187
<hr/>	
List of Messages	197
<hr/>	

Appendix	201
Safety Precautions	201
Preventing Malfunctions	205
Battery Handling	206
Handling the Memory Card	208
Using an AC Adapter Kit (Sold Separately)	210
Using an Externally Mounted Flash (Sold Separately)	211
Camera Care and Maintenance	213
Specifications	214
Index	224
★ Functions Available in Each Shooting Mode	228

Symbol Conventions in this Guide

Commonly Used Shooting Functions | 77

Configuring the Postcard Mode

Use Functions Available in Each Shooting Mode (p. 247)

You can shoot images with the optimal settings for postcards by composing them inside the print area (width-to-height ratio of approximately 3:2) shown in the LCD monitor.

Select

1. Press the **DISP** button.
2. Use the **▲** or **▼** button to select **1** and choose **OK** with the **▶** or **◀** button.
3. Press the **DISP** button.

- The area that will not print displays in gray.
- The recording pixel and compression settings are fixed (2M).

The digital zoom or the digital tele-converter cannot be used in this mode.

For printing instructions, refer to the *Direct Print User Guide*.

Mode switch position

Available shooting modes

These modes are not available

These modes are available

Warning icon This mark denotes issues that may affect the camera's operation.

Document icon This mark denotes additional topics that complement the basic operating procedures.

Explanations in this guide are based on the camera's default settings at time of purchase.

Please Read

Test Shots

Before you try to photograph important subjects, we highly recommend that you shoot several trial images to confirm that the camera is operating and being operated correctly.

Please note that Canon Inc., its subsidiaries and affiliates, and its distributors are not liable for any consequential damages arising from any malfunction of a camera or accessory, including memory cards, that results in the failure of an image to be recorded or to be recorded in a way that is machine readable.

Warning Against Copyright Infringement

Please note that Canon digital cameras are intended for personal use and should never be used in a manner that infringes upon or contravenes international or domestic copyright laws and regulations. Please be advised that in certain cases the copying of images from performances, exhibitions, or commercial properties by means of a camera or other device may contravene copyright or other legal rights even if the image was shot for personal use.

Warranty Limitations

For information on your camera's warranty, please refer to the Canon European Warranty System (EWS) Booklet supplied with your camera.

For Canon Customer Support contacts, please see the European Warranty System (EWS) Booklet.

Camera Body Temperature

If your camera is used for prolonged periods, the camera body may become warm. Please be aware of this and take care when operating the camera for an extended period.

About the LCD Monitor

The LCD monitor is produced with extremely high-precision manufacturing techniques. More than 99.99% of the pixels operate to specification. Less than 0.01% of the pixels may occasionally misfire or appear as red or black dots. This has no effect on the recorded image and does not constitute a malfunction.

Video Format

Please set the camera's video signal format to the one used in your region before using it with a TV monitor.

Language Setting

Please see *Setting the Display Language* (p. 13) to change the language setting.

Getting Started

- **Preparations**
- **Shooting Still Images**
- **Viewing Still Images**
- **Shooting Movies**
- **Viewing Movies**
- **Erasing**
- **Printing**
- **Downloading Images to a Computer**
- **System Map**

Preparations

Charging the Battery

1. Insert the battery into the battery charger.

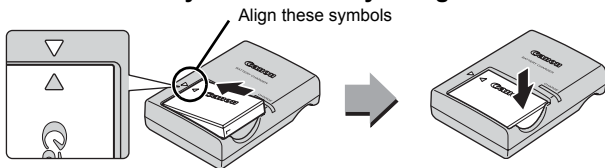

2. Plug the battery charger (CB-2LX) into a power outlet, or attach the power cord to the battery charger (CB-2LXE) and plug it into a power outlet.

Battery charger model names and types vary by region.

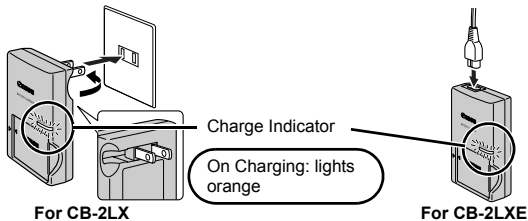

3. Remove the battery after charging is complete.

Charging takes approximately 2 hours 5 minutes.

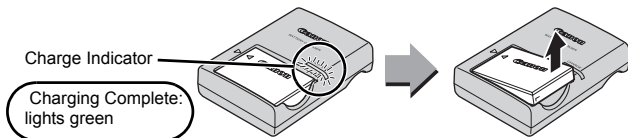

To protect the battery and prolong its life, do not charge it for longer than 24 hours continuously.

Installing the Battery and Memory Card

1. Slide the cover and open it out (①, ②).

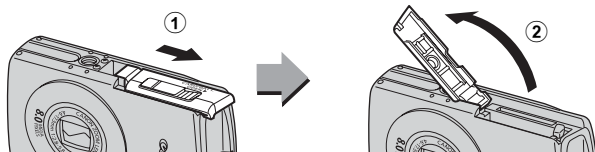

2. Insert the battery.

It will lock into place with a click.

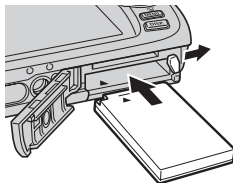

3. Insert the memory card until it clicks into place.

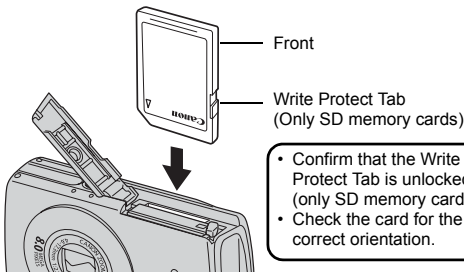

- Confirm that the Write Protect Tab is unlocked (only SD memory cards).
- Check the card for the correct orientation.



Ensure that the memory card is correctly oriented before inserting it in the camera. Inserting it backward may cause the camera to fail to recognize the memory card or to malfunction.

4. Close the cover (①, ②).

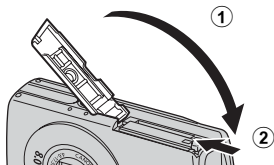

■ To Remove the Battery

Press the battery lock in the direction of the arrow (①) and pull the battery out (②).

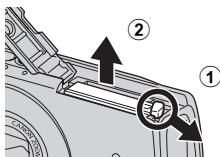

■ To Remove the Memory Card

Push the memory card with your finger or the toggle on the wrist strap until the memory card clicks and then release it.

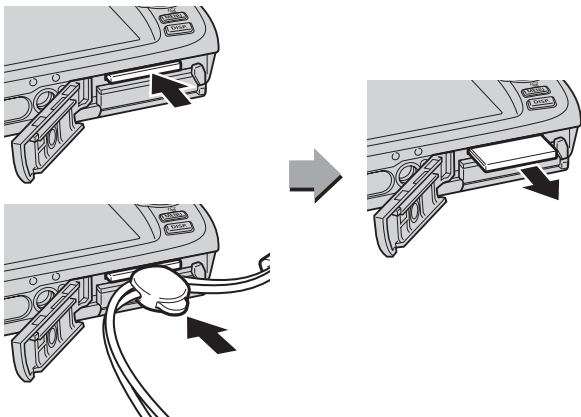

Attaching the Wrist Strap

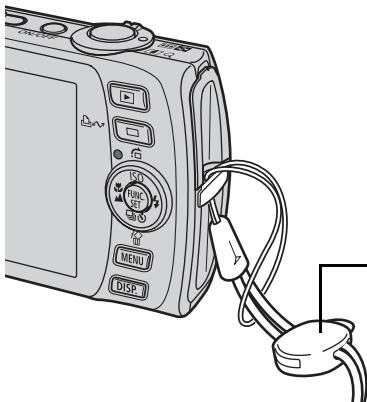

Toggle

The toggle can be used to open the DIGITAL terminal cover and when inserting or removing a memory card. Its position on the strap can be changed.



It is recommended to use the Wrist Strap to avoid dropping during camera use.

Setting the Date and Time

The Date/Time settings menu will appear the first time the power is turned on. Set the date and time as shown in step 3 and 4 in the explanation below.

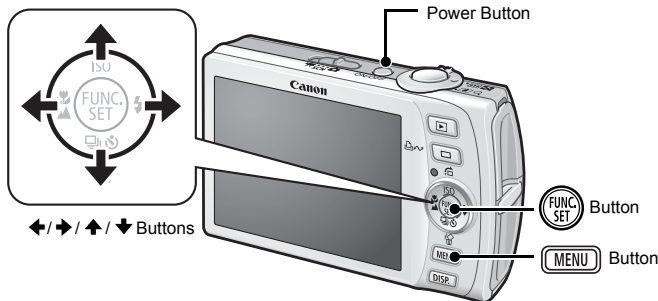

1. Press the power button.

2. Select [Date/Time].

1. Press the **[MENU]** button.
2. Use the **←** or **→** button to select the **[T]** (Set up) menu.
3. Use the **↑** or **↓** button to select **[Date/Time]**.
4. Press the **[FUNC. SET]** button.



3. Select the year, month, day and time, and the display order.

1. Use the **←** or **→** button to select a category.
2. Use the **↑** or **↓** button to set the value.

4. Press the **[FUNC. SET] button.**

5. Press the **[MENU] button.**

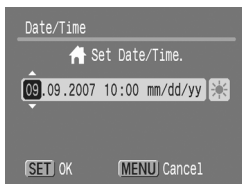









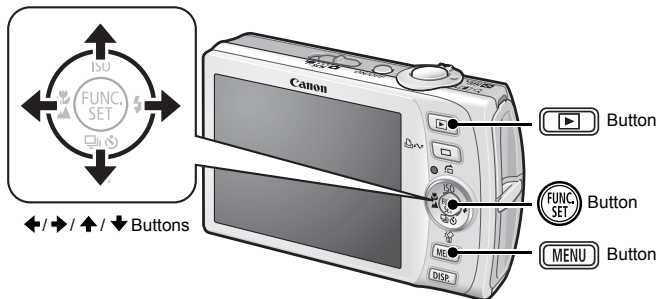

- A rechargeable lithium battery is built into the camera to save such settings as the date/time. Insert a charged battery into the camera. Or if you use the separately sold AC Adapter Kit ACK-DC30, the battery will charge in about four hours. It will charge even if the camera is turned off.
- The date/time settings may be lost after approximately three weeks if you remove the main battery. Reset the date/time settings if this occurs.
- You can imprint the date and time you have set onto images (p. 78).

Setting the Display Language

You can change the language displayed in the LCD monitor menus and messages.



1. Press the  button.
2. Hold down the  button and press the  button.
3. Use the , ,  or  button to select a language.
4. Press the  button.

Shooting Still Images (📷 Auto Mode)

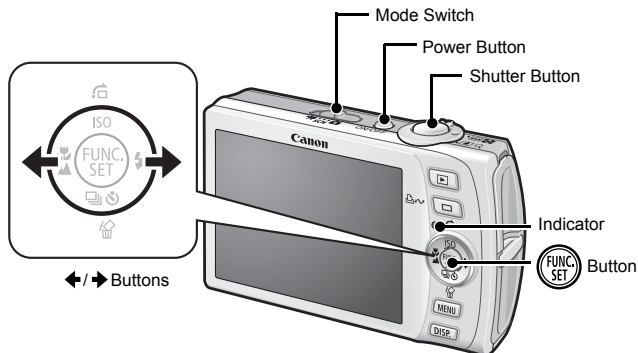

1. Press the power button.

- The start-up sound will play and the start-up image will display in the LCD monitor.
- Pressing the power button again turns the power off.

2. Select a shooting mode.

1. Set the mode switch to 📷 (Shooting).
2. Press the button.
3. Use the ← or → button to select (Auto).
4. Press the button.

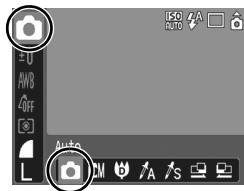

3. Aim the camera at the subject.

4. Press the shutter button lightly (press halfway) to set the focus.

- When the camera focuses, it beeps twice and the indicator lights green (orange when the flash fires).



- AF frames will display in green on the LCD monitor at the points of focus.



AF frame

5. Without changing anything else, press the shutter button all the way (press fully) to shoot.

- The shutter sound will play once and the image will record.
- The indicator will blink green and the file will record to the memory card.

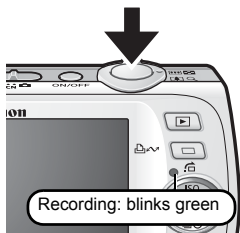

Mute Setting

Pressing the **DISP.** button while switching on the camera power will set the mute setting to [On] to silence all camera sounds except for warning sounds. Setting can be changed from the [**f**] (Set up) Menu [Mute] (p. 51).

Reviewing an Image Right After Shooting (Rec. Review)

Recorded images are displayed on the LCD monitor for approximately 2 seconds immediately after shooting.

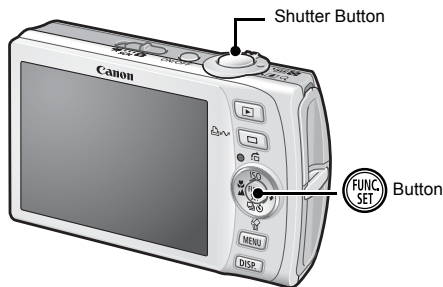

You can also use the following methods to continue displaying the image immediately after shooting so that you can check it.

- **Keep the shutter button pressed fully.**
- **Press the  button while the recorded image is displayed.**

You can shoot by pressing the shutter button even when an image is being displayed.



You can change the interval for which images are displayed by configuring the [Review] item in the [ (Rec.)] menu.

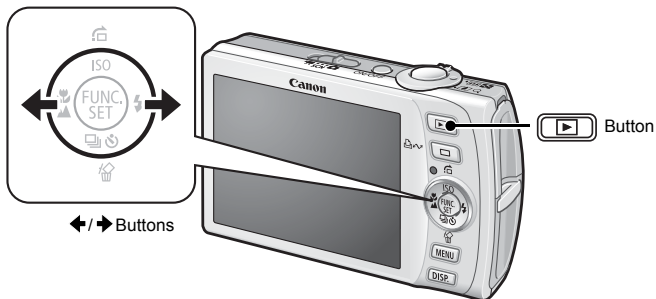

Viewing Still Images



1. Press the button.

The last recorded image will display.

2. Use the or button to display the image you wish to view.

- Use the  button to move to the previous image and the  button to move to the next image.
- The images advance more quickly if you keep the button pressed continuously, but they will appear coarse.







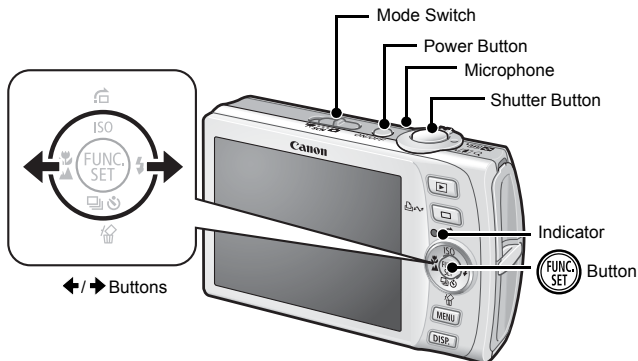

If you have replayed images, the last image viewed will display (Resume Playback). If the memory card has been switched, or the images on the memory card have been edited with a computer, the newest image on the memory card appears.

Shooting Movies (Standard Mode)



1. Press the power button.

2. Select a shooting mode.

1. Set the mode switch to  (Movie).
2. Press the  button.
3. Use the  or  button to select  (Standard).
4. Press the  button.

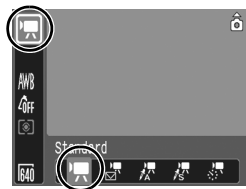

3. Aim the camera at the subject.



- Do not touch the microphone while recording.
- Do not press any buttons other than the shutter button. The sound that buttons make will be recorded in the movie.

4. Press the shutter button lightly (press halfway) to set the focus.

- An electronic beep will sound twice and the indicator will light green when the camera focuses.
- The exposure, focus and white balance are automatically set when you press the button halfway.



5. Without changing anything else, press the shutter button all the way (press fully) to shoot.

- Recording starts.
- During the recording, the elapsed recording time and [● Rec.] will display in the LCD monitor.

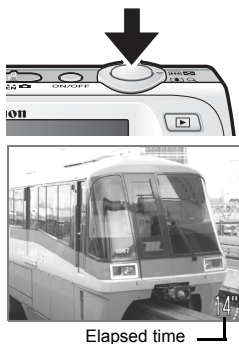

6. Press the shutter button fully again to stop recording.

- The indicator will blink green and the data will be recorded onto the memory card.
- Recording will stop automatically when the maximum recording time elapses, or the built-in memory or memory card become full.

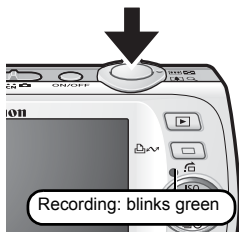

Viewing Movies

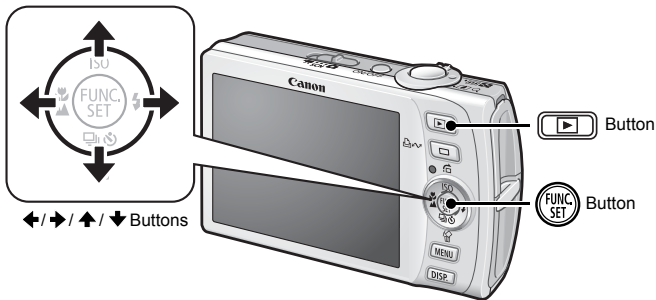







1. Press the  button.

2. Use the  or  button to display a movie and press the  button.

Images with a   icon are movies.









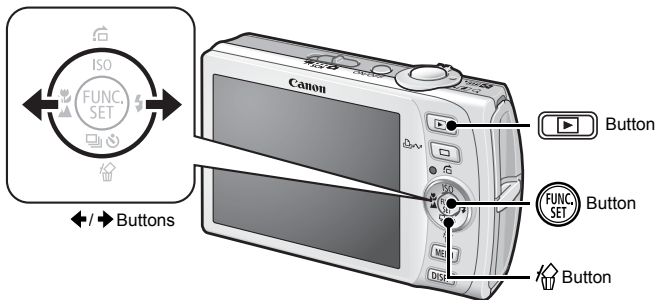

3. Use the  or  button to select  (Playback) and press the  button.

- The movie will start playing.
- If you press the **FUNC./SET** button during playback, you can pause and restart the movie.
- You can adjust the playback volume with the  or  button.



Erasing



1. Press the  button.
2. Use the  or  button to select an image to erase and press the  button.
3. Use the  or  button to select [Erase] and press the  button.

To exit instead of erasing, select [Cancel].



Please note that erased images cannot be recovered. Exercise adequate caution before erasing an image.

Printing

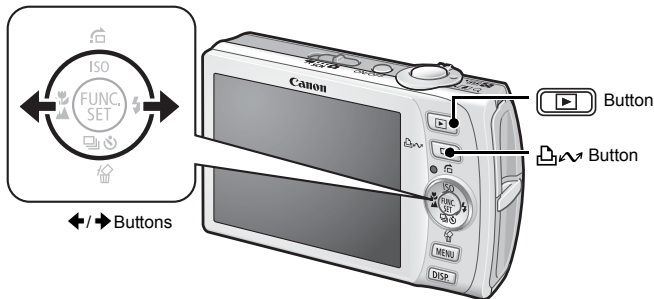

1. Connect the camera to a direct print compatible printer*1.

- Slip a fingernail under the upper edge of the terminal cover to open it and insert the interface cable all the way into the connector.
- See the printer's user guide for connection instructions.

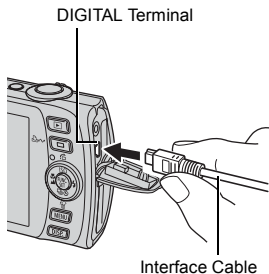
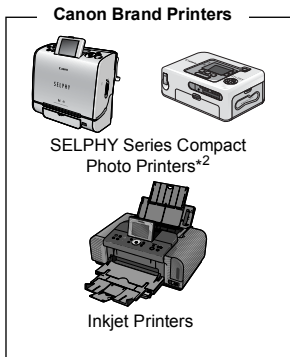







*1 Since this camera uses a standard protocol (PictBridge), you can use it with other PictBridge-compliant printers in addition to Canon-brand printers.

*2 You can also use the CP-10/CP-100/CP-200/CP-300.

2. Turn on the printer.

3. Press the camera's button and turn on the power.

- The  button will light blue.
- A ,  or  icon will appear in the LCD monitor if the connection is correct (the displayed icons differ according to the connected printer).
-   will display on movies.



4. Use the or button to select an image to print and press the button.

The  button will blink blue and printing will start.

After you finish printing, turn off the camera and the printer and disconnect the interface cable.

Downloading Images to a Computer

Items to Prepare

- Camera and computer
- Canon Digital Camera Solution Disk supplied with the camera
- Interface cable supplied with the camera

System Requirements

Please install the software on a computer meeting the following minimum requirements.

■ Windows

OS	Windows Vista Windows XP Service Pack 2 Windows 2000 Service Pack 4
Computer Model	The above OS should be pre-installed on computers with built-in USB ports.
CPU	Windows Vista Windows XP/Windows 2000 Pentium 1.3 GHz or higher Pentium 500 MHz or higher
RAM	Windows Vista Windows XP/Windows 2000 512 MB or more 256 MB or more
Interface	USB
Free Hard Disk Space	<ul style="list-style-type: none"> • Canon Utilities - ZoomBrowser EX 200 MB or more - PhotoStitch 40 MB or more • Canon Camera TWAIN Driver 25 MB or more
Display	1,024 x 768 pixels/High Color (16 bit) or better

■ Macintosh

OS	Mac OS X (v10.3–v10.4)
Computer Model	The above OS should be pre-installed on computers with built-in USB ports.
CPU	PowerPC G3/G4/G5 or Intel Processor
RAM	256 MB or more
Interface	USB
Free Hard Disk Space	<ul style="list-style-type: none"> • Canon Utilities - ImageBrowser 300 MB or more - PhotoStitch 50 MB or more
Display	1,024 x 768 pixels/32,000 Colors or better

Preparing to Download Images

Ensure that you install the software first before connecting the camera to the computer.

1. Installing the software.

■ Windows

1. Place the Canon Digital Camera Solution Disk in the computer's CD-ROM drive.

2. Click [Easy Installation].

Follow the onscreen messages to proceed with the installation.

3. Click [Restart] or [Finish] once the installation is complete.

When the installation is finished, [Restart] or [Finish] will display. Click the button that appears.

4. Remove the CD-ROM from the drive when your normal desktop screen appears.



■ Macintosh

Double-click the  icon in the CD-ROM window. When the installer panel appears, click [Install]. Follow the onscreen instructions to proceed.



2. Connecting the camera to a computer.

1. Connect the supplied interface cable to the computer's USB port and to the camera's DIGITAL terminal.

- Slip a fingernail under the upper edge of the terminal cover to open it and insert the interface cable all the way into the connector.

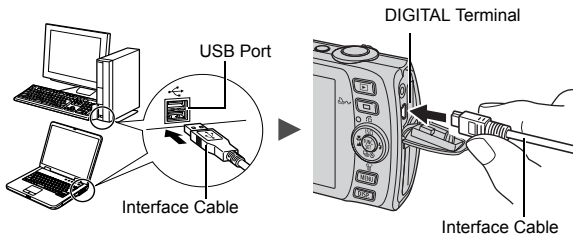

3. Preparing to download images to the computer.

1. Press the camera's button and turn on the power.

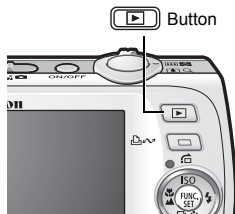

Always grasp the sides of the connector when disconnecting the interface cable from the camera's DIGITAL terminal.



If the Digital Signature Not Found window appears, click [Yes]. The USB driver will automatically finish installing onto the computer when you attach the camera and open a connection.

■ Windows

Select [Canon CameraWindow] and click [OK].



If this Events dialog does not appear, click the [Start] menu and select [All Programs] or [Programs], followed by [Canon Utilities], [CameraWindow], [CameraWindow] and [CameraWindow].

CameraWindow will display.



Preparations for downloading images are now finished. Please proceed to the Downloading Images Using the Camera section (p. 29) (except Windows 2000).



With Windows 2000, you can download images using the computer. Please refer to the *Software Starter Guide* for details.

■ Macintosh

CameraWindow will appear when you establish a connection between the camera and computer. If it fails to appear, click the [CameraWindow] icon on the Dock (the bar which appears at the bottom of the desktop).



Preparations for downloading images are now finished. Please proceed to the Downloading Images Using the Camera section (p. 29).







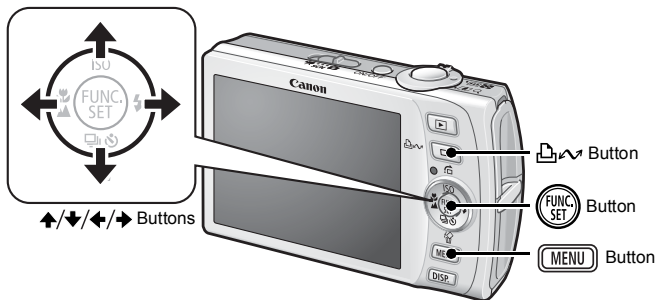

Please refer to the *Software Starter Guide* regarding how to download images using the computer.

Downloading Images Using the Camera (Direct Transfer)

Install the software before downloading images via the Direct Transfer method for the first time (p. 25).

Use this method to download images using camera operations (except Windows 2000).



	All Images	Transfers and saves all images to the computer.
	New Images	Transfers and saves to the computer only the images that have not been previously transferred.
	DPOF Trans. Images	Transfers and saves to the computer only the images with DPOF Transfer Order settings.
	Select & Transfer	Transfers and saves single images to the computer as you view and select them.
	Wallpaper	Transfers and saves single images to the computer as you view and select them. The transferred images as the background on the computer desktop.

1. Confirm that the Direct Transfer menu is displayed on the camera's LCD monitor.

- The  button will light blue.
- Press the **MENU** button if the Direct Transfer menu fails to appear.



Direct Transfer Menu

■ All Images/New Images/DPOF Trans. Images

2. Use the or button to select , or and press the button.

- The images will download. The  button will blink blue while downloading is in progress.
- The display will return to the Direct Transfer menu when the download is complete.
- To cancel the download, press the **FUNC./SET** button.



■ Select & Transfer/Wallpaper

2. Use the or button to select or and press the (or) button.

3. Use the or button to select images to download and press the button.

- The images will download. The  button will blink blue while downloading is in progress.
- Pressing the **FUNC./SET** button will cancel a download in progress.



4. Press the **MENU** button after downloading finishes.

You will return to the Direct Transfer menu.



Only JPEG images can be downloaded as wallpaper for a computer.



The option selected with the  button is retained even when the camera's power is turned off. The previous setting will be in effect the next time the Direct Transfer menu is displayed. The image selection screen will appear directly when the [Select & Transfer] or the [Wallpaper] option was last selected.

Click  at the bottom right of the window to close the CameraWindow and the downloaded images will display on the computer.

■ Windows

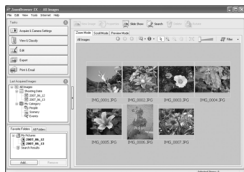

ZoomBrowser EX

■ Macintosh



ImageBrowser

By default, images are saved on the computer in folders according to the shooting date.

System Map

Supplied with Camera



Wrist Strap
WS-DC2



Battery Pack NB-5L*1
(with Terminal Cover)

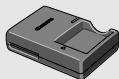

Battery Charger
CB-2LX/CB-2LXE*1

Interface Cable IFC-400PCU*1



Memory Card (32MB)



Canon Digital Camera
Solution Disk

AV Cable
AVC-DC300*1

AC Adapter Kit ACK-DC30



DC Coupler
DR-30



Power Cord



Compact Power Adapter
CA-DC10



Waterproof Case
WP-DC17



High-Power Flash
HF-DC1

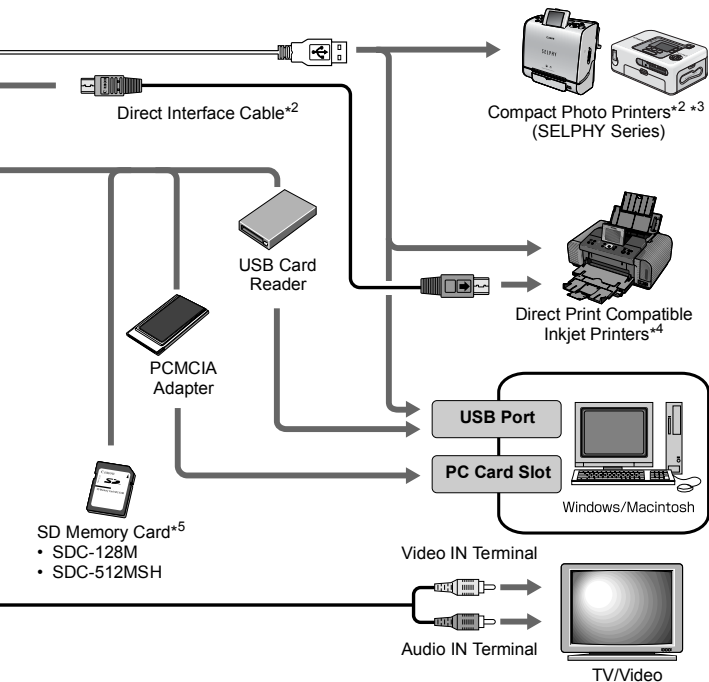

*1 Also available for purchase separately.

*2 See the user guide supplied with the printer for more information on the printer.

*3 This camera can also be connected to the CP-10/CP-100/CP-200/CP-300.

*4 See the user guide supplied with the inkjet printer for more information on the printer and interface cables.

*5 Not sold in some regions.

Optional Accessories

The following camera accessories are sold separately.

Some accessories are not sold in some regions, or may no longer be available.

■ Flash

- **High-Power Flash HF-DC1**

This attachable supplementary flash can be used to capture photographic subjects that are too distant for the built-in flash to illuminate.

■ Power Supplies

- **AC Adapter Kit ACK-DC30**

Kit for using power from a household electrical outlet.

Recommended to power a camera for an extended period of time or when connecting to a computer.

- **Battery Charger CB-2LX/CB-2LXE**

An adapter for charging Battery Pack NB-5L.

- **Battery Pack NB-5L**

Rechargeable lithium-ion battery.

■ Other Accessories

• SD Memory Card

SD Memory Cards are used to store images recorded by the camera. Canon brand cards are available in 128 MB and 512 MB capacities.

• Interface Cable IFC-400PCU

Use this cable to connect the camera to a computer, Compact Photo Printer (SELPHY series), or to a inkjet printer (refer to your inkjet printer user guide).

• AV Cable AVC-DC300

Use this cable to connect the camera to a TV set.

• Waterproof Case WP-DC17

When you attach this waterproof case to the camera, you can use it to take underwater shots at depths of up to 40 meters (130 feet), and of course it is ideal for taking worry-free pictures in the rain, at the beach, or on the ski slopes.

Direct Print Compatible Printers

Canon offers the following separately sold printers for use with the camera. You can produce photo quality prints quickly and easily by connecting them to the camera with a single cable and operating the camera's controls.

- **Compact Photo Printers (SELPHY series)**
- **Inkjet Printers**

For more information, visit your nearest Canon retailer.

Use of genuine Canon accessories is recommended.

This product is designed to achieve excellent performance when used with genuine Canon accessories. Canon shall not be liable for any damage to this product and/or accidents such as fire, etc., caused by the malfunction of non-genuine Canon accessories (e.g., a leakage and/or explosion of a battery pack). Please note that this warranty does not apply to repairs arising out of the malfunction of non-genuine Canon accessories, although you may request such repairs on a chargeable basis.

Learning More

Components Guide

■ Front View

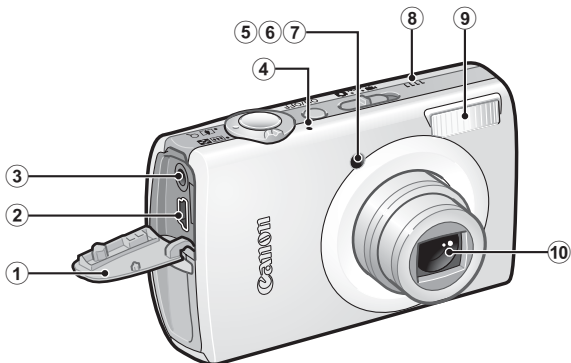

- ① Terminal Cover
- ② DIGITAL Terminal (pp. 22, 26)
- ③ A/V OUT (Audio/Video output) Terminal (p. 183)
- ④ Microphone
- ⑤ AF-assist Beam (p. 49)
- ⑥ Red-Eye Reduction Lamp (p. 86)
- ⑦ Self-Timer Lamp (p. 73)
- ⑧ Speaker
- ⑨ Flash (p. 71)
- ⑩ Lens

How to Open the Terminal Cover

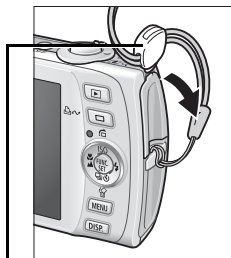

Insert a fingernail or the wrist strap's toggle into the top of the terminal cover to open it.

■ Back View

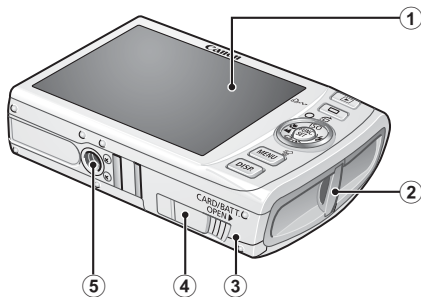

- ① LCD Monitor (pp. 54, 55)
- ② Wrist Strap Mount
- ③ Memory Card Slot / Battery Cover (p. 9)
- ④ DC Coupler Terminal Cover (p. 210)
- ⑤ Tripod Socket



The LCD monitor may be covered with a thin plastic film for protection against scratches during shipment. If so, remove the film before using the camera.



The interface cable and AV cable cannot be connected simultaneously.

■ Controls

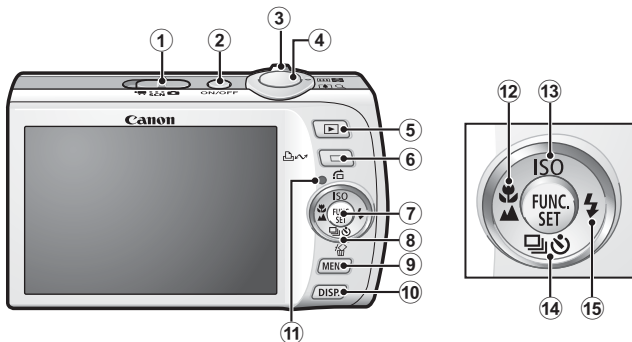

- ① Mode Switch (pp. 14, 44)
- ② Power Button (p. 14)
- ③ Zoom Lever (pp. 66, 130)
Shooting: (Wide Angle)/ (Telephoto)
Playback: (Index)/ (Magnify)
- ④ Shutter Button (p. 14)
- ⑤ (Playback) Button (pp. 43, 172)
- ⑥ (Print/Share) Button (p. 122)
- ⑦ **FUNC./SET** Button (p. 47)
- ⑧ Touch Control Dial (p. 41)
- ⑨ **MENU** Button (p. 48)
- ⑩ **DISP.** Button (p. 54)
- ⑪ Indicator (p. 45)
- ⑫ (Macro)/ (Infinity)/ Button (p. 72)
- ⑬ ISO (ISO Speed)/ (Jump)/ Button (pp. 104, 134)
- ⑭ (Continuous)/ (Self-timer)/ (Single Image Erase)/
 Button (pp. 21, 73, 85)
- ⑮ (Flash)/ Button (p. 71)

Using the Touch Control Dial

■ Touching the Dial

An enlarged icon of the touch control dial will display on the LCD monitor when you place a finger on the touch control dial and the icon of the currently selected item will be enlarged. By holding down the touch control dial in the position of the enlarged icon, you can determine the item to set.

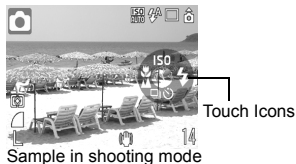
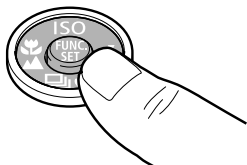

■ Circling Your Finger on the Dial

You can select shooting modes, categories or images by circling your finger on the dial. Circling counterclockwise works the same as the ◀ button and circling clockwise the same as the ▶ button. (It may also work as the ▲ / ▼ buttons with some functions.)

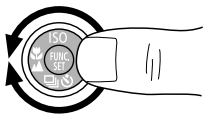

Screen shot of selecting a shooting mode







Screen shot of selecting images in playback mode





- Functions that cannot be configured are shown in gray.
- The dial display (Touch Icons) can be turned On/Off in the [Fn] menu (p. 51).
- When Touch Icons is set to [Off], the icon of the function being touched appears in green on the LCD monitor.

The following functions can be operated using the touch control dial. Please note that some of the options for some functions cannot be operated with it.

	Operable Functions	Reference Page
Shooting	Selecting a shooting mode	p. 44
	Selecting options in  /  /  /  /  /ISO	pp. 71, 72, 73, 85, 104
	Selecting options in the FUNC. menu	p. 47
	Change exposure (movie)	p. 90
Playback	Selecting images	pp. 17, 20, 136, 164, 168
	Operations for playing/editing movies	pp. 140, 142
	Operations for sound memos and the Sound Recorder	pp. 160, 162
	Operations for DPOF print settings and direct transfer settings.	pp. 174, 181
Shooting and Playback	Selecting options in menus	p. 48
	Selecting time zones for the world clock	p. 61
	Changing the clock display color	p. 46
	Selecting options for the My Camera settings	p. 184

Using the Button

The  button can turn the camera on/off and switch between the shooting/playback modes. In addition, you can register slideshow or sound recorder functions to the  button ([p. 172](#)).

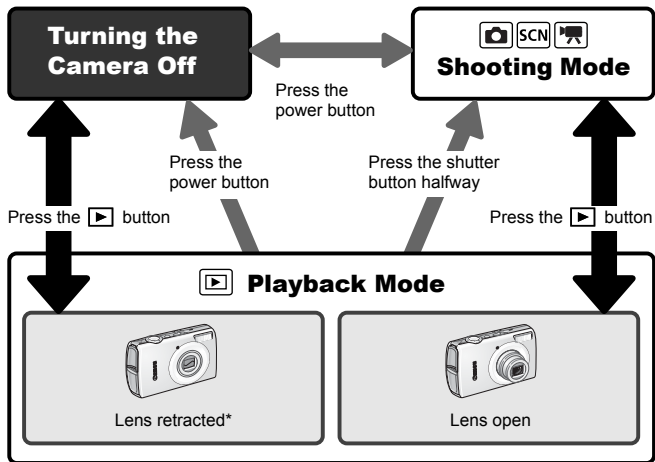
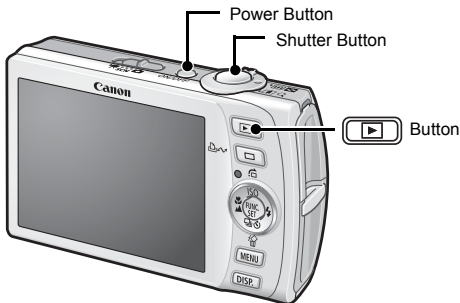

• May operate differently than above when functions are registered to the  button.

* [Lens Retract] time can be changed from the [ (Set up)] menu ([p. 52](#)).

How to Use the Mode Switch

Slide the switch to the mode you wish to use.

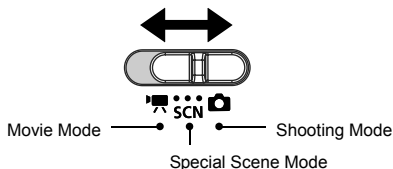

📷 Shooting Mode

- | | |
|-------------------------|-------------------------|
| : Auto (p. 14) | : Manual (p. 84) |
| : Digital Macro (p. 70) | : Color Accent (p. 116) |
| : Color Swap (p. 118) | : Stitch Assist (p. 93) |

SCN Special Scene Mode (p. 81)

- | | |
|-------------|------------------|
| : Portrait | : Night Snapshot |
| : Kids&Pets | : Indoor |
| : Foliage | : Snow |
| : Beach | : Fireworks |
| : Aquarium | : Underwater |

🎥 Movie Mode (p. 88)

- | | |
|----------------|--------------|
| : Standard | : Compact |
| : Color Accent | : Color Swap |
| : Time Lapse | |

Indicator

The indicator on the back of the camera lights or blinks under the following conditions.

- Green:** Ready to shoot (camera beeps twice)*/connected to computer/display off
- Blinking Green:** Camera starting up/Time Lapse (movie) recording/Image recording/reading/erasing/transferring (when connected to a computer/printer)
- Orange:** Ready to shoot (flash on)
- Blinking Orange:** Ready to shoot (camera shake warning)

* Camera beeps once if difficult to focus.



Never do the following while the indicator blinks green. These actions may corrupt image data.

- Shake or jolt the camera
- Turn off the camera, or open the memory card slot/battery cover

Power Saving Function

This camera is equipped with a power saving function. The power will shut off in the following circumstances. Press the power button again to restore power.

Shooting Mode	Powers down approximately 3 minutes after the last control is accessed on the camera. The LCD monitor automatically turns off 1 minute* after the last control is accessed even if [Auto Power Down] is set to [Off]. Press any button other than the power button or change the camera orientation to turn the LCD monitor back on.
Playback Mode Connected to a Printer	Powers down approximately 5 minutes after the last control is accessed on the camera.

* This time can be changed.



- The power saving function will not activate during a slide show or while the camera is connected to a computer.
- The power saving function settings can be changed ([p. 51](#)).

Using the Clock

You can display the current date and time for a 5-second* interval using the following two methods.

* Default setting



Method 1

Hold the **FUNC./SET** button down while turning on the power.

Method 2

In a shooting/playback mode, press the **FUNC./SET** button for more than one second.

If you hold the camera horizontally, it displays the time. If you hold it vertically, the time and date display.

However, if you hold the camera vertically and use method 1 to display the date and time, the time will be initially displayed in the same way as when the camera is held horizontally.

- You can change the display color by pressing the ◀ or ▶ button.
- The clock display will disappear when the display interval is over or when a button is operated for a subsequent operation.
- The clock's display interval can be changed in the [Fn] menu (p. 52).
- The clock cannot be displayed when images are magnified or it is in the index playback mode.

Basic Operations

Menus and Settings

Settings for the shooting or playback modes or such camera settings as the print settings, date/time and sounds are set using the FUNC. menu or the Rec., Play, Print, Set up or My Camera menu.

FUNC. Menu

This menu sets many of the common shooting functions.

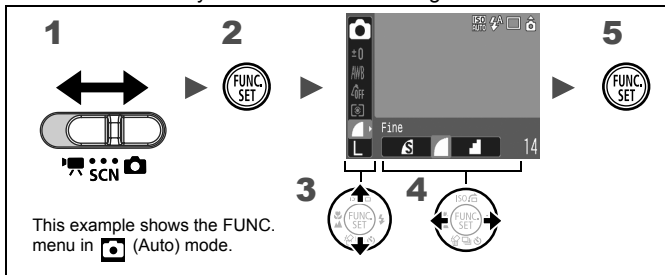



- 1** Set the mode switch to , SCN or .
- 2** Press the button.
- 3** Use the or button to select a menu item.
 - Some items may not be selectable in some shooting modes.
- 4** Use the or button to select an option for the menu item.
 - Items showing the icon can be changed with the DISP. button
 - After selecting an option, you can press the shutter button to shoot immediately. After shooting, this menu will appear again, allowing you to adjust the settings easily.
- 5** Press the button.

Rec., Play, Print, Set up and My Camera Menus

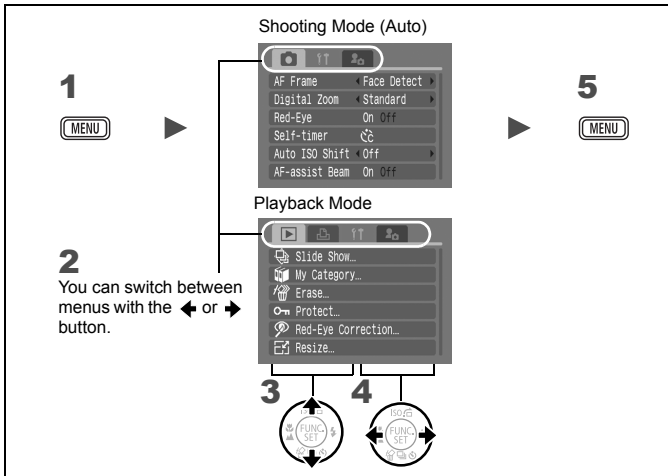
Convenient settings for shooting, playback or printing can be set with these menus.









- 1** Press the  button.
- 2** Use the **←** or **→** button to switch between menus.
 - You can also use the zoom lever to switch between menus.
- 3** Use the **↑** or **↓** button to select a menu item.
- 4** Use the **←** or **→** button to select an option.
 - Menu items followed by an ellipsis (...) can only be set after pressing the **FUNC./SET** button to display the next menu. Press the **FUNC./SET** button again to confirm the setting, then press the **MENU** button to return to the menu screen.
- 5** Press the  button.







Menus and Default Settings

See *Functions Available in Each Shooting Mode* (p. 228).

FUNC. Menu

The icons shown here indicate the default settings (factory settings).









Menu Item	Page
 Shooting Mode	p. 44
 Special Scene Mode	p. 81
 Movie Mode	p. 88
 Exposure Compensation	p. 107
 Long Shutter Mode	p. 109
 White Balance	p. 111

Menu Item	Page
 My Colors	p. 114
 Metering Mode	p. 108
 Compression (Still Image)	p. 76
 Shooting Interval (Movie)	p. 92
 Recording Pixels (Still Image)	p. 75
 Recording Pixels (Movie)	p. 91













Rec. Menu

*Default setting

Menu Item	Options	Page/Topic
AF Frame	Face Detect*/AiAF/Center	p. 97
AF Frame Size	Normal*/Small	p. 99
Digital Zoom		
(Still image)	Standard*/Off/1.6x/2.0x	p. 67
(Movie)	Standard*/Off (In standard movie mode only)	
Slow Synchro	On/Off*	p. 87
Red-Eye	On*/Off	p. 86
Self-timer	Delay: 0–10*, 15, 20, 30 sec. Shots: 1–3*–10	p. 73
Auto ISO Shift	Off*/  button/On	p. 105
AF-assist Beam	On*/Off	p. 191
Review	Off/2*–10 seconds/Hold	You can set the length of time images display after being shot (p. 16).

Menu Item	Options	Page/Topic
Review Info	Off*/Detailed/Focus Check	p. 95
Save Original	On/Off*	p. 120
Auto Category	On*/Off	p. 121
Disp. Overlay		
(Still image)	Off*/Grid Lines/3 : 2 Guide/Both	p. 124
(Movie)	Off*/Grid Lines	
IS Mode		
(Still image)	Continuous*/Shoot Only/ Panning/Off	p. 79
(Movie)	Continuous*/Off	
Date Stamp	Off*/Date/Date & Time	p. 78
Set  button	 /  / WB /  /  /  /  /  / 	p. 122

Play Menu

Menu Item	Page
 Slide Show	p. 146
 My Category	p. 136
 Erase	p. 168
 Protect	p. 164
 Red-Eye Correction	p. 151
 Resize	p. 158
 My Colors	p. 155
 Sound Memo	p. 160
 Sound Recorder	p. 162
 Rotate	p. 144
 Transfer Order	p. 181
 Set Play button	p. 172
 Transition	p. 145

Print Menu

Menu Item	Page
Print	
Select Image & Qty.	
Select Range	
Select by Date	
Select by Category	p. 174
Select by Folder	
Select All Images	
Clear All Selections	
Print Settings	



Set up Menu

*Default setting

Menu Item	Options	Page/Topic
Mute	On/Off*	Set to [On] to silence all operation sounds except for the warning sounds.
Volume	Off/1/2*/3/4/5	Adjusts the volume of the start-up sound, operation sound, self-timer sound, shutter sound and playback sound. The volume cannot be adjusted if [Mute] is set to [On].
Start-up Vol.		Adjusts the volume of the start-up sound when the camera is turned on.
Operation Vol.		Adjusts the volume of the operation sound that beeps when any button other than the shutter button is pressed.
Selftimer Vol.		Adjusts the volume of the self-timer sound played 2 sec. before the shutter is released.
Shutter Volume		Adjusts the volume of the sound played when the shutter releases. The shutter sound does not play when a movie is recording.
Playback Vol.		Adjusts the playback volume of movies and sound memos.
Touch Icons	On*/Off	Sets whether or not the Touch Icons display in the LCD monitor when the touch control dial is touched (p. 41).
LCD Brightness	-7 to 0* to +7	Use the ◀ or ▶ button to adjust the brightness. You can check the brightness in the LCD monitor while you are adjusting the setting.
Power Saving		p. 45
Auto Power Down	On*/Off	Sets whether or not the camera automatically powers down after a set period of time elapses without the camera being operated.
Display Off	10 sec./20 sec./30 sec./1 min.*/2 min./3 min.	Sets the length of time before the LCD monitor turns off when no camera operation is performed.



Menu Item	Options	Page/Topic
Time Zone	Home*/World	p. 61
Date/Time		p. 12
Clock Display	0–5*–10 sec./ 20 sec./30 sec./1 min./2 min./3 min.	p. 46
Format		You can also select a low level format (p. 65).
File Numbering	Continuous*/ Auto Reset	p. 128
Create Folder		p. 126
Create New Folder	Check mark (On)/No check mark (Off)	Creates a folder during the next shooting session.
Auto Create	Off*/Daily/ Monday- Sunday/Monthly	You can also set an auto creation time.
Auto Rotate	On*/Off	p. 125
Lens Retract	1 minute* / 0 seconds	Sets the lens retraction timing when switching from shooting mode to playback mode.
Language		p. 13
Video System	NTSC/PAL	p. 183
Print Method	Auto*/ 	See below
Reset All		p. 64

Print Method

You can change the printer connection method. There is usually no need to change the settings, but select  when you print an image recorded in the  (Widescreen) mode at the full page setting for wide paper using a Canon SELPHY CP750/CP740/CP730/CP720/CP710/CP510 Compact Photo Printer. Since this setting is saved even when the power is turned off, ensure that you return the setting to [Auto] to print other image sizes. (However, it cannot be changed while the printer is connected.)

My Camera Menu

*Default setting

Menu Item	Available Settings	Page
Theme	Selects a common theme for each My Camera settings item.	p. 184
Start-up Image	Sets the image displayed when the camera power is turned on.	
Start-up Sound	Sets the sound played when the camera power is turned on.	
Operation Sound	Sets the sound played when any button other than the shutter button is pressed.	
Selftimer Sound	Sets the sound played 2 seconds before the shutter releases in self-timer mode.	
Shutter Sound	Sets the sound played when the shutter button is pressed. There is no shutter sound for movies.	
My Camera Menu Contents	 (Off) / 1 * /  / 	

Using the LCD Monitor



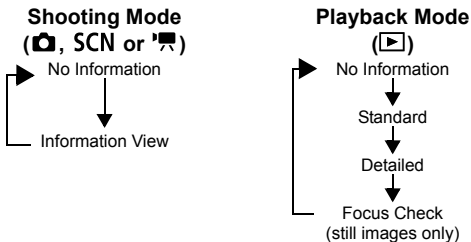

1 Press the button.

- The display mode changes as follows with each press.



- The shooting information displays for approximately 6 sec. when a setting is changed, regardless of the selected display mode.



- The LCD monitor is set to the Information View in the , , ,  or  mode.
- The LCD monitor will not switch to the detailed display or focus check display while in the magnified display or index playback mode.





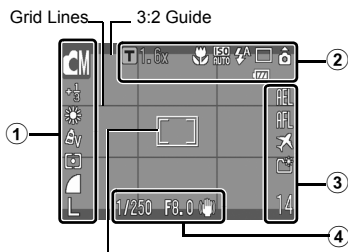















Information Displayed on the LCD Monitor

■ Shooting Mode



[] Spot AE Point Frame/ [] Face Frame/ □ AF Frame

Shooting Mode		pp. 14, 70, 81, 84, 88
Exposure Compensation	-2...+2	p. 107
Long Shutter Mode	1" ... 15"	p. 109
White Balance		p. 111
① My Colors		p. 114
Metering Mode		p. 108
Compression (Still image)		p. 76
Shooting Interval (Movie)	1" 2" (selected)	p. 92
Recording Pixels	L M1 M2 M3 S	p. 75
Recording Pixels (Movies)	640	p. 91
Camera Shake Warning	(Red)	p. 189
Digital Tele-Converter/ Safety Zoom	T 1.6x/2.0x 	p. 67
② Macro/Infinity		p. 72
ISO Speed*	ISO AUTO ISO HI 80 100 200 400 800 1600 (ISO 80 ... ISO 1600)	p. 104

	Flash	  	p. 71
	Drive Mode	    	pp. 73, 85
②	Auto Rotate	  	p. 125
	Movie Recording	[● Rec.]	p. 89
	Low Battery	  	p. 206
	AE Lock/FE Lock	AEL FEL	pp. 102, 103
	AF Lock	AFL	p. 100
③	Time Zone		p. 61
	Create Folder		p. 126
	Stills: Recordable Shots		p. 219
	Movies: Remaining Time/Elapsed Time		p. 220
	Shutter Speed*		–
	Aperture Value*		–
④	Exposure Shift Bar (Movie)		p. 90
	Image Stabilizer	  	p. 79

* Displays when the shutter button is pressed halfway. During flash photography, however, the camera automatically readjusts the ISO speed, shutter speed or aperture setting to an optimal setting, which may cause the playback information to differ from the displayed information.



If the indicator blinks orange and the camera shake warning icon () displays in red, this indicates that a slow shutter speed may have been selected due to insufficient illumination. Use the following methods to shoot:

- Set the IS mode to any setting other than [off] (p. 79)
- Raise the ISO speed (p. 104)
- Configure Auto ISO Shift to a setting other than [Off] (p. 105)
- Select a setting other than  (flash off) (p. 71)
- Attach the camera to a tripod or other device

■ Playback Mode (Standard)



①	Defined Playback		p. 134
	Remaining battery charge will display.		p. 206
②	Displayed image number/Total number of images		–
	Folder Number-File Number		p. 126
	Compression (Still Images) Recording Pixels (Still Images) Movie		pp. 75, 91
③	Red-Eye Correction/My Colors/Resize		pp. 151, 155, 158
	WAVE Format Sound		p. 160
	Protection Status		p. 164
	Shooting Date/Time		p. 12

■ Playback Mode (Detailed)

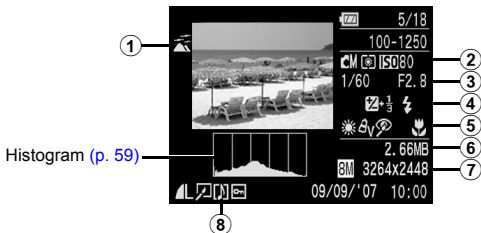

①	Auto Category/ My Category		pp. 121, 136
②	Shooting Mode		pp. 14, 70, 81, 84, 88
	Metering Mode		p. 108
	ISO Speed	ISO 80 ... ISO 1600	p. 104
③	Shutter Speed		–
	Aperture Value		–
	Shooting Interval (Movie)	selected)	p. 92
	Recording Pixels/Frame Rate (Movies)		p. 91
④	Exposure Compensation		p. 107
	Flash		p. 71
⑤	White Balance		p. 111
	My Colors, Color Accent, Color Swap		pp. 114, 116, 118
	Red-Eye Correction Function		p. 151
	Macro/Infinity		p. 72
	File size		p. 221
⑦	Still Image: Recording Pixels, Movies: Movie Length		pp. 75, 88

■ Focus Check

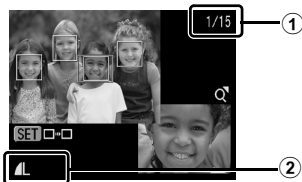

①	Displayed image number/Total number of images		
②	Compression (Still Images)		p. 76
	Recording Pixels		p. 75

The following information may also be displayed with some images.

	A sound file in a format other than the WAVE format is attached or the file format is not recognized.
	JPEG image not conforming to Design rule for Camera File System Standards (p. 215)
	RAW image
	Image recording pixel setting not recognized



Information for images shot on other cameras may not display correctly.

Histogram Function

The histogram is a graph that allows you to check the brightness of the image. The greater the bias toward the left in the graph, the darker the image. The greater the bias toward the right, the brighter the image.

If the image is too dark, adjust the exposure compensation to a positive value. Similarly, adjust the exposure compensation to a negative value if the image is too bright (p. 107).

Sample Histograms



Dark Image



Balanced Image

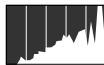

Bright Image

LCD Monitor Brightness

LCD Monitor Brightness Settings

The brightness of the LCD monitor can be changed in the following two ways.

- Changing Settings Using the Set up Menu (p. 51)
- Changing Settings Using the **DISP.** Button (Quick-bright LCD Function)

You can set the LCD monitor to the brightest setting regardless of the option selected in the Set up menu by pressing the **DISP.** button for more than one second.*

- To restore the previous brightness setting, press the **DISP.** button for more than one second again.
- The next time you turn on the camera, the LCD monitor will be at the brightness setting selected in the Set up menu.

* You cannot change the brightness of the LCD monitor with this function if you have already set it to its highest setting in the Set up menu.

Night Display

When shooting in dark conditions, the camera automatically brightens the LCD monitor to suit the brightness of the subject, making it easier to frame the subject.

- Although noise may appear and the movement of the subject shown on the LCD monitor may appear somewhat jagged, there is no effect on the recorded image. The brightness of the image displayed in the monitor, and the brightness of the actual image recorded will be different.

Setting the World Clock

When traveling abroad, you can record images with local dates and times simply by switching the time zone setting if you pre-register the destination time zones. You can enjoy the convenience of not having to switch the Date/Time settings.

Setting the Home/World Time Zones

1 Select [Time Zone].

1. Press the **MENU** button.
2. Use the **←** or **→** button to select **[M]** Menu.
3. Use the **↑** or **↓** button to select **[Time Zone]**.
4. Press the **FUNC./SET** button.



2 Select **[H]** (Home).

1. Use the **↑** or **↓** button to select **[H]**.
 2. Press the **FUNC./SET** button.
- When using for the first time, confirm that the screen to the right appears, then press the **FUNC./SET** button.



3 Select an area as home.



1. Use the **←** or **→** button to select a home time zone.
 2. Press the **FUNC./SET** button.
- To set the daylight saving option, use the **↑** or **↓** button to display **[Sun]**. The time will advance by 1 hour.



4 Select  (World).

1. Use the  button to select .
2. Press the  button.

**5 Select a destination area.**







1. Use the  or  button to select a destination time zone.
2. Press the  button.
 - As in Step 3, you can set daylight saving time.

Time Difference from the Home Time Zone



Switching to the Destination Time Zone

1 Select [Time Zone].

1. Press the  button.
2. Use the  or  button to select  Menu.
3. Use the  or  button to select [Time Zone].
4. Press the  button.



2 Select (World).







1. Use the  or  button to select .
2. Press the  button.
 - To change the destination time zone, use the **FUNC./SET** button.
 - When you switch to the destination time zone,  will display on the monitor.



If you change the date and time when the World option is selected, the Home date and time will also change automatically.



Resetting Settings to Their Default Values

1 Select [Reset All].

1. Press the  button.
2. Use the  or  button to select  Menu.
3. Use the  or  button to select [Reset All].
4. Press the  button.



2 Accept the setting.

1. Use the  or  button to select [OK]
2. Press the  button.

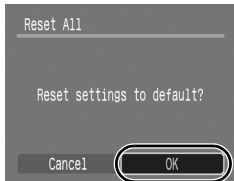

- Settings cannot be reset when the camera is connected to a computer or to a printer.
- The following cannot be reset.
 - Shooting mode
 - The [Time Zone], [Date/Time], [Language] and [Video System] options in the  menu (p. 52)
 - White balance data recorded with the custom white balance function (p. 112)
 - Colors specified in the [Color Accent] (p. 116) or [Color Swap] (p. 118) modes
 - Newly added My Camera settings (p. 185)







Formatting Memory Cards

You should always format a new memory card or one from which you wish to erase all images and other data.







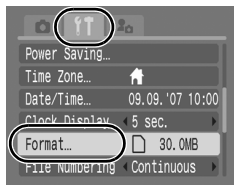

- Please note that formatting (initializing) a memory card erases all data, including protected images and other file types.
- When the  icon is displayed, sound data recorded with the sound recorder exists. Exercise adequate caution before formatting the memory card.

1 Select [Format].

1. Press the  button.
2. Use the  or  button to select  Menu.
3. Use the  or  button to select [Format].
4. Press the  button.



2 Accept the setting.

1. Use the  or  button to select [OK]
 2. Press the  button.
- To perform a low level format, use the  button to select [Low Level Format] and the  or  button to add a check mark.

- You can stop formatting a card when [Low Level Format] is selected by pressing the **FUNC./SET** button. You can still use a card without problem when formatting is halted, but its data will be erased.

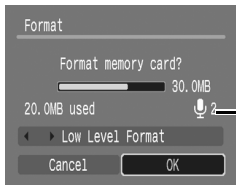

Displays when sound data recorded with the sound recorder is present (p. 162).



Low Level Format

We recommend you select [Low Level Format] when you think that the recording/reading speed of a memory card has dropped. A low level format may require 2 to 3 minutes with some memory cards.

Commonly Used Shooting Functions

You can also use the touch control dial to select shooting modes or FUNC. menu options. See [p. 41](#).

Shooting with the Optical Zoom



See *Functions Available in Each Shooting Mode* ([p. 228](#)).



The zoom can be adjusted from 28 mm – 105 mm (focal length) in 35mm film equivalent terms.

1 Press the zoom lever toward or .

- **Wide Angle:** Zooms out from the subject.
- **Telephoto:** Zooms in on the subject.

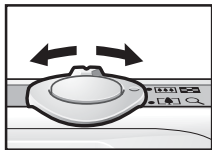

Using the Digital Zoom/Digital Tele-Converter



➔ See *Functions Available in Each Shooting Mode* (p. 228).



You can combine digital zoom with optical zoom when shooting. The available shooting characteristics and focal lengths (35mm film equivalent) are as follows:

Selection	Focal Length	Shooting Characteristics
Standard	28 – 420 mm	Enables shooting at zoom factors of up to 15x with digital and optical zoom combined. In movie mode, only the Standard mode can be selected.
Off	28 – 105 mm	Enables shooting without digital zoom.
1.6x	44.8 – 168 mm	Digital zoom is fixed at the selected zoom factor, and the focal length shifts to maximum telephoto. This enables a faster shutter speed and less chance of camera shake than a shot taken at the same angle of view with [Standard] or [Off].
2.0x	56 – 210 mm	



- The digital zoom cannot be used in or (Postcard), or (Widescreen) modes.
- [1.6x] or [2.0x] cannot be set in mode.

Shooting with the Digital Zoom

1 Select [Digital Zoom].

1. Press the button.
2. In the menu, use the or button to select [Digital Zoom].

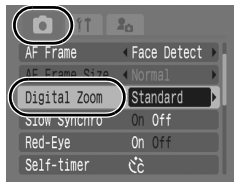

2 Accept the setting.

1. Use the \leftarrow or \rightarrow button to select [Standard].
2. Press the  button.

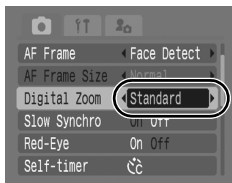



3 Press the zoom lever toward and shoot.

- The combined digital and optical zoom setting will display in the LCD monitor.
- The image may appear coarse depending upon the selected recording pixels (the zoom factor appear in blue).
- Press the zoom lever toward  to zoom out.



Safety Zoom Zone

This camera is equipped with a Safety Zoom feature that shifts from optical zoom to digital zoom without pausing until image quality is lost at any given recording pixel setting. The  icon will display at the maximum zoom setting before image quality is lost and you can advance the zoom further by pressing the zoom lever toward the  icon again. The Safety Zoom zone changes according to the selected recording pixel setting as shown below.

Safety Zoom Factor

	Optical Zoom	Digital Zoom	
L	3.8x \rightarrow		
M1		4.8x \rightarrow	
M2			6.1x \rightarrow
M3			7.8x \rightarrow
S			15.0x \rightarrow

  Zone without deterioration  Zone with deterioration

Shooting with the Digital Tele-Converter



The digital tele-converter feature uses digital zoom to achieve the effects of a tele-converter (a lens used in telephoto shooting).

1 Select [Digital Zoom].

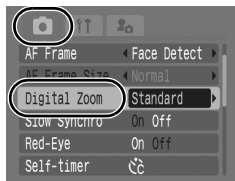
1. Press the  button.
2. In the [] menu, use the  or  button to select [Digital Zoom].



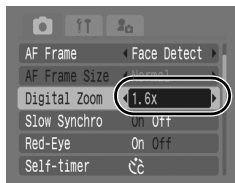

2 Accept the setting.

1. Use the  or  button to select [1.6x] or [2.0x].
2. Press the  button.



3 Adjust the angle of view with the zoom lever and shoot.

-  will appear on the LCD monitor.
- The image may appear coarse depending upon the selected recording pixels (the  icon and the zoom factor appear in blue).











Magnified Close-Up Shooting (Digital Macro)

 See Functions Available in Each Shooting Mode (p. 228).



You can shoot a subject 3 – 60 cm (1.8 in. – 2.0 ft.) from the end of the lens at the maximum wide angle setting. With the digital zoom, the image area is 12 x 9 mm (0.47 x 0.35 in.) at maximum zoom (approximately 4.0x).

1 Select Digital Macro.

1. Set the mode switch to .
2. Press the  button.
3. Use the  or  button to select  and choose  with the  or  button.
4. Press the  button.

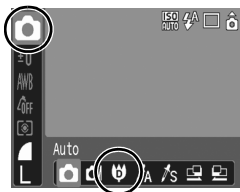

2 Choose the angle of view with the zoom lever and shoot.

- The zoom factor appears on the LCD monitor.

⚡ Using the Flash





➡ See Functions Available in Each Shooting Mode (p. 228).



1 Press the ⚡ button.

1. Use the ← or → button to change the flash mode.

-  : [Auto]
-  : [On]
-  : [Off]

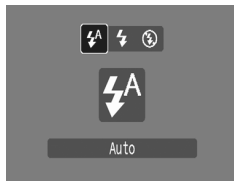

You are recommended to shoot with the camera attached to a tripod or other device if the camera shake warning icon  appears.



Shooting Close-Ups/Infinity Shot







 See Functions Available in Each Shooting Mode (p. 228).



You can shoot close-ups or infinity shots.

	Macro	<p>Use this mode to shoot close-ups of flowers or small items. Image Area at Minimum Focusing Distance from End of Lens to Subject</p> <ul style="list-style-type: none"> • Maximum wide angle setting: 46 × 34 mm (1.8 × 1.3 in.) Minimum focusing distance: 3 cm (1.2 in.) • Maximum telephoto setting: 108 × 81 mm (4.3 × 3.2 in.) Minimum focusing distance: 30 cm (1.0 ft.)
	Infinity	Use this mode to record subjects 3 m (9.8 ft.) or more from the end of the lens.

1 Press the button.

1. Use the  or  button to select  or .



To Cancel the Macro Mode

Press  button and use the  or  button to select  (Normal).



Using the flash in macro mode may cause image edges to darken.

Using the Self-Timer



See Functions Available in Each Shooting Mode (p. 228).



You can set the time delay and the numbers of shots you wish to take in advance.

	<p>10 sec. Self-Timer: shoots 10 seconds after you press the shutter button.</p> <ul style="list-style-type: none"> • 2 seconds before the shutter releases, the self-timer lamp and sound speed up*.
	<p>2 sec. Self-Timer: shoots 2 seconds after you press the shutter button.</p> <ul style="list-style-type: none"> • The self-timer sound beeps quickly* when you press the shutter button and the shutter releases 2 seconds later.
	<p>Custom Timer: you can change the delay time (0–10, 15, 20, 30 sec.) and number of shots (1–10).</p> <ul style="list-style-type: none"> • When [Delay] is set to 2 or more seconds, the self-timer sound beeps quickly 2 seconds before the shutter releases. When [Shots] is set to more than 1, the self-timer sound only beeps before the first shot. • Cannot be set in the , , or movie mode.

* This may differ depending on your My Camera settings (p. 184).

1 Press the button.

1. Use the or button to change the self-timer mode.



2 Shoot.

- When the shutter button is pressed fully, the self-timer will activate and the self-timer lamp will blink (when using red-eye reduction, it will stay lit for the last 2 seconds).

To Cancel the Self-Timer

Press the button and use the or button to select .







Changing the Delay Time and Number of Shots (📷)

1 Select [Self-timer].

1. Press the  button.
2. In the  menu, use the  or  button to select [Self-timer].
3. Press the  button.



2 Accept the setting.

1. Use the  or  button to select [Delay] or [Shots] and change the settings with the  or  button.
2. Press the  button.
3. Press the  button.

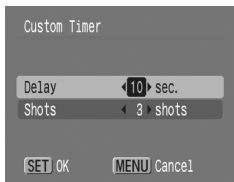

If the [Shots] option is set to 2 or more shots, the following occurs.

- The exposure and white balance are locked at the settings selected for the first shot.
- If the flash is used, the interval between shots lengthens because the flash must charge.
- The interval between shots may lengthen when the built-in memory of the camera fills.
- Shooting will automatically cease if the memory card becomes full.

Changing the Recording Pixels/ Compression (Still Images)



➔ See Functions Available in Each Shooting Mode (p. 228).



1 Select a resolution setting.

1. Press the button.
2. Use the or button to select **L** and the or button to change the option.
3. Press the button.

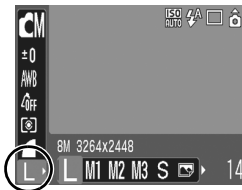







Approximate Values for Recording Pixels

Recording Pixels				Purpose*
L (Large)	8M	3264 x 2448 pixels	High ↑ ↓ Low	Printing to about A3-size 297 x 420 mm (11.7 x 16.5 in.)
M1 (Medium 1)	5M	2592 x 1944 pixels		Printing to about A4-size 210 x 297 mm (8.3 x 11.7 in.) Printing to about Letter-size 216 x 279 mm (8.5 x 11 in.)
M2 (Medium 2)	3M	2048 x 1536 pixels		Printing to about A5-size 148 x 210 mm (6 x 8.3 in.)
M3 (Medium 3)	2M	1600 x 1200 pixels		Print postcard-size prints 148 x 100 mm (6 x 4 in.) Print L-size prints 119 x 89 mm (4.7 x 3.5 in.)
S (Small)	0.3M	640 x 480 pixels		Send images as e-mail attachments or shoot more images
or (Postcard)	1600 x 1200 pixels			When printing to postcards.
W (Widescreen)	3264 x 1832 pixels			Printing on wide size paper (you can check the composition at a 16:9 aspect ratio. Areas that will not be recorded appear on the LCD monitor as a black border.)





: Approximate number of recording pixels. (M is short for megapixels.)

* Paper sizes vary according to region.

1 Select a compression setting.

1. Press the  button.
2. Use the  or  button to select  and the  or  button to change the option.
3. Press the  button.

**Approximate Values for Compression Settings**

Compression		Purpose
 Superfine	High Quality	Shoot higher quality images
 Fine		Shoot normal quality images
 Normal		Normal



- See *Image Data Sizes (Estimated)* ([p. 221](#)).
- See *Memory Cards and Estimated Capacities* ([p. 219](#)).

Configuring the Postcard Mode



See Functions Available in Each Shooting Mode (p. 228).



You can shoot images with the optimal settings for postcards by composing them inside the print area (width-to-height ratio of approximately 3:2) shown in the LCD monitor.

1 Select the Postcard Mode.

1. Press the button.
2. Use the or button to select and choose with the or button.
3. Press the button.

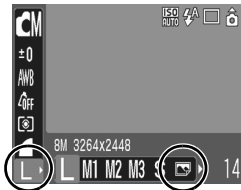

- Approximately 2M recording pixels, and compression settings are fixed to Fine.
- The area that will not print displays in gray.



The digital zoom or the digital tele-converter cannot be used in this mode.



For printing instructions, refer to the *Direct Print User Guide*.









Embedding the Date in the Image Data SCN

 See Functions Available in Each Shooting Mode (p. 228).





You can embed the date in the image data when  (Postcard) is selected.

1 Select the Postcard Mode.

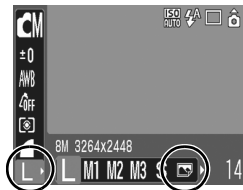
1. Press the  button.
2. Use the  or  button to select  and choose  with the  or  button.
3. Press the  button.





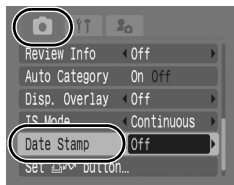

2 Select [Date Stamp].

1. Press the  button.
2. In the [] menu, use the  or  button to select [Date Stamp].



3 Set the date and time.

1. Use the  or  button to select [Date] or [Date & Time].
2. Press the  button.
 - LCD Monitor Display
 -  : [Off]
 -  : [Date]/[Date & Time]

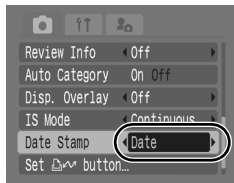

- Ensure that the camera's date/time is set beforehand (p. 12).
- The date stamp cannot be deleted from the image data once it has been embedded.



To imprint the date on images for all but postcard size images, use the supplied software (ZoomBrowser EX or ImageBrowser) or printer settings. For details, please see the user guide for each product.

Setting the Image Stabilizer Function



See Functions Available in Each Shooting Mode (p. 228).



The image stabilizer function allows you to minimize the camera shake effect (blurred images) when you shoot distant subjects that have been magnified or when you shoot in dark conditions without a flash.

-	Off	-
	Continuous	You can check the effect of the IS mode on image blur on the LCD monitor since the IS mode runs continually. This makes it easier to compose images and focus on subjects.
	Shoot Only	IS mode is only activated when the shutter button is pressed, so subjects will be captured with reduced blur even if their movements on the LCD monitor are not smooth. This option is not available in the movie mode.
	Panning	This option only stabilizes the effect of up and down camera motions on the image. This option is recommended for shooting objects moving horizontally. This option is not available in the movie mode.

1 Select [IS Mode].

1. Press the **[MENU]** button.
2. In the **[]** menu, use the **↑** or **↓** button to select [IS Mode].

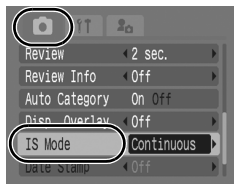

2 Accept the setting.

1. Use the ◀ or ▶ button to select an image stabilizer option.
2. Press the  button.



- Camera shake may not be fully corrected when shooting with slow shutter speeds, such as with evening shots. Set Auto ISO Shift (p. 105) to a setting other than [Off] or use a tripod to shoot.
- If camera shake is too strong, it may not be fully corrected.
- Hold the camera horizontally while panning (stabilization does not work when the camera is held vertically).
- If you select [Shoot Only] or [Panning] in shooting mode (still images) and then switch to movie mode, the setting will change to [Continuous].

Various Shooting Methods

You can also use the touch control dial to select shooting modes or FUNC. menu options. See [p. 41](#).







Shooting in Modes for Special Conditions SCN

➔ See Functions Available in Each Shooting Mode ([p. 228](#)).



You can shoot with the most appropriate settings for the scene.

1 Select a shooting mode.

1. Set the mode switch to **SCN**.
2. Press the  button.
3. Use the  or  button to select  and the  or  button to select a mode.
4. Press the  button.



Portrait

Produces a soft effect when photographing people.



Night Snapshot

Allows you to take snapshots of people against twilight or night backgrounds by reducing the effects of camera shake even without using a tripod.

**Kids&Pets**

Allows you to capture subjects that move around, such as children and pets, without missing photo opportunities.

**Indoor**

Prevents camera shake and maintains the subject's true color when shooting under fluorescent or tungsten lighting.

**Foliage**

Shoots trees and leaves—such as new growth, autumn leaves or blossoms—in vivid colors.

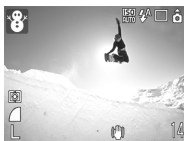
**Snow**

Shoots without a blue tinge and without making people appear dark against a snowy background.

**Beach**

Shoots without making people appear dark near water or sand where reflected sunlight is strong.

**Fireworks**

Captures fireworks in the sky sharply and at optimal exposure.



Aquarium



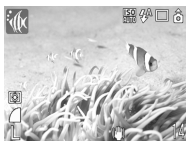



Selects the optimal ISO speed, white balance and color balance to capture fish and other items in an indoor aquarium.



Underwater

Appropriate for shooting images with Waterproof Case WP-DC17 (sold separately). This mode uses an optimal white balance setting to reduce bluish tones and record images with a natural hue.



- The shutter speed is slow in  mode. Always use a tripod to avoid camera shake.
- In , , ,  or  mode, the ISO speed may increase and cause noise in the image depending on the scene being shot.



Install the camera in Waterproof Case WP-DC17 to shoot underwater. You are also recommended to use this case for shooting in rainy conditions, at the beach or on the ski slopes.

Shooting in Manual Mode



See *Functions Available in Each Shooting Mode* (p. 228).



Allows you to select settings yourself, such as the exposure compensation, white balance or my colors.

1 Select manual mode.

1. Set the mode switch to .
2. Press the button.
3. Use the or button to select and choose with the or button.
4. Press the button.

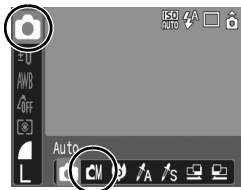

Continuous Shooting



See Functions Available in Each Shooting Mode (p. 228).



In this mode, the camera shoots continuously while the shutter button is held down. If you use the recommended memory card*, you can shoot continuously (smooth continuous shooting) at a set shooting interval until the memory card is full (p. 219).

*Recommended Memory Card:

Super high-speed SDC-512MSH memory card (sold separately) to which low-level formatting (p. 65) is conducted immediately before shooting.

- This reflects standard shooting criteria established by Canon. Actual results may vary according to the subject and shooting conditions.
- Even if continuous shooting suddenly stops, the memory card may not be full.

1 Press the button.

1. Use the or button to select .

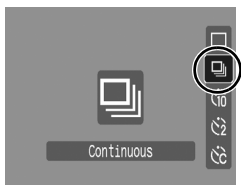

2 Shoot.

- The camera will continue to record successive images while the shutter button is held down.
- Recording will cease when the shutter button is released.

To Cancel Continuous Shooting

Follow step 1 to display .



- The interval between shots lengthens when the built-in memory of the camera fills.
- If the flash is used, the interval between shots lengthens because the flash must charge.

Setting the Red-Eye Reduction Function

 See Functions Available in Each Shooting Mode (p. 228).





This function reduces the red appearance of eyes when the flash fires and light is reflected back.

1 Select [Red-Eye].

1. Press the  button.
2. In the  menu, use the  or  button to select [Red-Eye].



2 Accept the setting.

1. Use the  or  button to select [On] or [Off].
2. Press the  button.

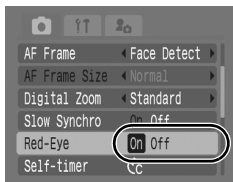

The red-eye reduction lamp lights orange before the flash fires when the Red-Eye option is set to [On].





Setting the Slow Synchro Function

 See Functions Available in Each Shooting Mode (p. 228).





You can shoot with the flash at slow shutter speeds. You can limit the extent to which only the background darkens with flash photography while shooting night scenes or under indoor lighting.

1 Select [Slow Synchro].

1. Press the  button.
2. In the  menu, use the  or  button to select [Slow Synchro].



2 Set Slow Synchro.

1. Use the  or  button to select [On] or [Off].
2. Press the  button.



Please note that camera shake becomes a factor when [Slow Synchro] is set to [On]. If this occurs, you are recommended to fix the camera to a tripod to shoot in this mode.

Movie Shooting



See Functions Available in Each Shooting Mode (p. 228).



The following movie modes are available.

For information on the recording pixels and frame rate in each mode, refer to *Changing Recording Pixels* (p. 91).

* The recording time will vary according to the capacity of the memory card you use (p. 220).



Standard

You can select the recording pixels and record until the memory card is full*¹. The digital zoom can be used while shooting in this mode (p. 67).

- Maximum Size: 4 GB*²/movie



Compact

Since there are few recording pixels and also the data size is small, this mode is convenient for sending movies as e-mail attachments or when the memory card capacity is low.

- Maximum Clip Length: 3 minutes



Color Accent



Color Swap

You can have only the specified color remain and change all others into black and white, or change a specified color into a different color (pp. 116, 118). As with the Standard mode, you can also select the recording pixels and frame rate and record until the memory card is full*¹.

- Maximum Size: 4 GB*/movie



Time Lapse









Select a shooting interval (1 or 2 sec.) to have a single frame shot at that interval. When played back, two hours worth of recorded frames is compressed to 8 minutes (1-sec. interval) or 4 minutes (2-sec. interval). You can record events from a fixed perspective, such as the spectacle of a flower budding over time, or view changing elements in a short period. Sound cannot be recorded in this mode.

- Maximum recording session: 2 hours.



*1 When a super high-speed memory card is used: SDC-512MSH is recommended.

*2 Even if the clip size has not reached 4 GB, recording will stop at the moment the clip length reaches 1 hour. Depending on the volume and data writing speed of the memory card, recording may stop before reaching 1 hour or before the recorded data volume has reached 4 GB.

1 Select a shooting mode.

1. Set the mode switch to .
2. Press the  button.
3. Use the  or  button to select  and the  or  button to change the option.
4. Press the  button.



- See Changing Colors (p. 116) for the procedures for using  and .

2 Shoot.





- Pressing the shutter button halfway automatically sets the exposure, focus and white balance settings.
- Pressing the shutter button fully starts recording video and sound simultaneously.
- During shooting, the recording time and [●Rec] appear on the LCD monitor.
- Pressing the shutter button fully again stops recording. Recording will stop automatically under the following circumstances.
 - When the maximum recording time elapses
 - When the built-in memory or memory card becomes full





- You are recommended to use a memory card that has been formatted in your camera to shoot movies (p. 65). The memory card supplied with the camera may be used without further formatting.

- Be careful of the following while recording.
 - Do not touch the microphone (p. 38).
 - Do not press any buttons other than the shutter button. The sound that buttons make will be recorded in the movie.
 - The camera will automatically adjust the exposure and white balance to suit the shooting conditions during recording. Please note, however, that the sounds made by the camera automatically adjusting the exposure may also be recorded.
- The focus and optical zoom settings remain fixed for subsequent frames at the values selected for the first frame.









- Before recording, you can set the AE lock and exposure shift. This is effective on ski slopes and the beach when the contrast is too strong between the subject and background or where there are both light and dark areas in the scene and it is desirable to adjust the exposure.
 1. Press the **[ISO]** button. The exposure will lock (AE lock) and the exposure shift bar will appear in the LCD monitor.
 2. Use the **◀** or **▶** button to adjust the exposure. Press the **[ISO]** button again to release the setting. Also, the setting will be canceled if you press the **MENU** button or change the white balance, My Colors or shooting mode settings.
- If you register the  function with the  button, you can start shooting a movie simply by pressing the  button even if the mode switch is set to  or **SCN** (p. 122).
- QuickTime is required to play back movies (Data type: AVI/ Compression method: Motion JPEG) on a computer (Only Windows 2000).

Changing Recording Pixels

You can change the recording pixels when the movie mode is set to  (Standard),  (Color Accent) or  (Color Swap).





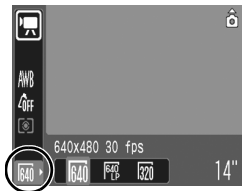





1 Select the number of recording pixels.

1. Press the  button.
2. Use the  or  button to select  and the  or  button to change the option.
3. Press the  button.







Recording Pixels and Frame Rates

Frame rates indicate the number of frames recorded or played back each second. The higher the frame rate, the smoother the appearance of motion.

 Standard	 *1	640 x 480 pixels, 30 frames/sec.
 Color Accent	 *2	640 x 480 pixels, 30 frames/sec. LP
 Color Swap		320 x 240 pixels, 30 frames/sec.
 Compact		160 x 120 pixels, 15 frames/sec.
 Time Lapse	 *3	640 x 480 pixels, 15 frames/sec.

*1 Default setting.

*2 To give priority to recording length over quality, select the option displaying [LP] (Long Play). For the same file size, you can record approximately twice the length.







*3 Frame rate when the shooting interval is : 1 frame/sec. (shooting interval: 1 sec.), : 0.5 frame/sec. (shooting interval: 2sec.). Frame rate when playing back ( or ): 15 frames/sec.



- See *Image Data Sizes (Estimated)* (p. 221).
- See *Memory Cards and Estimated Capacities* (p. 219).

Changing the Shooting Interval (Time Lapse)

1 Select a shooting interval.

1. Press the  button.
2. Use the  or  button to select  and the  button to change the option.
3. Press the  button.
 - The indicator will blink green while the camera is recording.

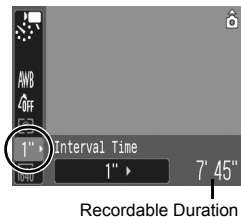

- You are recommended to use a fully charged battery or an AC adapter since the recording period may be lengthy.
- The power saving setting (p. 45) will determine whether or not the LCD monitor shuts off. The LCD monitor will turn on if something other than the power button or shutter button is operated.
- The LCD monitor displays the elapsed time from the start of recording to the end in playback mode, but the actual playback time is shorter than the displayed time.

Shooting Panoramic Images (Stitch Assist)



See Functions Available in Each Shooting Mode (p. 228).



Stitch Assist can be used to shoot overlapping images that can later be merged (stitched) to create one panoramic image on a computer.



The overlapping seams of several adjacent images can be joined into a single panoramic image.



1 Select a shooting direction.

1. Set the mode switch to .
2. Press the button.
3. Use the or button to select and the or button to select or .
4. Press the button.

: Left to right horizontally

: Right to left horizontally

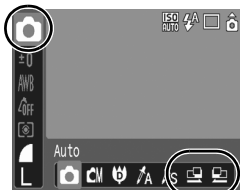

2 Shoot the first image in the sequence.

- The exposure and white balance are set and locked with the first image.



3 Compose the second image so that it overlaps a portion of the first and shoot.

- You can press the ◀ or ▶ button to return to the previously recorded image to retake the shot.
- Minor discrepancies in the overlapping portions can be corrected when the images are stitched together.

4 Repeat the procedure for additional images.

- A sequence may contain up to 26 images.

5 Press the  button after the last shot.

- You cannot display the images on a TV when shooting in Stitch Assist mode.
- The settings for the first image are applied to the second image onward.



Use PhotoStitch, a supplied software program, to merge the images on a computer.

3 Shoot.

- The recorded image displays.

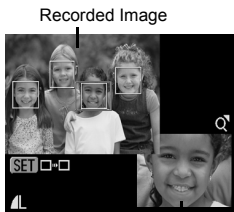

Orange frame contents

- The frame displays as follows.

Frame Color	Content
Orange	Displays the area of the image shown at the bottom right
White	Displays at the focal point (AF frame)

- The orange frame can be shown at a different magnification, moved or switched to a different frame (p. 133).

To Cancel Checking the Focus

Press the shutter button halfway.



- When the bottom right of the image is enlarged, pressing the  button will not delete the image.
- You can also check the focus in playback mode (p. 132).



The AF frame appears as follows when the shutter button is pressed halfway.

- Green : Focus is achieved
- Yellow : Focusing difficulty (AF frame set to [Center])
- No AF frame : Focusing Difficulty (AF frame set to [Face Detect] or [AiAF])

Face Detect Feature

- Maximum of three Face frames will be displayed at the position of the face the camera recognizes. At this point, the frame the camera judges to be the main subject appears in white while the others appear in gray. When the shutter button is pressed halfway, up to 9 green AF frames may appear.
- The camera will shoot using [AiAF] not the [Face Detect] function if a white frame fails to appear and only gray frames display, or if a face is not detected.
- The camera may mistakenly identify non-human subjects as a face.
- In certain cases, faces may not be detected.

Examples:

- If faces are at the edge of the screen, or appear extremely small, large, dark or bright, relative to the overall composition.
- Faces turned to the side or at a diagonal, or faces with a portion hidden.

Changing the AF Frame Size

When the [AF Frame] is set to [Center], the AF frame can be resized to correspond to the subject. Select [Small] to constrict the focal frame to suit a small subject or to focus on a particular area of a subject.

1 Select [AF Frame Size].

1. Press the **MENU** button.
2. In the [] menu, use the **↑** or **↓** button to select [AF Frame Size].





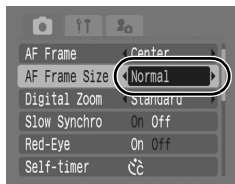

2 Accept the setting.



1. Use the **←** or **→** button to select [Normal] or [Small].
2. Press the **MENU** button.



The setting is configured to [Normal] when the digital zoom or digital tele-converter is used.

Shooting with the AF Lock

The AF lock can be used in the , , ,  or  mode.

- 1 Aim the camera so that an object at the same focal distance as the main subject is centered in the AF frame.**
- 2 Press and hold the shutter button halfway and press the /▲ button.**
 - The  icon will display.
- 3 Re-aim the camera to compose the shot as desired and shoot.**

To Release the AF Lock

Press the /▲ button.



- When shooting with the focus lock or AF lock using the LCD monitor, setting [AF Frame] to [Center] (p. 97) makes shooting easier since the camera focuses using the center AF frame only.
- The AF lock is convenient because you can let go of the shutter button to compose the image. Moreover, the AF lock is still effective after the picture is taken, allowing you to capture a second image with the same focus.
- The AF frame will not appear in movie mode.

ISO Adjusting the ISO Speed



➔ See Functions Available in Each Shooting Mode (p. 228).



Raise the ISO speed to use a fast shutter speed when you wish to reduce the effects of camera shake or avoid blurry subjects, or to turn the flash off when shooting in a dark area.

1 Press the **ISO** button.

- Use the **▲** or **▼** button to change the ISO speed.
 - You can advance to the next option each time you press the button.
 - Selecting **ISO AUTO** (Auto) puts priority on image quality in setting the optimal ISO speed for the light level when shooting. Since the ISO speed setting will automatically be raised in dark places, the camera will select a faster shutter speed and reduce the chances of camera shake.
 - Selecting **ISO HI** (High ISO Auto)* sets a higher sensitivity than for **ISO AUTO**. As the shutter speed becomes even faster, camera shake and blurred photos caused by subject movement will be reduced even more than when shooting the same scene in **ISO AUTO**.

* Noise may increase in the captured image compared to **ISO AUTO**.
 - When in **□** (Auto) shooting mode, only **ISO AUTO** or **ISO HI** can be selected.
 - ISO AUTO** and **ISO HI** cannot be selected in Long Shutter mode (p. 109).

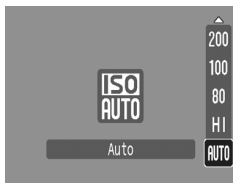

- The camera automatically applies noise reduction processing when you shoot at a high ISO speed.
- If the camera is set at **ISO AUTO** or **ISO HI**, the ISO speed automatically set by the camera will be displayed when pressing shutter button halfway or in playback information.

Reducing the Effects of Camera Shake (Auto ISO Shift)







➔ See Functions Available in Each Shooting Mode (p. 228).





If the camera shake warning icon () displays while shooting, you can raise the ISO speed and record at a shutter speed that compensates for camera shake.

Off	–
 button	Allows you to check the ISO speed and the shutter speed setting in the LCD monitor before and after the change.
On	Automatically sets the optimal ISO speed to compensate for camera shake.





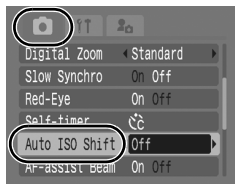

- Auto ISO Shift does not work with , , , or in Long Shutter mode or with the flash.
- Depending on the shooting conditions, the camera shake warning icon () may not disappear even when the ISO speed is elevated.

1 Select [Auto ISO Shift].

1. Press the  button.
2. In the [] menu, use the  or  button to select [Auto ISO Shift].



2 Accept the setting.

1. Use the  or  button to select [ button] or [On].
2. Press the  button.

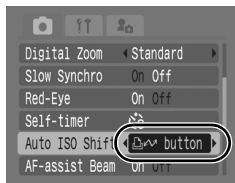

■ Shoot with [On] Selected

3 Press the shutter button halfway.



- The camera selects the optimal speed according to light levels to compensate for camera shake.



4 Now press the shutter button fully.

■ Shoot with [button] Selected

3 Press the shutter button halfway.

- If  appears, the  button will light blue.



4 Press the button while holding the shutter button down halfway.

- The post-change ISO Speed will display.
- With the shutter button pressed halfway, pressing the  button again returns the ISO speed to the original setting.
- If you set the AE Lock (p. 102) after raising the ISO speed, the ISO speed will not return to the previous setting, even if you release the shutter button.



5 Now press the shutter button fully.







Adjusting the Exposure Compensation

 See Functions Available in Each Shooting Mode (p. 228).



Adjust the exposure compensation to a positive value to avoid making the subject too dark when it is backlit or shot against a bright background. Adjust the exposure compensation to a negative value to avoid making the subject too bright in night shots or when shot against a dark background.

1 Adjust the exposure.

1. Press the  button.
2. Use the  or  button to select  and the  or  button to adjust the setting.
3. Press the  button.

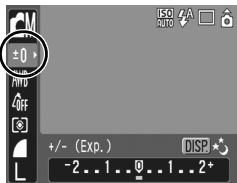

To Cancel the Exposure Compensation

Restore the compensation value to [0].



In movie mode, the exposure shift can be set/canceled (p. 90).

Setting the Shutter Speed

(Long Shutter Mode)

 See Functions Available in Each Shooting Mode (p. 228).





You can set the shutter speed to a slow setting to make dark subjects appear brighter.

1 Select the Long Shutter Mode.

1. Press the  button.
2. Use the  or  button to select .
3. Press the  button.



2 Adjust the setting.

1. Use the  or  button to change the shutter speed.
2. Press the .

- The higher the value, the brighter the recorded image becomes.
- If you press the **DISP.** button at this point, you will return to the Exposure Compensation setting screen.



- The brightness of the image appearing on the LCD monitor and the recorded image may differ.
- The nature of CCD image sensors is such that noise in the recorded image increases at long shutter speeds. This camera, however, applies special processing to images shot at shutter speeds of 1.3 seconds or slower to eliminate the noise, thereby producing high-quality images. A certain amount of processing time, however, may be required before the next image can be shot.











- Use the LCD monitor to confirm that the image was recorded at the desired brightness.
- Please note that camera shake becomes a factor at low shutter speeds. Shoot with the camera attached to a tripod.
- Use of the flash may result in an over-exposed image. If this occurs, shoot with the flash set to .
- The following are unavailable:
 - Exposure Compensation
 - Metering
 - AE Lock
 - FE Lock
 - ISO speed: Auto, High ISO Auto
 - Auto ISO Shift
 - Flash: Auto
 - Slow Synchro

Adjusting the Tone (White Balance)







 See Functions Available in Each Shooting Mode (p. 228).





Normally, the  (Auto) white balance setting selects an optimal white balance. When the  setting cannot produce natural looking colors, change the white balance using a setting appropriate for the light source.

	Auto	Settings are automatically set by the camera.
	Day Light	For recording outdoors on a bright day.
	Cloudy	For recording under overcast, shady or twilight skies.
	Tungsten	For recording under tungsten and bulb-type 3-wavelength fluorescent lighting.
	Fluorescent	For recording under warm-white, cool-white or warm-white (3-wavelength) fluorescent lighting.
	Fluorescent H	For recording under daylight fluorescent, or daylight fluorescent-type 3-wavelength fluorescent lighting.
	Custom	For recording with the optimal white balance data memorized in the camera from a white-colored object, such as white paper or cloth.

1 Select a white balance setting.

1. Press the  button.
2. Use the  or  button to select  and the  or  button to change the option.
3. Press the  button.



The white balance setting cannot be adjusted when  or  is selected for My Colors.

Using the Custom White Balance

You can set a custom white balance to obtain the optimal setting for the shooting conditions by having the camera evaluate an object, such as a piece of white paper or cloth, or a photo-quality gray card that you wish to establish as the standard white color.

In particular, take a custom white balance reading for the following situations that are difficult for the **AWB** (Auto) setting to detect correctly.

- Shooting close-ups (Macro)
- Shooting subjects of monotone color (such as sky, sea or forest)
- Shooting with a particular source of light (such as a mercury-vapor lamp)

1 Select .

1. Press the  button.
2. Use the  or  button to select **AWB** and choose  with the  or  button.

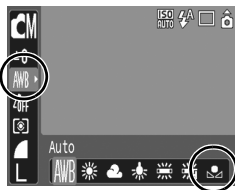

2 Aim the camera at a piece of white paper or cloth and press the button.

- Ensure that the center frame is completely filled with the white image. Please note that the center frame will not appear when the digital zoom is in use or **T** displays.



3 Press the button.



- You are recommended to set the shooting mode to  and the exposure compensation setting to $[\pm 0]$ before setting a custom white balance. The correct white balance may not be obtained when the exposure setting is incorrect (image appears completely black or white).
- Shoot with the same settings as when reading the white balance data. If the settings differ, the optimal white balance may not be set. In particular, the following should not be changed.
 - ISO Speed
 - Flash
 - Setting the flash to [On] or [Off] is recommended. If the flash fires when reading the white balance data with the flash set to [Auto], make sure that you also use the flash when you shoot.
- Since the white balance data cannot be read in Stitch Assist mode, preset the white balance in another shooting mode beforehand.
- White balance data is retained even if the camera's power is turned off.

Shooting in a My Colors Mode



➔ See Functions Available in Each Shooting Mode (p. 228).



You can change the look of an image when it is shot.

	My Colors Off	Records normally with this setting.
	Vivid	Emphasizes the contrast and color saturation to record bold colors.
	Neutral	Tones down the contrast and color saturation to record neutral hues.
	Sepia	Records in sepia tones.
	B/W	Records in black and white.
	Positive Film	Use this option to make red, green or blue colors more intense like the Vivid Red, Vivid Green or Vivid Blue effects. It can produce intense natural-looking colors like those obtained with positive film.
	Lighter Skin Tone*	Use this option to make skin tones lighter.
	Darker Skin Tone*	Use this option to make skin tones darker.
	Vivid Blue	Use this option to emphasize blue tints. It makes blue subjects, such as the sky or ocean, more vivid.
	Vivid Green	Use this option to emphasize green tints. It makes green subjects, such as mountains, new growth, flowers and lawns, more vivid.
	Vivid Red	Use this option to emphasize red tints. It makes red subjects, such as flowers or cars, more vivid.
	Custom Color	Use this option to adjust the contrast, sharpness or saturation settings or the color balance between red, green, blue and skin tones*. It can be used to make subtle adjustments, such as making blue colors more vivid or face colors brighter.

* If the image contains colors that are the same as human skin, those colors will also be changed. You may not obtain the expected results depending on the skin color.

Configuring My Colors Settings (Except **Ac**)

1 Select a My Colors setting.

1. Press the **FUNC. SET** button.
2. Use the **▲** or **▼** button to select **COFF** and the **◀** or **▶** button to change the option.
3. Press the **FUNC. SET** button.



Setting the Camera to a Custom Color Mode (**Ac**)

1 Select **Ac**.

1. Press the **FUNC. SET** button.
2. Use the **▲** or **▼** button to select **COFF** and choose **Ac** with the **◀** or **▶** button.

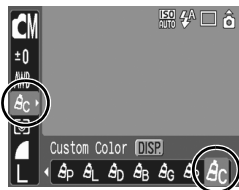

2 Adjust the setting.

1. Press the **DISP.** button.
2. Use the **▲** or **▼** button to select [Contrast], [Sharpness], [Saturation], [Red], [Green], [Blue] or [Skin Tone].
3. Use the **◀** or **▶** button to adjust the setting.
 - The adjustment results show in the LCD monitor.
 - If you press the **DISP.** button, you will return to the screen where you can select a My Colors mode.



3 Press the **FUNC. SET** button.

- This completes the setting.

Changing Colors



➔ See Functions Available in Each Shooting Mode (p. 228).



You can shoot images with the original colors transformed. This can be performed on movies as well as still images, allowing you to enjoy photographing with image or movie effects. However, depending on the shooting conditions, the images may appear rough or you may not get the expected color. Before you try to photograph important subjects, we highly recommend that you shoot trial images and check the results. If you set [Save Original] (p. 120) to [On] when shooting a still image, you can record the original image as well the transformed one.

	Color Accent	Use this option to have only the color specified in the LCD monitor remain and to transform all others to black and white.
	Color Swap	Use this option to transform a color specified in the LCD monitor into another. The specified color can only be swapped into one other color, and multiple colors cannot be chosen.



The ISO speed will rise depending on the shooting conditions, which may increase the "noise" in the image.

Shooting in the Color Accent Mode







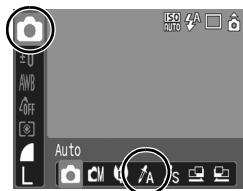

1 Select the color accent mode.

Still Images:

1. Set the mode switch to .
2. Press the button.
3. Use the or button to select and choose with the or button.
4. Press the button.





Movies:

1. Set the mode switch to .
2. Press the  button.
3. Use the  or  button to select  and choose  with the  or  button.
4. Press the  button.

**2 Press the  button.**

- The camera will switch to color input mode and the display will alternate between the original image and the color accent image (using the previously set color).

**3 Aim the camera so that the color you wish to retain appears at the center of the LCD monitor and press the .**

- Only one color can be specified.
- You can use the  or  button to specify the range of colors that are retained.
 - 5: Only takes the color that you want to retain
 - +5: Also takes colors close to the one that you want to retain

4 Press  to complete the setting, then shoot.

- The default color accent is green.
- You may not obtain the expected results if you use the flash.
- The specified color accent and color range is retained even if the camera's power is turned off.

Shooting in the Color Swap Mode

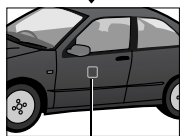
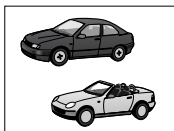

Original Color
(Before Swapping)

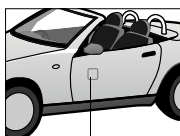



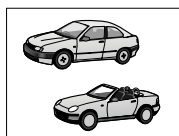





Desired Color
(After Swapping)









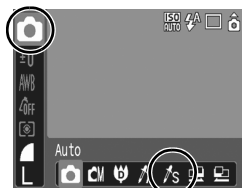

1 Select the color swap mode.

Still Images:

1. Set the mode switch to .
2. Press the  button.
3. Use the  or  button to select  and choose  with the  or  button.
4. Press the  button.



Movies:

1. Set the mode switch to .
2. Press the  button.
3. Use the  or  button to select  and choose  with the  or  button.
4. Press the  button.



2 Press the button.

- The camera will switch to color input mode and the display will alternate between the original image and the color swap image (using the previously set color).



3 Aim the camera so that the original color appears at the center of the LCD monitor and press the ← button.

- Only one color can be specified.
- You can use the ↑ or ↓ button to specify the range of colors that are swapped.
 - 5: Only takes the color that you want to swap
 - +5: Also takes colors close to the one that you want to swap

4 Aim the camera so that the desired color appears at the center of the LCD monitor and press the → button.

- Only one color can be specified.

5 Press to complete the setting, then shoot.







- The default setting for color swap mode changes green into white.
- You may not obtain the expected results if you use the flash.
- The colors specified in the color swap mode and the color range are retained even if the camera's power is turned off.
- The ISO speed may increase, or the noise in the image may increase depending on the shooting conditions.

Changing the Save Method for the Original Image



When shooting still images in the Color Accent or Color Swap mode, you can set whether or not to save the original image as well as the transformed one.

1 Select [Save Original].

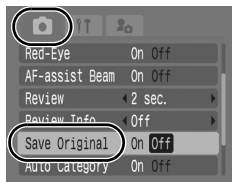
1. Press the  button.
2. In the  menu, use the  or  button to select [Save Original].



2 Accept the setting.

1. Use the  or  button to select [On] or [Off].
2. Press the  button.

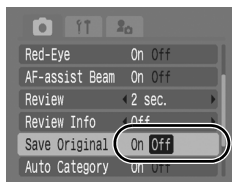

When [Save Original] is Set to [On]

- Only the transformed image displays in the LCD monitor while shooting in the Color Accent or Color Swap mode.
- The transformed image is reviewed in the LCD monitor after shooting in the Color Accent or Color Swap mode. If you erase the image at this point, the original image is erased along with the transformed image. Exercise adequate caution before deleting a file.
- The images are numbered consecutively. The original images are assigned the lower number and the transformed color accent or color swap images the next number.
- Since two images are recorded with each shot, the number of shots remaining is approximately half the number displayed when this function is set to [Off].

Categorizing Images Automatically (Auto Category)



➔ See Functions Available in Each Shooting Mode (p. 228).



If you set Auto Category to [On], images are automatically sorted into preset categories as they are recorded.

	People	For images shot in , or mode, or images with faces detected when [AF Frame] is set to [Face Detect].
	Scenery	For images shot in mode.
	Events	For images shot in , , , or mode.

1 Select [Auto Category].

1. Press the button.
2. In the menu, use the or button to select [Auto Category].

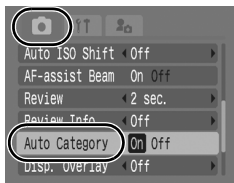

2 Accept the setting.

1. Use the or button to select [On] or [Off].
2. Press the button.

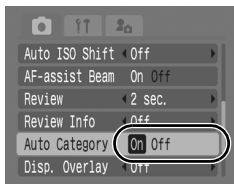

Movies are not automatically categorized, but they can be categorized using the My Category function (p. 136).

☰ Registering Settings to the Print/Share Button



☰ See Functions Available in Each Shooting Mode (p. 228).



You can register a function that you often use when shooting with the ☰ button. The following functions can be registered.

Menu Item	Page	Menu Item	Page
Not Assigned	—	DISP. Overlay	p 124
+/- (Exp.)	p 107	Rec. Movie	p 88
White Balance	p 111	Display Off	p 51
Custom White Balance	p 112	Play Sound Effect*	p 53
Digital Tele-converter	p 69		

* Sets the sound registered to , found in the [Shutter Sound] section of the My Camera menu.

1 Select [Set ☰ button].

1. Press the button.
2. In the [] menu, use the or button to select [Set ☰ button].
3. Press the button.



2 Accept the setting.

1. Use the or button to select the function you wish to register.
2. Press the button.
 - If displays to the icon's lower right, you can register the function, but you cannot use it with some shooting modes or settings even if you press the ☰ button.
 - Press the **MENU** button to complete the setting.

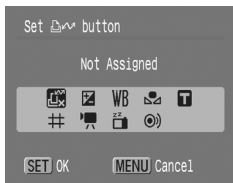













To Cancel the shortcut button

Select  in Step 2.

Using the Button

1 Press the button.

- Each time that the  button is pressed, the  and  settings are switched.
- For  and , the corresponding setup screen is displayed.
- Each press of the  button records the white balance data with the  option. Since the frame does not appear at this point, ensure that the white paper or cloth is positioned so it appears at the center of the LCD monitor and then press the  button. After using this function once, the white balance setting changes to the custom white balance setting.
- With the  function registered, the movie recording starts with the recording pixels and frame rate settings selected in the Standard mode when you press the  button even if the mode switch is set to  or **SCN**.
- The  function is useful for directing your subject's attention to the camera right before taking a shot because it plays a sound when you press the  button.



If a function that cannot be used in the currently selected shooting mode is selected, nothing will happen when you press the  button.

Setting the Display Overlays



➔ See *Functions Available in Each Shooting Mode* (p. 228).



You can display vertical and horizontal grid lines, a 3:2 print area guide, or both on the LCD monitor while shooting to help check the position of your subject.

Off	–
Grid Lines	Displays grid lines to divide the screen into 9 parts. Helps confirm the vertical and horizontal positioning of the subject.
3:2 Guide	Helps confirm the print area for a 3:2 print.* Areas outside the printable area are grayed out.
Both	Displays both the grid lines and the 3:2 guide simultaneously.

* Images are still recorded at the standard aspect ratio of 4:3.

1 Select [Disp. Overlay].

1. Press the button.
2. In the menu, use the or button to select [Disp. Overlay].

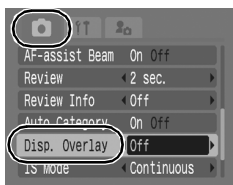

2 Accept the setting.

1. Use the or button to select [Off], [Grid Lines], [3:2 Guide] or [Both].
2. Press the button.

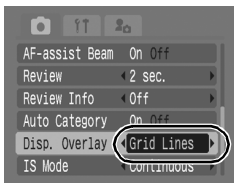

- The grid lines and 3:2 guide will not be recorded in the image.
- Only [Grid Lines] can be used when or is selected, or in movie mode







Setting the Auto Rotate Function

 See Functions Available in Each Shooting Mode (p. 228).







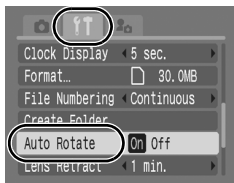

Your camera is equipped with an Intelligent Orientation sensor that detects the orientation of an image shot with the camera held vertically and automatically rotates it to the correct orientation when viewing it in the LCD monitor.

1 Select [Auto Rotate].

1. Press the  button.
2. Use the  or  button to select the  menu.
3. Use the  or  button to select [Auto Rotate].



2 Accept the setting.

1. Use the  or  button to select [On] or [Off].
2. Press the  button.
 - When the Auto Rotate function is set to [On] and the LCD monitor is set to the detailed display mode during shooting,  (normal),  (right end is down) or  (left end is down) will appear in the display.

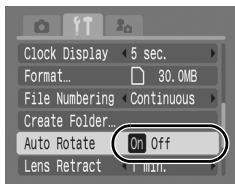

- This function may not operate correctly when the camera is pointed straight up or down. Check that the arrow  is pointing in the right direction and if it is not, then set the Auto Rotate function to [Off].
- Even if the Auto Rotate function is set to [On], the orientation of images downloaded to a computer will depend upon the software used to download the images.



When the camera is held vertically to shoot, the Intelligent Orientation sensor judges the upper end to be “up” and the lower end to be “down”. It then regulates the optimal white balance, exposure and focus for vertical photography. This function operates regardless of the on/off status of the Auto Rotate function.

Creating an Image Destination (Folder)

 See Functions Available in Each Shooting Mode (p. 228).









You can create a new folder at any time and the recorded images will be automatically saved to that folder.

Create New Folder	Creates a new folder the next time you shoot images. To create an additional folder, insert the check mark again.
Auto Create	You can also specify a date and time if you wish to create a new folder using a shooting time after the specified date and time.



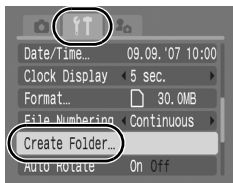

Creating a Folder the Next Time You Shoot.

1 Select [Create Folder].

1. Press the  button.
2. Use the  or  button to select the  menu.
3. Use the  or  button to select [Create Folder].
4. Press the  button.







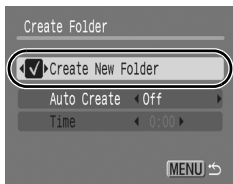

2 Accept the setting.

1. Use the  or  button to check mark [Create New Folder].
2. Press the  button.
 -  will be displayed on the LCD monitor when shooting. The symbol will cease to display after the new folder is created.
 - Press the **MENU** button again to complete the setting.









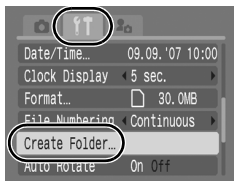



Setting the Day or Time for Automatic Folder Creation.

1 Select [Create Folder].

1. Press the  button.
2. Use the  or  button to select the  menu.
3. Use the  or  button to select [Create Folder].
4. Press the  button.



2 Accept the setting.

1. Use the  or  button to select [Auto Create] and the  or  button to select a creation date.
2. Use the  or  button to select [Time] and the  or  button to select a time.
3. Press the  button.
 -  displays when the specified time arrives. The symbol will cease to display after the new folder is created.
 - Press the **MENU** button again to complete the setting.

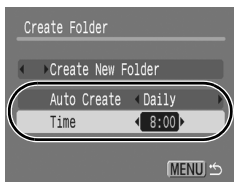

Up to 2000 images can be saved into one folder. A new folder will automatically be created when you record more than that number even if you are not creating new folders.

Resetting the File Number



➔ See Functions Available in Each Shooting Mode (p. 228).



The images you shoot are automatically assigned file numbers. You can select how the file number is assigned.

<p>Continuous</p>	<p>A number one higher than the last one recorded is assigned to the next image. This is convenient for managing all your images together on a computer because you avoid file name duplication when changing folders or memory cards.*</p> <p>* When a blank memory card is used. If a memory card with recorded data is used, the 7-digit number for the last recorded folder and image is compared with the last one on the card, and the larger of the two is utilized as the basis for new images.</p>
<p>Auto Reset</p>	<p>The image and folder number are reset to the starting value (100-0001).* This is convenient for managing images on a folder-by-folder basis.</p> <p>* When a blank memory card is used. If a memory card with recorded data is used, the number following the 7-digit number for the last recorded folder and image on the card is utilized as the basis for new images.</p>

1 Select [File Numbering].

1. Press the **[MENU]** button.
2. Use the **◀** or **▶** button to select the **[f/i]** menu.
3. Use the **▲** or **▼** button to select [File Numbering].

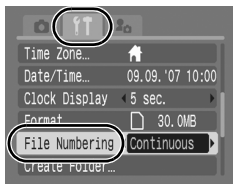

2 Accept the setting.

1. Use the **◀** or **▶** button to select [Continuous] or [Auto Reset].
2. Press the **[MENU]** button.

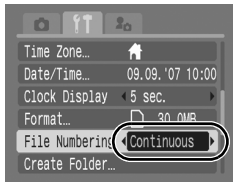

File and Folder Numbers

Recorded images are assigned consecutive file numbers starting with 0001 and ranging up to 9999, while folders are assigned numbers starting with 100 and ranging up to 999. Up to 2,000 images can be saved into a single folder.

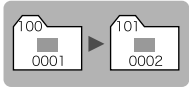
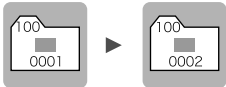
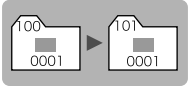
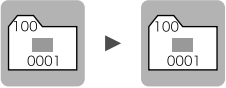
	New Folder Created	Memory Card Exchanged for Another
Continuous	<p>Memory Card 1</p> 	<p>Memory Card 1 Memory Card 2</p> 
Auto Reset	<p>Memory Card 1</p> 	<p>Memory Card 1 Memory Card 2</p> 

- Images may be saved to a new folder when there is insufficient free space even if the total number of images in a folder is less than 2,000 because the following types of images are always saved together into the same folder.
 - Images from continuous shooting
 - Self-timer images (custom)
 - Stitch Assist mode images
 - Still images shot in Color Accent/Color Swap mode with the [Save Original] category set to [On].
- Images cannot be played back when the folder numbers are duplicated or image numbers are duplicated within folders.
- Please refer to the *Software Starter Guide* for information regarding folder structures or image types.

Playback/Erasing

You can also use the touch control dial to select images and perform various operations. See [p. 41](#).

Q Magnifying Images



1 Press the zoom lever toward Q.

- **SET** will display and a magnified portion of the image will display.
- Images can be magnified up to a factor of approximately 10x.



Approximate Location
of the Displayed Area

2 Use the **↑**, **↓**, **←** or **→** button to move around the image.

- If you press the **FUNC./SET** button while in magnified display, the camera switches to image advance mode and **SET** will display. You can use the **←** or **→** button to advance to the next or previous image at the same level of magnification. The image advance mode is cancelled when you press the **FUNC./SET** button again.
- You can change the magnification level with the zoom lever.

To Cancel the Magnified Display

Press the zoom lever toward . (You can also cancel it immediately by pressing the **MENU** button.)



Movie frames and index playback images cannot be magnified.

☒ Viewing Images in Sets of Nine (Index Playback)



1 Press the zoom lever toward ☒.

- Up to nine images can be viewed at once in index playback.
- Use the **▲**, **▼**, **◀** or **▶** button to change the image selection.

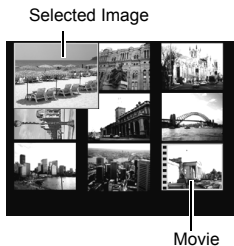

To Return to Single Image Playback

Press the zoom lever toward **Q**.

Switching between Sets of Nine Images

The jump bar will display if you press the zoom lever toward ☒ while in index playback and you can switch the display between sets of nine images.

- Use the **◀** or **▶** button to move to the previous or next set of 9 images.
- Hold the **FUNC./SET** button down and press the **◀** or **▶** button to jump to the first or last set.



Checking the Focus and Peoples' Expressions (Focus Check display)

You can check the focus and peoples' expressions by using the focus check display. Since you can also change the magnification level and switch between images, it is easy to check peoples' expressions and look for closed eyes.

Displaying the Focus Check

- 1** Press the  button.

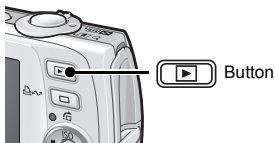

- 2** Press the  button several times until the focus check screen appears.

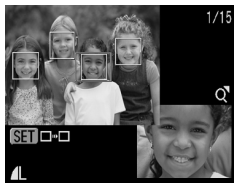

- The frame displays on the screen as follows.

Frame Color	Content
Orange	Displays the area of the image shown at the bottom right
White	Displays at the focal point (AF frame)
Gray	Displays around a face detected in playback mode (Face Frame)

- The orange frame can be shown at a different magnification, moved or switched to a different frame (p. 133).

■ Changing the Display Magnification

3 Press the zoom lever toward .

- The bottom right of the screen is magnified.

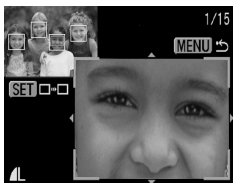

■ Changing between Frames

3 Press .

- When multiple frames display around focal points or multiple faces are detected, pressing the **FUNC./SET** button switches the position of the orange frame. After you change the display magnification, the orange frame will adjust to the size of the face when you switch the position of the frame.

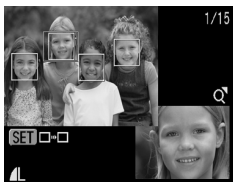

■ Changing the Display Position

3 Press the zoom lever toward .

- The bottom right of the screen is magnified.

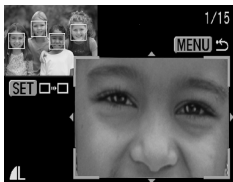

4 Use the **↑**, **↓**, **←** or **→** button to change the display position.

- Pressing the **FUNC./SET** button returns the orange frame to the prior position. If multiple frames are displayed, the position of the orange frame changes.









To cancel the Focus Check display

Press the **MENU** button.

Jumping to Images

When you have many images recorded onto a memory card, it is handy to use the five search keys below to jump over images to find the object of your search.

	Shot Date	Jumps to the first image of each shooting date.
	My Category	Jumps to the first image in each category.
	Folder	Jumps to the first image of each folder.
	Movie	Jumps to a movie.
	By 10 Images	Displays the image 10 images ahead.
	By 100 Images	Displays the image 100 images ahead.

1 In single image playback mode, press the button.

- The camera will switch to jump search mode.

2 Use the **↑** or **↓** button to select a search key

- The screen sample will vary slightly according to the search key.
- You can show/hide image information using the **DISP.** button.

Image Information

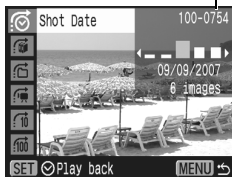

3 Display the Images.

DISP., **DISP.**, **DISP.** Selected

1. Use the **←** or **→** button to select date, category or folder for playback.
2. Press the **FUNC./SET** button.

- If you circle your finger on the Touch Control Dial you can check the target image.
- The camera will switch to defined playback mode and display a blue frame. You can limit playback to the images corresponding to the search key.
- Press the **DISP.** button to cancel defined playback mode.

Select the search key

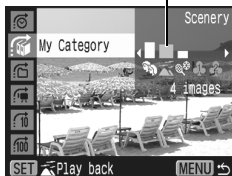

DISP., **DISP.**, **DISP.** Selected

1. Press the **←** or **→** button.
- Pressing the **MENU** button cancels the setting.
 - Press the **FUNC./SET** button to switch the camera to defined playback mode when the **DISP.** is selected. Press the **DISP.** button to cancel this mode.

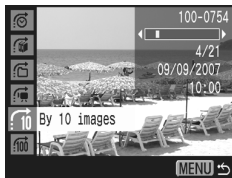



The defined playback mode will be canceled under the following circumstances.

- When selecting images in a range
- When displaying images not supported in defined playback
- When newly saving images that have effects added or edited
- When images are deleted using [Erase] from the [▶] menu

Organizing Images by Category (My Category)



You can organize images into prepared categories. The following operations can be performed if the images are sorted into categories.

- Image searches (p. 134)
- Slide Show (p. 146)
- Protect (p. 164)
- Erase (p. 168)
- Configure print settings (p. 174)

Categories

	People		My Category 1–3
	Scenery		To Do
	Events		

Category Selection Methods

Select	For viewing and selecting images singly.
Select Range	For picking a first and last image and selecting all the images in the range.

1 Select [My Category].

1. Press the button.
2. In the [▶] menu, use the or button to select .
3. Press the .



2 Choose a selection method.

1. Use the **↑** or **↓** button to choose a selection method.
2. Press the  button.

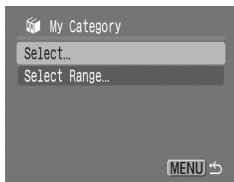

■ [Select]

3 Categorize the images.

1. Use the **←** or **→** button to select images to categorize.
2. Use the **↑** or **↓** button to select a category.
3. Press the  button.

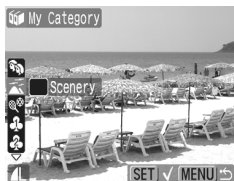



- Pressing the **FUNC./SET** button again cancels the setting.
- Press the **MENU** button to complete the setting.
- If you press the  button in playback mode, you can display this screen immediately.

■ [Select Range]

3 Select the first image.

- You can circle your finger on the Touch Control Dial to select the first and last image.

1. Press the  button.

2. Use the  or  button to select the first image to categorize.



3. Press the  button.



4 Select the last image.

1. Use the  button to select [Last Image].

2. Press the  button.

3. Use the  or  button to select the last image to categorize.

4. Press the  button.

- An image with a lower number than the first image cannot be selected as the last image
- Up to 500 images can be selected.



5 Select a category.

1. Press the **↓** button.
2. Use the **←** or **→** button to select a category.

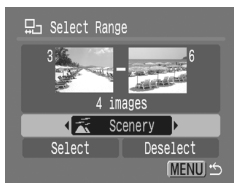

6 Accept the setting.

1. Press **↓** and choose [Select].
2. Press the **FUNC. SET** button.
 - The screen will return to the selection method screen.
 - Selecting [Deselect] cancels categorization of the selected range.

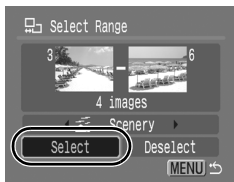





This also can be set in the index playback mode.

Viewing Movies (Operating the Movie Control Panel)







Movies cannot be played in the index playback mode.

1 Display the movie file.

1. Use the  or  button to select a movie.
2. Press the  button.
 - Images with a  icon are movies.



2 Play the movie.



1. Use the  or  button to select .
2. Press the  button.
 - The movie will pause if you press the **FUNC./SET** button during playback. It will resume when you press the button again.
 - When playback ends, the movie stops at the last frame displayed. Press the **FUNC./SET** button to display the movie control panel.
 - You can switch between showing/hiding the playback progress bar by pressing the **DISP.** button while playing a movie.
 - If playback was halted partway through in the prior viewing session, playback will resume from the last frame displayed.

Movie Control Panel











Playback Progress Bar

Time movie was shot

Volume Level
(Adjust it with the  or  button)

Operating the Movie Control Panel

Use the ◀ or ▶ button to select a control and press the **FUNC./SET** button.

	Exit	Ends playback and returns to single image playback
	Print	An icon will display when a printer is connected. See the <i>Direct Print User Guide</i> for details.
	Play	Play
	Slow Motion	You can use the ◀ button to slow down or the ▶ button to speed up playback.
	First Frame	Displays the first frame
	Previous Frame	Rewinds if the FUNC./SET button is held down.
	Next Frame	Fast Forwards if the FUNC./SET button is held down.
	Last Frame	Displays the last frame
	Edit	Switches to the movie editing mode



- Use the television's controls to adjust the volume when playing a movie on a TV set (p. 183).
- Sound cannot be played back in slow motion playback or



Editing Movies



You can delete portions of recorded movies.



- The actual position of the edited movie may differ slightly from editing the results viewed on the LCD monitor.
- Movies 1 second or longer before editing can be edited in 1-second increments, but those that are protected or less than 1 second long (of 15 sec.* or 30 sec.**) cannot be edited.

* When the shooting interval is 1 sec.

** When the shooting interval is 2 sec.

1 Select [Edit].

1. Use the ◀ or ▶ button to select .
2. Press the button.
 - The movie editing panel and the movie editing bar will display.



Movie Editing Panel



Movie Editing Bar

2 Edit the movie.

1. Use the ▲ or ▼ button to select (Cut Beginning) or (Cut End).
2. Use the ◀ or ▶ button to specify the cut point (▮).
 - To check a temporarily edited movie, select (Play) and press the **FUNC./SET** button.
 - To continue editing, repeat Step 2.
 - Selecting (Exit) cancels the edit and restores the movie control panel.

3 Select [Save].

1. Use the **↑** or **↓** button to select .
2. Press the  button.

4 Save the file.

1. Use the **↑** or **↓** button to select [New File] or [Overwrite]
2. Press the  button.
 - [New File] saves the edited movie under a new file name. The pre-edit data is left unchanged.
Note, if you press the **FUNC./SET** button while saving the movie, saving is canceled.
 - [Overwrite] saves the edited movie with its original name. The pre-edit data is lost.
 - When there is not enough space left on the memory card, only [Overwrite] can be selected.



Depending on the movie's file size, it may take some time to save an edited movie. If the battery runs out of charge partway through, edited movie clips cannot be saved. When editing movies, it is recommended to use a fully charged battery or the separately sold AC Adapter Kit ACK-DC30 (p. 210).

Rotating Images in the Display



Images can be rotated clockwise 90° or 270° in the display.

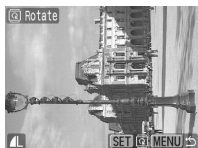

Original



90°



270°

1 Select [Rotate].

1. Press the **[MENU]** button.
2. In the **[▶]** menu, use the **↑** or **↓** button to select **[📷]**.
3. Press the **[FUNC./SET]** button.



2 Rotate the image.





1. Use the **←** or **→** button to select an image to rotate.
2. Press the **[FUNC./SET]** button.
 - Cycle through the 90°/270°/original orientations with each press of the **FUNC./SET** button.
 - This also can be set in the index playback mode.



When images are downloaded to a computer, the orientation of images rotated by the camera will depend upon the software used to download the images.

Playback with Transition Effects

You can select the transition effect displayed when switching between images.

	No transition effect.
	The displayed image darkens and the next image gradually brightens until it is displayed.
	Press the  button to have the previous image display from the left and the  button to have the next image display from the right.

1 Select [Transition].

1. Press the  button.
2. In the  menu, use the  or  button to select .



2 Accept the setting.







1. Use the  or  button to select an effect.
2. Press the  button.



Automated Playback (Slide Shows)

Automated playback of memory card images.

Image settings for slide shows are based on the Digital Print Order Format (DPOF) standard.











	All Images	Plays all images on a memory card in order.
	Date	Plays images bearing a specified date in order.
	My Category	Plays the images in the selected category in order.
	Folder	Plays images in a specified folder in order.
	Movies	Plays movie files only, in order.
	Stills	Plays still images only, in order.
	Custom 1-3	Plays the images selected for each slide show, Custom 1, Custom 2 or Custom 3, in order (p. 149).

1 Select [Slide Show].

1. Press the  button.
2. In the  menu, use the  or  button to select .
3. Press the  button.



2 Select a playback method.

1. Press the  button.
2. Use the  or  button to select the slide show type.
 - , , : press the **FUNC./SET** button to select a date, category or folder to be played back (p. 148).
 - : press the **FUNC./SET** button to select the images to be played back (p. 149).
 - If you want to add a transition effect to play back images, use the  button to select [Effect] and choose the type of effect with the  or  button (See the next page).



3 Start the slide show.

1. Press the **↓** button.
2. Use the **←** or **→** button to select [Start].
3. Press the  button.
 - The following functions are available during slide shows.

- Pausing/resuming: Press the **FUNC./SET** button
- Fast forwarding/rewinding: press the **←** or **→** button (continue to hold the button to switch between images more rapidly)







To Stop the Slide Show

Press the **MENU** button

Transition Effects

You can select the transition effect used when one image is replaced by another.

	No transition effect.
	The new image gradually brightens as it moves upward from the bottom.
	The new image first appears in a cross shape and gradually expands to display the full image.
	Portions of the new image move horizontally, then the image expands to display the full image.



In single image playback mode, you can start a slide show from the current image displayed by holding the **FUNC./SET** button while you press the **⏮** button. Please note that if you do this while the last image shot is displayed, the slide show will start from the first image using the same date.

Select a date/category/folder to play back



1 Select a playback method.

1. Use the ← or → button to select



2. Press the button.



2 Select images to play back.

1. Use the ↑ or ↓ button to select a date/category/folder to playback.

2. Press the button.

- A ✓ will appear on selected images.
- To cancel the selection: press the **FUNC./SET** button again.
- Multiple selections can be made for the date/category/folder.
- The images will play back in the order of selection.
- To check the images for each date/category/folder: use the ← or → button.
- Pressing the **MENU** button completes the setting.



Selecting Images for Playback (1-3)

Select only the images that you wish to play back and save them as a slide show (Custom 1, 2 or 3). Up to 998 images can be selected. They will be played back in their order of selection.

1 Select a playback method.

1. Use the ◀ or ▶ button to select **+1**, **+2** or **+3**.

- Only the **+1** icon will display at first.

2. Press the  button.

- When you set **+1**, the icon will change to **+1V** and **+2** will display. **+2** and **+3** will change in the same way when they are set.



2 Select images to play back.

1. Use the ◀ or ▶ button to choose images to play back.

2. Use the  button to select/deselect the images.

- You can also select images in the index playback mode.
- Pressing the **MENU** button completes the setting.

Check mark indicating selection
Number indicating the selection order



Selecting All Images

1. After selecting **+1**–**+3** in step 1, use the ▲ button to select [Mark all] and press the **FUNC./SET** button.
 2. Use the ▲ button to select [Mark all], press the **FUNC./SET** button.
 3. Use the ▶ button to select [OK] and press the **FUNC./SET** button.
- To deselect all images, select [Reset].

Adjusting the Play Time and Repeat Settings

• Play Time

Sets the duration that each image displays. Choose between 3–10 seconds, 15 seconds and 30 seconds. Displaying time can vary slightly depending on the image.

• Repeat

Sets whether the slide show stops when all the slides have been displayed or continues until stopped.

1 Select [Set up].

1. Use the **←** or **→** button to select [Set up].
2. Press the  button.



2 Configure the setting.

1. Use the **↑** or **↓** button to select [Play Time] or [Repeat].
2. Use the **←** or **→** button to select a setting.
3. Press the  button.



Red-Eye Correction Function



You can correct red eyes in recorded images.



Red eyes may not be automatically detected in some images or the results may not turn out as you intended.

Examples:

- Faces near the screen edges or faces that appear extremely small, large, dark or bright in relation to the overall image.
- Faces turned to the side or at a diagonal, or faces with a portion hidden.

1 Select [Red-Eye Correction].

1. Press the button.
2. In the [] menu, use the or button to select .
3. Press the button.



2 Select an image.

1. Use the or button to select the image you wish to correct red eyes.
2. Press the button.
 - A frame will automatically display where a red eye is detected.
 - If red-eye is not automatically detected, select [Add Frame] with or button and press **FUNC./SET** button (p. 153).
 - To cancel the correction frame, select [Remove Frame] and press the **FUNC./SET** button (p. 154).





3 Correct the image.

1. Use the ◀ or ▶ button to select [Start].
2. Press the  button.

**4 Save the image.**

1. Use the ◀ or ▶ button to select [New File] or [Overwrite].
2. Press the  button.
 - [New File]: Saved as new file with a new name. The uncorrected image is stored. The new image is stored as the last file.
 - [Overwrite]: Saved with the same file name as the uncorrected image. The uncorrected image is erased.
 - When [New File] is selected, proceed to the step 5.

**5 Display the saved image.**

1. Press the  button.
2. Use the ◀ or ▶ button to select [Yes].
3. Press the  button.
 - Selecting [No] returns to the Play menu.

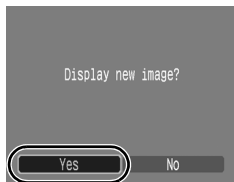

- Red-eye correction cannot be performed on movies.
- Overwriting cannot be performed on protected images.



- When there is not enough space left on the memory card, red-eye correction cannot be performed.
- Although you can apply red eye correction any number of times to an image, the image quality will gradually deteriorate with each application.
- Since the correction frame will not appear automatically on images that have already been corrected once with the Red-Eye Correction function, use the [Add Frame] option to correct them.

Add Correction Frame

1 Select [Add Frame].

1. Use the ◀ or ▶ button to select [Add Frame].
2. Press the  button.
 - A green frame will display.



2 Adjust the position of the frame.

1. Use the ▲, ▼, ◀ or ▶ button to move the frame.
 - Size of the frame can be changed with the zoom lever.

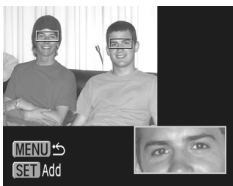

3 Add a correction frame.

1. Press the  button.
 - The correction frame will be added and the frame color will change to white.
 - To add additional frames, adjust the position and then press the **FUNC./SET** button.
 - Up to 35 frames can be added.
 - When you finish adding frames, press the **MENU** button.



To correctly perform red-eye correction, take note of the following (refer to the image in step 2 on [page 153](#)):

- Adjust the correction frame size so that it only surrounds the red-eye portion to be corrected.
- When there are several subjects with red-eye, be sure to add one correction frame per subject.

Removing Correction Frames

1 Select [Remove Frame].

1. Use the ◀ or ▶ button to select [Remove Frame].
2. Press the  button.

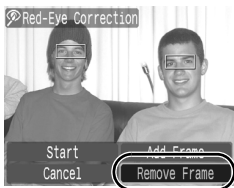

2 Adjust the position of the frame.

1. Use the ◀ or ▶ button to select a frame to remove.
 - The selected frame will appear in green.



3 Delete the frame.

1. Press the  button.
 - The selected frame will disappear.
 - To continue deleting frames, return to Step 2.
 - When you finish deleting frames, press the **MENU** button.

Adding Effects with the My Colors Function



You can add effects to recorded images (stills only) using the My Colors function. The following selection of My Colors effects is available. For details, see [p. 114](#).

	Vivid		Lighter Skin Tone
	Neutral		Darker Skin Tone
	Sepia		Vivid Blue
	B/W		Vivid Green
	Positive Film		Vivid Red

1 Select [My Colors].

1. Press the button.
2. In the [] menu, use the or button to select .
3. Press the button.



2 Select an image.

1. Use the or button to select an image.
2. Press the button.



3 Select a My Colors type.

1. Use the ◀ or ▶ button to select the My Colors type

2. Press the  button.

- The displayed image will reflect the My Colors effect.
- You can press the zoom lever toward  to check the image at a higher magnification. While the image is zoomed, you can press the **FUNC./SET** button to switch between the image transformed with the My Colors effect and the original non-transformed image.

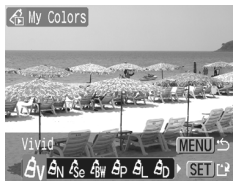

4 Save the image.

1. Use the ◀ or ▶ button to select [OK].

2. Press the  button.

- The newly saved image transformed with the My Colors effect will be the last one in the list.
- To continue adding effects to other images, repeat the procedures from Step 2 onward.

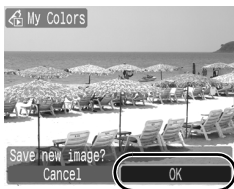

5 Display the saved image.

1. Press the  button.

2. Use the ◀ or ▶ button to select [Yes].

3. Press the  button.

- Selecting [No] returns to the Play menu.

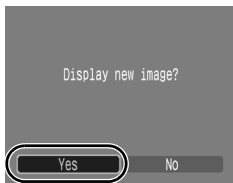



- When there is not enough space left on the memory card, the My Colors effects cannot be added.
- Although My Colors effects can be added any number of times to an image, the image quality will gradually deteriorate with each application and the intended colors may not be achieved.
- Color in images taken using My Colors (p. 114) in shooting mode and images edited with the My Colors function in playback mode may differ slightly.

Resizing Images



You can resave images that were recorded at high recording pixel settings at lower settings.

M3	1600 x 1200 pixels
S	640 x 480 pixels
XS	320 x 240 pixels

1 Select [Resize].

1. Press the **MENU** button.
2. In the **[MENU]** menu, use the **↑** or **↓** button to select **[Resize]**.
3. Press the **FUNC./SET** button.

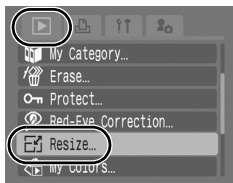

2 Select an image.

1. Use the **←** or **→** button to select an image to resize.
2. Press the **FUNC./SET** button.
 - The **FUNC./SET** button is not selectable for images that cannot be resized.



3 Select a resolution.

1. Use the **←** or **→** button to select **M3**, **S** or **XS**.
2. Press the **FUNC./SET** button.
 - Some recording pixel settings cannot be selected depending on the available space of the memory card.



4 Save the image.

1. Use the **←** or **→** button to select [OK].
2. Press the **FUNC. SET** button.
 - The resized image will be saved in a new file.
 - To continue resizing other images, repeat the procedures from Step 2.



5 Display the saved image.

1. Press the **MENU** button.
2. Use the **←** or **→** button to select [Yes].
3. Press the **FUNC. SET** button.
 - Selecting [No] returns to the Play menu.

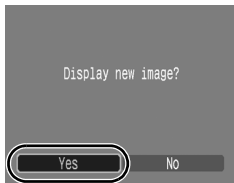

Movies and images shot in wide mode cannot be resized.

Attaching Sound Memos to Images



In playback mode, you can attach sound memos (up to 1 min.) to an image. The sound data is saved in the WAVE format.

1 Select [Sound Memo].

1. Press the  button.
2. In the [] menu, use the  or  button to select .
3. Press the  button.





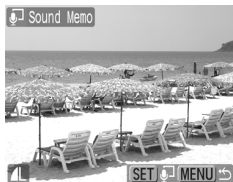

2 Select an image.

1. Use the  or  button to select an image to which you wish to attach a sound memo.
2. Press the  button.
 - The sound memo control panel will display.



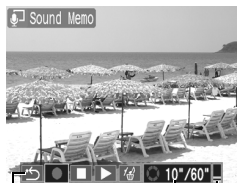

3 Record the memo.

1. Use the  or  button to select .
2. Press the  button.
 - The elapsed time and the remaining time display.
 - Pressing the **FUNC./SET** button pauses the recording. Pressing it again resumes recording.
 - Up to 1 minute of recordings can be added to any one image.







Sound Memo Panel

Elapsed Time/
Remaining Time

Volume _____
(Adjust it with the  or  button)

Sound Memo Panel

Use the ← or → button to select an option and press **FUNC./SET**.

	Exit	Ends the operation.
	Record	Starts recording.
	Pause	Stops recording, playback.
	Play	Plays back.
	Erase	Erases.



- You cannot attach sound memos to movies.
- Sound memos for protected images cannot be erased.

Sound-Only Recording (Sound Recorder)







You can record a continuous sound memo for up to approximately 2 hours without taking a picture.

1 Select [Sound Recorder].

1. Press the  button.
2. In the  menu, use the  or  button to select .
3. Press the  button.







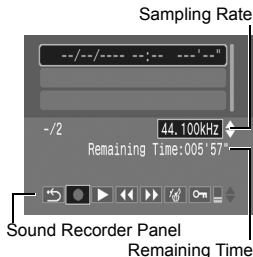



2 Record a sound.

1. Use the  or  button to select .
2. Press the  button.
 - The elapsed recording time displays.
 - You can use the  or  button to change the sampling rate. The recording quality rises progressively as you select [11.025 kHz], [22.050 kHz] or [44.100 kHz], but the recorded file sizes increase correspondingly.
 - Press the **FUNC./SET** button to stop the recording session. Pressing the button again starts a new recording session.



Sound Recorder Panel

Use the **←** or **→** button to select an option and press **FUNC./SET**.

	Exit	Returns to the menu screen.
	Record	Starts recording.
	Pause	Stops recording, playback.
	Play	Use the ↑ or ↓ button to select a sound to play and press the FUNC./SET button.
	Rewind	Holding down the FUNC./SET button rewinds. The sound cannot be heard while rewinding.
	Fast Forward	Holding down the FUNC./SET button fast forwards. The sound cannot be heard while fast forwarding.
	Erase	Select [Erase] or [Erase all] in the confirmation screen and press the FUNC./SET button.
	Protect	Protects against accidental erasure. Use the ↑ or ↓ button to select a sound and the FUNC./SET button to select/deselect protection.
	Volume	You can use the ↑ or ↓ button to adjust the volume.



- See *Sound Recorder Data Rates and Recording Durations (Estimated)* (p. 220).
- Recording will automatically stop when the memory card is full.

Protecting Images



You can protect important images and movies from accidental erasure.

Select	You can configure the protection settings for each image singly while viewing them.
Select Range	You can select a first and last image and protect all the images in the range.
Select by Date	You can protect the images from a specified date.
Select by Category	You can protect the images in a specified category.
Select by Folder	You can protect the images in a specified folder.
All Images	You can protect all the images on a memory card.

1 Select [Protect].

1. Press the button.
2. In the [] menu, use the or button to select .
3. Press the button.

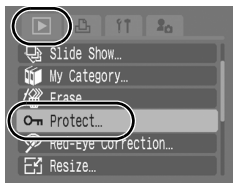

2 Choose a selection method.

1. Use the or button to choose a selection method.
 - Pressing the **MENU** button returns to the prior screen.
2. Press the button.

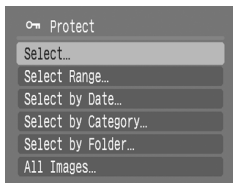

■ [Select]

3 Protect the image.



1. Use the ◀ or ▶ button to select an image to protect.
2. Press the  button.
 - Pressing the **FUNC./SET** button again cancels the setting.
 - To continue protecting other images, repeat the procedure.
 - Press the **MENU** button to complete the setting.



Protection Icon

■ [Select Range]

3 Select the first image.

- You can circle your finger on the Touch Control Dial to select the first and last image.
1. Press the  button.
 2. Use the ◀ or ▶ button to select the first image for the range to protect.
 3. Press the  button.



4 Select the last image.

1. Use the **→** button to select [Last Image].
2. Press the **FUNC. SET** button.
3. Use the **←** or **→** button to select the last image in the range.
4. Press the **FUNC. SET** button.
 - An image with a lower number than the first image cannot be selected as the last image
 - Up to 500 images can be selected.



5 Protect the images.

1. Press **↓** and choose [Protect].
2. Press the **FUNC. SET** button.
 - The screen will return to the selection method screen.
 - Selecting [Unlock] cancels selection of the protected image.

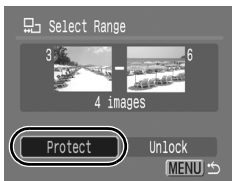

■ [Select by Date]/[Select by Category]/[Select by Folder]

3 Select the images.

1. Use the **▲** or **▼** button to select a date/category/folder to protect.
2. Press the **FUNC./SET** button.
 - A **✓** will appear on selected images.
 - Pressing the **FUNC./SET** button again cancels the setting.
 - You can select multiple dates, categories or folders.
 - Use the **◀** or **▶** button to confirm each date, category or folder image.
3. Press the **MENU** button.





4 Protect the images.

1. Use the **▲** or **▼** button to select [Protect].
2. Press the **FUNC./SET** button.
 - Returns to the selection method screen.
 - Selecting [Unlock] removes protection for the selected images.
 - Selecting [Stop] cancels protection settings for the current selection.



■ [All Images]

3 Protect the images.

1. Use the  or  button to select [Protect].
2. Press the  button.
 - Returns to the selection method screen.
 - Selecting [Unlock] removes protection for all the images.
 - Selecting [Stop] cancels protection settings for the current selection.



This also can be set in the index playback mode.

Erasing Images



You can erase images from a memory card.

Select	Erase images after selecting them one at a time.
Select Range	For picking a first and last image and erasing all the images in the range.
Select by Date	Erases images corresponding to the selected date.
Select by Category	Erases images in the selected category.
Select by Folder	Erases images in the selected folder.
All Images	Erases all images on a memory card.



- Note that erased images cannot be recovered. Exercise adequate caution before erasing an image.
- Protected images cannot be erased with this function.

1 Select [Erase].

1. Press the **[MENU]** button.
2. In the **[▶]** menu, use the **▲** or **▼** button to select **[Erase]**.
3. Press the **[FUNC. SET]** button.

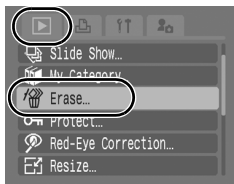
**2 Select an erasure method.**

1. Use the **▲** or **▼** button to select an erasure method.
 - Pressing the **MENU** button returns to the prior screen.
2. Press the **[FUNC. SET]** button.

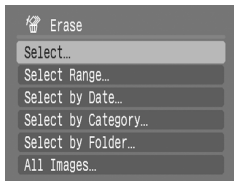
**■ [Select]****3 Select the image.**

1. Use the **◀** or **▶** button to select an image to erase.
2. Press the **[FUNC. SET]** button.
 - Pressing the **FUNC./SET** button again deselects the setting.
3. Press the **[MENU]** button.

**4 Erase the image.**



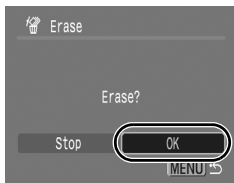

1. Use the **◀** or **▶** button to select **[OK]**.
2. Press the **[FUNC. SET]** button.
 - Selecting **[Stop]** cancels selection of the image you are about to erase and returns to Step 2.



■ [Select Range]





3 Select the first image.

- You can circle your finger on the Touch Control Dial to select the first and last image.

- Press the  button.
- Use the  or  button to select the first image for the range to erase.
- Press the  button.



4 Select the last image.

- Use the  button to select [Last Image].
- Press the  button.
- Use the  or  button to select the last image in the range.
- Press the  button.
 - An image with a lower number than the first image cannot be selected as the last image
 - Up to 500 images can be selected.



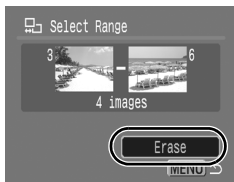

5 Erase the images.

1. Press \blacktriangledown and choose [Erase].
2. Press the  button.
 - Pressing the **MENU** button cancels selection of the image you are about to erase and returns to Step 2.



■ [Select by Date]/[Select by Category]/[Select by Folder]

3 Select the images.

1. Use the \blacktriangle or \blacktriangledown button to select a date/category/folder to erase.
2. Press the  button.
 - A \checkmark will appear on selected images.
 - Pressing the **FUNC./SET** button again cancels the setting.
 - You can select multiple dates, categories or folders.
 - Use the \blacktriangleleft or \blacktriangleright button to confirm each date, category or folder image.
3. Press the  button.



4 Erase the images.

1. Use the \blacktriangleleft or \blacktriangleright button to select [OK].
2. Press the  button.
 - Selecting [Stop] cancels selection of the image you are about to erase and returns to Step 2.

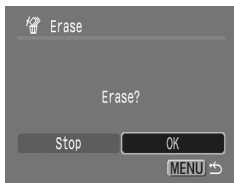

■ [All Images]

3 Erase the images.

1. Use the or button to select [OK].
2. Press the button.
 - Selecting [Cancel] cancels selection of the image you are about to erase and returns to Step 2.
 - Pressing the **FUNC./SET** button while erasing is in progress cancels the procedure.



- This also can be set in the index playback mode.
- Please format the memory card when you want to erase not only image data but also all the data contained on the memory card (p. 65).

Registering Functions to the Playback Button



You can register a function that you often use to the button. The following functions can be registered.

	Function	Reference Page
	Standard* ¹	—
	Slide Show* ²	p. 146
	Sound Recorder	p. 162

*1 Default setting (It can be used to switch between power off/playback mode/shooting mode (p. 43)).



*2 Slide Show will not play in the Index playback mode.

1 Select [Set Play button].

1. Press the button.
2. In the [] menu, use the or button to select .
3. Press the button.



2 Accept the setting.

1. Use the  or  button to select a function you wish to register.
2. Press the  button.





To cancel: select  in Step 2.

Using the Button

1 In playback mode, press the button.

- This will call up the registered function.



- When you press the  button in shooting mode, it switches the camera to playback mode. Then when it is pressed a second time, the registered function is called up.
- Registering a function to the  button disables its ability to turn off the camera power.

Print Settings/Transfer Settings

You can also use the touch control dial to select images and perform various operations. See [p. 41](#).

Setting the DPOF Print Settings





You can select images on a memory card for printing and specify the number of print copies in advance using the camera. The settings used on the camera comply with the Digital Print Order Format (DPOF) standards. This is extremely convenient for printing on a direct print compatible printer, or for sending the images to a photo developing service that supports DPOF.

The  icon may display for a memory card with print settings set by a different DPOF-compliant camera. These settings will be overwritten by those set by your camera.









Setting the Print Style

After setting the print style, select the images for printing. The following settings can be selected.

* Default setting





Print Type	 Standard*	Prints one image per page.
	 Index	Prints the selected images together at a reduced size in an index format.
	 Both	Prints the images in both the standard and index formats.
 Date (On/Off*)	Adds the date to the print.	
 File No. (On/Off*)	Adds the file number to the print.	
Clear DPOF data (On*/Off)		Clears all print settings after the images print.

1 Select [Print Settings].



1. Press the  button.
2. Press the  button.
3. Use the  or  button to select the  menu.
4. Use the  or  button to select [Print Settings].
5. Press the  button.

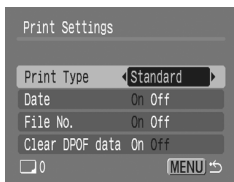

2 Accept the setting.

1. Use the  or  button to select a menu item.
2. Use the  or  button to select a setting to configure.



- The Date and File No. settings change according to the Print Type as follows.
 - Index
[Date] and [File No.] cannot be set to [On] at the same time.
 - Standard or Both
[Date] and [File No.] can be set to [On] at the same time, however, the printable information may vary between printers.
- To Print Two or More Copies
 1. Select [Print Settings] and set [Print Type] to [Standard] or [Both].
 2. Choose [Select Images & Qty.], select an image and press the **FUNC./SET** button.
 3. Use the  or  button to set the number of print copies.
- Images dated using  (Postcard Date Imprint mode) (p. 78) are always printed with the date, regardless of the [Date] setting. As a result, some printers may print the date twice on these images if [Date] is also set to [On].
- Dates print in the style specified in the [Date/Time] menu (p. 12).









Select a print settings method

Select Images & Qty.	Configures print settings for single images as you view them.
Select Range	For picking a first and last image and printing all the images in the range.
Select by Date	Configures print settings for images corresponding to the selected date.
Select by Category	Configures print settings for images in the selected category.
Select by Folder	Configures print settings for images in the selected folder.
Select All Images	Configures print settings for all images.
Clear All Selections	Removes all print settings from images.



Only one copy will be printed for each selected image. With the [Select Images & Qty.] option, you can only set the number of copies to print when the [Print Type] option is set to [Standard] or [Both] (p. 174).

1 Choose a selection method.

1. Press the  button.
2. Press the  button.
3. Use the  or  button to select the  menu.
4. Use the  or  button to choose a selection method.
5. Press the  button.

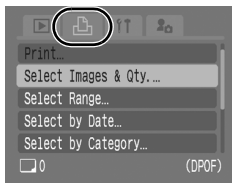







■ [Select Images & Qty.]

2 Select the images.

- Selection methods differ for the Print Type settings (p. 174).



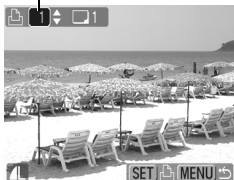

- Standard ()/Both ()

1. Use the  or  button to select the images.
2. Press the  button.
3. Use the  or  button to select the number of print copies (up to 99).
4. Press the  button.

Number of Print Copies



- Index ()

1. Use the  or  button to select the images.
 2. Select and deselect with .
 3. Press the  button.
- This also can be set in the index playback mode.

Index Print Selection

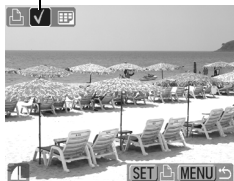



■ [Select Range]

2 Select the first image.

- You can circle your finger on the Touch Control Dial to select the first and last image.

1. Press the  button.

2. Use the  or  button to select the first image in the print range.



3. Press the  button.



3 Select the last image.

1. Use the  button to select [Last Image].

2. Press the  button.

3. Use the  or  button to select the last image in the range.

4. Press the  button.

- An image with a lower number than the first image cannot be selected as the last image

- Up to 500 images can be selected.



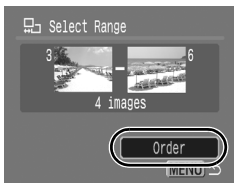

4 Configure the print settings.

1. Press \downarrow and choose [Order].
2. Press the  button.
 - The screen will return to the selection method screen.
 - Pressing the **MENU** button cancels the print settings for the selected range of images.



■ [Select by Date]/[Select by Category]/[Select by Folder]

2 Select the images.

1. Use the \uparrow or \downarrow button to select a date/category/folder to print.
2. Press the  button.
 - A \checkmark will appear on selected images.
 - Pressing the **FUNC./SET** button again cancels the setting.
 - You can select multiple dates, categories or folders.
 - Use the \leftarrow or \rightarrow button to confirm each date, category or folder image.
3. Press the  button.



3 Configure the print settings.

1. Use the \leftarrow or \rightarrow button to select [OK].
2. Press the  button.
 - The screen will return to the selection method screen.
 - Selecting [Cancel] cancels print settings of the selected image.



■ [Select All Images]

2 Configure the print settings.

1. Use the ◀ or ▶ button to select [OK].
2. Press the  button.
 - The screen will return to the selection method screen.
 - Selecting [Cancel] cancels print settings of the selected image.



■ [Clear All Selections]



2 Deselect the images.

1. Use the ◀ or ▶ button to select [OK].
2. Press the  button.
 - The screen will return to the selection method screen.
 - Selecting [Cancel] cancels the operation.



- The output of some printers or photo developing services may not reflect the specified print settings.
- Print settings cannot be set for movies.



- Images are printed in order according to the file number.
- A maximum of 998 images can be selected.
- When the camera is connected to a printer, the  button will light blue. At this time, printing will begin after performing the following.
 1. Press the  button.
 2. Confirm that [Print] is selected, then press the **FUNC./SET** button.

Setting the DPOF Transfer Settings

You can use the camera to specify settings for images before downloading to a computer. Refer to the *Software Starter Guide* for instructions on how to transfer images to your computer.

The settings used on the camera comply with the DPOF standards.



The  icon may display for a memory card with transfer settings set by a different DPOF-compliant camera. These settings will be overwritten by those set by your camera.

1 Select [Transfer Order].

1. Press the  button.
2. In the [] menu, use the  or  button to select .
3. Press the  button.



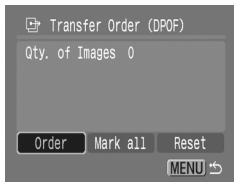

2 Choose a selection method.

1. Use the  or  button to choose a selection method.
2. Press the  button.
 - Selecting [Reset] cancels all transfer order settings.



■ [Order]

3 Select the images.

1. Use the ◀ or ▶ button to select images to transfer.
2. Press the  button.
 - Pressing the **FUNC./SET** button again deselects the setting.
 - This also can be set in the index playback mode.
3. Press the  button.

Transfer Selection

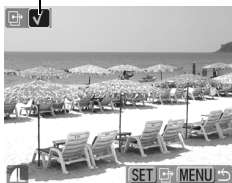

■ [Mark all]

3 Select [OK].

1. Use the ◀ or ▶ button to select [OK].
2. Press the  button.

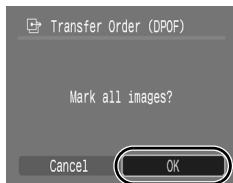

- Images are transferred in order according to the file number.
- A maximum of 998 images can be selected.

Connecting to a TV

Shooting/Playback Using a TV

You can use the supplied AV cable to shoot or playback images using a TV.

1 Turn off the camera and the TV.

2 Connect the AV cable to the camera's A/V OUT terminal.

- Open the terminal cover by slipping a fingernail under the upper edge and plug the AV cable in all the way.

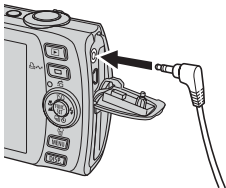

3 Plug the other ends of the AV cable to the VIDEO IN and AUDIO IN jacks on the TV.

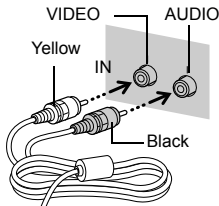

4 Turn on the TV and switch it to video mode.

5 Turn on the camera.



- The video output signal can be switched (NTSC or PAL) to accommodate different regional standards (p. 52). The default setting varies between regions.
 - NTSC: Japan, U.S.A., Canada, Taiwan and others
 - PAL: Europe, Asia (excluding Taiwan), Oceania and others
- If the video system is set incorrectly, the camera output may not display properly.







Customizing the Camera (My Camera Settings)

You can also use the touch control dial to select images and perform various operations. See [p. 41](#).

My Camera allows you to customize the start-up image and start-up, operation, self-timer and shutter sounds. You can change and register these settings, enabling you to customize the camera to suit your own tastes.



Changing My Camera Settings

1 Select a menu item.

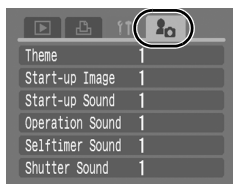
1. Press the  button.
2. Use the  or  button to select the  menu.
3. Use the  or  button to select menu item.



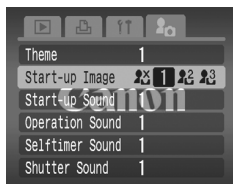

2 Accept the setting.

1. Use the  or  button to select contents you wish to set.
2. Press the  button.
 - Select [Theme] to set all to the same settings.









Registering My Camera Settings

Images recorded onto the memory card and newly recorded sounds can be added as My Camera settings to the  and  menu items. You can also use the supplied software to upload your computer's images and sounds to the camera.





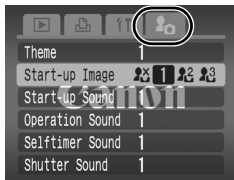

A computer is required to restore the My Camera settings to the defaults. Use the supplied software (ZoomBrowser EX/ImageBrowser) to restore the default settings to the camera.

1 Select a menu item.

1. Press the  button.
2. Press the  button.
3. Use the  or  button to select the  menu.
4. Use the  or  button to select menu item to register.





2 Select a setting.

1. Use the  or  button to select  or .
2. Press the  button.









3 Accept the setting.

- [Start-up Image]

1. Use the  or  button to select image to register.
2. Press the  button.



- [Start-up]/[Operation]/[Self-timer]/[Shutter Sounds]

1. Use the ◀ or ▶ button to select  (Record).
2. Press the  button.
3. After recording, use the ◀ or ▶ button to select  (Register).
4. Press the  button.
 - Recording will automatically stop when the recording time elapses.
 - To play it, select  (Play).
 - To exit instead of registering, press  (Exit).



4 Register the setting.

1. Use the ◀ or ▶ button to select [OK].
2. Press the  button.
 - To cancel registering, select [Cancel].



- The following cannot be registered as My Camera settings.
 - Movies
 - Sounds recorded with the sound memo function (p. 160)
 - Sounds recorded with the Sound Recorder (p. 162)
- The prior setting is erased when a new My Camera setting is added.



See the supplied *Software Starter Guide* for more information on creating and adding to the My Camera data.

Troubleshooting

- Camera (p. 187)
- When the power is turned on (p. 188)
- LCD monitor (p. 188)
- Shooting (p. 190)
- Shooting movies (p. 194)
- Playback (p. 195)
- Battery/Battery Charger (p. 196)
- TV monitor output (p. 196)
- Printing with a direct print compatible printer (p. 196)

Camera

Camera will not operate.

Power is not turned on.	<ul style="list-style-type: none"> ● Press the power button (p. 14).
Memory card slot/battery cover is open.	<ul style="list-style-type: none"> ● Confirm that the memory card slot / battery cover is securely closed (p. 10).
Battery charge insufficient to operate camera ("Change the battery pack" message displays).	<ul style="list-style-type: none"> ● Insert a fully charged battery into the camera (p. 8). ● Use the AC Adapter Kit ACK-DC30 (sold separately) (p. 210).
Poor contact between camera and battery terminals.	<ul style="list-style-type: none"> ● Polish the terminals with a soft cotton swab before charging or using the battery (p. 206).

Sounds come from the camera interior.

The camera's horizontal/vertical orientation was changed.	<ul style="list-style-type: none"> ● The camera's orientation mechanism is operating. There is no malfunction.
---	---

When the power is turned on

“Card locked!” message appears.

The SD memory card's or SDHC memory card's write protect tab is set to “Write protect”.

- When recording to, erasing from or formatting the memory card, slide the write protect tab upward (p. 208).

The Date/Time menu appears.

The built-in rechargeable lithium battery charge is low.

- Recharge the built-in battery immediately (p. 13).

LCD monitor

Nothing is displayed.

[Power Saving] is set to [Display Off].

The LCD monitor will shut off during shooting.

If [Power Saving] is set to [Display Off], the power saving function will shut down the LCD monitor while shooting in  mode.

Camera screen is black at start-up

Incompatible image has been selected as the start-up image in the My Camera settings.

- Change the start-up image in the My Camera settings (p. 184) or use the supplied software program ZoomBrowser EX or ImageBrowser to restore the default settings.

The display darkens.

The image in the LCD monitor will darken in strong sunlight or bright light.

- This is a normal occurrence in devices containing CCDs and does not constitute a malfunction. This image will not be recorded when shooting still photos, but it will be recorded when shooting movies.

Display flickers.

Display flickers when shot under fluorescent lighting.

- This is not a camera malfunction (flickering recorded in movies, but not in still images).

A bar of light (purplish red) appears on the LCD monitor.

Sometimes appears when shooting a bright subject, such as the sun or other light source.

- This is a normal occurrence in devices containing CCDs and does not constitute a malfunction. This bar of light will not be recorded when shooting still photos, but it will be recorded when shooting movies.

 appears.

A slow shutter speed has likely been selected because of insufficient lighting.

- Set the IS Mode to any setting other than [Off] (p. 79).
- Raise the ISO speed (p. 104).
- Set the Auto ISO Shift to any setting other than [Off] (p. 105).
- Select a setting other than  (flash off) (p. 71).
- Set the self-timer and attach the camera to a tripod or other device (p. 73).

 appears.

This displays when using a memory card that has print settings, transfer settings or slide show image selections set by other DPOF-compliant cameras.

- These settings will be overwritten by those set by your camera (pp. 146, 174).

Noise displays./Subject's movements are irregular.

Camera automatically lightened the image displayed on the LCD monitor to make it easier to see when shooting in a dark area (p. 60).

- There is no effect on the recorded image.

Shooting**Camera will not record.**

Flash is charging.

- When the flash is charged, the indicator will light orange. Shooting is now possible (p. 45).

Memory card is full.

- Insert a new memory card (p. 9).
- If required, download the images to a computer and erase them from the memory card to make space.

Memory card is not formatted correctly.

- Format the memory card (p. 65).
- If reformatting does not work, the memory card logic circuits may be damaged. Consult the nearest Canon Customer Support Help Desk.

SD memory card or SDHC memory card is write protected.

- Slide the write protect tab upward (p. 208).

Image is blurred or out of focus.

The camera moves when the shutter button is pressed.

- Confirm the procedures in “ appears” (p. 189).

AF-assist Beam is set to [Off].	<ul style="list-style-type: none"> ● In dark places where it is difficult for the camera to focus, the AF-assist Beam will emit to assist focusing. As the AF-assist Beam will not function when turned off, set it [On] to activate it (p. 49). Take care not to obstruct the AF-assist Beam with your hand when used.
Subject is out of focal range.	<ul style="list-style-type: none"> ● Shoot with the subject at the correct focusing distance (p. 214). ● The camera may be set to an unintended function (such as macro). Cancel the setting.
The subject is hard to focus on.	<ul style="list-style-type: none"> ● Use the focus lock, AF lock to shoot (p. 100).

Subject in recorded image is too dark.

Insufficient light for shooting.	<ul style="list-style-type: none"> ● Set the flash to  (Flash on) (p. 71).
The subject is underexposed because the surroundings are too bright.	<ul style="list-style-type: none"> ● Set the exposure compensation to a positive (+) setting (p. 107). ● Use the AE Lock or spot metering functions (pp. 102, 107).
Subject is too far away for flash to reach.	<ul style="list-style-type: none"> ● Shoot with the subject within the correct flash range when using the built-in flash (p. 215). ● Raise the ISO speed and then shoot (p. 104).

Subject in recorded image is too bright, or image flashes white.

Subject is too close, making the flash too strong.	<ul style="list-style-type: none"> ● Shoot with the subject within the correct flash range when using the built-in flash (p. 215).
The subject is overexposed because the surroundings are too dark.	<ul style="list-style-type: none"> ● Set the exposure compensation to a negative (-) setting (p. 107). ● Use the AE Lock or spot metering functions (pp. 102, 107).

Too much light is shining directly into the camera, or is being reflected off the subject.









- Change the shooting angle.

Flash is set to on.

- Set the flash to  (Flash off) (p. 71).

Image contains noise.

ISO speed is too high.

- Higher ISO speeds and  (High ISO Auto) setting may increase image noise. For higher image quality, use as low an ISO speed as possible (p. 104).
- In , , , , ,  and  modes, the ISO speed increases and noise can appear.

White dots appear on the image.

Light from the flash has reflected off dust particles or insects in the air. This is particularly noticeable when shooting using the wide angle.

- This is a phenomenon that occurs with digital cameras and does not constitute a malfunction.

Eyes appear red.

Light is reflected back from the eyes when the flash is used in dark areas.

- Turn [On] the Red-Eye setting in the Rec. menu (p. 86). For this mode to be effective, the subject must be looking right at the red-eye reduction lamp. Try asking them to look directly at the lamp. Even better results can be obtained by increasing the lighting in indoor settings or approaching closer to the subject. The shutter will not activate for approximately 1 second after the red-eye reduction lamp fires in order to improve the effect.
- You can correct red eyes in images using the Red-Eye Correction function (p. 151).

Continuous shooting slows down.

The memory card's performance has dropped.

- To enhance the continuous shooting performance, you are recommended to format the memory card in the camera after you save all its images to your computer ([p. 65](#)).

Recording images to memory card takes a long time.

Memory card was formatted in another device.

- Use a memory card formatted in your camera ([p. 65](#)).

Lens will not retract.

Memory card slot/battery cover was opened with power on.

- After closing the memory card slot/battery cover, turn the power on then back off.

Shooting movies

The recording time may not display properly or shooting may stop unexpectedly.

The following types of memory cards are used.

- Slow recording cards.
- Cards formatted on a different camera or a computer.
- Cards which have had images recorded and erased repeatedly.

- Although the recording time may not display properly during shooting, the movie will be recorded correctly on the memory card. Recording time will display properly if you format the memory card in this camera (excluding slow recording memory cards) (p. 65).

“!” displayed on the LCD monitor in red and shooting automatically stopped.

There is insufficient free space in the camera's built-in memory.

- Try the following procedures.
 - Format the card with a low level format before shooting (p. 65)
 - Lower the recording pixels (p. 91)
 - Use a high-speed memory card (SDC-512MSH, etc.)

Zoom does not operate.

Zoom lever was pressed while shooting in movie mode.

- Operate the zoom before shooting in movie mode (p. 66). Note the digital zoom is available while shooting, but only in Standard movie mode (p. 67).

Playback

Cannot play back.

You attempted to play back images shot with another camera or images edited with a computer.

- Computer images that cannot be played back may play back if they are added to the camera using the supplied software program ZoomBrowser EX or ImageBrowser.

File name was changed with a computer or file location was changed.

- Set the file name or location on the file format/structure of the camera. (Refer to the *Software Starter Guide* for details).

Movies cannot be edited.

Some movies shot with another camera cannot be edited.

Movies do not play back correctly.

Movies recorded with high recording pixels and frame rates may momentarily stop playing if played on slow reading memory cards.

You may experience frame dropping and audio breakup when playing back a movie on a computer with insufficient system resources.

Reading images from memory card is slow.

Memory card was formatted in another device.

- Use a memory card formatted in your camera ([p. 65](#)).

Battery/Battery Charger

Battery consumed quickly.

Battery is not being used to its full capacity.	● See Battery Handling Precautions (p. 206).
Battery life exceeded if battery loses its charge quickly at normal temperature (23 °C/73 °F).	● Replace the battery with a new one (p. 9).

Battery will not charge.

Battery life exceeded.	● Replace the battery with a new one (p. 9).
------------------------	--

TV monitor output

Image is distorted or not showing on TV monitor.

Incorrect video system setting.	● Set the video system to the appropriate setting, NTSC or PAL, for your TV (p. 52).
Shooting in Stitch Assist mode.	● The output will not appear on a TV in Stitch Assist mode. Shoot in a different shooting mode (p. 44).

Printing with a direct print compatible printer

Cannot print

The camera and printer are not properly connected.	● Securely connect the camera and printer with the specified cable.
The printer power is not turned on.	● Turn on the printer power.
The print connection method is not correct.	● In the [Fn] menu, select [Print Method] and select [Auto] (p. 52).

List of Messages

The following messages may appear on the LCD monitor during shooting or playback. Please refer to the *Direct Print User Guide* for the messages that display during a printer connection.

Busy...

Image is being recorded to the memory card, or the playback mode is starting up.

No memory card

You turned on the camera without a memory card installed, or with a memory card installed in the wrong orientation (p. 9).

Card locked!

The SD memory card or SDHC memory card is write-protected (p. 208).

Cannot record!

You attempted to shoot an image without a memory card installed, with a memory card installed in the wrong orientation, or attempted to attach a sound memo to a movie.

Memory card error

There may be something wrong with the memory card. By formatting the malfunctioning memory card with the camera, you may be able to continue using it (p. 65). However, if this error message appears even when using the supplied memory card, contact your Canon Customer Support Help Desk as there may be a problem with the camera.

Memory card full

Memory card is full of images and no more can be recorded or saved. Or no more image settings, Sound Recorder files or sound memos can be recorded.

Naming error!

The file name could not be created because there is an image with the same name as the folder that the camera is attempting to create, or the highest possible file number has already been reached. In the Set up menu, set [File Numbering] to [Auto Reset]; alternatively, save all the images you wish to retain onto a computer, then reformat the memory card. Please note that formatting will erase all the existing images and other data.

Change the battery pack.

Battery charge is insufficient to operate the camera. Replace it at once with a charged one or recharge the battery. Also, see Battery Handling Precautions (p. 206).

No image.

No images recorded on memory card.

Image too large.

You attempted to play back an image larger than 5616 x 3744 pixels or with a large data size.

Incompatible JPEG

You attempted to play back an incompatible JPEG image (edited with a computer, etc.).

RAW

You attempted to play back an incompatible RAW image.

Unidentified Image

You attempted to play back an image with corrupted data, an image with a recording type specific to another manufacturer's camera, or an image that has been downloaded to a computer and altered.

Cannot magnify!

You attempted to magnify an image recorded in a different camera or data type, an image edited with a computer, or a movie.

Cannot rotate

You attempted to rotate the image shot with a different camera or data type, or an image edited with a computer.

Incompatible WAVE

A sound memo cannot be added to this image since the data type of the existing sound memo is incorrect. In addition, sound cannot be played back.

Cannot register this image!

You attempted to register an image recorded in a different camera or a movie as a start-up image.

Cannot modify image

You attempted to apply My Color effects, red-eye compensation or resizing to a movie or an image recorded by another camera. Or you attempted to resize an image recorded using **[W]**, or already resized to **[XS]**.

Cannot assign to category

You attempted to categorize an image recorded in a different camera.

Cannot Modify

Cannot apply red-eye correction as no red-eye is detected.

Cannot transfer!

When transferring images to your computer using the Direct Transfer menu, you attempted to select an image with corrupted data or an image taken with another camera. You may have also attempted to select a movie when [Wallpaper] was selected in the Direct Transfer menu.

Protected!

You attempted to erase or edit a protected image, movie or sound memo.

Too many marks.

Too many images have been marked with print settings, transfer settings or slide show settings. Cannot process any more.

Cannot complete!

Could not save a part of the print, transfer or slide show settings.

Unselectable image.

You attempted to set the print settings for a non-JPEG image.

Cannot select

In selecting the image range for categorizing via the My Category function, protecting images, erasing images or specifying print settings, you selected a starting image with a file number higher than the last image or a last image with a file number lower than the starting image. Or, you specified more than 500 images.

Communication error

The computer was unable to download the image due to the large amount of images (approx. 1000) stored on the memory card. Use a USB card reader or a PCMCIA card adapter to download the images.

Lens error, restart camera

An error was detected while the lens was in motion, and the power has been automatically turned off. This error can occur if you hold the lens while it is in motion or you operate it in a location with excessive dust or sand in the air. Try turning the power back on, and resume shooting or playback. If this message continues to display, contact your Canon Customer Support Help Desk as there may be a problem with the lens.

Exx

(xx: number) Camera detected error. Turn the power off and then back on, then shoot or play back. A problem exists if the error code reappears. Note the number and contact your Canon Customer Support Help Desk. If an error code displays directly after taking a picture, the shot may not have been recorded. Check image in playback mode.

Appendix

Safety Precautions

- Before using the camera, please ensure that you read the safety precautions described below and in the “Safety Precautions” section. Always ensure that the camera is operated correctly.
- The safety precautions noted on the following pages are intended to instruct you in the safe and correct operation of the camera and its accessories to prevent injuries or damage to yourself, other persons and equipment.
- Equipment refers to the camera, battery charger or separately sold compact power adapter.
- Battery refers to the battery pack.

⚠ Warnings

Equipment

- **Do not point the camera directly at the sun or bright light sources.**
It may damage the image sensor (CCD).
- **Store this equipment out of the reach of children and infants.**
 - Wrist strap: Placement of the strap around the child’s neck could result in asphyxiation.
 - Memory card: Dangerous if accidentally swallowed. If this occurs, contact a doctor immediately.

Equipment

- **Do not attempt to disassemble or alter any part of the equipment that is not expressly described in this guide.**
- **To avoid the risk of high-voltage electrical shock, do not touch the flash portion of the camera if it has been damaged.**
- **Stop operating the equipment immediately if it emits smoke or noxious fumes.**
- **Do not allow the equipment to come into contact with, or become immersed in, water or other liquids. If the exterior comes into contact with liquids or salt air, wipe it dry with a soft, absorbent cloth.**

Continued use of the equipment may result in fire or electrical shock. Immediately turn the camera power off and remove the camera battery or unplug the battery charger or compact power adapter from the power outlet. Please consult your camera distributor or the closest Canon Customer Support Help Desk.

- **Do not use substances containing alcohol, benzine, thinners or other flammable substances to clean or maintain the equipment.**
- **Do not cut, damage, alter or place heavy items on the power cord.**
- **Use only recommended power accessories.**
- **Remove the power cord on a regular periodic basis and wipe away the dust and dirt that collects on the plug, the exterior of the power outlet and the surrounding area.**
- **Do not handle the power cord if your hands are wet.**

Continued use of the equipment may result in fire or electrical shock.

Battery

- **Do not place the battery near a heat source or expose it to direct flame or heat.**
- **The battery should not be immersed in water or sea water.**
- **Do not attempt to disassemble, alter or apply heat to the battery.**
- **Avoid dropping or subjecting the battery to severe impacts that could damage the casing.**
- **Use only recommended battery and accessories.**

Use of battery not expressly recommended for this equipment may cause explosions or leaks, resulting in fire, injury and damage to the surroundings. In the event that a battery leaks and the eyes, mouth, skin or clothing contact these substances, immediately flush with water and seek medical assistance.

- **Disconnect the battery charger and compact power adapter from both the camera and the power outlet after recharging or when they are not in use to avoid fire and other hazards.**
- **Do not place anything, such as tablecloths, carpets, bedding or cushions, on top of the battery charger while it is charging.**
Leaving the units plugged in for a long period of time may cause them to overheat and distort, resulting in fire.

- **Use only the specified battery charger to charge the battery.**
- **The battery charger and compact power adapter are designed for exclusive use with your camera. Do not use it with other products or batteries.**
There is a risk of overheating and distortion which could result in fire or electrical shock.

- **Before you discard a battery, cover the terminals with tape or other insulators to prevent direct contact with other objects.**
Contact with the metallic components of other materials in waste containers may lead to fire or explosions.

Others

- **Do not trigger the flash in close proximity to human or animal eyes. Exposure to the intense light produced by the flash may damage eyesight.**
In particular, remain at least one meter (39 inches) away from infants when using the flash.
- **Keep objects that are sensitive to magnetic fields (such as credit cards) away from the speaker of the camera.**
Such items may lose data or stop working.

Cautions

Equipment

- **Be careful not to bang the camera or subject it to strong impacts or shocks when wearing or holding it by the strap.**
- **Be careful not to bump or strongly push the end of the lens.**
The above-mentioned could lead to injury or damage the equipment.
- **Do not store the equipment in humid or dusty areas.**
- **Do not allow metal objects (such as pins or keys) or dirt to contact the charger terminals or plug.**
Such conditions could lead to fire, electrical shock or other damage.
- **Avoid using, placing or storing the equipment in places subject to strong sunlight or high temperatures, such as the dashboard or trunk (boot) of a car.**
- **Do not use the equipment in a manner that exceeds the rated capacity of the electrical outlet or wiring accessories. Do not use if the power cord or plug are damaged, or if not fully plugged into the outlet.**
- **Do not use in locations with poor ventilation.**
The above-mentioned can cause leakage, overheating or explosion, resulting in fire, burns or other injuries. High temperatures may also cause deformation of the casing.
- **When not using the camera for extended periods of time, remove the battery from the camera or battery charger and store the equipment in a safe place.**
The battery can run down.

Equipment

- **Do not connect compact power adapters or battery chargers to devices such as electrical transformers for foreign travel because it may lead to malfunctions, excessive heat generation, fire, electric shock or injury.**

Flash

- **Do not operate the flash with dirt, dust or other items stuck to the surface of the flash.**
- **Be careful not to cover the flash with your fingers or clothing when shooting.**
The flash may be damaged and emit smoke or noise. The resulting heat build-up could damage the flash.
- **Do not touch the surface of the flash after taking several pictures in rapid succession.**
Doing so could result in burns.

Preventing Malfunctions

Avoid Strong Magnetic Fields

- **Never place the camera in close proximity to electric motors or other equipment generating strong electromagnetic fields.**
Exposure to strong magnetic fields may cause malfunctions or corrupt image data.

Avoid Condensation Related Problems

- **When moving the equipment rapidly from cold to a hot place, you can avoid condensation by placing the equipment in an airtight, resealable plastic bag and letting it adjust to temperature changes slowly before removing it from the bag.**
Moving the equipment rapidly from a cold to a hot place may cause condensation (water droplets) to form on its external and internal surfaces.



If Condensation Forms Inside the Camera

- **Stop using the camera immediately.**
Continued use may damage the equipment. Remove the memory card and battery or compact power adapter from the camera and wait until the moisture evaporates completely before resuming use.

Battery Handling

Battery Charge

- The following icon and message will display.

Icons	Message
	Sufficient battery charge.
	Recharge the battery soon for extended use.
 (blinking red)	Low battery charge. Recharge the battery.
Change the batteries	Battery is fully depleted and the camera can no longer operate. Charge the battery immediately.

Battery Handling Precautions

- Keep the battery terminals clean at all times.**
Dirty terminals may cause poor contact between the battery and camera. Polish the terminals with a soft cotton swab before charging or using the battery.
- At low temperatures, battery performance may be reduced and the low battery icon () may appear earlier than usual.**
Under these conditions, revive the battery by warming it in a pocket immediately before use.
- However, ensure that there are no metallic items in the pocket that could cause a short circuit, such as a key ring, etc.**
The battery may be short circuiting.
- Do not allow any metal objects such as key rings to touch the (+) and (-) terminals (Fig. A). To carry the battery or store it during periods of disuse, always replace the terminal cover (Fig. B).**
These conditions can damage the battery.

Fig. A



Fig. B

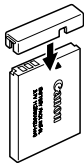

You may be able to check the charge state depending upon how the terminal cover is attached (Fig. C, D).

Fig. C
Charged Battery



Attach it so the ▲ is visible.

Fig. D
Spent Battery

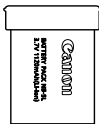

Attach it the opposite way to Fig. C.

- You are recommended to use it in the camera until it is depleted and to store it in an indoor location with low relative humidity and between the temperatures of 0 – 30 °C (32 – 86 °F).

Storing a fully charged battery for long periods of time (about one year) may shorten its life cycle or affect its performance. If you do not use the battery for long periods of time, charge it fully and discharge it in the camera about once a year before returning it to storage.

Charging the Battery

- Since this is a lithium-ion battery, you need not discharge it before recharging.
- It takes approximately 2 hours 5 minutes to fully charge the battery from a depleted state (based on Canon's testing standards).
 - Charging it within a temperature range of 5 – 40 °C (41 – 104 °F) is recommended.
 - Charge times may vary according to the ambient temperature and the battery's charge state.
- You are advised to charge the battery on the day of use, or one day before, to ensure a full charge.
 - Even charged batteries continue to discharge naturally.
- If the performance of the battery diminishes substantially even when it is fully charged, its life has been exceeded and it should be replaced.

Handling the Memory Card

SD memory card or SDHC memory card Write Protect Tab

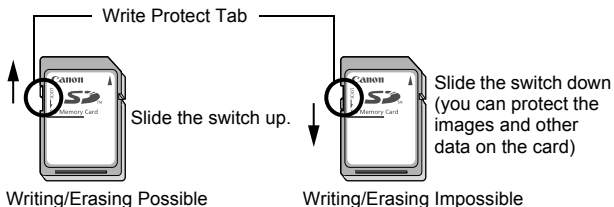

Cautions When Handling

- Memory cards are high-precision electronic devices. Do not bend them, apply force to them, or subject them to shocks or vibration.
- Do not attempt to disassemble or alter the memory card.
- Do not allow dirt, water or foreign objects to contact the terminals on the back of the card. Do not touch the terminals with your hands or metal objects.
- Do not peel away the original label on the memory card or cover it with another label or sticker.
- When writing on the memory card, do not use a pencil or ball-point pen. Only use a soft point pen (e.g. felt-tip pen).
- Do not use or store memory cards in the following locations.
 - Locations subject to dust or sand
 - Locations subject to high humidity and high temperatures
- Since some or all of the data recorded on the memory card may be corrupted or erased by electrical noise, static electricity, camera or card malfunction, making a backup copy of important data is recommended.

Formatting

- **Please note that formatting (initializing) an memory card erases all data, including protected images.**
- **You are recommended to use memory cards that have been formatted in your camera.**
 - The card supplied with the camera may be used without further formatting.
 - When the camera is malfunctioning, a corrupted memory card might be the cause. Reformatting the memory card may solve the problem.
 - When a non-Canon brand memory card is malfunctioning, reformatting it may solve the problem.
 - Memory cards formatted in other cameras, computers, or peripheral devices may not operate correctly in this camera. When that happens, reformat the memory card with this camera.
- **If formatting in the camera does not work properly, turn the camera off and re-insert the memory card. Then turn the camera back on and format again.**
- **Be careful when transferring or disposing of a memory card. Formatting or erasing the data on a memory card merely changes the file management information on the card and does not ensure that its contents are completely deleted. When disposing of a memory card, take precautions, such as physically destroying the card, to prevent personal information leaks.**

Using an AC Adapter Kit (Sold Separately)

It is best to power the camera with AC Adapter Kit ACK-DC30 (sold separately) when you are using it for long periods of time or connecting it to a computer.



Turn the camera power off before connecting or disconnecting the AC adapter.

- 1 Connect the power cord to the compact power adapter first and then plug the other end into the power outlet.**

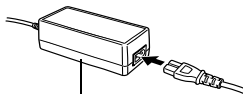

Compact Power Adapter CA-DC10

- 2 Open the memory card slot/battery cover, push the battery lock in the direction of the arrow and insert the DC coupler until it locks.**

- Slide the memory card slot/battery cover closed.

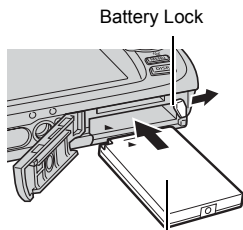

DC Coupler DR-30

- 3 Open the DC coupler terminal cover and attach the cord to the DC terminal.**

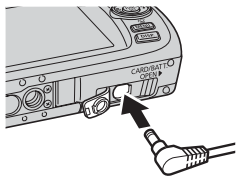

Using an Externally Mounted Flash (Sold Separately)

High-Power Flash HF-DC1

This flash is used to supplement the camera's built-in flash when the subject is too far away for proper illumination. Use the following procedures to affix the camera and High-Power Flash to the supporting bracket.

Please read the instructions accompanying the flash along with this explanation.

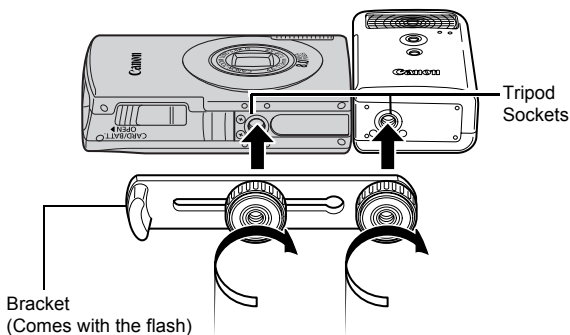

- The flash charge time will lengthen as the battery charge gets weaker. Always set the power/mode switch to [OFF] when you finish using the flash.
- Be careful not to touch the flash window or sensor windows with your fingers while the flash is in use.
- The flash may fire if another flash is being used in close proximity.
- The High-Power Flash may not fire outdoors in daylight or when there are no reflective items.
- For continuous shooting, although the flash fires for the first shot, it does not fire for subsequent shots.
- Fasten the attachment screws securely so that they do not loosen. Failure to do so may lead to the dropping of the camera and flash resulting in damage to both.



- Before attaching the bracket to the flash, check that the lithium battery (CR123A or DL123) is installed.
- To illuminate the subjects properly, install the flash so that it is up against the side of the camera and parallel with the camera's front panel.
- A tripod can be used even when the flash is attached.

■ Batteries

● Charge becomes Severely Limited

If the battery usage time has considerably diminished, wipe the battery terminals well with a dry cloth. The terminals may be dirty from fingerprints.

● Usage in Cold Temperatures

Get a spare generic lithium battery (CR123A or DL123). You are recommended to place the spare battery in your pocket to warm it up before switching it for the battery in the flash.

● Non-Use over Extended Periods

Leaving batteries in the High-Power Flash could allow the battery fluid to leak, damaging the product. Remove the batteries from the High-Power Flash and store them in a cool, dry place.

Camera Care and Maintenance

Never use thinners, benzine, detergents or water to clean the camera. These substances may distort or damage the equipment.

Camera Body

Gently wipe dirt off the camera body with a soft cloth or eyeglass lens wiper.

Lens

First use a lens blower brush to remove dust and dirt, then remove any remaining dirt by wiping the lens lightly with a soft cloth.



Never use organic solvents on the camera body or lens. If dirt remains, contact the closest Canon Customer Support Help Desk as listed on the European Warranty System (EWS) Booklet.

LCD Monitor

Use a lens blower brush to remove dust and dirt. If necessary, gently wipe with a soft cloth or an eyeglass lens wiper to remove stubborn dirt.



Never rub or press strongly on the LCD monitor. These actions may damage it or lead to other problems.

Specifications

All data is based on Canon's standard testing methods. Subject to change without notice.

DIGITAL IXUS 860 IS

(W): Max. wide angle (T): Max. telephoto

Camera Effective Pixels	: Approx. 8.0 million
Image Sensor	: 1/2.5-inch type CCD (Total number of pixels: Approx. 8.3 million)
Lens	: 4.6 (W) – 17.3 (T) mm (35mm film equivalent: 28 (W) – 105 (T) mm) f/2.8 (W) – f/5.8 (T)
Digital Zoom	: Approx. 4.0x (Up to approx. 15x in combination with the optical zoom)
LCD Monitor	: 3.0-inch type, amorphous silicon TFT color LCD, approx. 230,000 pixels (Picture coverage 100%)
AF System	: TTL autofocus Face Detect/AiAF (9-point)/Center* * Size of AF frame can be selected
Focusing Range	: Normal: 45 cm (1.5 ft.) – infinity Macro: 3 – 60 cm (W)/30 – 60 cm (T) (1.2 in. – 2.0 ft. (W)/1.2 – 2.0 ft. (T)) Infinity: 3 m (9.8 in.) – infinity Kids&Pets: 1 m (3.3 ft.) – infinity
Shutter	: Mechanical shutter and electronic shutter
Shutter Speeds	: 15 – 1/1600 sec. • The shutter speed varies depending on the shooting mode. • Slow shutter speeds of 1.3 sec. or slower operate with noise reduction.
Image Stabilization	: Lens shift type Continuous/Shoot Only*/Panning*/Off * Still images only

Metering System	: Evaluative* ¹ , Center-weighted average or Spot* ² *1 When [AF Frame] is set to [Face Detect], the brightness of the face is also evaluated *2 Fixed to center
Exposure Compensation	: ±2 stops in 1/3-stop increments
ISO speed (Standard Output Sensitivity, Recommended Exposure Index)	: Auto*, High ISO Auto*, ISO 80/100/200/400/ 800/1600 * Camera automatically sets the optimal speed.
White Balance	: Auto, Day Light, Cloudy, Tungsten, Fluorescent, Fluorescent H or Custom
Built-in Flash	: Auto*, on*, off * Red-eye reduction, FE Lock and slow synchro available
Compensation Range of Built-In Flash	: Normal: 30 cm – 4.0 m (1.0 – 13.1 ft.) (W), 30 cm – 2.0 m (1.0 – 6.6 ft.) (T) (ISO speed: Auto)
Shooting Modes (Still Images)	: Auto, Manual ¹ , Digital macro, Color Accent, Color Swap, Stitch assist, Special Scene Mode ² *1 Long shutter mode available *2 Portrait, Night Snapshot, Kids&Pets, Indoor, Foliage, Snow, Beach, Fireworks, Aquarium, Underwater
	(Movies): Standard, Compact, Color Accent, Color Swap, Time Lapse
Continuous Shooting	: Approx. 1.3 shots/sec. (Large/Fine mode)
Self-timer	: Activates shutter after an approx. 10-sec./ approx. 2-sec. delay, Custom Timer
Recording Media	: SD memory card/SDHC memory card/ MultiMediaCard/MMCplus card/ HC MMCplus card
File Format	: Design rule for camera file system and DPOF compliant

Data Type (Still images)	: Exif 2.2 (JPEG)* Sound memos: WAVE (monaural)
(Movies)	: AVI (Image data: Motion JPEG; Audio data: WAVE (monaural)) * This digital camera supports Exif 2.2 (also called "Exif Print"). Exif Print is a standard for enhancing the communication between digital cameras and printers. By connecting to an Exif Print-compliant printer, the camera's image data at the time of shooting is used and optimized, yielding extremely high quality prints.
Compression	: Superfine, Fine, Normal
Number of (Still images)	: Large: 3264 x 2448 pixels
Recording	Medium 1: 2592 x 1944 pixels
Pixels	Medium 2: 2048 x 1536 pixels
	Medium 3: 1600 x 1200 pixels
	Small: 640 x 480 pixels
	Postcard: 1600 x 1200 pixels
	Widescreen: 3264 x 1832 pixels
(Movies)	: Standard, Color Accent, Color Swap: 640 x 480 pixels (30 frames/sec., 30 frames/sec. LP) 320 x 240 pixels (30 frames/sec.) Recording can continue until the memory card is full* ¹ (can record up to a maximum of 4 GB at one time)* ² Compact: (can record for 3 min.) 160 x 120 pixels (15 frames/sec.) Time Lapse: (can record 2 hours) 640 x 480 pixels (1 frame/sec. (shooting interval: 1 sec.), 0.5 frame/sec. (shooting interval: 2 sec.)) (15 frames/sec. (during playback)) * ¹ Using super high-speed memory cards (SDC-512 MSH recommended). * ² Even if the clip size has not reached 4 GB, recording will stop at the moment the clip length reaches 1 hour. Depending on the volume and data writing speed of the memory card, recording may stop before reaching 1 hour or before the recorded data volume has reached 4 GB.

Sound Memo	: Bit Rate: 16 bits Sampling Rate Sound memo, movie (Compact): 11.025 kHz Movie (other than Compact): 44.100 kHz Sound Recorder: 11.025 kHz/ 22.050 kHz/ 44.100 kHz
Playback Modes	: Single (histogram displayable), Index (9 thumbnail images), Magnified (approx. 10x (max.) in LCD monitor, advance or reverse through magnified images possible), My Category, Jump (date, my category, folder, movie, tenth, hundredth). In index playback mode, it displays 9 images at once., Slide show, Red-Eye Correction, My Colors, Sound memos (recording/playback up to 1 min.), Movie (edit/slow motion play back possible), Sound Recorder (up to 2 hours sound-only recording/playback possible) or Resize.
Direct Print	: <i>PictBridge</i> compliant, and <i>Canon Direct Print</i> and <i>Bubble Jet Direct</i> compatible
My Camera Settings	: Start-up image, start-up sound, operation sound, self-timer sound, and shutter sound.
Interface	: USB 2.0 Hi-Speed (mini-B) Audio/Video output (NTSC or PAL selectable, monaural audio)
Communication Settings	MTP, PTP
Power Source	: Battery Pack NB-5L (Rechargeable lithium-ion battery) AC Adapter Kit ACK-DC30
Operating Temperatures	: 0 – 40 °C (32 – 104 °F)
Operating Humidity	: 10 – 90%
Dimensions (excluding protrusions)	: 92.6 x 58.8 x 25.9 mm (thinnest section 24.5mm) (3.65 x 2.32 x 1.02 in.) (thinnest section 0.96 in.)
Weight (camera body only)	: Approx. 155 g (5.5 oz.)

Battery Capacity (Battery Pack NB-5L (Fully charged))

Number of Images Shot	Playback Time
LCD Monitor On (Based on the CIPA standard)	
Approx. 270 images	Approx. 6 hours

- The actual figures will vary according to the shooting conditions and settings.
- Movie data is excluded.
- At low temperatures, the battery performance may diminish and the low battery icon may appear very rapidly. In these circumstances, the performance can be improved by warming the battery in a pocket before use.

Test Conditions

Shooting: Normal temperature (23°C ±2°C/73°F ±3.6°F), normal relative humidity (50% ±20%), alternating wide angle end and telephoto end shots at 30 second intervals with the flash fired once every two shots and the camera power turned off after every tenth shot. Power is left off for a sufficient amount of time*, then the power is turned back on and the testing procedure is repeated.

- A Canon-brand memory card is used.
- * Until the battery returns to normal temperature





















Playback: Normal temperature (23°C ±2°C/73°F ±3.6°F), normal relative humidity (50% ±20%), continuous playback at 3 seconds per image.



See *Battery Handling Precautions* (p. 206).

Memory Cards and Estimated Capacities











: Card included with the camera

Recording Pixels	Compression	32MB	SDC-128M	SDC-512MSH
L (Large) 3264 x 2448 pixels		8	35	139
		14	59	231
		29	123	479
M1 (Medium 1) 2592 x 1944 pixels		11	49	190
		20	87	339
		41	173	671
M2 (Medium 2) 2048 x 1536 pixels		18	76	295
		32	136	529
		64	269	1041
M3 (Medium 3) 1600 x 1200 pixels		29	121	471
		52	217	839
		99	411	1590
S (Small) 640 x 480 pixels		111	460	1777
		171	711	2747
		270	1118	4317
 (Postcard) 1600 x 1200 pixels		52	217	839
W (Widescreen) 3264 x 1832 pixels		11	47	183
		18	79	307
		39	166	642

-  Capable of smooth continuous shooting (p. 85) when card has been formatted with a low level format.
- This reflects standard shooting criteria established by Canon. Actual results may vary according to the subject and shooting conditions.



Movie

: Card included with the camera

	Recording Pixels /Frame Rate	32MB	SDC-128M	SDC-512MSH
 Standard  Color Accent  Color Swap	 640 x 480 pixels 30 frames/sec.	14 sec.	1 min. 1 sec.	3 min. 57 sec.
	 640 x 480 pixels 30 frames/sec. LP	27 sec.	1 min. 56 sec.	7 min. 30 sec.
	 320 x 240 pixels 30 frames/sec.	38 sec.	2 min. 42 sec.	10 min. 29 sec.
 Compact	 160 x 120 pixels 15 frames/sec.	3 min. 9 sec.	13 min. 2 sec.	50 min. 21 sec.
 Time Lapse	 *1 640 x 480 pixels	7 min. 30 sec.	31 min. 45 sec.	2 hrs. 3 min. 30 sec.
	 *2 640 x 480 pixels	15 min.	1 hr. 3 min. 30 sec.	4 hrs. 7 min.

*1 1 frame/sec. (shooting interval: 1 sec.)

*2 0.5 frame/sec. (shooting interval: 2 sec.)





- Maximum movie clip length at : 3 min., : 2 hours. The figures indicate the maximum continuous recording time.
- As  plays back at 15 frames/sec., the recording time and the playback time will differ.











Sound Recorder Data Rates and Recording Durations (Estimated)

: Card included with the camera

	Data Rates	32MB	SDC-128M	SDC-512MSH
11.025 KHz	22 KB/sec.	23 min. 28 sec.	1 hr. 36 min. 59 sec.	6 hrs. 14 min. 16 sec.
22.050 KHz	44 KB/sec.	11 min. 44 sec.	48 min. 30 sec.	3 hrs. 7 min. 8 sec.
44.100 KHz	88 KB/sec.	5 min. 52 sec.	24 min. 15 sec.	1 hr. 33 min. 34 sec.

Image Data Sizes (Estimated)

Recording Pixels	Compression		
			
L 3264 x 2448 pixels	3436 KB	2060 KB	980 KB
M1 2592 x 1944 pixels	2503 KB	1395 KB	695 KB
M2 2048 x 1536 pixels	1602 KB	893 KB	445 KB
M3 1600 x 1200 pixels	1002 KB	558 KB	278 KB
S 640 x 480 pixels	249 KB	150 KB	84 KB
 1600 x 1200 pixels	—	558 KB	—
W 3264 x 1832 pixels	2601 KB	1540 KB	736 KB

	Frame Rate/Recording Pixels		File size
 Standard		640 x 480 pixels, 30 frames/sec.	1963 KB/sec.
 Color Accent		640 x 480 pixels, 30 frames/sec. LP	1003 KB/sec.
 Color Swap		320 x 240 pixels, 30 frames/sec.	703 KB/sec.
 Compact		160 x 120 pixels, 15 frames/sec.	131 KB/sec.
 Time Lapse	 *1	640 x 480 pixels	64 KB/sec.
	 *2		32 KB/sec.

*1 1 frame/sec. (shooting interval: 1 sec.)

*2 0.5 frame/sec. (shooting interval: 2 sec.)

SD Memory Card

Interface	Compatible with SD memory card standards
Dimensions	32.0 x 24.0 x 2.1 mm (1.26 x 0.94 x 0.08 in.)
Weight	Approx. 2 g (0.07 oz.)

MultiMediaCard

Interface	Compatible with MultiMediaCard standards
Dimensions	32.0 x 24.0 x 1.4 mm (1.26 x 0.94 x 0.06 in.)
Weight	Approx. 1.5 g (0.05 oz.)

Battery Pack NB-5L

Type	Rechargeable lithium-ion battery
Nominal Voltage	3.7 V DC
Typical Capacity	1120 mAh
Cycle Life	Approx. 300 times
Operating Temperatures	0 – 40 °C (32 – 104 °F)
Dimensions	32.0 x 44.9 x 7.9 mm (1.26 x 1.77 x 0.31 in.)
Weight	Approx. 25 g (0.88 oz.)

Battery Charger CB-2LX/CB-2LXE

Rated Input	100 – 240 V AC (50/60 Hz) 0.085 A (100 V) – 0.05 A (240 V)
Rated Output	4.2 V DC, 0.7 A
Charging Time	Approx. 2 hour 5 minutes
Operating Temperatures	0 – 40 °C (32 – 104 °F)
Dimensions	57.5 x 81.6 x 21.0 mm (2.26 x 3.21 x 0.83 in.)
Weight	Approx. 65 g (2.29oz.) (CB-2LX) Approx. 59 g (2.08 oz.) (CB-2LXE) (excluding power cord)

Compact Power Adapter CA-DC10

(Included with the separately sold AC Adapter Kit ACK-DC30)

Rated Input	100 – 240 V AC (50/60 Hz)
Rated Output	4.3 V DC, 1.5 A
Operating Temperatures	0 – 40 °C (32 – 104 °F)
Dimensions	42.6 x 104.4 x 31.4 mm (1.68 x 4.11 x 1.24 in.)
Weight (excluding power cord)	Approx. 180 g (6.35 oz.)

Index

Numerics

3:2 Guide 124

A

AC Adapter Kit ACK-DC30 210
 AE Lock 102
 AF Frame 55, 97
 AF Lock 101
 AF-assist Beam 49, 191
 AiAF 97
 Auto ISO Shift 105
 Auto Rotate Function 125
 AV cable 183

B

Battery

Battery Capacity 218
 Charging 8
 Handling 206
 Installing 9

C

Category 136
 Clock Display 46
 Compression 75
 Continuous Shooting 85
 Create Folder 126
 Custom White Balance 112

D

Date/Time 12
 Using the Clock 46
 World Clock 61
 Digital Tele-Converter 67
 DIGITAL Terminal 22, 26, 38

Digital Zoom 67
 Direct Transfer 29
 Downloading Images to
 a Computer 24
 DPOF Print Order
 Print Style 174
 Selecting Images 174
 DPOF Transfer Order 181

E

Erasing

All Images 172
 Select Range 170
 Single Images 21
 Exposure Compensation 107
 Exposure Shift 90

F

FE Lock 103
 File Number 57, 128, 174
 Flash 71
 Focus
 AF Lock 101
 Lock 100
 Focus Check 95, 132
 Focus Lock 100
 Frame Rate 91
 FUNC./SET 40, 47

G

Grid Lines 124

H

HF-DC1 211
 Histogram 59

- I**
- Image Data Sizes (Estimated) 221
 - Image Stabilizer Function 79
 - Index Playback..... 131
 - Indicator 45
 - Infinity..... 72
 - Interface Cable..... 24
 - ISO Speed 104
- J**
- Jump (Image Search) 134
- L**
- Language 13
 - LCD Monitor
 - Night Display..... 60
 - Playback Information 57
 - Quick-bright LCD 60
 - Shooting Information..... 55
 - Using the LCD Monitor..... 54
 - List of Messages 197
- M**
- Macro 72
 - Magnifying..... 130
 - Maintenance 213
 - Memory Card
 - Estimated Capacities 219
 - Formatting..... 65
 - Handling..... 208
 - Inserting 9
 - Menu
 - FUNC. Menu 47, 49
 - MENU Button 48
 - Menus and Settings 47, 48
 - My Camera Menu 53
 - Play Menu 48, 50
 - Print Menu 48
 - Rec. Menu 49
 - Set up Menu 51, 53
 - Metering Modes 108
 - Mode Switch 14, 40
 - Movie 18
 - Editing..... 142
 - Playback 140
 - Shooting 88
 - Mute..... 51
 - My Camera Menu 53
 - My Camera Settings 184
 - My Colors..... 114, 155
- P**
- Playback 17
 - Playback Button..... 13, 40, 43
 - Registering 172
 - Postcard 77
 - Power Button 14, 40
 - Power Saving 45, 51
 - Print/Share Button 23, 30, 40, 122
 - Printing 22, 174
 - Protect 164
- R**
- Recording Pixels..... 49, 75
 - Red-Eye Correction 151
 - Red-Eye Reduction..... 86
 - Reset All 64
 - Resize..... 158
 - Review..... 16, 49
 - Rotate 144
- S**
- Safety Zoom 68
 - Self-Timer 73
 - Shooting 14
 - Shooting Mode
 - Functions Available 228
 - Manual..... 84
 - Movie 88

Scene Mode.....	81
Stitch Assist	93
Shutter Button.....	40
Fully	15
Halfway	15
Slide Show	146
Slow Synchro Function	87
Smooth Continuous Shooting ...	85
Sound Memo	160
Sound Recorder.....	162
Spot AE Point Frame	55, 108
Stitch Assist	93
System Requirements.....	24

T

Telephoto	66
Time Zone.....	61
Touch Control Dial	41
Transition Effects	145
Troubleshooting	187

V

Video Output System	183
---------------------------	-----

W

White Balance.....	111
Wide Angle	66
Wrist Strap	11

Z

Zoom.....	66
-----------	----







Disclaimer









- While every effort has been made to ensure that the information contained in this guide is accurate and complete, no liability can be accepted for any errors or omissions.
- Canon reserves the right to change the specifications of the hardware and software described herein at anytime without prior notice.
- No part of this guide may be reproduced, transmitted, transcribed, stored in a retrieval system, or translated into any language in any form, by any means, without the prior written permission of Canon.
- Canon makes no warranties for damages resulting from corrupted or lost data due to a mistaken operation or malfunction of the camera, the software, SD memory cards (SD cards), personal computers, peripheral devices, or use of non-Canon SD cards.

Trademark Acknowledgments

- Microsoft, Windows Vista and the Windows Vista logo are trademarks or registered trademarks of Microsoft Corporation in the United States and/or other countries.
- Macintosh, the Mac logo, QuickTime and the QuickTime logo are trademarks of Apple Inc., registered in the U.S. and other countries.
- The SDHC logo is a trademark.

Functions Available in Each Shooting Mode

Function								
			Long Shutter					
Exposure Compensation (p. 107)		○	–	○	–	○	–	○
Long Shutter Mode (p. 109)		–	○	–	–	–	–	–
ISO Speed (p. 104)	Auto	○	–	○	○	○	○	○
	High ISO Auto	○	–	○	–	–	○	–
	ISO 80/100/200/400/800/1600	○	○	○	–	–	–	–
White Balance (p. 111)	Auto	○	○	○	○	○	○	○
	Auto, Day Light, Cloudy, Tungsten, Fluorescent, Fluorescent H, Custom	○	○	○	–	○	–	–
Drive Mode (pp. 73, 85)	Single Shot	○	○	○	○	○	○	○
	Continuous	○	○	○	–	–	–	○
	Self Timer (2 sec. 10 sec.)	○	○	○	○	○	○	○
	Custom Timer	○	○	○	–	–	○	○
My Colors (p. 114)		○	○	○	–	○	–	–
Metering System (p. 108)	Evaluative	○	○	○	○	○	○	○
	Center Weighted Avg.	○	–	○	–	–	–	–
	Spot	○	–	○	–	–	–	–
Recording Pixels (Still Images) (p. 75)		○	○	○* ¹	○	○* ¹	○	○
Compression (Still Images) (p. 76)		○	○	○	○	○	○	○
Recording Pixels/Frame Rate (Movies) (p. 91)	640 x 480, 30 fps	–	–	–	–	–	–	–
	640 x 480, 30 fps LP	–	–	–	–	–	–	–
	320 x 240, 30 fps	–	–	–	–	–	–	–
	160 x 120, 15 fps	–	–	–	–	–	–	–
AE/FE Lock (pp. 102, 103)		○	–	○	–	–	–	–
AE Lock, Exposure Shift (movies) (p. 102)		–	–	–	–	–	–	–
AF Lock (p. 101)		○	○	○	–	–	–	–
Shooting Zone (p. 72)	Normal	○	○	–	○	○	○	○
	Macro	○	○	○	○	○	○	○
	Infinity	○	○	–	○	○	–	○
Flash (p. 71)	Auto	○	–	–	○	–	○	○
	On	○	○	–	○	○	–	○
	Off	○	○	○	○	○	○	○
LCD Monitor Setting (p. 54)	LCD Monitor (no information)	○	○	○	–	–	○	○
	LCD Monitor (information view)	○	○	○	○	○	○	○

Function								
			Long Shutter					
AF Frame (p. 97)	Face Detect	○	○	○	○	—	○	○
	AiAF (9 point)	○	○	○	○	—	○	○
	Center	○	○	○	○	○	○	○
AF Frame Size (p. 99)		○	○	—	—	—	—	—
Digital Zoom	Standard (p. 67)	○	○	○*3	—	—	○	○
	Digital Tele-Converter (p. 69)	○	○	—	—	—	○	○
Slow Synchro (p. 87)		○	○*3	—	—	○	—	—
Red-Eye (p. 86)		○	○	—	○	○	○	○
Self Timer (Custom Timer) (p. 73)		○	○	○	—	—	○	○
Auto ISO Shift (p. 105)	Auto/  button	○	—	○	—	—	○	—
	Off	○	○	○	○	○	○	○
AF-assist Beam (p. 49)		○	○	○	○	○	○	○
Rec. Review (p. 95)		○	○	○	○	○	○	○
Review Info (p. 132)	Off	○	○	○	○	—	○	○
	Detailed/Focus Check	○	○	○	○	—	○	○
Save Original (p. 120)		—	—	—	○	—	—	—
Auto Category (p. 121)		○	○	○	○	○	○	○
Disp. Overlay (p. 124)	Grid Line	○	○	○	○	—	○	○
	3:2 Guide/Both	○	○	○	○	—	○	○
IS Mode (p. 79)	Continuous	○	○	○	○	○	○	○
	Shooting Only/Panning	○	○	○	○	○	○	○
Date Stamp (p. 78)		○	○	—	○	—	○	○
Set  Button (p. 122)		○	○	○	○	○	○	○

○ : Setting available or optimum value is automatically set by the camera. As a rule, with the "Stitch Assist", only the first image is available.

— : Not available.

■ (Shaded Area): Settings are retained even when the camera power is turned off.

*1 Postcard Date Imprint and Widescreen are not available.

*2 Frame rate when shooting: 1 frame/sec.(shooting interval: 1 sec.) / 0.5 frame/sec. (shooting interval: 2sec.). Frame rate when playing back: 15 frames/sec.

*3 Always set to [On].

*4 Only available when the flash is set to [On].



Canon