



HP Scitex FB500 Printer
HP Scitex FB700 Printer

User Cleaning Instructions

© 2010 Hewlett-Packard Development
Company, L.P.

The information contained herein is subject to change without notice. The only warranties for HP products and services are set forth in the express warranty statements accompanying such products and services. Nothing herein should be construed as constituting an additional warranty. HP shall not be liable for technical or editorial errors or omissions contained herein.

Part number CQ114-90034 Revision A1

User cleaning

Schedule of tasks

The parts and supplies required for these procedures may be purchased as a kit (HP product number CQ121A). Consistent and proper use of this kit will contribute to optimal printer performance, extend lamp and printhead life, reduce the number of service calls, increase image quality, and reduce the potential for output artifacts.

Follow the cleaning schedule or clean as needed (depending on frequency of use and amount of dust and airflow around the printer). The printer displays maintenance reminders on the control panel according to this schedule or actual in-service time, as appropriate. You can display the service intervals and actual elapsed printing time for each task from the control panel menu (**System Page > Tools > User Cleaning and Maintenance > Maintenance Reminders**).

To perform these procedures, follow the instructions in this chapter or on the control panel under **System Page > Tools > User Cleaning and Maintenance**.

Table 1 Schedule of cleaning tasks

Task and Frequency	Required supplies
Replace UV lamp bulb (500–1000 hours) on page 3	2 of HP UV Replacement Bulb Kit.
Clean the rail encoder strip (bi-weekly) on page 10	One lint-free cleaning cloth Cleaning fluid
Clean ionizer needles (quarterly) on page 11	Ionizer cleaning brush
Clean and lubricate rail strips (bi-weekly) on page 12	Oiled cloth kit 1-2 lint-free cleaning cloths Cleaning fluid
Clean the print head orifice plates (bi-weekly) on page 14	Three lint-free cleaning cloths One pair of gloves Cleaning fluid
Clean and lubricate the service station rails (monthly) on page 16	One grease pack One pair of gloves One cotton swab Cleaning fluid
Clean service station wiper (monthly) on page 17	One lint-free cleaning cloth One pair of gloves Cleaning fluid
Clean carriage wheels (monthly) on page 18	Two long-stick swabs Cleaning fluid
Vacuum bottom of carriage (monthly) on page 21	N/A

Table 1 Schedule of cleaning tasks (continued)

Task and Frequency	Required supplies
Clean the carriage home sensor (monthly) on page 21	Long stick swab Cleaning fluid
Replace the UV lamp filters (quarterly) on page 23	Lamp filter kit
Clean the electronics box filters (quarterly) on page 24	Vacuum cleaner
Replace the service station wiper (quarterly) on page 25	Wiper blade
Drain waste from service station (quarterly) on page 26	Waste ink container
Clean the media thickness sensor roller (quarterly) on page 27	One lint-free cleaning cloth Cleaning fluid

Substitute cleaning procedures for air quality regulatory compliance

The various Air Quality Management Districts in California may have rules that restrict the use of cleaning solvents containing Volatile Organic Compounds (VOCs). This document provides alternative cleaning procedures for printers located in the areas of California where the use of solvents containing VOCs is restricted. These revised procedures supersede any previous instructions, guidelines, or recommendations issued by HP regarding the cleaning or maintenance of the relevant printers in California. Maintenance procedures that do not involve the use of VOCs for cleaning are not affected.

Printers located in California should not be cleaned using SolaChrome-UV Printhead Flush, HP UV Printhead Flush (HP product number CH122A) or isopropyl alcohol (IPA) unless other VOC compliance measures are in place. This includes the use of any product samples which came with the printer when it was purchased. Dispose of any remaining Printhead Flush in accordance with applicable regulations.

The compliant alternative liquid for cleaning and maintaining this printer is: Methyl Acetate (CAS# 79-20-9), at least 98% pure, undiluted.

Follow these safety guidelines when handling parts and cleaning chemicals:

- When handling parts and cleaning liquids use appropriate personal protective equipment (PPE) as prescribed in the Material Safety Data Sheet (MSDS). This includes the use of safety goggles, chemical protective gloves, and other protective personal clothing. Additional useful information may also be provided on websites operated by the Occupational Safety and Health Administration (OSHA) and the National Institute for Occupational Safety and Health.
- Only those components originally designated for cleaning with Printhead Flush or IPA should be cleaned with the alternative cleaning liquid.
- Methyl Acetate is a flammable liquid; read and adhere to the instructions in the MSDS document for safe handling and storage. State and local agencies or fire departments may impose additional requirements.
- Follow all health, safety and environmental protection regulations when using any solvents to clean or maintain the printer. An agency that administers health and safety regulations within the State of California is the Department of Industrial Regulations, Division of Occupational Safety and Health (Cal-OSHA).

- Minimize the quantity of cleaning liquid used during maintenance to avoid spills, contamination, or harm to printer parts. Carefully moisten cleaning cloths or swabs with the cleaning liquid, and ensure that none of it drips onto the printer. Any excess or residual liquid should be removed by cleaning the area with a dry cloth. Failure to clean off any residual cleaning liquid could cause damage to the printer, or could adversely affect the printer's level of image quality.
- Disposal of waste must be in accordance with applicable regulations.

Replace UV lamp bulb (500–1000 hours)

The UV ink curing lamp bulbs will gradually emit light of diminishing intensity with use. To compensate, increase the power setting to the lamps. (From the control panel Media Page, press **Wizard**, then press **Print Mode Specific Settings**.) The UV lamp bulbs are warranted for 500 hours, but by operating them at low power initially, and increasing the power only when necessary to ensure a full curing of the ink, a service life of 1000 hours is possible.

Replace both bulbs at the same time, so that both bulbs emit light of equal intensity. Order quantity 2 of HP product number CH231A, HP UV Replacement Bulb Kit. The replacement procedure consists of these parts:

1. Removing the lamp housings from the carriage
2. Removing the old lamp bulbs
3. Installing the new lamp bulbs
4. Re-installing the lamp housings

Remove the lamp housings

1. From the control panel (**System page > Tools > User Cleaning and Maintenance**), select **Replace UV Lamp Bulb or Bulbs**.

The control panel asks whether you want to proceed with changing the bulbs.

2. Press **Yes**.

The printer positions the rail and carriage for replacing the bulbs, then displays the prompt, "Select Lamp to Change."

3. In most cases, select **Both Lamps** to replace both lamps (recommended). Otherwise, select the lamp to change.
4. Press **Proceed**.

This resets the lamp service hours counter to zero hours. Next, the control panel prompts you to power down the printer.

5. Turn off the power switch to the printer. Do not disconnect the main power cable from the printer: this ensures that the proper vacuum is maintained to the printheads, which prevents ink from leaking out.
6. Wait five minutes to allow any existing current to drain from the capacitors.
7. Open the top cover to access the printhead carriage.

8. Disconnect the auxiliary cable from the top of the user-end lamp.

Figure 1 Disconnect the user-end auxiliary cable



Remove the user-end lamp housing

1. Remove the lamp power cable from the side of the lamp housing by turning the coupling counterclockwise.

Figure 2 Remove the user-end power cable

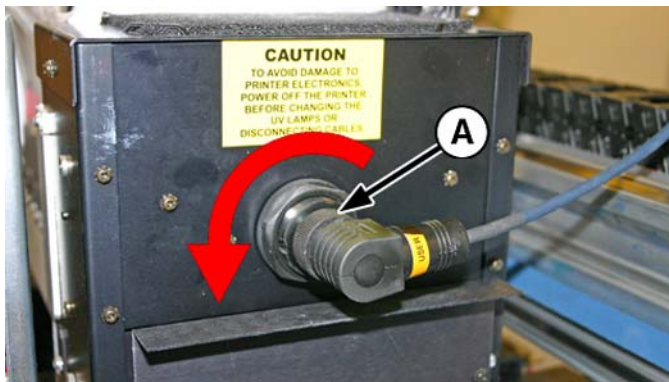

2. Remove the four sliver screws (A and B in the following figure) that secure the lamp housing to the lower lamp assembly.

Figure 3 User end screws

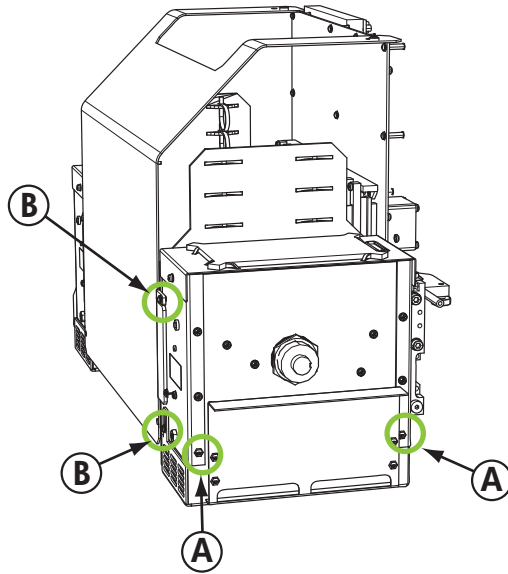

3. Lift up to remove the lamp housing from the printer.

Remove the service-end lamp housing

1. Disconnect the auxiliary cable from the top of the service-end lamp. See [Figure 1 Disconnect the user-end auxiliary cable on page 4](#) for location.
2. Remove the lamp power cable from the side of the lamp housing by turning the coupling counterclockwise. See [Figure 2 Remove the user-end power cable on page 4](#) for location.

3. Remove the four silver screws that secure the lamp housing to the lower lamp assembly, A and B as shown in the following figure. You can access one of the screws through the access hole in the ionizer bracket, as shown in the following figure.

Figure 4 Service end screws

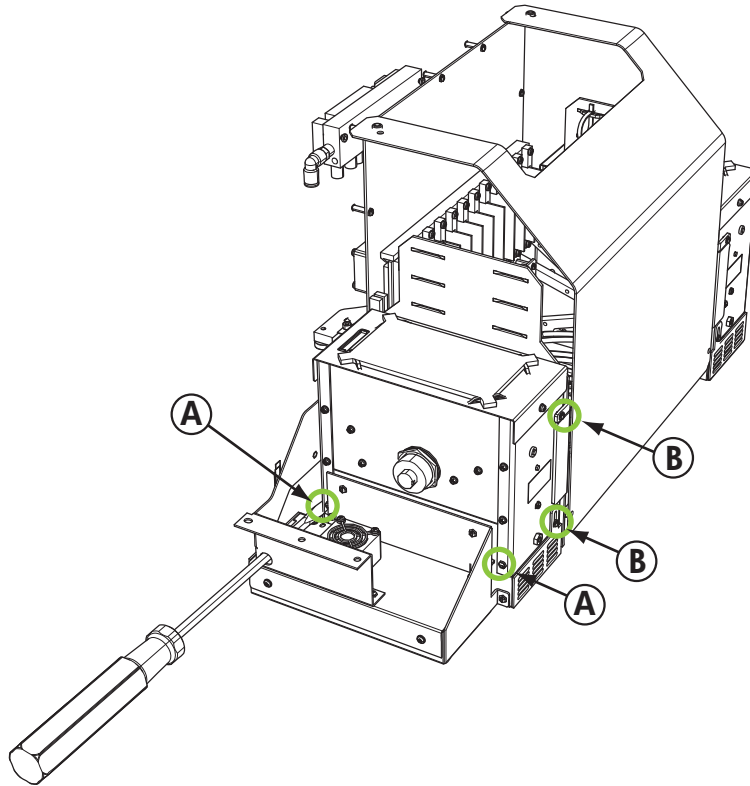

4. Lift up to remove the lamp housing from the printer.

Remove the old UV lamp bulb

 **NOTE:** Wear cotton gloves to protect the reflector and replacement bulb from fingerprints which would reduce bulb life and reflector efficiency.

1. Pull the spring-loaded clamp (A) from the side of the lamp reflector (B) as shown below.

Figure 5 Spring-loaded clamp

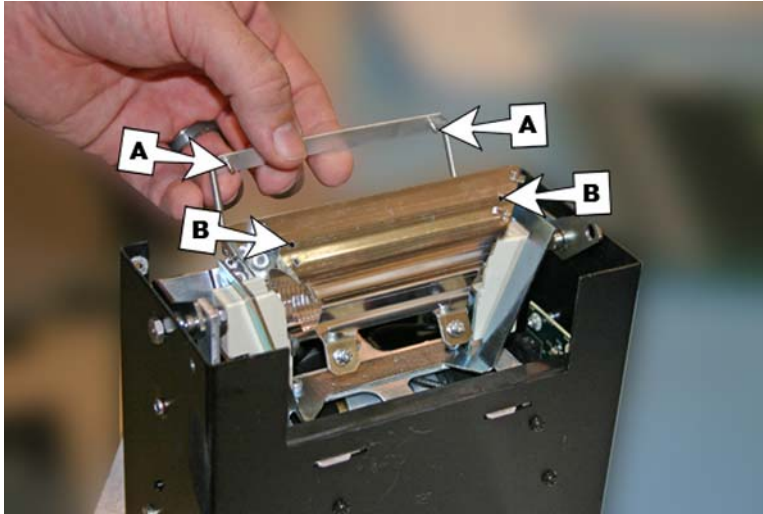

2. Loosen the two screws that hold the two reflectors together until the outside reflector can be removed.

Figure 6 Reflector screws

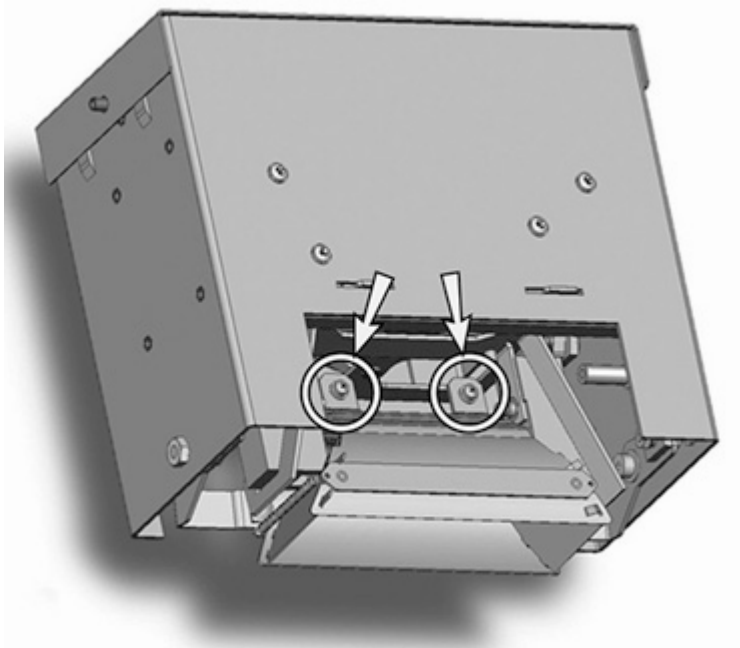

3. The reflector screws are captive screws and are not meant to be fully removed. If you do fully remove the screws, take care that the screws do not drop into the lamp housing.

 **NOTE:** Do not bend any of the tabs on the reflectors.

4. Push the lamp bulb to one side slightly (against the spring), and lift it from the lamp housing.

Figure 7 Removing the bulb

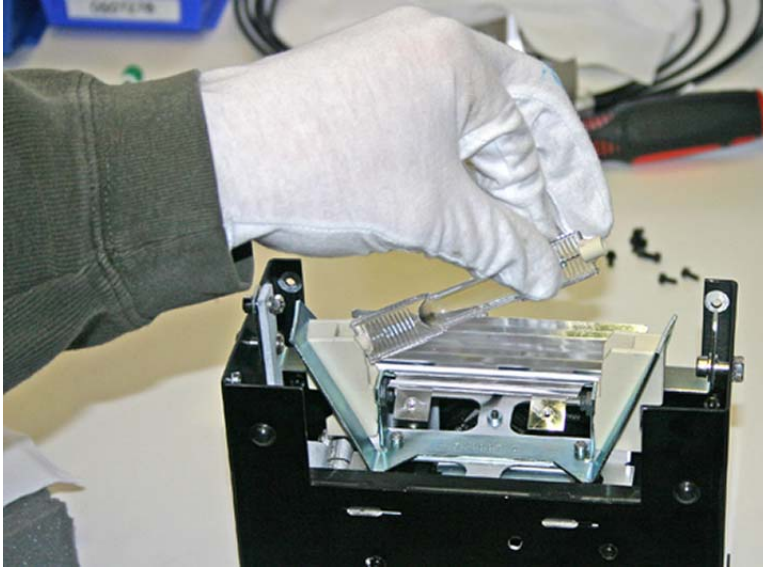

Material disposal: mercury lamps

This HP product contains the following materials that might require special handling at end-of-life: Mercury is present in the UV lamps. Disposal of mercury can be regulated because of environmental considerations. For disposal or recycling information, please contact your local authorities or the Electronic Industries Alliance (EIA) (<http://www.eiae.org>).

Install the new UV lamp bulbs

1. Insert the replacement bulb into the lamp housing, pressing it to the left, and then down into place.

Figure 8 Installing the bulb

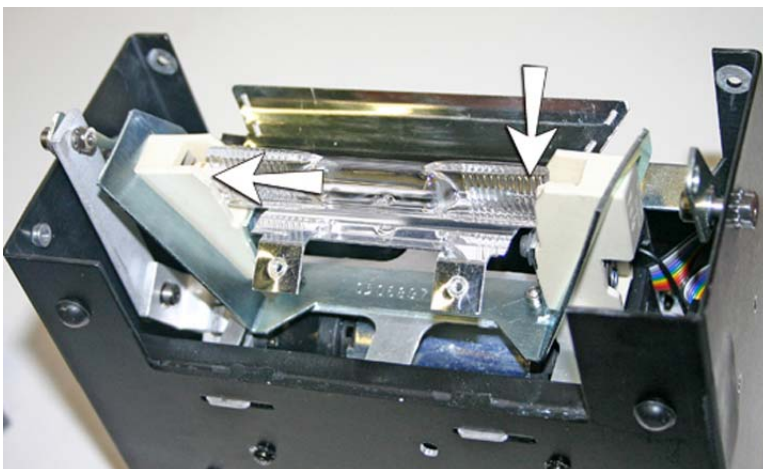

2. Tighten the two screws that hold the reflectors together (see [Figure 6 Reflector screws on page 7](#) for screw locations).

3. Install the spring-loaded clamp's dowels (A and B below) into the reflector.

Figure 9 Installing the dowels into the reflector

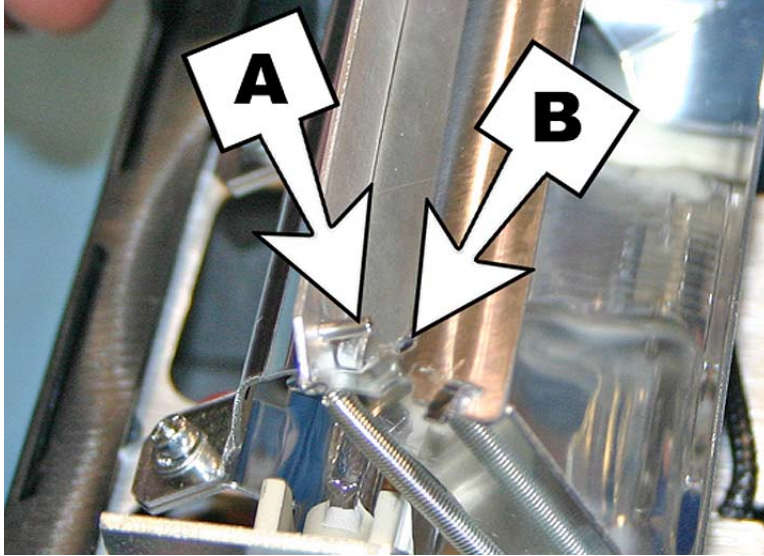

4. Repeat this procedure for the other lamp.

Re-install the lamp housings

Re-install the user-end lamp housing

1. Secure the lamp housing to the lamp assembly using the original two lower silver screws on the user end of the carriage (see screws A in [Figure 3 User end screws on page 5](#) for locations).
 - If you have difficulty fitting the lamp housing back onto the lamp base, loosen the four screws indicated below.
 - If the lamp housing is still difficult to install, squeeze the side of the lamp base to bend the side in about 0.8 mm (0.031 in).

Figure 10 Loosening screws to ease installation

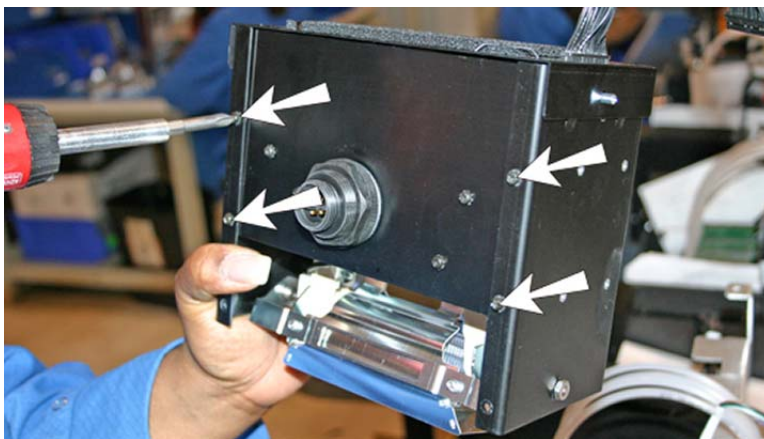
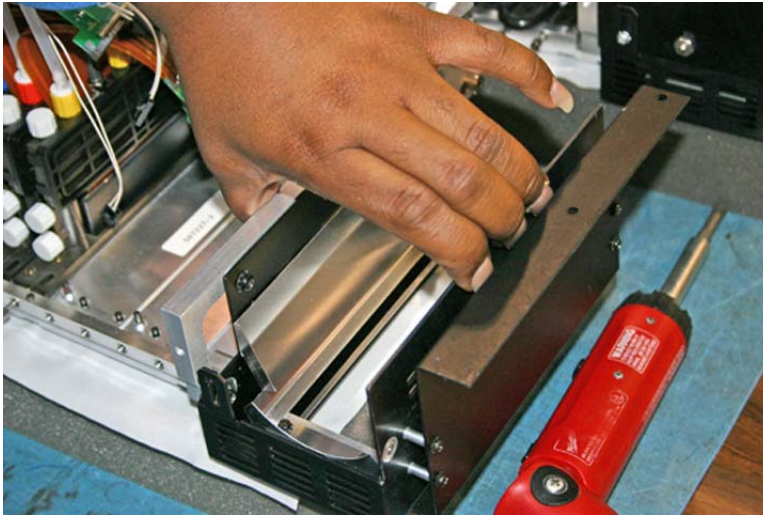

Figure 11 Squeeze the sides of the lamp base



Once the lamp housing is installed into the lamp base, tighten the four screws that you loosened in the previous step.

2. Install the two screws that secure the lamp housing to the carriage cover (see screws B in [Figure 3 User end screws on page 5](#) for locations).
3. Connect the auxiliary cable to the top of the lamp. See [Figure 1 Disconnect the user-end auxiliary cable on page 4](#) for location.
4. Connect the lamp power cable to the side of the lamp. See [Figure 2 Remove the user-end power cable on page 4](#) for location.

Re-install the service-end lamp housing

1. Secure the lamp housing to the lamp assembly using the original two silver screws on the service end of the carriage (see screws A in [Figure 4 Service end screws on page 6](#) for locations).

If you have difficulty fitting the lamp housing back onto the lamp base, see “Installing the User-End Carriage Lamp”

2. Install the two output-side screws (see screws B in [Figure 4 Service end screws on page 6](#) for locations).
3. Connect the auxiliary cable to the top of the lamp. See [Figure 1 Disconnect the user-end auxiliary cable on page 4](#) for location.
4. Connect the lamp power cable to the side of the lamp. See [Figure 2 Remove the user-end power cable on page 4](#) for location.
5. Power up the printer.

Clean the rail encoder strip (bi-weekly)

Ink dust and debris can accumulate on the encoder strip and block accurate reading of the encoder marks by the carriage encoder reader.

 **NOTE:** Users of printers in California must disregard all references to the Printhead Flush or IPA in the instructions or when displayed on the control panel. Instead, the alternative cleaning liquid specified at the beginning of this section must be used.

1. From the control panel (**System page > Tools > User Cleaning and Maintenance**), select **Clean Rail Encoder Strip**.
2. Press **Proceed** to continue.
The printer raises the rail and lowering the output roller into position for this operation.
3. Using a lint-free cloth moistened with IPA (Isopropyl alcohol), wipe the top of the encoder strip, cleaning the entire length of strip.
Use common rubbing alcohol, which is 70% isopropyl alcohol and 30% water.

Figure 12 Cleaning the encoder strip

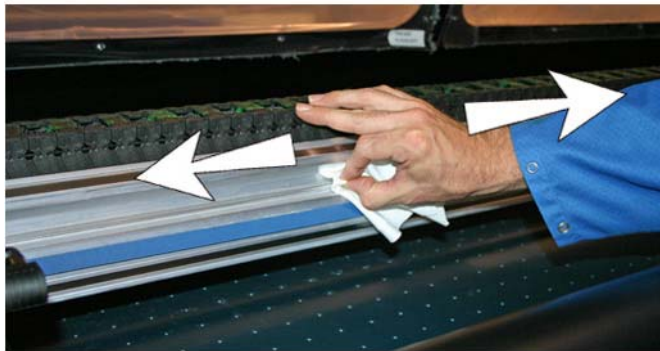

4. After cleaning most of the encoder strip, move the carriage to clean the section of the encoder strip that was behind the carriage. This enables you to clean the entire encoder strip from end to end.
5. To reset the maintenance counter for this task and complete the procedure, press **Proceed**.

Clean ionizer needles (quarterly)

Ink dust and debris can collect on the ionizer needles which degrades its ability to eliminate static. Cleaning the ionizer needles keeps the ionizer bar in optimal performance.

1. From the control panel (**System page > Tools > User Cleaning and Maintenance**), select **Clean Ionizer Needles**.
2. Press **Proceed** to continue.
The printer moves the rail for easier access to the ionizer bar.
3. If installed, move the output table (and accessory table, if installed) away from the printer.
4. Open the output door.

5. Using the brush supplied with the printer (shown in the photo below), clean the ionizer needles (A in the photo below) located beneath the ionizer bar.

The ionizer bar is located between the input roller and the alignment bar on the input side of the printer.

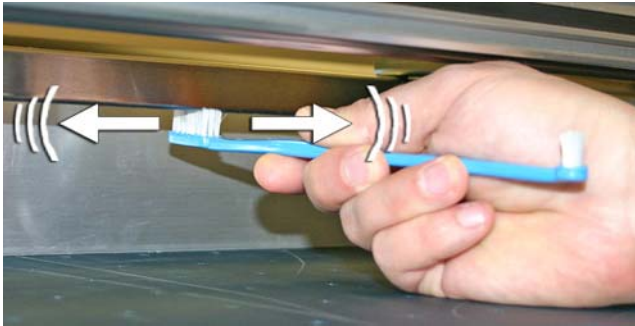

The needles (A in the photo below) run the length of the ionizer bar.

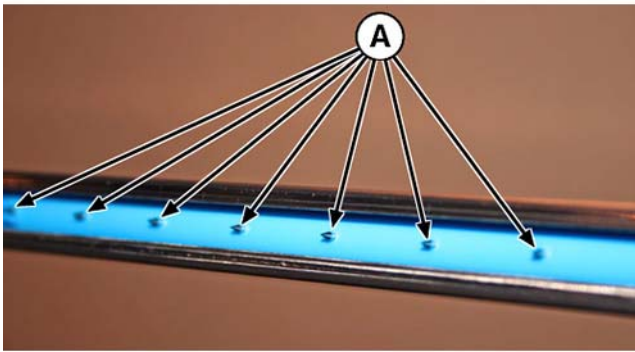

6. To reset the maintenance counter for this task and complete the procedure, press **Proceed**.

The printer repositions the rail and carriage to their home positions.

Clean and lubricate rail strips (bi-weekly)

Ink dust and debris can accumulate on the carriage-wheel strips. These particles become obstacles and friction for the carriage wheels, which can appear as repeating output anomalies on the printed media.

 **NOTE:** Users of printers in California must disregard all references to the Printhead Flush or IPA in the instructions or when displayed on the control panel. Instead, the alternative cleaning liquid specified at the beginning of this section must be used.

1. From the control panel (**System page > Tools > User Cleaning and Maintenance**), select **Clean and Lube Rail Strips**.

2. Process **Proceed** to continue.

The printer raises the rail and output roller for easier access to the rail.

3. Using a lint-free cloth and isopropyl alcohol, clean the top carriage-wheel strip from end to end on the rail (moving the carriage to clean the full length of the rail).

4. Lubricate the top carriage-wheel strip from end to end on the rail (moving the carriage to clean the full length of the rail).

The included oiled rags can be reused until there is no clear surface remaining on the rag (rags should be replaced quarterly). Clean these surfaces weekly or more frequently, depending on the amount of debris in the environment.

- △ **CAUTION:** Do not add additional oil to the lubrication cloths. The cloths are created to distribute a very thin film of oil. If too much oil is deposited, oil pockets can cause friction with the carriage wheels, which will produce output anomalies.

Figure 13 Top carriage-wheel strip

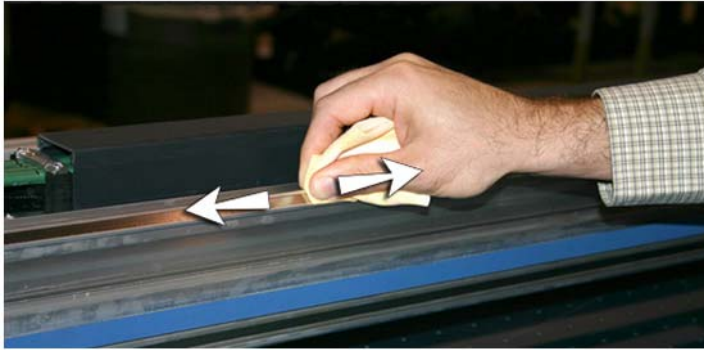

5. Lubricate behind the top area of the rail where the carriage wheels contact.

Figure 14 Back of top carriage-wheel strip



6. Using a lint-free cloth and Printhead Flush, clean the lower carriage-wheel strip from end to end on the rail (moving the carriage to clean the full length of the rail).

7. Lubricate the lower carriage-wheel strip from end to end on the rail (moving the carriage to clean the full length of the rail).



 **NOTE:** Even if the oiled cloth appears clean, it should be discarded quarterly so that the oil does not become sticky.

Figure 15 Lower carriage-wheel strip

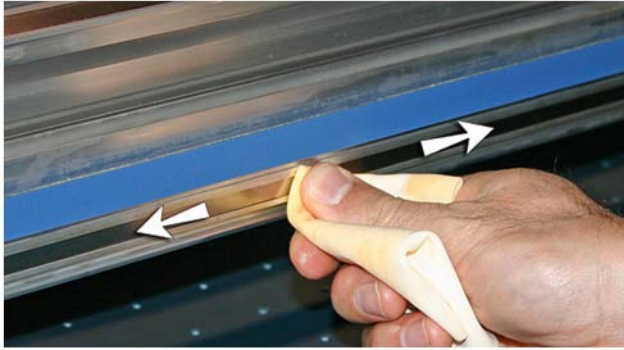

8. To reset the maintenance counter for this task and complete the procedure, press **Proceed**.

Clean the print head orifice plates (bi-weekly)

 **NOTE:** Users of printers in California must disregard all references to the Printhead Flush or IPA in the instructions or when displayed on the control panel. Instead, the alternative cleaning liquid specified at the beginning of this section must be used.

1. From the control panel (**System page > Tools > User Cleaning and Maintenance**), select **Clean Print Head Orifice Plates**.
2. Process **Proceed** to continue.

3. Open the service door to access the carriage over the service station.

△ **CAUTION:** Wear protective gloves, such as latex, to protect your hands from being stained with ink.

CAUTION: Wear safety glasses to protect your eyes from ink and head flush that may splash into your eyes.

Figure 16 Reaching the printheads through the access door



4. Fully saturate a lint-free cloth with printhead flush solution.



5. For each printhead, press a clean portion of the cloth with two fingers, each on one printhead, and draw the cloth across the printhead toward you (see A in the following figure).

 **NOTE:** To avoid pushing debris into the printhead orifice, make sure each wipe is done with a clean area of the cloth. The cloth should be fully saturated with head flush.

Figure 17 Wiping printheads



6. Using a lint-free cloth saturated with head flush, clean the bottom of the pen plate (see B in the previous figure).
7. To reset the maintenance counter for this task and complete the procedure, press **Proceed**.
8. From the control panel, select **Ink page > Purge**.
9. When the purge completes, select **Ink page > Check Jet Health** from the control panel.
10. Examine the prime bars for missing jets. If a printhead has missing jet, repeat steps [5](#) through [10](#).

Clean and lubricate the service station rails (monthly)

Cleaning and lubricating the wiper rails keeps the wiper motion moving smoothly for best cleaning performance.

 **NOTE:** Users of printers in California must disregard all references to the Printhead Flush or IPA in the instructions or when displayed on the control panel. Instead, the alternative cleaning liquid specified at the beginning of this section must be used.

1. From the control panel (**System page > Tools > User Cleaning and Maintenance**), select **Clean/Lube Service Station Rails**.
2. Press **Proceed** to continue.
3. Open the service door on the output side of the printer.

- Using a cloth moistened with head flush, wipe ink and debris from the top of the service station.

Figure 18 Cleaning the top of the service station



- Using a lint-free cloth, clean both of the wiper rails on both sides of the wiper carriage. Clean the exposed rails on all sides, moving the wiper carriage to clean the full length of the rails.

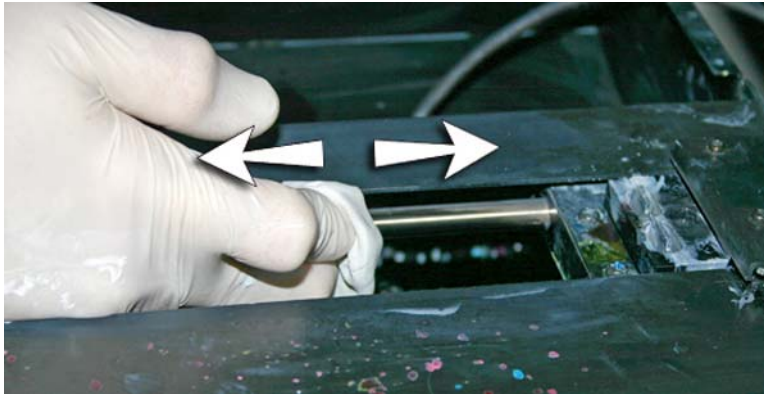

- As prompted by the control panel, close the access door, and press Proceed. Then wait for the wiper carriage to move.
- Open the access door.
- Apply a dab of grease (supplied) onto a cotton swab.
- Apply the grease to both rails (A and B in photo below), making sure to grease the entire surface of the rail (top, bottom and sides).
- As prompted by the control panel, close the access door, and press **Proceed**.

When you press Proceed, the printer resets the maintenance counter and moves the wiper carriage back and forth on the rails to spread the lubricant evenly.

Clean service station wiper (monthly)

Clumps of ink can accumulate around the wiper blades. If not cleaned off, the wipers can press the clumps of ink into the printhead orifices, which can clog the printhead jets.

 **NOTE:** Users of printers in California must disregard all references to the Printhead Flush or IPA in the instructions or when displayed on the control panel. Instead, the alternative cleaning liquid specified at the beginning of this section must be used.

1. From the control panel (**System page > Tools > User Cleaning and Maintenance**), select **Clean service station wiper**.
2. Press **Proceed** to continue.
3. Wear gloves, such as latex, to protect your hands from ink.
4. Using a lint-free cloth saturated with head flush (do not use IPA) wipe both sides of the rubber wiper.

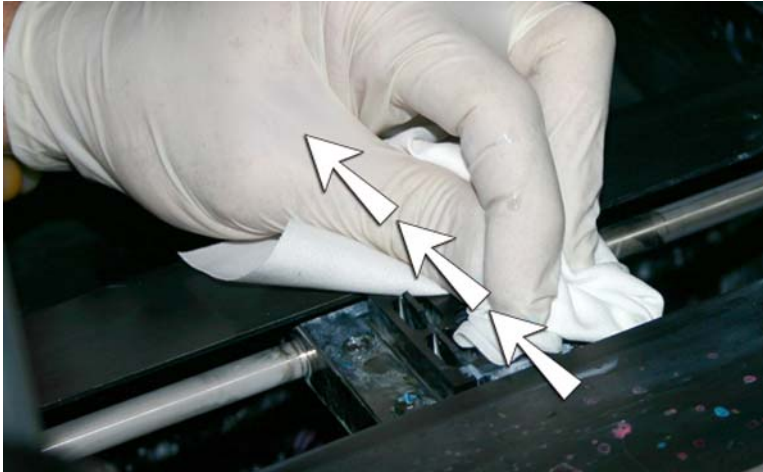

5. To reset the maintenance counter for this task and complete the procedure, press **Proceed**.

Clean carriage wheels (monthly)

Ink dust and debris can accumulate on the carriage wheels. These particles become obstacles and friction for the carriage wheels, which can appear as repeating output anomalies on the printed media.

 **NOTE:** Users of printers in California must disregard all references to the Printhead Flush or IPA in the instructions or when displayed on the control panel. Instead, the alternative cleaning liquid specified at the beginning of this section must be used.

There are five carriage wheels to clean (A, B, C, D, and E in the figure below).

Figure 19 Location of carriage wheels

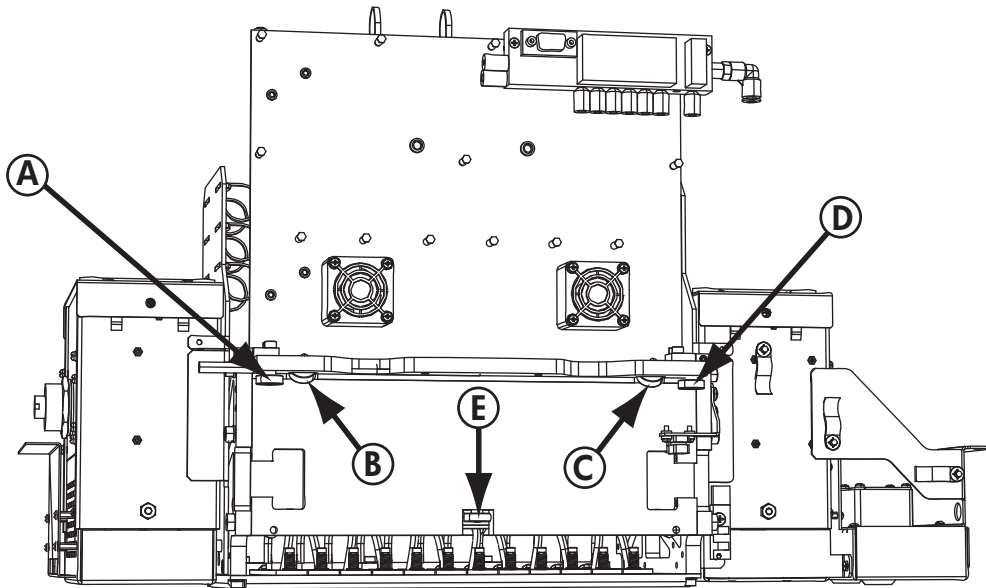

1. Raise the rail by selecting the following from the printer's control panel: **System page > Tools > User Cleaning and Maintenance > Clean Carriage Wheels.**
2. Press **Proceed** to continue.
The rail and the output roller will raise to the maximum height. You can move the carriage to any position on the rail that is convenient for cleaning.
3. Clean the top service-end wheel by placing an IPA (Isopropyl alcohol) moistened cotton swab against the side of the wheel (A in photo below) and moving the carriage back and forth about 10 cm (4 in).

Figure 20 Location of carriage wheels

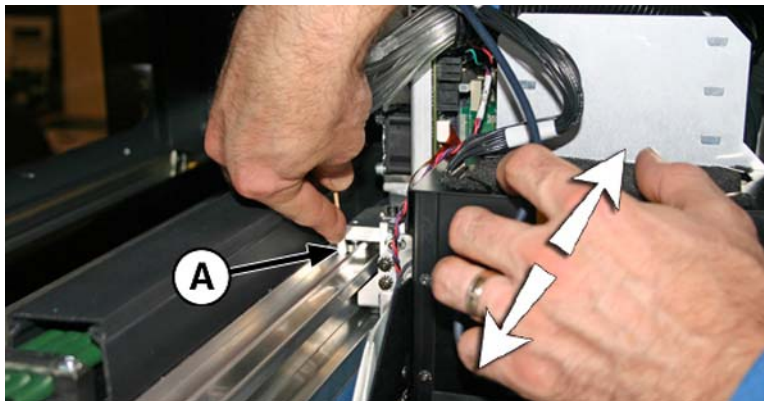

4. Clean the top user-end carriage wheel with an IPA moistened cotton swab.



5. Clean the top slanted wheels by inserting an IPA moistened cotton swab into the opening above the wheels (A) and moving the carriage back and forth.

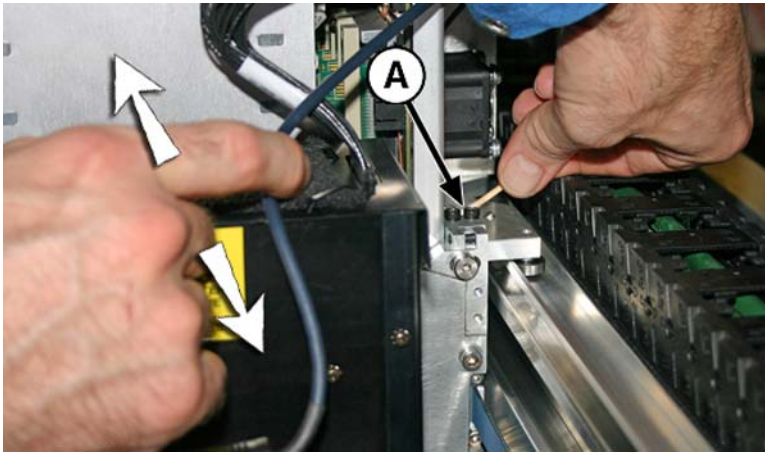

6. Clean the lower carriage wheel by placing an IPA moistened cotton swab next to the wheel and moving the carriage back and forth.

Manually move the carriage over the service station. Access the lower wheel through the service door.

Figure 21 Lower carriage wheels



7. To reset the maintenance counter for this task and complete the procedure, press **Proceed**.

Vacuum bottom of carriage (monthly)

Clumps of ink and debris can accumulate around the printheads, where the service station's printhead wiper does not reach. This routine uses the printer's internal printhead vacuum cleaner to clean as much of this surface area as possible. This reduces the possibility of ink debris moving from the edge of the printhead orifice area onto the printhead, which can clog jets.

1. From the printer's menu, select **System page > Tools > User Cleaning and Maintenance**), select **Vacuum Bottom of Carriage**.
2. Press **Proceed** to continue.
3. Press **Proceed** to reset the maintenance counter and begin the procedure.
4. When the procedure completes, clean the wipers as shown in the section [Clean service station wiper \(monthly\) on page 17](#).
5. To reset the maintenance counter for this task and complete the procedure, press **Proceed**.

Clean the carriage home sensor (monthly)

The home sensor is located on the user-end of the carriage between the lamp assembly and the carriage side plate (on the input-side of the carriage). Ink dust and debris can accumulate in the thin slits of the optical sensor and cause errors.

 **NOTE:** Users of printers in California must disregard all references to the Printhead Flush or IPA in the instructions or when displayed on the control panel. Instead, the alternative cleaning liquid specified at the beginning of this section must be used.

1. From the control panel (**System page > Tools > User Cleaning and Maintenance**), select **Clean Carriage Home Sensor**.

2. Press **Proceed** to continue.

The printer raises the printhead carriage rail and lowers the output roller.

3. Open the output-side door.

Opening the output-side door will disable the carriage servo, allowing the carriage to be moved manually.

4. Pull the carriage out from the end of the rail to access the home sensor more easily.

5. Locate the home sensor (A in photo below).

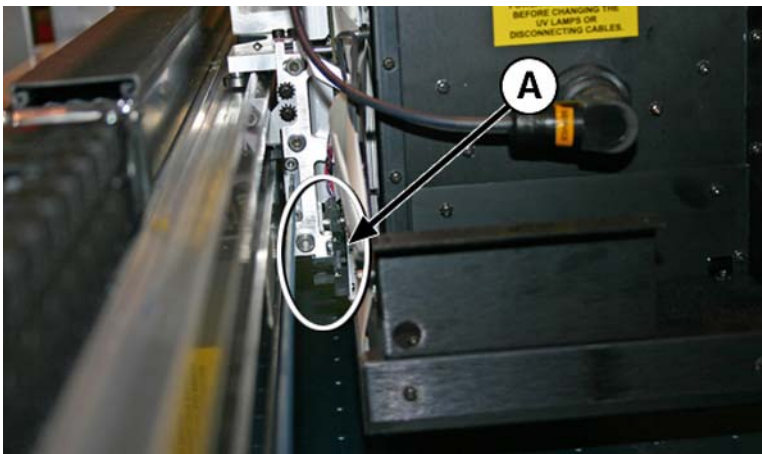

6. Locate the upper and lower slits of the optical sensor.

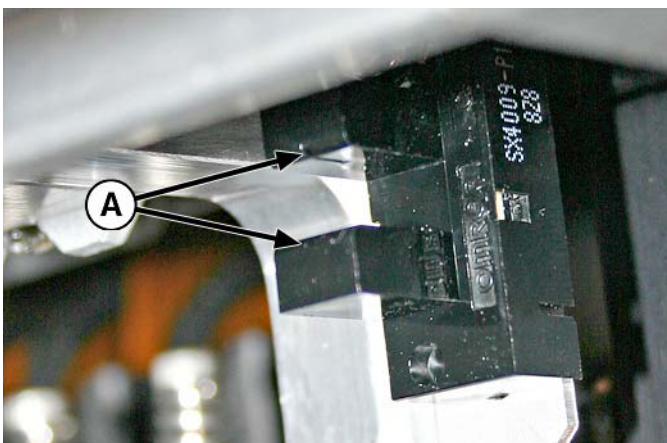

- Using a long cotton swab that is saturated in isopropyl alcohol, clean the top and bottom slit by inserting the swab into the opening from the input-side of the sensor (versus inserting from the user-end of the sensor).

△ **CAUTION:** Insert the swab from the input side to keep from pushing debris into the slits. Insert the swab moving from the input-side toward the output-side direction. Do not wipe across the slits, as this will force debris down into the openings.

Figure 22 Cleaning the home sensor

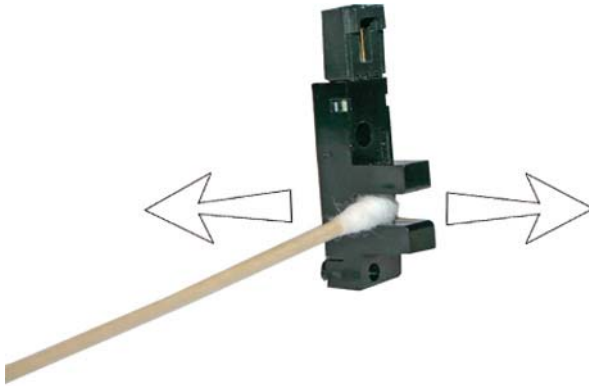

- To reset the maintenance counter for this task and complete the procedure, press **Proceed**.

Replace the UV lamp filters (quarterly)

Lamp filters keep ink dust and other debris from entering the air-cooled lamp area. If the filters become clogged, the lamps may overheat, reducing the life of the bulbs. Overheating causes printing to stop, which can ruin a print job.

- From the printer's menu, select **System page > Tools > User Cleaning and Maintenance**), select **Replace UV Lamp Filters**.
- Press **Proceed** to continue.
The printer centers the printhead carriage.
- Remove the original air filters for both carriage lamps (B in photo below).

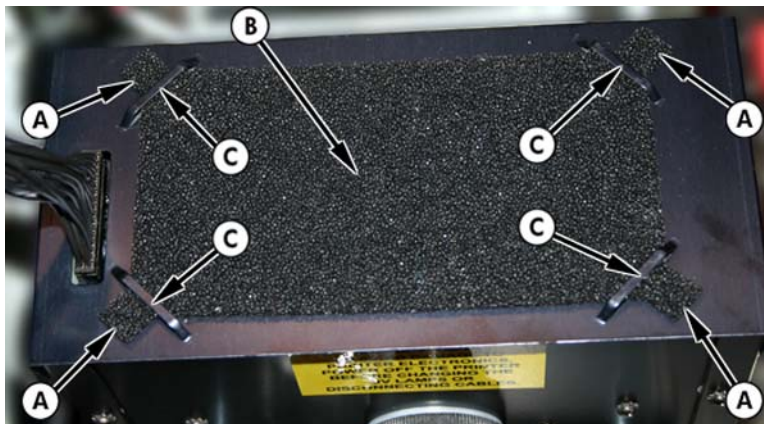

- Install the new air filters by insert the corner tabs (A in photo in previous step) under the corner slots (C in photo in previous step) on top of the lamps.
- To reset the maintenance counter for this task and complete the procedure, press **Proceed**.

Clean the electronics box filters (quarterly)

Electronics box fan filters keep dust and other debris from entering the air-cooled area of the electronics box. If the filter becomes clogged, the electronics may overheat, causing performance errors. There are two air intake fans to clean. One is located near the power switch on the user-end of the printer (input side). The other is located in the middle area under the printer chassis where the power cord attaches on the user-end.

1. From the control panel (**System page > Tools > User Cleaning and Maintenance**), select **Clean Electronics Box Filters**.
2. Press **Proceed** to continue.
3. Vacuum the dust and debris from the front of the fan on the input-side of the electronics box (located behind the user-end enclosure in the area indicated by (A) in the figure below).

If the chassis wheels are still attached to the printer, rotate the wheel out of the way as shown below.

Figure 23 Cleaning the electronics box fan filter on the input side

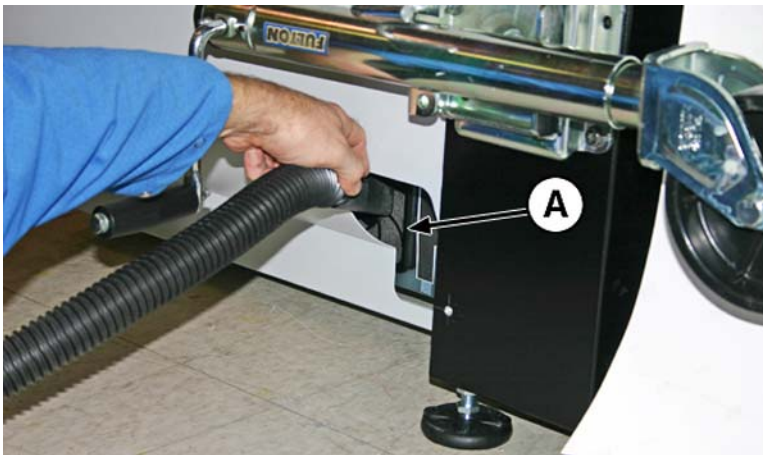

4. Vacuum the filter (A in photo below.) located under the printer's chassis near the power cord attachment point, and remove dust from the surrounding area.

Figure 24 Cleaning dust from the electronics box fan filter

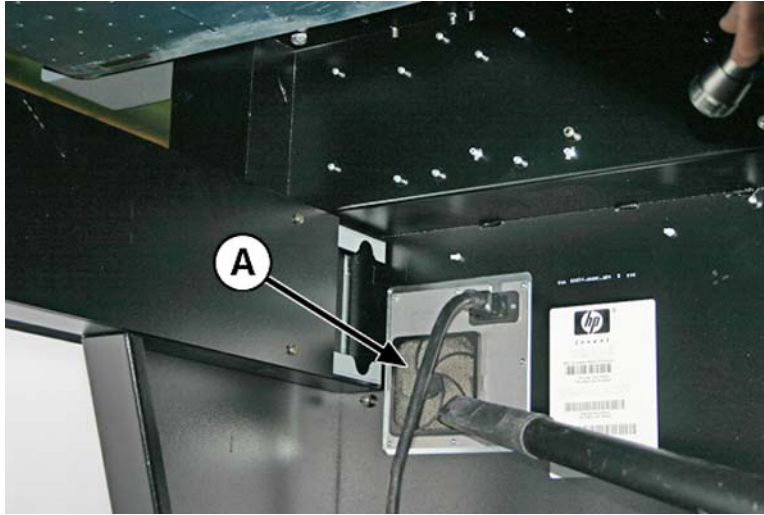

5. To reset the maintenance counter for this task and complete the procedure, press **Proceed**.

Replace the service station wiper (quarterly)

The wiper blade deteriorates with use. Replacing the wiper blade periodically restores the wiping to optimal performance and wiper height.

 **NOTE:** Replace the wiper according to the schedule in [Table 1 Schedule of cleaning tasks on page 1](#). The wiper replacement schedule is calculated to be frequent enough to avoid the need for wiper-height calibrations between replacements. If the wipers are not making adequate contact with the printheads, contact your service provider to calibrate the wiper height.

1. From the control panel (**System page > Tools > User Cleaning and Maintenance**), select **Replace Service Station Wiper**.
2. Press **Proceed** to continue.
3. Open the service door to access the service station.
4. Move the printhead carriage away from the service station.

5. Remove the screw (A in the figure below) that secures the wiper clamp to the wiper assembly.

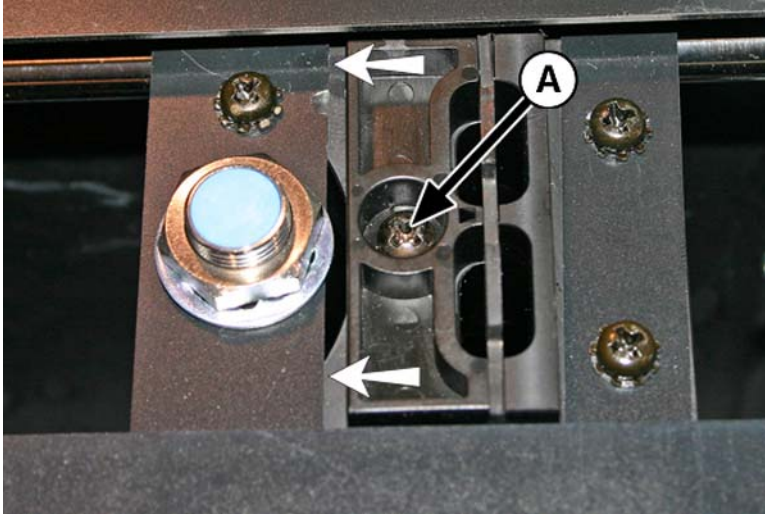

6. Separate the two wiper clamp halves and remove the original wiper blade.
7. Install the replacement wiper blade in the orientation shown below.

Figure 25 Wiper clamp screw



8. Secure the wiper blade clamp to the wiper assembly using the original screw.
9. To reset the maintenance counter for this task and complete the procedure, press **Proceed**.

Drain waste from service station (quarterly)

Waste ink accumulates in the service station until drained. Dispose of the collected ink according to local regulations.

1. Place the waste ink container (included with the printer) beneath the waste ink spigot, under the media drive belt at the service end of the printer.
2. From the control panel (**System page > Tools > User Cleaning and Maintenance**), select **Drain Waste from Service Station**.
3. Press **Proceed** to continue.

4. Turn the spigot (A in the photo below) to the open position



5. After the waste ink has drained, turn the spigot to the closed position

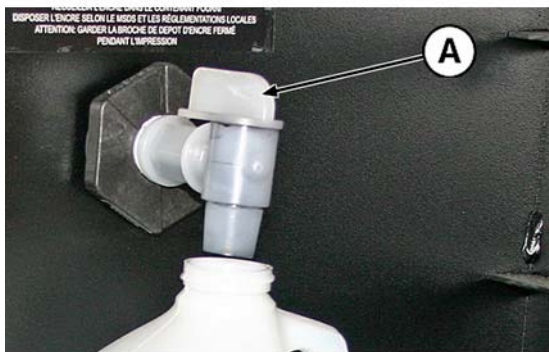

△ **CAUTION:** The drain spigot must remain closed during printing and service station use. An open spigot affects the vacuum level in the service station and will degrade service station performance if left open.

6. To reset the maintenance counter for this task and complete the procedure, press **Proceed**.

Clean the media thickness sensor roller (quarterly)

The media thickness sensor is located on the carriage rail, on the user end. Debris on the media thickness sensor roller can result in inaccurate measurements. Clean the roller to keep the sensor operating correctly.

 **NOTE:** Users of printers in California must disregard all references to the Printhead Flush or IPA in the instructions or when displayed on the control panel. Instead, the alternative cleaning liquid specified at the beginning of this section must be used.

1. From the control panel (**System page > Tools > User Cleaning and Maintenance**), select **Clean Media Thickness Sensor Roller**.
2. Press **Proceed** to continue.

3. Using a lint-free cloth that is saturated with IPA (isopropyl alcohol), clean the media thickness sensor roller by manually turning the roller with your finger while applying the cloth to the roller surface.



4. To reset the maintenance counter for this task and complete the procedure, press **Proceed**.