



MASERGY



USER GUIDE | CLOUD COMMUNICATIONS



MASERGY

Quick Guide for
Panasonic KX-TGP600

February 2019

Contents

Panasonic KX-TGP600 Button Diagram	3
Telephone Display and Icons Overview	4
Telephone Overview	5
Features	5
Reading the Display	5
Using the Panasonic KX-TGP600	6
Answer the Phone	6
Voicemail	6
Transfer a call (Announced)	7
To transfer a call, while on the phone:	7
Transfer a call (Blind - Not Announced)	7
Transfer a call to voicemail	7
Conference Call (Three-Way Calling)	7
Call Park	7
Park Pickup (or to retrieve the call)	7
Key Features	8
Adjust the Volume	8
Panasonic KX-A406 Repeater	9
Additional Setup	10
Transferring a Call between Handsets	13
More Help	13

QUICK GUIDE - PANASONIC KX-TGP600

Panasonic KX-TGP600 Button Diagram



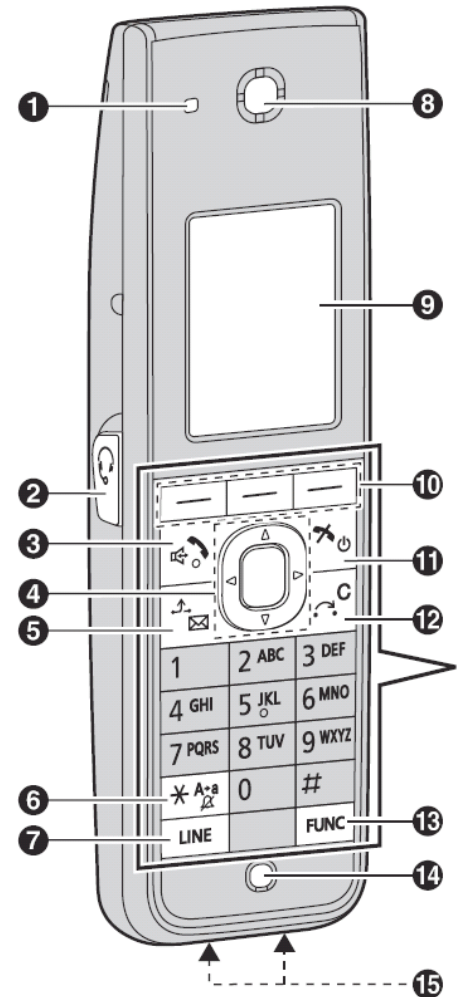



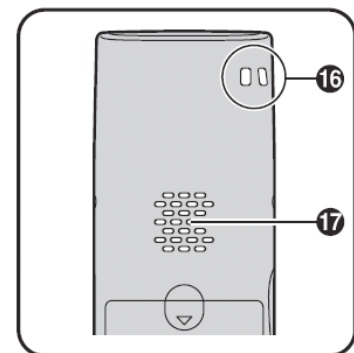









1. Ringer/Charge/Message Indicator
2. Headset Jack
3. Talk/Speakerphone Key
4. Navigator Key (press to select and scroll up/down/left/right) If phone is idle, pressing the following keys performs the following functions:
5. Hold/Message Key
6. Silent Mode Key (when pressed for 2 seconds when phone is idle turn silent on or off)
7. Line Key (confirms line status or seize a line)
8. Receiver
9. Display
10. Soft Keys
11. Power/Cancel Key (press and hold to turn handset on or off)
12. XFER/CLR Key (transfer call to another party and clear digits/characters)
13. FUNC Key – Function Keys:
14. Microphone
15. Charge Contacts for handset
16. Strap Holes
17. Speaker



[Back View]



QUICK GUIDE - PANASONIC KX-TGP600 Telephone Display and Icons Overview

	Signal Strength Indicator - Strong		Battery Indicator*1 - Full
	Signal Strength Indicator - Medium		Battery Indicator*1 - Medium
	Signal Strength Indicator - Weak		Battery Indicator*1 - Low
	Signal Strength Indicator - Very weak		Battery Indicator*1 - Very low
	Signal Strength Indicator - Out of range		Battery Indicator*1 - Needs to be charged.
	Off-hook Status		Incoming Call Log
	Intercom Indicator*2		Outgoing Call Log
	Voice Message		Phonebook
	Navigator Key Guidance		

*1 KX-TPA60 only.

*2 Not displayed when connecting to a base unit other than the KX-TGP600.

Display

[Example]



1. Pictograph
2. Handset Phone Status Information
3. Time Display
4. Date, New Message or Missed Call Display
5. Handset Phone Number and Name
6. Soft Keys

QUICK GUIDE - PANASONIC KX-TGP600 Telephone Overview

Features

- Base uses DECT 6.0 technology
- Supports up to eight simultaneous calls
- Wide Band Audio (G.722)
- Large handset display with 2.1" backlit LCD
- Message Waiting light and notifications
- Keeps up to ten of the last numbers dialed
- Integrated full duplex speakerphone
- Up to eight hours of talk time
- Up to 200 hours standby
- Simple, elegant design
- Standard 50 meter range can be extended up to 200 meters using up to three additional repeaters (see diagram below)

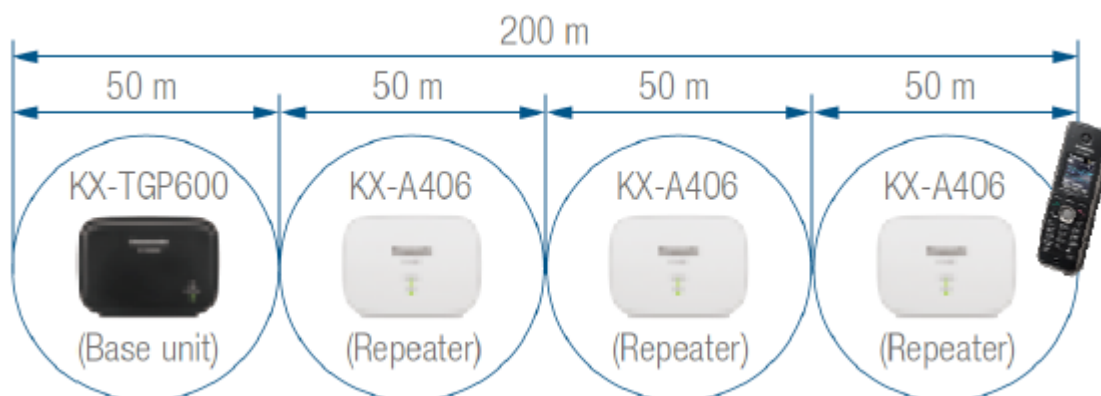

Reading the Display

When the phone is idle, the phone displays alerts for any “Missed Calls” and “New Voicemail” received.

There is a tower display at the top/left. Below you will see a handset icon representing up to eight calls at a time. These calls appear in order they were received from left to right. These handset icons will change according to activity:

- Steady hollow handset icon indicates an open line
- Steady black handset icon indicates line is in use (on any handset)
- Blinking black handset icon indicates a ringing line or call on hold
- A new ringing call will blink faster than the held call

There are three soft keys (right, middle and left). In this document we refer to the buttons as Right soft key, Left soft key, and MENU button. The MENU button is also used to scroll. Press or scroll up/down/left/right.

QUICK GUIDE - PANASONIC KX-TGP600

Using the Panasonic KX-TGP600

Answer the Phone

To answer a call

- While phone is ringing, press the green TALK button to answer
- Alternatively, press TALK again for speakerphone

To answer a second call

- While on a call, a second call is indicated by a call waiting beep
- When you look at the handset, you can see the caller ID of the second caller and the line two indicator will blink on the display
- To answer, press the LINE key (lower left) and scroll to new call.
- You can see the first line on the display go from solid to blinking

To go back to the first call

- Press the LINE key (lower left) and scroll to move between calls

To mute a call

- Press the left soft key labeled MUTE
- The MUTE soft key will blink and the display shows <Mute>

To make a call

- Simply enter all the digits you wish to dial
- Press the green TALK button

Voicemail

- Ask your system administrator to be sure the voicemail is enabled, and get the voicemail portal number and default password. For more information, contact client services
- The first time you call your voicemail, you need to set up a new password and record your spoken name. Simply follow the prompts

Redial

- Press the green Call to display the REDIAL soft key
- Use scroll key up/down to scroll through list to select desired number
- To call the last number dialed press the REDIAL soft key after selection

To put a call on hold

- Press the left HOLD/MSG key to place call on hold
- The display will read <Line on hold>
- To take line off hold, press HOLD/MSG key to resume call
- Hold only works on line 1. Line 2 call should be transferred

To pick up from hold

- Press the Left HOLD/MSG key to resume call

From your cordless Masergy phone

- Press HOLD/MSG or star 62 (*62) to call voice mail
- Enter your voicemail password followed by pound (#)
- Follow the prompts to retrieve your messages

To clear the new voicemail message on the display

- Press 7 after listening to your message to delete.

QUICK GUIDE - PANASONIC KX-TGP600

Transfer a call (Announced)

To transfer a call, while on the phone:

- Press the TRANSFER/CLEAR key
- Dial the extension or phone number you want to transfer the call to
- Press the CALL soft key
- When the second caller answers, tell them who is on the line
- Press the right soft key labeled TRANS to connect the two callers
- To return to the call before the transfer answers, press CANCEL soft key

Note: An announced transfer is recommended to some mobile phone providers. A blind transfer can sometimes go directly to mobile voice mail.

Transfer a call (Blind - Not Announced)

- To transfer a call while on the phone, press the BLIND soft key
- Dial the extension or phone number you want to transfer the call to
- Press the CALL soft key
- The call is transferred

Transfer a call to voicemail

To transfer a call directly to a voicemail while on a call

- Press the BLIND soft key
- Dial star 55 (*55) to enable the transferred call to go directly to voicemail
- Dial the extension where you want to send the call
- Press the CALL soft key to transfer the call into the person's voicemail box

Conference Call (Three-Way Calling)

To make a three-way call

- Press the FUNC (function) key during your call
- Scroll down or press 5 on the keypad for CONFERENCE
- Dial the extension or phone number you want to conference
- Press the CALL soft key

- When the second caller answers, tell them who is on the line.
- Press the soft key labeled CONF
- Everyone is together on a Three-Way Call. Your display will show <Conference>
- When you press OFF, both calls will disconnect

Call Park

Call Park is a “nonexclusive hold.” It puts a call on hold that can be picked up anywhere at the company. A call can be parked by anyone at any extension and then the call picked up from any extension.

Once a call has been parked your phone is free for other calls. You should use overhead paging or instant messaging to utilize Call Park most efficiently. Only one call can be parked at any extension. If the parked call has not been picked up after 50 seconds, the call will ring back to the phone from where the call was answered and parked. The 50 second timer is customizable.

To park a call

- Place current call on hold
- Press the FUNC/FUNCTION key
- Scroll down or press 9 on the keypad for Call Park or dial star 68 (*68) followed by the pound key (#)
- After hearing the operator prompt, dial the extension where you want to park the call and press the pound key (#) or press the pound key (#) to park the call on your extension
- Press the OFF button

Park Pickup (or to retrieve the call)

To pick up a parked a call

- Pick up any call parked at any extension while your phone is idle
- Dial star 88 (*88) and listen to the operator prompt
- Dial the extension where the call was parked followed by the pound key (#)
- If the call was parked on your extension, press the pound key (#) to immediately be connected to the call

QUICK GUIDE - PANASONIC KX-TGP600

Key Features

Adjust the Volume

While the phone is idle or ringing

- Scroll the MENU button up or down to adjust the volume of the ringer. Note that this adjustment will impact all future incoming calls
- To mute the ringer just for the current call or to make silent, press the * (asterisk) key on number pad (left of 0) and hold for 2 seconds
- In the display, an image of a bell with line through it will be shown. To unmute the ringer, repeat previous steps.

While on the handset, headset or speakerphone

- Scroll the MENU button up or down to adjust the listening volume

Change the Ring Type

- Press MENU button
- Scroll to SETTING icon
- Select INCOMING OPTIONS
- Scroll down to RINGER TYPE
- Select either the first option or name of user then select RINGER PATTERN
- Scroll through the over twenty choices to find the desired RINGER TONE
- Press the OK soft key
- Press the OFF button when finished

Missed Calls Alert

- Review the calls if you like by using the scroll bar up or down
- To delete missed calls, press the MENU soft key and choose to either "Delete" or "Delete All"
- Press the OFF key



QUICK GUIDE - PANASONIC KX-TGP600 Panasonic KX-A406 Repeater

The Panasonic KX-A406 is a small hardware add-on to the Panasonic KX-TGP600. It is designed to sync to the Panasonic KX-TGP 600 base unit and repeat the signal to up to 4 handsets outside the range of the base unit. The repeater doubles the range of the base unit for the handsets by adding an additional 50m range to the base unit. A total of three repeaters may be synced to the base unit in a “cascade” style setup, effectively quadrupling (200m) the range of the Panasonic KX- TGP 600 base unit for up to 4 handsets.

Each repeater must be purchased separately and in addition to the base unit.



Location of Controls

Below is the location of controls for the Panasonic KX-A406 repeater, an optional accessory.

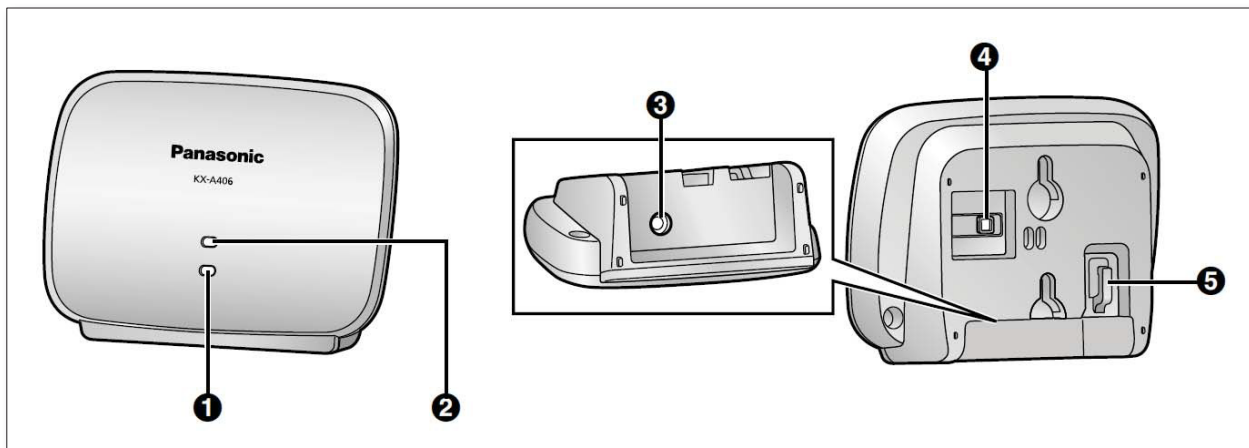

Overview

- A KX-A406 Repeater is used when you need to extend the wireless coverage of a KX-TGP600 to include areas where reception was previously not available.
- Up to 6 KX-A406 repeaters can be registered to one TGP600 main unit.
- Up to 3 repeaters can be arranged in cascade.
- Coverage will vary depending on the environment. Building structure can impact wireless coverage and penetration
- KX-TGP600 can support up to 8 simultaneous calls. Each KX-A406 repeater can support up to 4 simultaneous calls.
- Edge repeater in cascade configuration can support up to 4 simultaneous calls.

QUICK GUIDE - PANASONIC KX-TGP600

IMPORTANT: The maximum number of simultaneous calls defined above are supported when the TGP600 is configured in Narrowband mode. The number of simultaneous calls is reduced when the TGP600 is configured in Wideband mode.

See KX-TGP600 and KX-A406 Manuals for details. Visit www.Panasonic.net to obtain these manuals.

Configuration Examples

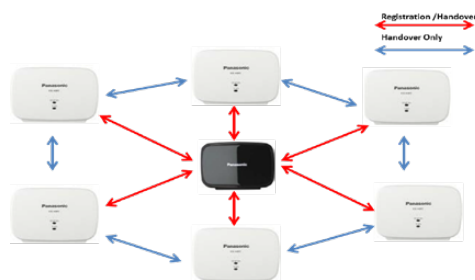

Additional Setup

Setting up a Repeater

A repeater is used when you need to extend the range of a handset to areas where reception was previously not available. A repeater extends the range in all directions, allowing several floors to be covered. You must register the repeater to the Panasonic KX-TGP600 base unit before the repeater can be used. Follow the instructions below to do this.

Enabling Repeater Mode through the Phone Menu

1. Pick up a handset registered to the Panasonic KX-TGP600 base unit from the charger.
2. Press the Menu softkey (middle softkey) at the bottom of the screen.
3. Select System Settings \rightarrow Repeater Mode \rightarrow On from the menu.

Enabling Repeater Mode through the Web Configuration Utility

Before a repeater can be registered to the Panasonic KX-TGP600 base unit, Repeater Mode must be enabled on the base unit. Follow the instructions below to do this.

QUICK GUIDE - PANASONIC KX-TGP600

1. From the main screen of a handset registered to the Panasonic TGP600, select **Menu ▶ Setting Handset ▶ Other Option ▶ Embedded Web ▶ On**.
2. On a handset registered to the Panasonic KX-TGP600, press the **MENU** softkey (middle softkey).
3. Select **System Settings** from the menu.
4. Select **Status ▶ IPv4 Settings ▶ IP Address** from the menu.
5. Record the IP address that appears on the screen.
6. Enter the IP address into the **address bar** of a web browser on your computer.
7. Enter **admin** as the **User Name** and **adminpass** as the Password.

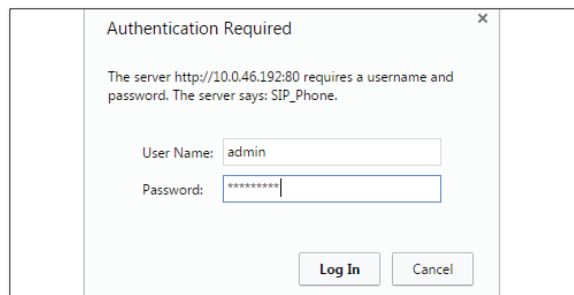

Log in to Phone interface

8. Click the **System** tab at the top of the screen

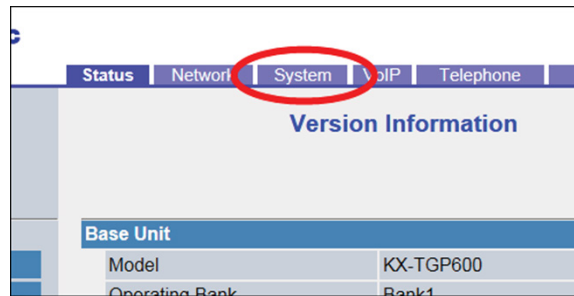

System Tab

9. Click **System Settings** on the left side of the screen

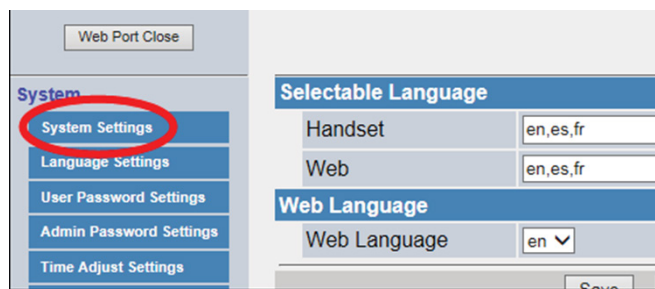

System Settings

QUICK GUIDE - PANASONIC KX-TGP600

10. Select the **Yes** radio button to the right of **Enable Repeater Mode**

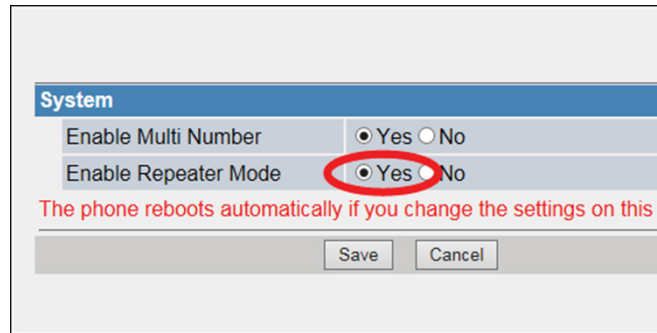

Enable Repeater Mode

11. Click **Save** at the bottom of the screen. The Panasonic KX-TGP600 base unit will reboot, after which Repeater Mode will be enabled

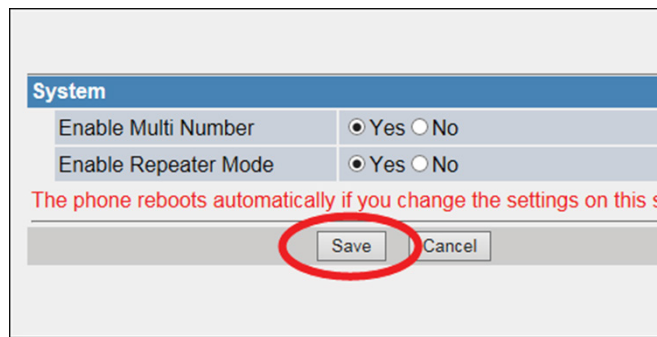

Registering the Repeater

After Repeater Mode has been enabled on the Panasonic KX-TGP600 base unit, you can register the Panasonic KX-A406 repeater to the base unit. Follow the instructions below to do this.

1. Disconnect the AC adapter from the repeater, if it is not already.
2. Press and hold the handset locator button on the base unit until the status indicator light flashes red, and then release the handset locator button.
3. Connect the AC adapter to the repeater.
4. When the status light on the repeater flashes red, press and hold the PROGRAM button on the back of the repeater until the status light and the RSSI/ID light turn solid green.
5. If the status light on the base unit is still flashing red, press the handset locator button once until the status light is solid green. The repeater is now ready for use.

QUICK GUIDE - PANASONIC KX-TGP600

Transferring a Call between Handsets

1. While on a call on the Panasonic KX-TPA60 handset, press the **MENU** softkey (middle softkey) at the bottom of the screen.
2. Press the **INT** softkey (right softkey) at the bottom of the screen.
3. **Select** the handset you want to transfer the call to. The person you were speaking to is put on hold while the handset you are transferring the call to rings.

NOTE: To cancel the transfer and return to the original party, press the **CANCEL** softkey (right softkey).

1. 1. When the second party is ready to take the call, press the **XFER/CLR** key to complete the transfer.

NOTE: Alternatively, you can press the red **POWER/CANCEL** key to complete the transfer.

More Help

Thank you for using Masergy. Should you need any assistance with anything in this guide or other services feel free to contact Masergy Support using the following options:

- Dial 611 from your Masergy phone
- 1-800-942-4700, Option 1
- ucsupport@masergy.com
- <http://www.masergy.com>

