

EPSON[®]
EXCEED YOUR VISION

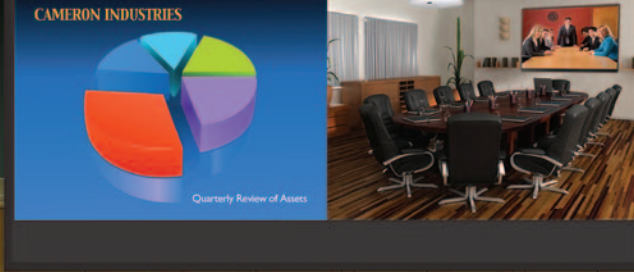

PowerLite[®] **D6155W** MULTIMEDIA PROJECTOR



Widescreen performance. Dust-resistant design. Cutting-edge technology.

Featuring widescreen resolution, a robust, dust-resistant design, advanced features and networking capabilities, the PowerLite D6155W is the perfect solution for lecture halls and corporate conference rooms alike. With its unprecedented exhaust vent shutter, dust-resistant design, cable locks and long filter/lamp life, the D6155W gives you added peace of mind that your investment will last longer. This innovative projector gives you the performance you want at a price that won't break your bottom line.

Robust design — dust-resistant body, 10000-hour recommended cleaning cycle¹ and up to 4000-hour lamp life² mean less down time and a low cost of ownership

Widescreen with bright images — true-to-life color with 3500 lumens of color and white light output³ and WXGA resolution

Cutting-edge technology — split-screen function; HDMI, USB, LAN and 2 VGA inputs plus optional wireless

Advanced networking features — remote monitor and control functions, message broadcasting and Crestron RoomView[®] enabled

Additional benefits — easy setup tools such as our innovative horizontal keystone correction and Quick Corner[®], built-in closed captioning, a 5 W speaker and more



PowerLite® D6155W MULTIMEDIA PROJECTOR

The best-selling projectors in the world.

Epson offers a wide range of high-quality projectors to meet most any need. Built with image quality and reliability in mind, Epson projectors enhance communication and inspire collaboration, while offering a low total cost of ownership. From ultraportable projectors designed for educational settings to boardroom-ready business projectors, Epson has the model made for you.



3LCD technology — for quality and color that's beyond amazing

- 3 chips for full-time, vibrant color
- 25% less electricity required per lumen of brightness when compared to 1-chip DLP projectors⁴
- Over 20 years of road-tested reliability built into every projector

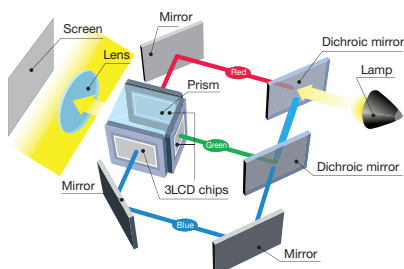

▲ 3LCD, 3-chip technology



Amazing color and white light output

The PowerLite D6155W delivers 3500 lumens of color light output and 3500 lumens of white light output³ for true-to-life, vibrant, colorful images. For today's color-rich, multimedia content, users want a projector that delivers both optimum white and color imagery. That's why the industry has developed a new metric called Color Light Output.



Always look for Color Light Output when choosing a projector

- For optimum image quality and performance, the projector you choose should offer equal levels of color and white light output
- When the two measurements are not identical, images do not look balanced. Whites may be brighter, making the colored areas look dull and flat
- The combination of color richness (color light output) and brightness (white light output) is as critical as the combination of bass and treble would be when purchasing audio equipment



Award-winning Faroudja DCDi Cinema for advanced video

The PowerLite D6155W features Faroudja DCDi[®] Cinema chipset, a video enhancement technology that produces exceptional image quality without introducing artifacts. Faroudja DCDi (Directional Correlational Deinterlacing) was developed to eliminate jagginess, using a unique algorithm. This technology, in combination with decoding, deinterlacing and enhancement technologies, won an Emmy Award from the National Academy of Television Arts and Sciences in 2001.



How is CLO measured?

The Color Light Output spec measures Red, Green and Blue, each on a 9-point grid, applying the same method used in the ISO 21118 standard for measuring White Light Output.

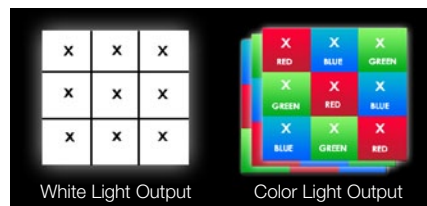

Better Products for a Better Future™

For more information on Epson's environmental programs, go to eco.epson.com

Eco Features

- Energy-efficient 3LCD light engine
- Energy-efficient E-TORL[®] lamp
- Low power consumption of 0.3 W in Standby Mode (network communication off)
- Designed to be recycled⁵
- RoHS compliant
- Epson America, Inc. is a SmartWaySM Transport Partner⁶



Robust design

Dust-resistant design to protect your investment

The PowerLite D6155W features an innovative design with a glass cover in front of the lens and dust-resistant seals around the lens levers, offering added protection against dust and reduced maintenance costs. It also features exhaust vent shutters for protection against dust or bugs when not in use. In addition, a cable cover is included to protect the cables and prevent anyone from tampering with them.



1 World's first vent shutter

Projectors typically don't have exhaust vent shutters, so dust and bugs can enter into the projector, reducing the life of the equipment. With the D6155W's vent shutter, your projector is protected.



2 Cable cover

The D6155W protects connectors from dust and other harmful elements with its convenient cable cover. And, it provides a sleek, finished look by hiding unsightly cables.



3 Two cable locks

For added security, the D6155W includes two cable locks that allow you to secure the power and HDMI cables to the projector, thereby preventing others from tampering with the equipment.



4 Long-life E-TORL lamp

The innovative E-TORL lamp lasts up to 4000 hours.² The special E-TORL design minimizes both light diffraction and light leakage, providing you the ultimate in lamp longevity.

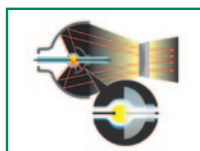

5 10000-hour high-efficiency filter

This high-efficiency filter was designed to protect the optical engine, lamp and electronics from small dust particles that can enter any projector. It has a recommended 10000-hour filter cleaning schedule¹ and can capture 99.5%⁷ of dust particles, thanks to its electrostatically charged, pleated, expanded design.



6 Enclosed lens

The glass cover in front of the lens protects it from being broken and from dust and other elements.



7 Lens lever cover with seal

Offering added protection from harmful elements, the D6155W offers a unique design, with no gaps around the focus and zoom levers.



Cutting-edge technology

Split-screen feature

Project two images (video or still) side-by-side from two different sources simultaneously. Choose from three layout options including a 50/50% split-screen, a layout with the main image on the left and a layout with the main image on the right. You can swap the images, choose the source for the audio and even display closed captioning if the source signal includes it.



Equal size layout option

HDMI for high-definition video and audio

- HDMI digital connectivity — delivers both audio and brilliant HD video content with just one cable
- Compatible with the latest laptops, Blu-ray® and media players
- Future proof for digital content

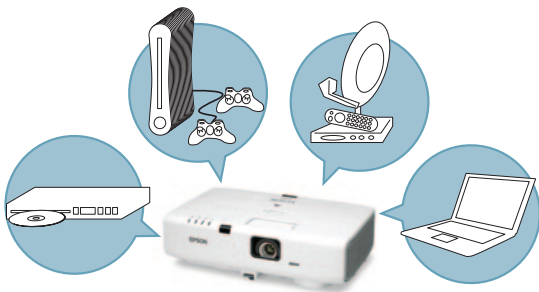

Optional wireless connectivity with 802.11n

- Quickly connect to a wireless infrastructure (network) via the wireless LAN module
- Make wireless presentations with an adhoc (peer-to-peer) wireless connection using the Quick Connect Key



Innovative horizontal keystone correction

- New, innovative horizontal keystone allows for unique positioning of the projector
- Horizontal (+/- 30 degrees) keystone correction for the ultimate in positioning flexibility
- Project images from a u-shaped tabletop, without having to move the table or put a stand in the center
- When the projector is placed off center, the presenter can stand in front of the screen without blocking the image

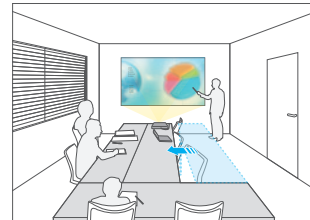
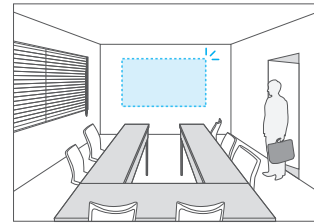

Without horizontal keystone

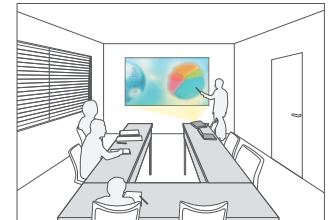

With horizontal keystone

Quick Corner

Fit the image to your screen perfectly. You can move any of the four corners of an image independently at setup, using the remote control to adjust each corner for a perfectly rectangular picture.



Before

After

1.6x optical zoom

- Enlarge images 40% more than competitive models that have 1.2x optical zoom
- Maximizes space by enabling closer positioning of the projector to the screen



Advanced networking and more

Monitor and control

Easily monitor and control up to 1024 networked Epson projectors using the RJ-45 connector and included EasyMP® software

- Schedule remote power on/off functionality; saves energy, money and time
- Check the status of each projector as part of your maintenance routine
- Access maintenance alerts for connected projectors, right from your office
- Crestron RoomView enabled — monitor and control your projector with RoomView software, without the need for an A/V control box



Network presentations

- Present in up to four rooms from one networked location
- Ideal for remote meetings and distance learning applications
- Use for multi-display configurations to create a panoramic image
- Also works wirelessly with the optional wireless LAN module

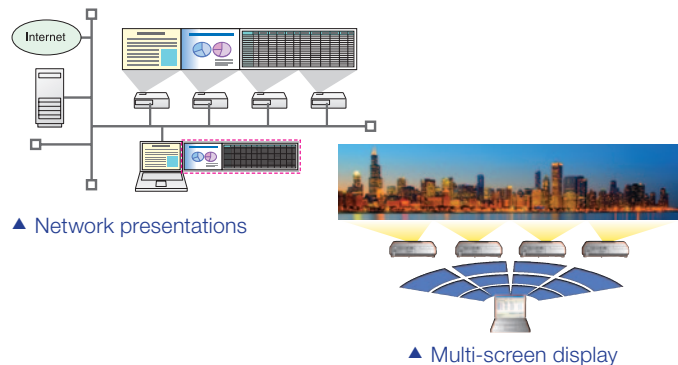

Message broadcasting

Broadcasts customized and scheduled alerts/messages over the network for announcements or instructions

- Sends messages to up to 1024 projectors at the same time
- Sends ordinary messages as JPEG files, so you can create slides/charts/images
- Create a slideshow by using multiple files within a folder

PowerLite D6155W multimedia projector

Added features

- **Built-in 5 W speaker** — engage your audience without the cost of external speakers
- **A/V Mute button** — pause your presentation; it's right at your fingertips
- **Sleep Mode** — set from 1 to 30 minutes to save energy when the A/V Mute Slide is closed or no signal is detected
- **Direct Power On/Off** — power the projector on and off with the flip of a wall switch

Dual computer inputs and a monitor output

The PowerLite D6155W features two computer VGA inputs and 3.5 mm audio connectors, which allow you to connect two computers at the same time and switch from one input to another. The monitor and audio output connectors will transfer the video and audio from the first computer, so you can connect an external monitor or a second projector and show the same image.

Built-in closed captioning



- **Essential for education** — helps meet ADA508 requirements for students with hearing impairments
- **Helps save money** — no need to pay for an additional decoder and its installation
- **Effective and easy to use** — easily enabled or disabled through the projector remote or menu



>>>Phase one projected to be early.

PowerLite® D6155W

Multimedia Projector

Product Name	Product Code	UPC
PowerLite D6155W	V11H396020	0 10343 88322 2
Genuine Epson Lamp	V13H010L64	0 10343 88384 0
Replacement Air Filter	V13H134A30	0 10343 88383 3

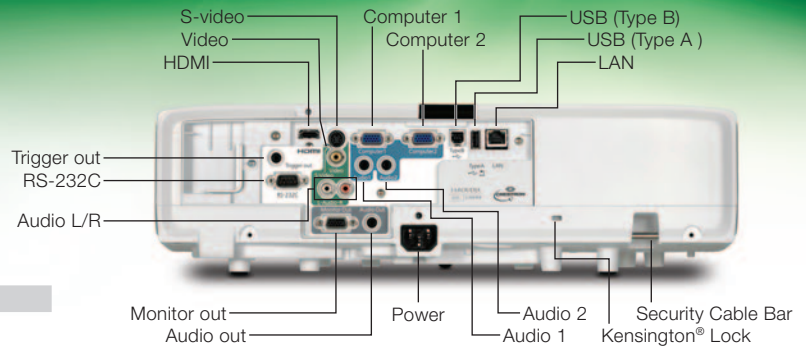

Specifications

Projection System

Epson 3LCD, 3-chip technology

Projection Method

Front/rear/ceiling mount

Driving Method

Epson Poly-silicon TFT Active Matrix

Pixel Number

1,024,000 pixel x 3 LCDs (1280 x 800)

Native Resolution

1280 x 800 (WXGA)

Aspect Ratio

16:10

Color Light Output³

3500 lumens

White Light Output³

3500 lumens (ISO 21118 standard)

Contrast Ratio

(High Brightness, Dynamic Mode)

2000:1

Brightness Uniformity (typical)

89%

Color Reproduction

16.7 million colors

Size (projected distance)

29" – 280"

Keystone Correction

Vertical: ± 30 degrees - manual

Horizontal: ± 30 degrees - manual

Lamp Type

275 W UHE E-TORL

Lamp Life²

3000 hours (Normal Mode)

4000 hours (ECO Mode)

Effective Scanning Frequency Range

Pixel Clock

13.5 MHz – 162 MHz (up to UXGA 60 Hz)

Horizontal

15 kHz – 92 kHz

Vertical

50 Hz – 85Hz

Video I/O

Display Performance

NTSC: 480 line

PAL: 576 line

(depends on the observation of the multi-burst pattern)

Input Signal

NTSC/NTSC4.43/PAL/M-PAL/N-PAL/

PAL60/SECAM

480i/576i/480p/576p/720p/1080i/1080p

Interfaces

HDMI x 1

Computer: D-sub 15 pin x 2

Monitor-out: D-sub 15 pin x 1

Video: RCA x 1

S-Video x 1

Network: RJ-45 x 1, 100 Mbps

Wireless LAN: Optional 802.11 a/b/g/n

Serial: RS-232c

USB: Type-A x 1, Type-B x 1

Audio-in: Mini stereo x 2

Audio-in: RCA (L and R)

Audio out: Mini stereo x 1

Trigger out: 3.5mm x 1

Projection Lens

Type

Powered focus/Manual zoom

F-number

1.51 – 1.99

Focal Length

18.2 mm – 29.2 mm

Zoom Ratio

Optical zoom 1.0 – 1.6

Throw Ratio Range

1.38 – 2.24

Other

Speaker

5 W (mono)

Operating Temperature

32° to 104° F (0° to 40° C)

Power Supply Voltage

100 – 240 V ± 10%, 50/60 Hz AC

Power Consumption

395 W (Normal Mode)

322 W (ECO Mode)

6.0 W Standby (Communication On)

0.29 W Standby (Communication Off)

Fan Noise

39 dB (Normal Mode)

33 dB (ECO Mode)

Security

Security cable hole, Kensington® lock provision

Dimensions (W x D x H)

Including feet: 17.72" x 10.78" x 5.16"

Excluding feet: 17.72" x 10.78" x 4.49"

Weight: 9.7 lb

Remote Control

Features

Power, input signal selection, computer, video, A/V mute, freeze, user, ID num, auto, aspect, color mode, page up and down, E-zoom, volume, help, menu, enter, esc and pointer functions

Operating Angle

Right/left:

Front: ± 60 degrees

Rear: ± 30 degrees

Upper/lower:

Front: +10 to +80 degrees

Rear: -10 to +70 degrees

Operating Distance

19.6 ft

Support

The Epson ConnectionSM

Pre-sales support

U.S. and Canada 800-463-7766

Internet website www.epson.com

Service Programs

Two-year limited warranty, Epson Road

Service program, PrivateLine® dedicated

toll-free support (U.S. and Canada only)

and 90-day limited lamp warranty

What's In The Box

PowerLite D6155W projector, power cable, computer cable (VGA), projector remote control with batteries, user manual CD, EasyMP software CD, password protection sticker, cable cover, cable locks (x2)

Accessory Part Numbers

Genuine Epson lamp	V13H010L64
Replacement air filter	V13H134A30
50" portable roll screen	ELPSC06
60" portable roll screen (4:3)	ELPSC27
80" portable roll screen (4:3)	ELPSC28
100" roll screen (4:3)	ELPSC29
53" magnet type screen (4:3)	ELPSC30
70" magnet type screen (16:10)	ELPSC31
80" magnet type screen (16:10)	ELPSC23
80" magnet type screen (16:10)	ELPSC24
90" magnet type screen (16:10)	ELPSC25
6' computer cable	ELPKC02
10' computer cable	ELPKC09
65' computer cable	ELPKC10
Component video cable	ELPKC19
HD-TV cable	ELPKC22
Ceiling mount	ELPMB23
Pipe 450 mm	ELPFP13
Pipe 700 mm	ELPFP14
Wireless LAN module	V12H418P12
Quick Connect Wireless USB key	V12H005M08
USB document camera	V12H321001
Ceiling mount speaker AP-60	V12H329020
Wireless mic unit	ELPMC01
DC-06 document camera	V12H377020
Interactive unit (wall type)	V12H415020

Packaging Specifications

PowerLite D6155W

Dimensions 19.53" x 21.46" x 10.4" (W x D x H)

Weight 16.84 lb

Genuine Epson Lamp

Dimensions 6.3" x 5.6" x 5.6" (W x D x H)

Weight 0.7 lb

Master Carton

Dimensions 28.4" x 13.1" x 6.8" (W x D x H)

Weight 9.5 lb

Units Per Master Carton 10

Replacement Air Filter

Dimensions 4.9" x 3.9" x 1.2" (W x D x H)

Weight 0.1 lb

Master Carton

Dimensions 12.7" x 5.2" x 4.6" (W x D x H)

Weight 1.1 lb

Units Per Master Carton 10

1 Recommendation based on normal room conditions. Cleaning requirements may vary depending on use, environment and other conditions. Cleaning intervals may be adjusted to accommodate the environment in which the projector is used.

2 Lamp life will vary depending upon mode selected, environmental conditions and usage. Lamp brightness decreases over time.

3 Color and white light output will vary depending on mode selected. White light output measured using ISO 21118 standard.

4 Data source: ProjectorCentral.com, Jan. 2011. Average of 1038 shipping models for which the manufacturers provided lumens and total power data, all resolutions and brightness levels.

5 See our website for convenient and reasonable recycling options at www.epson.com/recycle

6 SmartWay is an innovative partnership of the U.S. Environmental Protection Agency that reduces greenhouse gases and other air pollutants and improves fuel efficiency.

7 Tested with JIS Z 8901 Type 8 Dust (size: 6.6-8.6 micrometers, density: 2.9-3.1g/cm³) with wind speed = 0.25m/sec.