

# J

CHAPTER

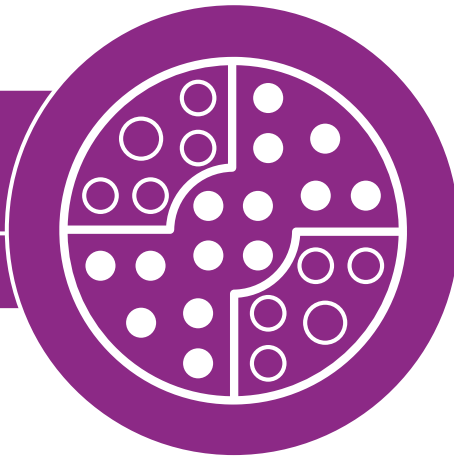

# FISCHER MINIMAX™ SERIES

HIGH-DENSITY MINIATURIZATION | HIGH-SPEED DATA TRANSFER | RELIABILITY

## KEY FEATURES

- Signal and Power
- Designed and tested to high-speed data transfer protocols
- IP68 sealed to-20m | 24h



MINIMAX

# MINIMAX



MINIMAX

## PLUGS



### CABLE MOUNTED

- Body styles (MP11-L/S/Q)..... J-7
- Technical dimensions ..... J-8
- Dimensions of overmolding..... J-9

## RECEPTACLES



### CABLE MOUNTED

- Body styles (MR50-L/S/Q) ..... J-10
- Technical dimensions ..... J-11
- Dimensions of overmolding..... J-9



### PANEL REAR MOUNTED

- Body styles ( MR11-L/S/Q; MR12-L/S/Q) ..... J-12
- Technical dimensions ..... J-13

## FOR ALL MINIMAX

- Features..... J-3
- Body styles & technical dimensions ..... J-7
- Electrical & contact configurations..... J-16
- Mechanical coding..... J-17
- PCB hole layout ..... J-18
- Part numbering..... J-22
- Accessories ..... J-23
- Tooling ..... J-25
- Technical information..... J-26

This catalog covers our standard connector solutions. For specific requests, including hybrid or custom connectors, please contact your local sales representative.

## HIGH-DENSITY MINIATURIZATION

- Unique combinations of signal and power
- Replace multiple large connectors with fewer and smaller ones
- Combine multiple protocols into one connector

### SIZE COMPARISON 1:1

#### SIZE 06, 08 AND 10

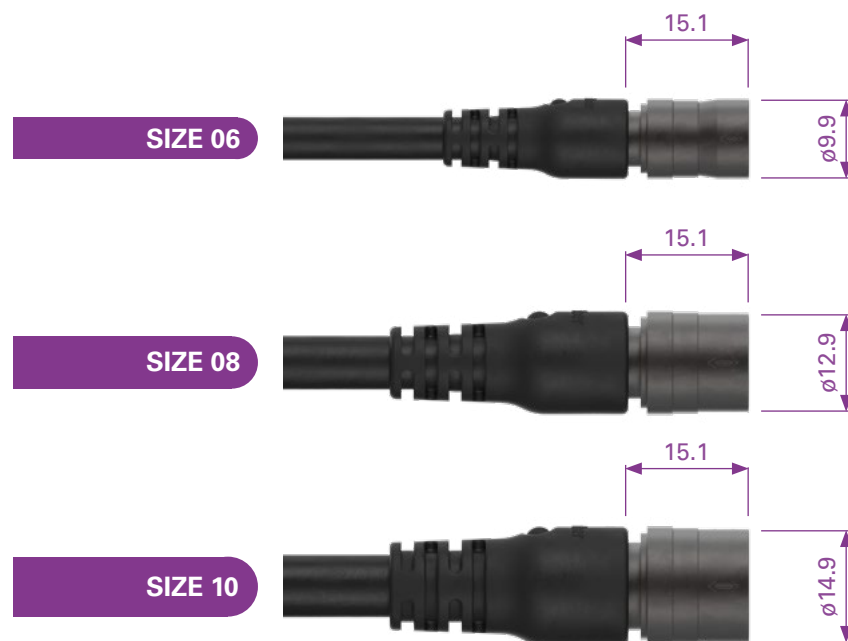

### UPTO 45% SMALLER

#### SIZE 08

COMPARED TO STANDARD RECEPTACLES WITH SIMILAR NUMBER OF CONTACTS



### UPTO 75% LIGHTER

#### SIZE 08

PLUGS & RECEPTACLES WEIGHT COMPARISON WITH SIMILAR NUMBER OF CONTACTS

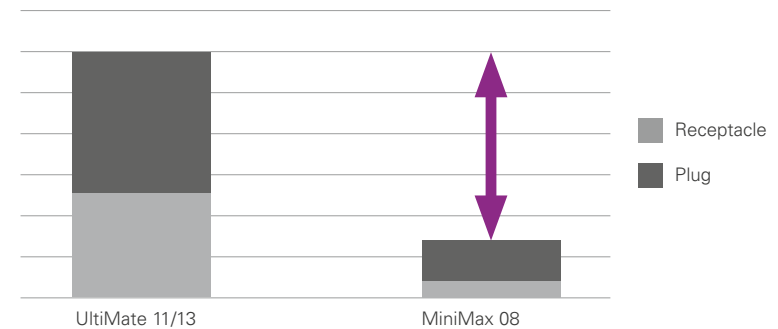

All dimensions and images shown are in millimeters and are for reference only.

# HIGH-SPEED DATA TRANSFER



		Size 06-4 pins	Size 06-7 pins	Size 06-12 pins	Size 08-8 pins	Size 08-09 pins	Size 08-19 pins	Size 08-19 pins	Size 08-24 pins	Size 10-12 pins	Size 10-30 pins
USB 2.0		YES	YES	YES	YES	YES	YES	-	YES	YES	YES
USB 3.2 GEN 1 (5 Gbit/s)		-	-	-	-	YES	-	-	-	YES	-
USB 3.2 GEN 2 (10 Gbit/s)		-	-	-	-	-	-	-	-	-	-
ETHERNET (10 Gbit/s)		-	-	YES*	YES	-	-	-	-	-	-
Standard audio/video protocol (10.2 Gbit/s)		-	-	-	-	-	YES*	YES	-	-	-
Standard audio/video protocol (18.0 Gbit/s)		-	-	-	-	-	-	YES	-	-	-
Single pair Ethernet (1 Gbit/s)		YES	-	-	-	-	-	-	-	-	-

\* Application dependent  
 Note that for USB 3.2 the full spec is set with 1 m cable

## ETHERNET SIZE 08 | 8 PINS

A unique robust and sealed miniature connector for Ethernet applications in harsh environments.

- AWG24, compatible with long range standard Ethernet cables
- Symmetrical hermaphroditic contact block
- 0.5 mm contacts

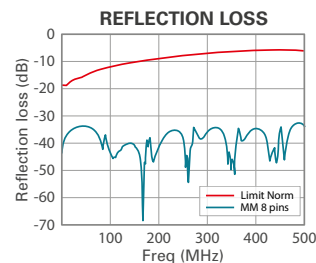

## USB 3.2 SIZE 08 | 9 PINS + SIZE 10 | 12 PINS

Optimized design for full USB 3.2 Gen 1 and Gen 2 performance, successfully tested to the full S-parameter standards with cables up to 1 m.

- Advanced power contacts
- Hermaphroditic contact block
- 0.5 mm contacts

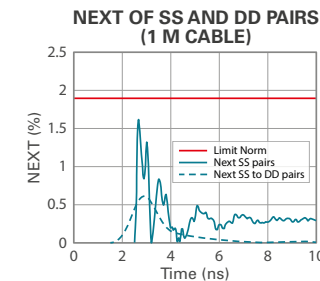
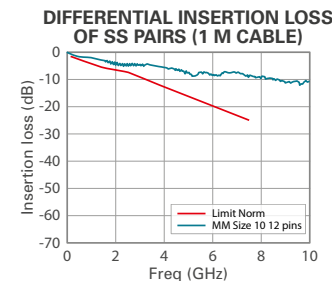



**RELIABILITY**

- IP68, -20m/24h\* water sealing  
   <math>10^{-6}</math> mbar l/s gas sealing
- 5,000 mating cycles
- 1,000 h salt mist spray

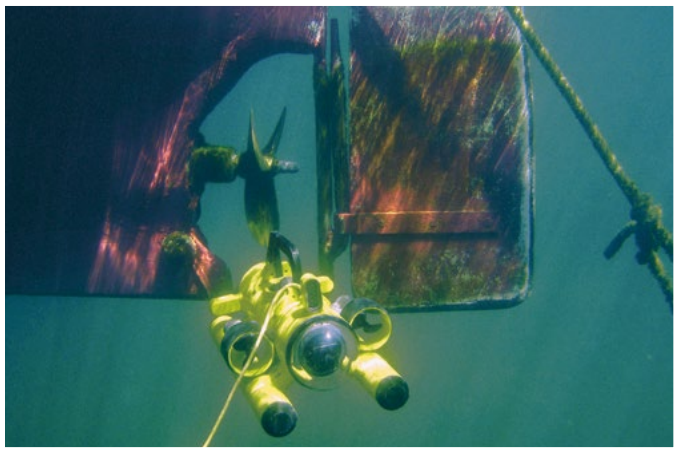

\*The standard sealing level can be achieved on all MiniMax panel mounted receptacles when correctly integrated.

For all cabled mounted connectors, the sealing level depends on the quality of the assembly process and the size and type of cable being used. For MiniMax, Fischer Connectors guarantees an IP64 cable assembly sealing as standard. Upon request, MiniMax cable assemblies with an IP68 sealing rating-20 m for a duration of 24 hours are available and might require additional testing.

MINIMAX

## HOUSING COLORS

MiniMax is available in two housing colors:  
**ANTHRACITE Nickel** and **BLACK Chrome**. <sup>1)</sup>

- Both color solutions are non-reflective and offer a discreet connector solution for military applications.
- The anthracite treatment offers an improved panel grounding of <5 mΩ as required by MIL specs.

**Anthracite**  
standard



**Black**  
optional



Ground contact connected to housing:  
 - Pin for PCB contact (P) versions  
 - Solder barrel for solder contact (S) versions

## CONTACT COMBINATIONS

The MiniMax contact block is specified by a combination of 4 digits:

- First digit indicates the number of advanced contacts for first mate / last break.
- Second digit indicates the number of larger contacts (and with larger solder cup) for power.
- Digits 3 and 4 are to be considered as one number and will indicate the number of remaining contacts (of standard size and not advanced).

MiniMax uses a hermaphroditic contact block for all configurations except for the 4-pin (2 power + 2 signal) and the 7-pin (3 power + 4 signal) in size 06.

For the 4-pin and 7-pin in size 06, a polarity choice<sup>2)</sup> has to be specified and the mating part will reflect an opposite polarity (F mating M; M mating F).

For clarity reasons, the 4-pin in size 06 with 2 power contacts that are also advanced is designated by the digits 0202 and not 2202. A designation by the digits 2202 may confusingly suggest it has 6 contacts instead of the actual 4.

The table on the right shows **all** available standard contact block combinations to help specify the correct product designation. (Also see page J-20).



Size	MR11 / MR12 / MR50	MP11
06	0202 xxFx	0202 xxMx
	0202 xxMx	0202 xxFx
	0304 xxFx	0304 xxMx
08	0210	0210
	0008	0008
	0009	2007
	0019	0019
	2017	
	0420 2418	0420
10	0309	2307
	0624	0624

Mates with

<sup>1)</sup> MR12 body style not available in BLACK. Please contact your local sales representative.

<sup>2)</sup> Size 06 7-pin configuration is receptacle with female contacts and plug with male contacts. For customization please contact your local sales representative.

**PLUGS**

<b>CABLE MOUNTED</b>					
<b>Body style</b>		<b>MP11-L</b>	<b>MP11-S</b>	<b>MP11-Q</b>	<b>References to detailed information</b>
<b>Protection</b>	<b>Sealed up to IP68</b>	●	●	●	Sealing categories, page A-6
	<b>Hermetic</b>				
<b>Locking system</b>	<b>Push-pull</b>	●			Electrical & contact configurations, page J-16
	<b>Quick-release</b>			●	
	<b>Screw</b>		●		
<b>Termination</b>	<b>Crimp contact</b>				Part numbering, page J-20
	<b>Solder contact</b>	●	●	●	
<b>Housing color</b>	<b>ANTHRACITE Nickel</b>	●	●	●	Body styles, chapter J
	<b>BLACK Chrome</b>	●	●	●	
<b>Design</b>	<b>Shortened body</b>				-
	<b>60° angle <sup>1)</sup></b>	●	●	●	
	<b>Straight</b>	●	●	●	
	<b>Right-angle <sup>1)</sup></b>	●	●	●	
<b>Cabling</b>	<b>Cable clamp sets</b>				Accessories, page J-21 and J-22
	<b>Overmoldable</b>	●	●	●	
	<b>Heat shrinkable</b>	●	●	●	
<b>Accessories</b>	<b>Cable bend reliefs <sup>1)</sup></b>	●	●	●	Technical dimensions, page J-8 and J-9 For more information visit our website <a href="http://www.fischerconnectors.com/technical">www.fischerconnectors.com/technical</a>
	<b>Protective sleeves</b>				
	<b>Sealing caps</b>	●	●	●	
<b>Size</b>	<b>06</b>	●	●	●	
	<b>08</b>	●	●	●	
	<b>10</b>	●		●	

<sup>1)</sup> Not available for size 10.

**PLUGS**

**CABLE MOUNTED**

**MP11-L / PUSH-PULL**

BODY STYLE

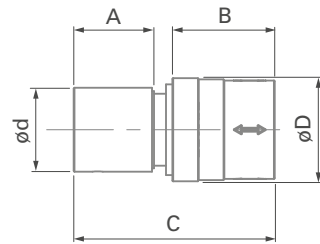

**MP11-Q / QUICK-RELEASE**

BODY STYLE

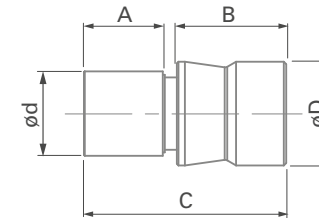

**MP11-S / SCREW-LOCKING**

BODY STYLE

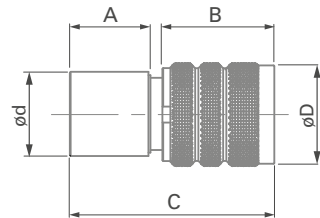

MINIMAX

Size	Locking	ød	øD	A	B	~ C
06	Push-pull	8.5	9.9	10.1	12.8	25
	Quick-release	8.5	9.9	10.1	13.6	25
	Screw	8.5	9.9	10.1	14.0	25
08	Push-pull	10.4	12.9	10.1	12.8	25
	Quick-release	10.4	12.9	10.1	13.6	25
	Screw	10.4	12.9	10.1	14.0	25
10	Push-pull	12.4	14.9	10.1	12.8	25
	Quick-release	12.4	14.9	10.1	13.6	25
	Screw	-	-	-	-	-



**DIMENSIONS OF OVERMOLDING<sup>1)</sup>**

**CABLE MOUNTED**

**MP11-L/S/Q – MR50-L/S/Q**

STRAIGHT OVERMOLDING

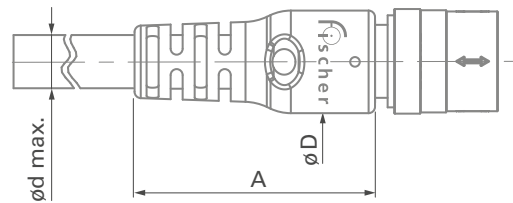

**MP11-L/S/Q**

RIGHT ANGLE & 60° OVERMOLDING

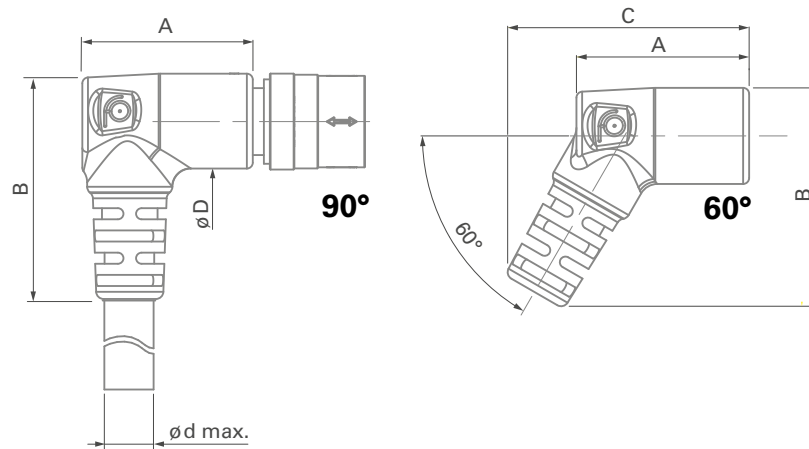

Size	Angle	$\varnothing d \text{ max.}$	$\varnothing D$	A	B	C
06	Straight	4.7 <sup>2)</sup>	10.8	30	-	-
	60°	4.7 <sup>2)</sup>	10.8	23	29.1	32.2
	90°	4.7 <sup>2)</sup>	10.8	23	30	-
08	Straight	6.7	12.8	30	-	-
	60°	6.7	12.8	23	29.1	32.2
	90°	6.7	12.8	23	30	-
10	Straight	8.7	14.8	30	-	-
	60°	-	-	-	-	-
	90°	-	-	-	-	-

<sup>2)</sup> 5.8 for MiniMax size 06 with 7 contacts.

**8 POSITIONS**

ORIENTATION PARALLEL TO PANEL

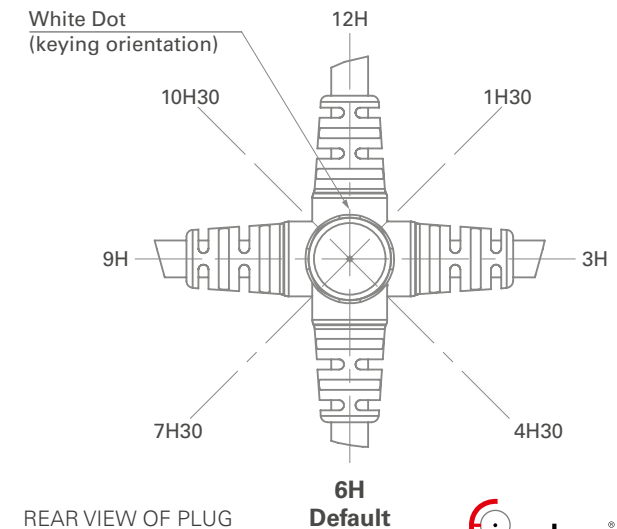

REAR VIEW OF PLUG

**6H Default**



<sup>1)</sup> Overmolding available on request. Contact your Fischer Connectors sales representative for details.

All dimensions and images shown are in millimeters and are for reference only.

## RECEPTACLES

### CABLE MOUNTED



Body style		MR50-L	MR50-S	MR50-Q	References to detailed information
Protection	Sealed up to IP68	●	●	●	Sealing categories, page A-6
	Hermetic				
Locking system	Push-pull	●			
	Quick-release			●	
	Screw		●		
Termination	Crimp contact				Electrical & contact configurations, page J-16
	Solder contact	●	●	●	
Housing	ANTHRACITE Nickel	●	●	●	Part numbering, page J-20
	BLACK Chrome	●	●	●	
Design	Shortened body				Body styles, chapter J
	60° angle				
	Straight	●	●	●	
	Right-angle				
Cabling	Cable clamp sets				-
	Overmoldable	●	●	●	
	Heat shrinkable	●	●	●	
Accessories	Cable bend reliefs	●	●	●	Accessories, page J-21 and J-22
	Protective sleeves				
	Sealing caps	●	●	●	
Size	06	●	●	●	Technical dimensions, page J-11 For more information visit our website <a href="http://www.fischerconnectors.com/technical">www.fischerconnectors.com/technical</a>
	08	●	●	●	
	10				

**RECEPTACLES**

**CABLE MOUNTED**

**MR50-L / PUSH-PULL**

BODY STYLE

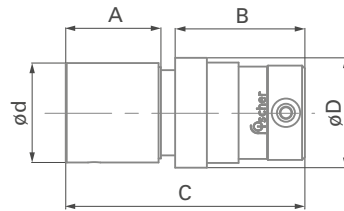

**MR50-Q / QUICK-RELEASE**

BODY STYLE

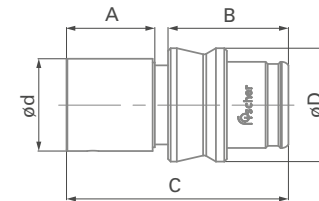

**MR50-S / SCREW-LOCKING**

BODY STYLE

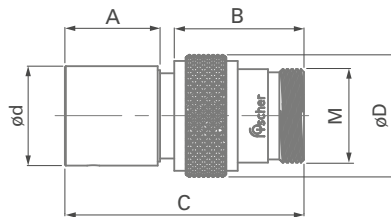

Size	Locking	ød	øD	A	B	~ C	M
06	Push-pull	8.5	9.9	10.1	13.7	25	-
	Quick-release	8.5	9.9	10.1	13.7	25	-
	Screw	8.5	9.9	10.1	13.7	25	M8x2
08	Push-pull	10.5	11.6	10.1	13.7	25	-
	Quick-release	10.5	12.9	10.1	13.7	25	-
	Screw	10.5	12.9	10.1	13.7	25	M10x2
10	Push-pull	-	-	-	-	-	-
	Quick-release	-	-	-	-	-	-
	Screw	-	-	-	-	-	-

All dimensions and images shown are in millimeters and are for reference only.

**RECEPTACLES**

**PANEL MOUNTED**



Body style		MR11-L	MR11-S	MR11-Q	MR12-L	MR12-S	MR12-Q	References to detailed information
Protection	Sealed up to IP68	●	●	●	●	●	●	Sealing categories, page A-6
	Hermetic							
Termination	Crimp contact							Electrical & contact configurations, page J-16
	Solder contact	●	●	●	●	●	●	
	PCB contact	●	●	●	●	●	●	
Housing color	ANTHRACITE Nickel	●	●	●	●	●	●	Part numbering, page J-20
	BLACK Chrome	●	●	●				
Design	Right-angle							Body styles, chapter J
	Flush							
	Front-projecting	●	●	●	●	●	●	
	Bulkhead feedthrough							
Assembly	Front-mounting							
	Rear-mounting	●	●	●	●	●	●	
Accessories	Sealing caps	●	●	●	●	●	●	Accessories, page J-21 and J-22
	Spacers							
	Color-coded washers							
	Grounding washers							
	Locking washers							
Size	06	●	●	●	●	●	●	Technical dimensions, page J-13 to J-15 For more information visit our website <a href="http://www.fischerconnectors.com/technical">www.fischerconnectors.com/technical</a>
	08	●	●	●	●	●	●	
	10	●		●				

MINIMAX

**RECEPTACLES**

**PANEL REAR MOUNTED**

**MR11-L / PUSH-PULL**

BODY STYLE

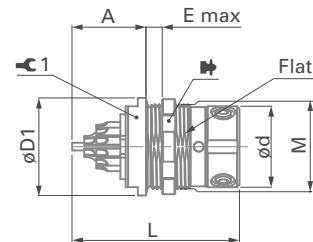

SOLDER

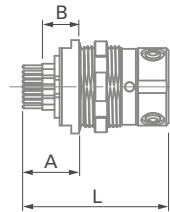

PCB

**MR12-L / PUSH-PULL**

BODY STYLE

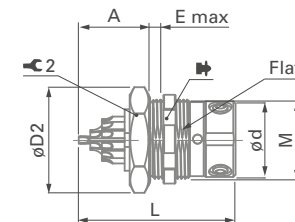

SOLDER

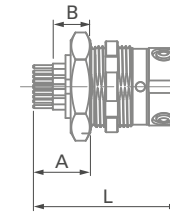

PCB

PANEL CUT-OUT

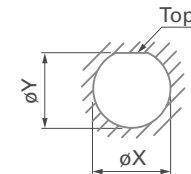

Size	Locking	Termination	ød	øD1	øD2	A	B	L	E max	M Panel thread	1	2	Torque
06	Push-pull	Solder contact	8.0	10.0	11.4	7.6	-	19.1	3.0	M8.5x0.35	8	10	1.0 Nm
		PCB contact	8.0	10.0	11.4	7.3	4.7	18.8	3.0	M8.5x0.35	8	10	1.0 Nm
08	Push-pull	Solder contact	10.0	12.0	13.7	9.1	-	20.6	3.0	M10.5x0.5	10	12	1.5 Nm
		PCB contact	10.0	12.0	13.7	7.3	4.7	18.8	3.0	M10.5x0.5	10	12	1.5 Nm
10	Push-pull	Solder contact	12.0	14.0	-	7.6	-	19.1	3.0	M12.5x0.5	12	-	2.0 Nm
		PCB contact	12.0	14.0	-	7.3	4.7	18.8	3.0	M12.5x0.5	12	-	2.0 Nm

Size	øX	øY
06	8.58 +0.1/0	8.25 +0.1/0
08	10.45 +0.1/0	10.2 +0.1/0
10	12.45 +0.1/0	12.2 +0.1/0

All dimensions and images shown are in millimeters and are for reference only.

**RECEPTACLES**

**PANEL REAR MOUNTED**

**MR11-Q / QUICK-RELEASE**

BODY STYLE

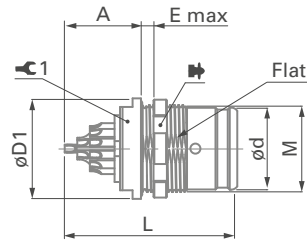

SOLDER

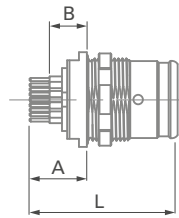

PCB

**MR12-Q / QUICK-RELEASE**

BODY STYLE

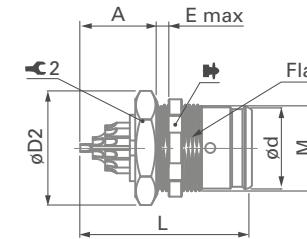

SOLDER

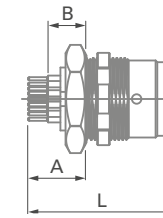

PCB

PANEL CUT-OUT

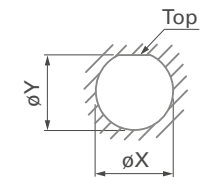

Size	Locking	Termination	ød	øD1	øD2	A	B	L	E max	M Panel thread	C 1	C 2	Torque
06	Quick-release	Solder contact	7.8	10.0	11.4	7.6	-	19.1	3.0	M8.5x0.35	8	10	1.0 Nm
		PCB contact	7.8	10.0	11.4	7.3	4.7	18.8	3.0	M8.5x0.35	8	10	1.0 Nm
08	Quick-release	Solder contact	9.8	12.0	13.7	9.1	-	20.6	3.0	M10.5x0.5	10	12	1.5 Nm
		PCB contact	9.8	12.0	13.7	7.3	4.7	18.8	3.0	M10.5x0.5	10	12	1.5 Nm
10	Quick-release	Solder contact	11.8	14.0	-	7.6	-	19.1	3.0	M12.5x0.5	12	-	2.0 Nm
		PCB contact	11.8	14.0	-	7.3	4.7	18.8	3.0	M12.5x0.5	12	-	2.0 Nm

Size	X	Y
06	8.58 +0.1/0	8.25 +0.1/0
08	10.45 +0.1/0	10.2 +0.1/0
10	12.45 +0.1/0	12.2 +0.1/0



**RECEPTACLES**

**PANEL REAR MOUNTED**

**MR11-S / SCREW-LOCKING**

BODY STYLE

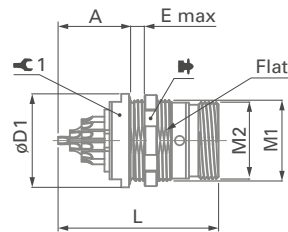

SOLDER

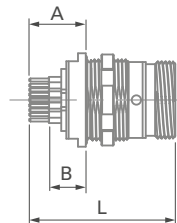

PCB

**MR12-S / SCREW-LOCKING**

BODY STYLE

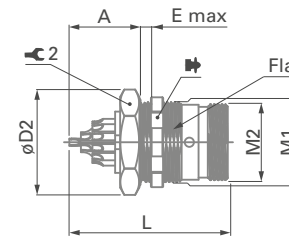

SOLDER

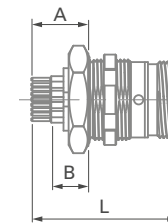

PCB





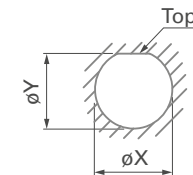







Size	Locking	Termination	$\phi D1$	$\phi D2$	A	B	L	E max	M1 Panel thread	M2 Locking thread	$\hookrightarrow 1$	$\hookrightarrow 2$	Torque
06	Screw	Solder contact	10.0	11.4	7.6	N/A	19.1	2.3	M8.5x0.35	M8x2	8	10	1.0 Nm
		PCB contact	10.0	11.4	7.3	4.7	18.8	2.3	M8.5x0.35	M8x2	8	10	1.0 Nm
08	Screw	Solder contact	12.0	13.7	9.1	-	20.6	2.3	M10.5x0.5	M10x2	10	12	1.5 Nm
		PCB contact	12.0	13.7	7.3	4.7	18.8	2.3	M10.5x0.5	M10x2	10	12	1.5 Nm
10	Screw	Solder contact	-	-	-	-	-	-	-	-	-	-	-
		PCB contact	-	-	-	-	-	-	-	-	-	-	-

PANEL CUT-OUT



Size	$\phi X$	$\phi Y$
06	8.58 +0.1/0	8.25 +0.1/0
08	10.45 +0.1/0	10.2 +0.1/0
10	-	-

All dimensions and images shown are in millimeters and are for reference only.

Size	Pin layout	Number of contacts	Contact diameter [mm]	Wire size <sup>1)</sup>		PCB contacts	Current [A]	Rated voltage r.m.s [V]	Test voltage [kV] in mated position			
				Solder contacts		Pin diameter [mm]	IEC 60512-5-2-5b <sup>2)</sup>		IEC 60664-1 <sup>3)</sup>	IEC 60512-4-1 test 4a		
								AC r.m.s.		DC		
								Contact to body		Contact to contact	Contact to body	Contact to contact
06	 <sup>8)</sup>	4	2	0.5	Max ø0.70 mm – AWG24 [19/36]	0.4	1.0	≤200	1.4	1.2	2.3	1.9
			2	1.3	Max ø1.33 mm – AWG18 [19/30]	0.7	10					
		7	4	0.5	Max ø0.70 mm – AWG24 [19/36]	0.4	0.02 (2x) + 1.5 (2x)	≤160	1.0	1.2	2.0	1.7
			3	0.7	Max ø0.90 mm – AWG22 [19/34]	0.5						
		12	10	0.5	Max ø0.43 mm – AWG28 [19/40]	0.4	1.0	≤50	0.9	0.9	1.5	1.2
			2	0.5	Max ø0.70 mm – AWG24 [19/36]	0.4	5.0					
08	 ETHERNET	8	0.5	Max ø0.70 mm – AWG24 [19/36]	0.4	3.8	≤320	1.6	1.6	2.2	2.2	
	 USB 3.2	9	7	0.5	Max ø0.43 mm – AWG28 [19/40]	0.4	1.0	≤250	1.5	1.2	2.4	1.8
			2 <sup>5)</sup>	0.5	Max ø0.70 mm – AWG24 [19/36]	0.4	5.0					
		19	15	0.5	Max ø0.70 mm – AWG24 [19/36]	0.4	1.0	≤100	0.9	0.9	1.5	1.2
			4	0.5	Max ø0.70 mm – AWG24 [19/36]	0.4	5.0					
		19	13+2 <sup>4)</sup>	0.5	Max ø0.70 mm – AWG24 [19/36]	0.4	1.0	≤100	0.9	0.9	1.5	1.2
			4	0.5	Max ø0.70 mm – AWG24 [19/36]	0.4	5.0					
		19H	12	0.5	Max ø0.55 mm – AWG26 [19/38]	0.4	1.5 <sup>10)</sup>	≤125	1.0	1.0	1.8	1.8
			7	0.5	Max ø0.43 mm – AWG28 [19/40]	0.4						
		24	20	0.5	Max ø0.43 mm – AWG28 [19/40]	0.4	1.0	≤63	0.9	0.9	1.5	1.2
4			0.5	Max ø0.70 mm – AWG24 [19/36]	0.4	5.0						
	24	18+2 <sup>4)</sup>	0.5	Max ø0.43 mm – AWG28 [19/40]	0.4	1.0	≤63	0.9	0.9	1.5	1.2	
		4	0.5	Max ø0.70 mm – AWG24 [19/36]	0.4	5.0						
10	 USB 3.2	12	7	0.5	Max ø0.43 mm – AWG28 [19/40]	0.4	0.02	≤250	1.7	1.5	2.3	2.0
			2 <sup>5)</sup>	0.5	Max ø0.70 mm – AWG24 [19/36]	0.4	3.0					
		3	0.9	Max ø1.03 mm – AWG20 [26/34]	0.7	8.0	-		2.0 <sup>6)</sup>	-	2.7 <sup>6)</sup>	
		24	0.5	Max ø0.43 mm – AWG28 [19/40]	0.4	1.0						
		30	6	0.5	Max ø0.70 mm – AWG24 [19/36]	0.4	5.0	≤160	1.2	1.0	1.9	1.7

<sup>1)</sup> Stranding values in brackets.

<sup>2)</sup> Current per contact at 40 °C temperature rise measured on the basic curve according to IEC 60512-5-2-5b. For the max. operating current a reduction factor must be used and limitations due to the size of the wires and the permissible upper temperature limit of the materials employed must be taken into account. See page A-12 for details.

<sup>3)</sup> Recommended operating voltage at sea level. This rated voltage is a general guideline where no other electrical safety standard applies. In

cases where other standards rule a specific use of the connector, the application-specific safety criteria shall be considered first. This must be evaluated in the framework of equipment engineering.

<sup>4)</sup> Two advanced signal contacts for USB power are available for Solder (S) or PCB (P) receptacles.

<sup>5)</sup> USB 3.2 contact blocks come with two advanced power contacts on the plug side (MP11) as standard (size 08 plug 9-pin contact block 2007 and size 10 plug 12-pin contact block 2307).

<sup>6)</sup> Test voltage between contacts 0.9 and contacts 0.5 for configuration MiniMax size 10 2307/0309.

<sup>7)</sup> Test voltage between contacts 0.7 and contacts 0.5 for configuration MiniMax size 06 0304.

<sup>8)</sup> Contacts 0.7mm suitable for SPE data protocol 1 Gbit/s.

<sup>9)</sup> Layout dedicated to 4K UHD Audio/Video Protocol 18.0 Gbit/s.









<sup>10)</sup> Current of 1.4 A at a maximum temperature rise of 30 °C according to UHD specifications.









**MECHANICAL AND VISUAL CODING**









The mechanical coding for MiniMax is available as standard in 4 different variants : code 1, 2, 3, 4.

When size, body type, configuration and code matches the plug and receptacle will mate by aligning the exterior white marks (coding guide).

For additional differentiation, the odd codes are visually identified by a beige contact block while the even codes will vary with a black insulator.

PLUGS	Size 06			
	Code 1	Code 2	Code 3	Code 4
				
Visual coding				

PLUGS	Size 08			
	Code 1	Code 2	Code 3	Code 4
				
Visual coding				

PLUGS	Size 10			
	Code 1	Code 2	Code 3	Code 4
				
Visual coding				

MINIMAX

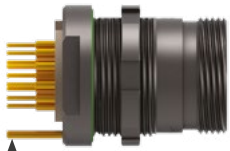

Ground contact connected to housing:  
 - Pin for PCB contact (P) versions  
 - Solder barrel for solder contact (S) versions

**Recommended wiring**

Size	06			08			10
	2+2	3+4	12	8	19	24	30
<b>Configuration</b>	2+2	3+4	12	8	19	24	30
<b>Power</b>	2; 4	5; 6; 7	5; 9	any2	9; 12; 15; 18 <sup>1)</sup>	14; 17; 20; 23	14; 17; 20; 23; 26; 29
<b>Ethernet</b>	-	-	1/6; 3/10; 7/8; 11/12 <sup>1)</sup>	1/2; 3/4; 5/6; 7/8 <sup>1)</sup>	8/19; 10/11; 13/14; 16/17 <sup>1)</sup>	15/16; 18/19; 21/22; 13/24 <sup>1)</sup>	Any other <sup>1)</sup>
<b>Advanced pin</b>	2; 4	-	-	-	13; 19 <sup>2)</sup>	18; 24 <sup>2)</sup>	-

<sup>1)</sup> Recommended

<sup>2)</sup> Optional on MR11 / MR12

**USB Signal name <sup>3)</sup>**

**Size 08, configuration 9 contacts**

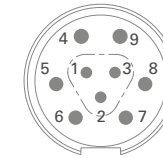

- |               |             |
|---------------|-------------|
| 1) USB 2.0 D- | 5) SS TX+   |
| 2) SS drain   | 6) SS TX-   |
| 3) USB 2.0 D+ | 7) SS RX+   |
| 4) Vbus 5 V   | 8) SS RX-   |
|               | 9) Vbus GND |

**UHD 18.0 Gbit/s protocol**

**Size 08, configuration 19 contacts**

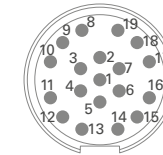

- |                          |                          |
|--------------------------|--------------------------|
| 1) +5 Power              | 11) TMDS data 1-         |
| 2) DDC/CEC Ground        | 12) TMDS data 0 shield   |
| 3) Utility               | 13) TMDS data 0+         |
| 4) Hot plug detect       | 14) TMDS data 0- shield  |
| 5) SDA                   | 15) TMDS data CLK shield |
| 6) SCL                   | 16) TMDS data CLK +      |
| 7) CEC (delayed contact) | 17) TMDS data CLK -      |
| 8) TMDS data 2-          | 18) TMDS data 2 shield   |
| 9) TMDS data 1 shield    | 19) TMDS data 2+         |
| 10) TMDS data 1+         |                          |

**Size 10, configuration 12 contacts**

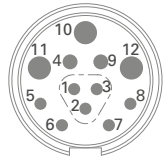

- |               |             |
|---------------|-------------|
| 1) USB 2.0 D- | 7) SS RX+   |
| 2) SS drain   | 8) SS RX-   |
| 3) USB 2.0 D+ | 9) Vbus GND |
| 4) Vbus 5 V   | 10) Power   |
| 5) SS TX+     | 11) Power   |
| 6) SS TX-     | 12) Power   |

<sup>3)</sup> RXTX labelling of Fischer Rugged Flash Drive. The RX of one device must always connect to the TX of the other device and vice versa.

View from the back of the plug/front of receptacle (guide mark at 12 o'clock)

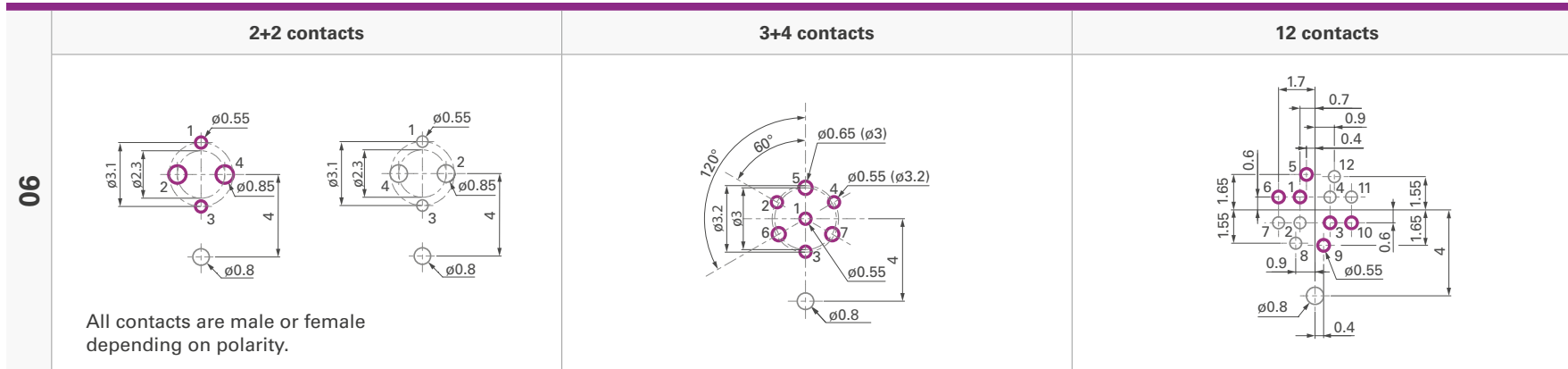

	Contacts	
	Plugs	Receptacles
○	Male	Female
○	Female	Male

MINIMAX

View from the back of the plug/front of receptacle (guide mark at 12 o'clock)

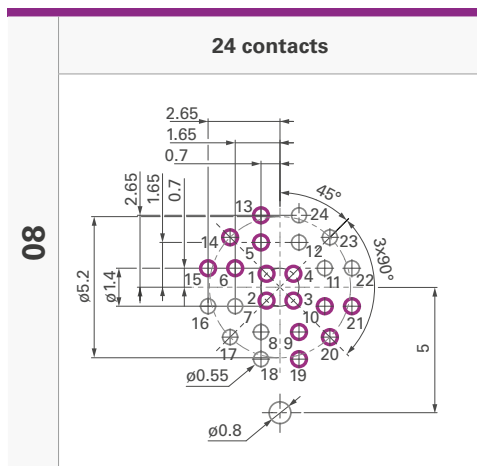
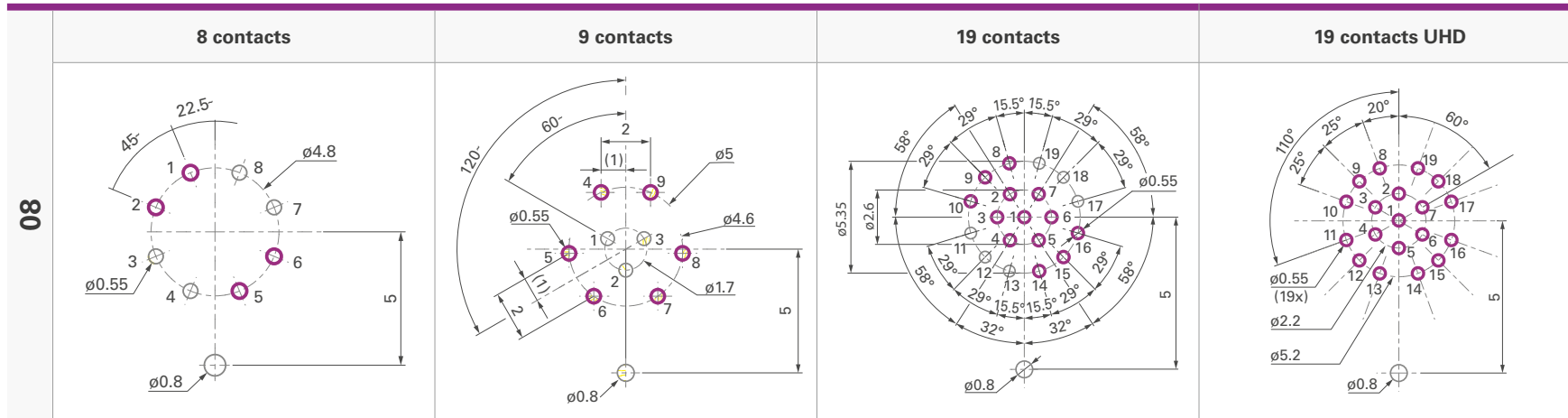

Contacts		
	Plugs	Receptacles
	Male	Female
	Female	Male



# PCB hole layout

View from the back of the plug/front of receptacle (guide mark at 12 o'clock)

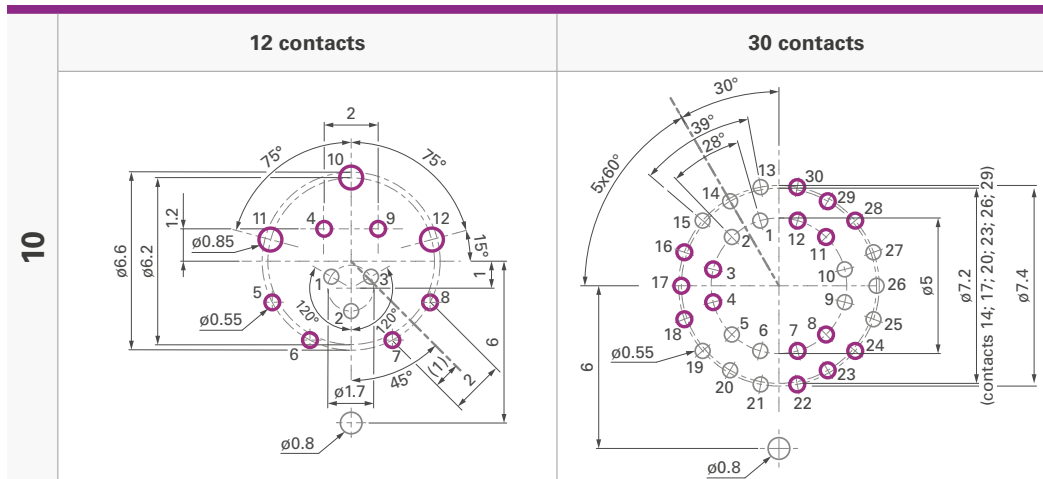

Contacts		
	Plugs	Receptacles
○	Male	Female
○	Female	Male

MINIMAX

# PLUGS & RECEPTACLES

Example:	Connector design				Contact block	Housing		Standard options			
	MP11	Z	L	08	0420	BK	1	Z	1	A	S
	MR11	W	S	08	2017	BK	2	E	1	A	P
	MR50	Z	Q	08	0019	BK	4	E	1	A	S



**Body style**

**MiniMax plug = MP**

- MP11 = Cable mounted

**MiniMax receptacle = MR**

- MR11 = Panel mounted
- MR12 = Panel mounted
- MR50 = Cable mounted

---

**Sealing level**

**MP11, MR50**

- Z = not applicable

**MR11, MR12**

- W = water sealing (IP68)

---

**Locking system**

**MiniMax plug & receptacle**

- L = Push-pull locking
- S = Screw-locking
- Q = Quick-release

---

**Connector size**

- 06 = Size 6
- 08 = Size 8
- 10 = Size 10

---

**Number of contacts (see page J-6)**

- Digit 1 = Advanced contacts (if applicable)
- Digit 2 = Power contacts (where physically larger than the other contacts)
- Digit 3+4 = Remaining contacts

**Termination**

**MP11, MR50**

- S = Solder contact

**MR11, MR12**

- P = PCB contact
- S = Solder contact

---

**Contact bloc**

- A = Hermaphroditic (both MR and MP need to be "A")
- F\* = Female contacts
- M\* = Male contacts

\* only for size 06 configuration 0202 and 0304<sup>2)</sup>  
(if MR = "F" then MP = "M"; if MR = "M" then MP = "F")

---

**Insulating material**

- 1 = PEEK

---

**Interface O-ring material**

**MP11**

- Z = Not applicable

**MR11, MR12, MR50**

- E = EPDM

---

**Keying code**

- 1 = Code 1 (insulator= Beige)
- 2 = Code 2 (insulator= Black)
- 3 = Code 3 (insulator= Beige)
- 4 = Code 4 (insulator= Black)

---

**Housing color**

- AN = Anthracite
- BK = Black<sup>1)</sup>

<sup>1)</sup> MR12 body style not available in Black (BK). Please contact your local sales representative.

<sup>2)</sup> Configuration 0304 is standard with F for receptacle and M for plug. For customization please contact your local sales representative.

**SOFT CAPS**

**CABLE MOUNTED**

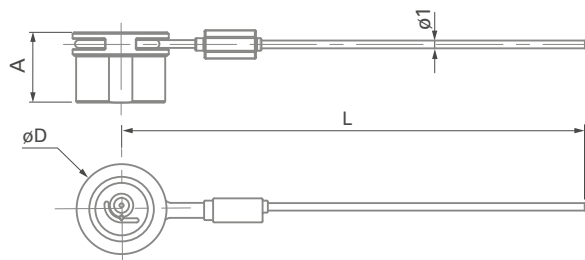
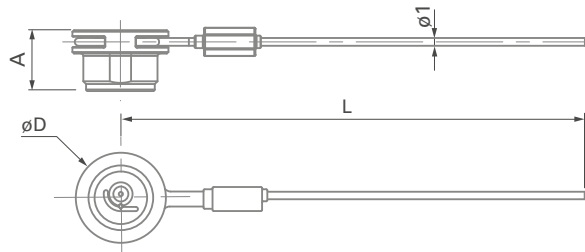

**PANEL MOUNTED**

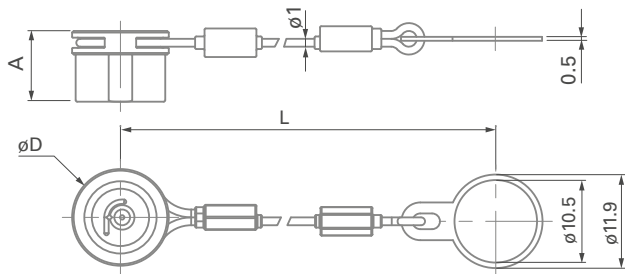

Size	Body style	Images	Push-pull	Quick-release	Screw-lock	A	øD	L	Part number
06	MP11 <sup>1)</sup>		●			9.6	10.0	200	MCP06C 1B2 A200 AA
				●	●	7.8	10.0	200	MCP06C 1B2 A200 BA
08			●			9.6	12.3	200	MCP08C 1B2 A200 AA
				●	●	7.8	12.3	200	MCP08C 1B2 A200 BA
10			●		-	9.6	14.3	200	MCP10C 1B2 A200 AA
				●	-	7.8	14.3	200	MCP10C 1B2 A200 BA
06	MR50 <sup>1)</sup>		●	●	●	9.0	10.0	200	MCR06C 1B2 A200 AA
08			●	●	●	9.0	12.3	200	MCR08C 1B2 A200 AA
10			-	-	-	-	-	-	-

<sup>1)</sup>Crimp ferrule and heat shrink tube are included.

Size	Body style	Images	Push-pull	Quick-release	Screw-lock	A	øD	L	ød1	ød2	Part number
06	MR11 <sup>1)</sup> MR12 <sup>1)</sup>		●	●	●	9.0	10.0	95	8.5	9.9	MCR06P 1B2 A095 AA
08			●	●	●	9.0	12.3	95	10.5	11.9	MCR08P 1B2 A095 AA
10			●	●	-	9.0	14.3	95	12.6	13.9	MCR10P 1B2 A095 AA

<sup>1)</sup>Crimp ferrule, heat shrink tube and mounting ring are included.

All dimensions and images shown are in millimeters and are for reference only.

To avoid getting debris into the caps when the connectors are mated, please mate the caps together. Please make sure that the cap is in place when the plug or the receptacle is in unmated position.

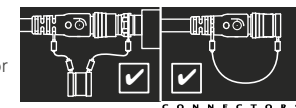

## STRAIGHT BEND RELIEF

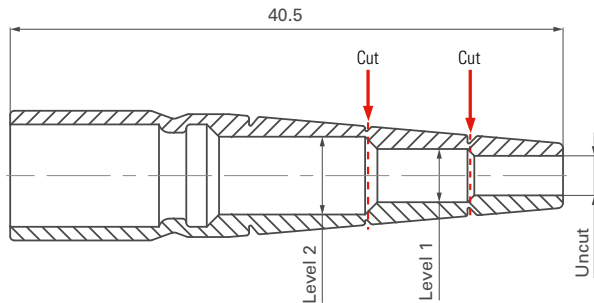

### CUTTING DIAMETERS

Size	Uncut	Level 1	Level 2	Part Number
06	ø2.9	ø3.9	ø5.7	MB06 A1BK
08	ø3.9	ø5.4	ø6.7	MB08 A1BK
10	-	-	-	-

## PC-BOARD TERMINATION



- Rigid flex solution available for SMD connectors
- Compatible with signal & power
- Available for 19 & 24 pin configuration.<sup>1)</sup>

Size	Configuration	Part number	Designation	Description
08	19-pin	221725	Flex MiniMax 502615A-19 pôles	Rigid Flex for SMD connector for receptacles size 08 19 pins with PCB terminations
	19-pin	127897	CA S 19xFX MR11L1/OE 0.03m	Assembled Rigid Flex with MR11 receptacle push-pull size 08 19 pins with PCB terminations, black, code 1
	24-pin	221726	Flex MiniMax 502735A-24 pôles	Rigid Flex for SMD connector for receptacles size 08 24 pins with PCB terminations
	24-pin	127898	CA S 24xFX MR11L1/OE 0.03m	Assembled Rigid Flex with MR11 receptacle push-pull size 08 24 pins with PCB terminations, black, code 1

<sup>1)</sup> Custom design and other configurations available upon request. Contact your Fischer Connectors sales representative.

**SPANNER & NUT DRIVER**

**DOUBLE-ENDED OPEN SPANNER EXTRA THIN** 



Size	Part number	Opening across flats	Length	Fork thickness
06	TX00.008	8	96	2.3
08	TX00.010	10	104	2.5
	TX00.012	12		
10	TX00.012	12	104	2.5

Material – Chrome Alloy Steel, Chrome plated, Fork Angles – 15° and 75°.

**NUT DRIVER WITH T-HANDLE AND HEX DRIVE** 



Part number	Thread size	Nut outer dia.	øD	Hex drive
TX00.383	M8.5x0.35	10	14	7
TC00.007	M10.5x0.5	12	16	7
TX00.403	M12.5x0.5	14	18	7

Material – Hardened Tool Steel, Nickel plated.

**SINGLE SIDED HEX NUT DRIVER**



Part number	Thread size	Nut outer dia.	øD	Hex drive
TX00.386	M8.5x0.35	10	14	12
TX00.385	M10.5x0.5	13	16	12
TX00.412	M12.5x0.5	15	18	12

Material – Hardened Tool Steel, Nickel plated and plastic.

**CABLE ASSEMBLY**

Note: Cable assembly is only possible with special tooling developed by Fischer Connectors. Due to the complexity of the connector purchase costs may be significant. As an alternative solution, Fischer Connectors offers premium cable assembly services.



Part number	Description
130257	Hand press Luthy HP150T or equivalent



Part number	Description
130254	MiniMax support tool



Part number	Description
130252	MiniMax tool kit Size 06
139451	MiniMax tool kit Size 06 (7 contacts)
130253	MiniMax tool kit Size 08
137461	MiniMax tool kit Size 10

All dimensions and images shown are in millimeters and are for reference only.

## MATERIAL & SURFACE FINISH

Metal components		Material		Finish	
		Designation ISO	Standard	Designation	Standard
<b>Housing, Nut</b>		Brass CuZn39Pb3	CW614N UNS C 38500	Black Chrome over Nickel Anthracite Nickel	SAE-AMS2460 SAE-AMS2404 SAE-AMS-QQ-N-290
<b>Back nut (MP11, MR50)</b>		Brass CuZn39Pb3	CW614N UNS C 38500	Nickel	SAE-AMS-QQ-N-290B SAE-AMS2404G
<b>Ground contact</b>		Brass CuZn39Pb3	CW614N UNS C 38500	Nickel	SAE-AMS-QQ-N-290B SAE-AMS2404G
<b>Push-pull locking spring Quick-release locking spring</b>		Stainless steel	X10CrNi18-8 (1.4310)	-	-
<b>Contacts</b>	- Male, Ground Pin	Brass CuZn39Pb3	CW614N; UNS C 38500	1 µm Gold over Nickel	MIL-DTL-45204D Type I; ASTM B488
	- Female	Bronze CuSn4Zn4Pb4	CW456K; ASTM B139 UNS C 54400	1 µm Gold over Nickel	MIL-DTL-45204D Type I; ASTM B488
<b>Ball-locking</b>		Ceramic Si3N4	-	-	-

Insulator and sealing		International symbol	Flammability
<b>Insulators</b>		PEEK <sup>1)</sup>	UL 94 V-0
<b>O-rings</b>	- General	FPM (Viton®)	-
	- Interface	EPDM	-
<b>Sealant</b>	- Cable connectors	Epoxy compound	-
	- Panel receptacles	Silicone/Epoxy <sup>2)</sup> compound	UL 94 V-0
<b>Bend relief</b>	- Cable connectors	Santoprene™ TPV 101-73	UL 94 HB
<b>Cap</b>	- Cable connectors	TPV (Santoprene™)	UL 94 HB
	- Panel receptacles		

<sup>1)</sup> Or any material in the PAEK family that provides equal or better overall performances.

<sup>2)</sup> For panel receptacle size 10.



## ENVIRONMENTAL & MECHANICAL DATA

Characteristic	Performance	Standard
<b>Sealing performance</b> mated and unmated	IP68, -20m/24h water sealing <10 <sup>-6</sup> mbar l/s gas sealing	IEC 60529 IEC 60068-2-17 Test Qk, Method 3
<b>Sealing performance Soft Cap</b>	IP67; 15 cm submersion for 30 min	IEC 60529
<b>Operating temperature range</b> <sup>1)</sup>	-40 °C to +135 °C	IEC 60512-6-1 IEC 60068-2-14-Nb
<b>Corrosion resistance mated</b>	Salt mist 1,000 hours ; 5% salt solution, 35 °C Plug and receptacle in mated position or with cap when unmated. Appearance may change over time without impacting mechanical or electrical functions.	IEC 60068-2-11 Test Ka; MIL-STD-202 Method 101; EIA-364-26
<b>Endurance</b>	5,000 mating cycles Preserved mechanical and electrical functionality. Normal wear will appear.	IEC 60512-9-1
<b>Vibration</b> Screw-locking version only	10 to 2,000 Hz, 1.5 mm or 15 g, 12 sweep cycles per axis, 20 minutes per 10-2,000-10 Hz sweep cycle, no discontinuity >1 µs, no visible signs of damage	MIL-STD-202 Method 204 Condition B
<b>Vibration</b> Push-pull version	10 to 500 Hz, (1.5 mm or 10 g, 12 sweep cycles per axis, 15 minutes per 10-500-10 Hz sweep cycle, no discontinuity >1 µs, no visible signs of damage	MIL-STD-202 Method 204 Condition A
<b>Unlocking Force</b> Quick-release version only	Size 06 = Typical 25 N±40% Size 08 = Typical 35 N±40% Size 10 = Typical 60 N±40%	
<b>Shock</b>	300 g	MIL-STD-202 Method 213; EIA-364-27

<sup>1)</sup> Max temperature of +85 °C for soft caps.

## ELECTRICAL DATA

Characteristic	Performance	Standard
<b>Contact resistance</b>	5 mΩ (typical value)	IEC 60512-2-1-2a; IEC 60512-2-2-2b
<b>Shell resistance</b> <sup>2)</sup>	ANTHRACITE	<5 mΩ (Cabled) IEC 60512-2-6-2f
	BLACK	<50 mΩ (Cabled) IEC 60512-2-6-2f
<b>Insulation resistance</b>	>10 <sup>10</sup> Ω	IEC 60512-3-1-3a
<b>Shielding effectiveness</b>	360° shielded	-

<sup>2)</sup> Measured for a mated pair of panel receptacle and cable plug between the grounding pin and the cable shielding.

All dimensions and images shown are in millimeters and are for reference only.