

PHILIPS

Philips

**components
for radio,
TV and audio**

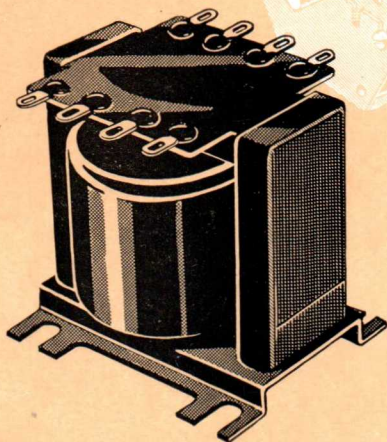
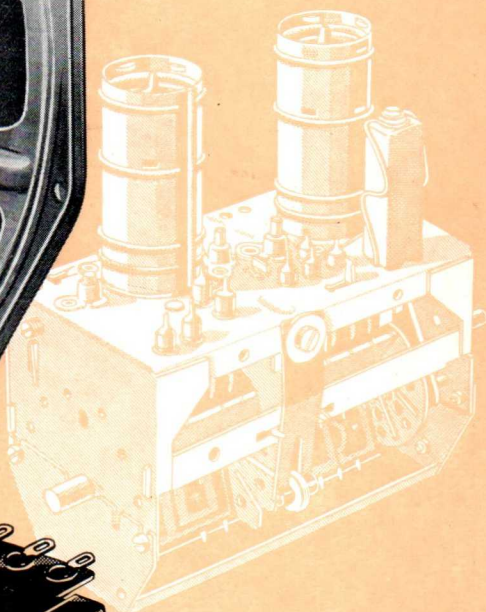
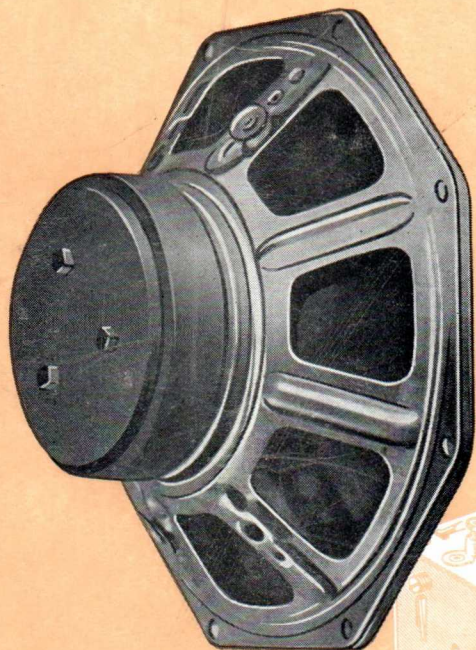

INDUSTRIAL COMPONENTS
AND MATERIALS DIVISION

1960

Here is your sample of

another sales promotional print!

How many are you going to order for increasing your turnover?

I N D E N T

to Comm. Dept. ICOMA (Publicity Div.), Eindhoven.

Please send us copies of

(title)

(print No.)

(firm)

(signature)

INTRODUCTION

It is with much pleasure that we present you with the 1960 edition of this midget catalogue which summarizes our range of components in the domain of radio, TV and audio.

In order to achieve the optimum suitability for daily use, merely preferred types are quoted for the majority of products and no more technical data are given than those usually required.

In behalf of those who want more detailed information and complete type-ranges, relevant data sheets are indicated for the various items.

Please note that, in addition to the components represented in this concise catalogue, a wide programme of components for professional and semi-professional purposes is at your disposal, for instance components for telecommunications in the broadest sense, capacitors for fluorescent lamps, precision and high-power wire-wound resistors and potentiometers, quartz-crystal units, etc. (see back of cover).

We trust that you will use this booklet intensively and that, whenever occasion arises, you will not hesitate to ask for more detailed data or full quotations.

CONTENTS

FIXED CAPACITORS

Tubular polyester capacitors . . .	3
Anti-interference capacitors . . .	4
Metallized-paper feed-through capacitors	4
Electrolytic capacitors with wire terminals	5
Electrolytic capacitors with tag terminals	8
Electrolytic capacitors with screw base	9
Electrolytic capacitors for printed-wiring boards	10
Tantalum capacitors	10
Class-IB ceramic capacitors . . .	11
Class-II ceramic capacitors . . .	12
Midget tubular ceramic capacitors	13
Triple ceramic by-pass capacitors	14
Tubular RC combinations	14

VARIABLE CAPACITORS

Variable capacitors	16
Variable capacitor for FM tuning	17
Air-gap trimmers	18
Tubular ceramic trimmers	19

RESISTORS

Insulated cracked-carbon resistors	20
Midget insulated cracked-carbon resistors	21
Low-power wire-wound resistors .	21
Load resistors 5.5—16 W	22
Carbon potentiometers 23 \emptyset . . .	23
Carbon trimming potentiometers .	25

NTC resistors ("thermistors") . .	26
Voltage-dependent resistors (VDR - "varistors")	27

TUBE SOCKETS

Sockets for tubes with noval base	28
Sockets for miniature and sub-miniature tubes	29
Sockets for tubes with rimlock base	30
Sockets for tubes with octal base	30
Sockets for tubes with loctal base	31
Sockets for TV picture tubes 110°	32
Sockets for printed-wiring boards	32

VARIABLE TRANSFORMERS 33

LOUDSPEAKERS

Universal range	34
Space-economy range	36
Master range	37

OUTPUT TRANSFORMERS . . 38

PERMEABILITY TUNER 42

PERMEABILITY-TUNED COILS 42

FM TUNERS 43

BAND-PASS FILTERS 44

RATIO DETECTOR COIL 45

MAINS TRANSFORMERS 45

TV COMPONENTS 46

FERROXCUBE 48

Tubular polyester capacitors

These modern, small-size, high-quality capacitors are ideally suited for coupling and decoupling in radio and TV sets. They are fully tropic-proof and consist of low-inductively interwound layers of aluminium and polyester foils.

Permissible ambient temperature:
-40 to +100 °C.

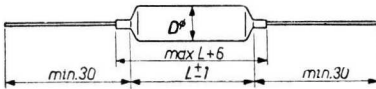
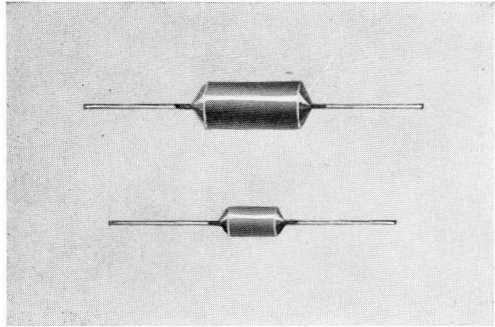

C (±10%)	$E_{\max} = 125 \text{ V D.C.}$ Test voltage = 375 V D.C.		D (mm)	L (mm)	$E_{\max} = 400 \text{ V D.C.}$ Test voltage = 1,200 V D.C.	
		D (mm)			L (mm)	
1,000 pF	C296AA/A10K	max. 7.5	max. 19	max. 32	C296AC/A1K	max. 19
1,200					1K2	8
1,500					1K5	8.5
1,800					1K8	9.5
2,200					2K2	7.8
2,700					2K7	8
3,300					3K3	8.5
3,900					3K9	7.5
4,700					4K7	8
5,600					5K6	8.5
6,800					6K8	9.5
8,200					8K2	7.5
10,000					10K	7.5
12,000					12K	7.5
15,000					15K	7.5
18,000					18K	7.5
22,000					22K	9
27,000					27K	10
33,000					33K	11
39,000					39K	12
47,000	47K	13				
56,000	56K	11.5				
68,000	68K	12				
82,000	82K	13				
0.10 μF	100K	10.5	max. 32			
0.12	120K	11				
0.15	150K	12				
0.18	180K	10				
0.22	220K	10.5				
0.27	270K	11.5				
0.33	330K	12				
0.39	390K	13				
0.47	470K	14				
0.56	560K	15				
0.68	680K	16				
0.82	820K	17.5				
1	1M	19				

Preferred types in bold print.

Anti-interference capacitors

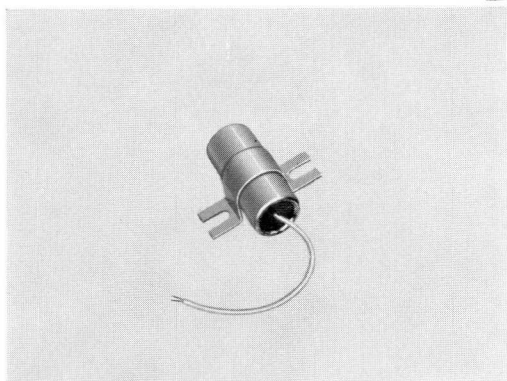

These capacitors are widely used for eliminating radio and TV interferences caused by small motor-operated tools, gas-discharge lamps, etc.

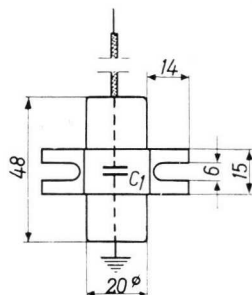

E_{max}	Type number	C (-10/ +20 %)	Insulation resistance
70 V D.C.	7350	$0.5 \mu F$	min. 200 M Ω

For detailed information and full type-range, see data sheet EP 2024.

Metallized-paper feed-through capacitors

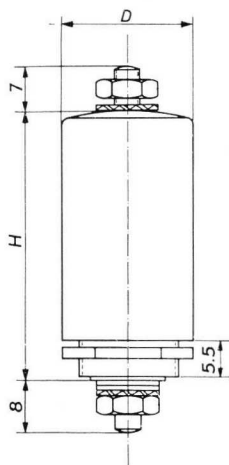

These metallized-paper dielectric capacitors have been developed for suppressing interference from various electrical car-accessories. Being feed-through capacitors, their self-inductance is very low, so as required for use in conjunction with short-wave and FM car-radio sets.

Type number	B8 002 03	B8 002 02
D	21 mm	28 mm
H	42 mm	60 mm
Capacitance	min. $0.5 \mu F$	min. $2 \mu F$
Insulation resistance	min. 4,000 M Ω	min. 1,000 M Ω
R at 100 Mc/s	max. 0.3Ω	max. 0.5Ω
X at 100 Mc/s	max. 2.5Ω	max. 3.3Ω
Mounting bracket	B1 020 06	B1 020 07

For detailed information see data sheet EP 2027.

Electrolytic capacitors with wire terminals

These small electrolytic capacitors are eminently suitable for miniaturized equipment such as transistor apparatus, e.g. car radios, hearing aids and other portable equipment. Moreover, they find a wide employment in conventional radio and TV sets.

The insulated items are equipped with an insulating sleeve.

The **class-A capacitors** are high-capacity items, more particularly suitable for transistor circuits having a moderate ambient temperature and where small dimensions are imperative.

Normal working temperature: max. 50 °C for capacitors size I, and max. 60 °C for all the other sizes.

A peak temperature of 60 and 70 °C respectively is permissible for max. 12 hours per 24 h.

The **class-B capacitors** are high-temperature items, more particularly suitable for tube circuits, where service life should be adequate notwithstanding elevated ambient temperatures.

Normal working temperature: max. 70 °C.

A peak temperature of 85 °C is permissible for max. 12 hours per 24 h.

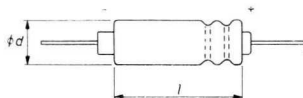
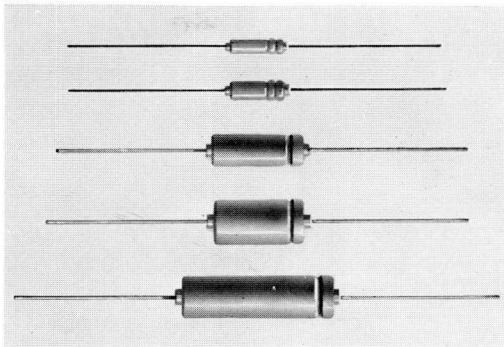

Fig. 1

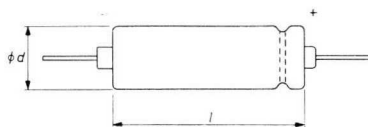

Fig. 2

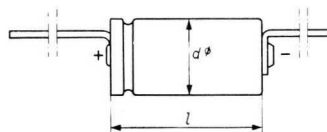

Fig. 3

Can size	Fig.	$d \times l$ (mm)	
		Non-insulated	Insulated
I	1	3.1 × 10	3.4 × 10.5
II	2	4.4 × 10	4.7 × 10.5
III	2	6.3 × 18	6.6 × 18.5
IV	2	9.1 × 18	9.4 × 18.5
V	2	9.1 × 30	9.4 × 30.5
0	3	10 × 20	10.3 × 20.5
00	3	10 × 32	10.3 × 32.5
01	3	12.5 × 32	12.9 × 32.5
02	3	15 × 32	15.4 × 32.5
03	3	18 × 32	18.5 × 32.5

CLASS-A CAPACITORS

Capacitance (μF)	E_{max} (V)	Type number		Can size	Max. ripple current (mA)	Max. leakage current (μA)	Max. impedance (Ω)	Max. $\tan \delta$
		Non-insulated	Insulated					
0.32	64	C426AD/H0,32	C426AN/H0,32	I	1.3	1.6	100	0.15
0.5	40	AD/G0,5	AN/G0,5	I	1.3	1.6	100	0.15
0.8	25	AD/F0,8	AN/F0,8	I	1.3	1.6	100	0.15
1.25	16	AD/E1,25	AN/E1,25	I	1.3	1.6	100	0.15
1.6	64	AE/H1,6	AM/H1,6	II	10	8	40	0.10
2	10	AD/D2	AN/D2	I	1.3	1.6	100	0.15
3.2	6.4	AD/C3,2	AN/C3,2	I	1.3	1.6	100	0.20
	40	AE/G3,2	AM/G3,2	II	10	10	40	0.10
4	4	AD/B4	AN/B4	I	1.3	1.3	100	0.25
5	2.5	AD/A5	AN/A5	I	1.3	1	100	0.30
6.4	25	AE/F6,4	AM/F6,4	II	10	12.5	40	0.10
	64	AE/H6,4	AM/H6,4	III	40	33	10	0.10
10	16	AE/E10	AM/E10	II	10	13	40	0.15
12.5	40	AE/G12,5	AM/G12,5	III	40	40	10	0.10
16	10	AE/D16	AM/D16	II	10	12.8	40	0.15
	64	AE/H16	AM/H16	IV	100	80	4	0.10
20	6.4	AE/C20	AM/C20	II	10	10	40	0.15
25	4	AE/B25	AM/B25	II	10	8.3	40	0.20
	25	AE/F25	AM/F25	III	40	50	10	0.10
32	2.5	AE/A32	AM/A32	II	10	6.5	40	0.25
	40	AE/G32	AM/G32	IV	100	100	4	0.10
	64	AE/H32	AM/H32	V	200	160	2	0.10
40	16	AE/E40	AM/E40	III	40	51	10	0.10
64	10	AE/D64	AM/D64	III	40	51	10	0.15
	25	AE/F64	AM/F64	IV	100	128	4	0.15
	40	AE/G64	AM/G64	V	200	210	2	0.10
80	6.4	AE/C80	AM/C80	III	40	41	10	0.15
100	4	AE/B100	AM/B100	III	40	32	10	0.20
	16	AE/E100	AM/E100	IV	100	130	4	0.10
125	2.5	AE/A125	AM/A125	III	40	25	10	0.20
	25	AE/F125	AM/F125	V	200	250	2	0.10
160	10	AE/D160	AM/D160	IV	100	128	4	0.15
200	6.4	AE/C200	AM/C200	IV	100	100	4	0.15
	16	AE/E200	AM/E200	V	200	260	2	0.10
250	4	AE/B250	AM/B250	IV	100	83	4	0.20
320	2.5	AE/A320	AM/A320	IV	100	65	4	0.20
	10	AE/D320	AM/D320	V	200	256	2	0.15
400	6.4	AE/C400	AM/C400	V	200	200	2	0.15
500	4	AE/B500	AM/B500	V	200	166	2	0.20
640	2.5	AE/A640	AM/A640	V	200	125	2	0.20

CLASS-B CAPACITORS

Capacitance (μF)	E_{max} (V)	Type number		Can size	Max. ripple current (mA)	Max. leakage current (μA)	Max. impedance (Ω)	Max. tan δ
		Non-insulated	Insulated					
0.64	64	C425AF/H0,64	C425AL/H0,64	III	16	3.2	6	0.10
1	40	/G1	/G1	III	16	3.2	6	0.10
1.6	25	/F1,6	/F1,6	III	16	3.2	6	0.10
2.5	16	/E2,5	/E2,5	III	16	3.2	6	0.10
4	64	/H4	/H4	III	16	20	5	0.10
6.4	40	/G6,4	/G6,4	III	16	20	5	0.10
10	25	/F10	/F10	III	16	20	5	0.10
	64	/H10	/H10	IV	40	50	2	0.10
16	16	/E16	/E16	III	16	20	5	0.10
	40	/G16	/G16	IV	40	50	2	0.10
20	64	/H20	/H20	V	80	100	1	0.10
25	10	/D25	/D25	III	16	20	5	0.15
	25	/F25	/F25	IV	40	50	2	0.10
	64	C435AF/H25	C435AL/H25	00	100	100	1	0.10
32	6.4	C425AF/C32	C425AL/C32	III	16	17	5	0.15
	40	/G32	/G32	V	80	100	1	0.10
	4	/B40	/B40	III	16	13	5	0.15
	16	/E40	/E40	IV	40	50	2	0.10
	40	C435AF/G40	C435AL/G40	00	100	100	1	0.10
	64	/H40	/H40	01	130	130	0.5	0.10
50	25	C425AF/F50	C425AL/F50	V	80	100	1	0.10
64	10	/D64	/D64	IV	40	50	2	0.15
	25	C435AF/F64	C435AL/F64	00	100	100	1	0.10
	40	/G64	/G64	01	160	130	0.5	0.10
	64	/H64	/H64	02	180	190	0.5	0.10
80	6.4	C425AF/C80	C425AL/C80	IV	40	40	2	0.15
	16	/E80	/E80	V	80	100	1	0.10
100	4	/B100	/B100	IV	40	30	2	0.15
	16	C435AF/E100	C435AL/E100	00	100	100	1	0.10
	25	/F100	/F100	01	160	130	0.5	0.10
	40	/G100	/G100	02	225	190	0.5	0.10
	64	/H100	/H100	03	245	290	0.5	0.10
125	10	C425AF/D125	C425AL/D125	V	80	100	1	0.15
160	6.4	/C160	/C160	V	80	80	1	0.15
	16	C435AF/E160	C435AL/E160	01	160	130	0.5	0.10
	25	/F160	/F160	02	250	190	0.5	0.10
	40	/G160	/G160	03	315	290	0.5	0.10
200	4	C425AF/B200	C425AL/B200	V	80	60	1	0.15
250	10	C435AF/D250	C435AL/D250	01	160	130	0.5	0.15
	16	/E250	/E250	02	250	190	0.5	0.10
	25	/F250	/F250	03	400	280	0.5	0.10
320	6.4	/C320	/C320	01	160	110	0.5	0.25
400	4	/B400	/B400	01	160	100	0.5	0.25
	10	/D400	/D400	02	250	190	0.5	0.15
	16	/E400	/E400	03	400	290	0.5	0.10
500	6.4	/C500	/C500	02	250	160	0.5	0.25
640	4	/B640	/B640	02	250	130	0.5	0.25
	10	/D640	/D640	03	400	290	0.5	0.15
800	6.4	/C800	/C800	03	400	240	0.5	0.25
1,000	4	/B1000	/B1000	03	400	190	0.5	0.25
	2	AC8108/2	AC8128/2	0	20	60	16	0.10
	4	AC8108/4	AC8128/4	00	40	90	8	0.10
	8	AC8107/8	AC8127/8	01	60	130	5	0.10
12.5	300	AC8107/12,5	AC8127/12,5	02	80	180	3	0.10
16	350	AC8108/16	AC8128/16	03	100	250	2	0.10

Electrolytic capacitors with tag terminals

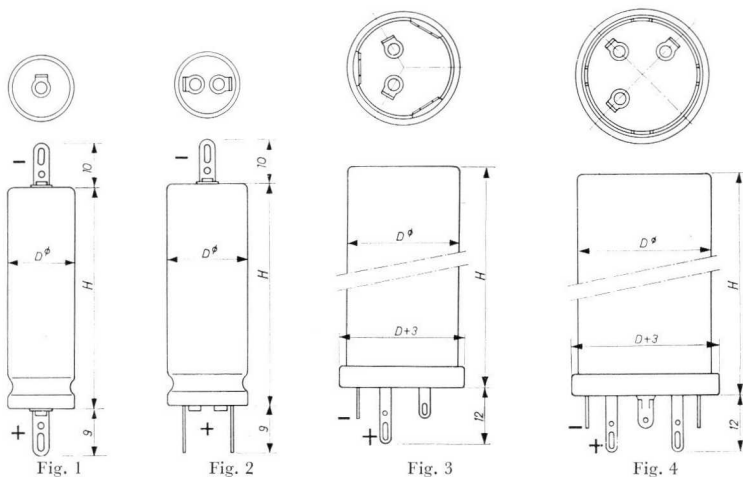

The capacitors are available with single or multiple capacitances, the preferred types being quoted in the table below.

E_{max} is the highest voltage (DC voltage plus the peak value of any superposed AC voltage) that may occur continuously.

E_{peak} may occur at most 10 times for 10 minutes with intervals of at least 24 hours, provided that the initial working temperature does not exceed 35 °C.

The normal working temperature is max. 70 °C.

Capacitances (μ F)	Permissible voltages		Type number	Fig.	D	H	Ripple current (mA)	Leakage current (μ A)	Impedance (Ω)	t_{min} (°C)
	E_{max} (V)	E_{peak} (V)								
2 × 8	350	395	AC 5208/8+8	2	18	33	max. 50	max. 140	1—3.5	—30
2 × 16	450	500	AC 5210/16+16	2	25	49	max. 80	max. 320	2—6	—30
25	350	395	AC 5108/25	1	18	49	max. 140	max. 380	1—3	—30
	450	500	AC 5110/25	1	21	49	max. 140	max. 480	3—9	—10
2 × 25	350	395	AC 5308/25+25	3	25	51	max. 125	max. 380	max. 0.5	—30
	500	550	AC 5311/25+25	3	25	80	max. 125	max. 530	2—6	—5
32	350	395	AC 5108/32	1	21	49	max. 160	max. 480	0.5—1.5	—30
2 × 32	350	395	AC 5308/32+32	3	25	80	max. 150	max. 480	max. 0.5	—30
50	350	395	AC 5108/50	1	25	49	max. 250	max. 700	max. 0.5	—30
	350	395	AC 5308/50	3	25	51	max. 250	max. 700	max. 0.5	—30
	450	500	AC 5310/50	3	25	80	max. 250	max. 900	0.7—2	—10
2 × 50	300	340	AC 5307/50+50	3	25	80	max. 200	max. 600	max. 0.5	—40
	350	395	AC 5308/50+50	3	25	80	max. 200	max. 700	max. 0.5	—30
	400	450	AC 5409/50+50	4	30	80	max. 200	max. 800	max. 0.5	—20

Electrolytic capacitors with screw base

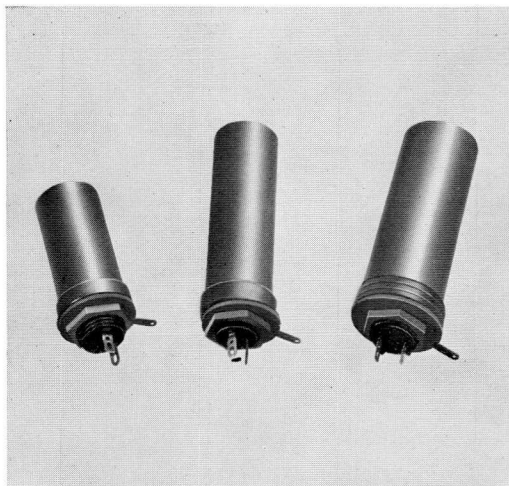
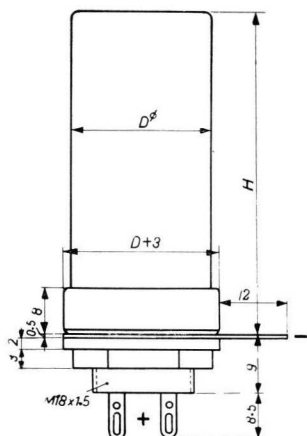

Capacitances (μF)	Permissible voltages		Type number	D (mm)	H (mm)	Ripple current (mA)	Leakage current (μA)	Impedance (Ω)	t_{\min} ($^{\circ}\text{C}$)
	E_{\max} (V)	E_{peak} (V)							
2 × 12.5	500	550	AC 6011/12,5+12,5	25	54	max. 70	max. 280	5-24	- 5
2 × 16	450	500	AC 6010/16+16	25	54	max. 90	max. 320	2- 8	-10
25	500	550	AC 6011/25	25	54	max. 140	max. 530	5-24	- 5
2 × 25	300	340	AC 6007/25+25	25	54	max. 100	max. 330	1- 1.2	-40
	350	395	AC 6008/25+25	25	54	max. 125	max. 380	1- 1.2	-30
	500	550	AC 6011/25+25	25	83	max. 125	max. 530	3-14	- 5
2 × 32	450	500	AC 6010/32+32	30	83	max. 150	max. 600	1- 3.6	-10
50	350	395	AC 6008/50	25	54	max. 250	max. 700	1- 1.2	-30
	450	500	AC 6010/50	25	83	max. 250	max. 900	1- 5	-10
2 × 50	200	225	AC 6005/50+50	25	54	max. 200	max. 430	max. 1	-40
	300	340	AC 6007/50+50	25	83	max. 200	max. 600	max. 1	-40
	350	395	AC 6008/50+50	30	83	max. 200	max. 700	max. 1	-30
	400	450	AC 6009/50+50	30	83	max. 200	max. 800	1- 1.2	-20
	450	500	AC 6010/50+50	30	83	max. 200	max. 900	1- 3.6	-10

Electrolytic capacitors for printed-wiring boards

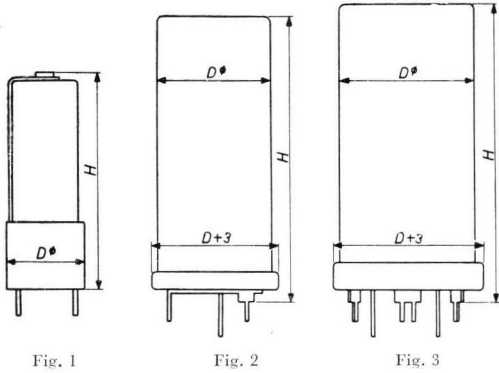

Fig. 1

Fig. 2

Fig. 3

With a view to the ever growing utilization of printed wiring in the electronics industry, the terminals and mounting elements of these electrolytic capacitors are specially adapted to the characteristics of printed-wiring boards, and they enable the capacitors to be mounted perpendicular to the print.

The smaller cans are placed in an adapter base of plastic material, the leads being shaped into two parallel pins; see fig. 1.

The larger cans are equipped with a built-in metallic base containing three or four soldering pins for the attachment; see figs. 2-3.

For detailed information and full type-range, see data sheet EP 2205(2).

Tantalum capacitors

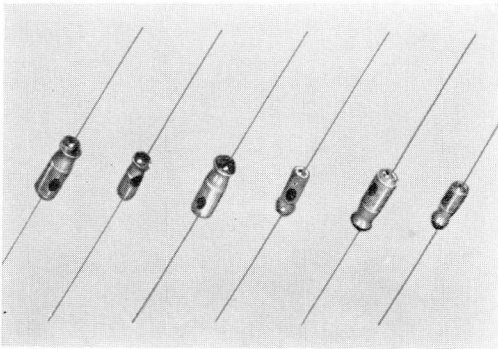

Minute dimensions are the star feature of this new kind of electrolytic capacitors for by-passing, coupling and smoothing. They are extremely suitable for transistorized and other miniaturized equipment, where space saving is of utmost importance, e.g. hearing aids.

The tantalum capacitors are contained in a tiny silver can ($2.6 \text{ } \phi \times 7 \text{ mm}$, or $3.2 \text{ } \phi \times 9 \text{ mm}$), insulated by means of a plastic sleeve.

The capacitance and voltage ratings are indicated by three colour dots.

Capacitance range: $0.04 - 40 \text{ } \mu\text{F}$.

Working voltage: 2.5, 4, 6.4, 10, 16 or 25 V.

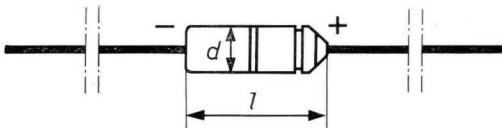

Class-IB ceramic capacitors

These fully tropic-proof ceramic capacitors are suited to resonant-circuit applications, or any other applications where low losses and high stability of capacitance are essential and where close-tolerance temperature coefficients are not required. The IB types will appear to be fully adequate for common temperature-compensation such as in radio and TV sets.

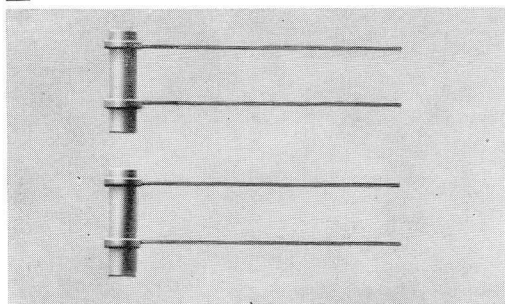

Working voltage: max. 500 V D.C.

Test voltage: 1,500 V D.C. (1 sec).

Ambient temperature: -40 to $+85$ °C.

Losses: $\tan \delta = \max. 10 \times 10^{-4}$ at 1 Mc/s (on average less than 5×10^{-4}).

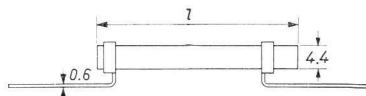

C_n pF	Tolerance	N 750 temp. coeff. ($-500/-870$) $\times 10^{-6}$	l mm	N 150 temp. coeff. ($-90/-190$) $\times 10^{-6}$	l mm	NPO temp. coeff. $\pm 40 \times 10^{-6}$	l mm
0.8	± 0.25 pF	C304GH/NE8	12				
1	"	/N1E	12				
1.2	"	/N1E2	12				
1.5	"	/N1E5	12			C304GB/N1E8	12
1.8	"	/N1E8	12			/N2E2	12
2.2	"	/N2E2	12			/L2E7	12
2.7	± 0.5 pF	/L2E7	12			/L3E3	12
3.3	"	/L3E3	12			/L3E9	12
3.9	"	/L3E9	12			/L4E7	12
4.7	"	/L4E7	12			/L5E6	12
5.6	"	/L5E6	12	C304GC/L5E6	12	/L6E8	12
6.8	"	/L6E8	12	/L6E8	12	/L8E2	12
8.2	"	/L8E2	12	/L8E2	12	/L10E	12
10	"	/L10E	12	/L10E	12	/B12E	12
12	$\pm 5\%$	/B12E	12	/B12E	12	/B15E	12
15	"	/B15E	12	/B15E	12	/B18E	12
18	"	/B18E	12	/B18E	12	/B22E	12
22	"	/B22E	12	/B22E	12	/B27E	12
27	"	/B27E	12	/B27E	12	/B33E	12
33	"	/B33E	12	/B33E	12	/B39E	12
39	"	/B39E	12	/B39E	12	/B47E	14
47	"	/B47E	12	/B47E	12	/B56E	14
56	"	/B56E	12	/B56E	14	/B68E	16
68	"	/B68E	12	/B68E	14	/B82E	18
81	"	/B82E	12	/B82E	16	/B100E	20
100	"	/B100E	12	/B100E	18	/B120E	22
120	"	/B120E	14	/B120E	20	/B150E	26
150	"	/B150E	16	/B150E	24	/B180E	30
180	"	/B180E	18	/B180E	28	/B220E	34
220	"	/B220E	20	/B220E	32		
270	"	/B270E	22	/B270E	38		
330	"	/B330E	26				
390	"	/B390E	28				
470	"	/B470E	34				
560	"	/B560E	38				
680	"	/B680E	44				
820	"	/B820E	52				

The capacitors are grey coloured, whilst a colour dot indicates the temperature coefficient:

N 750 = violet — N 150 = orange — NPO = black.

From 12 pF onwards the capacitors are also available in $\pm 10\%$ tolerance, and from 56 pF onwards in $\pm 2\%$ or $\pm 1\%$ tolerance.

Class-II ceramic capacitors

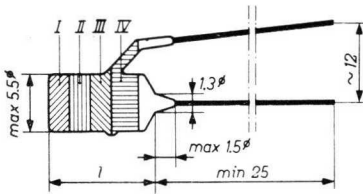
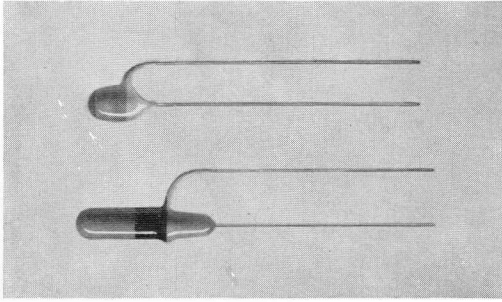

These capacitors have been developed for by-pass, coupling and general-purpose applications; a high insulation resistance and low self-inductance are their main features.

Moreover, they are extremely suitable for use in conjunction with printed-wiring boards; mounted in a vertical position, they occupy but a minor area. Their being suitable for automatic or semi-automatic insertion and dip-soldering results in appreciable savings in cost. The capacitors are colour-coded in accordance with the I.E.C. proposal.

Working voltage: max. 500 V D.C.
Test voltage: 1,500 V D.C. (1 sec).
Ambient temperature: -40 to + 85 °C.

C _n pF	Tolerance	Type number	l mm	Colour code				ΔC C
				I	II	III	IV	
1.5	± 0.5 pF	C322BD/L1E5	max. 6.5	brown	green	white		
2	± 0.5	BD/L2E	max. 8.5	red	black	white		
3	± 0.5	BD/L3E	max. 8.5	orange	black	white		
4	± 1	BD/M4E	max. 7	yellow	black	white		
5	± 1	BD/M5E	max. 8.5	green	black	white		
6	± 1	BD/M6E	max. 8	blue	black	white		
7	± 1	BD/M7E	max. 9	violet	black	white		
8	± 1	BD/M8E	max. 10	grey	black	white		
9	± 1	BD/M9E	max. 6.5	white	black	white		
10	± 1	BD/M10E	max. 7	brown	black	black		
15	± 20%	BD/P15E	max. 9	brown	green	black		
22	± 20	BD/P22E	max. 7.5	red	red	black		
33	± 20	BD/P33E	max. 8.5	orange	orange	black		
47	± 20	BC/P47E	max. 6.5	yellow	violet	black		
68	± 20	BC/P68E	max. 7	blue	grey	black		max. 25%
100	± 20	BC/P100E	max. 9	brown	black	brown		max. 25
150	± 20	BC/P150E	max. 7.5	brown	green	brown		max. 25
220	± 20	BC/P220E	max. 8	red	red	brown		max. 25
330	± 20	BC/P330E	max. 11	orange	orange	brown		max. 25
470	± 20	BC/P470E	max. 8	yellow	violet	brown		max. 25
680	± 20	BC/P680E	max. 8.5	blue	grey	brown		max. 25
1,000	± 20	BC/P1K	max. 12	brown	black	red	black	max. 25
1,000	-20/+50	BA/H1K	max. 8	brown	black	red		max. 40
1,500	± 20	BC/P1K5	max. 14	brown	green	red	black	max. 25
1,500	-20/+50	BA/H1K5	max. 9	brown	green	red		max. 40
2,200	± 20	BC/P2K2	max. 18	red	red	red	black	max. 25
2,200	-20/+50	BA/H2K2	max. 12	red	red	red		max. 40
3,300	-20/+50	BA/H3K3	max. 14	orange	orange	red		max. 40
4,700	-20/+50	BA/H4K7	max. 18	yellow	violet	red		max. 40

Midget tubular ceramic capacitors

These midget-type capacitors for 70 V A.C. are characterized by low HF losses, high stability and a very low self-inductance. Therefore they are widely used in RF and HF tuned circuits. In their properties they much resemble mica capacitors, but they have smaller dimensions and are much less expensive. Their shape is very suitable for use in IF transformers, discriminators, noise-limiters etc.

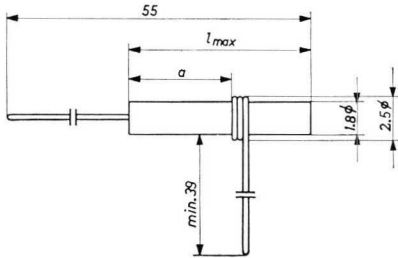
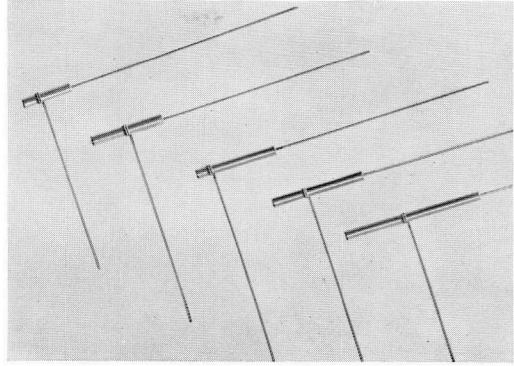

Capacitance pF	Tolerance	Type number	l_{max}	a	Capacitance pF	Tolerance	Type number	l_{max}	a				
			mm					mm					
3.9	±0.5 pF	C302AB/L3E9	12	4-6	47	±2%	C302AC/C47E	15	10-12				
4.7		/L4E7	12	4-6									
5.6	±10%	/A5E6	12	4-6									
6.8		/A6E8	12	4-6									
8.2		/A8E2	12	4-6									
10	±1 pF	C302AB/M10E	9	4-6						51	/C51E	16.5	10-12
11		/M11E	10	4-6						56	/C56E	11	6-8
12		/M12E	11	6-8						62	/C62E	12	6-8
13		/M13E	12	6-8						68	/C68E	13	6-8
15		/M15E	13.5	6-8						75	/C75E	11	6-8
16		/M16E	14.5	10-12						82	/C82E	12	6-8
18		/M18E	16	10-12						91	/C91E	13	6-8
20		/M20E	11	6-8						100	/C100E	14.5	6-8
22		/M22E	12	6-8						110	/C110E	16	10-12
24		/M24E	13	6-8						120	/C120E	13.5	6-8
27		/M27E	14.5	6-8						130	/C130E	14.5	6-8
30		/M30E	16	10-12						150	/C150E	16.5	10-12
33		C302AC/M33E	/M33E	10.5						6-8	160	/C160E	17.5
36	/M36E		11.5	6-8						180	/C180E	20	10-12
39	/M39E		12.5	6-8						200	/C200E	22	10-21
43	/M43E		14	6-8									

Triple ceramic by-pass capacitors

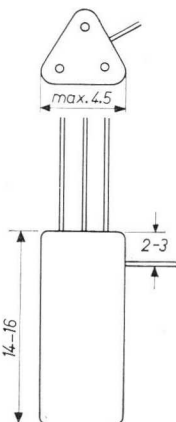
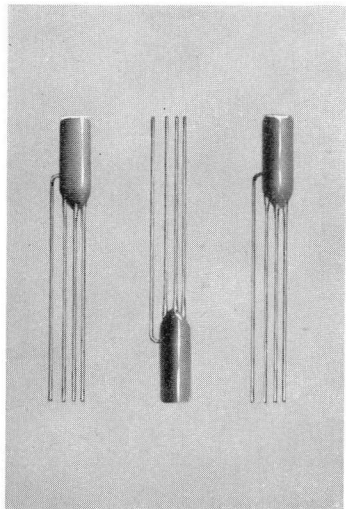

This combined assembly of three ceramic capacitors has been developed for use in TV sets and FM receivers. They are so small that they can be inserted in the centre screen of rimlock, noval and miniature tube-sockets.

The advantages are: very short leads and an appreciable saving of space. Moreover, only four contacts need be soldered.

Type number: B8 600 01/02.

Capacitance: 1,500 pF ($-20 / +100\%$ at 20 °C).

Working voltage: max. 250 V D.C.

For detailed information see data sheet EP 7803.

Tubular RC combinations

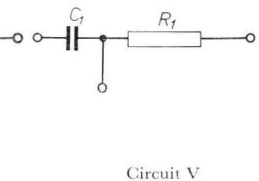
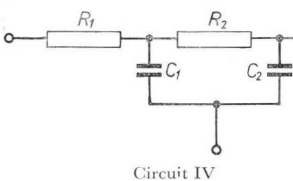
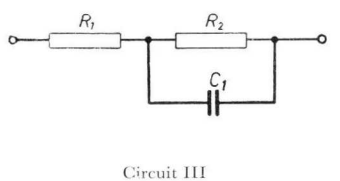
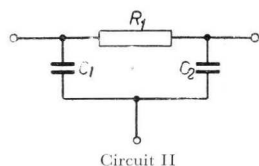
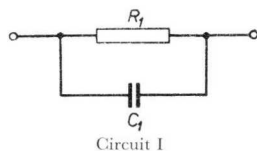
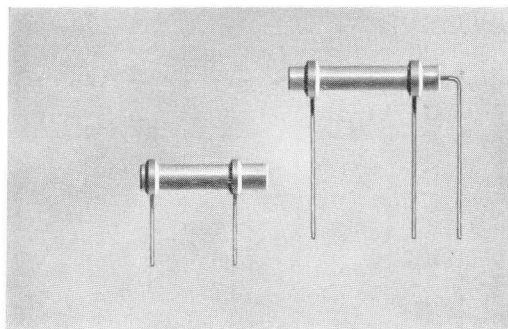

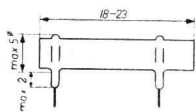

Fig. 1

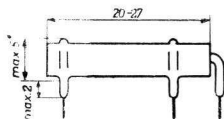

Fig. 2

These tubular multiple components — having the shape and size of ceramic capacitors — are combinations of one or two carbon resistors and one or two ceramic capacitors, equipped with two (fig. 1) or three (fig. 2) connecting wires. The elementary components are interconnected so as to form one of the five circuits illustrated on page 14.

These units can realize appreciable savings in space, labour and cost; defective solder connections and wiring errors are reduced and the inspection is simplified. The number of holes required in printed-wiring boards is diminished and more compact circuits can be designed.

STANDARD COMBINATIONS

Circuit	Type number	Resistances		Capacitances		Main application
		R_1 ($\pm 10\%$)	R_2 ($\pm 10\%$)	C_1 (pF)	C_2 (pF)	
I	E551AA/24+40	100 Ω	—	2,200 $-20/+50\%$	—	Cathode circuit in television IF stages
	/24+44	100	—	4,700 $-20/+50\%$	—	
	/26+38	150	—	1,500 $-20/+50\%$	—	
	/26+40	150	—	2,200 $-20/+50\%$	—	
	/27+38	180	—	1,500 $-20/+50\%$	—	
	/27+40	180	—	2,200 $-20/+50\%$	—	
	/28+38	220	—	1,500 $-20/+50\%$	—	
	/28+40	220	—	2,200 $-20/+50\%$	—	
	/29+38	270	—	1,500 $-20/+50\%$	—	
	/51+38	18 k Ω	—	1,500 $-20/+50\%$	—	
	/60+24	100	—	100 $\pm 10\%$	—	
	/68+20	470	—	47 $\pm 10\%$	—	
/68+24	470	—	100 $\pm 10\%$	—		
II	E553AA/36+38	1 k Ω	—	1,500 $-20/+50\%$	1,500 $-20/+50\%$	Screen-grid and decoupling in television IF stages; decoupling of AVC leads
	/48+38	10	—	1,500 $-20/+50\%$	1,500 $-20/+50\%$	
	/56+35	47	—	820 $-20/+50\%$	820 $-20/+50\%$	
	/56+20	47	—	47 $\pm 10\%$	47 $\pm 10\%$	
	/56+24	47	—	100 $\pm 10\%$	100 $\pm 10\%$	
	/56+26	47	—	150 $\pm 10\%$	150 $\pm 10\%$	
	/60+24	100	—	100 $\pm 10\%$	100 $\pm 10\%$	
	/64+20	220	—	47 $\pm 10\%$	47 $\pm 10\%$	
III	E555AA/01	47 Ω $\pm 20\%$	$R_1 + R_2 =$ 150 Ω	2,700 $-20/+50\%$	—	Cathode circuit in gain-controlled IF stages
	/02	47	120	1,000 $-20/+50\%$	—	
	/03	39	180	1,500 $-20/+50\%$	—	
	/04	39	120	2,700 $-20/+50\%$	—	
	/05	47	120	2,700 $-20/+50\%$	—	
	/06	39	150	2,700 $-20/+50\%$	—	
	/07	39	180	2,700 $-20/+50\%$	—	
	/08	47	180	2,700 $-20/+50\%$	—	
	/09	39	220	2,700 $-20/+50\%$	—	
	/10	47	220	2,700 $-20/+50\%$	—	
IV	E556AA/56+35	47 k Ω	47 k Ω	820 $-20/+50\%$	820 $-20/+50\%$	Vertical-integrator circuit
V	E554AA/36+38	1 k Ω	—	1,500 $-20/+50\%$	—	Miscellaneous
	/40+38	2.2	—	1,500 $-20/+50\%$	—	
	/44+38	4.7	—	1,500 $-20/+50\%$	—	
	/48+38	10	—	1,500 $-20/+50\%$	—	
	/52+38	22	—	1,500 $-20/+50\%$	—	
	/56+38	47	—	1,500 $-20/+50\%$	—	
	/60+38	100	—	1,500 $-20/+50\%$	—	
	/64+38	220	—	1,500 $-20/+50\%$	—	
/68+38	470	—	1,500 $-20/+50\%$	—		

Variable capacitors

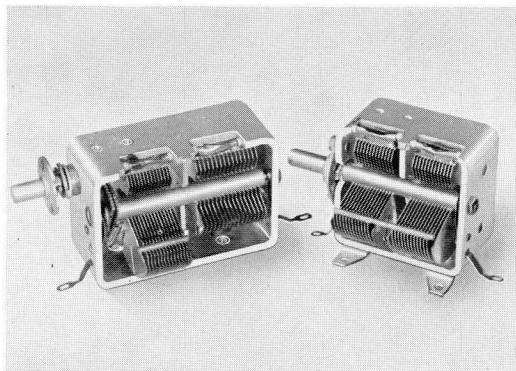

The rigid die-cast aluminium frame and the soldered brass vanes of these variable capacitors have for long proved their stability and reliability. The efficient construction results in small dimensions. The capacitance law ensures an even distribution of frequencies over the scale.

Apart from type 5127, all types have specially shaped vanes in the oscillator section, thus eliminating the need for a padding capacitor. Frame: die-cast aluminium.

Vanes: brass, soldered to brass spindle; type AC1025 has aluminium vanes clamped on to brass spindle.

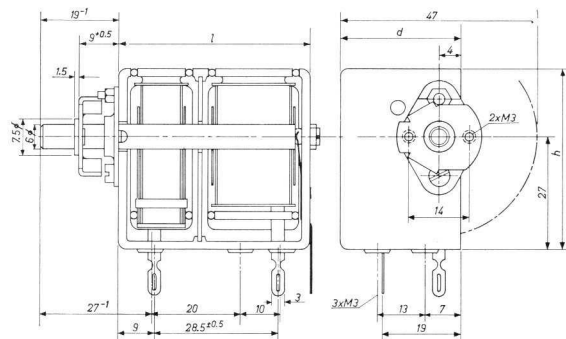

Type number	Version	Variable capacitance (pF)		Zero capacitance (pF)		Torque (gcm)	Test voltage (V D.C.)	Dimensions $l \times d \times h$ (mm)
		Aerial section	Oscillator section	Aerial section	Oscillator section			
5127/00	2 gang AM	488	488	12.5	12.5	225	300	46 × 28 × 43.5
AC 1010	3 gang AM ¹⁾	2 × 489	511.8	2 × 10	13	225	300	46 × 28 × 43.5
AC 1014	2 gang AM ¹⁾	489	511.8	10	12.5	225	300	46 × 28 × 43.5
AC 1022	2 gang AM ²⁾	326	126	12	11.5	150-500	300	46 × 28 × 43.5
AC 1025	2 gang AM	493	518	12.5	10.5	225	300	46 × 28 × 43.5

¹⁾ Gear transmission: 1 : 3.

²⁾ Gear transmission: 1 : 2 with higher torque for direct dial mounting.

Angle of rotation: $\alpha = 172.5^\circ$.

Temp. range: -40 to $+85^\circ\text{C}$.

Temp. coeff.: $\Delta C/C = 10^{-4}/^\circ\text{C}$.

Variable capacitor for FM tuning

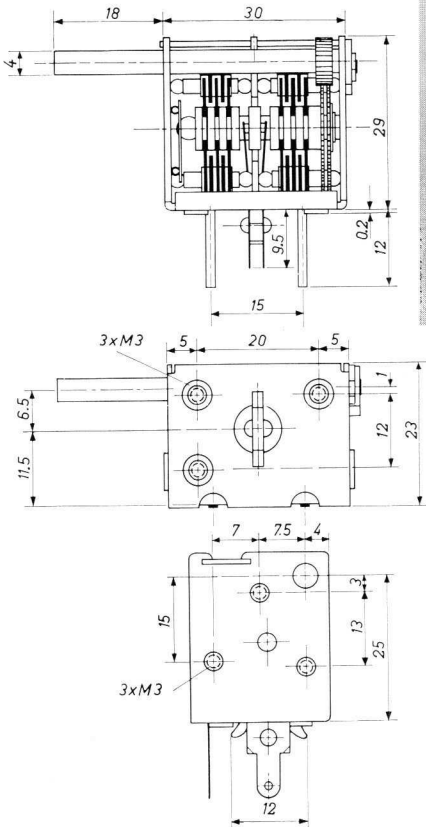
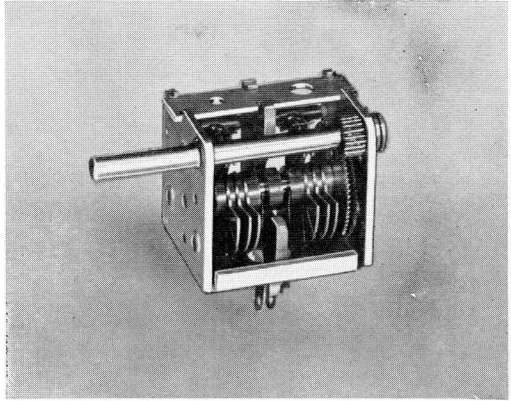

The variation of this capacitor fully covers the European and American frequency bands (87 — 100 Mc/s and 87.5–108 Mc/s). The sturdy frame ensures a high stability. The special spring-loaded ball-bearing and 1 : 3 gearing guarantee a smooth tuning without any backlash.

Type number

Frame

Vanes

Variable capacitance

Variation

Tolerance

Zero capacitance

Test voltage

Insulation resistance

Parallel damping at 1.5 Mc/s

Torque

Angle of spindle rotation

AC 1020

cadmium-plated steel casing

aluminium plates dressed in slotted brass spindle

2×10 pF

linear

$\pm 0.25\%$

2×3.5 pF

300 V D.C

min. 10^4 M Ω

min. 10 M Ω

max. 125 gcm

517.5°

Air-gap trimmers

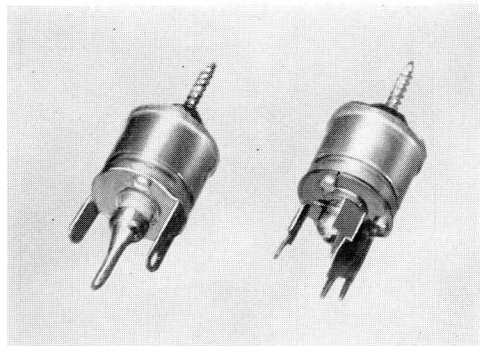

These trimmers of rather unconventional but highly efficient design are distinguished by features such as ease and accuracy of adjustment, stability, low weight and small size. Consequently they are suitable for use in a coil can and for suspension in the wiring of an apparatus. For many years they have proved their adequacy in innumerable radio and TV sets.

Construction: Die-cast aluminium rotor and stator, either provided with a set of concentric rings.

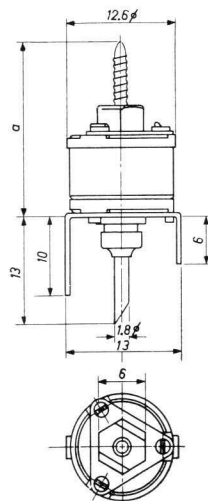

Version for printed-wiring boards:

- * C 005 CC/30 E
- ** C 005 CC/60 E

Type number	7864/01*	AC 2011/60**
Variable capacitance	min. 27 pF	min. 58 pF
Zero capacitance	max. 3 pF	max. 3.5 pF
Parallel damping	min. 10 MΩ	min. 3 MΩ
Test voltage	300 V D.C.	300 V D.C.
Insulation resistance	min. 5,000 MΩ	min. 5,000 MΩ
Torque	max. 300 gcm	max. 300 gcm
Dimension <i>a</i>	25.5 mm	37 mm

Tubular ceramic trimmers

The simple construction of this trimmer guarantees high reliability; it features, moreover, a high break-down voltage, good stability and high accuracy of adjustment. For many applications the negative temperature coefficient results in a favourable compensation at varying temperatures. The very small dimensions are a further contribution towards miniaturization of electronic equipment.

Construction:

Internally ground ceramic tube with brass outer electrode and special-alloy rotor.

Mounting in panel by means of an M3 screw.

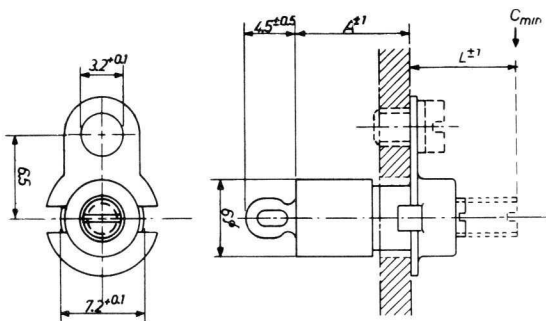
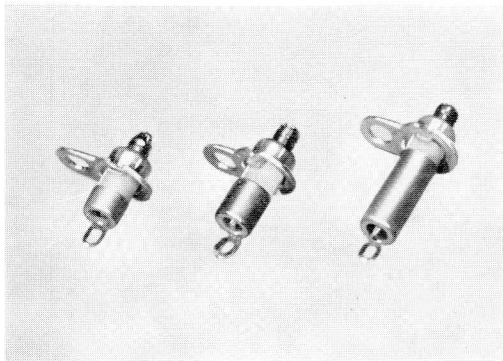

Type number	C004AA/3E	C004AA/6E	C004AA/12E
A (mm)	5.5	8.5	14.5
L (mm)	13.5	16.5	22.5
Capacitance (pF)	0.7—3.7	0.8—6.8	1—13
Temp. coeff. $\Delta C/C$	$-200 \times 10^{-6}/^{\circ}\text{C}$	$-250 \times 10^{-6}/^{\circ}\text{C}$	$-300 \times 10^{-6}/^{\circ}\text{C}$
Test voltage (V D.C.)		1,000	
Insulation resistance		min. 10,000 M Ω	
Parallel damping		min. 3 M Ω	
Torque		max. 400 gcm	

Insulated cracked-carbon resistors

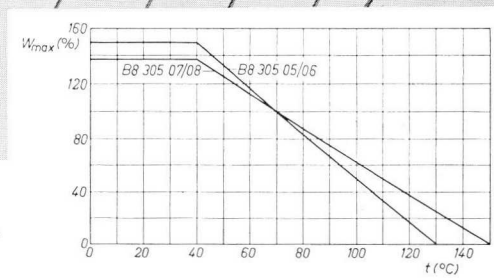
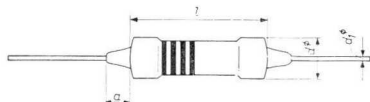
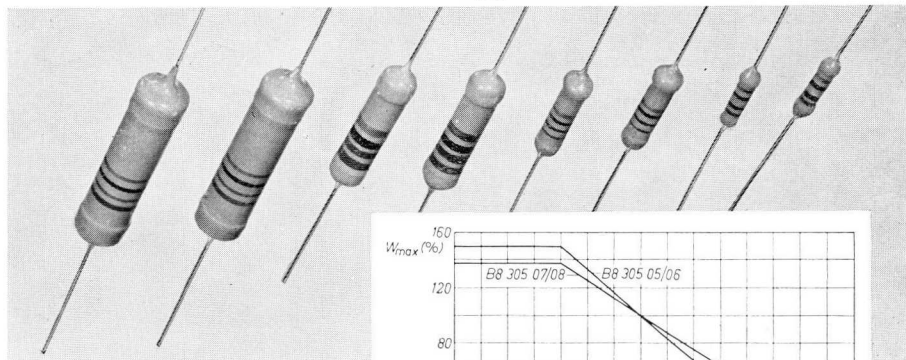

These all-round carbon-film resistors combine high stability, resistance to atmospheric influences, very low noise-level and exceptionally long life with small dimensions.

Resistance range:
from 10 Ω up to R_{max} , according to the tables below.

TABLE 1

W_{max} at 40 °C W	W_{max} at 70 °C W	Type number xxx: see table 2	Tolerance %	R_{max} MΩ	E_{peak} V	d	l	d_1	a
						mm			
0.38	0.25	B8 305 05B/xxx B8 305 05A/xxx	± 5	0.56	500	max.	max.	0.7	max. 3
			± 10	10		3.7	10.9		
0.75	0.5	B8 305 06B/xxx B8 305 06A/xxx	± 5	1.5	700	max.	max.	0.8	max. 3
			± 10	10		4.9	16.1		
1.35	1	B8 305 07B/xxx B8 305 07A/xxx	± 5	2.2	1,000	max.	max.	1	max. 3
			± 10	10		6.7	25.5		
2.70	2	B8 305 08B/xxx B8 305 08A/xxx	± 5	10	1,400	max.	max.	1	max. 4
			± 10	10		9.2	36		

TABLE 2

R_{nom} Ω	Indi- cation xxx	R_{nom} Ω	Indi- cation xxx	R_{nom} Ω	Indi- cation xxx	R_{nom} Ω	Indi- cation xxx	R_{nom} Ω	Indi- cation xxx	R_{nom} MΩ	Indi- cation xxx
10	10E	100	100E	1,000	1K	10,000	10K	100,000	100K	1	1M
12	12E	120	120E	1,200	1K2	12,000	12K	120,000	120K	1.2	1M2
15	15E	150	150E	1,500	1K5	15,000	15K	150,000	150K	1.5	1M5
18	18E	180	180E	1,800	1K8	18,000	18K	180,000	180K	1.8	1M8
22	22E	220	220E	2,200	2K2	22,000	22K	220,000	220K	2.2	2M2
27	27E	270	270E	2,700	2K7	27,000	27K	270,000	270K	2.7	2M7
33	33E	330	330E	3,300	3K3	33,000	33K	330,000	330K	3.3	3M3
39	39E	390	390E	3,900	3K9	39,000	39K	390,000	390K	3.9	3M9
47	47E	470	470E	4,700	4K7	47,000	47K	470,000	470K	4.7	4M7
56	56E	560	560E	5,600	5K6	56,000	56K	560,000	560K	5.6	5M6
68	68E	680	680E	6,800	6K8	68,000	68K	680,000	680K	6.8	6M8
82	82E	820	820E	8,200	8K2	82,000	82K	820,000	820K	8.2	8M2

The indication for a resistance of 10 MΩ is 10M.

Midget insulated cracked-carbon resistors

These small carbon resistors are eminently suitable for transistor circuits and for miniaturized apparatus such as radio sondes, computers, hearing aids, military equipment and the like.

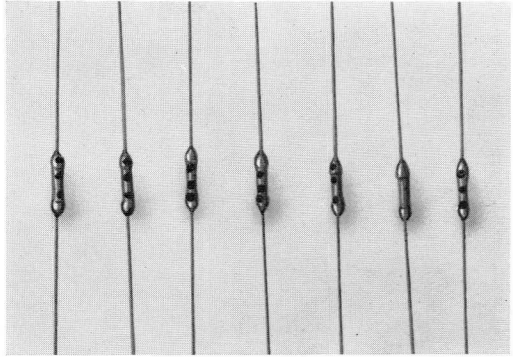

Resistance range:

$10\ \Omega$ — $10\ \text{M}\Omega$ ($\pm 10\%$ or $\pm 5\%$)
(see "Insulated cracked-carbon resistors", page 20).

W_{max} at $40\ ^\circ\text{C}$: 0.2 W.

W_{max} at $70\ ^\circ\text{C}$: 0.1 W.

E_{peak} : max. 100 V.

Type number:

B8 305 00A/xxx (tolerance = $\pm 10\%$), or

B8 305 00B/xxx (tolerance = $\pm 5\%$).

For detailed information and colour code, see data sheet EP 1109(3).

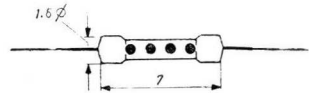

Low-power wire-wound resistors

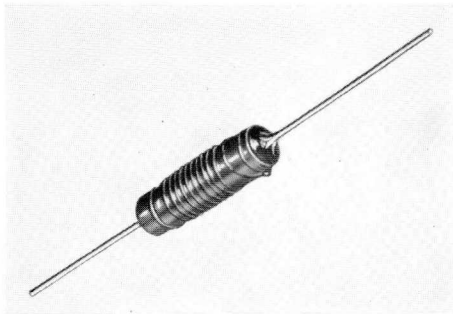

These resistors meet the want for low-power resistances of values lower than those provided by carbon resistors — a want that exists in modern transistor circuitry.

The resistance wire is wound in a single layer around a ceramic tube and covered with a green lacquer as a seal against moisture and mechanical damage.

Resistance range: 0.10 — $10\ \Omega$
($\pm 10\%$).

W_{max} at $40\ ^\circ\text{C}$: 2.6 W.

W_{max} at $70\ ^\circ\text{C}$: 2 W.

Type number: E104AA/Axxx.

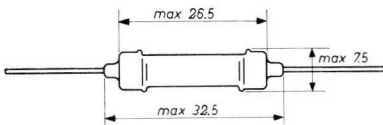

For detailed information and full type-range, see data sheet EP 1021.

Load resistors 5.5 - 16 W

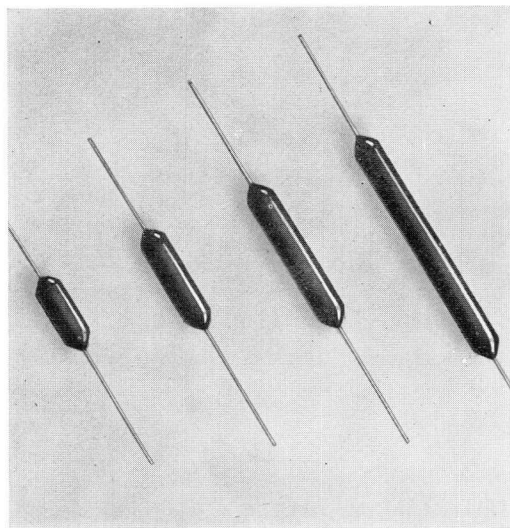

These lightweight, brown-enamelled, wire-wound resistors have been designed with the main object of obtaining maximum reliability and great mechanical strength, so that a prolonged service life is ensured.

Resistance range:
from R_{\min} up to R_{\max} , according to the tables below.

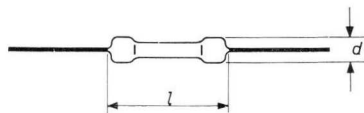
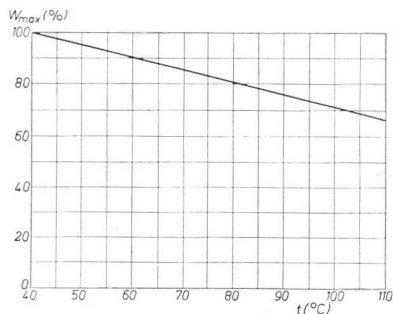

TABLE 1

W_{\max} at 40 °C W	Type number xxx: see table 2	Tolerance %	R_{\min} Ω	R_{\max} Ω	E_{peak} V	l mm
5.5	83540B/xxx	± 5	4.7	15,000	400	20
8	83541B/xxx	± 5	4.7	33,000	725	29
10	83542B/xxx	± 5	10	56,000	1,050	43
16	83543B/xxx	± 5	15	100,000	1,800	66



The percentage of W_{\max} permissible at higher ambient temperatures t .

TABLE 2

R_{nom} Ω	Indi- cation xxx	R_{nom} Ω	Indi- cation xxx	R_{nom} Ω	Indi- cation xxx	R_{nom} Ω	Indi- cation xxx	R_{nom} Ω	Indi- cation xxx	R_{nom} Ω	Indi- cation xxx
4.7	4E7	27	27E	150	150E	820	820E	4,700	4K7	27,000	27K
5.6	5E6	33	33E	180	180E	1,000	1K	5,600	5K6	33,000	33K
6.8	6E8	39	39E	220	220E	1,200	1K2	6,800	6K8	39,000	39K
8.2	8E2	47	47E	270	270E	1,500	1K5	8,200	8K2	47,000	47K
10	10E	56	56E	330	330E	1,800	1K8	10,000	10K	56,000	56K
12	12E	68	68E	390	390E	2,200	2K2	12,000	12K	68,000	68K
15	15E	82	82E	470	470E	2,700	2K7	15,000	15K	82,000	82K
18	18E	100	100E	560	560E	3,300	3K3	18,000	18K	100,000	100K
22	22E	120	120E	680	680E	3,900	3K9	22,000	22K		

Carbon potentiometers 23 ø

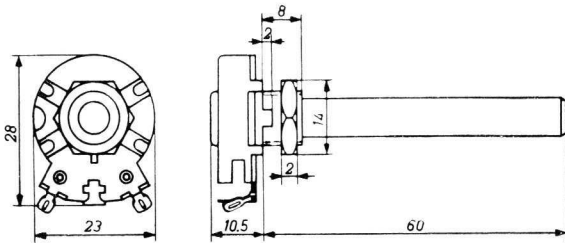
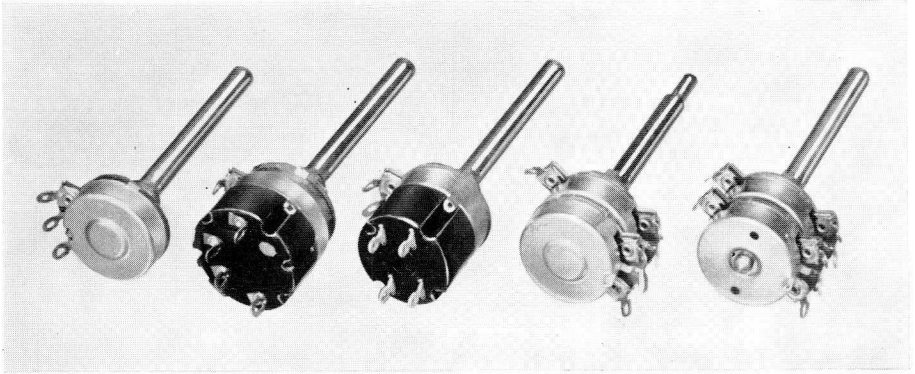

Mounting holes:

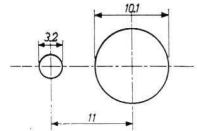

These potentiometers satisfy the ever growing demand for first-rate, yet moderately priced, resistance controls of reduced dimensions. Notwithstanding the small size, the construction is quite rugged and warrants a fully satisfactory operation for many years, whilst the electrical properties are outstanding.

The track noise is exceptionally low and will not show any perceptible increase after prolonged use, even under adverse climatic conditions.

The standard spindle design is plain, diameter 6 mm or 1/4", and length 60 mm. Other spindle lengths and designs on demand.

Standard resistance values ($\pm 20\%$):

Linear (0.25 W)	Logarithmic (0.125 W)
300 Ω	300 Ω
1 k Ω	1 k Ω
2	2
5	5
10	10
20	20
50	4 + 16
100	50
200	100
500	200
1 M Ω	40 + 160
0.4 + 0.6	500
2	50 + 450
	1 M Ω
	0.1 + 0.9
	0.2 + 0.8
	2
	0.2 + 1.8
	0.4 + 1.6

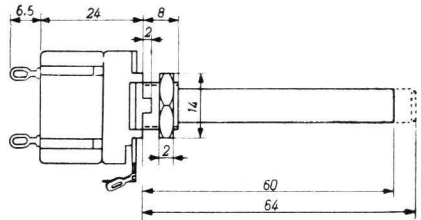
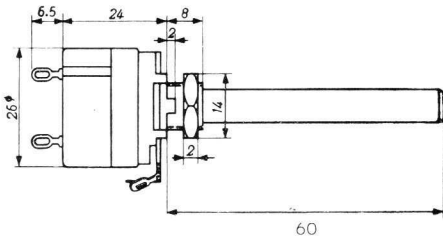

The potentiometers are available with internationally approved double-pole mains switches, either the well-known **rotary switches** or **push-pull items** of

a very efficient and advanced design and operating independent of the resistance control.

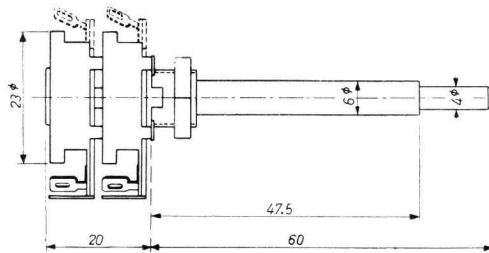

Twin potentiometers meet the demand for combined controls with duplex knob operation. Virtually, they are composed of independent items, mounted one on top

of the other. The lower one is operated by means of a hollow spindle, and the upper one by means of a protruding coaxial spindle.

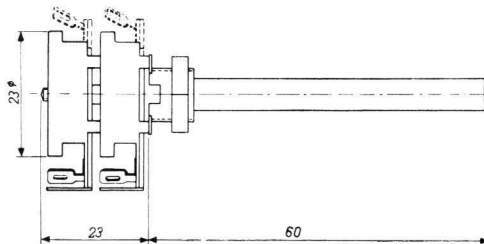

Tandem potentiometers for stereophonic recording and reproduction are likewise available. The two items, having identical resistance values and gradings, are paired by mounting on one spindle. Their low disparity ensures adequate

equality of the two signals both in volume and tone.

For current standard resistance ratings, see the table on page 23.

Carbon trimming potentiometers

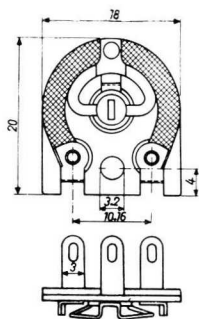
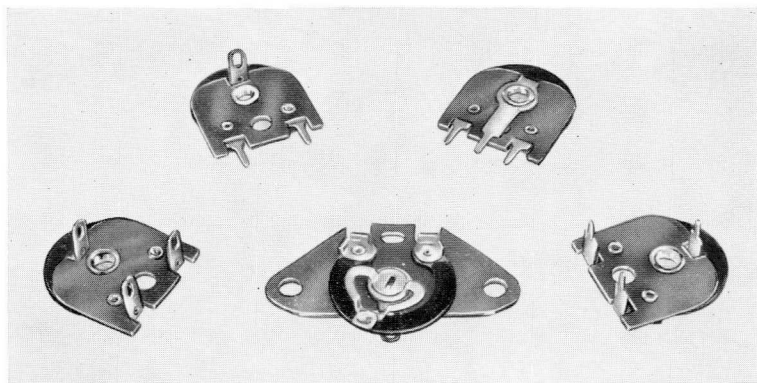

E097AA/xxx

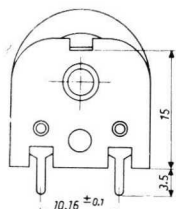

E097AB/xxx

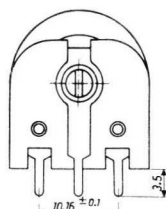

E097AC/xxx

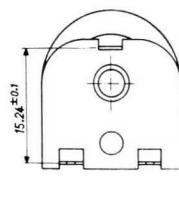

E097AD/xxx

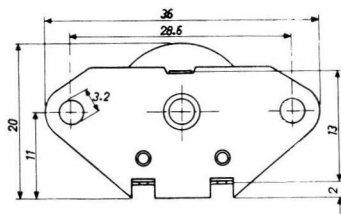

E097AE/xxx

These extremely simple, yet stout and efficient, potentiometers satisfy the needs — particularly in the TV sector — for pre-set resistance controls with facilities for casual adjustments with a screwdriver. Five versions are available for various modes of mounting and connection, including the printed-wiring technique. The resistance variation as a function of runner rotation is linear.

Standard resistance values ($\pm 20\%$):
0.5, 1, 2, 5, 10, 20, 50, 100, 200, 500 k Ω ,
1 and 2 M Ω .

NTC resistors ("thermistors")

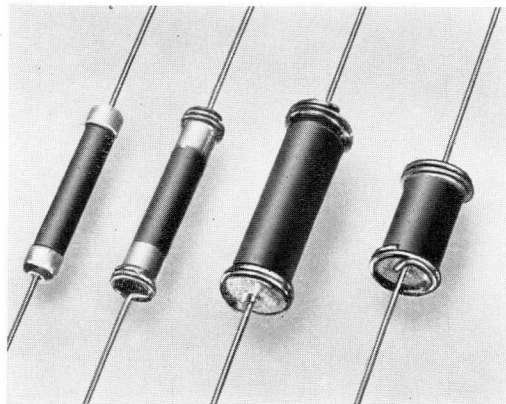

"NTC" resistors are distinguished from other resistors by the *high Negative Temperature Coefficient*, of their resistance (-3 to $-6\frac{1}{2}\%$ per $^{\circ}\text{C}$), i.e. a rapid drop in resistance value when the working temperature rises. In A.C./D.C. radio sets and in TV receivers using series heater connection, "NTC" resistors are widely used for protecting filaments and dial lamps against current surges shortly after switching-on, and to prevent the set from becoming non-operative when a dial lamp in the filament chain happens to burn out.

Another application for "NTC" resistors in radio and TV sets is compensating the increase in resistance due to temperature rise in certain components such as focus coils and deflection coils (compensation of picture-height shrinkage).

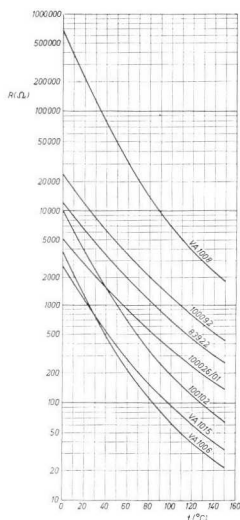
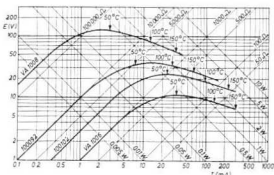
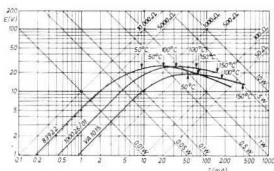
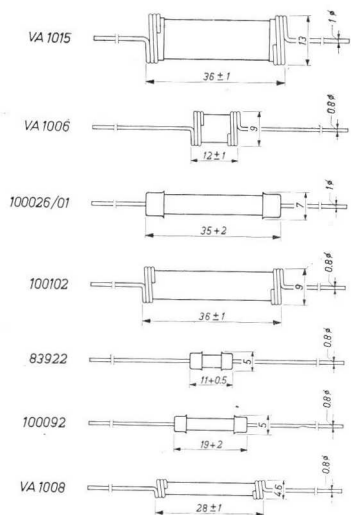

Type number	W_{\max} W	Normal operating conditions		Dissipation constant $\text{mW}/^{\circ}\text{C}$	Recovery time sec	Weight g
		mA	Ω			
VA 1015	6	300	35–48	60	450	15
VA 1006	2	200	36–52	16	150	2.6
100026/01	3	100	200–250	20	190	4.6
100102	4	300	38–50	24	285	6
83922	3	200	60–90	10	110	1.2
100092	3	100	200–280	10	140	1.6
VA 1008	2	10	7,200–10,800	14	90	1.1

For detailed information see data sheet EP 1510(2). Other standard series of NTC resistors are the **miniature types** (data sheet EP 1501), the **disc types** (data sheet EP 1505) and the **B8 rod types** (data sheet EP 1506).

The essential property of these ceramic resistors is that any increase of the voltage applied immediately causes a substantial decrease in resistance value, i.e. their current-voltage characteristic is by no means linear. Fig. 1 shows a typical example of such a graph on a linear scale. In fig. 2 the graph is plotted on a double-logarithmic scale.

Both for professional and non-professional purposes (e.g. telecommunications and TV respectively) VDR's are extremely adequate stabilizing and protective elements against voltage, load and frequency variations.

VDR's are supplied in the form of discs (fig. 3) or rods (fig. 4). The standard types quoted below are mainly used in the TV sector. The load permissible at an ambient temperature of 70 °C is max. 1 W in the case of the rods, and max. 0.5 W for the discs.

The working temperature may not exceed 150 °C.

Voltage-dependent resistors (VDR - "varistors")

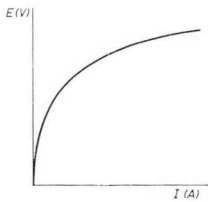
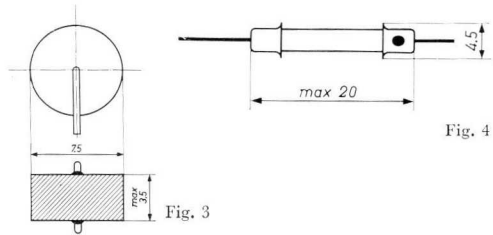
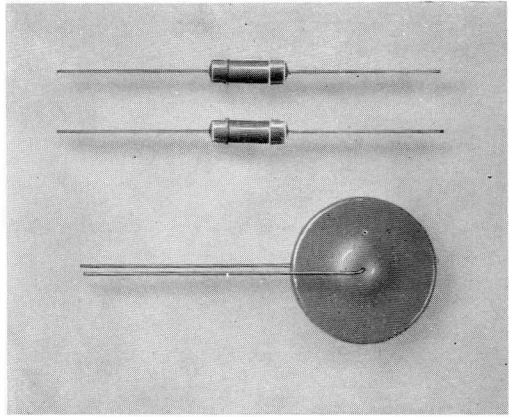

Fig. 1

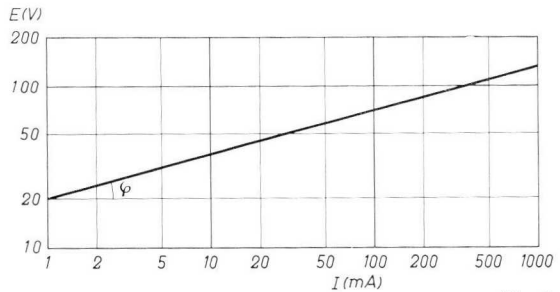

Fig. 2

Rod-type VDR's			
Type number	Voltage at 10 mA	Tolerance	Colour dot
E298GD/A258	470 V	±10%	green
GD/A260	560	±10%	blue
GD/A262	680	±10%	violet
GD/A265	910	±10%	white
ED/P268	1,200	±20%	grey
ZZ/01	950*	±10%	tan

Disc-type VDR's			
Type number	Voltage at 1 mA	Tolerance	Colour dot
E299CC/P340	82 V	±20%	yellow
E299CC/P342	100	±20%	red
VD 9010	**		—

* At 2 mA.

** When 100 V is applied to these resistors, the current will be between 60 and 120 μA.

TUBE SOCKETS

To ensure the reliability of any electronic equipment, a permanently good electrical contact between the tubes and the circuit is of paramount importance. It is the task of the sockets to provide adequate and lasting contacts. Therefore, very high requirements have to be imposed on their design and qualities, both electrical and mechanical. Even the best tube will not behave better than its socket will allow it to do!

The sockets for radio and TV tubes have been designed with the aim to obtain optimum performance at an attractive price. According to the application, the insulating material is either resin-bonded paper, synthetic resin or ceramics.

Sockets for tubes with noval base (B9A)

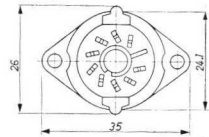
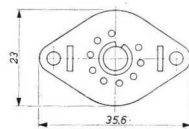
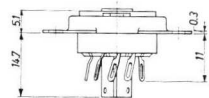
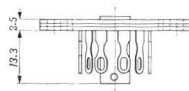
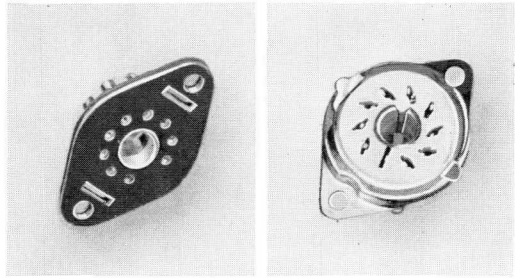

Resin-bonded paper
Type number:
B8 700 03

Ceramics
Type number:
B8 700 19

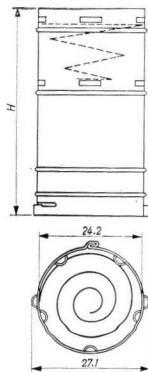
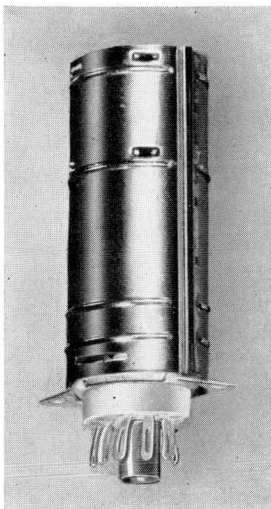

Screen cans of tin-plated steel,
suitable for B8 700 19:

$H = 41$ mm,
type number: B8 700 54

$H = 52$ mm,
type number: B8 700 55

$H = 57.5$ mm,
type number: B8 700 56

$H = 63$ mm,
type number: B8 700 57

$H = 74$ mm,
type number: B8 700 58

Sockets for miniature and sub-miniature tubes (B7G-B8D)

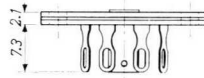
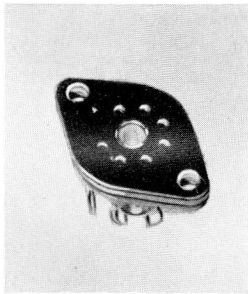

Resin-bonded paper

Type number:

B8 700 00

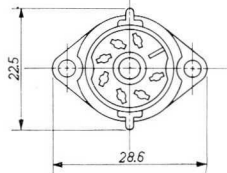
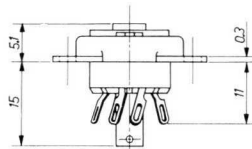
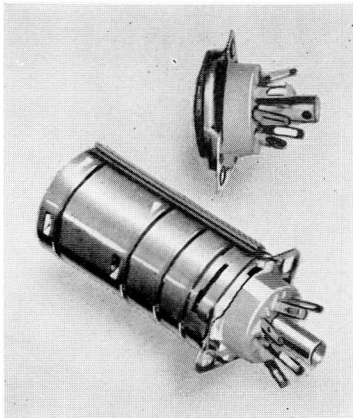
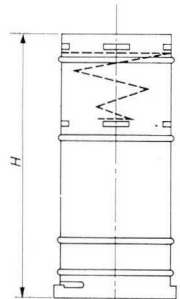
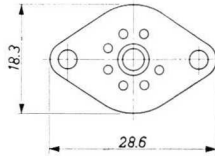

Ceramics
Type number: 5909/36

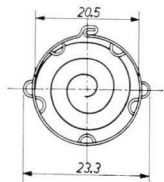

Screen cans of tin-plated steel,
suitable for 5909/36:

$H = 41$ mm,
type number: B8 700 06

$H = 52$ mm,
type number: B8 700 07

$H = 57.5$ mm,
type number: B8 700 08

$H = 63$ mm,
type number: B8 700 09

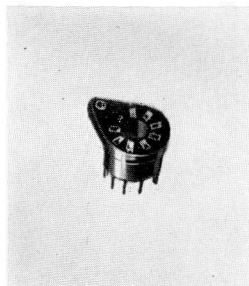

Synthetic resin

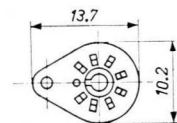
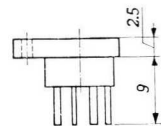

Type number: 5907/23

Sockets for tubes with rimlock base (B8A)

For detailed information see data sheet EP 3410/2.

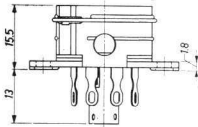
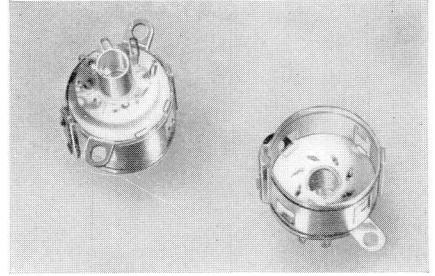
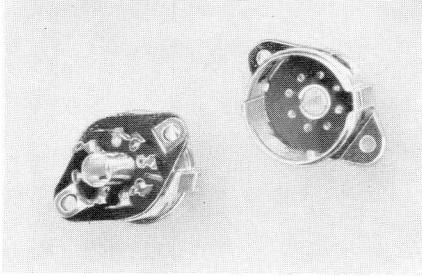

Resin-bonded paper
Type number:
5904/01

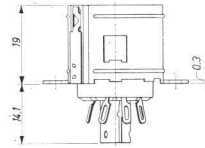
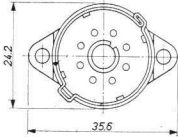

Ceramics
Type number:
5904/36

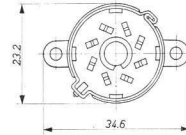

Sockets for tubes with octal base

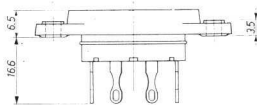
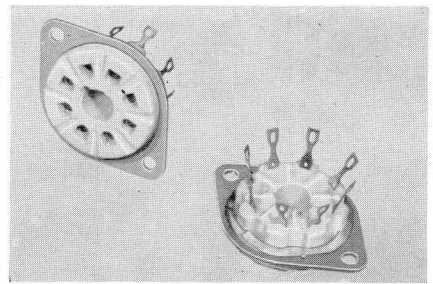
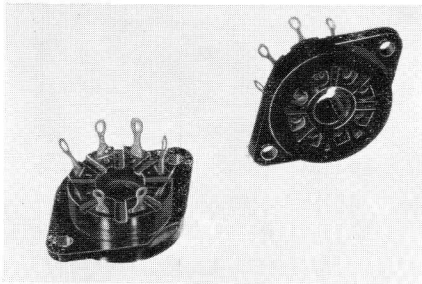

Synthetic resin
Type number:
5903/12

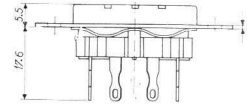
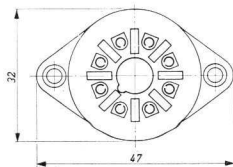

Ceramics
Type number:
5903/13

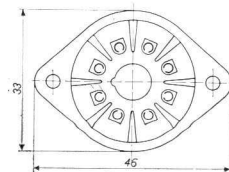

Sockets for tubes with loctal base (B8G-B9G)

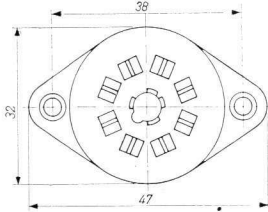
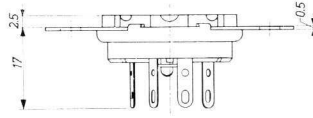
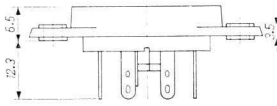
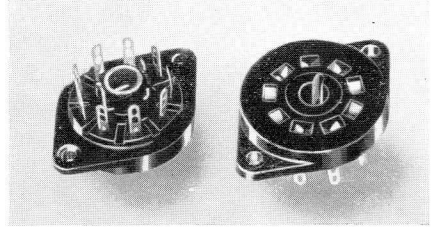
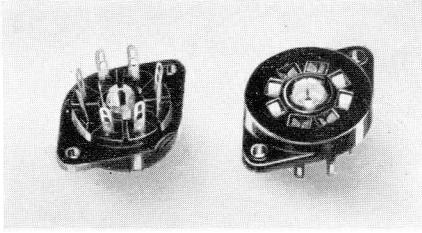

Synthetic resin
Type number:
5902/20

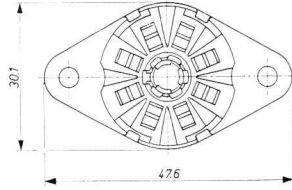

Synthetic resin
Type number:
5906/20

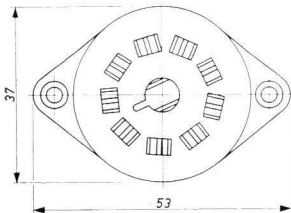
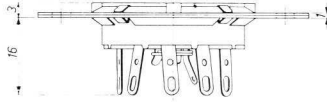
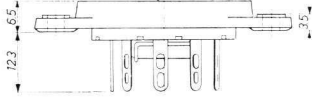
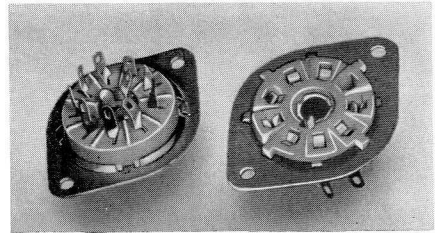
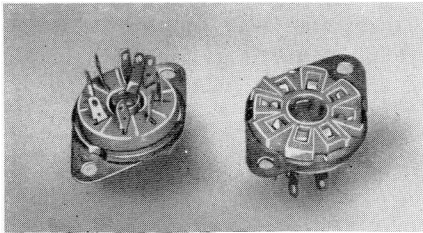

Ceramics
Type number:
40213

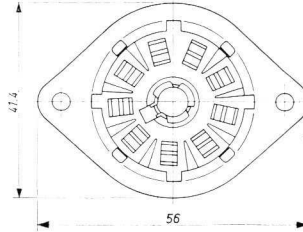

Ceramics
Type number:
40212

For detailed information see data sheet EP 3411/2.

Sockets for TV picture tubes 110°

For detailed information see data sheet EP 3412(2).

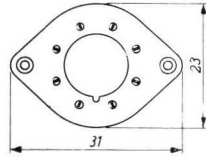
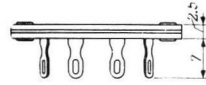
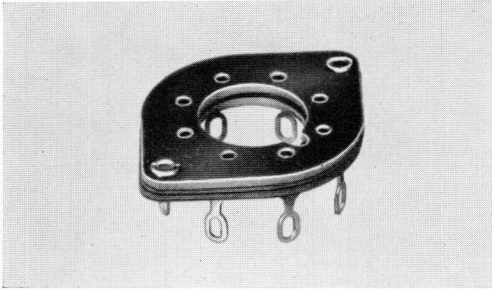

Resin-bonded paper
Type number:
B8 700 63

Sockets for printed-wiring boards

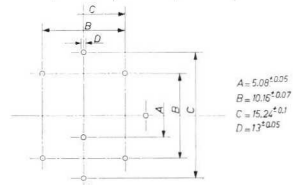
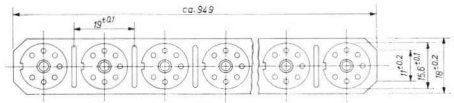
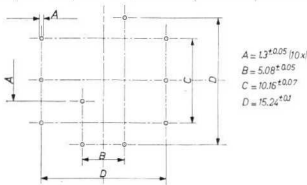
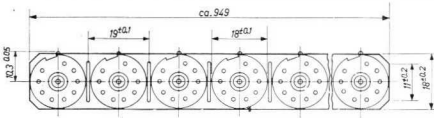
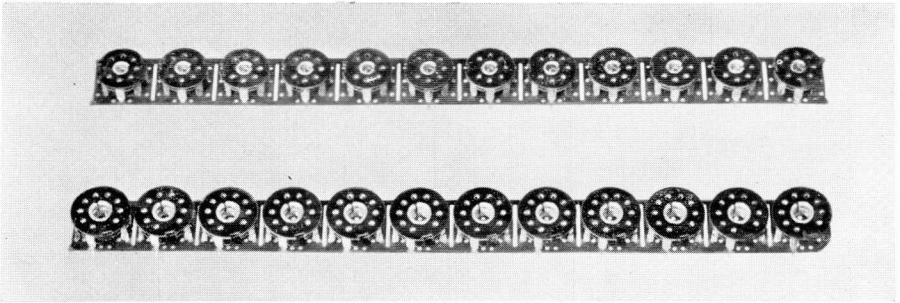

For use in conjunction with printed-wiring boards, a 7-pins and a 9-pins socket of resin-bonded paper are available, suitable for a 0.1 inch grid.

They are mounted on strips containing 50 sockets per strip, which makes them eminently suitable for automatic-insertion machines.

Type number in the case of noval sockets:
B8 700 49/50.

Type number in the case of miniature sockets:
B8 700 46/50.

As these strips are packed in boxes containing 1,000 sockets, this is the minimum supply quantity.

Variable transformers

Variable transformers provide a relatively inexpensive means of regulating low-frequency alternating voltages. As compared with resistors, they have the paramount advantage of low energy losses, and an almost unlimited life; unlike tapped transformers, they permit accurate adjustment. They are extremely easy to operate and require a minimum of maintenance. From the wealth of applications, two principal uses emerge:

- a. adjusting varying A.C. voltages to their nominal value;
- b. transforming A.C. supply voltages to a liberal value between 0 and 120% of their actual value.

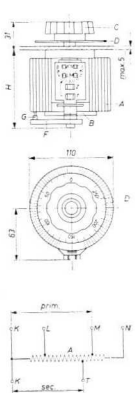
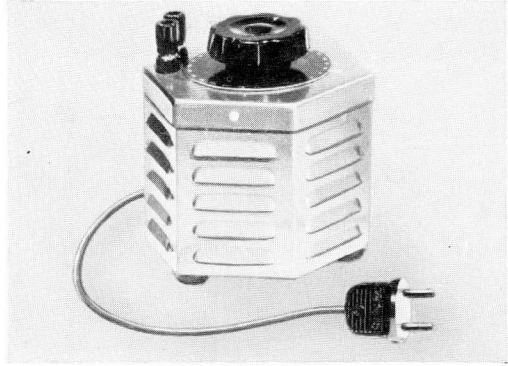

Fig. 1

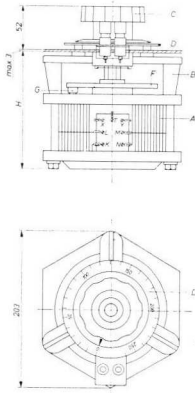

Fig. 2

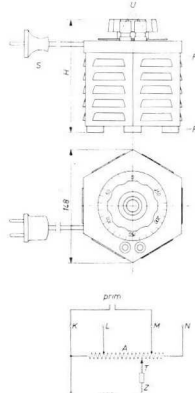

Fig. 3

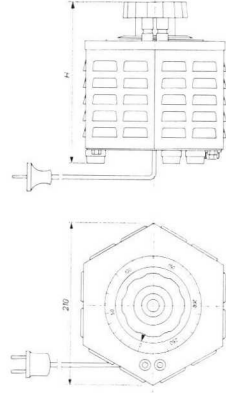

Fig. 4

Nominal primary voltage (50-60 c/s) V	Output rating VA	Nominal secondary voltage V	Nominal secondary current A	Max. no-load losses W	Panel mounting				Bench mounting			
					Type number	Fig.	H mm	Weight kg	Type number	Fig.	H mm	Weight kg
130 (110)	345 (318)	0-150 (0-127)	2.3 (2.5)	3	84525/01	1	100	3	84524/01	3	150	3.8
	675 (635)		4.5 (5)	6	84529/01	1	120	4	84528/01	3	170	4.9
	1,350 (1,270)		9 (10)	9	84533/01	2	150	9	84532/01	4	215	10.7
220	260	0-260	1	3	84527/01	1	100	3	84526/01	3	150	3.7
	520		2	4	84531/01	1	120	4	84530/01	3	170	4.8
	1,040		4	7	84535/01	2	150	9	84534/01	4	215	10.5
	2,080		8	12.5	84537/01	2	175	12	84536/01	4	240	13.2

LOUDSPEAKERS

This loudspeaker programme provides a suitable type for any kind of radio and TV set, radiogram and amplifier. All speakers are of a sturdy and reliable tropic-proof construction. They are equipped with powerful magnet-systems which combine small dimensions with high flux density.

Sensitivity

There are 3 sensitivity classes, viz:

Class 1: attractively priced, yet efficient light-weight speakers.

Class 2: loudspeakers offering a favourable compromise between weight, price and sensitivity.

Class 3: loudspeakers with maximum sensitivity.

Versions

.../M Bi-cone speakers, reproducing the whole frequency spectrum from fundamental resonance up to 20 kc/s.

.../00 Speakers with a smooth response curve, low resonance-frequency and perfect high-note reproduction.

.../X Speakers with increased sensitivity between 1 and 4 kc/s.

.../Z Speakers with increased sensitivity between 1 and 3.5 kc/s, with a "cut-off" at 4 kc/s.

The dimensions of the Universal and the Space-Economy speakers comply with the E.I.A. (formerly RETMA) specifications, so that the speakers can also be used as replacement units.

Universal range

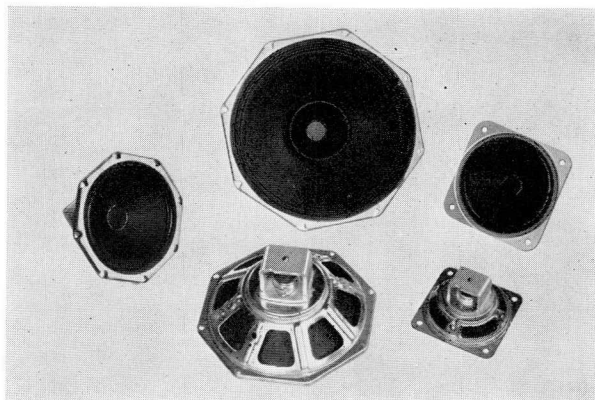

The speakers of any kind are also available in single packing.

Several speakers can be supplied with a voice-coil impedance of 400 Ω or 800 Ω .

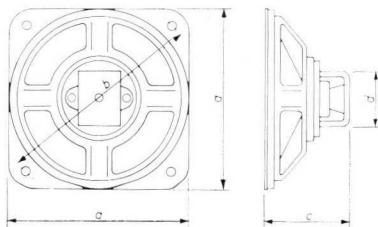

Fig. 1

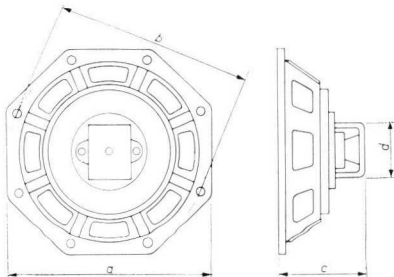

Fig. 2

	Type number	Power-handling capacity	Cone diam.	Voice coil impedance at 1 kc/s	Resonance frequency	Efficiency at 400 c/s	Total magnetic flux	Flux density	Fig.	<i>a</i>	<i>b</i>	<i>c</i>	<i>d</i>	
		W		Ω	c/s	%	maxw.	gauss		mm	mm	mm	mm	
CLASS 1	AD 1300 1300Z	2	3"	3	230 275	1 1.6	9,500	6,800	1	80	92	43	33	
	AD 1400 1400Z	3	4"	3	165 185	1.8 2	9,500	6,800	1	105	119	50.2	33	
	AD 1500 1500X 1500Z	3 6 3	5"	3	130 130 160	1.1 1.3 2.5	9,500	6,800	2	121	119	52.5	33	
	AD 1700 1700X 1700Z	3 6 3	7"	3	90 110 130	1.1 1.4 2.2	9,500	6,800	2	155.1	156	62	33	
	AD 1800 1800X	6	8"	3	75 95	1.5 2	9,500	6,800	2	191.6	194	72.5	33	
	AD 2200Z	1	2"	3	300	1.5*	12,100	6,500	1	63.5	74.2	23.2	39	
CLASS 2	AD 2300 2300Z	2	3"	3	230 275	2 3.5	15,800	8,500	1	80	92	54.8	43	
	AD 2400 2400Z	3	4"	3	165 200	3.6 4	15,800	8,500	1	105	119	62	43	
	AD 2500 2500X 2500Z	3 6 3	5"	3	130 130 160	1.8 2 4	15,800	8,500	2	121	119	64.3	43	
	AD 2700 2700M 2700X 2700Z	3 3 6 3	7"	5	90 90 110 130	2 2 2.5 4	15,800	8,500	2	155.1	156	72.8	43	
	AD 2800 2800M 2800X	6	8"	5	75 75 95	3 3 4	15,800	8,500	2	191.6	194	83.1	43	
	CLASS 3	AD 3500 3500M 3500X 3500Z	3 3 6 3	5"	5	130 130 130 155	4 4 4.5 8	26,200	11,000	2	121	119	69.3	53
		AD 3700 3700M 3700X 3700Z	3 3 6 3	7"	5	90 90 110 130	6 6 6.5 8	26,200	11,000	2	155.1	156	79	53
		AD 3800 3800M 3800X	6	8"	5	75 75 95	6 6 8	26,200	11,000	2	191.6	194	89.1	53

*) At 800 c/s.

For detailed information and full type-range, see data sheet EP 7501.

Space-economy range

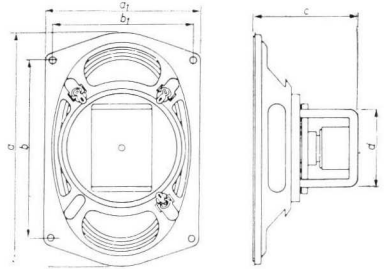
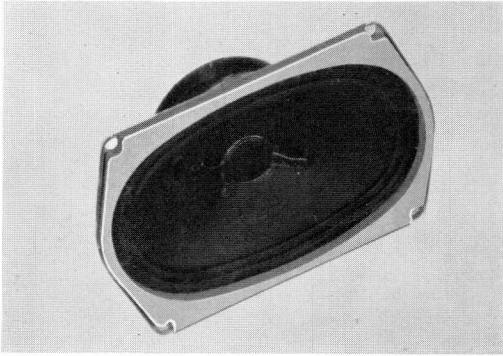
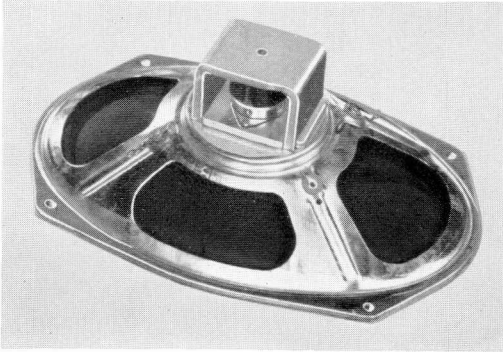

	Type number	Power-handling capacity W	Cone size	Voice-coil impedance at 1 kc/s Ω	Resonance frequency c/s	Efficiency at 400 c/s %	Total magnetic flux maxw.	Flux density gauss	a mm	a_1 mm	b mm	b_1 mm	c mm	d mm								
CLASS 2	AD 2460	3	4"×6"	5	130	1.8	15,200	8,500	155	103	117.5	92	64	43								
	2460M	3				1.8																
	2460X	6				2																
	AD 2690	6	6"×9"	5	80	2.5									15,200	8,500	234	161	167	118	84	43
2690M				80	2.5																	
2690X				100	3																	
CLASS 3	AD 3460	3	4"×6"	5	113	4	26,200	11,000	155	103	117.5	92	70	53								
	3460M	3			130	4																
	3460X	6			130	4.5																
	3460Z	3	155	6																		
	AD 3690	6	6"×9"	5	80	5.5									26,200	11,000	234	161	167	118	90	53
	3690M				80	5.5																
3690X				100	6																	

Master range

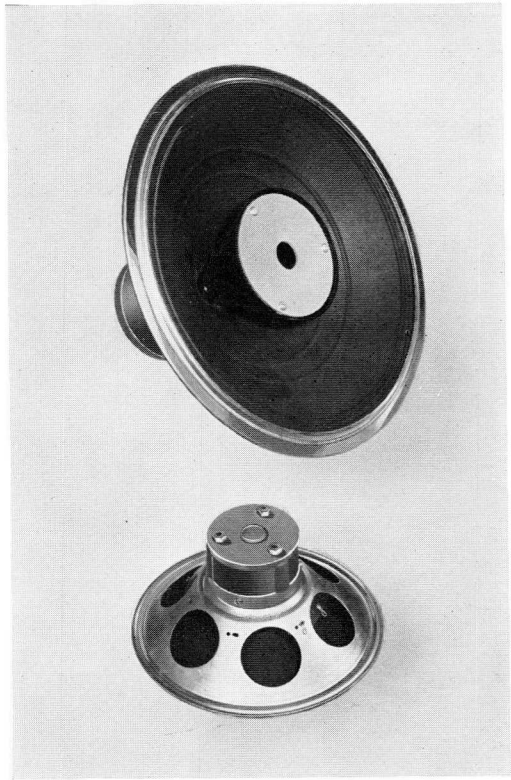
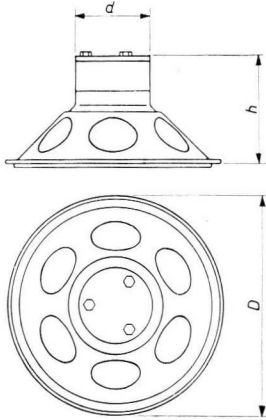

Type number	Power-handling capacity W	Cone diam.	Voice-coil impedance at 1 kc/s Ω	Resonance frequency c/s	Efficiency at 400 c/s %	Total magnetic flux maxw.	Flux density gauss	D mm	h mm	d mm
9750 9750/05 9750M	6	8"	5	60	10	58,300	13,000	216	123	74 ϕ
9710 9710M	10	8"	7	50	4.5	97,600	8,000	216	116	74 ϕ
9758 9758/05 9758M	10	10"	7	50	6	97,600	8,000	260	130	74 ϕ
9760 9760/05 9760M	20	12"	7	45	7	97,600	8,000	320	150	74 ϕ
9762 9762/05 9762M	20	12"	7	45	14	134,000	11,000	320	165	92 ϕ

Output transformers

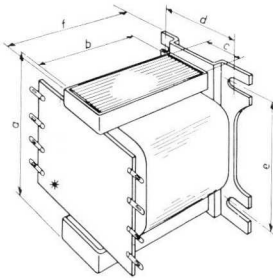
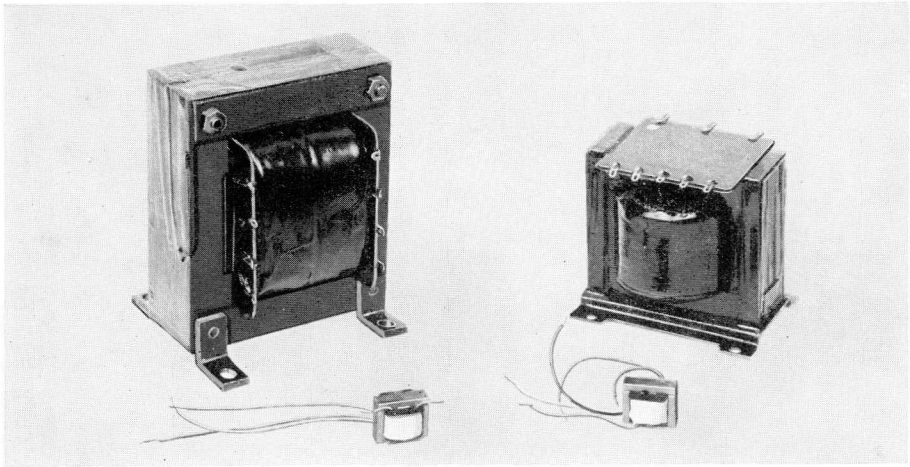

	<i>a</i>	<i>b</i>	<i>c</i>	<i>d</i>	<i>e</i>	<i>f</i>
	mm					
AD 9008	40	32	16	36.5	38	41
9009	75	62.5	25	47	62.5	71.5
9010	40	32	16	36.5	38	41
9012	50	40	20	41	45.5	49
9018	50	40	20	41	45.5	49
9019	50	40	20	41	45.5	49
9020	50	40	20	41	45.5	49
9022	40	32	16	36.5	38	41

Star features:

- Suitability for use with the most current tubes and circuits.
- Very high efficiency.
- High copper-space factor and stable construction, due to compressed coils.
- Moisture-repellent, plastic-insulated coils.
- Special impregnation avoids burn-outs.
- Low distortion and flat frequency-response curve.
- Tropic-proof.

The push-pull transformers AD 9009, AD 9015, AD 9019 and AD 9021 have symmetrical windings in order to obtain identical halves as regards inductance, capacitance and D.C. resistance.

AD 9021 is intended for distributed-load circuits.

AD 9009 and AD 9020 are suitable for Hi-Fi equipment.

AD 9014 and AD 9015 have been designed for transistor circuits.

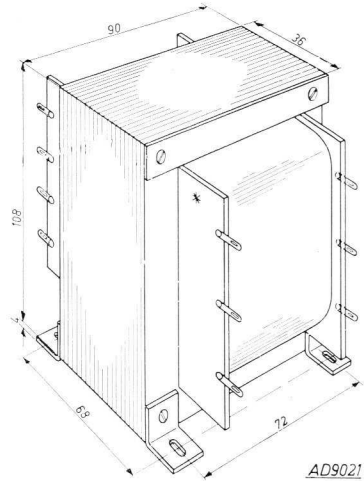
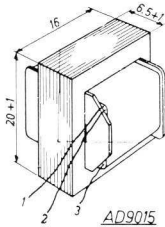
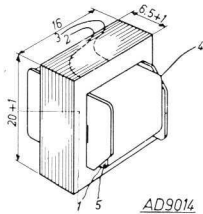
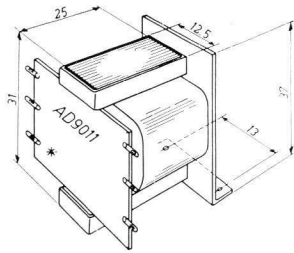

Type	AD 9008	AD 9009	AD 9010	AD 9011	AD 9012	AD 9014	AD 9015	AD 9018	AD 9019	AD 9020	AD 9021	AD 9022	
Primary impedance	5,400	8,000	9,000	2,400-5,400	5,400	—	360	2,400	8,000	5,400	6,600	2,400	Ω
Secondary impedance	3-5	7-14	3-5	3	3-5	—	3	3-5	3-5-7	3-5	7-14	3-5	Ω
Tubes (transistors)	ECL 82 UCL 82	2 × EL 84	EL 95	ECL 82 UL 84 UCL 82	ECL 82 UCL 82 EL 84	OC 71	2 × OC 72	UL 84	2 × ECL 82 2 × EL 84	EL 84	2 × EL 34	UL 84	
Power	3	15	3	3	6	—	0.2	6	12	6	30	3	W
Efficiency at 400 c/s	75	88	76	75	76	70	85	75	80	76	85	82	%
Extra windings: anti-hum (% of N _{prim}) feed-back (% of N _{sec})	10 —	— —	3.4 300	5 —	— 109	— —	— —	2.3 74	— —	— 112	— —	— 77	% %
Transformation ratio	45-34	36-24	60-42	29-42	46-33	1	11	31-22	2-40-34	46-33	31-21	29-22	
Primary inductance	10	28	10	3.4	10	10	0.6	6.5	40	10	30	2.5	henry
D.C. bias magnetization	36	5	25	36	70	1	—	70	—	70	—	65	mA
Primary resistance	550	420	600	400	520	400	16	320	230	540	270	200	Ω
Frequency response between -3 dB points (reference 1,000 c/s)	50-10,000	40-40,000	100-16,000	60-15,000 120-30,000	50-10,000	20-40,000	45-35,000	45-10,000	35-20,000	40-20,000	20-60,000	60-15,000	c/s
Distortion is 1% at	60	30	110	70-110	75	70	160	55	75	65	60	75	c/s
Core height	32	62.5	32	25	40	16	16	40	40	40	108	32	
width	40	75	40	31	50	21	21	50	50	50	90	40	mm
depth	16	25	16	12.5	20	7.5	7.5	20	20	20	36	16	

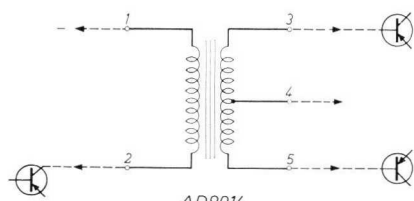
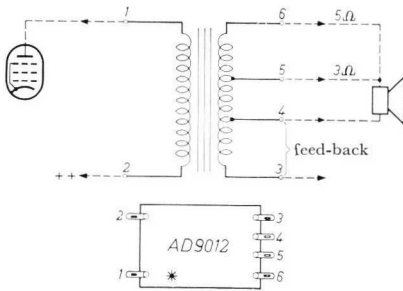
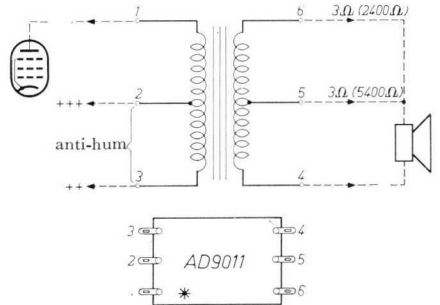
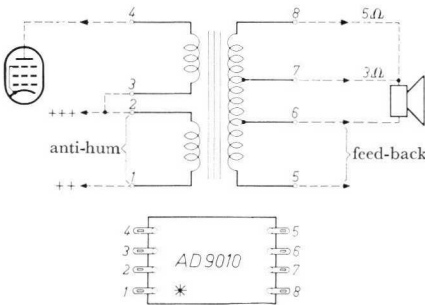
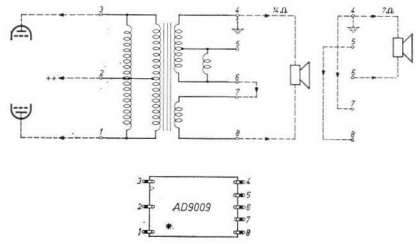
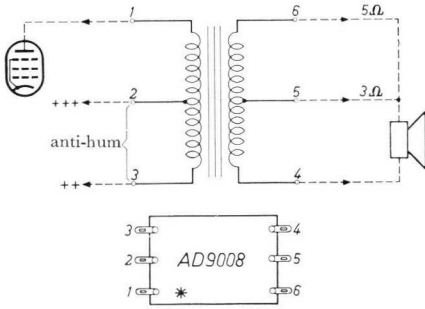

Terminal lead 1 = red
 2 = blue
 3 = yellow
 4 = black
 5 = green

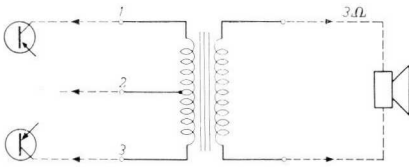

AD9075

Terminal lead 1 = brown
 2 = red
 3 = blue

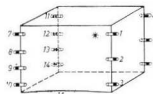
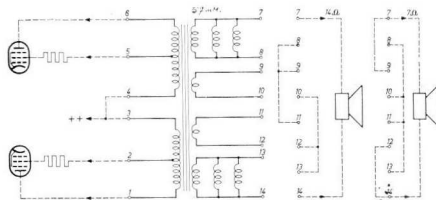
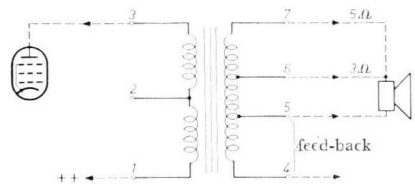
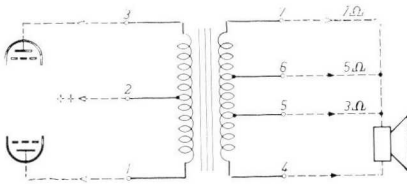
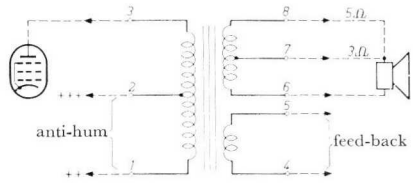

AD9021

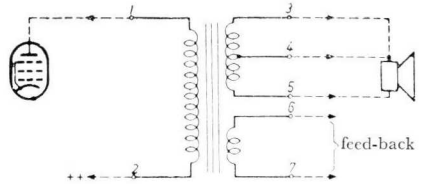

Permeability tuner AP 2106

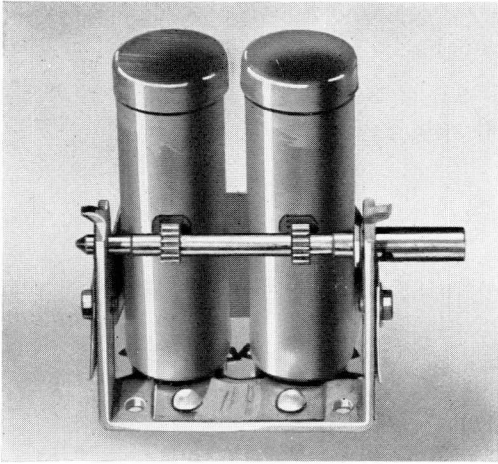

For detailed information see data sheet EP 7061.

This tuner can be applied for both medium and long wave reception. Thanks to the use of ferroxcube tuning slugs, a very smooth variation of the self-inductance is obtained.

For AC and AC/DC sets (tubes ECH 42 — ECH 81 — UCH 81).

Intermediate frequency: 456 kc/s.

Wave range: 508 — 1,620 kc/s.

Inductance of the aerial coil:

max. 1,500 μH — min. 150 μH .

Inductance of the oscillator coil:

max. 290 μH — min. 62 μH .

Quality factor of the aerial circuit:

70 (508 — 1,620 kc/s).

Oscillator current:

for ECH 42 : 400 — 500 μA .

for ECH 81 : 200 μA .

for UCH 81 : 200 μA .

Working temperature: max. 65 °C.

Permeability-tuned coils

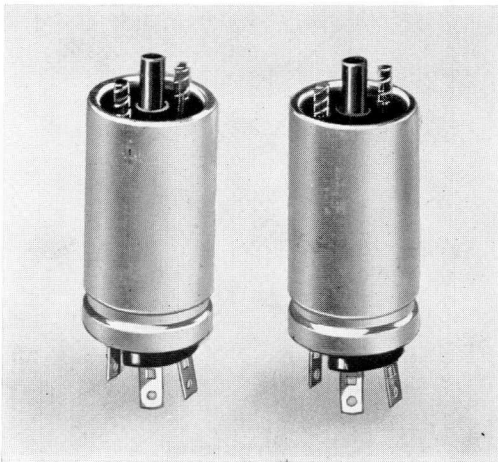

These coils have the same high quality as the ones used for the complete tuner AP 2106. They permit the setmaker to build permeability tuners with a tuning mechanism adapted to his own requirements.

Type AP 2108

Aerial coil/interstage RF coil.

Self-inductance: 150 ÷ 1,750 μH .

Intermediate frequency: 456 kc/s.

Type AP 2109

Oscillator coil.

Self-inductance: 45—245 μH .

Intermediate frequency: 456 kc/s.

FM Tuners

These tuners meet with very high quality standards. The circuitry has been carefully matched with the tube ECC 85. Special features are the low radiation and the very good tuning selectivity.

Type AP 2110: FM tuner with tube ECC 85 for European band.

Type AP 2110/01: FM tuner with tube ECC 85 for American band.

For specifications see page 44.

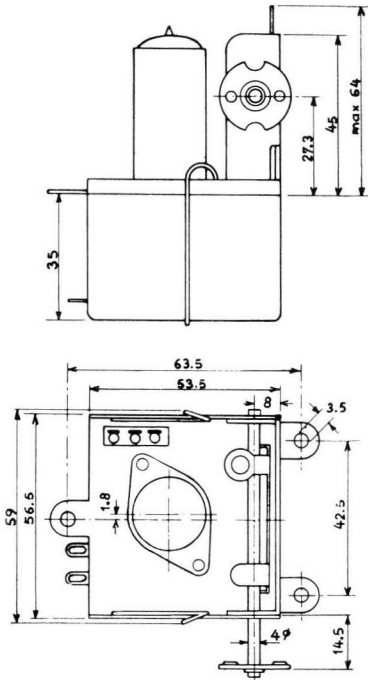
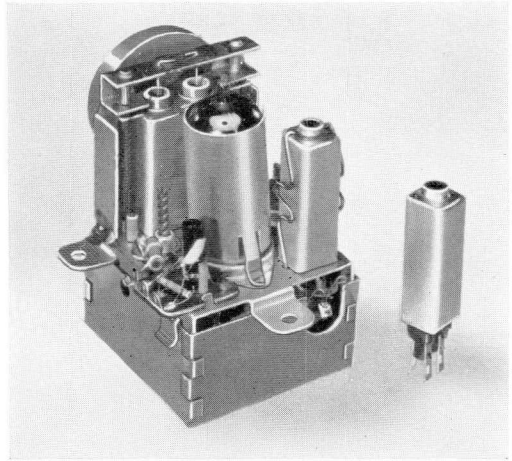

Stroke, 14.9 mm (1.44 turns = 518.4°).

	AP 2110	AP 2110/01
Wave range	87-100.5 Mc/s ± 150 kc/s	87-108.5 Mc/s ± 250 kc/s
Padding deviation	max. 0.5 Mc/s	max. 0.5 Mc/s
Total gain	min. 140 ×	min. 100 ×
IF band width	180-220 kc/s (3 dB)	180-220 kc/s (3 dB)
Frequency drift	max. 30 kc/s	max. 30 kc/s
Radiation: fundamental oscillation (measured at 30 m) second harmonic	max. 50 μ V/m max. 10 μ V/m	max. 50 μ V/m max. 10 μ V/m

IF band-pass filters AP 1001

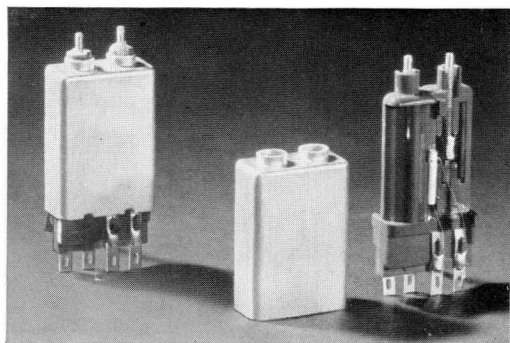

This filter is suitable for use in any receiver having an intermediate frequency between 435 and 483 kc/s, and where space saving is of prime importance. A high Q value goes combined with great stability of adjustment.

Since all the constituent components are housed in one casing, the overall stability is high, and the electrical separation between primary and secondary remains perfect in all climates.

Quality factor Q : 140.

kQ : 1.

Capacitance across primary: 110 pF.

Capacitance across secondary:
195 pF.

Average frequency drift: 5 c/s/°C.

Maximum working temperature:
85 °C.

Dimensions: 35 × 24 × 12 mm.

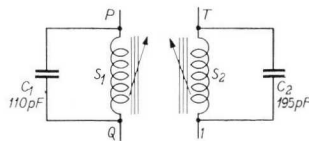

A version for use in conjunction with printed-wiring boards is also available.

Type number	Normal IF frequency*) in kc/s	Frequency limit**) in kc/s
AP 1001/41	441	435—454
AP 1001/52	452	446—464
AP 1001/70	470	464—483

*) Adjustable if the wiring capacitance does not exceed 17 pF, 18 pF and 19 pF respectively.

**) The filters can be adjusted to these values provided that the minimum wiring-capacitance is not below 5 pF for the lower, nor above 10 pF for the upper limit.

IF bandpass-filters AP 1014/52 and AP 1014/70

Based on the same principles as AP 1001 (see page 44).
Normal intermediate frequencies: 452 kc/s and 470 kc/s respectively.
Frequency limits: 446 — 464 kc/s and 464 — 483 kc/s.

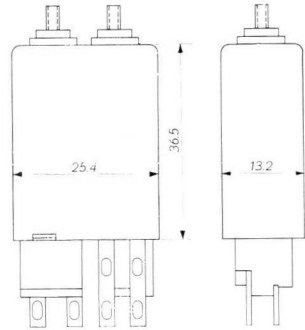

Quality factor Q	106
kQ	1.05
Capacitance across primary	110 pF
Capacitance across secondary	110 pF
Average frequency drift	6 c/s/°C
Max. working temperature	85 °C

FM bandpass-filter AP 1108/01 (10.7 Mc/s)

for use in conjunction with printed-wiring boards (orthodox version also available).



Ratio detector coil AP 1113/01 (10.7 Mc/s)

for use in conjunction with printed-wiring boards (orthodox version also available).

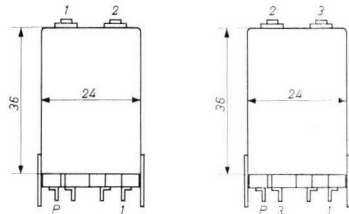

Mains transformers

Type AD 9027

Primary: 90, 110, 127, 145, 190, 220 V.
Secondary: 560 V with central tap (65 mA);
6.3 V with tap at 4 V (1.1 A); 6.3 V (2.5 A).

Type AD 9028

Primary: 90, 110, 125, 145, 200, 225, 245 V.
Secondary: 560 V with central tap (90 mA);
4 V (1.1 A); 2—4—6.3 V (3.5 A); 6.3—4 V
(1.1 A).

Type AD 9029

Primary: 90, 110, 125, 145, 200, 245 V.
Secondary: 650 V with central tap (130 mA); 4—6.3 V
(1.2 A); 6.3 V (4.5 A).

For detailed information see data sheets EP 7001/7002

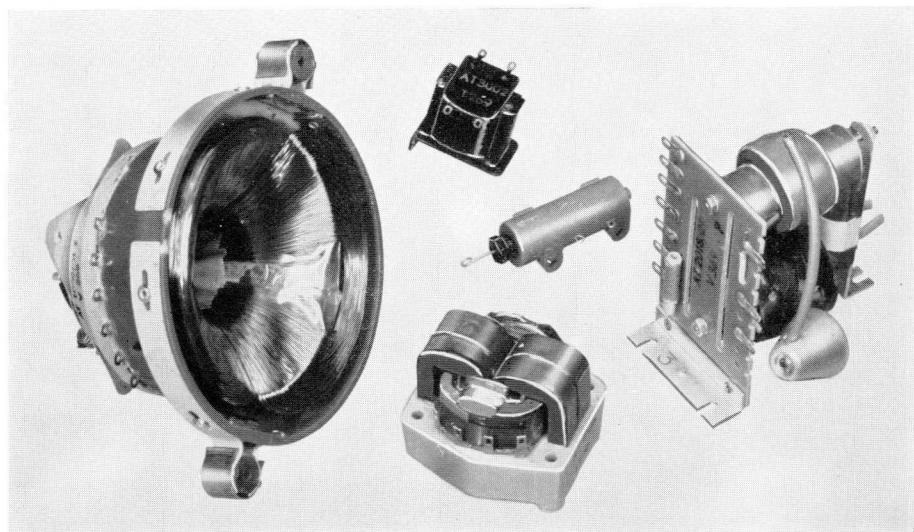

A complete set of components having an outstanding standard of quality is available for TV receivers 110°, either in the C.C.I.R. system (625 lines, 25 images per sec) or in the U.S.A. system (525 lines, 30 im. per sec).

Deflection unit AT 1009/01

Because of its sensitivity, picture geometry and sharpness, this deflection unit gives an excellent performance.

It is also obtainable without a built-in NTC resistor for the prevention of picture-height shrinkage; in that case the type number is AT 1009.

Line-output transformers AT 2018/20 and AT 2018/21

Although these transformers are very compactly built, all requirements in respect of the high voltages are complied with. The transformers can be used under all climatic conditions and at high altitudes. AT 2018/20: supply voltage 220 V, 21% flyback.

AT 2018/21: 200/220 V, flyback time 17%.

Appurtenant components such as rectifier sockets having a filament resistor incorporated, filament cables and EHT cables can also be supplied.

Frame-output transformer AT 3507 Frame-blocking transformer AT 3002

These transformers are suitable for time-base circuits which require no supply of booster voltage. The coils are compressed and a moisture-repellent insulator is used; the transformers can, therefore, be used under the most adverse climatic conditions. Thanks to the employment of a new and advanced technique, the frame-output transformer is remarkably small, light and inexpensive.

Adjustable linearity control AT 4008

This control features a range of regulation between -7% and +5%, easy adjustment and simple mounting. It is suitable for handling saw-tooth currents of up to 2.5 A.

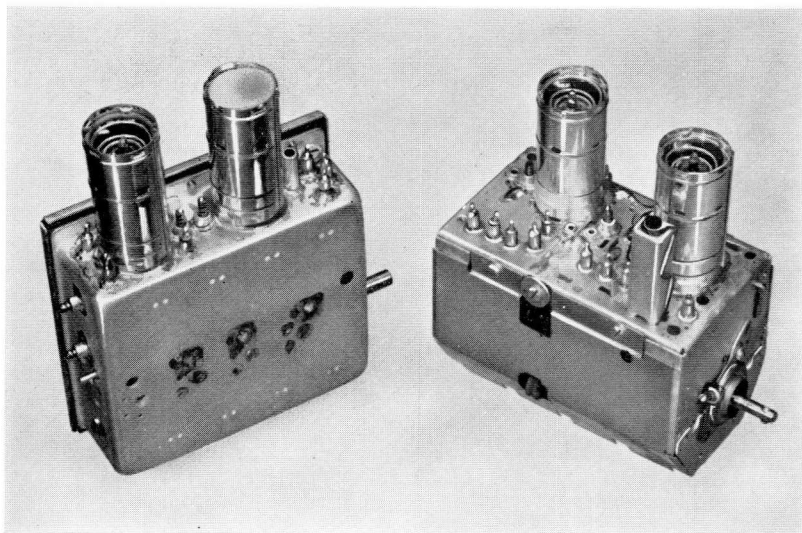

Channel selectors series AT 7635

These low-noise VHF tuners are equipped with a PCC 88 twin triode operating as a cascode RF amplifier, and a triode-pentode PCF 80 operating as an oscillator mixer. The AGC characteristics are outstanding, and the stability under variations of temperature and supply voltage is very high.

Various versions are available for different channel combinations.

Channel selectors series AT 6321

These items have been developed for the reception of TV signals in the bands IV and V, covering the frequency range between 470 Mc/s and 790 Mc/s.

The tuners are equipped with two triodes PC 86, which particularly meet UHF requirements. One tube is used as a self-oscillating mixer, and the other one is incorporated in a grounded-grid UHF amplifier.

The noise figures are better than 25 kTo at frequencies in the neighbourhood of 700 Mc/s.

Ferroxcube

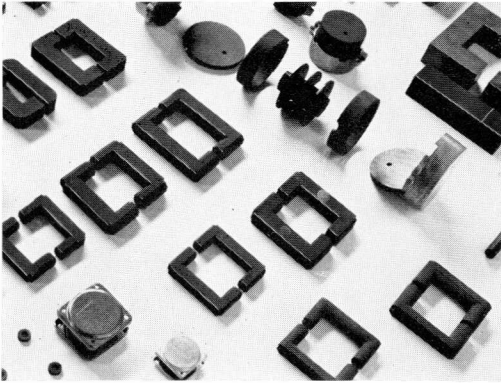

Ferroxcube is used as a core material in an abundance of applications in radio, TV and telecommunications engineering,

and in many other branches of the electronics domain. A few examples are:

Radio and television	Telecommunications	Other uses
Rod aerials IF band-pass filters RF transformers Permeability tuning Variable inductors Line-output transformers Deflection units Linearity correctors Amplitude adjusters Aerial coils	Loading coils Filter coils HF chokes Wide-band transformers Telecommunications transformers Power transformers Pulse transformers Delay lines	Tape-recorder heads Computer elements Magnetostrictive applications Noise-suppressors Micro-wave modulators High-frequency heating Frequency modulation Ignition coils

Ferroxcube is made in several grades, which should be used according to the application. The current range of aerial rods is listed below.

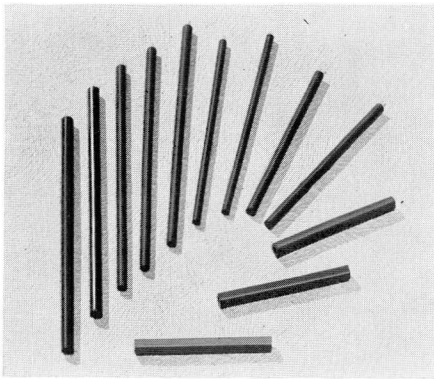

Type number	Dimensions (mm)
56 681 85/4B	$7.8\phi \pm 0.2 \times 100 \pm 2$
56 681 03/4B	$7.8\phi \pm 0.2 \times 140 \pm 3$
56 681 26/4B	$7.8\phi \pm 0.2 \times 203 \pm 4$
56 681 25/4B	$9.5\phi \pm 0.3 \times 100 \pm 3$
56 681 31/4B	$9.5\phi \pm 0.3 \times 160 \pm 4$
56 680 99/4B	$9.5\phi \pm 0.3 \times 203 \pm 4$
56 681 65/4B	$9.7\phi \pm 0.3 \times 100 \pm 3$
56 681 33/4B	$9.7\phi \pm 0.3 \times 120 \pm 4$
56 681 32/4B	$9.7\phi \pm 0.3 \times 160 \pm 5$
56 681 24/4B	$9.7\phi \pm 0.3 \times 175 \pm 5$
56 681 23/4B	$9.7\phi \pm 0.3 \times 203 \pm 6$
K5 070 85/4B	$9.7\phi \pm 0.3 \times 228 \pm 7$



27
203

Not represented in this midjet catalogue is our wide range of components for professional purposes, such as

- **COMPONENTS FOR THE TELECOMMUNICATIONS INDUSTRIES**
- **PAPER, POLYSTYRENE, MICA AND VARIABLE CAPACITORS**
- **CAPACITORS FOR FLUORESCENT LAMPS**
- **WIRE-WOUND PRECISION AND HIGH-POWER RESISTORS**
- **WIRE-WOUND LOW- AND HIGH-POWER POTENTIOMETERS**
- **HOLDERS FOR LAMPS, TUBES AND FUSES**
- **COMPONENTS FOR MOUNTING AND CONTROL**
- **QUARTZ-CRYSTAL UNITS**
- **COUNTING UNITS**
- **UNITS FOR DATA-PROCESSING MACHINES AND AUTOMATION EQUIPMENT**
- **FERROXCUBE POT-CORES**
- **PERMANENT MAGNETS**

Ask for separate data sheets.