











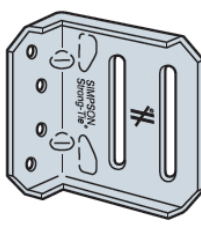
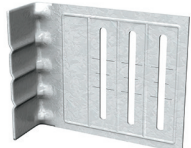

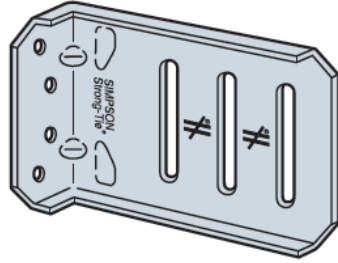

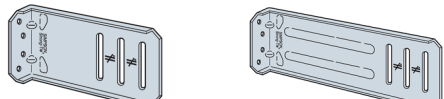

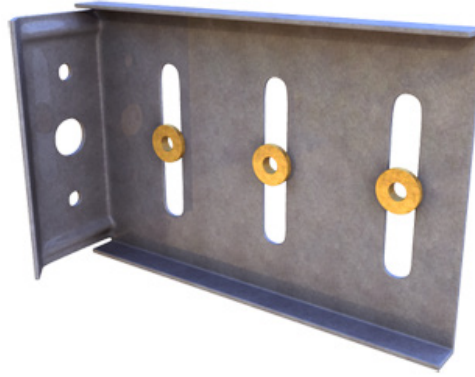
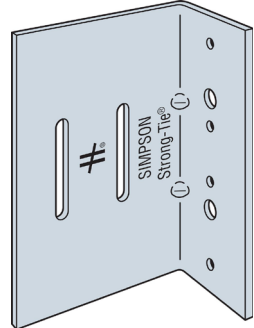

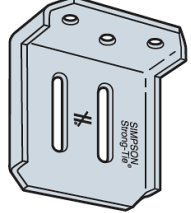

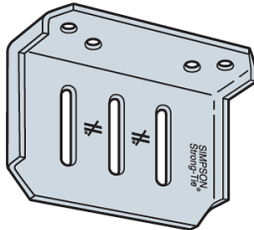

The Steel Network

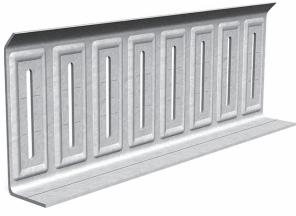
Simpson

<p>FastClip™ Slide Clip <a href="#">FCSC 3.5</a></p> 	<p>VertiClip SLB Bypass Slab SLB362</p> 	<p>SCB43.5</p> 
<p><a href="#">FCSC 5.5-14ga</a> <a href="#">FCSC 5.5-12ga</a></p>  <p>Extended FastClip™ Slide Clip <a href="#">FCEC 6</a></p> 	<p>VertiClip SLB Bypass Slab SLB600</p> 	<p>SCB45.5 MSCB45.5</p> 
<p><a href="#">FCEC8</a>, <a href="#">FCEC10</a>, <a href="#">FCEC12</a></p> 	<p>VertiClip SLB Bypass Slab SLB800, SLB600-10", SLB600-12"</p>	<p>SCB47.5, 49.5, 411.5 MSCB47.5 (14ga)</p> 
<p><a href="#">FCSC 6" w/Anchor</a> <a href="#">FCSC-HD</a></p> 	<p>VertiClip SLB-HD</p> 	<p>Heavy Duty ByPass Slide Clip SC32-5/97-KT25 SC62-5/97-KT25 SC62-5/118-KT25 SC82-5/118-KT25</p> 
<p>FastTop™ Clip <a href="#">FTC3</a></p> 	<p>VertiClip SL362, SLD362, SL400 SLD400</p> 	<p>SCW3.25</p> 
<p><a href="#">FTC5</a> <a href="#">FTC8</a> <a href="#">FTC10</a> <a href="#">FTC12</a></p> 	<p>VertiClip SL600 SLD600 SL800 SLD800 SL1000</p> 	<p>SCW5.5</p> 

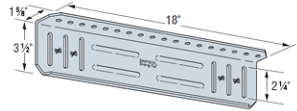

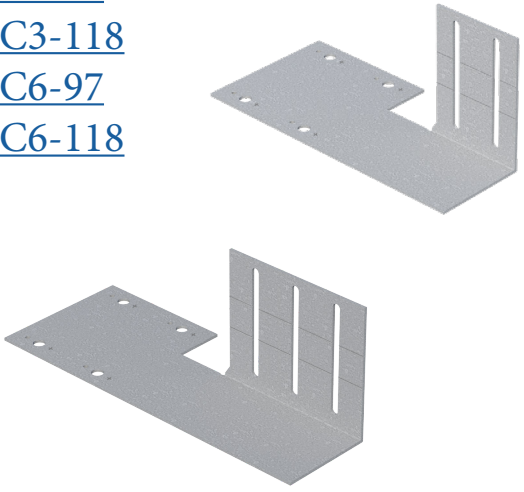

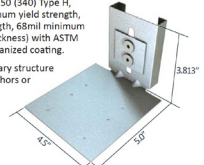
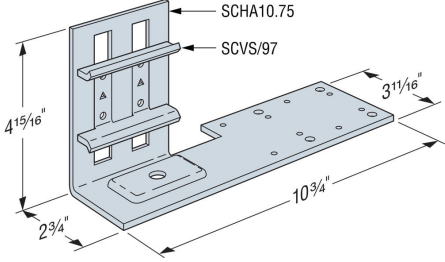
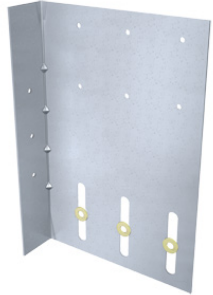
Notes: 1 All clip conversions should be reviewed by the engineer of record (EOR).

2 Every effort was made to assure the information curated from competitive websites was accurate at the time of development.

<p>FastStrut™ <a href="#">FS12</a></p> 	<p>Verticlip SLS Bypass Structure SLS362-12, SLS400-12, SLS600-12</p> 	<p>N/A</p>
<p><a href="#">FS15</a></p> 	<p>Verticlip SLS Bypass Structure SLS600-15, SLS800-15</p> 	<p>N/A</p>
<p><a href="#">FS18</a></p>	<p>SLS600-18, SLS800-18</p>	<p>SSB3.518 (18" only)</p> 
<p><a href="#">FS20</a></p>	<p>SLS600-20, SLS800-20</p> 	<p>N/A</p>
<p><a href="#">FS22</a></p>	<p>N/A</p>	<p>N/A</p>
<p><a href="#">FS24</a></p>	<p></p>	<p></p>
<p>Flat Tail Slide Clip™ <a href="#">FTSC3-97</a> <a href="#">FTSC3-118</a> <a href="#">FTSC6-97</a> <a href="#">FTSC6-118</a></p> 	<p>Verticlip SLT Flat Plate Bypass SLT9.5" SLT12" SLT15" SLT18"</p>  <p>VertiClip SLF</p>  <p>50 (340) Type H, minimum yield strength, 68ksi minimum (stress) with ASTM zinc coating. any structure, shores or</p>	<p>Horizontal Anchorage Slide-Clip SCHA10.75-KT</p> 
<p></p>	<p>VertiClip Splice Multi-Stud Clip</p> 	<p></p>

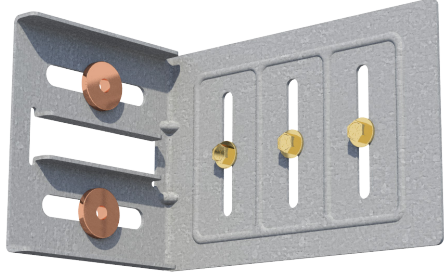
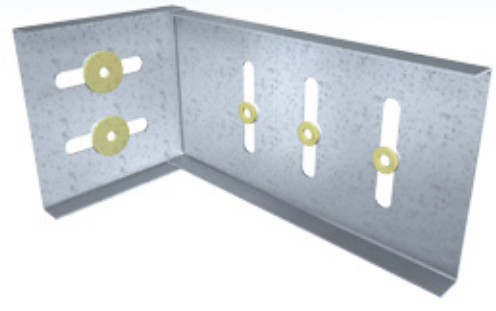
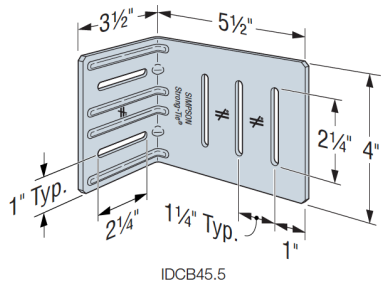
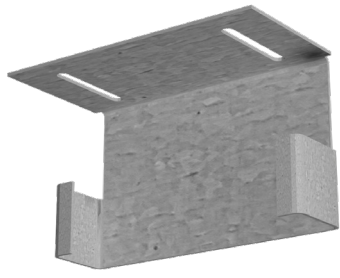
Notes: 1 All clip conversions should be reviewed by the engineer of record (EOR).

2 Every effort was made to assure the information curated from competitive websites was accurate at the time of development.

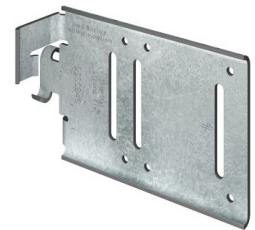
<p>Drift FCSC  <a href="#">3.5 D-FCSC350</a>  <a href="#">6 D-FCSC6</a>  <a href="#">8 D-FCSC8</a></p> 	<p>Driftclip DSLB Bypass Clip                  DSLB362/400                  DSLB600                  DSLB800</p> 	<p>IDCB45.5                  (6" only)</p> 
<p>Drift HOW  <a href="#">DHOW3-LG</a>  <a href="#">DHOW6-LG</a>  <a href="#">DHOW8-LG</a> &gt; For structural gauges: 20, 18, 16</p> <p><a href="#">DHOW3-HG</a>  <a href="#">DHOW6-HG</a>  <a href="#">DHOW8-HG</a> &gt; For structural gauges: 14, 12</p> 	<p>HOW                  DSLD (20ga)                  362                  600                  800</p> <p>DSLD (12ga)                  362                  600                  800</p> 	
<p>Drift Rail  <a href="#">DRC3-68</a>  <a href="#">DRC6-68</a>  <a href="#">DRC8-68</a>  <a href="#">DRC3-97</a>  <a href="#">DRC6-97</a>  <a href="#">DRC8-97</a>                  DR97</p> 	<p>DriftTrak DTSLB</p> 	<p>DSSCB Drift Strut</p> 

Notes: 1 All clip conversions should be reviewed by the engineer of record (EOR).

2 Every effort was made to assure the information curated from competitive websites was accurate at the time of development.



The Steel Network

Simpson

[S543](#) [LS543](#)  
[S545](#) [LS545](#)  
[S547](#) [LS547](#)  
[S549](#) [LS549](#)  
[S541](#) [LS541](#)

[S683](#) [LS683](#)  
[S685](#) [LS685](#)  
[S687](#) [LS687](#)  
[S689](#) [LS689](#)  
[S681](#) [LS681](#)

[S973](#) [LS973](#)  
[S975](#) [LS975](#)  
[S977](#) [LS977](#)  
[S979](#) [LS979](#)  
[S971](#) [LS971](#)

[E543](#) [LE543](#)  
[E545](#) [LE545](#)  
[E547](#) [LE547](#)  
[E549](#)  
[E541](#)

[E683](#) [LE683](#)  
[E685](#) [LE685](#)  
[E687](#) [LE687](#)  
[E689](#)  
[E681](#)

[E973](#) [LE973](#)  
[E975](#) [LE975](#)  
[E977](#) [LE977](#)  
[E979](#)  
[E971](#)

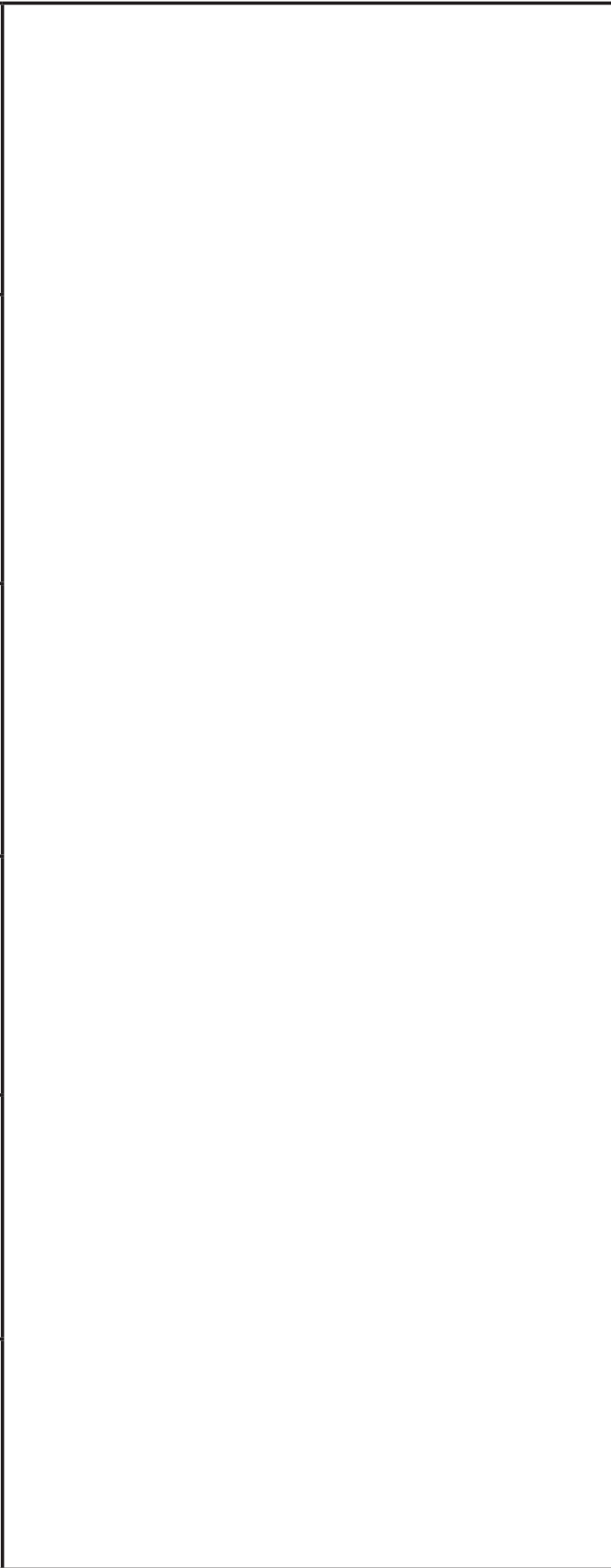

LSFC2.25-R300 or SFC2.25-R300  
 LSFC4.25-R175 or SFC4.25-R175  
 LSFC6.25-R125 or SFC6.25-R100

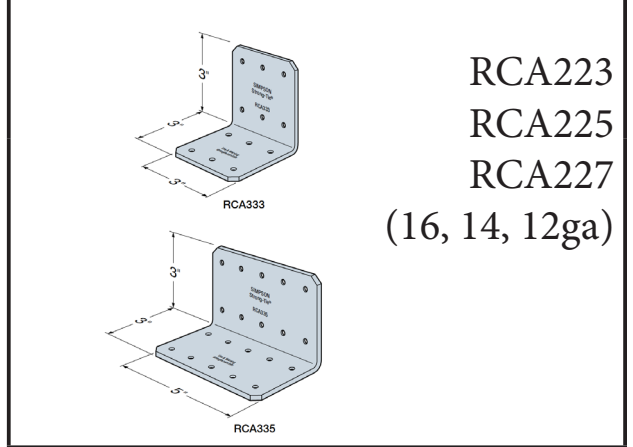
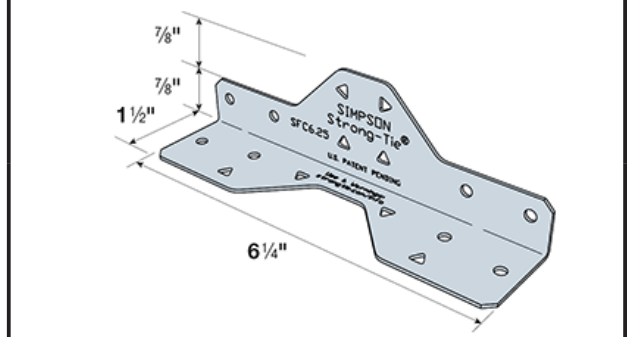

RCA223  
 RCA225  
 RCA227  
 (16, 14, 12ga)

LSSC4.25-R50  
 LSSC6.25-R30

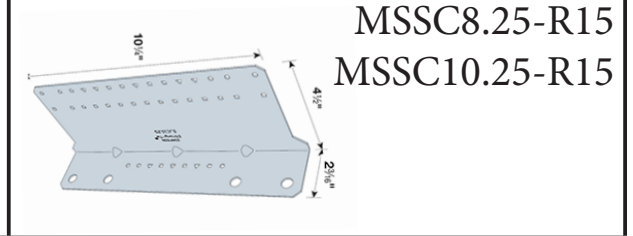
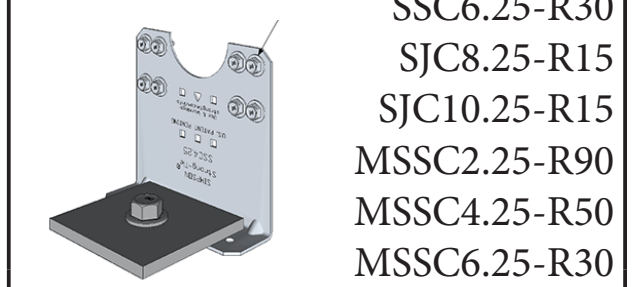
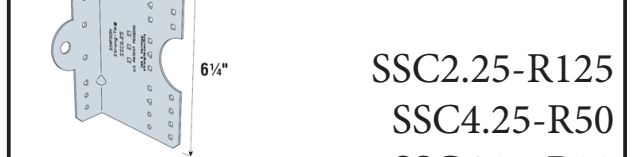

SSC2.25-R125  
 SSC4.25-R50  
 SSC6.25-R30  
 SJC8.25-R15  
 SJC10.25-R15  
 MSSC2.25-R90  
 MSSC4.25-R50  
 MSSC6.25-R30  
 MSSC8.25-R15  
 MSSC10.25-R15

QTWS 3.5" or 6"



Uni-Clip™ End Clip  
[UCEC](#)

EasyClip™ E-Series™ Clip  
[E543](#)  
[E683](#)  
[E973](#)

Stiff Clip AL  
 AL362  
 AL600



Notes: 1 All clip conversions should be reviewed by the engineer of record (EOR).  
 2 Every effort was made to assure the information curated from competitive websites was accurate at the time of development.

### Extended SwiftClip™ LE-Series

- [LE6816](#)
- [LE6818](#)
- [LE6820](#)
- [LE6824](#)
- [LE6830](#)
- [LE6836](#)

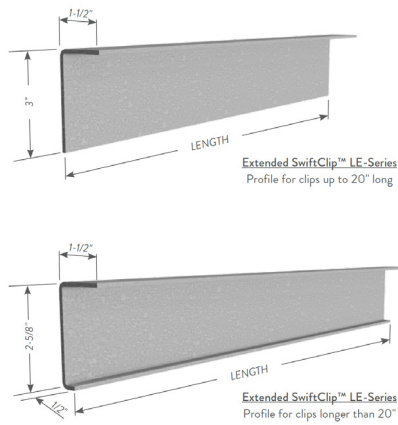

Extended SwiftClip™ LE-Series Profile for clips up to 20" long

Extended SwiftClip™ LE-Series Profile for clips longer than 20"

### StiffClip LS

- LS < 20"
- LS > 20"

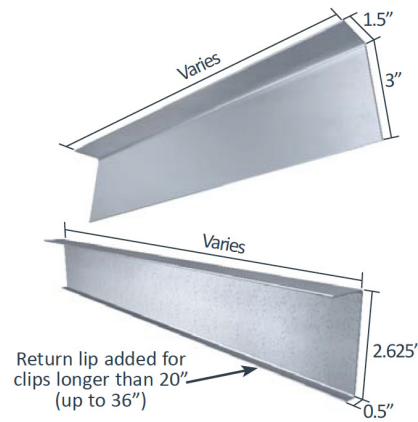

Return lip added for clips longer than 20" (up to 36")

### ByPass Fixed-Clip Strut

FSB 3.518-R25

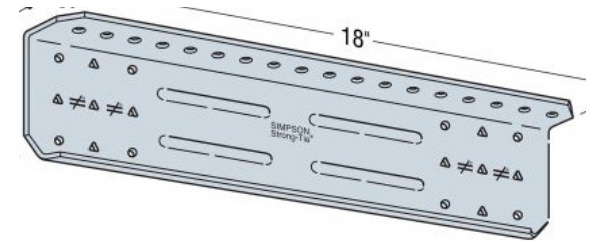

### UXRC-HD w/5/8" Angle Hole



### StiffClip Heavy Duty

LB600-HD

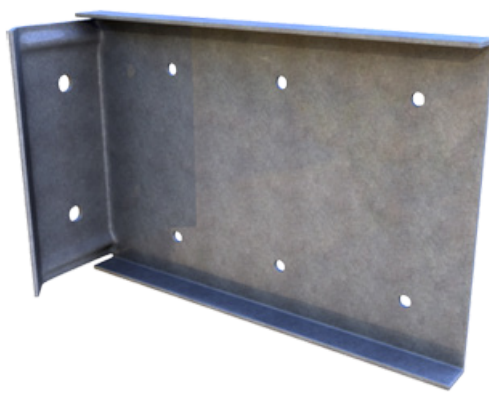

### Heavy Duty ByPass Fixed-Clip

- FC32-5/97-R25
- FC62-5/97-R25
- FC62-5/118-R25
- FC82-5/118-R25

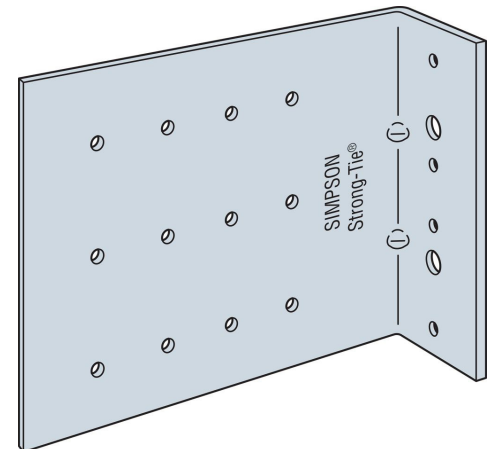

### Uni-Clip™ End Clip & Extended

- Uni-Clip™
- [UCEC](#)
- [UXRC 6"](#)
- [UXRC 8"](#)
- [UXRC 10"](#)
- [UXRC 12"](#)

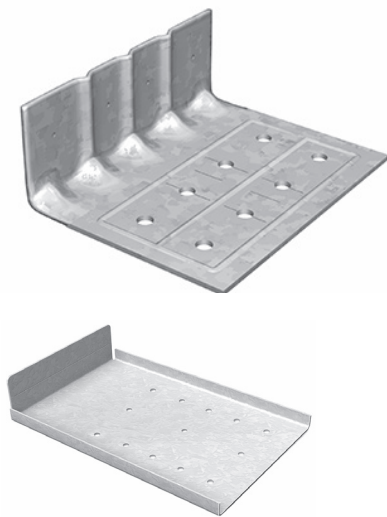

### StiffClip LB Multi-Directional Load

- Resistant Angle
- LB362/400
- LB600
- LB800
- LB1000
- LB1200

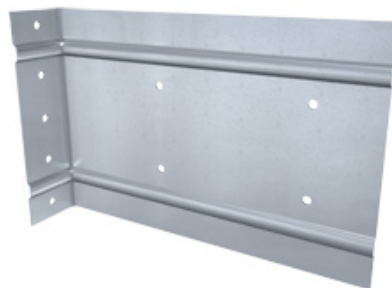

### FCB43.5

- FCB45.5
- FCB47.5
- FCB49.5
- FCB411.5

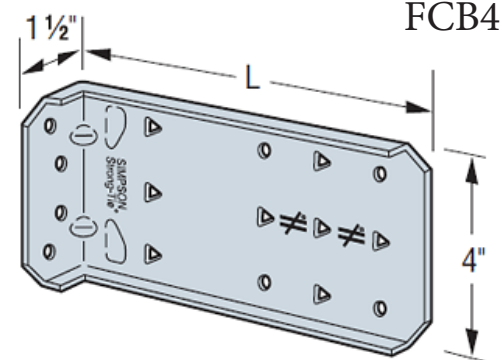

Notes: 1 All clip conversions should be reviewed by the engineer of record (EOR).

2 Every effort was made to assure the information curated from competitive websites was accurate at the time of development.



The Steel Network

Simpson

**FastBridge**

- [FB-43](#)
- [FB-68](#)
- [FB-33](#)

[CC33](#)

- [U543](#)   [LS543](#)
- [U545](#)   [LS545](#)
- [U547](#)   [LS547](#)
- [U549](#)   [LS549](#)

- [U683](#)   [LS683](#)
- [U685](#)   [LS685](#)
- [U687](#)   [LS687](#)
- [U689](#)   [LS689](#)

- [U973](#)   [LS973](#)
- [U975](#)   [LS975](#)
- [U977](#)   [LS977](#)
- [U979](#)   [LS979](#)

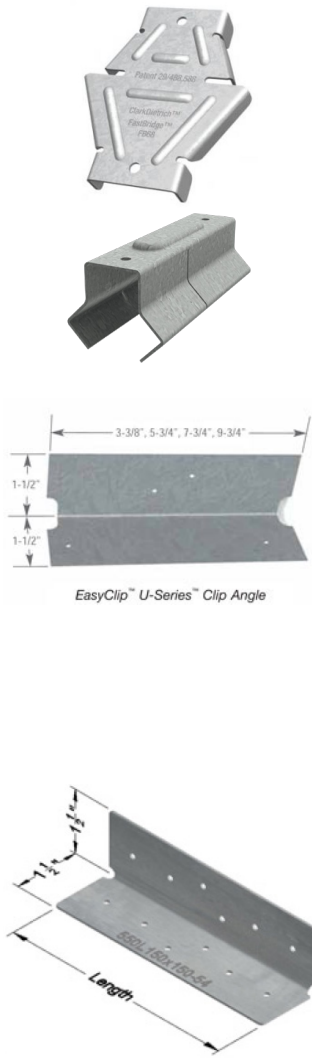

**BridgeClip®, BC600/BC800**

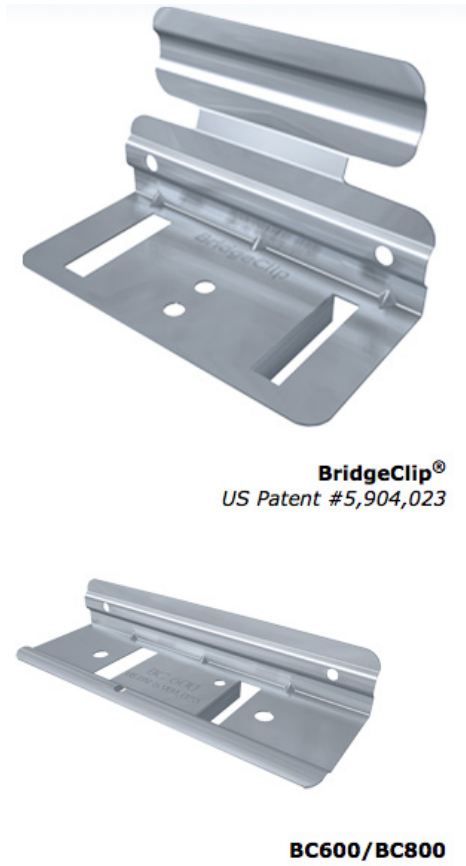

- SUBH-3.25 (18ga)
- MSUBH-3.25 (14ga)
- LSUBH-3.25 (20ga)

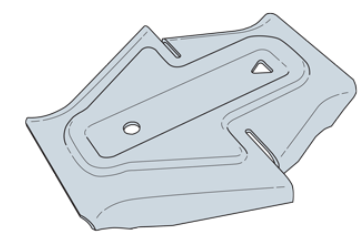

Drywall Only  
DBC 2.5 (20ga)

**Uni-Clip™ End Clip**

[UCEC](#)



**EasyClip™ E-Series™ Clip**

- [E543](#)
- [E683](#)
- [E973](#)

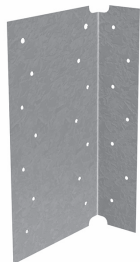

**Stiff Clip AL**

- AL362
- AL600



**EasyClip™ D-Series™ and T-Series™**

- [D683](#)
- [T683](#)
- [D685](#)
- [T685](#)
- [D973](#)
- [T973](#)
- [D975](#)
- [T975](#)

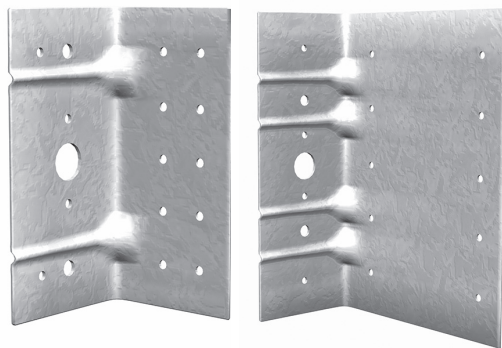

**Stiff Clip CL Floor Tie**

- CL362-68
- CL400-68
- CL600-68
- CL800-68

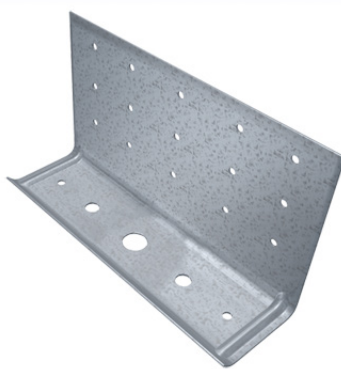

**MSSC4.25KW-KT20-BP1 Optional**  
**MSSC6.25KW-KT20-BP1 Optional**

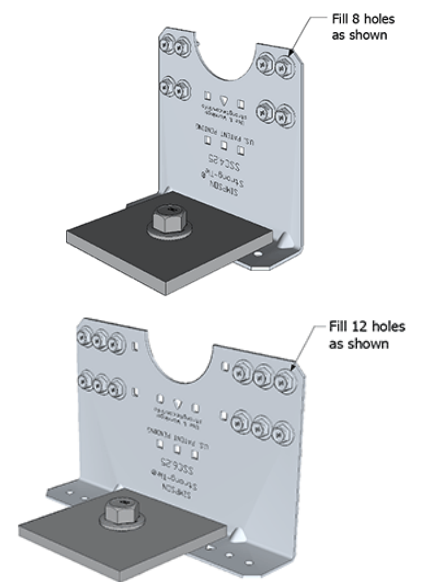

**Moment Clips W/Plate**

- [MC683](#)   [MC973](#)
- [MC685](#)   [MC975](#)
- [MC687](#)   [MC977](#)

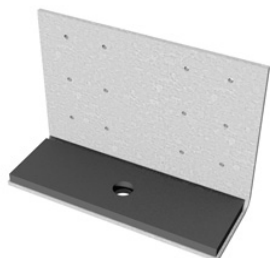

**StiffClip CL w/(H) Plate**

- |             |           |
|-------------|-----------|
| CL362-68(H) | CL362-118 |
| CL400-68(H) | CL400-118 |
| CL600-68(H) | CL600-118 |
| CL800-68(H) | CL800-118 |

- RCKW3   RCKW3S w/Stiffness
- RCKW5.5   RCKW5.5S w/Stiffness
- RCKW7.5

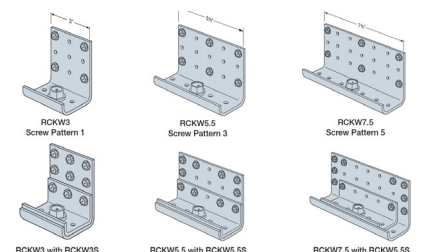

Notes: 1 All clip conversions should be reviewed by the engineer of record (EOR).

2 Every effort was made to assure the information curated from competitive websites was accurate at the time of development.

H-Series™ Universal Header Hanger  
H436  
H546  
H686

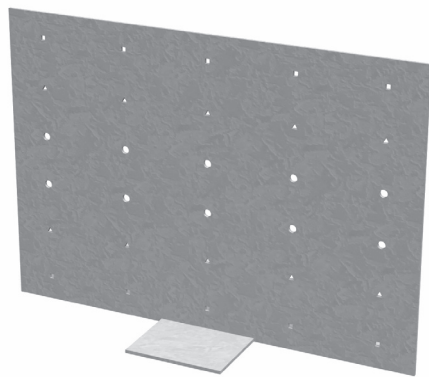

Stiff Clip HE Header Clip  
HEH-68  
HEL-43



G436 \*Unpunched sizes available.  
G546  
G686

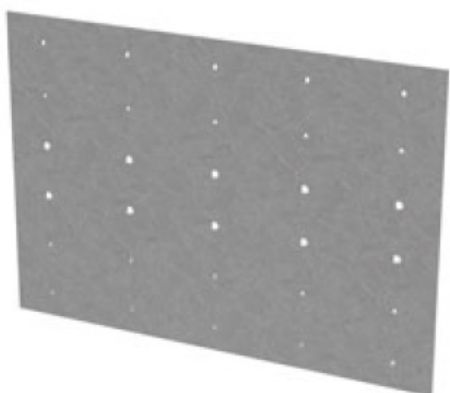

StiffClip PL Truss Plate Connector  
Various Sizes



[X543](#)  
[X545](#)  
[X547](#)  
[X549](#)

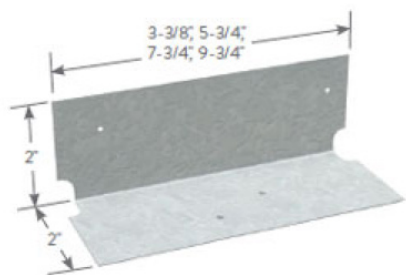

BC600 or BC800 Bridge Clip



BridgeClip®  
US Patent #5,904,023

[X683](#)  
[X685](#)  
[X687](#)  
[X689](#)

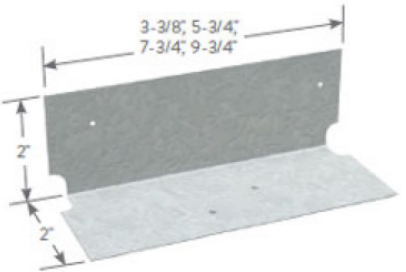

BC600/BC800

[X973](#)  
[X975](#)  
[X977](#)  
[X979](#)

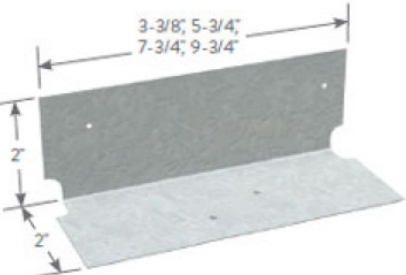

Floor Joist Blocking  
800JB 12, 16, 14 O.C.  
925JB 12, 16, 14 O.C.  
1000JB 12, 16, 14 O.C.  
1125JB 12, 16, 14 O.C.  
1200JB 12, 16, 14 O.C.

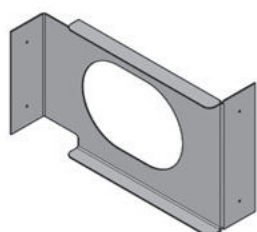

Notes: 1 All clip conversions should be reviewed by the engineer of record (EOR).

2 Every effort was made to assure the information curated from competitive websites was accurate at the time of development.

[A543](#)    [LA543](#)  
[A546](#)    [LA545](#)  
[A683](#)    [LA683](#)  
[A686](#)    [LA685](#)  
[A973](#)    [LA973](#)  
[A976](#)    [LA975](#)

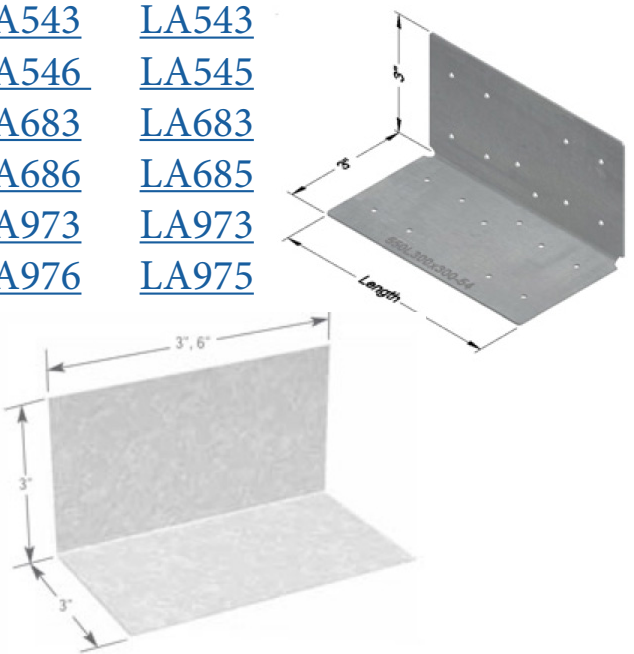
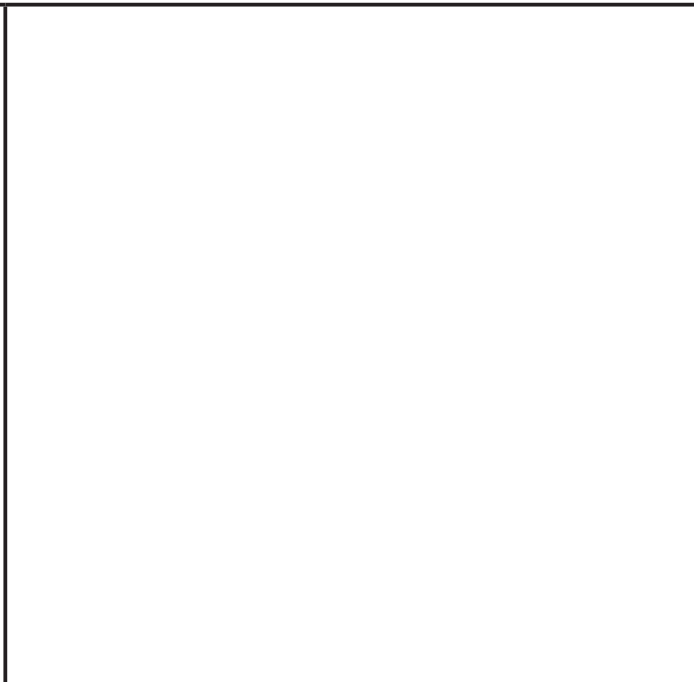

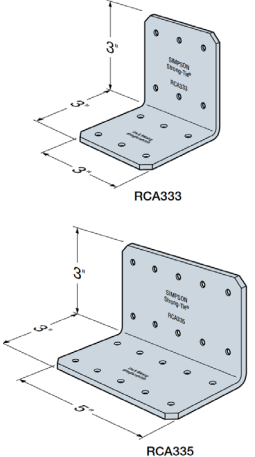

**SIMPSON**  
RCA333  
RCA335  
16, 14, 12ga

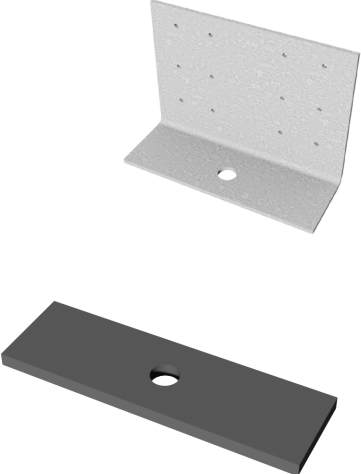

**Moment Clips 10GA:**  
[MC103P](#)  
[MC105P](#)  
[MC107P](#)

1/4" Plate  
 P338  
 P538  
 P738



**Stiff Clip CL W|H plate**  
 CL362-118  
 CL400-118  
 CL600-118  
 CL800-118

W|H Plate  
 CL362-118(H)  
 CL400-118(H)  
 CL600-118(H)  
 CL800-118(H)

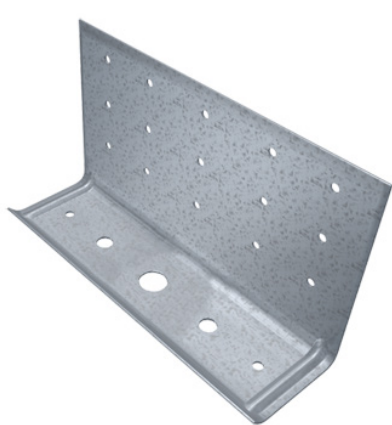

**RCKW3S w/stiff**  
**RCKW5.5S w/stiff**

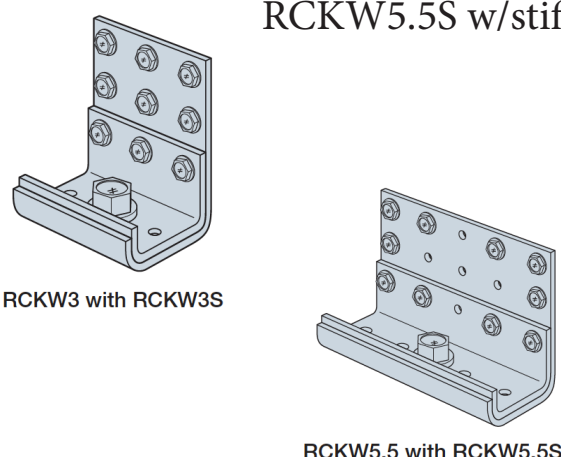

**Skewable Angle**  
[SA4](#)  
[SA6](#)  
[SA3](#)  
[SA5](#)  
[SA7](#)  
[SA9](#)

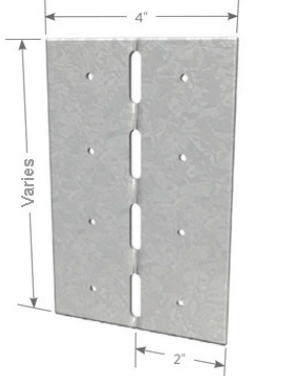

**StiffClip HC Hip Connector**  
 HC600  
 HC800



**Skewable Angle**  
 SLS5  
 SLS7

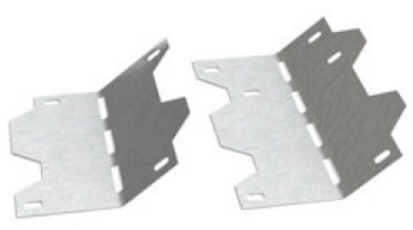

**CD Holddown**  
[CD8](#)  
[CD10](#)  
[CD15](#)



**Stiff Clip TD**



**Holddown**  
 S/HD8S  
 S/HD10S  
 S/HD15S



**UJH**  
 Universal  
 Joist Hanger  
[UJH-68](#)  
[UJH-97](#)

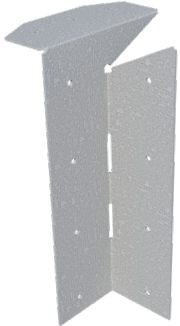

**JC - Joist Clip**



**SJCT 14ga**  
**SHJCT 12ga**

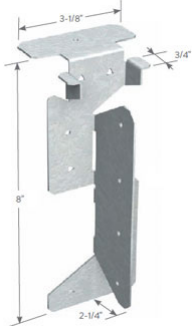

Notes: **1** All clip conversions should be reviewed by the engineer of record (EOR).  
**2** Every effort was made to assure the information curated from competitive websites was accurate at the time of development.



<p>Pony Wall <a href="#">PW24</a> <a href="#">PW36</a> <a href="#">PW48</a></p> 	<p>Mid Wall</p> 	
<p>Bridle Hanger CDBV CDBM</p> 	<p>StiffClip JH</p> 	<p>S/LBV, S/B, S/BA Hangers</p> 
<p>Seismic &amp; Hurricane Clips CDH2.0 CDH2.5 CDH2A CDH3</p> 	<p>StiffClip RT Roof Tie</p> 	<p>SH2 SH25 SH3</p>
<p>LSTA24 LSTA36 MSTA24 MSTA36 KST224 KST227 KST237</p>	<p>Stiff Clip FS Floor Strut</p> 	<p>LSTA24 LSTA36 MSTA24 MSTA36 ST6224 MST27 MST37</p> 
<p>RS150 RS200 RS250</p>		<p>CS16 CS18 CS20</p> 
<p>MTW12</p>		<p>MTS12</p> 
<p>N27</p>		<p>TB27</p> 

Notes: 1 All clip conversions should be reviewed by the engineer of record (EOR).

2 Every effort was made to assure the information curated from competitive websites was accurate at the time of development.

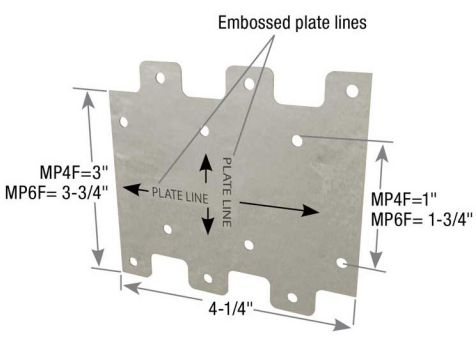
<p>MP6F</p> 		
---	--	--

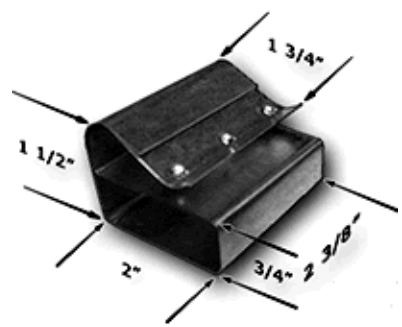
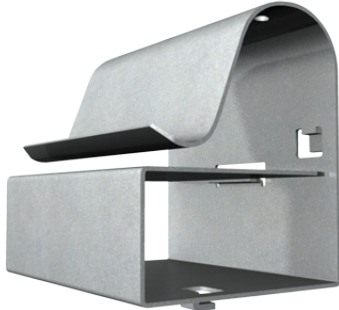
<p>The CLAW</p> 	<p>Grip Clip-Column Beam Clip</p> 	
--	---	--

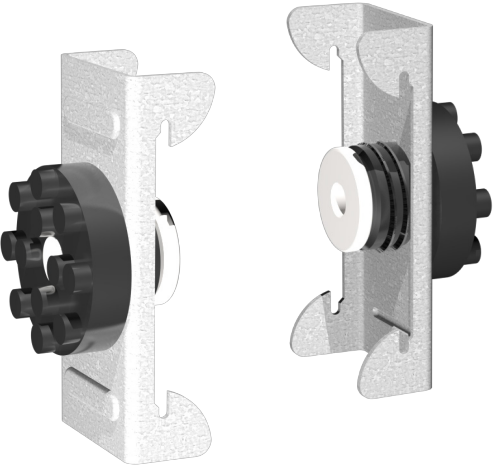
<p><a href="#">CDSC</a></p> 		
---	--	--

Notes: **1** All clip conversions should be reviewed by the engineer of record (EOR).  
**2** Every effort was made to assure the information curated from competitive websites was accurate at the time of development.