

**ALMEDIC
SURGICAL
INSTRUMENT
CATALOGUE**



ALMEDIC

ALMEDIC surgical instruments
are guaranteed against defects
in material and workmanship.

Great care has been taken to
describe the instruments reliably.
However, the indicated measurements
in some cases, may be approximate.
Because our instruments are hand crafted
this may result in minor variations.

ALMEDIC instruments bear the trade mark
 or ALMEDIC

© Copyright 1982 by
ALMEDIC Division of Rhoing (1975) Limited
All rights reserved.
This catalogue or any part thereof, may not be
reproduced in any form without written
permission from ALMEDIC Division of
Rhoing (1975) Limited.

PRINTED IN CANADA, 2011

Condensed Index

Catalogue Prefix Number	Instrument Category	Page
A2	Diagnostic Instruments	1-6
A3	Anesthesia	7
A4	Dermatology	8-11
A5	Trocars	12-13
A5	Suction Tubes	14
A6	Scalpel Handles and Blades	15-16
A7	Bandage and Plaster Instruments	17-19
A8	Operating Scissors	20-39
A9	Operating Scissors with Tungsten Carbide Inserts.....	40-43
A10	Dressing and Tissue Forceps	44-54
A10	Splinter Forceps	55-57
A11	Dressing Forceps with Tungsten Carbide Jaws	58
A12	Hemostatic Forceps	59-67
A13	Towel Clamps	68
A14	Retractors	69-86
A15	Probes and Directors	87
A16	Needle Holders	88-95
A17	Needle Holders with Tungsten Carbide Jaws.....	96-100
A18	Suture Instruments	101-104
A19	Eye Instruments	105-134
A20	Ear Instruments	135-150
A21	Nasal Instruments	151-170
A22	Tonsil Instruments	171-179
A23	Tracheal Instruments	180-190
A24	Oral Instruments	191-194
A25	Laryngeal Instruments	195-200
A26	Goitre Instruments	201
A27	Gall Bladder Instruments	202-208
A28	Stomach and Intestinal Instruments	209-218
A29	Thoracic and Cardiovascular Instruments.....	219-230
A30	Vein Strippers	231
A31	Neurosurgical Instruments	232-240
A32	Orthopedic Instruments	241-260
A33	Chisels, Osteotomes, Gouges	261-265
A34	Mallets	266
A35	Urological Instruments.....	267-271
A36	Gynecological Instruments	272-286
A37	Sterilization Forceps	287
A38	Obstetrical Instruments	288-294
A39	Rectal Instruments	295-299



Diagnostic Instruments



WARTENBERG
Neurological
Pinwheel
19 cm 7½"

A2-100

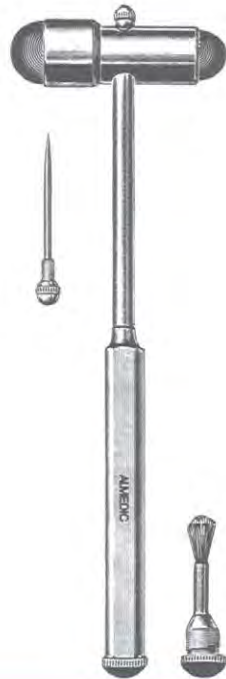

BUCK
Neurological
Hammer
with brush and needle
18 cm 7"

A2-102



BABINSKI
Percussion
Hammer
with adjustable head

A2-104 22 cm 8¾"

A2-106 rubber ring only

Neurological Pinwheels and Percussion Hammers



TAYLOR

A2-108 small 18 cm 7"
A2-110 regular 20 cm 8"



VERNON
15 cm 6"

A2-112



BERLINER
17 cm 6¾"

A2-114

Percussion Hammers

Diagnostic Instruments



Percussion Hammers

TRAUBE
16 cm 6¼"

TROEMNER
24 cm 9½"

DEJERINE
without pin
20 cm 8"

A2-116

A2-118

A2-120



Percussion Hammers

DEJERINE
with pin
21 cm 8¼"

Queens Square
39 cm 15½"

A2-122

A2-126

Diagnostic Instruments



FRANCKE
Blood Lancet
cone tip

A2-130



FRANCKE
Blood Lancet
bell tip

A2-132



COLLIN
Dynamometer
kilograms scale

A2-136 adult size
A2-138 child size

Blood Lancets and Dynamometers



BERGER
Binocular
Loupe

A2-140

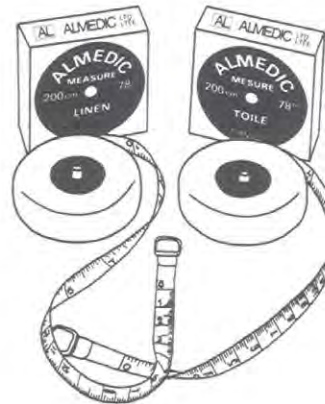

Tape Measures
inches and cm scale
200 cm 78"

A2-150 steel
A2-152 linen

Binocular Loupes Tape Measures



Diagnostic Instruments

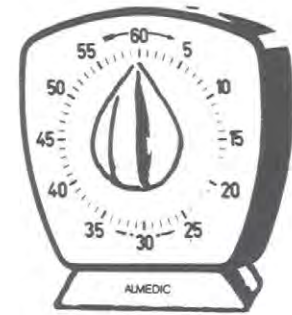

**Penlight
Counter
Timers**

Penlight

A2-160 with batteries
A2-162 without batteries

Counter
4 figures

A2-170

Timers

A2-172 30 minutes
A2-174 60 minutes

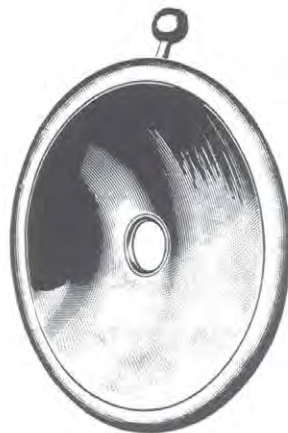

**Head Mirrors
Headbands**

Head Mirror
with rubber rim
and 1/2" hole
90 mm 3 1/2" diameter

A2-200

Head Mirror
with headband

A2-202 black headband
A2-206 white headband

Diagnostic Instruments



White
40 mm 1/2" wide

A2-210

Black
25 mm 1" wide

A2-212

Headbands



Plastic Joint
for headband

A2-222

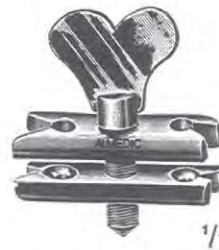

Brass nickel plated joint
for headband

A2-224

Joints for Headbands



Diagnostic Instruments

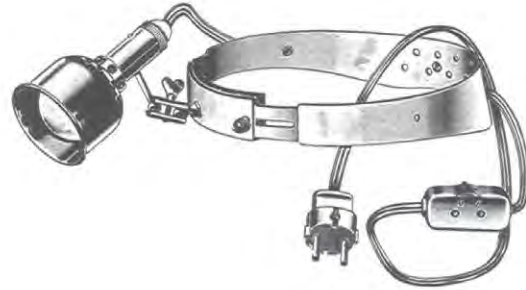

Headlights

Clar
white plastic headband
cable 2 meter 6½ foot
with plug • 6 volt

A2-226

Thiry
white plastic headband
25 watt lamp
push button switch

A2-230 110 volt AC
A2-232 220 volt AC



Laryngoscopes

**Laryngoscope
Battery Handle only**

A2-240

Macintosh Blades

A2-242 No. 1 90 mm 3½"
A2-244 No. 2 108 mm 4¼"
A2-246 No. 3 130 mm 5⅛"
A2-248 No. 4 160 mm 6¼"

Anesthesia

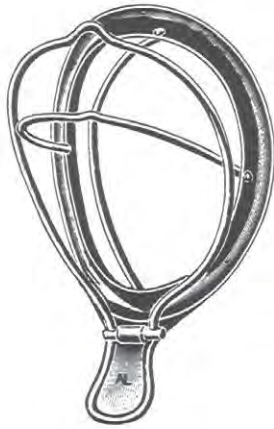

SCHIMMELBUSH
adult size
folding type

A3-102

CONNELL
airway

A3-120 child size
A3-122 adult size

LUMBARD
airway

A3-124 child size
A3-126 adult size

**Ether Masks
Airways**



MAGILL

A3-130 child size 20 cm 8"
A3-132 adult size 24 cm 9½"

**Catheter
Introducing
Forceps**

Dermatology



**Dermal Curettes
Dermal Punches
Skin Hooks**

FOX
dermal curette
14 cm 5½"

- A4-100** size 1, 3 mm
- A4-102** size 2, 4 mm
- A4-104** size 3, 5 mm
- A4-106** size 4, 6 mm

PIFFARD
dermal curette
14.5 cm 5½"

- A4-108** size 1, 3 mm
- A4-110** size 2, 4 mm
- A4-112** size 3, 5 mm

KEYES
dermal punch 9.5 cm 3¾"

- A4-120** 2 mm
- A4-122** 3 mm
- A4-124** 4 mm
- A4-126** 6 mm
- A4-128** 8 mm

FRAZIER
skin hook

- A4-140** sharp 14 cm 5½"
- A4-142** blunt 15 cm 6"



**Abcess Knife
Comedone Extractors**

VAUGHAN
abcess knife

A4-146

KATSCH

A4-150

UNNA

- A4-152** 11.5 cm 4½"
- A4-154** 14.5 cm 5½"

SAALFELD
10 cm 4"

A4-156

SAALFELD
14.5 cm 5½"

A4-158

SCHAMBERG
10 cm 4"

A4-160

Dermatology



with 3
drill points

A4-170



with hand support
and 3 drill points

A4-172



set of 3 drill points
for A4-170, A4-172

A4-174

Finger Nail Drills

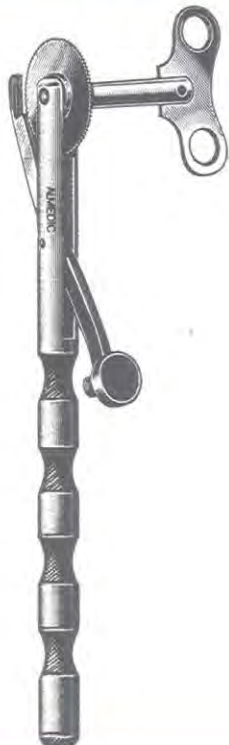

finger ring
cutter

A4-180



with blade
protector

A4-182

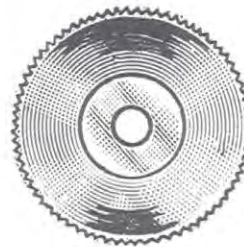

circular saw
for A4-180, A4-182

A4-184

Finger Ring Cutters



Dermatology

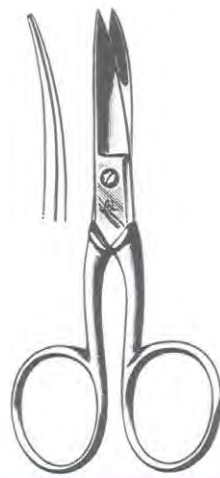
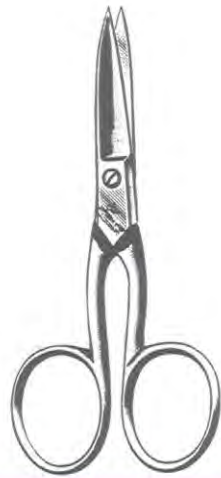

Nail Scissors
Cuticle Scissors

nail scissors
straight
9 cm 3/2"

nail scissors
curved
9 cm 3/2"

cuticle scissors
straight
9 cm 3/2"

cuticle scissors
curved
9 cm 3/2"

A4-202

A4-204

A4-206

A4-208

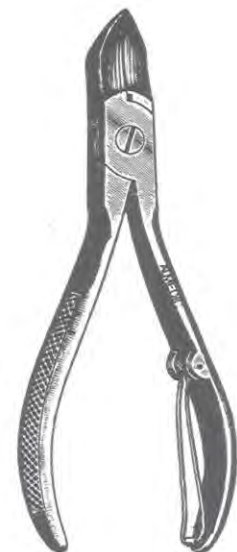

Cuticle Nippers
Nail Nipper

cuticle nipper
ring handle
10 cm 4"

cuticle nipper
plier handle
10 cm 4"

nail nipper
11 cm 4 1/4"
N/P

A4-210

A4-212

A4-222

Dermatology



nail nipper
12.5 cm 5"

A4-224



nail nipper
14 cm 5½"

A4-226

Nail Nippers



nail splitter
13 cm 5"

A4-230

Nail Splitter



Trocars



Trocars

Universal
set of 4
6, 9, 13, 18 French
in flat handle

A5-100

DAVIDSON
graduated
23 cm 9"

A5-102

BIRCH
with perforated cannula
14 French
18 cm 7"

A5-104



Trocars

OCHSNER
gall bladder trocar
15 cm 6"

A5-106 10 French
A5-108 14 French
A5-110 18 French

A5-112 20 French
A5-114 22 French
A5-116 24 French
A5-118 28 French

NELSON (PATTERSON) 21 cm 8½"

A5-120 22 French
A5-122 28 French
A5-124 34 French
A5-126 38 French

LICHTWICZ
antrum trocar
with stylet and
luer lock
connection
11.5 cm 4½"

A5-128

LICHTWICZ
antrum needle
11 cm 4½"

A5-130

Trocars



FEIN
antrum trocar
with luer lock
11 cm 4½"

A5-132



DOUGLAS
antrum trocar
9 French

A5-134

Trocars



COAKLEY
antrum trocar
16.5 cm 6½" 7 French

A5-136



PIERCE
antrum trocar with
tubing connection
16.5 cm 6½" 15 French

A5-138

Trocars



Suction Tubes

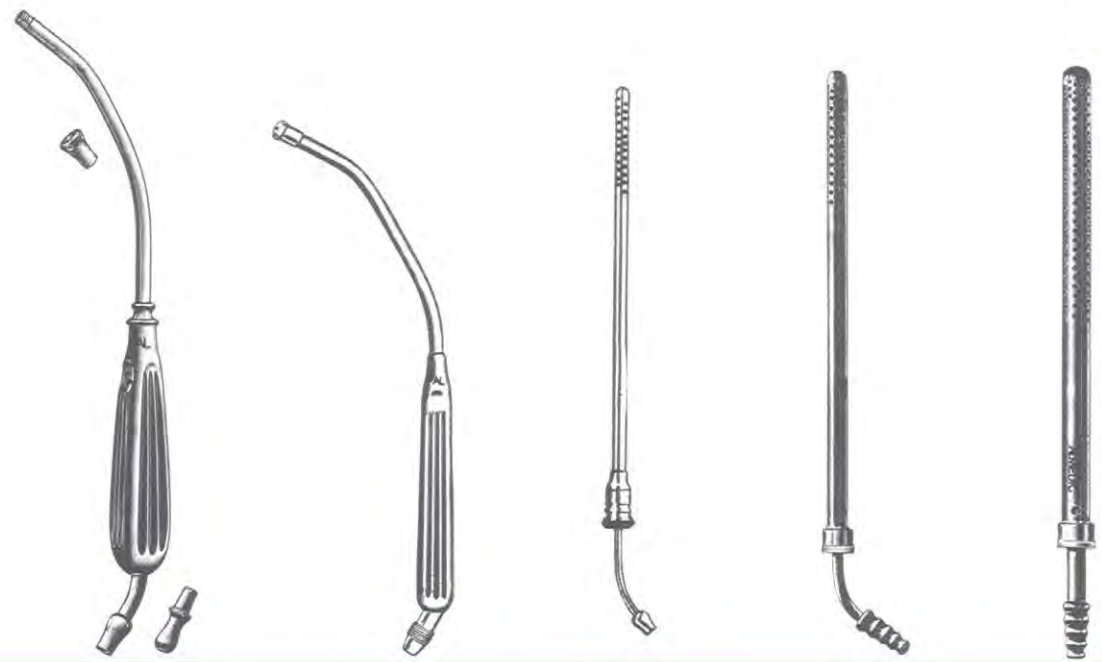

Suction Tubes	YANKAUER	YANKAUER with threaded end	POOLE pediatric 19.5 cm 7¾"	POOLE curved 23 French	POOLE straight 30 French
	A5-140 with slip on end A5-142 perforated tip only A5-144 tubing connector only	A5-146	A5-148	A5-150	A5-152

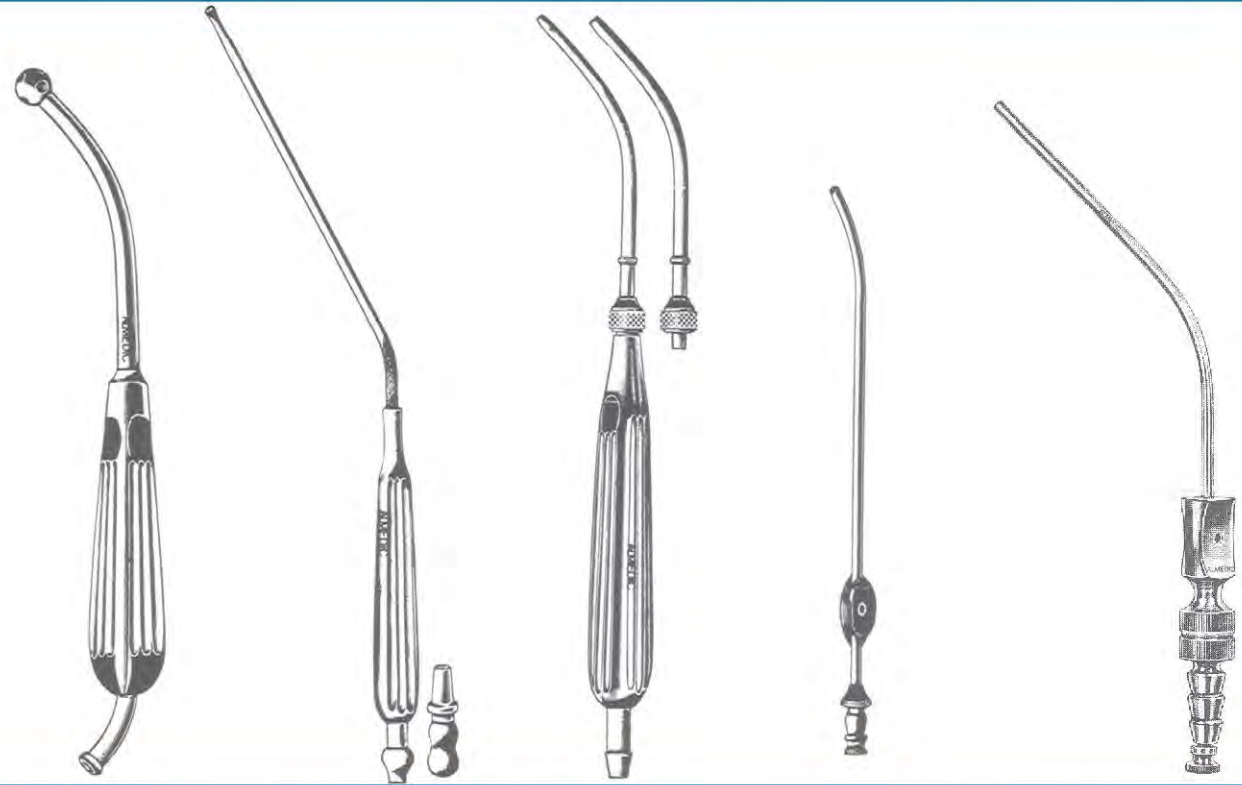

Suction Tubes	PYNCHON with removable tubing connection	ANTHONY with tubing connection 2 mm opening 25.5 cm 10"	COUPLAND with 2 interchangeable tips and slip-on end 24 cm 9½"	ADSON curved 4 mm Ø 12 French 15 cm 6"	FRAZIER with finger valve 18 cm 7"
	A5-154	A5-156	A5-158	A5-160	A5-162 6 French A5-164 8 French A5-166 10 French A5-168 12 French

Scalpel Handles



No. 3

A6-100 chrome
A6-102 stainless



No. 3L
21 cm 8¼"

A6-104



No. 7

A6-106



No. 4

A6-108 chrome
A6-110 stainless



No. 4L
21 cm 8¼"

A6-112



COLLIN
No. 8
hollow handle

A6-114



COLLIN
No. 9
hollow handle

A6-116



Scalpel Handle
No. 4S
stainless
for no. 60
blades only

A6-117



Scalpel Handle
No. 9S
stainless
for no. 60
blades only

A6-118

Scalpel Handles

Almedic Scalpel Handles are interchangeable with all standard scalpel blades.

Handles No. 3, 3L and 7 fit blades #10 - 11 - 12 - 15.

Handles No. 4, 4L, 8 and 9 fit blades #20 - 21 - 22 - 23 - 24 - 25.

Handles No. 4S, 9S fit blade #60.



Scalpel Blades



stainless steel, sterile	A6-120	A6-122	A6-124	A6-126
carbon steel, sterile	A6-150	A6-152	A6-154	A6-156
carbon steel, non-sterile	A6-180	A6-182	A6-184	A6-186



stainless steel, sterile	A6-128	A6-130	A6-132	A6-134	A6-136	A6-138	Post-Mortem blade no. 60 heavy pattern carbon steel non-sterile	Stitch Cutter sterile. Can also be used by hand.
carbon steel, sterile	A6-158	A6-160	A6-162	A6-164	A6-166	A6-168		
carbon steel, non-sterile	A6-188	A6-190	A6-192	A6-194	A6-196	A6-198		
							A6-200	A6-300

Bandage and Plaster Instruments



LISTER
 stainless
A7-100 9 cm 3½"
A7-102 11 cm 4½"
A7-104 14 cm 5½"
A7-106 18 cm 7¼"

chrome
A7-108
A7-110
A7-112
A7-114

KNOWLES
 14 cm 5½"

A7-116

Universal
 one serrated edge
 plastic handles
 autoclavable at 143°C

A7-118 14½ cm 5¾"
A7-120 18 cm 7"

Bandage and Gauze Scissors



U.S. Army Pattern
 gauze scissors
 20 cm 8"

A7-130

ESMARCH
 gauze and plaster
 shears
 20 cm 8"

A7-132

BERGMANN
 plaster shears
 23 cm 9"

A7-134

Dressing Scissor
Gauze Shears
Plaster Shears

Bandage and Plaster Instruments



Plaster Shears

Almedic
first aid dressing
and plaster shears,
with wire cutting
notch, angled to side
21 cm 8 1/2"
A7-136

BRUNS
smooth edge
24 cm 9 1/2"

A7-140

BRUNS
serrated edge
24 cm 9 1/2"

A7-142



Plaster Shears

STILLE
for one hand
24 cm 9 1/2"

A7-144

STILLE
for two hands

A7-146 26 cm 10 1/4"
A7-148 38 cm 15"

Bandage and Plaster Instruments



MURPHY
plaster knife

A7-160



WIGMORE
plaster saw
with lift
19 cm 7½"

A7-162



ENGEL
plaster saw
15 cm 6"

A7-164



HENNIG
plaster spreader
28 cm 11"

A7-170

**Plaster Knife
Plaster Saws
Plaster Spreader**



BEESON
plaster spreader
30 cm 12"

A7-172



HAGLUND-STILLE
plaster spreader
33 cm 13"

A7-174



WOLFF
cast breaker
24 cm 9½"

A7-176

**Plaster Spreader
Cast Breaker**

Operating Scissors



Straight Operating Scissors

Blunt - Blunt

- A8-100** 11.5 cm 4½"
- A8-106** 12.5 cm 5"
- A8-112** 14 cm 5½"
- A8-118** 15 cm 6"
- A8-124** 16.5 cm 6½"
- A8-130** 19 cm 7½"

Sharp - Blunt

- A8-102** 11.5 cm 4½"
- A8-108** 12.5 cm 5"
- A8-114** 14 cm 5½"
- A8-120** 15 cm 6"
- A8-126** 16.5 cm 6½"
- A8-132** 19 cm 7½"

Sharp - Sharp

- A8-104** 11.5 cm 4½"
- A8-110** 12.5 cm 5"
- A8-116** 14 cm 5½"
- A8-122** 15 cm 6"
- A8-128** 16.5 cm 6½"
- A8-134** 19 cm 7½"



Curved Operating Scissors

Blunt - Blunt

- A8-140** 11.5 cm 4½"
- A8-146** 12.5 cm 5"
- A8-152** 14 cm 5½"
- A8-158** 15 cm 6"
- A8-164** 16.5 cm 6½"
- A8-170** 19 cm 7½"

Sharp - Blunt

- A8-142** 11.5 cm 4½"
- A8-148** 12.5 cm 5"
- A8-154** 14 cm 5½"
- A8-160** 15 cm 6"
- A8-166** 16.5 cm 6½"
- A8-172** 19 cm 7½"

Sharp - Sharp

- A8-144** 11.5 cm 4½"
- A8-150** 12.5 cm 5"
- A8-156** 14 cm 5½"
- A8-162** 15 cm 6"
- A8-168** 16.5 cm 6½"
- A8-174** 19 cm 7½"

Operating Scissors



A8-180



A8-182



A8-184

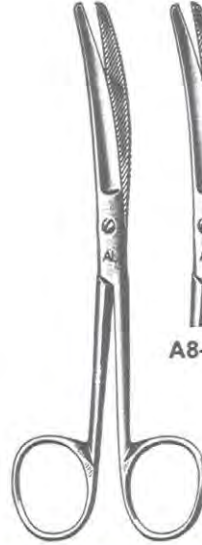

A8-190



A8-192



A8-194



Straight Delicate
12.5 cm 5"

A8-180 blunt-blunt
A8-182 sharp-blunt
A8-184 sharp-sharp

Curved Delicate
12.5 cm 5"

A8-190 blunt-blunt
A8-192 sharp-blunt
A8-194 sharp-sharp

Baby Operating Scissors



DEAVER
straight 14 cm 5½"

A8-200 blunt-blunt
A8-202 sharp-blunt
A8-204 sharp-sharp



DEAVER
curved 14 cm 5½"

A8-206 blunt-blunt
A8-208 sharp-blunt
A8-210 sharp-sharp



LANGE
14 cm 5½"

A8-220 straight
A8-222 curved



LANGE
serrated
14 cm 5½"

A8-224 straight
A8-226 curved

Operating Scissors

Operating Scissors



Operating Scissors	MIXTER 15.5 cm 6¼"		MAYO		MAYO-HARRINGTON	
	straight	curved	straight	curved	straight	curved
	A8-230	A8-232	A8-240	A8-242	A8-260	A8-262
			A8-244	A8-246	A8-264	A8-266
			A8-248	A8-250		
			A8-252	A8-254		



Operating Scissors	MAYO-STILLE		MAYO-NOBLE		WERTHEIM	
	straight	curved	straight	curved	straight	curved
	A8-270	A8-272	A8-280	A8-282	A8-290	
	A8-274	A8-276	A8-284	A8-286	A8-292	
					A8-294	



DUBOIS
26.5 cm 10½"

A8-300 straight
A8-302 curved



KELLY
fistula
15.5 cm 6¼"

A8-310 straight
A8-312 curved
A8-314 angular



DOYEN
18 cm 7"

A8-320 straight
A8-322 curved

Operating Scissors



FERGUSON
angled
18 cm 7"

A8-330



MILLER
rectal scissors
serrated blades
16.5 cm 6½"

A8-334



PRATT
rectal scissors
21.5 cm 8½"

A8-336



REYNOLDS
dissecting scissors
curved one
smooth blades serrated blade
A8-340 14.5 cm 5¾" **A8-344**
A8-342 18 cm 7" **A8-346**

Operating Scissors Rectal Scissors



Operating Scissors



Gynecological Scissors

SIMS
straight
blunt-blunt
A8-350 19 cm 7½"
A8-356 20 cm 8"
A8-362 21.5 cm 8½"
A8-368 23 cm 9"

SIMS
straight
sharp-blunt
A8-352 19 cm 7½"
A8-358 20 cm 8"
A8-364 21.5 cm 8½"
A8-370 23 cm 9"

SIMS
straight
sharp-sharp
A8-354 19 cm 7½"
A8-360 20 cm 8"
A8-366 21.5 cm 8½"
A8-372 23 cm 9"



Gynecological Scissors

SIMS
curved
blunt-blunt
A8-376 19 cm 7½"
A8-382 20 cm 8"
A8-388 21.5 cm 8½"
A8-394 23 cm 9"

SIMS
curved
sharp-blunt
A8-378 19 cm 7½"
A8-384 20 cm 8"
A8-390 21.5 cm 8½"
A8-396 23 cm 9"

SIMS
curved
sharp-sharp
A8-380 19 cm 7½"
A8-386 20 cm 8"
A8-392 21.5 cm 8½"
A8-398 23 cm 9"

Operating Scissors



THOREK
curved

A8-402 18.5 cm 7¼"
A8-404 25.5 cm 10"



RICHTER
angular
12.5 cm 5"

A8-410

Operating Scissors



BRAUN
episiotomy
scissors
14 cm 5½"

A8-414



BRAUN
episiotomy
scissors
21.5 cm 8½"

A8-416

Episiotomy Scissors



Operating Scissors



Umbilical Scissors

Umbilical scissors
American pattern
10 cm 4"

A8-420



Umbilical Scissors

BUSCH
umbilical
curved

A8-422 12 cm 5"
A8-424 16 cm 6¼"

BUSCH
umbilical
straight
16 cm 6¼"

A8-426

Operating Scissors



METZENBAUM
straight
blunt-blunt
14 cm 5½"

A8-430

METZENBAUM
straight
sharp-blunt
14 cm 5½"

A8-432

METZENBAUM
straight
sharp-sharp
14 cm 5½"

A8-434

Dissecting Scissors Straight



METZENBAUM
curved
blunt-blunt
14 cm 5½"

A8-436

METZENBAUM
curved
sharp-blunt
14 cm 5½"

A8-438

METZENBAUM
curved
sharp-sharp
14 cm 5½"

A8-440

Dissecting Scissors Curved

Operating Scissors



Operating Scissors	METZENBAUM straight	METZENBAUM curved	NELSON-METZENBAUM straight	NELSON-METZENBAUM curved
	A8-444 18 cm 7"	A8-450 18 cm 7"	A8-476 23 cm 9"	A8-484 23 cm 9"
	A8-446 20 cm 8"	A8-452 20 cm 8"	A8-478 25.5 cm 10"	A8-486 25.5 cm 10"
			A8-480 28 cm 11"	A8-488 28 cm 11"
			A8-482 30.5 cm 12"	A8-490 30.5 cm 12"



Operating Scissors	LAHEY-METZENBAUM straight	LAHEY-METZENBAUM curved	BABY-METZENBAUM straight, delicate	BABY-METZENBAUM curved, delicate
	A8-494 14.5 cm 5 3/4"	A8-496 14.5 cm 5 3/4"	A8-500 14 cm 5 1/2"	A8-506 14 cm 5 1/2"
			A8-502 15 cm 6"	A8-508 15 cm 6"
			A8-504 18 cm 7"	A8-510 18 cm 7"

Operating Scissors



BABY LEXER
10 cm 4"

A8-520 straight
A8-522 curved



BABY LEXER
saw edge
10 cm 4"

A8-524 straight
A8-526 curved



LEXER
straight
15.5 cm 6 1/4"

A8-528



LEXER
curved
15.5 cm 6 1/4"

A8-530

Operating Scissors



MAYO-LEXER
straight
21.5 cm 8 1/2"

A8-534



MAYO-LEXER
curved
21.5 cm 8 1/2"

A8-536



SANVENERO
dissecting
straight
14 cm 5 1/2"

A8-540



SANVENERO
dissecting
curved
14 cm 5 1/2"

A8-542

Operating Scissors Dissecting Scissors



Operating Scissors



Dissecting Scissors
Lung Scissors

JOSEPH
dissecting scissors
straight
14 cm 5½"

A8-546

JOSEPH
dissecting scissors
curved
14 cm 5½"

A8-548

CRAFOORD
lung scissors
curved
30.5 cm 12"

A8-550

SATINSKY
s-curved
25.5 cm 10"

A8-554



Thoracic Scissors
Dissecting Scissors

WILLAUER
thoracic scissors

straight
A8-560 24 cm 9½"
A8-562 28 cm 11"

curved
A8-564
A8-566

ADA
dissecting scissors
straight

A8-570 15 cm 6"
A8-572 20 cm 8"

ADA
dissecting scissors
curved

A8-574 15 cm 6"
A8-576 20 cm 8"

Operating Scissors

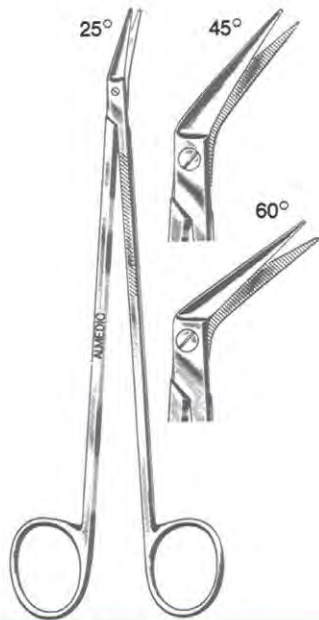

POTTS-SMITH
19 cm 7½"

- A8-580** 25° angle
- A8-582** 45° angle
- A8-584** 60° angle



SWEET
esophageal
angled blades
21.5 cm 8½"

A8-588



STRULLY
22 cm 8¾"

A8-590

Operating Scissors Esophageal Scissors



DANDY
trigeminal

- A8-594** 17 cm 6¾"
- A8-596** 19 cm 7¾"



SCHMIEDEN
17 cm 6¾"

A8-600



ADSON
ganglion scissors
straight
15.5 cm 6¼"

A8-604



ADSON
ganglion scissors
curved
15.5 cm 6¼"

A8-606

Trigeminal Scissors Operating Scissors Ganglion Scissors



Operating Scissors



Dura Scissors Operating Scissors

TAYLOR
dura
14.5 cm 5¾"

A8-610

TOENNIS-ADSON
18 cm 7"

A8-614

TOENNIS
straight
18 cm 7"

A8-616

TOENNIS
curved
18 cm 7"

A8-618

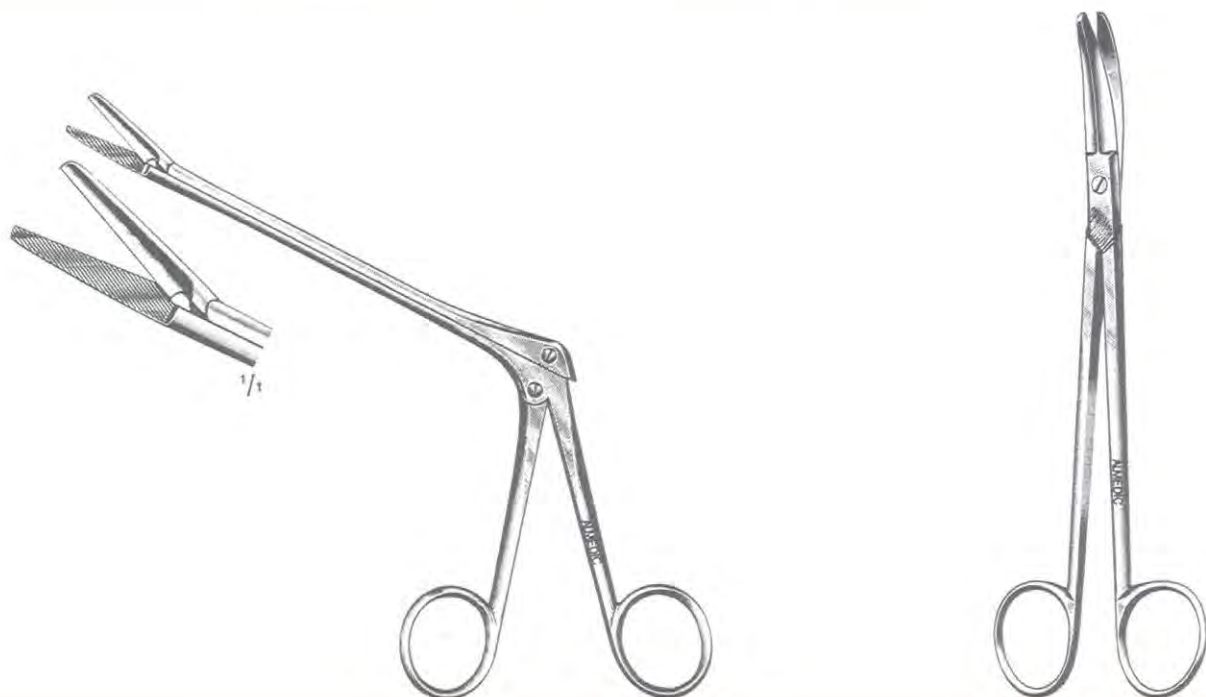

Alligator Scissors Operating Scissors

OLIVECRONA
23 cm 9"

A8-622

BOETTCHER
curved
18 cm 7"

A8-626

Operating Scissors



PRINCE
18 cm 7"

A8-630



YANKAUER
full curve
serrated blades
19 cm 7 1/2"

A8-634



DEAN
one serrated blade
17 cm 6 3/4"

A8-640

Operating Scissors



LILLIE
tonsil scissors
20 cm 8"

A8-644



GOOD
19 cm 7 1/2"

A8-648



HEYMANN
18 cm 7"

A8-652

Tonsil Scissors Operating Scissors

Operating Scissors



**Operating Scissors
Nasal Scissors**

SEILER
18 cm 7"

BECKMAN
19 cm 7½"

KNIGHT
18 cm 7"

A8-656

A8-660

A8-664



**Operating Scissors
Rhino-Plasty Scissors**

QUIMBY
12 cm 4¾"

NEUMANN
11.5 cm 4½"

KILNER
rhino-plasty

A8-668

A8-672

A8-674 12 cm 4¾"
A8-676 13.5 cm 5¼"
A8-678 15 cm 6"

Operating Scissors



Iris
straight

A8-680 9 cm 3½"
A8-682 10.5 cm 4¼"
A8-684 11.5 cm 4½"

Iris
curved

A8-686 9 cm 3½"
A8-688 10.5 cm 4¼"
A8-690 11.5 cm 4½"

Iris
angled
11.5 cm 4½"

A8-692

Iris Scissors



Iris
straight
probe tips
10.5 cm 4¼"

A8-698

Iris
curved
probe tips
10.5 cm 4¼"

A8-700

Iris
angled
probe tips
10.5 cm 4¼"

A8-702

Iris Scissors



Operating Scissors



A8-710



A8-712



A8-714



A8-716

Tenotomy Scissors

STEVENS
tenotomy
10.5 cm 4 1/4"

straight

A8-710

sharp points

A8-712

blunt points

curved

A8-714

A8-716

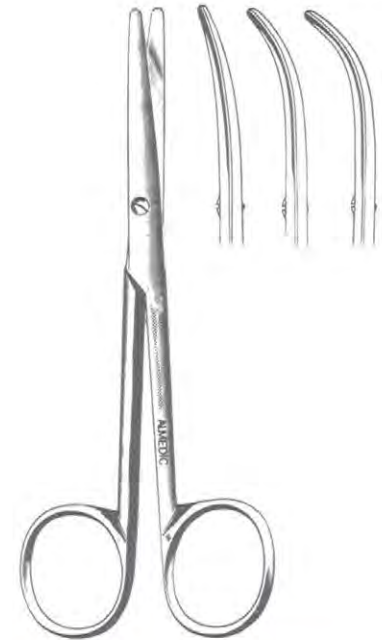

Strabismus Scissors Enucleation Scissors

Strabismus
straight
11.5 cm 4 1/2"

A8-724

Strabismus
curved
11.5 cm 4 1/2"

A8-726

Enucleation Scissors
12.5 cm 5"

A8-730 slight curved
A8-732 medium curved
A8-734 full curved

Operating Scissors



BROPHY
straight
14.5 cm 5¾"

BROPHY
curved
14.5 cm 5¾"

Operating Scissors

A8-740

A8-742



Dissecting Scissors
straight
sharp points
A8-750 11.5 cm 4½"
A8-752 13 cm 5"
A8-754 14 cm 5½"

Dissecting Scissors
curved
sharp points
A8-756 11.5 cm 4½"
A8-758 13 cm 5"
A8-760 14 cm 5½"

Dissecting Scissors
straight
one guarded point
A8-762 11.5 cm 4½"
A8-764 13 cm 5"
A8-766 14 cm 5½"

Dissecting Scissors



Operating Scissors



Artery Scissors

Artery straight
11.5 cm 4½"

Artery angled
11.5 cm 4½"

A8-768

A8-770



Enterotomy Scissors

Enterotomy

Enterotomy with hook blade

Enterotomy with probe point

A8-780 17 cm 6¾"
A8-782 21.5 cm 8½"

A8-784 17 cm 6¾"
A8-786 21.5 cm 8½"

A8-788

Operating Scissors



SISTRUNK
dissecting scissors
14 cm 5½"

A8-792



SPENCER
stitch scissors
straight

A8-800 9 cm 3½"
A8-802 11 cm 4½"



SPENCER
stitch scissors
angled
11 cm 4½"

A8-804

Dissecting Scissors
Stitch Scissors



LITTAUER-BUCK
stitch scissors
12.5 cm 5"

A8-806



LITTAUER
stitch scissors

A8-808 14 cm 5½"
A8-810 16 cm 6¼"



EISELBERG
ligature scissors
11 cm 4¼"

A8-814



HEATH
suture scissors
16 cm 6¼"

A8-818

Stitch Scissors
Ligature Scissors
Suture Scissors



Operating Scissors with Tungsten Carbide Inserts

ALCARB™ Brand Scissors have special tungsten carbide cutting edges permanently inlaid into the stainless steel.

Since tungsten carbide is one of the hardest and strongest alloys known, the ALCARB™ cutting edge seldom needs sharpening.

ALCARB™ Scissors have gold plated rings for easy identification.

ALCARB™ tungsten carbide scissors are guaranteed against defects in material and workmanship.



Operating Scissors, T-C Straight

blunt-blunt
14 cm 5½"

sharp-blunt
14 cm 5½"

sharp-sharp
14 cm 5½"

A9-100

A9-102

A9-104



Operating Scissors, T-C Curved

blunt-blunt
14 cm 5½"

sharp-blunt
14 cm 5½"

sharp-sharp
14 cm 5½"

A9-110

A9-112

A9-114

Operating Scissors with Tungsten Carbide Inserts



MAYO

straight

A9-120 14 cm 5½"
A9-122 17 cm 6¾"
A9-124 23 cm 9"

MAYO

curved

A9-126 14 cm 5½"
A9-128 17 cm 6¾"
A9-130 23 cm 9"

MAYO-STILLE

straight

A9-140 15 cm 6"
A9-142 17 cm 6¾"
A9-144 21.5 cm 8½"

MAYO-STILLE

curved

A9-146 15 cm 6"
A9-148 17 cm 6¾"
A9-150 21.5 cm 8½"

Operating Scissors T-C



METZENBAUM

straight

A9-160 14 cm 5½"
A9-162 18 cm 7"
A9-164 20 cm 8"

METZENBAUM

curved

A9-166 14 cm 5½"
A9-168 18 cm 7"
A9-170 20 cm 8"

NELSON-METZENBAUM

straight

A9-180 23 cm 9"
A9-182 25.5 cm 10"
A9-184 28 cm 11"
A9-186 30.5 cm 12"

NELSON-METZENBAUM

curved

A9-188 23 cm 9"
A9-190 25.5 cm 10"
A9-192 28 cm 11"
A9-194 30.5 cm 12"

Operating Scissors T-C

Operating Scissors with Tungsten Carbide Inserts



Operating Scissors, T-C

METZENBAUM
straight, slender

- A9-200** 14 cm 5½"
- A9-202** 18 cm 7"
- A9-204** 23 cm 9"

METZENBAUM
curved, slender

- A9-206** 14 cm 5½"
- A9-208** 18 cm 7"
- A9-210** 23 cm 9"



Operating Scissors, T-C

LAHEY-METZENBAUM
straight
14 cm 5¼"

A9-220

LAHEY-METZENBAUM
curved
14.5 cm 5¾"

A9-222

LEXER
straight
15 cm 6"

A9-230

LEXER
curved
15 cm 6"

A9-232

Operating Scissors with Tungsten Carbide Inserts



Iris
straight
11.5 cm 4½"

A9-240

Iris
curved
11.5 cm 4½"

A9-242

Strabismus
straight
11.5 cm 4½"

A9-250

Strabismus
curved
11.5 cm 4½"

A9-252

Iris Scissors T-C
Strabismus
Scissors T-C



Suture and Wire
scissors
angular
12 cm 4¾"

A9-260

LISTER
bandage scissors

A9-270 14 cm 5½"
A9-272 18 cm 7"

BRUNS
plaster shears
smooth
23 cm 9"

A9-280

Suture and Wire T-C
Bandage Scissors T-C
Plaster Shears T-C



Dressing and Tissue Forceps



Dressing Forceps

Standard Pattern straight

- A10-100** 10 cm 4"
- A10-102** 11.5 cm 4½"
- A10-104** 12.5 cm 5"
- A10-106** 14 cm 5½"
- A10-108** 15 cm 6"
- A10-110** 18 cm 7"
- A10-112** 20 cm 8"

Standard Pattern straight with pin

- A10-114** 25.5 cm 10"
- A10-116** 30.5 cm 12"



Dressing Forceps

Standard Pattern curved

- A10-120** 11.5 cm 4½"
- A10-122** 12.5 cm 5"
- A10-124** 14 cm 5½"
- A10-126** 15 cm 6"
- A10-128** 18 cm 7"
- A10-130** 20 cm 8"

Standard Pattern curved with pin

- A10-132** 25.5 cm 10"
- A10-134** 30.5 cm 12"

Dressing and Tissue Forceps



Narrow Pattern straight

A10-140 11.5 cm 4½"	A10-148 18 cm 7"
A10-142 12.5 cm 5"	A10-150 20 cm 8"
A10-144 14 cm 5½"	A10-152 25.5 cm 10"
A10-146 15 cm 6"	A10-154 30.5 cm 12"

Narrow Pattern curved

A10-160 11.5 cm 4½"	A10-168 18 cm 7"
A10-162 12.5 cm 5"	A10-170 20 cm 8"
A10-164 14 cm 5½"	A10-172 25.5 cm 10"
A10-166 15 cm 6"	A10-174 30.5 cm 12"

Dressing Forceps



U.S. Model fluted handle

A10-190 12.5 cm 5"	A10-198 20 cm 8"
A10-192 14 cm 5½"	A10-200 25.5 cm 10"
A10-194 15 cm 6"	A10-202 30.5 cm 12"
A10-196 18 cm 7"	

U.S. Model fluted handle narrow tips

A10-204 12.5 cm 5"
A10-206 14 cm 5½"
A10-208 15 cm 6"

Dressing Forceps

Dressing and Tissue Forceps

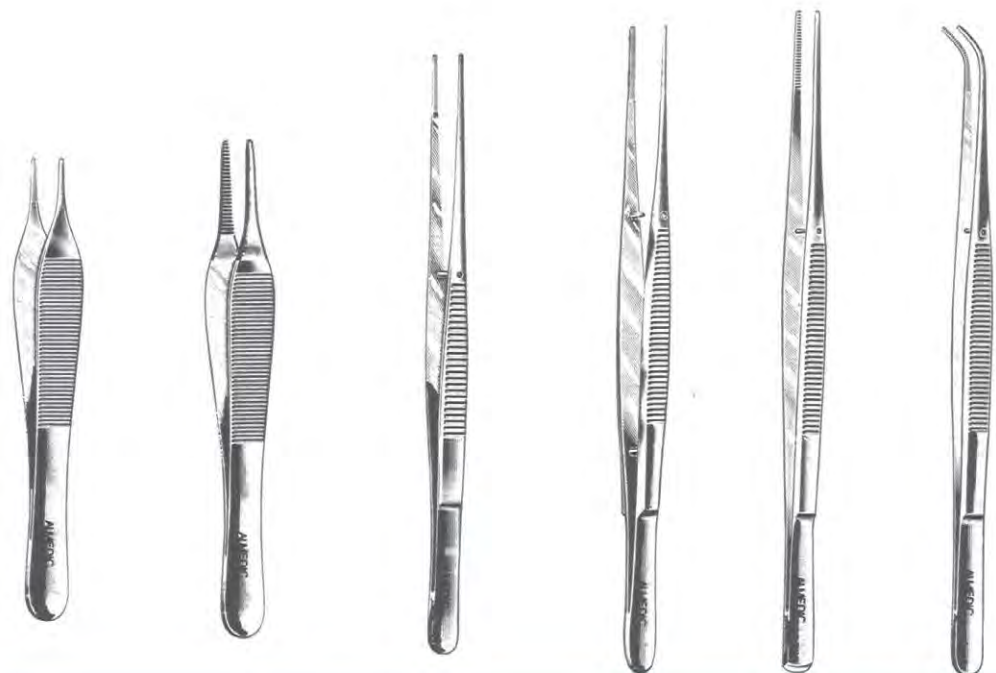

Dressing Forceps	ADSON 12 cm 4¾"	HUDSON (EWALD) 12 cm 4¾"	SEMKIN	TAYLOR straight 18 cm 7"	TAYLOR straight with rasp 18 cm 7"	TAYLOR curved 18 cm 7"
	A10-220	A10-224	A10-228 12.5 cm 5" A10-230 15 cm 6"	A10-232	A10-234	A10-236



Dressing Forceps	TAYLOR curved with rasp 18 cm 7"	TAYLOR bayonet 18 cm 7"	TAYLOR bayonet with rasp 18 cm 7"	GERALD straight 18 cm 7"	GERALD curved 18 cm 7"
	A10-238	A10-240	A10-242	A10-250	A10-252

Dressing and Tissue Forceps



McINDOE
15 cm 6"

A10-256



CUSHING
straight
18 cm 7"

A10-260



CUSHING
curved
18 cm 7"

A10-262



POTTS-SMITH
straight

A10-270 18 cm 7"

A10-272 21 cm 8¼"

A10-274 25.5 cm 10"

**Dressing
Forceps**



POTTS-SMITH
curved

A10-280 18 cm 7"

A10-282 21 cm 8¼"

A10-284 25.5 cm 10"



BROPHY
straight
20 cm 8"

A10-290



BROPHY
curved
20 cm 8"

A10-292



WANGENSTEEN
suture forceps
23 cm 9"

A10-296



**Dressing
Forceps
Suture
Forceps**



Dressing and Tissue Forceps



1 X 2 teeth



1 X 2 teeth
extra fine
teeth

Tissue Forceps

- A10-300** 10 cm 4"
- A10-302** 11.5 cm 4½"
- A10-304** 12.5 cm 5"
- A10-306** 14 cm 5½"
- A10-308** 15 cm 6"

- A10-310** 18 cm 7"
- A10-312** 20 cm 8"
- A10-314** 25.5 cm 10"
- A10-316** 30.5 cm 12"

- A10-320** 12.5 cm 5"
- A10-322** 14 cm 5½"
- A10-324** 15 cm 6"
- A10-326** 20 cm 8"



2 X 3 teeth



3 X 4 teeth



4 X 5 teeth

Tissue Forceps

- A10-330** 12.5 cm 5"
- A10-332** 14 cm 5½"
- A10-334** 15 cm 6"
- A10-336** 18 cm 7"

- A10-338** 20 cm 8"
- A10-340** 25.5 cm 10"
- A10-342** 30.5 cm 12"

- A10-350** 12.5 cm 5"
- A10-352** 14 cm 5½"
- A10-354** 15 cm 6"

- A10-360** 12.5 cm 5"
- A10-362** 14 cm 5½"

Dressing and Tissue Forceps



U.S. MODEL
1 X 2 teeth
fluted handle



U.S. MODEL
2 X 3 teeth
fluted handle

A10-370 12.5 cm 5"
A10-372 14 cm 5½"
A10-374 15 cm 6"
A10-376 18 cm 7"

A10-378 20 cm 8"
A10-380 25.5 cm 10"
A10-382 30.5 cm 12"

A10-390 12.5 cm 5"
A10-392 14 cm 5½"
A10-394 15 cm 6"
A10-396 18 cm 7"

A10-398 20 cm 8"
A10-400 25.5 cm 10"
A10-402 30.5 cm 12"

Tissue Forceps



U.S. MODEL
extra slender
1 X 2 teeth
fluted handle



ADSON
12 cm ¾"

A10-410 12.5 cm 5"
A10-412 14 cm 5½"
A10-414 15 cm 6"

A10-420 1 X 2 teeth
A10-422 1 X 2 teeth
cross serrated
A10-424 2 X 3 teeth

Tissue Forceps

**Dressing and
Tissue
Forceps**



**Tissue
Forceps**

**EWALD
(HUDSON)**
1 X 2 teeth
12 cm 4 3/4"

BROWN-ADSON
7 X 7 teeth
side grasping
12 cm 4 3/4"

A10-430

A10-434



**Tissue
Forceps**

BROWN
7 X 7 teeth
side grasping

STILLE
4 X 5 teeth
12.5 cm 5"

STONE
4 X 5 teeth
15 cm 6"

A10-438 15 cm 6"
A10-440 20 cm 8"

A10-444

A10-448

Dressing and Tissue Forceps



SEMKIN
1 X 2 teeth

SEMKIN
2 X 3 teeth
12 cm 4 3/4"

TAYLOR
straight
1 X 2 teeth
18 cm 7"

TAYLOR
straight
with rasp
1 X 2 teeth
18 cm 7"

Tissue Forceps

A10-452 12 cm 4 3/4"
A10-454 15 cm 6"

A10-456

A10-468

A10-470



TAYLOR
curved
1 X 2 teeth
18 cm 7"

TAYLOR
curved
with rasp
1 X 2 teeth
18 cm 7"

TAYLOR
bayonet
1 X 2 teeth
18 cm 7"

TAYLOR
bayonet
with rasp
1 X 2 teeth
18 cm 7"

GERALD
straight
1 X 2 teeth
18 cm 7"

Tissue Forceps

A10-472

A10-474

A10-476

A10-478

A10-480

Dressing and Tissue Forceps



Tissue Forceps

GERALD
curved
1 X 2 teeth
18 cm 7"

GILLIES
1 X 2 teeth
15 cm 6"

CUSHING
straight
1 X 2 teeth
18 cm 7"

CUSHING
curved
1 X 2 teeth
18 cm 7"

A10-482

A10-486

A10-490

A10-492



Tissue Forceps

POTTS-SMITH
straight
1 X 2 teeth
A10-500 18 cm 7"
A10-502 21 cm 8¼"
A10-504 25.5 cm 10"

POTTS-SMITH
curved
1 X 2 teeth
A10-510 18 cm 7"
A10-512 21 cm 8¼"
A10-514 25.5 cm 10"

BROPHY
straight
1 X 2 teeth
20 cm 8"
A10-520

BROPHY
curved
1 X 2 teeth
20 cm 8"
A10-522

Dressing and Tissue Forceps



KELLY
23 cm 9"
A10-530 1 X 2 teeth
A10-532 2 X 3 teeth
A10-534 3 X 4 teeth
A10-536 4 X 5 teeth



LANE
1 X 2 teeth
14 cm 5½"

A10-540



LANE
2 X 3 teeth
14 cm 5½"

A10-542

Tissue Forceps



FERRIS-SMITH
1 X 2 teeth
18 cm 7"

A10-546



FERRIS-SMITH
2 X 3 teeth
18 cm 7"

A10-548



BONNEY
1 X 2 teeth
18 cm 7"

A10-552

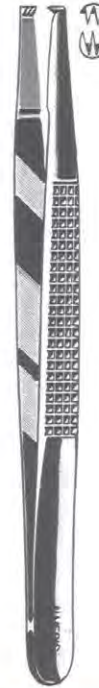

BONNEY
2 X 3 teeth
18 cm 7"

A10-554

Tissue Forceps

Dressing and Tissue Forceps



Tissue Forceps Cardiovascular Forceps

RUSSIAN

- A10-560** 15 cm 6"
- A10-562** 20 cm 8"
- A10-564** 25.5 cm 10"

MAYO-RUSSIAN
23 cm 9"

A10-568

DE BAKEY
cardiovascular forceps

- A10-576** 15 cm 6"
- A10-578** 20 cm 8"
- A10-580** 24 cm 9½"
- A10-582** 30 cm 12"



Tissue Forceps Lung Grasping Forceps

DAVIS
25.5 cm 10"

A10-586

SINGLEY-TUTTLE
23 cm 9"

A10-588

NELSON
6 X 7 teeth
23 cm 9"

A10-590

COLLIN-DUVAL
lung grasping forceps
21.5 cm 8½" jaw width

- A10-592** 14 mm
- A10-594** 18 mm
- A10-596** 27 mm

Splinter Forceps



straight
smooth

A10-600 9 cm 3½"
A10-602 10 cm 4"
A10-604 11.5 cm 4½"
A10-606 12.5 cm 5"

curved
smooth

A10-610 9 cm 3½"
A10-612 10 cm 4"
A10-614 11.5 cm 4½"
A10-616 12.5 cm 5"

straight
serrated with pin

A10-620 9 cm 3½"
A10-622 10 cm 4"
A10-624 11.5 cm 4½"
A10-626 12.5 cm 5"

curved
serrated with pin

A10-630 9 cm 3½"
A10-632 10 cm 4"
A10-634 11.5 cm 4½"
A10-636 12.5 cm 5"

**Splinter
Forceps**



FEILCHENFELD

A10-640 7.5 cm 3"
A10-642 11.5 cm 4½"

HUNTER
straight
11.5 cm 4½"

A10-650

HUNTER
curved
11.5 cm 4½"

A10-652

**Splinter
Forceps**

**Splinter
Forceps**



<p>Splinter Forceps</p>	<p>WALTER (CARMALT) straight 10.5 cm 4 1/4"</p> <p>A10-660</p>	<p>WALTER (CARMALT) angled 10.5 cm 4 1/4"</p> <p>A10-662</p>	<p>Splinter Forceps with magnifier and set screw 7.5 cm 3"</p> <p>A10-670</p>
------------------------------------	--	--	---



<p>Splinter Forceps</p>	<p>FEILCHENFELD with magnifier 7.5 cm 3"</p> <p>A10-672</p>	<p>Physician Type 12.5 cm 5"</p> <p>A10-680</p>	<p>PEET 12 cm 4 3/4"</p> <p>A10-684</p>	<p>RALKS (Virtus) 15 cm 6"</p> <p>A10-688</p>
------------------------------------	---	---	---	---

Splinter Forceps



No. 1
heavy sharp
points
12 cm 4¾"

A10-700



No. 3
very sharp
points
12 cm 4¾"

A10-702



No. 5
long points
11 cm 4⅜"

A10-704

Splinter Forceps



No. 6
sharp hooked
points
11.5 cm 4½"

A10-706



No. 7
fine curved
points
11 cm 4⅜"

A10-708



No. H
wide shanks
fine points
9 cm 3½"

A10-710

Splinter Forceps



Dressing Forceps with Tungsten Carbide Jaws

ALCARB™ Brand Dissecting Forceps have tungsten carbide jaw inserts which are permanently inlaid into the instruments.

Since tungsten carbide is one of the hardest and strongest alloys known, these forceps have exceptional durability and resistance to wear. The fine non-traumatic serrations of the jaw surfaces provide a firm, yet gentle grip of tissues without slipping.

ALCARB™ Tungsten Carbide Dissecting Forceps have gold plated handles for easy identification.

ALCARB™ Tungsten Carbide Dissecting Forceps are guaranteed against defects in material and workmanship.



Dressing Forceps with T-C Jaws

straight

- A11-100** 13 cm 5"
- A11-102** 14 cm 5½"
- A11-104** 15 cm 6"

straight with guide pin

- A11-106** 18 cm 7"
- A11-108** 20 cm 8"
- A11-110** 25.5 cm 10"
- A11-112** 30.5 cm 12"



Dressing Forceps with T-C Jaws

ADSON
12 cm 4¾"

A11-126

CUSHING
with dissecting end
18 cm 7"

A11-130

POTTS-SMITH

- A11-140** 18 cm 7"
- A11-142** 20 cm 8"
- A11-144** 25.5 cm 10"

Hemostatic Forceps



DIEFFENBACH
straight
4 cm 1½"

A12-100

DIEFFENBACH
curved
4 cm 1½"

A12-102

DIEFFENBACH
straight
6.5 cm 2½"

A12-104

DIEFFENBACH
curved
6.5 cm 2½"

A12-106

**Serrefines
Bulldog Clamps**



JOHNS HOPKINS bulldog clamps
straight
A12-110 4 cm 1½"
A12-114 5 cm 2"
A12-118 6.5 cm 2½"
A12-122 7.5 cm 3"
A12-126 9 cm 3½"

curved
A12-112
A12-116
A12-120
A12-124
A12-128

Bulldog
clamp
applying
forceps
21 cm 8¼"
A12-132

HARTMANN
straight
9 cm 3½"
A12-140

HARTMANN
curved
9 cm 3½"
A12-142

**Bulldog Clamps
Clamp Applying
Forceps
Mosquito Forceps**

**Hemostatic
Forceps**



**Hemostatic
Forceps**

HALSTEAD
12.5 cm 5"

A12-150 straight
A12-152 curved

HALSTEAD
1 X 2 teeth
12.5 cm 5"

A12-154 straight
A12-156 curved

ALMEDIC
21 cm 8 1/4"

A12-160 straight
A12-162 curved

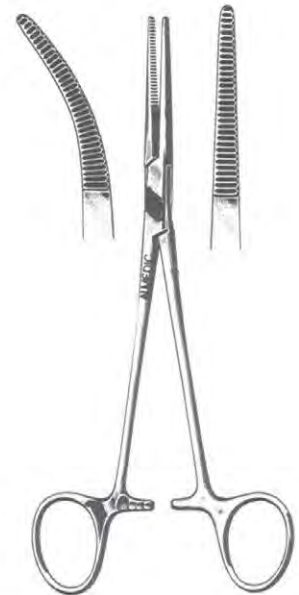

**Hemostatic
Forceps**

**PROVIDENCE
HOSPITAL**
14 cm 5 1/2"

A12-170 straight
A12-172 curved

KELLY (MURPHY)
14 cm 5 1/2"

A12-180 straight
A12-182 curved

KELLY-RANKIN
15.5 cm 6 1/4"

A12-184 straight
A12-186 curved

Hemostatic Forceps

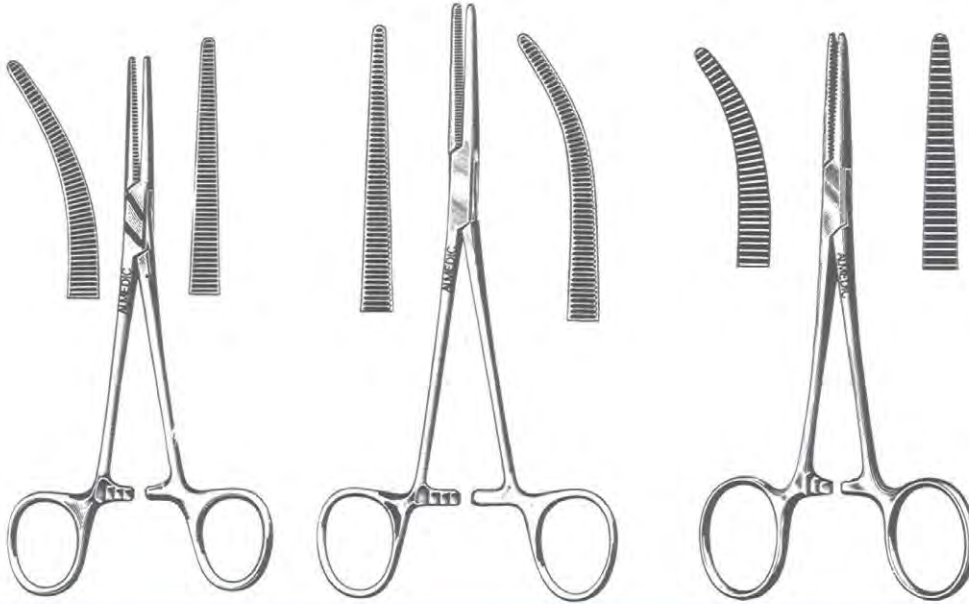

CRILE
14 cm 5½"

A12-190 straight
A12-192 curved

CRILE-RANKIN
15.5 cm 6¼"

A12-194 straight
A12-196 curved

LAHEY
14 cm 5½"

A12-200 straight
A12-202 curved

**Hemostatic
Forceps**

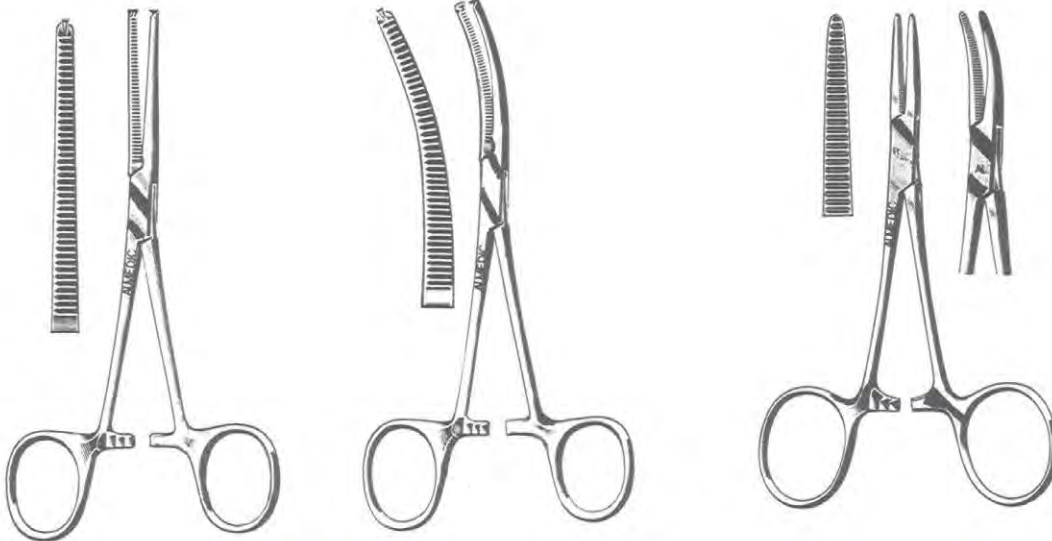

OCHSNER (KOCHER)
1 X 2 teeth
14 cm 5½"
straight

A12-210

OCHSNER (KOCHER)
1 X 2 teeth
14 cm 5½"
curved

A12-212

JONES
14 cm 5½"

A12-220 straight
A12-222 curved

**Hemostatic
Forceps**



Hemostatic Forceps



Hemostatic Forceps

SPENCER-WELLS
straight

- A12-230** 12.5 cm 5"
- A12-232** 15 cm 6"
- A12-234** 18 cm 7"
- A12-236** 20 cm 8"

SPENCER-WELLS
curved

- A12-238** 12.5 cm 5"
- A12-240** 15 cm 6"
- A12-242** 18 cm 7"
- A12-244** 20 cm 8"

COLLER
curved

- A12-252** 15.5 cm 6 1/4"

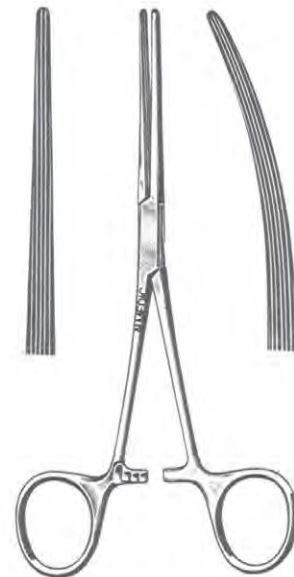

Hemostatic Forceps

LOVELACE
1 X 2 teeth
15.5 cm 6 1/4"

A12-260

DANDY
curved sideways
14 cm 5 1/2"

A12-264

BAINBRIDGE

- straight **A12-270** 15 cm 6"
- curved **A12-272**
- A12-274** 18.5 cm 7 1/4"
- A12-276**



Hemostatic Forceps

ADSON
18.5 cm 7¼"

A12-280 straight
A12-282 curved

PEAN
14 cm 5½"

A12-290 straight
A12-292 curved

ROCHESTER-CARMALT

straight	curved
A12-300 15.5 cm 6¼"	A12-304
A12-302 20 cm 8"	A12-306

Hemostatic Forceps



straight	ROCHESTER-PEAN	curved
A12-310	14 cm 5½"	A12-322
A12-312	15.5 cm 6¼"	A12-324
A12-314	18.5 cm 7¼"	A12-326
A12-316	20 cm 8"	A12-328
A12-318	23 cm 9"	A12-330
A12-320	26 cm 10¼"	A12-332

	ROCHESTER-OCHSNER	
straight		curved
A12-340 14 cm 5½"		A12-348
A12-342 15.5 cm 6¼"		A12-350
A12-344 18.5 cm 7¼"		A12-352
A12-346 20 cm 8"		A12-354

Hemostatic Forceps

**Hemostatic
Forceps**



**Hysterectomy
Forceps**

PEAN
hysterectomy forceps
horizontal serrations

straight	curved
A12-360 20 cm 8"	A12-366
A12-362 23 cm 9"	A12-368
A12-364 26 cm 10¼"	A12-370

PEAN
hysterectomy forceps
longitudinal serrations

straight
A12-380 20 cm 8"
A12-382 23 cm 9"

PEAN
hysterectomy forceps
longitudinal serrations

curved
A12-384 20 cm 8"
A12-386 23 cm 9"



**Hysterectomy
Forceps**

HEANEY
double tooth
21 cm 8¼"

A12-400

HEANEY
single tooth
21 cm 8¼"

A12-402

WERTHEIM
24.5 cm 9¾"

A12-404

Hemostatic Forceps



PHANEUF
straight
1 X 2 teeth
21.5 cm 8½"

A12-406



PHANEUF
hysterectomy forceps
angled
1 X 2 teeth
21.5 cm 8½"

A12-408



MIXTER
hemostatic
forceps

A12-410 15.5 cm 6¼"
A12-412 18.5 cm 7¼"

Hysterectomy Forceps Hemostatic Forceps



MAYO-GUYON
kidney pedical clamp
23 cm 9"

A12-420



STILLE
kidney pedical clamp
23 cm 9"

A12-424



HERRICK
kidney pedical clamp
24 cm 9½"

A12-432

Kidney Pedical Clamp



Hemostatic Forceps



Kidney Pedicle Clamp

WERTHEIM-CULLEN
21.5 cm 8½"

A12-436

OCKERBLAD
kidney clamp
23.5 cm 9¼"

A12-438



Peritoneal Clamp "T" Clamp Hemostatic Forceps

MIKULICZ
peritoneal clamp
20 cm 8"

A12-460

PRATT
"T" clamp
15 cm 6"

A12-470

PENNINGTON
15 cm 6"

A12-474



Hemostatic Forceps

FERGUSON
angiotribe

straight
A12-480 15.5 cm 6¼"
A12-482 19 cm 7½"

FERGUSON
angiotribe

curved
A12-484 15.5 cm 6¼"
A12-486 19 cm 7½"

Angiotribes



14 cm 5½"

A12-494



18 cm 7¼"

A12-496

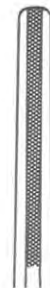

20 cm 8"

A12-498

ALMEDIC
tube occluding
forceps

**Tube Occluding
Forceps**



Towel Clamps



Towel Clamps

JONES
9 cm 3½"

DOYEN
18 cm 7"

BACKHAUS

A13-100

A13-102

A13-110 9 cm 3½"
A13-112 13.5 cm 5¼"



Towel Clamps

ROEDER
13.5 cm 5¼"

MOYNIHAN
19 cm 7½"

LANE
19 cm 7½"

A13-120

A13-124

A13-132



Retractors

Trachea Retractor
sharp rigid shank
15.5 cm 6¼"

A14-100 1 prong
A14-102 2 prongs
A14-104 3 prongs

Trachea Retractor
blunt rigid shank
15.5 cm 6¼"

A14-106 1 prong
A14-108 2 prongs
A14-110 3 prongs

Trachea Retractor
with flexible neck
15.5 cm 6¼"

sharp	blunt
A14-120 2 prongs	A14-126
A14-122 3 prongs	A14-128
A14-124 4 prongs	A14-130

Finger Retractors



MATHIEU
16 cm 6¼"

A14-140 sharp
A14-142 blunt

SENN
16 cm 6¼"

A14-150 sharp
A14-152 blunt

CRILE
thyroid retractor
11.5 cm 4½"

A14-156

Finger Retractors

Retractors

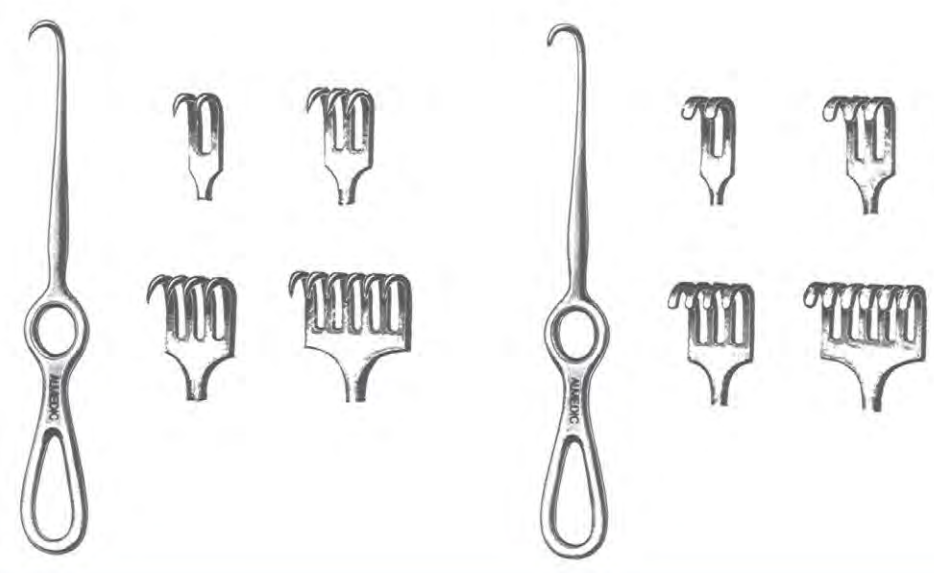

Finger Retractors

	VOLKMANN ring handle 21.5 cm 8½"		
	sharp		blunt
A14-160	1 prong		A14-170
A14-162	2 prongs		A14-172
A14-164	3 prongs		A14-174
A14-166	4 prongs		A14-176
A14-168	6 prongs		A14-178



Finger Retractors

	VOLKMANN flat handle 21.5 cm 8½"				MEYERDING 18 cm 7"			
	sharp	blunt	sharp	blunt	blade	size	blade	size
A14-180	1 prong	A14-190			A14-200	smooth 18 X 7 mm	A14-206	smooth 10 X 3 mm
A14-182	2 prongs	A14-192	A14-186	4 prongs	A14-202	toothed 16 X 5 mm	A14-208	concave 7 X 4 mm
A14-184	3 prongs	A14-194	A14-188	6 prongs	A14-204	toothed 7 X 4 mm	A14-210	3 sharp prongs 10 X 4 mm

Retractors

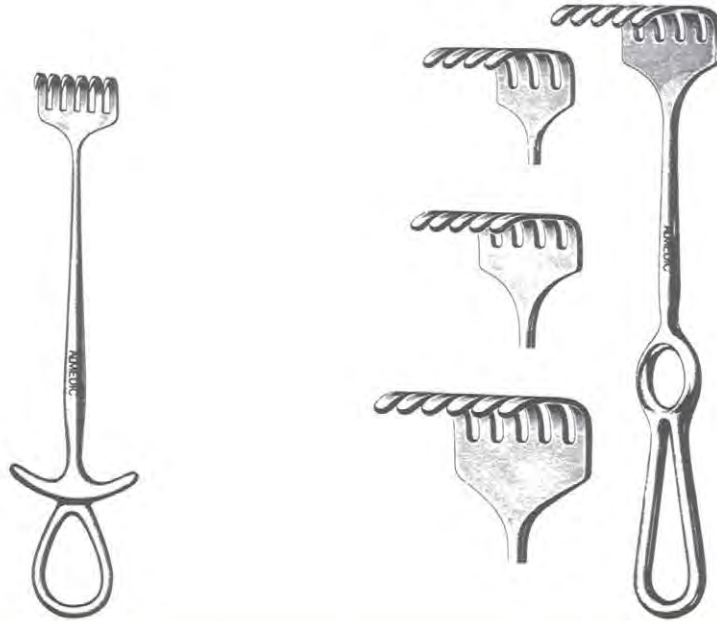

MURPHY
19 cm 7½"

sharp		blunt
A14-220	2 prongs	A14-230
A14-222	3 prongs	A14-232
A14-224	4 prongs	A14-234
A14-226	6 prongs	A14-236

ISRAEL
25 cm 10"

		size
A14-240	4 prongs	40 X 40 mm
A14-242	5 prongs	50 X 40 mm
A14-244	6 prongs	50 x 60 mm

Finger Retractors

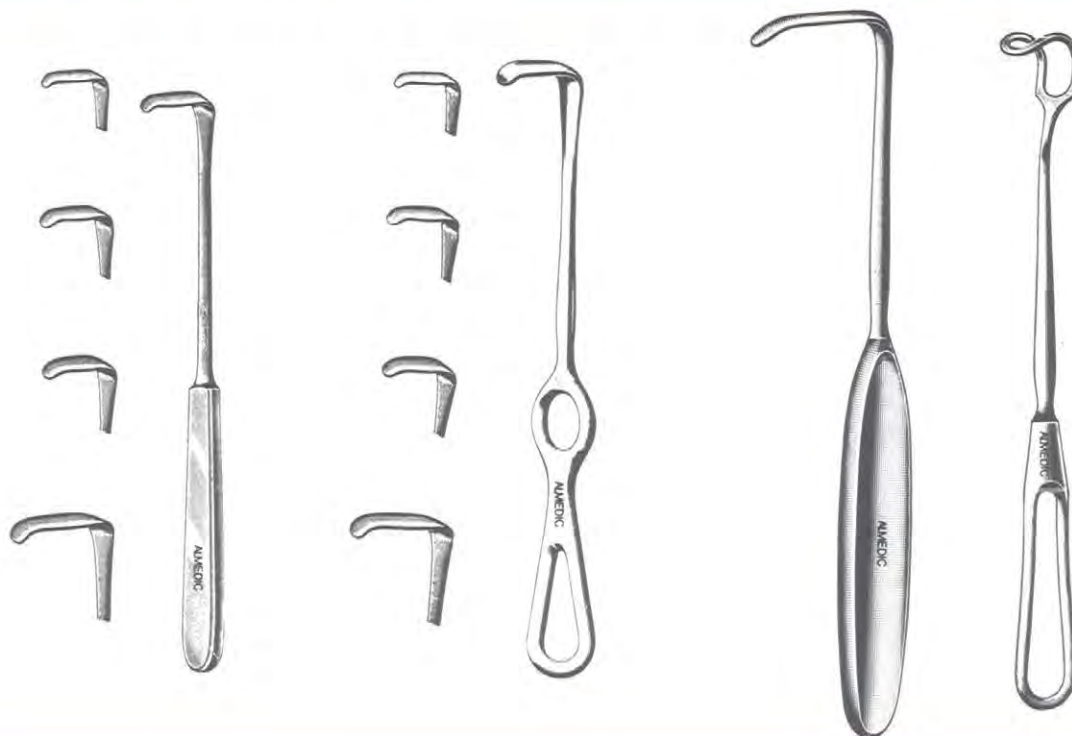

LANGENBECK flat handle
22 cm 8¾"

	blade
A14-250	30 X 11 mm
A14-252	30 X 14 mm
A14-254	30 X 16 mm
A14-256	40 X 11 mm

LANGENBECK ring handle
22 cm 8¾"

	blade
A14-260	30 X 11 mm
A14-262	30 X 14 mm
A14-264	30 X 16 mm
A14-268	40 X 11 mm

LAHEY
thyroid retractor
19 cm 7½"

A14-290

GREEN
thyroid retractor
21.5 cm 8½"

A14-294

Finger Retractors Thyroid Retractors



Retractors



Hand Retractors

RICHARDSON
24 cm 9½"
blade
A14-300 28 X 20 mm
A14-302 36 X 28 mm
A14-304 38 X 38 mm
A14-306 50 X 20 mm

RICHARDSON-EASTMAN
set of 2 blades
large 28 cm 11"
small 26 cm 10¼"

A14-310



Hand Retractor Spinal Retractors Tibia Retractors

KELLY
hollow grip handle
length blade
A14-320 24 cm 9½" 50 X 40 mm
A14-322 24 cm 9½" 65 X 50 mm
A14-324 25 cm 10" 75 X 65 mm
A14-326 26.5 cm 10½" 85 X 70 mm

TAYLOR
spinal retractor
16.5 cm 6½"
blade
A14-330 75 mm wide
A14-332 100 mm wide

BENNETT
tibia retractor
24 cm 9½"
blade
A14-340 45 mm wide
A14-342 65 mm wide

Retractors



MEYERDING

	length	blade
A14-344	20 cm 8"	15 X 60 mm
A14-346	23 cm 9"	25 X 75 mm
A14-348	24 cm 9½"	50 X 90 mm

FRITSCH abdominal retractors

	blade
A14-350	45 mm wide
A14-352	65 mm wide

MURPHY gall bladder retractor

	blade
A14-368	30 mm wide
A14-370	50 mm wide

Abdominal Retractors

Gall Bladder Retractors



HEANY 26.5 cm 10½"

	blade
A14-390	45 X 25 mm
A14-392	65 X 28 mm
A14-394	82 X 28 mm

HEANEY-SIMON 28 cm 11"

	blade
A14-396	115 X 27 mm

SAUERBRUCH 23 cm 9"

	blade
A14-400	45 X 15 mm
A14-402	60 X 23 mm
A14-404	75 X 20 mm

BABY HARRINGTON 24 cm 9½"

	blade
A14-408	20 mm wide

Retractors

Retractors



Hand Retractors
Scapula Retractor

HARRINGTON
32 cm 12½"

blade
A14-410 40 mm wide
A14-412 65 mm wide

HIBBS
23.5 cm 9¼"
blade 25 X 75 mm

A14-420

DAVIDSON
scapula retractor
16 cm 6¼"
blade 75 X 50 mm

A14-422



Thoracic Retractors
Lung Retractor

DAVIDSON
scapula retractor
16 cm 6¼"
blade 75 X 90 mm

A14-424

CORYLLOS
thoracic retractor
24 cm 9½"
blade

A14-426 82 X 22 mm
A14-428 108 X 43 mm
A14-430 115 X 65 mm

ALLISON
lung retractor
32 cm 12½"

A14-434

Retractors



BABY-DEAVER
18 cm 7"
blade 19 mm wide

A14-448



BABY DEAVER
21.5 cm 8½"
blade 22 mm wide

A14-450



DEAVER
30 cm 12"
blade 22 mm wide

A14-452

**Deaver
Retractors**



DEAVER
33 cm 13"
blade 25 mm wide

A14-454



DEAVER
30 cm 12"
blade 38 mm wide

A14-456



DEAVER
30 cm 12"
blade 50 mm wide

A14-458



DEAVER
30 cm 12"
blade 75 mm wide

A14-460

**Deaver
Retractors**



Retractors



Ribbon Retractor Hand Retractors

Ribbon Retractor
malleable
33 cm 13"

	width		width
A14-470	50 mm	A14-476	25 mm
A14-472	40 mm	A14-478	20 mm
A14-474	35 mm		

ROUX

A14-490	14 cm 5½"
A14-492	15 cm 6"
A14-494	17 cm 6¾"



Hand Retractors

PARKER
set of 2 blades
13.5 cm 5¼"
blade 15 mm wide

A14-500

PARKER
set of 2 blades
18 cm 7"
blade 25 mm wide

A14-502

Retractors



BABY FARABEU
set of 2 blades
12 cm 4¾"
blade widths
10 mm and 13 mm
A14-510



FARABEU
set of 2 blades
15 cm 6"
16 mm wide
A14-512



MAYO-COLLIN
set of 2 blades
15 cm 6"
blade widths
18 mm and 20 mm
A14-520

**Hand
Retractors**



U.S. Army
retractor
21.5 cm 8½"
A14-524



PARKER-MOTT
set of 2
16 cm 6¼"
blade 24 mm wide
A14-528



GOELET
19 cm 7½"
A14-532

**Hand
Retractors**



Retractors

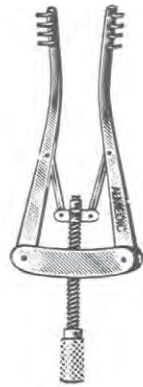

Self Retaining Retractors Mastoid Retractors

ALM
sharp

A14-600 7 cm 2¾"
A14-602 10 cm 4"

JANSEN
sharp
11.5 cm 4½"

A14-610

JANSEN
blunt
11.5 cm 4½"

A14-612



Self Retaining Retractors Mastoid Retractors

JANSEN-WAGNER
swivel blades
11.5 cm 4½"

A14-614

ALLPORT
10 cm 4"

A14-618

Retractors

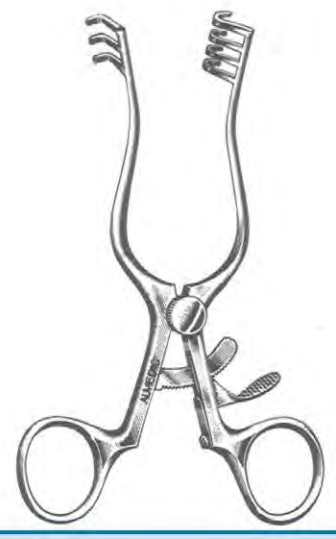

Self Retaining Retractors

WEITLANER with grip lock
3 X 4 teeth

sharp		blunt
A14-642	13 cm 5"	A14-644
A14-646	16½ cm 6½"	A14-648
A14-650	20 cm 8"	A14-652
A14-654	24 cm 9½"	A14-656

BECKMAN
sharp
31 cm 12¼"

A14-670

BECKMAN-WEITLANER
with hinged arms and grip lock

sharp		blunt
A14-680	14 cm 5½"	A14-682
A14-684	16.5 cm 6½"	A14-686
A14-688	23 cm 9"	A14-690

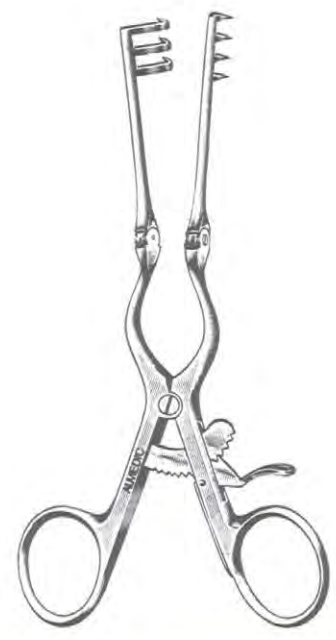
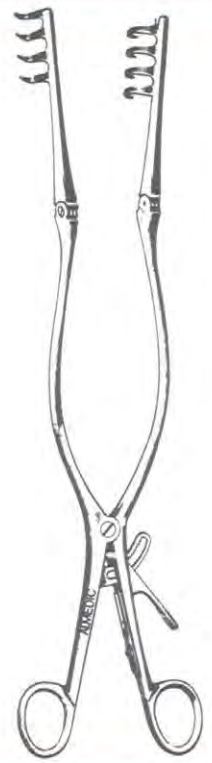

Self Retaining Retractors

BECKMAN-ADSON
with hinged arms
4 X 4 teeth
32 cm 12½"

	blade
A14-700	1" X 1"
A14-704	1" X 1½"

BABY ADSON
with hinged arms
and grip lock
3 X 4 teeth
16 cm 6¼"

A14-710	sharp
A14-712	blunt

ADSON
with hinged arms
and grip lock
4 X 5 teeth blunt
32 cm 12½"

A14-714

Retractors



ANDERSON-ADSON
with grip lock
sharp
20 cm 8"

A14-716

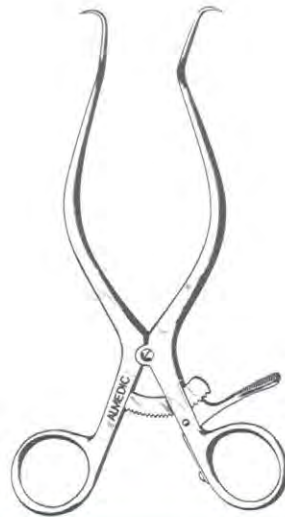

GELPI
with grip lock

A14-730 12.5 cm 5" (BABY)
A14-732 19 cm 7½"

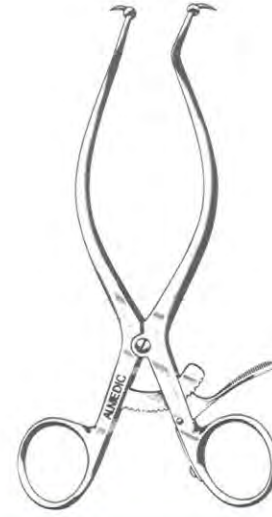

GELPI
with grip lock
and ball stops
19 cm 7½"

A14-734

**Self
Retaining
Retractors**



RIGBY
18 cm 7"

A14-740



MAYO-ADAMS
2 blades
17 cm 6¾"

A14-742

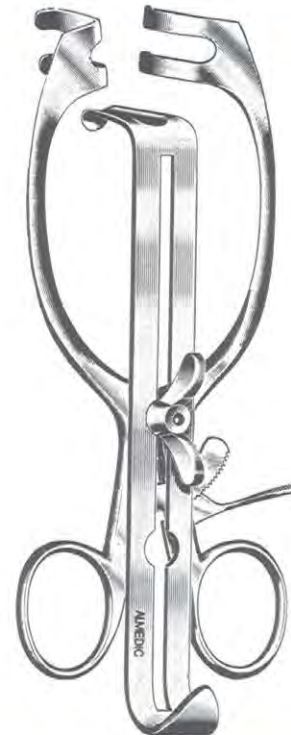

MAYO-ADAMS
3 blades
17 cm 6¾"

A14-744

**Self
Retaining
Retractors**

Retractors

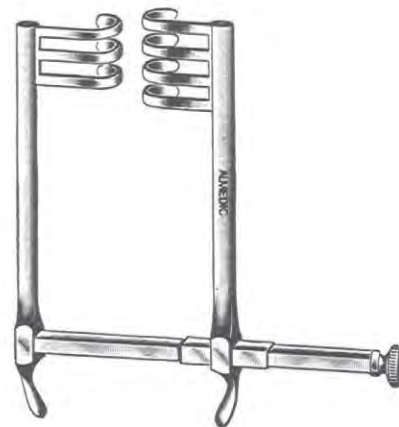
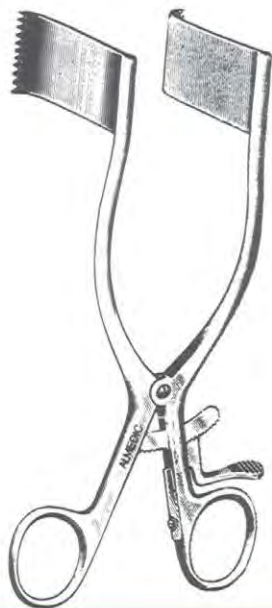

Self Retaining Retractors Laminectomy Retractors

MEYERDING
laminectomy retractor
18 cm 7" blade
A14-750 25 X 45 mm
A14-752 25 X 55 mm
A14-754 20 X 60 mm
A14-756 25 X 60 mm

FRAZIER
laminectomy retractor
spread 85 mm 3½"
blade depth 32 mm 1¼"

A14-760

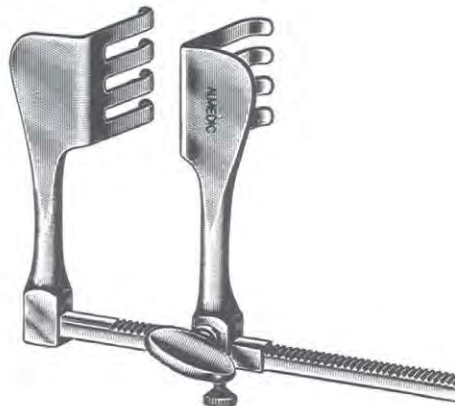
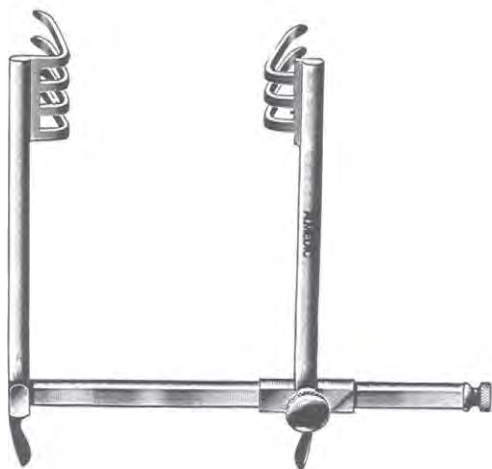

Self Retaining Retractors Laminectomy Retractors Bladder Retractors

TEMPLE-FAY
laminectomy retractor
spread 120 mm 4¾"
blade depth 50 mm 2"

A14-764

BADGLEY
laminectomy retractor
A14-768 spread 115 mm 4½"
blades 50 X 45 mm
A14-770 spread 165 mm 6½"
blades 50 X 45 mm

Retractors

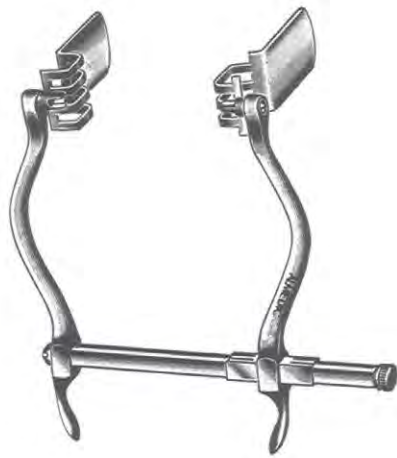

JUDD-MASSON
2 blades
spread 110 mm 4¼"
blades 70 mm 2¾"

A14-780

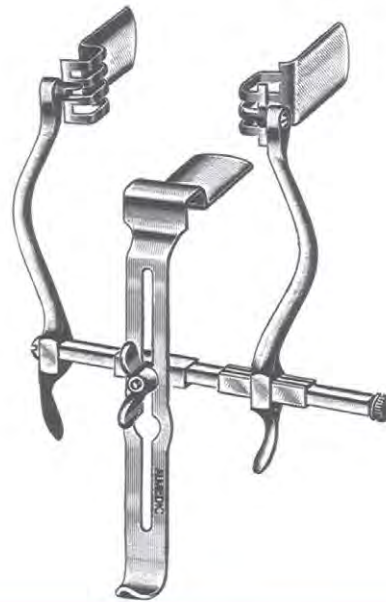

JUDD-MASSON
3 blades
spread 110 mm 4¼"
blades 70 mm 2¾"

A14-782

**Self Retaining
Retractors
Bladder
Retractors**



GOSSET
straight arms
spread 100 mm 4"
blades 30 X 40 mm

A14-800

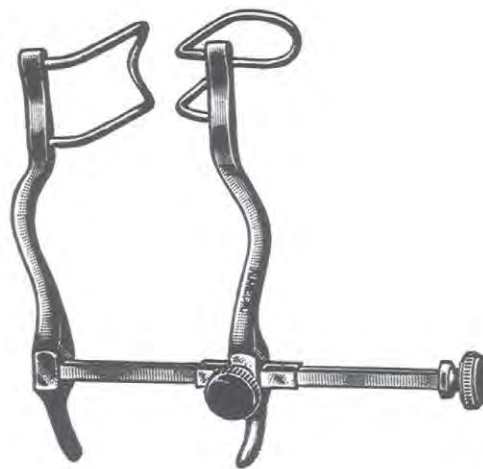

GOSSET
bent arms
spread 100 mm 4"
blades 30 X 40 mm

A14-802

**Self Retaining
Retractors
Abdominal
Retractors**

Retractors



**Self-Retaining
Retractors
Abdominal
Retractors**

GOSSET
bent arms
spread 140 mm 5½"

A14-804

GOSSET

spread 160 mm 6¼"
centre blade 57 X 60 mm
end blades 35 X 63 mm

A14-806

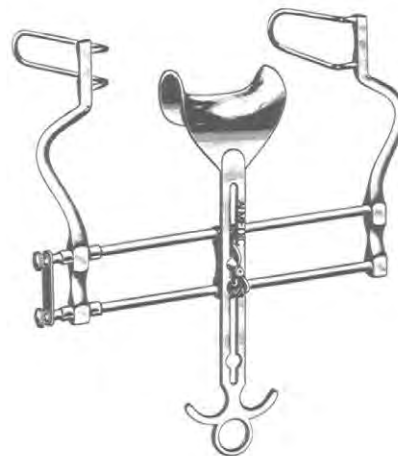
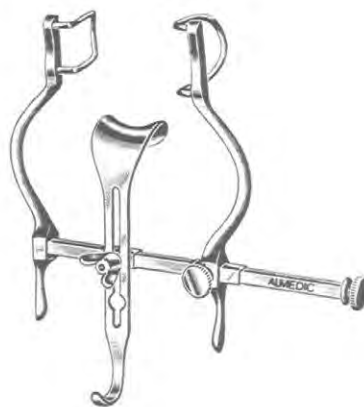

**Self Retaining
Retractors
Abdominal
Retractors**

BABY BALFOUR
open end blades
spread 90 mm 3½"
centre blade 20 X 24 mm
end blades 27 X 27 mm

A14-830

BALFOUR
open end blades
spread 180 mm 7"
centre blade 45 X 80 mm
end blades 35 X 63 mm

A14-832

Retractors

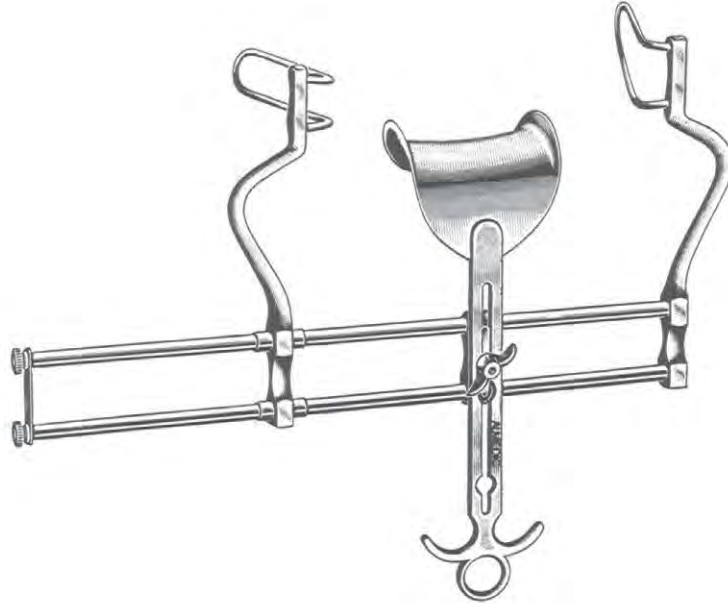

BALFOUR
open end blades
spread 250 mm 9 3/4"
centre blade 70 X 85 mm
end blades 35 X 100 mm

A14-834

**Abdominal
Retractors**



BALFOUR
closed end blades
spread 180 mm 7"
centre blade 45 X 80 mm
end blades 45 X 80 mm

A14-836



Center Blade Only
for balfour retractor

A14-838 45 X 80 mm
A14-840 70 X 85 mm

**Abdominal
Retractors**



Retractors

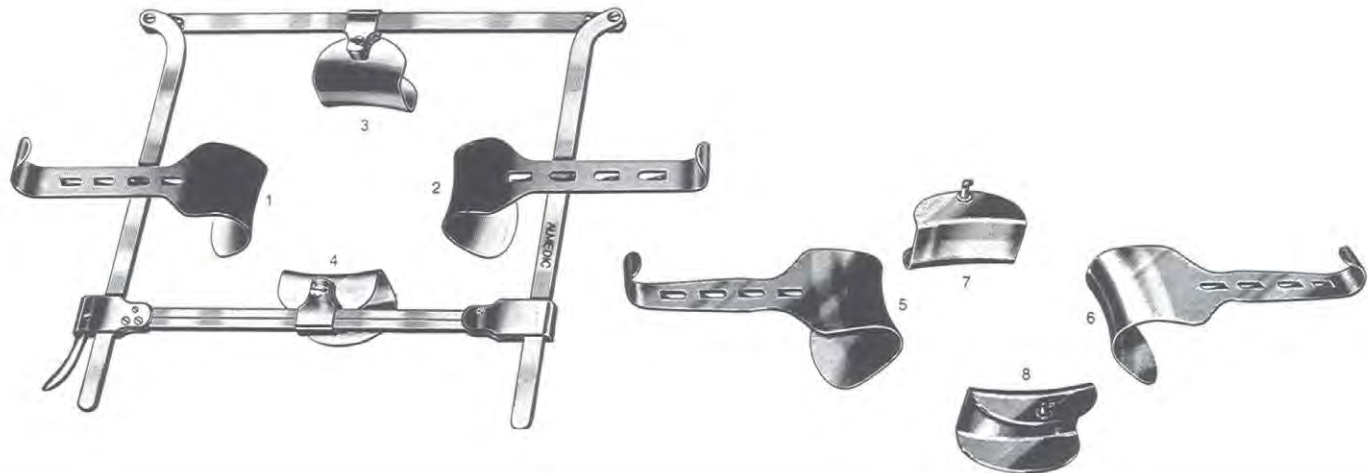

Abdominal Retractors

FRANZ

blades size

A14-850 complete with blades 1 - 4
A14-852 complete with blades 1 - 8

1, 2	50 X 60 mm
3, 4	40 X 60 mm
5, 6	60 X 85 mm
7, 8	46 X 80 mm



80 x 45 mm

80 x 45 mm

110 x 70 mm

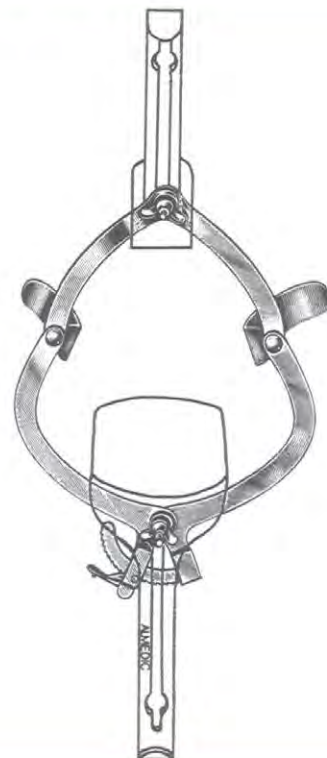

Abdominal Retractors

O'SULLIVAN-O'CONNER

A14-860

Probes and Directors

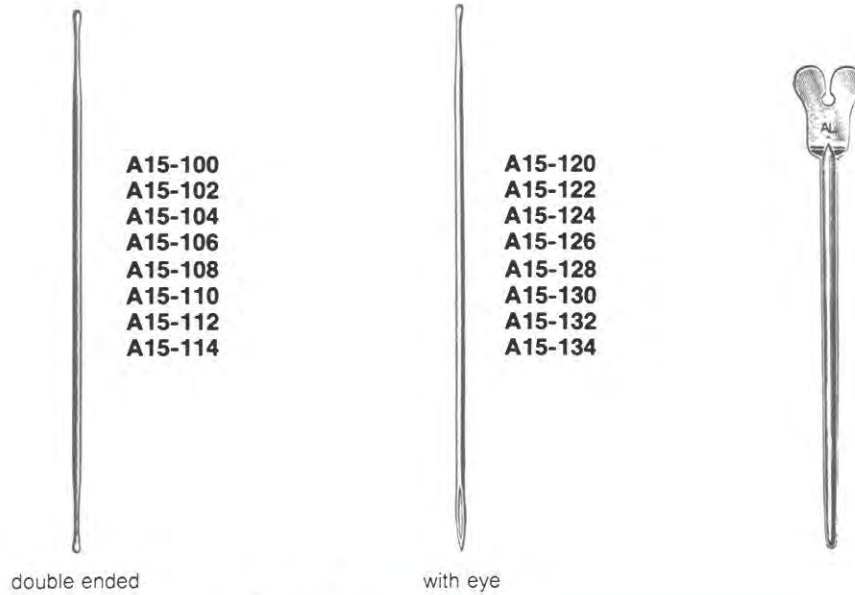

A15-100
A15-102
A15-104
A15-106
A15-108
A15-110
A15-112
A15-114

A15-120
A15-122
A15-124
A15-126
A15-128
A15-130
A15-132
A15-134

double ended

with eye

PROBE

double ended	with eye	double ended	with eye
A15-100 11.5 cm 4½"	A15-120	A15-108 18 cm 7"	A15-128
A15-102 12.5 cm 5"	A15-122	A15-110 20 cm 8"	A15-130
A15-104 14 cm 5½"	A15-124	A15-112 25 cm 10"	A15-132
A15-106 15 cm 6"	A15-126	A15-114 30 cm 12"	A15-134

GROOVED DIRECTOR with tongue tie

Probes Grooved Directors

A15-140 12.5 cm 5"
A15-142 14 cm 5½"
A15-144 15 cm 6"
A15-146 20 cm 8"



WITH PROBE POINT and tongue tie
A15-148 12.5 cm 5"
A15-150 14 cm 5½"
A15-152 15 cm 6"
A15-154 20 cm 8"

WITH SPEAR POINT and tongue tie
14 cm 5½"
A15-156

GROOVED DIRECTOR and aneurysm needle
12.5 cm 5"
A15-158

ANEURYSM NEEDLE
A15-164

Grooved Directors Aneurysm Needle

Needle Holders



Needle Holders

DERF
12 cm 4¾"

COLLIER
12.5 cm 5"

WEBSTER
12.5 cm 5"

A16-100

A16-104

A16-108



Needle Holders

HALSEY
smooth jaws
12.5 cm 5"

HALSEY
serrated jaws
12.5 cm 5"

NEIVERT
with one angled ring
12.5 cm 5"

A16-112

A16-114

A16-118

Needle Holders



ABBEY
12.5 cm 5"

A16-122



BAUMGARTNER
14 cm 5½"

A16-126



BROWN
fine serrations

A16-130 13.5 cm 5¼"
A16-132 17 cm 6¾"

Needle Holders



CRILE
15 cm 6"

A16-136



CRILE-MURRAY
15 cm 6"

A16-138



CRILE-WOOD

A16-140 15 cm 6"
A16-142 18 cm 7"

Needle Holders

Needle Holders



Needle Holders

SAROT

ADSON
18 cm 7"

METZENBAUM
straight
18 cm 7"

A16-146 18 cm 7"
A16-148 26.5 cm 10½"

A16-152

A16-156



Needle Holders

NEW ORLEANS
18 cm 7"

M.G.H.
18 cm 7"

A16-162

A16-166

Needle Holders



HODLICK
one fenestrated
jaw
18 cm 7"

A16-170



MAYO-HEGAR

A16-174 15 cm 6"
A16-176 18 cm 7"
A16-178 20 cm 8"



HEANEY
20 cm 8"

A16-182

**Needle
Holders**

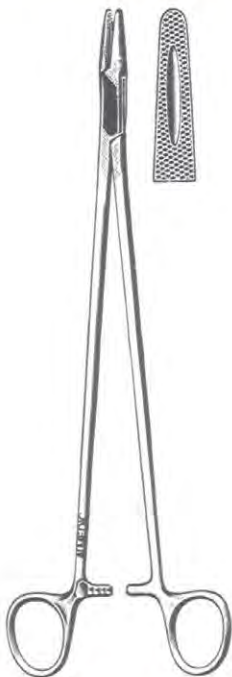

MASSON
26.5 cm 10½"

A16-186



FINOCHIETTO
angled jaws

A16-190 20 cm 8"
A16-192 27 cm 10½"



WANGENSTEEN
short jaws
27 cm 10½"

A16-196

**Needle
Holders**

Needle Holders

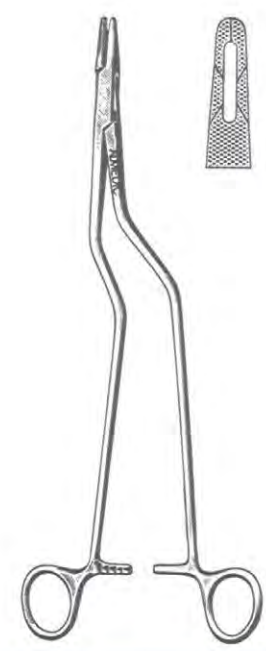

Needle Holders

WANGENSTEEN
long jaws
26.5 cm 10½"

RIENHOFF
26.5 cm 10½"

MASSON-LUETHY
26 cm 10¼"

A16-198

A16-202

A16-204



Needle Holders

STRATTE
23 cm 9"

JOHNSON
prostatic
needle holder
27.5 cm 10¾"

OLSEN-HEGAR
combined needle
holder and scissors
A16-214 14 cm 5½"
A16-216 16.5 cm 6½"
A16-218 18.5 cm 7¼"

A16-206

A16-210

Needle Holders



GILLIES
combined
needle holder
and scissors
16.5 cm 6½"
A16-220



LANGENBECK

A16-222 16 cm 6¼"
A16-224 20 cm 8"



MATHIEU
standard ratchet

A16-226 14 cm 5½"
A16-228 17 cm 6¾"
A16-230 20 cm 8"

Needle Holders



MATHIEU
recessed ratchet

A16-232 14 cm 5½"
A16-234 17 cm 6¾"
A16-236 20 cm 8"



BARRAQUER
13 cm 5"

A16-238



STEVENS
13 cm 5"

A16-246

Needle Holders

Needle Holders



Needle Holders

STEPHENSON
12 cm 4 3/4"

ARRUGA
14 cm 5 1/2"

KALT
14 cm 5 1/2"

A16-250

A16-252

A16-254 straight
A16-256 curved



Needle Holders

KALT-ARRUGA
14 cm 5 1/2"

POTTS-SMITH
21.5 cm 8 1/2"

PATON
10.5 cm 4 1/4"

A16-258

A16-260

A16-264

Needle Holders



BOYNTON
12.5 cm 5"

A16-266



CASTROVIEJO
straight
without catch
14.5 cm 5 3/4"

A16-268



CASTROVIEJO
curved
without catch
14.5 cm 5 3/4"

A16-270

Needle Holders



CASTROVIEJO
straight
with catch
14.5 cm 5 3/4"

A16-272



CASTROVIEJO
curved
with catch
14.5 cm 5 3/4"

A16-274



GREENE
with suture
pulling forceps
11 cm 4 3/8"

A16-278

Needle Holders

**Needle Holders
with Tungsten
Carbide Jaws**

ALCARB™ Brand Needle Holders have special tungsten carbide jaws permanently inlaid into the instruments. These jaws are precision made with sharply defined serrations that firmly grip the suture needle.

Since tungsten carbide is one of the hardest and strongest alloys known, ALCARB™ Needle Holders are exceptionally durable and long lasting. They provide a superior grip of the suture needle without slipping or twisting.

The level box lock edges of the needle holders eliminate snagging of suture material.

ALCARB™ Needle Holders have gold plated handles for easy identification.

ALCARB™ Tungsten Carbide Needle Holders are guaranteed against defects in material and workmanship.



**Needle Holders
with T-C Jaws**

DERF
12 cm 4¾"

COLLIER
12.5 cm 5"

A17-100

A17-104



**Needle Holders
with T-C Jaws**

WEBSTER
12.5 cm 5"

HALSEY
smooth jaws
12.5 cm 5"

HALSEY
serrated jaws
12.5 cm 5"

A17-108

A17-112

A17-114

A
L
M
E
D
I
C

ALMEDIC
SURGICAL
INSTRUMENT
CATALOGUE

AL ALMEDIC CANADA

SURGICAL
INSTRUMENT
CATALOGUE

AL ALMEDIC CANADA

Needle Holders with Tungsten Carbide Jaws



ABBEY
12.5 cm 5"

A17-118

BABY CRILE-WOOD
15 cm 6"

A17-130

CRILE-WOOD

A17-132 15 cm 6"
A17-134 18 cm 7"
A17-136 20 cm 8"
A17-138 23 cm 9"

**Needle Holders
with T-C Jaws**

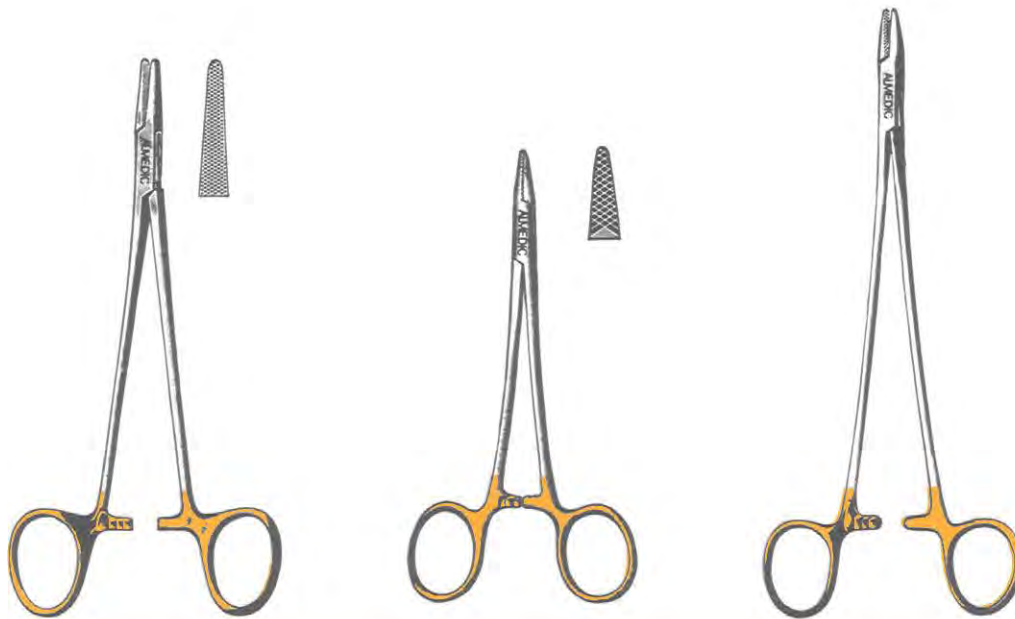

CRILE-MURRAY
15 cm 6"

A17-142

BAUMGARTNER
14 cm 5½"

A17-144

NEW ORLEANS
18 cm 7"

A17-160

**Needle Holders
with T-C Jaws**

**Needle Holders
with Tungsten
Carbide Jaws**



**Needle Holders
with T-C Jaws**

MAYO-HEGAR
A17-166 15 cm 6"
A17-168 18 cm 7"
A17-170 20 cm 8"

HEGAR
A17-178 20 cm 8"
A17-180 24 cm 9½"

HEANEY
A17-182 20 cm 8"
A17-184 26.5 cm 10½"



**Needle Holders
with T-C Jaws**

MASSON
A17-188 26.5 cm 10½"
A17-190 29 cm 11½"

FINOCHIETTO
A17-194 20 cm 8"
A17-196 27 cm 10½"

SAROT
A17-200 18 cm 7"
A17-202 20 cm 8"
A17-204 26 cm 10¼"



WANGENSTEEN
27 cm 10½"

A17-220

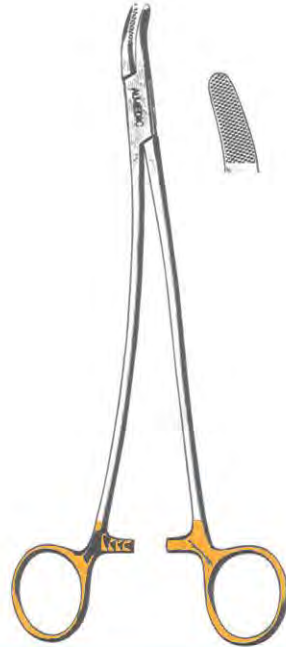

STRATTE
23 cm 9"

A17-224



OLSEN-HEGAR
combined needle holder
and scissors

A17-228 14 cm 5½"

A17-230 15.5 cm 6¼"

A17-232 18 cm 7"

Needle Holders with Tungsten Carbide Jaws

Needle Holders with T-C Jaws



MATHIEU
standard ratchet

A17-236 14 cm 5½"

A17-238 17 cm 6¾"

A17-240 20 cm 8"



MATHIEU
recessed ratchet

A17-242 14 cm 5½"

A17-244 17 cm 6¾"

A17-246 20 cm 8"



LANGENBECK

A17-250 16 cm 6¼"

A17-254 20 cm 8"

Needle Holders with T-C Jaws



Needle Holders with Tungsten Carbide Jaws



Needle Holders with T-C Jaws

RYDER
French eye

A17-264 15 cm 6"
A17-268 20 cm 8"
A17-272 25 cm 10"

STEVENS
13 cm 5"

A17-276

KALT
14 cm 5½"

A17-280

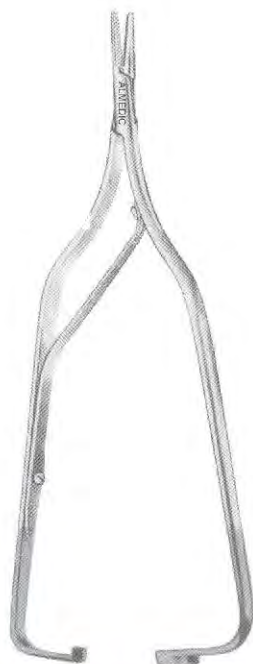

Needle Holders with T-C Jaws

ARRUGA
15.5 cm 6¼"

A17-284 straight
A17-286 curved

BARRAQUER
13.5 cm 5¼"

A17-290

CASTROVIEJO
with catch straight

A17-296

CASTROVIEJO
with catch curved

A17-298

Suture Instruments



A18-100 A18-102

A18-104 A18-106

A18-110



REVERDIN
suture needles
19 cm 7½"

YOUNG
Boomerang
20 cm 8"

Needles only
for Young Boomerang
needle holder

Suture Needles
Ligature Needles

A18-100
A18-102

A18-104
A18-106

A18-110

A18-112 small
A18-114 medium
A18-116 large



DESCHAMPS
right
sharp
20 cm 8"

DESCHAMPS
left
sharp
20 cm 8"

DESCHAMPS
right
blunt
20 cm 8"

DESCHAMPS
left
blunt
20 cm 8"

Suture Needles

A18-120

A18-122

A18-124

A18-126



Suture Instruments



Ligature Needles Ligature Conductors

BRUNNER
ligature needles
30 cm 12"
A18-130 slight curve
A18-132 full curve
A18-134 curved left
A18-136 curved right

BRUNNER
ligature conductor
30 cm 12"
A18-140 slight curve
A18-142 full curve
A18-144 curved left
A18-146 curved right



Ligature Carrier Clip Applying Forceps

WANGENSTEEN
dissector and
ligature carrier
24 cm 9½"

A18-150

CHILD
clip applying
forceps
18 cm 7"

A18-160

CHILD
clip applying forceps
with clip holder
18 cm 7"

A18-162

MICHEL
clip applying forceps
12 cm 4¾"

A18-164

HEGENBARTH
clip applying forceps
12.5 cm 5"

A18-166

Suture Instruments



WACHENFELDT
12.5 cm 5"

A18-170



WACHENFELDT
cross action
12.5 cm 5"

A18-172



MICHEL
12.5 cm 5"

A18-180



RALKS (COLLIN)
clip removing forceps
12.5 cm 5"

A18-190

**Clip Applying
and Removing
Forceps**



**RICHTER-HEATH
(MICHEL)**
14 cm 5½"

A18-200



Wire Cutting Scissors
one serrated blade
10 cm 4"

A18-210 straight
A18-212 curved



**Suture and Wire
Cutting Scissors**
one serrated blade
12 cm 4¾"

A18-214

**Suture and
Wire Cutting
Scissors**



Suture Instruments

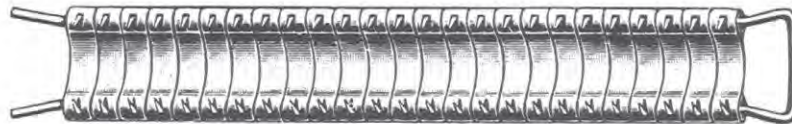

Wound Clips

MICHEL

- | | |
|----------------------|----------------------|
| A18-220 11 mm | A18-228 18 mm |
| A18-222 12 mm | A18-230 20 mm |
| A18-224 14 mm | A18-232 22 mm |
| A18-226 16 mm | |



Wound Clips

WACHENFELDT

- | | |
|----------------------|----------------------|
| A18-240 12 mm | A18-246 18 mm |
| A18-242 14 mm | A18-248 20 mm |
| A18-244 16 mm | |

Eye Instruments



GRAEFE
9 cm 3/2"

ZIEGLER
6 cm 2/4"

KNAPP
8 cm 3/4"

Eye Specula

A19-100

A19-102

A19-106

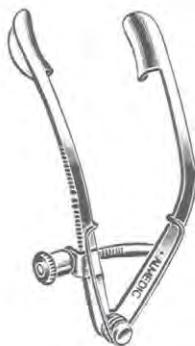

LANCASTER
7 cm 2/4"

LISTER-BURCH
8 cm 3/4"

WILLIAMS

Eye Specula

A19-108

A19-110

A19-112 7 cm 2/4"
A19-114 8 cm 3/4"

Eye Instruments

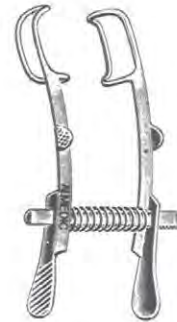
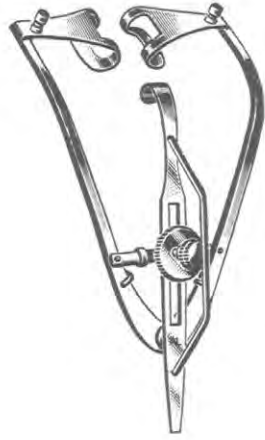

Eye Specula

GUYTON-PARK
8 cm 3/4"

MURDOCK
5 cm 2"

MELLINGER
7 cm 2 3/4"

A19-116

A19-118

A19-120



**Eye Specula
Eye Retractors**

SAUER
3 cm 1/4"

CASTROVIEJO
eye speculum
9 cm 3/2"

MUELLER
lacrimal sac
retractor
7 cm 2 3/4"

A19-122

A19-124

A19-140

Eye Instruments



AGRICOLA
lacrimal sac
retractor
4 cm 1½"

A19-142



STEVENSON
lacrimal sac
retractor
7 cm 2¾"

A19-144



GOLDSTEIN
lacrimal sac
retractor
3.5 cm 1⅜"

A19-146

Eye Retractors



PAUL
lid retractor

A19-148



DESMARRES
lid retractor
A19-150 12 mm
A19-152 14 mm
A19-154 16 mm
A19-156 18 mm



CASTROVIEJO
lid clamp

A19-160

Lid Retractors Lid Clamp



Eye Instruments

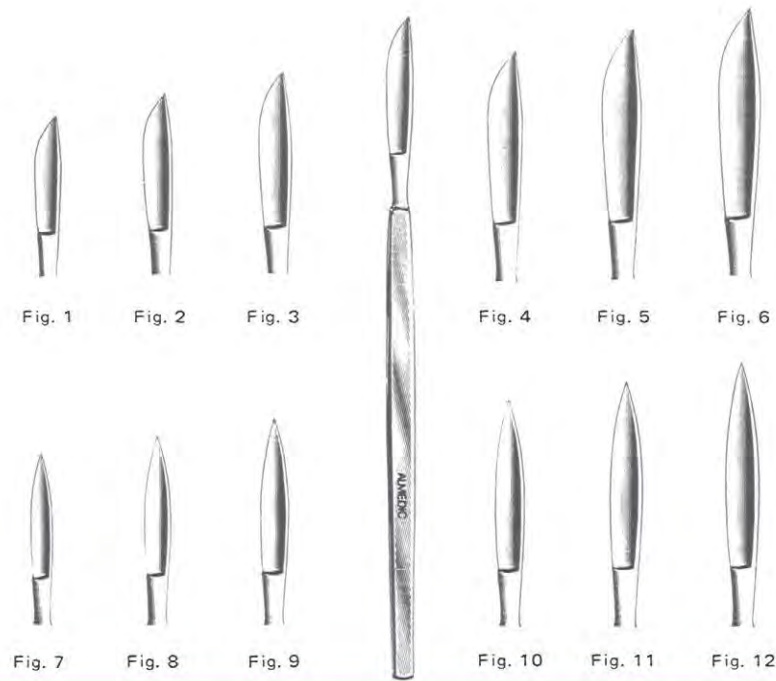

Eye Scalpels Cataract Knives

A19-170 Fig. 1
A19-172 Fig. 2
A19-174 Fig. 3

A19-176 Fig. 4
A19-178 Fig. 5
A19-180 Fig. 6

Eye Scalpel

A19-182 Fig. 7
A19-184 Fig. 8
A19-186 Fig. 9

A19-188 Fig. 10
A19-190 Fig. 11
A19-192 Fig. 12

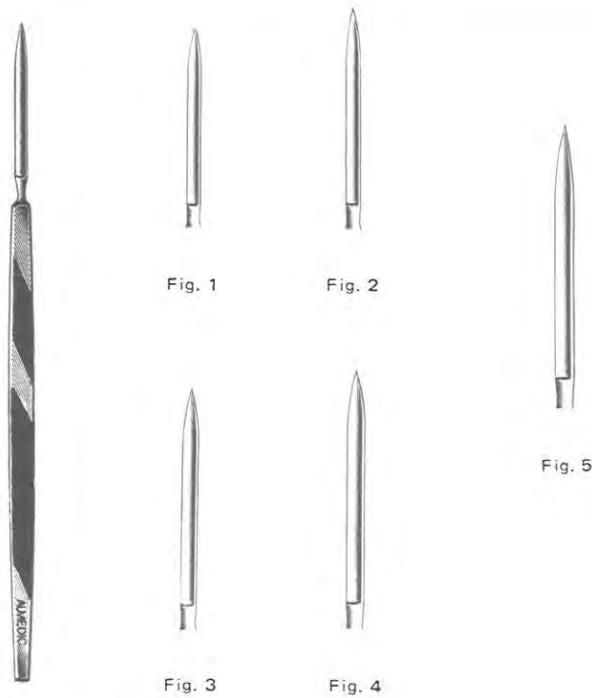

Eye Scalpels Cataract Knives

VON GRAEFE cataract knife

A19-200 Fig. 1 1.5 X 25 mm
A19-202 Fig. 2 1.7 X 27 mm
A19-204 Fig. 3 2.0 X 30 mm

A19-206 Fig. 4 2.3 X 33 mm
A19-208 Fig. 5 2.5 X 35 mm

Eye Instruments



3 mm

5 mm

6 mm

7 mm

WHEELER
discission knife
1 X 18 mm

A19-214

KNAPP
cataract knife
1 X 20 mm

A19-218

ZIEGLER
knife needle
A19-220 3 mm
A19-222 5 mm
A19-224 6 mm
A19-226 7 mm

Ophthalmic Knives



5 mm



6 mm



7 mm



KNAPP
iris knife

A19-230 5 mm
A19-232 6 mm
A19-234 7 mm

DEAN
iris knife

A19-238

Ophthalmic Knives



Eye Instruments



Ophthalmic Knives

BARKAN
goniotomy knife

TOOK
corneal knife

A19-240

A19-242



Ophthalmic Needles

BOWMAN
iris needle

DESMARRES
paracentesis
needle
straight

DESMARRES
paracentesis
needle
angled

A19-244

A19-246

A19-248

Eye Instruments



JAEGER
straight
A19-260 small
A19-262 medium
A19-264 large
A19-266 extra large

Keratomes



JAEGER
angled
A19-268 small
A19-270 medium
A19-272 large
A19-274 extra large

GRIESHABER
angled
A19-276 small
A19-278 medium
A19-280 large
A19-282 extra large

Keratomes



Eye Instruments



Keratomes Sclerotomes

WIENER
keratome

CASTROVIEJO
keratome
4 X 13 mm

LUNDSGAARD
sclerotome

CURDY
sclerotome

A19-284

A19-286

A19-290

A19-292



Hooks

TYRELL
iris hook

GUTHRIE
fixation hook
small

GUTHRIE
fixation hook
large

WIENER
iris hook

A19-300 sharp
A19-302 blunt

A19-304

A19-306

A19-310 sharp
A19-312 blunt

Eye Instruments



BURCH
fixation pick

KNAPP
retractor

STEVENS
tenotomy
hook

GREEN
strabismus
hook

**Fixation Pick
Retractors
Hooks**

A19-316

A19-320 sharp
A19-322 blunt

A19-326

A19-330

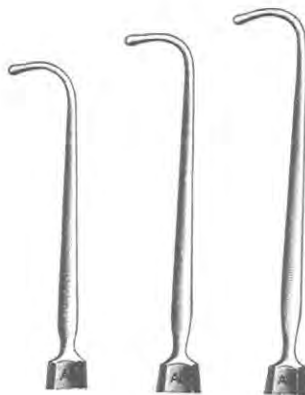

JAMESON
strabismus
hook

VON GRAEFE
strabismus hook

ARRUGA
lens expressor

**Hooks
Lens Expressors**

A19-332

A19-334 small
A19-336 medium
A19-338 large

A19-350 right
A19-352 left



Eye Instruments



Lens Expressors Lens Spoons

VERHOFF
lens expressor

WILMER-BAGLEY
lens expressor

DAVIEL
lens spoon

DAVIEL
lens spoon extra small

HESS
lens expressor

A19-354

A19-356

A19-360

A19-362

A19-364



Lens Scoops Lens Loops

KNAPP
lens scoop

LEWIS
lens loop serrated

LEWIS
lens loop smooth

WILDER
lens loop

ARLT
lens loop serrated

WELLS
enucleation scoop

A19-366

A19-370

A19-372

A19-374 serrated
A19-376 smooth

A19-378

A19-382

Eye Instruments



		diameter
A19-390	size 000	0.5 mm
A19-392	size 00	1.0 mm
A19-394	size 0	1.5 mm
A19-396	size 1	1.8 mm

MEYHOEFER

		diameter
A19-398	size 2	2.0 mm
A19-400	size 3	2.5 mm
A19-402	size 4	3.5 mm

Chalazion Curettes

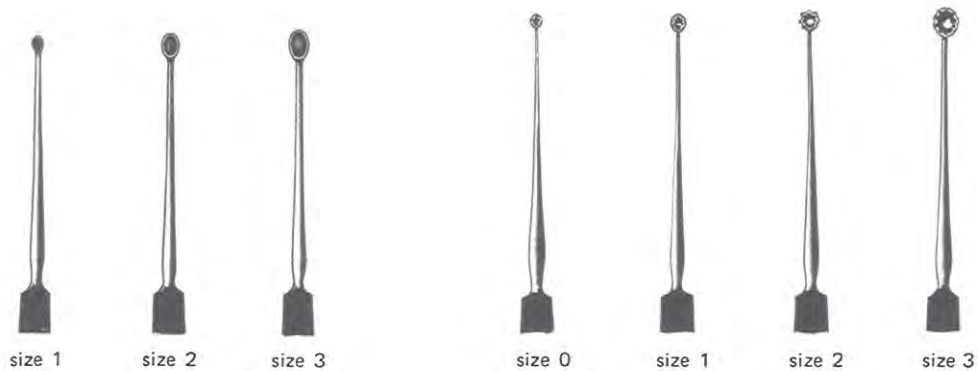

HEBRA oval

		diameter
A19-406	size 1	1.0 mm
A19-408	size 2	2.0 mm
A19-410	size 3	2.5 mm

SKEELE serrated

		diameter
A19-414	size 0	1.5 mm
A19-416	size 1	2.0 mm
A19-418	size 2	2.5 mm
A19-420	size 3	3.0 mm

Chalazion Curettes



Eye Instruments



Chalazion Curettes Evisceration Spoons

HEATH
chalazion curette

	size	diameter
A19-424	size 0	0.5 mm
A19-426	size 1	1.0 mm
A19-428	size 2	2.0 mm
A19-430	size 3	3.0 mm

BUNGE
evisceration
spoon
small

A19-440

BUNGE
evisceration
spoon
large

A19-442



Spatulas

LINDNER
cyclodialysis
spatula and spoon
graduated
12.5 cm 5"

A19-444

CASTROVIEJO
double ended
spatula
sterling

A19-446

SMITH-FISHER
iris spatula
sterling

A19-448

Eye Instruments



FISHER
spatula
and needle
14.5 cm 5 3/4"

A19-450



GREEN

A19-452



SMITH-FISHER
cataract spatula
14.5 cm 5 3/4"

A19-454

Spatulas



CASTROVIEJO
cyclodialysis
spatula
semi-sharp

A19-456 10 mm

A19-458 15 mm



ELSCHNIG
cyclodialysis
spatula
10 mm

A19-460



WECKER
cyclodialysis
spatula
sterling silver

A19-462



WHEELER
cyclodialysis
spatula
sterling silver

A19-464

Spatulas



Eye Instruments



Kirby Eye Instruments

KIRBY
cataract
knife

A19-470

KIRBY
intracapsular
lens expressor

A19-472

KIRBY
intracapsular
lens spoon

A19-474

KIRBY
intracapsular
lens loop

A19-476

KIRBY
intracapsular
lens loop

A19-478



Kirby Eye Instruments

KIRBY
keratome

A19-480

KIRBY
iris spatula
angular

A19-482

KIRBY
fixation
hook

A19-484

KIRBY
lid retractor

A19-486

KIRBY
capsulotomy
expressor spoon

A19-488

Eye Instruments



KIRBY
spoon and
cylinder

A19-490



KIRBY
lens expressor

A19-492



KIRBY
lens expressor
double ball

A19-494

**Kirby
Eye
Instruments**



KIRBY
lens expressor
and cylinder

A19-496



KIRBY
lens expressor
straight spatula

A19-498



KIRBY
lens expressor
curved spatula

A19-500

**Kirby
Eye
Instruments**

Eye Instruments



Kirby Eye Instruments

KIRBY
fixation
forceps
slide catch
1 X 2 teeth
10 cm 4"
A19-502

KIRBY
capsular
forceps
10 cm 4"
A19-504

KIRBY
capsular
forceps
10 cm 4"
A19-506



Kirby Eye Instruments

KIRBY
forceps
serrated
10 cm 4"
A19-508 1 X 2 teeth
A19-510 2 X 3 teeth

KIRBY
cornea forceps
curved serrated
1 X 2 teeth
10 cm 4"
A19-512

KIRBY
forceps
curved smooth
1 X 2 teeth
10 cm 4"
A19-514

KIRBY
forceps
straight smooth
1 X 2 teeth
10 cm 4"
A19-516

Eye Instruments



A19-520 **A19-522** **A19-524**

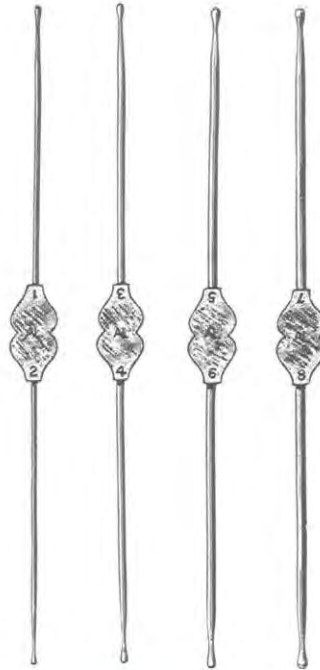

WILDER
lacrimal dilator
10 cm 4"

A19-520 long taper
A19-522 medium taper
A19-524 short taper

WILLIAMS
lacrimal probes
sterling

A19-532 Fig. 1 / 2
A19-534 Fig. 3 / 4
A19-536 Fig. 5 / 6
A19-538 Fig. 7 / 8

Lacrimal Dilators
Lacrimal Probes



Fig.	Ø mm
00	0.7
0	0.8
1	0.9
2	1.1
3	1.3
4	1.4
5	1.5
6	1.6
7	1.8
8	1.9



BOWMAN
lacrimal probes
sterling

A19-540 Fig. 00 / 0 **A19-546** Fig. 5 / 6
A19-542 Fig. 1 / 2 **A19-548** Fig. 7 / 8
A19-544 Fig. 3 / 4

Dressing Forceps
straight
serrated
10 cm 4"
A19-560

Dressing Forceps
half-curve
serrated
10 cm 4"
A19-562

Dressing Forceps
full curve
serrated
10 cm 4"
A19-564

Lacrimal Probes
Dressing Forceps



Eye Instruments



Iris Forceps

Iris Forceps
straight
1 X 2 teeth
10 cm 4"

A19-570

Iris Forceps
half curve
1 X 2 teeth
10 cm 4"

A19-572

Iris Forceps
full curve
1 X 2 teeth
10 cm 4"

A19-574

Iris Forceps
1 X 2 teeth
10 cm 4"

A19-576 straight
A19-578 curved



Dressing Forceps Iris Forceps

GRAEFE
eye dressing
forceps
straight serrated
7 cm 2¾"

A19-580

GRAEFE
eye dressing
forceps
curved serrated
7 cm 2¾"

A19-582

GRAEFE
iris forceps
straight
1 X 2 teeth
7 cm 2¾"

A19-584

GRAEFE
iris forceps
curved
1 X 2 teeth
7 cm 2¾"

A19-586

Eye Instruments



FUCHS
iris forceps
1 X 2 teeth
7 cm 2¾"

A19-590



GILL-HESS
iris forceps
1 X 2 teeth
7 cm 2¾"

A19-592



GILL
iris forceps
1 X 2 teeth
7 cm 2¾"

A19-594

Iris Forceps



FISHER-ARLT
iris forceps
1 X 2 teeth
7 cm 2¾"

A19-596



STRABISMUS
1 X 2 teeth
10 cm 4"

A19-600 straight
A19-602 curved



BISHOP-HARMON
dressing forceps
serrated
8 cm 3½"

A19-604

Iris Forceps Strabismus Forceps Dressing Forceps

**Eye
Instruments**



**Iris Forceps
Fixation Forceps**

BISHOP-HARMON iris forceps 1 X 2 teeth 8 cm 3/4"	GRAEFE fixation forceps 10.5 cm 4 1/4"	GRAEFE fixation forceps with catch 10.5 cm 4 1/4"	WALDAU fixation forceps 11 cm 4 1/2"
A19-606	A19-610	A19-612	A19-614



**Fixation
Forceps**

CASTROVIEJO fixation forceps 1 X 1 teeth straight 9 cm 3/2"	CASTROVIEJO fixation forceps 1 X 1 teeth curved 9 cm 3/2"	CASTROVIEJO fixation forceps 2 X 2 teeth straight 9 cm 3/2"	CASTROVIEJO fixation forceps 2 X 2 teeth curved 9 cm 3/2"
A19-616	A19-618	A19-620	A19-622

Eye Instruments



BARRAQUER
10 cm 4"

A19-624



O'BRIEN
1 X 2 teeth
10 cm 4"

A19-626



ELSCHNIG-O'CONNOR
1 X 2 teeth
with sliding lock
10.5 cm 4 1/4"

A19-628



ELSCHNIG
1 X 2 teeth
10.5 cm 4 1/4"

A19-630

Fixation Forceps



LESTER
fixation forceps
9.5 cm 3 3/4"

A19-632 1 X 2 teeth
A19-634 2 X 3 teeth



HARMON
fixation forceps
6.5 cm 2 1/2"

A19-636



GREEN
fixation forceps
12 mm jaws
10 cm 4"

A19-638



CASTROVIEJO
suture forceps
straight 10 cm 4"

A19-650 0.5 mm teeth
A19-652 1.0 mm teeth
A19-654 1.5 mm teeth

Fixation Forceps Suture Forceps

**Eye
Instruments**



**Suture Forceps
Capsule Forceps**

CASTROVIEJO
suture forceps
curved 10 cm 4"
A19-656 0.5 mm teeth
A19-658 1.0 mm teeth
A19-660 1.5 mm teeth

CASTROVIEJO
suture forceps
wide handle
9 cm 3½"
A19-662 1 mm teeth
A19-664 1.5 mm teeth

BARRAQUER
suture forceps
7 mm tips
5.5 cm 2¼"
A19-666

ARRUGA
capsule forceps
10 cm 4"
A19-670



Capsule Forceps

ARRUGA
capsule forceps
10 cm 4"
A19-672

VERHOFF
capsule forceps
8 cm 3¼"
A19-674

TERSON
5 X 6 teeth
9 cm 3½"
A19-676

KALT
10 cm 4"
A19-678

Eye Instruments



CASTROVIEJO
10 cm 4"

A19-680



SCHWEIGGER
4 X 5 teeth
10 cm 4"

A19-682



FUCHS
7 cm 2 3/4"

A19-684



LITTAUER
cilia forceps
9 cm 3 1/2"

A19-690

Capsule Forceps
Cilia Forceps



BEER
9 cm 3 1/2"

A19-692



ZIEGLER
9 cm 3 1/2"

A19-694



DOUGLAS
9 cm 3 1/2"

A19-696



BERGH
10 cm 4"

A19-698



BENNETT
7 cm 2 3/4"

A19-700

Cilia Forceps



Eye Instruments



**Cilia Forceps
Ptosis Forceps
Lid Forceps**

SCHAAF
cilia forceps
9.5 cm 3 3/4"

A19-702

BARRAQUER
cilia forceps
10.5 cm 4 1/4"

A19-704

BERKE
ptosis forceps
10 cm 4"

A19-710 20 mm blades
A19-712 27 mm blades

ERHARDT
lid forceps
9 cm 3 1/2"

A19-716



A19-720



A19-722



AYER
chalazion forceps
9 cm 3 1/2"

A19-730



LAMBERT
chalazion forceps
9 cm 3 1/2"

A19-732



HUNT
chalazion forceps
9.5 cm 3 1/2"

A19-734

**Entropium Forceps
Chalazion Forceps**

SNELLEN
entropium forceps
9 cm 3 1/2"

A19-720 left
A19-722 right

Eye Instruments



HEATH
chalazion forceps
10 cm 4"

A19-736



DESMARRES
chalazion forceps
9 cm 3½"

A19-738 16 mm wide
A19-740 20 mm wide
A19-742 26 mm wide



LORDAN
chalazion forceps
9 cm 3½"

A19-744

Chalazion Forceps



KNAPP
trachoma forceps
10.5 cm 4¼"

A19-748



REESE
advancement
forceps
10 cm 4"

A19-750



PRINCE
advancement
forceps
10 cm 4"

A19-752

Trachoma Forceps Advancement Forceps



Eye Instruments



Muscle Forceps Recession Forceps

FINK-JAMESON
muscle forceps
10 cm 4"

A19-756

BERENS
recession forceps
9.5 cm 3 3/4"

A19-760

JAMESON
recession forceps
10 cm 4"

A19-764 left
A19-766 right



Utility Forceps

NUGENT
10.5cm 4 1/4"

A19-770 smooth
A19-772 serrated

McCULLOUGH
10 cm 4"

A19-774 smooth
A19-776 cross serrated

McCULLOUGH
1 X 2 teeth serrated
10 cm 4"

A19-778

WILLS
cross-serrated
10 cm 4"

A19-780

Eye Instruments



McCLURE
iris scissors
straight
10 cm 4"

A19-804



McCLURE
iris scissors
angled
10 cm 4"

A19-806

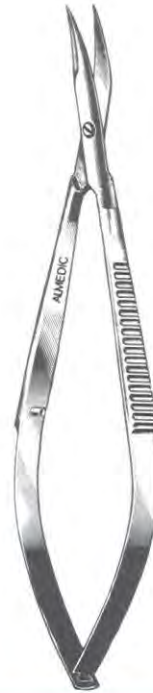

WESTCOTT
tenotomy scissors
curved, sharp
11.0 cm 4½"

A19-808

Iris Scissors Tenotomy Scissors



WESTCOTT
tenotomy scissors
curved, blunt
11.0 cm 4½"

A19-810



WESTCOTT
iris scissors
straight
10.5 cm 4¼"

A19-812



WESTCOTT
iris scissors
curved
10.5 cm 4¼"

A19-814

Tenotomy Scissors Iris Scissors

Eye Instruments



**Iridectomy Scissors
Iris Scissors**

NOYES
iridectomy scissors
15 cm 6"
1 sharp point and
1 probe point
A19-820

NOYES
iridectomy scissors
15 cm 6"
2 sharp points
A19-822

NOYES
iris scissors
12 cm 4 3/4"
A19-824

CASTROVIEJO
iridectomy scissors
curved
2 sharp points
10 cm 4"
A19-830



**Iridectomy Scissors
Corneal Scissors
Synechia Scissors**

CASTROVIEJO
iridectomy scissors
curved
2 blunt points
10 cm 4"
A19-832

CASTROVIEJO
corneal scissors
angled left
11 cm 4 1/2"
A19-834

CASTROVIEJO
corneal scissors
angled right
11 cm 4 1/2"
A19-836

CASTROVIEJO
anterior synechia
scissors
11 cm 4 1/2"
A19-838

Eye Instruments



VANNAS
iridectomy scissors
7.5 cm 3"
A19-840 straight
A19-842 slightly curved
A19-844 angled to side

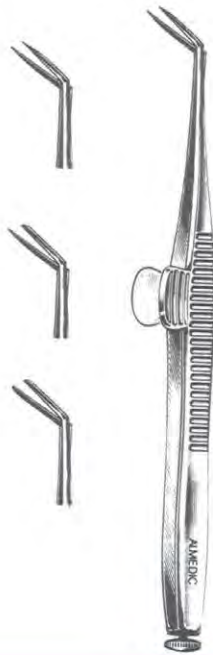

WECKER
iris scissors
11.5 cm 4½"
A19-850 sharp and sharp
A19-852 sharp and blunt
A19-854 blunt and blunt



BARRAQUER
iris scissors
7 mm blade
5.5 cm 2¼"
A19-856



BERENS
capsulotomy scissors
16 cm 6¼"
A19-858

Iris Scissors Capsulotomy Scissors



SCHIOTZ TONOMETER
A19-870 with straight scale
A19-872 with straight scale and Allen-plunger retractor
A19-874 with inclined scale
A19-876 with inclined scale and Allen plunger retractor
A19-878 with inclined mirror-backed scale

Tonometers

Eye Instruments



**Eye Magnets
Eye Loops**

DIX

A19-890 needle and spud
A19-892 needle only
A19-894 spud only

**Eye Magnet
and nylon
loop in
reversible
handle**

A19-900

**Eye Magnet
and nylon
loop with
magnifier**

A19-902

**FIRLENE
eye magnet
with 2 tips**

A19-904



**Caliper
Erisophake
Protector
Eye Shield**

Test Drum
with kid skin
for eye knives
and needles

A19-910

CASTROVIEJO
caliper
20 mm scale
9 cm 3/2"

A19-914

BELL
erisophake
6 cm 2 1/2"

A19-922

ARRUGA
protector and
retractor

A19-926

FOX
eye shield
aluminum

A19-930

Ear Instruments



TOYNBEE
set of 3
diameter
5 mm
6 mm
7 mm
A20-080

BOUCHERON
set of 4 diameter
4.5 mm
5.5 mm
6.5 mm
7.5 mm
A20-082

GRUBER
oval set of 3
diameter
5.5 mm
6.5 mm
7.5 mm
A20-084

Ear Specula



TROELTSCH
set of 3
diameter
2 mm
3 mm
4 mm
A20-086

ERHARDT
set of 3
diameter
4 mm
5 mm
6 mm
A20-088

HARTMANN
set of 3
diameter
5 mm
6 mm
7 mm
A20-090

Ear Specula

Ear Instruments

**ALMEDIC QUALITY
MEDICAL TUNING FORKS**

Tuning forks made from special aluminum-magnesium-alloy, for medical purposes, such as hearing examinations (air and bone conduction), for sensibility examinations, and other diagnostic purposes.

VPS = VIBRATIONS PER SECOND.



Tuning Forks

**C-64 VPS
with clamps**

**C-128 VPS
with clamps**

**C1-256 VPS
with clamps**

A20-100

A20-102

A20-104



Tuning Forks

C²-512 VPS

C³-1024 VPS

C⁴-2048 VPS

C⁵-4096 VPS

A20-106

A20-108

A20-110

A20-112

Ear Instruments



**SET OF 5 SPECIAL ALUMINUM — MAGNESIUM ALLOY
TUNING FORKS NOS. A20-102, A20-104, A20-106, A20-108, A20-110
(C-128 TO C⁴-2048)**

A20-114 in leatherette case

A20-116 in a khaki roll

Tuning Forks

STANDARD QUALITY TUNING FORKS (NOT ILLUSTRATED)

These tuning forks are manufactured from a special aluminum-alloy. They are suitable for all medical applications as well as for various scientific investigations.

- A20-120** C-128 VPS with clamps similar to A20-102
- A20-122** C-256 VPS with clamps similar to A20-104
- A20-124** C-128 VPS without clamps
- A20-126** C-256 VPS without clamps
- A20-128** D-288 VPS
- A20-130** E-320 VPS
- A20-132** F-341.3 VPS
- A20-134** G 384 VPS
- A20-136** A 426.7 VPS
- A20-138** B 480 VPS
- A20-140** C-512 VPS
- A20-142** C-1024 VPS
- A20-144** C-2048 VPS
- A20-146** C-4096 VPS

Tuning Forks



Ear Instruments



C-64 VPS
with clamps

A20-172



C-128 VPS
with clamps

A20-174



C-256 VPS
with clamps

A20-176



C-128 VPS
25.5 cm 10"
long type

A20-178

HARTMANN PATTERN
STEEL TUNING FORKS
VPS = VIBRATIONS PER SECOND



C1-256 VPS
19 cm 7½"
long type

A20-180



C2-512 VPS

A20-182



C3-1024 VPS

A20-184



C4-2048 VPS

A20-186



C5-4096 VPS

A20-188

HARTMANN PATTERN
STEEL TUNING FORKS
VPS = VIBRATIONS PER SECOND

Hartmann Tuning Forks

Ear Instruments



- A20-192** set of 5 Hartmann steel tuning forks in velvet lined leatherette case, C-128 to C⁴-2048 (**A20-174, A20-176, A20-182, A20-184, A20-186**)
- A20-194** set of 6 Hartmann steel tuning forks in velvet lined leatherette case, C-128 to C⁵-4096 (**A20-174, A20-176, A20-182, A20-184, A20-186, A20-188**)

Tuning Forks



Neuro-Set (Neurotone 5)
consisting of tuning fork C-256 VPS,
percussion hammer, pin wheel,
hair brush and teasing needle

A20-196



Touching Hammer
for tuning forks

A20-198

Tuning Forks



Ear Instruments



**Lucae
Tuning Forks**

C-128 VPS
length 6 3/4"

C1-256 VPS

C2-512 VPS

A20-200

A20-202

A20-204

LUCAE PATTERN
STEEL TUNING FORKS
WITH FOOT
VPS = VIBRATIONS PER SECOND



**Lucae
Tuning Forks**

C3-1024 VPS

C4-2048 VPS

C5-4096 VPS

A20-206

A20-208

A20-210

CONVERSION TABLES INCHES : CENTIMETERS

The conversions of inches to centimeters are only approximate for practical purposes.

INCHES	CENTIMETERS	INCHES	CENTIMETERS
1	2.5	5 $\frac{3}{4}$	14.6
1 $\frac{1}{4}$	3.2	6	15.2
1 $\frac{1}{2}$	3.8	6 $\frac{1}{4}$	15.9
1 $\frac{3}{4}$	4.4	6 $\frac{1}{2}$	16.5
2	5.0	6 $\frac{3}{4}$	17.1
2 $\frac{1}{4}$	5.7	7	17.8
2 $\frac{1}{2}$	6.4	7 $\frac{1}{4}$	18.4
2 $\frac{3}{4}$	7.0	7 $\frac{1}{2}$	19.0
3	7.6	7 $\frac{3}{4}$	19.7
3 $\frac{1}{4}$	8.3	8	20.3
3 $\frac{1}{2}$	8.9	8 $\frac{1}{4}$	21.0
3 $\frac{3}{4}$	9.5	8 $\frac{1}{2}$	21.6
4	10.2	8 $\frac{3}{4}$	22.2
4 $\frac{1}{4}$	10.8	9	22.9
4 $\frac{1}{2}$	11.4	9 $\frac{1}{4}$	23.5
4 $\frac{3}{4}$	12.0	9 $\frac{1}{2}$	24.1
5	12.7	9 $\frac{3}{4}$	24.8
5 $\frac{1}{4}$	13.3	10	25.4
5 $\frac{1}{2}$	14.0	10 $\frac{1}{4}$	26.0

INCHES	CENTIMETERS	INCHES	CENTIMETERS
10 $\frac{1}{2}$	26.7	18 $\frac{1}{2}$	47.0
10 $\frac{3}{4}$	27.3	19	48.3
11	28.0	19 $\frac{1}{2}$	49.5
11 $\frac{1}{4}$	28.6	20	50.8
11 $\frac{1}{2}$	29.2	20 $\frac{1}{2}$	52.1
11 $\frac{3}{4}$	29.8	21	53.4
12	30.5	21 $\frac{1}{2}$	54.6
12 $\frac{1}{2}$	31.8	22	55.9
13	33.0	22 $\frac{1}{2}$	57.1
13 $\frac{1}{2}$	34.3	23	58.4
14	35.6	23 $\frac{1}{2}$	59.7
14 $\frac{1}{2}$	36.8	24	61.0
15	38.1	24 $\frac{1}{2}$	62.2
15 $\frac{1}{2}$	39.4	25	63.5
16	40.6	26	66
16 $\frac{1}{2}$	41.9	27	68.5
17	43.2	28	71
17 $\frac{1}{2}$	44.5	29	73.6
18	45.7	30	76.2



Ear Instruments



Eustachian Catheters
Ear Snares
Ear Dressing Forceps

HARTMANN
eustachian catheter
olive tip
A20-250 Fig. 0 A20-256 Fig. 3
A20-252 Fig. 1 A20-258 Fig. 4
A20-254 Fig. 2 A20-260 Fig. 5

KRAUSE
ear snare
18 cm 7"
A20-270
A20-272 stylet only

Snare Wire
for ear snares
sizes 5 to 9
A20-274

BLAKE
ear dressing
forceps
10.5 cm 4½"
A20-280



Ear Forceps

WILDE
ear dressing
forceps
12.5 cm 5"
A20-284

WILDE
1 X 2 teeth
12.5 cm 5"
A20-288

LUCAE
14 cm 5½"
A20-292

JANSEN
16.5 cm 6½"
A20-296

Ear Instruments



LITTAUER
ear dressing
forceps
12.5 cm 5"

A20-300



HARTMANN
ear dressing
forceps
12 cm 4 3/4"

A20-304

Ear Dressing Forceps



HARTMANN
ear forceps
14 cm 5 1/2"

A20-308



**RALKS
(BUCK)**
ear forceps
7.5 cm 3"

A20-312

Ear Dressing Forceps



Ear Instruments



**Mechanical
Finger
Alligator
Forceps**

QUIRE
mechanical
finger
10 cm 4"

A20-316

HARTMANN
alligator forceps
serrated
8 cm 3 1/4"

A20-320

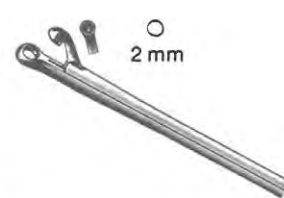
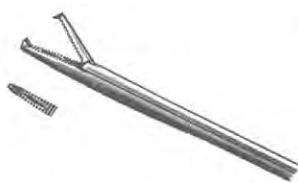

**Alligator
Forceps**

HARTMANN
1 X 2 teeth
8 cm 3 1/4"

A20-322

HARTMANN
round cup
jaws 3 mm
8 cm 3 1/4"

A20-324

HOFFMAN
punch forceps
jaws 2 mm
8 cm 3 1/4"

A20-330

STREUMPPEL
8 cm 3 1/4"

A20-334

Ear Instruments

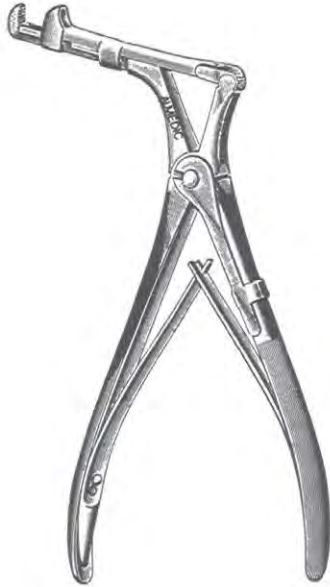

CITELLI
ear punch
18 cm 7"

A20-338



BEYER
ear punch
9.5 cm 3 3/4" shaft

A20-342

Punches

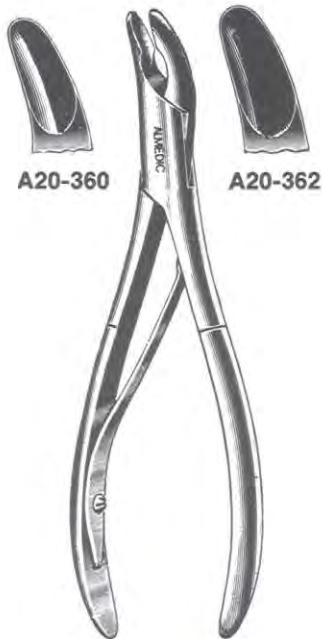

BANE
mastoid rongeur
19 cm 7 1/2"

A20-360 small jaw
A20-362 large jaw



FERRIS - SMITH - KERRISON
rongeur
12.5 cm 5"

A20-370 up-cutting
A20-372 down-cutting



KERRISON
rongeur

A20-380 4 mm
A20-382 5 mm
A20-384 6 mm

Mastoid Rongeurs

Ear Instruments



**Ear Hooks
Ear Curettes
Ear Spoons**

GROSS
ear hook and
spoon
12 cm 4¾"

A20-400

GROSS
ear hook
and curette
12 cm 4¾"

A20-402

GROSS
ear spoon
and spud
12 cm 4¾"

A20-404

DAY
ear hook
16.5 cm 6½"

A20-406 small
A20-408 large

ALLPORT
ear hook
16.5 cm 6½"

A20-412

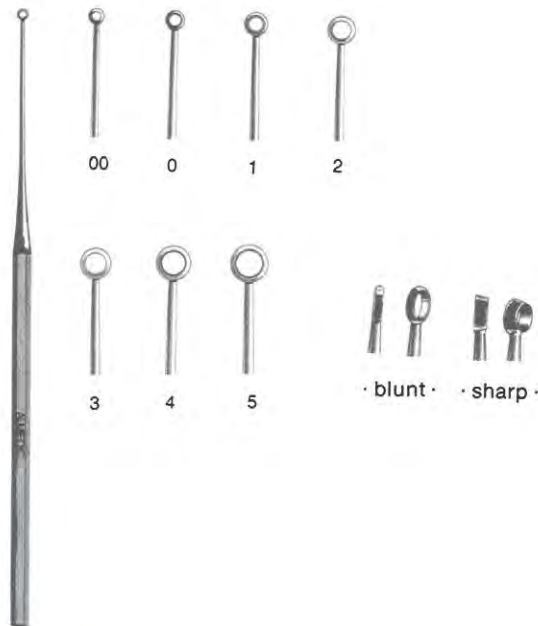

**Ear Curettes
Salpingeal
Curettes**

	BUCK				
	blunt	size	sharp	blunt	size sharp
A20-420		00	A20-440		
A20-422		0	A20-442	A20-428	3 A20-448
A20-424		1	A20-444	A20-430	4 A20-450
A20-426		2	A20-446	A20-432	5 A20-452

SHAPLEIGH
15 cm 6"

A20-460 small
A20-462 large

YANKAUER
salpingeal curette

A20-470 size 1 small
A20-472 size 2 medium
A20-474 size 3 large

Ear Instruments

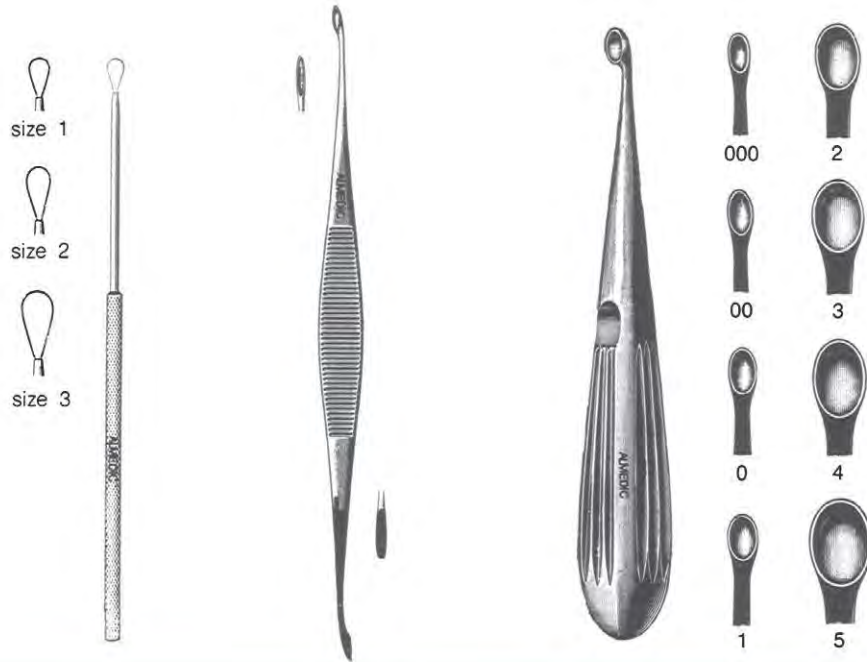

BILLEAU
ear loop
flexible

- A20-480** size 1 small
- A20-482** size 2 medium
- A20-484** size 3 large

BARTH
mastoid curette
18 cm 7"

A20-490

SPRATT bone curette oval spoon
21.5 cm 8½"

- | size | size |
|--------------------|------------------|
| A20-500 000 | A20-508 2 |
| A20-502 00 | A20-510 3 |
| A20-504 0 | A20-512 4 |
| A20-506 1 | A20-514 5 |

**Ear Loop
Mastoid Curette
Bone Curettes**

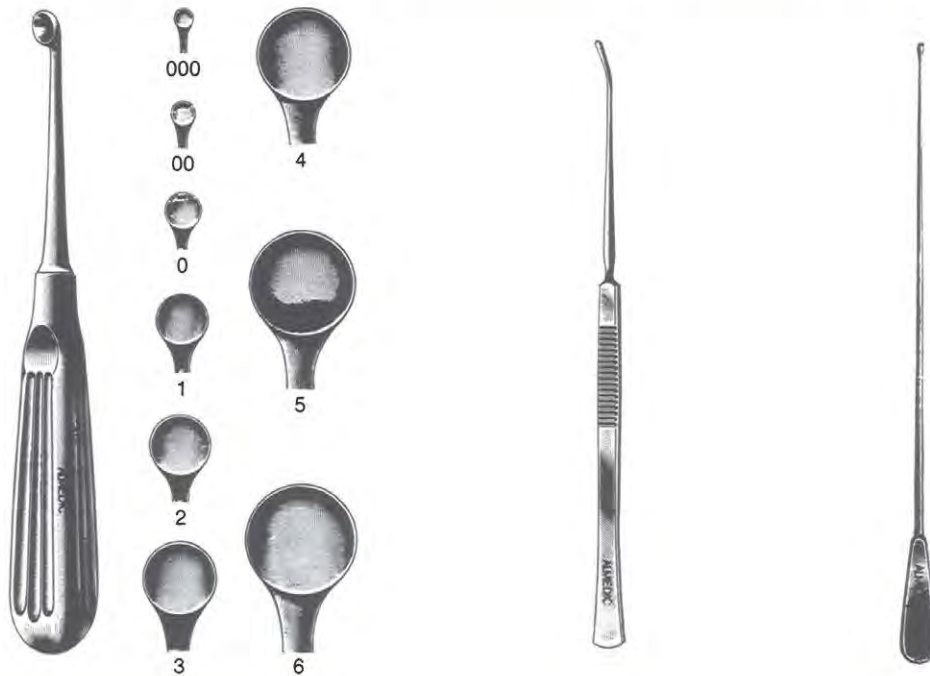

BRUNS bone curette, round spoon, 17 cm 6¾"

- | size | size |
|--------------------|------------------|
| A20-518 000 | A20-528 3 |
| A20-520 00 | A20-530 4 |
| A20-522 0 | A20-532 5 |
| A20-524 1 | A20-534 6 |
| A20-526 2 | |

YANKAUER
salpingeal probe
16.5 cm 6½"

A20-540

FISH
antrum probe
silver
14 cm 5½"

A20-544

**Bone Curettes
Probes**



Ear Instruments



**Ear Instrument Set
Ear Knife and
Curette**

SPRAGUE
ear instruments
set of 6 with
universal handle

A20-550

DENCH
ear knife
and curette

A20-554



Ear Knives

MOOREHEAD
ear knife
in hinged
case

A20-558

FREISNER
ear knife

A20-562

Ear Instruments



SEXTON
ear knife
straight
18 cm 7"

A20-566



SEXTON
ear knife
angular
18 cm 7"

A20-568



SEXTON
ear knife
bayonet
18 cm 7"

A20-570

Ear Knives



POLITZER
ear knife
straight
18 cm 7"

A20-574



POLITZER
ear knife
angular
18 cm 7"

A20-576



POLITZER
ear knife
bayonet
18 cm 7"

A20-578

Ear Knives

Ear Instruments



Cotton Applicators

KYLES
15 cm 6"

LATHBURY
14 cm 5½"

FARRELL
16.5 cm 6½"

UEBE
18 cm 7"

A20-590 twisted end
A20-592 triangular end

A20-602 twisted end
A20-604 triangular end

A20-608 twisted end
A20-610 triangular end

A20-614 twisted end
A20-616 triangular end

A20-630 Self-Filling Ear Syringe

automatic
complete with valve
connection. 4 tips; shield,
rubber tubing and sinker

A20-631
syringe only, 10. ml.

A20-632
double valve attachment

A20-633
protection shield

A20-634
olive tip

A20-635
straight tip

A20-636
fistula tip

A20-637
catheter tip

A20-638
metal sinker

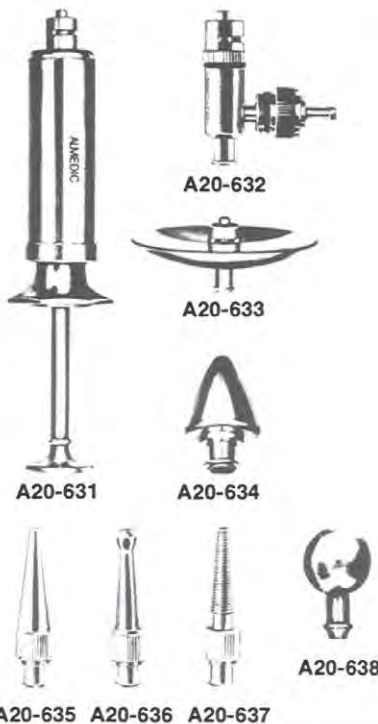

Ear Syringes

Metal Ear Syringe
with 2 tips only

A20-640 2 oz. **A20-650** shield only
A20-642 3 oz. **A20-652** bulbous tip only
A20-644 4 oz. **A20-654** conical tip only

Nasal Instruments



VIENNA

A21-100 infant size
A21-102 child size
A21-104 adult size

VIENNA
 lightweight model
 adult size

A21-106

Nasal Specula



KILLIAN

blade
A21-108 35 mm
A21-110 50 mm
A21-112 65 mm
A21-114 75 mm
A21-116 90 mm

TIECK-HALLE
 for infants
 14 cm 5½"

A21-120

YANKAUER
 nasopharyngeal
 speculum

A21-124

Nasopharyngeal Specula



Nasal Instruments



**Septum Speculum
Nasal Snares**

PATTON
septum speculum

KRAUSE
nasal snare
25.5 cm 10"

A21-128

A21-140



**Nasal Snares
Snare Wires**

DOUGLAS
nasal snare
with 2 cannulas

Snare Wire
for nasal
snares
sizes 5 to 9

A21-144

A21-148

Nasal Instruments



WILDE
16.5 cm 6½"

A21-160



JANSEN-GRUENWALD
19 cm 7½"

A21-164

Nasal Dressing Forceps

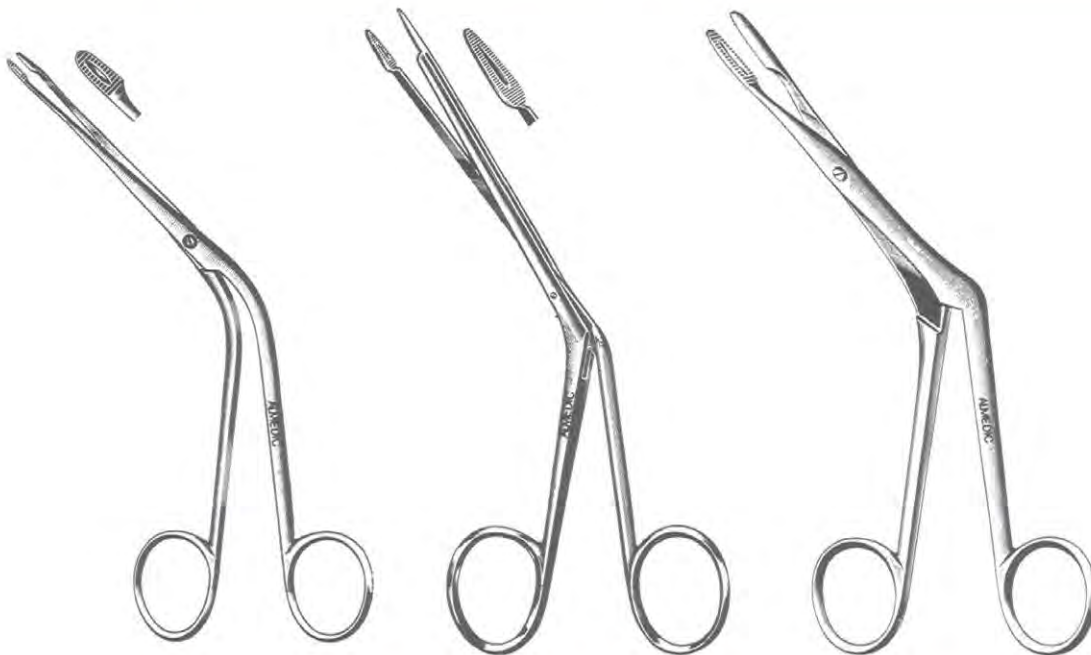

HARTMANN

A21-170 15.5 cm 6¼"
A21-172 20 cm 8"

LITTAUER
18 cm 7"

A21-176

KNIGHT
polypus forceps
18 cm 7"

A21-180

Polypus Forceps

Nasal Instruments



Septum Forceps

KILLIAN
septum forceps
17 cm 6 3/4"

A21-184

NOYES
septum forceps
serrated jaws
shaft
A21-190 14 cm 5 1/2"
A21-192 16.5 cm 6 1/2"

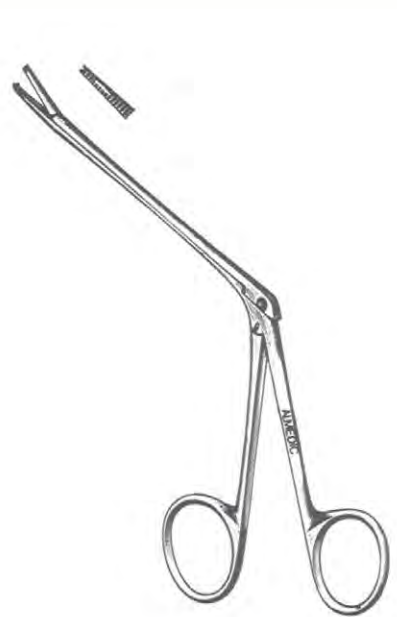

Nasal Forceps

NOYES
nasal forceps
1 X 2 teeth
shaft 14 cm 5 1/2"

A21-194

KNIGHT
nasal cutting forceps
16.5 cm 6 1/2"

A21-200

WATSON-WILLIAMS
nasal polypus
forceps
19 cm 7 1/2"

A21-210

Nasal Instruments

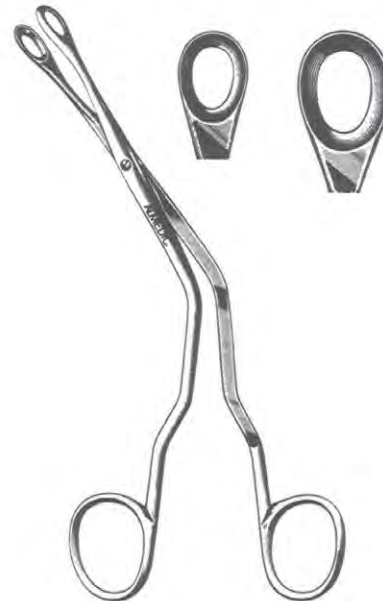
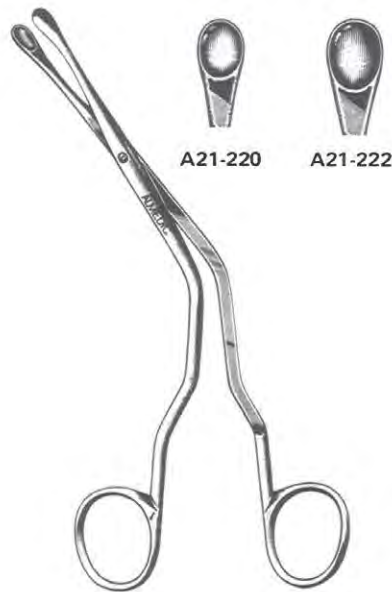

LUC
septum cutting
forceps
20 cm 8"

A21-220 5.5 mm wide
A21-222 7 mm wide

LUC
septum cutting forceps
fenestrated
20 cm 8"

A21-224 9 mm wide
A21-226 11.5 mm wide

**Septum
Cutting
Forceps**

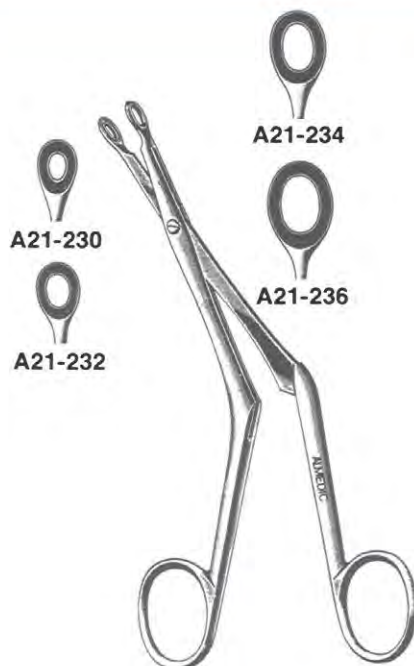

BRUENING
19 cm 7 1/2"
A21-230 5 mm
A21-232 6 mm
A21-234 8 mm
A21-236 10 mm

JANSEN-MIDDLETON
cup jaws
19 cm 7 1/2"
A21-250

JANSEN-MIDDLETON
fenestrated jaws
19 cm 7 1/2"
A21-252

**Septum
Cutting
Forceps**

Nasal Instruments



HAJEK
12 cm 4¾" shaft

Nasal Cutting Forceps

	bite		bite
A21-300	1.5 mm	A21-304	2.5 mm
A21-302	2.0 mm	A21-306	3.0 mm



STRUYKEN
12 cm 4¾" shaft
1 mm bite

A21-310



HARTMANN
12 cm 4¾" shaft

Nasal Cutting Forceps

	bite		bite
A21-320	5 mm	A21-324	9 mm
A21-322	7 mm	A21-326	11 mm



Nasal Instruments



Nasal Cutting Forceps

SCHMEDEN
 triangular punch
 12 cm 4 3/4" shaft
A21-330 small
A21-332 medium
A21-334 large

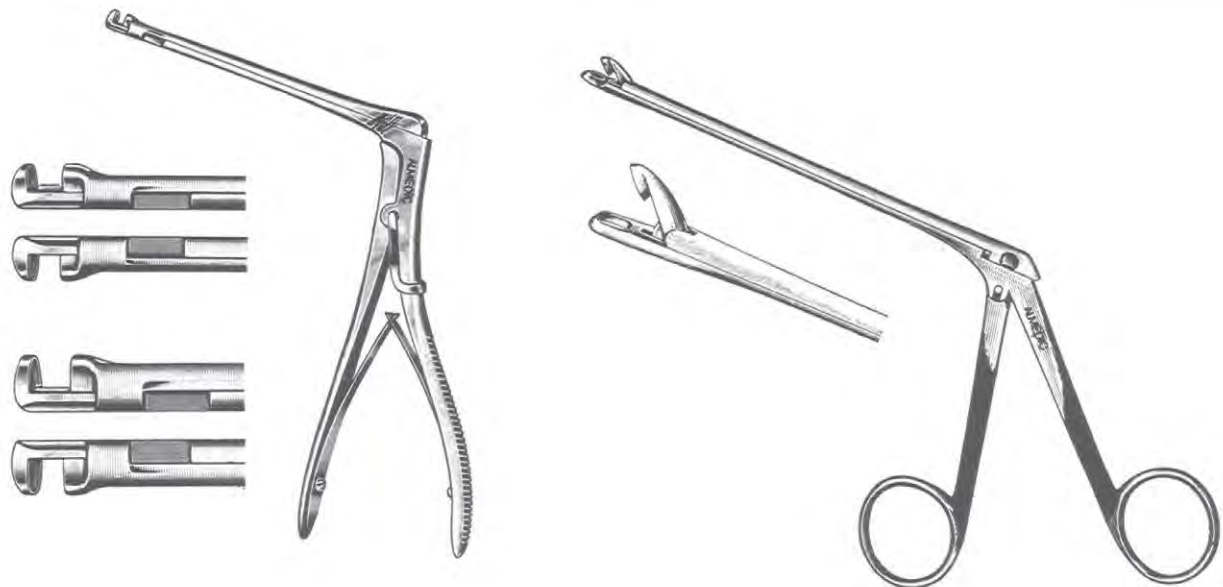

Nasal Punches

HAJEK-KOFLER
 14 cm 5 1/2" shaft

up cutting		down cutting
A21-350 3.5 mm		A21-352
A21-354 4 mm		A21-356

GRUENWALD
 12 cm 4 3/4" shaft

bite
A21-360 2.5 mm
A21-362 3 mm
A21-364 4 mm

Nasal Instruments



KAZANJIAN
nasal hump cutting
forceps
19 cm 7½"

A21-374



ASCH
septum
straightening
forceps
23 cm 9"

A21-380

Nasal Cutting Forceps Septum Forceps



A21-400



A21-404



A21-402



A21-406



A21-408



A21-412



A21-410



A21-414

JOSEPH
double edge knife
15 cm 6"
narrow blade
straight curved
A21-400 sharp **A21-402**
A21-404 blunt **A21-406**

JOSEPH
double edge knife
15 cm 6"
wide blade
straight curved
A21-408 sharp **A21-410**
A21-412 blunt **A21-414**

Nasal Knives



Nasal Instruments



Nasal Knives

JOSEPH
button end knife
straight
15 cm 6"

A21-420

JOSEPH
button end knife
16.5 cm 6½"

A21-422 angled right
A21-424 angled left



Nasal Knives

COTTLE
button end knife
15 cm 6"

A21-426

COTTLE
nasal knife
straight
14 cm 5½"

A21-430

BALLENGER
mucosa and
cartilage
knife
14.5 cm 5¾"

A21-432

Nasal Instruments



FREER
septum knife
16.5 cm 6½"

A21-436



FREER
mucosa knife
18 cm 7"

A21-438



FREER-INGALS
submucous knife
18 cm 7"

A21-440

Nasal Knives



BALLENGER
septum swivel knife, straight
19 cm 7½" blade width

A21-450 3 mm
A21-452 4 mm
A21-454 5 mm



BALLENGER
septum swivel knife, bayonet
19 cm 7½" blade width

A21-456 3 mm
A21-458 4 mm
A21-460 5 mm

Nasal Knives



Nasal Instruments



Septum Elevators

KILLIAN
semi sharp and blunt
23 cm 9"

FREER
sharp and blunt
19 cm 7½"

A21-470

A21-474



Septum Elevators

BALLENGER-HAJEK
semi sharp and blunt
19 cm 7½"

PIERCE
19 cm 7½"

PENNINGTON
21.5 cm 8½"

A21-478

A21-482

A21-486

Nasal Instruments



ROGER
septum elevator
19 cm 7½"

A21-490



COTTLE
septum elevator
graduated
23 cm 9"

A21-494



FREER
septum
chisel
straight
16.5 cm 6½"

A21-500

Septum Elevators Septum Chisels



FREER
septum
chisel
curved
16.5 cm 6½"

A21-502



FREER
septum
gouge
15 cm 6"

A21-506



BALLENGER
septum V-shaped chisel
15.5 cm 6¼"

A21-510 width 4 mm
A21-512 6 mm
A21-514 8 mm

Septum Chisels and Gouges

Nasal Instruments



**Nasal Saws
Nasal Rasps**

JOSEPH
nasal saw

A21-520 right
A21-522 left

GOOD
frontal sinus
antrum rasp
left
16 cm 6¼"

A21-530

GOOD
frontal sinus
antrum rasp
right
16 cm 6¼"

A21-532



Nasal Rasps

JOSEPH
nasal rasp

A21-534

COTTLE
nasal rasp

A21-538

MALTZ
nasal rasp

A21-542

Nasal Instruments

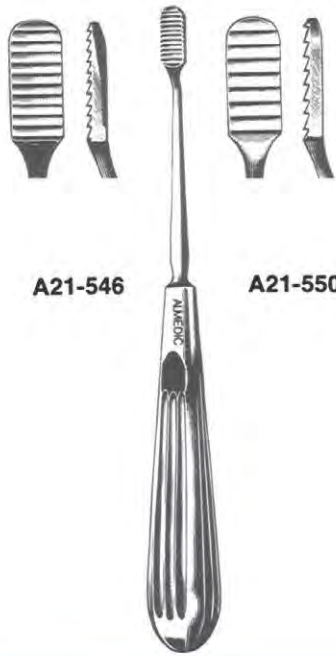

A21-546

A21-550

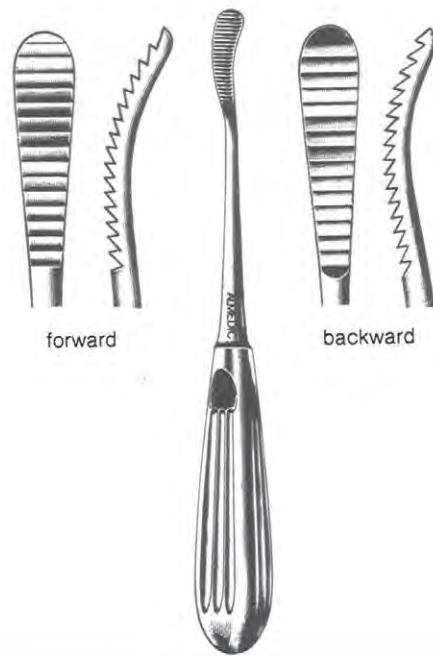

forward

backward

LEWIS
nasal rasp

AUFRICHT
glabella rasp

Nasal Rasps
Sinus Rasps

A21-546 fine
A21-550 coarse

A21-554 forward
A21-556 backward



WIENER
antrum rasp
19.5 cm 7 7/8"

A21-560 trocar point
A21-562 rounded tip



BRAWLEY
frontal sinus rasp
19 cm 7 1/2"

A21-566

Nasal Rasps
Sinus Rasps



Nasal Instruments

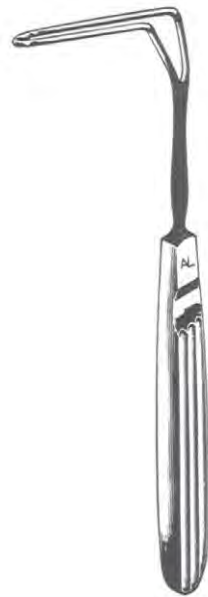

Nasal Retractors

AUFRICHT
nasal retractor
fenestrated blade
16 cm 6 1/4"

A21-580

AUFRICHT
nasal retractor
solid blade
16 cm 6 1/4"

A21-582



Skin Hooks

KLEINERT-KUTZ
skin hook, sharp
13 cm 5"
A21-584 3 mm hook
A21-586 5 mm hook
A21-588 7 mm hook

JOSEPH
skin hook
15 cm 6"
A21-590 2 mm **A21-594** 7 mm
A21-592 5 mm **A21-596** 10 mm

Nasal Instruments



COTTLE
skin hook
14 cm 5½"

FOMON
retractor
15 cm 6"

Skin Hook Retractor

A21-600

A21-604



Fig. 1



Fig. 2



Fig. 3



Fig. 4



Fig. 5



Fig. 6



Fig. 7



Fig. 8

YANKAUER
septum needle
16.5 cm 6½"
A21-626

Septum Needle

A21-610 Fig. 1
A21-612 Fig. 2

A21-614 Fig. 3
A21-616 Fig. 4

A21-618 Fig. 5
A21-620 Fig. 6

A21-622 Fig. 7
A21-624 Fig. 8

Nasal Instruments



**Ethmoid Curettes
Adenoid Curettes**

FAULKNER
ethmoid curette
21.5 cm 8½"

A21-630

PRATT
ethmoid curette
21.5 cm 8½"

A21-638

BARNHILL
adenoid curette
21.5 cm 8½"

size		size	
A21-640	0	A21-646	3
A21-642	1	A21-648	4
A21-644	2		

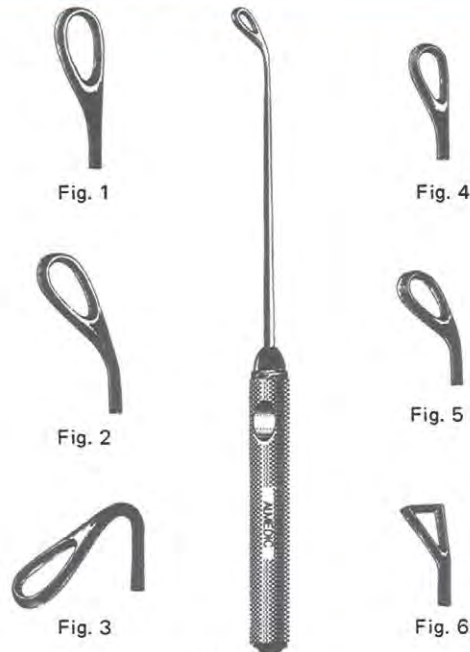

COAKLEY
antrum curette
20 cm 8"
A21-660 set of 6

**Antrum
Curettes**

A21-662 Fig. 1 large, light curve
A21-664 Fig. 2 large, medium curve
A21-666 Fig. 3 large, deep angle

A21-668 Fig. 4 small, light curve
A21-670 Fig. 5 small, medium curve
A21-672 Fig. 6 small, medium curve, triangular

Nasal Instruments



La FORCE
adenotome
with perforated
blades
25 cm 10"

	size	width
A21-680	0	8 mm
A21-682	1	11 mm
A21-684	2	13.5 mm
A21-686	3	16 mm
A21-688	4	18 mm

Blades
for American
and German
adenotomes,
perforated

	size	width
A21-690	0	8 mm
A21-692	1	11 mm
A21-694	2	13.5 mm
A21-696	3	16 mm
A21-698	4	18 mm

Adenotomes and Blades



VAN ALYEA
frontal sinus cannula
slight curve
with luer lock
11.5 cm 4½"

A21-700

VAN ALYEA
frontal sinus cannula
full curve
with luer lock
11.5 cm 4½"

A21-702

VAN ALYEA
antrum cannula
slight curve
with luer lock
11.5 cm 4½"

A21-704

Sinus Cannulas Antrum Cannulas



Nasal Instruments



Antrum Cannulas

VAN ALYEA
 antrum cannula
 full curve
 with luer lock
 11.5 cm 4½"

A21-706

INGAL
 antrum cannula
 luer hub
 silver

A21-710 7 cm 2¾" **A21-714** 10 cm 4"
A21-712 9 cm 3½" **A21-716** 11.5 cm 4½"



Antrum Cannulas Sinus Probe

MYLES
 antrum cannula
 hose end
 silver

A21-720 9 cm 3½"
A21-722 10 cm 4"
A21-724 11.5 cm 4½"

KILLIAN-EICKEN
 antrum cannula
 14 cm 5½"

A21-730

SKILLERN
 sinus probe
 graduated
 sterling
 16.5 cm 6½"

A21-740

Tonsil Instruments

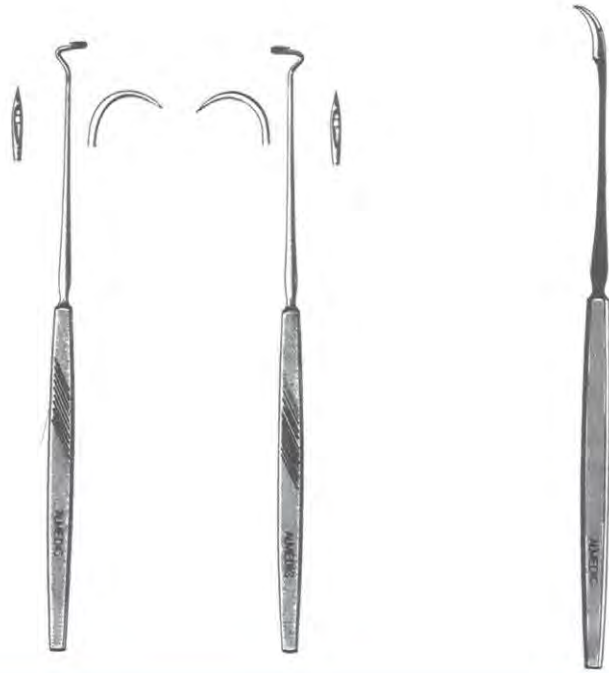

DUPUY-WEISS
tonsil needle
right
23 cm 9"

A22-100

DUPUY-WEISS
tonsil needle
left
23 cm 9"

A22-102

ABRAHAM
tonsil knife
21 cm 8¼"

A22-110

Tonsil Needles Tonsil Knives



CANFIELD
tonsil knife
21 cm 8¼"

A22-114

DAY
tonsil knife
21.5 cm 8½"

A22-118

DOUGLAS
tonsil knife
21 cm 8¼"

A22-122

Tonsil Knives



Tonsil Instruments



Tonsil Knives

ROBERTSON
21.5 cm 8½"

TYDING
21 cm 8¼"

DEAN
double edge
straight
19 cm 7½"

A22-126

A22-130

A22-134



Tonsil Knives

DEAN
double edge
angular
19 cm 7½"

ROBB
double edge
21.5 cm 8½"

LOTHROP
double ended
28 cm 8"

A22-136

A22-140

A22-144

Tonsil Instruments



FISHER
tonsil knife
and dissector
semi sharp with teeth
23 cm 9"

A22-150



CARPENTER
tonsil knife
and dissector
25 cm 10"

A22-154

Tonsil Knives and Dissectors



HARRIS
tonsil knife
and dissector
23 cm 9"

A22-158



LYNCH
tonsil knife
and dissector
20 cm 8"

A22-162



ALDERDYCE
tonsil dissector
and elevator
21.5 cm 8½"

A22-166

Tonsil Knives and Dissectors Tonsil Elevator

Tonsil Instruments



**Tonsil Dissector
Tonsil Hooks
Tonsil Screws**

HURD
tonsil dissector
and pillar retractor
22 cm 8 3/4"

A22-170

BOETTCHER
tonsil hook
20 cm 8"

A22-180 small
A22-182 large

LEWIS
tonsil screw
20 cm 8"

A22-190 small
A22-192 large



Retractors

**COLVER
(SCHMIDT)**
tonsil retractor
20 cm 8"

A22-200

WIEDER
pillar
retractor
18 cm 7"

A22-204

LOVE
nasopharyngeal retractor 15 cm 6"

A22-210 18 mm wide
A22-212 20 mm wide
A22-214 22 mm wide

Tonsil Instruments



TYDING
2 X 2 prongs
closed rings
19 cm 7½"

A22-220



TYDING
2 X 2 prongs
one open ring
19 cm 7½"

A22-222



BALLENGER
tonsil seizing
forceps
3 X 3 prongs
21.5 cm 8½"

A22-224

Tonsil Seizing Forceps



TIVNEN-TYDING
3 X 3 prongs
one open ring
19 cm 7½"

A22-226



COLVER
18.5 cm 7¼"

A22-230 straight
A22-232 curved



WHITE
tonsil seizing
forceps

A22-236 18.5 cm 7¼"
A22-238 24 cm 9½"

Tonsil Seizing Forceps

Tonsil Instruments



Tonsil Hemostats

SCHNIDT
tonsil hemostat
closed rings
19 cm 7½"

A22-250

SCHNIDT
tonsil hemostat
one open ring
19 cm 7½"

A22-252



Tonsil Hemostats

SAWTELL
closed rings
19 cm 7½"

A22-256

SAWTELL
one open ring
19 cm 7½"

A22-258

Tonsil Instruments



MIKULICZ
1 X 2 teeth
18 cm 7"

A22-262

LEWIS
18 cm 7"

A22-266

**McWHORTER
(LOTHROP)**
tonsil hemostat
and ligature forceps
19 cm 7½"

A22-270

Tonsil Hemostats

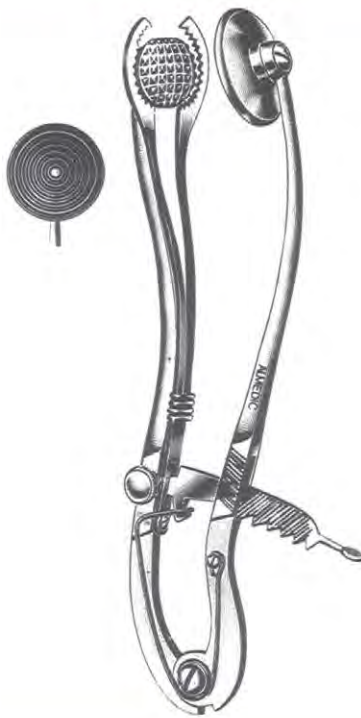

CORWIN
tonsil hemostat
15 cm 6"

A22-274



EVES
tonsil snare
with ratchet
28 cm 11"

A22-300



EVES
tonsil snare
without ratchet
28 cm 11"

A22-302

Tonsil Hemostats Tonsil Snares

Tonsil Instruments



Tonsil Snares and Tips

BECK-SCHENCK

- A22-310** with 1 straight and 3 vedder tips
- A22-312** with 1 straight tip only

Vedder Tip only for Beck-Schenck tonsil snare

- A22-314** small
- A22-316** medium
- A22-318** large

Straight Tip only for Beck-Schenck tonsil snare

A22-320

LEWIS

A22-330



Tonsil Snare and Tips

BROWN

- A22-340** with one straight and one vedder tip
- A22-342** straight tip only
- A22-344** vedder tip only

TYDING

- A22-350** with 1 straight tip and 1 vedder tip
- A22-352** with 1 straight tip only
- A22-354** straight tip only
- A22-356** vedder tip only

Tonsil Instruments

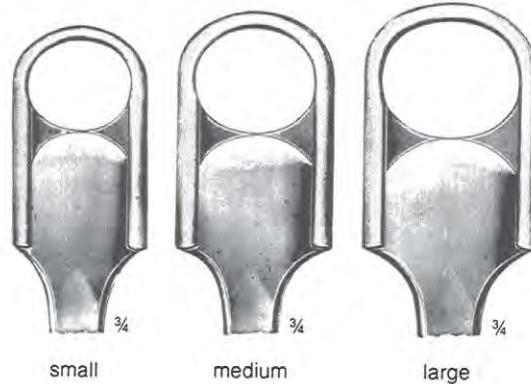

SLUDER-BALLEGER
tonsillectome
with 3 blades

Tonsillectome

A22-360



HARTMANN
tonsil punch
12 cm 4 $\frac{3}{4}$ " shaft

Tonsil Snare Wire
sizes 5 to 9

A22-370

	punch diameter
A22-380	13 mm
A22-382	15 mm
A22-384	17 mm

Tonsil Snare Wires
Tonsil Punches



Tracheal Instruments

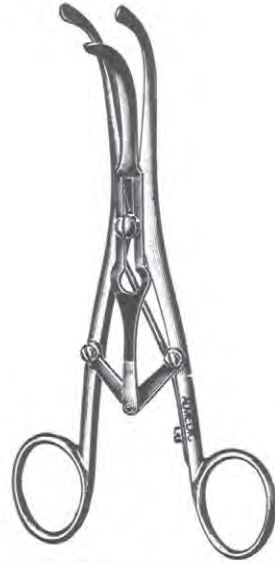

Trachea Dilators

La BORDE
tri-valve
14 cm 5½"

TROUSSEAU
14 cm 5½"

A23-100

A23-104



Life Saving Tubes Trachea Bistoury Trachea Tenaculum

MOSHER
life saving tube

A23-110 16 French
A23-112 20 French
A23-114 26 French

JACKSON
trachea bistoury
blade 2"
16.5 cm 6½"

A23-120

JACKSON
trachea tenaculum
15 cm 6"

A23-124

Almedic Trachea and Laryngectomy Tubes

Explanations and Technical Data for Trachea and Laryngectomy Tubes

A complete line of interchangeable tubes (within a size and style) in sterling silver, stainless steel, or silver plated, available from one source.

Trachea tubes come in many different styles and sizes to fill the different needs of the patient, and to satisfy the personal preferences of the attending medical staff. Special models and sizes can be made to order. Please enquire.

All trachea tubes consist of one outer tube, one inner tube, and one pilot.

Trachea tubes come in sizes 000 - 12. The size refers to the outer diameter of the tube. The following sizes are for the average person.								
Size	000 - 1	1 - 2	2 - 4	4 - 5	5 - 6	6 - 7	8 - 10	12
AGE (years)	Infant	1 - 4	5 - 12	12 - 15	average woman	average man	special cases	laryngectomy only
Trachea & Laryngectomy Tube Dimensions								
Size	00	0	1	2	3	4	5	
outside diameter mm.	3	4	5	6	7	8	9	
Actual Size								
Size	6	7	8	9	10	12		
outside diameter mm.	10	11	12	13	14	16		
Actual Size								



Almedic Trachea and Laryngectomy Tubes

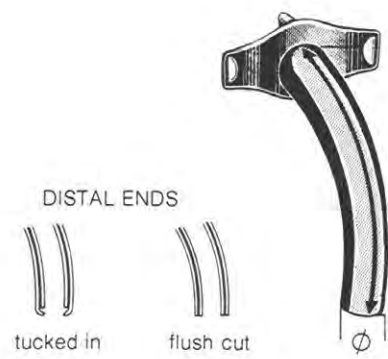

Explanations and Technical Data for Trachea and Laryngectomy Tubes

Length: the tube lengths are measured from the shield (neck plate) along the outside curve to the end of the tube (distal end).

Diameter: The diameter of the outer tube is measured in millimeters (mm) at the distal end of the tube.

TUBE LENGTHS IN INCHES
Measured on Outside Curve

Almedic Cat. No.	00	0	1	2	3	4	5	6	7	8	9	10	12
A23-140 to A23-166 A23-170 to A23-194 A23-196 to A23-220 A23-396 to A23-418 A23-420 to A23-442 A23-444 to A23-466	1 3/4	2	2 1/4	2 1/2	2 3/4	3	3 3/8	3 5/8	4	4 1/4	4 3/8	4 3/8	4 3/8
A23-222 to A23-246 A23-248 to A23-272 A23-274 to A23-298	1 1/2	1 3/4	2 1/8	2 1/4	2 3/8	2 1/2	2 5/8	2 7/8	3	3 1/8	3 1/4	3 3/8	
A23-468 to A23-492 A23-494 to A23-518 A23-520 to A23-544	1 3/8	1 5/8	1 3/4	1 7/8	2	2 1/8	2 1/4	2 3/8	2 1/2	2 5/8	2 3/4	2 7/8	
A23-746 to A23-750 A23-752 to A23-756 A23-758 to A23-762 A23-764 to A23-768 A23-770 to A23-774 A23-776 to A23-780										2 1/4		2 1/4	2 1/4
A23-782 to A23-804 A23-806 to A23-826		2 7/8	2 7/8	2 7/8	2 7/8	2 7/8	2 7/8	2 7/8	2 7/8	2 7/8	2 7/8	2 7/8	2 7/8
A23-828 to A23-848									2 1/2	2 3/4	3	3 3/8	

Tracheal Instruments



JACKSON
original model
90° curve
distal end tucked in

size no.	sterling silver	stainless steel	silver plated	size no.	sterling silver	stainless steel	silver plated	size no.	sterling silver	stainless steel	silver plated	Trachea Tubes
000	A23-140			3	A23-150	A23-178	A23-204	8	A23-160	A23-188	A23-214	
00	A23-142	A23-170	A23-196	4	A23-152	A23-180	A23-206	9	A23-162	A23-190	A23-216	
0	A23-144	A23-172	A23-198	5	A23-154	A23-182	A23-208	10	A23-164	A23-192	A23-218	
1	A23-146	A23-174	A23-200	6	A23-156	A23-184	A23-210	12	A23-166	A23-194	A23-220	
2	A23-148	A23-176	A23-202	7	A23-158	A23-186	A23-212					

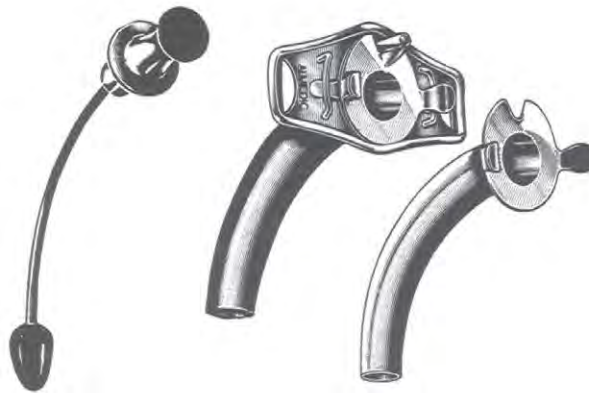

JACKSON
short model
approximately ¼" shorter
than the regular Jackson
but longer than the luer tube

size no.	sterling silver	stainless steel	silver plated	size no.	sterling silver	stainless steel	silver plated	size no.	sterling silver	stainless steel	silver plated	Trachea Tubes
00	A23-222	A23-248	A23-274	4	A23-232	A23-258	A23-284	8	A23-240	A23-266	A23-292	
0	A23-224	A23-250	A23-276	5	A23-234	A23-260	A23-286	9	A23-242	A23-268	A23-294	
1	A23-226	A23-252	A23-278	6	A23-236	A23-262	A23-288	10	A23-244	A23-270	A23-296	
2	A23-228	A23-254	A23-280	7	A23-238	A23-264	A23-290	12	A23-246	A23-272	A23-298	
3	A23-230	A23-256	A23-282									

Tracheal Instruments



JACKSON
improved model
distal end flush cut
rotating lock with no protruding
parts to snag on clothing or bandages

Trachea Tubes

size no.	sterling silver	stainless steel	size no.	sterling silver	stainless steel	size no.	sterling silver	stainless steel
00	A23-300	A23-324	3	A23-308	A23-332	7	A23-316	A23-340
0	A23-302	A23-326	4	A23-310	A23-334	8	A23-318	A23-342
1	A23-304	A23-328	5	A23-312	A23-336	9	A23-320	A23-344
2	A23-306	A23-330	6	A23-314	A23-338	10	A23-322	A23-346

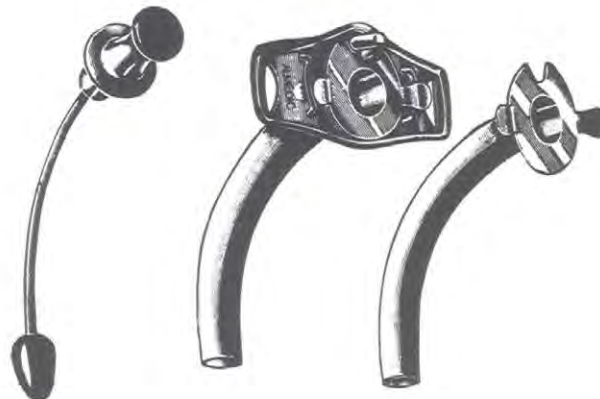

JACKSON
original 90° curve model
distal end flush cut

Trachea Tubes

size no.	sterling silver	stainless steel	size no.	sterling silver	stainless steel	size no.	sterling silver	stainless steel
00	A23-348	A23-372	3	A23-356	A23-380	7	A23-364	A23-388
0	A23-350	A23-374	4	A23-358	A23-382	8	A23-366	A23-390
1	A23-352	A23-376	5	A23-360	A23-384	9	A23-368	A23-392
2	A23-354	A23-378	6	A23-362	A23-386	10	A23-370	A23-394

Tracheal Instruments

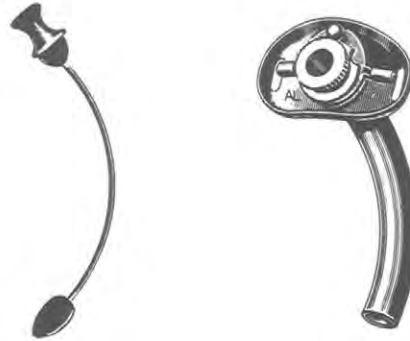

JACKSON
improved model
distal end tucked in
rotating lock with no protruding
parts to snag on clothing or bandages

size no.	sterling silver	stainless steel	silver plated	size no.	sterling silver	stainless steel	silver plated	size no.	sterling silver	stainless steel	silver plated	Trachea Tubes
00	A23-396	A23-420	A23-444	3	A23-404	A23-428	A23-452	7	A23-412	A23-436	A23-460	
0	A23-398	A23-422	A23-446	4	A23-406	A23-430	A23-454	8	A23-414	A23-438	A23-462	
1	A23-400	A23-424	A23-448	5	A23-408	A23-432	A23-456	9	A23-416	A23-440	A23-464	
2	A23-402	A23-426	A23-450	6	A23-410	A23-434	A23-458	10	A23-418	A23-442	A23-466	



LUER
regular
short model tubes
more accutely curved
than Jackson

size no.	sterling silver	stainless steel	silver plated	size no.	sterling silver	stainless steel	silver plated	size no.	sterling silver	stainless steel	silver plated	Trachea Tubes
00	A23-468	A23-494	A23-520	4	A23-478	A23-504	A23-530	8	A23-486	A23-512	A23-538	
0	A23-470	A23-496	A23-522	5	A23-480	A23-506	A23-532	9	A23-488	A23-514	A23-540	
1	A23-472	A23-498	A23-524	6	A23-482	A23-508	A23-534	10	A23-490	A23-516	A23-542	
2	A23-474	A23-500	A23-526	7	A23-484	A23-510	A23-536	12	A23-492	A23-518	A23-544	
3	A23-476	A23-502	A23-528									



Tracheal Instruments



LUER
fenestrated
short model tubes
more accurately curved
than Jackson

Trachea Tubes

size no.	sterling silver	stainless steel	silver plated	size no.	sterling silver	stainless steel	silver plated	size no.	sterling silver	stainless steel	silver plated
00	A23-546	A23-572	A23-598	4	A23-556	A23-582	A23-608	8	A23-564	A23-590	A23-616
0	A23-548	A23-574	A23-600	5	A23-558	A23-584	A23-610	9	A23-566	A23-592	A23-618
1	A23-550	A23-576	A23-602	6	A23-560	A23-586	A23-612	10	A23-568	A23-594	A23-620
2	A23-552	A23-578	A23-604	7	A23-562	A23-588	A23-614	12	A23-570	A23-596	A23-622
3	A23-554	A23-580	A23-606								



MARTIN
tracheostomy dressing
extension set
consists of a complete
tube and an additional inner
tube with a 1" extension
on the proximal end. This
extends out of bulky dressings
and permits easier breathing

Trachea Tubes

size no.	sterling silver	stainless steel	silver plated	size no.	sterling silver	stainless steel	silver plated	size no.	sterling silver	stainless steel	silver plated
0	A23-624	A23-648	A23-672	4	A23-632	A23-656	A23-680	8	A23-640	A23-664	A23-688
1	A23-626	A23-650	A23-674	5	A23-634	A23-658	A23-682	9	A23-642	A23-666	A23-690
2	A23-628	A23-652	A23-676	6	A23-636	A23-660	A23-684	10	A23-644	A23-668	A23-692
3	A23-630	A23-654	A23-678	7	A23-638	A23-662	A23-686	12	A23-646	A23-670	A23-694

Tracheal Instruments



Cane Shaped
all sizes are the same
radius on the inside curve

size no.	sterling silver
00	A23-696
0	A23-698
1	A23-700
2	A23-702

size no.	sterling silver
3	A23-704
4	A23-706
5	A23-708
6	A23-710

size no.	sterling silver
7	A23-712
8	A23-714
9	A23-716
10	A23-718

Trachea Tubes



HOLINGER
all sizes are available
in various lengths —
please specify

primarily for pediatric use
short lightweight tube with
plate affixed at a more
acute angle (65°)

size no.	sterling silver
000	A23-720
00	A23-722
0	A23-724
1	A23-726

size no.	sterling silver
2	A23-728
3	A23-730
4	A23-732
5	A23-734

size no.	sterling silver
6	A23-736
7	A23-738
8	A23-740

Trachea Tubes

Tracheal Instruments



MARTIN

shorter than trachea tubes and have the cannula affixed to plate shield at an accute angle available with or without an extension tube

Laryngectomy Tubes

without extension tube				with extension tube (dressing extension set)			
size no.	sterling silver	stainless steel	silver plated	size no.	sterling silver	stainless steel	silver plated
8	A23-746	A23-752	A23-758	8	A23-764	A23-770	A23-776
10	A23-748	A23-754	A23-760	10	A23-766	A23-772	A23-778
12	A23-750	A23-756	A23-762	12	A23-768	A23-774	A23-780



JACKSON

the curve of the Jackson laryngectomy tube is the same as the original Jackson trachea tube. The laryngectomy tubes are shorter than trachea tubes, all sizes 2 7/8" long. The cannula is affixed to the neck plate at an acute angle.
distal end tucked in or flush cut — please specify

Laryngectomy Tubes

0	sterling silver	stainless steel	4	sterling silver	stainless steel	8	sterling silver	stainless steel
1	A23-782	A23-806	5	A23-790	A23-814	9	A23-798	A23-822
2	A23-784	A23-808	6	A23-792	A23-816	10	A23-800	A23-824
3	A23-786	A23-810	7	A23-794	A23-818	12	A23-802	A23-826
	A23-788	A23-812		A23-796	A23-820		A23-804	

Tracheal Instruments



LEWIS
acutely curved tube
tapered approximately
2 mm from proximal to
distal end (top to bottom)

size no.	sterling silver	size no.	sterling silver	size no.	sterling silver
0	A23-828	4	A23-836	8	A23-844
1	A23-830	5	A23-838	9	A23-846
2	A23-832	6	A23-840	10	A23-848
3	A23-834	7	A23-842		

Laryngectomy Tubes



JACKSON
improved model,
shorter than trachea tubes, all sizes 27/8" long
distal ends tucked in — or flush cut — please specify
rotating lock with no protruding parts
to snag on clothing or bandages

size no.	sterling silver	stainless steel	size no.	sterling silver	stainless steel	size no.	sterling silver	stainless steel
0	A23-850	A23-872	4	A23-858	A23-880	8	A23-866	A23-888
1	A23-852	A23-874	5	A23-860	A23-882	9	A23-868	A23-890
2	A23-854	A23-876	6	A23-862	A23-884	10	A23-870	A23-892
3	A23-856	A23-878	7	A23-864	A23-886			

Laryngectomy Tubes

Tracheal Instruments



Brush
for cleaning trachea tubes
nylon bristles, steel handle
length 5½" 14 cm

A23-896



Packaged in a
clear lucite case



Cannula with
Trocar removed

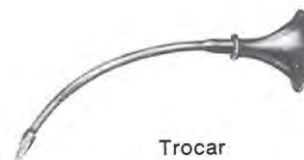

Trocar



Assembled Cannula

ABELSON
CRICOTHYROTOMY CANNULA
for emergency tracheostomy

A23-900

Oral Instruments



MAUNDER
oral screw
hard rubber

A24-100

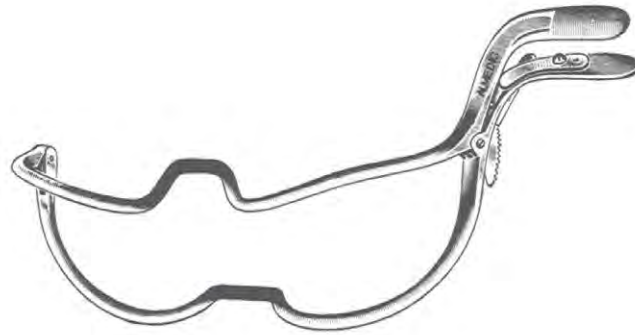

JENNINGS
mouth gag

- A24-110** infant 9 cm 3½"
- A24-112** child 11 cm 4¼"
- A24-114** medium 13 cm 5"
- A24-116** adult 15 cm 6"

Oral Screw Mouth Gags



DENHARDT
mouth gag
with grip ratchet
12 cm 4¾"

A24-120



DOYEN-JANSEN
mouth gag
with grip ratchet

- A24-130** child 10 cm 4"
- A24-132** adult 15 cm 6"

Mouth Gags

Oral Instruments



WIEDER

A24-180 child 14 cm 5½"
A24-182 adult 15 cm 6"

BOSWORTH

A24-186

Tongue Depressors



ANDREW
 11 cm 4½"

A24-190



HASLINGER
 uvula retractor
 15.5 cm 6¼"

A24-200

Tongue Depressor Uvula Retractor

**Oral
Instruments**



Tongue Forceps

COLLIN
tongue forceps
small rings
16.5 cm 6½"

A24-210

COLLIN
tongue forceps
large rings
18 cm 7"

A24-212



Tongue Forceps

YOUNG
tongue forceps
with rubber pads
15.5 cm 6¼"

A24-220

Rubber Pads
for Young
tongue forceps

A24-222

MATHIEU
tongue forceps
18.5 cm 7¼"

A24-230

Laryngeal Instruments



Threaded Stem
without handle

	no.	diam.		no.	diam.		no.	diam.
A25-100	00	12 mm	A25-108	3	20 mm	A25-114	6	26 mm
A25-102	0	14 mm	A25-110	4	22 mm	A25-116	7	28 mm
A25-104	1	16 mm	A25-112	5	24 mm	A25-118	8	30 mm
A25-106	2	18 mm						

Laryngeal
Mirrors



Threaded Stem
with handle

	no.	diam.		no.	diam.		no.	diam.
A25-120	00	12 mm	A25-128	3	20 mm	A25-134	6	26 mm
A25-122	0	14 mm	A25-130	4	22 mm	A25-136	7	28 mm
A25-124	1	16 mm	A25-132	5	24 mm	A25-138	8	30 mm
A25-126	2	18 mm						

Laryngeal
Mirrors
and Handles



Laryngeal Instruments



Laryngeal Mirror Handles

With Thread Opening

With Screw Set Opening

A25-140

A25-142

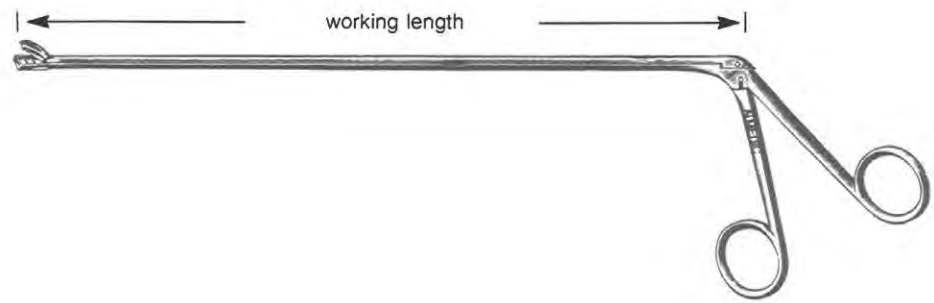

serrated



cup jaws straight



cup jaws angled

Endoscopic Forceps

working length	JACKSON		
	serrated jaws	cup jaws 4 mm straight	cup jaws 4 mm up-angled
30 cm 12"	A25-200	A25-210	A25-220
40 cm 16"	A25-202	A25-212	A25-222
50 cm 20"	A25-204	A25-214	A25-224
60 cm 24"	A25-206	A25-216	A25-226

Laryngeal Instruments



BRUENING
extension cannula
to fit
universal
handle
A25-290

straight		angular
A25-260	20 cm	A25-270
A25-262	30 cm	A25-272
A25-264	40 cm	A25-274
A25-266	50 cm	A25-276
A25-268	60 cm	A25-278

Extension Cannula



BRUENING
extension cannula to fit
universal handle A25-290
curved
20 cm

A25-280

Extension Cannula



Laryngeal Instruments



Universal Handle

HUBER
universal handle for use
with interchangeable universal
tips and extension cannulae

A25-290



Universal Forceps Tips and Cutting Tips

FRAENKEL
serrated jaw

A25-300

FRAENKEL
cup jaw

A25-302

SEIFFERT
toothed jaw

A25-306

BARACANI
forceps tip

A25-310

LANGE
forceps tip
oval cup jaw

A25-314

Laryngeal Instruments



BRUENING
straight
cup jaw

A25-320 2 mm
A25-322 3 mm

BRUENING
up-cutting
cup jaw

A25-324 2 mm
A25-326 3 mm

SCHEINMANN
angular
cup jaw

A25-330

**Universal
Forceps Tips
and
Cutting Tips**



KRAUSE
through cutting
oval jaw

A25-340 3.5 mm
A25-342 4 mm

KRAUSE
through cutting
square end jaw

A25-344 4 mm
A25-346 4.5 mm

ROSENBERG
forceps tip

A25-350

CORDES
through cutting
semi-circle jaw

A25-360 3 mm **A25-364** 5 mm
A25-362 4 mm **A25-366** 6 mm

**Universal
Forceps Tips
and
Cutting Tips**



Laryngeal Instruments

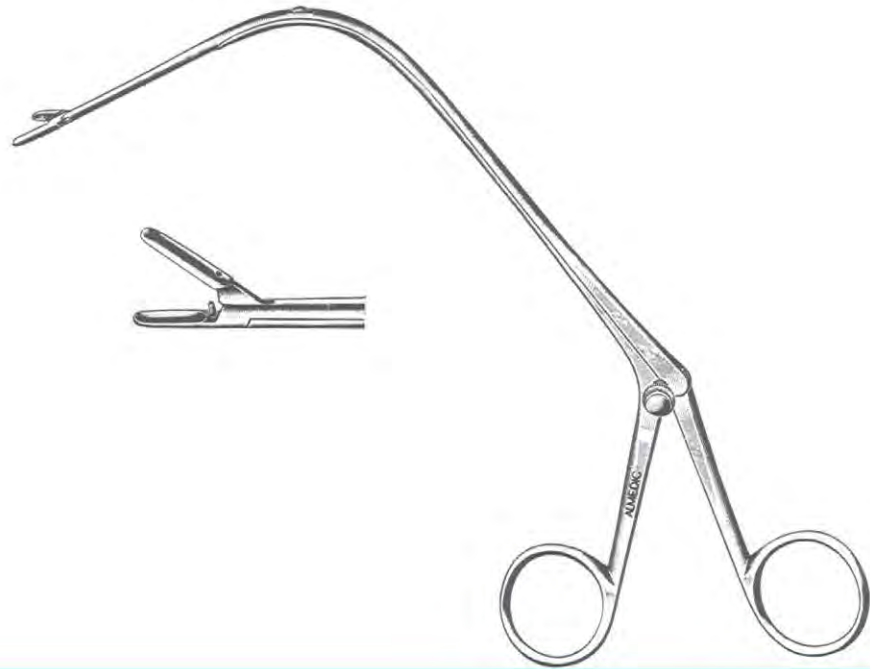

Laryngeal Forceps

- JURASZ**
23 cm 9"
jaw opening
- A25-400** right
 - A25-402** left
 - A25-404** down
 - A25-406** up



Laryngeal Forceps

FRAENKEL
19 cm 7½"

A25-410

JACKSON
cross action
21.5 cm 8½"

A25-420 with teeth
A25-422 without teeth

Goitre Instruments



MASTIN
muscle clamp
17 cm 6¾"

A26-100



LAHEY
traction forceps
3 X 3 teeth
15.5 cm 6¼"

A26-110

**Muscle Clamp
Traction Forceps**



LOVELACE
traction forceps
2 X 2 teeth
15 cm 6"

A26-114



KOCHER
bronchocele sound
(enucleator)
with eye
15 cm 6"

A26-120



LAHEY
ligature carrier
18.5 cm 7¼"

A26-130 right
A26-132 left

**Traction Forceps
Bronchocele Sound
Ligature Carrier**



Gall Bladder Instruments



Gall Duct Probes

OCHSNER (FENGER)
 spiral gall duct probe
 malleable
 38 cm 15"
A27-100

MAYO
 common duct probe malleable
 25 cm 10"
A27-110 15 French tip
A27-112 18 French tip
A27-114 20 French tip



Gall Duct Probes Gall Stone Scoops

DESJARDIN
 gall duct probe malleable
 28 cm 11"
A27-120 13 French tip
A27-122 18 French tip
A27-124 21 French tip

MIXTER
 dilating probe
 irrigating
 malleable
 30 cm 12"
A27-130

MOYNIHAN
 gall stone probe
 and scoop
 pure tin
 35 cm 13 3/4"
A27-134

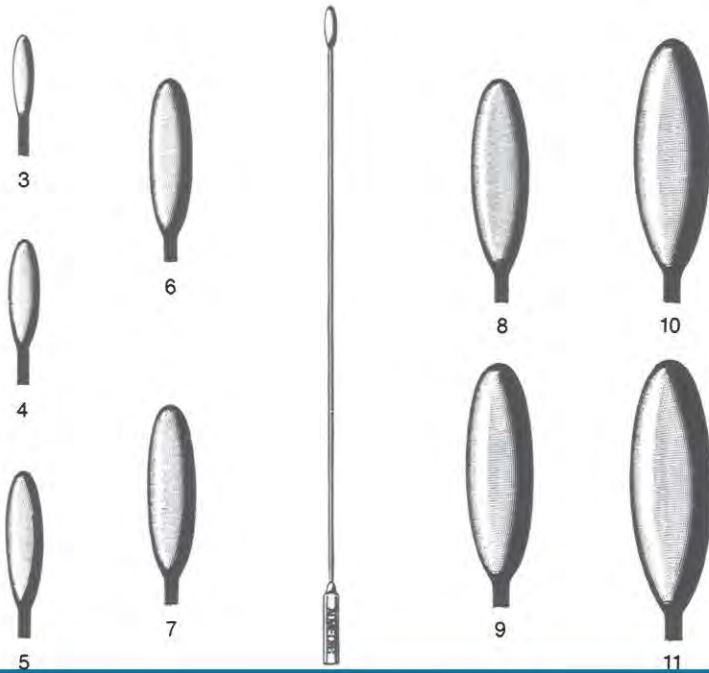

Gall Bladder Instruments

BAKES
common duct dilators
rigid
30 cm 12"

A27-140 set of 9 in khaki case 3 mm to 11 mm
no. size

A27-142 1 3 mm	A27-152 6 8 mm
A27-144 2 4 mm	A27-154 7 9 mm
A27-146 3 5 mm	A27-156 8 10 mm
A27-148 4 6 mm	A27-158 9 11 mm
A27-150 5 7 mm	

Common Duct Dilators



MAYO
gall stone scoop
28 cm 11"

A27-170



MOORE
gall stone scoop
29 cm 11½"

A27-174

Gall Stone Scoops

Gall Bladder Instruments



Gall Stone Scoops

DESJARDIN

gall stone scoop
malleable
28 cm 11"

- A27-180** 17 French **A27-184** 24 French
- A27-182** 21 French **A27-186** 27 French

FERGUSON

gall stone scoop

- A27-190** small 21.5 cm 8½"
- A27-192** medium 22 cm 8¾"
- A27-194** large 23.5 cm 9¼"



**Common Duct Scoops
Cystic Duct Scoops**

MAYO

common duct scoop malleable
silver plated 26.5 cm 10½"

- A27-200** small
- A27-202** medium
- A27-204** large

MAYO

cystic duct scoop
malleable
silver plated
26.5 cm 10½"

- A27-210**

Gall Bladder Instruments



BLAKE
straight
21.5 cm 8½"

A27-220

BLAKE
curved
21.5 cm 8½"

A27-222

MAYO-BLAKE
20 cm 8"

A27-230 straight
A27-232 curved

Gall Stone Forceps



MIXTER
23 cm 9"

A27-240



DESJARDIN
23 cm 9"

A27-244

Gall Stone Forceps

Gall Bladder Instruments



Gall Bladder Forceps

JOHNS-HOPKINS
20 cm 8"

MIXTER
23 cm 9"

A27-250

A27-256



Gall Bladder Forceps

VARCO
19 cm 7½"

SHALLCROSS
double curve
18 cm 7"

A27-260 full curve
A27-262 shallow curve

A27-266

Gall Bladder Instruments



LOWER
18 cm 7"

A27-270



LAHEY

A27-274 19 cm 7½"
A27-276 23 cm 9"

Gall Duct Forceps



MOYNIHAN
22 cm 8¾"

A27-280

CRILE
20 cm 8"

A27-284



MIXTER
jaw 9 cm 3½"
16.5 cm 6½"

A27-288

Gall Duct Forceps

Gall Bladder Instruments



Gall Duct Clamps

MIXTER

- A27-290** 22 cm 8 3/4"
- A27-292** 25 cm 10"
- A27-294** 28 cm 11"

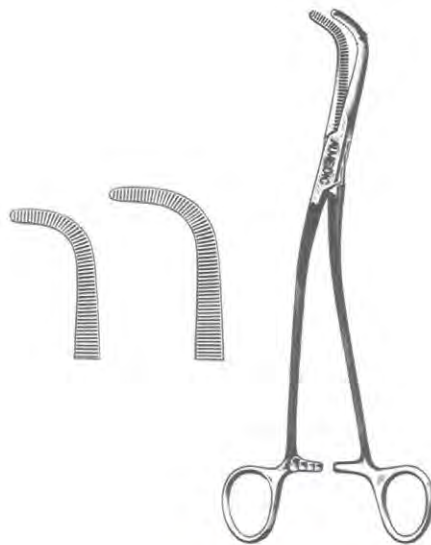

Cystic Duct Forceps

GREY
without mouse tooth
set of 2
23 cm 9"

A27-300

GREY
with mouse tooth
set of 2
23 cm 9"

A27-302

Stomach and Intestinal Instruments



SCHOENBERG
19.5 cm 7¾"

SCHOENBERG
with ring handle
22 cm 8¾"

**Intestinal Holding
Forceps**

A28-100

A28-102



YOUNG
with rubber jaws
21.5 cm 8½"

COLLIN
20 cm 8"

**Intestinal Holding
Forceps**

A28-106

jaws
A28-110 ½" wide
A28-112 1" wide

**Stomach and
Intestinal
Instruments**



**Intestinal Holding
Forceps**

CHILD
24.5 cm 9 3/4"

WILLIAMS
16.5 cm 6 1/2"

A28-116

A28-120



**Intestinal Holding
Forceps**

PERCY
15 cm 6"

BABCOCK

A28-124

A28-132 15.5 cm 6 1/4"
A28-134 19.5 cm 7 1/4"
A28-136 23.5 cm 9 1/4"

Stomach and Intestinal Instruments

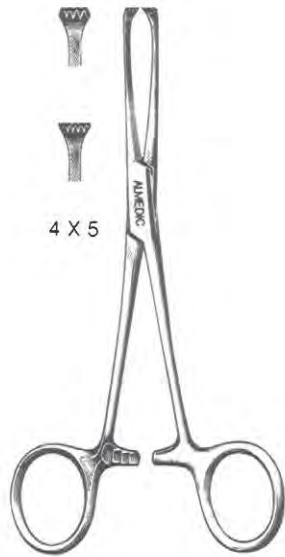

BABY ALLIS
4 X 5 teeth
14.5 cm 5½"

A28-150

ALLIS

A28-152 4 X 5 teeth 15 cm 6"
A28-154 5 X 6 teeth 15 cm 6"
A28-156 5 X 6 teeth 19 cm 7½"
A28-158 5 X 6 teeth 25 cm 10"

Intestinal Tissue Forceps



ALLIS-ADAIR
9 X 10 teeth
15 cm 6"

A28-162

THOMS-ALLIS
6 X 7 teeth
20 cm 8"

A28-166

Intestinal Tissue Forceps

**Stomach and
Intestinal
Instruments**



**Intestinal Tissue
Forceps**

JUDD-ALLIS
3 X 4 teeth

LOCKWOOD-ALLIS
15.5 cm 6 1/4"

A28-170 15 cm 6"
A28-172 19 cm 7 1/2"

A28-176



**Intestinal Tissue
Forceps
Intestinal Forceps**

LOCKWOOD
intestinal forceps
19.5 cm 7 3/4"

BRUNNER
intestinal forceps
24 cm 9 1/2"

A28-190

A28-194

Stomach and Intestinal Instruments



KOCHER
longitudinal serrations
28 cm 11"

A28-200 straight
A28-202 curved



BABY DOYEN
diagonal serrations
16.5 cm 6½"

A28-210 straight
A28-212 curved

Intestinal Forceps

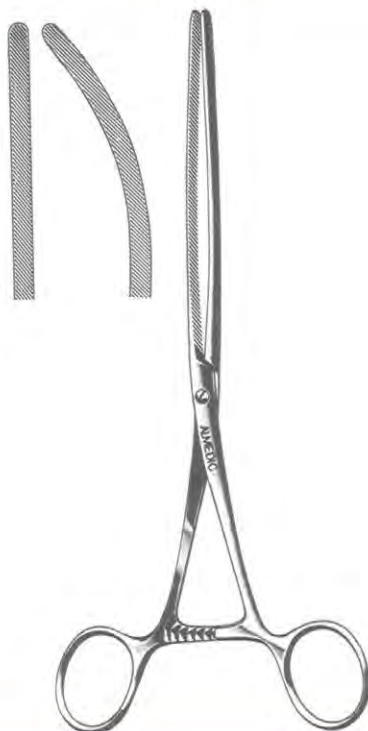

DOYEN
diagonal serrations
23 cm 9"

A28-214 straight
A28-216 curved



MAYO-ROBSON
longitudinal serrations
25 cm 10"

A28-220 straight
A28-222 curved

Intestinal Forceps



Stomach and Intestinal Instruments

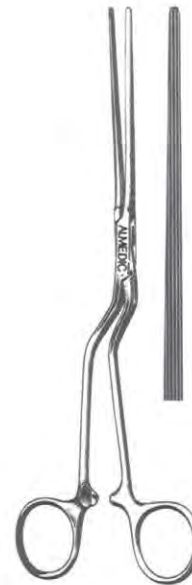

Intestinal Forceps Colon Forceps

SCUDDER

- A28-230** 24 cm 9½" solid blades
- A28-234** 33 cm 13" solid blades
- A28-236** 33 cm 13" fenestrated blades

GAVIN-MILLER intestinal and colon forceps jaw 7.5 cm 3" 20 cm 8"

A28-240



Intestinal Clamps Stomach Clamps

ALLEN intestinal clamp 1 X 2 teeth

- A28-244** baby 15 cm 6"
- A28-250** 20 cm 8"

SCUDDER stomach clamp fenestrated with end lock 36 cm 14" **A28-260** straight **A28-262** curved

Stomach and Intestinal Instruments



STONE set consisting of
 1 applying forceps **A28-278**
 1 clamp 7.5 cm 3" **A28-272**
 1 clamp 10 cm 4" **A28-274**
 1 locking device **A28-276**

				Intestinal Clamps
	STONE intestinal clamp 7.5 cm 3"	STONE intestinal clamp 10 cm 4"	STONE locking device	
A28-270	A28-272	A28-274	A28-276	

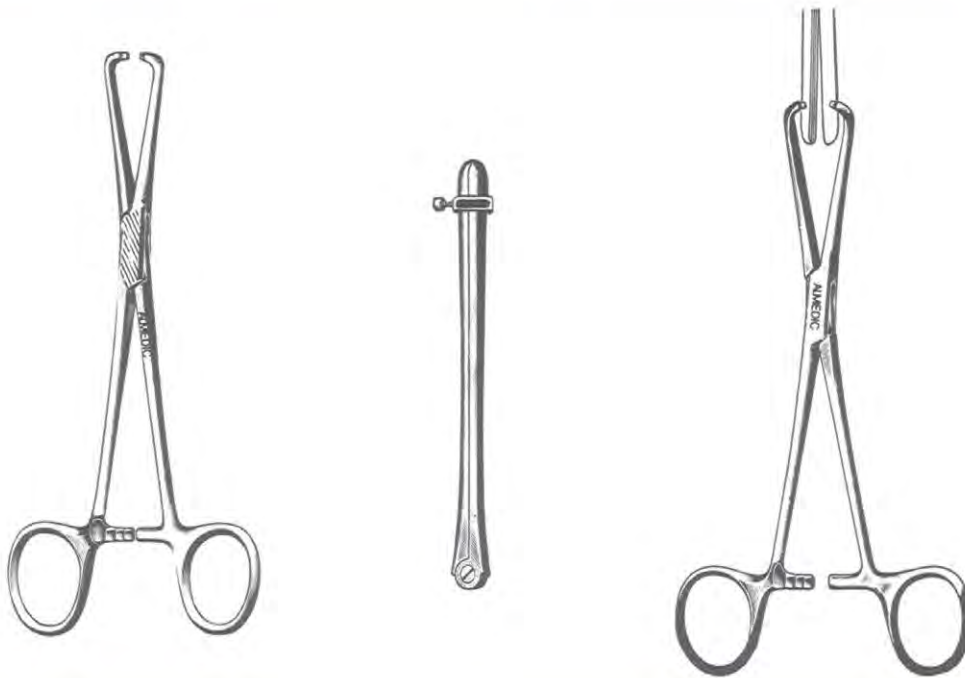

			Intestinal Clamps
STONE clamp applying forceps 15.5 cm 6"	procedure for securing clamp with locking device	procedure for applying intestinal clamp with the forceps	
A28-278			

**Stomach and
Intestinal
Instruments**



Intestinal Clamps

De MARTEL-WOLFSON
anastomosis clamp

- A28-290** 5 cm 2" set of 3
- A28-292** 7.5 cm 3" set of 3
- A28-294** 10 cm 4" set of 3

De MARTEL-WOLFSON
clamp holder

- A28-298** 8 cm 3¼"
- A28-302** 23 cm 9"



Intestinal Clamps

De MARTEL-WOLFSON
clamp closing forceps
27.5 cm 10¾"

A28-306

Stomach and Intestinal Instruments

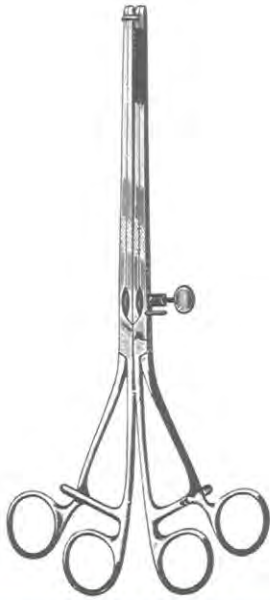

LANE
straight
30 cm 12"

A28-330



ROOSEVELT
stomach clamp
with 3 fenestrated
clamps
33 cm 13"

A28-334



RANKIN
anastomosis clamp
23 cm 9"

A28-338

Gastro-Intestinal Clamps

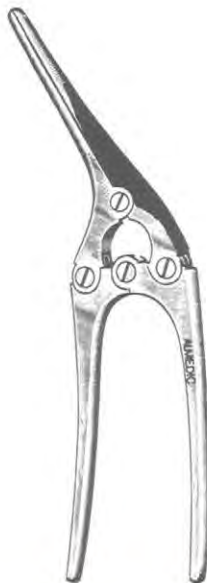

BABY PAYR
pylorus clamp
15 cm 6"

A28-350



PAYR
pylorus clamp

A28-352 20 cm 8"
A28-354 28 cm 11"
A28-356 35 cm 13¾"



BENSON
pylorus separator
14.5 cm 5¾"

A28-360

Gastro-Intestinal Clamps Gastro-Intestinal Separator

Stomach and Intestinal Instruments

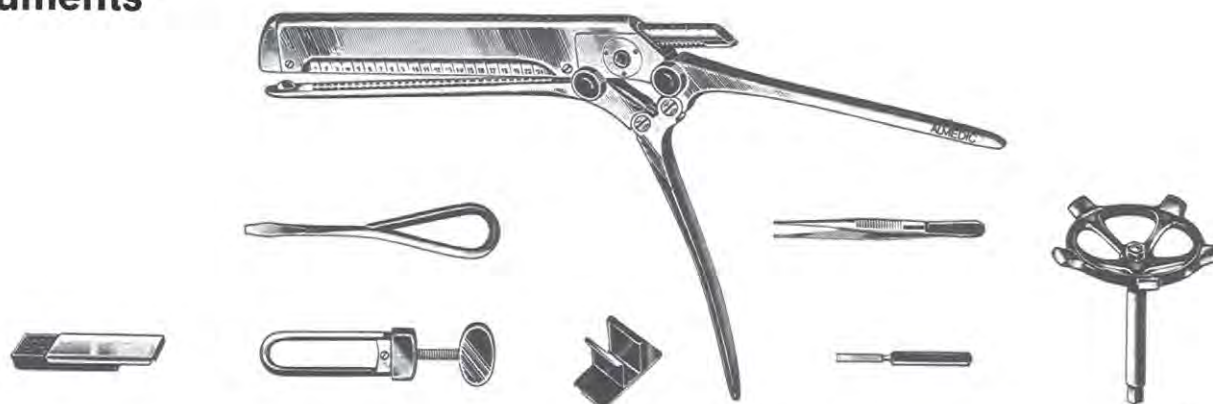

VON PETZ

Stomach and Intestinal Suture Apparatus

The Von Petz apparatus places two precise and straight rows of fine silver clips on the stomach or intestinal walls.

The line of resection is closed very quickly so that the danger of spilling infectious contents of the stomach or intestines toward the oral or aboral sides is reduced to a minimum.

The complete set is supplied in a fitted well-finished wooden case.

The set consists of:

- Suturing apparatus
- Metal box for clips
- 300 silver suturing clips
- Screwdriver
- Clip filling pin
- Turning wheel
- Additional clamp
- Clip introducing rack
- Tweezers

A28-370



Suture Clips
for Von Petz
apparatus
box of 300
German silver

A28-372

Thoracic and Cardiovascular Instruments



GLUCK
21.5 cm 8½"

STILLE
21.5 cm 8½"

SAUERBRUCH
26.5 cm 10½"

Rib Shears

A29-100

A29-104

A29-108



SAUERBRUCH-FREY
36 cm 14"

BRUNNER
right
33 cm 13"

BRUNNER
left
33 cm 13"

Rib Shears

A29-110

A29-114

A29-116



Thoracic and Cardiovascular Instruments

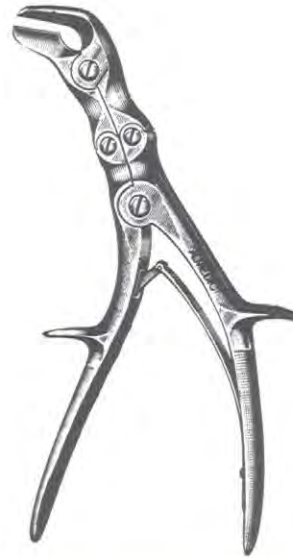

Rib Shears

GIERTZ
25 cm 10"

SEMB
25 cm 10"

A29-118

A29-122



Rib Shears

BETHUNE
35 cm 13³/₄"

LEBSCHKE
23 cm 9"

A29-126

A29-128

Thoracic and Cardiovascular Instruments



TUFFIER
with grooved blades
50 X 45 mm

A29-130 115 mm spread
A29-132 165 mm spread

FINOCHIETTO
straight arms

	blades	spread
A29-140 (baby)	18 X 20 mm	100 mm
A29-142	40 X 40 mm	165 mm

Rib Spreaders

	blades	spread
A29-144	45 X 65 mm	200 mm
A29-146	70 X 65 mm	250 mm



FINOCHIETTO
curved arms

	blades	spread
A29-148	38 X 45 mm	165 mm
A29-150	40 X 65 mm	200 mm
A29-152	45 X 65 mm	250 mm

HAIGHT
30 X 30 mm blades
90 mm spread

A29-154

Rib Spreaders

Thoracic and Cardiovascular Instruments



Rib Spreaders

BURFORD-FINOCHIETTO
with 2 pairs of interchangeable blades
46 X 63 mm and 68 X 63 mm

	spread		spread
A29-156	200 mm	A29-158	250 mm
		A29-160	300 mm

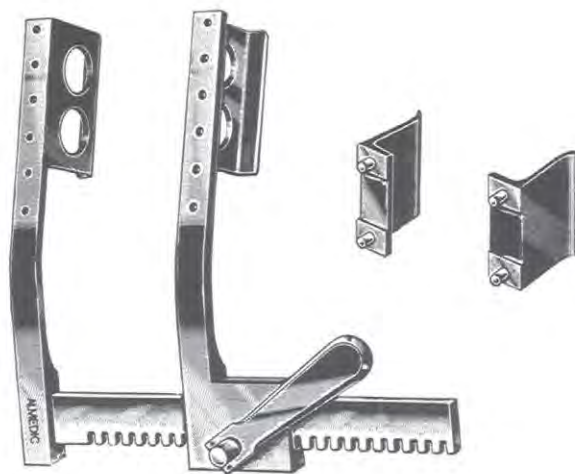

Rib Spreaders

HARKEN
with 2 fixed blades 45 X 75 mm and 2 detachable scapula blades 36 X 50 mm

	spread
A29-170	200 mm
A29-172	250 mm



Thoracic and Cardiovascular Instruments

BABY-BAILEY
14 cm 5½"

BAILEY
16 cm 6¼"

BAILEY-GIBBON
16 cm 6¼"

Rib Contractors

A29-188

A29-190

A29-196



FINOCHIETTO
thoracic forceps
and ligature
carrier
24 cm 9½"
A29-240

SEMB
dissecting and
ligature forceps
24 cm 9½"
A29-244 full curve
A29-246 slight curve

OVERHOLT
thoracic forceps
21.5 cm 8½"
A29-250 small jaw
A29-252 medium jaw
A29-254 large jaw

Thoracic Forceps

Thoracic and Cardiovascular Instruments

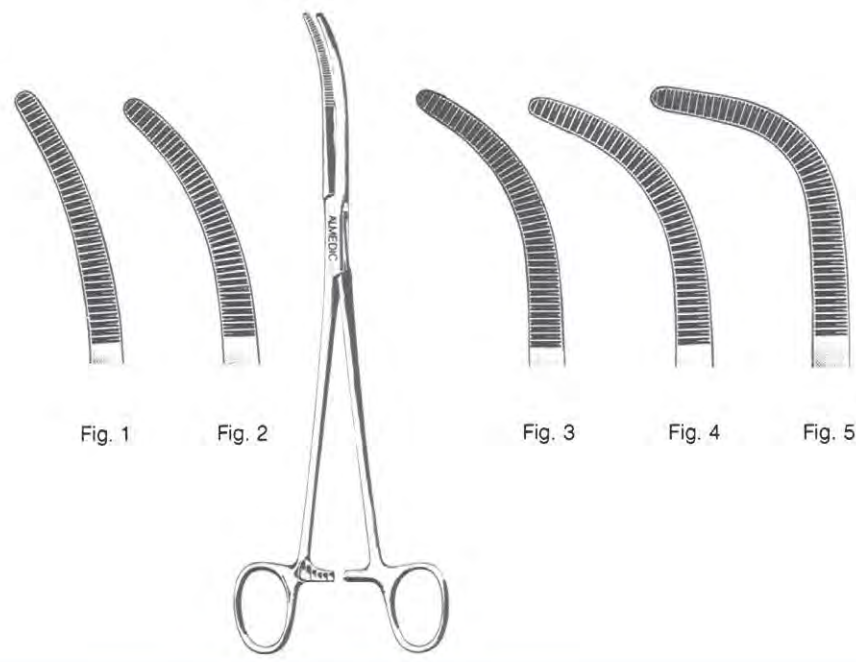

Fig. 1

Fig. 2

Fig. 3

Fig. 4

Fig. 5

Thoracic Forceps

RUMEL
thoracic forceps
23 cm 9"

- A29-260** Fig. 1 **A29-266** Fig. 4
- A29-262** Fig. 2 **A29-268** Fig. 5
- A29-264** Fig. 3



**Thoracic Forceps
Thoracic Clamps**

SAROT
thoracic forceps
24 cm 9½"

A29-270

HARRINGTON
thoracic clamp
curved
30 cm 12"

A29-276

HARRINGTON
thoracic clamp
angular
30 cm 12"

A29-278



Thoracic and Cardiovascular Instruments

SAROT
bronchus clamp
23 cm 9"
left jaws right
A29-290 1" **A29-292**
A29-294 1½" **A29-296**

DAVIDSON
pulmonary vessel
clamp
23 cm 9"

A29-300

Bronchus Clamp
Pulmonary Vessel Clamp



LOVELACE
lung grasping
forceps
straight
jaws 1" wide
20 cm 8"
A29-310

LOVELACE
lung grasping
forceps
curved
jaws 1" wide
20 cm 8"
A29-312

DUVAL
lung grasping
forceps
A29-320 ½" 20 cm 8"
A29-322 1" 20 cm 8"
A29-324 1" 23 cm 9"

Lung Grasping Forceps

Thoracic and Cardiovascular Instruments



Occluding Clamps

JOHNS HOPKINS
occluding clamp
longitudinal serrations
23 cm 9"
A29-340 straight
A29-342 curved



**Occluding Clamps
Vena Cava Clamps**

JOHNS HOPKINS
occluding clamp
horizontal serrations
23 cm 9"
A29-344 straight
A29-346 curved

BABY SATINSKY
vena cava
clamp
15 cm 6"
A29-354

Thoracic and Cardiovascular Instruments



SATINSKY
vena cava
clamp
26.5 cm 10½"

A29-356



WANGENSTEEN
patent ductus
clamp
28 cm 11"

A29-360



CRAFOORD
coarctation
clamp
24 cm 9½"

A29-362

**Vena Cava Clamp
Patent Ductus Clamp
Coarctation Clamp**



HARKEN
25 cm 10"
Fig. 1

A29-370



HARKEN
25 cm 10"
Fig. 2

A29-372



HARKEN
25 cm 10"
Fig. 3

A29-374



HARKEN
25 cm 10"
Fig. 4

A29-376

Auricle Clamps

Thoracic and Cardiovascular Instruments



**Pulmonic Stenosis Clamps
Aorta Clamps**

BLALOCK pulmonic stenosis clamp		length	jaws
A29-390		15 cm 6"	14 mm
A29-392		20 cm 8"	18 mm
A29-394		20 cm 8"	23 mm

POTTS aorta clamp 21.5 cm 8½"		jaws
A29-400		19 X 19 mm
A29-402		25 X 25 mm
A29-404		32 X 32 mm

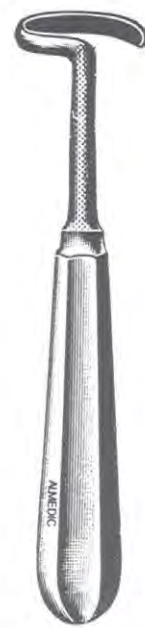

Raspatories

SAUERBRUCH raspatory for first rib 22 cm 8½"	
A29-408	

DOYEN rib raspatory left 18 cm 7"	
A29-410	child
A29-412	adult

DOYEN rib raspatory right 18 cm 7"	
A29-414	child
A29-416	adult

Thoracic and Cardiovascular Instruments



SEMB
stirrup shape
22.5 cm 9"

A29-420

SEMB
angular blade
with notch
17.5 cm 7"

A29-422

SEMB
angular blade
with notch
21 cm 8¼"

A29-424

SEMB
angular blade
17.5 cm 7"

A29-426

Raspatories



SEMB
angular blade
21 cm 8¼"

A29-428

SEMB
slightly
curved
blade
20 cm 8"

A29-430

SEMB
angular
blade
20 cm 8"

A29-432

Raspatories



Thoracic and Cardiovascular Instruments



**Raspatories
Rib Stripper
Periosteal
Elevators**

ALEXANDER
raspatory
20 cm 8"

A29-450

DAVIDSON-ALEXANDER
raspatory
29 cm 11½"

A29-458

MATSON
rib stripper
and elevator
22 cm 8¾"

A29-470

OVERHOLT
periosteal
elevator
29 cm 11½"

A29-480



**Periosteal
Elevators
Cardiovascular
Tourniquet**

OVERHOLT
periosteal
elevator
29 cm 11½"

A29-482

OVERHOLT
periosteal
elevator
29 cm 11½"

A29-484

RUMEL
cardiovascular
tourniquet
30 cm 12"

A29-520 diameter
3.2 mm
A29-522 6.4 mm

**Threading Stylet
for Rumel
tourniquet**

A29-524

Vein Strippers

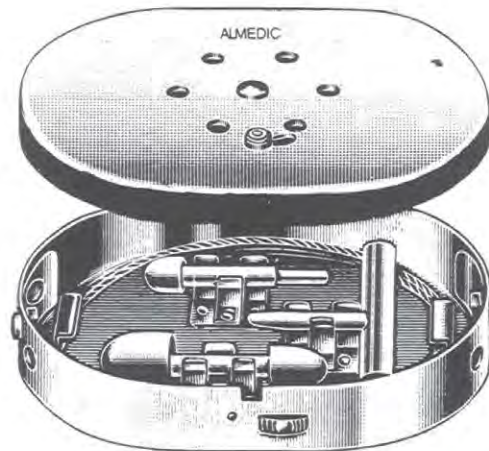

NABATOFF
complete set in metal sterilizer
case consisting of:
2 tips
3 olives 9, 12 and 15 mm
probe tip, handle, flexible cable
A30-100

Vein Strippers

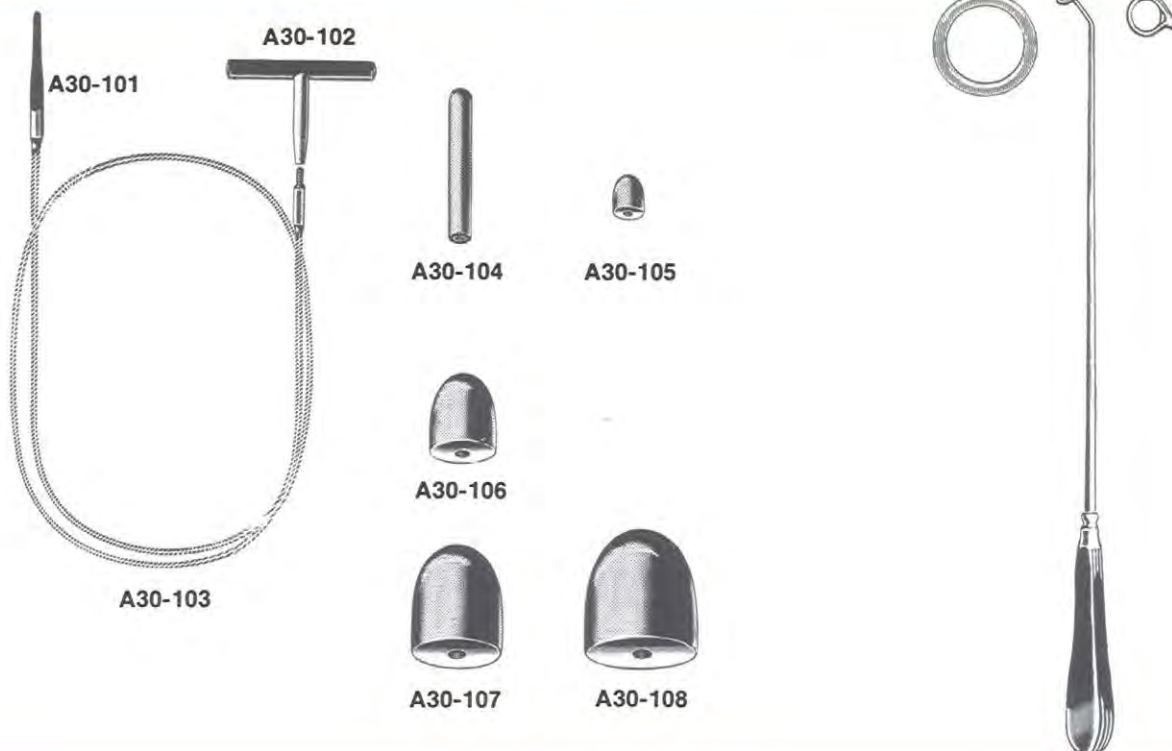

NABATOFF parts

A30-101 probe tip
A30-102 handle
A30-103 flexible cable
A30-104 tip

A30-105 tip
A30-106 olive small, 9 mm
A30-107 olive medium, 12 mm
A30-108 olive large, 15mm

MAYO 38 cm 15"

inside diameter
A30-110 5 mm
A30-112 7 mm
A30-114 10 mm

Vein Strippers



Neurosurgical Instruments



Cranial Rongeurs

De VILBISS
with one long
and one short
blade
21 cm 8 1/4"
A31-100

De VILBISS
blade only
long bite
A31-102

De VILBISS
blade only
short bite
A31-104



Cranial Rongeurs

ADSON
straight
20 cm 8"
A31-108

CUSHING
20 cm 8"
A31-112 straight
A31-114 curved

Neurosurgical Instruments



ADSON
20 cm 8"

FRAZIER
12.5 cm 5"

**Dura Hooks
Nerve Hooks**

A31-120 sharp
A31-122 blunt

A31-126 sharp
A31-128 blunt



CUSHING
probe point
19 cm 7½"

SMITHWICK
nerve hook
21 cm 8¼"

SMITHWICK
sympathectomy
hook and dissector
30 cm 12"

**Dura Hooks
Nerve Hook
Dissectors**

A31-132 small
A31-134 large

A31-140

A31-142



Neurosurgical Instruments



Nerve Hooks

DANDY
23 cm 9"
straight

A31-146

DANDY
23 cm 9"
angled left

A31-148

DANDY
23 cm 9"
angled right

A31-150

SCOVILLE
curved
30 cm 12"

A31-152

SCOVILLE
angular
30 cm 12"

A31-154



Nerve Retractors Brain Retractors

LOVE
21.5 cm 8½"
straight

A31-160

LOVE
21.5 cm 8½"
45° angle

A31-162

LOVE
21.5 cm 8½"
90° angle

A31-164

CUSHING
decompression
(brain)
retractor
20 cm 8"

A31-166

CUSHING
vein
(nerve)
retractor
20 cm 8"

A31-168

Neurosurgical Instruments



SCOVILLE
nerve root retractor
straight
24 cm 9½"

A31-180



SCOVILLE
nerve root retractor
angular
24 cm 9½"

A31-182



HORSLEY
dura separator
and guard
20 cm 8"

A31-190

Nerve Root Retractors Dura Separator



FRAZIER
dura
separator
15 cm 6"

A31-194



SACHS
nerve separator
and spatula
semi-sharp
21 cm 8¼"

A31-198



FRAZIER
cordotomy
knife
16.5 cm 6½"

A31-210

Dura Separator Nerve Spatula Cordotomy Knife

Neurosurgical Instruments



**Aneurysm Needle
Knot Tier
Pituitary Spoons**

ADSON
aneurysm needle
22 cm 8 3/4"

ADSON
knot tier
24 cm 9 1/2"

CUSHING
pituitary spoon
19 cm 7 1/2"
A31-230 small
A31-232 medium
A31-234 large

A31-220

A31-224



**Brain Spatulas
Pituitary Elevators**

CUSHING
brain spatula
concave
A31-240 17 cm 6 3/4"
A31-242 19.5 cm 7 3/4"
A31-244 28 cm 11"

CUSHING
pituitary
elevator
curved right
19 cm 7 1/2"
A31-260

CUSHING
pituitary
elevator
curved left
19 cm 7 1/2"
A31-262

Neurosurgical Instruments



ADSON
hypophyseal forceps
straight
21.5 cm 8½"

A31-270



ADSON
hypophyseal
forceps
curved up
23 cm 9"

A31-272



ADSON
hypophyseal
forceps
curved down
20 cm 8"

A31-274

Hypophyseal Forceps



ADSON
brain exploring
cannula, graduated
10 French
A31-280 10 cm 4"
A31-282 14 cm 5½"



FRAZIER
brain exploring trocar and
cannula, graduated
8 French
12 cm 4¾"
A31-290



Brain Exploring Cannulas



Neurosurgical Instruments



Clip Applying Forceps

SMITHWICK
clip applying forceps

- A31-300** 23 cm 9"
- A31-302** 26.5 cm 10½"



Clip Applying Forceps

SCOVILLE (OLIVECRONA-TOENNIS)
clip applying forceps
shaft

- A31-310** 18 cm 7"
- A31-312** 25 cm 10"



McKENZIE
clip applying forceps
straight handle
curved jaws

- A31-316** 15 cm 6"
- A31-318** 19 cm 7½"

Neurosurgical Instruments

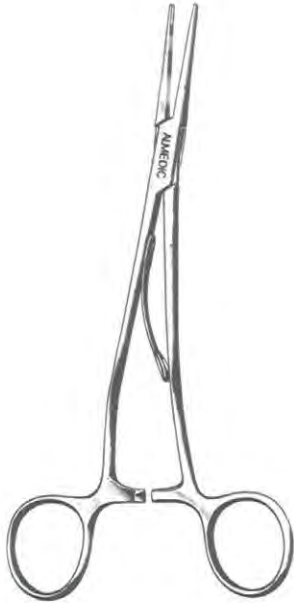

McKENZIE
clip applying forceps
curved handle
straight jaws
A31-320 15 cm 6"
A31-322 19 cm 7½"

McKENZIE
brain clips
vial of 300
silver
A31-324

Clip Applying Forceps Brain Clips

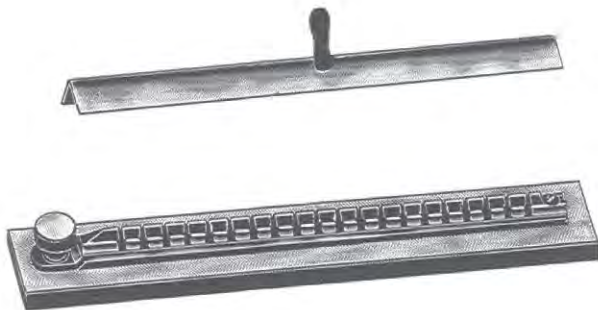

McKENZIE
clip holding rack
for 20 clips

A31-326

McKENZIE
clip holding rack
for 40 clips

A31-328

Clip Holding Racks



Neurosurgical Instruments



Pituitary Rongeurs

OLDBERG
jaws: 7 mm cup
shaft: 18 cm 7"

A31-340

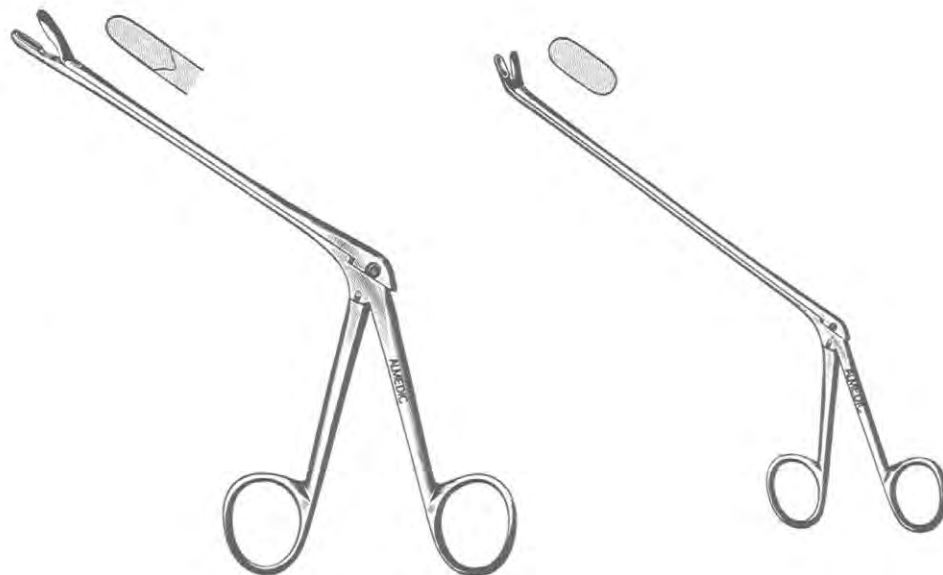

Pituitary Rongeurs

SPURLING		4 X 10 mm bite	
shaft		shaft	
12.5 cm 5"		18 cm 7"	
A31-350	straight	A31-356	
A31-352	angled up	A31-358	
A31-354	angled down	A31-360	

LOVE-GRUENWALD		3 X 10 mm bite	
shaft		shaft	
12.5 cm 5"		18 cm 7"	
A31-370	straight	A31-376	
A31-372	angled up	A31-378	
A31-374	angled down	A31-380	

Orthopedic Instruments



CHARRIÈRE
solid blade

A32-100 27 cm 10½"
A32-102 34 cm 13½"

CHARRIÈRE bow frame
A32-104 complete with 2 blades
blade width: 12 mm and 18 mm
blade length: 35 cm 14"
A32-106 blade only 12 mm
A32-108 blade only 18 mm

Bone Saws



SATTERLEE
29 cm 11½"

A32-110
A32-112 blade only 21.5 cm 8½"



LANGENBECK
metacarpal
saw
23 cm 9"

A32-116

Bone Saws



Orthopedic Instruments

HUDSON
brace complete
with 4 burs
A32-124 10 mm
A32-126 14 mm
A32-128 16 mm
A32-130 22 mm
 and cerebellar attachment
A32-132



Bone Drills and Burs

A32-120

HUDSON
brace only
23 cm 9"

A32-122

BUR
for Hudson
brace
10 mm

A32-124



Bone Drills and Burs

BUR
for Hudson
brace
14 mm

A32-126

BUR
for Hudson
brace
16 mm

A32-128

BUR
for Hudson
brace
22 mm

A32-130

cerebellar
attachment
for Hudson
brace

A32-132

Orthopedic Instruments



CUSHING
cranial drill
14 mm

ADSON-ROGERS
cranial bur

McKENZIE
perforating
twist drill

**Cranial Drills
and Burs**

A32-142

A32-152

A32-160



McKENZIE
cranial enlarging bur

D'ERRICO
drill

GALT
trephine
with removable handle

**Drills and Burs
Trephine**

A32-162

A32-166

A32-180 13 mm
A32-182 16 mm **A32-186** 22 mm
A32-184 19 mm **A32-188** 25 mm

Orthopedic Instruments

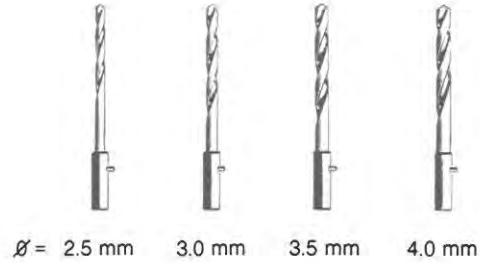

Cranial Drills

STILLE
bone drill 25 cm 10"
A32-200 complete with the following
A32-202 4 drills
A32-206 4 burs
A32-208 1 trephine

Drills
set of 4
2.5 mm
3.0 mm
3.5 mm
4 mm
A32-202

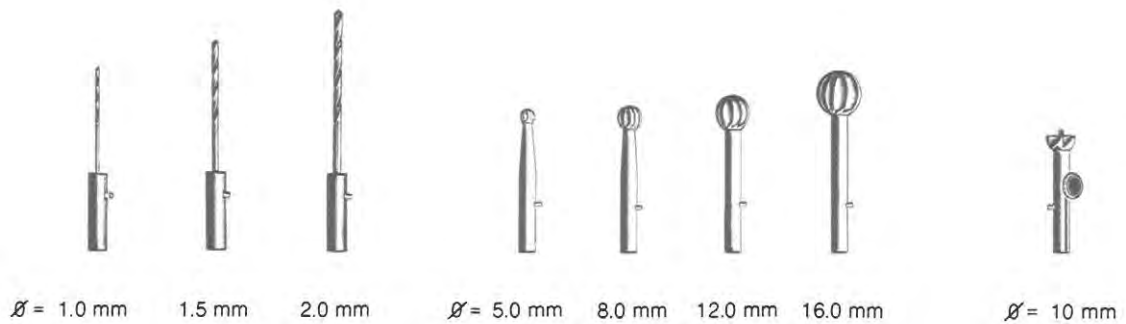

**Drills and Burs
Trephine**

Drills
set of 3
1.0 mm
1.5 mm
2.0 mm
A32-204

Burs
set of 4
5 mm
8 mm
12 mm
16 mm
A32-206

Trephine
10 mm
A32-208

Orthopedic Instruments



ADSON
drill guide
and dura protector
15 cm 6"

A32-212

GIGLI
saw wire

- | | |
|--------------------------|--------------------------|
| A32-220 30 cm 12" | A32-226 60 cm 24" |
| A32-222 40 cm 16" | A32-228 70 cm 28" |
| A32-224 50 cm 20" | |

Drill Guide Saw Wires



GIGLI
saw handles
solid, pair

A32-230

GIGLI
saw handles
loop style, pair

A32-232

Saw Handles



Orthopedic Instruments



**Saw Guide
Screw Holding Forceps**

BAILEY-GIGLI
saw guide
30 cm 12"

LANE
bone screw
holding forceps
23 cm 9"

A32-240

A32-250



**Screw Holding Forceps
Plate Holding Forceps
Plate Wrench**

LANE
bone screw holding
forceps
ring handles
18 cm 7"

LANE
bone plate
holding forceps
22 cm 8 3/4"

LANE
bone plate wrench
18 cm 7"

A32-252

A32-256

A32-258

Orthopedic Instruments



LOWMAN bone holding clamp
calibrated to measure diameter of bone
jaws length

A32-260 2 cm 12 cm 4¾"

A32-262 3 cm 18.5 cm 7¼"

A32-264 4 cm 20 cm 8"

PARHAM-MARTIN
bone holding clamp
with 2 bands
23 cm 9"

A32-270

Bands
for Parham-Martin
holding clamp, 5 mm wide

A32-272 Length 18 cm 7"

A32-274 25 cm 10"

A32-276 30 cm 12"

Bone Holding Clamps



DEMEL
bone wire tightening
and twisting forceps
26.5 cm 10½"

A32-280



DEMEL
wire guide 28 cm 11"
loop
diameter

A32-282 3 cm

A32-284 4.5 cm

A32-286 6 cm

Wire Tightening Forceps Wire Guides



Orthopedic Instruments



Bone Holding Forceps

FERGUSON
21.5 cm 8½"

LANE

A32-290

A32-294 33 cm 13"
A32-296 43 cm 17"



Bone Holding Forceps

LANE
with ratchet

KERN

KERN
with ratchet

A32-298 33 cm 13"
A32-300 43 cm 17"

A32-302 17 cm 6¾"
A32-304 21 cm 8¼"

A32-306 17 cm 6¾"
A32-308 21 cm 8¼"

Orthopedic Instruments



LANGENBECK
21.5 cm 8½"

SEMB
19 cm 7½"

FARABEUF-LAMBOTTE
with ratchet
26.5 cm 10½"

**Bone Holding
Forceps**

A32-310

A32-314

A32-318



FARABEUF
26.5 cm 10½"

LAMBOTTE
double articulation
with ratchet
A32-326 22 cm 8¾"
A32-328 27.5 cm 10¾"
A32-330 32.5 cm 12¾"

LEWIN
18 cm 7"

VAN BUREN
sequestrum
forceps
21.5 cm 8½"

**Bone Holding
Forceps
Sequestrum
Forceps**

A32-322

A32-334

A32-338



Orthopedic Instruments



Rongeurs

MEAD
19 cm 7½"

DEAN
19 cm 7½"

A32-350

A32-354



Rongeurs

HARTMANN
18.5 cm 7¼"

BACON
jaws angled
to side
20 cm 8"

LUER
18 cm 7"

A32-358

A32-362

A32-366 straight
A32-368 curved

Orthopedic Instruments



BEYER
multiple action
18 cm 7"

BLUMENTHAL
45° curve
15 cm 6"

Rongeurs

A32-372

A32-376



BLUMENTHAL
90° curve
15 cm 6"

LEMPERT
19 cm 7½"

ZAUFEL-JANSEN
slightly curved
18 cm 7"

Rongeurs

A32-378

A32-380

A32-386

**Orthopedic
Instruments**



Rongeurs

RUSKIN
straight
18.5 cm 7¼"

RUSKIN
curved
18.5 cm 7¼"

A32-390

A32-392

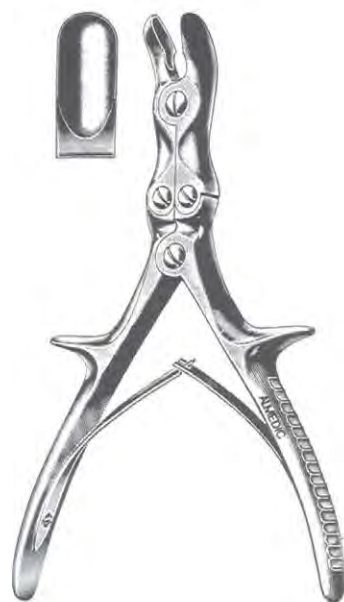

Rongeurs

STILLE-LUER
23 cm 9"

STILLE
angled to side
23 cm 9"

A32-400 straight
A32-402 curved

A32-404

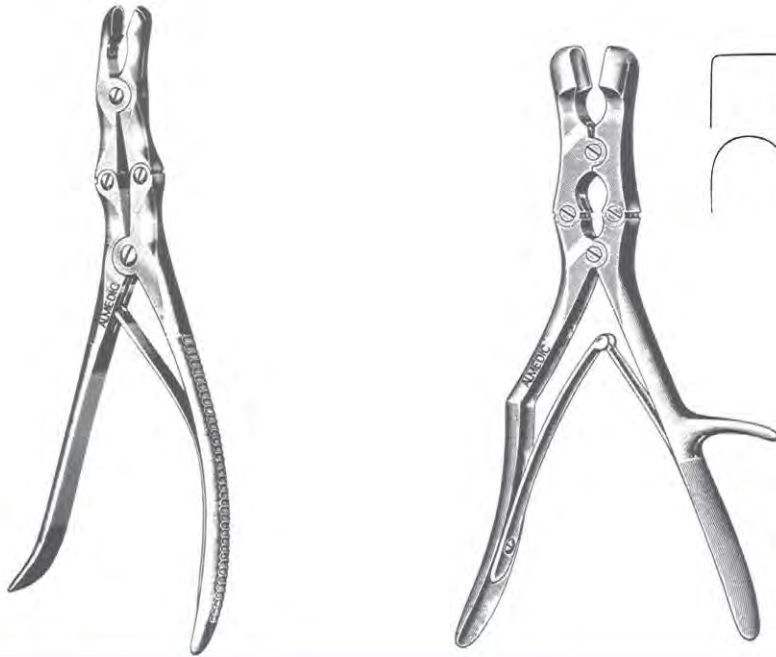

Orthopedic Instruments

LEKSELL
multiple action
curved to side
24 cm 9½"

A32-410

SAUERBRUCH rib rongeur 30 cm 12"
square jaws

straight	curved	jaw width	straight	round jaws	curved
A32-420	A32-426	13 mm	A32-432	A32-438	
A32-422	A32-428	17 mm	A32-434	A32-440	
A32-424	A32-430	20 mm	A32-436	A32-442	

Rib Rongeurs



LISTON
bone cutting forceps
straight

A32-450	14 cm 5½"
A32-452	19 cm 7½"
A32-454	22 cm 8¾"
A32-456	25 cm 10"

LISTON
bone cutting forceps
angled to side

A32-458	14 cm 5½"
A32-460	19 cm 7½"
A32-462	22 cm 8¾"
A32-464	25 cm 10"

LITTAUER-LISTON
15 cm 6"

A32-468

Bone Cutting Forceps



Orthopedic Instruments

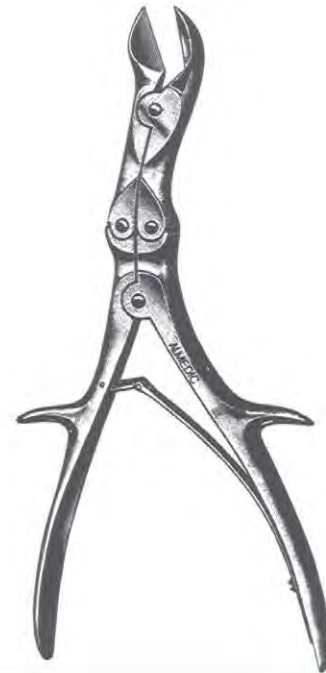

Bone Cutting Forceps

RUSKIN-LISTON
straight
18.5 cm 7¼"

A32-470

RUSKIN-LISTON
angled
18.5 cm 7¼"

A32-472

STILLE-HORSLEY
bayonet jaws
26.5 cm 10½"

A32-476



Bone Cutting Forceps

STILLE-LISTON
straight
26.5 cm 10½"

A32-480

STILLE-LISTON
angled
26.5 cm 10½"

A32-482

Orthopedic Instruments

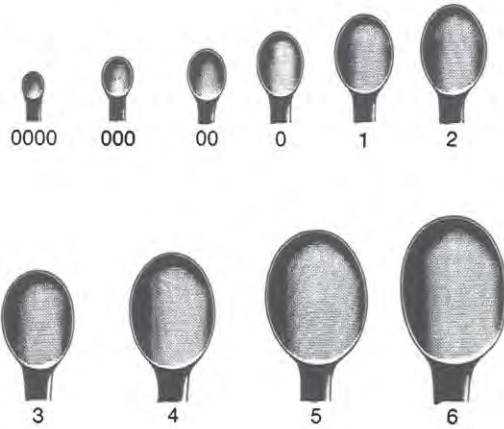

VOLKMANN

oval
17 cm 6¾"

Bone Curettes

	size		size		size		size
A32-500	0000	A32-504	00	A32-508	1	A32-512	3
A32-502	000	A32-506	0	A32-510	2	A32-514	4
						A32-516	5
						A32-518	6

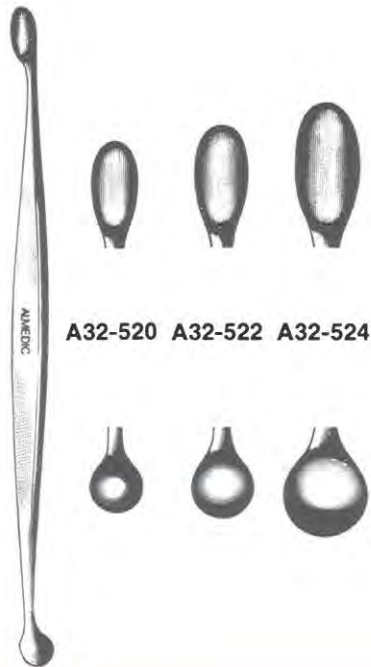

A32-520 A32-522 A32-524



PUTTI
bone rasp
flat blades
26.5 cm 10½"

A32-530



PUTTI
bone rasp
round and
half round blades
30 cm 12"

A32-532

VOLKMANN
double ended,
round end and
oval end

A32-520 12.5 cm 5"
A32-522 16.5 cm 6½"
A32-524 20 cm 8"

Bone Curettes Bone Rasps



Orthopedic Instruments



Bone Skids

MURPHY-LANE
bone skid
30 cm 12"

A32-540

MEYERDING
hip and shoulder
bone skid
33 cm 13"

A32-544



Raspatories

MATHIEU
raspatory
straight edge
15.5 cm 6 1/4"

A32-550

MATHIEU
raspatory
convex edge
15.5 cm 6 1/4"

A32-552

MATHIEU
raspatory
concave edge
15.5 cm 6 1/4"

A32-554

Orthopedic Instruments



FARABEUF
raspatory
curved with
straight edge
15.5 cm 6 1/4"
A32-560



FARABEUF
raspatory
straight with
convex edge
15.5 cm 6 1/4"
A32-562



KIRMISSION
raspatory
straight with
convex edge
15.5 cm 6 1/4"
A32-566

Raspatories



KEY
periosteal elevator
19 cm 7 1/2"
blade
A32-570 6 mm **A32-574** 19 mm
A32-572 12 mm **A32-576** 25 mm



LANGENBECK
periosteal elevator
slightly curved
broad style
19.5 cm 7 3/4"
A32-580



LANGENBECK
periosteal elevator
slightly curved
narrow style
19.5 cm 7 3/4"
A32-582

Periosteal Elevators



Orthopedic Instruments



Periosteal Elevators

ADSON
chisel edge
sharp
17 cm 6¾"

A32-590

ADSON
curved
blunt edge
17 cm 6¾"

A32-592

ADSON
curved
semi-sharp
edge
17 cm 6¾"

A32-594

ADSON
straight
semi-sharp
edge
17 cm 6¾"

A32-596



Periosteal Elevators

SAYRE
16.5 cm 5½"

A32-600 sharp
A32-602 blunt

SEDILLOT
19 cm 7½"

A32-606

LANE
periosteal
elevator
narrow style
17 cm 6¾"

A32-610

LANE
periosteal
elevator
broad style
17 cm 6¾"

A32-614

Orthopedic Instruments



SMILLIE
meniscus
knife
straight edge
17 cm 6 3/4"

A32-630



SMILLIE
meniscus
knife
right guard
17 cm 6 3/4"

A32-632



SMILLIE
meniscus
knife
left guard
17 cm 6 3/4"

A32-634



LOWE-BRECK
epiphyseal cartilage knife
straight edge
with guards
25 cm 10"

A32-640

Meniscus Knives Epiphyseal Cartilage Knife



DOWNING
epiphyseal cartilage knife
concave edge
25 cm 10"

A32-644



VIRCHOW
cartilage knife
9 cm center
point blade

A32-648



VIRCHOW
cartilage knife
9 cm bellied
blade

A32-650



LANGENBECK
flap knife
11.5 cm blade

A32-654

Cartilage Knives Flap Knife

Orthopedic Instruments



**Brain Knives
Amputating Knives**

VIRCHOW
brain knife

blade
A32-658 2 X 16 cm
A32-660 4 X 24 cm

LISTON
amputating knife

blade
A32-664 16.5 cm 6½"
A32-666 20 cm 8"

CATLIN
amputating knife

blade
A32-670 16.5 cm 6½"
A32-672 20 cm 8"



**Cartilage Clamps
Tendon Strippers
Tendon Forceps**

MARTIN
cartilage clamp

A32-680 18 cm 7"
A32-682 20 cm 8"

BUNNELL
tendon stripper
15 cm 6" diameter

A32-700 2 mm diameter
A32-702 3 mm diameter
A32-704 4 mm diameter
A32-706 5 mm diameter
A32-708 6 mm diameter

LARSEN
tendon forceps
10 cm 4" diameter

A32-720 2 mm diameter
A32-722 3 mm diameter
A32-724 4 mm diameter
A32-726 5 mm diameter
A32-728 6 mm diameter

Chisels Osteotomes Gouges



U.S. Army
chisel
15.5 cm 6¼"
A33-100 6 mm
A33-102 12 mm
A33-104 18 mm



U.S. Army
osteotome
15.5 cm 6¼"
A33-110 6 mm
A33-112 12 mm
A33-114 18 mm



U.S. Army
gouge
15.5 cm 6¼"
A33-120 6 mm
A33-122 12 mm
A33-124 18 mm

**Bone Chisels
Bone Osteotomes
Bone Gouges**



STILLE
chisel
21 cm 8¼"
A33-130 10 mm
A33-132 15 mm
A33-134 20 mm
A33-136 25 mm



STILLE
osteotome
21 cm 8¼"
A33-140 10 mm
A33-142 15 mm
A33-144 20 mm
A33-146 25 mm



STILLE
gouge
21 cm 8¼"
A33-150 10 mm
A33-152 15 mm
A33-154 20 mm
A33-156 25 mm

**Bone Chisels
Bone Osteotomes
Bone Gouges**



Chisels Osteotomes Gouges



Bone Chisels Bone Osteotomes Bone Gouges

HIBBS
chisel
22 cm 8 3/4"

- A33-160** 10 mm
- A33-162** 13 mm
- A33-164** 16 mm
- A33-166** 19 mm

- A33-168** 25 mm
- A33-170** 32 mm
- A33-172** 38 mm

HIBBS
osteotome
22 cm 8 3/4"

- A33-180** 10 mm
- A33-182** 13 mm
- A33-184** 16 mm
- A33-186** 19 mm

- A33-188** 25 mm
- A33-190** 32 mm
- A33-192** 38 mm

HIBBS
gouge
22 cm 8 3/4"

- A33-200** 10 mm
- A33-202** 13 mm
- A33-204** 16 mm
- A33-206** 19 mm

- A33-208** 25 mm
- A33-210** 32 mm
- A33-212** 38 mm



Bone Chisels Bone Osteotomes Bone Gouges

Almedic
chisel
14 cm 5 1/2"

- A33-220** 8 mm
- A33-222** 10 mm
- A33-224** 12 mm

- A33-226** 14 mm
- A33-228** 16 mm

Almedic
osteotome
14 cm 5 1/2"

- A33-230** 8 mm
- A33-232** 10 mm
- A33-234** 12 mm

- A33-236** 14 mm
- A33-238** 16 mm

Almedic
gouge
14 cm 5 1/2"

- A33-240** 8 mm
- A33-242** 10 mm
- A33-244** 12 mm

- A33-246** 14 mm
- A33-248** 16 mm

Chisels Osteotomes Gouges



MEYERDING
chisel
25 cm 10"
A33-250 6 mm
A33-252 12 mm
A33-254 18 mm

MEYERDING
osteotome
25 cm 10"
A33-260 6 mm
A33-262 12 mm
A33-264 18 mm

MEYERDING
gouge
25 cm 10"
A33-270 6 mm
A33-272 12 mm
A33-274 18 mm

Bone Chisels Bone Osteotomes Bone Gouges



SMITH-PETERSON
osteotome
straight 21 cm 8 1/4"
A33-280 6 mm **A33-288** 19 mm
A33-282 10 mm **A33-290** 25 mm
A33-284 13 mm **A33-292** 32 mm
A33-286 16 mm

SMITH-PETERSON
osteotome
curved 21 cm 8 1/4"
A33-300 6 mm **A33-308** 19 mm
A33-302 10 mm **A33-310** 25 mm
A33-304 13 mm **A33-312** 32 mm
A33-306 16 mm

Bone Osteotomes



Chisels Osteotomes Gouges



Bone Gouges

SMITH-PETERSON
gouge
straight
21 cm 8¼"

- A33-320** 10 mm **A33-324** 19 mm
- A33-322** 16 mm **A33-326** 25 mm

SMITH-PETERSON
gouge
curved
21 cm 8¼"

- A33-330** 10 mm **A33-334** 19 mm
- A33-332** 16 mm **A33-336** 25 mm



Bone Osteotomes

LAMBOTTE
osteotome
straight
24.5 cm 9¾"

- A33-342** 15 mm **A33-346** 25 mm
- A33-344** 20 mm **A33-348** 30 mm
- A33-350** 38 mm

LAMBOTTE
osteotome
curved
24.5 cm 9¾"

- A33-362** 15 mm **A33-366** 25 mm
- A33-364** 20 mm **A33-368** 30 mm
- A33-370** 38 mm

Chisels Osteotomes Gouges



ALEXANDER mastoid chisel
17 cm 6 $\frac{3}{4}$ "

A33-380	4 mm
A33-382	6 mm
A33-384	8 mm
A33-386	10 mm
A33-388	12 mm
A33-390	14 mm

ALEXANDER mastoid gouge
17 cm 6 $\frac{3}{4}$ "

A33-400	4 mm
A33-402	6 mm
A33-404	8 mm
A33-406	10 mm
A33-408	12 mm
A33-410	14 mm

BISHOP mastoid chisel
17 cm 6 $\frac{3}{4}$ "

A33-420	3 mm
A33-422	4 mm
A33-424	5 mm
A33-426	6 mm
A33-428	7 mm
A33-430	8 mm

Mastoid Chisels Mastoid Gouges



BISHOP mastoid gouge
17 cm 6 $\frac{3}{4}$ "

A33-440	3 mm
A33-442	4 mm
A33-444	5 mm
A33-446	6 mm
A33-448	7 mm
A33-450	8 mm

WEST
bone chisel
19 cm 7 $\frac{1}{2}$ "

A33-454

WEST
bone gouge
19 cm 7 $\frac{1}{2}$ "

A33-456

BRUNETTI
spinal column
chisel
right guard
28.5 cm 11 $\frac{1}{4}$ "

A33-460

BRUNETTI
spinal column
chisel
left guard
28.5 cm 11 $\frac{1}{4}$ "

A33-462

Bone Gouges Bone Chisel Spinal Column Chisel

Mallets



Bone Mallets

Almedic
solid stainless steel
24 cm 9½"
head
A34-100 7 cm X 3 cm, 1 pound
A34-102 8 cm X 4.5 cm, 2 pounds

LUCAE
solid brass head
2.5 cm diameter
9 ounces
19 cm 7½"
A34-110

HAJEK
solid bronze head
1.6 cm diameter
12 ounces
20 cm 8"
A34-120

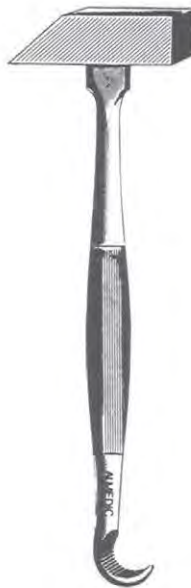

**Bone Mallets
Hammers
Skull Breakers**

GERZOG
lead filled head
2.5 cm diameter
14 ounces
16.5 cm 6½"
A34-130

Post Mortem
hammer with hook handle
2.5 cm square head
20 ounces
25 cm 10"
A34-140

VIRCHOW
skull breaker
13 mm edge
7.5 cm 3"
A34-150

Urological Instruments



- A35-100** 8 French
- A35-102** 10 French
- A35-104** 12 French
- A35-106** 14 French
- A35-108** 16 French
- A35-110** 18 French
- A35-112** 20 French
- A35-114** 22 French
- A35-116** 24 French
- A35-118** 26 French
- A35-120** 28 French
- A35-122** 30 French
- A35-124** 32 French
- A35-126** 34 French

A35-130 set of 6 sizes 14 to 24 French in cloth roll

A35-132 set of 12 sizes 8 to 30 French in cloth roll



- A35-140** 8 French
- A35-142** 10 French
- A35-144** 12 French
- A35-146** 14 French
- A35-148** 16 French
- A35-150** 18 French
- A35-152** 20 French
- A35-154** 22 French
- A35-156** 24 French
- A35-158** 26 French
- A35-160** 28 French
- A35-162** 30 French
- A35-164** 32 French
- A35-166** 34 French
- A35-168** 36 French



- A35-170** 8 French
- A35-172** 10 French
- A35-174** 12 French
- A35-176** 14 French
- A35-178** 16 French
- A35-180** 18 French
- A35-182** 20 French
- A35-184** 22 French
- A35-186** 24 French
- A35-188** 26 French
- A35-190** 28 French
- A35-192** 30 French
- A35-194** 32 French
- A35-196** 34 French
- A35-198** 36 French

VAN BUREN
28 cm 11"

DITTEL
straight
28 cm 11"

DITTEL
(OTIS)
short curve
28 cm 11"

Urethral Sounds

TABLES OF SCALE MEASUREMENTS FOR SOUNDS AND CATHETERS											
French Scale:	No.	1	2	3	4	5	6	7	8	9	10
(Charrière):	mm.	1/3	2/3	1	1 1/3	1 2/3	2	2 1/3	2 2/3	3	3 1/3
French Scale:	No.	11	12	13	14	15	16	17	18	19	20
(Charrière):	mm.	3 2/3	4	4 1/3	4 2/3	5	5 1/3	5 2/3	6	6 1/3	6 2/3
French Scale:	No.	21	22	23	24	25	26	27	28	29	30
(Charrière):	mm.	7	7 1/3	7 2/3	8	8 1/3	8 2/3	9	9 1/3	9 2/3	10
French Scale:	No.	31	32	33	34	35	36	37	38	39	40
(Charrière):	mm.	10 1/3	10 2/3	11	11 1/3	11 2/3	12	12 1/3	12 2/3	13	13 1/3
On the French Scale, No. 1 equals 1/3 mm. Each larger number is increased by 1/3 mm.											
English Scale:	No.	1	2	3	4	5	6	7	8	9	10
	mm.	1 1/2	2	2 1/2	3	3 1/2	4	4 1/2	5	5 1/2	6
English Scale:	No.	11	12	13	14	15	16				17
	mm.	6 1/2	7	7 1/2	8	8 1/2	9				

On the English Scale, No. 1 equals 1 1/2 mm.

Each larger number is increased by 1/2 mm.

Urethral Sounds



Urological Instruments



- A35-200** 8 French
- A35-202** 10 French
- A35-204** 12 French
- A35-206** 14 French
- A35-208** 16 French
- A35-210** 18 French
- A35-212** 20 French
- A35-214** 22 French
- A35-216** 24 French
- A35-218** 26 French
- A35-220** 28 French
- A35-222** 30 French
- A35-224** 32 French
- A35-226** 34 French
- A35-228** 36 French

Urethral Sounds

GUYON
urethral sound
25 cm 10"



- A35-270** 8 French
- A35-272** 10 French
- A35-274** 12 French
- A35-276** 14 French
- A35-278** 16 French
- A35-280** 18 French
- A35-282** 20 French
- A35-284** 22 French
- A35-286** 24 French



- A35-290** 10 French
- A35-292** 12 French
- A35-294** 14 French
- A35-296** 16 French
- A35-298** 18 French
- A35-300** 20 French

Urethral Catheters

Catheter
male
26.5 cm 10½"

Catheter
female
15 cm 6"

Urological Instruments



MATHIEU
serrated jaws
shaft
A35-310 20 cm 8"
A35-312 28 cm 11"

MATHIEU
punch jaw
shaft
A35-314 20 cm 8"
A35-316 28 cm 11"

YOUNG
lateral
blade 50 X 11 mm
24 cm 9½"
A35-320

Urethral Forceps Prostatic Retractor



YOUNG
large bifurcated
blade 45 X 38 mm
20 cm 8"

A35-322

YOUNG
small bifurcated
blade 25 X 25 mm
22 cm 8¾"

A35-324

YOUNG
anterior
blade 64 X 38 mm
20 cm 8"

A35-326

YOUNG
prostatic lobe
holding forceps
19 mm jaw
20 cm 8"

A35-334

Prostatic Retractors Lobe Holding Forceps



Urological Instruments



**Kidney Retractor
Capsule Forceps**

LEGUEU
kidney retractor
19 cm 7½"

A35-340

MILLIN
capsule
forceps
23 cm 9"

A35-350



**Prostatic Lobe
Holding Forceps
Suture Carrying
Forceps
Bladder Neck Spreader**

MILLIN
prostatic lobe
holding forceps
9 X 9 teeth
23 cm 9"

A35-354

MILLIN
suture
carrying
forceps
23 cm 9"

A35-358

MILLIN
bladder neck
spreader
28 cm 11"

A35-362

Urological Instruments



RANDALL
kidney stone
forceps
quarter curve
23 cm 9"
A35-380

RANDALL
kidney stone
forceps
half curve
23 cm 9"
A35-382

Kidney Stone Forceps

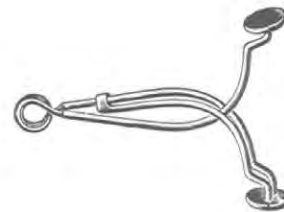

RANDALL
kidney stone
forceps
three-quarter curve
23 cm 9"
A35-384

RANDALL
kidney stone
forceps
full curve
23 cm 9"
A35-386

**ZIPSER
(STOCKMAN)**
penis clamp
A35-390

Kidney Stone Forceps Penis Clamp



Gynecological Instruments



Vaginal Specula

GRAVES

- A36-100** small 8 X 2 cm
- A36-102** medium 10 X 3 cm
- A36-104** large 11.5 X 3 cm

PEDERSON

- A36-110** virgin size 7.5 X 2 cm
- A36-112** medium 10 X 2.2 cm
- A36-114** large 12 X 2.5 cm

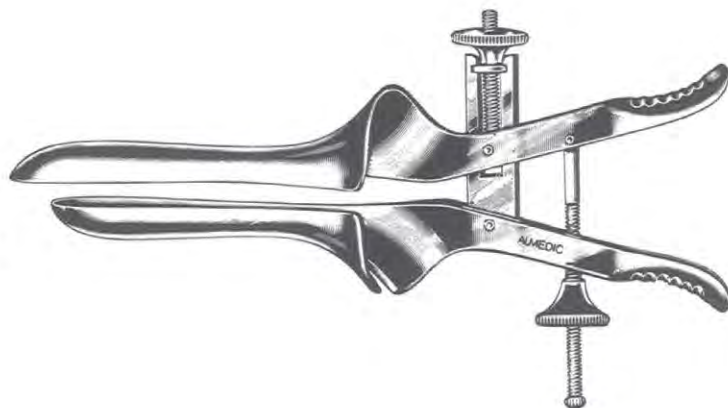

Vaginal Specula

CUSCO

- A36-120** small 9.5 X 2 cm
- A36-122** medium 10 X 2.5 cm
- A36-124** large 10 X 3.5 cm

De VILBISS (MILLER)

3 X 10 cm

A36-126

Gynecological Instruments

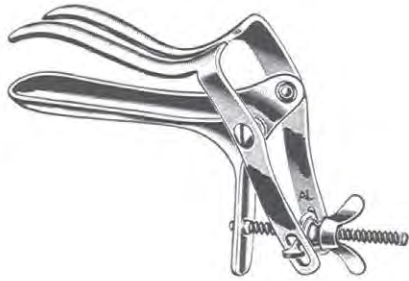

NOTT

A36-130 9 X 2.5 cm
A36-132 10 X 3.5 cm

COLLIN

A36-140 small 9.5 X 3.5 cm
A36-142 medium 10.5 X 4 cm
A36-144 large 11.5 X 4 cm

Vaginal Specula

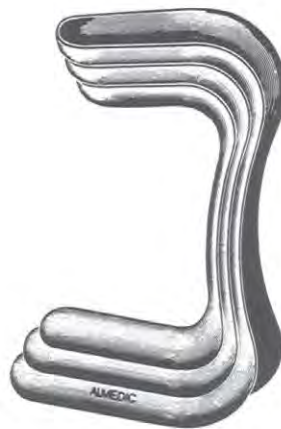

SIMS

A36-150 small 6.5 X 2.5 cm
A36-152 medium 7.5 X 3.5 cm
A36-154 large 10 X 4 cm

SIMS

double ended blade widths
A36-160 small 2.5 and 3.5 cm
A36-162 medium 3.5 and 4 cm
A36-164 large 4.0 and 4.5 cm

AUVARD weighted

A36-170 2 lbs.
A36-172 2.5 lbs.
A36-174 3 lbs.

Vaginal Specula

Gynecological Instruments

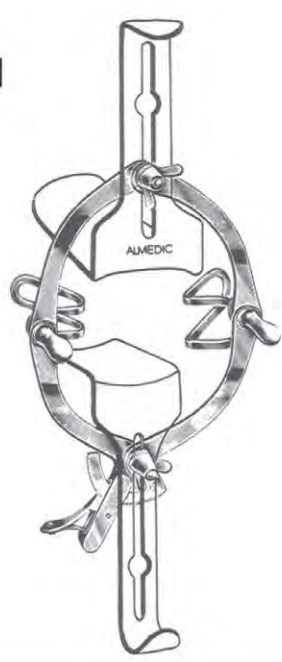

Vaginal Retractor

O'SULLIVAN-O'CONNOR
 self-retaining vaginal retractor
 complete with 3 blades
 45 X 10 mm, 90 X 32 mm, 90 X 45 mm
A36-200

Blade
 45 x 10 mm
A36-202

Blade
 90 x 32 mm
A36-204

Blade
 90 x 45 mm
A36-206

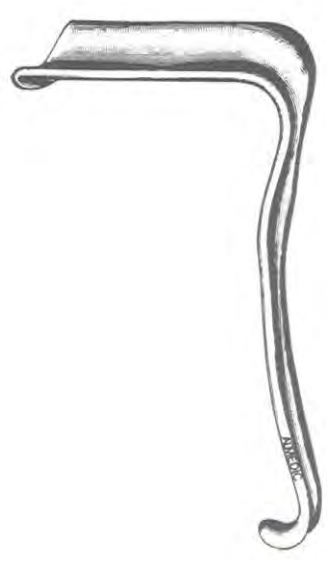

Vaginal Retractors

JACKSON
 blade dimension
A36-210 small 7.5 X 4 cm
A36-212 medium 9.0 X 4 cm
A36-214 large 10 X 4 cm

EASTMAN
 blade dimension
A36-220 small 7.5 X 4 cm
A36-222 medium 9.0 X 4 cm
A36-224 large 10 X 4 cm

DOYEN
 21.5 cm 8½" blade dimension
A36-230 small 5.5 X 4.5 cm
A36-232 medium 8.5 X 4.5 cm
A36-234 large 11.5 X 4.5 cm

Gynecological Instruments



	SIZES	mm diam.
A36-252	9/10	4.5/5
A36-254	11/12	5.5/6
A36-256	13/14	6.5/7
A36-258	15/16	7.5/8
A36-260	17/18	8.5/9
A36-262	19/20	9.5/10



	SIZES
A36-272	3/4 mm
A36-274	5/6 mm
A36-276	7/8 mm
A36-278	9/10 mm
A36-280	11/12 mm
A36-282	13/14 mm
A36-284	15/16 mm
A36-286	17/18 mm

HANK
double ended
American scale

HEGAR
double ended

Uterine Dilators

A36-250 set of 6 in canvas roll
sizes 9/10 to 19/20

A36-270 set of 8 in canvas roll
sizes 3/4 mm to 17/18 mm



WYLIE
with gauge
30 cm 12"

A36-290 smooth
A36-292 corrugated



WYLIE
30 cm 12"

A36-294 smooth
A36-296 corrugated



GOODELL
with gauge

A36-300 28 cm 11"
A36-302 33 cm 13"

Uterine Dilators



Gynecological Instruments



Uterine Gauze Packers
Uterine Douche

RAPID
uterine gauze packer
33 cm 13" diameter
A36-310 8 mm
A36-312 10 mm
A36-314 12 mm

BOZEMAN-FRITSCH
uterine douch
10 mm 30 French
A36-320



Uterine Sounds
Uterine Dressing Forceps

SIMS
uterine sound
graduated in centimeters
malleable silver plated
32 cm
A36-330

SIMPSON
uterine sound
graduated in inches
malleable silver plated
12 1/2"
A36-334

BOZEMAN
straight
26.5 cm 10 1/2"
A36-340

Gynecological Instruments



BOZEMAN
S-curved
26.5 cm 10½"

A36-342



BOZEMAN-DOUGLAS
with one large ring
26.5 cm 10½"

A36-344

**Uterine Dressing
Forceps**



CHERON
25 cm 10"

A36-350



MAIER
straight
25 cm 10"

A36-356



MAIER
curved
25 cm 10"

A36-358

**Uterine Dressing
Forceps**

Gynecological Instruments



Polypus Forceps

MAIER polypus forceps straight 25 cm 10"	MAIER polypus forceps curved 25 cm 10"	MAIER polypus forceps with catch straight 25 cm 10"	MAIER polypus forceps with catch curved 25 cm 10"
A36-360	A36-362	A36-364	A36-366

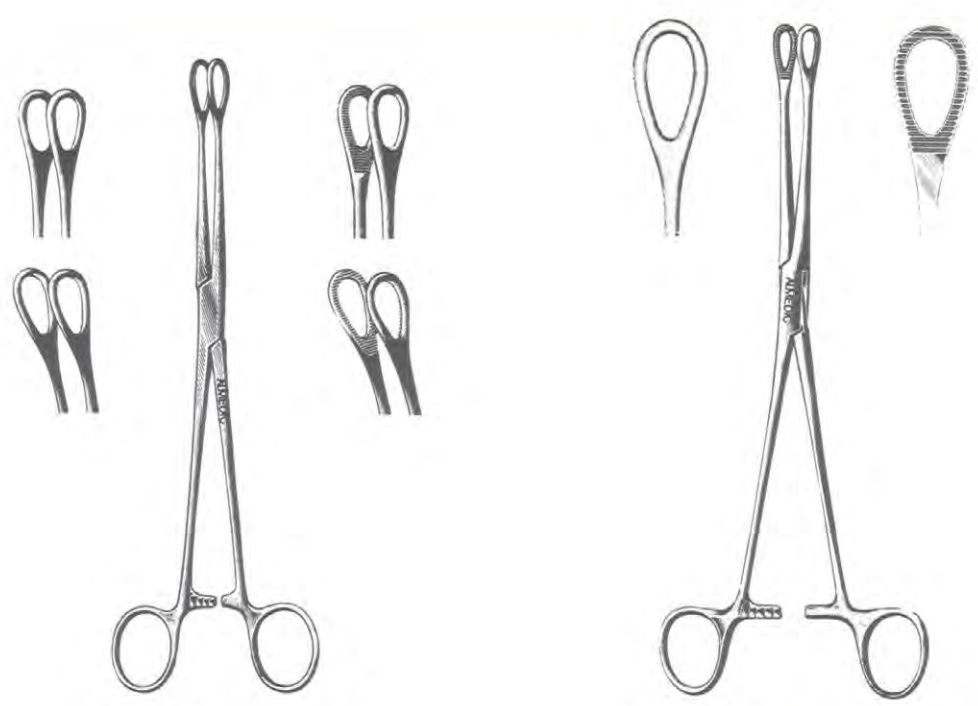

Sponge Forceps

FOERSTER sponge forceps 18 cm 7"	FOERSTER sponge forceps 24 cm 9½"	BALLENGER sponge forceps 18 cm 7"
A36-370 straight serrated	A36-378 straight serrated	A36-390 straight serrated
A36-372 straight smooth	A36-380 straight smooth	A36-392 curved serrated
A36-374 curved serrated	A36-382 curved serrated	A36-394 straight smooth
A36-376 curved smooth	A36-384 curved smooth	A36-396 curved smooth

Gynecological Instruments

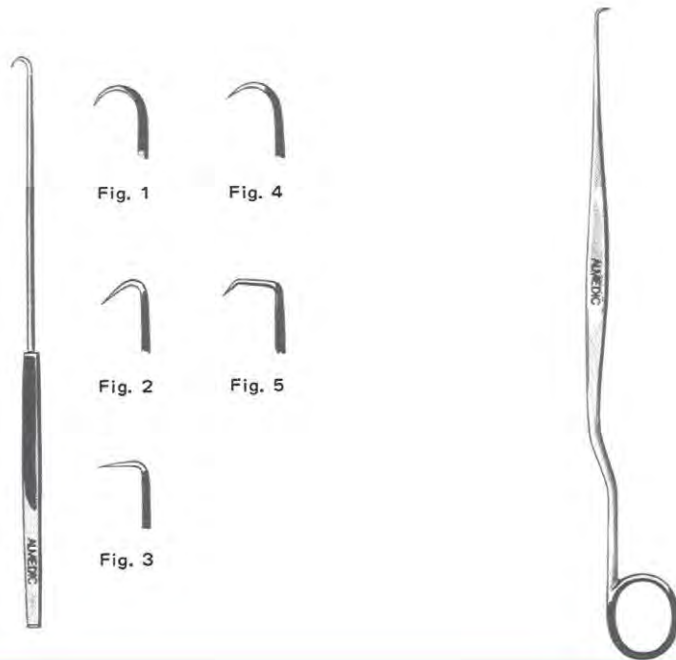

EMMETT
tenaculum hook
23 cm 9"

- A36-400 Fig. 1
- A36-402 Fig. 2
- A36-404 Fig. 3
- A36-406 Fig. 4
- A36-408 Fig. 5

BEACHAM
amniotome
26 cm 10¼"

A36-410

Tenaculum Hooks Amniotome

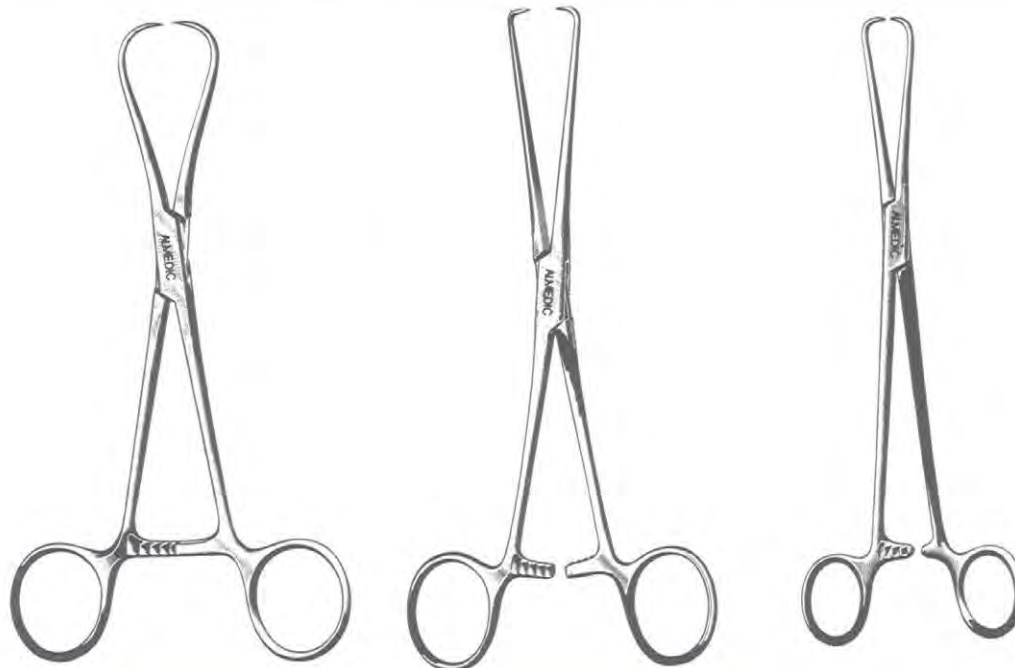

STAUDE-MOORE
16.5 cm 6½"

A36-420

BARRETT
18 cm 7"

A36-424

SCHROEDER
24 cm 9½"

A36-428

Tenaculum Forceps

Gynecological Instruments



Tenaculum Forceps

SCHROEDER
flat shanks
24 cm 9½"

BRAUN
24 cm 9½"

SCHROEDER-BRAUN
angular
24 cm 9½"

A36-430

A36-432

A36-436



Tenaculum Forceps

DUPLAY
28 cm 11"

SKENE
curved to side
23 cm 9"

JARCHO
double curve
20 cm 8"

A36-440

A36-444

A36-448

Gynecological Instruments



SCHROEDER
straight
23 cm 9"

A36-460

SCHROEDER
curved on flat
23 cm 9"

A36-462

SCHROEDER
curved to side
23 cm 9"

A36-464

SKENE
curved to side
23 cm 9"

A36-470

Vulsellum Forceps



JACOBS
serrated jaws
straight
21.5 cm 8½"

A36-474

JACOBS
serrated jaws
curved to side
21.5 cm 8½"

A36-476

HENROTIN
2 X 3 teeth
21.5 cm 8½"

A36-480

TEALE
3 X 4 teeth
24 cm 9½"

A36-484

Vulsellum Forceps

Gynecological Instruments



**Vulsellum Forceps
Tumor Forceps**

M.G.H.
16.5 cm 6½"

A36-488

BILLROTH
tumor forceps
4 X 4 teeth
27.5 cm 10¾"

A36-500



**Forceps
Tumor Screw**

IOWA
membrane
puncturing
forceps
25 cm 10"

A36-504

SOMER
uterine
elevating
forceps
23 cm 9"

A36-508

DOYON
tumor
(myoma) screw
diameter 24 mm
16.5 cm 6½"

A36-512

Gynecological Instruments



LAPAROTOMY RING

inside diameter

A36-520 38 mm 1½"

A36-522 45 mm 1¾"

A36-524 50 mm 2"

SIMS

uterine sponge holder
straight

26.5 cm 10½"

A36-530

SIMS

uterine sponge holder
curved

26.5 cm 10½"

A36-532

Laparotomy Rings

Uterine Sponge Holders



RANDALL
endometrial biopsy
suction curette
with Luer hub
24 cm 9½"

A36-540

NOVAK
endometrial biopsy
suction curette
with Luer hub
24.5 cm 9¾"

A36-542

HEANEY
uterine biopsy curette
with sharp serrated edge
open cup
24 cm 9½"

A36-544

Biopsy Curettes

Gynecological Instruments



Uterine Biopsy Forceps

THOMS-GAYLOR

GAYLOR
21.5 cm 8½"

FAURE
24 cm 9½"

A36-560 22 cm 8¾"
A36-562 24 cm 9½"

A36-566

A36-568

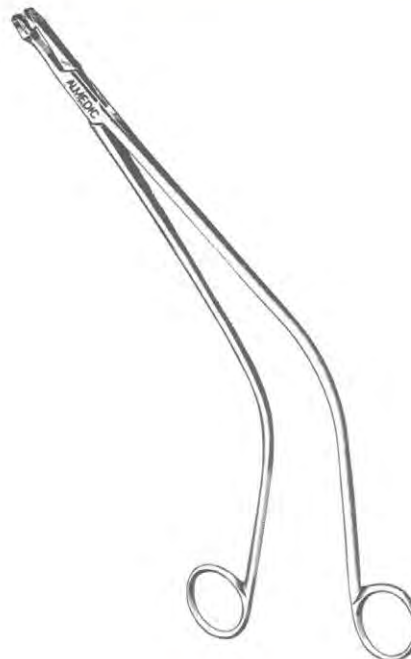

Uterine Biopsy Forceps

SCHUBERT
straight

SCHUBERT
curved to side
26 cm 10¼"

GELLHORN
23.5 cm 9¼"

A36-570 21.5 cm 8½"
A36-572 28 cm 11"

A36-574

A36-576

Gynecological Instruments



WITTNER
23 cm 9"

Uterine Biopsy Forceps

- A36-580** straight jaw
- A36-582** angled jaw



SIMS
sharp 28 cm 11"

		size
A36-600	7 mm	1
A36-602	8 mm	2
A36-604	9 mm	3

THOMAS
blunt 28 cm 11"

		size
A36-620	7 mm	1
A36-622	8 mm	2
A36-624	9 mm	3

Uterine Curettes

A36-606	11 mm	4	A36-626	11 mm	4
A36-608	12 mm	5	A36-628	12 mm	5
A36-610	14 mm	6	A36-630	14 mm	6

Gynecological Instruments

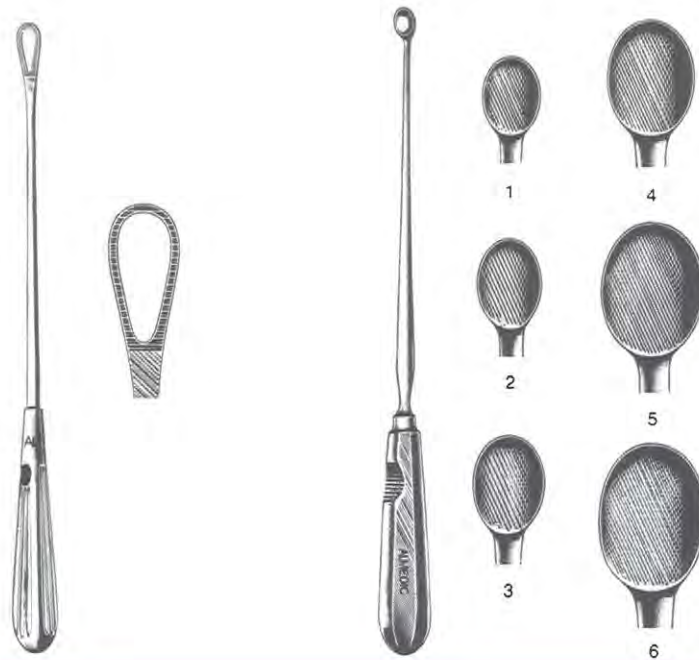

Uterine Curettes

GREEN
blunt serrated
28 cm 11"
size
A36-660 2
A36-662 4
A36-664 6

SCHROEDER
spoon type
sharp 28.5 cm 11¼"
size
A36-690 1 **A36-696** 4
A36-692 2 **A36-698** 5
A36-694 3 **A36-700** 6

MEASUREMENTS FOR FRENCH (CHARRIERE) AND ENGLISH SCALES											
French Scale:	No.	1	2	3	4	5	6	7	8	9	10
(Charrière):	mm.	1/3	2/3	1	1 1/3	1 2/3	2	2 1/3	2 2/3	3	3 1/3
French Scale:	No.	11	12	13	14	15	16	17	18	19	20
(Charrière):	mm.	3 2/3	4	4 1/3	4 2/3	5	5 1/3	5 2/3	6	6 1/3	6 2/3
French Scale:	No.	21	22	23	24	25	26	27	28	29	30
(Charrière):	mm.	7	7 1/3	7 2/3	8	8 1/3	8 2/3	9	9 1/3	9 2/3	10
French Scale:	No.	31	32	33	34	35	36	37	38	39	40
(Charrière):	mm.	10 1/3	10 2/3	11	11 1/3	11 2/3	12	12 1/3	12 2/3	13	13 1/3
On the French Scale, No. 1 equals 1/3 mm. Each larger number is increased by 1/3 mm.											
English Scale:	No.	1	2	3	4	5	6	7	8	9	10
	mm.	1 1/2	2	2 1/2	3	3 1/2	4	4 1/2	5	5 1/2	6
English Scale:	No.	11	12	13	14	15	16				
	mm.	6 1/2	7	7 1/2	8	8 1/2	9				

On the English Scale, No. 1 equals 1 1/2 mm. Each larger number is increased by 1/2 mm.

Sterilization Forceps



**DAVIS
(RALKS)**

A37-100 15 cm 6"
A37-102 20 cm 8"
A37-104 25 cm 10"

CHEATLE
28 cm 11"

A37-120

ROGGE
23 cm 9"

A37-130

Almedic
utility forceps
straight

A37-140 20 cm 8"
A37-142 28 cm 11"

Sterilizer Forceps



Almedic
utility forceps
curved

A37-144 20 cm 8"
A37-146 28 cm 11"

Almedic
3 prong

A37-148 20 cm 8"
A37-150 30 cm 12"

**PYE-SMITH
(HARRISON)**
27.5 cm 10 3/4"

A37-160

BUNT
forceps holder

A37-170

**Sterilizer Forceps
Forceps Holder**



Obstetrical Instruments



Obstetrical Stethoscopes

De LEE HILLIS

PINARD
aluminum

A38-100

A38-104



Stethoscopes Pelvimeters

LEFF

MARTIN
cm / inch scale

COLLYER
cm / inch scale

A38-108

A38-120

A38-124

Obstetrical Instruments



BREISKY
cm/inch scale

De LEE
cm/inch scale

Pelvimeters

A38-128

A38-132

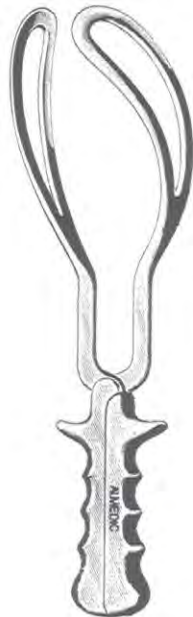

SIMPSON
short model
30 cm 12"

SIMPSON
long model
36 cm 14"

De LEE
short model
30 cm 12"

De LEE

Obstetrical Forceps

A38-150

A38-152

A38-156

A38-158 standard model 36 cm 14"
A38-160 extra long model 39 cm 15½"

Obstetrical Instruments



Obstetrical Forceps

ELLIOT

KIELLAND
39 cm 15½"

KIELLAND-LUIKART
solid blades
39 cm 15½"

A38-164 short model 32 cm 12½"
A38-166 long model 38 cm 15"

A38-170

A38-174



Obstetrical Forceps

LUIKART
solid blades
39 cm 15½"

SIMPSON-LUIKART
solid blades
36 cm 14"

MCLEAN
solid blades
short shanks
37 cm 14½"

A38-178

A38-182

A38-186

Obstetrical Instruments



McLEAN-LUIKART
solid blades
39 cm 15½"

A38-190



McLEAN TUCKER
solid blades
39 cm 15½"

A38-194



McLEAN-TUCKER-LUIKART
solid blades
38 cm 15½"

A38-198

Obstetrical Forceps



BARTON
36 cm 14"

A38-202



PIPER
45 cm 17½"

A38-210



PIPER
with axis traction
45 cm 17½"

A38-212

Obstetrical Forceps



Obstetrical Instruments

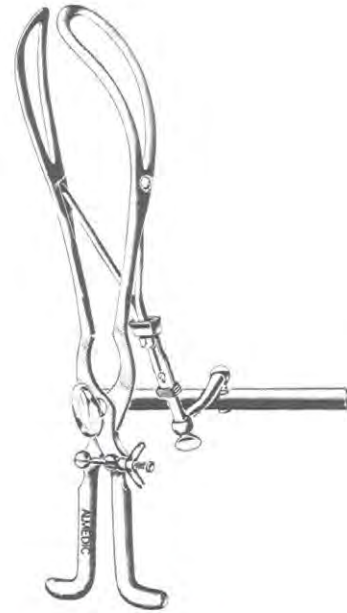

Obstetrical Forceps

DEWEY
with axis traction
37 cm 14½"

A38-216

TARNIER
with axis traction
42 cm 16½"

A38-220



Traction Handles

BILL
traction handle
for all forceps
with standard
type handle

A38-230

LUIKART-BILL
traction handle for A38-170,
A38-174, A38-178,
A38-198 forceps

A38-234

BARTON
traction handle
for barton
obstetrical
forceps A38-202 (light type)

A38-238

Obstetrical Instruments



GREEN-ARMYTAGE
Cesarian hemostat
22 cm 8½"

A38-246



WILLET
placenta forceps
for scalp traction
19 cm 7½"

A38-250

**Caesarean Hemostat
Placenta Forceps**



KELLY
placenta forceps
30 cm 12"

A38-254



COREY
placenta forceps
24 cm 9½"

A38-258

Placenta Forceps

Obstetrical Instruments

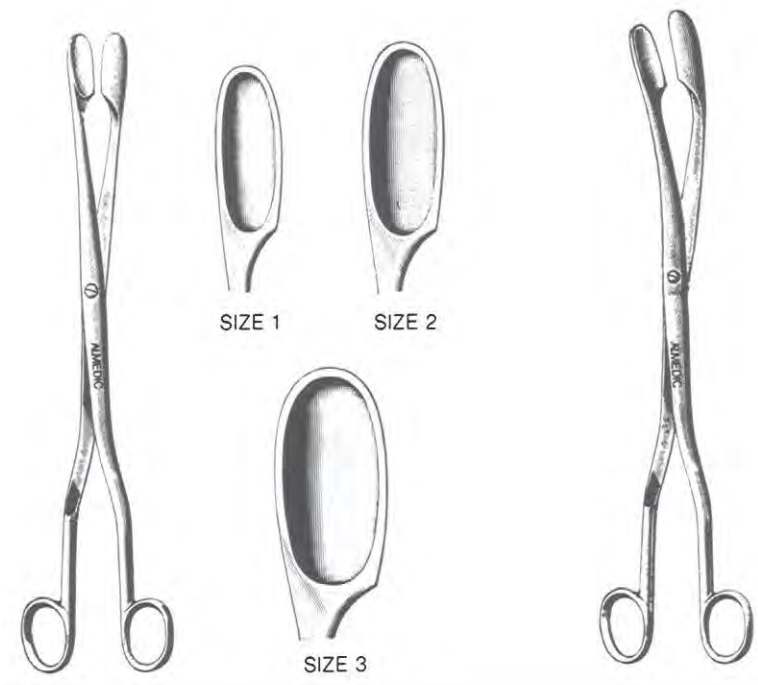

Placenta Forceps

WINTER
straight
29 cm 11½"
A38-270 size 1
A38-272 size 2
A38-274 size 3

WINTER
curved
29 cm 11½"
A38-276 size 1
A38-278 size 2
A38-280 size 3



Perforator
Decapitation Hook
Cranioclast
Umbilical Clamp

SMELLIE
perforator
25 cm 10"
A38-300

BRAUN
decapitation hook
32 cm 12½"
A38-308

BRAUN
cranioclast
42 cm 16½"
A38-312

KANE
umbilical clamp
9 cm 3½"
A38-316

Rectal Instruments

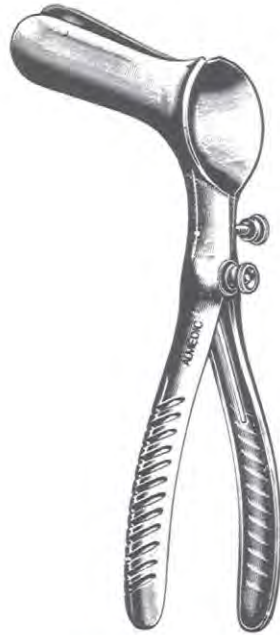

PRATT
21.5 cm 8½"

A39-100



SIMS
fenestrated blades
15 cm 6"

A39-104

Rectal Specula



BODENHAMMER

A39-108



BARR
with grip lock
17 cm 6¾"

A39-112



COOK
with 3 blades
self retaining
19 cm 7½"

A39-116

Rectal Specula

Rectal Instruments



Rectal Specula

IVES-FANSLER

Obturator
for Ives-Fansler
rectal speculum
plastic
boilable

A39-120

A39-122



**Rectal Specula
Anoscopes**

BRINKERHOFF

**HIRSCHMAN
anoscope**

		length	largest diameter
A39-130	small	9 cm	2.5 cm
A39-132	medium	10 cm	2.5 cm
A39-134	large	11.5 cm	3.2 cm

		length	diameter
A39-140	small	6 cm	16 mm
A39-142	medium	7 cm	19 mm
A39-144	large	9 cm	22 mm

Rectal Instruments



KELLY
sphincteroscope
5 cm long
largest diameter
A39-150 2.5 cm
A39-152 3 cm

KELLY
proctoscope
22 mm diameter

A39-160 5 cm 2" **A39-164** 15 cm 6"
A39-162 10 cm 4" **A39-166** 20 cm 8"

Sphincteroscopes Proctoscopes

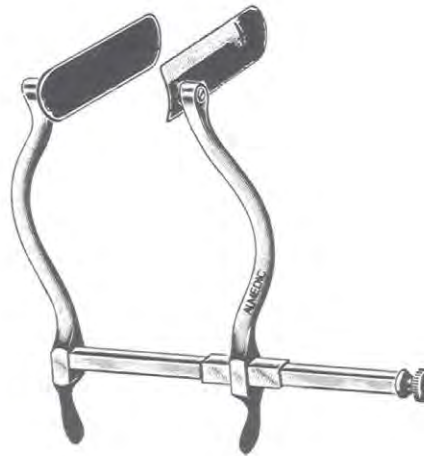

SAWYER
rectal retractor
25 cm 10"
blade
A39-180 6.5 X 2.2 cm
A39-182 7.5 X 2.5 cm
A39-184 9.0 X 4 cm

SMITH-BUIE
self-retaining
anal retractor
with swivel blades
15 cm 6"

A39-190

Rectal Retractors



Rectal Instruments



Probes

LARRY
rectal probe
18 cm 7"

BARR
fistula probe
sterling shaft
24.5 cm 9 3/4"

A39-200

A39-204



FIG 1



FIG 2



FIG 3



Hooks

PRATT
crypt hook
21.5 cm 8 1/2"

A39-210 narrow hook Fig. 1

A39-212 short hook Fig. 2

A39-214 long hook Fig. 3

BARR
crypt hook
25 cm 10"

A39-226

Rectal Instruments

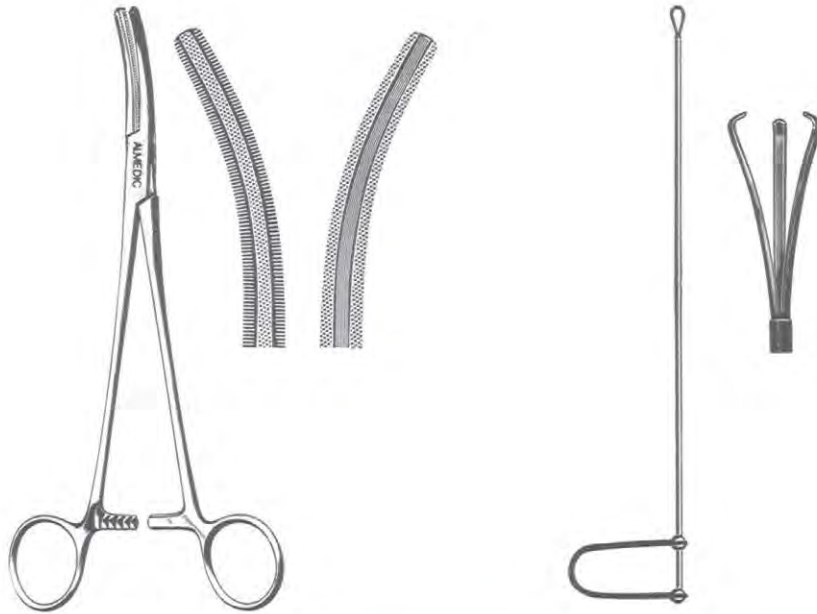

BUIE
pile clamp
21.5 cm 8½"

A39-240

EDER
cotton carrier
3 prongs
38 cm 15"

A39-260

**Pile Clamp
Cotton Carrier**

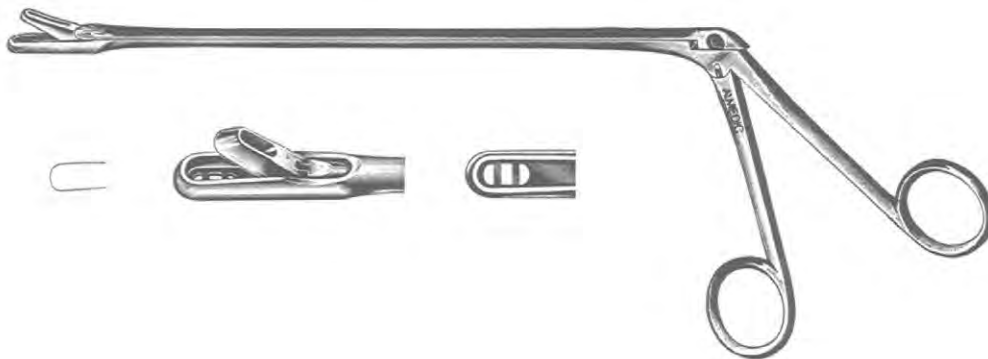

YEOMAN
biopsy punch
length
A39-270 28 cm 11"
A39-272 35 cm 14"
A39-274 42 cm 16½"

Biopsy Punches



A	
Abbey Needle Holder	89
Abbey Needle Holder with T/C Jaws	97
Abcess Knife	8
Abdominal Retractors	73, 83-86
Abelson Cricothyrotomy Cannula	190
Abraham Tonsil Knife	171
Ada Dissecting Scissors	30
Adair-Allis Tissue Forceps	211
Adams-Mayo Appendectomy Retractors	81
Adenoid Curettes	168
Adenotome Blades	169
Adenotomes	169
Adson Aneurysm Needle	236
Adson Brain Exploring Cannula	237
Adson Cranial Rongeur	232
Adson Dressing Forceps	46
Adson Dressing Forceps with T/C Jaws	58
Adson Drill Guide and Dura Protecting Forceps	245
Adson Dura Hooks	233
Adson Dura Knife	236
Adson Ganglion Scissors	31
Adson Hemostatic Forceps	63
Adson Hypophyseal Forceps	237
Adson Knot Tier	236
Adson Needle Holder	90
Adson Periosteal Elevators	258
Adson Retractors	80
Adson Suction Tube	14
Adson Tissue Forceps	49
Adson-Anderson Retractor	81
Adson-Beckman Retractors	80
Adson-Brown Tissue Forceps	50
Adson-Rogers Cranial Bur	243
Adson-Toennis Scissors	32
Advancement Forceps	129
Agricola Lacrimal Sac Retractor	107
Airways	7
Alderdyce Tonsil Dissector and Elevator ..	173
Alexander Mastoid Chisels	265
Alexander Mastoid Gouges	265
Alexander Raspatory	230
Alexander-Davidson Raspatory	230
Allen Intestinal Clamps	214
Alligator Forceps	
Bronchial	196
Ear	144
Esophageal	196
Jackson	196
Laryngeal	196
Nasal	153, 154, 156-158
Alligator Scissors	32
Allis Tissue Forceps	211
Allis-Adair Tissue Forceps	211
Allis-Judd Tissue Forceps	212
Allis-Lockwood Tissue Forceps	212
Allis-Thoms Tissue Forceps	211
Allison Lung Retractor	74
Allport Ear Hook	146
Allport Mastoid Retractor	78
Alm Retractors	78
Almedic Bone Chisels	262
Almedic Bone Gouges	262
Almedic Bone Mallet	266
Almedic First Aid Dressing and Plaster Shears	18
Almedic Hemostatic Forceps	60
Almedic Osteotomes	262
Almedic Sterilizer Forceps	287
Almedic Tube Occluding Forceps	67
Almedic Tuning Forks	136, 137
Almedic Utility Forceps	287
Amniotome	279
Amputating Knives	260
Anal Retractors	297
Anastomosis Clamps	216, 217
Anderson-Adson Retractor	81
Andrew Tongue Depressor	193
Anesthetic Instruments	7
Aneurysm Needles	87, 236
Angiotribes	67
Anoscopes	296
Anterior Synechia Scissors	132
Anthony Suction Tube	14
Antrum Cannulas	169, 170
Antrum Curettes	168
Antrum Needle	12
Antrum Probe	147
Antrum Rasps	165
Antrum Trocars	12, 13
Aorta Clamps	228
Appendectomy Retractors	81
Applicators, Cotton	150
Arlt Lens Loop	114
Arlt-Fisher Iris Forceps	123
Armytage-Green Forceps	293
Arruga Capsule Forceps	126
Arruga Lens Expressors	113
Arruga Needle Holder	94
Arruga Needle Holder with T/C Jaws	100
Arruga Protector	134
Arruga-Kalt Needle Holders	94
Artery Dissecting Scissors	38
Asch Septum Straightening Forceps	159
Aufricht Glabella Rasps	165



Aufricht Nasal Retractors	166
Auricle Clamps	227
Automatic Ear Syringe	150
Auvard Vaginal Specula	273
Ayer Chalazion Forceps	128

B

Babcock Intestinal Holding Forceps	210
Babinski Percussion Hammer	1
Baby Adson Retractors	80
Baby Allen Intestinal Clamps	214
Baby Allis Tissue Forceps	211
Baby Bailey Rib Contractor	223
Baby Balfour Abdominal Retractor	84
Baby Crile-Wood Needle Holders with T/C Jaws	97
Baby Deaver Retractors	75
Baby Doyen Intestinal Forceps	213
Baby Farabeuf Retractors	77
Baby Gelpi Retractor	81
Baby Harrington Retractor	73
Baby Lexer Scissors	29
Baby Metzenbaum Scissors	28
Baby Operating Scissors	21
Baby Payr Pylorus Clamps	217
Baby Poole Suction Tube	14
Baby Satinsky Vena Cava Clamp	226
Backhaus Towel Clamps	68
Bacon Bone Rongeur	250
Badgley Laminectomy Retractors	82
Bagley-Wilmer Lens Expressor	114
Bailey Rib Contractor	223
Bailey-Gibbon Rib Contractor	223
Bailey-Gigli Saw Guide	246
Bainbridge Hemostatic Forceps	62
Bakes Common Duct Dilators	203
Balfour Abdominal Retractors	84, 85
Balfour Retractor Blades	85
Ballenger Cartilage Knife	160
Ballenger Chisels	163
Ballenger Mucosa Knife	160
Ballenger Septum Chisels	163
Ballenger Sponge Forceps	278
Ballenger Swivel Knives	161
Ballenger Tonsil Seizing Forceps	175
Ballenger-Hajek Septum Elevator	162
Ballenger-Sluder Tonsillectome	179
Bandage Instruments	17-19
Bandage Scissors	17, 18
Bandage Scissors with T/C Blades	43
Bands for Parham-Martin Clamp	247
Bands, Head	5
Bane Mastoid Rongeurs	145
Baracani Laryngeal Forceps Tip	198
Barkan Goniotomy Knife	110
Barnhill Adenoid Curettes	168
Barr Crypt Hook	298
Barr Fistula Probe	298
Barr Rectal Speculum	295
Barraquer Cilia Forceps	128
Barraquer Fixation Forceps	125
Barraquer Iris Scissors	133
Barraquer Needle Holder	93
Barraquer Needle Holder with T/C Jaws ..	100
Barraquer Suture Forceps	126
Barrett Uterine Tenaculum Forceps	279
Barth Mastoid Curette	147
Barton Obstetrical Forceps	291
Barton Traction Handle	292
Baumgartner Needle Holder	89
Baumgartner Needle Holder with T/C Jaws	97
Beacham Amniotome	279
Beck-Schenck Tonsil Snare	178
Beckman Retractor	80
Beckman Scissors	34
Beckman-Adson Retractors	80
Beckman-Weitlaner Retractors	80
Beer Cilia Forceps	127
Beeson Plaster Spreader	19
Bell Erisophake	134
Bennett Cilia Forceps	127
Bennett Tibia Retractors	72
Benson Pylorus Separator	217
Berens Capsulotomy Scissors	133
Berens Recession Forceps	130
Berger Binocular Loupe	3
Bergh Cilia Forceps	127
Bergmann Plaster Shears	17
Berke Ptosis Forceps	128
Berliner Percussion Hammer	1
Bethune Rib Shears	220
Beyer Bone Rongeur	251
Beyer Ear Punch	145
Bill Traction Handle	292
Bill-Luikart Traction Handle	292
Billeau Ear Loops	147
Billroth Tumor Forceps	282
Binocular Loupe	3
Biopsy Curettes	283
Biopsy Forceps, Rectal Punch	299
Biopsy Forceps, Uterine	284, 285
Birch Trocar	12
Bishop Mastoid Chisels	265
Bishop Mastoid Gouges	265
Bishop-Harmon Iris Forceps	123, 124

Bistoury, Trachea	180
Bladder Neck Spreader	270
Bladder Retractors	82, 83
Blades for Adenotomes	169
Blades for Balfour Retractor	85
Blades for Charrière Bone Saw	241
Blades for De Vilbiss Rongeur	232
Blades for MacIntosh Laryngoscope	6
Blades for Mouthgags	192
Blades for O'Sullivan-O'Connor Vaginal Retractor	274
Blades for Scalpel Handles	16
Blades, Surgical	16
Blake Ear Dressing Forceps	142
Blake Gall Stone Forceps	205
Blake-Mayo Gall Stone Forceps	205
Blakesley-Wilde Nasal Cutting Forceps	156
Blalock Pulmonic Stenosis Clamps	228
Blood Lancets	3
Blumenthal Bone Rongeurs	251
Bodenhammer Rectal Speculum	295
Boettcher Scissors	32
Boettcher Tonsil Hooks	174
Bone Burs	242-244
Bone Chisels	261-265
Bone Curettes	147, 255
Bone Cutting Forceps	253, 254
Bone Drills	242-244
Bone Gouges	261-265
Bone Holding Clamps	247
Bone Holding Forceps	248, 249
Bone Mallets	266
Bone Osteotomes	261-265
Bone Plate Holding Forceps	246
Bone Plate Wrench	246
Bone Raspatories	256, 257
Bone Rasps	255
Bone Rongeurs	250-253
Bone Saws	241, 245
Bone Screw Holding Forceps	246
Bone Skids	256
Bone Wire Tightening & Twisting Forceps	247
Bonney Tissue Forceps	53
Boomerang Needle Holder	101
Bosworth Tongue Depressor	193
Boucheron Ear Specula	135
Bowman Iris Needle	110
Bowman Lacrimal Probes	121
Boynton Needle Holder	95
Bozeman Uterine Dressing Forceps	276, 277
Bozeman-Douglas Uterine Dressing Forceps	277
Bozeman-Fritsch Uterine Douche	276
Brain Clips	239
Brain Exploring Cannula	237
Brain Exploring Trocar	237
Brain Knives	260
Brain Retractors	234
Brain Spatula	236
Braun Cranioclast	294
Braun Decapitation Hook	294
Braun Episiotomy Scissors	25
Braun Uterine Tenaculum Forceps	280
Braun-Schroeder Uterine Tenaculum Forceps	280
Brawley Frontal Sinus Rasp	165
Breck-Lowe Cartilage Knife	259
Breisky Pelvimeter	289
Brinkerhoff Rectal Speculum	296
Bronchial Alligator Forceps	196
Bronchial Forceps	196, 198-200
Bronchocele Sound (Enucleator)	201
Bronchus Clamps	225
Brophy Dressing Forceps	47
Brophy Scissors	37
Brophy Tissue Forceps	52
Brown Needle Holders	89
Brown Tissue Forceps	50
Brown Tonsil Snare	178
Brown-Adson Tissue Forceps	50
Bruening Cannula	197
Bruening Laryngeal Forceps Tips	199
Bruening Septum Cutting Forceps	155
Brunetti Spinal Column Chisels	265
Brunner Intestinal Forceps	212
Brunner Ligature Conductors	102
Brunner Ligature Needles	102
Brunner Rib Shears	219
Bruns Bone Curettes	147
Bruns Plaster Shears	18
Bruns Plaster Shears with T/C Blades	43
Brush For Trachea Tubes	190
Buck Ear Curettes	146
Buck Ear Forceps	143
Buck Neurological Hammer	1
Buck-Littauer Stitch Scissors	39
Buie Pile Clamp	299
Buie-Smith Anal Retractor	297
Bulldog Clamp Applying Forceps	59
Bulldog Clamps	59
Bunge Evisceration Spoons	116
Bunnell Tendon Strippers	260
Bunt Forceps Holder	287
Burch Fixation Pick	113
Burch-Lister Eye Speculum	105

Burford-Finochietto Rib Spreaders	222
Burs, Bone	242-244
Burs, Cranial	242-244
Busch Umbilical Scissors	26

C

Caesarean Hemostat	293
Cane Shaped Trachea Tubes	187
Canfield Tonsil Knife	171
Cannulas	169, 170, 190, 197, 237
Cannulas, Antrum	169, 170
Cannulas, Brain Exploring	237
Cannulas, Cricothyrotomy	190
Cannulas, Frontal Sinus	169
Cannulas, Laryngeal	197
Cannulas, Sinus	169
Caliper, Eye	134
Capsular Forceps	120
Capsule Forceps	126, 127, 270
Capsulotomy Expressor Spoon	118
Capsulotomy Scissors	133
Cardiovascular & Thoracic Instruments	54, 219-230
Cardiovascular Forceps	54
Cardiovascular Tourniquets	230
Carmalt Splinter Forceps	56
Carmalt-Rochester Hemostatic Forceps	63
Carpenter Tonsil Knife & Dissector	173
Carrier, Cotton	299
Carriers, Ligature	102, 201
Cartilage Clamps	260
Cartilage Knives	160, 259
Cast Breaker	19
Castroviejo Anterior Synechia Scissors	132
Castroviejo Calipers	134
Castroviejo Capsule Forceps	127
Castroviejo Corneal Scissors	132
Castroviejo Cyclodialysis Spatula	117
Castroviejo Eye Speculum	106
Castroviejo Fixation Forceps	124
Castroviejo Iridectomy Scissors	132
Castroviejo Keratome	112
Castroviejo Lid Clamp	107
Castroviejo Needle Holders	95
Castroviejo Needle Holders with T/C Jaws	100
Castroviejo Spatula	116
Castroviejo Suture Forceps	125, 126
Cataract Knives	108, 118
Cataract Spatula	117
Catheter Introducing Forceps	7
Catheters, Eustachian	142

Catheters, Female	268
Catheters, Male	268
Catheters, Urethral	268
Catlin Amputating Knives	260
Cerebellar Extension	242
Chalazion Curettes	115, 116
Chalazion Forceps	128, 129
Charrière Bone Saws	241
Charrière Scale	267
Cheatele Sterilizer Forceps	287
Cheron Uterine Dressing Forceps	277
Child Clip Applying Forceps	102
Child Intestinal Holding Forceps	210
Chisels	163, 261-265
Chisels, Bone	261-265
Chisels, Mastoid	265
Chisels, Septum	163
Chisels, Spinal Column	265
Cilia Forceps	127, 128
Citelli Ear Punch	145
Clamp Applying Forceps	59
Clamps Anastomosis	216, 217
Aorta	228
Auricle	227
Bone Holding	247
Bulldog	59
Bronchus	225
Cartilage	260
Coarctation	227
Gall Duct	208
Gastro-Intestinal	217
Holder, De Martel-Wolfson	216
Intestinal	214-217
Kidney Pedicle	65, 66
Lid, Eye	107
Muscle	201
Occluding	226
Patent Ductus	227
Penis	271
Peritoneal	66
Pile	299
Pulmonary Vessel	225
Pulmonic Stenosis	228
Pylorus	217
Stomach	214-217
"T", Pratt	66
Thoracic	224
Towel	68
Umbilical	294
Vena Cava	226, 227
Clar Headlight	6
Clip Applying and Removing Forceps	103

Clip Applying Forceps	102, 238, 239	Cranial Burs	242-244
Clip Holding Racks	239	Cranial Drills	242-244
Clip Removing Forceps	103	Cranial Hand Drills	242, 244
Clips, Brain	239	Cranial Rongeurs	232
Clips, Suture	218	Cranioclast	294
Clips, Wound	104	Cricothyrotomy Cannula, Abelson	190
Coakley Antrum Curettes	168	Crile Gall Duct Forceps	207
Coakley Antrum Trocar	13	Crile Hemostatic Forceps	61
Coarctation Clamp	227	Crile Needle Holder	89
Coller Hemostatic Forceps	62	Crile Thyroid Retractor	69
Collier Needle Holder	88	Crile-Murray Needle Holder	89
Collier Needle Holder with T/C Jaws	96	Crile-Murray Needle Holder with T/C Jaws	97
Collin Dynamometers	3	Crile-Rankin Hemostatic Forceps	61
Collin Intestinal Holding Forceps	209	Crile-Wood Needle Holders	89
Collin Scalpel Handle	15	Crile-Wood Needle Holders with T/C Jaws	97
Collin Tongue Forceps	194	Crypt Hooks	298
Collin Vaginal Speculum	273	Cullen-Wertheim Kidney Pedicle Clamp	66
Collin-Duval Lung Grasping Forceps	54	Curdy Sclerotome	112
Collin-Mayo Retractors	77	Curettes	
Collins Clip Removing Forceps	103	Adenoid	168
Collyer Pelvimeter	288	Antrum	168
Colon Forceps	214	Biopsy	283
Colver Tonsil Retractor	174	Bone	147, 255
Colver Tonsil Seizing Forceps	175	Chalazion	115, 116
Comedone Extractors	8	Dermal	8
Common Duct Dilators	203	Ear	146
Common Duct Probes	202	Endometrial Biopsy Suction	283
Common Duct Scoops	204	Ethmoid	168
Conductors, Ligature	102	Mastoid	147
Connector for Yankauer Suction Tube	14	Salpingeal	146
Connell Airway	7	Uterine	285, 286
Contractors, Rib	223	Cusco Vaginal Specula	272
Conversion Tables in. and cm	141	Cushing Brain Retractor	234
Cook Rectal Speculum	295	Cushing Brain Spatulas	236
Cordes Laryngeal Forceps Tips	199	Cushing Cranial Bur	243
Cordotomy Knife	235	Cushing Cranial Rongeur	232
Corey Placenta Forceps	293	Cushing Decompression Retractor	234
Corneal Forceps	120	Cushing Dressing Forceps	47
Corneal Knife	110	Cushing Dura Hooks	233
Corneal Scissors	132	Cushing Forceps with T/C Jaws	58
Corwin Tonsil Hemostat	177	Cushing Nerve Retractor	234
Coryllos Thoracic Retractors	74	Cushing Pituitary Elevators	236
Cottle Button End Knife	160	Cushing Pituitary Spoons	236
Cottle Nasal Knife	160	Cushing Tissue Forceps	52
Cottle Nasal Rasp	164	Cushing Vein Retractor	234
Cottle Septum Elevator	163	Cuticle Nippers	10
Cottle Skin Hook	167	Cuticle Scissors	10
Cotton Applicators	150	Cutters, Ring	9
Cotton Carriers	299	Cutting Forceps	155-159
Counter	4	Cutting Tips for Universal Handle	198, 199
Coupland Suction Tube	14	Cyclodialysis Spatula	116, 117
Crafoord Coarctation Clamp	227		
Crafoord Lung Scissors	30		

Cylinder, Lens	119
Cystic Duct Forceps	208
Cystic Duct Scoop	204

D

Dandy Hemostatic Forceps	62
Dandy Nerve Hooks	234
Dandy Trigeminus Scissors	31
Davidson Pulmonary Vessel Clamp	225
Davidson Scapula Retractors	74
Davidson Trocar	12
Davidson-Alexander Raspatory	230
Daviel Lens Spoons	114
Davis Mouth Gags	192
Davis Sterilizer Forceps	287
Davis Tissue Forceps	54
Day Ear Hooks	146
Day Tonsil Knife	171
Dean Iris Knife Needle	109
Dean Bone Rongeur	250
Dean Scissors	33
Dean Tonsil Knives	172
Deaver Retractors	75
Deaver Scissors	21
DeBakey Cardiovascular Forceps	54
Decapitation Hook	294
Decompression Retractor	234
Dejerine Percussion Hammers	2
DeLee Obstetrical Forceps	289
DeLee Pelvimeter	289
DeLee-Hillis Obstetrical Stethoscope	288
DeMartel-Wolfson Anastomosis Clamps	216
DeMartel-Wolfson Clamp Closing Forceps	216
DeMartel-Wolfson Clamps Holder	216
Demel Bone Wire Tightening and Twisting Forceps	247
Demel Wire Guide	247
Dench Ear Knife & Curette	148
Denhardt Mouth Gag	191
Depressors, Tongue	193
Derf Needle Holder	88
Derf Needle Holder with T/C Jaws	96
Dermal Curettes	8
Dermal Punches	8
Dermatological Instruments	8-11
D'Errico Cranial Drill	243
Deschamps Ligature Needles	101
Desjardin Gall Duct Probes	202
Desjardin Gall Stone Forceps	205
Desjardin Gall Stone Scoops	204
Desmarres Chalazion Forceps	129
Desmarres Lid Retractors	107
Desmarres Paracentesis Needles	110
DeVilbiss Cranial Rongeurs	232
DeVilbiss Vaginal Speculum	272
Dewey Obstetrical Forceps	292
Diagnostic Instruments	1-6
Dieffenbach Serrefines	59
Dilating Probe	202
Dilators, Common Duct	203
Dilators, Lacrimal	121
Dilators, Trachea	180
Dilators, Uterine	275
Directors	87
Discission Knife	109
Dissecting Scissors	23, 27-30, 37-39
Dissectors	233
Dissectors, Nerve	233
Dissectors, Tonsil	173, 174
Dittel Urethral Sounds	267
Dix Eye Needle & Spud	134
Douche, Uterine	276
Douglas Antrum Trocar	13
Douglas Cilia Forceps	127
Douglas Nasal Snare	152
Douglas Tonsil Knife	171
Douglas-Bozeman Uterine Dressing Forceps	277
Downing Cartilage Knife	259
Doyen Intestinal Forceps	213
Doyen Rib Raspatories	228
Doyen Scissors	23
Doyen Towel Clamps	68
Doyen Tumor (Myoma) Screw	282
Doyen Vaginal Retractors	274
Doyen-Jansen Mouth Gags	191
Dressing Forceps	44-47
Dressing Forceps, Ear	142, 143
Dressing Forceps, Eye	121-123
Dressing Forceps, Nasal	153
Dressing Forceps, Uterine	276, 277
Dressing Forceps, T/C Jaws	58
Dressing Forceps, U.S. Model	45
Dressing Scissors	17, 18
Drill Guide & Dura Protecting Forceps	245
Drills, Bone	242-244
Drills, Cranial	242-244
Drills, Finger Nail	9
Drum, Testing	134
Dubois Scissors	23
Duplay Uterine Tenaculum Forceps	280
Dupuy-Weiss Tonsil Needles	171
Dura Hooks	233
Dura Knife	236
Dura Scissors	32
Dura Separator	235

Duval Lung Grasping Forceps	225
Duval-Collin Lung Grasping Forceps	54
Dynamometers	3

E

Ear Applicators, Cotton	150
Ear Curettes	146
Ear Dressing Forceps	142, 143
Ear Hook & Curette	146
Ear Hook & Spoon	146
Ear Hooks	146
Ear Instruments	135-150
Ear Knife & Curette	148
Ear Knives	148, 149
Ear Loops	147
Ear Probes	147
Ear Punches	145
Ear Rongeurs	145
Ear Snares	142
Ear Specula	135
Ear Spoon & Spud	146
Ear Spoons	146
Ear Syringes	150
Eastman Vaginal Retractors	274
Eastman-Richardson Retractors	72
Eder Cotton Carrier	299
Eicken-Killian Antrum Cannula	170
Eiselberg Ligature Scissors	39
Elevators, Periosteal	230, 257, 258
Elevators, Pituitary	236
Elevators, Septum	162, 163
Elevators, Tonsil	173
Elliot Obstetrical Forceps	290
Elschnig Cyclodialysis Spatula	117
Elschnig Fixation Forceps	125
Elschnig-O'Connor Fixation Forceps	125
Emmett Tenaculum Hooks	279
Endometrial Biopsy Suction Curettes	283
Endoscopic Forceps	196
Engel Plaster Saw	19
English Scale	267
Enterotomy Scissors	38
Entropium Forceps	128
Enucleation Scissors	36
Enucleation Scoop	114
Enucleators, Bronchocele	201
Episiotomy Scissors	25
Erhardt Ear Specula	135
Erhardt Lid Forceps	128
Erisophake	134
Esmarch Gauze and Plaster Shears	17
Esophageal Alligator Forceps	196
Esophageal Scissors	31
Ether Masks	7
Ethmoid Curettes	168
Ethmoid Forceps	156
Eustachian Catheters	142
Eves Tonsil Snares	177
Evisceration Spoon	116
Ewald Dressing Forceps	46
Ewald Tissue Forceps	50
Exploring Cannulas	237
Expressor Spoon	118
Expressors, Capsulotomy	118
Expressors, Intracapsular	118
Expressors, Lens	113, 114, 118, 119
Extension, Cerebellar	242
Extractors, Comedone	8
Eye Calipers	134
Eye Dressing Forceps	121-123
Eye Instruments	105-134
Eye Loops	134
Eye Magnets	134
Eye Protector	134
Eye Retractors	107, 134
Eye Scalpels	108
Eye Shield	134
Eye Specula	105, 106

F

Fansler-Ives Rectal Speculum	296
Farabeuf Bone Holding Forceps	249
Farabeuf Raspatories	257
Farabeuf Retractors	77
Farabeuf-Lambotte Bone Holding Forceps	249
Farrell Cotton Applicators	150
Faulkner Ethmoid Curette	168
Faure Uterine Biopsy Forceps	284
Fay-Temple Laminectomy Retractor	82
Feilchenfeld Splinter Forceps	55
Feilchenfeld Splinter Forceps with Magnifier	56
Fein Antrum Trocar	13
Female Urethral Catheters	268
Fenger Gall Duct Probe	202
Ferguson Angiotribes	67
Ferguson Bone Holding Forceps	248
Ferguson Gall Stone Scoops	204
Ferguson Scissors	23
Ferris-Smith-Kerrison Rongeurs	145
Ferris-Smith Tissue Forceps	53
Finger Nail Drills	9
Finger Retractors	69-71
Finger Ring Cutters	9
Fink-Jameson Muscle Forceps	130

Finochietto Needle Holders	91	Forceps Cont'd	
Finochietto Needle Holders with T/C Jaws ..	98	Dressing, Eye	121-123
Finochietto Rib Spreaders	221	Dressing, Nasal.....	153
Finochietto Thoracic Forceps and		Dressing, T/C Jaws	58
Ligature Carrier	223	Dressing, Uterine	276, 277
Finochietto-Burford Rib Spreaders	222	Drill Guide	245
Firlene Eye Magnet	134	Dura Protecting.....	245
First Aid Dressing & Plaster Shears	18	Ear Dressing	142, 143
Fish Antrum Probe	147	Endoscopic	196
Fisher Spatula & Needle.....	117	Entropium	128
Fisher Tonsil Knife & Dissector.....	173	Esophageal Alligator	196
Fisher-Arlt Iris Forceps	123	Ethmoid	156
Fisher-Smith Cataract Spatula.....	117	Eye Dressing	121-123
Fisher-Smith Iris Spatula.....	116	Fixation	120, 124, 125
Fistula Probe	298	Gall Bladder.....	206
Fistula Scissors	23	Gall Duct	207
Fixation Forceps	120, 124, 125	Gall Stone	205
Fixation Hooks	113, 118	Goitre Traction	201
Fixation Pick	113	Grasping.....	54, 225
Flap Knife	259	Hemostatic.....	59-67, 176, 177
Foerster Sponge Forceps	278	Hypophyseal	237
Fomon Retractor	167	Hysterectomy	64, 65
Forceps		Intestinal	211-214
Advancement	129	Intestinal Holding	209, 210
Alligator	144	Iris	122-124
Angiotribe	67	Jeweller Type	57
Biopsy, Rectal	299	Kidney Pedicle Clamp	65, 66
Biopsy, Uterine	284, 285	Kidney Stone	271
Bone Cutting	253, 254	Laryngeal	200
Bone Holding.....	248, 249	Laryngeal Alligator	196
Bone Plate Holding	246	Lid, Eye.....	128
Bone Screw Holding	246	Ligature	177, 223
Bone Wire Tightening	247	Lung Grasping	54, 225
Bone Wire Twisting	247	Membrane Puncturing	282
Bronchial	196, 198-200	Mosquito.....	59, 60
Bronchial Alligator	196	Muscle	130
Bulldog Clamp Applying	59	Nasal.....	154
Capsular.....	120	Nasal Cutting.....	155-159
Capsule	126, 127, 270	Nasal Dressing	153
Cardiovascular	54	Nasal Hump Cutting.....	159
Catheter Introducing	7	Obstetrical	289-292
Chalazion	128, 129	Peritoneal Clamp	66
Cilia	127, 128	Placenta	293, 294
Clamp Applying.....	59	Plate Holding	246
Clamp Closing.....	216	Polypus.....	153, 278
Clip Applying	238, 239	Prostatic Lobe Holding	270
Clip Applying & Removing	103	Ptosis	128
Clip Removing.....	103	Recession	130
Colon	214	Rectal Biopsy	299
Cornea	120	Screw Holding.....	246
Cystic Duct	208	Seizing	175
Dressing	44-47	Septum	154, 159
Dressing, Ear	142, 143	Septum Cutting	155

Forceps Cont'd	
Septum Straightening	159
Sequestrum	249
Splinter	55-57
Splinter with Magnifier	56
Sponge	278
Sterilizer	287
Strabismus	123
Suture	47, 125, 126
Suture Carrying	270
T/C Jaws	58
Tenaculum	279, 280
Tendon	260
Thoracic	223, 224
Tissue	48-54, 211, 212
Tongue	194
Tongue Seizing	194
Tonsil Hemostatic	176, 177
Tonsil Ligature	177
Tonsil Seizing	175
Towel	68
Towel Clamps	68
Trachoma	129
Traction	201
Tube Occluding	67
Tumor	282
Urethral	269
Uterine Biopsy	284, 285
Uterine Dressing	276, 277
Uterine Elevating	282
Uterine Tenaculum	279, 280
Uterine Vulsellum	281, 282
Utility	130
Vulsellum	281, 282
Watchmaker	57
Wire Tightening	247
Wire Twisting	247
Forceps Holder	287
Forceps with T/C Jaws	58
Fox Dermal Curettes	8
Fox Eye Shield	134
Fraenkel Laryngeal Forceps	200
Fraenkel Laryngeal Forceps Tips	198
Francke Blood Lancets	3
Franz Abdominal Retractor	86
Frazier Brain Exploring Trocar and Cannula	237
Frazier Cordotomy Knife	235
Frazier Dura Hooks	233
Frazier Dura Separator	235
Frazier Laminectomy Retractor	82
Frazier Skin Hooks	8
Frazier Suction Tubes	14
Freer Mucosa Knife	161
Freer Septum Chisels	163
Freer Septum Elevator	162
Freer Septum Gouge	163
Freer Septum Knife	161
Freer-Ingals Submucous Knife	161
Freisner Ear Knife	148
French Scale	267
Frey-Sauerbruch Rib Shears	219
Fritsch Abdominal Retractors	73
Fritsch-Bozeman Uterine Douche	276
Frontal Sinus Cannulas	169
Frontal Sinus Rasps	164
Fuchs Capsule Forceps	127
Fuchs Iris Forceps	123
G	
Gags, Mouth	191, 192
Gall Bladder Forceps	206
Gall Bladder Instruments	12, 73, 202-208
Gall Bladder Retractors	73
Gall Bladder Trocars	12
Gall Duct Clamps	208
Gall Duct Forceps	207
Gall Duct Probes	202
Gall Stone Forceps	205
Gall Stone Probes	202
Gall Stone Scoops	202-204
Galt Trephine	243
Ganglion Scissors	31
Gastro-Intestinal Clamps	217
Gastro-Intestinal Separator	217
Gauze Packers, Uterine	276
Gauze Scissors	17
Gauze Scissors, US Army Pattern	17
Gauze Shears	17
Gavin-Miller Intestinal and Colon Forceps	214
Gaylor Uterine Biopsy Forceps	284
Gaylor-Thoms Uterine Biopsy Forceps	284
Gellhorn Uterine Biopsy Forceps	284
Gelpi Perineal Retractors	81
Gerald Dressing Forceps	46
Gerald Tissue Forceps	51, 52
Gerzog Bone Mallet	266
Gibbon-Bailey Rib Contractor	223
Giertz Rib Shears	220
Gigli Saw Handles	245
Gigli Saw Wires	245
Gigli-Bailey Saw Guide	246
Gill Iris Forceps	123
Gill-Hess Iris Forceps	123
Gillies Needle Holder & Scissors	93



Gillies Tissue Forceps	52
Glabella Rasps	165
Gluck Rib Shears	219
Goelet Retractor	77
Goitre Instruments	201
Goitre Traction Forceps	201
Goldstein Lacrimal Sac Retractor	107
Goniotomy Knife	110
Good Frontal Sinus Rasps	164
Good Scissors	33
Goodell Uterine Dilators	275
Gosset Abdominal Retractors	83, 84
Gouges, Bone	261-265
Gouges, Mastoid	265
Gouges, Septum	163
Graefe Cataract Knives	108
Graefe Eye Speculum	105
Graefe Fixation Forceps	124
Graefe Iris Forceps	122
Graefe Strabismus Hooks	113
Grasping Forceps	54, 225
Graves Vaginal Specula	272
Green Fixation Forceps	125
Green Spatula	117
Green Strabismus Hooks	113
Green Thyroid Retractor	71
Green-Armytage Forceps	293
Greene Needle Holder	95
Greene Uterine Curettes	286
Grey Cystic Duct Forceps	208
Grieshaber Keratomes	111
Grooved Directors	87
Gross Ear Hook & Curette	146
Gross Ear Hook & Spoon	146
Gross Ear Spoon & Spud	146
Gruber Ear Specula	135
Gruenwald Nasal Punch	158
Gruenwald-Jansen Nasal Dressing Forceps	153
Gruenwald-Love Pituitary Rongeurs	240
Guide, Drill	245
Guide for Gigli Saws	245, 246
Guides, Bone Wire	247
Guthrie Fixation Hooks	112
Guyon Urethral Sounds	268
Guyon-Mayo Kidney Pedicle Clamp	65
Guyton-Park Eye Speculum	106
Gynecological Instruments	24, 272-286
Gynecological Scissors	24

H

Haglund-Stille Plaster Spreader	19
Haight Rib Spreader	221

Hajek Bone Mallet	266
Hajek Nasal Cutting Forceps	157
Hajek-Ballenger Septum Elevator	162
Hajek-Kofler Nasal Punch	158
Halle-Tieck Nasal Speculum	151
Halsey Needle Holders	88
Halsey Needle Holders with T/C Jaws	96
Halstead Mosquito Forceps	60
Hammer, for Tuning Forks	139
Hammers, Neurological	1, 2
Hammers, Percussion	1, 2
Hammers, Post Mortem	266
Hand Drills, Bone	242-244
Hand Drills, Cranial	242-244
Hand Retractors	72-77
Hand Tally Counter	4
Handle, Universal	198
Handles for Gigli Saws	245
Handles for Laryngeal Mirrors	195, 196
Handles for Laryngoscope	6
Handles for Scalpel Blades	15
Handles, Traction	292
Hank Uterine Dilators	275
Harken Auricle Clamps	227
Harken Rib Spreaders	222
Harmon Fixation Forceps	125
Harmon-Bishop Iris Forceps	123, 124
Harrington Retractors	73, 74
Harrington Thoracic Clamps	224
Harrington-Mayo Scissors	22
Harris Tonsil Knife and Dissector	173
Harrison Sterilizer Forceps	287
Hartmann Alligator Forceps	144
Hartmann Bone Rongeur	250
Hartmann Ear Forceps	143
Hartmann Ear Specula	135
Hartmann Eustachian Catheters	142
Hartmann Mosquito Forceps	59
Hartmann Nasal Cutting Forceps	157
Hartmann Nasal Dressing Forceps	153
Hartmann Tonsil Punches	179
Hartmann Tuning Forks	138, 139
Haslinger Uvula Retractor	193
Head Band Joints	5
Head Bands	5
Head Lights	6
Head Mirrors	4
Heaney Biopsy Curette	283
Heaney Hysterectomy Forceps	64
Heaney Needle Holder	91
Heaney Needle Holders with T/C Jaws	98
Heaney Retractors	73
Heaney-Simon Retractor	73

Heath Chalazion Curettes	116
Heath Chalazion Forceps	129
Heath Suture Scissors	39
Heath-Richter Clip Removing Forceps	103
Hebra Chalazion Curettes	115
Hegar Needle Holders with T/C Jaws	98
Hegar Uterine Dilators	275
Hegar-Mayo Needle Holders	91
Hegar-Mayo Needle Holders with T/C Jaws	98
Hegar-Olsen Needle Holder & Scissors	92
Hegar-Olsen Needle Holder & Scissors with T/C Jaws	99
Hegenbarth Clip Applying Forceps	102
Hemostat Forceps	59-67, 176, 177, 293
Hemostat, Tonsil	176, 177
Hennig Plaster Spreader	19
Henrotin Uterine Vulsellum Forceps	281
Herrick Kidney Pedicle Clamp	65
Hess Lens Expressor	114
Hess-Gill Iris Forceps	123
Heymann Scissors	33
Hibbs Bone Chisels	262
Hibbs Bone Gouges	262
Hibbs Osteotomes	262
Hibbs Retractor	74
Hillis-DeLee Obstetrical Stethoscope	288
Hirschman Anoscopes	296
Hodlick Needle Holder	91
Hoffman Alligator Forceps	144
Holding Clamps, Bone	247
Holding Forceps, Intestinal	209, 210
Holinger Trachea Tubes	187
Hooks	
Crypt	298
Decapitation	294
Dura	233
Ear	146
Fixation	112, 113, 118
Iris	112
Nerve	233, 234
Rectal	298
Retractor	113
Skin	8, 166, 167
Strabismus	113
Sympathectomy	233
Tenaculum	279
Tenotomy	113
Tonsil	174
Hopkins-Johns Bulldog Clamps	59
Hopkins-Johns Bulldog Clamp Applying Forceps	59
Hopkins-Johns Gall Bladder Forceps	206

Hopkins-Johns Occluding Clamps	226
Horsley Dura Separator	235
Horsley-Stille Bone Cutting Forceps	254
Huber Universal Handle	198
Hudson Brace	242
Hudson Cranial Burs	242
Hudson Cranial Hand Drill	242
Hudson Dressing Forceps	46
Hudson Tissue Forceps	50
Hunt Chalazion Forceps	128
Hunter Splinter Forceps	55
Hurd Tonsil Dissector & Pillar Retractor ...	174
Hypophyseal Forceps	237
Hysterectomy Forceps	64, 65
Hysterectomy Retractors	73

I

Ingall Antrum Cannulas	170
Ingalls-Freer Submucous Knife	161
Interval Timer	4
Intestinal & Stomach Instruments	209-218
Intestinal Clamp Set	215
Intestinal Clamps	214-217
Intestinal Forceps	212-214
Intestinal Holding Forceps	209, 210
Intestinal Suture Apparatus	218
Intestinal Tissue Forceps	211, 212
Intracapsular Lens Expressor	118
Intracapsular Lens Loops	118
Intracapsular Lens Spoon	118
Iowa Membrane Puncturing Forceps	282
Iridectomy Scissors	132, 133
Iris Forceps	122-124
Iris Hooks	112
Iris Knife Needles	109
Iris Needles	110
Iris Scissors	35, 131-133
Iris Scissors with T/C Blades	43
Iris Spatulas	116, 118
Israel Retractors	71
Ives-Fansler Rectal Speculum	296

J

Jackson Bronchial Alligator Forceps	196
Jackson Endoscopic Forceps	196
Jackson Esophageal Alligator Forceps	196
Jackson Laryngeal Alligator Forceps	196
Jackson Laryngeal Forceps	200
Jackson Laryngectomy Tubes	188, 189
Jackson Trachea Bistoury	180
Jackson Trachea Tenaculum	180
Jackson Trachea Tubes	183-185
Jackson Vaginal Retractors	274



Jacobs Uterine Vulsellum Forceps	281
Jaeger Keratomes	111
Jameson Recession Forceps	130
Jameson Strabismus Hook	113
Jameson-Fink Muscle Forceps	130
Jansen Ear Forceps	142
Jansen Mastoid Retractors	78
Jansen-Doyen Mouth Gags	191
Jansen-Gruenwald Nasal Dressing Forceps	153
Jansen-Middleton Septum Cutting Forceps	155
Jansen-Wagner Mastoid Retractor	78
Jansen-Zaufel Bone Rongeur	251
Jarcho Uterine Tenaculum Forceps	280
Jennings Mouth Gags	191
Jeweller Forceps	57
Johns-Hopkins Bulldog Clamp Applying Forceps	59
Johns-Hopkins Bulldog Clamps	59
Johns-Hopkins Gall Bladder Forceps	206
Johns-Hopkins Occluding Clamps	226
Johnson Prostatic Needle Holder	92
Joints for Headband	5
Jones Hemostatic Forceps	61
Jones Towel Clamps	68
Joseph Button End Knives	160
Joseph Dissecting Scissors	30
Joseph Double Edge Knives	159
Joseph Nasal Rasp	164
Joseph Nasal Saw	164
Joseph Skin Hooks	166
Judd-Allis Tissue Forceps	212
Judd-Masson Bladder Retractors	83
Jurasz Laryngeal Forceps	200

K

Kalt Capsule Forceps	126
Kalt Needle Holder with T/C Jaws	100
Kalt Needle Holders	94
Kalt-Arruga Needle Holder	94
Kane Umbilical Clamp	294
Katsch Comedone Extractor	8
Kazanjian Nasal Hump Cutting Forceps ...	159
Kelly Fistula Scissors	23
Kelly Hemostatic Forceps	60
Kelly Placenta Forceps	293
Kelly Proctoscope	297
Kelly Retractors	72
Kelly Sphincteroscopes	297
Kelly Tissue Forceps	53
Kelly-Rankin Hemostatic Forceps	60
Keratomes	111, 112, 118

Kern Bone Holding Forceps	248
Kerrison Rongeurs	145
Key Periosteal Elevators	257
Keyes Dermal Punches	8
Kidney Pedicle Clamps	65, 66
Kidney Retractor	270
Kidney Stone Forceps	271
Kielland Obstetrical Forceps	290
Kielland-Luikart Obstetrical Forceps	290
Killian Nasal Specula	151
Killian Septum Elevator	162
Killian Septum Forceps	154
Killian-Eicken Antrum Cannula	170
Kilner Rhino-Plasty Scissors	34
Kirby Capsular Forceps	120
Kirby Capsulotomy Expressor Spoon	118
Kirby Cataract Knife	118
Kirby Cornea Forceps	120
Kirby Eye Instruments	118-120
Kirby Fixation Forceps	120
Kirby Fixation Hook	118
Kirby Intracapsular Lens Expressor	118
Kirby Intracapsular Lens Loop	118
Kirby Intracapsular Lens Spoon	118
Kirby Iris Spatula	118
Kirby Keratome	118
Kirby Lens Expressor	119
Kirby Lens Spoon & Cylinder	119
Kirby Lid Retractor	118
Kirmission Raspatory	257
Kleinert-Kutz Skin Hooks	166
Knapp Cataract Knife	109
Knapp Eye Speculum	105
Knapp Iris Knife Needle	109
Knapp Lens Scoop	114
Knapp Retractor	113
Knapp Trachoma Forceps	129
Knight Nasal Scissors	34
Knight Polypus Forceps	153
Knight Septum Cutting Forceps	154
Knives	
Abscess	8
Amputating	260
Brain	260
Cartilage	160, 259
Cataract	108, 118
Cordotomy	235
Corneal	110
Discission	109
Dura	236
Ear	148, 149
Flap	259
Goniotomy	110

Knives Cont'd	
Meniscus	259
Mucosa	160, 161
Nasal	159-161
Needle	109
Ophthalmic	109, 110
Plaster	19
Septum	161
Tonsil	171-173
Knot Tiers	236
Knowles Bandage Scissors	17
Kocher Bronchocele Sound (Enucleator) ..	201
Kocher Hemostatic Forceps	61
Kocher Intestinal Forceps	213
Kofler-Hajek Nasal Punch	158
Krause Ear Snares	142
Krause Laryngeal Forceps Tips	199
Krause Nasal Snare	152
Kutz-Kleinert Skin Hooks	166
Kyles Cotton Applicators	150
L	
La Borde Trachea Dilator	180
Lacrimal Dilators	121
Lacrimal Probes	121
Lacrimal Sac Retractors	106, 107
LaForce Adenotomes	169
Lahey Gall Duct Forceps	207
Lahey Goitre Traction Forceps	201
Lahey Hemostatic Forceps	61
Lahey Ligature Carriers	201
Lahey Thyroid Retractor	71
Lahey-Metzenbaum Scissors	28
Lahey-Metzenbaum Scissors with T/C Blades	42
Lambert Chalazion Forceps	128
Lambotte Bone Holding Forceps	249
Lambotte Osteotomes	264
Lambotte-Farabeuf Bone Holding Forceps	249
Laminectomy Retractors	82
Lancaster Eye Speculum	105
Lancets, Blood	3
Lane Bone Holding Forceps	248
Lane Bone Plate Holding Forceps	246
Lane Bone Plate Wrench	246
Lane Bone Screw Holding Forceps	246
Lane Gastro-Intestinal Clamp	217
Lane Periosteal Elevators	258
Lane Tissue Forceps	53
Lane Towel Clamps	68
Lane-Murphy Bone Skid	256
Lange Laryngeal Forceps Tip	198
Lange Operating Scissors	21
Langenbeck Bone Holding Forceps	249
Langenbeck Flap Knife	259
Langenbeck Metacarpal Saw	241
Langenbeck Needle Holders	93
Langenbeck Needle Holders with T/C Jaws	99
Langenbeck Periosteal Elevators	257
Langenbeck Retractors	71
Laparotomy Rings	283
Larry Rectal Probe	298
Larsen Tendon Forceps	260
Laryngeal Alligator Forceps	196
Laryngeal Extension Cannula	197
Laryngeal Forceps	200
Laryngeal Instruments	195-200
Laryngeal Mirror Handles	195, 196
Laryngeal Mirrors	195
Laryngectomy Tubes	188, 189
Laryngoscope Battery Handle	6
Laryngoscope Blades	6
Lathbury Cotton Applicators	150
Lebsche Rib Shears	220
Leff Obstetrical Stethoscope	288
Legueu Kidney Retractor	270
Leksell Bone Rongeur	253
Leksell Rib Rongeur	253
Lempert Bone Rongeur	251
Lens Cylinder, Eye	119
Lens Expressors, Eye	113, 114, 118, 119
Lens Loops, Eye	114, 118
Lens Scoops, Eye	114
Lens Spoons, Eye	114, 118
Lester Fixation Forceps	125
Lewin Bone Holding Forceps	249
Lewis Laryngectomy Tubes	189
Lewis Lens Loops	114
Lewis Nasal Rasps	165
Lewis Tonsil Hemostatic Forceps	177
Lewis Tonsil Screws	174
Lewis Tonsil Snare	178
Lexer Scissors	29
Lexer Scissors with T/C Blades	42
Lexer-Mayo Scissors	29
Lichtwicz Antrum Needle	12
Lichtwicz Antrum Trocar	12
Lid Clamp, Eye	107
Lid Forceps, Eye	128
Lid Retractors, Eye	106, 107, 118
Life Saving Tubes	180
Ligature Carriers	102, 201
Ligature Conductors	102
Ligature Forceps	177, 223



Ligature Needles	101, 102
Ligature Scissors	39
Lillie Tonsil Scissors	33
Lindner Cyclodialysis Spatula & Spoon	116
Lister Bandage Scissors	17
Lister Bandage Scissors with T/C Blades ...	43
Lister-Burch Eye Speculum	105
Liston Amputating Knives	260
Liston Bone Cutting Forceps	253
Liston-Littauer Bone Cutting Forceps	253
Liston-Ruskin Bone Cutting Forceps	254
Liston-Stillé Bone Cutting Forceps	254
Littauer Cilia Forceps	127
Littauer Ear Forceps	143
Littauer Nasal Dressing Forceps	153
Littauer Stitch Scissors	39
Littauer-Buck Stitch Scissors	39
Littauer-Liston Bone Cutting Forceps	253
Locking Device for Stone Intestinal Clamps	215
Lockwood Intestinal Forceps	212
Lockwood-Allis Tissue Forceps	212
Loops, Ear	147
Loops, Eye	134
Lordan Chalazion Forceps	129
Lothrop Tonsil Hemostatic and Ligature Forceps	177
Lothrop Tonsil Knife	172
Love Nasopharyngeal Retractors	174
Love Nerve Retractors	234
Love-Gruenwald Pituitary Rongeurs	240
Lovelace Hemostatic Forceps	62
Lovelace Lung Grasping Forceps	225
Lovelace Traction Forceps	201
Lowe-Breck Cartilage Knife	259
Lower Gall Duct Forceps	207
Lowman Bone Holding Clamps	247
Luc Septum Cutting Forceps	155
Lucae Bone Mallet	266
Lucae Ear Forceps	142
Lucae Tuning Forks	140
Luer Bone Rongeurs	250
Luer Trachea Tubes	185, 186
Luer-Stillé Bone Rongeurs	252
Luethy-Masson Needle Holder	92
Luikart Obstetrical Forceps	290
Luikart-Bill Traction Handle	292
Luikart-Kielland Obstetrical Forceps	290
Luikart-McLean Obstetrical Forceps	291
Luikart-McClean-Tucker Obstetrical Forceps	291
Luikart-Simpson Obstetrical Forceps	290
Lumbard Airways	7

Lundsgaard Sclerotome	112
Lung Grasping Forceps	54, 225
Lung Retractors	74
Lung Scissors	30
Lynch Tonsil Knife & Dissector	173

M

MacIntosh Laryngoscope Blades	6
Magill Catheter Introducing Forceps	7
Magnets, Eye	134
Maier Polypus Forceps	278
Maier Uterine Dressing Forceps	277
Male Urethral Catheters	268
Mallets	266
Maltz Nasal Rasp	164
Martin Cartilage Clamps	260
Martin Laryngectomy Tubes	188
Martin Pelvimeter	288
Martin Tracheostomy Dressing Extension Set	186
Martin-Parham Bone Holding Clamp	247
Masks, Ether	7
Masson Needle Holders	91
Masson Needle Holders with T/C Jaws	98
Masson-Judd Bladder Retractors	83
Masson-Luethy Needle Holder	92
Mastin Muscle Clamp	201
Mastoid Chisels	265
Mastoid Curettes	147
Mastoid Gouges	265
Mastoid Retractors	78, 79
Mastoid Rongeurs	145
Mathieu Needle Holders	93
Mathieu Needle Holders with T/C Jaws	99
Mathieu Raspatories	256
Mathieu Retractors	69
Mathieu Tongue Seizing Forceps	194
Mathieu Urethral Forceps	269
Matson Rib Stripper & Elevator	230
Maunder Oral Screw	191
Mayo Common Duct Probes	202
Mayo Common Duct Scoops	204
Mayo Cystic Duct Scoops	204
Mayo Gall Stone Scoop	203
Mayo Scissors	22
Mayo Scissors with T/C Blades	41
Mayo Vein Strippers	231
Mayo-Adams Appendectomy Retractors	81
Mayo-Blake Gall Stone Forceps	205
Mayo-Collin Retractors	77
Mayo-Guyon Kidney Pedicle Clamp	65
Mayo-Harrington Scissors	22
Mayo-Hegar Needle Holders	91

Mayo-Hegar Needle Holders with T/C Jaws	98	Michel Clip Removing Forceps	103
Mayo-Lexer Scissors	29	Michel Wound Clips	104
Mayo-Noble Scissors	22	Middleton-Jansen Septum Cutting Forceps	155
Mayo-Robson Intestinal Forceps	213	Mikulicz Peritoneal Clamp	66
Mayo-Russian Tissue Forceps	54	Mikulicz Tonsil Hemostatic Forceps	177
Mayo-Stillé Scissors	22	Miller Rectal Scissors	23
Mayo-Stillé Scissors with T/C Blades	41	Miller Vaginal Speculum	272
McClellan Obstetrical Forceps	290	Miller-Gavin Intestinal & Colon Forceps ...	214
McClellan-Luikart Obstetrical Forceps	291	Millin Bladder Neck Spreader	270
McClellan-Tucker Obstetrical Forceps	291	Millin Capsule Forceps	270
McClellan-Tucker-Luikart Obstetrical Forceps	291	Millin Prostatic Lobe Holding Forceps	270
McClure Iris Scissors	131	Millin Suture Carrying Forceps	270
McCullough Utility Forceps	130	Mirror Handles	195, 196
McIndoe Dressing Forceps	47	Mirrors, Head	4
McIvor Mouth Gags	192	Mirrors, Laryngeal	195
McKenzie Brain Clips	239	Mixer Dilating Probe	202
McKenzie Clip Applying Forceps	238, 239	Mixer Gall Bladder Forceps	206
McKenzie Clip Holding Rack	239	Mixer Gall Duct Clamps	208
McKenzie Cranial Bur	243	Mixer Gall Duct Forceps	207
McKenzie Cranial Drill	243	Mixer Gall Stone Forceps	205
McWhorter Tonsil Hemostatic & Ligature Forceps	177	Mixer Hemostatic Forceps	65
Mead Bone Rongeur	250	Mixer Scissors	22
Measuring Tapes	3	Moore Gall Stone Scoop	203
Mechanical Finger	144	Moore-Staude Uterine Tenaculum Forceps	279
Mellinger Eye Speculum	106	Moorehead Ear Knife	148
Membrane Puncturing Forceps	282	Mosher Life Saving Tubes	180
Meniscus Knives	259	Mosquito Forceps	59, 60
Metacarpal Saw	241	Mott-Parker Retractors	77
Metzenbaum Dissecting Scissors	27, 28	Mouth Gags	191, 192
Metzenbaum Needle Holders	90	Moynihan Gall Duct Forceps	207
Metzenbaum Scissors	27, 28	Moynihan Gall Stone Probe & Scoop	202
Metzenbaum Scissors with T/C Blades .	41, 42	Moynihan Towel Clamps	68
Metzenbaum-Lahey Scissors	28	Mucosa Knives	160, 161
Metzenbaum-Lahey Scissors with T/C Blades	42	Mueller Lacrimal Sac Retractor	106
Metzenbaum-Nelson Scissors	28	Murdock Eye Speculum	106
Metzenbaum-Nelson Scissors with T/C Blades	41	Murphy Gall Bladder Retractors	73
Meyerding Bone Chisels	263	Murphy Hemostatic Forceps	60
Meyerding Bone Gouges	263	Murphy Plaster Knife	19
Meyerding Hip & Shoulder Bone Skid	256	Murphy Retractors	71
Meyerding Laminectomy Retractors	82	Murphy-Lane Bone Skid	256
Meyerding Osteotomes	263	Murray-Crile Needle Holder	89
Meyerding Retractors	70, 73	Murray-Crile Needle Holder with T/C Jaws	97
Meyhoefer Chalazion Curettes	115	Muscle Clamp	201
M.G.H. Needle Holder	90	Muscle Forceps	130
M.G.H. Uterine Vulsellum Forceps	282	Myles Antrum Cannulas	170
Michel Clip Applying Forceps	102	Myles Nasal Cutting Forceps	156
Michel Clip Applying & Removing Forceps	103	Myoma Screw	282

N

Nabatoff Vein Stripper	231
Nail Drills	9
Nail Nippers	10, 11
Nail Scissors	10
Nail Splitter	11
Nasal Alligator Forceps.....	153, 154, 156-158
Nasal Cutting Forceps	155-159
Nasal Dressing Forceps	153
Nasal Forceps	153, 154
Nasal Hump Cutting Forceps	159
Nasal Instruments	34, 151-170
Nasal Knives	159-161
Nasal Punch	158
Nasal Rasps	164, 165
Nasal Retractors	166, 167
Nasal Saws	164
Nasal Scissors	34
Nasal Snares	152
Nasal Specula	151
Nasopharyngeal Retractors	174
Nasopharyngeal Speculum	151
Needle Holders.....	88-95
Needle Holders with T/C Jaws	96-100
Needles	
Aneurysm.....	87, 236
Antrum	12
Iris	110
Ligature	101, 102
Ophthalmic	110
Paracentesis	110
Septum	167
Suture	101
Tonsil	171
Young Boomerang	101
Neivert Needle Holder.....	88
Nelson Tissue Forceps	54
Nelson Trocars	12
Nelson-Metzenbaum Scissors	28
Nelson-Metzenbaum Scissors with T/C	
Blades	41
Nerve Dissectors	233
Nerve Hooks	233, 234
Nerve Retractors	234, 235
Nerve Separator	235
Nerve Spatula	235
Neumann Scissors.....	34
Neuro-Set, Tuning Fork.....	139
Neurological Hammers	1, 2
Neurological Instruments	1, 139, 232-240
Neurological Pinwheels.....	1
Neurosurgical Instruments	232-240
Neurotone "5".....	139

New Orleans Needle Holder	90
New Orleans Needle Holder with T/C	
Jaws	97
Nippers, Cuticle	10
Nippers, Nail	10, 11
Noble-Mayo Scissors	22
Nott Vaginal Specula.....	273
Novak Endometrial Biopsy Suction	
Curette	283
Noyes Alligator Forceps	154
Noyes Iridectomy Scissors.....	132
Noyes Iris Scissors	132
Noyes Nasal Forceps	154
Noyes Septum Forceps	154
Nugent Utility Forceps.....	130

O

O'Brien Fixation Forceps	125
Obstetrical Forceps	289-292
Obstetrical Instruments	288-294
Obstetrical Stethoscopes	288
Obturator for Rectal Speculum	296
Occluding Clamps	226
Occluding Forceps	67
Ochsner Gall Bladder Trocars	12
Ochsner Gall Duct Probe	202
Ochsner Hemostatic Forceps	61
Ochsner-Rochester Hemostatic Forceps	63
Ockerblad Kidney Clamp	66
O'Connor-Elschnig Fixation Forceps	125
O'Connor-O'Sullivan Abdominal Retractor	86
O'Connor-O'Sullivan Vaginal Retractor	274
Oldberg Pituitary Rongeurs	240
Olivecrona Alligator Scissors.....	32
Olivecrona-Toennis Clip Applying	
Forceps	238
Olsen-Hegar Needle Holder & Scissors	92
Olsen-Hegar Needle Holder & Scissors	
with T/C Jaws	99
Operating Scissors	20-39
Operating Scissors with T/C Blades	40-43
Ophthalmic Knives.....	109, 110
Ophthalmic Needles	110
Oral Instruments.....	191-194
Orthopedic Instruments	241-260
Osteotomes.....	261-265
O'Sullivan-O'Connor Abdominal	
Retractor	86
O'Sullivan-O'Connor Vaginal Retractor	274
Otis Urethral Sounds	267
Overholt Periosteal Elevators.....	230
Overholt Thoracic Forceps	223

P

Pads, Rubber, for Young Forceps	194	Plaster Shears with T/C Blades	43
Paracentesis Needles	110	Plaster Spreaders	19
Parham-Martin Bone Holding Clamp	247	Plate Holding Forceps	246
Park-Guyton Eye Speculum	106	Plate Wrench	246
Parker Retractors	76	Politzer Ear Knives	149
Parker-Mott Retractors	77	Polypus Forceps	153, 278
Patent Ductus Clamp	227	Poole Suction Tubes	14
Paton Needle Holder	94	Post Mortem Hammer	266
Patterson Trocars	12	Potts Aorta Clamps	228
Patton Septum Speculum	152	Potts-Smith Dressing Forceps	47
Paul Lid Retractor	107	Potts-Smith Forceps with T/C Jaws	58
Payr Pylorus Clamps	217	Potts-Smith Needle Holder	94
Pean Hemostatic Forceps	63	Potts-Smith Scissors	31
Pean Hysterectomy Forceps	64	Potts-Smith Tissue Forceps	52
Pean-Rochester Hemostatic Forceps	63	Pratt Crypt Hooks	298
Pederson Vaginal Specula	272	Pratt Ethmoid Curette	168
Pediatric Suction Tube	14	Pratt Forceps	66
Pedical Clamps	65, 66	Pratt Rectal Scissors	23
Peet Splinter Forceps	56	Pratt Rectal Speculum	295
Pelvimeters	288, 289	Pratt "T" Clamp	66
Penis Clamp	271	Prince Advancement Forceps	129
Penlight	4	Prince Scissors	33
Pennington Hemostatic Forceps	66	Probes	87
Pennington Septum Elevator	162	Antrum	147
Percussion Hammers	1, 2	Common Duct	202
Percy Intestinal Holding Forceps	210	Dilating	202
Perforated Tip for Yankauer Suction Tube ...	14	Double Ended	87
Perforator	294	Ear	147
Periosteal Elevators	230, 257, 258	Fistula	298
Peritoneal Clamps	66	Gall Duct	202
Peterson-Smith Bone Gouges	264	Gall Stone	202
Peterson-Smith Osteotomes	263	Grooved Director	87
Phaneuf Hysterectomy Forceps	65	Lacrimal	121
Physician Splinter Forceps	56	Rectal	298
Pick, Fixation	113	Salpingeal	147
Pierce Antrum Trocar	13	Sinus	170
Pierce Septum Elevator	162	With Eye	87
Piffard Dermal Curettes	8	Proctoscopes	297
Pile Clamp	299	Prostatic Lobe Holding Forceps	270
Pillar Retractor	174	Prostatic Needle Holders	92
Pin Wheels, Neurological	1	Prostatic Retractors	269
Pinard Obstetrical Stethoscope	288	Providence Hospital Hemostatic Forceps ...	60
Piper Obstetrical Forceps	291	Ptoisis Forceps	128
Pituitary Elevators	236	Pulmonary Vessel Clamp	225
Pituitary Rongeurs	240	Pulmonic Stenosis Clamps	228
Pituitary Spoons	236	Punch, Dermal	8
Placenta Forceps	293, 294	Punch, Ear	145
Plaster Cast Breaker	19	Punch, Nasal	158
Plaster Instruments	17-19	Punch, Rectal Biopsy	299
Plaster Knife	19	Punch, Tonsil	179
Plaster Saws	19	Putti Bone Rasps	255
Plaster Shears	17, 18	Pye-Smith Sterilizer Forceps	287
		Pylorus Clamps	217



Pylorus Separator 217
 Pynchon Suction Tube 14

Q

Queens Square Percussion Hammer 2
 Quimby Scissors 34
 Quire Mechanical Finger 144

R

Racks, Clip Holding 239
 Ralks Clip Removing Forceps 103
 Ralks Ear Forceps 143
 Ralks Splinter Forceps 56
 Ralks Sterilizer Forceps 287
 Randall Endometrial Biopsy Suction
 Curette 283
 Randall Kidney Stone Forceps 271
 Rankin Anastomosis Clamp 217
 Rankin-Crile Hemostatic Forceps 61
 Rankin-Kelly Hemostatic Forceps 60
 Rapid Uterine Gauze Packers 276
 Raspatories 228-230
 Raspatories, Bone 256, 257
 Rasps, Antrum 165
 Rasps, Bone 255
 Rasps, Glabella 165
 Rasps, Nasal 164, 165
 Rasps, Sinus 165
 Recession Forceps 130
 Rectal Biopsy Forceps 299
 Rectal Hooks 298
 Rectal Instruments 23, 295-299
 Rectal Probes 298
 Rectal Retractors 297
 Rectal Scissors 23
 Rectal Specula 295, 296
 Reese Advancement Forceps 129
 Retractors 69-86
 Abdominal 73, 84-86
 Anal 297
 Appendectomy 81
 Bladder 82, 83
 Brain 234
 Deaver 75
 Decompression 234
 Eye 107, 134
 Finger 69-71
 Gall Bladder 73
 Hand 72-77
 Hook 113
 Hysterectomy 73
 Kidney 270
 Lacrimal Sac 106, 107

Retractors Cont'd
 Laminectomy 82
 Lid, Eye 106, 107, 118
 Lung 74
 Mastoid 78, 79
 Nasal 166, 167
 Nasopharyngeal 174
 Nerve 234, 235
 Pillar 174
 Prostatic 269
 Rectal 297
 Ribbon 76
 Scapula 74
 Self-Retaining 78-84
 Skin 167
 Spinal 72
 Thoracic 74
 Thyroid 69, 71
 Tibia 72
 Tonsil 174
 Trachea 69
 Uvula 193
 Vaginal 274
 Vein 234
 Reverdin Suture Needles 101
 Reynolds Dissecting Scissors 23
 Rhino-Plasty Scissors 34
 Rib Contractors 223
 Rib Raspatories 228
 Rib Rongeurs 253
 Rib Shears 219, 220
 Rib Spreaders 221, 222
 Rib Strippers 230
 Ribbon Retractors 76
 Richardson Retractors 72
 Richardson-Eastman Retractors 72
 Richter Scissors 25
 Richter-Heath Clip Removing Forceps 103
 Rienhoff Needle Holder 92
 Rigby Retractor 81
 Ring Cutters 9
 Rings, Laparotomy 283
 Robb Tonsil Knife 172
 Robertson Tonsil Knife 172
 Robson-Mayo Intestinal Forceps 213
 Rochester-Carmalt Hemostatic Forceps 63
 Rochester-Ochsner Hemostatic Forceps 63
 Rochester-Pean Hemostatic Forceps 63
 Roeder Towel Clamps 68
 Roger Septum Elevator 163
 Rogers-Adson Cranial Bur 243
 Rogge Sterilizer Forceps 287
 Rongeurs, Bone 250-253

Rongeurs, Cranial	232
Rongeurs, Ear	145
Rongeurs, Mastoid	145
Rongeurs, Pituitary	240
Rongeurs, Rib	253
Roosevelt Stomach Clamp	217
Rosenberg Laryngeal Forceps Tip	199
Roux Retractors	76
Rubber Pads for Tongue Forceps	194
Rumel Cardiovascular Tourniquets	230
Rumel Thoracic Forceps	224
Ruskin Bone Rongeurs	252
Ruskin-Liston Bone Cutting Forceps	254
Russian Tissue Forceps	54
Russian-Mayo Tissue Forceps	54
Ryder Needle Holder with T/C Jaws	100

S

Saalfeld Comedone Extractors	8
Sachs Nerve Separator & Spatula	235
Salpingeal Curettes	146
Salpingeal Probe	147
Sanvenero Dissecting Scissors	29
Sarot Bronchus Clamps	225
Sarot Cardiovascular Needle Holders	90
Sarot Needle Holders with T/C Jaws	98
Sarot Thoracic Forceps	224
Satinsky Scissors	30
Satinsky Vena Cava Clamps	226, 227
Satterlee Bone Saw	241
Sauer Eye Speculum	106
Sauerbruch Raspatory	228
Sauerbruch Retractors	73
Sauerbruch Rib Rongeurs	253
Sauerbruch Rib Shears	219
Sauerbruch-Frey Rib Shears	219
Saw Guides	245, 246
Saw Handles	245
Saw Wires	245
Saws, Bone	241, 245
Saws, Finger Ring	9
Saws, Metacarpal	241
Saws, Nasal	164
Saws, Plaster	19
Sawtell Tonsil Hemostatic Forceps	176
Sawyer Rectal Retractors	297
Sayre Periosteal Elevators	258
Scale, Charrière	267
Scale, English	267
Scale, French	267
Scalpel Blades	16
Scalpel Handles	15
Scalpels, Eye	108
Scapula Retractors	74
Schaaf Cilia Forceps	128
Schamberg Comedone Extractor	8
Scheinmann Laryngeal Forceps Tip	199
Schenck-Beck Tonsil Snare	178
Schimmelbush Ether Mask	7
Schiotz Tonometers	133
Schmeden Nasal Cutting Forceps	158
Schmidt Tonsil Retractor	174
Schmieden Scissors	31
Schnidt Tonsil Hemostatic Forceps	176
Schoenberg Intestinal Holding Forceps	209
Schroeder Uterine Curettes	286
Schroeder Uterine Tenaculum Forceps	279, 280
Schroeder Uterine Vulsellum Forceps	281
Schroeder-Braun Uterine Tenaculum Forceps	280
Schubert Uterine Biopsy Forceps	284
Schweigger Capsule Forceps	127
Scissors	
Alligator	32
Almedic	18
Artery	38
Baby Operating	21, 28, 29
Bandage	17, 18
Bandage with T/C Blades	43
Capsulotomy	133
Corneal	132
Cuticle	10
Dissecting	23, 27-30, 37-39
Dressing	17, 18
Dura	32
Enterotomy	38
Enucleation	36
Episiotomy	25
Esophageal	31
Fistula	23
Ganglion	31
Gauze	17
Gynecological	24
Iridectomy	132, 133
Iris	35, 131-133
Iris with T/C Blades	43
Ligature	39
Lung	30
Nail	10
Nasal	34
Operating	20-39
Operating with T/C Blades	40-43
Plaster	17, 18
Rectal	23
Rhino-Plasty	34



Scissors Cont'd	
Stitch	39
Strabismus	36
Strabismus with T/C Blades	43
Suture	39
Suture and Wire Cutting	103
Suture and Wire Cutting with T/C	
Blades	43
Synechia	132
Tenotomy	36, 131
Thoracic	30
Tonsil	33
Trigeminus	31
U.S. Army Pattern	17
Umbilical	26
Universal	17
Uterine	24
Wire and Suture Cutting	103
Wire and Suture Cutting with	
T/C Blades	43
Wire Cutting	103
Scissors with T/C Blades	40-43
Bandage	43
Iris	43
Lahey-Metzenbaum	41
Lexer	42
Mayo	41
Mayo-Stille	41
Metzenbaum	41, 42
Nelson-Metzenbaum	41
Operating	40-43
Plaster Shears	43
Strabismus	43
Suture and Wire	43
Sclerotomes	112
Scoops, Common Duct	204
Scoops, Cystic Duct	204
Scoops, Enucleation	114
Scoops, Gall Stone	202-204
Scoops, Lens, Eye	114
Scoville Clip Applying Forceps	238
Scoville Nerve Hook & Dissector	234
Scoville Nerve Root Retractors	235
Screw Holding Forceps	246
Screw, Myoma	282
Screws, Oral	191
Screws, Tonsil	174
Screws, Tumor	282
Scudder Intestinal Forceps	214
Scudder Stomach Clamps	214
Sedillot Periosteal Elevator	258
Seiffert Laryngeal Forceps Tip	198
Seiler Scissors	34
Seizing Forceps, Tonsil	175
Self-Retaining Retractors	78-84
Semb Bone Holding Forceps	249
Semb Dissecting & Ligature Forceps	223
Semb Raspatories	229
Semb Rib Shears	220
Semkin Dressing Forceps	46
Semkin Tissue Forceps	51
Senn Retractors	69
Separators, Dura	235
Separators, Nerve	235
Separators, Pylorus	217
Septum Chisels	163
Septum Cutting Forceps	155
Septum Elevators	162, 163
Septum Forceps	154, 159
Septum Gouges	163
Septum Knives	161
Septum Needle	167
Septum Speculum	152
Septum Straightening Forceps	159
Sequestrum Forceps	249
Serrefines	59
Sexton Ear Knives	149
Shallcross Gall Bladder Forceps	206
Shapleigh Ear Curettes	146
Shears, Plaster	17, 18
Shears, Plaster with T/C Blades	43
Shears, Rib	219, 220
Sheldon Laminectomy Retractor	79
Shield for Eye	134
Shields for Ear Syringe	150
Simon-Heaney Retractor	73
Simpson Obstetrical Forceps	289
Simpson Uterine Sound	276
Simpson-Luikart Obstetrical Forceps	290
Sims Rectal Speculum	295
Sims Uterine Curettes	285
Sims Uterine Scissors	24
Sims Uterine Sound	276
Sims Uterine Sponge Holders	283
Sims Vaginal Specula	273
Singley-Tuttle Tissue Forceps	54
Sinus Cannulas	169
Sinus Probes	170
Sinus Rasps	165
Sistrunk Dissecting Scissors	39
Skeele Chalazion Curettes	115
Skene Uterine Tenaculum Forceps	280
Skene Uterine Vulsellum Forceps	281
Skids, Bone	256
Skillern Sinus Probe	170
Skin Hooks	8, 166, 167

Skin Retractors	167
Skull Breakers	266
Sluder-Ballenger Tonsillectome	179
Smellie Perforator	294
Smillie Meniscus Knives	259
Smith-Buie Anal Retractor	297
Smith-Ferris Tissue Forceps	53
Smith-Ferris-Kerrison Rongeurs	145
Smith-Fisher Cataract Spatula	117
Smith-Fisher Iris Spatula	116
Smith-Kerrison-Ferris Rongeurs	145
Smith-Peterson Bone Gouges	264
Smith-Peterson Osteotomes	263
Smith-Potts Dressing Forceps	47
Smith-Potts Forceps with T/C Jaws	58
Smith-Potts Needle Holder	94
Smith-Potts Scissors	31
Smith-Potts Tissue Forceps	52
Smith-Pye Sterilizer Forceps	287
Smithwick Clip Applying Forceps	238
Smithwick Nerve Hook	233
Smithwick Sympathectomy Hook & Dissector	233
Snare Wire	142, 152, 179
Snares, Ear	142
Snares, Nasal	152
Snares, Tonsil	177, 178
Snellen Entropium Forceps	128
Somer Uterine Elevating Forceps	282
Sounds, Bronchocele	201
Sounds, Urethral	267, 268
Sounds, Uterine	276
Spatulas, Brain	236
Spatulas, Cataract	117
Spatulas, Cyclodialysis	116, 117
Spatulas, Iris	116, 118
Spatulas, Nerve	235
Specula, Ear	135
Specula, Eye	105, 106
Specula, Nasal	151
Specula, Nasopharyngeal	151
Specula, Rectal	295, 296
Specula, Septum	152
Specula, Vaginal	272, 273
Spencer Stitch Scissors	39
Spencer-Wells Hemostatic Forceps	62
Sphincteroscopes	297
Spinal Column Chisels	265
Spinal Retractors	72
Splinter Forceps	55-57
Splinter Forceps, Jeweller Type	57
Splinter Forceps with Magnifier	56
Splitter, Nail	11
Sponge Forceps	278
Sponge Holders	283
Spoons, Capsulotomy Expressor	118
Spoons, Ear	146
Spoons, Expressor	118
Spoons, Evisceration	116
Spoons, Intracapsular Lens	118
Spoons, Lens, Eye	114, 118
Spoons, Pituitary	236
Sprague Ear Instruments	148
Spratt Bone Curettes	147
Spreaders, Bladder Neck	270
Spreaders, Plaster	19
Spreaders, Rib	221, 222
Spurling Pituitary Rongeurs	240
Staude-Moore Uterine Tenaculum Forceps	279
Stephenson Needle Holder	94
Sterilization Forceps	287
Stethoscopes, Obstetrical	288
Stevens Needle Holder	93
Stevens Needle Holder with T/C Jaws	100
Stevens Tenotomy Hook	113
Stevens Tenotomy Scissors	36
Stevenson Lacrimal Sac Retractor	107
Stille Bone Chisels	261
Stille Bone Drill	244
Stille Bone Gouges	261
Stille Bone Rongeur	252
Stille Kidney Pedicle Clamp	65
Stille Osteotomes	261
Stille Plaster Shears	18
Stille Rib Shears	219
Stille Tissue Forceps	50
Stille-Haglund Plaster Spreader	19
Stille-Horsley Bone Cutting Forceps	254
Stille-Liston Bone Cutting Forceps	254
Stille-Luer Bone Rongeurs	252
Stille-Mayo Scissors	22
Stille-Mayo Scissors with T/C Blades	41
Stitch Cutter Blade	16
Stitch Scissors	39
Stockman Penis Clamp	271
Stomach & Intestinal Instruments	209-218
Stomach Clamps	214-217
Stomach Suture Apparatus	218
Stone Clamp Applying Forceps	215
Stone Intestinal Clamp Set	215
Stone Tissue Forceps	50
Strabismus Forceps	123
Strabismus Hooks	113
Strabismus Scissors	36
Strabismus Scissors with T/C Blades	43



Stratte Needle Holder	92
Stratte Needle Holder with T/C Jaws	99
Streumpel Alligator Forceps	144
Stripper, Rib	230
Strippers, Tendon	260
Strippers, Vein	231
Strully Scissors	31
Struyken Nasal Cutting Forceps	157
Stylet, Threading, for Rumel Tourniquet	230
Submucous Knife	161
Suction Tubes	14
Surgical Blades	16
Suture Apparatus	218
Suture Carrying Forceps	270
Suture Clips	218
Suture Clips for Von-Petz Apparatus	218
Suture Forceps	47, 125, 126
Suture Instruments	101-104
Suture Needles	101
Suture Scissors	39
Suture Wire Scissors	103
Suture Wire Scissors with T/C Blades	43
Sweet Esophageal Scissors	31
Sympathectomy Hook and Dissector	233
Synechia Scissors	132
Syringe, Ear	150

T

"T" - Clamp, Pratt	66
T/C Forceps	58
T/C Needle Holders	96-100
T/C Scissors	40-43
Takahashi Ethmoid Forceps	156
Tally Counter	4
Tape Measures	3
Tarnier Obstetrical Forceps	292
Taylor Dressing Forceps	46
Taylor Dura Scissors	32
Taylor Percussion Hammers	1
Taylor Spinal Retractors	72
Taylor Tissue Forceps	51
Teale Uterine Vulsellum Forceps	281
Temple-Fay Laminectomy Retractor	82
Tenaculum Forceps	279, 280
Tenaculum Hooks	279
Tenaculum, Trachea	180
Tendon Forceps	260
Tendon Strippers	260
Tenotomy Hook	113
Tenotomy Scissors	36, 131
Terson Capsule Forceps	126
Test Drum	134

Thiry Headlight	6
Thomas Uterine Curettes	285
Thoms-Allis Tissue Forceps	211
Thoms-Gaylor Uterine Biopsy Forceps	284
Thoracic and Cardiovascular Instruments	30, 74, 219-230
Thoracic Clamps	224
Thoracic Forceps	223, 224
Thoracic Retractors	74
Thoracic Scissors	30
Thorek Scissors	25
Threading Stylet	230
Thyroid Retractors	69, 71
Tibia Retractors	72
Tieck-Halle Nasal Speculum	151
Timers	4
Tips For Ear Syringe	150
Tips For Tonsil Snare	178
Tips For Universal Handle	198, 199
Tips For Yankauer Suction Tubes	14
Tissue Forceps	48-54, 211, 212
Tivnen-Tyding Tonsil Seizing Forceps	175
Toennis Scissors	32
Toennis-Adson Scissors	32
Toennis-Olivecrona Clip Applying Forceps	238
Tongue Depressors	193
Tongue Forceps	194
Tongue Seizing Forceps	194
Tonometers	133
Tonsil Dissectors	173, 174
Tonsil Elevators	173
Tonsil Hemostatic Forceps	176, 177
Tonsil Hemostats	176, 177
Tonsil Hooks	174
Tonsil Instruments	33, 171-179
Tonsil Knives	171-173
Tonsil Ligature Forceps	177
Tonsil Needles	171
Tonsil Punch	179
Tonsil Retractors	174
Tonsil Scissors	33
Tonsil Screws	174
Tonsil Seizing Forceps	175
Tonsil Snare Wire	179
Tonsil Snare	177, 178
Tonsillectome	179
Took Corneal Knife	110
Touching Hammer For Tuning Forks	139
Tourniquets, Cardiovascular	230
Towel Clamps	68
Towel Forceps	68
Toynbee Ear Specula	135

Trachea Bistoury	180
Trachea Dilators	180
Trachea Instruments	69, 180-190
Trachea Retractors	69
Trachea Tenaculum	180
Trachea Tube Brush	190
Trachea Tubes	183-190
Tracheostomy Dressing Extension Set	186
Trachoma Forceps	129
Traction Forceps	201
Traction Handles	292
Traube Percussion Hammer	2
Trephines	243, 244
Trigeminus Scissors	31
Trocars	12, 13
Trocars, Antrum	12, 13
Trocars, Brain Exploring	237
Trocars, Gall Bladder	12
Troeltsch Ear Specula	135
Troemner Percussion Hammer	2
Trousseau Trachea Dilator	180
Tube Occluding Forceps	67
Tubes, Laryngectomy	188, 189
Tubes, Life Saving	180
Tubes, Suction	14
Tubes, Trachea	183-190
Tubing Connector for Yankauer Suction Tube	14
Tucker-McLean Obstetrical Forceps	291
Tucker-McLean-Luikart Obstetrical Forceps	291
Tuffier Rib Spreaders	221
Tumor Forceps	282
Tumor Screw	282
Tungsten Carbide Forceps	58
Tungsten Carbide Needle Holders	96-100
Tungsten Carbide Scissors	40-43
Tuning Forks	136-140
Tuttle-Singley Tissue Forceps	54
Tyding Tonsil Knife	172
Tyding Tonsil Seizing Forceps	175
Tyding Tonsil Snare	178
Tyding-Tivnen Tonsil Seizing Forceps	175
Tyrell Iris Hook	112

U

Uebe Cotton Applicators	150
Umbilical Clamps	294
Umbilical Scissors	26
Universal Forceps Tips	198, 199
Universal Handle	198
Universal Scissors	17
Universal Trocars	12

Unna Comedone Extractors	8
Urethral Catheters	268
Urethral Forceps	269
Urethral Sounds	267, 268
Urological Instruments	267-271
U.S. Army Bone Chisels	261
U.S. Army Bone Gouges	261
U.S. Army Osteotomes	261
U.S. Army Retractors	77
U.S. Army Scissors	17
U.S. Model Dressing Forceps	45
U.S. Model Tissue Forceps	49
Uterine Biopsy Forceps	284, 285
Uterine Curettes	285, 286
Uterine Dilators	275
Uterine Douche	276
Uterine Dressing Forceps	276, 277
Uterine Elevating Forceps	282
Uterine Gauze Packers	276
Uterine Scissors	24
Uterine Sounds	276
Uterine Sponge Holders	283
Uterine Tenaculum Forceps	279, 280
Uterine Vulsellum Forceps	281, 282
Utility Forceps	130
Uvula Retractor	193

V

Vaginal Retractors	274
Vaginal Specula	272, 273
Valve for Automatic Ear Syringe	150
Van Alyea Antrum Cannulas	169, 170
Van Alyea Frontal Sinus Cannulas	169
Van Buren Sequestrum Forceps	249
Van Buren Urethral Sounds	267
Vannas Iris Scissors	133
Varco Gall Bladder Forceps	206
Vaughan Abcess Knife	8
Vedder Tips for Tonsil Snares	178
Vein Retractors	234
Vein Strippers	231
Vena Cava Clamps	226, 227
Verhoff Capsule Forceps	126
Verhoff Lens Expressor	114
Vernon Percussion Hammer	1
Vienna Nasal Speculum	151
Virchow Brain Knives	260
Virchow Cartilage Knives	259
Virchow Skull Breaker	266
Virtus Splinter Forceps	56
Volkman Bone Curettes	255
Volkman Retractors	70
Von Graefe Cataract Knives	108

Von Graefe Strabismus Hooks	113
Von Petz Stomach & Intestinal Suture Apparatus	218
Vulsellum Forceps	281, 282

W

Wachenfeldt Clip Applying & Removing Forceps	103
Wachenfeldt Wound Clips	104
Wagner-Jansen Mastoid Retractor	78
Waldau Fixation Forceps	124
Walter Splinter Forceps	55
Wangensteen Dissector & Ligature Carrier	102
Wangensteen Needle Holder with T/C Jaws	99
Wangensteen Needle Holders	91, 92
Wangensteen Patent Ductus Clamp	227
Wangensteen Suture Forceps	47
Wartenberg Neurological Pinwheel	1
Watchmaker Forceps	57
Watson-Williams Nasal Polypus Forceps ..	154
Webster Needle Holder	88
Webster Needle Holder with T/C Jaws	96
Wecker Cyclodialysis Spatula	117
Wecker Iris Scissors	133
Weiss-Dupuy Tonsil Needles	171
Weitlaner Retractors	79, 80
Weitlaner-Beckman Retractors	80
Wells Enucleation Scoop	114
Wells-Spencer Hemostatic Forceps	62
Wertheim Hysterectomy Forceps	64
Wertheim Scissors	22
Wertheim-Cullen Kidney Pedicle Clamp	66
West Bone Chisel	265
West Bone Gouge	265
Westcott Iris Scissors	131
Westcott Tenotomy Scissors	131
Wheeler Cyclodialysis Spatula	117
Wheeler Discission Knife	109
White Tonsil Seizing Forceps	175
Wieder Pillar Retractor	174
Wieder Tongue Depressors	193
Wiener Antrum Rasps	165
Wiener Iris Hook	112
Wiener Keratome	112
Wigmore Plaster Saw	19
Wilde Ear Forceps	142
Wilde Nasal Dressing Forceps	153
Wilde-Blakesley Nasal Cutting Forceps	156
Wilder Lacrimal Dilators	121
Wilder Lens Loop	114
Willauer Thoracic Scissors	30
Willet Placenta Forceps	293
Williams Eye Speculum	105
Williams Intestinal Holding Forceps	210
Williams Lacrimal Probes	121
Williams-Watson Nasal Polypus Forceps ..	154
Wills Utility Forceps	130
Wilmer-Bagley Lens Expressor	114
Winter Placenta Forceps	294
Wire & Suture Scissors	103
Wire & Suture Scissors with T/C Blades	43
Wire Cutting Scissors	103
Wire Guides	247
Wire, Saw	245
Wire Tightening Forceps	247
Wire Twisting Forceps	247
Wires For Ear Snares	142
Wires For Nasal Snares	152
Wires For Tonsil Snares	179
Wittner Uterine Biopsy Forceps	285
Wolff Plaster Cast Breaker	19
Wolfson-DeMartel Anastomosis Clamps ...	216
Wolfson-DeMartel Clamp Closing Forceps .	216
Wolfson-DeMartel Clamp Holder	216
Wood-Crile Needle Holders	89
Wood-Crile Needle Holders with T/C Jaws	97
Wound Clips	104
Wrenches, Bone Plate	246
Wylie Uterine Dilators	275

Y

Yankauer Nasopharyngeal Speculum	151
Yankauer Salpingeal Curettes	146
Yankauer Salpingeal Probe	147
Yankauer Scissors	33
Yankauer Septum Needles	167
Yankauer Suction Tubes	14
Yeoman Biopsy Punch	299
Yeoman Rectal Biopsy Forceps	299
Young Boomerang Needle Holder	101
Young Intestinal Holding Forceps	209
Young Prostatic Lobe Holding Forceps	269
Young Prostatic Retractors	269
Young Tongue Forceps	194

Z

Zaufel-Jansen Bone Rongeur	251
Ziegler Cilia Forceps	127
Ziegler Eye Speculum	105
Ziegler Iris Knife Needle	109
Ziegler Knife Needles	109
Zipser Penis Clamp	271

SUPPLEMENT



QUEENS SQUARE
telescopic
percussion hammer
A2-128



MILLER
laryngoscope blades

A2-250	size 0	55mm	2¼"
A2-252	size 1	80mm	3¼"
A2-254	size 2	130mm	5¼"
A2-256	size 3	170mm	6¾"
A2-258	size 4	180mm	7"



McINTOSH FIBER OPTIC
laryngoscope blades

A2-260	size 1	75mm	3"
A2-262	size 2	90mm	3½"
A2-264	size 3	110mm	4¼"
A2-266	size 4	135mm	5¼"



MILLER FIBER OPTIC
laryngoscope blades

A2-268	size 0	55mm	2¼"
A2-270	size 1	80mm	3¼"
A2-272	size 2	130mm	5¼"
A2-274	size 3	170mm	6¾"
A2-276	size 4	180mm	7"



NAIL NIPPER
front cutting
14cm 5½"
A4-232



SCALPEL HANDLE #3
with 6cm ruler
on handle
Stainless
A6-103



SCALPEL HANDLE #7S
13cm 5"
Stainless
A6-105



SCALPEL HANDLE #4
with 6cm ruler
on handle
Stainless
A6-111



FOLDING SCALPEL HANDLE

- A6-210** for blade size 60
- A6-400** for blade sizes 10-15
- A6-410** for blade sizes 20-25



UNIVERSAL SCISSORS

- plastic handles
18cm 7"
- A7-120** black
- A7-122** red
- A7-123** blue
- A7-124** green

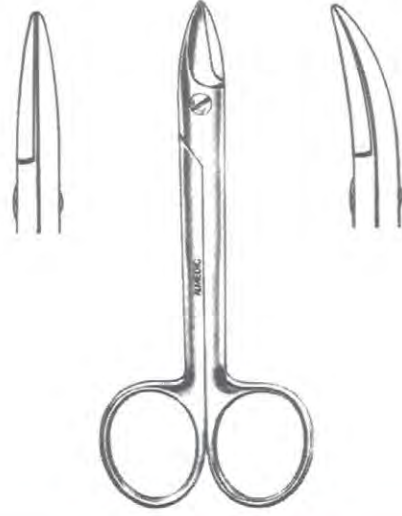

GUM SCISSORS
straight
12cm 4¾"
A8-900

GUM SCISSORS
curved
12cm 4¾"
A8-902

BEE BEE
CROWN SCISSORS
straight
11.5cm 4½"
A8-910

BEE BEE
CROWN SCISSORS
curved
11.5cm 4½"
A8-912



SPLINTER FORCEPS No. Oc 9
very fine taper points
9cm 3½"
A10-698

TWEEZERS
bent tips
9cm 3½"
A10-720



College Pliers
serrated
without lock
15cm 6"

A10-800



College Pliers
serrated
with lock
15cm 6"

A10-802



Meriam Pliers
serrated
without lock
16cm 6¼"

A10-810



Flagg Pliers
smooth
without lock
15cm 6"

A10-820



Flagg Pliers
smooth
with lock
15cm 6"

A10-822



Cotton Pliers
with notched tip
15cm 6"

A10-830



Perry Pliers
serrated
without lock
13cm 5"

A10-838



LORNA TOWEL CLAMP

A13-140 10cm 4"
A13-144 12cm 5"



PEERS TOWEL CLAMP
14.5cm 5¾"

A13-150

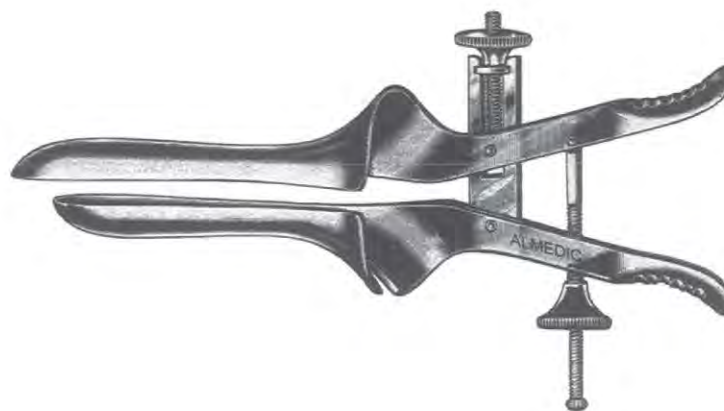

DE VILBISS (MILLER)
Vaginal Speculum

		width	large blade	small blade
A36-125	small	2.5cm 1"	8cm 3¼"	7cm 2¼"
A36-126	medium	3.5cm 1¼"	10cm 4"	9cm 3½"
A36-127	large	3.8cm 1½"	11.8cm 4½"	10.5cm 4¼"



McGIVNEY
hemorrhoidal ligator
complete with loading cone
18cm 7"

A39-280



LOADING CONE
for
McGivney Ligator

A39-282



McGIVNEY
hemorrhoid grasping
forceps
19cm 7½"

A39-284



LATEX "O" RINGS
for
McGivney Ligator

A39-286



OPERATING SCISSORS
SUPER CUT
 straight
 sharp/blunt
 14cm 5½"
A50-114



OPERATING SCISSORS
SUPER CUT
 curved
 sharp/blunt
 14cm 5½"
A50-154



MAYO SCISSORS
SUPER CUT
 straight
A50-244 15cm 6"
A50-248 17cm 6¼"



MAYO SCISSORS
SUPER CUT
 curved
A50-246 15cm 6"
A50-250 17cm 6¼"



MAYO STILLE SCISSORS
SUPER CUT
 straight
A50-270 15cm 6"
A50-274 17cm 6¼"



MAYO STILLE SCISSORS
SUPER CUT
 curved
A50-272 15cm 6"
A50-276 17cm 6¼"



KELLY SCISSORS
SUPER CUT
 straight
 15.5cm 6¼"
A50-310



KELLY SCISSORS
SUPER CUT
 curved
 15.5cm 6¼"
A50-312



IRIS SCISSORS
SUPER CUT
 straight
 11.5cm 4½"
A50-684

IRIS SCISSORS
SUPER CUT
 curved
 11.5cm 4½"
A50-686

STRABISMUS SCISSORS
SUPER CUT
 straight
 blunt/blunt
 11.5cm 4½"
A50-724

STRABISMUS SCISSORS
SUPER CUT
 curved
 blunt/blunt
 11.5cm 4½"
A50-726



GRAVES LASER SPECULUM
 black coated
 with evacuation tube

non-conductive		conductive
A80-100	small	A80-110
A80-102	medium	A80-112
A80-104	large	A80-114