



RDX QuikStor™ SATA III Internal Dock Reference Manual



©2016 Tandberg Data. All rights reserved.

Overland[®], Overland Storage[®], ARCvault[®], DynamicRAID[®], GuardianOS[®], NEO[®], NEO Series[®], PowerLoader[®], Protection OS[®], RAINcloud[®], REO[®], REO 4000[®], REO Series[®], Snap Appliance[®], Snap Care[®] (EU only), SnapSAN[®], SnapScale[®], SnapScale X2[®], SnapServer[®], StorAssure[®], Ultamus[®], VR2[®], and XchangeNOW[®] are registered trademarks of Overland Storage, Inc.

Tandberg Data[®], AccuGuard[®], AccuVault[®], DPS1000 Series[®], DPS1100[®], DPS1200[®], DPS2000[®], Magnum[®], QuikStation[®], QuikStor[®], RDX[®], RDXPRO[®], StorageLibrary[®], StorageLoader[®], Tandberg SecureService[®], Tandberg StorageLibrary[®], and VXA[®] are registered trademarks of Tandberg Data, Inc.

Desktop Cloud Orchestrator[®] and V3[®] are registered trademarks of Sphere 3D Corp.

Campus Cluster[™], NEO Agility[™], RapidRebuild[™], Snap ECR[™], Snap Encrypted Continuous Replication[™], SnapExpansion XSR[™], SnapScale X4[™], SnapServer DX Series[™], SnapServer XSD Series[™], SnapServer XSD 40[™], SnapServer XSR Series[™], SnapServer XSR 40[™], SnapServer XSR 120[™], SnapServer Manager[™], SnapStorage Manager[™], and SnapSync[™] are trademarks of Overland Storage, Inc.

BizNAS[™], QuadPak[™], and RDX+[™] are trademarks of Tandberg Data, Inc.

G-Series[™], Glassware 2.0[™], and SnapCLOUD[™] are trademarks of Sphere 3D Corp.

All other brand names or trademarks are the property of their respective owners.

The names of companies and individuals used in examples are fictitious and intended to illustrate the use of the software. Any resemblance to actual companies or individuals, whether past or present, is coincidental.

PROPRIETARY NOTICE

The information contained in this document is subject to change without notice.

This document contains proprietary information which is protected by copyright. All rights are reserved. No part of this document may be reproduced, modified, distributed, or translated to another language without prior written consent of Tandberg Data.

Tandberg Data, is a wholly owned subsidiary of Sphere 3D.

This document may describe designs for which patents are pending, or have been granted. By publishing this information, Tandberg Data conveys no license under any patent or any other right.

Tandberg Data shall not be liable for errors contained herein or for incidental or consequential damages (including lost profits) in connection with the furnishing, performance or use of this material whether based on warranty, contract, or other legal theory. Tandberg Data makes no representation or warranty with respect to the contents of this document and specifically disclaims any implied warranties of merchantability or fitness for any particular purpose. Further, Tandberg Data reserves the right to revise or change this document without obligation on the part of Tandberg Data to notify any person or organization of such revision or change.

Revision	Changes
Rev A	Initial Revision – December 2016

Preface

About This Manual

This is the Reference Manual for the Tandberg Data RDX QuikStor SATA III Removable Disk Dock product. The main purpose of this document is to provide customers with technical and operational details about the product design.

The following chapters are included in this manual:

- ▶ **Chapter 1** provides an overview of the basic features of the RDX QuikStor SATA III Removable Disk System.
- ▶ **Chapter 2** describes the Dock technical specifications in detail.
- ▶ **Chapter 3** describes the basic installation information.
- ▶ **Chapter 4** covers the hardware and software interfaces.
- ▶ **Appendix A** provides a list of additional related documentation.

Conventions Used in This Manual

This manual uses the following conventions:

NOTE: Notes provide additional information or suggestions about the topic or procedure being discussed.



IMPORTANT: Read text marked by the “Important” icon for information that will help you complete a procedure or avoid extra steps.



CAUTION: Read text marked by the “CAUTION” icon for information you must know to avoid damaging the RDX SATA III Internal Dock or losing data.



WARNING: Read text marked by the warning icon for information you must know to avoid personal injury.

AVERTISSEMENT: Lisez le texte marqué par le symbole avertissement pour prendre note des informations que vous devez connaître afin d'éviter des dommages corporels.

Product Warranty Caution

The RDX SATA III Internal Dock by Tandberg Data is warranted to be free from defects in materials, parts, and workmanship and will conform to the current product specification upon delivery. For the specific details of your warranty, refer to your sales contract or see the Tandberg Data web site:

www.tandbergdata.com

The warranty for the appliance shall not apply to failures caused by:

- Physical abuse or use not consistent with the operating instructions or product specifications.
- Repair or modification by anyone other than Tandberg Data's personnel or agent in a manner differing from the maintenance instructions provided by Tandberg Data.
- Removal of the Tandberg Data identification labels.
- Physical abuse due to improper packaging of returned unit.

If problems with the RDX SATA III Internal Dock dock occur, contact your maintenance organization; do not void the product warranty by allowing untrained or unauthorized personnel to attempt repairs.

Contacting Tandberg Data

Visit the Support section of the Tandberg Data web site (www.tandbergdata.com) for information on contacting technical support.



Contents

Preface

About This Manual	3
Conventions Used in This Manual	3
Product Warranty Caution	4
Contacting Tandberg Data	4

1: Product Overview

RDX Storage System	7
RDX QuikStor Internal SATA III Dock	7
RDX Cartridge	8

2: Dock Specifications

Dock Block Diagram	9
Mechanical Dimensions and Weight	10
Power Requirements	10
Dock SATA III Power Source	10
Dock Current Requirements	10
Environmental Specifications	10
Temperature and Relative Humidity	11
Vibration	11
Impact and Shock	11
Product Regulatory Compliance	11
Acoustic/Audible Noise Emissions	12
EMC Emission	12
Safety Compliance	13
Product Reliability	13
Electronics and Media MTBF	13
Mechanics MTTF	13
Useful Life Cycle	14
Functional Specifications	14
Eject Button and Emergency Eject Hole	14
Normal ejects	14
Unconditional Eject	15
Emergency Eject	15
Service Mode	15
Eject Button/Power LED	16

Activity LED 16
Supported Hardware SATA Interfaces 17

3: Installation Information

General Mounting Information 19
Rear Connectors 20
Power Dissipation 20

4: Hardware & Software Interfaces

Power Interface 21
Host Interface – SATA III 22
Software Interface 22

A: Reference Documentation

Index

Product Overview

RDX Storage System

RDX storage devices are disk-based storage systems with removable cartridges that offers rugged, reliable, secure, and convenient backup.

Supporting a wide range of applications, the RDX system is available with different host interfaces and a variety of cartridge capacities.

A complete operable RDX system is composed of the dock bay (Dock), the recording media and its physical carrier (Cartridge). The Cartridge is recognized by the docking bay and its media is recognized as a volume on a host system. For RDX products this volume is removable.

When a RDX Cartridge is inserted and loaded it is in the state where the device is capable of executing media access commands. After unloading, the volume media access commands cannot be performed.

The *write-protected* state determines whether an Initiator may or may not write information on a volume. This attribute is controlled by the user of the volume through a physical switch on the RDX Cartridge and through OS file system attributes.

RDX QuikStor Internal SATA III Dock

The RDX QuikStor SATA III cartridge-based removable storage system is designed for rugged, reliable and convenient digital data storage.



Figure 1: RDX QuikStor SATA III Internal Dock

For information on the Host Interface Software protocol reference the most recent RDX-SCSI specification document.

RDX Cartridge

The RDX QuikStor Cartridge system delivers a robust design that is physically, environmentally, and electrically shock-resistant for digital data protection and secure handling. The cartridge media defines the capacity of the product.



Figure 2: RDX Cartridge

The Dock is both backwards and forwards compatible with all RDX Cartridges – users can use higher or lower capacity cartridge media. Each RDX Cartridge contains features intended to protect the data written to the cartridge media including ESD protection, shock and vibration alleviation, and a physical Write Protect Switch detectable by the RDX Dock which may be set by the user to disallow modification of user data on the cartridge.

2

Dock Specifications

This section contains a set of specifications for the RDX QuikStor SATA III Dock.

Dock Block Diagram

All Dock operations are controlled by the main Micro Controller. This includes the motor operating the eject function in addition to communication with the user, the host, and the media.

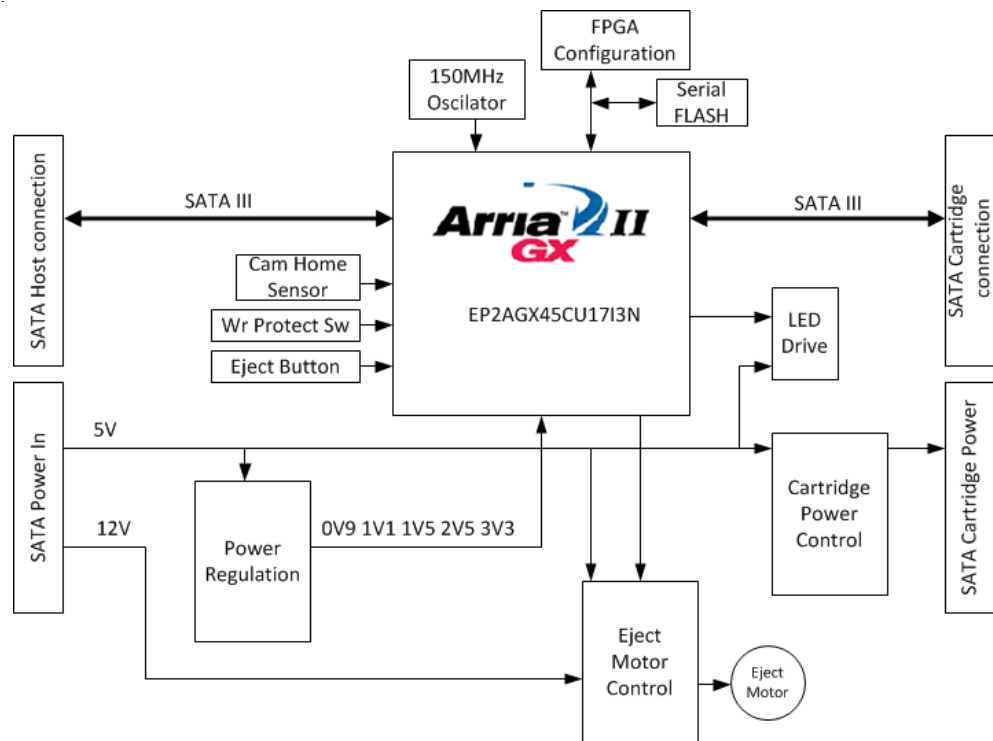

Figure 1: RDX SATA III Internal Dock Block Diagram

Mechanical Dimensions and Weight

The Internal Dock fits both 3½ and 5¼ inch half-height enclosure for diskette or disk drive using standard mounting holes for a half-height drive.

Table 1: Mechanical Dimensions and Weight

Form Factor	3 ½" Internal SATA III	5 ¼" Internal SATA III
Height	41.4mm (1.63")	41.4mm (1.63")
Width	101.6mm (4.00")	146.0mm (5.75")
Length (Including Bezel)	159.4mm (6.28")	171.9mm (6.77")
Weight	408g (0.90lb.)	635g (1.40lb.)
Orientation	Horizontal ±90°	Horizontal ±90°

Power Requirements

This addresses both the power source and power requirements.

Dock SATA III Power Source

The RDX QuikStor SATA III Internal Dock draws power from the Host power supply.

Dock Current Requirements

Table 2: Power Requirements SATA III Dock

Mode	Sleep without Cartridge [mA]	Standby with Cartridge [mA]	Operating Read or Write Typical/Peak [mA]	Eject Cartridge Typical/Peak [mA]
5 V Current	180mA	600mA	1200/2400mA	840/2400mA
12 V Current	75mA	250mA	800/1000mA	350/1000mA

Environmental Specifications

The following definitions are used in this section:

- **Operating** – The unit is unpacked, power is turned on, and a cartridge is inserted.
- **Storage** – The unit is unpacked and power is turned off (non-operating).
- **Transport** – The unit is packed in original package as when ready for shipment from factory.

Temperature and Relative Humidity

Table 3: Temperature and Relative Humidity

Mode	Temperature	Rel. Humidity	Max. Wet Bulb Non-condensing	Thermal Gradient	Maximum HDD Temp	Altitude
Operating	10 to 40 °C (50 to 104 °F)	20 to 80%	29 °C (84 °F)	10 °C/hr (18 °F/hr)	60 °C (140 °F)	-15 to 3048m (-50 to 10000ft)
Storage or Transport	-40 to 65 °C (-40 to 149 °F)	8 to 90%	38 °C (100 °F)	20 °C/hr (36 °F/hr)	N/A	-15 to 10660m (-50 to 35000ft)

Vibration

Table 4: Vibration Specifications Internal Dock

Mode	Frequency Range	Acceleration Level	PSD ¹ Break Points	PSD ¹ Level [g ² /Hz]	Application
Operating; Swept Sine	5-500-5Hz Upward & downward sweep	0.5g	—	—	X, Y, Z axes Sweep Rate: 1 Hz/s
Non-Operating; Swept Sine	5-500-5Hz Upward & downward sweep	1.0g	—	—	X, Y, Z axes 0.5 Octaves/min
Non-operating; Random	1 - 200Hz	2.0g rms	ISTA/ASTM Procedure 2A (Hz)	—	X, Y, Z axes 15 min. per axis

1. PSD = Power Spectral Density

Impact and Shock

Table 5: Impact and Shock Specifications Internal Dock

Mode	Acceleration Level	Duration [ms]	Application
Operating; ½ Sine Pulse	10g 65g	11ms 2ms	X, Y, Z axes
Non-Operating; ½ Sine Pulse	40g 145g	11ms 2ms	X, Y, Z axis

Product Regulatory Compliance

This sections covers regulatory emissions and safety compliance.

Acoustic/Audible Noise Emissions

The table below lists the acoustic noise emissions levels for the RDX QuikStor SATA III, per ISO 9296 and ISO 7779/EN27779/ECMA 74 (Clauses 6 & 7):

Table 6: Acoustic Noise Emissions

Mode	Sound Power Level	Sound Pressure Level
Operating	4.3 LwA, B	32 LpAm, dBA
Non-Operating (Idle)	N/A	N/A

EMC Emission

The RDX QuikStor SATA III meets or exceeds the regulations listed in the table below.

NOTE: Countries in orange text are not approved at time of publication. Future approval is pending.

Table 7: EMC Emission

Country	Regulatory Organization	Compliant to:
USA	Federal Communications Commission (FCC)	FCC 15B 107&109, Class B device
EU member nations	CE	Emissions Class B per EN55022:2010+AC:2011, EN55032:2012, EN61000-6-3, EN61000-3-2:2006 +A1:2009+A2:2009 & EN61000-3-3:2013 Immunity per EN55024: 2010& 61000-6-2
Canada	Limits and methods of measurement of Radio Disturbance Characteristics of IT equipment	CAN/CSA-CISPR 22-10
Australia and New Zealand	Australia Communications and Media Authority, ACMA (RCM)	AS/NZS CISPR 22:2009 + A1:2010 Class B
Japan	Voluntary Control Council for Interface (VCCI)	VCCI V-3 Class B
South Korea	Radio Research Agency Korea Communications Commission Republic of Korea (KCC)	KN 22 KN 24

FCC Compliance Notice



NOTE: This equipment has been tested and found to comply with the limits for a Class B digital device, pursuant to part 15 of the FCC Rules. These limits are designed to provide reasonable protection against harmful interference in a residential installation. This equipment generates, uses and can radiate radio frequency energy and, if not installed and used in accordance with the instructions, may cause harmful interference to radio communications. However, there is no guarantee that interference will not occur in a particular installation. If this equipment does cause harmful interference to radio or television reception, which can be determined by turning the equipment off and on, the user is encouraged to try to correct the interference by one or more of the following measures:

- Reorient or relocate the receiving antenna.
- Increase the separation between the equipment and receiver.
- Connect the equipment into an outlet on a circuit different from that to which the receiver is connected.
- Consult the dealer or an experienced radio/ TV technician for help.

Safety Compliance

The RDX QuikStor SATA III meets or exceeds the safety regulations listed in the table below:

Table 8: Safety Compliance

Country	Regulatory Organization	Compliant to:
USA	Nemko (NRTL)	UL 60950-1:2011-12
EU member nations	CE	IEC 60950-1:2005 (Second Edition) + Am 1:2009 + Am 2:2013
Canada	Nemko (NRTL)	CAN/CSA C22.2 60950-1/A1:2007
South Korea		No Safety
Member nations of IECEE (CEE, is a generic term for the group of countries in Central Europe , Southeast Europe , and Eastern Europe)	IECEE International Electrotechnical Commission on Electrical Equipment (IECEE) for Mutual Recognition of Test Certificates for Electrical Equipment "CB Scheme"	IEC 60950-1:2005 (Second Edition) + Am 1:2009 + Am 2:2013 with details and exceptions for each member country
Russia		CB Scheme
Japan		No Safety
Taiwan		No Safety

Product Reliability

The predicted reliability of the Dock is expressed in two parts that will cover the expected random Mean Time Between Failures (MTBF) for the electronics based on the Power On Hours (POH) and the Mean Time to Failure (MTTF) for the mechanical parts based on the POH *and* the Duty Cycle.

Electronics and Media MTBF

Table 9: Electronics and Media MTBF

Predicted, Actual "Mature" Dock Electronics MTBF	550 000 Hours
Predicted, Actual "Mature" Media MTBF	Dependent on HDD specifications. Typically greater than 550,000 Hours

Mechanics MTF

The failure rate for these parts is related to how often the Dock is actually used. In the case of the most critical components the reliability is specified as the Mean Time to Failure (MTTF) based on the POH and the Duty Cycle. The MTTF-values are not accumulative as the wear takes place in parallel.

Table 10: Mechanics MTF

The expected number of cartridge insertions a Dock can accept before the Dock connector fails	> 10 000 load/ejects
The expected number of times a cartridge can be inserted before the Cartridge connector fails	> 5 000 load/ejects

Useful Life Cycle

This is the period during which the Dock is serviceable either by adjustment or replacement of defective parts. In the case of the mechanical parts, replacements must be expected as soon as the lifetime is approached. This will depend on the actual usage of the Dock. This is not the product warranty period.

Table 11: Useful Life Cycle

Useful Life Cycle	> 10 years
-------------------	------------

Functional Specifications

The front of the internal RDX QuikStor SATA III has the following features.

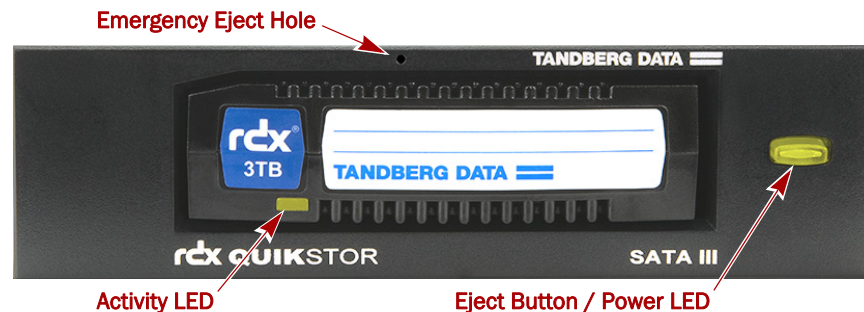
**Figure 2:** Front View of RDX QuikStor SATA III Dock and Features

- <TD Light Blue>Eject Button and Emergency Eject Hole
- <TD Light Blue>Eject Button/Power LED
- <TD Light Blue>Activity LED

Eject Button and Emergency Eject Hole

The eject button is used to initiate normal cartridge eject functions. It is also used to initiate an unconditional eject or service menu options as described below.

Normal ejects

Press the Eject Button to eject the RDX Cartridge. An Eject cycle may also be initiated by an eject command from the host. If the cartridge does not eject, make sure all write operations to the RDX system are complete before proceeding.

NOTE: The time from Eject Button press until the cartridge is ejected may vary. Eject may be prevented by the host OS or Host Software. Refer to the RDX SCSI specification for more detail.

When removing the cartridge, wait until the soft-eject function has terminated its operation. Then pull the cartridge straight out.

When inserting and removing the cartridge, to prevent damage:

- DO NOT use excessive force.
- BE SURE to insert the cartridge in correct orientation. Note that the cartridge has a beveled corner to prevent insertion upside-down.

Unconditional Eject

If the cartridge does not eject with a normal eject cycle it may be in the PREVENT state described in the cartridge LED state table below. This can be overridden using an unconditional eject. To initiate an unconditional eject by the RDX Dock press and hold the eject button until the eject cycle begins (approximately 5 seconds, varies with OEM firmware versions).

Emergency Eject

If the cartridge still will not eject after trying the steps above, use the following emergency methods to recover the cartridge:

- Insert the RDX Emergency Media Eject Pin into the Emergency Eject Hole to eject the cartridge.



Figure 3: RDX Emergency Media Eject Pin

NOTE: If the RDX Emergency Media Eject Pin is not available, a stiff paper clip, wire, or pin may be used instead.

Service Mode

The Service Mode is activated from the Eject Button. In order to activate the RDX service menu the cartridge needs to be ejected.

The RDX service menu can be entered by keeping the Eject button pressed for more than five (5) seconds when the cartridge is ejected.

When RDX service is entered, the menu entry will be indicated by a series of green LED blinks between a pair of amber LED blinks of the Eject Button/ Power LED. The number of Green LED blinks indicates the menu entry number.

If the user presses the eject button once, the display of the current menu entry indication is aborted and the start of the next menu entry item will be displayed.

If the user presses the eject button twice during one second (double-click) the requested menu function is started. The start of the menu item is indicated by the Eject Button/ Power LED flashing green rapidly for five (5) seconds.

The service menu exits when a menu entry is selected, if no button activates are detected for 60 seconds, or if the Eject button is pressed for more than five (5) seconds.







The implemented menu entry functions are:

- **Entry 1** - Set Removable Disk mode.
- **Entry 7** - Reset the RDX Dock.

Eject Button/Power LED

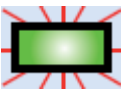
The Eject Button is illuminated by a Power LED. The table below describes the operation of this indicator:





Table 12: Eject Button/Power LED Activity

LED Color	LED Status	Meaning	Description	Host Activity
	OFF	NO POWER	Dock does not have power through SATA power connection	ON
	Steady GREEN	READY	Power is on, RDX is ready and the Dock is working properly	ON
	Blinking GREEN	EJECTING	Dock is ejecting the cartridge	ON
	Steady AMBER	FAULT	Dock has detected a Dock fault condition. For more information, run a diagnostic application.	ON
 	Steady GREEN changing to Blinking AMBER once eject button is pressed.	PREVENT	Host computer is accessing the media, and the user has pressed the Eject Button. The Dock will eject the cartridge after the Host access completes. Press and hold eject button for 5 seconds to force cartridge eject.	ON

Activity LED

The Activity LED displays the current status of the cartridge. The table below describes the operation of this LED:

Table 13: Cartridge Activity LED

LED Color	LED Activity	Meaning	Description
	OFF	NOT READY	Cartridge is not inserted properly or is powered down due to low power mode and host inactivity.
	On GREEN	READY	Cartridge is ready
	Blinking GREEN	ACTIVITY	Reading, writing, seeking
	On AMBER	FAULT	Dock has detected a cartridge fault condition. For more information, run a diagnostic application.

Supported Hardware SATA Interfaces

The following hardware interfaces are supported for the RDX QuikStor SATA III product:

- SATA III with an internal interface speed of 6Gbps
- SATA II with an internal interface speed of 3Gbps
- SATA I with an internal interface speed of 1.5Gbps

Installation Information

General Mounting Information

Table 1: General Mounting Information

Mounting Positions	Mounting position is either horizontal with the Eject button and indicator LEDs to the right, or vertical.
Mechanical Dimensions	The Dock occupies a half-size 3½ or 5¼ inch slot with standard holes for 3mm mounting screws on both sides and at the bottom of the Dock chassis. See Figure 6 for the mechanical dimensions of the Dock. Dimensions are in mm. General tolerances: +/-0.5mm.
Screw and Torque	Use standard 3mm mounting screws (M3x0.5) with maximum screw torque 0.5 Nm. Maximum screw length is 5mm.
Cable Lengths	The recommended maximum SATA III cable length is 1 meter. However, to increase system noise immunity, the cable should be kept as short as possible.
Power Connector	The power connector is a standard 15-pin SATA power connector.
Chassis Grounding	The Dock chassis must be grounded to the system chassis through the mounting screws. Correct grounding of the chassis is important to reduce radiated electromagnetic interference, and for electrostatic discharge (ESD) protection.

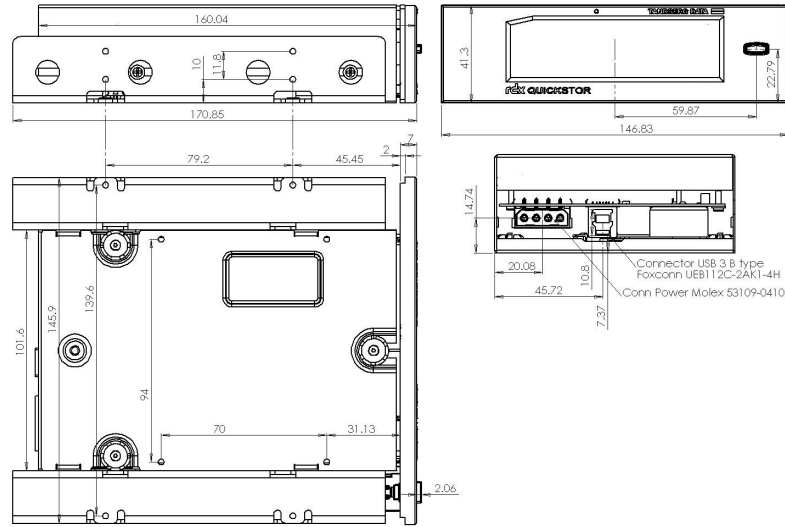

Figure 1: Dock Mounting Details

IMPORTANT: As system-mounting and grounding are outside our control, Tandberg Data cannot be held responsible for any problems due to systems not meeting the relevant testing standards.

Rear Connectors

The SATA Power Connector and SATA Host Interface are located at the rear end of the Dock and the layout shown in the figure below.

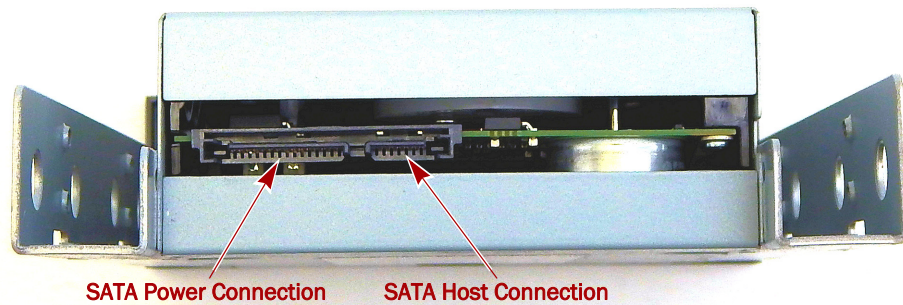

Figure 2: Rear View of SATA III Dock and Features

Power Dissipation

The maximum allowed internal temperature in the Dock in operating mode is limited by the media. The ambient temperature should be kept between 10°C and 40°C, humidity between 20% and 80%, and maximum Wet Bulb temperature is set

to 29°C. The host server must provide sufficient airflow to keep the HDDs in the RDX Cartridges within their allowable temperature range as long as the ambient temperature does not exceed 40°C.

Care should be taken, when designing a system, to provide sufficient cooling to meet the specifications above.

4

Hardware & Software Interfaces

The hardware interface connectors are located on the rear side of the product.

Power Interface

Power for the Internal Dock is provided through a 15-pin SATA power connector. The same type is used as power connectors on most SATA hard disk drives.

Table 1: Power Connector Pins

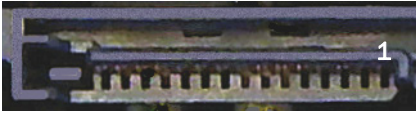
Connector	Pin	Signal Name
 Internal Dock Power Connector	P1	3.3V ¹
	P2	3.3V ¹
	P3	3.3V ¹
	P4	GND
	P5	GND
	P6	GND
	P7	5.0 V
	P8	5.0 V
	P9	5.0 V
	P10	GND
	P11	Common or GND
	P12	GND
	P13	12 V
	P14	12 V
	P15	12 V

1. It is not necessary to provide 3.3V on the SATA power connector to the dock. External 3.3V is not used in the RDX SATA III dock design.

Host Interface – SATA III

The RDX SATA III Dock interfaces to the Host computer via a standard SATA receptacle. The table below summarizes the signals on the SATA Host connector.

Table 2: SATA Host Connector Pins

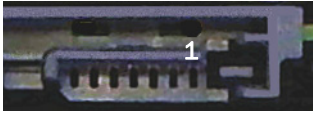
Connector	Pin	Signal Name
SATA Host Connector 	S1	GND
	S2	RX+
	S3	RX-
	S4	GND
	S5	TX-
	S6	TX+
	S7	GND

Software Interface

RDX QuikStor SATA III connects to a Host computer via a SATA interface. The device uses the ATAPI command set to transport SCSI commands over the interface. RDX is a block-access device and the Host computer has direct access to each logical block. File system management is controlled by the Host computer.

For information on the software interface, refer to the RDX-SCSI Specification.

A

Reference Documentation

Contents of this document are based on:

- *RDX-SCSI Specification Revision 1.99*, Tandberg Data Corporation, August 2016, available online at www.tandbergdata.com.

For additional information about the RDX SATA III Internal Dock, refer to the following publications:

- *RDX QuikStor Internal USB and Internal SATA Quick Start Guide*, part number 433822, available online at www.tandbergdata.com.
- RDX SATA III Knowledge Base articles available online at www.tandbergdata.com.
- Tandberg Data RDX Knowledge Base articles available online at <https://community.sphere3d.com/community/documentation/rdx>.



Index

#

15-pin SATA power connector 21

A

acoustic/audible noise emissions 12

C

cable lengths 19

chassis grounding 19

conventions 3

D

Dock block diagram 9

Dock dimensions 19

E

EMC emission 12

environmental specifications 10

H

hardware interfaces 17

I

impact and shock 11

interface speeds 17

M

mechanical dimensions 10

mounting position 19

P

power connector 19, 21

power requirements 10

product reliability 13

product warranty caution 4

R

RDX Cartridge 8

RDX QuikStor SATA III system 7

RDX system makeup 7

rear connectors 20

regulatory compliance 11

S

safety compliance 13

SATA Host connector 22

SATA III power source 10

screw and torque 19

service, contacting Tandberg Data 4

T

technical support, contacting 4

temperature and relative humidity 11

temperatures 20

V

vibration 11

W

weight 10

