

# Genetic and morphological characterization of the Physidae of South Carolina (Gastropoda: Pulmonata: Basommatophora), with description of a new species

**Amy R. Wethington**

Department of Biology  
Chowan University  
1 University Place  
Murfreesboro, NC 27855 USA  
wethia@chowan.edu

**John Wise**

**Robert T. Dillon, Jr.**  
Department of Biology  
College of Charleston  
Charleston, SC 29424 USA

## ABSTRACT

Recent experimental studies of reproductive isolation have distinguished three physid species in South Carolina: the cosmopolitan *Physa acuta*, bearing a one-part penial sheath, and two more restricted species bearing subdivided penial sheaths: *Physa pomilia* and *Physa* “Species A.” Here we describe “Species A” as *Physa carolinae*, an inhabitant of floodplain swamps and ditches of a vernal or intermittent character, ranging through coastal plain and lower piedmont regions from Virginia to Florida. *Physa carolinae* may be distinguished from *P. pomilia* by its larger adult size, more slender and elongate shell, and uniformly dark pigmentation. A sample of 11 *P. carolinae* from five South Carolina populations averaged greater than 10% sequence divergence from standard populations of *P. acuta* and *P. pomilia* for both CO1 and 16S mitochondrial genes. The circumstances under which a widespread and seasonally abundant freshwater gastropod such as *P. carolinae* might escape scientific notice for almost 200 years are reviewed.

*Additional keywords:* Taxonomy, Phylogeny, Gastropoda, *Physella*, *Physa acuta*, *Physa pomilia*, mtDNA sequence, CO1, 16S.

## INTRODUCTION

Pulmonate gastropods of the family Physidae are a common element of the freshwater benthos in South Carolina and throughout North America. Longstanding taxonomic confusion has, however, impeded any real advance in our understanding of their ecology and distribution. The initial monographic review of the family was that of Halde- man (1842), who recognized 12 species in the United States, only one of which ranged into South Carolina, *Physa heterostropha* (Say, 1817). Binny’s (1865) mono- graph included 30 specific physid nomina in two genera (*Physa* and *Bulinus*), three of which might potentially inhabit South Carolina: *Physa gyrina* (Say, 1821) and *Physa ancillaria* (Say, 1825) in addition to *P. heterostro- pha*. Crandall (1901) recognized as valid only 17 physid

species in eastern North America, two of which he admitted to South Carolina: *Physa gyrina* and *P. pomilia* (Conrad, 1834). Only four species were listed as confirmed for the state by Mazyck (1913): *P. gyrina*, *P. pomilia*, *P. heterostropha* and *P. cubensis* (Pfeiffer, 1839). Walker (1918) catalogued 77 specific nomina in the family Physidae of North America, approximately half of which were in syn- onymy at the time, but did not provide ranges.

The most influential twentieth century monograph of the American Physidae was that of Te (1978; 1980). He recognized approximately 40 species and subspecies, classified by penial morphology into four genera: *Physa* (sensu stricto), *Physella*, *Aplexa*, and *Stenophysa*. Te (in Burch, 1989) listed three species whose range might include South Carolina: *Physella gyrina* (with several subspecies), *Physella hendersoni* (Clench, 1925), and *Physella heterostropha pomilia*.

Recent studies of genetics, morphology, and repro- ductive biology have shown, however, that the number of valid North American species in the family Physidae has been overestimated. Wethington and Lydeard (2007) have proposed a return to the two-genus classi- fication of the Physidae, *Aplexa*, and *Physa*, the former with one North American species and the latter with approximately ten. *Physa heterostropha* and *P. cubensis* have been shown to be junior synonyms of the cosmo- politan *P. acuta* (Draparnaud, 1805), and *P. hendersoni* a junior synonym of *P. pomilia* (Dillon et al., 2002; Para- ense and Pointier, 2003; Wethington, 2004; Dillon et al., 2007; Wethington and Lydeard, 2007). No populations of bona fide *P. gyrina* have been confirmed from South Carolina (unpublished observations).

During preliminary surveys of mtDNA sequence di- vergence among South Carolina populations of *Physa acuta*, Wethington (2004) distinguished a population of *Physa* from Johns Island (Charleston County) bearing elongate shells and dark bodies. This population, previ- ously referred to *Physa heterostropha pomilia* (“JNI”) by Dillon and Wethington (1995), was phylogenetically distinct from known *P. acuta* controls, with a genetic

distance between 14.5–18.9% (combined mtDNA 16S +CO1, without loops and truncated). Additional populations bearing similar morphology and mtDNA haplotypes were identified and referred to “*Physa* species A” by Wethington and Lydeard (2007).

Controlled breeding experiments have recently confirmed reproductive isolation between “*Physa* Species A” and both *P. acuta* and *P. pomilia* (Dillon, in review). In this paper we describe “Species A” as *Physa carolinae* and distinguish it both morphologically and genetically from *P. acuta* and *P. pomilia*, which themselves have been confused and poorly characterized in some respects.

## MATERIALS AND METHODS

**STUDY POPULATIONS:** Our reference population of *Physa acuta* was sampled from the main pond at Charles Towne Landing State Park, within the city limits of Charleston, South Carolina (32.8062°N, 79.9862°W). Breeding experiments have shown this population to be conspecific with near-topotypic *P. acuta* from France (Dillon et al., 2002). This population has previously been designated “Ctl” by Dillon and Wethington (1995), population “C” by Dillon et al. (2005) and Wethington (2004), and population A by Dillon et al. (2004, 2007) and Dillon (in review). The habitat has been described by Dillon and Dutra-Clark (1992).

Our reference population of *Physa pomilia* was collected from the Combahee River at the US 21/17A bridge in Yemassee, South Carolina (32.7060°N; 80.8281°W). This site was given as the type locality for *Physa pomilia hendersoni* by Clench (1925). Dillon et al. (2007) reported no reproductive isolation between the Yemassee population (population H) and snails sampled from Conrad’s (1834) type locality for *Physa pomilia* in Alabama. Reproductive isolation is complete, however, between population H and both *P. acuta* and Species A (*P. carolinae* new species) (Dillon, in review). This population was designated “*ysr*” by Wethington (2004) and “*scysr*” by Wethington and Lydeard (2007).

Our reference population of Species A (*P. carolinae* new species) was sampled from a spring by Huger Creek at Huger Landing, 4 km N of Huger, Berkeley County, South Carolina (33.1305°N, 79.8111°W). This is the same population from which Dillon (in review) founded the line “S” for studies of reproductive isolation. For mtDNA sequence analysis we sampled five additional populations from South Carolina, as follows. Population jni was collected from agricultural ditches 3.5 km NE of Legareville, Johns Island, Charleston County (33.1305°N, 79.8111°W). This is the original “JNi” of Dillon and Wethington (1995), also analyzed as “scjni” by Wethington (2004) and Wethington and Lydeard (2007). Population blac was collected from the Black River at the boat ramp near the SC 41 bridge, Williamsburg County (33.4905°N, 79.5459°W). Population bull was sampled from Bull Bridge Creek at SSR 38 bridge, Charleston County (32.8182°N, 80.3994°W). Population

hell was sampled from Hellhole Bay Swamp by SC 41, 1.5 km SW of Jamestown, Berkeley County (33.2749°N, 79.7041°W). Population mac was collected from Melichamp Creek near the SC 165 bridge, Charleston County (32.7620°N, 80.2416°W).

**SEQUENCING:** DNA was extracted from 36 individual snails: 20 *Physa acuta*, 5 *Physa pomilia*, and 11 *Physa* Species A (*P. carolinae* new species) from five populations (jni = 4, blac = 2, bull = 2, mac = 2, hell = 1). Although all 36 were successfully amplified and sequenced for 16S mtDNA, only a subset of 23 were sequenced for CO1 (14 *P. acuta*, three *P. pomilia*, and six *Physa* Species A (*P. carolinae* new species): 2 jni, 2 bull, 1 blac, 1 hell).

DNA was extracted from whole tissue using standard phenol chloroform procedures (Sambrook et al., 1989). Pieces of mtDNA from genomic DNA were copied and augmented via the Polymerase Chain Reaction using 16S primers (L2510 and H3080=16Sar-L and 16Sbr-H; Palumbi et al., 1991) for a 550 base pair segment and CO1 primers (LCO1490 and HCO2198; Folmer et al., 1994) for a 650 base pair segment, cleaned using standard procedures and then cycle-sequenced. The double-stranded PCR products were generated using 50–500 ng of template genomic DNA in 25 µl volumes (10 mM Tris, 50 mM KCL, 2.5 mM MgCl<sub>2</sub>, 1 µM of each primer, 0.1 mM of each dNTP, 1.5 units Taq DNA polymerase; Fisher Scientific). The amplification regime began with a denaturation at 92°C for two minutes followed by 35 cycles of the following: denaturation at 92°C for 40 seconds, annealing at 52°C for 60 seconds (16S) or 50°C for 60 seconds (CO1), and extension at 68°C for 90 seconds. The amplified DNA was then concentrated using Millipore Ultrafree MC filters and provided the template for cycle sequencing using the ABI BigDye kit following manufacturer’s instructions. The reactions were purified using Quiagen DyeEx spin columns and sequenced on an ABI3100 genetic analyzer.

Sequences were aligned by eye directly for CO1 and by using the LSU rDNA secondary structure for 16S (Lydeard et al., 2000) using BioEdit (Hall, 1999). Loops and indels were excluded from analysis of the 16S data set, lowering the effective sequence length from 533 to 446 base pairs. Two separate phylogenetic analyses were employed: a Bayesian analysis and a Maximum Likelihood analysis.

MrBayes v3.0B4 (Ronquist and Huelsenbeck, 2003) was used for the Bayesian analysis, with posterior probabilities guided by the General Times Reversible model. The CO1 and 16S gene portions were analyzed separately due to limitations in computer memory. There were four separate Monte Carlo Markov chains and the number of generations was preset to 10,000,000 with the first 10,000 generations excluded from the analysis for both runs. The burn in value was sufficient for stable likelihood tree values for each analysis. Probabilities were calculated for each node. Since CO1 is a coding region of the mtDNA genome, a coding block was used. The data were partitioned by codon and the GTR model

applied for each defined partition within the 600 base pair segment used. A non-coding block was used to analyze the 446 bp of the 16S gene, again under the GTR model, to infer the Bayesian phylogeny.

Modeltest (Prosada and Crandall, 1998) was employed to pick the best fitting model for the evolution of base pair substitution for a maximum likelihood analysis. The JC model, equal base frequencies, and all rates equal appeared to be the best model to use for the CO1 gene portion while the HKY + G,  $K = 5$ , different base frequencies ( $A = 0.3678$ ,  $C = 0.1324$ ,  $G = 0.1840$ , and  $T = 0.3158$ ) with a ti/tv substitution ratio of 0.9928 appeared to be the best model for the 16S gene portion. Since different models were picked, the CO1 and 16S gene portions were analyzed separately.

**MORPHOLOGY:** Standard length was measured as the maximum shell dimension on samples of 30 adults from each of the three reference populations. Shell width was measured as the maximum dimension perpendicular to shell length. The significance of the difference in shell width between *Physa* Species A (*P. carolinae* new species) and *P. pomilia* (holding length constant) was tested with analysis of covariance using the separate slopes model (JMP version 7). All 90 of these specimens have been deposited as vouchers in the Academy of Natural Sciences of Philadelphia, 20 as dry shells and 10 in absolute ethanol for each species. The 30 individuals of *Physa* species A constitute the holotype and paratypes of *Physa carolinae* new species.

Initial anatomical observations were made on living snails with a Zeiss dissecting microscope. Shells were then cracked and whole animals dissected and stained with toluidine blue. Line drawings were composed both freehand and with the aid of a camera lucida. Radula were extracted from the buccal mass with a dilute solution of commercial bleach, air-dried, coated with gold-palladium and examined with a JEOL JSL 6000 scanning electron microscope set from 5–10 KV.

## RESULTS

**SEQUENCE DIVERGENCE:** A total of 28 unique mtDNA sequences were obtained from the 36 snails we amplified for the 16S gene, and 15 unique mtDNA sequences were obtained from the subset of 23 snails successfully amplified for CO1. Genbank accession numbers are given in Table 1. Bayesian analysis of both data sets confirmed that *Physa* Species A (*P. carolinae* new species), *P. acuta*, and *P. pomilia* were all monophyletic approaching 1.0 probability, all five populations of Species A (*P. carolinae* new species) clustered together quite distinctly from *P. acuta* and *P. pomilia* (Figures 1 and 2). The maximum likelihood analysis of both data sets confirmed the Bayesian analyses (Figures 3 and 4). There appear to be three separate phylogenetic species uncovered in our sampling of South Carolina snails. Both 16S analyses reveal a basal and distinct population (“mac”) within the Species A (*P. carolinae* new species) clade.

Table 1. Genbank accession numbers for all individual *Physa* sequenced.

Species	Individual	Genbank 16S	Genbank CO1	
<i>Physa acuta</i>	Ctl1	GQ415009	See C14	
	Ctl3	GQ415010	See C12	
	C1	GQ415011	–	
	C2	GQ415012	GQ415033	
	C3	GQ415013	GQ415034	
	C4	See C11	See C12	
	C5	GQ415014	GQ415035	
	C6	See C11	See C12	
	C9	See C11	GQ415036	
	C11	GQ415015	GQ415037	
	C12	See C11	GQ415038	
	C14	GQ415016	GQ415039	
	C15	GQ415017	–	
	C16	GQ415018	See C12	
	C18	GQ415019	–	
	C19	See C11	–	
	C21	See C11	See C14	
	C23	GQ415020	–	
	C24	GQ415021	–	
	C27	See C11	See C14	
	<i>Physa carolinae</i>	blac1	GQ415022	GQ415040
		blac2	GQ415023	–
		bull1	GQ415024	GQ415041
		bull2	GQ415025	GQ415042
		hell1	GQ415026	GQ415043
		jni1	EU038348	EU038395
		jni2	EU038349	EU038396
jni7		GQ415027	–	
jni11		GQ415028	–	
mac1		GQ415029	–	
mac2		GQ415030	–	
<i>Physa pomilia</i>	ysr1	AY651232	AY651194	
	ysr2	AY651233	AY651195	
	ysr3	AY651234	AY651196	
	ysr4	GQ415031	–	
	ysr5	GQ415032	–	

However, the bootstrap support for this group is weak in the maximum likelihood analysis.

*Physa acuta* and *Physa* Species A (*P. carolinae* new species) appear to be the most genetically similar species pair by a slight margin. Their 16S sequence divergence ranged from 8.5%–12.6% (uncorrected p-values), with 446 nucleotides in the denominator, and their CO1 divergence ranged from 14.7%–17.1%, with 600 nucleotides in the denominator. Both of these ranges were slightly below those recorded for *P. pomilia* and Species A (*P. carolinae* new species) (16.1–17.7% 16S, 17.5–18.8% CO1), and *P. pomilia* and *P. acuta* (15.5–16.6% 16S, 18.5–20.5% CO1). Within-species percent base pair divergence ranged up to 7.4% for 16S and 13.0% for CO1, both values recorded between individuals sampled from rather distant populations of Species A (*P. carolinae* new species).

**MORPHOMETRICS:** Regressions of shell width on shell length for 30 individuals sampled from each of the three reference populations are shown in Figure 5. The regression equations of  $Y = 0.42x + 1.1$  ( $r = 0.68$ ) for *P. pomilia*

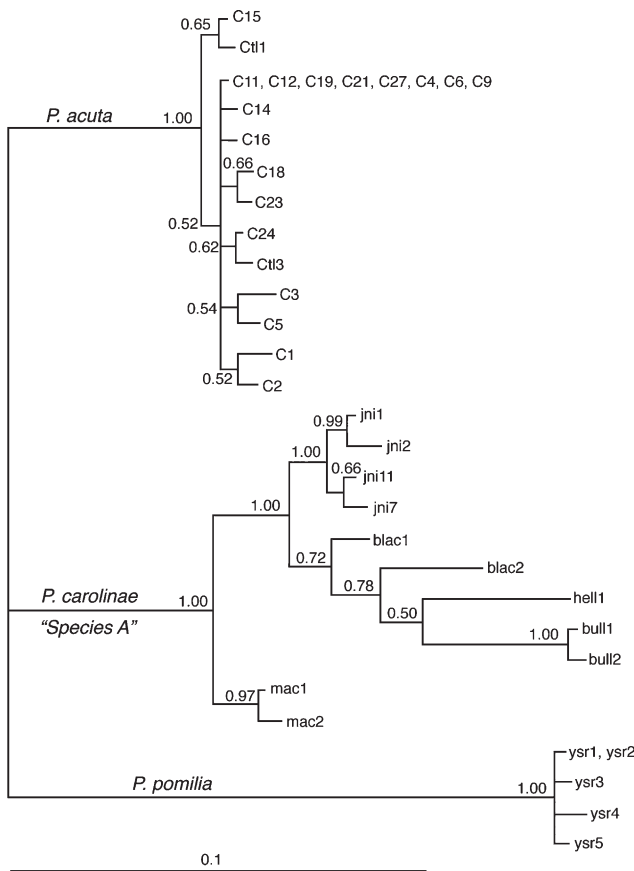

**Figure 1.** 16S Bayesian analysis showing the three genetically distinct South Carolina species: *Physa acuta*, *P. pomilia*, and *Physa* Species A (*P. carolinae* new species).

and  $Y = 0.40x + 0.95$  ( $r = 0.69$ ) for Species A (*P. carolinae* new species) demonstrated no significant difference in slope ( $0.42 \pm 0.09$  and  $0.40 \pm 0.08$ , respectively). Their Y-intercepts were significantly different, however, separate-slopes analysis of covariance returning a value of  $t = -2.82$  ( $p = 0.007$ ). Thus, while *P. carolinae* bears a more significantly slender shell, the rate at which its whorls expand is similar to that of the anatomically similar *P. pomilia*.

The regression of shell width on shell length for *P. acuta* was  $Y = 0.71x - 0.48$  ( $r = 0.92$ ). With a slope significantly greater than 0.5 ( $0.71 \pm 0.08$ ), shells of individual *P. acuta* tend to grow wider as they mature, while those of *Physa* Species A (*P. carolinae* new species) and *P. pomilia* tend to grow narrower.

## SYSTEMATICS

Family Physidae Fitzinger, 1833  
Genus *Physa* Draparnaud, 1801

*Physa acuta* Draparnaud, 1805  
(Figures 1–14)

*Physa acuta* Draparnaud, 1805: 55, pl. 3, figs. 10–11.  
*Lymnaea heterostropha* Say, 1817: no pagination, pl. 1, fig. 6.

*Physa cubensis* Pfeiffer, 1839: 354.

*Physa integra* Haldeman, 1841a: cover, 3. 1842–43: 33, pl. 4, figs. 7–8.

*Physa mexicana* Philippi, 1841: 5, pl. 1, figs. 3–4.

*Physa osculans* Haldeman, 1841b: 78, pl. 4, fig. 6.

*Physa venustula* Gould, 1847: 215; 1852: 115, pl. 8, figs. 134–134b

*Physa jamaicensis* C. B. Adams, 1851: 174.

*Physa virgata* Gould, 1855: 128.

*Physa niagarensis* Lea, 1864: 114; 1866: 168, pl. 24, fig. 97.

*Physa billingsi* Heron, 1880: 62, fig. 5.

*Physa conoidea* Fischer and Crosse, 1886: 101, pl. 39, figs. 8–8a.

*Physa lacustris* Clessin, 1886: 344, pl. 48, fig. 9.

*Physa cupreonitens* Cockerell, 1889a: 63; 1889b: 1, fig. 1.

*Physa osculans patzcuarensis* Pilsbry, 1891a: 9; 1891b: 323, pl. 15, fig. 5.

*Physa porteri* Germain, 1913: 161, fig. 20.

*Physa bottimeri* Clench, 1924: 12.

*Physa elegans* Clench and Aguayo, 1932: 37, Clench 1936: 342, pl. 25, fig. 1.

*Physa natricina* Taylor, 1988: 67, fig. 6a–n.

*Physella winnipegensis* Pip, 2004: 42–48; Pip and Frank, 2008: 10–16.

**Description:** The shell and anatomical morphology have been well-characterized by Paraense and Pointier (2003). Our observations on individuals sampled from

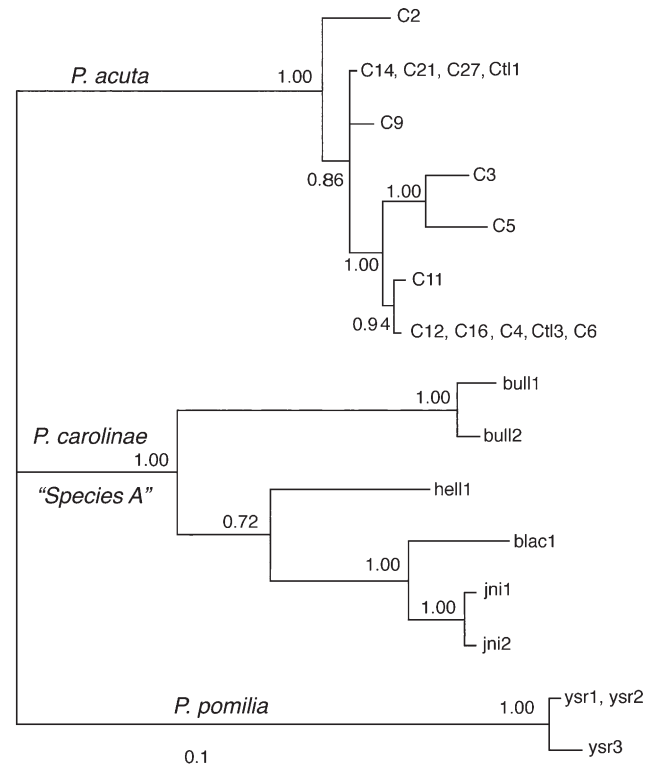

**Figure 2.** CO1 Bayesian analysis showing the three genetically distinct South Carolina species: *Physa acuta*, *P. pomilia*, and *Physa* Species A (*P. carolinae* new species).

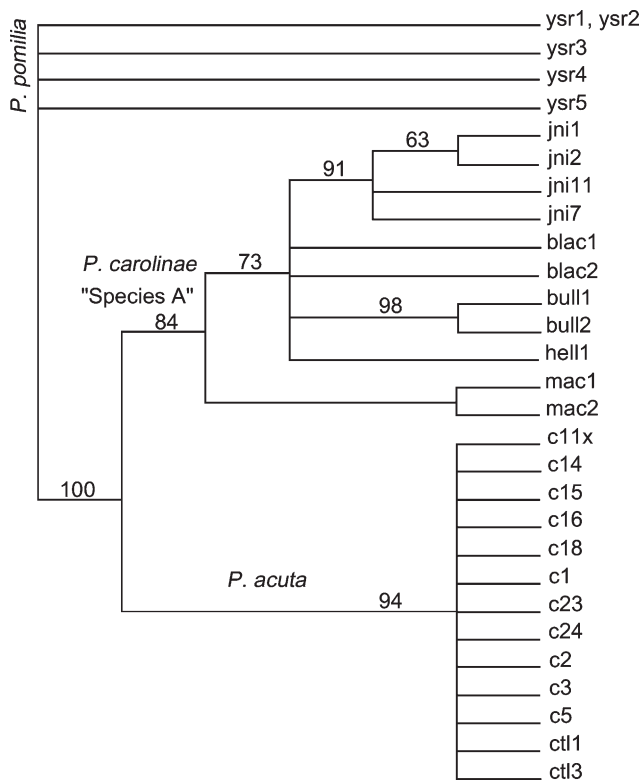

**Figure 3.** 16S Maximum likelihood analysis using HKY+G model with the following base frequencies: A = 0.3678, C = 0.1324, G = 0.1840, and T = 0.3158 showing three genetically distinct South Carolina species: *Physa acuta*, *P. pomilia*, and *Physa* Species A (*P. carolinae* new species). C11x represents the following identical haplotypes: c11, c12, c19, c21, c27, c4, c6, and c9.

the reference population at Charles Town Landing do not differ in any material respect. Shell (Figure 6) sinistral, elongate-ovate, high spired, thin, translucent, lustrous, with faint spiral growth lines. Body whorl approximately 85% of shell length, with four to five adult whorls, with rounded shoulders and impressed sutures. Spire profile flat to slightly concave, apex sharply pointed (“acute”). Large auricular aperture, approximately 75% of shell length, with thin outer lip. Mature size is reached about 6–8 weeks post-hatch in our standard culture conditions, at mean shell lengths ranging from 5.3–7.4 mm (Wethington and Dillon, 1993; 1997). From the regression shown in Figure 3, the predicted ratio of length to width for a 6 mm individual would be 1.59, and that of an 8 mm individual would be 1.54. Cephalopedal mass (Figure 9) light gray to tan, with long, slender tentacles and rounded or fan-like labial palps. Jaw simple, lacking lateral processes. Mantle typically bearing a reticulate pigmentation pattern, sometimes demonstrating digitations. Foot extending approximately the length of the shell, pointed posteriorly. Penial complex (Figure 11) includes a preputium (with preputial gland) and a muscular (non-glandular) penial sheath. This general penial morphology has been characterized as “type-c”

(Te, 1978; Wethington and Lydeard, 2007). When everted, the penis slides through the preputium to form a long, simple, fingerlike projection, with a lateral lobe corresponding to the preputial gland. Radula (Figure 14) comprising approximately 30–40 V-shaped rows of approximately 120–160 comb-like teeth. Each row has a tricuspid median flanked by 60–80 teeth bearing approximately 8–12 cusps.

**Synonymy:** An extensive synonymy has been published by Taylor (2003). In addition, breeding studies have uncovered no evidence of reproductive isolation between *P. acuta*, *P. heterostropha*, *P. integra*, or *P. virgata* (Dillon et al., 2002; 2005). *Physa cubensis* Pfeiffer was synonymized under *P. acuta* by Paraense and Pointier (2003), and *Physa natricina* Taylor by Rogers and Wethington (2007). The weight of these studies, together with the DNA sequence results of Wethington and Guralnick (2004) and Wethington and Lydeard (2007), combine to suggest the additions to the synonymy of Taylor (2003) listed above.

**Vouchers:** Academy of Natural Sciences of Philadelphia, 20 dry shells (ANSP 422686) and 10 in 100% ethanol (ANSP A21949).

**Type Locality:** River Garonne, France.

**Distribution and Habitat:** Dillon et al. (2002) nominated *P. acuta* as “the world’s most cosmopolitan freshwater gastropod,” with a modern range extending across six continents. Populations are common throughout South Carolina in ponds, reservoirs, and the margins of

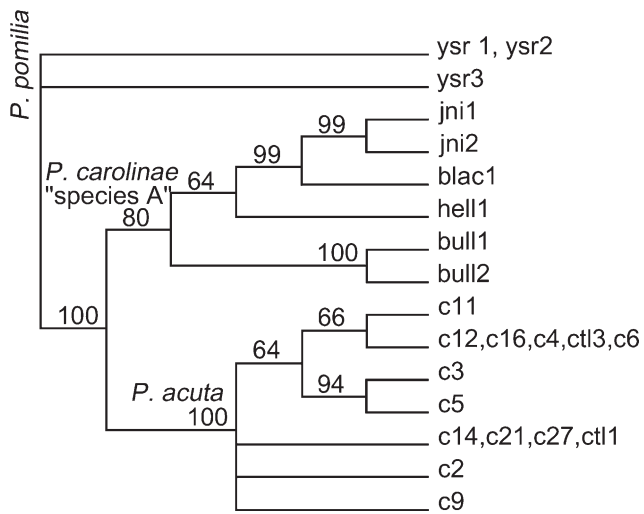

**Figure 4.** CO1 Maximum likelihood analysis using JC model with equal base frequencies and an equal rate substitution showing the three genetically distinct South Carolina species: *Physa acuta*, *P. pomilia*, and *Physa* Species A (*P. carolinae* new species).

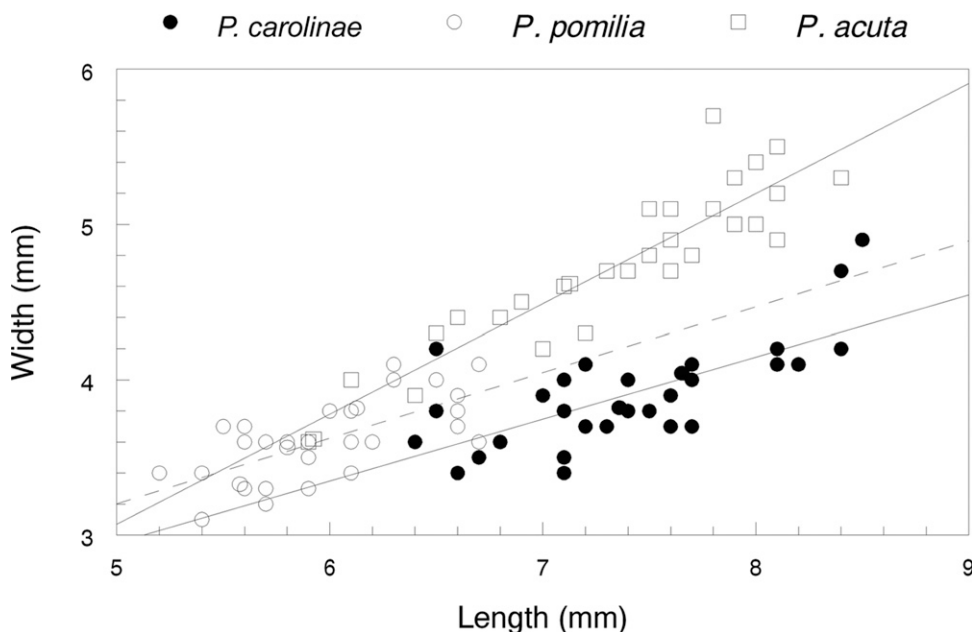

**Figure 5.** Shell width as a function of shell length in three samples of *Physa* from South Carolina: *Physa carolinae* new species (Species A) (dark circles, lower solid line), *P. pomilia* (open circles, dashed line) and *P. acuta* (squares, upper solid line).

rivers and streams with low current, especially in rich or disturbed environments.

*Physa pomilia* Conrad 1834 (Figures 1–13)

*Physa pomilia* Conrad, 1834: 343; 1866: 278, pl. 15, figs. 1–3.

*Bulinus pumilus* Beck, 1837–38: 117.

*Physa showalteri* Lea, 1864: 115; 1866: 170, pl. 24, fig. 92.

*Physa pomilia ariomus* Clench, 1925a: 2, pl. 1, fig. 2.

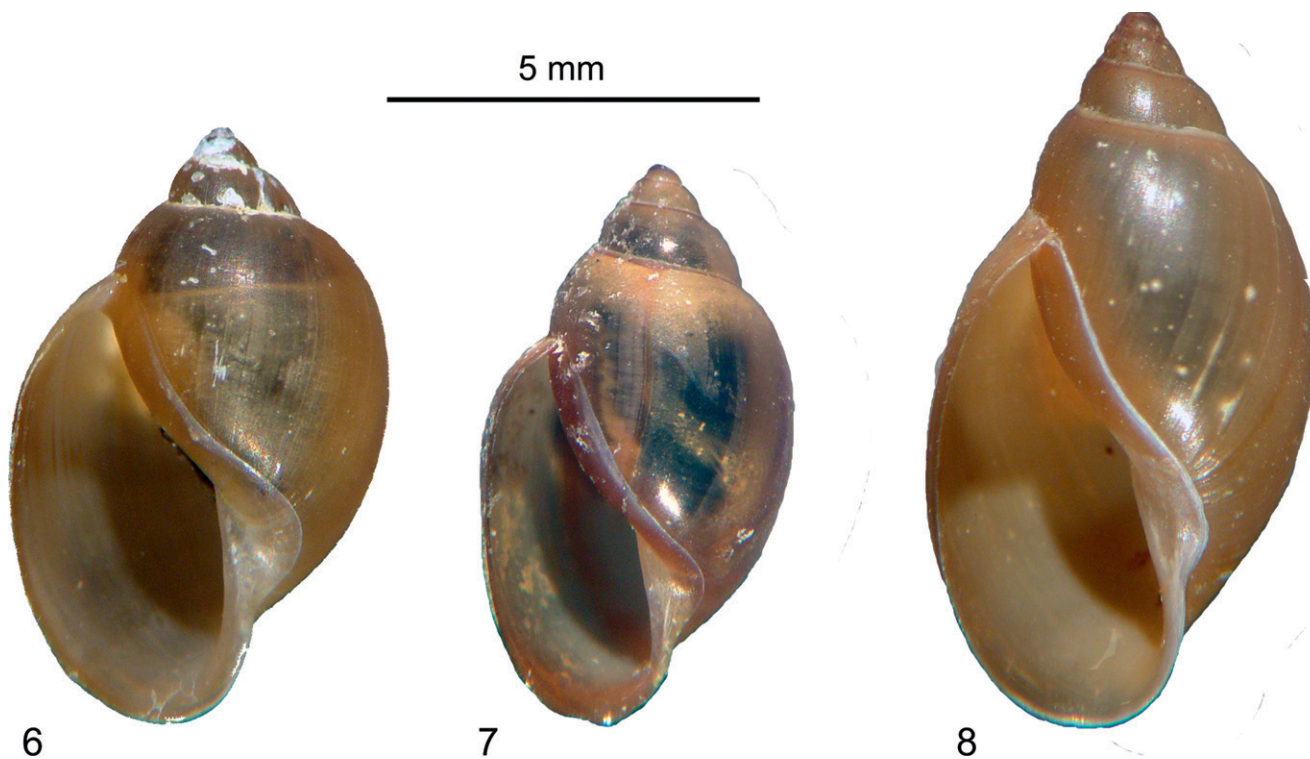

**Figures 6–8.** Example shells from the three reference populations. **6.** *Physa acuta* (ANSP 422686) **7.** *Physa pomilia* (ANSP 422687) **8.** *Physa carolinae*, new species (holotype, ANSP 422688).

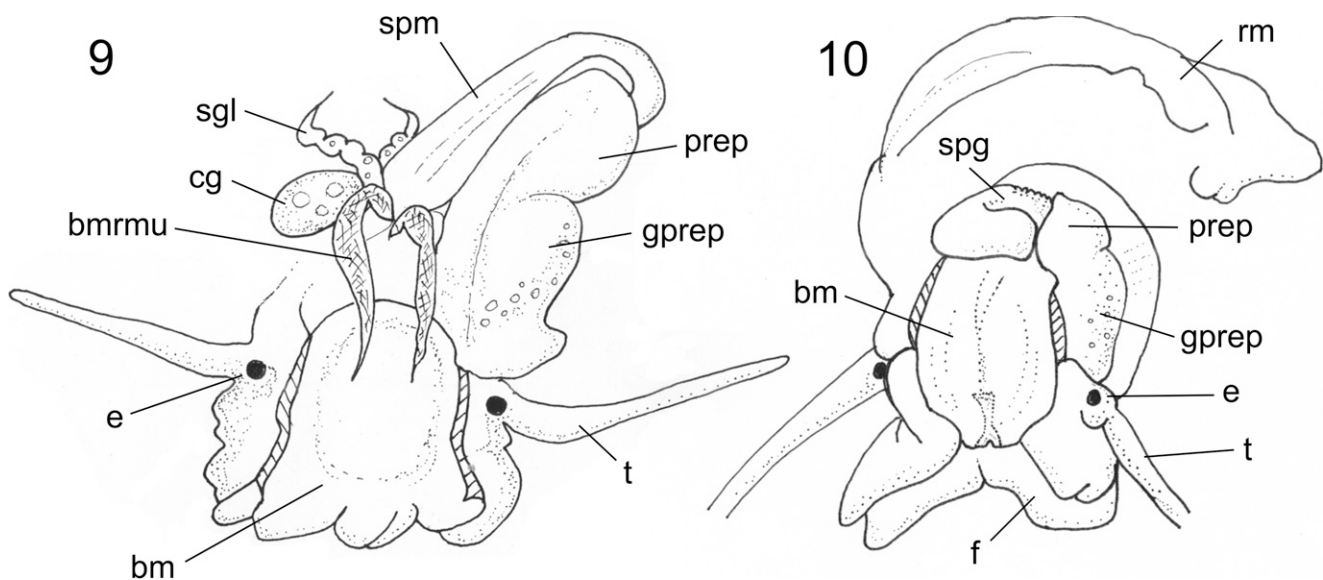

**Figures 9–10.** The head regions of *Physa* species, bisected to reveal the penial complex in situ. **9.** *Physa acuta*. **10.** *Physa pomilia* and *P. carolinae* new species. Abbreviations: **bm**, buccal mass; **bmmu**, buccal mass retractor muscles; **cg**, cerebral ganglion; **e**, eye; **f**, foot; **gprep**, preputial gland; **prep**, preputium; **rm**, reflected mantle; **sgl**, salivary gland; **spg**, glandular portion of penial sheath; **spm**, muscular portion of penial sheath.

*Physa pomilia hendersoni* Clench, 1925a: 4, pl. 1, fig. 3.

*Physa barberi* Clench, 1925b: 2, pl. 1, fig. 1–3.

*Physella hendersoni hendersoni* Te, 1980: 184; Burch, 1989: 188, figs 675–677.

*Physella hendersoni floridana* “Pilsbry MS” Te, 1980: 184.

**Description:** The shell and anatomical morphology have not been well-characterized previously. They are similar in most respects to *Physa acuta*, with exceptions as noted below. Shell (Figure 7) sinistral, elongate-ovate, high spired, thin, translucent, lustrous, with faint spiral growth lines. Body whorl approximately 85% of shell length, with four to five adult whorls, with rounded shoulders but sutures not so deeply impressed as *P. acuta*. Spire profile flat to slightly convex, apex more rounded than *P. acuta*. Moderately auricular aperture, approximately 70% of shell length, with thin outer lip. Adulthood is reached quite rapidly in culture and at a small size. Dillon et al. (2007) reported a modal age of 4 weeks at first reproduction and Dillon (in review) recorded 7 weeks post-hatch. Growth rate seems to decrease markedly at maturity, such that individuals rarely attain shell lengths much greater than 7 mm. From the regression shown in Figure 5, the predicted length to width ratio would be 1.66 for a 6 mm animal and 1.79 for a (hypothetical) 8 mm animal. Cephalopodal mass (Figure 10) light gray to tan, with long, slender tentacles and rounded or fan-like labial palps. Jaw simple, lacking lateral processes. Mantle typically bearing a reticulate pigmentation pattern, sometimes demonstrating digitations. Foot extending approximately the length of the shell, pointed posteriorly. Penial

complex (Figure 12) includes a preputium (with preputial gland) and a two-part penial sheath, which is divided into a muscular portion and a (smaller) glandular portion. This general penial morphology has been characterized as “type-bc” (Te, 1978; Wethington and Lydeard 2007). When everted, the penis slides through the preputium to form a long, slightly irregular, finger-like projection, with a lateral lobe corresponding to the preputial gland. Radula not different from *P. acuta* - comprising approximately 30–40 V-shaped rows of approximately 120–160 comb-like teeth. Each row has a tricuspid median flanked by 60–80 teeth bearing approximately 8–12 cusps.

**Vouchers:** Academy of Natural Sciences of Philadelphia, 20 dry shells (ANSP 422687) and 10 in 100% ethanol (ANSP A21950).

**Type Locality:** Randon’s Creek, near Claiborne, Alabama.

**Synonymy:** Clench (1925) originally proposed *hendersoni* as a subspecies of *Physa pomilia*. Te (1978; 1980) reduced *pomilia* to subspecific rank under *P. heterostropha* (a junior synonym of *P. acuta*), and elevated *hendersoni* to the full species level. The breeding experiments of Dillon et al. (2007) confirmed, however, that *P. hendersoni* is conspecific with *P. pomilia*, as originally suggested by Clench, and that populations of *hendersoni/pomilia* are reproductively isolated from *heterostropha/acuta*. These observations have been corroborated by DNA sequence data, which cluster *P. hendersoni* and *P. pomilia* in a monophyletic group separate and distinct

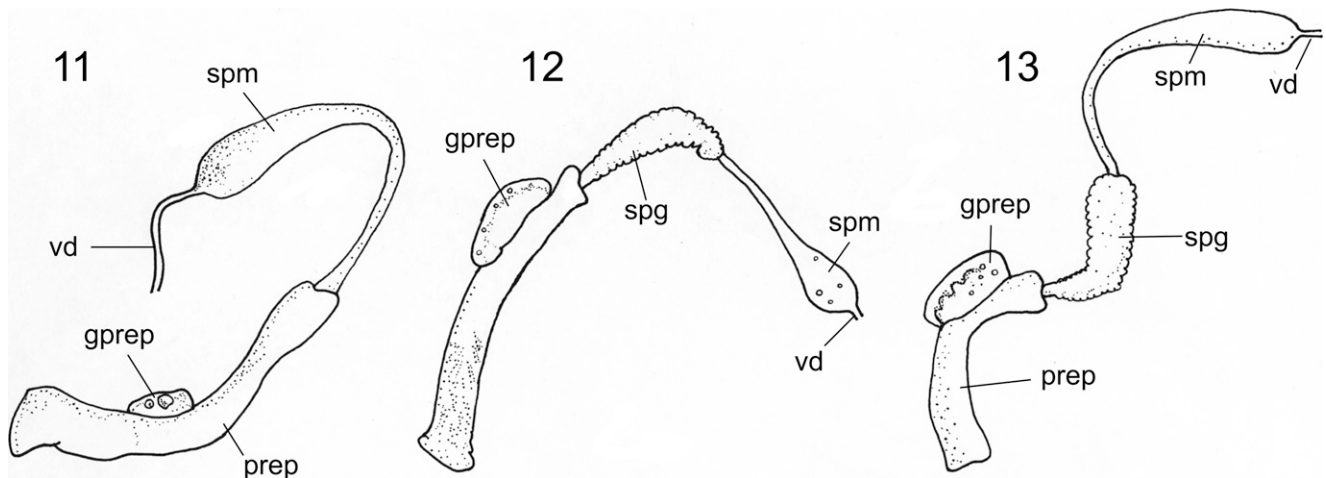

**Figures 11–13.** Extracted penial complexes of *Physa* species. **11.** *Physa acuta*. **12.** *Physa pomilia*. **13.** *Physa carolinae* new species. Abbreviations: **gprep**, preputial gland; **prep**, preputium; **spg**, glandular portion of penial sheath; **spm**, muscular portion of penial sheath; **vd**, vas deferens.

from the larger group that includes *P. acuta* (Wethington, 2004; Wethington and Lydeard, 2007).

**Distribution and Habitat:** *Physa pomilia* appears to inhabit much of the eastern and southern United States, although confusion with *P. acuta* makes the actual extent of its range uncertain. In South Carolina, *P. pomilia* is moderately common in the slow pools and backwaters of rivers draining the coastal plain, typically on vegetation, both submerged and emergent. The water of such rivers is often colored with tannins, but probably not strongly acidic. *Physa pomilia* populations are not typically associated with polluted or otherwise disturbed habitats.

*Physa carolinae* new species  
(Figures 1–13, 15)

*Physa heterostropha*, “JNI population.”—Dillon and Wethington, 1995: 400–408.

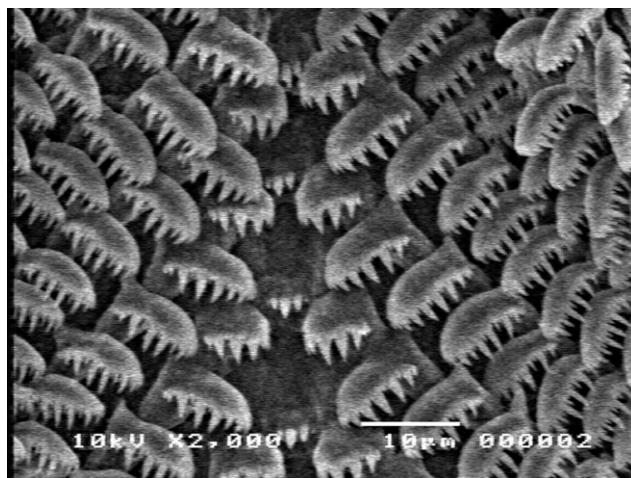

**Figure 14.** SEM microphotograph showing the radular morphology of *Physa acuta*.

*Physa* sp. “John’s Island.”—Wethington, 2004: 18–19.

*Physa* species A.—Wethington and Lydeard 2007: 241–257.

*Physa* species A.—Dillon (in review)

**Description:** The shell and anatomical morphology are similar in most respects to *Physa pomilia*, with exceptions as noted below. Shell (Figure 8) sinistral, narrowly elongate-ovate, high spired, thin, translucent, lustrous, with faint spiral growth lines. Body whorl approximately 85% of shell length, with four to five adult whorls, with rounded shoulders but sutures not deeply impressed. Spire profile flat to slightly convex, apex not acute. Moderately auricular aperture, approximately 70% of shell length, with thin outer lip. In culture, adulthood is reached at a modal age of 8 weeks post-hatch, approximately the same as in *P. acuta*, but at a later age and larger shell length than demonstrated by *P. pomilia* (Dillon, in review). From the regression shown in Figure 5, the predicted length to width ratio of a 6 mm animal would be 1.79, and for an 8 mm animal 1.92. Cephalopodal mass (Figure 10) generally black, much darker than *P. pomilia*, with long slender tentacles and rounded or fan-like labial palps. Jaw simple, lacking lateral processes. Mantle typically black, without reticulation, sometimes demonstrating digitations. Foot extending approximately the length of the shell, pointed posteriorly. Penial complex (Figure 13) including a preputium (with preputial gland) and a two-part penial sheath which is divided into a muscular portion and a (smaller) glandular portion. This general penial morphology has been characterized as “type-bc” (Te, 1978; Wethington and Lydeard 2007). When everted, the penis slides through the preputium to form a long, slightly irregular, fingerlike projection, with a lateral lobe corresponding to the preputial gland. Radula not different from *P. acuta*, comprising approximately 30–40 V-shaped rows of approximately 120–160 comb-like teeth. Each



row has a tricuspid median flanked by 60–80 teeth bearing approximately 8–12 cusps.

**Type:** The dry holotype has been deposited at the Academy of Natural Sciences of Philadelphia (ANSP 422688). We have also deposited 19 dry paratypes (ANSP 422689) and 10 paratypes in 100% ethanol (ANSP A21948).

**Type Locality:** Small spring at Huger Landing on the bank of Huger Creek, 4 km North of Huger, Berkeley County, South Carolina (33.1305°N, 79.8111°W). Springs are unusual in the South Carolina lowcountry, and this is the only population of *Physa carolinae* inhabiting such a habitat of which we are aware. We selected this type locality because the site is on public land, easily accessible, and snails can be sampled year round. Snails are also seasonally abundant in the ditch by the dirt road leading to the landing, which is a more typical habitat.

**Distribution and Habitat:** The natural habitat of *Physa carolinae* seems to be the broad and shallow waters of forested swamps in the lower coastal plain, such as Hellhole Bay in the Francis Marion National Forest or Wassamassaw Swamp west of Moncks Corner, SC. Such swamps typically swell with the rains of winter and spring and recede in the heat of summer. But because the thick base of spongy organic debris that builds up on the floor of such swamp forests never evaporates to dryness, snails are able to find refuge by burrowing. This life habit is similar to that displayed by the circum-boreal physid genus *Aplexa*, which *P. carolinae* superficially resembles. The southern Atlantic Coastal plain has, however, been heavily impacted by human land use practices for several hundred years. *Physa carolinae* is today most commonly collected in manmade drainage ditches by roads and agricultural fields.

In addition to the type locality and the five supplementary populations sampled for DNA analysis, we have South Carolina records of *P. carolinae* as follows: Barnwell Co: Lower Three-Runs Ck 2 km W of Lyndhurst at S-39 (33.13°N, 81.45°W). Berkeley Co: Wassamassaw Swamp at US 176 (33.15°N, 80.17°W). Main pond at Cypress Gardens (33.0477°N, 79.9490°W). Charleston Co: Pond at Drayton Hall Plantation (32.8703°N; 80.0769°W). Ditch at Dill Wildlife Refuge, W of Riverland Dr., Charleston (32.7272°N; 79.9875°W). Reserve Pond, Santee Coastal Preserve, 10 km NE of McClellanville (33.1546°N, 79.3567°W). Jasper Co: Coosawhatchie Swamp, 2 km N of Coosawhatchie (32.6096°N, 80.9270°W).

The range of *P. carolinae* extends through the coastal plain and lower piedmont regions of Virginia, North Carolina, and Georgia (Figure 15). We have collections and observations on approximately 20 populations of *P. carolinae* in Virginia, 35 populations in North Carolina, and 20 populations in Georgia (available from RTD on request). Our extensive field surveys have not uncovered any populations inhabiting the upper piedmont or mountains to the west. We have no personal observations north of Virginia or south of Georgia. But the

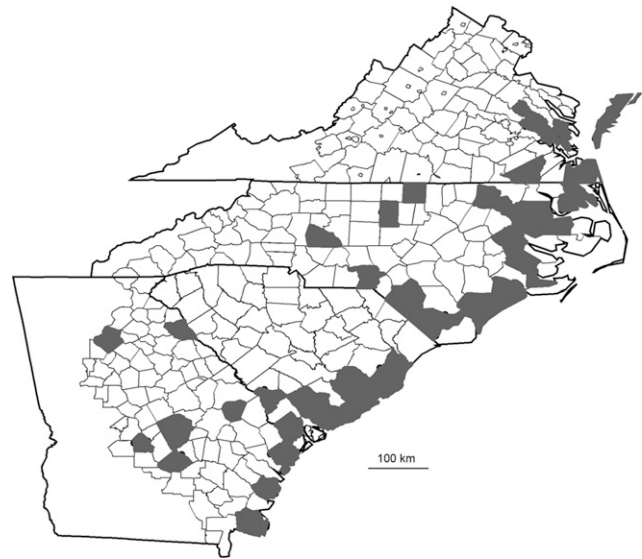

**Figure 15.** Counties in the southern Atlantic drainages of the United States with records of *Physa carolinae* new species.

collection of the Florida Museum of Natural History in Gainesville holds a large number of physid lots from Florida, catalogued primarily under the name “*Physa hendersoni*,” that appear to represent *Physa carolinae*.

**Etymology:** Latin *carolinae*, genitive case of *carolina* meaning of Carolina (this species is first described from populations in South Carolina).

## DISCUSSION

The genetic and morphological evidence reviewed in the present work, together with the experimental breeding results of Dillon (in review), make it clear that a widespread and seasonally common species of freshwater gastropod has escaped the attention of malacologists in the American South for almost two centuries. Part of the explanation doubtless lies in the difficult and ephemeral nature of its habitat. *Physa carolinae* populations are most often found in coastal plain swamps that are seasonally flooded and hence difficult to access, or in the ditches of disturbed habitats not typically surveyed by field biologists.

A second explanation for the protracted obscurity of *Physa carolinae* must be the longstanding confusion that has persisted in the taxonomy and systematics of the North American Physidae. The newly described species often lives in close proximity with two other earlier-described physid species which themselves have often been confused, *Physa acuta* (previously identified as *P. heterostropha*) and *Physa pomilia* (previously *P. heterostropha pomilia* or *P. hendersoni*). We ourselves misidentified a population of *P. carolinae* as *P. heterostropha* in our early surveys of allozyme variation among physids in the Charleston area (Dillon and Wethington, 1995). Once the previously described species were better

characterized and distinguished from each other (Dillon et al., 2007), the undescribed third species became easier to recognize.

We do not think that our experience with the physids of South Carolina will prove to be unique. Future studies combining genetic, morphological, ecological, and behavioral data will likely continue to prompt taxonomic revisions of even the most familiar elements of the North American freshwater gastropod fauna into the future.

#### ACKNOWLEDGMENTS

We thank Tom Smith, Ginny Dillon, and the late Julian Harrison for help in the field. Ms. Carol Moskos of the Department of Pathology and Laboratory Medicine, Medical University of South Carolina, provided assistance with the scanning electron microscopy. Eugene J. Phillips, Jr. was very helpful in constructing Figures 1 and 2. Figure 15 was drafted with the help of Dr. James D. Florian. Funding was provided by a grant from the National Science Foundation, DEB-0128964.

#### LITERATURE CITED

- Adams, C.B. 1851. Descriptions of new freshwater shells which inhabit Jamaica. *Contributions to Conchology* 9: 174–175.
- Beck, H. 1837–38. Index Molluscorum Præsentis Aevi Musei Principis Augustissimi Christiani Frederici. Hafniae. p. 1–100 [1837], 101–124 [1838].
- Binney, W.G. 1865. Land and fresh water shells of North America. Part 2, Pulmonata Limnophila and Thalassophila. *Smithsonian Miscellaneous Collections* 7: 1–161.
- Burch, J.B. 1989. North American Freshwater Snails. Malacological Publications, Hamburg, Michigan, 365 pp.
- Clench, W.J. 1924. A new species of *Physa* from Texas. *The Nautilus* 38: 12–13.
- Clench, W.J. 1925a. Notes on the genus *Physa* with descriptions of three new subspecies. *Occasional Papers of the Museum of Zoology, University of Michigan* 161: 1–10.
- Clench, W.J. 1925b. Description of a new species of *Physa* from the Pleistocene of Florida. *Occasional Papers of the Museum of Zoology, University of Michigan* 164: 1–4.
- Clench, W.J. and C.G. Aguayo. 1932. New Haitian mollusks. *Proceedings of the New England Zoological Club* 13: 35–38.
- Clench, W.J. 1936. The Physidae of the West Indies. *Memorias de la Sociedad Cubana de Historia Natural "Felipe Poey"* 10: 335–342.
- Clessin, S. 1886. Die familie der limnaeiden enthaltend die Genera *Planorbis*, *Limnaeus*, *Physa* und *Amphipeplea*. In: Küster, H.C., F.W. Martini, and J.H. Chemnitz, (eds). *Systematisches Conchylien-Cabinet* Bd 1, Abt. 17. Bauer and Raspe, Nürnberg, pp. 311–430.
- Crandall, O. 1901. The American physae. *The Nautilus* 15: 25–30, 42–45, 54–58, 69–71.
- Cockerell, T.D.A. 1889a. Preliminary remarks on the molluscan fauna of Colorado. *Journal of Conchology* 6: 60–63.
- Cockerell, T.D.A. 1889b. The Thirteenth Report of the Colorado Biological Association. Custer County Courant, Colorado. 1 p.
- Conrad, T.A. 1834. Description of some new species of freshwater shells from Alabama, Tennessee, &c. *American Journal of Science and Arts* 25: 338–343.
- Conrad, T.A. 1866. Descriptions of American freshwater shells. *American Journal of Conchology* 2: 278–279.
- Dillon, R.T., Jr. 2009. Empirical estimates of reproductive isolation among the *Physa* of South Carolina (Pulmonata: Basommatophora). *The Nautilus* 123: 276–281.
- Dillon, R.T., Jr. and A. Dutra-Clarke. 1992. *Biomphalaria* in South Carolina. *Malacological Review* 25: 129–130.
- Dillon, R.T., Jr., C. Eamhardt, and T. Smith. 2004. Reproductive isolation between *Physa acuta* and *Physa gyrina* in joint culture. *American Malacological Bulletin* 19: 63–68.
- Dillon, R.T., Jr., J. Robinson, T. Smith, and A.R. Wethington. 2005. No reproductive isolation between the freshwater pulmonate snails *Physa acuta* and *Physa virgata*. *Southwestern Naturalist* 50: 415–422.
- Dillon, R.T., Jr., J. Robinson, and A.R. Wethington. 2007. Empirical estimates of reproductive isolation among the freshwater pulmonate snails *Physa acuta*, *P. pomilia*, and *P. hendersoni*. *Malacologia* 49: 283–292.
- Dillon, R.T., Jr. and A.R. Wethington. 1995. The biogeography of sea islands: Clues from the population genetics of the freshwater snail, *Physa heterostropha*. *Systematic Biology* 44: 400–408.
- Dillon, R.T., Jr., A.R. Wethington, J. Rbett, and T. Smith. 2002. Populations of the European freshwater pulmonate *Physa acuta* are not reproductively isolated from American *Physa heterostropha* or *Physa integra*. *Invertebrate Biology* 121: 226–234.
- Draparnaud, J. 1805. *Histoire Naturelle des Mollusques Terrestres et Fluviales de la France*. Louis Colas, Paris, 140 pp.
- Fischer, P. and H. Crosse. 1886. *Etudes sur les mollusques terrestres et fluviales du Mexique et du Guatemala*, Part 7. In: *Mission scientifique au Mexique et dans l'Amérique Centrale, Recherches Zoologiques*, Volume 2. 731 pp.
- Folmer, O., M. Black, W. Hoeh, R. Lutz, and R. Vrijenhoek. 1994. DNA primers for amplification of mitochondrial cytochrome c oxidase subunit I from diverse metazoan invertebrates. *Molecular Marine Biology and Biotechnology* 3: 294–299.
- Germain, L. 1913. Quelques nouvelles terres et de mollusques écouter du Chili. *Revista Chilena de Historia Natural* 17: 155–169.
- Gould, A.A. 1847. Descriptions of *Physa*, from the collection of the Exploring Expedition. *Proceedings of the Boston Society of Natural History* 2: 214–215.
- Gould, A.A. 1852. *Mollusca and Shells*. Volume 12. In: *United States Exploring Expedition, during the years 1838, 1839, 1840, 1841, 1842, under the command of Charles Wilkes, USN*. Gould and Lincoln, Boston, 510 pp.
- Gould, A.A. 1855. New species of land and fresh-water shells from western (N.) America. *Proceedings of the Boston Society of Natural History* 5: 127–130.
- Haldeman, S.S. 1841a. A monograph of the freshwater univalve Mollusca of the United States, No. 3, *Limnea*. J. Dobson, Philadelphia, 16 pp.
- Haldeman, S.S. 1841b. Descriptions of two new freshwater shells. *Proceedings of the Academy of Natural Sciences of Philadelphia* 1: 78–79.

- Haldeman, S.S. 1842–43. A monograph of the freshwater univalve Mollusca of the United States, No. 6, Physidae. J. Dobson, Philadelphia, 40 pp.
- Hall, T.A. 1999. BioEdit: a user-friendly biological sequence alignment editor and analysis program for Windows 95/98/NT. Nucleic Acids Research Symposium Series 41: 95–98.
- Heron, G.C. 1880. On the land and freshwater shells of Ottawa. Ottawa Field Naturalists' Club Transactions 1: 36–40.
- Lea, I. 1864. Descriptions of twenty-four new species of *Physa* of the United States and Canada. Proceedings of the Academy of Natural Sciences of Philadelphia 16: 114–116.
- Lea, I. 1866. New Unionidae, Melanidae, etc., chiefly of the United States. Journal of the Academy of Natural Sciences of Philadelphia 6: 113–187.
- Lydeard, C., W.E. Holznagel, M.N. Schnare, and R.R. Gutell. 2000. Phylogenetic analysis of Molluscan mitochondrial LSU rDNA sequences and secondary structures. Molecular Phylogenetics and Evolution 15: 83–102.
- Mazyck, W. 1913. Catalog of Mollusca of South Carolina. Ed. P. Rea. Contributions from the Charleston Museum, Vol. II. Charleston Museum, Charleston, 39 pp.
- Palumbi, S., A. Martin, S. Romano, W. McMillan, L. Stice and G. Grabowski. 1991. The Simple Fool's Guide to PCR. Privately distributed, University of Hawaii, Honolulu, 43 pp.
- Paraense, W. and J.-P. Pointier. 2003. *Physa acuta* Draparnaud, 1805 (Gastropoda: Physidae): a study of topotypic specimens. Memórias do Instituto Oswaldo Cruz 98: 513–517.
- Pfeiffer, L. 1839. Bericht über die ergebnisse meiner Reise nach Cuba im Winter 1838–1839. Archiv für Naturgeschichte 5: 346–358.
- Philippi, R.A. 1841. Limnaeaceen. Bd 5, Abt 32. In: Küster, H.C., F. W. Martini, and J. H. Chemnitz, J.H. (eds). Systematisches Conchylien-Cabinet, Ed. 2. Bauer and Raspe, Nürnberg, 47 pp.
- Pilsbry, H.A. 1891a. Preliminary notices of new Mexican shells. The Nautilus 5: 8–10.
- Pilsbry, H.A. 1891b. Land and fresh-water mollusks collected in Yucatan and Mexico. Proceedings of the Academy of Natural Sciences of Philadelphia 43: 310–334.
- Pip, E. 2004. A new species of *Physella* (Gastropoda: Physidae) endemic to Lake Winnipeg, Canada. Visaya 1: 42–48.
- Pip, E. and J.P.C. Frank. 2008. Molecular phylogenetics of central Canadian Physidae (Pulmonata: Basommatophora). Canadian Journal of Zoology 86: 10–16.
- Prosada, D. and K.A. Crandall. 1998. Modeltest: testing the model of DNA substitution, Bioinformatics 14: 817–818.
- Rogers, D.C. and A.R. Wethington. 2007. *Physa natricina* Taylor 1988, junior synonym of *Physa acuta* Draparnaud, 1805 (Pulmonata: Physidae). Zootaxa 1662: 45–51.
- Ronquist, F. and J.P. Huelsenbeck. 2003. MrBayes 3: Bayesian phylogenetic inference under mixed models. Bioinformatics 19: 1572–1574.
- Sambrook, J., E.F. Fritsch, and T. Maniatis. 1989. Molecular Cloning: A Laboratory Manual, Second Edition. Cold Spring Harbor Laboratory Press, Cold Spring Harbor, 253 pp.
- Say, T. 1817. Conchology. In: Nicholson, W. (ed.) British Encyclopedia, American edition, Vol. 2., no pagination.
- Taylor, D.W. 1988. New species of *Physa* (Gastropoda: Hygrophila) from the western United States. Malacological Review 21: 43–79.
- Taylor, D.W. 2003. Introduction to Physidae (Gastropoda: Hygrophila) biogeography, classification, morphology. Revista de Biología Tropical, Supplement 51: 1–287.
- Te, G.A. 1978. The systematics of the family Physidae (Basommatophora: Pulmonata). Ph.D. Dissertation, University of Michigan, Ann Arbor, 325 pp.
- Te, G.A. 1980. New classification system for the family Physidae. Archiv für Molluskenkunde 110: 179–184.
- Walker, B. 1918. A Synopsis of the Classification of the Freshwater Mollusca of North America, North of Mexico. Miscellaneous Publications, Vol. 6. University of Michigan Press, Ann Arbor, 213 pp.
- Wethington, A.R. 2004. Phylogeny, taxonomy, and evolution of reproductive isolation in *Physa* (Pulmonata: Physidae). Ph.D. Dissertation, University of Alabama, Tuscaloosa, 119 pp.
- Wethington, A.R. and R.T. Dillon, Jr. 1993. Reproductive development in the hermaphroditic freshwater snail, *Physa*, monitored with complementing albino lines. Proceedings of the Royal Society of London B 252: 109–114.
- Wethington, A.R. and R.T. Dillon, Jr. 1997. Selfing, outcrossing, and mixed mating in the freshwater snail *Physa heterostropha*: lifetime fitness and inbreeding depression. Invertebrate Biology 116: 192–199.
- Wethington, A.R. and R. Guralnick. 2004. Are populations of physids from different hot-springs distinctive lineages? American Malacological Bulletin 19: 135–144.
- Wethington, A.R. and C. Lydeard. 2007. A molecular phylogeny of Physidae (Gastropoda: Basommatophora) based on mitochondrial DNA sequences. Journal of Molluscan Studies 73: 241–257.