

Gigaset

C590 IP

Gigaset C590 IP – your perfect companion

... with impressive internal qualities. Go crazy for the vibrant 3.5" TFT display and first-class sound quality. Your Gigaset can do a lot more than just make calls:

Ethernet port

Connect your Gigaset to the Internet and your PC via Ethernet. Use your public and private directories on the Internet (→ [page 78](#)). Update the directory on your Gigaset and your directory on the PC simultaneously.

Directory for 150 vCards – appointments

Save phone numbers and other data to the local directory (→ [page 71](#)). Enter anniversaries in the directory and set reminders (→ [page 76](#)).

Use your Gigaset as a PABX

Register up to six handsets. Assign each device its own phone number.

It's easy to configure your Gigaset thanks to the wizards

They help you to configure the VoIP connections for your phone and to assign the receive and send connections to the registered handsets.

Go online with your Gigaset

Use your phone's Info Center and have information specifically provided for the phone from the Internet shown on the display (→ [page 108](#)).

Other practical information

Transfer the directory from an existing Gigaset handset (→ [page 75](#)), use the programmable digit and display keys (→ [page 134](#)) for quick dial or quick access to important functions, use your phone to read your e-mail (without a PC).

Environment

Gigaset Green Home – be environmentally aware when using your phone. For details of our ECO DECT products, visit www.gigaset.com/service.

Gigaset C590 IP – your perfect companion





For more information about your phone, visit www.gigaset.com/gigasetC590ip or www.gigaset.com/gigasetC595ip.

After purchasing your Gigaset phone, please register it at www.gigaset.com/service – this will ensure any questions you may have or warranty services you request are dealt with even faster!

Have fun using your new phone!

Please note

To change the display language, proceed as follows (→ **page 137**):

- ▶ Press right on the control key .
- ▶ Press left on the control key  to select the  symbol and confirm the selection with the **right display key**.
- ▶ Press the bottom of the control key  three times and confirm with the **right display key**.
- ▶ Press the bottom of the control key  until the correct language is selected. Then press the **right display key**.

Handset at a glance





- 1 Display in idle status
- 2 Battery charge status (→ [page 37](#))
- 3 Display keys (→ [page 41](#))
- 4 Message key (→ [page 69](#))
Access to call and message lists;
Flashing: new message or new call
- 5 End call key, On/Off key
End a call;
cancel function;
go back one menu level (press briefly);
return to idle status (press and hold);
handset on/off (press and hold in idle status)
- 6 Hash key
Keypad lock on/off (press and hold in
idle status);
toggles between upper/lower case and digits
- 7 Mute key (→ [page 58](#))
Muting the microphone
- 8 Microphone
- 9 Recall key
- Consultation call (flash)
- Insert a dialling pause (press and hold)
- 10 Star key
Activate/deactivate ringtones
(press and hold);
with an open connection: switch between
pulse dialling/tone dialling (press briefly);
text input: open table of special characters
- 11 Connection socket for headset (→ [page 37](#))
- 12 Key 1
Dial Network mailbox (press and hold)
- 13 Talk key
Flashing: incoming call;
accept call;
open redial list (press briefly);
open connection list (press and hold);
→ [page 50](#));
when writing an SMS: send SMS
- 14 Speaker key
Switch between earpiece and speaker mode
- 15 Control key (→ [page 40](#))
- 16 Signal strength (→ [page 37](#))
Green: Eco Mode (→ [page 121](#)) activated

Display icons

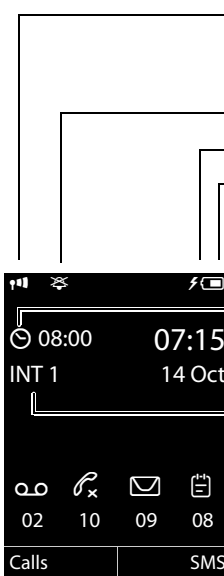
The following icons are displayed dependent on the settings and the operating status of your telephone:



Signal strength  (→ [page 121](#))
or Eco Mode+ icon  (→ [page 121](#))

Ringtone switched off (→ [page 142](#))

Battery charging (→ [page 37](#))

Battery charge status (→ [page 37](#))





Alarm clock switched on and wake-up time set (→ [page 123](#))

Current time (→ [page 37](#))

Current day and month (→ [page 37](#))

Name of the handset (→ [page 133](#))

Number of new messages:

- ◆  On the network mailbox (→ [page 67](#))
- ◆  In the missed calls list (→ [page 69](#))
- ◆  In the SMS list (→ [page 95](#)), the e-mail list (→ [page 104](#))
- ◆  In the missed alarms list (→ [page 70](#))

Signalling

External call (→ [page 53](#))



Alarm clock (→ [page 123](#))



Internal call (→ [page 130](#))



Anniversary (→ [page 77](#))



The base at a glance

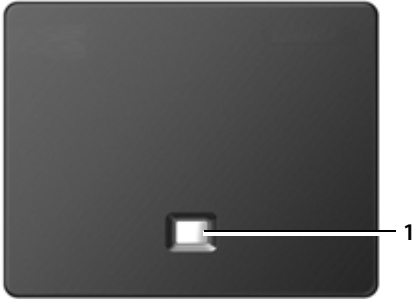

Base key

1 Paging key

Lights up:

LAN connection active (phone is connected to router)

Flashes:

Data transfer to LAN connection

Press **briefly**:

start paging, display IP address on handset

Press and **hold**:

set base to registration mode

Contents

Gigaset C590 IP – your perfect companion	1
Handset at a glance	3
Display icons	4
The base at a glance	5
Safety precautions	10
First steps	12
Checking the package contents	12
Setting up the handset for use	14
Installing the base	17
Connecting the base	18
Setting up the phone – installation wizard	23
Date/time	37
Connecting the headset to the handset (optional)	37
Attaching the belt clip (optional)	38
Proceeding	39
Using the phone	40
Control key	40
Display keys	41
Keys on the keypad	41
Correcting incorrect entries	41
Menu guidance	42
Activating/deactivating the handset	43
Activating/deactivating the keypad lock	43
Understanding the operating steps in the user guide	44
Menu tree	46
Making calls	50
Making an external call	50
Ending a call	53
Accepting a call	53
Calling Line Identification	54
Notes on calling line display (CLIP)	55
VoIP telephony via Gigaset.net	56
Gigaset HDSP – telephony with brilliant sound quality	57
Activating/deactivating speaker mode	58
Muting the handset	58
Making calls using network services	59
Configuring general settings for all calls	59
Configuring settings for the next call	63
Configuring settings during an external call	63

Using lists	66
Redial list	66
Incoming message list	67
Call lists	67
Opening lists with the message key	69
Missed alarms list	70
Using directories	71
Local handset directory	71
Using online directories	78
Using the private net directory	82
Using the Gigaset.net directory	84
Making cost-effective calls	89
Defining dialling plans	89
Linking a number with a call-by-call number	89
Displaying the call duration	90
Sending SMS (text messages)	91
Writing/sending SMS	91
Receiving an SMS	95
SMS with vCard	98
Receiving notifications via SMS	99
Setting the SMS service centre/defining the send line	100
Activating/deactivating first ringtone muting	101
Activating/deactivating SMS function	101
Troubleshooting SMS problems	102
E-mail notifications	103
Opening the incoming e-mail list	104
Viewing the message header and text of an e-mail	106
Viewing e-mail sender's address	107
Deleting e-mail messages	107
Info Center – continuous Internet access from your phone	108
Customising info services	109
Starting the Info Center, selecting info services	112
Login for personalised info services	113
Operating the Info Center	114
Accessing info services using quick dial	116
Displaying information from the Internet as a screensaver	117
Using the network mailbox	118
Activating/deactivating the network mailbox, entering numbers	118
Configuring a network mailbox for quick dial	119
ECO DECT	121
Setting the alarm clock	123

- Using a handset as a room monitor 124**
- Connecting/using other handsets 127**
 - Registering handsets 127
 - De-registering handsets 128
 - Searching for a handset, finding the phone's IP address ("Paging") 129
 - Changing the base 130
 - Making internal calls 130
 - Changing the name of an internal party 133
 - Changing the internal number of an internal party 133
- Setting the handset 134**
 - Accessing functions and numbers quickly 134
 - Changing the display language 137
 - Setting the display 137
 - Activating/deactivating auto answer 139
 - Changing the speaker/earpiece volume 140
 - Changing ringtones 141
 - Activating/deactivating advisory tones 143
 - Restoring the handset default settings 143
- Configuring the system settings 144**
 - Setting the date and time manually 144
 - Protecting against unauthorised access 144
 - Your own area code setting 145
 - Activating/deactivating music on hold 145
 - Setting the base's IP address in LAN 146
 - Configuring VoIP connections 148
 - Assigning send and receive connections to internal parties 150
 - Updating the phone firmware 152
 - Repeater support 153
 - Resetting the base to the default settings 153
 - Restarting the base 154
 - Checking the base MAC address 154
- Connecting the phone to a PABX 155**
 - Dialling modes and recall 155
 - Saving an access code (outside line code) 156
 - Setting pauses (fixed line) 157
 - Switching temporarily to tone dialling (DTMF) 157
- Configuring the phone via the Web configurator 158**
 - Connecting the PC with the telephone's Web configurator 159
 - Logging in to/off the Web configurator 161
 - Understanding the structure of the Web configurator pages 163
 - Web configurator menu 167
 - Functions of the Web configurator 168

Customer Service & Assistance	183
Questions and answers	184
Information on operating Gigaset VoIP telephones with Network Address Translation (NAT) routers	186
VoIP status codes	188
Checking service information	191
Authorisation	192
Environment	193
Appendix	194
Care	194
Contact with liquid	194
Specifications	194
Writing and editing text	197
Glossary	198
Accessories	208
Mounting the base on the wall	211
Mounting the charger on the wall	211
Index	212

Safety precautions

Warning

Read the safety precautions and the user guide before use.

Explain their content and the potential hazards associated with using the telephone to your children.



Use only the power adapter supplied, as indicated on the underside of the base or charger.

Use only the cables supplied for fixed line and LAN connection and connect these to the intended port only.



Use only **rechargeable batteries** that correspond to the **specification** (→ **page 194**). Never use a conventional (non-rechargeable) battery or other battery types as this could result in significant health risks and personal injury.



Using your telephone may affect nearby medical equipment. Be aware of the technical conditions in your particular environment, e.g., doctor's surgery.

If you use a medical device (e.g., a pacemaker), please contact the device manufacturer. They will be able to advise you regarding the susceptibility of the device to external sources of high frequency energy. Please refer to the "Appendix" chapter for the specifications of this Gigaset product.



Do not hold the rear of the handset to your ear when it is ringing or when speaker mode is activated. Otherwise you risk serious and permanent damage to your hearing.

Your Gigaset is compatible with the majority of digital hearing aids on the market. However, perfect function with all hearing aids cannot be guaranteed.

The handset may cause interference in analogue hearing aids (humming or whistling) or cause them to overload. If you require assistance, please contact the hearing aid supplier.



Do not install the base or charger in bathrooms or shower rooms. The base and charger are not splashproof (→ **page 194**).



Do not use your phone in environments with a potential explosion hazard (e.g., paint shops).



If you give your phone to a third party, make sure you also give them the user guide.



Remove faulty bases from use or have them repaired by our Service team, as these could interfere with other wireless services.

Please note

- ◆ Please note that only terminals that are operated in-house (inside buildings) may be connected to the analogue TAE connection.
- ◆ Not all of the functions described in this user guide are available in all countries.
- ◆ The device cannot be used in the event of a power failure. It is also **not** possible to transmit **emergency calls**.

First steps

Checking the package contents



- 1 Gigaset C590 IP **base**
- 2 One power cable for connecting the base to the mains power supply
- 3 One phone cable to connect the base to the analogue fixed line (TAE RJ11 6-pole; flattened cable) 3a or 3b, depending on the country/provider
- 4 One Ethernet (LAN) cable (Cat 5 with 2 RJ45 modular jacks) for connecting the base to a router (LAN/Internet)
- 5 **One** Gigaset C59H **handset**
- 6 Two batteries for the handset (uncharged)
- 7 One battery cover for the handset
- 8 One belt clip for the handset
- 9 One handset charger
- 10 One power adapter for connecting the charger to the mains power supply
- 11 One quick guide and a CD

Firmware updates

This user guide describes the functions of your phone from firmware version 020 onwards.

Whenever there are new or improved functions for your Gigaset, firmware updates are made available for you to download to your base (→ **page 152**). If this results in operational changes for using your phone, a new version of this user guide or the necessary amendments will be published on the Internet at www.gigaset.com.

Select the product to open the relevant product page for your base, where you will find a link to the user guide.

To find out what version of firmware is currently loaded, → **page 191**.

Setting up the handset for use

The display is protected by a plastic film.
Please remove the protective film!

Inserting the batteries and closing the battery cover

Warning

Use only rechargeable batteries (→ [page 194](#)) recommended by Gigaset Communications GmbH i.e., never use a conventional (non-rechargeable) battery, as this could result in significant health risks and personal injury. For example, the outer casing of the batteries could be damaged or the batteries could explode. The phone could also malfunction or be damaged as a result of using batteries that are not of the recommended type.

- ▶ Insert the batteries with the polarity in the correct direction.
The polarity is indicated in/on the battery compartment.

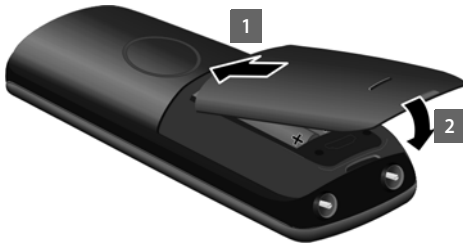

- ▶ First insert the battery cover at the top **1**.
- ▶ Then press the cover **2** until it clicks into place.

To open the battery cover, for instance to change the batteries:

- ▶ Insert a coin into the cavity on the casing, then pull the battery cover in an upward direction.



Connecting the charger

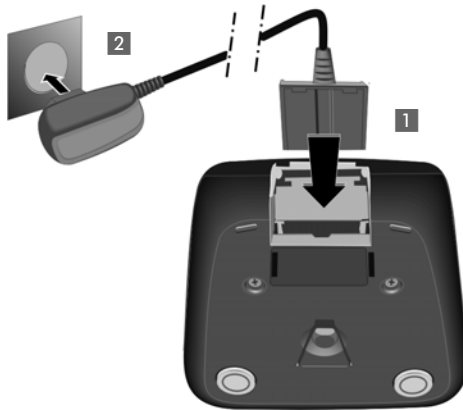

- ▶ Connect the flat plug from the power adapter **1**.
- ▶ Plug the power adapter into the plug socket **2**.

To disconnect the plug from the charger, press the release button **3** and disconnect the plug **4**.

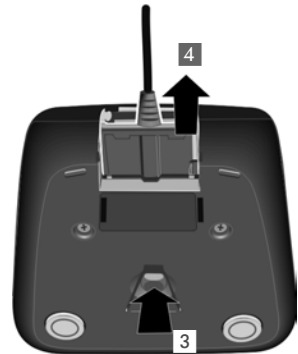

Placing the handset in the charger

- ▶ Place the handset in the charger with its **display facing forward**.

Each handset is registered with the base at the factory. You do not need to register the handset again. If you wish to use your handset with a different base or use additional handsets with your base, you have to register the handset manually

→ [page 127](#).

To charge the batteries, leave the handset in the charger.

Please note

Only place the handset in the charger that is intended for it.

Initial charging and discharging of the batteries

The correct charge level can only be displayed if the batteries are first fully charged and discharged.



- ▶ Place the handset in the charger for ten hours.

- ▶ Then remove the handset from the charger and do not replace it until the batteries are fully discharged.

Please note

- ◆ After the first battery charge **and** discharge, you may place your handset in the charger after every call.
- ◆ Always repeat the charging and discharging procedure if you remove the batteries from the handset and reinsert them.
- ◆ The batteries may warm up during charging. This is not dangerous.
- ◆ After a while, the charge capacity of the batteries will decrease for technical reasons.

Installing the base

The base is designed for use in dry rooms in a temperature range of +5°C to +45°C.

- ▶ Set up the base at a central point in the building.

Please note

Pay attention to the range of the base. This is up to 300 m in unobstructed outdoor areas and up to 50 m inside buildings. The range is reduced when **Eco Mode** is activated (→ [page 121](#)).

The phone's feet do not usually leave any marks on surfaces. However, due to the multitude of different varnishes and polishes used on today's furnishings, the occurrence of marks on the surfaces cannot be completely ruled out.

Warning

- ◆ Never expose the telephone to any of the following: heat sources, direct sunlight or other electrical appliances.
- ◆ Protect your Gigaset from moisture, dust, corrosive liquids and fumes.

Connecting the base

The following diagram is an overview of all connections for your base. The individual connections are described in detail below. In order for you to make calls on your phone via the fixed line and VoIP, you need to connect the base to the fixed line and Internet (see diagram below).



Follow the steps in the order given below:

- 1 Connect the phone and power cables to the base.
- 2 Connect the base to the telephone network and the mains power supply.
- 3 Connect the base to the router for accessing the Internet (via router and modem or via router with integrated modem) and for configuring the base via the Web configurator.
- 4 Connect the PC to the router.

You can then connect a wire-bound headset to the handset.

1. Connecting the phone and power cables to the base

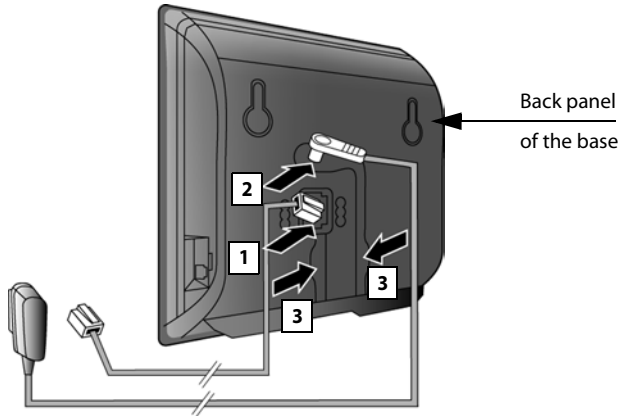

- 1 Insert the phone cable (TAE connection cable with RJ11 plug) into the lower connection socket at the rear of the base.
- 2 Insert the power cable of the power adapter into the upper connection socket at the rear of the base.
- 3 Push both cables into the appropriate cable channels.

Warning

Use only the power and telephone cables **supplied**. Pin connections on telephone cables can vary (pin connections → [page 196](#)).

2. Connecting the base to the fixed line and the mains power supply

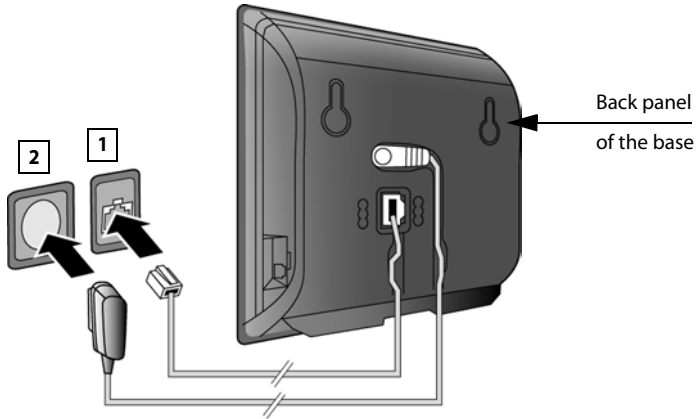

- 1 Insert the phone cable into the fixed line connection socket.
- 2 **Then** insert the power adapter into the mains socket.

Warning

Keep the power cable **plugged in at all times** for operation, as the phone does not work without a mains connection.

You can now use your phone to make calls via the fixed line and can be reached on your fixed line number.

3. Connecting the base with a router (Internet)

Data protection notice

When the device is connected to the router, it automatically contacts the Gigaset support server to make it easier for you to configure the devices and to enable communication with the Internet services.

For this purpose, every device sends the following device-specific information once every day:

- ◆ Serial number/item number
- ◆ MAC address
- ◆ Private IP address for the Gigaset in the LAN/its port numbers
- ◆ Device name
- ◆ Software version

On the support server, this information is linked to the existing device-specific information:

- ◆ Gigaset.net phone number
- ◆ System-related/device-specific passwords

Further information about the Gigaset.net service data saved can be found at www.gigaset.net/privacy-policy

Your base features a LAN connection that you can use to connect the base to a router.

Connection to a router is required for Internet telephony VoIP (Voice over Internet Protocol). You can set up and configure up to six accounts (VoIP phone numbers) from one or more VoIP provider(s) on the phone.

You also need a connection to the router for the following features on your phone:

- ◆ You want to be notified as soon as new software is available for your phone on the Internet.
- ◆ You want the date and time on your phone to be updated by a time server on the Internet.
- ◆ You want to use info services and/or online directories on your phone.

You can also connect a PC to the router if you want to set your phone via its Web configurator.

For Internet access you need a router connected to the Internet via a modem (this may be integrated in the router).

Please note

For telephony via the Internet, you need a broadband Internet connection (e.g., DSL) with flat rate (recommended) or volume rate and a router that connects your phone to the Internet. You can find a list of recommended routers on the Internet at:

www.gigaset.com/service

From here, go to the FAQ page and select your Gigaset IP telephone. Search for "Router", for example.

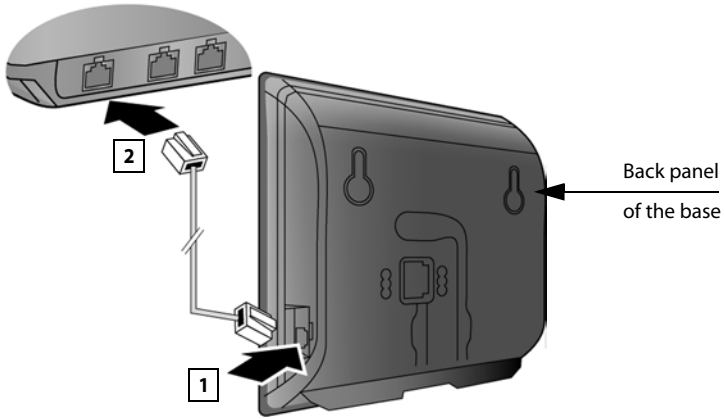

- 1 Insert a plug from the Ethernet cable supplied (Cat 5 with 2 RJ45 Western modular plugs) into the LAN connection socket at the side of the base.
- 2 Then insert the second Ethernet cable plug into a LAN socket on the router.

As soon as the cable connecting the phone and router is plugged in and the router is switched on, the key lights up on the front of the base (paging key).



You are now able to establish VoIP connections within Gigaset.net (→ [page 56](#)).

Setting up the phone – installation wizard

Auto configuration:

The configuration process for VoIP connections is automated for some VoIP providers. The provider creates a configuration file with all required VoIP access data (the general VoIP provider data and your personal account data). This file is placed on a configuration server on the Internet for downloading to your phone.

Your provider gives you a configuration code.

The installation wizard on your phone (→ [page 23](#)) prompts you to enter the code at the relevant point. All the required VoIP data is then downloaded automatically onto your phone.

The configuration file is only transferred via a secure connection (TLS authentication). If the TLS authentication fails, the message key  flashes. Press the message key to display the **Certificate error - Please check your certificates in the Web configurator.** message. Press the right display key to confirm the message.

Log in to the Web configurator (→ [page 161](#)).

The **Security** (→ [page 172](#)) Web page tells you why the secure connection could not be established and what you can do.

If the configuration file fails to download (e.g., because the configuration server is not available), the phone keeps trying to establish a connection until the file is downloaded successfully to the phone.

If no VoIP connections have been generated on the phone yet, you can start the installation wizard. The wizard allows you to make all necessary settings for your phone.

Two individual wizards are combined to form the installation wizard.

- 1 IP wizard
- 2 Connection wizard

Starting the installation wizard



As soon as the handset battery is sufficiently charged, the message key  on the handset will flash (approx. 20 minutes after you have put the handset in the charger).

- ▶ Press the message key .

1. IP wizard: making VoIP settings

You will see the following display:



Before you can use the Internet (VoIP) to phone any other numbers on the Internet, the fixed line or the mobile network, you need the services of a VoIP provider who supports the VoIP SIP standard.

Prerequisite: you have registered with a VoIP provider (e.g., via your PC) and set up at least one VoIP account (IP account).

To use VoIP, you now need to enter the access data for your VoIP account. You will receive all the necessary data from your VoIP provider. This will include:

Either:

- ◆ Your user name (if required by the VoIP provider).
This is the user name of your IP account (caller ID), frequently identical to your phone number.
- ◆ Your authentication name or login ID
- ◆ The (login) password registered with the VoIP provider
- ◆ General settings for your VoIP provider (server addresses etc.)

Or:

- ◆ An auto configuration code (activation code)

Your Gigaset phone's IP wizard can help you make these entries.

Please note

You can configure up to six VoIP connections. When you get started with the phone, you can initially only configure one VoIP connection. You can configure additional VoIP connections later with the IP wizard (→ [page 148](#)) or Web configurator.

Starting the IP wizard

Prerequisite: the phone is connected to the router. Your router is connected to the Internet (→ [page 21](#)).

- ▶ Press on the centre of the control key  or on the right display key **Yes** to start the IP wizard.



Information about the IP wizard appears in the display.

- ▶ Press the bottom of the control key  to scroll down.

- ▶ Press the **OK** display key to continue.



A list of all possible IP connections is shown in the display (IP 1 to IP 6). VoIP connections that are already configured are marked with .

- ▶ If necessary, press down on the control key  to select a connection.
- ▶ Press the **OK** display key to continue.

You will see the following display:



Your VoIP provider has supplied you with an **authentication name/password** and, where applicable, a user name:

- ▶ Press the key below **No** on the display screen.
- ▶ For further information, please see "**Downloading VoIP provider data**" → **page 29**.

You have received an **auto configuration code** (activation code) from your VoIP provider:

- ▶ Press the key below **Yes** on the display screen.
- ▶ For further information, please see "**Entering the auto configuration code**" → **page 28**.

No Internet connection:

The phone requires an Internet connection for you to register your telephone with a VoIP provider. If a connection cannot be made, one of the following messages is displayed:

- ◆ If the phone cannot establish a connection to the router, the message **IP address not available** is displayed.

Check the plug connection between the router and the base and check the settings on the router.

Your phone is preconfigured for dynamic assignment of the IP address. In order for your router to "recognise" the phone, dynamic IP address assignment must also be activated on the router i.e., the router's DHCP server must be activated.

If the DHCP server cannot or should not be activated, you must assign a fixed IP address to the phone (→ **page 146**).

- ◆ If the phone cannot establish a connection to the Internet, the message **Internet connection not available** is displayed.

The IP server may be temporarily unavailable. In this case, try to make a connection again later.

Otherwise: check the plug connection between the router and the modem or DSL connection and check the settings on the router.

- ▶ Press **OK**; the IP wizard is closed.

You will then need to call up the wizard later via the menu to configure the IP connection.

Entering the auto configuration code



- ▶ Using the keypad, enter the auto configuration code you received from the provider (max. 32 characters).
- ▶ Press the key below **OK** on the display screen.

All data required for VoIP telephony is loaded directly from the Internet to your phone.

When all the data has been successfully loaded onto your phone, **Your IP account is registered with your provider.** appears on the display.

- ▶ For further information, please see "**2. Connection wizard**", **page 33**.

Downloading VoIP provider data

The connection wizard establishes a connection with the Gigaset configuration server on the Internet. Various profiles with general access data for different VoIP providers can be downloaded here.

After a brief period you will see the following display:



A list of countries is loaded.

- ▶ Press up or down on the control key  repeatedly until the country in which you want to use the phone is selected in the display.

- ▶ Press the key below **OK** on the display screen to confirm your selection.



A list of the VoIP providers for which a profile with the general access data is available on the configuration server is displayed.

- ▶ Press up or down on the control key  repeatedly until your VoIP provider is selected in the display.

- ▶ Press the key below **OK** on the display screen to confirm your selection.

The general access data for your VoIP provider will be downloaded and saved on the phone.

You have not been able to download your provider's data

If your VoIP provider does not appear in the list, i.e., its general data is not provided for download, you must cancel the IP wizard:

- ▶ **Briefly** press the end call key  repeatedly until **End wizard?** appears in the display and then press the display key **Yes**.

You can perform the subsequent steps of the installation wizard.

You must then make the required VoIP provider and IP account settings using the Web configurator. You receive the general provider data from your VoIP provider.

You can change the assignment of the VoIP connection as send/receive connection at a later time via the telephone menu or the Web configurator.

Entering user data for your VoIP account

You are now prompted to enter your personal access data for your VoIP account.

The following are provider-dependent:

◆ User ID, Password, User name

Please note ...

... when entering access data, it is case sensitive.

To switch between upper and lower case and digits, press the **[↔#]** key (several times if necessary). You can see briefly in the display whether upper case, lower case or digit input is selected.

Characters entered incorrectly can be deleted using the left display key below **<C**. The character to the left of the cursor is deleted.

You can navigate within the input field using the control key **[↔]** (left/right).



► Using the keypad, enter the authentication name that you received from your VoIP provider.

► Press the key under **OK** on the display screen.



► Use the keypad to enter your password.

► Press the key under **OK** on the display screen.

First steps



► Using the keypad, enter the user name that you received from your VoIP provider.

► Press the key under **OK** on the display screen.



Once you have made all the necessary entries, the IP wizard will try to register the phone with the VoIP provider.

After successful registration, the message "**Your IP account is registered with your provider.**" appears in the display.

The connection wizard starts.

2. Connection wizard

The connection wizard enables you to assign previously configured connections (fixed line connection, Gigaset.net and VoIP connections, → [page 56](#) and → [page 24](#)) to internal parties as receive and, if applicable, as send connections. Internal parties are the registered handsets.

- ◆ **Receive connections** are the phone numbers (connections) on which you can be called. Incoming calls are only forwarded to the internal parties (end devices) for which the relevant connection is assigned as receive connection.
- ◆ **Send connections** are the numbers that are sent to the called party. The network provider calculates charges based on the send connections. You can assign each internal party a number or the associated connection as a send connection.
- ◆ Each connection (number) of your phone can be both a send as well as a receive connection. You can assign each connection to several internal parties as send and/or receive connection.

Default assignment

All configured connections are assigned as receive connections to the handsets at registration/start-up.

The fixed line connection is assigned to the handsets as a send connection.

Starting the connection assistant

a.



- ▶ Press the display key **Yes** if you wish to change the setting for the send and receive connections of the **handset** with the internal name **INT1**.
- ▶ Press the display key **No** if you do not wish to change the setting for this handset.

b.



The list of receive connections currently assigned is displayed. Press down on the control key  to scroll through the list if necessary.

- ▶ Press the display key **Change** if you wish to change the receive connection setting.
- ▶ Press the display key **OK** if you do not wish to change the setting.

Press **OK** to skip the following steps. Continue from → e.

Press **Change** to display the following:

c.



If no calls to the VoIP connection IP1 are to be signalled on the handset:

- ▶ Press **right** on the control key  to set to **No**.



d.



- ▶ Press **down** on the control key  to switch to the next connection. Select either **Yes** or **No** as described above.
- ▶ Repeat the steps for each connection.

- ▶ Press the display key **Save** once you have finished configuring the settings for the handset.

The updated list of receive connections is displayed one more time for you to check.

Press the display key **OK** to confirm the assignment.

e.



The send connection currently set for the handset is displayed: **Fixed Line**.

- ▶ Press the display key **OK** if you do not wish to change the setting. Skip the following step.
- ▶ To change the setting, press the display key **Change**.

f.



If the handset is to make calls via a different connection/phone number:

- ▶ Press **right** on the control key  repeatedly, until the required connection is displayed (in the example, IP1).



- ▶ Press the display key **Save** to save the settings.

Instead of a connection, you can also select **Sel. at each call**. Each time you make a call, you can then select the connection you wish to use on this handset.

If other handsets are already registered to the base, you are requested to assign send and receive connections for the handsets. The following is shown in the display:

Assign connections to handset ?

- ▶ Perform steps **a.** to **f.** for each registered handset.

After successfully configuring the settings, you will briefly see the following display:



Completing the installation

The handset then returns to idle status (an example of the display in idle status):

Displays

◆ Reception between the base and the handset:

- Good to poor:    
- No reception:  (red)

Green: Eco Mode activated

◆ Charge status of the batteries:

-     (empty to full)
-  flashes red: batteries almost empty
-    (charging)

◆ INT 1

Internal name of the handset

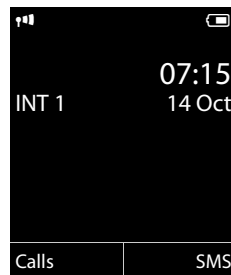

Please note

To protect your phone and its system settings from unauthorised access, please define a 4-digit number code (system PIN) known only to yourself. This code must be entered before you can register/de-register handsets or alter your phone's VoIP or LAN settings.

The default system PIN is 0000 (4 x zero).

For instructions on changing the PIN, → [page 144](#).

Date/time

There are two methods of setting the date and time:

- ◆ By default, your phone is configured so that the date and time are transferred from a time server on the Internet, provided it is connected to the Internet. You can activate/deactivate the synchronisation with a time server via the Web configurator (→ [page 178](#)).
- ◆ You can also set the date and time manually via the menu of one of the registered handsets (→ [page 144](#)).

To ensure you have the correct time for incoming calls and to use the alarm clock, the date and time must be set.

Connecting the headset to the handset (optional)



You can connect a headset with 2.5 mm jack connectors. See the relevant product page for information on recommended headsets
www.gigaset.com/customer-care.

Attaching the belt clip (optional)

The handset has notches on each side to attach the belt clip.

- ▶ **To attach** – press the belt clip onto the back of the handset so that the protrusions on the belt clip engage with the notches.
- ▶ **To remove** – press the centre of the belt clip firmly with your right thumb, push the fingernail of your left index finger up between the clip and the housing and pull the clip in an upward direction.



Proceeding

Now you have successfully set up your phone, you will certainly want to adapt it to your personal requirements. Use the following guide to quickly locate the most important subjects.



If you are unfamiliar with menu-driven devices such as other Gigaset telephones, read the section entitled "**Using the phone**" → **page 40** first.

Information on is located here.
Making external calls and accepting calls	▶ page 50
Setting the ringtone melody and volume	▶ page 140
Storing your own area code in the telephone	▶ page 145
Setting Eco Mode	▶ page 121
Preparing the telephone for SMS reception	▶ page 91
Operating the telephone on a PABX	▶ page 155
Registering available Gigaset handsets to the base and transferring their directory entries to the new handset	▶ page 127 ▶ page 75
Using online directories	▶ page 78
Entering additional VoIP accounts	▶ page 148
Configuring the phone via the Web configurator	▶ page 158

If you have any questions about using your phone, please read the tips on troubleshooting (→ **page 184**) or contact our Customer Care team (→ **page 184**).

Using the phone





Control key

Below, the side of the control key that you must press in the respective operating situation is marked in black (top, bottom, right, left, centre) e.g.,  for "press right on the control key" or  for "press the centre of the control key".







The control key has a number of different functions:



When the handset is in idle status

-  Press **briefly** to open the handset directory.
Press and **hold** to open the list of available online directories.
-  Open the main menu.
-  Open the list of handsets.
-  Call up the menu for setting the handset's call volume ([page 140](#)).







In the main menu

- , ,  or  Navigate to the required function.



In submenus and lists

- / Scroll up/down line by line.

In input fields

Use the control key to move the cursor up , down , right  or left .
Press and **hold**  or  to move the cursor **word by word**.

During an external call

-  Open the directory.
-  Initiate an internal consultation call.
-  Adjust the loudspeaker volume for earpiece and speaker mode.

Functions when pressing the middle of the control key

Depending on the operating situation, the key has different functions.

- ◆ **In idle status** the key opens the main menu.
- ◆ **In submenus, selection and input fields**, the key takes on the function of the display keys **OK**, **Yes**, **Save**, **Select** or **Change**.

Please note

These instructions demonstrate opening the main menu by pressing the right of the control key  and confirming the functions by pressing the appropriate display key. However, if you prefer, you can use the control key as described above.

Display keys



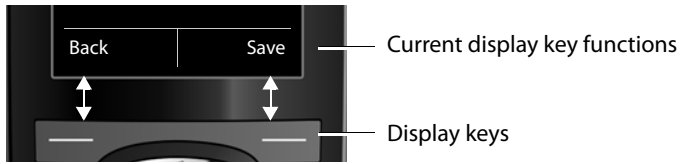

The functions of the display keys change depending on the particular operating situation. Example:



Some important display keys:

Options	Open a menu for further functions.
OK	Confirm selection.
< C	Delete key: delete character by character/word by word from right to left.
Back	Go back one menu level or cancel operation.
Save	Save entry.
→→	Open the redial list.

Keys on the keypad

-  /  /  etc.
Press the matching key on the handset.
-  Enter digits or letters.

Correcting incorrect entries

You can correct incorrect characters in the input fields by navigating to the incorrect entry using the control key. You can then:

- ◆ Delete the **character** to the left of the cursor with the display key **<C** (**press and hold** to delete the **word**)
- ◆ Insert characters at the cursor position
- ◆ Overwrite the highlighted (flashing) character e.g., when entering time and date.

Menu guidance

You can access your telephone's functions by using a menu that has a number of levels.

The menu view can be extended (**expert mode** ) or restricted (**standard mode**). Expert mode is the active default setting.

Settings or functions that are only available in expert mode are marked in these instructions with the  icon.

Switching between standard mode/expert mode and the menu overview → [page 46](#).

Main menu (first menu level)

- ▶ When the handset is in idle status, press the **right** control key  to open the main menu.

The main menu functions are shown in the display as icons. The icon for the selected function is highlighted in orange and the name of the associated function appears in the display header.

To access a function i.e., to open the corresponding sub-menu (next menu level):

- ▶ Use the control key  to select the required function and press the display key **OK**.

Briefly press the display key **Back** or the end call key  to revert back to idle status.

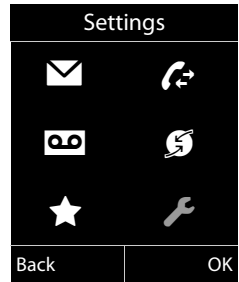

Submenus

The functions in the submenus are displayed as lists (example on the right).

To access a function:

- ▶ Scroll to the function with the control key  and press **OK**.

Briefly press the display key **Back** or the end call key  to return to the previous menu level/cancel the operation.

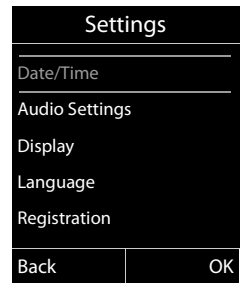

Reverting to idle status

You can revert to idle status from anywhere in the menu as follows:

- ▶ Press and **hold** the end call key .

Or:

- ▶ Do not press any key: After 2 minutes the display will **automatically** revert to idle status.

Settings that have not been saved by selecting the display keys **OK**, **Yes**, **Save** or **Change** are lost.

An example of the display in idle status is shown on [page 37](#).

Activating/deactivating the handset



With the phone in idle status, press and **hold** the end call key (confirmation tone) to deactivate the handset.
Press and **hold** the end call key again to reactivate the handset.

Please note

When the handset is activated, an animation showing the **Gigaset** logo is displayed for several seconds.

Activating/deactivating the keypad lock

The keypad lock prevents any unwanted use of the phone.



Press and **hold** the hash key in idle status to activate or deactivate the keypad lock. You will hear the confirmation tone.

If the keypad lock is activated, you will see a message when you press a key.

The keypad lock deactivates automatically when you receive a call. It is reactivated when the call is finished.

Please note



When the keypad lock is active, you cannot call emergency numbers.

Understanding the operating steps in the user guide

The operating steps are shown in abbreviated form.

Example:

The display:

 →  → **Eco Mode** → **Eco Mode+**  = on)

means:



- ▶ Press **right** on the control key  to open the main menu.



- ▶ Press right, left, down and up on the control key  to navigate to the **Settings** submenu.

- ▶ Press the display key **OK** to confirm your selection.



- ▶ Press down on the control key  until the **Eco Mode** menu option is highlighted.

- ▶ Press the display key **OK** to confirm your selection.



- ▶ Press down on the control key  until the **Eco Mode+** menu option is highlighted.

- ▶ Press the display key **Change** to activate/deactivate the function.



The change is effective immediately and does not need to be confirmed.

- ▶ Press the key below **Back** to skip back to the previous menu level.

Or

- Press and **hold** the end call key  to return to idle status.

Menu tree

Setting standard or expert mode

The menu view can be extended (**expert mode** ⚙️) or restricted (**standard mode**). Menu options that are only available in expert mode are marked with the ⚙️ icon.

To change these settings:

Select → → **Menu View** → **Simplified** (standard mode) or **Complete** (expert mode) → **Select** (the active mode is marked with ●)

To open the main menu: press when the handset is in **idle status**.

✉ Messaging

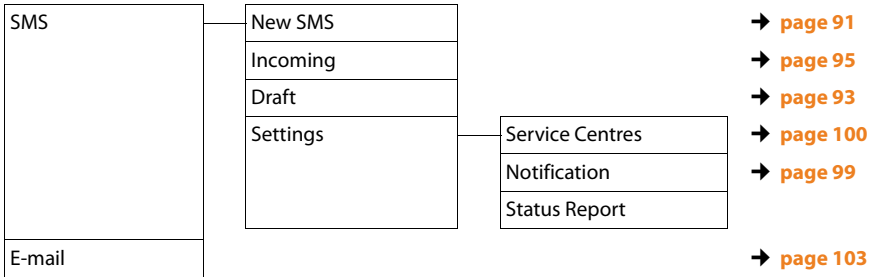

📞 Call Lists

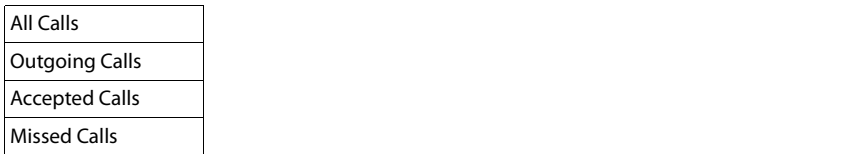

📞 Voice Mail

Play Messages	Net AM: Fixed Line
	Net AM: IP1
	Net AM: IP2
	:
	Net AM: IP6
Network Mailboxes	Net AM: Fixed Line
	Net AM: IP1
	Net AM: IP2
	:
	Net AM: IP6
Set Key 1	Net AM: FixedLn.
	Net AM: IP1
	Net AM: IP2
	:
	Net AM: IP6

→ [page 118](#)

→ [page 118](#)

→ [page 119](#)

📞 Select Services

Nxt Call Anonymous	<table border="1"> <tr><td>Internal</td></tr> <tr><td>Fixed Line</td></tr> <tr><td>IP1</td></tr> <tr><td>IP2</td></tr> <tr><td>:</td></tr> <tr><td>IP6</td></tr> </table>	Internal	Fixed Line	IP1	IP2	:	IP6
Internal							
Fixed Line							
IP1							
IP2							
:							
IP6							
Call Divert							
Call Waiting							
All Calls Anony.							
Transfer (ECT)							

→ [page 61](#)

→ [page 60](#)

→ [page 62](#)

→ [page 59](#)

→ [page 62](#)

★ Additional Features

Info Center
Alarm Clock
Room Monitor

→ [page 108](#)

→ [page 123](#)

→ [page 124](#)

Menu tree



Settings

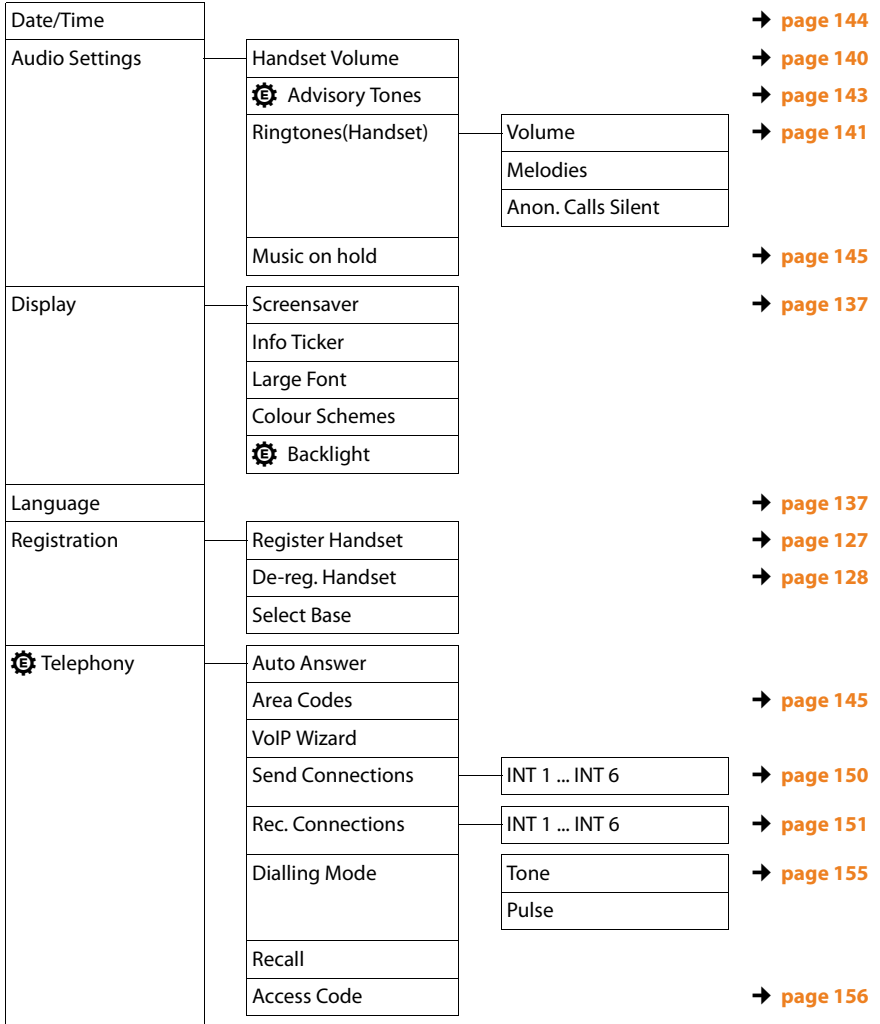

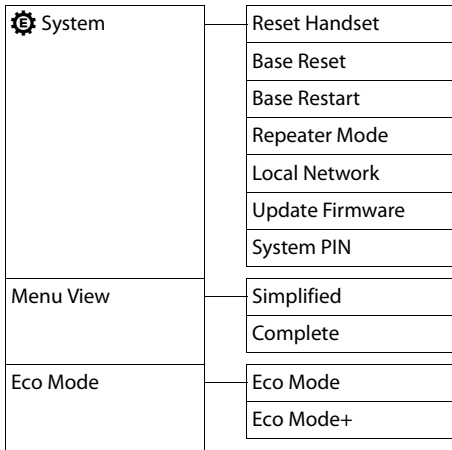

→ [page 153](#)

→ [page 153](#)

→ [page 153](#)

→ [page 146](#)

→ [page 152](#)

→ [page 144](#)

→ [page 121](#)

→ [page 121](#)

Making calls

If the display backlight is deactivated (→ [page 139](#)), it can be reactivated by pressing any key.

Please note

You can make up to two external calls at the same time via your base, depending on the quality of your DSL connection.

Making an external call

External calls are calls made via the public telephone network (fixed line, mobile phone network) or via the Internet (VoIP).

To make an external call, you need to define one of the phone connections as a send connection. You have the following options:

- ◆ Assign a connection to the handset as a send connection permanently (→ [page 150](#)).
You can use a "fallback" via a display key (→ [page 134](#)).
- ◆ Select a send connection on the handset each time you make a call.

Permanently assigned send connection

Prerequisite:

A specific connection (fixed line or VoIP connection) is assigned to the handset as a send connection (→ [page 150](#)).



Enter the number and press the talk key. The number is dialed.

Or:



Press and **hold**. A list of your phone's connections will be displayed.





Select a connection.



Press the display key or the middle of the control key.



Enter the number. The number is dialed approximately 3.5 seconds after the last digit is entered.

Instead of the talk key , you can also press the speaker key  to make a call in speaker mode.

In this user guide, each of these variants is indicated by "Press the talk key ".

The dialed number and the send connection used are shown in the display (e.g., **via IP2**). The connection name you have assigned is displayed where available. Otherwise, the standard name is used.

Please note

- ◆ If a dialling plan has been defined for the dialled phone number (→ [page 174](#)), then the connection specified in the dialling plan will be used to establish the connection instead of the send connection. If the phone number is blocked by a dialling plan, it will not be dialled. **Not possible** is displayed.
- ◆ If you use VoIP to make a call to a fixed line, you may also have to dial the area code for local calls (depending on the provider). You can avoid having to dial your own area code by entering it in the configuration and activating the **Predial area code for local calls via VoIP** option (see Web configurator).
- ◆ You have activated the **Automatic Fallback to Fixed Line** option with the Web configurator. If an attempt to make a call via a VoIP connection fails, the phone automatically attempts to establish the connection via the fixed line.
- ◆ Gigaset.net numbers ending with the suffix #9 are automatically dialled via the Gigaset.net connection. The calls are free of charge (→ [page 56](#)).

Selecting a connection at each call

Prerequisite: "Sel. at each call" has been assigned to the handset instead of a send connection (→ [page 150](#)).



Enter the number and press the talk key. The list of all the phone's connections is displayed.



Select a connection.



Press the display key or the middle of the control key.

If a dialling plan has been defined for the dialled phone number (→ [page 174](#)), then the send connection specified in the dialling plan is used.

Please note

- ◆ You can cancel the dialling process with the end call key .
- ◆ You are shown the duration of the call while the call is in progress.
- ◆ Dialling with the directory ([page 71](#)) or call and redial list ([page 66](#)) saves you from repeatedly keying in phone numbers.
- ◆ If you have multiple handsets registered to the base, you can make **internal** calls free of charge ([page 130](#)).

Using an alternative connection/connection list on the display key

Prerequisite: you have assigned an "alternative connection" or the list with all configured connections to a display key (→ [page 134](#)).



Press the display key.



Select a connection.



Press the talk key or display key.



Enter a number. The number is dialled approximately 3.5 seconds after the last digit is entered.

Any dialling plan (→ [page 174](#)) that has been defined for the dialled phone number is ignored. The selected send connection is always used.

Calling an IP address (provider-dependent)

You can also dial an IP address instead of a phone number using VoIP.

- ▶ Press the star key **[* a]** to separate the sections of the IP address (e.g., 149*246*122*28).
- ▶ If necessary, press the hash **[→ #]** key to attach the SIP port number of the person you are calling to the IP address (e.g., 149*246*122*28#5060).

If your VoIP provider does not support the dialling of IP addresses, each part of the address will be interpreted as a normal phone number.

Dialling emergency numbers

If no dialling plans for emergency numbers are preset on your telephone, you should set dialling plans yourself. Assign them to a connection that you know supports emergency numbers. Calls to emergency numbers are always supported by fixed lines.

Please note: if no dialling plans are defined for emergency numbers and you have programmed an automatic local area code, the code will also be prefixed to emergency numbers as soon as they are dialled via a VoIP connection.

Displaying the phone number you are calling (COLP)

Prerequisites:

- ◆ Your network provider supports COLP (**C**onnected **L**ine **I**dentification **P**resentation). You may need to activate COLP with the provider (ask your provider about this).
- ◆ The called party has not activated COLR (**C**onnected **L**ine **I**dentification **R**estriction).

For outgoing calls, the phone number of the connection on which the call is received is displayed on the handset.

The displayed number may differ from the number you have dialled. Examples:

- ◆ The called party has activated call divert.
- ◆ The call is answered by another connection within a PABX system.

If there is an entry in the directory for this phone number, the corresponding name will be displayed.

Please note

- ◆ The actual number of the connection you have reached (or the assigned name) is displayed instead of the called number during call swapping, conference calls and consultation calls.
- ◆ When the phone number is copied to the directory and the redial list, the dialled number (not the displayed number) is copied.

Ending a call



Press the end call key.

Accepting a call

An incoming call is indicated in three ways: By ringing, by a display on the screen and by the flashing speaker key .



Please note

Only calls to the receive connections assigned to the handset are signalled (→ [page 151](#)).

The following applies in particular if VoIP connections are configured on your base:

- ◆ If you have not assigned the receive connections on your phone, all incoming calls are signalled on all registered handsets.
- ◆ If you have assigned connections but not assigned a connection to any handset as the receive connection, calls on this connection will not be signalled.
- ◆ If a call cannot be assigned to any connection on the phone, this call is signalled on all handsets.

Accept the call by:

- ▶ Pressing the talk key .
- ▶ Pressing the speaker key .

To deactivate the ringtone, press the **Silence** display key. You can accept the call as long as it is displayed on the screen.

If you press the end call key , a call to a VoIP connection is rejected. For a call to the fixed line connection, only the ringtone is deactivated as with **Silence**.

Calling Line Identification

When you receive a call, the caller's number is displayed on the screen if the following prerequisites are met:

- ◆ Your network provider supports CLIP, CLI.
 - CLI (Calling Line Identification): the caller's number is transmitted.
 - CLIP (Calling Line Identification Presentation): the caller's number is displayed.
- ◆ You have requested CLIP from your network provider.
- ◆ The caller has arranged CLI with the network provider.

Call display

If the caller's number is saved in your directory, the caller's name will be displayed. You can use the display to decide which receive connection the call is directed to. Example of display:

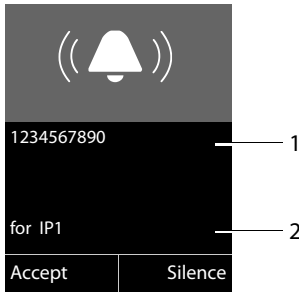

1 Number or name of caller

2 Receive connection: Indicates which of your phone numbers the caller has dialled. The name you set when configuring the phone or the default name is displayed (**Fixed Line** or **IP1** to **IP6**). For calls from Gigaset.net, **for Gigaset.net** is displayed.

The following is displayed instead of the number:

- ◆ **External**, if no number is transmitted.
- ◆ **Withheld**, if the caller has withheld Calling Line Identification ([page 59](#)).
- ◆ **Unavailable**, if the caller has not arranged Calling Line Identification.

Notes on calling line display (CLIP)

By default, the number of the caller is shown in the display of your Gigaset telephone. You do not have to make any other settings on your Gigaset telephone.

However, if the caller's number is not displayed, this can be due to the following:

- ◆ You have not requested CLIP from your provider
- ◆ Your telephone is connected via a PABX or a router with an integrated PABX (gateway) that does not transmit all information.

Is your telephone connected via a PABX/gateway?

You can establish this by checking for an additional device connected between your telephone and home connection e.g., a PABX, gateway etc. In most cases, simply resetting this device will remedy the situation:

- ▶ Briefly disconnect the PABX power plug. Re-insert the plug and wait for the device to restart.

If the caller number is still not displayed:

- ▶ Check the CLIP settings of your PABX and activate this function if necessary. In the user guide for the device, search for the term "CLIP" (or an alternative term such as "calling line identification", "phone number transmission", "caller ID" etc.). If necessary, contact the device manufacturer.

If this does not resolve the problem, it is possible that your network provider does not provide the CLIP service for this number.

Have you ordered the calling line display service from your network provider?

- ▶ Check whether your provider supports calling line display (CLIP) and that the function has been activated for you. If necessary, contact your provider.

Additional information on this subject can be found on the Gigaset homepage at: www.gigaset.com/service

VoIP telephony via Gigaset.net

You can use **Gigaset.net** to make free phone calls via the Internet **directly** to other Gigaset.net users without having to set up an account with a VoIP provider or make any further settings. You simply have to connect your phone to the power supply and the Internet connection and, if necessary, enter yourself in the Gigaset.net online directory under a name of your choice (→ [page 87](#)).

Gigaset.net is a VoIP service provided by Gigaset Communications GmbH to which all users of a Gigaset VoIP device can subscribe.

You can call other subscribers to Gigaset.net **free of charge** i.e., there are no telephone charges other than the costs for your Internet connection. Connections to/from other networks are not possible.

Numbers ending with the suffix #9 are automatically dialled via the Gigaset.net connection.

Please note

Gigaset.net supports broadband telephony: Gigaset.net calls that you make from your phone with a different broadband-capable terminal have excellent sound quality.

Every Gigaset VoIP device is assigned a Gigaset.net phone number by default (→ [page 191](#)).

All registered subscribers are included in the Gigaset.net directory, which you are able to access.

An echo service is available for you to check your VoIP connection.

The echo service is available in six languages:

- ◆ 12341#9 (English)
- ◆ 12342#9 (Dutch)
- ◆ 12343#9 (Italian)
- ◆ 12344#9 (French)
- ◆ 12345#9 (German)
- ◆ 12346#9 (Spanish)

After an announcement, the echo service immediately sends back the voice data you have received in the form of an echo.

Exclusion of liability

Gigaset.net is a voluntary service provided by Gigaset Communications GmbH with no liability or guarantee for the availability of the network. This service can be terminated at any time with a notice period of three months.

Please note

If you do not use your Gigaset.net connection for six months, it is automatically disabled. You cannot be reached for calls from Gigaset.net.

The connection is reactivated as soon as you:

- ◆ Start a search in the Gigaset.net directory
- ◆ Make a call via Gigaset.net (dial a number with #9 at the end)
- ◆ Activate the connection via the Web configurator

Gigaset HDSP – telephony with brilliant sound quality



Your Gigaset telephone supports the broadband codec G.722. You can therefore use it to make calls with brilliant sound quality (High Definition Sound Performance).

If you register broadband-capable handsets with your base, internal calls between these handsets will also be made via broadband.

The following are prerequisites for broadband connections on your telephone:

◆ **For internal calls:**

The handsets involved are broadband-capable, i.e., they support codec G.722.

◆ **For external calls via VoIP:**

- You make the call from a broadband-capable handset.
- You have selected codec G.722 for outgoing calls.
- Your VoIP provider supports broadband connections.
- The recipient's phone supports codec G.722 and accepts the establishment of a broadband connection.

Please note

The VoIP service **Gigaset.net** (→ **page 56**) supports broadband connections.

Activating/deactivating speaker mode

In speaker mode, instead of holding the handset to your ear you can put it down, for example on the table in front of you. For example, this allows others to participate in the call.

Activating speaker mode while dialling



Enter the number and press the speaker key.

Switching between earpiece and speaker mode



Press the speaker key.

During a call, activate or deactivate speaker mode.

If you wish to place the handset in the charger during a call:

- ▶ Press and hold the speaker key  while placing the handset in the base.

For instructions on adjusting the speaker volume, → [page 140](#).

Muting the handset

You can deactivate the handset's microphone during an external call (including during a conference or when call swapping). The other parties cannot hear you, but you can still hear them.

Prerequisite: you are conducting an external call.

Deactivating the microphone



Press the mute key. The display shows **Microphone is off**.

Unmuting the microphone





Press the mute key again to unmute the microphone.

If a second call (call waiting) is received in mute mode, this is signalled acoustically as usual. However, it is only shown on the display once the microphone has been unmuted.

Please note

In mute mode, all keys on the handset are deactivated with the exception of the:

- ◆ Mute key 
- ◆ End call key , that you can use to end the call.

Making calls using network services

Network services are functions that your network provider makes available to you.

Please note:

- ◆ Some settings cannot be made simultaneously on multiple handsets. If this is the case, you will hear a negative acknowledge tone.
- ◆ Some network services may only be used if you have requested them from your fixed line provider (there may be an extra charge).
- ▶ **If you require assistance, please contact your network provider.**

Configuring general settings for all calls

Anonymous calling – withholding number

You can make anonymous calls (CLIR = Calling Line Identification Restriction). Your phone number will not be displayed when you make outgoing calls. You are calling anonymously.

Prerequisites:

- ◆ For anonymous calls via your fixed line connection, you need to have requested the relevant service (feature) from your network provider.
- ◆ Anonymous calls are only possible via VoIP connections through providers that support the "anonymous calling" function. You may have to ask your VoIP provider to activate this function.

Activating/deactivating "anonymous calling" for all calls

Withholding caller ID can be permanently activated/deactivated for all your phone's connections.

When this function is activated, the phone number is withheld for all fixed line calls and for all calls via VoIP connections. Withholding caller ID is activated for all registered handsets.

 →  **Select Services**

All Calls Anony.

Select and press **OK** (✓ = on).

For instructions on withholding the number temporarily for a subsequent call see [page 63](#).

General call divert (CD)

A distinction is made between

- ◆ Diverting calls internally and
- ◆ Diverting calls to an external phone number

Call divert to an external connection

With call divert the call is diverted to another external connection. Your call divert settings can be specific to a particular connection i.e., for every connection (fixed line number and VoIP connection) that is assigned to the handset as a receive connection.

Prerequisite: the VoIP provider supports call divert.

 →  **Select Services** → **Call Divert**

A list containing the configured and activated receive connections for your phone and **Internal** is displayed.

- ▶ Select the receive connection for which you want to activate or deactivate call divert, and press **OK**.
- ▶ You can enter data in the following fields:

Status

Activate/deactivate call divert.

Phone Number

Enter the number to which the call is to be diverted. You can specify a different fixed line, VoIP or mobile number for every connection.

You must specify another Gigaset.net number when diverting a call from your Gigaset.net number.

When

Select **All Calls** / **When Busy** / **No Answer**.

All Calls: calls are diverted immediately i.e., no more calls to this connection are signalled on your phone.

No Answer: calls are diverted if no one accepts the call within several rings (only VoIP).

When Busy: calls are diverted when your line is busy (only VoIP).

Send Press the display key.

For diverting calls from the fixed line:

A connection is established to the telephone network to activate/deactivate call divert.

- ▶ After confirmation from the fixed line, press the end call key .

Please note

Diverting calls to your phone numbers can result in **additional costs**.
Please consult your provider.

Diverting calls internally

You can divert all **external** calls intended for a receive connection on the handset to a different handset.

 →  **Select Services** → **Call Divert**

Internal Select and press **OK**.

▶ You can enter data in the following fields:

Activation

Activate/deactivate call divert.

To Handset

Select internal party.

No Handset is displayed if internal call divert has not been set previously or if the previously set handset is no longer registered.

Ring Delay

If you prefer to have a delay before the call is diverted, select the length of the delay (**None**, **10 sec.**, **20 sec.** or **30 sec.**). If you select **None**, the call is not signalled on the handset and is diverted immediately.

Save Press the display key.

Internal call divert is only single-stage i.e., if calls for the handset are diverted to a different handset (e.g., MT1) on which a call divert is also active (e.g., to MT2), this second call divert is not activated. The calls are signalled on handset MT1.

Please note

- ◆ Any call for the handset that has been diverted is entered in the call lists.
- ◆ If a call to a receive connection that is only assigned to the handset is diverted to a handset that is not available (e.g., the handset is deactivated), the call is rejected after a short time.

Activating/deactivating call waiting for external calls

If the function is activated, during an **external** call you will hear a call waiting tone to signal that another external caller is trying to get through. If you have CLIP, the number of the waiting caller or the corresponding directory entry is shown in the display. The caller will hear the ringing tone.

When call waiting is deactivated, the caller will hear the busy tone if you are already making a call and you are the only party assigned to this connection.

Activating/deactivating call waiting

Prerequisite for calls via VoIP: parallel VoIP connections are permitted on your telephone (default setting; setting can be changed via the Web configurator).

 →  **Select Services** → **Call Waiting**

Status Select **On** / **Off** to activate/deactivate call waiting.

▶ Press the display key **Save**.

Call waiting is activated/deactivated for all connections to the telephone and all registered handsets.

To activate/deactivate the function for the fixed line connection, the phone establishes a connection to the exchange to send the relevant code.

▶ After confirmation from the fixed line, press the end call key .

Special settings for calls via VoIP

Activating/deactivating transfer – ECT (Explicit Call Transfer)

If the **Transfer (ECT)** function is activated, you can connect two external callers on a VoIP connection with each other by pressing the end call key  (→ **page 64**). This assumes that you are making an external call via one of your VoIP connections and start an external consultation call.

You can activate/deactivate this function via your handset.

 →  **Select Services**

Transfer (ECT)

Select and press **OK**  = on).

Please note



You can use the Web configurator to make further settings for the call transfer on a VoIP connection (→ **page 177**).

Configuring settings for the next call

Activating "anonymous calling" for the next call

You can withhold your phone number for the next call (CLIR = Calling Line Identification Restriction). The setting applies to all the phone's connections.

In idle status:

 →  **Select Services** → **Nxt Call Anonymous**
Select and press **OK**.



Enter the number or copy from the directory.



Press the display or talk key. The number is dialed.

Generally, you can withhold your number for all calls, → [page 59](#).

Configuring settings during an external call

Please note

For VoIP telephony, the services described below are only available if parallel IP connections are permitted.

Accepting a waiting call (only VoIP)

You are making an external call and hear the call waiting tone.

Accept Press the display key.

Once you have accepted the waiting call, you can switch between the two callers ("**Call swapping (only VoIP)**" → [page 64](#)) or speak to both at the same time ("**Conference**" → [page 65](#)).

Please note

- ◆ Without CLIP, a waiting call is only announced with a signal tone.
- ◆ An internal, waiting call is shown on the display. You can neither accept the internal call nor reject it.
- ◆ For instructions on accepting a waiting external call during an internal call, → [page 132](#).



Rejecting a waiting call (only VoIP)

You can hear the call waiting tone but do not want to speak to the caller.

Reject Press the display key.

The caller hears the busy tone.

Please note

You can also press the end call key  to end the current call, and then press the talk key  again to accept the second call.

Consultation calls (external)

You can call a second external caller. The first call is placed on hold.

During an external call:

Ext. Call Press the display key.
The previous call is placed on hold. The caller hears an announcement or music on hold.



Enter the second participant's telephone number.

The phone number is dialled. You are connected to the second participant.

If the participant does not answer, select the display key **End** to return to the first participant.

The consultation call is established via the same send connection as the first call.

Please note

You can also select the second participant's phone number from the directory (page 76), redial list or a call list (page 67).

Ending a consultation call (only VoIP)

Options → End Active Call

You are reconnected to the first call participant.

If you have established the consultation call via your fixed line connection, you can also end the consultation call by pressing the end call key . The connection is briefly interrupted and you will receive a recall. As soon as the receiver is lifted, you are reconnected to the first call participant.

This only applies to VoIP connections if the call transfer is not activated by ending the call ("ECT" → page 62 and "Transfer Call by On-Hook" → page 177).

Call swapping (only VoIP)

You can speak to two callers one at a time (call swap).

Prerequisite: you are conducting an external call and have called a second participant (consultation call) or have accepted a waiting call.

▶ Use  to swap between the participants.

The caller you are currently speaking to is marked with the  icon.

Ending a currently active call

Options → End Active Call

You are re-connected to the waiting caller.

Conference

You can speak to two participants simultaneously.

Prerequisite: you are conducting an external call and have called a second participant (consultation call) or have accepted a waiting call.

- ▶ Press the display key **Conf.**

You and the other two callers (both marked by the  icon) can hear and speak to each other simultaneously.

Ending a conference call (only VoIP)

- ▶ Press the display key **EndConf.**

You return to "call swap" status. You are reconnected to the caller with whom you started the conference.

Or:

Prerequisite:

- ◆ You are making the conference call via your fixed line connection or
- ◆ For VoIP connections: Transfer Call by On-Hook is not activated ("ECT" → [page 62](#); VoIP: "Transfer Call by On-Hook" → Web configurator).



Press the end call key to end the call with both participants.

Each of the callers can end their participation in the conference call by pressing the end call key and replacing the handset.

Transferring calls

Transferring a call to an internal party

You are making an **external** call and would like to transfer it to another handset.

- ▶ Set up an **internal** consultation call (→ [page 131](#)).



Press the end call key (even before the other party has answered) to transfer the call.

Transferring a call to an external number – ECT (Explicit Call Transfer)

You are making an **external** call via a VoIP connection and wish to transfer the call to another external party.

Prerequisite: the feature is supported by the relevant network provider.

If you have activated the **Transfer Call by On-Hook** function for VoIP using the Web configurator (→ [page 177](#)).



Press the end call key (even before the other party has answered) to transfer the call.

Using lists

The options are:

- ◆ Redial list
- ◆ Incoming message list
- ◆ E-mail list
- ◆ Call lists

Redial list

The redial list contains the 20 numbers last dialed (max. 32 digits). If one of the numbers is in the directory, the corresponding name will be displayed.

Manual redial



Press the key **briefly** to open the redial list.



Select entry.



Press the talk key again. The number is dialed.

When a name is displayed, you can display the corresponding phone number:

- ▶ Press the display key **View** or the middle of the control key.
- ▶ Press right or left on the control key as required to view the next/previous number.

Open the redial list. Once you have assigned a line (e.g., to establish an external consultation call); you must then press the display key **OK** to dial the selected number.

Managing entries in the redial list

In idle status:



Press the key **briefly**.



Select entry.



Open menu.

You can select the following functions with :

Copy to Directory

Copy an entry to the directory ([page 71](#)).

Display Number

(As in the directory, [page 74](#))

Delete Entry

Delete selected entry.

(As in the directory, [page 74](#))

Delete List

Delete complete list.

(As in the directory, [page 75](#))

Incoming message list

All received SMS messages are saved in the incoming message list (→ [page 95](#)).

Call lists

Prerequisite: Calling Line Identification Presentation (CLIP, → [page 54](#))

Your base saves a range of call types:

- ◆ Accepted calls
- ◆ Outgoing calls
- ◆ Missed calls

You can view each type of call separately or gain an overview of all calls. The list of accepted and missed calls contains the last 30 entries for each. The list of outgoing calls contains the last 60 entries.

In idle status, open the call lists by selecting the **Calls** (→ [page 136](#)) display key or via the menu:

 →  → **All Calls / Outgoing Calls / Accepted Calls / Missed Calls**



Please note

You can receive information on unknown numbers free of charge via the reverse search in the online directory (→ [page 78](#)).

List entry

New messages are displayed at the top.



Example of list entries:

All Calls	
 Frank for IP2 14.10.09, 15:40	
 089563795 for IP1 14.10.09, 15:32	
View	Options

The following is displayed:

- ◆ List type (in header)
- ◆ The entry status (only in the list of missed calls)
 - Bold:** new entry
- ◆ The caller's number or the name that is saved against this number in the local or online directory
- ◆ Name of the connection to which the missed/accepted call was directed (**for** receive connection), or via which the outgoing call was dialed (**via** send connection). The connection name you have assigned is displayed where available. Otherwise, the standard name is used.

Using lists

- ◆ Date and time of call (if set).
- ◆ Type of entry:
 - Accepted calls ()
 - Missed calls ()
 - Outgoing calls ()
- ◆ In the missed calls list:

The number of missed calls from this number in the form [3] ([1] = "A missed call" is not displayed)

Please note

Multiple calls from the same number are stored once in the missed calls list (the latest call). The number of calls from this number is shown in brackets after the entry.

One Withheld entry is created for all missed calls for which the number of the caller is withheld.

In addition, **one Unavailable** entry is created for every call for which the number was not transferred.

Press the talk key  or the speaker key  to call the selected caller back.

Press the **View** display key to access additional information, including for example the number linked to the name.

Use the **Options** display key to select the following options:

Copy to Directory

Copy number to the directory.

Delete Entry

Delete selected entry.

Delete List

Delete all entries.

When you exit the call lists, all entries are set to the status "old", i.e., the next time you call up the list, they will no longer be shown in bold.

Please note





In the case of each handset, only those accepted/missed calls directed to its receive connections are shown.

Opening lists with the message key

Use the message key  to open the following lists:

- ◆ Network mailbox, if your network provider supports this function and quick dial is set for the network mailbox (→ [page 119](#)).
- ◆ Incoming message list (→ [page 95](#))
- ◆ Missed calls list
- ◆ Missed alarms list

An advisory tone sounds as soon as a **new entry** appears on a list. The  key flashes (it goes off when the key is pressed). In **idle status**, the display shows an icon for the new message:

Icon	New message ...
	... on the network mailboxes
	... in the Missed Calls list
	... in the SMS list or e-mail list
	... in the Missed Alarms list

The number of new entries is displayed under the corresponding icon.

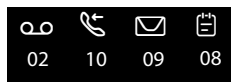

Please note

If calls are saved in the network mailbox, you will receive a message if the appropriate settings have been made (see your network provider user guide).

After pressing the message key , you can see all lists containing messages and the network mailbox lists.

Lists containing new messages are at the top of the list and are marked in a bold font.

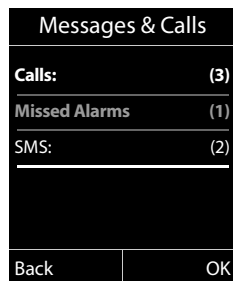

Select a list with . To open, press **OK**.

Missed alarms list

Missed anniversaries (→ [page 77](#)) are displayed in the **Missed Alarms** list if:

- ◆ You do not accept an anniversary.
- ◆ The anniversary was signalled during a phone call.
- ◆ The handset is deactivated at the time of the anniversary.
- ◆ You open the list by pressing the **message key**  (→ [page 69](#)).

Each entry is displayed with:

- ◆ Number or name
- ◆ Date/time

The most recent entry is at the head of the list.

Press the **Delete** display key, to delete the selected entry.

If 10 entries are already stored in the list, the next appointment reminder will delete the oldest entry.

Using directories

The options are:

- ◆ (Local) directory (→ [page 71](#))
- ◆ Public online directory and Yellow Pages (→ [page 78](#))
- ◆ Gigaset.net directory (→ [page 84](#))
- ◆ Private net directory

Local handset directory

You can save a total of 150 entries in the directory.

You can create a personalised directory for your own individual handset. You can also send entries to other handsets ([page 75](#)).

Please note

You can assign numbers from the directory to the digit/display keys for quick access (quick dial) ([page 134](#)).

Directory entries

You can save the following information in a directory entry:

- ◆ First name and surname
- ◆ Up to three numbers
- ◆ E-mail address
- ◆ Anniversary with reminder
- ◆ VIP ringtone with VIP icon.

Open the directory in idle status or during an external call with the  key (press briefly).

Length of the entries

3 numbers:	Max. 32 digits each
First name and surname:	Max. 16 characters each
E-mail address:	Max. 60 characters

Saving number(s) in the directory – new entry

 → <New Entry>

▶ You can enter data in the following fields:

First Name: / Surname:

Enter first names and/or surnames.

If you do not enter a name in either of the fields, the first phone number saved in the entry is saved and displayed in place of a surname.



For instructions on entering text and special characters, → [page 197](#).

Phone (Home): / Phone (Office): / Phone (Mobile):

Enter a number in at least one of the fields.

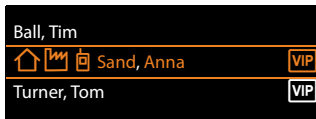
When scrolling through the directory, prefixed icons indicate which numbers are contained in the entry:



 denotes **Phone (Home)**,  denotes **Phone (Office)**,
 denotes **Phone (Mobile)**.

E-mail:

Enter the e-mail address.

Anniversary:

Select **On** or **Off**.

With setting **On**:

Enter **Annivers. (Date)** and **Anniversary (time)** and select reminder type:

Anniversary (tone) → [page 76](#).

VIP Group:

Mark directory entry as **VIP** (Very Important Person).

You can assign one of 6 VIP groups to each entry. These groups are defined by the colour of the  icon, the name of the VIP group and the corresponding ringtone.

You recognise VIP calls by the ringtone. The ringtone animation background colour changes to the VIP group colour.

Prerequisite: Calling Line Identification ([page 54](#)).

Save

Press the display key.

Order of directory entries

Directory entries are generally sorted alphabetically by surname. Spaces and digits take first priority. If only the first name was entered in the directory, this is incorporated into the sort order instead of the surname.

The sort order is as follows:





- 1 Space
- 2 Digits (0–9)
- 3 Letters (alphabetical)
- 4 Remaining characters (*, #, \$ etc.)

To get round the alphabetical order of the entries, insert a space or a digit in front of the first letter of the surname. These entries will then move to the beginning of the directory.

Searching for a directory entry



 Open the directory.

You have the following options:

- ◆ Use  to scroll through the entries until the required name is selected.
Press  briefly to scroll on an entry-to-entry basis.
Press and hold  to scroll through the directory.
- ◆ Enter the first letter of the name; use the  key to scroll to the entry if necessary.

The directory searches for the surname. If a surname has not been added, then it will search for the first name.

Dialling with the directory



 →  (Select entry)

 Press the talk key.



Or during a call:

 Press the display key.

If the entry only contains one phone number, this is the number that is dialled.

If the entry contains several numbers, the icons for the numbers stored are displayed:  /  / .

 Select a number.



 /  Press the talk key or display key. The number is dialled.

Please note

When dialling, you can link several numbers from the directory (e.g., a call-by-call number to a telephone number, → [page 89](#)).

Managing directory entries

Viewing entries

 →  (Select entry)

View /  Press the display key or the middle of the control key. The entry will be displayed.

 Scroll through the entry if necessary.



Using other functions

Prerequisite: the directory was opened while the handset was in idle status.

Options Press the display key.

You can select the following functions with :

Display Number

To edit or add to a saved number, or to save it as a new entry, press  after the number is displayed. Select the number for the entry, if necessary, and change or edit the saved number before dialling with , or press  to save as a new entry.



Delete Entry

Delete selected entry.

Copy Entry

- **to Internal:** Send a single entry to a handset (→ [page 75](#)).
- **vCard via SMS:** Send a single entry in vCard format via SMS.

Editing entries



 →  (Select entry)

View **Change**
Press the display keys one after the other.

▶ Perform changes and save.

Using other functions

When the handset is in idle status:

 →  (Select entry) → **Options** (Open menu)

You can select the following functions with :

Display Number

(see above/[page 74](#))

Edit Entry

Edit selected entry.

Delete Entry

Delete selected entry.

Copy Entry

(see above/[page 74](#))

VIP Groups

Edit VIP group name and ringtone. To do this:

Select VIP group → **Edit** → Edit entry → **Save**.

Delete List

Delete **all** entries in the directory.

Copy All

to Internal: Send the complete list to a handset (→ [page 75](#)).

Available Memory

Display the number of entries that are still available in the directory.

Exchanging directory/entries with other handsets

You can send entries from the local directory or the complete local directory to handsets as well as receive directory entries from the handsets.

Please note:

- ◆ Entries with identical numbers are not overwritten on the receiving handset.
- ◆ The transfer is cancelled if the phone rings or the receiver's memory is full.
- ◆ Pictures and sounds assigned to entries are not transferred.

Prerequisites:

- ◆ The sending and receiving handsets must both be registered to the same base.
- ◆ The other handset can send and receive directory entries.

Sending a directory/directory entries to a handset

 →  (Select entry) → **Options** (Open menu) → **Copy Entry / Copy All**
→ **to Internal**

 Select the internal number of the receiving handset and press **OK**.

The transfer begins.

You can transfer several individual entries one after the other by responding to the **Entry copied - Copy next entry?** prompt with **Yes**, selecting the entry and pressing the middle of the control key .

A successful transfer is confirmed by a message and confirmation tone on the receiving handset.

Please note

The transfer is interrupted in the event of an external incoming call.

Receiving a directory/directory entries from a handset

Prerequisite: the handset is in idle status.

- ▶ Start the transfer of directory entries on the handset as described in the handset user guide.

If the data has been transferred successfully, the display on your handset will indicate the number of entries received (so far).

Adding a displayed number to the directory

You can add numbers to the directory:

- ◆ From a list e.g., the call list, incoming SMS message list or the redial list
- ◆ From the text of an SMS
- ◆ From a public online directory or the Yellow Pages
- ◆ From your private net directory
- ◆ When dialling a number

A number is displayed:





Options → **Copy to Directory**

Or:

 Press the display key.

The directory is opened. You can create a new entry or extend an existing entry.

 Select <New Entry> or the directory entry and press **OK**.

 Select the type of phone number  /  /  and press **OK**.
The number is copied into the corresponding field.

If the number field is already occupied, **Overwrite existing number?** is displayed.

Yes Press the display key to overwrite the number. If you select **No**, you are asked to select another type of phone number.

- ▶ If necessary, complete the entry (→ [page 72](#)).

Please note

For a new entry:

- ◆ If you are copying a number from an online directory, the surname or nickname (if available) are copied into the **First Name** field.

Copying a number or e-mail address from the directory



In some operating situations, you can open the directory to copy a number or e-mail address, for example. Your handset need not be in idle status.

- ▶ Depending on the operating situation, open the directory with  or .

 Select entry (→ [page 73](#)).

Saving an anniversary in the directory

For each entry in the directory, you can save an anniversary and specify a time at which a reminder call should be made on the anniversary (default setting: **Off**).

 →  (Select entry)

View **Change**

Press the display keys one after the other.

 Scroll to the **Anniversary**: line.

 Select **On**. The following fields are displayed.

► You can enter data in the following fields:

Annivers. (Date)

Enter day/month/year in 8-digit format.

Anniversary (time)

Enter the hour/minute for the reminder call in 4-digit format.

Anniversary (tone)



Select the reminder type.

Save Press the display key.

Please note

A time must be specified for reminder calls. If you select a visual signal, a time is not required and is automatically set to 00.00.

Deactivating anniversaries

 →  (Select entry)

View **Change**

Press the display keys one after the other.

 Scroll to the **Anniversary:** line.

 Select **Off**.

Save Press the display key.

Anniversary reminder call

In **idle status**, a reminder call is shown in the display of the handset (→ [page 4](#)) and signalled with the selected ringtone.

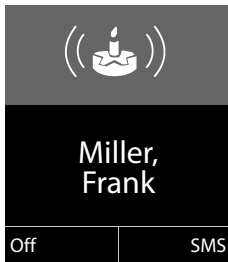

You can:

SMS Write an SMS.

OFF Press the display key to acknowledge and end the reminder call.

When you are on the phone, a reminder call is indicated on the handset with a **single** advisory tone.

Anniversaries that are indicated during a call and are not acknowledged are entered in the **Missed Alarms** list (→ [page 70](#)).

Using online directories

You can use public online directories (online directories and classified directories e.g., "Yellow Pages") depending on your provider.

You can configure the online directories you wish to use via the Web configurator.

Exclusion of liability

Gigaset Communications GmbH assumes no guarantee or liability for the availability of this service. The service may be discontinued at any time.

Opening an online directory/Yellow Pages

Prerequisite: the handset is in idle status.

 Press and **hold**.

This opens the list of online directories. Provider-specific names appear in the display.

 Select a directory (online directory or Yellow Pages) from the list and press **OK**.

This establishes a connection to the online directory or the Yellow Pages.

If there is only one online directory available, a connection is immediately established if you press and **hold** down the control key .

Please note

You can also establish a connection to the online directory as follows:

- ▶ When the handset is idle, dial **1#91** and press the talk key .
- ▶ To establish a connection to the Yellow Pages, dial **2#91**.
- ▶ To establish a connection to the Gigaset.net directory, dial **1188#9**.

Calls to the online directory are always free of charge.

Searching for an entry

Prerequisite: you have opened the online directory/Yellow Pages.

▶ You can enter data in the following fields:

Surname: (online directory) or

Category/Name: (Yellow Pages)

Enter the name, part of a name or the category (max. 30 characters).

City: Enter the name of the town/city in which the party you are searching for lives (max. 30 characters).

If you have already completed a search, the last names of the towns/cities you entered are displayed (maximum of five).

You can enter a new name or select one of the city names displayed using  and confirm with **OK**.

Or:

Number: Enter the number (max. 30 characters).

▶ Press the display key **Search** or  to start the search.

You must make an entry in **Surname** or **Category/Name:** and in **City** or in **Number**. Searching by number is only possible if supported by the online directory you have selected. For instructions on entering text see [page 197](#).

A list of the towns/cities found is displayed if the search returns more than one result:



Select the town/city.

If the name of a town/city is longer than one line, it is abbreviated.

Select **View** to view the complete name.

If no matching town/city is found: Press **Change** to change the search criteria. The entries for **Category/Name** and **City** are copied and you can change them.

Search

Press the display key to continue the search.

A corresponding message will appear on the display if no party is found to match the search criteria. You have the following options:

- ▶ Press the display key **New** to start a new search.

Or

- ▶ Press the display key **Change** to change the search criteria. The name and town/city are copied over and you can change them.

No hits are displayed if the list of hits is too large. A message to this effect is displayed.

- ▶ Press the display key **Refine** to start a refined search (→ [page 81](#)).

Or

- ▶ Depending on the provider, you can view the list if the number of hits is shown on the display. Press the display key **View**.



Search result (hit list)

The search result is shown as a list on the display. Example:



1. 1/50: Consecutive number/total number of hits (only the consecutive number is displayed if the total number of hits >99).
2. Four lines including party's name, category, telephone number and address (possibly abbreviated). If a fixed line number is not available, the mobile number (if available) is displayed.

You have the following options:

- ▶ You can scroll through the list with .
- ▶ Press the display key **View**. Displays the full details of the entry (name, category where applicable, address, telephone numbers). You can scroll through the entry with .

Use **Options** to access the following options:

Refine search

Refine search criteria and restrict hit list (→ [page 81](#)).

New search

Start a new search.

Copy to Directory

Copy an entry to the local directory. If an entry contains several numbers, they are displayed in a selection list. A new entry is created for the selected number. The surname is transferred to the **Surname** field of the local directory (→ [page 76](#)).

Copy to Private NetDir.

Transfer the selected entry to the private net directory. The private directory and online directory must be provided by the same provider.

Depending on your provider, you can add a nickname to the entry in your private directory.

Calling subscribers

Prerequisite: a hit list is displayed.

- ▶ Select the entry and press the talk key .

If the entry only contains one phone number, this is the one that is dialed.

A list of numbers appears if there is more than one number.

- ▶ Using , select a number and press the display key **Dial**.

Starting a refined search

You can use the search options available in the refined search (first name and/or street) to limit the number of hits returned by a previous search.

Prerequisite: a search result is displayed (hit list with multiple entries or a message indicating too many hits).

Refine Press the display key.

Or

Options → **Refine search**
Select and press **OK**.

The search criteria from the previous search are copied and entered in the corresponding fields.

Surname: (online directory) or

Category/Name: (Yellow Pages)

If necessary, change the name/category or extend the partial name.

City: Name of the city/town from the previous search is shown (cannot be changed).

Street: If necessary, change the name of the street (max. 30 chars.).

First Name: (only in the online directory)

If necessary, enter the first name (max. 30 characters).

Search Start refined search.

Using the private net directory

Some providers offer users the option of creating and managing a private net directory on the Internet.

The advantage of an online directory is that you can call up entries from any telephone or PC, e.g., from your VoIP phone in the office or your PC at a hotel.

You can use the private net directory on your handset.

Prerequisites:

- ◆ Create your private net directory using your PC's Web browser.
- ◆ Create and manage entries in the online directory via your PC's Web browser.
- ◆ Activate the online directory on your phone using the Web configurator. You must save the username and password in particular for accessing your personal online directory on the phone.

You can use the directory from every registered handset.

Opening the online directory

Prerequisite: the handset is in idle status.

 Press and **hold**.



This opens the list of (online) directories. The provider-specific name is displayed for the private net directory.

 Select the private online directory from the list and press **OK**.

Your private online directory is opened.

Please note

If there is no other online directory available apart from the private online directory:

- ▶ Press  **briefly**. The private online directory opens.
- ▶ Press and **hold** . The handset's local directory opens.

The entries in the online directory are sorted alphabetically according to the first non-space field in the entry. This is generally the nickname or surname.

Selecting, viewing and managing entries in the online directory

Prerequisite: the online directory is open (see above).

▶ Scroll with  to the required entry.

Or:

Enter the first letter of the name and scroll with  to the required entry.

▶ Press the display key **View**.

The detailed view with the complete entry opens. You can scroll through the entry with the control key .

The following data is shown, if available (in the sequence specific to the provider):

Nickname, name, first name, phone number, mobile number, VoIP number, street, house number, post code, town/city, company name, category, date of birth, e-mail.

Using other functions

Options Press the display key.

You can select the following functions with :

Edit nickname

You can edit or delete the nickname in an entry. Press **Save** to save the change.

Copy to Directory

Copy an entry to the local directory ([→ page 76](#)).

Please note

You can copy numbers from a public directory to your private online directory ([→ page 80](#)).

Calling up an entry in the online directory

Prerequisite: you have opened the online directory.

 Select entry (open the details view, if necessary).

 Press the talk key.

If the entry only contains one phone number, this is the one that is dialled.

If the entry contains more than one phone number (e.g., mobile number and phone number), they are offered to you for selection.

 Select the number to be dialled.

OK Press the display key.

The selected phone number is dialled.

Transferring the local directory to the private online directory

You can save entries in the local directory in vCard format as a vcf file on your PC using the Web configurator ([→ Web configurator on page 178](#)).

Several providers support functions on your Web pages that you can use to copy these files to the online directory.

Using the Gigaset.net directory

The handset is in idle status.



Press and **hold**.

This opens the list of online directories.

Gigaset.net

Select and press **OK**.

The Gigaset.net directory opens.

Please note

- ◆ Calls to the Gigaset.net directory are always **free of charge**.
- ◆ You can also open the Gigaset.net directory by dialling **1188#9** (phone number of the Gigaset.net directory) and pressing the talk key .

If a connection cannot be established with the Gigaset.net directory, an error message is sent and the handset will return to idle status.

Opening the Gigaset.net directory for the first time

When you open the Gigaset.net directory for the first time, you are asked to enter a nickname for your connection. You are entered in the Gigaset.net directory under this name.

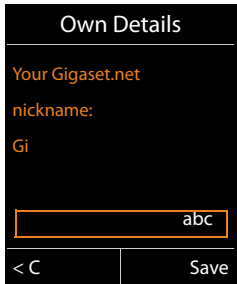

- ▶ Using the keypad, enter the name that you would like to be listed under in the Gigaset.net directory. The name may contain a maximum of 25 characters.
- ▶ Press the right-hand display key **Save**.

Data protection notice

If you enter a nickname at this point, it is stored on a central Gigaset server. The nickname appears in the Gigaset.net directory, and other subscribers that use the Gigaset.net service can call you using this nickname.

By entering your data, you agree to having your data saved. If you do not wish this to happen, you can cancel the operation at this point.

Cancel operation:

Do **not** enter a name and press the display key **Save**. You can use the directory to search for other Gigaset.net subscribers and call them. However, no nickname is entered for you (your phone).

Or:

Press and **hold** the end call key  to exit the Gigaset.net directory (without performing a search).

Further information about the Gigaset.net service data saved can be found at www.gigaset.net/privacy-policy

If an entry with this name already exists, the message **Nickname already exists. Please change.** is displayed. You are prompted to enter a name again.

Searching for subscribers in the Gigaset.net directory

Once the connection to the Gigaset.net directory has been established, you are asked to enter a name that you want to search for.

Gigaset.net name:

Enter the name or part of a name (max. 25 characters).

Search Press the display key to start the search.

If the search has been successful, a hit list is displayed containing all the names that begin with the specified character string.

Example:

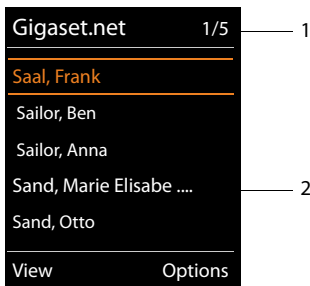

1. 1/5: Entry number/number of hits

2. Name of an entry, possibly abbreviated

You can scroll through the hit list with .

If **no matching** entry is found, a corresponding message is displayed. You have the following options:

Using directories

- ▶ Press the display key **New** to start a new search.

Or

- ▶ Press the **Change** display key to change the search criteria. The name you previously entered in the search field is used as search criterion. You can then expand or edit as required.

If there are **too many matching** entries in the Gigaset.net directory, the message **Too many entries found** is displayed instead of a hit list.

- ▶ Press the display key **Refine** to start a refined search. The previously entered name is copied and you can edit/expand it.

Calling subscribers

-  Select the subscriber from the hit list and press the talk key.

Viewing the subscriber's number

-  Select the subscriber from the hit list.

- View** Press the display key.

The display shows the Gigaset.net number and the subscriber's name, whereby the name may appear over a number of lines.

-  Display the name and number of the next/previous subscriber in the hit list.

Please note

- ◆ Connections to Gigaset.net are always established via the Internet. This is regardless of the send connection configured/selected on your handset.
- ◆ You can open the Gigaset.net directory and establish connections, even if you have not entered yourself in the Gigaset.net directory.

Using other functions

Prerequisite: the hit list is displayed.

-  (Select entry) → **Options**

You can select the following functions with :

Copy to Directory

Copy the number to the handset directory. The number and name (abbreviated if necessary, max. 16 characters) are copied to the local directory.

- ▶ Edit and save the entry where necessary (→ [page 72](#)).

The hit list is displayed again.

New search

Start a search with a new name (→ [page 85](#)).

Refine search

Start a refined search. The name previously searched for is copied and you can edit/expand it.

Own Details

See "[Entering, editing and deleting own entry](#)" on [page 87](#).

Please note

If you select a Gigaset.net number from the local directory, the connection is automatically established via Gigaset.net (Internet).

Entering, editing and deleting own entry

You have the following options:

- ◆ Edit the name of your entry in the Gigaset.net directory.
- ◆ Delete your entry from the Gigaset.net directory.

Viewing your own entry

You are connected to the Gigaset.net directory and have performed a search. A hit list is displayed:

- ▶ Select **Options** → **Own Details** and press **OK**.

Your Gigaset.net number and, where applicable, your current name are displayed.

Entering/editing a name

Change

Press the display key.



Edit the name or enter a new name (max. 25 characters) and press **OK**.

You can delete the name with **<C**.

Data protection notice

If you enter a nickname at this point, it is stored on a central Gigaset server. The nickname appears in the Gigaset.net directory, and other subscribers that use the Gigaset.net service can call you using this nickname.

By entering your data, you agree to having your data saved. If you do not wish this to happen, you can cancel the operation at this point.

Cancel operation:

- ▶ Do **not** enter a name (or delete the name currently entered) and press the display key **Save**. You return to the hit list.

Or:

- ▶ Press and **hold** the end call key to return to the hitlist.

Further information about the Gigaset.net service data saved can be found at www.gigaset.net/privacy-policy

If there is no existing entry with this name in the Gigaset.net directory, the name is saved. A message to this effect is displayed. The handset switches to idle status.

If there is already an entry with this name, or the entered name contains impermissible characters, you are requested to enter a different name.

If an entry was created successfully in the Gigaset.net directory, the message "**Saved**" is displayed.

Please note

- ◆ If you delete the name, your entry is deleted from the directory. You are no longer "visible" to other Gigaset.net subscribers. However, you can still be reached via your Gigaset.net number. For instructions on displaying the number, → [page 191](#).
- ◆ You can also enter/edit your Gigaset.net name via the Web configurator.

Calling a Gigaset.net subscriber

You can call a Gigaset.net subscriber directly via the Gigaset.net directory (see above) or via their Gigaset.net number:



Enter the Gigaset.net number (including the #9) or select it from the local directory.



Press the talk key.

Every number ending with #9 is dialled via Gigaset.net.

Making cost-effective calls

Make phone calls through a network provider who offers particularly low-cost call rates (call-by-call; fixed line only).

Using the Internet (VoIP) is the preferred cost-effective way of making calls.

Defining dialling plans

You can also use your phone's cost control function for calls to fixed line or mobile networks. In addition to your fixed line connection, you can open accounts with various VoIP providers offering favourable rates for calls to other networks. In the phone configuration, define the best connections (account), e.g., for specific regional, national and mobile network codes, to be used when calls are made (→ Web configurator, **Dialling Plans**). Or define the send connection to be used when you actually dial the number (dialling via line selection, → [page 51](#)).

Linking a number with a call-by-call number

You can predial call-by-call numbers for calls via your fixed line connection. Use the call-by-call numbers to select the network of a cost-effective provider for a call.

You can store the call-by-call numbers from several network providers in the local directory (→ [page 72](#)).

To prefix a number with a call-by-call number ("linking"), when the handset is in idle status:



Press **briefly** to open the local directory.



Select entry (call-by-call number).

Options

Press the display key.

Display Number

Select and press **OK**.

The call-by-call number is shown on the display.



Enter the phone number and press the talk key.

Or:



Press **briefly** again to copy the number from the local directory.



Select entry (→ [page 73](#)).



If there are several numbers stored in the entry:
Select the number and press **OK**.



Press the talk key. Both numbers are dialled.

Displaying the call duration

The **duration** of each call appears in the display for all external calls

- ◆ During the conversation
- ◆ Until approximately 3 seconds after replacing the receiver.

Please note

The actual duration of the call can vary from that shown by a few seconds.

Sending SMS (text messages)

You can use your telephone to send and receive SMS messages via the fixed line and VoIP.

You must specify the line via which SMS are sent. You can receive SMS messages (abbreviation: SMS) via all of your phone's connections except for Gigaset.net.

Your telephone is delivered ready to send SMS messages as soon as the phone is connected to the fixed line. If you do not specify any settings the SMS messages are sent via the fixed line.

Prerequisites:

- ◆ Calling Line Identification is enabled for the VoIP connections/fixed line via which you wish to send/receive SMS messages. Calling Line Identification must not be withheld → [page 59](#).
- ◆ Your network provider supports the SMS service (information on this is available from your network provider).
- ◆ To receive SMS messages, you must be registered with your SMS service provider. This happens automatically when you send the first SMS via the provider's service centre.

Writing/sending SMS

Writing an SMS

 →  **Messaging** → **SMS**

New SMS Select and press **OK**.



Write SMS.

Please note

- ◆ For instructions on entering text and special characters, → [page 197](#).
- ◆ An SMS can be up to 612 characters. If there are more than 160 characters, the SMS is sent as a **linked** SMS (up to 4 SMS messages with 153 characters each). The top right of the display shows how many characters are still available and the number in brackets shows which part of a linked SMS is currently being written. Example **447 (2)**.
- ◆ Please note that linking SMS messages usually incurs higher charges.

Sending SMS (text messages)

Sending an SMS

Options Press the display key.

Send Select and press **OK**.

SMS Select and press **OK**.



Select number with area code (even if you are in that area) from the directory or enter directly. For sending SMS messages to an SMS mailbox: add the mailbox ID to the **end** of the number.

Send Press the display key. The SMS is sent.

Please note

- ◆ If you are interrupted by an external call while writing an SMS, the text is automatically saved in the draft list.
- ◆ If the memory is full, or if the SMS function is being used by a handset, the operation is cancelled. An appropriate message appears in the display. Delete SMS messages you no longer require or send the SMS later.

SMS status report

Prerequisite: your network provider supports this feature.

If you have activated the status report, you will receive an SMS with a confirmation message after sending.

Activating/deactivating a status report

 →  **Messaging** → **SMS** → **Settings**

Status Report

Select and press **Change** (= on).

Reading/deleting status report/saving number to directory

▶ Open the incoming message list (→ **page 95**) and then:



Select SMS with **State OK** or **State not OK** status.

Read Press the display key.

- ◆ Delete:
Options → **Delete Entry** → **OK**.
- ◆ Copy to directory:
Options → **Copy to Directory** → **OK**.
- ◆ Delete entire list:
Options → **Delete List** → **OK**.

Draft list

You can save an SMS in the draft list and edit and send it later.

Saving an SMS in the draft list

▶ You are writing an SMS (→ [page 91](#)).

Options Press the display key.

Save Select and press **OK**.

After saving, the SMS editor will be displayed again with your SMS. You can continue writing the text and save it again. The SMS that was saved previously will be overwritten.

Opening the draft list

 →  **Messaging** → **SMS** → **Draft**

The first list entry is displayed, for example:

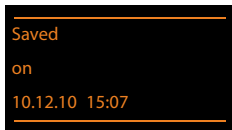

If the entry has been saved with the phone number e.g., when an SMS was saved from the incoming list, the number is displayed in the first line.

Reading or deleting SMS messages

▶ Open the draft list and then:

 Select SMS.

Read Press the display key. The text is displayed. Scroll line by line using .

Or delete the SMS with

Options → **Delete Entry** → **OK**.

Writing/changing an SMS

▶ You are reading an SMS in the draft list.

Options Open menu.

You have the following options:

Send

Send stored SMS (→ [page 92](#)).

Edit

Edit the text of the saved SMS and then send it (→ [page 92](#)).

The SMS that was saved previously remains unaltered in the draft message list

Character Set (one SMS is opened for reading)

Select the character set to be used to show the text (→ [page 96](#)). The setting only applies to the current SMS.

Sending SMS (text messages)

Deleting the draft list

▶ Open the draft list and then:

Options Open menu.



Delete List

Select, press **OK** and confirm with **Yes**. The list is deleted.

Sending SMS messages to an e-mail address

If your service provider supports the **SMS as e-mail** feature, you can also send your SMS messages to e-mail addresses.

The e-mail address must be at the beginning of the text. You must send the SMS to your SMS service centre's e-mail service.

 →  **Messaging** → **SMS** → **New SMS**

E-mail / **Options** → **Insert E-mail Adr.** / 

Load the e-mail address from the directory or enter it directly. End the entry with a space or colon (depending on the service provider).



Enter the SMS text.

Options Press the display key.

Send Select and press **OK**.

E-mail Select and press **OK**. If the number of the e-mail service is not entered (→ **page 100**), enter the number of the e-mail service.

Send Press the display key.

Sending SMS messages as a fax

You can also send an SMS to a fax machine.

Prerequisite: your network provider supports this feature.

▶ You are writing an SMS (→ **page 91**).

Options Press the display key.

Send Select and press **OK**.

Fax Select and press **OK**.



Select number from the directory or enter it manually. Enter the number with area code (even if you are in the same area).

Send Press the display key.

Receiving an SMS

All received SMS messages are saved in the incoming list. Linked SMS messages are displayed as **one** message. If this is too long or is not transferred completely, it is split into individual messages. Since an SMS remains in the list even after it has been read, **regularly delete SMS messages from the list**.

The display tells you if the SMS memory is full.

- ▶ Delete SMS messages you no longer require (→ [page 96](#)).



Please note

Each incoming SMS on the fixed line connection is signalled by a single ring (ringtone as for external calls). If you accept the "call", the SMS is lost. To prevent this ring, suppress the first ringtone for all external calls (→ [page 101](#)).

Incoming list

The incoming list contains:

- ◆ All received SMS messages regardless of the connection it was intended for. All received SMS messages are displayed on all handsets.
- ◆ SMS messages that could not be sent due to an error.

New SMS messages are indicated by the  icon in the display, the  message key flashing and an advisory tone sounding.

Opening the incoming list with the key

 Press.

The incoming list displays the number of entries (example):



SMS: (2)

Bold: new entries

Normal font: old entries

- ▶ Open list with **OK**.

Every entry in the list contains:

- ◆ The number or name of the sender
- ◆ The receive connection to which the SMS is addressed
- ◆ The date of receipt

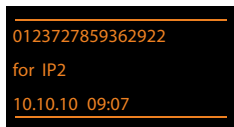

Example:



0123727859362922
for IP2
10.10.10 09:07

Sending SMS (text messages)

Opening the incoming list via the SMS menu

 →  Messaging → SMS → Incoming

Deleting the incoming list

All **new and old** SMS messages in the list are deleted.

▶ Open the incoming list.

Options Open menu.

Delete List

Select, press **OK** and confirm with **Yes**. The list is deleted.

Reading or deleting SMS messages

▶ Open the incoming list, then:

 Select SMS.

Read Press the display key. The text is displayed. Scroll line by line using 

Or delete the SMS with

Options → **Delete Entry** → **OK**.

After you have read a new SMS, it is given the status "Old" (is no longer shown in bold).

Changing the character set



If you cannot see any text or symbols, the SMS may have been written with a different character set (Cyrillic, Greek etc.).

▶ Read the SMS

Options Press the display key.

Character Set

Select and press **OK**.

 Select character set (e.g., **Turkish, Greek**) and press the display key **Select** ( = on).

The text is shown in the selected character set. The setting only applies to the current SMS.

Replying to or forwarding SMS messages

▶ Read the SMS

Options Press the display key.

You have the following options:

Reply

Write and send a new SMS to the sender (→ [page 91](#)).

Edit

Edit the text in the SMS and return it to the sender (→ [page 92](#)).

Forward

Forward the SMS to another number (→ [page 92](#)).

Copying the number to the directory

Copying the sender's number

- ▶ Open the incoming list and select the SMS (→ [page 95](#)).

Options → **Copy to Directory**

- ▶ Complete the entry (→ [page 72](#)).

Please note

An attached mailbox identifier is added to the directory.

Copying/dialling numbers from an SMS

- ▶ Read the SMS and scroll to the telephone number.

The digits are highlighted.

 Press the display key.

Complete the entry (→ [page 72](#)).

Or:

 Press the talk key to dial the number.

If you wish to use the number to send an SMS:

- ▶ Save the number with the local area code (dialling code) in the directory.

If an SMS contains several numbers, the next number will be highlighted if you scroll down until the first number disappears from the display.

Please note

- ◆ The + symbol is not transferred for international area codes.
 - ▶ You should then enter '00' at the start of the number.
- ◆ If there are no more entries available in the directory, you can only overwrite or modify an existing entry.

SMS with vCard

The vCard is an electronic business card. It is indicated by the  icon in the body of the SMS.

A vCard can include:

- ◆ Name
- ◆ Private number
- ◆ Business number
- ◆ Mobile number
- ◆ Birthday

Individual entries in a vCard can be saved to the directory one after the other.

Opening the vCard

- ▶ Read the SMS containing the vCard.

View Press the display key to open the vCard.

Then:

Back Press the display key to return to the SMS text.

Or:



Select the number.

Save Press the display key.

When you save a number, the directory is opened automatically. The number and name are copied. If a birthday is entered on the vCard, the date is copied to the directory as an anniversary.

- ▶ If necessary, edit the entry in the directory and save it. You will return to the vCard automatically.

Receiving notifications via SMS

You can be notified via SMS about missed calls.

Prerequisite: the caller's number (CLI) must have been transmitted in the missed call.

Notification is sent to your mobile phone or another phone with SMS functionality.

You only need to save the telephone number to which you wish the notification to be sent.

Please note

Your provider will usually charge for SMS notifications.

 →  **Messaging** → **SMS** → **Settings** → **Notification**

▶ You can enter data in the following fields:

To:

Enter the number (including area code) to which the SMS is to be sent.

On Missed Call:

Select **On** if you require SMS notification.

Msg. on Answer M.:

Select **On** if you require SMS notification.

Save

Press the display key.

Warning

Do **not** enter your own network number for the notification of missed calls. This can lead to chargeable endless looping.

Setting the SMS service centre/defining the send line



SMS messages are exchanged between SMS service centres operated by service providers. You must enter the SMS service centre through which you wish to send and receive SMS messages into your phone. You can receive SMS messages from **every** SMS service centre that is entered, provided you have registered with your service provider. This happens automatically when you send the first SMS via the relevant service centre.

Your SMS messages are sent via the **SMS service centre** that is entered as the **active send service centre**. However, you can activate any other SMS centre as the active send service centre to send a current message (→ [page 100](#)).

If no SMS service centre is entered, the submenu **SMS** only consists of the entry **Settings**. Enter an SMS Service Centre (→ [page 100](#)).

Entering/changing SMS service centres

- ▶ Find out about the services and special functions offered by your service provider **before you make a new application** and/or before you delete pre-configured numbers.

 →  **Messaging** → **SMS** → **Settings** → **Service Centres**

 Select an SMS centre (e.g., Service Centr. 1) and press **Edit**.

- ▶ You can enter data in the following fields:

Active Send:

Select **Yes** if SMS should be sent via the SMS service centre. For the SMS centres 2 to 4, the setting only applies to the next SMS.

SMS Service Centre no.:

Enter the number of the SMS service.

E-mail Service no.:

Enter the number of the e-mail service.

Send via:

Select the fixed line or VoIP connection that you want to use to send the SMS messages.

Save Press the display key.

Please note

- ◆ If you have selected a VoIP connection and the attempt to transmit the SMS messages fails, the SMS is stored in the incoming message list with error status. Even if you have activated the **Automatic Fallback to Fixed Line** option (→ [Web configurator](#)), your telephone will not attempt to send the SMS via the fixed line.
- ◆ If the selected send connection is deleted from the configuration, the fixed line connection in the configuration is used.

Sending an SMS via another SMS service centre











- ▶ Select **Service Centr. 2, 3 or 4** and activate it as the send service centre (set **Active Send = Yes**). **Service Centr. 1** is automatically deactivated as the send service centre for the next SMS.
- ▶ Send the SMS.

This setting only applies to the next SMS to be sent. After that the setting **Service Centr. 1** is reinstated.



Activating/deactivating first ringtone muting

Every SMS addressed to your fixed line connection is indicated by a single ring. To prevent this ring, suppress the first ringtone for all external calls on your fixed line connection.



 Open the main menu.

Press keys in sequence.

   Make the first ringtone audible.

Or:

   Mute the first ringtone.

Activating/deactivating SMS function



If you deactivate the SMS function, you cannot send or receive any SMS messages with your phone.

The settings you have made for sending and receiving SMS messages (e.g., the numbers of the SMS service centres) and the entries in the incoming and draft lists are saved even after deactivation.

 Open the main menu.

Enter the digits.

   Deactivate the SMS function.

Or:

   Activate the SMS function (default setting).

Troubleshooting SMS problems

Error codes when sending

E0	Calling Line Identification permanently restricted (CLIR) or Calling Line Identification not activated.
FE	Error occurred during SMS transfer.
FD	Connection to SMS service centre failed; see self-help.

Self-help with errors



The following table lists problem situations and possible causes and provides advice on troubleshooting.

<p>You cannot send messages.</p> <ol style="list-style-type: none"> You have not requested/enabled the Calling Line Identification Presentation (CLIP) feature. <ul style="list-style-type: none"> Ask your service provider to enable this service. SMS transmission has been interrupted (e.g., by a call). <ul style="list-style-type: none"> Re-send the SMS. The provider does not support this feature. No number or an invalid number is entered for the SMS service centre set as the active send service centre. <ul style="list-style-type: none"> Enter the number (→ page 100).
<p>You receive an incomplete SMS.</p> <ol style="list-style-type: none"> Your phone's memory is full. <ul style="list-style-type: none"> Delete old SMS messages (→ page 93). The service provider has not yet sent the rest of the SMS.
<p>You have stopped receiving SMS messages.</p> <p>Call divert is activated for All Calls or call divert is activated for All Calls for the network mailbox.</p> <ul style="list-style-type: none"> Change the call divert settings (→ page 60).
<p>The SMS is played back.</p> <ol style="list-style-type: none"> The "display call number" feature is not activated. <ul style="list-style-type: none"> Ask your service provider to enable this feature (there is a charge for this). No agreement is in place between your mobile operator and your fixed line SMS service provider. <ul style="list-style-type: none"> Obtain information from your fixed line SMS service provider. Your terminal has been recorded by your SMS provider as having no fixed line SMS functionality i.e., you are not registered with the provider. <ul style="list-style-type: none"> Send any SMS to automatically register your telephone to receive SMS.
<p>Messages are only received during the day.</p> <p>The terminal is recorded in your SMS provider's database as having no fixed line SMS functionality i.e., you are not registered with the provider.</p> <ul style="list-style-type: none"> Obtain information from your fixed line SMS service provider. Send any SMS to automatically register your telephone to receive SMS.



E-mail notifications

Your phone will notify you when new e-mail messages have been received on your POP3 server.

You can set your phone to periodically connect to your POP3 server and check whether you have new messages.

Any new e-mail messages that have been received are displayed on the handset: you will hear an advisory tone, the message key  will flash and the  icon will be displayed in the idle display.

Please note

- ◆ The  symbol is also displayed when you have new SMS messages.
- ◆ If new e-mail messages have been received, pressing the message key  will display them in the **E-mail** list.

Using the handset, you can display the sender, date/time of receipt and the subject and message text (abbreviated if necessary) for each e-mail in the incoming e-mail list (→ [page 104](#)).

The prerequisite for displaying the e-mail messages on the handset is that you have used the Web configurator to save the name of the POP3 server and your personal access data (account name, password) in the phone (→ [page 178](#)).

Please note

If you have also activated the authentication of the phone with the POP3 server via a secure connection in the Web configurator and this fails, the e-mail messages are not downloaded to your phone.

In this case, pressing the flashing message key  will display the message **Certificate error - Please check your certificates in the Web configurator..**

- ▶ Press the display key  to confirm the message.
- ▶ Log in to the Web configurator (→ [page 161](#)). The **Security** (→ [page 172](#)) Web page tells you why the secure connection could not be established and what you can do.

Opening the incoming e-mail list

Prerequisites:

- ◆ You have set up an e-mail account with an ISP.
- ◆ The incoming e-mail server uses the POP3 protocol.
- ◆ The name of the POP3 server and your personal access data (account name, password) are stored in the phone.

 →  **Messaging** → **E-mail**

Or if new e-mail messages have been received (message key  flashes):

 → **E-mail**

The phone establishes a connection to the POP3 server. A list of e-mail messages that are stored there is displayed.

New unread messages appear above old read messages. The most recent entry is at the head of the list.

The following details are displayed for each e-mail: name or e-mail address of the sender (one line, abbreviated if necessary) and date and time (date and time will only display correct values if sender and recipient are located in the same time zone).

Example display:

E-mail Incoming	
Frank.Miller@mailp.com	
10.10.10	15:40
Happy Birthday	
Anna Sand	
10.10.10	10:38
Read	Delete

1 E-mail address or name transmitted by the sender (abbreviated if necessary)

Bold: new message.

All e-mail messages that were not present in the incoming e-mail server when the inbox was last opened are identified as "new". All other e-mails are not marked, regardless of whether or not they have been read.

2 Date and time of receipt of e-mail message

If the inbox on the incoming e-mail server is empty, **No entries** will appear in the display.

Please note

Many e-mail providers activate spam protection measures by default. E-mail messages classified as spam are stored in a separate folder and are therefore not shown in the incoming mail list.

Some e-mail providers allow you to deactivate spam protection or show spam e-mails in the incoming mail list.

Other e-mail providers may send a message to the inbox when a new spam e-mail is received. This is to inform you that a suspected spam e-mail has been received.

The date and sender of this mail are repeatedly updated, so that it is always displayed as a new message.

Messages when establishing a connection

The following problems may occur when connecting to the POP3 server. The messages are displayed in the display for a few seconds.

Server not accessible

The connection to the POP3 server could not be established. This may have the following causes:

- Incorrect entry for the name of the incoming e-mail server (→ Web configurator).
- Temporary problems with the POP3 server (server is down or is not connected to the Internet).
 - ▶ Check settings in the Web configurator.
 - ▶ Try again later.

Currently not possible

The resources your phone requires to make the connection are busy, e.g.:

- The permitted number of VoIP connections has already been reached.
- One of the registered handsets is currently connected to the POP3 server.
 - ▶ Try again later.

Login failed

Error when logging in to the POP3 server. This may have the following cause:

- Incorrect entries for name of POP3 server, user name and/or password.
 - ▶ Check settings (→ Web configurator).

Mailbox settings incomplete

Incomplete entries for name of incoming e-mail server, user name and/or password.

- ▶ Check/add to settings (→ Web configurator).

Viewing the message header and text of an e-mail

Prerequisite: you have opened the incoming mail list (→ [page 104](#)).

 Select an e-mail entry.

Read Press the display key.

The subject of the e-mail (maximum of 120 characters) and the first few characters of the text are displayed.

Example display:

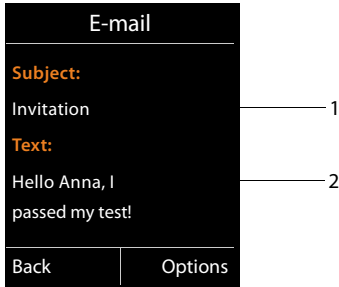

1 **Subject** of the e-mail message. A maximum of 120 characters are displayed.

2 **Text** of the e-mail message (abbreviated if necessary).

 Press the end call key to return to the incoming message list.

Please note

If the e-mail does not contain any standard text, the message **E-mail can't be displayed** will briefly appear.

Viewing e-mail sender's address

Prerequisite: you have opened the e-mail notification to read it (→ [page 106](#)).

Options → **From**

Select and press **OK**.

The sender's e-mail address is displayed, over several lines if necessary (maximum 60 lines).

Back Press the display key to return to the incoming message list.

Example:

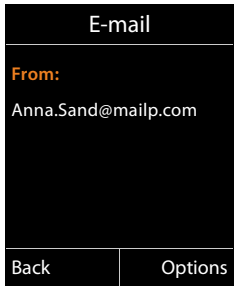

Deleting e-mail messages

Prerequisite: you have opened the incoming e-mail list (→ [page 104](#)) or the header or sender's address for an e-mail is displayed (→ [page 106](#)):

Options → **Delete**

Select and press **OK**.

Yes Press the display key to confirm the security prompt.

The e-mail is deleted from the POP3 server.

Info Center – continuous Internet access from your phone

Data protection notice

The information services enable you to use a Gigaset telephone to call up selected information, such as weather forecasts.

The inventory data corresponds to that of the VoIP service.

When you use the service for the first time, a standard profile is created with configuration data for the device. You can then change and store the configuration data specific to your device, for example, the city for the weather forecast or the date of birth for the biorhythm. You can delete this configuration data again at any time.

The information services use the HTTP protocol.

Further information about the Gigaset.net service data saved can be found at www.gigaset.net/privacy-policy

You can use your phone to retrieve online content from the Internet i.e., request info services that are provided specifically for the telephone. The info services available are constantly updated. A default selection has already been made.

Information on the gigaset.net info services is available on the Internet at:

www.gigaset.com/nextg/apps

Please note

You can launch the Info Center and display info services with every registered Gigaset C59H, SL78H, SL400H and S79H handset.

Customising info services

You can change the default setting for the Info Center (standard profile) and add new services. Visit the Gigaset.net page www.gigaset.net on the Internet and compile your personal info services.

- ▶ Open the Web configurator page on the PC **Settings** → **Info Services** (→ **page 178**).
- ▶ Click the link gigaset.net/myaccount.

You are automatically logged in with the username and password that have been assigned to your phone by default.

Or:

- ▶ Enter the following address in the address field of your PC's Web browser: www.gigaset.net
- ▶ Enter your Gigaset.net user ID and password on the Gigaset.net page. You will find your user ID and password on the Web configurator page specified above.

In both cases, your Gigaset.net web page is displayed, where you can customise info services for your Info Center ("Info Center" tab) and the info services for the **Info Services** screensaver ("Screensaver" tab).

The "Info Center" tab has an icon for every info service provided by Gigaset.net (e.g., weather, horoscope), and an icon for personal applications that you want to add to your Info Center.

Activating/deactivating a service

An info service is displayed on your Gigaset phone if the relevant icon is orange and the option at the top right of the icon is activated.

(Example):



- 1 Icon of an activated info service (orange). The info service is displayed in the Info Center on your Gigaset phone.
 - 2 Icon of a deactivated info service (grey). The info service is not displayed on your phone.
 - 3 Option to activate or deactivate the info service.
- ▶ Click the option for an icon to activate/deactivate the corresponding info service (☑ = activated).

All activated info services are provided in the display of the registered handset when you open the Info Center.

Customising info services

For some info services you can customise the information that you want from your Gigaset phone yourself.

- ▶ Click the icon that belongs to an info service (e.g., weather). This will open another Web page where you can customise the RSS feeds.

The Web pages for the individual info services describe which settings you can make.

Example "weather information"

- ▶ Click the icon for the weather information. This will open a Web page to configure the weather information for your Info Center.

The world weather is already set.



You can also set up to nine other locations (worldwide) that you can request weather information for.

- ▶ Enter the name of the location that you want to access weather information for in the editable field.
- ▶ Click the magnifying glass icon .

This will list the locations that start with the specified name.

- ▶ Click the list icon to open the list and select the required location.
- ▶ Right-click the arrow icon  to add this location to your Info Center.

The Web page lists all the locations for which the Info Center provides weather information.

- ▶ If a location is deleted from the list, click the trash icon  after the location name.
- ▶ Click the disk icon  at the top right of the Web page to save your settings.

Please note

You can also configure weather information on the handset itself.



- ▶ Start the Info Center on your handset (→ [page 112](#)).
- ▶ Select the entry for the weather information and press the display key **OK**.
- ▶ Select the entry "Add location" and press **OK**.
- ▶ Specify which location you want the weather information to be displayed for and press **OK**. This will show a list of locations with the name specified.
- ▶ Select the required location and press **OK**.
- ▶ Press OK again to confirm your selection.

Configuring your own applications/info services

In addition to the info services provided by Gigaset.net Service, you can also enter up to ten extra info services (applications, apps). You can enter URLs for info services from different providers or develop your own applications. Specifications and examples that can help you to create your own applications are available on the Gigaset.net page www.gigaset.com/nextg/appstoolkit

- ▶ Click the "My applications" icon.
- ▶ Enter a name for the additional service in the field on the left. This name will subsequently appear on the handset.
- ▶ Enter the URL for the additional service or your application in the field on the right and click the  icon on the right next to this field to add this info service.
- ▶ Repeat the procedure to add any other info services.

The Web page lists all personal info services and applications that have been configured.

- ▶ To delete a service from the list, click the trash icon  after the service.
- ▶ Click the disk icon  at the top right of the Web page to save your settings.
- ▶ Click the icon's option for your own applications to activate them. A separate entry for "My applications" will then appear under the Info Center on your Gigaset. Your own services and applications that you have configured will then be shown under this entry.

Starting the Info Center, selecting info services

 → ★ **Additional Features** → **Info Center**

Your Info Center menu i.e., a list of available info services is displayed. You can navigate between the info services.

 Select the info service and press **OK**.

To access certain info services (personalised services), you have to log in with a user name and password. In this case, enter your access data as described in the "**Login for personalised info services**" section on **page 113**.

Messages when loading requested information

The information is loaded from the Internet. Wait a few seconds until the information is displayed. The display shows **Please wait....**

If the information for an info service cannot be displayed, one of the following messages appears:

Requested page can't be reached.

Possible causes of this are:

- ◆ Time limit exceeded (timeout) when loading the information
- ◆ The Internet server for the info services cannot be accessed.
- ▶ Check your Internet connection and repeat the request at a later date.

Coding error on requested page

The content of the requested info service is coded in a format that the handset cannot display.

Can't display requested page

General error when loading the info service.

Login failed.

Login has failed. Possible causes of this are:

- ◆ You have not entered your login data correctly.
 - ▶ Reselect the info service and repeat the login process. Please remember that data is case sensitive.
- ◆ You are not entitled to access this info service.

Login for personalised info services

If a special login process with user name and password is required to access an info service, the following is displayed after the service has been called up:

Authent. Name

Enter the user name supplied by the provider of the info service.

Save Press the display key.

Password Enter the password associated with this user name.

Save Press the display key.

If login was successful, the requested info service is displayed.

If login failed, a message to this effect appears on the display → **Messages when loading requested information, page 112.**



Please note

Please remember that login data is case sensitive. For instructions on entering text, → **page 197.**

Operating the Info Center

Depending on the type of info service requested, you can perform the following operations:

Scrolling within an info service

- ▶ You can use  to scroll downwards within an info service, and  to scroll up (back).

Skipping back to the previous page

- ▶ Press the left display key.

Skipping back to the Info Center menu

- ▶ Briefly press the end call key .

You want to go offline:



Press and **hold** the end call key , the handset returns to idle status.

Selecting a hyperlink

Hyperlink to further information:





If the page contains a hyperlink to further information, this is indicated by the  icon.

If a page with hyperlinks is opened, the first hyperlink is highlighted.

- ▶ Using the control keys ( and/or ) as required, you can navigate to the hyperlink that you would like to select. The hyperlink is then highlighted by bars.
- ▶ Press the right display key  to open the relevant page.

Hyperlink to a phone number:

If a hyperlink contains a phone number, you can copy the number to the local directory or call the number directly (Click-2-Call functionality).

- ▶ Select the hyperlink using the  and/or  keys, as required.
- ▶ You can identify a hyperlink of this type by the fact that  is shown above the right display key.
- ▶ Press the display key  to copy the phone number to the local directory on your handset.

Or:

- ▶ Press  to call the stored number.

Depending on the provider, if you press **Call**,

- ◆ The number is dialled directly
- ◆ The number appears first in the display, in which case you must first confirm the number before it is dialled.

- ▶ If you press **Yes**, the number is dialled.



Or:

- ▶ If you press **No**, the page is displayed again with the hyperlink. The number will **not** be dialled.



Entering text

- ▶ If necessary, use  to navigate to the line containing the field into which you want to enter text. The cursor flashes in the text field.
- ▶ Enter the text using the keys on your handset (→ [page 197](#)).
- ▶ If necessary, navigate to other text fields to complete them or make a selection (see below).
- ▶ Press the right display key to complete the entry and send the data.

Making selections

- ▶ If necessary, use  to navigate to the line in which you would like to make a selection.
- ▶ Press left or right on the control key several times to make the required selection.
- ▶ Use  to navigate to other selection fields and make your selection as described above.
- ▶ Press the left display key to complete the selection and send the data.

Setting options

- ▶ Use  to navigate to the line containing the option. The line is highlighted.
- ▶ Activate or deactivate the option via the control key  (press right) or the left display key (e.g., **OK**).
- ▶ If necessary, navigate to other options or text fields to set or complete them.
- ▶ Press the left display key (e.g., **Send**) to complete the entry and send the data.

Accessing info services using quick dial

Each info service that is provided via Gigaset.net is assigned a quick dial that you can use to access the service. The table below contains examples.

Info service ¹	Quick dial ²
News	1#92
Weather	2#92
My eBay	3#92
Encyclopaedia	4#92
Translator	5#92
Unit converter	6#92
Horoscope	7#92
Biorhythm	8#92
My friends	9#92
Gigatweet	10#92
My applications (personal info services/applications that you have defined)	99#92

- 1 The list of info services is one example. Each info service is provider-dependent.
- 2 The numbers 11 to 98 are reserved for additional info services/applications that you are provided with in the future via Gigaset.net.

When the handset is in idle status:



Enter the quick dial for a service and press the talk key.

The Info Center page with this service/application is loaded and shown on the display.

Please note

If you enter the quick dial for an info service into the local directory and you assign this directory entry to a digit key on your handset (→ [page 134](#)), simply pressing and holding this digit key will show the relevant page of the Info Center on the display.

Displaying information from the Internet as a screensaver

You can configure your handset to display one of the info services from the Info Center (e.g., weather reports, newsfeeds) in the device's idle display.

To do this, you must switch on the **Info Services** (→ [page 137](#)) screensaver on your handset and activate the display of info services via the Web configurator (→ [page 178](#)).

The text information appears on the display approximately ten seconds after the handset returns to idle status.

Depending on the information feed selected, a display key appears on the right of the screensaver.

- ▶ Press the right display key to call up further information.
- ▶ Press and **hold** the end call key  to return to idle status.

Selecting information for the screensaver





The default setting for the **Info Services** screensaver is the weather forecast. You can change this setting:

- ◆ On the PC using your account on the Gigaset.net server (→ [page 109](#))
- ◆ On the handset using the Info Center (see below)

When the handset is in idle status:

 → ★ **Additional Features** → **Info Center**

The menu for your Info Center appears.

-  Select **Screensaver** and press **OK**.
-  Select the information service for the **Info Services** screensaver.
-   Scroll to the next line, if necessary, and make further settings for the information service selected.
- Save** Press the display key.

Using the network mailbox



Some providers offer answering machines on the network – network mailboxes. Each network mailbox accepts incoming calls made via the corresponding line (fixed line or corresponding VoIP phone number). To record all calls, you should therefore set up network mailboxes for both the fixed line and for each of your VoIP connections.

You need to have **requested** the network mailbox for your fixed line connection from your network provider. You can store the number of the network mailbox for the fixed line in the phone.

You can activate/deactivate the network mailboxes for your VoIP connections using the handset or the Web configurator. To do this, you only require the phone number of the network mailbox.

Activating/deactivating the network mailbox, entering numbers

On the handset, you can manage the network mailboxes that are assigned to one of its receive connections.

 →  **Voice Mail** → **Network Mailboxes**

The list of connections (VoIP and fixed line) that are assigned to the handset as receive connections is displayed. **Net AM: xxx** where xxx is replaced by the standard name in the connection (**Net AM: IP1** to **Net AM: IP6**, **Net AM: Fixed Line**).

 If several receive connections are assigned to the handset, select connection and press **OK**.

You have selected a VoIP connection:

▶ You can enter data in the following fields:

Status

Select **On** to activate the network mailbox. Select **Off** to deactivate.

Network Mailbox

The number that is currently stored for the network mailbox is displayed.

Enter or change the phone number for the network mailbox if necessary.

With some VoIP providers your network mailbox phone number is downloaded together with the general VoIP provider data, saved to your base and displayed under **Network Mailbox**.

▶ Press the display key **Save**.

You have selected the fixed line/connection:



Enter or change the phone number for the network mailbox if necessary.

Save Press the display key.

You cannot activate/deactivate the network mailbox for the fixed line connection via the handset. For instructions on activating/deactivating the network mailbox, see the information provided by the network provider.



Configuring a network mailbox for quick dial

You can use quick dial to make direct calls to a network mailbox.

Assigning key 1, changing assignment

Quick dial settings are device-specific. You can assign a different network mailbox to key  on each registered handset.



No answering machine is preconfigured for quick dial in the default settings.

 Press and **hold** key .

Or:

 →  **Voice Mail** → **Set Key 1**

The list of VoIP connections and the fixed line connection assigned to the handset as receive connections is displayed. **Net AM: xxx** where xxx is replaced by the standard name in the connection (**Net AM: IP1** to **Net AM: IP6**, **Net AM: Fixed Line**).

 Select entry and press **Select** ( = on).

If a number is already stored for this network mailbox, quick dial is activated immediately.

 Press and **hold** the end call key (idle status).

If no number is saved for the network mailbox, you are asked to enter the number of the network mailbox.

 Jump to the **Network Mailbox** line.

 Enter the number for the network mailbox.

 Press the display key.

 Press and **hold** the end call key (idle status).

Quick dial is activated.

Please note

You can only assign quick dial to **one** network mailbox.

You can also call the network mailboxes for the handset's receive connections directly via the message key (→ [page 120](#)).

Calling the answering machine via quick dial

 Press and **hold**.



If you have set a network mailbox for quick dial you are connected directly to this network mailbox.

 If necessary, press the speaker key.

You hear the network mailbox announcement.

 Select answering machine and press **OK**.

Displaying new messages in the handset's idle display

If a new message is present on one of the network mailboxes that is assigned to the handset via its receive connection, or on the local answering machine, the symbol  and the number of new messages are displayed in idle status. The  message key flashes.

Calling the network mailbox using the message key

Under the message key  you will find a list for each network mailbox that fulfils the following prerequisites:

- ◆ The corresponding connections are assigned to the handset as receive connections.
- ◆ The network mailbox phone number is saved on the phone.

You can use the list to call the network mailbox directly and listen to the messages.

 Press the message key.

The following is displayed (example):

Messages & Calls	
Net AM: Fixed Line (1)	1
Mailbox IP 1: (1)	2
Mailbox IP 2:	3
Mailbox IP 3:	4
Mailbox IP 4:	
Back	OK

- 1 **Net AM: Fixed Line** The network mailbox for the fixed line connection
- 2 If there are new messages in the network mailbox, the list entry is shown in bold. The number of new messages is shown in brackets following the list entry.
- 3 **Mailbox IP 1;** **Mailbox IP 2;** and so on are the network mailboxes for the VoIP connections. "IP1", "IP2" and so on are the standard names of the corresponding VoIP connections. The standard names are always displayed regardless of which connection name you specified during configuration.
- 4 If there are no new messages, no number is shown after the list entry for the network mailbox. The number of messages stored in the network mailbox is not displayed.

Net AM: Fixed Line / Mailbox IP 1: / Mailbox IP 2: / ... / Mailbox IP 6:

Select the network mailbox entry and press .

You are connected directly to the network mailbox and hear its announcement. Messages can generally be played back using your handset keypad (digit codes). Listen to the announcement.

Please note

- ◆ The network mailbox is automatically called via the corresponding connection. An automatic area code specific to your phone is **not** prefixed.
 - ◆ Network mailbox messages can generally be played back using your phone's keypad (digit codes). You need to define how the digit codes for VoIP should be converted to DTMF signals and transmitted (→ [page 176](#)).
- Ask your VoIP provider which type of DTMF transmission it supports.

ECO DECT

You are helping to protect the environment with your Gigaset.

Reduced energy consumption

Your telephone has a power-saving adapter plug and uses less power.

Reducing radiation

The radiation from your telephone is reduced **automatically**: the closer the handset is to the base, the lower the radiation.

You can reduce the radiation from the handset and the base even more by using Eco Mode:

Eco Mode

Reduces the radiation of the base and handset by 80% – whether you are making a call or not. **Eco Mode** reduces the range of the base by approx. 50%. Using **Eco Mode** always makes sense when a reduced range is sufficient.

Switching off radiation

◆ Eco Mode+

When you activate **Eco Mode+**, the radiation (DECT transmission power) of base and handset is switched off automatically in idle status. This is also true when multiple handsets are used, if the handsets support **Eco Mode+**.





Eco Mode/Eco Mode+ can be activated/deactivated independently of one another and can also be used with multiple handsets.

Activating/deactivating Eco Mode / Eco Mode+:

 →  Settings → Eco Mode → Eco Mode / Eco Mode+

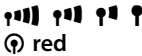
Change Press the display key (☑ = on).

Status displays

Display icon	
	Reception strength: – Good to poor – No reception
	Eco Mode deactivated
	Eco Mode enabled
	Eco Mode+ enabled (displays instead of the reception strength icon when in idle status)
	Eco Mode and Eco Mode+ activated



Please note

- ◆ When using **Eco Mode+**, you can ensure that the range of the base is sufficient by **pressing and holding** the talk key . You hear the dial tone if the base can be reached.
- ◆ When **Eco Mode+** is enabled:
 - Call setup is delayed by approx. 2 seconds.
 - Handset standby time is reduced by approx. 50%.
- ◆ Registering handsets that do not support **Eco Mode+** causes the mode to be deactivated on the base and all other handsets.
- ◆ Activating **Eco Mode** reduces the range of the base.
- ◆ **Eco Mode/ Eco Mode+** and repeater support (→ [page 153](#)) cancel each other out, i.e., if you use a repeater, you cannot use **Eco Mode** and **Eco Mode+**.

Setting the alarm clock

Prerequisite: the date and time have already been set.

Activating/deactivating the alarm clock and setting the wake-up time

 →  → Alarm Clock

▶ You can enter data in the following fields:

Activation:

Select **On** or **Off**.

Time:

Enter the wake-up time in 4-digit format.

Volume:

Set the volume (1–6).

Melody:

Select the melody.

Save Press the display key.

The  icon and wake up time are shown in idle status.

A wake-up call is shown on the display (→ [page 4](#)) and signalled with the selected ringtone melody. The wake-up call sounds for 60 seconds. If no key is pressed, the wake-up call is repeated twice at five minute intervals and then switched off.

During a call, the wake-up call is only signalled by a short tone.

Deactivating the wake-up call/repeating after a pause (snooze mode)

Prerequisite: a wake-up call is sounding.

OFF Press the display key. The wake-up call is deactivated.

Or

Snooze Press the display key or any key. The wake-up call is deactivated and then repeated after 5 minutes. After the second repetition the wake-up call is deactivated completely.

Using a handset as a room monitor

If the room monitor is activated, the phone number saved in the system is called as soon as a set noise level is reached. You can save an internal or external number in your handset as the destination number. All of the handset keys are deactivated except for the display keys.

The room monitor call to an external number is cancelled after approximately 90 seconds. The room monitor call to an internal number (handset) stops after approx. 3 minutes (depending on the base station). When the room monitor is activated, all keys are locked except the end call key. The handset's speaker is muted.

When room monitor mode is activated, incoming calls to the handset are indicated **without a ringtone** and are only shown on the display. The display and keypad are not illuminated and advisory tones are also turned off.

If you accept an incoming call, the room monitor is suspended for the duration of the call, but the function **remains** activated.

If you deactivate then reactivate the handset, the room monitor remains activated.

Caution!

- ◆ **Always check the operation of the room monitor before use. For example, test its sensitivity. Check the connection if you are diverting the room monitor to an external number.**
- ◆ Activating the function significantly reduces the operating time of your handset. If necessary, place the handset in the charger. This ensures that the battery does not run down.
- ◆ Ideally the handset should be positioned 1 to 2 metres away from the baby. The microphone must be pointed towards the baby.
- ◆ The connection that the room monitor is diverted to must not be blocked by an activated answering machine.

Activating the room monitor and entering the destination number

☰ → ★ Additional Features → Room Monitor

▶ You can enter data in the following fields:

Activation:

Select **On** to activate.

Alarm to:

Select **Internal** or **External**.

External number: select the number from the directory (press display key **☰**) or enter it directly.

Internal number: press the display key **Change** → select the handset or **Call All** to call all registered handsets → **OK**.

In idle status, the destination number or the internal destination number is displayed.

▶ Press **Save** to save the settings.

When the room monitor function is activated, the idle display looks like this:

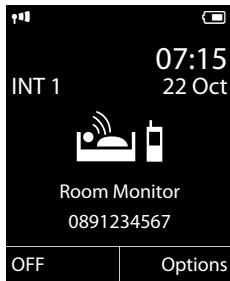

Changing the destination number saved

☰ → ★ Additional Features → Room Monitor

▶ Enter and save number as described in "**Activating the room monitor and entering the destination number**" (→ **page 125**).

Cancelling/deactivating the room monitor

Press the end call key **☎** to cancel the call when the **room monitor is activated**.

In **idle status**, press the display key **OFF** to deactivate room monitor mode.

Deactivating the room monitor remotely

Prerequisites:

- ◆ The telephone must support tone dialling
- ◆ The room monitor call is diverted to an external destination number.
- ◆ If room monitor is activated via a VoIP connection, the DTMF signalling must be done via SIP info or RFC2833 (→ [page 176](#)).
- ▶ Accept the call from the room monitor and press keys **9** **#**.

The room monitor function will deactivate after the call ends. There are no further room monitor calls. The other room monitor settings on the handset (e.g., no ring-tone) remain activated until you press the display key **OFF** on the handset.

To reactivate the room monitor function with the same phone number:

- ▶ Reactivate and save with **Save** (→ [page 125](#)).

Connecting/using other handsets

You can register up to six handsets and six Gigaset repeaters to your base.

Each registered device is assigned an internal number (1 – 6) and an internal name (INT 1 – INT 6). You can change the number assignment and names.

If all internal numbers have already been assigned on your base, you must deregister a handset that is no longer required before registering a new one.

When you register a Gigaset handset, the base transfers entries for the following online directories to the local directory on the handset to enable you to use the online directories on your new handset as well.

Prerequisite: the handset can send and receive directory entries (see handset user guide).

- ◆ The online directory currently set (→ **page 178**) with a provider-specific name.
- ◆ The Yellow Pages currently set (→ **page 178**) with a provider-specific name.
- ◆ The private directory currently set with the name **Prv.NetDir**.
- ◆ The Gigaset.net directory with the name **Gigaset.net**.

Successful registration is therefore acknowledged with the message **Data Transfer x** entries received.

Registering handsets

You can register up to six handsets to your base.

A Gigaset C59H handset can be registered on up to four bases.

Manually registering Gigaset C59H to Gigaset C590 IP

You must register the handset manually on both the handset (1) and the base (2).

Once registration is complete, the handset returns to idle status. The handset's internal number is shown in the display, e.g., **INT 1**. If not, repeat the procedure.

1) On the handset

The handset is not registered to a base.

Register Press the display key.

The handset is already registered to a base:

 →  **Settings** → **Registration** → **Register Handset**

If the handset is already registered to four bases:

 Select base, e.g., **Base 3** and press **OK**.

 Enter the system PIN for the base, if required, and press **OK**.

A message appears stating that the handset is searching for a base that is ready for registration.

2) On the base

Within 60 seconds, press and **hold** the register/paging key on the base (→ **page 5**) (for approx. 3 seconds).

Please note

All base connections are assigned to a handset as receive connections as soon as registration is complete.

The fixed line connection is assigned to the handset as a send connection.

You can change the assignment → [page 150](#).

Registering other handsets

You can register other Gigaset handsets and handsets for other devices with GAP functionality as follows.

1) On the handset

Start to register the handset as described in its user guide.

2) On the base

Press and **hold** the register/paging key on the base (→ [page 5](#)) (approx. 3 sec.).

Assigning the internal number

The base assigns the handset the lowest free internal number (possible numbers: 1–6). The internal number appears in the handset's display, e.g., INT 2. This means that the internal number 2 has been assigned to the handset.

De-registering handsets

You can de-register any other registered handset from any registered Gigaset C59H handset.



Settings → Registration → De-reg. Handset



Select the internal party you wish to de-register and press **OK**.
(The handset you are currently using is highlighted with <).



If the system PIN is not 0000: enter the current system PIN and press **OK**.



Press the display key.

Searching for a handset, finding the phone's IP address ("Paging")

You can locate your handset using the base.

- ▶ **Briefly** press the register/paging key on the base (→ [page 5](#)).

All handsets will ring at the same time ("paging"), even if the ringtones are switched off.

The current (local) **IP address** for the base appears in the handset displays.

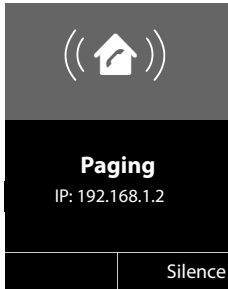

Ending paging

- ▶ **Briefly** press the registration/paging key on the base (→ [page 5](#)).

Or:

- ▶ Press the talk key  on the handset.

Or:

- ▶ Press the display key **Silence** on the handset.

Or:

- ▶ Do not press any key on the base or handset:
After approx. 30 seconds, the paging call will end **automatically**.

Please note

- ◆ An incoming external call will not interrupt the paging process.
- ◆ If there are already two internal connections between the handsets, then paging is not possible.
- ◆ A paging call is also signalled acoustically on handsets where the ringtone is permanently deactivated (→ [page 142](#)).

Changing the base

If your handset is registered to more than one base, you can set it to a particular base or to the base that has the best reception (**Best Base**).

 →  → **Registration** → **Select Base**

 Select one of the registered bases or select **Best Base** and press **Select**.

Making internal calls

Internal calls to other handsets registered on the same base are free.

Calling a specific handset

 Initiate internal call.

 Enter the number of the handset.

Or:

 Initiate internal call.

 Select handset.

 Press the talk key.

You hear the busy tone if:

- ◆ There are already two internal connections.
- ◆ The handset being called is not available (deactivated, outside range).
- ◆ The internal call is not accepted within three minutes.

Calling all handsets ("group call")

 Press **briefly** to initiate an internal call.

 Press the star key.

Or

 Press **briefly** to initiate an internal call.

Call All Select

 Press the talk key.

Or

 Press and **hold**.

All handsets are called.



Ending a call

 Press the end call key.

Transferring a call to another handset

You can transfer (connect) an external call to another handset.

You are conducting an **external** call:

-  Open the list of handsets.
The external party hears music on hold, if activated (→ [page 145](#)).
-  Select a handset or **Call All** and press **OK**.

When the internal party answers:

- ▶ If necessary, announce the external call.

-  Press the end call key.

The external call is transferred to the other handset.

If the internal party does **not** answer or the line is busy, press the display key **End** to return to the external call.



When transferring a call, you can also press the end call key  before the internal party answers.

If the internal party does not answer or the line is busy, the call will automatically return to you.

Initiating an internal consultation call/conference

When you are conducting an **external** call, you can call an **internal** participant at the same time for consultation or hold a conference call between all 3 participants.

You are conducting an **external** call:

-  Open the list of handsets.
The external party hears music on hold, if activated (→ [page 145](#)).
-  Select handset and press **OK**.
You are connected to the internal participant.

Either:

Options → **End Active Call**

You are reconnected with the external participant.

Or:

Conference Press the display key.

All three participants are connected with each other.

If the internal participant does not answer:

- ▶ Press the display key **End** to return to the first external caller.

Ending a conference call

-  Press the end call key.

If an **internal** participant presses the end call key , the other handset remains connected to the external participant.

External call waiting during an internal call

If you receive an **external** call during an **internal** call, you will hear the call waiting tone (short tone). The caller's number appears in the display if Calling Line Identification is enabled.

You have the following options:

Rejecting the external call

Reject Press the display key.

The call waiting tone is turned off. You remain connected with the internal participant.

For calls to a VoIP connection: the external caller hears the busy tone.

For calls to the fixed line connection:

The call continues to be signalled on the registered handsets.

Accepting an external call/Putting an internal party on hold

Accept Press the display key.

You are connected to the external caller. The internal call is placed on **hold**.

You have the following options:

- ◆ Swap between both participants:
 - ▶ Use  to swap between the participants.
- ◆ Speak to both participants at the same time:
 - ▶ Press the display key **Conf.** to establish the conference call. Press the display key **EndConf** to return to call swap mode.

Ending an internal call

 Press the end call key.

The external call is signalled as an incoming call. You can accept the call ([→ page 53](#)).

Internal call waiting during an internal/external call

If an internal party attempts to call you while you are involved in an external or external call, this call is shown on the display (internal call waiting). You can either accept or reject this call.

Press any key to make this prompt disappear from the display.

You must end the current call to accept the internal call. Then the internal call is signalled as per usual. You can accept the call.

Changing the name of an internal party

The names "INT 1", "INT 2" etc. are assigned automatically on registration. You can change these names. The name must be no more than 10 characters. The changed name is displayed in every handset's list.



Open the list of handsets. Your own handset is indicated by ◀.



Select handset.

Options

Open menu.

Rename



Enter the name.

Save

Press the display key.

Changing the internal number of an internal party

A handset is **automatically** assigned the lowest free internal number from 1–6 during registration. If all numbers are in use, then the number 6 is overwritten as long as this handset is in idle status. You can change the internal numbers of all registered handsets (1–6).



Open the list of handsets. Your own handset is indicated by ◀.

Options

Open menu.

Assign Handset No.

Select and press **OK**.



Select the handset, if necessary.



Select or enter the internal number.



Switch to another handset, if necessary, and select the number etc.

Save

Press the display key to save the entry.



You will hear the error tone if an internal number has been assigned twice.

- ▶ Repeat the procedure with a free number.

Setting the handset

Your handset comes with default settings, but you can change the settings to suit your individual requirements.

Accessing functions and numbers quickly

You can assign one **number from the directory** to each of the **digit keys**  and  to .

The left and right **display keys** have a default **function**. You can change the assignment (→ [page 135](#)).

The number is then dialled or the function started by simply pressing a key.

Assigning digit keys (quick dial)

Prerequisite: you have not yet assigned a number to the digit key.

- ▶ Press and **hold** the digit key



Or

Press the digit key **briefly** and press the display key **Quick Dial**.

The directory is opened.



Select an entry and press **OK**.

If the entry contains several numbers, the icons for the numbers stored are displayed:  /  / .



Select a number and press **OK**.

The entry is saved to the corresponding digit key.

Please note

If you delete or edit the entry in the directory at a later date, this will not affect the assignment to the number key.

Dialling a number

Prerequisite: the digit key already has a number assigned to it.

When the handset is in idle status

- ▶ Press and **hold** the digit key to dial the number.

Or

- ▶ **Briefly** press the digit key.

Press the left-hand display key with the number/name (abbreviated if necessary) to dial the number.

Changing number key assignments

Prerequisite: the digit key already has a number assigned to it.

When the handset is in idle status

- ▶ **Briefly** press the digit key
- ▶ Press the display key **Change**. The directory is opened.

Either:

- ▶ Select an entry and press **OK**. Select the number if necessary and press **OK**.

Or:

- ▶ Press the display key **Clear Key** to delete the assignment.

Assigning display keys, changing assignments

- ▶ Press and **hold** the left or right the display key. The list of possible key assignments is opened.
- ▶ Select a function and press **OK**.

The following functions are available:

Room Monitor

Assign the menu for setting and activating the room monitor to a key
(→ [page 125](#)).

 → ★ **Additional Features** → **Room Monitor**

Alarm Clock

Assign menu for setting and activating the alarm clock to a key (→ [page 123](#)):

 → ★ **Additional Features** → **Alarm Clock**

Withhold Number

Withhold Calling Line Identification for the next call (→ [page 63](#)).

Phone

Assign the fixed line connection to a key.

Press this display key if the fixed line connection should be used (temporarily) for the subsequent call (instead of the send connection for the handset).

E-mail

Opens the e-mail submenu for receiving and reading e-mail notifications
(→ [page 104](#)):

 → ✉ **Messaging** → **E-mail**

Redial

The key opens the redial list.

Services

The key opens a particular directory where you can save special services from your provider, e.g., the number for information or the hotline.

Setting the handset

More Functions...

More features are available:

◆ Send Connection

Assign an alternative send connection to a key.

- ▶ Select a connection as a (further) send connection for the handset from the list of connections and press **OK**.

Press this display key if the alternative send connection should be used (temporarily) for the subsequent call (instead of the send connection for the handset).

◆ Line Selection

Assign the list of connections for your phone to a key.

Select the send connection for each call from the list (→ **page 51**).

◆ Call Lists

Assign the call lists menu to a key (→ **page 67**).

 →  **Call Lists**

◆ Withhold Number (only VoIP)

Withhold Calling Line Identification for the next call (→ **page 63**).

◆ Call Divert

Assign menu for setting and activating/deactivating call divert to a key

(→ **page 60**):

Prerequisite: the provider supports call divert.

 →  **Select Services** → **Call Divert**

◆ E-mail

Opens the e-mail submenu for receiving and reading e-mail notifications

(→ **page 104**):

 →  **Messaging** → **E-mail**

Info Centre

Start Info Center and open the list of available information services – go online

(→ **page 112**).

 → **Additional Features** → **Info Center**

The selected function is displayed in the bottom display line above the display key (abbreviated if necessary).

Starting a function



With the telephone in idle status:

- ▶ Press the display key **briefly**.

The submenu opens and the function is performed.

Changing the display language

You can view the display texts in different languages.

 →  → **Language**

The current language is indicated by a .

 Select a language and press **Select**.

If you accidentally choose a language you do not understand:

 →  → 3x 

Press keys in sequence and confirm by selecting the **right-hand display key**.

 Select the correct language and press the **right display key**.

Setting the display

Setting the screensaver

You can display a screensaver when the handset is in idle status.

The following screensavers are available:

- ◆ One of the pre-loaded images
- ◆ The digital time (**Clock**)
- ◆ Information from an info service (**Info Services** – weather information, horoscope etc.). You must have activated the display of info services via the Web configurator.

The phone must be connected to the Internet to display info services.

The type of info service available to your phone is set on the Internet on the Gigaset.net server. You can change the setting (→ [page 117](#)).

If no information is currently available, the digital time (**Clock**) is displayed instead until information is available again.

Together with the information, display keys that open the Info Center selection menu can be shown.

The screensaver replaces the idle status display. This conceals the date, time and internal name.

The screensaver is not displayed in certain situations e.g., during a call and when a status message is displayed.

If a screensaver is activated, the **Screensaver** menu option is marked with ✓.

 →  → **Display** → **Screensaver**

The current setting is displayed.

▶ You can enter data in the following fields:

Activation:

Select **On** (screensaver is displayed) or **Off** (no screensaver).

Setting the handset

Selection:

Select screensaver or

 Press the display key. The active screensaver is displayed.

 Select screensaver and press **OK**.

Save Press the display key.

The screensaver is activated approx. 10 seconds after the display has changed to idle status.

If the screensaver conceals the display, **briefly** press  to show the idle display.

Activating/deactivating the info ticker

You can display text information from the Internet (weather information etc.) that is set for the screensaver **Info Services** as a scrolling message in the idle display. The scrolling message is shown in the bottom line of the idle display (immediately above the display keys). The end of one set of information and beginning of the next are separated by "+++".

 →  **Settings** → **Display** → **Info Ticker** (= on)

The ticker starts as soon as the telephone changes to idle status. If, however, a message is shown in the idle display, the information ticker is not displayed.

Setting large font

You can increase the font size of print and icons in call lists and the directory to improve readability. Only one entry is shown at a time on the display, instead of several entries, and names are abbreviated if necessary.

 →  → **Display** → **Large Font**

Change Press the display key (= on).

Setting the colour schemes

You can set the display to show a dark or a light background.

 →  → **Display** → **Colour Schemes**

Select **Colour Scheme 1** or **Colour Scheme 2** and press **OK**.

Setting the display backlight

Depending on whether or not the handset is in the charger, you can activate or deactivate the lighting. If it is activated, the display is permanently dimmed. If the display backlight is deactivated, you can reactivate it by pressing any key. The key has no further function in this situation.

 →  → **Display** → **Backlight**

The current setting is displayed.

▶ You can enter data in the following fields:

In Charger

Select **On** or **Off**.

Out of Charger

Select **On** or **Off**.

Please note

The **On** setting can significantly reduce the standby time of the handset.

Save

Press the display key.

Activating/deactivating auto answer

If this function is activated, you can simply lift the handset out of the charger without having to press the talk key  when you receive a call.

 →  → **Telephony** → **Auto Answer**





Change

Press the display key (= on).



Changing the speaker/earpiece volume

You can set the volume for speaker mode and earpiece mode to five different levels.

In idle status:

-  Open **Handset Volume** menu.
-  Set the earpiece volume.
-  Scroll to the **Speaker:** line.
-  Set the speaker volume.
- Save** Press the display key if necessary to save the setting permanently.

Setting the volume during a call:

-  Press the control key.
-  Select the volume.

The setting will automatically be saved after approximately 3 seconds or press the display key **Save**.

If  is assigned to another function, e.g., call swap (→ [page 64](#)):

Options Open menu.

Volume Select and press **OK**.



Configure the setting (see above).

Please note







You can also set the call volume using the menu (→ [page 48](#)).

Changing ringtones

Setting the volume

You can choose between five volumes (1–5; e.g., volume 3 = ) and the "crescendo" ringtone (6; volume increases with each ring = .

In idle status:

-  →  → **Audio Settings** → **Ringtones(Handset)** → **Volume**
-  Set the volume for internal calls and anniversaries.
-  Scroll to the next line.
-  Set the volume for external calls.
-  **Save** Press the display key to save the setting.







Setting a melody

You can select from a list of pre-loaded ringtones and melodies.

You can set different ringtones for the following functions:





- ◆ Internal Calls
- ◆ For external calls to each individual receive connection on the phone (**Landline, IP1 to IP6, Gigaset.net**).
- ◆ For all calls.

In idle status:

-  →  → **Audio Settings** → **Ringtones(Handset)** → **Melodies**
-  Select **Internal Calls** or a receive connection.
-  Select the melody for this connection.
-   Where necessary, select the next connection and set a melody etc.
-  **Save** Press the display key to save the setting.

Or:

You can set the ringtone melody so it is used for both internal and all external calls.

-  Select **All calls**.
-  Select melody.
-  **Save** Press the display key to save the setting.
-  **Yes** Press the display key to confirm the settings.

The setting for all calls will not work as soon as you change the setting for an individual connection.

Activating/deactivating the ringtone for anonymous calls

You can set your handset not to ring if a caller withholds their number. The call will only be signalled on the display.

In idle status:

 →  → **Audio Settings** → **Ringtones(Handset)** → **Anon. Calls Silent**

Press **Change** to activate or deactivate the function. means that the ringtone is deactivated for anonymous calls.

Activating/deactivating the ringtone

You can deactivate the ringtone on your handset before you answer a call or when the handset is in idle status; the ringtone can be deactivated permanently or just for the current call. The ringtone cannot be re-activated while an external call is in progress.

Deactivating the ringtone permanently

 Press and **hold** the star key.

The  icon appears in the display.

Reactivating the ringtone

 Press and **hold** the star key.

Deactivating the ringtone for the current call

Silence Press the display key.

Activating/deactivating alert tones

In place of the ringtone, you can activate an alert tone. When you receive a call, you will hear a **short tone** ("Beep") instead of the ringtone.

 Press and **hold** the star key and **within 3 seconds**:

Beep Press the display key. A call will now be signalled by **one** short alert tone.

 is shown in the display.

Activating/deactivating advisory tones

Your handset uses advisory tones to tell you about different activities and statuses. You can activate/deactivate the following advisory tones independently of each other:

- ◆ **Key tone:** every key press is confirmed.
- ◆ **Confirmation tones:**
 - **Confirmation tone** (ascending tone sequence): at the end of an entry/setting and when an SMS or a new entry arrives in the call list
 - **Error tone** (descending tone sequence): when you make an incorrect entry
 - **Menu end tone:** when scrolling to the end of a menu
- ◆ **Battery:** the battery needs charging.

In idle status:

 →  → **Audio Settings** → **Advisory Tones**

▶ You can enter data in the following fields:

Key Tones:

Select **On** or **Off**.

Confirmation:

Select **On** or **Off**.

Battery:

Select **On** or **Off**.

Save Press the display key.

Please note

You can also set the call volume, the ringtones and the advisory tones via the menu (→ [page 48](#)).

Restoring the handset default settings

You can reset any individual settings and changes that you have made.

The following settings are **not** affected by a reset

- ◆ Registering the handset to the base
- ◆ Date/time
- ◆ Directory entries, the call lists, the SMS lists

 →  → **System** → **Reset Handset**

Yes Press the display key.

Configuring the system settings

You can make the following settings via the menu on the relevant handset or on a registered Gigaset SL78H, SL400H, S79H handset or via the Web configurator on the phone.

Setting the date and time manually

To ensure you have the correct time for incoming calls and to use the alarm clock, the date and time must be set.

Please note

The address of a time server on the Internet is stored on your phone. The date and time are taken from this time server provided that the phone is connected to the Internet and synchronisation with the time server is activated. Manual settings are overwritten in this case.

If the date and time have not yet been set on the handset, the **Time** display key appears.









Time Press the display key.

Or:





 →  **Settings** → **Date/Time**

▶ You can enter data in the following fields:

Date:

Enter day, month and year as an 8-digit number via the keypad, e.g.,         for 14/01/2010.

Time:

Enter the hours and minutes in 4-digit format via the keypad, e.g.,     for 07:15 am.



▶ Press the display key **Save** to save the settings.

Protecting against unauthorised access

Protect the phone system settings with a PIN known only to you. You have to enter the system PIN if you register or de-register a handset, change local network settings, perform a firmware update or reset the phone to default settings.

Changing the system PIN

You can change the phone's 4-digit system PIN (default setting: **0000**) to a 4-digit PIN known only by you.

 →  **Settings** → **System** → **System PIN**



Enter the current system PIN if necessary and press **OK**.

Enter new system PIN.

Press the display key.

Your own area code setting





Your area code (international and local area code) must be saved on the phone before you can transfer phone numbers (e.g., in vCards).

Some of these numbers are already preset.

 →  **Settings** → **Telephony** → **Area Codes**

Check that the (pre)set area code is correct.

▶ You can enter data in the following fields:

-  Select/change input field.
-  Navigate in the input field.
-  < C If necessary, delete number: press the display key.
-  Enter number.
-  **Save** Press the display key.

Example:

Area Codes	
International code:	
00 - 420	
Local area code:	
0 - [X]	
< C	Save

Activating/deactivating music on hold

 →  **Settings** → **Audio Settings** → **Music on hold**

Press **Change** to activate or deactivate the music on hold (☑ = on).

Setting the base's IP address in LAN

Prerequisite: your base is connected to a router or a PC (→ [page 21](#)).

An IP address is required in order for the LAN to "recognise" your phone.

The IP address can be assigned to the phone automatically (by the router) or manually.

- ◆ If done **dynamically**, the router's DHCP server automatically assigns an IP address to the phone. The base's IP address can be changed according to router settings.
- ◆ For manual/**static** assignment, you assign a static IP address to the phone. This may be necessary depending on your network configuration (e.g., if your phone is connected directly to a PC).

Please note

To assign the IP address dynamically, the DHCP server on the router must be activated. Please also read the user guide for your router.

 →  **Settings** → **System** → **Local Network**



If the system PIN is not 0000: enter the system PIN and press **OK**.

▶ You can enter data in the following fields:

IP Address Type

Select **Static** or **Dynamic**.

For **IP Address Type Dynamic**:

The following fields show the current settings that the phone obtained from the router. These settings cannot be changed.

For **IP Address Type Static**:

You must manually define the IP address and the subnet mask for the phone as well as the standard gateway and DNS server in the following fields.

For **IP Address Type Static**:

IP Address

Enter the IP address that is to be assigned to the phone (overwriting the current settings).

The default is 192.168.1.2.

For information on the IP address, see the glossary (→ [page 202](#)).

Subnet Mask

Enter the subnet mask to be assigned to the phone (overwriting the current settings).

The default setting is 255.255.255.0

For information on the subnet mask, see the glossary (→ [page 206](#)).

DNS Server

Enter the IP address for the preferred DNS server. The DNS server (Domain Name System, → [page 199](#)) converts the symbolic name of a server (DNS name) into the public IP address for the server when the connection is made.

You can specify your router's IP address here. The router forwards phone address requests to its DNS server.

The default is 192.168.1.1.

Default Gateway

Enter the IP address for the standard gateway (→ [page 201](#)) through which the local network is connected to the Internet. This is generally the local (private) IP address for your router (e.g., 192.168.1.1). Your phone requires this information to be able to access the Internet.

The default is 192.168.1.1.

- ▶ Press **Save** to save the settings.

Please note

You can also make local network settings via the Web configurator (→ [page 168](#)).

Configuring VoIP connections

Please note

If auto configuration is used to download the VoIP data to your phone (provider-specific, → [page 23](#)), the VoIP wizard is not available. In this case you cannot change the VoIP settings manually.

You can configure up to six VoIP connections on your telephone, i.e., you can assign up to six VoIP phone numbers to your phone.

You need to set up an IP account (VoIP account) with a VoIP provider for each connection. You must save the access data for this IP account on your phone. The VoIP wizard will help you to do this.

Starting the VoIP wizard:

 →  Settings → Telephony → VoIP Wizard

You will see the following in the display



The remaining procedure for the IP wizard is described on [page 24](#).

Each time you run the IP wizard you can configure/reconfigure **one** VoIP connection (IP account).

- ▶ Restart the IP wizard if you wish to configure/reconfigure another VoIP connection.

Please note

You can also use the Web configurator to configure and manage VoIP connections (→ [page 170](#)).

Automatic update for the VoIP provider settings

After the first download of the VoIP provider settings, your phone will check daily whether a newer version of the file for your VoIP provider is available from the Internet on the configuration server.

Auto configuration has been used to download VoIP settings

(→ [page 23](#))

If there is new configuration data, this is automatically downloaded to your phone (without notification).

Manual VoIP configuration with the VoIP wizard

If there is new provider data, the idle display on the handset displays the message **New profile available**.

Yes

Press the display key to confirm the prompt.



Enter the system PIN if necessary and press **OK**.

The new data for your VoIP provider will be downloaded and saved on the phone.

If you answer the prompt with **No**, the phone returns to idle status. Your telephone will not remind you of this new profile again. The message will only be shown again if a newer version of the provider data is available.

A profile update will only be started if no other profile or firmware update is taking place at the time.

Assigning send and receive connections to internal parties

If you have several connections configured for your telephone system, you can do the following for each internal party:

- ◆ Assign a send connection or allow the internal party to select the line for each external call (select line).
- ◆ Assign one or several receive connections. Only calls received via one of the assigned connections are signalled on the device.

Assigning a send connection

Prerequisite: you have configured at least one VoIP connection on your phone.

 →  **Settings** → **Telephony** → **Send Connections**

A list of handsets is displayed.

 Select the handset that should be assigned a new send connection and press the display key **OK**.

 Choose **Sel. at each call** or a connection as the send connection. All configured connections are displayed with the names you have set.

Save Press the display key to save the changes.

Sel. at each call is only offered if more than one connection is configured.

If you select **Sel. at each call**, you can select the connection you want to use for each call you make.

The Gigaset.net connection is not included in the selection for the send connections. Gigaset.net numbers (suffix #9) are automatically dialled via Gigaset.net.

Please note

If the send connection on a handset is deleted or deactivated, the fixed line connection is assigned to it as the send connection.

Assigning receive connections

Prerequisite: several connections are configured for your phone.

 →  **Settings** → **Telephony** → **Rec. Connections**

A list of internal parties is displayed (handsets).

 Select the internal parties that should be assigned new receive connections and press the display key **OK**.

A list of all configured connections and the Gigaset.net connection is opened. You can select **Yes** or **No** for each connection.

 Select **Yes** if you want the relevant connection to be the receive connection for the internal party. Select **No** if it should not be the receive connection.

 Change to the next connection.

- ▶ Repeat these two steps for each connection.
- ▶ Press the display key **Save** to save the changes.

Please note

- ◆ If a new connection is configured, it is assigned as the receive connection to all internal parties and **Answer Machine 1**.
- ◆ If a connection is not assigned as the receive connection to any internal party, calls on this connection will not be signalled.

Updating the phone firmware

Prerequisite: the phone is connected to the Internet (i.e., connected to a router, → [page 21](#)).

If necessary, you can update your phone's firmware.

The firmware update is downloaded directly from the Internet by default. The relevant Web page is preconfigured in your phone.

Prerequisite:

The phone is in idle status i.e.,

- ◆ No calls are being made.
- ◆ There is no internal connection between the registered handsets.
- ◆ The base menu is not open in any of the handsets.

Starting the firmware update manually

 →  **Settings** → **System**

Update Firmware

Select and press **OK**.



Enter the system PIN and press **OK**.

The phone establishes a connection to the Internet.

Yes Press the display key to start the firmware update.

Please note

- ◆ The firmware update can last up to six minutes, depending on the quality of your DSL connection.
- ◆ When updating from the Internet, checks are made to ensure that no newer version of the firmware exists. If this is not the case, the operation is terminated and a message is issued to that effect.

Updating firmware automatically

Your phone will check daily whether a newer firmware version is available from the Internet on the configuration server. If firmware updates are available, the message

New firmware available is displayed in the idle display of the handset.

Yes Press the display key to confirm the prompt.

The firmware is uploaded to your phone.

Please note

If the telephone is not connected to the Internet at the time when the check for new firmware is to be performed (e.g., because the router is deactivated), the check is performed as soon as the phone is reconnected to the Internet.

You can deactivate the automatic version check via the Web configurator.

Repeater support

You can increase the range and signal strength of your phone using a repeater. To do this you need to activate repeater mode. This will terminate any calls that are in progress at the time.

Prerequisite: Eco mode(+) is deactivated.

 →  → **System** → **Repeater Mode**

Change Press the display key to activate or deactivate repeater mode (☑ = on).

Yes Press the display key to confirm the prompt.

Please note

- ◆ Repeater support and **Eco Mode / Eco Mode+** (→ [page 121](#)) cancel each other out, i.e., both functions cannot be used at the same time.
- ◆ The default encrypted transmission setting is deactivated when repeater mode is activated.

Resetting the base to the default settings

The individual settings are reset.

Resetting the base via the menu

When the settings are restored:

- ◆ Handsets are still registered
- ◆ The system PIN is not reset.

The following settings in particular are reset to the default settings (you can make the settings marked "*" via the Web configurator):

- ◆ The entered VoIP connections (are deleted)
- ◆ The assignment of send and receive connections
- ◆ Audio settings for VoIP connections *
- ◆ DTMF settings *
- ◆ Own area code
- ◆ Settings for the local network
- ◆ The names of the handsets
- ◆ SMS settings (e.g., SMS service centres)
- ◆ Eco Mode and Eco Mode+ are deactivated.
- ◆ PABX connection settings
- ◆ Digit and display key assignments as well as the  key
- ◆ Settings for network services: call divert

Configuring the system settings

The following lists are deleted:

- ◆ SMS lists
- ◆ Call lists

 →  → **System** → **Base Reset**

 Enter the system PIN and press **OK**.

 Press the display key.

After the reset, the base is restarted. The restart takes around ten seconds.

The installation wizard is launched (→ [page 23](#)).

Resetting the base using a key on the base

As with resetting the base via the menu, all individual settings are reset. The **system PIN** is also reset to "0000" and all **handsets** registered above and beyond the scope of delivery **will be de-registered**.

Please note

For instructions on re-registering the handsets after a reset (where applicable), → [page 127](#).

- ▶ Remove the cable connections from the base to the router (→ [page 21](#)) and fixed line (→ [page 19](#)).
- ▶ Remove the base power adapter from the socket (→ [page 19](#)).
- ▶ **Press and hold** the registration/paging key (→ [page 5](#)).
- ▶ Plug the power adapter back into the power socket.
- ▶ Press and hold the registration/paging key (at least 20 sec.).
- ▶ Release the registration/paging key. The base has now been reset.

Restarting the base

When the handset is in idle status:

 →  → **System** → **Base Restart**









The firmware for the base is then rebooted. This process takes about 20 seconds.

Checking the base MAC address

Depending on your network configuration, you may have to enter your base MAC address in your router's access control list, for example. You can check the MAC address on the handset.

In idle status:

 Open menu.

Press keys in sequence.

The MAC address is displayed.

 Return to idle status.

Connecting the phone to a PABX

The following settings are only necessary if your PABX requires them; see the PABX user guide.

Please note

You cannot send or receive SMS messages on PABXs that do not support Calling Line Identification.

Dialling modes and recall

The current setting is indicated by .



Changing the dialling mode

The following dialling modes can be selected:

- ◆ Tone dialling (**Tone**),
- ◆ Pulse dialling (**Pulse**).

Regardless of the setting options above, after dialling or during a call, the phone automatically switches to tone dialling (DTMF) e.g., for controlling an answering machine remotely.



 →  → **Telephony** → **Dialling Mode**

 Select dialling mode and press **Select** ( = selected).

Setting recall (fixed line)

By default, your phone is set for operation on the main connection (recall 250 ms). For operation on a PABX, you may have to change this value. Please refer to the user guide for your PABX.

 →  → **Telephony** → **Recall**

 Select recall and press **Select** ( = set value). Possible values include: 80 ms, 100 ms, 120 ms, 180 ms, 250 ms, 300 ms, 400 ms, 600 ms, 800 ms.

Saving an access code (outside line code)

You can save two access codes: one for dialling via the fixed line and one for dialling via VoIP.

Prerequisite: you must enter an access code for external calls using your PABX, e.g., "0".

 →  → **Telephony** → **Access Code**

▶ You can enter data in the following fields:

Access external line with:

For dialling via the fixed line: enter or change the access code, max. three digits.

For:

Specify when the access code should be inserted for dialling via the fixed line:

Call Lists

The access code is put in front of numbers dialled from one of the following lists:

- The SMS list
- The accepted calls list
- The missed calls list

All Calls

The access code prefixes all numbers dialled.

Off

The access code for the fixed line is deactivated. It does not prefix any phone number.

Access external IP line with:

For dialling via VoIP connections: Enter or change access code, max. 4 digits.

For:

Specify when the access code should also be dialled when dialling via VoIP:

Call Lists

For dialling from the SMS list, missed calls list, accepted calls list.

All Calls

For all numbers dialled on the handset.

Off

No access code should be dialled first for calls via a VoIP connection.

Save

Press the display key.

Please note









The access code never prefixes any emergency numbers or SMS service centre numbers.

Setting pauses (fixed line)

Changing the pause after line seizure

You can change the length of the pause that is inserted between pressing the talk key  and sending the number.

 Open the main menu.

Press keys in sequence.











Enter number for the length of the pause (1 = 1 sec.; 2 = 3 secs; 3 = 7 secs) and press **OK**.

Changing the pause after recall key

You can change the length of the pause if your PABX requires this (refer to the user guide for your PABX).

 Open the main menu.

       









Press keys in sequence.



Enter a digit for the length of the pause (1 = 800 ms; 2 = 1600 ms; 3 = 3200 ms) and press **OK**.

Changing a dialling pause (pause after access code)

 Open the main menu.

Press keys in sequence.



Enter a digit for the length of the pause (1 = 1 sec.; 2 = 2 sec.; 3 = 3 sec.; 4 = 6 sec.) and press **OK**.

To insert a dialling pause: press and hold  for 2 seconds. A P appears in the display.

Switching temporarily to tone dialling (DTMF)

If your PABX still operates with pulse dialling (PD), but you need tone dialling for a connection (e.g., to listen to the network mailbox), you must switch to tone dialling for the call.

Prerequisite: you are conducting a call or have already dialled an external number.

 Press the star key.

After the call ends, pulse dialling is automatically reactivated.

Configuring the phone via the Web configurator

The Web configurator for your Gigaset telephone enables you to make the settings for your phone conveniently on your PC.

- ◆ You can make settings that are also possible using your telephone handset using the web browser on your PC as an alternative, e.g., configure VoIP connections, download firmware updates or start Eco Mode.
- ◆ You can make additional settings that are not possible via the handset, e.g., meet particular prerequisites for connecting the phone to a company network or adjust the voice quality on VoIP connections
- ◆ On the base, you can save data that is required to access specific services on the Internet. These services include access to public and private online directories, to the POP3 server for your e-mail account and synchronising date/time with a time server.
- ◆ You can save data for your phone (base and handsets) in files on the PC and, in the event of an error, you can download them onto your phone again.

Below you will find a list of the Web configurator functions and the navigation paths to the Web configurator pages where the functions are available. See the Online Help for the Web configurator (→ [page 166](#)) for a detailed description of the Web pages and the required entries.

Connecting the PC with the telephone's Web configurator

Prerequisites:

- ◆ A standard Web browser is installed on the PC e.g., Internet Explorer version 7.0 or higher, Firefox version 3.5 or higher or Apple Safari version 3.x.
- ◆ The phone and PC are directly connected with each other via a router. The settings of any existing firewall installed on your PC allow the PC and phone to communicate with each other.

There are two ways of connecting your PC to the Web configurator of the phone:

- ◆ Via the phone's IP address in the local network;
- ◆ Via the Gigaset configuration service, if the phone and PC are connected to the Internet (→ [page 160](#)).

Please note

- ◆ Depending on your VoIP provider, it is possible that you will be unable to change individual settings in the Web configurator.
- ◆ The phone is **not** blocked while you select your settings in the Web configurator. You can make calls with your phone or modify settings at the same time.
- ◆ While you are connected to the Web configurator, it is blocked to other users. It cannot be accessed by more than one user at any time.

Establishing a connection via the phone's IP address

- ▶ Establish the telephone's current IP address on the handset:
You can see the phone's current IP address in the handset display by **briefly** pressing the registration/paging key on the base.
Your phone's IP address can change if you have activated dynamic IP address assignment (→ [page 146](#)).

Warning

If one of the four parts of the IP address contains leading zeros (e.g., 002), these zeros must not be entered in the Web browser address field. Otherwise, the Web browser will not be able to establish a connection to the Web configurator.

Example: the IP address 192.168.002.002 is displayed on the phone. 192.168.2.2 should be entered in the address field.

- ▶ Launch the web browser on your PC.
- ▶ Enter **http://** and the telephone's current IP address (for example: `http://192.168.2.2`) into the address field of the Web browser.
- ▶ Press the return key.

A connection is established to the phone's Web configurator.

Establishing a connection via Gigaset config

Prerequisite: your PC and phone are connected to the Internet.

- ▶ Launch the web browser on your PC.
- ▶ Enter the following URL into the Web browser's address field:
<http://www.gigaset-config.com>
- ▶ Press the return key.

You will receive a message stating that the connection has been forwarded to your phone.

If several Gigaset phones can be reached via your Internet connection, you are asked which of these phones you would like to be connected to.

After successfully forwarding the connection, the Web configurator's **Login** page is displayed in the Web browser.

Please note

The connection between the PC and the Web configurator is a local connection (LAN connection). The Internet is only accessed to establish the connection.

Logging in to/off the Web configurator

Prerequisite: your PC and phone are connected to the Internet.

Logging in, setting the interface language

Once you have successfully established the connection, the **Login** Web page is displayed in the Web browser.

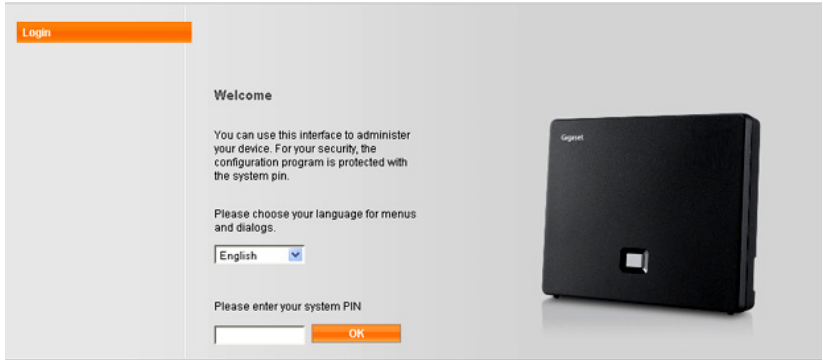

Figure 1 Start screen

You can select the language you want the menus and Web configurator dialogues to be displayed in. The language that is currently selected is displayed in the first field on the Web page.

- ▶ If necessary, click to open the list of available languages.
- ▶ Select the language.

The Web page is reloaded in the selected language. This may take some time, as the web pages for the Web configurator for the required language are loaded onto the base from the configuration server.

- ▶ Enter your phone's system PIN (default setting: 0000) in the bottom field of the Web page, to access the Web configurator functions.
- ▶ Click **OK**.

Once you have successfully logged in, the **Home** Web page opens with general information on the Web configurator.

If you enter an incorrect system PIN, a corresponding message is displayed. You are prompted to re-enter the PIN.

If you enter an incorrect system PIN a second time, the PIN field is blocked for a short time (greyed out). The duration of the block will double each time a PIN is subsequently entered incorrectly.

Please note

- ◆ If the system PIN is still set as 0000 on the phone (default setting), you will be notified during login that the device is not secure and you should change the PIN. You can deactivate this security notice for subsequent logins by selecting the option “**Don’t show this security advice again.**” Click **OK** to close the dialog box.
- ◆ If you do not make any entries for a lengthy period (approx. 10 minutes), you are automatically logged off. The next time you try to make an entry or open a Web page, the **Login** Web page is displayed. Re-enter the system PIN to log back in again.
- ◆ Any entries that you did not save on the phone before automatic log-off will be lost.

Logging off

In the menu bar (→ [page 163](#)) at the top right of every Web page in the Web configurator, you will see the **Log Off** command. Click **Log Off** to log off from the Web configurator.

Warning

Always use the **Log Off** command to end the connection to the Web configurator. If, for example, you close the Web browser without logging off beforehand, it is possible that access to the Web configurator is blocked for a few minutes.

Understanding the structure of the Web configurator pages

The Web configurator pages (Web pages) contain the UI elements shown in **Figure 2** (example).

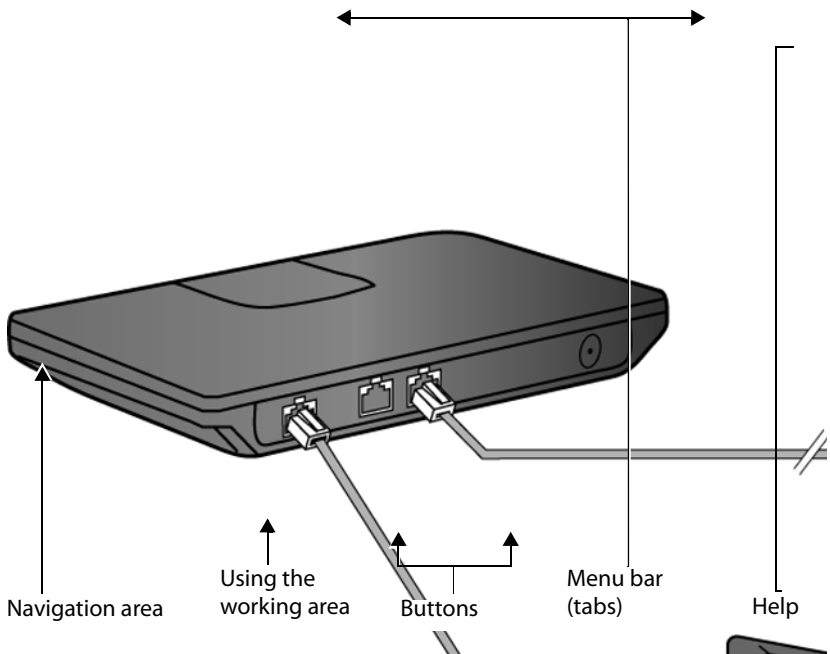

Figure 2 Example of the structure of a Web configurator page

Menu bar

The Web configurator menus are displayed in the form of tab pages in the menu bar.

The following menus are available:

Home

The home page opens once you have logged in to the Web configurator. It contains information on the Web configurator functions.

Settings

This menu allows you to make settings on your phone.

If you select the **Settings** menu, a list containing this menu's functions is displayed in the navigation area (→ **page 164**).

Status

This menu provides you with information about your phone.

Log Off

You will find the **Log Off** function to the right of the menu bar on every Web page.

Please note

For an overview of the Web configurator menus, → [page 167](#).

Using the navigation area

The functions of the menu (→ [page 163](#)) selected in the menu bar are listed in the navigation area.

If you select a function, the associated page containing information and input fields opens in the working area. The selected function is highlighted in orange.

If a function is assigned subfunctions, these are listed below the function as soon as you select the function (in the example **Telephony**).

The relevant page for the first subfunction (highlighted in orange) is displayed in the working area.



Using the working area

Depending on the function selected in the navigation area, information or dialogue boxes are displayed in the working area that allow you to make or change your phone settings.

Making changes

Make settings via input fields, lists or options.

- ◆ There may be restrictions regarding the possible values for a field e.g., the maximum number of characters, entering special characters or certain value ranges.
- ◆ To open a list, click . You can choose between default values.
- ◆ There are two kinds of options:
 - Checkboxes: you can activate one or more options from a list. Active options are indicated by , non-active options by . You can activate an option by clicking . The status of the other options in the list does not change. You can deactivate an option by clicking .
 - Alternative options (radio buttons). The active option in the list is indicated by , and the non-active by . You can activate an option by clicking . The previously activated option is deactivated. You can only deactivate an option by activating another option.

Entering Cyrillic and Turkish characters

In the following section, the specified maximum number of characters permitted in a field refers to Latin characters and digits (1 character = 1 byte), i.e., 1 character means 1 byte.

Cyrillic and Turkish characters require 2 bytes each, e.g., with a field length of 16 characters, you can enter a maximum of 8 Cyrillic or Turkish characters.

If you enter too many characters into a field, the entry is rejected (not saved in the phone). The "old" field content (or the default settings) is retained and displayed again when the Web page is updated. No warning/confirmation is given.

Applying changes

As soon as you have made your change on a page, save and activate the new setting on the phone by selecting **Set**.

If your entry does not comply with the rules for this field, an appropriate error message is displayed. You can then repeat the input.

Warning

Changes that have not been saved on your phone are lost if you move to another Web page or the connection to the Web configurator is lost e.g., due to exceeding the time limit (→ [page 162](#)).

Using the buttons

Buttons are displayed in the bottom section of the working area. Depending on the current function of a Web page, various buttons are displayed. The functions of these buttons are described in the Online Help of the Web configurator. The most important buttons are:

Cancel

Reject changes made on the Web page and reload the settings that are currently saved in your phone to the Web page.

Set

Store changes made on a Web page on the phone.

Help

You will see a question mark at the top right of most Web pages. Click this question mark to open the Online Help for this Web page in a separate window.

The Help pages are downloaded directly from the configuration server.

Please note

You may need to change your browser settings to display the Help pages correctly. Internet Explorer and Firefox require the following settings, for example:

- ▶ You must allow blocked active content for Help (right-click the information bar at the top of the browser window).
- ▶ Allow the pages to use their own fonts or set Arial as the standard font (general option).

Means of representation in Help

Bold font

User interface terms such as menu functions, names of input fields and options.

[Bold font]

Buttons.

[About this Help](#) ▶ / [About this Help](#) ▼

Blue, underlined text shows hidden text.

Click this link once to show the hidden text. The arrow at the end of the link rotates by 90°.

Click [About this Help](#) ▼ to hide the text again.

Telephony > Dialling Plans

Navigation to a Web configurator function.

Matches the illustration "Telephony → Dialling Plans" in this user guide (→ **Opening Web pages** below).

Searching in Help

Click inside the Help window and press the **Ctrl** and **F** keys. A search dialogue opens.

Opening Web pages

A brief outline of how to navigate to the individual Web configurator functions is given below.

Example

Defining dialling plans:

Settings → Telephony → Dialling Plans

To open the Web page, proceed as follows after registration:

- ▶ Select the **Settings** menu in the menu bar.
- ▶ Click the **Telephony** function in the navigation area.
The **Telephony** subfunctions are displayed in the navigation tree.
- ▶ Select the **Dialling Plans** subfunction.

Web configurator menu

Home			
Settings	IP Configuration		→ page 168
	Telephony	Connections	→ page 169
		Audio	→ page 171
		Number Assignment	→ page 173
		Call Forwarding	→ page 176
		Dialling Plans	→ page 174
		Network Mailboxes	→ page 175
		Security	→ page 172
		Advanced VoIP Settings	→ page 176
		E-Mail	→ page 178
		Info Services	→ page 178
		Online Directory	→ page 178
		Phonebook Transfer	→ page 179
		Management	Date & Time
		Miscellaneous	→ page 181
		Save & Restore	→ page 180
		Firmware Update	→ page 181
Status	Device		→ page 182

Functions of the Web configurator

Connecting the base to the local network (LAN/router)

You can find the functions for connecting to the LAN on the Web page:

Settings → IP Configuration

In most cases, special settings are not required to connect the phone to the router/ a local network. Your phone is preconfigured for dynamic assignment of the IP address by default (DHCP). In order for your router to "recognise" the phone, dynamic IP address assignment must also be activated on the router i.e., the router's DHCP server must be activated.

If the DHCP server cannot or should not be activated, you must assign a fixed/static IP address to the phone (→ [page 146](#)). A static IP address is useful, for example, if port forwarding or a DMZ is set up on the router for the phone.

You can also assign a static IP address via the handset.

You can also use the Web configurator to make further settings that are required if you connect your phone to a large (company-wide or organisation-wide) network, or if you want to manage the phone remotely using the Web configurator. You can:

- ◆ Specify the address of a HTTP proxy server within the LAN that the phone can use to establish connections to the Internet if direct access is not allowed in the LAN.
- ◆ Store **VLAN Identifier / VLAN Priority** for access to a tagged VLAN.
- ◆ Allow PCs outside your LAN to connect to the Web configurator.

Warning

- ◆ Authorising access from other networks increases the risk of unauthorised access. It is therefore recommended that you disable remote access if you no longer require it.
- ◆ The Web configurator can only be accessed from other networks if your router passes on the service requests from "outside" to port 80 (the default port) of the phone. Make sure you read the user manual for your router.

Managing base connections; activating/deactivating connections

You can manage your base connections using the Web page:

Settings → Telephony → Connections

This Web page displays a list with all possible connections and your status (e.g., connected, registered):

◆ Fixed Line Connection

You do not have to configure the fixed line connection. You can make or receive calls on the fixed line connection once your phone is connected to the fixed line connection.

You can change the name of the fixed line connection and the setting for the **Recall** by clicking the corresponding **[Edit]** button.

The name entered is shown, e.g., for calls to your fixed line connections, in the display of the registered handsets and in the call list.

The recall is set by default for operating the phone on the main connection.

You must change it if necessary if you connect the phone to a PABX (see the user guide for your PABX). The flash time specifies the duration of the line interruption used to send control signals to the exchange or the telecommunications system (call transfer, setting up a consultation call etc.).

◆ Gigaset.net

The Gigaset.net connection is preconfigured in your phone. Your phone is pre-assigned a Gigaset.net number.

You can activate and deactivate the Gigaset.net connection. If the connection is deactivated, the phone will not register with the Gigaset.net service. You are then not available via the Gigaset.net connection.

Click the corresponding **[Edit]** button to change the name of the Gigaset.net connection and deactivate STUN.

The Gigaset.net connection uses a STUN server as standard. In the sent data packets, Gigaset.net replaces the private IP address of your phone with its public IP address.

If you operate your phone behind a router with symmetric NAT, STUN cannot be used. You must deactivate it. Otherwise, when making Gigaset.net calls you will not be able to hear the caller.

◆ IP Connection

You can assign up to six VoIP connections (VoIP phone numbers) to your phone. You need to set up a VoIP account with a VoIP provider for each VoIP phone number. You must save the access data for each account and for the relevant VoIP provider in the phone.

A list entry is available for each VoIP connection; this is used to configure and manage the connection.

To do this, click on the corresponding **[Edit]** button.

Configuring/deleting VoIP connections

To configure and delete VoIP connections, open the Web page

Settings → Telephony → Connections

Click on the [Edit] button next to the list entry for the VoIP connection.

This opens a Web page with the following areas:

- ◆ **Auto Configuration**
- ◆ **Profile Download**
- ◆ **Personal Provider Data**
- ◆ **General data of your service provider**
- ◆ **Network data for your service provider**

For detailed information on the areas, see the Online Help for this Web page.

Open the Online Help by clicking on the  question mark (at the top right of the Web page).

There are various ways of configuring a VoIP connection:

- ◆ Some providers support auto configuration with an auto configuration code. In this case you simply have to enter this code in the **Auto Configuration** area. All the required VoIP data is then downloaded into the areas specified above. The configuration is complete.
- ◆ Most providers supply provider profiles with the general provider data on the configuration server. Select your provider in the **Profile Download** area and download the provider profile to the phone. The profile data is downloaded into the **General data of your service provider** and **Network data for your service provider** areas.

You then have to enter the data for your VoIP account in the **Personal Provider Data** area.

In exceptional cases, you also have to adjust the settings in the **Network data for your service provider** area to suit the settings for your router:

- If you cannot hear the caller on an outgoing call, you may have to switch between outbound proxy server mode and STUN use. In the sent data packets, STUN or outbound server replaces the private IP address of your phone with its public IP address. If you operate your phone behind a router with symmetric NAT, STUN cannot be used.
- If you are sometimes unavailable for incoming calls, you may have to adjust the value in **NAT refresh time**:
If you have not activated port forwarding or set up a DMZ on the router for the phone, an entry in the routing table for the NAT (in the router) is required to make the phone available. The phone must confirm this entry in the routing table at certain intervals (**NAT refresh time**) so that the entry stays in the routing table.
- ◆ There is no provider profile for your provider.
If this is the case, you must make the settings in the **Personal Provider Data**, **General data of your service provider** and **Network data for your service provider** areas yourself. Your VoIP provider will supply you with this data.

Optimising voice quality for VoIP connections

Functions to improve the voice quality on VoIP connections are available on the Web page:

Settings → Telephony → Audio

The voice quality for VoIP connections is mainly determined by the **voice codec** used for transferring the data and the available **bandwidth** of your DSL connection. In the case of the voice codec, the voice data is digitalised (coded/decoded) and compressed. A "better" codec (better voice quality) means more data needs to be transferred, i.e., perfect voice data transfer requires a DSL connection with a larger bandwidth.

You can influence the voice quality by selecting (bearing in mind the bandwidth of your DSL connection) the voice codecs your phone is to use, and specifying the order in which the codecs are to be suggested when a VoIP connection is established.

Default settings for the codecs used are stored in your phone; one setting optimised for low bandwidths and one for high bandwidths.

You can generally select one of these standard settings for all VoIP connections on your phone. If your DSL connection has a low bandwidth, you can also exclude parallel VoIP connection to increase the voice quality.

You can also make the settings for the voice codecs yourself by selecting the voice codecs to be used for each VoIP connection on your phone and specifying the sequence in which they should be suggested when establishing a VoIP connection.

The following voice codecs are supported by your phone:

G.722

Excellent voice quality. The **broadband** speech codec **G.722** works at the same bit rate as G.711 (64 kbit/s per speech connection) but with a higher sampling rate. This allows higher frequencies to be played back. The speech tone is therefore clearer and better than for the other codecs (High Definition Sound Performance).

G.711 a law / G.711 μ law

Excellent voice quality (comparable with ISDN). The necessary bandwidth is 64 kbit/s per voice connection.

G.726

Good voice quality (inferior to that with G.711 but better than with G.729). Your phone supports G726 with a transmission rate of 32 kbit/s per voice connection.

G.729

Average voice quality. The necessary bandwidth is less than or equal to 8 kbit/s per voice connection.

To save additional bandwidth and transmission capacity, on VoIP connections that use the **G.729** codec you can suppress the transmission of voice packets in pauses ("Silence Suppression"). Instead of the background noises in your environment, your caller then hears a synthetic noise generated in the receiver (option: **Enable Annex B for codec G.729**).

Please note

Observe the following for good voice quality:

- ◆ When making calls using VoIP, avoid performing other Internet activities (e.g., surfing the Internet).
- ◆ Please note that voice delays can occur depending on the codec used and the network capacity utilisation.

Making security settings – managing certificates for TLS authentication

The phone supports the establishment of secure data connections on the Internet with the TLS security protocol (Transport Layer Security). With TLS, the client (the phone) uses certificates to identify the server. These certificates must be stored on the base.

You can manage TLS certificates using the Web page:

Settings → Telephony → Security

This page contains the **Server Certificates / CA Certificates** lists. They contain the certificates saved in the base. The certificates have either already been saved on the base by default, or you have downloaded them to your base via the **Security Web** page.

The **Invalid Certificates** list contains the certificates received from servers that have not passed the certificate check when establishing a connection, and certificates from the **Server Certificates / CA Certificates** lists that have become invalid (e.g., because they have expired).

You can remove certificates and download new certificates to the base, and you can also accept or reject invalid certificates.

If the connection to a data server on the Internet is not made because the phone does not accept the certificate received from the server (e.g., when downloading your e-mail messages from the POP3 server), you will be prompted to open the **Security Web** page.

The **Invalid Certificates** list contains the certificate used to make the connection. You can display information on the certificate by marking it and clicking on the **[Details]** button. This information includes who issued the certificate (certification authority) and who for, as well as its validity period.

You must use the information to decide whether to accept or reject the certificate.

If you accept the certificate, depending on its type, it is transferred to one of the **Server Certificates / CA Certificates** lists (even if it has already expired). If a server responds again with this certificate, this connection is accepted immediately.

If you decline the certificate, it is transferred to the **Server Certificates** list with the label (**rejected**). If a server responds again with this certificate, this connection is rejected immediately.

Assigning send and receive connections

For the number assignment, open the Web page:

Settings → Telephony → Number Assignment

Assign send and receive connections to the registered handsets.

Please note:

- ◆ During registration, each handset is automatically assigned the fixed line connection as a send connection and all base connections as receive connections.
- ◆ You can assign each handset either a fixed send connection or a connection selection. For connection selection, you choose the connection to be used for each call.
- ◆ The Gigaset.net number is fixed as the send connection for each registered handset. Numbers that end in #9 are automatically dialed via Gigaset.net.

Please note

- ◆ You can override the assignment of the send connection for certain phone numbers by defining dialling plans for these numbers.
- ◆ For number assignment → [page 150](#).

Activating the fixed line connection as the fallback send connection

You can activate the fixed line connection on your phone as a fallback connection. If a call attempt fails via VoIP, an attempt is automatically made (without prompting) to establish a connection via the fixed line.

A fallback is used in the following situations:

- ◆ Your VoIP connections are busy
- ◆ The SIP server for the VoIP connection cannot be accessed
- ◆ The dialled VoIP connection has not yet been configured or has not been configured correctly (e.g., incorrect password)
- ◆ The phone does not have a connection to the Internet, for example, because your router is deactivated or not connected to the Internet.

Exception

SMS messages that are to be sent via a VoIP connection are **not** sent via the fallback connection.

The option to activate the fallback connection is on the Web page:

Settings → Telephony → Number Assignment

User-defined dialling plans – specifying rules for telephony

You can define your own dialling plans in the **Dialling Plans** area on the Web page:

Settings → Telephony → Dialling Plans

You can specify the following dialling plans:

- ◆ You can define a connection (fixed line or a VoIP connection) for specific phone numbers that are always used to dial these phone numbers and therefore for billing.

If you enter just a few digits (e.g., local area, national or mobile network code) any call to a number beginning with these digits will be made via the selected connection.

- ◆ If you block specific phone numbers, your phone will not establish a connection to these numbers (e.g., 0190 or 0900 numbers).

These dialling plans apply to all registered handsets. The send connection settings are inactive when you dial numbers that are governed by a dialling plan.

You can activate and deactivate the dialling plans as required.

Please note

Dialling plans, with the exception of a block, are not effective if you have assigned the choice of connection to a display key on the handset and you explicitly choose a send connection from the list of available connections before dialling.

Tips:

- ◆ Compare the rates for long-distance calls (especially for international calls) offered by your fixed line and VoIP providers, and determine which connection should be used specifically for these countries/locations, e.g., a dialling plan for the **Phone Number** "0033" would apply to every call made to France.
- ◆ Use dialling plans to define that numbers starting with a call-by-call number are always made via your fixed line connection. To do so, enter the call-by-call number in the **Phone Number** field.

Please note

If dialling plans overlap, the one with the greatest concordance will apply.

Example:

There is a dialling plan for the number "02" and one for the number "023". If you dial "0231..." the second plan will apply; if you dial "0208..." the first plan will apply.

Examples

All calls to the mobile phone network should be made via your VoIP connection with provider B.

Dialling plans:

Phone Number = 017 **Connection** = IP3, provider B
and the corresponding entries for "015" and "016".

Emergency numbers

If no emergency numbers are set by default, you should define dialling plans for emergency numbers yourself and assign them to a connection that you know supports emergency calls.

Local area codes – activating dialling plans for local calls using VoIP

If you use VoIP to make a call to the fixed line, you may also have to dial the area code for local calls (depending on the provider). You can avoid having to enter your own local area code by entering the full area code (with the international code) for the location where you are using the phone in the phone configuration and activating the **Predial area code for local calls via VoIP** option.

These settings are available in the **Area Codes** area on the Web page:

Settings → Telephony → Dialling Plans

Access codes – activating dialling plans when connecting to a PABX

If your phone is connected to a PABX, you may have to enter an access code for external calls (external prefixes e.g., "0").

Save one access code each for fixed line and VoIP connections and specify separately for VoIP and fixed line connections when the phone numbers should be automatically prefixed with the digits.

You can choose between **"All"**, **"None"** and **„from Call Lists“**.

These settings are available in the **Access Code** area on the Web page:

Settings → Telephony → Dialling Plans

Entering the network mailbox, enabling/disabling the network mailbox

A list of the network mailboxes for all connections on your phone is available on the Web page:

Settings → Telephony → Network Mailboxes

You can enter the phone numbers for the network mailboxes in this list.

You can use this list to activate/deactivate the network mailboxes for all configured VoIP connections.

Making special settings for VoIP telephony

Activating call divert (call forwarding) for VoIP connections

The settings for call divert (call forwarding) are on the Web page:

Settings → Telephony → Call Forwarding

You can divert calls to your VoIP connections and to your Gigaset.net number.

You can divert calls to your VoIP connections to any external number (VoIP, fixed line or mobile number). Call divert takes place via VoIP.

You can divert calls to your Gigaset.net number within the Gigaset.net, i.e., to another Gigaset.net number.

For each of your VoIP connections (VoIP accounts), you can determine if and when calls to the corresponding VoIP number should be diverted to a different VoIP phone number.

Setting DTMF signalling for VoIP

You make the settings for DTMF signalling in the **DTMF over VoIP connections** area on the Web page:

Settings → Telephony → Advanced VoIP Settings

DTMF signalling is required, for example, for querying and controlling certain network mailboxes via digit codes or for remote operation of an answering machine.

To send DTMF signals via VoIP you must first define how key codes should be converted into and sent as DTMF signals: as audible information via the speech channel or as a "SIP Info" message. Ask your VoIP provider which type of DTMF transmission it supports.

You can configure your phone so that, for each call, it tries to set the appropriate type of DTMF signalling for the current codec (**Automatic**).

Or you can explicitly define the type of DTMF signalling:

- ◆ **Audio** or **RFC 2833** if DTMF signals are to be transmitted acoustically (in voice packets).
- ◆ **SIP Info** if DTMF signals are to be transmitted as code.

Please note

- ◆ The settings for DTMF signalling apply to all VoIP connections (VoIP accounts).
- ◆ DTMF signals cannot be transmitted in the audio path (**Audio**) on broadband connections (the G.722 codec is used).

Configuring call transfer via VoIP

You make the settings for call transfer in the **Call Transfer** area on the Web page:

Settings → Telephony → Advanced VoIP Settings

You can connect an external call to one of your VoIP connections with a second external participant (depending on the provider). You do this by establishing an external consultation call to the second participant and pressing the recall key on the handset once you have registered the second participant. The call is forwarded.

You can expand or change the settings for call transfer as follows:

- ◆ You can activate call transfer by ending the call. The two external participants are connected with one another when you press the end call key  on the handset. Your connections with the participants are terminated.
- ◆ You can activate direct call transfer. You can then transfer the call before the two participants have registered.
- ◆ You can deactivate call transfer with the recall key if you want to assign a different feature to the recall key (see below "**Defining recall key functions for VoIP (hook flash)**").

Defining recall key functions for VoIP (hook flash)

You can specify the function for the recall key on the Web page:

Settings → Telephony → Advanced VoIP Settings

Your VoIP provider may support special performance features. To make use of these features, your phone needs to send a specific signal (data packet) to the SIP server. You can assign this "signal" as the recall function to the recall key of the handsets.

Prerequisite: the recall key is not used for call divert (default setting, see above).

If you press this key during a VoIP call, the signal is sent. This requires that DTMF signalling via SIP info messages is activated on the phone (see above).

Defining local communication ports for VoIP

The settings for the communication ports are on the Web page:

Settings → Telephony → Advanced VoIP Settings

The following communication ports are used for VoIP telephony:

◆ SIP port

The communication port via which the phone receives (SIP) signalling data. The default standard port number is set to 5060 for SIP signalling.

◆ RTP port

Two consecutive RTP ports (consecutive port numbers) are required for each VoIP connection. Voice data is received via one port and control data via the other. The default standard port number is set to 5004 for voice transmission.

This setting only has to be changed if the port numbers are already being used by other subscribers in the LAN. You can then specify other fixed port numbers or port number ranges for the SIP and RTP port.

Configuring the phone via the Web configurator

If several VoIP phones are operated on the same router with NAT, it makes sense to use randomly selected ports. The phones must then use different ports so that the router's NAT is only able to forward incoming calls and voice data to one (the intended) phone. Use the Web configurator to specify a port number range for the SIP and RTP port that the ports are chosen from.

Making settings for access to Internet services

You can use the following Internet services on your phone.

◆ E-mail notifications

In order to use the e-mail function of your base on the handset, you have to save the address of the POP3 server and your personal access data for your mailbox in the base.

You can also specify the time interval at which your phone should check whether the POP3 server has received new e-mail messages, and specify whether authentication on the incoming e-mail server should be carried out via a secure connection.

You make the settings on the Web page:

Settings → E-Mail

◆ Customising info services for the Info Center and the Info Services screensaver

You can customise your personal services on the Gigaset.net server for your Info Center (→ [page 108](#)) and for the Info Services (→ [page 137](#)) screensaver. You can access the Gigaset.net server (URL and personal access data) on the Web page:

Settings → Info Services

You can also activate the Info Services screensaver for your phone.

◆ Using net directories

You have to select the provider whose net directories you want to use on the registered handsets.

You make the settings on the Web page:

Settings → Online Directory

◆ Managing the synchronisation of the base with a time server

By default, your phone is configured so that the date/time is transferred from a time server on the Internet.

Changes to the settings for the time server and activating/deactivating the synchronisation are done via the Web page:

Settings → Management → Date & Time

Deleting handset directories and downloading to/from the PC

The functions to edit the directories are on the Web page:

Settings → Phonebook Transfer

The Web configurator has the following options for editing the directories of the registered handsets.

- ◆ Store the directories on a PC. Entries are stored in vCard format in a vcf file on the PC. You can download these files onto every registered handset. You can also copy directory entries to your PC directory.
- ◆ Copy contact details from your PC address book to handset directories. Export the contacts in vcf files (vCards) and transfer them to directories for the handsets using the Web configurator.
- ◆ Delete the directory on the handset.
If you have edited the directory file (vcf file) on the PC and would like to load this modified directory to the handset, you can delete the current directory on the handset before the transfer.

Tip: back up the current directory on your PC before deleting it. You can then reload it if the modified directory is affected by formatting errors and some, or all, of it cannot be loaded onto the handset.

Please note

- ◆ You can find information on vCard format (vcf) on the Internet e.g., at:
www.en.wikipedia.org/wiki/VCard (English) or
www.de.wikipedia.org/wiki/VCard (German)
(You can set the display language at the bottom left-hand side in the navigation area of the Web page.)
- ◆ If you wish to copy a directory (vcf file) with multiple entries stored on the PC to the Microsoft Outlook™ directory, please proceed as follows:
Microsoft Outlook™ only ever transfers the first (directory) entry from the vcf file to its directory.

Transfer rules

The directory entries from a vcf file that are loaded onto the handset will be added to the directory. If an entry already exists for a name, it will either be supplemented or a new entry for the name is created. The process will not overwrite or delete any phone numbers.

Please note

Depending on your device type, up to three entries with the same name are created in the directory for each vCard – one entry per entered number.

Understanding directory file content (vcf file)

The following data (if available) is written into the vcf file for entry into the directory or transferred from a vcf file into the handset directory.

- ◆ Name
- ◆ First name
- ◆ Number
- ◆ Number (office)
- ◆ Number (mobile)
- ◆ E-mail address
- ◆ Birthday (YYYY-MM-DD) and time of the reminder call (HH:MM) separated by a "T" (example: 2008-12-24T11:00).

Other information that a vCard may contain is not entered into the handset directory.

Example of an entry in vCard format:

```
BEGIN:VCARD
VERSION:2.1
N:Smith;Anna
TEL;HOME:1234567890
TEL;WORK:0299123456
TEL;CELL:0175987654321
E-MAIL:anna@smith.com
BDAY:2008-12-24T11:00
END:VCARD
```

Saving and restoring system settings

Once you have configured your base and after each configuration change, you can save the current base settings in a file on the PC (suffix .cfg).

If you change the settings accidentally or you need to reset the base due to a fault (base reset), you can reload the saved settings from the file on your PC to your phone.

The contents of the .cfg file include:

- ◆ The settings for the local network (IP configuration)
- ◆ The data for the (VoIP) connections established
- ◆ The assignment of send and receive connections
- ◆ Your own local area code and access code
- ◆ The network mailbox number
- ◆ The Internet services settings
- ◆ The ECO DECT settings.

You can save and restore the system settings via the Web page:

Settings → Management → Save & Restore

Changing the base settings, registering handsets

You can use the Web configurator to:

- ◆ Switch the base to registration mode to register more handsets to the base. This setting corresponds to pressing and holding the Registration/Paging key on the front of the base.
- ◆ Activate Eco Mode or Eco Mode+. For Eco Mode see [page 121](#).
- ◆ Change the system PIN (→ [page 144](#)) for your phone.
- ◆ Activate and deactivate the LED for the Registration/Paging key on the front of the base. See [page 5](#) for the meaning of the LED.
- ◆ Activate/deactivate the display of VoIP status messages on your handset.

The base settings are on the Web page

Settings → Management → Miscellaneous

Updating firmware for the base/restoring firmware updates, activating/deactivating automatic updates

You can start firmware updates and downgrades via the Web page:

Settings → Management → Firmware Update

Regular updates to the base firmware and the provider profile for your VoIP connections (general provider data) are made available on an Internet configuration server. You can download these updates onto your base as required. The URL for this server is stored in the base.

You have the following options:

- ◆ Starting a firmware update

If a **new** version of the firmware is available, this is downloaded to the base and the base is restarted. A firmware update lasts around six minutes. The duration also depends on the bandwidth of your DSL connection.

- ◆ Enabling/disabling the automatic version check

When the version check is enabled, the phone checks on a daily basis whether the Gigaset configuration server has a new version of the phone firmware.

If the telephone is not connected to the Internet at the time when the check is to be performed (e.g., because the router is disabled), the check is performed as soon as the phone is reconnected to the Internet.

If a new version is available, a message to this effect is shown on the display of the registered handsets. You can start the update of the firmware on one of the handsets.

- ◆ Downgrading firmware

You have the following options:

- You can reload the firmware version that was loaded before the last update on the base.
- You can reload the firmware version that was loaded by default onto the phone.

The selected firmware is reloaded on the phone and the current firmware is overwritten.

Displaying the phone status

The **Status** tab includes the following information about the phone:

- ◆ IP and MAC address for the base
- ◆ Version of the firmware currently loaded

The version is shown in the following format: aabbbxxyyyz.

aa denotes the phone's product variant

bbb is the version of the firmware and xx the sub-version (yyyz are only significant for the service).

Edition 420200000 means that version 20 of the firmware is currently loaded on your base.

- ◆ The connections for your phone and their status.
- ◆ A list of the registered handsets

Customer Service & Assistance

Do you have any questions? As a Gigaset customer, you can find help quickly in this User Manual and in the service section of our Gigaset online portal www.gigaset.com/service.

Please register your phone online right after purchase.

This enables us to provide you with even better service regarding questions or a warranty claim. In order to contact our customer service via email, please use the email contact form from our Gigaset online portal after selecting your home country.

Our representatives are also available on the telephone hotlines for consultation.

Australia	1300 780 878
Austria	0043 1 311 3046
Bahrain	97 31 73 11 173
Belgium	0 78 15 66 79
Bosnia Herzegovina	033 276 649
Brazil	4003 3020
(grandes cidades e regiões metropolitanas - Custo de uma ligação local)	
.....	0800 888 3020
(demais localidades - Gratuito)	
Bulgaria	+359 2 9710666
(0.50 евро на минута от всички държави за стационарни телефони. За обаждания от мобилни телефони може да има други цени).	
Canada	1-866 247-8758
China	0 21 400 670 6007 (RMB 0.11)
Croatia	01 2456 555 (0,23 Kn)
Czech Republic	0 233 032 727
Denmark	+45 (0) 35 25 86 00
Finland	09 231 134 25
France	+33 170 706 181
Coût d'un appel local depuis une ligne fixe France Télécom.	
Germany	01805 333 222
Der Anruf kostet Sie aus den deutschen Festnetzen 0,14 € pro Minute. Anrufe aus den deutschen Mobilfunknetzen kosten höchstens 0,42 € pro Minute.	
Greece	801-100.0.500
(Χρέωση 0,0026 € το λεπτό για το σταθερό δίκτυο της Ελλάδας. Για κλήσεις από κινητό ίσως ισχύουν άλλες χρεώσεις)	
Hong Kong	2763 0203
.....	2389 7285
Hungary	01 267 21 09 (27 Ft)
India	Please refer to your
.....	local warranty card
Indonesia	(62-21) 5673813
.....	(62-21) 888856000
Ireland	18 50 77 72 77
Italy	199.15.11.15
(€ cent 8,36 + IVA al minuto da telefono fisso della rete Telecom Italia senza scatto alla risposta mentre per le chiamate effettuate attra-	

verso la rete di altri operatori fissi o mobili consultate le tariffe del vostro operatore)	
Jordan	00962 6 5625460/1/2
Kuwait	+965 -22458737/22458738
Lebanon	+9611240259/
.....	+9611236110
Luxembourg	+352 8002 3811
Malaysia	+603-8076 9696
Malta	+390 2360 46789 (0,10 €)
Mexico	
... 01800 999 4442738 (01800 999 GIGASET)	
Netherlands	0900-3333102
(0,25 € per minuut (vast net). Voor oproepen uit het mobiele netwerk kunnen andere prijzen gelden.)	
New Zealand	0800 780 878
Norway	22 70 84 00
(Oppstartskost 89 øre + 15 øre pr minutt fra fasttelefon linje. For samtaler fra mobil vil det gjelde egne priser.)	
Oman	+968 709281 Ext. 49/21/75
Poland	801 140 160
Portugal	(351) 808 781 223
(custo de uma chamada local)	
Romania	+40 021 204 9130
Russia	8 (495) 2281312
Serbia	0800 222 111
Singapore	6735 9100
Slovak Republic	02 59 68 22 66 (4,428 sk)
Slovenija	01 5644171
South Africa	+2711 46 13 181
Spain	902 103935
Sweden	87 50 99 11
Switzerland	0848 212 00
Taiwan	02 266 24343
Turkey	0216 459 98 59
Ukraine	+380-44-451-71-72
United Arab Emirates	+97144458255/
.....	+97144458254
United Kingdom	0 84 53 67 08 12
USA	1-866 247-8758
Vietnam	1900 545 416

For questions about VoIP access, please contact the respective service provider.

Please have your record of purchase ready when calling.

Replacement or repair services are not offered in countries where our product is not sold by authorised dealers.

Questions and answers

If you have any queries about the use of your telephone, visit our website at www.gigaset.com/service for assistance 24/7. The table below also lists steps for troubleshooting.

<p>The display is blank.</p> <ol style="list-style-type: none">1. The phone is not connected to the mains power supply.<ul style="list-style-type: none">▶ Check the mains connection (→ page 20).2. The backlight is deactivated because a time control was activated (→ page 139).<ul style="list-style-type: none">▶ Press any key on the handset to temporarily activate the display backlight. <p>Or:</p> <ul style="list-style-type: none">▶ Deactivate the time control (→ page 139).
<p>No connection between the base and handset.</p> <ol style="list-style-type: none">1. The handset is outside the range of the base.<ul style="list-style-type: none">▶ Move the handset closer to the base.2. The range of the base is reduced because Eco Mode mode is activated.<ul style="list-style-type: none">▶ Deactivate Eco Mode (→ page 121) or reduce the distance between the handset and the base.3. The handset has not been registered or was deregistered due to the registration of an additional handset (more than six DECT registrations).<ul style="list-style-type: none">▶ Register the handset again (→ page 127).4. The firmware is currently being updated.<ul style="list-style-type: none">▶ Please wait until the update is complete.5. The base is not activated.<ul style="list-style-type: none">▶ Check the base power adapter (→ page 19).
<p>The handset does not ring.</p> <ol style="list-style-type: none">1. The ringtone is switched off.<ul style="list-style-type: none">▶ Activate the ringtone (→ page 142).2. Call divert set for "All Calls".<ul style="list-style-type: none">▶ Deactivate call divert (→ page 60).3. The connection on which the call is received is not assigned to the handset as a receive connection.<ul style="list-style-type: none">▶ Change the assignment of receive connections (→ page 151).
<p>You cannot hear a ringtone/dialling tone from the fixed line.</p> <p>The supplied phone cable is not being used or the phone cable may be faulty.</p> <ul style="list-style-type: none">▶ Replace the phone cable. When purchasing from a phone retailer, ensure the cable has the correct jack pin connections (→ page 196).
<p>Some of the network services do not work as specified.</p> <p>Features are not activated.</p> <ul style="list-style-type: none">▶ Query with the network provider.
<p>Error tone sounds after system PIN prompt.</p> <p>You have entered the wrong system PIN.</p> <ul style="list-style-type: none">▶ Repeat input of system PIN.

The other party cannot hear you.

You have pressed the mute button . The handset is "muted".

- ▶ Unmute the microphone (→ [page 58](#)).

The number of the caller is not displayed despite CLIP/CLI being activated.

Calling Line Identification is not enabled.

- ▶ The **caller** should ask the network provider to enable Calling Line Identification.

You hear an error tone (descending tone sequence) when keying an input.

Action has failed/invalid input.

- ▶ Repeat the process.
Watch the display and refer to the user guide if necessary.

No time is specified for a message in the call list.

Date and time have not been set.

- ▶ Set date/time or
- ▶ Activate synchronisation with a time server on the Internet via the Web configurator.

Firmware update or VoIP profile download is not performed.

1. If **Currently not possible** is displayed, the VoIP connections may be busy or a download/update is already being performed.
 - ▶ Repeat the process at a later date.
2. If **File unreadable** is displayed, the firmware file may be invalid.
 - ▶ Use only the firmware available on the preconfigured Gigaset configuration server.
3. If **Server not accessible** is displayed, the download server may not be accessible.
 - ▶ The server is currently not accessible. Repeat the process at a later date.
 - ▶ You have changed the preconfigured server address. Correct the address. If necessary, reset the base.
4. If **Transmission error XXX** is displayed, an error has occurred during the transmission of the file. An HTTP error code is displayed for XXX.
 - ▶ Repeat the process. If the error occurs again, consult the Service department.
5. If **Check IP settings** is displayed, your phone may not be connected to the Internet.
 - ▶ Check the cable connections between the base and router and between the router and the Internet.
 - ▶ Check whether the phone is connected to the LAN, i.e., it can be reached at its IP address.

You cannot establish a connection to the phone with your PC's Web browser.

- ▶ When establishing a connection, check the phone's local IP address that has been entered. You can check the IP address on your handset ([page 146](#)).
- ▶ Check the connections between the PC and base. Transmit a ping command to your base, e.g., from your PC (ping <base's local IP address>).
- ▶ You have tried to reach the phone via a secure http (https://...). Try again with http://....

Exclusion of liability

Some displays may contain pixels (picture elements), which remain activated or deactivated. As a pixel is made up of three sub-pixels (red, green, blue); it is possible that pixel colours may vary.

This is completely normal and does not indicate a fault.

Information on operating Gigaset VoIP telephones with Network Address Translation (NAT) routers

In general no special telephone or router configuration is required when operating a Gigaset VoIP phone with a NAT router. The configuration settings described in this section are only necessary if you encounter one of the following problems.

Typical problems caused by NAT

- ◆ No incoming calls are possible via VoIP. Calls to your VoIP phone number are not put through.
- ◆ Outgoing calls via VoIP are not connected.
- ◆ A connection is established with the other party, but you cannot hear them and/or they cannot hear you.

Possible solution

- 1 Change the port numbers of the communication ports (SIP and RTP ports) on your telephone (→ **"1. Changing the port numbers for SIP and RTP on your VoIP phone"**).
- 2 In some cases, you must also define port forwarding for the telephone's communication ports on the router (→ **"2. Setting port forwarding on the router"**).

1. Changing the port numbers for SIP and RTP on your VoIP phone

On your VoIP telephone, define different (local) port numbers for the SIP and RTP ports (between 1024 and 49152).

- ◆ These numbers must not be used by any other application or host in the LAN and
- ◆ be considerably higher or lower than the SIP and RTP port numbers that you usually use (and are preset on the phone).

This procedure is particularly useful if additional VoIP phones are connected to the router.

To change the SIP and RTP port numbers on your VoIP phone, proceed as follows:

- ▶ Connect your PC's browser to the Web configurator of the telephone and log in.
- ▶ Open the Web page **Settings → Telephony → Advanced VoIP Settings** and change the settings for the SIP and RTP ports (→ **page 177**).

To help you remember the new port numbers (e.g. for router configuration), you can choose numbers that are very similar to the standard settings, e.g.

SIP port	49060	instead of	5060
RTP port	49004 to 49010	instead of	5004 to 5010

- ▶ Save the changes on your telephone.
- ▶ Wait for the active VoIP connections to be re-registered. To do so, switch to the Web page **Settings → Telephony → Connections** to see the **Status** of your VoIP connections.
- ▶ Check to see whether the problem persists. If it does, perform step 2.

2. Setting port forwarding on the router

To ensure that your specified SIP and RTP port numbers are used on the WAN interface with the public IP address, you must define port forwarding rules for the SIP and RTP ports on the router.

To define port forwarding on the router, proceed as follows:

The terms used in the following can vary from router to router.

To forward a port, you must make the following specifications (example):

Protocol	Public port	Local port	Local host (IP)	
UDP	49060	49060	192.168.2.10	for SIP
UDP	49004–49010	49004–49010	192.168.2.10	for RTP

Protocol

Enter **UPD** as the protocol to be used.

Public port

Port number/port number range on the WAN interface

Local port

The SIP and RTP port numbers set on the telephone.

In the new firmware version for Gigaset VoIP telephones, you can set a RTP port range. In this case, you must also define corresponding port forwarding for this range.

Local host (IP)

Local IP address of your phone in the LAN. You can see the phone's current IP address in the handset display by pressing the paging key on the base.

To enable the router to perform this port forwarding, the DHCP settings of the router must ensure that the telephone is always assigned the same local IP address – i.e. the DHCP does not change the IP address assigned to the telephone during operation. Alternatively, you can assign a fixed (static) IP address to the telephone. However, you must ensure that this IP address is not within the address range reserved for DHCP and is not assigned to any other LAN subscriber.

VoIP status codes

In the following tables you will find the meaning of the most important VoIP status codes and messages.

Status code	Meaning
0x31	IP configuration error: IP domain not entered.
0x33	IP configuration error: SIP user name (User ID) not entered. This is shown, for example, when dialling with a line suffix, if no connection is configured for the suffix on the base.
0x34	IP configuration error: SIP password (Password) not entered.
0x300	The called party can be reached under multiple phone numbers. If the VoIP provider supports this, a list of the phone numbers is transmitted as well as the status code. The caller can select the number to which he wants to make the connection.
0x301	Permanently diverted. The called party can no longer be reached under this number. The new number is transferred to the phone together with the status code, and the phone then no longer accesses the old number but dials the new address immediately.
0x302	Temporarily diverted. The phone is informed that the called party cannot be reached under the dialled number. The call is diverted for a limited period. The phone is also notified of the length of the diversion.
0x305	The query is sent to a different "proxy server", e.g., to balance incoming queries. The phone will make the same query once again to another proxy server. This is not a redirection of the address per se.
0x380	Other service: The query or call could not be transferred. However, the phone is notified of other options available to connect the call.
0x400	Wrong call
0x401	Not authorised
0x403	The requested service is not supported by the VoIP provider.
0x404	Wrong phone number. No connection on this number. Example: While making a local call you have not dialled the area code although your VoIP provider does not support local calls.
0x405	Method not permitted.
0x406	Not acceptable. The requested service cannot be provided.
0x407	Proxy authentication required.
0x408	The party cannot be reached (e.g., account has been deleted).
0x410	The requested service is not available from the VoIP provider.
0x413	Message is too long.

Status code	Meaning
0x414	URI is too long.
0x415	Query format is not supported.
0x416	URI is faulty.
0x420	Incorrect ending
0x421	Incorrect ending
0x423	The requested service is not supported by the VoIP provider.
0x480	The dialled number is temporarily unavailable.
0x481	The recipient is not available.
0x482	Double service query
0x483	Too many "jumps": The query was rejected because the service server (proxy) has decided that this query has already passed through too many service servers. The maximum number is defined beforehand by the original sender of the query.
0x484	Wrong number: In most cases this response means that you have simply omitted one or more digits in the phone number.
0x485	The URI dialled is not unique and cannot be processed by the VoIP provider.
0x486	The called party is busy.
0x487	General faults: The call was cancelled before a call was established. The status code confirms receipt of the interruption signal.
0x488	The server cannot process the query because the data entered in the media description is not compatible.
0x491	The server notifies that the query will be processed as soon as a previous query has been completed.
0x493	The server rejects the query because the phone cannot decrypt the message. The sender has used an encryption method that either the server or the receiver phone cannot decrypt.
0x500	The proxy or the receiving device has discovered a fault while executing the query. It is therefore impossible to execute the query. If this occurs, the caller or the phone displays the fault and repeats the query after a few seconds. The number of seconds after which the query can be repeated may be transmitted to the caller or phone by the receiving device.
0x501	The query cannot be processed by the recipient because the recipient does not have the functionality that the caller requires. If the recipient understands the query but does not process it because the sender does not have the necessary rights or the query is not permitted in the current context, status code 405 is transmitted instead of 501.
0x502	In this case, the receiving device that transmits this error code is a proxy or a gateway and has received an invalid response from its gateway via which this query is to be processed.

Customer Service & Assistance

Status code	Meaning
0x503	The query cannot be processed by the receiving device or the proxy at present because the server is either overloaded or is being serviced. If it is possible for the query to be repeated in the foreseeable future, the server informs the caller or the phone of this.
0x504	Time limit exceeded at the gateway.
0x505	The server rejects the query because the indicated version number of the SIP protocol does not concur with at least the version that is used by the server or SIP device involved in this query.
0x515	The server rejects the query because the message exceeds the maximum permitted size.
0x600	The called party is busy.
0x603	The called party has rejected the call.
0x604	The called URI does not exist.
0x606	The communication settings are not acceptable.
0x701	The called party has hung up.
0x703	Connection cancelled because of timeout.
0x704	Connection interrupted because of a SIP error.
0x705	Wrong dialling tone
0x706	No connection established
0x751	Busy tone: No codec match between the calling and called party.
0x810	General socket layer error: User is not authorised.
0x811	General socket layer error: Wrong socket number
0x812	General socket layer error: Socket is not connected.
0x813	General socket layer error: Memory error
0x814	General socket layer error: Socket not available – check IP settings/connection problem/VoIP setting incorrect.
0x815	General socket layer error: Illegal application on the socket interface.

Checking service information

If you contact Customer Services, you may need the base's service information.

Prerequisite: you have assigned an outside line (try to establish an external call, make an external call).

Please note

You may need to wait a few seconds before **Options** appears on the display

Options → Service Info

Confirm selection with **OK**.

You can select the following information/functions with :

- 1: Serial number of the base (RFPI)
- 2: Not in use: - - -
- 3: Informs the service employees of the base settings (in hex diagram), e.g., the number of registered handsets, repeater mode.
- 4: Variant (digits 1 to 2),
Version of the phone's firmware (digits 3 to 5).
- 5: Gigaset.net number of your phone. A service employee can use this number to call you over the Internet without you needing to be registered with a VoIP provider. This means that the employee can test online connections and VoIP telephony regardless of the VoIP provider.
- 6: Device number of the base. This contains additional information for the service employee.

Unlock system

(only if the device has been locked by the provider)

Confirm selection with **OK**.

If necessary you can unlock a provider-specific device lock with a corresponding code.

Update profile

Confirm selection with **OK**.

Your current VoIP provider profiles (general provider data for all configured VoIP connections) are automatically loaded onto your phone. The general settings for all VoIP connections for which profiles are available on the Internet are updated.

Send config.

Select this option only if you are requested to do so by the Service employee.

Authorisation

This device is intended for analogue phone lines in your network.

Voice over IP telephony is possible with an additional modem via the LAN interface.

Country-specific requirements have been taken into consideration.

We, Gigaset Communications GmbH, declare that this device meets the essential requirements and other relevant regulations laid down in Directive 1999/5/EC.

A copy of the 1999/5/EC Declaration of Conformity is available at this Internet address:

www.gigaset.com/docs



Environment

Our environmental mission statement

We, Gigaset Communications GmbH, bear social responsibility and are actively committed to a better world. Our ideas, technologies and actions serve people, society and the environment. The aim of our global activity is to secure sustainable life resources for humanity. We are committed to a responsibility for our products that comprises their entire life cycle. The environmental impact of products, including their manufacture, procurement, distribution, utilisation, service and disposal, are already evaluated during product and process design.

Further information on environmentally friendly products and processes is available on the Internet at www.gigaset.com.

Environmental management system



Gigaset Communications GmbH is certified pursuant to the international standards EN 14001 and ISO 9001.

ISO 14001 (Environment): certified since September 2007 by TÜV SÜD Management Service GmbH.

ISO 9001 (Quality): certified since 17/02/1994 by TÜV SÜD Management Service GmbH.

Ecological energy consumption

The use of ECO DECT (→ [page 121](#)) saves energy and makes an active contribution towards protecting the environment.

Disposal

Batteries should not be disposed of in general household waste. Observe the local waste disposal regulations, details of which can be obtained from your local authority.

All electrical and electronic equipment must be disposed of separately from general household waste using the sites designated by local authorities.



If a product displays this symbol of a crossed-out rubbish bin, the product is subject to European Directive 2002/96/EC.

The appropriate disposal and separate collection of used equipment serve to prevent potential harm to the environment and to health. They are a precondition for the re-use and recycling of used electrical and electronic equipment.

For further information on disposing of your used equipment, please contact your local authority or your refuse collection service.

Appendix

Care

- ▶ Wipe the base, charger and handset with a **damp** cloth (do not use solvents) or an antistatic cloth.
- ▶ Impairments in the high-gloss finish can be carefully removed using display polishes for mobile phones.

Never use a dry cloth, this can cause static.

Contact with liquid

If the handset has come into contact with liquid:

- 1 **Deactivate the handset and remove the battery immediately.**
- 2 Allow the liquid to drain from the handset.
- 3 Pat all parts dry, then place the handset with the battery compartment open and the keypad facing down in a dry, warm place **for at least 72 hours (not in a microwave, oven etc.)**.
- 4 **Do not switch on the handset again until it is completely dry.**

When it has fully dried out, you will usually be able to use it again.

Specifications

Technology:

Nickel-metal-hydride (NiMH)

Size: AAA (Micro, HR03)

Voltage: 1.2 V

Capacity: 550 – 1000 mAh

We recommend the following battery types, because these are the only ones that guarantee the specified operating times, full functionality and long service life:

- ◆ Yuasa AAA 800 mAh

The device is supplied with two approved batteries.

Handset operating times/charging times

The operating time of your Gigaset depends on the capacity and age of the batteries and the way it is used. (All times are maximum possible times).

	Capacity (mAh) approx.			
	550	700	800	1000
Standby time (hours)*	160/48	185/56	210/64	260/79
Talktime (hours)	10	12	13	17
Operating time for 1.5 hours of calls per day (hours)**	85	100	115	140
Charging time in base (hours)	7,5	8,5	10	12
Charging time in charger (hours)	6,5	7,5	8,5	10,5

* Without/with display backlight

** Without display backlight

(Setting the display backlight → page 139)

Due to the constant progression in battery development, the list of recommended batteries in the FAQ section of the Gigaset Customer Care pages is updated regularly:

www.gigaset.com/customercare

Base power consumption

In standby mode: approx. 1.2 W

During a call: approx 1.3 W

General specifications





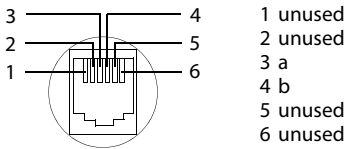

Interfaces	Analogue fixed line, Ethernet
DECT standard	Supported
GAP standard	Supported
No. of channels	60 duplex channels
Radio frequency range	1880–1900 MHz
Duplex method	Time multiplex, 10 ms frame length
Repeat frequency of the transmission pulse	100 Hz
Length of the transmission pulse	370 μs
Channel grid	1728 kHz
Bit rate	1152 kbit/s
Modulation	GFSK
Language code	32 kbit/s
Transmission power	10 mW, average power per channel 250 mW pulse power
Range	up to 300 m outdoors, up to 50 m indoors
Power supply	230 V ~/50 Hz
Environmental conditions for operation	+5°C to +45°C 20% to 75% relative humidity
Dialling mode	DTMF (tone dialling)/PD (pulse dialling)
Codec	G.711, G.726, G.729AB with VAD/CNG, G.722
Quality of Service	TOS, DiffServ
Protocols	SIP, RTP, DHCP, NAT Traversal (STUN), HTTP

Pin connections on the fixed line telephone jack



Writing and editing text

The following rules apply when writing text:

- ◆ Each key between **[0 +]** and **[WXYZ9]** is assigned several letters and characters.
- ◆ Control the cursor with    . Press and **hold**  or  to move the cursor **word by word**.
- ◆ Characters are inserted to the left of the cursor.
- ◆ Press the star key **[* Δ]** to display the table of special characters. Select the required character and press the display key **Insert** to insert the character at the cursor position.
- ◆ Press and **hold** **[0 +]** to **[WXYZ9]** to enter digits.
- ◆ Press display key **<C** to delete the **character** to the left of the cursor. Press and **hold** to delete the **word** to the left of the cursor.
- ◆ The first letter of the name of directory entries is automatically capitalised, followed by lower case letters.

Setting upper/lower case or digits

Repeatedly press the hash key **[*#]** to change the text input mode.

123	Digits
Abc	Upper case (first letter in capitals, all others in lower case)
abc	Lower case

The active mode is indicated at the bottom right of the screen.

Writing an SMS/names

Press the relevant key several times to enter letters/characters.



- ▶ Enter the individual letters/characters by pressing the corresponding key.

The characters assigned to the key are shown in a selection line at the bottom left of the screen. The selected character is highlighted.

- ▶ **Briefly** press the key several times in succession to select the required letter/character.

If you press and **hold** the key, the corresponding digit is inserted.

Standard characters

	1x	2x	3x	4x	5x	6x	7x	8x	9x	10x
[1 sp]	1									
[2 abc]	a	b	c	2	ä	á	à	â	ã	ç
[DEF 3]	d	e	f	3	ë	é	è	ê		
[4 ghi]	g	h	i	4	ï	í	ì	î		
[5 jkl]	j	k	l	5						
[MNO 6]	m	n	o	6	ö	ñ	ó	ò	ô	õ
[7 PQRS]	p	q	r	s	7	ß				
[8 TUV]	t	u	v	8	ü	ú	ù	û		
[WXYZ 9]	w	x	y	z	9	ÿ	ý	æ	ø	å
[0 +]	¹⁾ 	.	,	?	!	²⁾ 	0			

1) Space

2) Line break

Glossary

A

ADSL

Asymmetric Digital Subscriber Line

Special form of **DSL**.

ALG

Application Layer Gateway

NAT control mechanism of a router.

Many routers with integrated NAT use ALG. ALG lets the data packets in a VoIP connection pass and adds the public IP address of the secure private network.

The router's ALG should be deactivated if the VoIP provider offers a STUN server or an outbound proxy.

See also: **Firewall**, **NAT**, **Outbound proxy**, **STUN**.

Authentication

Restriction of access to a network/service by using an ID and password to log in.

Automatic ringback

See **Ringback when the number is busy**.

B

Block dialling

Enter the complete phone number, and correct it if necessary. Then pick up the earpiece or press the talk/speaker key to dial the phone number.

Broadband Internet access

See **DSL**.

C

Call divert

CD

Automatic diversion (CD) of a call to a different telephone number. There are three kinds of call divert:

- CDU, Call Divert Unconditional
- CDB, Call Divert Busy
- CDN, Call Divert No Reply

Call swapping

Call swapping allows you to switch between two callers or between a conference and an individual caller without allowing the waiting caller to listen to the call.

Call waiting

CW

Network provider feature. A beep during a call indicates that another caller is waiting. You can accept or reject the second call. You can activate/deactivate the feature.

CF

Call Forwarding

See **Call divert**.

Client

Application that requests a service from a server.

Codec

Coder/decoder

Codec is a procedure that digitalises and compresses analogue voice before it is sent via the Internet, and decodes – i.e., translates into analogue voice – digital data when voice packets are received. There are different codecs, with differing degrees of compression, for instance.

Both parties involved in the telephone connection (caller/sender and recipient) must use the same codec. This is negotiated between the sender and the recipient when establishing a connection.

The choice of codec is a compromise between voice quality, transmission speed and the necessary bandwidth. A high level of compression, for example, means that the bandwidth required for each voice connection is low. However, it also means that the time needed to compress/decompress the data is greater, which increases execution time for data in the network and thus impairs voice quality. The time required increases the delay between the sender speaking and the recipient hearing what has been said.

COLP / COLR

Connected Line Identification Presentation/Restriction

Feature provided by a VoIP/ISDN connection for outgoing calls.

COLP displays the phone number accepting the call on the calling party's display unit.

The number of the party accepting the call is different to the dialled number, e.g., if the call is diverted or transferred.

The called party can use COLR (Connected Line Identification Restriction) to prevent the number from appearing on the calling party's display.

Consultation call

You are on a call. With a consultation call, you interrupt the conversation briefly to establish a second connection to another participant. If you end the connection to this participant immediately, then this was a consultation call. If you switch between the first and second participant, it is called **Call swapping**.

D**DHCP**

Dynamic Host Configuration Protocol

Internet protocol that handles the automatic assignment of **IP addresses** to **Network subscriber**. The protocol is made available in the network by a server. A DHCP server can, for example, be a router.

The phone contains a DHCP client. A router that contains a DHCP server can assign the IP addresses for the phone automatically from a defined address block. The dynamic assignment means that several **Network subscribers** can share one IP address, although they can only use it alternately and not simultaneously.

With some routers you can specify that the IP address for the phone is never changed.

Displayed name

VoIP provider feature. You can specify any name that is to be shown to the other party during a call instead of your phone number.

DMZ (Demilitarised Zone)

DMZ describes a part of a network that is outside the firewall.

A DMZ is set up, as it were, between a network you want to protect (e.g., a LAN) and a non-secure network (e.g., the Internet). A DMZ permits unrestricted access from the Internet to only one or a few network components, while the other network components remain secure behind the firewall.

DNS

Domain Name System

Hierarchical system that permits the assignment of **IP addresses** to **Domain names** that are easier to memorise. This assignment has to be managed by a local DNS server in each (W)LAN. The local DNS server determines the IP address, if necessary by enquiring about superordinate DNS servers and other local DNS servers on the Internet.

You can specify the IP address of the primary/secondary DNS server.

See also: **DynDNS**.

Domain name

Name of one (of several) web server(s) on the Internet (e.g., Gigaset.net). The domain name is assigned to the relevant IP address by DNS.

DSCP

Differentiated Service Code Point

See **Quality of Service (QoS)**.

DSL

Digital Subscriber Line

Data transfer technology that allows Internet access with e.g., **1.5 Mbps** over a conventional telephone line. Prerequisites: DSL modem and the appropriate service offered by the Internet provider.

DSLAM

Digital Subscriber Line Access Multiplexer

The DSLAM is a switch cabinet in an exchange at which all subscriber connectors converge.

Glossary

DTMF

Dual Tone Multi-Frequency

Another description for dual tone multi-frequency dialling (DTMF).

Dynamic IP address

A dynamic IP address is assigned to a network component automatically via **DHCP**. The dynamic IP address for a network component can change every time it registers or at certain time intervals.

See also: **Fixed IP address**

DynDNS

Dynamic DNS

Domain names and IP addresses are assigned via **DNS**. For **Dynamic IP addresses** this service is enhanced with "Dynamic DNS". This permits the use of a network component with a dynamic IP address as a **Server** on the **Internet**. DynDNS ensures that a service can always be addressed on the Internet under the same **Domain name**, regardless of the current IP address.

E

ECT

Explicit Call Transfer

Participant A calls participant B. The participant puts the connection on hold and calls participant C. Rather than connect everyone in a three-party conference, A now transfers participant B to C and hangs up.

EEPROM

Electrically Erasable Programmable Read Only Memory

Memory building block in your phone with fixed data (e.g., default and customised settings) and data saved automatically (e.g., call list entries).

Ethernet network

Wired **LAN**.

F

Firewall

You can use a firewall to protect your network against unauthorised external access. This involves combining various measures and technologies (hardware and/or software) to control the flow of data between a private network you wish to protect and an unprotected network (e.g., the Internet).

See also: **NAT**.

Firmware

Device software in which basic information is saved for the functioning of a device. To correct errors or update the device software, a new version of the firmware can be loaded into the device's memory (firmware update).

Fixed IP address

A fixed IP address is assigned to a network component manually during network configuration. Unlike the **Dynamic IP address**, a fixed IP address does not change.

Flat rate

Billing system for an **Internet** connection. The Internet provider charges a set monthly fee. There are no additional charges for the duration of the connection or number of connections.

Fragmentation

Data packets that are too big are split into smaller packets (fragments) before they are transferred. They are put together again when they reach the recipient (defragmented).

Full duplex

Data transmission mode in which data can be sent and received at the same time.

G

G.711 a law, G.711 μ law

Standard for a **Codec**.

G.711 delivers a very good voice quality that corresponds to that in the ISDN network. As there is little compression, the necessary bandwidth is around 64 kbit/s per voice connection, but the delay caused by coding/decoding is only approx. 0.125 ms.

"a law" describes the European standard and " μ law" describes the North American/Japanese equivalent.

G.722

Standard for a **Codec**.

G.722 is a **broadband** language codec with a bandwidth of 50 Hz to 7 kHz, a net transmission rate of 64 kbit/s per voice connection and integrated speech pause recognition and comfort noise generation (silence suppression).

G.722 delivers very good voice quality. A higher sampling rate provides clearer and better voice quality than other codecs and enables a speech tone in High Definition Sound Performance (HDSP).

G.726

Standard for a **Codec**.

G.726 delivers a good voice quality. It is inferior to the quality with codec **G.711** but better than with **G.729**.

G.729A/B

Standard for a **Codec**.

The voice quality is more likely to be lower with G.729A/B. As a result of the high level of compression, the necessary bandwidth is only around 8 kbit/s per voice connection, but the delay is around 15 ms.

Gateway

Connects two different **Networks**, e.g., a router as an Internet gateway.

For phone calls from **VoIP** to the telephone network, a gateway has to be connected to the IP network and the telephone network (gateway/VoIP provider). It forwards calls from VoIP to the telephone network as required.

Gateway provider

See **SIP provider**.

Global IP address

See **IP address**.

GSM

Global System for Mobile Communication

Originally, a European standard for mobile networks. GSM can now be described as a worldwide standard. However, in the USA and Japan, national standards were previously more frequently supported.

H

Headset

Combination of microphone and headphone. A headset enables a comfortable speaker mode. Headsets that can be connected to the base via a cable (wire-bound) or via Bluetooth (wireless) are available.

HTTP Proxy

Server via which the **Network subscribers** can process their Internet traffic.

Hub

Uses one **Infrastructure network** to connect several **Network subscribers**. All data sent to the hub by one network subscriber is forwarded to all network subscribers.

See also: **Gateway**, **Router**.

I

IEEE

Institute of Electrical and Electronics Engineers
International body that defines standards in electronics and electrical engineering, concerned in particular with the standardisation of LAN technology, transmission protocols, data transfer rate and wiring.

Infrastructure network

Network with central structure: All **Network subscribers** communicate via a central **Router**.

Internet

Global **WAN**. A series of protocols known as TCP/IP have been defined for exchanging data.

Every **Network subscriber** is identifiable via their **IP address**. **DNS** assigns a **Domain name** to the **IP address**.

Important services on the Internet include the World Wide Web (WWW), e-mail, file transfer and discussion forums.

Internet Service Provider

Enables access to the Internet for a fee.

IP (Internet Protocol)

TCP/IP protocol on the **Internet**. IP is responsible for addressing subscribers in a **Network** using **IP addresses** and routes data from the sender to the recipient. IP determines the paths (routing) along which the data packets travel.

IP address

A unique address for a network component within a network based on the TCP/IP protocols (e.g., LAN, Internet). On the **Internet**, domain names are usually assigned instead of IP addresses. **DNS** assigns the corresponding IP address to the domain name.

The IP address has four parts (decimal numbers between 0 and 255) separated by full stops (e.g., 230.94.233.2).

The IP address is made up of the network number and the number of the **Network subscriber** (e.g., phone). Depending on the **Subnet mask**, the first one, two or three parts make up the network number and the rest of the IP address addresses the network component. The network number of all the components in any one network must be identical.

IP addresses can be assigned automatically with DHCP (dynamic IP addresses) or manually (static IP addresses).

See also: **DHCP**.

IP pool range

Range of IP addresses that the DHCP server can use to assign dynamic IP addresses.

L

LAN

Local Area Network

Network with a restricted physical range. A LAN can be wireless (WLAN) and/or wired.

Local IP address

The local or private IP address is the address for a network component in the local network (LAN). The network operator can assign any address he or she wants. Devices that act as a link from a local network to the Internet (gateway or router) have a public and a private IP address.

See also **IP address**.

Local SIP port

See **SIP port / local SIP port**.

M**MAC address**

Media Access Control address

Hardware address by means of which each network device (e.g., network card, switch, phone) can be uniquely identified worldwide. It consists of six parts (hexadecimal numbers) separated by "-" (e.g., 00-90-65-44-00-3A).

The MAC address is assigned by the manufacturer and cannot be changed.

Mbps

Million bits per second

Unit of the transmission speed in a network.

MRU

Maximum Receive Unit

Defines the maximum user data volume within a data packet.

MTU

Maximum Transmission Unit

Defines the maximum length of a data packet that can be carried over the network at a time.

Music on hold

Music that is played while you are on a **Consultation call** or during **Call swapping**. The waiting participant hears music while on hold.

N**NAT**

Network Address Translation

Method for converting (private) **IP addresses** to one or more (public) **IP addresses**. NAT enables the IP addresses of **Network subscribers** (e.g., VoIP telephones) in a **LAN** to be concealed behind a shared IP address for the **Router** on the **Internet**.

VoIP telephones behind a NAT router cannot be reached by VoIP servers (on account of the private IP address). To "get around" NAT, it is possible to use either **ALG** in the router, **STUN** in the VoIP telephone, or for the VoIP provider to use an **Outbound proxy**.

If an outbound proxy is made available, you must allow for this in the VoIP settings for your phone.

Network

Group of devices. Devices can be connected in either wired or wireless mode.

Networks can also differ in range and structure:

- Range: Local networks (**LAN**) or wide-area networks (**WAN**)
- Structure: **Infrastructure network** or ad-hoc network

Network subscriber

Devices and PCs that are connected to each other in a network e.g., servers, PCs and phones.

O**Outbound proxy**

Alternative NAT control mechanism to STUN and ALG.

Outbound proxies are implemented by the VoIP provider in firewall/NAT environments as an alternative to **SIP proxy server**. They control data traffic through the firewall.

Outbound proxy and STUN servers should not be used simultaneously.

See also: **STUN** and **NAT**.

Glossary

P

Paging (handset search)

Base function for locating the registered handsets. The base establishes a connection to every registered handset. The handsets start to ring.

PIN

Personal Identification Number

Protects against unauthorised use. When the PIN is activated, a number combination has to be entered to access a protected area.

You can protect your base configuration data with a system PIN (4-digit number combination).

Port

Data is exchanged between two applications in a **Network** via a port.

Port forwarding

The Internet gateway (e.g., your router) forwards data packets from the **Internet** that are directed to a certain **Port** to the port concerned. This allows servers in the **LAN** to offer services on the Internet without you needing a public IP address.

Port number

Indicates a specific application of a **Network subscriber**. Depending on the setting in the **LAN**, the port number is permanently assigned or it is assigned with each access.

The combination of **IP address / Port** number uniquely identifies the recipient or sender of a data packet within a network.

Pre-dialling

See **Block dialling**.

Private IP address

See **Public IP address**.

Protocol

Describes the agreements for communicating within a **Network**. It contains rules for opening, administering and closing a connection, about data formats, time frames and possible error handling.

Proxy / Proxy server

Computer program that controls the exchange of data between **Client** and **Server** in computer networks. If the phone sends a query to the VoIP server, the proxy acts as a server towards the phone and as a client towards the server. A proxy is addressed via **IP address / Domain name** and **Port**.

Public IP address

The public IP address is the address for a network component on the Internet. It is assigned by the Internet Service Provider. Devices that act as a link from a local network to the Internet (gateway, router) have a public and a local IP address.

See also: **IP address, NAT**

Q

Quality of Service (QoS)

Describes the quality of service in communication networks. Differentiations are made between various quality of service classes.

QoS influences the flow of data packets on the Internet e.g., by prioritising data packets, reserving bandwidth and optimising data packets.

In VoIP networks, QoS influences the voice quality. If the whole infrastructure (router, network server etc.) has QoS, the voice quality is better, i.e., fewer delays, less echoing, less crackling.

R**RAM**

Random Access Memory

Memory in which you have reading and storage rights. Items such as melodies and logos are saved in the RAM after you have loaded them onto the phone via the Web configurator.

Registrar

The registrar manages the current IP addresses of the **Network subscriber**. When you register with your VoIP provider, your current IP address is saved on the registrar. This means you can also be reached when on the move.

Ringback when the call is not answered

= CCNR (Completion of calls on no reply). If a party does not reply when called, a caller can arrange an automatic ringback. As soon as the destination phone has completed a call and is free again, the caller is called back. This feature must be supported by the exchange. The ringback request is automatically cancelled after about two hours (depending on the network provider).

Ringback when the number is busy

= CCBS (Completion of calls to busy subscriber). If a caller hears the busy tone, he or she can activate the ringback function. As soon as the connection is free, the caller is called back. As soon as the caller lifts the earpiece, the connection is made automatically.

ROM

Read Only Memory

A type of memory that can only be read.

Router

Routes data packets within a network and between different networks via the quickest route. Can connect **Ethernet networks** and WLAN. Can be a **Gateway** to the Internet.

Routing

Routing is the transfer of data packets to another subscriber in your network. On their way to the recipient, the data packets are sent from one router to the next until they reach their destination.

If data packets were not forwarded in this way, a network like the Internet would not be possible. Routing connects the individual networks to this global system.

A router is a part of this system; it transfers data packets both within a local network and from one network to the next. Transfer of data from one network to another is performed on the basis of a common protocol.

RTP

Real-Time Transport Protocol

Global standard for transferring audio and video data. Often used in conjunction with UDP. In this case, RTP packets are embedded in UDP packets.

RTP port

(Local) **Port** that is used to send and receive voice data packets for VoIP.

Glossary

S

Server

Provides a service to other **Network subscribers (Clients)**. The term can indicate a computer/PC or an application. A server is addressed via **IP address / Domain name** and **Port**.

SIP (Session Initiation Protocol)

Signalling protocol independent of voice communication. Used for establishing and ending a call. It is also possible to define parameters for voice transmission.

SIP address

See **URI**.

SIP port / local SIP port

(Local) **Port** that is used to send and receive SIP signalling data for VoIP.

SIP provider

See **VoIP provider**.

SIP proxy server

IP address of your VoIP provider's gateway server.

Static IP address

See **Fixed IP address**.

STUN

Simple Transversal of UDP over NAT
NAT control mechanism.

STUN is a data protocol for VoIP telephones. STUN replaces the private IP address in the VoIP telephone data packets with the public address of the secure private network. To control data transfer, a STUN server is also required on the Internet. STUN cannot be implemented with symmetric NATs.

See also: **ALG, Firewall, NAT, Outbound proxy**.

Subnet

Segment of a **Network**.

Subnet mask

IP addresses consist of a fixed line number and a variable subscriber number. The network number is identical for all **Network subscribers**. The size of the network number part is determined in the subnet mask. In the subnet mask 255.255.255.0, for example, the first three parts of the IP address are the network number and the last part is the subscriber number.

Symmetric NAT

A symmetric NAT assigns different external IP addresses and port numbers to the same internal IP addresses and port numbers – depending on the external target address.

T

TCP

Transmission Control Protocol

Transport protocol. Session-based transmission protocol: it sets up, monitors and terminates a connection between sender and recipient for transporting data.

TLS

Transport Layer Security

Protocol for encrypting data transmissions on the Internet. TLS is a superordinated **Transport protocol**.

Transmission rate

Speed at which data is transmitted in the **WAN** or **LAN**. The transmission rate is measured in data units per unit of time (Mbit/s).

Transport protocol

Controls data transport between two communication partners (applications).

See also: **UDP, TCP, TLS**.

U**UDP**

User Datagram Protocol

Transport protocol. Unlike **TCP**, **UDP** is a non session-based protocol. UDP does not establish a fixed connection. The data packets ("datagrams") are sent as a broadcast. The recipient is solely responsible for making sure the data is received. The sender is not notified about whether it is received or not.

URI

Uniform Resource Identifier

Character string for identifying resources (e.g., e-mail recipient, <http://gigaset.com>, files).

On the **Internet**, URIs are used as a uniform identification for resources. URIs are also described as SIP addresses.

URIs can be entered in the phone as a number. By dialling a URI, you can call an Internet subscriber with VoIP equipment.

URL

Universal Resource Locator

Globally unique address of a domain on the **Internet**.

A URL is a subtype of the **URI**. URLs identify a resource by its location on the **Internet**. For historical reasons the term is often used as a synonym for URI.

User ID

See **User name**.

User name

Name/number combination for access e.g., to your VoIP account or your private address directory on the Internet.

V**Voice codec**

See **Codec**.

VoIP

Voice over Internet Protocol

Telephone calls are no longer placed and transmitted over the telephone network but over the **Internet** (or other IP networks).

VoIP provider

A VoIP, SIP or **Gateway provider** is an Internet service provider that provides a **Gateway** for Internet telephony. As the phone works with the SIP standard, your provider must support the SIP standard.

The provider routes calls from VoIP to the telephone network (analogue, ISDN and mobile) and vice versa.

W**WAN**

Wide Area Network

Wide-area network that is unrestricted in terms of area (e.g., **Internet**).

Accessories

Gigaset handsets

Upgrade your Gigaset to a cordless PABX:

Gigaset SL400 handset

- ◆ Genuine metal frame and keypad
- ◆ High-quality keypad illumination
- ◆ 1.8" TFT colour display
- ◆ Bluetooth® and mini USB
- ◆ Directory for up to 500 vCards
- ◆ Talk/standby time of up to 14 h/230 h
- ◆ Large font for call lists and directory
- ◆ Brilliant sound quality in speaker mode: 4 speaker settings
- ◆ Caller pictures, slideshow and screensaver (analogue and digital clock)
- ◆ Silent alert, download ringtone melodies
- ◆ ECO DECT
- ◆ Calendar with appointment scheduler
- ◆ Night mode with time-controlled ringtone deactivation
- ◆ No interruptions from anonymous calls
- ◆ Room monitor
- ◆ SMS with up to 640 characters

www.gigaset.com/gigaset400



Gigaset S79H handset

- ◆ Illuminated graphic colour display (65k colours)
- ◆ Illuminated keypad
- ◆ Speaker operation
- ◆ Polyphonic ringtone melodies
- ◆ Directory for approx. 500 entries
- ◆ Caller picture
- ◆ SMS (prerequisite: CLIP must be enabled)
- ◆ PC interface e.g., for managing directory entries, ringtones and screensavers
- ◆ Bluetooth
- ◆ Headset socket
- ◆ Room monitor

www.gigaset.com/gigaset79h



Gigaset C59H handset

- ◆ Social life management with room monitor and birthday reminders
- ◆ Individual programming of ringtones with 6 VIP groups
- ◆ High-quality keypad with illumination
- ◆ 1.8" TFT colour display
- ◆ Directory for up to 150 vCards
- ◆ Talk/standby time of up to 12 h/180 h, standard batteries
- ◆ Large font for call lists and directory
- ◆ Brilliant sound quality in speaker mode
- ◆ Screensaver (digital clock)
- ◆ ECO DECT
- ◆ Alarm clock
- ◆ No interruptions from anonymous calls
- ◆ SMS with up to 640 characters

www.gigaset.com/gigasetc59h



Gigaset SL78H handset

- ◆ Illuminated graphic colour display (256k colours)
- ◆ Illuminated keypad
- ◆ Speaker operation
- ◆ Polyphonic ringtone melodies
- ◆ Directory for approx. 500 entries
- ◆ Caller picture
- ◆ SMS (prerequisite: CLIP must be enabled)
- ◆ PC interface e.g., for managing directory entries, ringtones and screensavers
- ◆ Bluetooth
- ◆ Room monitor

www.gigaset.com/gigasetsl78h



Accessories

Gigaset E49H handset

- ◆ Resistant to shocks, dust and water splashes
- ◆ Hardy illuminated keypad
- ◆ Colour display
- ◆ Directory for 150 entries
- ◆ Talk/standby time of up to 12 h/250 h, standard batteries
- ◆ Brilliant sound quality in speaker mode
- ◆ Screensaver
- ◆ ECO DECT
- ◆ Alarm clock
- ◆ Room monitor
- ◆ SMS with up to 640 characters

www.gigaset.com/gigasete49h



Gigaset repeater

You can use the Gigaset repeater to increase the reception range between your Gigaset handset and the base.

www.gigaset.com/gigasetrepeater



All accessories and batteries are available from your phone retailer.

Gigaset
Original
Accessories

Use only original accessories. This will avoid possible health risks and personal injury, and also ensure that all the relevant regulations are complied with.

Compatibility

For more information on handset functions in relation to Gigaset bases, please visit:

www.gigaset.com/compatibility

Mounting the base on the wall

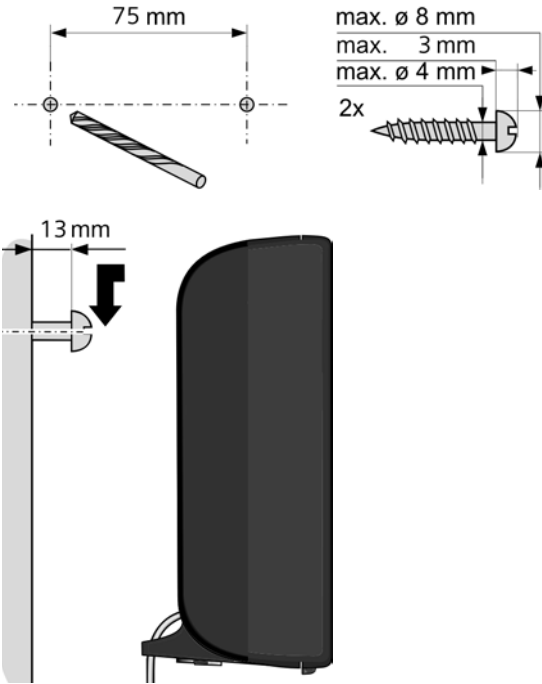

Mounting the charger on the wall

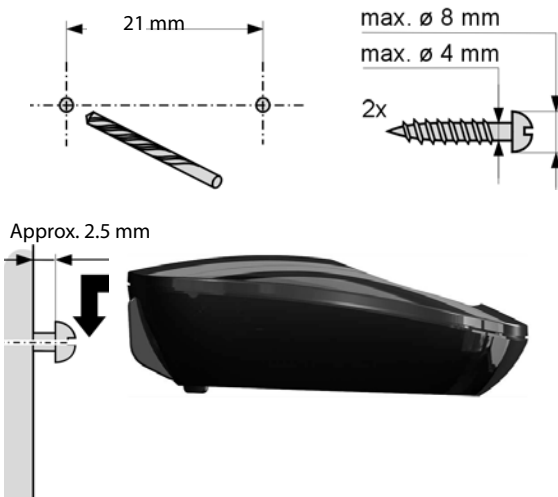

Index

A

Access code	156
for a PABX	156
Access protection	144
Accessories	208
Activate annex B for G.729	171
Activating	
advisory tones	143
call divert	60
handset	43
keypad lock	43
muting ringtone	101
network mailbox	118
ring delay	139
room monitor	125
withholding phone numbers	59
ADSL	198
Advisory tones	143
Alarm clock	123
Alert tone	142
ALG	198
Anniversary	76
deactivating	77
missed	70
saving in directory	76
Answering machine	
define for quick dial	119
Answering machine list	69
Application Layer Gateway (ALG)	198
Area codes	
setting own area code	145
Assigning a key	134
Assigning a number key	134
Asymmetric Digital Subscriber Line	198
Authentication	198
Authorisation	192
Auto configuration	23
code	24
Automatic	
ring delay	139
version check	181

B

Base	
changing	130
connecting to PABX	155
power consumption	195

restoring to default settings	153
setting up	17, 18, 144
system PIN	144
updating firmware	152
Battery	
charging	3, 4, 16
display	3, 4
icon	3, 4
inserting	14
tone	143
Best base	130
Birthday, see Anniversary	
Block dialling	198
Broadband connections	57
Broadband Internet access	198
Broadband voice codec	171, 201

C

Call	
accepting	53
ending	53
internal	130
transferring	65
transferring (connecting)	65, 131
Call charges, see Charges	
Call divert	60, 198
Call duration	51
Call forwarding	
Gigaset.net	60, 176
Call lists	67
Call swapping	64, 198
Call waiting	198
accepting/rejecting	63
activating/deactivating	62
external call	62
internal call	132
Call-by-call numbers	89
Calling	
anonymously	59
entering IP address	52
from online directory	81
from Yellow Pages	81
Gigaset.net	86, 88
internal	130
Calling line display, notes	55
Calling Line Identification	54
Capacity, directory	75
CD	198
Certificate error	23, 103

- Changing
 - destination number
 - (room monitor) 125
 - dialling mode 155
 - display language 137
 - earpiece volume 140
 - internal names 133
 - internal numbers 133
 - names of internal parties 133
 - pauses 157
 - ringtone 141
 - speaker volume 140
 - system PIN 144
 - Character set 93, 96, 197
 - Charge rates, see Charges
 - Charge status indicator 3, 4
 - Checkboxes 164
 - Checking service information 191
 - CLI, CLIP 54
 - Client 198
 - CLIP picture 54
 - Codecs 198
 - Colour scheme 138
 - COLP 52, 199
 - COLR 52, 199
 - Conference 65
 - internal 131
 - Configuring the system settings 144
 - Confirmation tone 143
 - Connected Line Identification
 - Presentation/Restriction 52, 199
 - Connecting
 - base to PABX 155
 - PC to the Web configurator 159
 - to the Web configurator 159
 - Connection wizard
 - starting (getting started) 25
 - Consultation call 64, 199
 - internal 131
 - Consumption of electricity, see
 - Power consumption
 - Control key 3, 40
 - Correcting incorrect entries 41
 - Cost control 89
 - Customer Care 183
 - Customer Service & Assistance 183
- D**
- Data packets, fragmentation 200
 - Deactivating
 - advisory tones 143
 - call divert 60
 - handset 43
 - keypad lock 43
 - muting ringtone 101
 - network mailbox 118
 - ring delay 139
 - room monitor 126
 - withholding phone numbers 59
 - Delete key 41
 - Deleting
 - characters 41
 - Demilitarised Zone 199
 - De-registering
 - from Web configurator 162
 - handset 128
 - Destination number (room monitor) ... 125
 - DHCP 199, 200
 - Dialling
 - directory 73
 - IP address 52
 - using quick dial 134
 - Dialling mode 155
 - Dialling pause 157
 - Dialling plans
 - for emergency numbers 175
 - Differentiated Service Code Point 199
 - Digital Subscriber Line 199
 - Digital Subscriber Line
 - Access Multiplexer 199
 - Directory 71
 - copying number from text 76
 - Gigaset.net 85
 - managing entries 74
 - opening 40, 78
 - order of entries 73
 - saving anniversary 76
 - saving entry 72
 - saving the sender's number (SMS) ... 97
 - searching for an entry 78
 - sending entry/list to handset 75
 - transferring to/from PC 179
 - using to enter numbers 76

Index

- Directory file
 - content (vCard format) 180
 - Directory transfer 179
 - Display
 - backlight 138, 139
 - call duration/costs 90
 - capacity (directory) 75
 - changing display language 137
 - colour scheme 138
 - in idle status 43
 - missed anniversaries 70
 - name (VoIP) 199
 - number (CLI/CLIP) 54
 - screensaver 137
 - setting 137
 - Display icons 4
 - Display keys 3, 41
 - assigning 134
 - Disposal 193
 - DMZ 199
 - DNS 199
 - DNS server, preferred 147
 - Domain name 199
 - Domain Name System 199
 - Draft list (SMS) 93
 - DSCP 199
 - DSL 199
 - DSLAM 199
 - DTMF-reminder for VoIP 176
 - Dynamic DNS 200
 - Dynamic Host Configuration
 - Protocol 199
 - Dynamic IP address 200
 - DynDNS 200
- ## E
- Earpiece volume 140
 - Echo service of Gigaset.net 56
 - ECO DECT 121
 - Eco mode 121
 - Eco mode+ 121
 - ECT 65
 - activating/deactivating 62
 - E-mail
 - deleting 107
 - list 104
 - messages whilst making
 - a connection 105
 - notification 103
 - settings 178
 - viewing the sender's address 107
 - E-mail address 94
 - copying from the directory 76
 - Emergency numbers
 - dialling plans for 175
 - End call key 3
 - Ending a call 53
 - Entering Cyrillic/Arabic characters 165
 - Entering user data (VoIP)
 - with handset 31
 - Entry, selecting from directory 73
 - Environment 193
 - Error tone 143
 - Ethernet network 200
 - Expert mode 46
 - Explicit Call Transfer 200
 - External call
 - call waiting 62
- ## F
- Fax (SMS) 94
 - Firewall 200
 - Firmware 200
 - automatic update 152, 181
 - checking version 191
 - starting update 152
 - updates 13
 - Fixed IP address 200
 - Flat rate 200
 - Fragmentation of data packets 200
 - Full duplex 200

G

- G.711 μ law 171
- G.711 a law 171
- G.722 57, 171
- G.722 broadband language codec 171
- G.726 171
- G.729 171
- Gateway 201
- Gateway provider 201
- Gigaset config 159, 160
- Gigaset HDSP see HDSP
- Gigaset.net 56
 - call forwarding 60, 176
 - calling subscriber 86, 88
 - changing/deleting own name 87
 - directory 85
 - echo service 56
 - entering name 87
 - searching for subscribers 85
- Global IP address 201
- Global System for
 - Mobile Communication 201
- Group call 130
- GSM 201

H

- Handset
 - activating/deactivating 43
 - advisory tones 143
 - changing internal number 133
 - changing name 133
 - changing to best reception 130
 - changing to different base 130
 - colour scheme 138
 - contact with liquid 194
 - de-registering 127, 128
 - display backlight 138, 139
 - display language 137
 - earpiece volume 140
 - idle status 43
 - large font 138
 - list 40
 - locating 129
 - paging 129
 - registering 127

- registering to different base 130
- restoring to default settings 143
- setting 134
- setting up 14
- speaker volume 140
- transferring a call 131
- using room monitor 124
- Handset operating time
 - in room monitor mode 124
- Hash key 3, 43
- HDSP 57, 171
- Headset 201
 - connecting 37
 - connecting (wire-bound) 18
- Headset socket 37
- Hearing aids 10
- Help 184
- High Definition Sound Performance,
 - see HDSP
- HTTP Proxy 201
- Hub 201

I

- Icon
 - alarm clock 123
 - for new messages 69
 - keypad lock 43
 - new SMS 95
 - ringtone 142
- Icons, display 4
- Idle status
 - display 43
 - returning to 43
- IEEE 202
- Incoming list (SMS) 95
- Incoming message list (e-mail) 104
- Incorrect entries (correction) 41
- Info centre 108
 - navigating 114
- Infrastructure network 202
- Input fields 164
- Installation wizard 23
- Institute of Electrical and
 - Electronics Engineers 202
- Interface language
 - Web configurator 161

Index

Internal	
conference	131
consultation	131
making calls	130
Internal call	130
call waiting	132
Internet	202
Internet access (broadband)	198
Internet protocol	202
Internet Service Provider	202
IP	202
IP address	202
assigning	146
automatically obtaining one	146
dialling	52
display on handset	5
dynamic	200
fixed	200
global	201
local	202
private	204
public	204
static	206
IP configuration	146
IP pool range	202
K	
Key 1 (quick dial)	3
assigning	119
Keypad lock	43
Keys	
control key	3, 40
delete key	41
display keys	3, 41
end call key	3
hash key	3, 43
message key	3
mute key	3
on/off key	3
paging key (base)	5
quick dial	3
recall key	3
speaker key	3
star key	3
talk key	3

L

LAN	202
Language	
display	137
Web configurator	161
Large font	138
Linking, see SMS	
Liquid	194
List	
answering machine	69
call lists	67
e-mail notifications	104
handsets	40
missed calls	67
network mailbox	69, 120
SMS draft list	93
SMS incoming list	95
SMS list	69
Lists	164
Local Area Network	202
Local communication ports	177
Local IP address	202
Local SIP port	206
Locating, handset	129
Lock	
activating/deactivating keypad lock ..	43
M	
MAC address	203
checking	154
Making calls	
accepting a call	53
cost-effective calls	89
external	50
internal	130
Manual redial	66
Maximum Receive Unit	203
Maximum Transmission Unit	203
Mbps	203
Media Access Control	203
Medical equipment	10
Menu	
end tone	143
opening	40
using	42
Web configurator overview	167
Menu bar	163

- Menu view
 - expert mode..... 46
 - standard mode 46
- Message
 - deleting (e-mail) 107
 - playing (network mailbox) 120
- Message key
 - open list..... 95
 - opening lists..... 69
- Message list
 - e-mail..... 104
 - network mailbox..... 120
- Messages
 - key3
- Microphone3
 - muting 58
- Million bits per second..... 203
- Missed calls..... 67
- MRU 203
- MTU 203
- Music on hold..... 145, 203
- Mute key3
- Muting
 - first ring..... 101
 - phone..... 58
- N**
- Name
 - displayed (VoIP)..... 199
 - of a handset 133
- NAT 203
 - symmetric..... 206
- Navigation area 164
- Network..... 203
 - Ethernet..... 200
- Network Address Translation 203
- Network mailbox..... 118
 - activating/deactivating..... 118
 - calling 119, 120
 - define for quick dial 119
 - entering number..... 118
 - list..... 120
- Network MB, see network mailbox
- Network services..... 59
- Notification
 - incoming e-mail 103
 - via SMS 99
- Number
 - as destination for room monitor..... 125
 - copying from an SMS..... 97
 - copying from directory 76
 - copying to directory..... 76
 - displaying caller's number (CLIP) 54
 - entering for network mailbox 118
 - entering with directory 76
 - saving in the directory..... 72
- O**
- On/Off key..... 3
- Online directory..... 78
 - Gigaset.net 85
 - selecting 178
- Opening the incoming e-mail list..... 104
- Operation (setting up the phone)..... 12
- Options 164
- Order in directory 73
- Outbound proxy 203
- P**
- PABX
 - connecting base 155
 - pauses 157
 - saving access code..... 156
 - setting dialling mode..... 155
 - switching to tone dialling..... 157
- Package contents 12
- Paging 5, 129, 204
- Pause
 - after access code..... 157
 - after line seizure 157
 - after recall key 157
- PD (pulse dialling)..... 155
- Personal Identification Number 204
- Phone
 - protecting against access 144
 - setting up 12, 144
- PIN..... 204
- Pin connections..... 196
- Port..... 204
- Port forwarding 204
- Port number..... 204
- Power adapter 10
- Power consumption (base)..... 195
- Pre-dialling 204

Index

Preferred DNS server	147
Private IP address	204
Protocol	204
Proxy	204
Proxy-Server	204
Public IP address	204
Pulse dialling	155

Q

Quality of Service	204
Questions and answers	184
Quick dial	71, 119, 134

R

R key	
function for VoIP	177
Radio buttons	164
RAM	205
Random Access Memory	205
Read Only Memory	205
Reading the subject (e-mail)	106, 107
Recall	155
Recall key	3, 157
Receive number	
display on the handset	54
Reception booster, see Repeater	
Redial	66
Registering	
handset	127
with Web configurator	161
Registrar	205
Reminder call	77
Repeater	153
RFC 2833 (DTMF signalling)	176
Ring delay	139
Ringback	
busy	205
no reply	205
Ringtone	
changing	141
muting	101
setting volume	141
ROM	205
Room monitor	124
Router	205
Routing	205
RTP	205
RTP port	205

S

Saving (access code)	156
Scope of delivery	12
Screensaver	137
Searching for subscribers	
on Gigaset.net	85
Searching in directory	73
Sender's address (e-mail)	107
Sending	
directory entry to handset	75
Server	206
Services, online directory	178
Setting	
date	48, 144
online directory	178
screensaver	137
time	48, 144
Setting up	
base	17, 18
handset	14
Signal tone, see Advisory tones	
Simple Transversal of UDP over NAT ...	206
SIP	206
SIP address	206
SIP port	206
SIP provider	206
SIP proxy server	206
SMS	91
deleting	93, 96
forwarding	96
incoming list	95
linked	91
notification via SMS	99
outgoing list	93
reading	93, 96
receiving	95
replying to or forwarding	96
saving number	97
self help with error messages	102
send service centre	100
sending as a fax	94
sending to an e-mail address	94
status report	92
troubleshooting	102
vCard	98
writing	91, 197
SMS list	69

- SMS service centre
 - changing number..... 100
 - setting 100
- Snooze mode..... 123
- Sound, see Ringtone
- Speaker operation..... 58
- Speaker, key3
- Special functions..... 155
- Specifications..... 194
- Standard mode 46
- Star key3
- Static IP address..... 206
- Status codes (VoIP)
 - codes table..... 188
- Structure of IP address..... 202
- Structure of Web page..... 163
- STUN..... 206
- Subnet 206
- Subnet mask..... 206
 - defining..... 146
- Suppressing
 - silence 171
 - speech pauses..... 171
 - speech pauses (VoIP)..... 171
- Symmetric NAT 206
- System settings
 - saving..... 144
- T**
- Talk key3
- TCP 206
- Telephone care 194
- Telephone jack
 - pin connections..... 196
- Text message, see SMS
- Three-party conference..... 65
- TLS..... 206
- Tone dialling..... 155, 157
- Transferring PC directory entries
 - to directory..... 179
- Transmission Control Protocol..... 206
- Transmission rate 206
- Transport Layer Security 206
- Transport protocol 206
- Troubleshooting
 - e-mail..... 105
 - general..... 184
 - SMS..... 102
- U**
- UDP..... 207
- Uniform Resource Identifier 207
- Universal Resource Locator 207
- Unknown..... 54
- Unknown caller 54
- URI..... 207
- URL 207
- User Datagram Protocol 207
- User ID 207
- User name..... 207
- Using the buttons..... 165
- V**
- vCard (SMS)..... 98
- vCard format 180
- vcf file..... 179
- Version check, automatic 181
- VIP group (directory entry)..... 72, 74
- Voice over Internet Protocol..... 207
- VoIP..... 207
 - configuring account (first) 31
 - loading provider data 29
 - show called party's number..... 52
 - status codes (table) 188
- VoIP provider 207
 - downloading data 29
 - selecting 29
- VoIP status messages
 - status codes table..... 188
- VoIP user data
 - entering (connection wizard) 31
- Volume
 - earpiece..... 140
 - handset speaker volume..... 140
 - ringtone 141
 - setting 141
 - speaker 140

Index

W

WAN	207
Warning tone, see Advisory tones	
Weather forecasts	
in idle display mode	117
Web configurator	
connecting with PC	159
de-registering	162
DTMF signalling for VoIP	176
interface language	161
menu	167
Web page, structure	163
Wide Area Network	207
Withholding	
phone number display	59
phone numbers	59
Working area	164
Writing (SMS)	91
Writing and editing text	197

Y

Yellow Pages	78
--------------------	----

Issued by

Gigaset Communications GmbH

Frankenstr. 2a, D-46395 Bocholt

Manufactured by Gigaset Communications GmbH
under trademark license of Siemens AG.

As of 1 Oct. 2011 Gigaset products bearing the
trademark 'Siemens' will exclusively use the trademark 'Gigaset'.

© Gigaset Communications GmbH 2010

All rights reserved. Subject to availability.

Rights of modification reserved.

www.gigaset.com

This user guide is made from 100% recycled paper.