

# Gigaset

## DE700 IP PRO

Version 02.00.03

**Gigaset**pro

INSPIRING CONVERSATION.\*  
\*POUR DES CONVERSATIONS INSPIRÉES.

# Gigaset DE700 IP PRO – More than just a telephone

---

Your Gigaset DE700 IP PRO is an IP phone designed for professional use.

◆ **Easy to set up**

Use the automatic configuration via the Gigaset phone system or the default settings for approx. 200 preconfigured VoIP providers.

◆ **Web user interfaces for configuration**

Operate and configure your telephone from your PC with ease.

◆ **High Definition Sound Performance – HDSP**

Make phone calls with brilliant sound quality.

◆ **Phone functions for the professional user**

Use the call divert, conference call, automatic ringback, call reject and Do Not Disturb (DND) functions.

◆ **Multiple directories**

Manage your personal directory with up to 500 vCards (caller pictures are possible). Use an LDAP online directory or online directories on the Internet.

◆ **Connection to a Gigaset T500 PRO or Gigaset T300 PRO Gigaset phone system**

Connect your telephone to a Gigaset phone system and make use of a shared line with colleagues and central management of your call lists or call switching, for example.

◆ **Network connection**

Connect your telephone to the local network via Ethernet. Connect a PC using your telephone as a gigabit Ethernet switch.

◆ **Protect the environment**

Reduce environmental pollution with the energy-saving power adapter .

◆ **Individual settings**

Load your own pictures and ringtones, subscribe to Internet services and choose how you want the display to look.

Assign functions or frequently used numbers to the keys.

Further information on your phone can be found online at



[www.gigaset.com/pro/gigasetDE700ipro](http://www.gigaset.com/pro/gigasetDE700ipro)

**Enjoy your new phone!**

# Phone overview

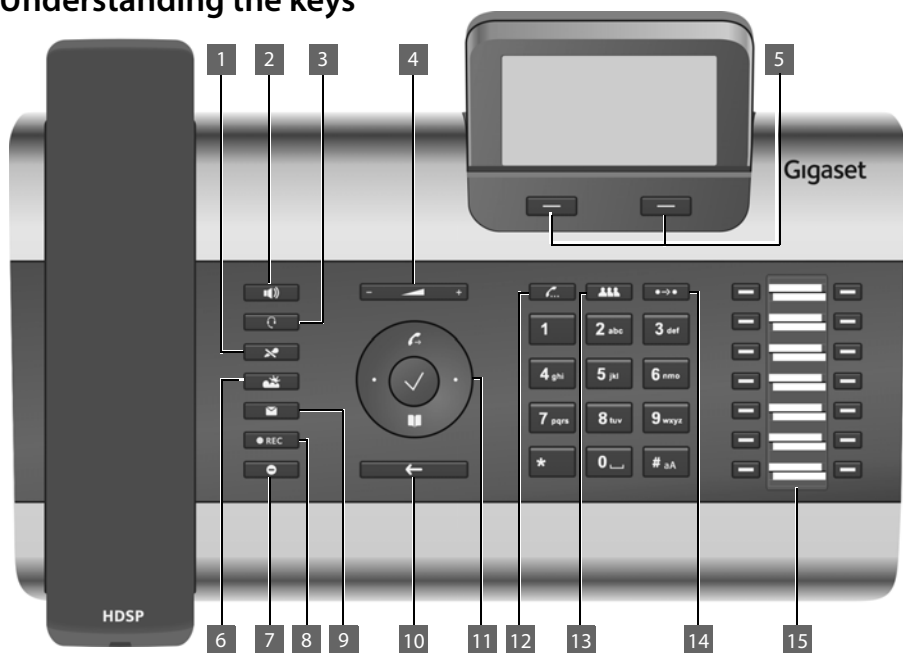
## Understanding the keys











- |    |                           |   |  |
|----|---------------------------|---|--|
| 1  | <b>Mute key</b>           | Activate/deactivate microphone (mute)   | → <a href="#">page 37</a>  |
| 2  | <b>Speaker key</b>        | Activate/deactivate speaker   | → <a href="#">page 37</a>  |
| 3  | <b>Headset key</b>        | Make call via headset   | → <a href="#">page 35</a>  |
| 4  | <b>Volume key</b>         | Depending on the operating mode: Adjust the volume of the speaker, receiver, headset or ringer  | → <a href="#">page 36</a>  |
| 5  | <b>Display keys</b>       | Activate display functions  | → <a href="#">page 22</a>  |
| 6  | <b>Information Centre</b> | Open the Information Centre   | → <a href="#">page 67</a>  |
| 7  | <b>Do Not Disturb key</b> | Do Not Disturb (DND) function   | → <a href="#">page 37</a>  |
| 8  | <b>Call records key</b>   | Record a call   | → <a href="#">page 38</a>  |
| 9  | <b>Message Centre</b>     | Open call and message lists   | → <a href="#">page 67</a>  |
| 10 | <b>End call/back key</b>  | End/reject call; cancel function;<br>go back one menu level (press briefly);<br>return to idle status (press and hold)  | → <a href="#">page 26</a><br>→ <a href="#">page 24</a>   |
| 11 | <b>Navigation key</b>     | Scroll through lists and entries. In idle status:<br> Open redial list.<br> Confirm or start action, select entry<br> Open directory | → <a href="#">page 24</a><br>→ <a href="#">page 46</a><br>→ <a href="#">page 24</a><br>→ <a href="#">page 50</a> |
| 12 | <b>Consultation key</b>   | Initiate/end consultation call  | → <a href="#">page 40</a>  |

## Phone overview

13	<b>Conference key</b>	Initiate conference call	→ <a href="#">page 41</a>
14	<b>Transfer key</b>	Transfer call to another party	→ <a href="#">page 42</a>
15	<b>Function keys</b>	Programmable keys	→ <a href="#">page 154</a>

## Understanding Light Emitting Diodes (LEDs)

	Flashes	Incoming call.	→ <a href="#">page 35</a>
	Lights up	Call is being made via the speaker.	→ <a href="#">page 37</a>
	Flashes	Incoming call (a headset must be connected).	→ <a href="#">page 35</a>
	Lights up	Call is being made via the headset.	→ <a href="#">page 35</a>
	Lights up	The microphone is muted.	→ <a href="#">page 37</a>
	Flashes	New message in the Message Centre.	→ <a href="#">page 67</a>
	Lights up	Call is being recorded.	→ <a href="#">page 38</a>
	Lights up	"Do Not Disturb" function is activated.	→ <a href="#">page 37</a>
	Lights up	One or more callers on hold.	→ <a href="#">page 40</a>
	Lights up	Conference call is activated.	→ <a href="#">page 41</a>
	Flashes	Incoming call on the number programmed to this key.	→ <a href="#">page 33</a>
	Lights up	Call is being made on the number programmed to this key.	

## Understanding the display





Display icons	▶		◀	Current time
Currently used account	▶		◀	Display icons
Date and Time	▶		◀	Area of application Adjustable display, e.g., time zone, time, calendar, picture → <a href="#">page 84</a>
			◀	Display functions ( <a href="#">page 22</a> )

Account 1   13   13   13

01.05.2010

Call   Select Line

## Understanding the display symbols

	Ringer deactivated.		→ <a href="#">page 81</a>
	New messages on the network mailbox.	The number is displayed to the right.	→ <a href="#">page 61</a>
	Missed calls.		→ <a href="#">page 46</a>
	New e-mails.		→ <a href="#">page 64</a>
	Alarm clock function activated. The wake-up time is displayed to the right.		→ <a href="#">page 70</a>

Other icons may appear depending on the function. These are displayed alongside the corresponding description.

# Contents

<b>Gigaset DE700 IP PRO – More than just a telephone</b> .....	<b>2</b>
<b>Phone overview</b> .....	<b>3</b>
Understanding the keys .....	3
Understanding Light Emitting Diodes (LEDs) .....	4
Understanding the display .....	4
<b>Following safety precautions</b> .....	<b>8</b>
<b>Using the phone in different scenarios</b> .....	<b>9</b>
<b>First steps</b> .....	<b>11</b>
Check the package contents .....	11
Setting up and connecting the device .....	12
Setting up the device (for the first time) .....	18
Proceeding .....	21
<b>Using the phone</b> .....	<b>22</b>
Operating via the keypad and display menu .....	22
Menu tree .....	29
<b>Making calls</b> .....	<b>31</b>
Calling .....	31
Receiving incoming calls .....	35
Ending a call .....	35
Using functions when making a telephone call .....	36
Making a call to multiple participants .....	39
Setting up call divert (CD) .....	43
<b>Using the call lists</b> .....	<b>46</b>
Viewing entries .....	46
Dialling a number from a list .....	48
Copying an entry from the call list to the directory .....	49
Deleting an entry or list .....	49
<b>Using directories</b> .....	<b>50</b>
Using the local directory .....	50
Using an LDAP directory .....	56
Using online directories .....	57
<b>Managing messages</b> .....	<b>61</b>
Voice mails on the network mailbox .....	61
Call records .....	63
Managing e-mail messages .....	64
Accessing messages via the Message Centre .....	67

## Contents

<b>Managing the calendar and alarms</b> .....	<b>68</b>
Managing the calendar .....	68
Displaying alarms .....	69
Missed alarms .....	69
Alarm clock function .....	70
<b>Using Internet services</b> .....	<b>72</b>
Door interphone .....	76
Closing info services .....	76
<b>Operating door interphones</b> .....	<b>77</b>
<b>Displaying maps</b> .....	<b>78</b>
On an incoming call or during a call .....	78
In the directory .....	78
As info service .....	79
<b>Configuring basic settings</b> .....	<b>80</b>
Info .....	80
Setting the date and time .....	80
Setting the ringer .....	81
Activating/deactivating advisory tones .....	84
Setting the display .....	84
Setting the language .....	92
Resetting the device to the default settings .....	92
<b>Configuring settings for the local network</b> .....	<b>93</b>
LAN settings .....	94
<b>Connecting a headset</b> .....	<b>99</b>
<b>Using the resource directory</b> .....	<b>100</b>
Managing screensavers .....	101
Managing caller pictures .....	102
Managing sounds .....	103
Checking the capacity of the Resource Directory .....	104
<b>Web configurator – configuring the phone on a PC</b> .....	<b>105</b>
Starting the Web configurator .....	105
Understanding the Web configurator menu tree .....	106
Running the setup assistant .....	108
<b>Configuring phone settings via the Web configurator</b> .....	<b>116</b>
Network and connectors .....	117
Telephony .....	132
Messaging .....	142
Services .....	145
Function keys .....	154
System settings .....	158

<b>Checking the status of the phone</b> .....	<b>170</b>
<b>Service (Customer Care)</b> .....	<b>172</b>
Questions and answers .....	172
<b>Protecting our environment</b> .....	<b>173</b>
<b>Appendix</b> .....	<b>174</b>
Caring for your telephone .....	174
Contact with liquid .....	174
Authorisation .....	174
Using insert strips .....	174
Using Gigaset QuickSync – additional functions for the PC interface .....	175
Key combinations for phone system functions .....	175
Specifications .....	177
<b>Open Source Software</b> .....	<b>178</b>
General .....	178
Information on license rights and copyright .....	178
License texts .....	178
<b>Accessories</b> .....	<b>185</b>
<b>Glossary</b> .....	<b>186</b>
<b>Index</b> .....	<b>200</b>







## Following safety precautions

---

### Warning

Be sure to read this user guide and the safety precautions before using your telephone.

---

	Use only the power adapter indicated on the device. Use only the cable supplied for LAN connection and connect it to the intended ports only.
	Using your telephone may affect nearby medical equipment. Be aware of the technical conditions in your particular environment, e.g. doctor's surgery. If you use a medical device (e.g. a pacemaker), please contact the device manufacturer. They will be able to advise you regarding the susceptibility of the device to external sources of high frequency energy (for the specifications of your Gigaset product see "Technical Data").
	The devices are not splashproof. For this reason do not install them in a damp environment such as bathrooms or shower rooms.
	Do not use the devices in environments with a potential explosion hazard (e.g. paint shops).
	If you give your Gigaset to a third party, make sure you also give them the user guide.
	Remove faulty devices from use or have them repaired by our Service team, as these could interfere with other wireless services.



## Using the phone in different scenarios

### Using your phone in a professional environment with phone system and server structure

If you use your Gigaset DE700 IP PRO in a corporate network with a telephone infrastructure, your phone incorporates functions and data from the phone system and servers.

In a corporate environment, the VoIP accounts and most of the settings are configured centrally by the phone system.

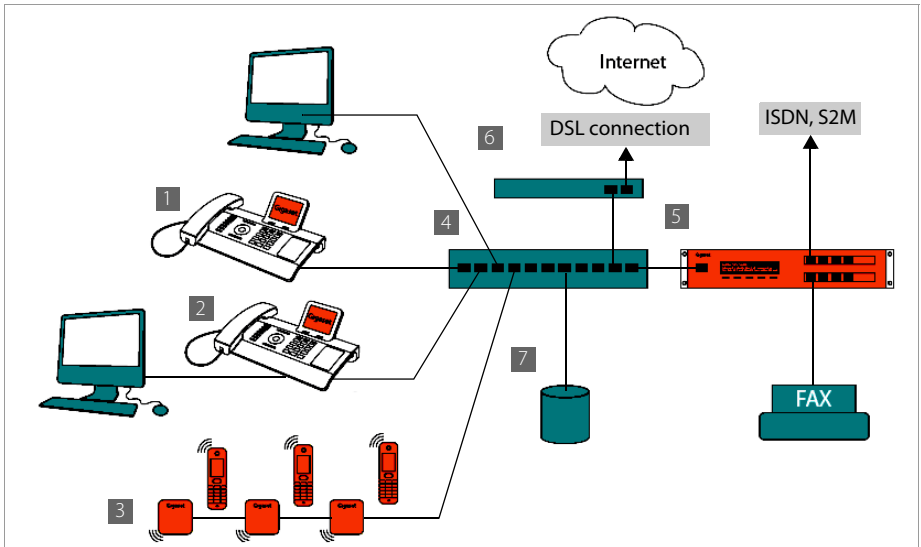

- 1 Gigaset IP telephone
- 2 Gigaset IP telephone with integrated gigabit switch (Gigaset DE700 IP PRO). Your PC is connected directly to the phone, providing you with an additional LAN connection in your network.
- 3 DECT base for connection to DECT handsets
- 4 Ethernet switch  
Supports Quality of Service (QoS), Gigabit Ethernet and PoE (Power over Ethernet).
- 5 Phone system (e.g., Gigaset T500 PRO)  
Forms Internet telephony, ISDN or S2M connections. Analogue devices can be connected. A network connection is established using Ethernet.
- 6 Acts as a gateway to the Internet for the connected devices. Routes VoIP calls from the phone system to the Internet.

## Using the phone in different scenarios

- File, e-mail and workgroup servers, or NAS systems, can be wirelessly integrated into the phone system architecture. As a result:
  - Invitations to conference calls can be organised via the phone system
  - The phone system can be backed up to a server or the system can be started via the network
  - Online directories (LDAP) can be managed centrally

## Using your phone in a simplified environment without a phone system

You can also use your Gigaset DE700 IP PRO without a phone system.

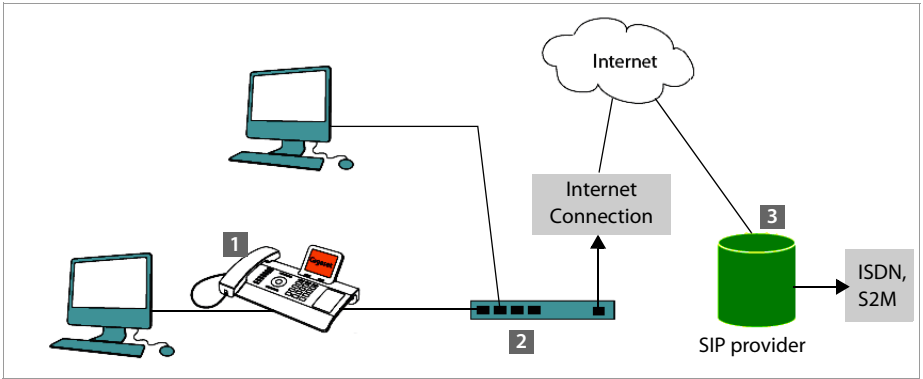

- Gigaset IP telephone with integrated gigabit switch (Gigaset DE700 IP PRO). Your PC is connected directly to the phone, providing you with an additional LAN connection in your network.
- Acts as a gateway to the Internet for the connected devices. Routes VoIP calls from the phone to the Internet.
- The SIP provider transfers calls from the Internet and establishes a connection with the standard telephone network.

In this scenario, you must **manually configure** the VoIP accounts for your phone. You can create up to 12 VoIP accounts on your phone.

# First steps

---

## Check the package contents



Telephone: Gigaset DE700 IP PRO



Receiver with cable for connection to the phone



Ethernet cable for connection to the local network (switch/router/gateway)

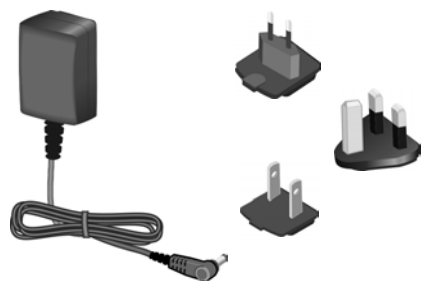

Power adapter for connecting the phone to the mains power supply (if required) with three different plug-in modules (Europe, Great Britain, USA)

The device is powered by PoE (Power over Ethernet) if it is connected to a switch with PoE-functionality ( → [page 15](#)).



CD containing Gigaset QuickSync™ PC software and this user guide

Insert strips for labelling the function keys (with protective film)

---

### Firmware update

Whenever there are new or improved functions for your Gigaset, firmware updates are made available for you to download to your phone (**page 168**). If this results in operational changes to your phone, a new version of this user guide or the necessary amendments are published on the Internet at [www.gigaset.com/pro](http://www.gigaset.com/pro).

Select the product to open the relevant product page for your telephone, where you will find a link to the user guide.

To find out what version of firmware is currently loaded on your phone, see **page 170**.

---

## Setting up and connecting the device

The phone is designed for use in dry rooms in a temperature range of  $\pm 0^{\circ}\text{C}$  to  $+45^{\circ}\text{C}$ .

- ▶ Set up the phone at a central point where a connection to the local network is available.

---

### Warning

- ◆ Never expose the Gigaset DE700 IP PRO to the following:  
heat sources, direct sunlight or other electrical appliances.
  - ◆ Protect your Gigaset from moisture, dust, corrosive liquids and fumes.
-

## Connecting the receiver

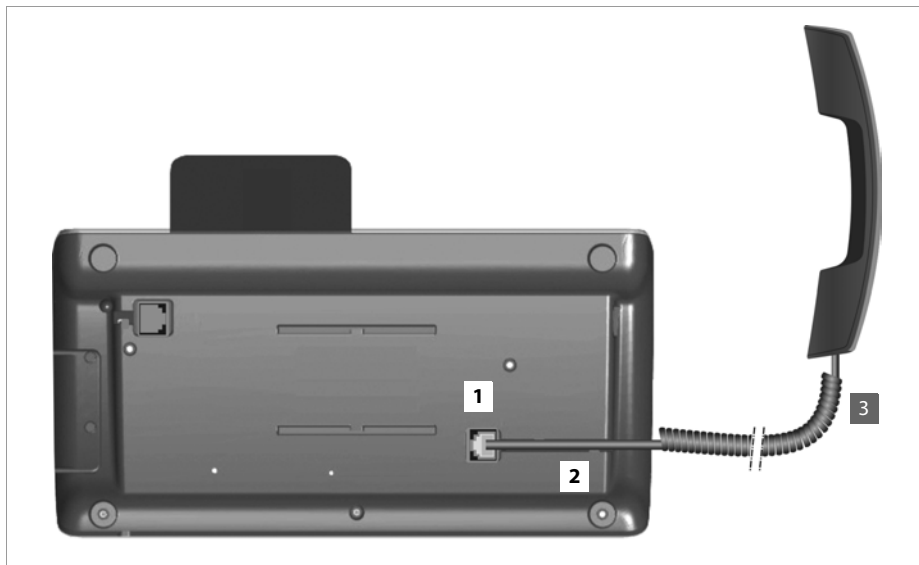

- 1** Insert the connector, which can be found on the longer straight end of the connection cable, into the connection port on the bottom of the phone.
- 2** Place the straight part of the cable in the cable recess provided.
- 3** Insert the other jack on the connection cable into the port on the receiver.

### Connecting the network cable

To make calls via VoIP, your phone must have Internet access. This connection is established in the local network via a gateway.

You connect your phone to the same local network as the gateway. See the **Using the phone in different scenarios** section on **page 9** for an overview of the different options.

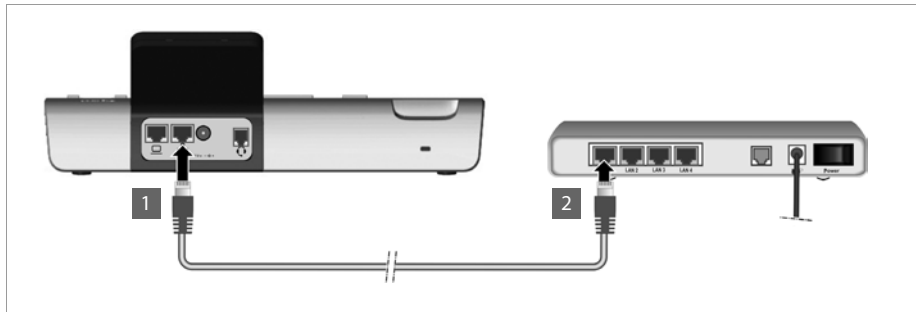

- 1 Attach one end of the Ethernet cable supplied to the right-hand LAN port on the rear of the phone.
- 2 Attach the other end of the Ethernet cable to a LAN port on your network Ethernet switch or on the router itself.



#### Warning

If you connect your Gigaset DE700 IP PRO to a PoE-capable Ethernet switch (PoE class IEEE802.3af), it will be supplied with power via PoE (Power over Ethernet). The PoE network must not exceed the premises boundaries.

## Connecting the PC

You must connect your Gigaset DE700 IP PRO to a PC to use the Web user interface or to configure the phone using the Web configurator.

Your phone has an integrated two-port switch. This allows you to connect your PC to the local network via the phone and avoid using additional connection ports on the switch or router.

You need an additional Ethernet cable to connect a PC.

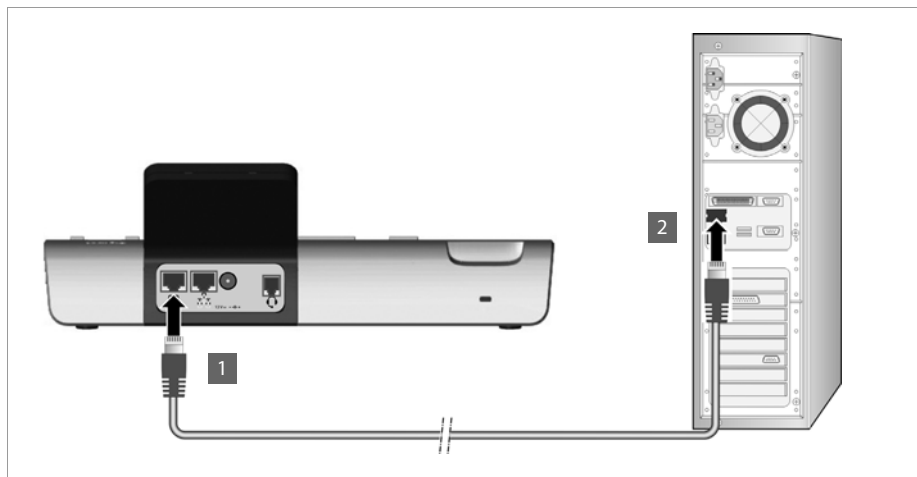

**1** Connect an Ethernet cable to the left-hand LAN port on the rear of the phone.

**2** Connect the other end of the Ethernet cable to a LAN port on the PC.



## Connecting a device to the mains power supply (if required)

Your Gigaset DE700 IP PRO is supplied with sufficient power by PoE (Power over Ethernet) and does not need to be connected to the mains power supply. **Prerequisite:** The device is connected to an Ethernet switch with PoE functionality (PoE class IEEE802.3af) ( → [page 14](#)).

The power adapter is supplied with three different plug-in modules for Europe, Great Britain and the USA. First attach the appropriate plug-in module to the power supply unit.

## First steps

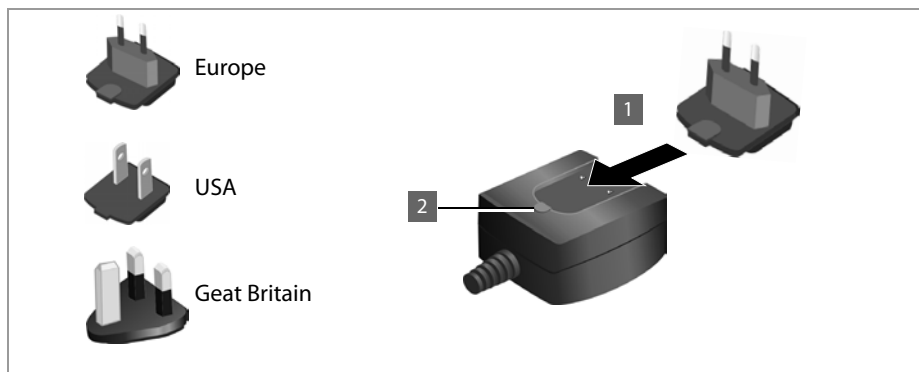

- 1 Slide the required plug-in module into the recess on the underside of the power supply unit until it clicks into place.
- 2 To remove the plug-in module again, press on the button marked **Push** and pull the plug-in module out of the power supply unit.

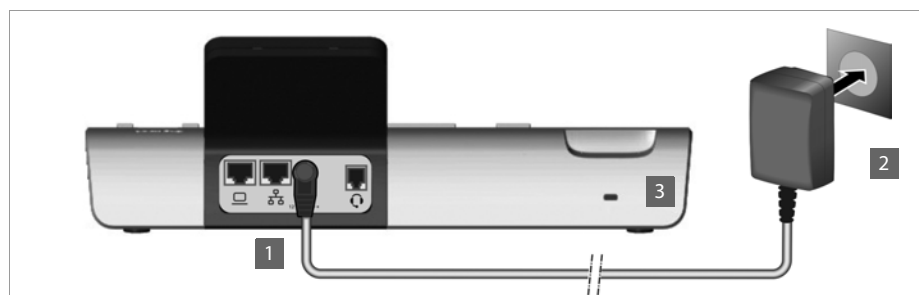

- 1 Connect the power adapter to the port on the rear of the phone.
- 2 Then insert the plug into the mains socket.

12V  $\equiv$  - G +

### Warning

Use only the power adapter **supplied**.

### Please note

You can safeguard your device against theft by fitting a Kensington lock. The corresponding hole can be found on the rear of the device (3).



## Connecting extension modules (optional)

You can increase the number of programmable keys using extension modules (max. three; can be ordered as accessories → [page 185](#)). Each module includes 14 additional programmable keys. The function keys can be programmed using the Web configurator (→ [page 154](#)).



Extension module

The package contains:

- ◆ One extension module
- ◆ One connection frame with four fastening screws
- ◆ One connection cable
- ◆ Insert strips

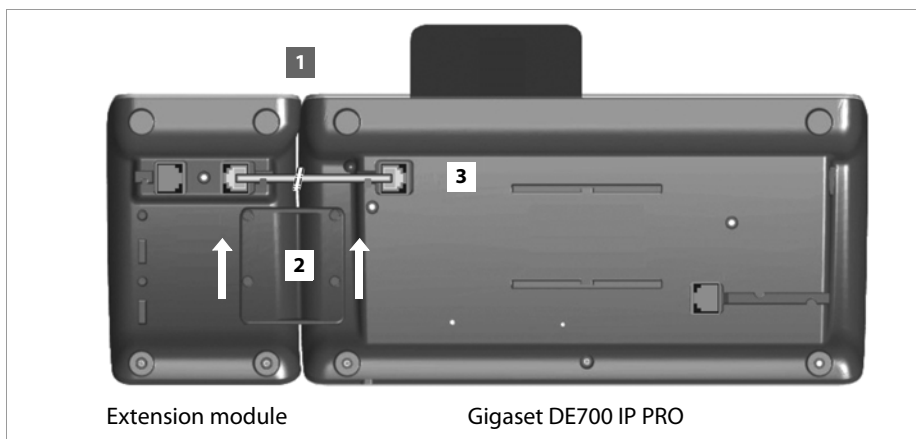

Extension module

Gigaset DE700 IP PRO

- 1** Position the extension module to the right of the phone (on left when viewed from below), so that the module and phone are the same height and meet in the centre.
- 2** Insert the clasps on the connection frame into the respective notches on the phone and module and push the connection frame upwards until it clicks into place. Secure the connection frame with the screws provided.
- 3** Establish the connections using the cable supplied.

### Setting up the device (for the first time)

Your device will start **automatically** as soon as it is connected to the mains power supply. Please be aware that the device is powered by PoE (Power over Ethernet). This means that it is supplied with power as soon as it is connected to an Ethernet switch with PoE-functionality. The first time you use the device, an installation wizard will start automatically and guide you through the necessary installation steps.

### Configuring language and time zone settings



- ▶ Use the navigation key to select the required language. To do this, press up or down on the navigation key (⤿). Further information about the navigation key can be found on → [page 24](#).
- ▶ Press the display key under **OK** to confirm your selection. You can also use the OK function on the navigation key (by pressing ✓ in the centre of the key).

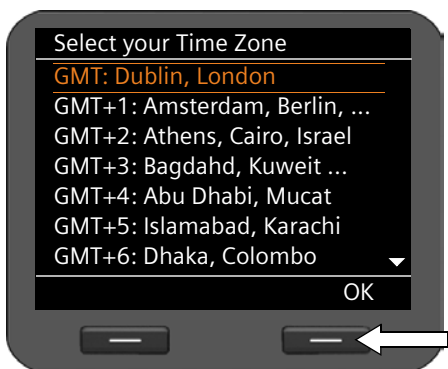

- ▶ Use the navigation key to select the required time zone.
- ▶ Press the display key under **OK** to confirm your selection.

When you have made your selection, press the end key (⏪) to return to the last entry screen. You can correct your selection if necessary.

---

#### Please note

The date and time are automatically set by a time server. You can select a time server using the Web configurator or deactivate this function (→ [page 158](#)).

---

## Establishing a connection to the local network

Your phone must be connected to the local network before it can connect to the Internet and before you can operate it from a PC.

The device checks to see if a network connection already exists. The network connection is automatically established if the phone has automatically been assigned an IP address from a DHCP server in the network. If this is the case, the following screen will not appear and you can skip to → [page 20](#).

### Please note

The following network configuration is the default setting on your device: LAN with IP protocol version 4 (IPv4) and DHCP.

If your phone has no network connection, you will need to configure the network manually. Depending on the type of network, you will need the following information about the configuration:

- ◆ If the network uses IP protocol version 4 (IPv4) with a static IP address, you will need:
  - The device IP address, the network subnet mask, the IP addresses of the standard gateway and DNS server.
- ◆ If the network uses IP protocol version 6 (IPv6):
  - IP addresses automatically: select **IPv6** as **Network Type**. The connection is then established automatically.
  - IP addresses statically: the device IP address, the address prefix length and the DNS server IP address.

If there is still no network connection, you will then be asked whether you wish to configure the connection manually.

- ▶ Select **Yes** if you have the required information.
- ▶ Select **No** if you want to use the display menu to configure the network at a later date (→ [page 93](#)).



If you selected **Yes**, you can configure the network immediately.

Depending on your selection, additional screens may be displayed so you can enter the required information.

More detailed information on LAN configuration can be found on → [page 93](#).

- ▶ Once you have configured the settings, press the display key under **Save**.

Your device is now connected to the local network and can be configured for Internet telephony.

## First steps

# Configuring Internet telephony

Before you can use the Internet to phone anyone over the Internet, the fixed line network or the mobile phone network, you need the services of a VoIP provider.

### Prerequisite:

- You have a phone system in your network that provides VoIP accounts for your device, or
- You have registered with a VoIP provider (e.g., via your PC) and set up a VoIP account.

The device searches the network for a provisioning file and checks whether VoIP accounts already exist. If the telephone has existing VoIP accounts, these accounts are configured automatically. You can now make calls with your phone via the Internet.

If the telephone has no existing VoIP accounts, you must configure them manually. The Web configurator's installation wizard will help you with this ( → [page 108](#)).

## Proceeding

Now you have successfully set up your phone, you can adapt it to your personal requirements. Use the following guide to quickly locate the most important topics.

If you are unfamiliar with menu-driven devices such as other Gigaset telephones, you should first read the section entitled **Using the phone** on **page 22**.

---

**Operating the phone via the keypad and display menu** → **page 22**

---

**Making calls** → **page 31**

---

**Setting up and using directories** → **page 50**

---

**Displaying Internet services** → **page 72**

---

**Setting ringers** → **page 81**

---

**Setting the idle display and screensavers** → **page 84**

---

**Connecting a headset** → **page 99**

---

**Loading your own pictures and sounds** → **page 100**

---

**Setting up VoIP accounts** → **page 108**

---

If you have any questions about using your phone, please read the tips on troubleshooting (**page 172**) or contact our Customer Care team (**page 172**).

## Using the phone

You have a **range of options** for operating and configuring your Gigaset DE700 IP PRO in a way that is convenient for you. For example, you can initiate a phone call or conference call using the phone's keypad and display menu. You can access your local telephone directory via the phone's display menu or the Web user interface. You can change your configuration settings using the display menu or the Web configurator.

If your phone is connected to a Gigaset T300 PRO or Gigaset T300 PRO phone system, you can also use the capabilities of the phone system, such as Call Manager, centrally-stored call lists, conference scheduling and function key assignment.

## Operating via the keypad and display menu

### Display and display keys

The display gives you quick access to all the functions on your phone, particularly the menu functions.

In idle status, icons on the display indicate the status of your phone (→ [page 4](#)). Alternatively, you can select the information you wish to display, e.g., time, calendar or pictures (→ [page 84](#)).

Use the display keys to activate the phone's functions and to navigate through the menu. Different functions are available depending on the operating situation. These functions are displayed at the bottom of the screen.

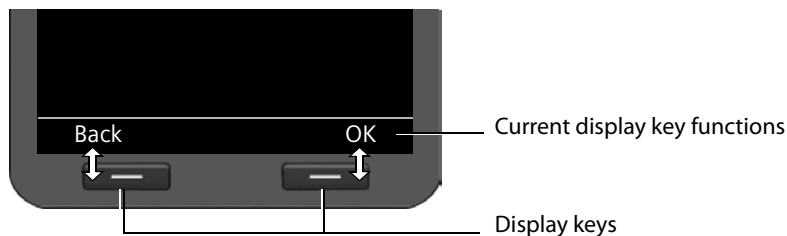

Some important display keys:



- Options** Open a menu for further functions.
- OK** Confirm selection.
- < C** Delete key: Delete one character at a time from right to left.
- Back** Skip back one menu level or cancel the operation.
- Save** Save entry.
- □** Copy the displayed entry to the directory.

## Writing and editing text

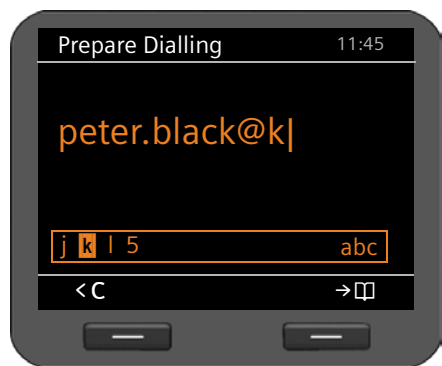
A text editor is provided for entering text via the keypad.



 Enter the text.

Each key between  and  is assigned several letters and digits. Press the relevant key a certain number of times to enter a particular character.

For example k = 2 x the  key.

The characters available are shown in the editor field. The highlighted character is inserted to the left of the cursor.

### Deleting/correcting characters

 Press the display key. The **character** to the left of the cursor is deleted. Press and **hold** to delete the **word** to the left of the cursor.

### Entry mode



A range of entry modes are available depending on the operating situation. The current mode is displayed on the right-hand side of the editor field.

- Abc Letters, first letter upper case, others lower case, e.g., for entering names.
- abc Lower case only, e.g., for entering e-mail addresses.
- 123 Digits only for entering numbers.

### Switching entry mode

 Press the hash key. The text entry mode will change.

### Moving the cursor

-  Press the navigation key **briefly**: moves the cursor **one character at a time**.  
Press and **hold** the navigation key: moves the cursor **word by word**.
-  Press the navigation key: moves the cursor **line by line**. The cursor stays in a horizontal position.

## Using the phone

### Entering special characters

 Press the star key. The table of special characters is displayed.



Insert

Select the required character.

Press the display key. The selected character is inserted at the cursor position.

### Navigation key



The navigation key enables you to access important telephone functions quickly. You can use it to scroll through lists and directories with ease.

### In idle status



Open redial list



Open main menu

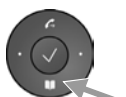

Open directory

### In menus and lists



Depending on the operating situation:

**OK**, **Yes**, **Save**, **Select** or **Change**.

Copy a number that has been entered or is shown in the display into the directory.



Press **briefly**:

Navigate to the line above/below.

Press and **hold**:

Scroll up/down the list one line at a time.



"Rotate" left or right (key is touch sensitive):

Quickly scroll through the list. Clockwise to scroll down. Anti-clockwise to scroll up.



## In input fields



Move the cursor up/down  
line by line



Press **briefly**:  
Move the cursor to the left/right **one character at a time**.

Press and **hold**:  
Move the cursor to the left/right quickly.

## Understanding the navigation key

The following illustrations demonstrate how to use the navigation key:

✓ Press the centre of the navigation key.

⬇️ ⬆️ ⬅️ ➡️ Press down/up/left/right on the navigation key.

🔄 Rotate the navigation key to scroll quickly up/down a list.

## Using the menus

Your telephone's functions are accessed using a menu that has a number of levels.

### Opening the main menu

▶ When the phone is in idle status, press the centre of the navigation key ✓.

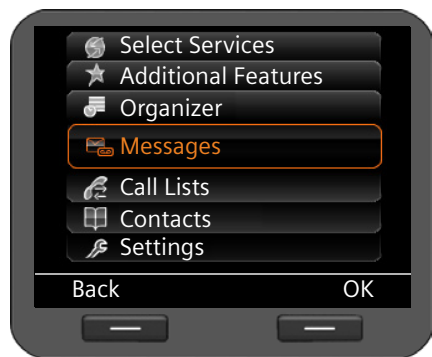

The display menu functions are shown as a list with the respective icons.

An orange box identifies the selected function.

### Accessing a function or opening the corresponding submenu

▶ Navigate to the required entry using the navigation key ⬇️ and press the **OK** display key or the ✓ navigation key.

### Back to the previous level

▶ Press the **Back** display key or **briefly** press the end key ⬅️.

The current operation is cancelled and you will return to the previous menu level.

You can revert to idle status from the main menu.

## Using the phone

### Reverting to idle status

You can revert to idle status from anywhere in the display menu as follows:

- ▶ Press and **hold** the end key .

Or:

- ▶ Do not press any key: After 3 minutes the display will **automatically** revert to idle status.

Settings that have not been saved by selecting the display keys **OK**, **Yes**, **Save** or **Change** or the navigation key  are lost.

### Scrolling through lists

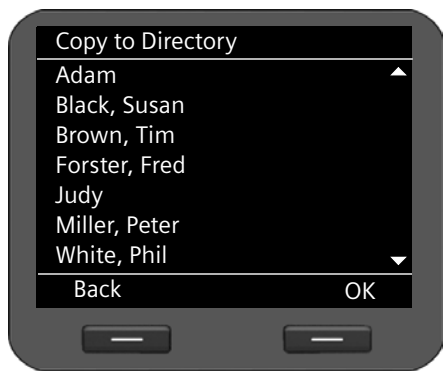

If it is not possible to view all of the functions/ list entries at the same time (list is too long), arrows appear on the right-hand side. The arrows indicate the direction in which you need to scroll to view the rest of the entries in the list.

## Understanding the operating steps

The operating steps used to navigate through the display menu are shown in abbreviated form.

### For example, setting the ringer volume

✓ → Settings → Audio Settings → Ringer Settings → Volume

means:

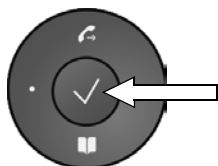

- ▶ Press the centre of the navigation key to open the main menu.

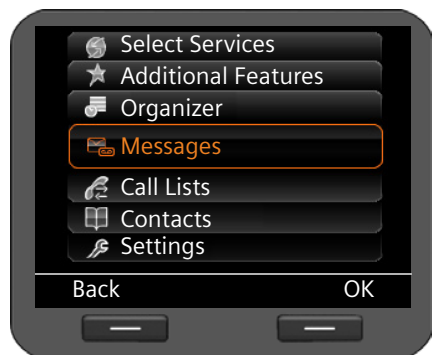

- ▶ Navigate up/down using the navigation key (a circular key with a vertical line) until the **Settings** submenu is selected.

- ▶ Press the display key **OK** to confirm your selection.

## Using the phone

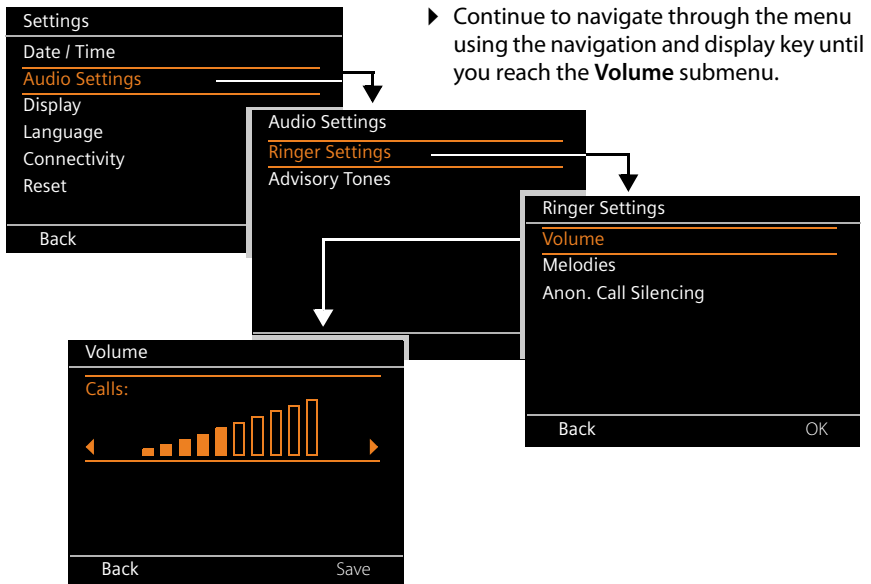

## Menu tree

The following menu tree shows all the components of the display menu.

Select Services	Next Call anonymous	→ page 38
	All Calls anonymous	→ page 38
	Call Divert	→ page 43
	Call Waiting	→ page 39
	Active Ringbacks	→ page 34
Additional Features	Internet Radio	→ page 74
	Resource Directory	Screensavers → page 101
		Caller Pictures → page 102
		Sounds → page 103
		Capacity → page 104
Organizer	Calendar	→ page 68
	Alarm Clock	→ page 70
	Missed Alarms	→ page 69
Messages	Voice Mail	→ page 61
	Call Records	→ page 63
	E-mail	→ page 64
Call Lists	All Calls	→ page 46
	Outgoing Calls	→ page 46
	Accepted Calls	→ page 46
	Missed Calls	→ page 46
Contacts	Directory	→ page 50
	LDAP Directory	→ page 56
	Online directories	→ page 57
Settings	→ continues on the next page	

You can choose any name

The name of these menu entries depends on Web configurator settings  
→ page 150.

## Using the phone

Settings	Info	→ page 80
	Date / Time	→ page 80
	Audio Settings	
	Ringer Settings	
		Volume → page 81
		Melodies → page 82
		Anon. Call Silencing → page 83
	Advisory Tones	→ page 84
	Display	
	Idle Display	→ page 84
	Screensaver	→ page 89
	Backlight	→ page 91
	Language	→ page 92
	Connectivity	
	Local Network	→ page 94
	Reset	→ page 92

# Making calls

## Calling

You make your calls using the default account if you do not make another selection. The first account that is created is used as the default account. You can change this using the Web configurator (→ [page 132](#)).

### Selecting VoIP account



If there are several VoIP accounts available on your device, you can select the account you wish to use for the call.

- Select Line** Press the display key.
-  Select the required account.
- OK** Press the display key to confirm the selection.

## Entering a number using the keypad

You make a call using the phone's receiver, speaker kit or a connected headset (→ [page 99](#)).



Enter the phone number.



Lift the receiver.

Or



Lift the receiver.



Enter the phone number.

**Dial**

Press the display key.

The number is dialled.

The duration of the call is shown while the call is in progress.



**Instead of putting the receiver to your ear:**



Press the speaker key to make a call via the speaker.



Press the headset key to make a call via the headset.

You can also switch at any time during the call. Throughout the whole of this section, the  icon can always represent either  or .

## Making calls

### When entering the phone number:

- < C Press the display key to delete incorrectly entered figures to the left of the cursor.
- □ Press the display key to copy entered phone numbers to the local directory (→ [page 50](#)).
- ← Press the end key to cancel dialling.

## Dialling a number from the directory

You can save up to 500 entries (vCards) in the local directory. You can create directory entries and manage them quickly and easily using the Web user interface (→ [page 163](#)) or the phone's display menu (→ [page 50](#)).





To dial a number proceed as follows:

-  Open the directory using the navigation key .

Or use the display menu

- ✓ → **Contacts** → **Directory**



-  Scroll through the list to the required name. Press  to show the details for the entry.
-  Lift the receiver. The number is dialled.
-  If more than one number is assigned to the entry, select the required number. If you do not select a number, the default phone number will be dialled after a brief period.



## Dialling a number using a function key

You can assign phone numbers to up to 14 function keys; you then only need to press a key once to dial the number. You can increase the number of function keys by connecting extension modules. Use the Web configurator to assign numbers to the function keys (→ [page 154](#)).



Press the function key.

The number assigned to the function key is dialled.

## Shared line

The Gigaset DE700 IP PRO allows one VoIP account to be used jointly by multiple phones. The phone number for the shared account is assigned to a function key.

### Prerequisites:

- ◆ Your phone system supports this function. All users who share a VoIP account are merged into one group on the phone system.
- ◆ The VoIP account for the shared line is assigned to a function key (→ [page 154](#)).

If you make a call via the function key on a "split line", the corresponding function keys light up on all the extensions in this group. The users of these extensions cannot use the "split line" until it is back in idle status or the call is put on hold or ended.

## Dialling a number from the call lists

The following calls are saved:

- ◆ Outgoing calls (redial list)
- ◆ Accepted calls
- ◆ Missed calls

The last 30 numbers are stored in each of the call lists. The name will appear on the display if you have saved the number in the directory.



You can browse through the entries and dial directly from within the record.

If there are new entries in the missed calls list, the Message Centre key  **flashes**.

To save numbers from a list in the directory, see (→ [page 46](#)).

## Viewing call lists and dialling numbers

Open the required call list:

 Open the redial list using the navigation key .

 Open the list of missed messages in the Message Centre.

Or use the display menu

✓ → Call Lists → All Calls

✓ → Call Lists → Outgoing Calls

✓ → Call Lists → Missed Calls

✓ → Call Lists → Accepted Calls

## Making calls

The last (most recent) call or dialled phone number is shown on the display.

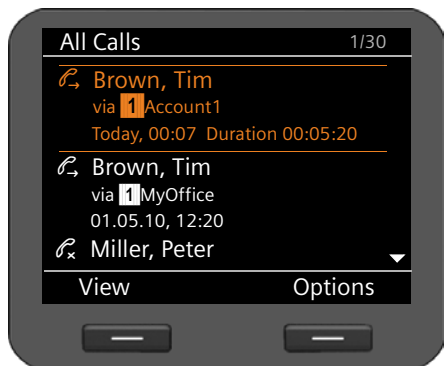

Select another entry if necessary.



Lift the receiver.

The number is dialled.

---

### Please note

You can also access the call lists using the Web user interface ( → [page 165](#)).

---

## Initiating ringback

You can initiate a ringback if the number you have called is busy. **Prerequisite:** This function is supported by your phone system or your provider.

**Ringback** Press the display key to initiate a ringback.

Ringback is initiated as soon as the line is free again.

## Deactivating ringback

You can deactivate the ringback for all of the VoIP accounts configured on your phone or just for certain VoIP accounts.

✓ → **Select Services** → **Active Ringbacks**

Accounts for which ringback is permitted are marked with a tick.



Select the required entry.

**Change**

Press the display key to remove a tick and to deactivate the ringback.

## Receiving incoming calls

You hear the ringer and the speaker key  flashes.

If the function key has been assigned a „shared line“ (→ [page 33](#)), an incoming call is indicated on all extensions by the flashing of the corresponding function keys. The call can be answered on any extension by pressing the function key.

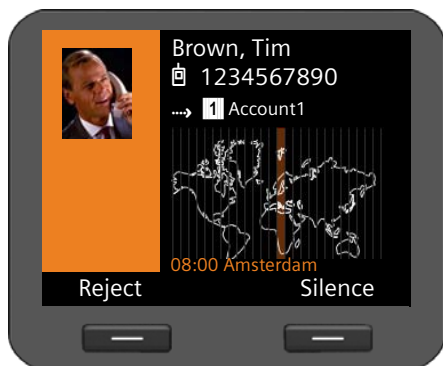

The display shows the caller's number (where calling line identification is permitted → [page 38](#)) and their name, if they are saved in the directory. If a picture is assigned to the caller, this will also appear.

The account that the call is received on is also shown.

 Lift the receiver. You can speak to the caller.

---

### Please note

When you receive a call, the phone first of all searches for a corresponding entry in the local directory. If the number doesn't appear there, the other directories are searched (if configured) (→ [page 150](#)).

---

### Deactivating the ringer

**Silence**

Press the display key to deactivate the ringer. You can then decide whether to accept or reject the call.

### Rejecting a call

**Reject**

Press the display key or the end key  to reject the call.

## Ending a call



Put down the receiver or press the end key .

## Using functions when making a telephone call

### Display when establishing a connection or during a call

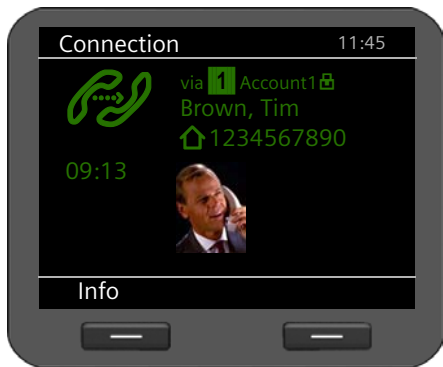

The display shows

- ◆ The VoIP account you are using to make the call. The  icon next to the account description indicates that it is an encrypted connection.
- ◆ The caller's number (where calling line identification is permitted → [page 38](#)) and their name, if they are saved in the directory. If a picture is assigned to the caller, this will also appear.



Connection icon. This indicates the status of the connection.



Establishing a connection



Connection interrupted



Connection established



Conference call

HDSP in the screen picture indicates a connection with the highest voice quality.

09:13 The duration of the call is displayed under the screen picture.

**Info** Press the display key to view technical information about the phone. This function is helpful when calling the Service Hotline, for example.

### Adjusting the volume

You can adjust the volume of the receiver, speaker kit or headset during a call. You can adjust the volume of the ringer while the phone is ringing.



To decrease the volume press the left side of the key and to increase the volume press the right side of the key. Each time you press the key, the volume will increase or decrease by one level.



There are ten volume settings available. The current setting is shown on the display.

The last setting is saved when you change the ringer volume.

Use the display menu to permanently configure the ringer melody and volume ( → [page 81](#)).

## Muting

You can deactivate the microphone for the receiver, the speaker kit and the headset. The other party can then no longer hear you.



 Press the mute key during the phone call.

Press the key again to reactivate the microphone.

The  key is lit up while the function is activated.

## Activating/deactivating speaker mode

**Activating via the receiver during a call:**

  Press the speaker key and put down the receiver.

The  key is lit up while the function is activated.

In speaker mode, you hear the caller via the speaker.

**Deactivating speaker mode during a call:**

 Lift the receiver. Continue the call via the receiver.

---

### Please note

You should tell your caller if you have activated the speaker.

---

## Do not disturb

You can activate the Do Not Disturb (DND) function if you do not want to receive any calls and you do not want the phone to ring.

You can still make calls when this function is activated.

 Press the Do Not Disturb key.

Press the same key again to deactivate the function.

The  key is lit up while the function is activated.

---

### Please note

- ◆ You can permanently deactivate the ringer for anonymous calls ( → [page 83](#)).
  - ◆ You can use the Web configurator to create a blacklist of unwanted names and numbers ( → [page 141](#)). Once you activate the blacklist function, calls from these numbers will not be put through.
-

## Making calls

### Two-way recording

You can record your two-way telephone conversations.

 Press the call records key.

Press the key again to end the call record.

The  key is lit up while the function is activated.

The phone memory can store two-way call records of up to 30 minutes. Calls can also be recorded onto a server (→ [page 141](#)).

Go into the display menu to play back and delete two-way call recordings **Messages** → **Call Records** (→ [page 63](#)).

---

#### Please note

- ◆ Conference calls cannot be recorded.
  - ◆ You should tell your caller if you are recording a two-way conversation.
- 

### Anonymous calling – withholding caller ID

You can make anonymous calls (CLIR = Calling Line Identification Restriction). Your phone number will not be displayed when making outgoing calls. You are calling anonymously.

**Prerequisite:** Anonymous calls are only possible via VoIP connections through providers that support the "anonymous calling" function. You may have to ask your VoIP provider to activate this function.

### Making an anonymous call

Select:

✓ → **Select Services** → **Next Call anonymous**

Then proceed as normal:



Enter the phone number.



Lift the receiver.

The number is dialled. Your number is not transferred.

### Activating/deactivating "anonymous calling" for all calls

You can permanently activate/deactivate the anonymous call function for all of the VoIP accounts configured on your phone or just for certain accounts.

✓ → **Select Services** → **All Calls anonymous**

Accounts for which anonymous calling is permitted are marked with a tick.



Select the required entry.

**Change** Press the display key to tick the box.

Press the display key again to remove the tick.

## Making a call to multiple participants

### Initiating a consultation call

During a call, you want to consult a second participant.

 Press the consultation call key during the call.

The call is placed on hold. You can make another call to a second participant. Once the call has ended, press the consultation key again. You are reconnected to the first participant.

### Accepting/rejecting call waiting

You hear the call waiting tone during a phone call.





The display shows the caller's number (where calling line identification is permitted → [page 38](#)) and their name, if they are saved in the directory.

The display also shows the subscriber number used to receive the call and indicates whether this is a ringback.

#### Accepting a call:

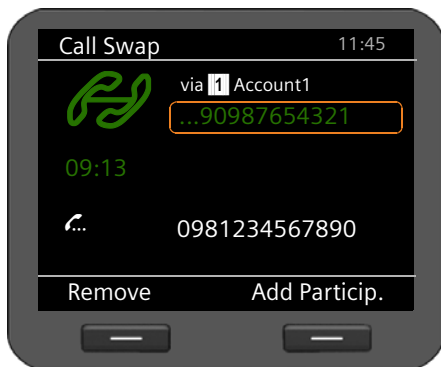
**Accept** Press the display key to accept the call.



You are connected to the waiting participant. The first participant hears music on hold. The number is displayed and the  icon identifies it as the waiting participant.

 Select the connection.

**Remove** Press the display key to end the selected connection.

#### Rejecting a call:

**Reject** Press the display key to reject the waiting call.

## Making calls

### Activating/deactivating call waiting

You can deactivate call waiting during a call for all of the accounts configured on your phone or just for certain accounts.

✓ → **Select Services** → **Call Waiting**

Accounts for which call waiting is permitted are marked with a tick. Callers via other accounts hear the busy tone.



Select the required entry.

**Change**

Press the display key to tick the box.

Press the display key again to remove the tick.

### Call swapping

You are speaking to one participant and a second is on hold; this may be because you have accepted a waiting call or have placed one caller on hold.



Press the consultation call key to swap from one caller to the other.

### Initiating a consultation call with a third participant:

**Add Particip.**

Press the display key. Both participants are placed on hold.



Enter the phone number for the third participant.

**Dial**

Press the display key. The number is dialed.

To speak to one of the participants on hold again after you have finished the ringback:



Select the relevant participant.



Press the ringback key.



## Initiating a conference

You are speaking to one participant while another is on hold.



Select the participant who is on hold.



Press the conference key to add the waiting participant to a conference.

Or

You are speaking to one or more participants and you wish to add an additional participant.



Press the conference key.



Enter the phone number for the additional participant.



Press the display key. The number is dialled.

As soon as the participant answers, they are automatically connected to the conference call.

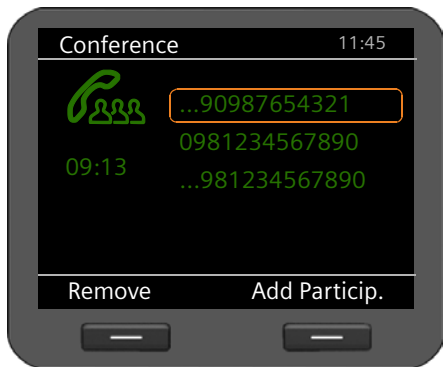

All the participants in the conference are listed on the display.

**Removing a participant from the conference call:**



Select the participant.



Press the display key to end the conference for the highlighted participant.

**Add Particip.**

Press the display key to begin a consultation call with another participant. In contrast to conference key . The conference participants are put on hold.

## Making calls

### Transferring a call to another number

You are speaking to one participant and you want to transfer the call to a third participant.

#### Transfer without consultation:



Press the transfer key. The call is placed on hold.



Enter the phone number for the participant to whom you want to transfer the call.



Press the transfer key again. The call is transferred to the number you have dialled. Your connection to the participant is ended.

#### Transfer with consultation:

Use this function to ensure that the connection is actually established.



Press the transfer key. The call is placed on hold.



Enter the phone number for the participant to whom you want to transfer the call.



Press the display key. The number is dialled.

You can now hang up or press the transfer key  to forward the call.

When you call the third participant you can also wait for them to answer and speak to them, for instance to tell them you are forwarding a call. Then press the transfer key .

#### Transfer to participants on hold:

You are speaking to one participant and there are others on hold. You can transfer the current call to one of the participants on hold.



Select one of the participants on hold.



Press the transfer key. The chosen participant is connected to the person you are currently speaking to.

## Setting up call divert (CD)

When diverting a call, the call is forwarded to another connection. You can set up call divert differently for each connection (i.e. for each configured VoIP account).

**Prerequisite:** Your VoIP provider supports call divert or the service is provided by a phone system.

### Call divert using the provider's network services

✓ → Select Services → Call Divert

The list contains the accounts configured on your telephone.

 Select the desired account.

**OK** Press the display key to confirm the selection.

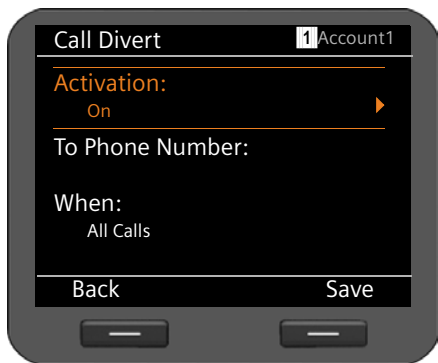

 Switch **Activation** on/off.

 Select **To Phone Number**.

 Enter the phone number to which the call should be diverted.

 Select **When**.

 Select when call divert should apply:

**All Calls** All calls are diverted.

**No Answer** Calls are diverted if no one accepts the call within several rings.

**When Busy** Calls are diverted if your line is busy.

**Save** Press the display key to save the settings for this account.

---

### Note

Please also refer to:

- ◆ Setting up call divert via the Web configurator ( → [page 138](#)).
  - ◆ Programming call divert to function keys ( → [page 156](#)).
-

## Making calls

### Call divert using the phone system

If your Gigaset DE700 IP PRO is connected to a Gigaset phone system, call divert is saved to the phone system and not the phone. You can set up call divert for each number assigned to your phone.

✓ → **Select Services** → **Call Divert**

The list contains the accounts configured on your telephone.

⊙ Select the desired account.

**OK** Press the display key to confirm the selection.

If there are multiple numbers assigned to the account on the phone system, these are displayed.

⊙ Select the number for which you wish to set up a divert.

**OK** Press the display key to confirm the selection.

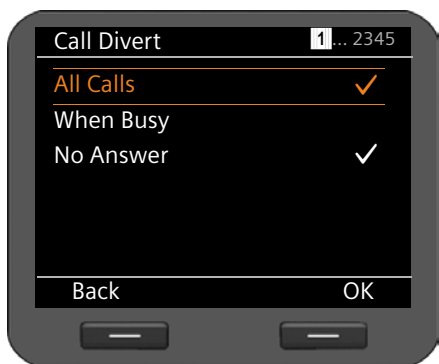

The account and number selected are shown in the top right of the display. Active call diverts are marked with a ✓.

▶ Select the call divert you wish to edit.

**All Calls**

All calls are diverted.

**When Busy**

Calls are diverted if your line is busy.

**No Answer**

Calls are diverted if no one accepts the call within several rings. The also applies to calls in call waiting that are not accepted.

**OK**

Press the display key to edit the call divert.

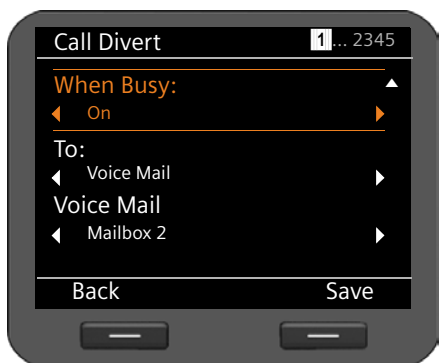

Switch call divert on/off.



Select **To**.

You can divert calls to an answering machine or phone number.



Select **Voice Mail** or **Number**.



Enter the number of the voice mail service or phone number to which the call should be diverted.

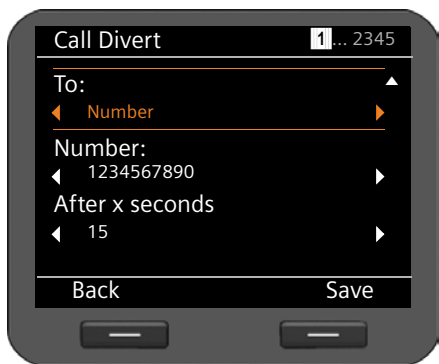

For a call divert of the type **No Answer**, select a length of time after which the call should be diverted.



Select the desired length of time.

You can choose from values ranging from 5 to 120 seconds.

**Save**

Press the display key to save the settings for this account.

## Using the call lists

The following call lists are available:

All Calls	All outgoing, accepted and missed calls.
Outgoing Calls	Last dialled numbers (redial list).
Accepted Calls	Calls that were accepted.
Missed Calls	Calls that were not answered.

If the list contains entries that you have not yet viewed, the display shows the  icon and the number of new entries. You can also access the list via the Message Centre (→ [page 67](#)).

A maximum of 30 entries is saved in the lists. The next entry overwrites the oldest one. You can access all of the lists via the display menu.

### Note

You can also access the call lists using the Web user interface (→ [page 165](#)).

If your telephone is connected to a Gigaset T500 PRO or Gigaset T300 PRO phone system, calls are managed by the phone system rather than locally using the telephone and are transferred to all phones assigned to it.

## Viewing entries

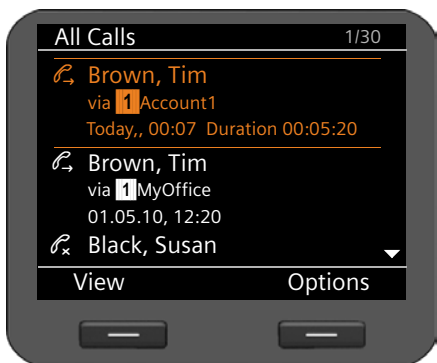

You can open a list when the telephone is in idle status via the display menu.

- ✓ → Call Lists → All Calls
- ✓ → Call Lists → Outgoing Calls
- ✓ → Call Lists → Accepted Calls
- ✓ → Call Lists → Missed Calls



The calls are displayed in chronological order, from the most recent through to the oldest.

The number of the selected entry and the total number of entries in the list (e.g., 1/30) is displayed in the top right corner.

An icon is shown in front of each entry to indicate whether it is an outgoing () , accepted () or missed () call.

**Information on the entry:**

- ◆ Phone number of the caller/called party. If the number is saved in the directory, the name is displayed instead.
- ◆ VoIP account on which the call was made/received.
- ◆ Date and time of the call. Outgoing calls also include the duration of the connection.

The information displayed is determined by the information transferred by the caller and whether or not the caller appears in the directory.

If the caller has activated CLIP (Calling Line Identification Presentation), the caller's phone number is identified. The caller can then be identified by this number if he or she is already saved in the directory. **Prerequisite:** The feature is activated for the VoIP account.

**Displaying detailed information**

**View** Press the display key. The information available is displayed, with the phone number as a minimum.

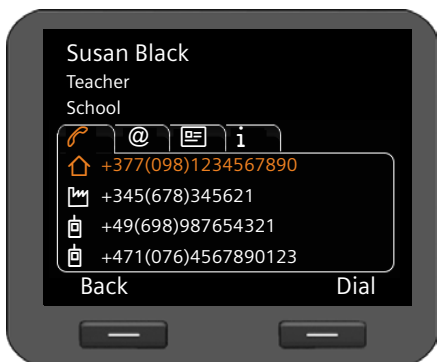

If the number is saved in the directory, the directory entry is displayed ( → [page 50](#)).

**Please note**

When you receive a call, the phone first of all searches for a corresponding entry in the local directory. If the number doesn't appear there, the other directories are searched (if configured) ( → [page 150](#)).

## Dialling a number from a list

You have the following options for dialling a phone number from a list:

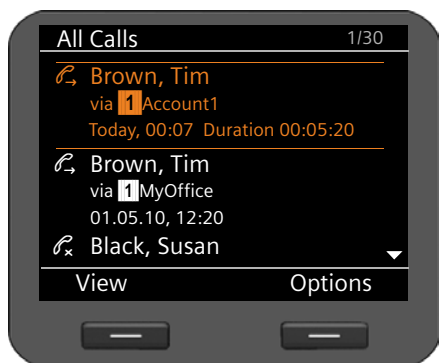



 Scroll through the list to the required name.

 Lift the receiver.

The number is dialled.

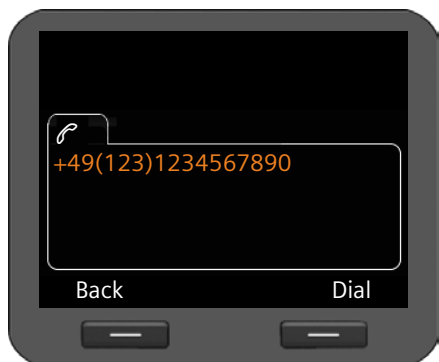
Or



 Scroll through the list to the required name.

**View** Press the display key to show the entry.

 Lift the receiver.

Or

**Dial** Press the display key.

The number is dialled.



## Copying an entry from the call list to the directory.

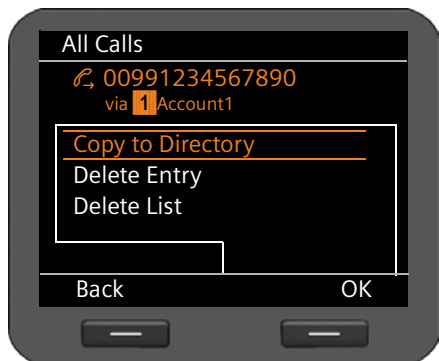

Scroll through the list to the required name.

**Options**

Press the display key.



Select the **Copy to Directory** entry.

**OK**

Press the display key to confirm the action.

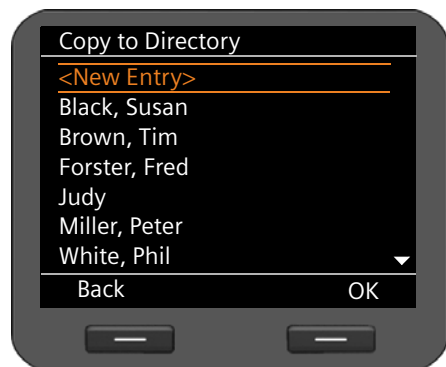

The directory is opened.

You can create a new entry in the directory or edit an existing one.

See directory → [page 52](#).

## Deleting an entry or list

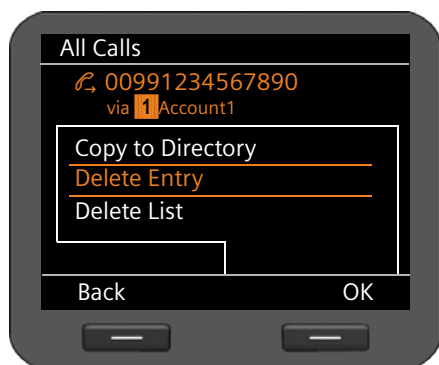

**Options**

Press the display key.



Select the required action:  
**Delete Entry** or **Delete List**

**OK**

Press the display key to confirm the action.

You must confirm the action again.

## Using directories

---

The options are:

- ◆ Local directory
- ◆ LDAP directory → [page 56](#)
- ◆ Personal or public online directory → [page 57](#)

---

### Please note

The default directory is the local directory. This is the directory that you can open with the  key and the directory to which entries are saved using the "Copy to Directory" function.

You can set a different directory as the default directory via the Web configurator (→ [page 155](#)).

---

## Using the local directory

You can save a total of 500 entries in the local directory.

Directory entries are saved in the form of vCards. These are virtual business cards for exchanging contact information (file extension .vcf). You can assign a picture to a directory entry. This must be held in the phone's resource directory (→ [page 102](#)).

You create a personalised directory.

---

### Notes

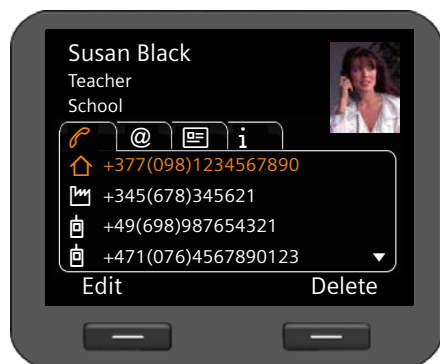

- ◆ You can also access your local directory via the Web user interface (→ [page 163](#)).
  - ◆ You can synchronise your telephone's directory with Outlook. The "**Gigaset Quick-Sync**" program must be installed on your computer in order to do this. The program is provided on the product CD.
-

## Directory entries



A directory entry contains the following information:

- ◆ First name, surname, picture
- ◆ Up to seven phone numbers
- ◆ E-mail address, Web address, fax number
- ◆ Job title/position, company, address
- ◆ Birthday, time zone, further information

An icon in front of a phone number indicates whether it is a home () , office () or mobile number () .

## Opening the directory

Open the directory in idle status with the  key (navigation key )

Or use the display menu

✓ → **Contacts** → **Directory**

## Displaying an entry



Scroll through the list to the required name.

**View**

Press the display key. The entry is shown with all tabs as in the illustration on **page 51**.



Press the arrow to the right of the entry. The entry will be shown as an overview screen.

### Creating a new entry

**Options** Press the display key.

**OK** Press the display key to start the **New Entry** action.

Each directory entry has five tabs.

 Scroll from tab to tab.

 Navigate to the required field or to the tab level.

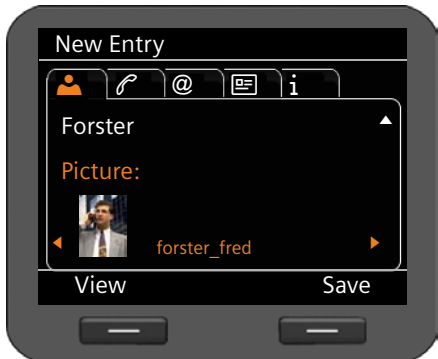
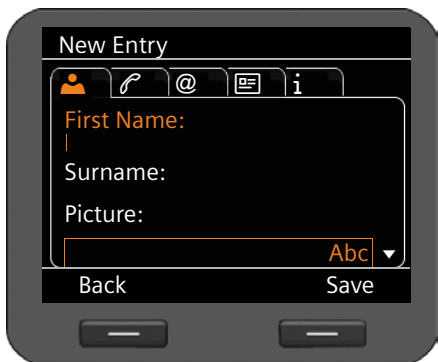

#### Tab 1: Entering the name

 Enter the **Name** and **First Name**.

For information on entering text → [page 23](#).

#### Assigning a picture:

If you wish to assign a personal picture, it must be saved in the phone's resource directory (→ [page 102](#)).

As soon as you select the **Picture** field, the first available picture is shown.



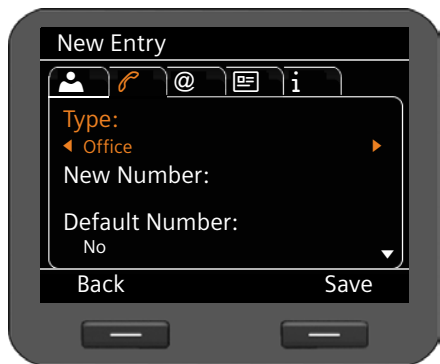

 Scroll through the list.

**View** Show the picture in the display size.



### Tab 2: Entering the phone number

You can enter up to seven phone numbers. One of the phone numbers must be assigned as the default phone number (→ [page 54](#)).

-  Select the **New Number** entry.
-  Confirm the selection.
-  Select the type (**Office/Home/Mobile / URI**),
-  Enter the phone number.
-  Select the **Yes** option in the **Default Number** field if this is to be the default phone number.

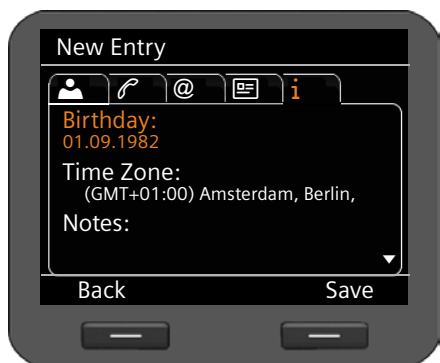

The following information can be saved in the other tabs:

**Tab 3:** E-mail, Web Address, Fax

**Tab 4:** Job Title, Company, Street, City, ZIP, Country

**Tab 5:** Birthday, Time Zone, Notes

If you activate the **Reminder** function, the birthday will be shown as an alarm on the display (→ [page 69](#)).

**Save**

Save the directory entry if you have entered all the data.

## Editing entries

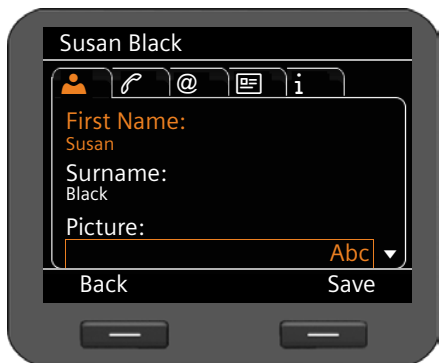

Scroll to the required directory entry.

**Options**

Press the display key



Select **Edit Entry**.

Directory entry fields can be edited. The procedure is the same as for **Creating a new entry**.

## Changing the default number

The default phone number is the first number in the participant's list and is dialled first. You can change the default phone number.

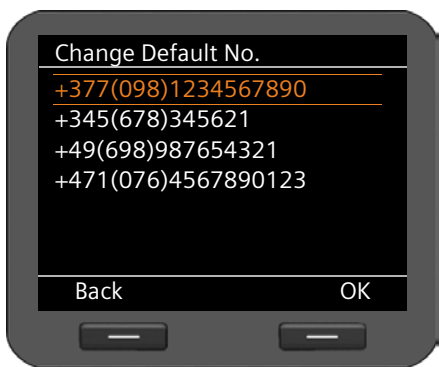

Scroll to the required directory entry.

**Options**

Press the display key



Select **Change Default No.**

**OK**

Confirm the selection.



Select the required number.

**OK**

Confirm the selection.

## Deleting a directory entry or the entire directory

### Deleting a selected entry from the list:

 Scroll to the required entry.

**Options** Press the display key

 Select **Delete Entry**.

**OK** Confirm the selection.

Or

**View** → **Delete** Press the display keys in sequence.

**Yes** Confirm the deletion.

### Deleting the entire list:

**Options** Press the display key

 Select **Delete List**.

**Yes** Confirm the deletion.

## Selecting a number from the directory

 Scroll to the required entry.

 Lift the receiver.

The number is dialled.

If several numbers are saved on the vCard, a list of numbers is displayed once the receiver is lifted. If you do not select a number, the default phone number will be dialled after a brief period (→ [page 54](#)).

## Using directories

### Using an LDAP directory

If your corporate network provides a directory via an LDAP server, you can access this on your phone (LDAP = Lightweight Directory Access Protocol). **Prerequisite:** You have set up this function via the Web configurator (→ [page 151](#)).



You can give the LDAP directory a name in the Web configurator. This will then appear in the display in place of **LDAP Directory**.

#### Opening an LDAP directory

You can open the LDAP directory in idle status via the display menu

✓ → **Contacts** → **LDAP Directory**

Or

 Press and hold (navigation key )

### Searching for and displaying an entry





 Enter the name (or first few letters).

For information on entering text → [page 23](#)

The search will automatically start as soon as you stop inputting characters.

All matching entries are displayed. The search field is displayed again if no matching entries are found. You can start a new search.

 Scroll to the required entry.

 Press the display key.

The entry will be displayed.

### Dialling from the LDAP directory

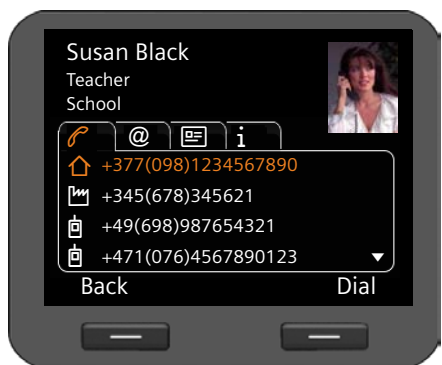

Display the entry.

 Press the display key

Or

 Lift the receiver.

The number is dialled.



## Using online directories

Online directories are available on the Internet. You can:

- ◆ Use public online directories that are available on the Internet, such as KlickTel or the Yellow Pages and
- ◆ Create a personal online directory if your provider permits this.

Select which public online directory you want to use via the Web configurator ( → [page 150](#)).

### ◆ White Pages

a public directory provided on the Internet

### ◆ Yellow Pages

yellow pages provided on the Internet

### ◆ Private NetDirectory

Some providers offer users the option of creating and managing a personal online directory on the Internet.

You can use the personal online directory on your phone.

#### Prerequisite:

- You enter the data for the provider of your personal online directory in the Web configurator ( → [page 150](#))
- You must create and manage your personal online directory using your PC's Web browser.

## Opening a online directory

You can open a online directory in idle status via the display menu

✓ → **Contacts** → **Name of directory**

Select the required public or private online directory. The directory name depends on the settings for the directory in the Web configurator. It can be the name the provider uses for their directory or a name you have chosen yourself.

### Searching for an entry in the online directory

You can search for a phone number or a name. Provided that you haven't entered a search criterion, you can switch between a **Name Search** and a **Number Search**.

#### Searching for a number

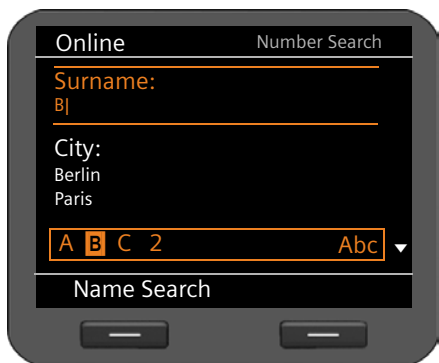

Enter the surname and city of the subscriber you are looking for.

For information on entering text → [page 23](#)

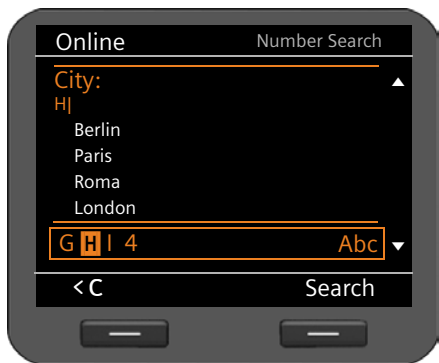

The last five locations for which you have carried out a search are displayed in the **City** field. You can select one of these instead of entering a city via the keypad.



Press the display key to start the search.

If several entries are found for the city, a list is displayed so that you can narrow down the location search.

**Please note:** The **City** field is not available in the private directory.

## Searching for a name



### Name Search

Press the display key.



Enter the number for the entry you are searching for.

### Search

Press the display key to start the search.

A message is displayed if no entry is found. You can then:

**Change** Press the display key to change your search request.

Or

**New Search** Press the display key to start a new search.

## Search results

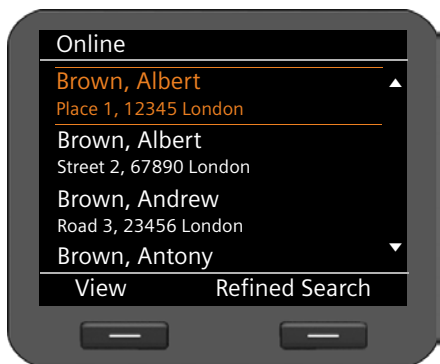

Search results are displayed as a list.

If more than 99 entries are found, a message including the number of results found is displayed. You can then refine the search or request for the entire list to be displayed.

### Refining a search:

**Refined Search** Press the display key.

## Using directories



Specify your search request in the various fields.

**Surname, First name, Category/Name or Street.**

**Search**

Press the display key to restart the search.

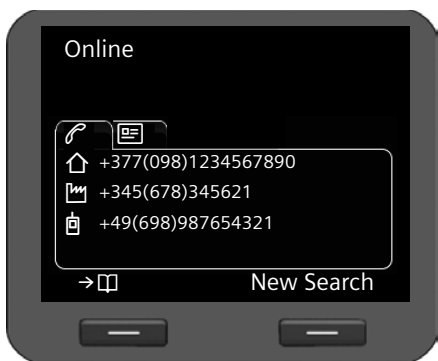

**Displaying entry details:**



Scroll to the required entry.

**View**

Press the display key.

The tabs contain the available phone numbers and address information.



Scroll from tab to tab.

**Dialling a number:**



Select the number.



Lift the receiver.

## Transferring a number to the local directory

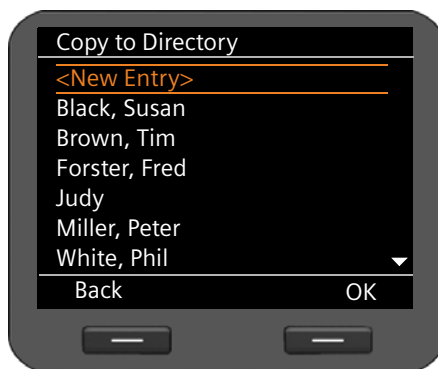

You can transfer entries from a online directory to your local directory.

→ □

Press the display key.

You can create a new entry in the directory or edit an existing one.

See directory → **page 52**.

## Managing messages

You can access the following message types via the display menu:

- ◆ Voice mails on network mailboxes
- ◆ Recorded calls ( → [page 63](#))
- ◆ E-mails ( → [page 64](#))

The Message Centre also allows you to access voice mails, missed calls, e-mails and missed alarms at the press of a key ( → [page 67](#)).

### Voice mails on the network mailbox

You can listen to your messages that have been recorded on a network mailbox. Each network mailbox accepts incoming calls on the corresponding VoIP phone number. Network mailboxes are provided by a Gigaset T500 PRO or Gigaset T300 PRO phone system, for example, or you can use a network mailbox offered by an Internet provider.

**Prerequisite:** Voice mail boxes must be set up for your VoIP accounts on the phone system. You can set up internet provider network mailboxes in the Web configurator ( → [page 142](#)).

If there are new messages on the network mailbox, these are indicated by the **OO** icon. The number of new messages is displayed to the right.

You can also access your network mailbox via the Message Centre ( → [page 67](#)). The  key flashes if a new message has been received on the network mailbox.

### Displaying voice mails

Display recorded messages via the display menu:

✓ → Messages → Voice Mail

Display recorded messages via the Message Centre:

 → Voice Mail

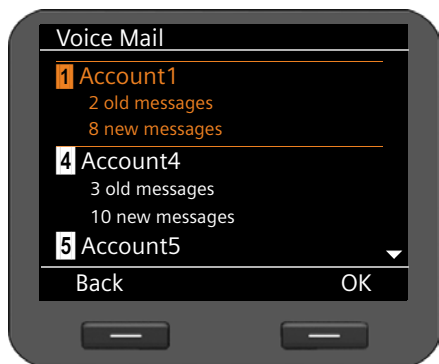

A list of available network mailboxes arranged in order of VoIP accounts is displayed along with the number of new and old messages.

 Scroll through the list to the desired network mailbox.

 Press the display key to connect to the network mailbox.

## Managing messages

Voice mails are displayed in the following categories:

**Inbox:** Newly received voice mails.

**Private:** Voice mails from numbers marked as private in the directory.

**Old:** Messages that have already been played, or which have been moved to the "Old" folder on the Gigaset telephone system.

 Select the desired category and confirm by pressing **OK**.

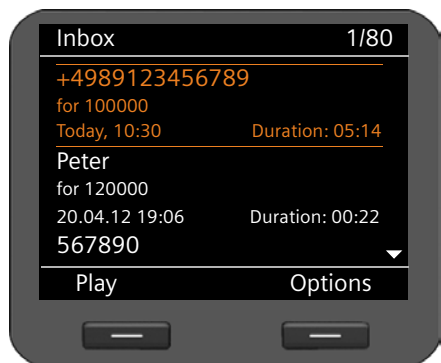



The stored messages are listed in chronological order.

The number of the selected message and the number of entries in the list are shown in the top right corner.

 Select the desired message.

## Playing a message

**Play** Press the display key to listen to the message.

The message is played via the loudspeaker. Alternatively, you can start playback with  or .

Or  
 Lift the receiver to start playback over the receiver.

## Ending playback

**Stop** Press the display key to end playback.  
Alternatively, press the speaker key  or replace the receiver.

 Select another voice mail with the navigation key. Current playback is ended and playback of the newly selected message is started.

---

### Note

An incoming call ends playback.

---

## Call records

You can record a two-way telephone conversation (→ [page 38](#)).

The phone saves two-way call records of up to 30 minutes in MP3 format. If your network has a server, you can also save call records there. You can set this up using the Web configurator (→ [page 141](#)).

## Playing back call records

You can manage recorded conversations via the display menu.

✓ → Messages → Call Records

If more than one VoIP account is configured on your phone, first select the account. The call records for this account are displayed.

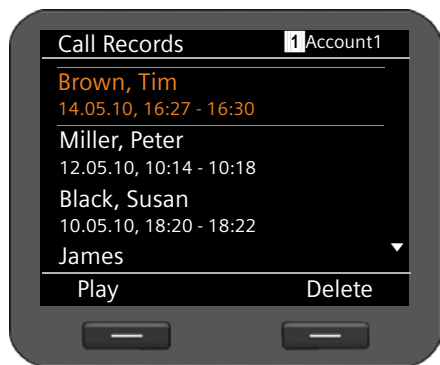

The call records are displayed in chronological order, from the most recent through to the oldest.

The name of the call participant and the date/time of the call record are displayed.

If there are several VoIP accounts, the account is displayed in the top right-hand corner.

### Playing back a call record:



Scroll through the list to the required call record.



Start playback.



The name of the participant will be displayed during playback. The elapsed time and the total duration of the call record are displayed in the top right corner.



End playback.



Pause playback.

Continue playback with **Continue**.

By default, call records are played back via the speaker. If a headset is connected, you can listen to the playback through this.

### Deleting call records

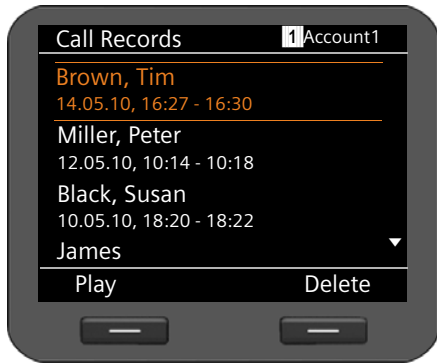

Delete

Scroll through the list to the required call record.

Press the display key to delete the call record.

### Managing e-mail messages

Your phone will notify you when new e-mail messages have been received on your incoming e-mail server. You can connect to this server and display the sender, date/time of receipt, subject and body of the message for every message.

#### Prerequisites:

- You have set up an e-mail account with an ISP.
- The incoming e-mail server uses the POP3 protocol.
- You have set up the name of the incoming e-mail server and your personal registration data (account name, password) using the Web configurator ( → [page 114](#)).

New incoming e-mails are indicated by the  icon. The number of new e-mails is shown to the right. If more than 99 e-mails have been received, the number will flash. If no more capacity is available for e-mails, the e-mail icon will flash red. The maximum storage capacity is 5 MB.

The phone checks at regular intervals whether new e-mails have been received. You can set the time intervals via the Web configurator in multiple stages between 15 minutes and 24 hours ( → [page 142](#)).

You can also access your inbox via the Message Centre ( → [page 67](#)). The  key flashes if there are new e-mails on the incoming e-mail server.



## Opening the incoming e-mail list

Via the display menu: ✓ → Messages → E-mail

Via the Message Centre: ✉ → E-mail

The phone will connect to the incoming e-mail server. A list of e-mail messages that are stored there is displayed.

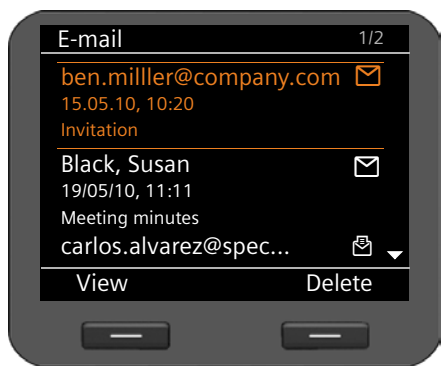

The e-mail messages are displayed in chronological order, from the most recent through to the oldest, along with the following information:

- ◆ Name/e-mail address of the sender (single line; shortened if necessary)
- ◆ Date and time (prerequisite for correct details: the sender and recipient are in the same time zone)
- ◆ Subject

New messages are identified by the ✉ icon; ones that have already been read are followed by ✉. Messages are classed as new if they have been received since the last time the incoming e-mail list was accessed.

**If a new e-mail is selected:** The number of the selected new message and the total number of new messages is displayed in the top right corner.

**If an old e-mail is selected:** The number of the selected old message and the total number of old messages is displayed in the top right corner.

---

### Note

Many e-mail providers activate spam protection measures by default. E-mail messages classified as spam are stored in a separate folder and are therefore not shown in the incoming e-mail list.

Some e-mail providers allow you to deactivate spam protection or show spam e-mails in the incoming e-mail list.

Other e-mail providers may send a message to the inbox when a new spam e-mail is received. This is to inform you that a suspected spam e-mail has been received.

The date and sender of this mail are repeatedly updated, so that it is always displayed as a new message.

---

## Managing messages

### If establishing a connection fails

If a connection to the incoming e-mail server cannot be established, the **No Connection** message is displayed.

This may have the following causes:

- Incorrect entry of incoming e-mail server name ( → [page 114](#))
  - Temporary problems with the incoming e-mail server (server is down or not connected to the Internet).
- ▶ Check settings.
- ▶ Try again later.

### Reading e-mail messages

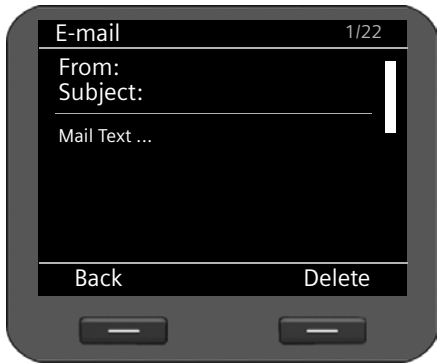

In the opened incoming e-mail list:

**View** Press the display key to display e-mail.

The first 10 KB of an e-mail is downloaded to the phone. The message header, the message and the name of any attachments are displayed. The attachments are not transferred. If the e-mail is longer than 10 KB, the message cannot be transferred in full and may not be readable.

---

#### Notes

- ◆ If the e-mail message contains more than just text, a message to this effect is displayed. The subject of the message is then displayed.
- ◆ If the subject and/or the message text are formatted in HTML, they are converted into text format.

---

### Deleting e-mail messages

The incoming e-mail list is opened ( → [page 65](#)).

 Select an e-mail entry.

**Delete** Press the display key to delete the e-mail.

Or

If you have opened the e-mail message to read it.

**Delete** Press the display key to delete the e-mail.

The e-mail is deleted from the phone's e-mail list. To delete e-mails from the server as well, use the Web configurator ( → [page 142](#)).

## Accessing messages via the Message Centre

The Message Centre gives you quick access to newly-received messages at the press of a key. It provides centralised access to the following messages:

- ◆ Voice mails ( → [page 61](#))
- ◆ Missed calls ( → [page 46](#))
- ◆ E-mails ( → [page 64](#))
- ◆ Missed alarms ( → [page 69](#))

The message key  flashes if a new entry is received for one of these message types. A new entry is classed as anything that has been received since the corresponding list was last opened.



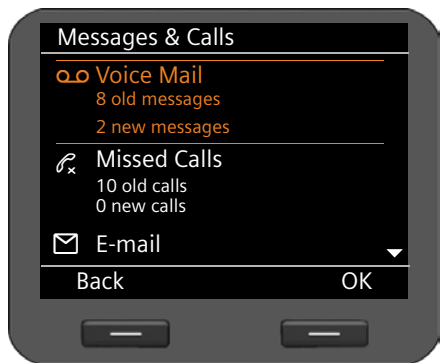

You use the Web configurator to specify which message types can be accessed via the Message Centre ( → [page 144](#)).

### Opening the Message Centre

You open the Message Centre with the  key.





The list shows the message types together with the relevant icon:

-  Network mailbox (with relevant VoIP account)
-  Missed calls
-  E-mails
-  Missed alarms

For each message type the number of old and new messages is displayed.

#### To open the list:

-  Scroll to the required message type.
-  Press the display key to display the list.

---

#### Note

The Gigaset T500 PRO and Gigaset T300 PRO phone systems do not distinguish between old and new missed calls. If your phone is connected to this type of phone system, this information is not available.

---

# Managing the calendar and alarms

Alarms include anniversaries (e.g., birthdays). Birthdays that are entered in the directory (→ [page 53](#)) are automatically recorded in the calendar.

## Managing the calendar

You open the calendar via the display menu. You can also display the calendar permanently on the idle display (→ [page 86](#)).

### Opening the calendar

✓ → Organizer → Calendar

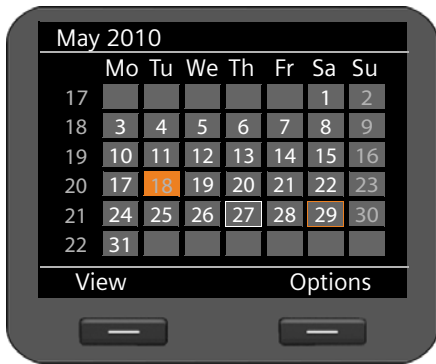

The current month is displayed.

Special days are highlighted.

White box: Current date

Orange box: Selected date

Highlighted orange: Date with assigned alarm

If one or more alarms are scheduled on the same day, you can display these:



Navigate to the required date.

**View**

Press the display key.

**Note:** Select a date and press the  key on the upper or lower edge of the calendar to scroll to the previous or following month.

The alarms for the selected day are displayed with an icon.



Birthday/anniversary: Name as it appears in the directory entry and age based on the date of birth

### Deleting an entry:



Select an entry.

**Delete**

Press the display key.



## Displaying alarms

An alarm occurs when the date of an anniversary is reached. Alarms are shown on the idle display.

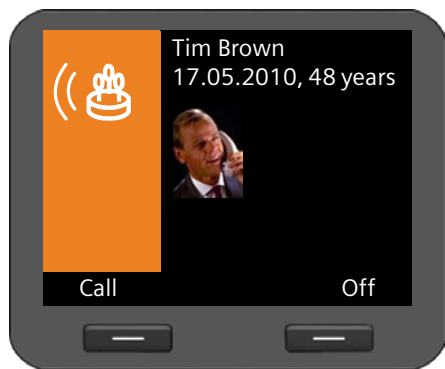

### Displaying a birthday

The date and age based on the date of birth are displayed.

The display starts at 09:00 on the specified anniversary.

**Off** Press the display key to switch the display off. The display returns to idle status.

**Call** Press the display key to call the participant.

If you do not react to a displayed alarm, the alarm is added to the list of missed alarms (→ [page 69](#)).

## Missed alarms

Alarms that you do not react to are added to the missed alarms list. You can access this via the display menu or via the Message Centre (→ [page 67](#)).

Via the display menu: ✓ → **Organizer** → **Missed Alarms**

Via the Message Centre: 📧 → **Missed Alarms**

Missed alarms are displayed in chronological order, from the most recent through to the oldest, and are accompanied by an icon.

 Birthday/anniversary: Name as it appears in the directory entry and age based on the date of birth

The number and status of the entry is displayed in the top right-hand corner.

Missed alarms are classed as new if they have been entered since the last time the list was accessed.

### Deleting an entry:

 Select an entry.

**Delete** Press the display key.

When you close the list, the status of all entries is set to "old", regardless of whether you viewed the entry or not.

### Alarm clock function

You can set a signal to wake you at a certain time.

If the alarm clock is activated, the  icon appears. The wake-up time is shown on the right-hand side (→ [page 4](#)).

The wake-up call will sound at the specified time either Monday to Friday or daily.

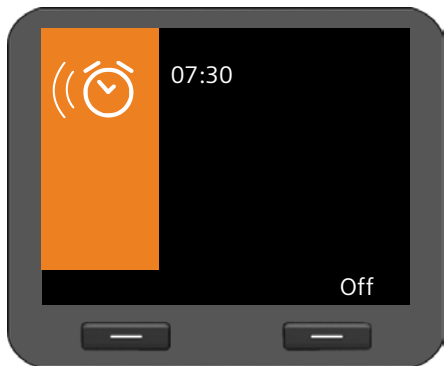

A wake-up call is signalled on the display and the selected ringer also rings for 60 seconds.

**Off** Press the display key to deactivate the wake-up call.

You can manage the alarm clock function via the display menu:

✓ → **Organizer** → **Alarm Clock**

### Activating/deactivating the alarm clock function

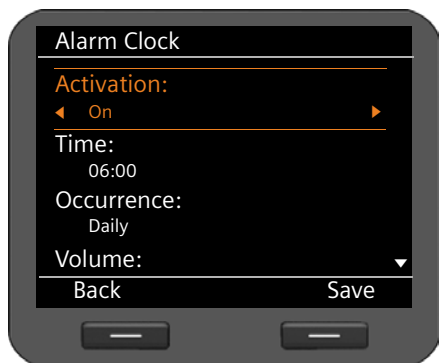

 Select **On** or **Off**.

**Time:**

 Enter the time for the wake-up call in four-digit format, e.g., 0715 for 07:15 (24-hour format) or 07:15 AM (12-hour format).

**Occurrence:**

 Specify on which days the wake-up call should be activated:  
**Monday-Friday** or **Daily**.

## Setting the volume and ringer

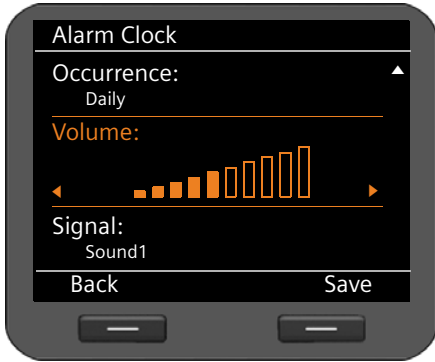
**Save**

Press the display key to save your settings.

**Volume:**

 Set the volume for the wake-up call at one of ten levels. The current setting is displayed graphically.

**Signal:**

 Set the signal.  
All available ringers can be selected.  
The selected ringer is played back.

You can load individual ringers to your phone (→ [page 103](#)).

## Using Internet services

The telephone's Information Centre provides a range of services (info services) with which information can be retrieved from the Internet and Web devices in your network and displayed. The Info Centre offers access to the following information:

News	Fetch information from RSS feeds ( → <a href="#">page 73</a> ).
Weather reports	Display local weather reports ( → <a href="#">page 74</a> ).
Internet radio	Listen to Internet radio ( → <a href="#">page 75</a> ).
Webcam	Display images from webcams ( → <a href="#">page 75</a> ).
Map	Display the location of call participants or any other addresses in a map ( → <a href="#">page 78</a> ).
Door interphone	Display images from intercom video cameras ( → <a href="#">page 76</a> ).

**Prerequisite:** The **info services** function has been activated in the Web configurator and the required info services have been set up ( → [page 145](#)).

---



### Note

Info services of the **News**, **Weather** and **Webcam** types can also be used as a screensaver( → [page 89](#)).

---

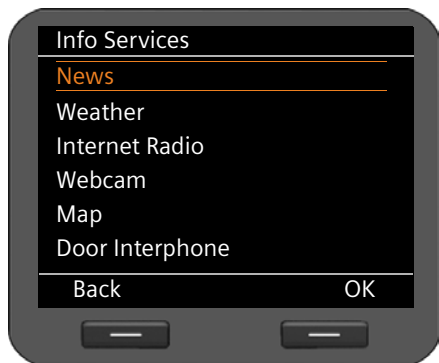
Open the Information Centre using the  key.



- ▶ Select between displaying **News**, **Weather**, **Internet Radio**, **Webcam**, **Map** and **Door Interphone**.
-  Select the required display.
-  Press the display key to confirm the selection.



## News

The **News** menu offers a list of RSS feeds that were selected in the Web configurator. RSS feeds are information that is provided in a standardised format for simple and structured publication on websites (e.g., news sites, blogs, audio/video logs etc.) and that you normally have to subscribe to.

**News** is divided into a range of topics: **Headlines**, **Entertainment**, **Computer**, **Sports**, **Business**, **Sci/Tech**. The RSS feed library of a provider is assigned to each topic in the Web configurator (max. ten RSS feeds per topic). You normally have to subscribe to RSS feeds with a provider.

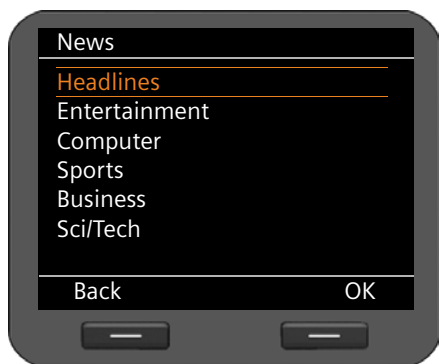

Select the required topic.



Press the display key to confirm the selection.

The sub-topics defined are displayed, depending on your selection.



Select the required sub-topic.



Press the display key to confirm the selection.

The screen of the selected info service is displayed.

### Example: Headlines

If the full line cannot be displayed, the text scrolls through from right to left.

The display is updated every 10 seconds.



Select the required headlines.



Press the display key to confirm the selection.

The headline for the news item is displayed.



Scroll through the news item.



Scroll to the next or previous news item.

## Weather reports



You can display **Weather Reports** for a maximum of ten locations. You specify the city in the Web configurator (→ [page 147](#)).

The weather reports for the next three days are displayed.

 Scroll to the next or previous weather report.

If you use the weather reports as a screen-saver and multiple locations have been defined, the display cycles through them every 10 seconds.

## Listening to Internet radio

**Prerequisite:** The Internet Radio function has been activated in the Web configurator and a list of radio stations has been selected (→ [page 148](#)).

### Activating Internet radio

In addition to access via the Information Centre, you can also activate Internet radio via the display menu:

✓ → **Additional Features** → **Internet Radio**

The device automatically tries to connect to the last Internet radio station that was set.



If a connection is established, you can listen to the station's current programme. Any information supplied by the station, such as the name of the station and the artist and title of the song currently being played, are shown in the display.

An error message is displayed if a connection could not be established. You can then select a different station.

The broadcast is ended if a call comes in or if you make a call.

## Selecting a station



### Stations

Press the display key.  
All of the configured Internet radio stations are displayed.



Select the required station.

### OK

Press the display key to confirm the selection.

## Displaying webcam images

You can show images from webcams on the display.

Images from all configured webcams can be accessed via the Info Centre. You can use a webcam as a display for the screensaver (→ [page 89](#)).

**Prerequisite:** Info services have been activated in the Web configurator and the URL(s) of the webcam(s) has/have been entered (→ [page 147](#)).



Press the button to open the Info Centre.



Select **Webcam** and press **OK** to confirm.



Select the required webcam and press **OK** to confirm.



### Update

Press the display key to load the image.

### End

Press the display key to end display, after which you can select another webcam.

### Note

An incoming call ends display.

### Door interphone

You can operate multiple door interphones using your telephone. If one of the door interphones is rung, the display shows a picture from the connected video camera ( → [page 77](#)). Pictures from all configured door interphone video cameras can be accessed via the Info Centre. These pictures can also be accessed when the interphone has not been rung.

**Prerequisite:** The door interphone cameras have been registered on the Web configurator ( → [page 149](#)).



Press the button to open the Info Centre.



Select **Door Interphone** and press **OK** to confirm.



Select the required camera and press **OK** to confirm.

The display shows the webcam ( → [page 75](#)).

**Update**

Press the display key to load the image.

**End**

Press the display key to end display, after which you can select another video camera.

### Closing info services

The info services display automatically closes if an event occurs, e.g., an incoming call.

If an info service has been activated as a screensaver, you can close the display by pressing the key.

# Operating door interphones

You can operate one or more door interphones with video surveillance using the phone. The pictures from the camera(s) are shown on the phone's display.

**Prerequisite:** The door interphone must have been configured on the Web configurator (→ [page 149](#)) or the Gigaset phone system.

If someone rings the door interphone, this is displayed as an incoming call on the phone. The image from the video camera is also shown.

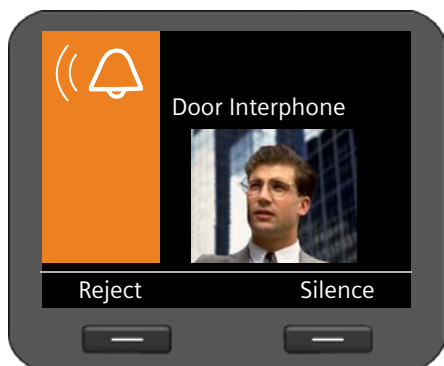

## Switching the ringer off



**Silence** Press the display key to switch off the ringer. You can then decide whether or not to open the door.

## Ending the connection to the door interphone

**Reject** Press the display key or end key  to reject the request.



## Conduct a call over the door interphone

 Pick up the receiver to talk with the person at the door. Alternatively you can conduct the call using the speaker key  or the headset .

**Open Door** Press the display key to operate the door opener.

**End** Press the display key to end the call without opening the door.

## Note

- ◆ If you are carrying out a telephone call at the same time, the ring at the door is signalled by Call Waiting (→ [page 39](#)). You can either reject the call or accept and open the door. When the connection to the door interphone is ended, the previous connection is restored. Toggling between calls is not possible.
- ◆ An incoming call is signalled as a Call Waiting if you are already connected to the door interphone. If you accept the call the connection to the door interphone is ended.

## Displaying maps

You can display a map section on the telephone display in a variety of situations, for example, to show you the location of a call participant or to search for an address.

**Prerequisite:** The display of maps has been activated in the Web configurator:

**Settings** → **System** → **Display** ( → **page 160**).

The zoom factor and the type of display (**Roadmap**, **Terrain** or **Hybrid**) can be changed in the Web configurator.

### On an incoming call or during a call

**Prerequisite:** The address of the caller must be known, either in the entry in the local directory or through automatic search in an online directory.

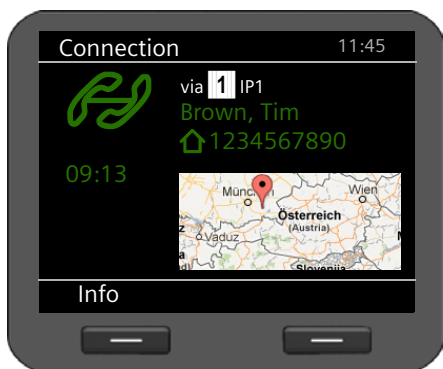

The location of the other caller is shown on the map on an incoming call or during a call.

### In the directory

Directory entries for which an address has been entered have the additional entry **Show in map** in the options menu.

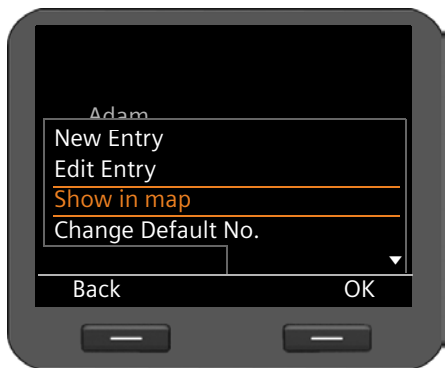

Scroll through the list to the required name.



Press the display key.



Select **Show in map** and press **OK** to confirm.

The map is displayed. The display covers the entire surface of the screen.

## As info service

You can search for an address of choice. This function is available through the Information Centre.



Open the Information Centre.



Select **Map** and press **OK** to confirm.

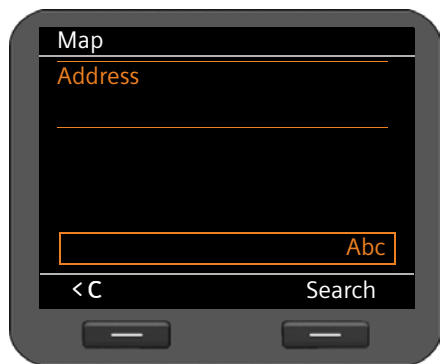

- ▶ Enter a location in the **Address** field. You must the international name here, e.g. Munich for München.

**Search** Press the display key to start the search.

For instructions on entering text see

→ **page 23**.

If the location is found, the map is shown with the location marker.



Press right, left, up or down on the navigation key to move the section.



Slide your finger on the edge of the navigation key right or left to enlarge or shrink the section (zoom). Right: shrink section (zoom in); left: enlarge section.

**Satellite**

Press the display key to switch between map view and satellite view.

---

### Note

An incoming call ends display.

---

## Configuring basic settings

---

Your telephone is preconfigured, but you can change the settings to suit your individual requirements.

### Info

The first time you access the **Settings** menu, you will receive information about important settings for your phone.

✓ → **Settings** → **Info**



The following settings are displayed:

- ◆ SW Version
- ◆ Country Version
- ◆ MAC Address LAN
- ◆
- ◆ IP Address

### Setting the date and time

The date and time must be set accurately to record the correct time for incoming calls and use the alarm clock and calendar.

---

#### Please note

The address of a time server on the Internet or the local network is saved on your phone. The date and time are taken from this time server provided that the phone is connected to the network and synchronisation with the time server is activated. Manual settings are overwritten in this case.

The settings for the time server should be made via the Web configurator ( → [page 158](#)).

---

You use the display menu to manually set the date and time:

✓ → **Settings** → **Date / Time**

How the date and time are displayed depends on which time and date format is set ( → [page 161](#)).



**Date:**

Enter the day, month and year in eight-digit format, e.g., for 14 January 2010:

For the date format **dd.mm.yyyy** 14012010

For the date format **mm.dd.yyyy** 01142010

**Time:**

Enter the time in four-digit format, e.g., 0715 for 07:15.

Time display for this setting in **24-hour format**: 07:15

Time display for this setting in **12-hour format**: 07:15 AM

**Save**

Press the display key to save your settings.

## Setting the ringer

You can set the volume and melody of the ringer. You can select two different volume levels for time-based operations and completely silence the ringer for anonymous calls.

## Setting the volume

The volume of the ringer for incoming calls can be adjusted over ten levels.

### Setting the volume in idle status

✓ → Settings → Audio Settings → Ringer Settings → Volume

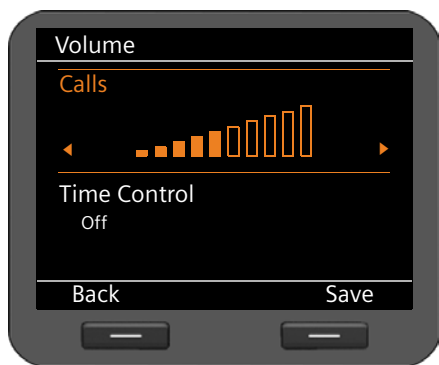

Select the required volume.

The volume is adjusted immediately. You can test the setting by playing back the ringer with the melody set at the selected volume level.

**Save**





Press the display key to save the settings.

## Configuring basic settings

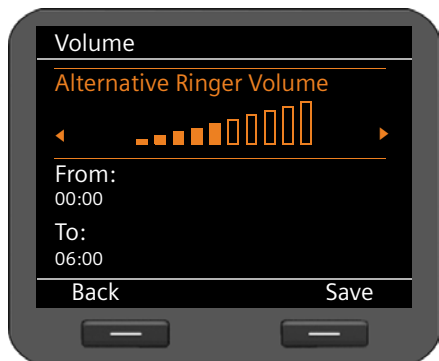
### Setting alternative volumes for particular times

You can set a different volume for a particular time period, e.g., during the night.



-  Select **Time Control** and activate the function using the  navigation key.
-  Select **Alternative Ringer Volume**.
-  Select the required volume.
-  In the **From** and **To** fields enter the time period (start and finish) for the alternative ringer volume in four-digit format, e.g., 2215 for 22:15 and 0600 for 06:00.

**Save** Press the display key to save the settings.

### Setting the volume while the phone is ringing

You can adjust the volume while the phone is ringing using the  key. Each time you press the key, the volume will increase or decrease by one level. The last setting is saved.

### Setting a melody

You can choose various ringer settings, melodies or sounds from the resource directory (→ [page 103](#)) and configure different ringer settings for each VoIP account.

✓ → Settings → Audio Settings → Ringer Settings → Melodies

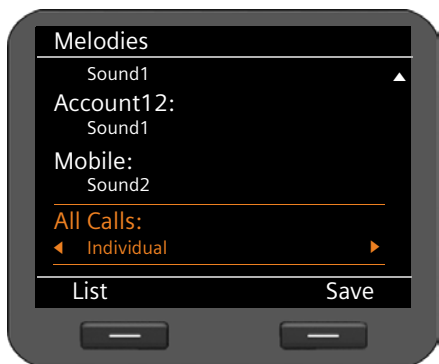

Each configured VoIP account is listed along with its current melody. The default setting for **All Calls** is **Individual**, i.e., the relevant setting is applied to each account. If you select a melody for **All Calls**, this applies to all accounts.

-  Select the VoIP account you want to set the ringer for or select **All Calls**.

**List** Press the display key to display the melodies.

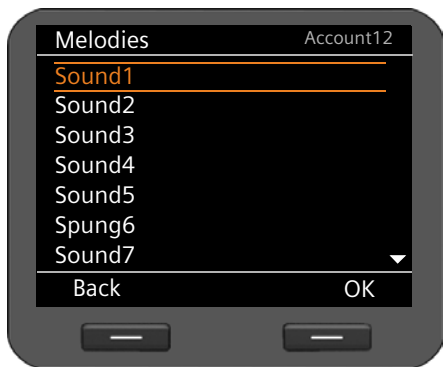

All of the melodies from the resource directory are displayed.

At the top right-hand corner of the screen, you can see which VoIP account you are editing or **All Calls**.

 Choose the melody.  
The selected melody is played at the set volume.

**OK** Press the display key to confirm the selection.

**Save** Press the display to save the settings if you have created the settings for all accounts.

## Silencing the ringer for anonymous calls

You can silence the ringer for external calls where the caller has withheld their number.

✓ → **Settings** → **Audio Settings** → **Ringer Settings**

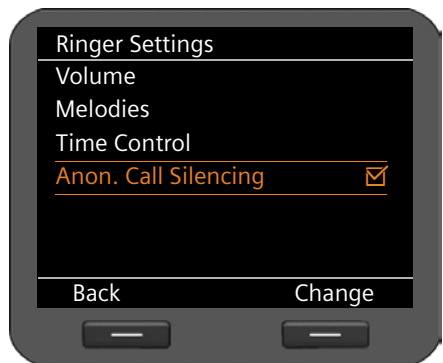

If the function is activated, the **Anon. Call Silencing** entry is marked with . The phone will then not ring if an anonymous call is received. The call is still shown on the display.

**Change** Activate/deactivate the function with the display key.

The change is made immediately.

## Activating/deactivating advisory tones

Your phone uses advisory tones to tell you about different activities and statuses. The following advisory tones can be activated/deactivated independently of each other:

- ◆ **Key Tones** Each key press is signalled acoustically.
- ◆ **Confirmations** After completing an entry/setting and when a new entry appears in the network mailbox or call list, when you make an incorrect entry or when you scroll to the top of a menu.

✓ → Settings → Audio Settings → Advisory Tones

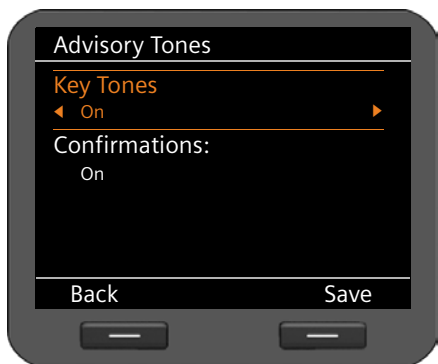

### Key Tones:



Select **On** or **Off**.

### Confirmations:



Select **On** or **Off**.

**Save**

Press the display key to save the setting.

## Setting the display

When setting the display, you can configure the idle display, screensaver and backlight.

### Display in idle status

The idle display shows the time zones, an analogue or digital clock, the calendar, a picture or pictures in the form of a slide show. Default setting: **Time Zone**.

✓ → Settings → Display → Idle Display

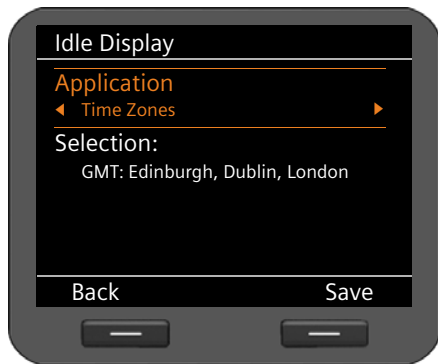

Select from **Time Zones**, **Clock**, **Calendar**, **Slide Show** and **Pictures**.

The options you have chosen will then be available at the bottom of the display.



Move the cursor to **Selection**.

## Setting the time zone



When setting the **Time Zones**, a map of the world showing the time zones appears on the screen. The current setting is highlighted.

You can change the time zone here or via the Web configurator (→ [page 158](#)).

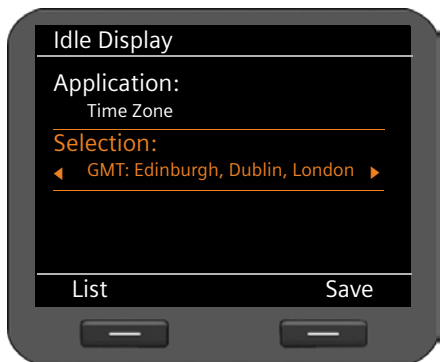

## Changing the time zone:

- List** Press the display key to display the list of all time zones.
-  Select the required time zone.
- OK** Press the display key to apply the chosen time zone.
- Save** Press the display key to save the settings.

## Configuring basic settings

### Clock

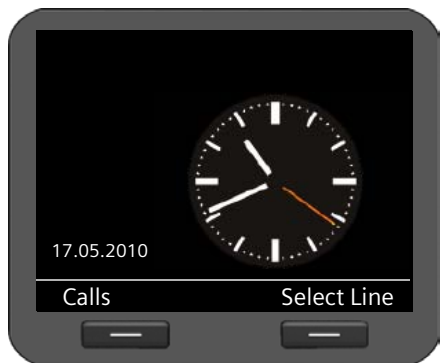

If you select **Clock**, a clock showing the current time is displayed.

By default, the time is set by a time server (→ [page 158](#)). You can deactivate the time server and set the time manually (→ [page 80](#)).

Choose between an analogue and a digital time display.



#### Selection:



Choose between **Analog Clock** and **Digital Clock**.

#### Save

Press the display key to save the settings.

### Calendar

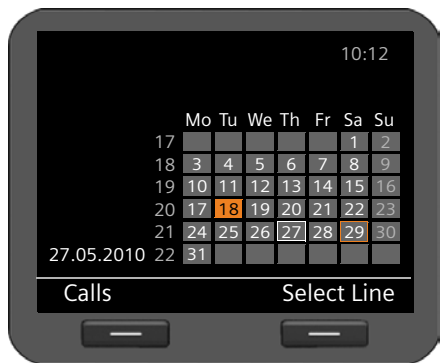

If you select **Calendar**, a calendar showing the current month is displayed. You can find out more about the calendar function in the [Managing the calendar](#) section on [page 68](#).

No further settings are required.

#### Save

Press the display key to save the settings.

## Slide show



If you choose **Slide Show** you select a series of pictures to be displayed one after the other at 10-second intervals.

If you prefer to use your own pictures, you will need to add them to your phone's resource directory ( → [page 102](#)).

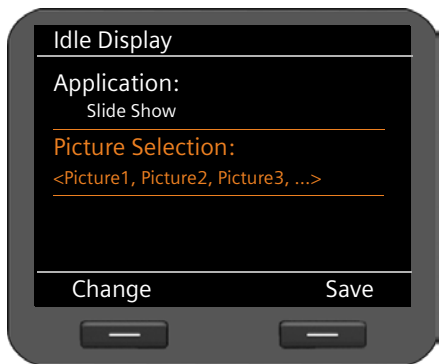
**Selecting pictures:**

The names of the pictures chosen for the slide show are listed.

**Change** Press the display key to select different pictures.

A list containing all of the pictures from the resource directory is displayed.

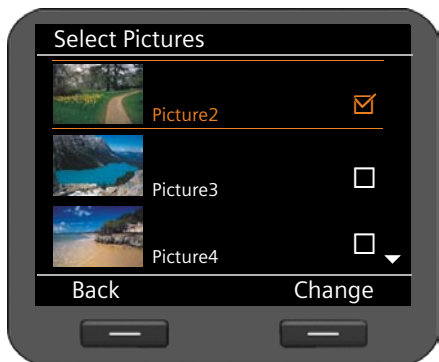

A  appears next to the pictures selected for the slide show.

 Select the required picture.

**Change** Press the display key to select a picture for the slide show or to remove the tick.

**Back** Press the display key when you have selected all the pictures.

**Save** Press the display key to save the settings.

## Configuring basic settings

### Pictures



If you choose **Pictures** you can select a picture to be shown on the display.

If you want to use your own picture, you must save it beforehand in the resource directory (→ [page 102](#)).

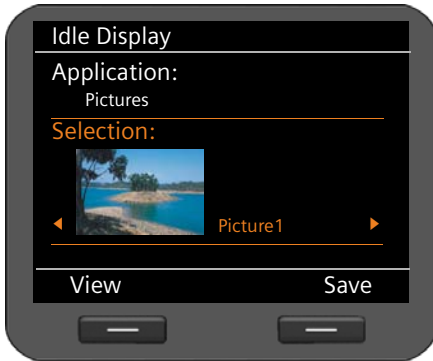

#### Selecting a picture:

All of the pictures are loaded from the resource directory. The first picture is displayed.



Scroll through the list.

**View**

Press the display key to enlarge the picture. Return to normal view by pressing **OK**.

**Save**

Press the display key to save the settings.



## Activating a screensaver

If a screensaver is activated, this replaces the idle display (→ [page 84](#)). The screensaver appears if the phone is not used for a period of 15 seconds. Similar to the idle display, the screensaver can consist of an analogue or digital clock, the calendar, a picture or a series of pictures in slide show format. However, unlike the idle display, the screensaver covers the whole of the screen.

You can also set the screensaver to display information from an info service (RSS feed, weather information).

✓ → Settings → Display → Screensaver

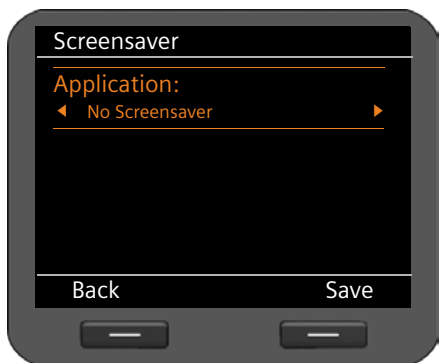

### Setting the screensaver:

⊙ Select from **No Screensaver, Clock, Calendar, Slide Show, Pictures and Info Services.**

The options you have chosen will then be available at the bottom of the display.

**Save** Press the display key to save your settings.

The settings for configuring the screensaver are identical to those used to configure the idle display:

**Clock** → [page 86](#), **Calendar** → [page 86](#), **Slide Show** → [page 87](#), **Pictures** → [page 88](#).

## Displaying the info service as a screensaver

You can display specific information that is available on the Internet or your network as a screensaver. The following categories are available.

- ◆ News RSS feeds
- ◆ Weather reports
- ◆ Images from webcams
- ◆ Your own services, provided as an XML page.

### Prerequisites:

- ◆ You choose **Info Services** as the **Screensaver** for your phone.
- ◆ The display of info services is activated via the Web configurator; an info service is selected for the screensaver (→ [page 148](#)).

---

### Please note

Use the  key to call up the Information Centre (→ [page 67](#)) for a list of all the info services available.

---

## Configuring basic settings

### Selecting an info service

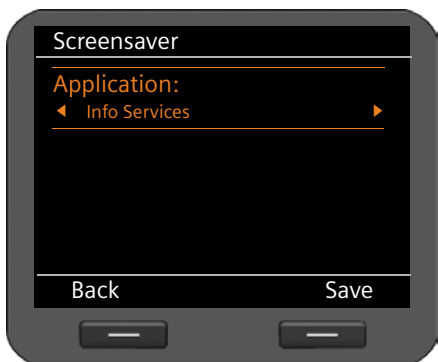

Select **Info Services** as the screensaver.

**Save**

Press the display key to save the settings.

If no info service is available, the **Analog Clock** will be displayed as the screensaver instead.

---

#### Please note

The display of info services may be blocked via the Web configurator ( → [page 145](#)).

---

## Setting the backlight

The brightness of the backlight for the display can be set to one of seven levels or you can specify a time period during which the backlight is deactivated completely, e.g., at night.

If the display backlight is deactivated, it can be reactivated by pressing any key or by an incoming call. In this situation, pressing the key has no further function.

**Prerequisite:** The date and time have already been set.

✓ → Settings → Display → Backlight

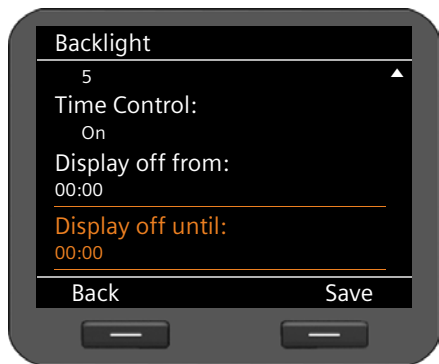
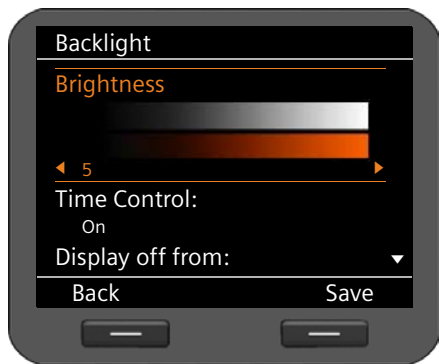

### Brightness

Select the required brightness level from 1 to 7. Your setting is activated immediately so that you can check it and correct it if necessary.

### Time Control

Select **On** or **Off**.

The following fields only appear when **Time Control = On**.

### Display off from



Enter the time at which the display backlight should be deactivated, in four-digit format.

### Display off until



Enter the time at which the display backlight should be reactivated, in four-digit format.

### Save

Press the display key to save your settings.

### Setting the language

You can view the display texts in different languages.

✓ → Settings → Language



The current language is indicated by a .



Select the required language.

**Select**

Press the display key to activate the selected language.

The language is changed.

### Resetting the device to the default settings

If you give your device to a third party or change workstation, you can delete your individual settings and data by resetting the device to the factory settings. All system settings are reset to the default settings. User-specific data is deleted.

This means that network configurations, VoIP accounts, directories, call lists, data in the resource directory and all of your individual settings are deleted or reset to the factory settings.

You need the administrator password before you can use this function ( → [page 159](#)).

✓ → Settings → Reset



Enter the administrator password.

**OK**

Press the display key. The password is verified.

If the password is correct, you must now confirm the operation.

**Yes**

Press the display key. The device is reset to the factory settings.

# Configuring settings for the local network

---

All of the settings for connecting your phone to the local network must be correct to enable communication with other devices in the network and phone calls via the Internet.

Your phone can be connected to the local network using an Ethernet cable. When you first set up the phone, the device will automatically try to connect to the local network

(→ [page 19](#)).

This will work, if:

- You have connected the device to the network using an Ethernet cable (→ [page 14](#))
- The gateway automatically assigns network IP addresses using DHCP
- The network uses IP protocol version 4 (IPv4).

The phone is then automatically assigned an IP address and is connected to the local network. You can then continue configuring your phone via the Web configurator at a PC

(→ [page 105](#)).

If the network connection is not established automatically, you will initially not be able to access the Web configurator. If this is the case, you will have to establish the network connection manually via the display menu:

- ◆ If your device is assigned a static IP address, your network administrator must tell you the IP address of your device. You then assign this address to your phone (→ [page 94](#)).
- ◆ If your network uses IPv6, you have to set your phone to Internet protocol version 6 (IPv6) (→ [page 96](#)). The connection is established if the address is assigned automatically. If a static IP address should be assigned to your phone, your network administrator must inform you of this. You then assign this to your phone.

Whether you configure the network settings when you initially set up the phone (→ [page 19](#)) or you start configuration via the display menu – the settings are the same.

---

## Warning

The connection may be interrupted if you change the configuration for a functioning network connection. You will then **no longer be able to access** the local network or the Web configurator and you **will no longer be able to make calls via the Internet**.

---

### LAN settings

You start network configuration via the display menu:

✓ → Settings → Connectivity → Local Network

---

#### Please note:

To get access to network configuration you need to enter the administrator password. The default setting is **admin**.

---

### Selecting the network type

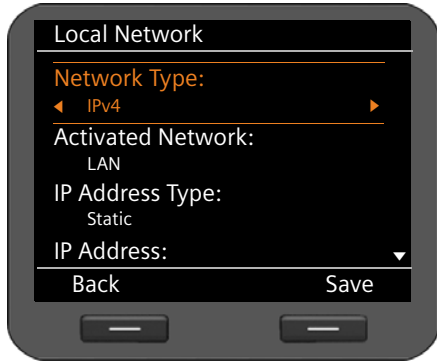

#### Network Type

 Select the IP protocol that is used in your network (**IPv4** or **IPv6**).

You may be asked to configure additional settings depending on your selection.

### IPv4 configuration

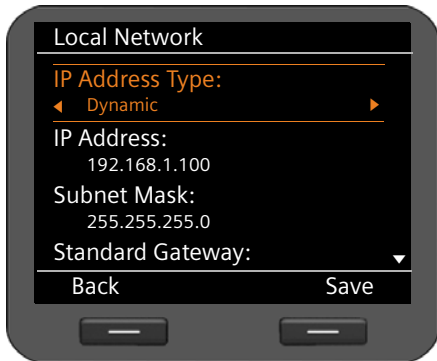

#### IP Address Type

 Select **Dynamic** if your device receives the IP address via a DHCP server. Select **Static** if your device receives a fixed IP address.

If the **Dynamic** setting is selected, all further settings are automatically configured. They are displayed here and cannot be changed.



If you have selected **Static** as the address type, you must now create the following settings:

- **IP Address**
- **Subnet Mask**
- **Standard Gateway**
- **Preferred DNS Server** and
- **Alternate DNS Server**

### IP Address

Enter an IP address for your phone. This IP address allows your phone to be reached by other subscribers in your local network (e.g., PC).

The IP address comprises four individual groups of numbers with decimal values from 0 to 255 that are separated by a dot, e.g., 192.168.2.1.

Please note:

- The IP address must be included in the address block used by the router for the local network. The valid address block is defined by the router's IP address and the subnet mask (see example).
- The IP address must be unique in the local network, which means that it must not be used by another device connected to the router.
- The static IP address must not belong to the address block that is reserved for the router's DHCP server.

Check the settings on the router or ask your network administrator.

#### Example:

Router IP address:	192.168.2.1
Network subnet mask	255.255.255.0
DHCP server address block	192.168.2.101 – 192.168.2.255
Possible IP addresses for the phone	192.168.2.2 – 192.168.2.100

### Subnet Mask:

The subnet mask specifies how many parts of an IP address the network prefix must comprise.

For example, 255.255.255.0 means that the first three parts of the IP address must be the same for all devices in the network, while the last part is specific to each device. In subnet mask 255.255.0.0, only the first two parts are reserved for the network prefix. Enter the subnet mask that is used by your network.

### Standard Gateway

Enter the IP address for the standard gateway through which the local network is connected to the Internet. This is generally the local (private) IP address for your router (e.g., 192.168.2.1). Your phone requires this information to be able to access the Internet.

## Configuring settings for the local network

### Preferred DNS Server:

Enter the IP address for the preferred DNS server. DNS (Domain Name System) allows you to assign public IP addresses to symbolic names. The DNS server is required to convert the DNS name into the IP address when a connection is being established to a server.

You can specify the IP address for your router/gateway here. This forwards address requests from the phone to its DNS server.

There is no default setting for a DNS server.

### Alternate DNS Server:

Enter the IP address for the alternate DNS server that should be used in situations where the preferred DNS server cannot be reached.

- ▶ Once all the settings are complete, press the display key **Save** to save the configuration settings.

## IPv6 configuration



### IP Address Type:

- ⦿ Select **Automatic Scan** if your device receives the IP address via a DHCP server. Select **Static** if your device receives a fixed IP address.

If the **Automatic Scan** setting is selected, all further settings are automatically configured. They are displayed here and cannot be changed.



If you have selected **Static** as the address type, you must now create the following settings:

- **IP Address**
- **Prefix Length** and
- **Preferred DNS Server**
- **Alternate DNS Server**

Ask your network administrator for your network settings.



## IP Address

Enter an IP address for your phone. This IP address allows your phone to be reached by other subscribers in your local network (e.g., PC).

The IP address comprises 128 bits and is represented by eight blocks of hexadecimal figures from 0 to FFFFFFFF that are separated by a colon, e.g., 2001:b021:189:0:205:5dff:fe6b:87.

The IP address comprises a prefix and an interface identifier. The length of the prefix (usually 64 bits) is determined by the **Prefix Length** value.

## Prefix Length

The prefix length stipulates how many bits of the IP address are used for the network prefix. Enter the prefix length that is used in your network.

## Preferred DNS Server:

Enter the IP address for the preferred DNS server. DNS (Domain Name System) allows you to assign public IP addresses to symbolic names. The DNS server is required to convert the DNS name into the IP address when a connection is being established to a server.

You can specify the IP address for your router/gateway here. This forwards address requests from the phone to its DNS server.

There is no default setting for a DNS server.

## Alternate DNS Server:

Enter the IP address for the alternate DNS server that should be used in situations where the preferred DNS server cannot be reached.

- ▶ Once all the settings are complete, press the display key **Save** to save the configuration settings.

## VLAN tagging

A local network can be divided into logical subnetworks, so-called VLANs (Virtual Local Area Network, standard IEEE 802.1Q). Multiple VLANs share a physical network and its components, e.g., switches. Data packets of a VLAN are not forwarded to another VLAN. VLANs are often used to separate the data traffic of different services (Internet telephony, Internet TV, ...) and to define different priorities for the data traffic.

If you are operating your phone in a VLAN, enter the identifier of your VLAN (VLAN tag) here. You get this from your network operator.

---

### Warning

If you enter an incorrect value here, you must reset the phone to its default settings (→ [page 92](#)). After this you must re-establish phone access to the local network.

---

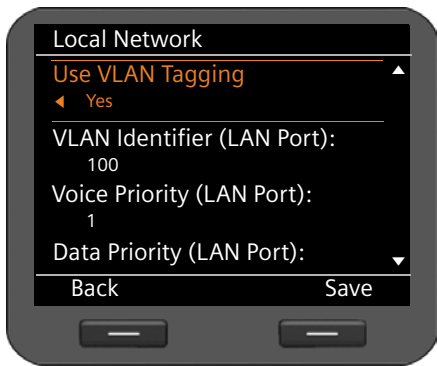

- Select **Yes** for **Use VLAN Tagging**.
- Enter the **VLAN Identifier (LAN Port)**.  
Value range: 1 – 4094

Data packets from VLANs can be prioritised. The priority determines whether the data traffic from a VLAN is given preferential treatment by the network components. You can define the priority for voice and data separately. In the case of a local network with a lot of data traffic, you can achieve better-quality phone connections by giving a high priority to voice data.

- ▶ On the menus **Voice Priority (LAN Port)** and **Data Priority (LAN Port)**, select the priorities you want for the transfer of voice and data.

Range of values and their Class of Service assignments (according to IEEE 802.1p):

- 0 No priority (Best Effort)
- 1 Background services, e.g., News Ticker (Background)
- 2 Not defined
- 3 General data services (Excellent Effort)
- 4 Control services, e.g., routing (Controlled Load)
- 5 Video
- 6 Voice data (Voice)
- 7 Top priority for network control software (Network Control)

- ▶ Once all the settings are complete, press the display key **Save** to save the configuration settings.

---

### Please note

Further options for optimising the voice quality are available in the Web configurator under **QoS settings (Quality of Service)** → **page 125**.

---

## Connecting a headset

You can connect a headset via the RJ9 connector of your Gigaset DE700 IP PRO.

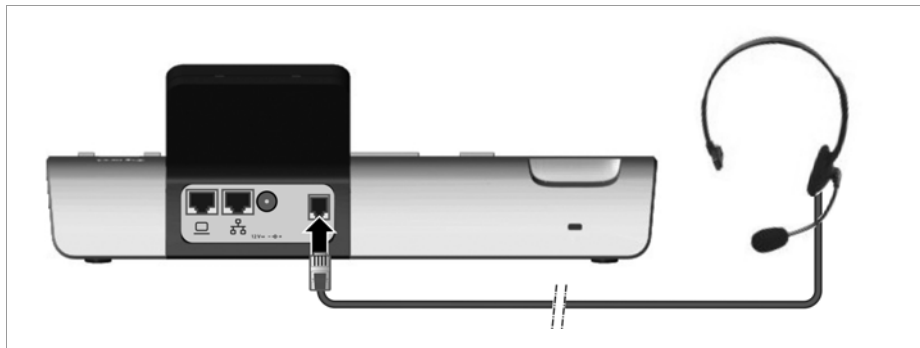

► Connect the cable for the headset to the RJ9 connector on the phone.



**Options**

Press display key.



Select **Delete Entry**.

## Using the resource directory

---

The resource directory in your Gigaset DE700 IP PRO provides a memory in which you can manage pictures and sounds. The **Resource Directory** contains

- ◆ Sounds that you can use as ringers
- ◆ Pictures that you can use as screensavers
- ◆ Pictures that you can use as caller pictures in directory entries (Vcard pictures).

The **Resource Directory** supports the following file formats:

Type	Format	Size
Sounds	mp3	Max. 2 MB
Pictures	JPG	
– Pictures	320 x 240 pixels	Max. 250 KB
– Vcard pictures (CLIP)	64 x 78 pixels	Max. 250 KB

Your phone contains a variety of default sounds and pictures. You can play the available sounds and view the pictures.

You can download other pictures and ringers from the Web configurator into the **Resource Directory** ( → [page 166](#)).

## Managing screensavers

Your phone includes a selection of pictures that can be used as screensavers. You can load your own pictures into the resource directory via the Web configurator .

You can view, rename and delete pictures in the **Resource Directory**.

To use one or more pictures (slide show) as a screensaver, you must activate the screensaver function and select the required picture or set up a slide show ( → [page 89](#)).

Open the list of available pictures via the display menu:

✓ → **Additional Features** → **Resource Directory** → **Screensavers**

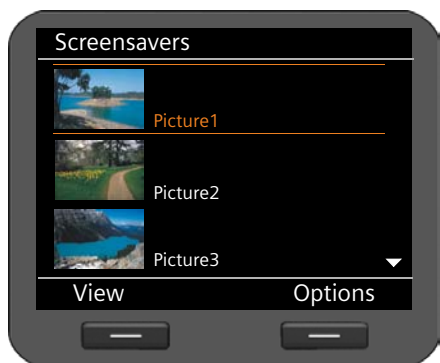

The pictures are alphabetically sorted by name.

### Displaying a picture in large scale:

 Select the picture.

**View** Press the display key.

### Renaming a picture:

**Options** Press the display key.

 Select the **Rename** action.

**OK** Press the display key to confirm the action.

 Enter the name.

**Save** Press the display key.

### Deleting a picture:

**Options** Press the display key.

 Select **Delete**.

**OK** Press the display key to confirm the action. The selected picture is deleted.

You can only delete pictures you have imported yourself, not default pictures.

If you delete a picture that is used as a screensaver, the screensaver function is deactivated.

# Managing caller pictures

Any pictures that you want to use as caller pictures must be saved in the **Resource Directory**. You can add your own pictures to the resource directory using the Web configurator.

A caller picture forms part of the directory entry (vCard). To transfer vCards, the CLIP feature must be enabled by the caller and recipient.

You can view, rename and delete pictures in the **Resource Directory**.

You assign a caller picture from the **Resource Directory** to an entry in your directory → **page 52**.

You open the list of available caller pictures via the display menu:

✓ → **Additional Features** → **Resource Directory** → **Caller Pictures**

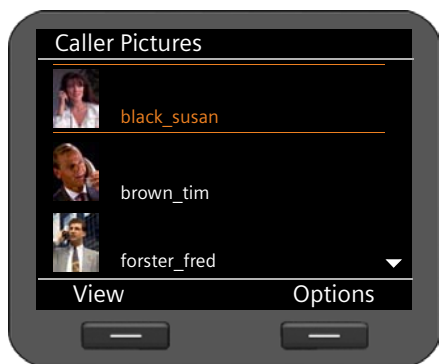

The pictures are alphabetically sorted by name.

### Displaying a picture in large scale:

 Select the picture.

**View** Press the display key.

### Renaming a picture:

**Options** Press the display key.

 Select the **Rename** action.

**OK** Press the display key to confirm the action.

 Enter the name.

**Save** Press the display key.

If you change the name of a picture that is used in a directory entry, it will also be renamed in the directory entry.

### Deleting a picture:

**Options** Press the display key.

 Select **Delete**.

**OK** Press the display key to confirm the action. The selected picture is deleted.

If you delete a picture that is used in a directory entry, it will also be removed from the directory entry.

## Managing sounds

The **Resource Directory** includes a range of sounds that you can use as ringers. You can load your own ringers via the Web configurator (→ [page 166](#))

You can play, rename and delete sounds in the **Resource Directory**.

Sounds can be assigned as ringers via the display menu (→ [page 81](#)).

You open the list of available sounds via the display menu:

✓ → **Additional Features** → **Resource Directory** → **Sounds**



The sounds are alphabetically sorted by name.

### Playing sounds:

 Select a sound.

The sound is played after a few moments.

### Renaming a sound:

**Options** Press the display key.

 Select the **Rename** action.

**OK** Press the display key to confirm the action.

 Enter the name.

**Save** Press the display key.

### Deleting a sound:

**Options** Press the display key.

 Select **Delete**.

**OK** Press the display key to confirm the action. The selected sound is deleted.

You can only delete sounds you have imported yourself, not default sounds.

If you delete a sound that is being used as a ringer, default sound **Sound1** is assigned to all the affected accounts.

## Checking the capacity of the Resource Directory

You can display the available capacity in the **Resource Directory**.

✓ → **Additional Features** → **Resource Directory** → **Capacity**

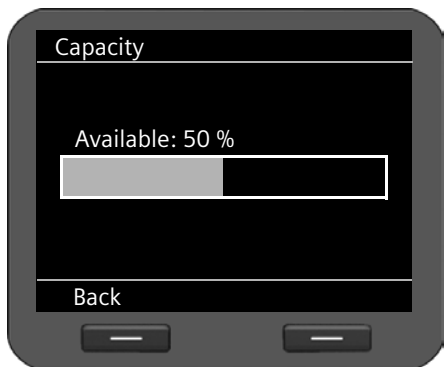

The available capacity is displayed as a percentage.



## Web configurator – configuring the phone on a PC

---

The Web configurator provides you with a user interface that you can use to configure your Gigaset DE700 IP PRO on the PC. The setup assistant makes it easier for you to set your device up for the first time.

**Prerequisite:** Your phone is connected to the local network.

In most cases, this connection is established automatically as soon as you connect the device using a network cable (→ [page 14](#)). If this is not the case, you establish the connection to the local network via the display menu when you set the device up for the first time (→ [page 18](#)).

### Starting the Web configurator

You will need the IP address for your phone. You will find this via the display menu, in the LAN settings for the device:

✓ → **Settings** → **Connectivity** → **Local Network** (→ [page 94](#)).

---

#### Note

The IP address can sometimes change, depending on the settings of the DHCP server in your network.

---

#### Accessing the Web configurator:

- ▶ Launch the Internet browser on your PC.
- ▶ Enter the IP address in the browser's address field:

Example: 

The login screen appears.

- ▶ Select the appropriate language.
- ▶ Select the required user type and enter the corresponding password:

**User**                      If you want to operate your phone on the PC.  
Default password: **user**

**Administrator**        If you want to configure your phone.  
Default password: **admin**

- ▶ Click on **OK**.

The Web configurator will now start.

The following describes all functions of the Web configurator. Please be aware that not all functions are available in **User** mode.

---

#### Note

For your security, you should change the default passwords (→ [page 159](#)).

---

### Launching the Web configurator

In administrator mode: If you have not set up a VoIP account yet, the setup assistant screen will appear (→ [page 108](#)).

If you have already set up a VoIP connection, select the function that you wish to use.

- ◆ Use the **Settings** tab to set or change individual functions on your phone (→ [page 116](#)).
- ◆ Open the **Status** tab to obtain information about the status of your phone (→ [page 170](#)).

### Understanding the Web configurator menu tree

The following illustration shows the Web configurator menu tree.

Only a limited number of functions are available in user mode. These are marked with an asterisk (\*) in the following table.

Configuration Assistant	→ <a href="#">page 108</a>																			
Settings *	Network and Connections	<table border="1"> <tr> <td>LAN Settings</td> <td>→ <a href="#">page 117</a></td> </tr> <tr> <td>Server and Phone Systems</td> <td>→ <a href="#">page 123</a></td> </tr> <tr> <td>QoS Settings</td> <td>→ <a href="#">page 125</a></td> </tr> <tr> <td>VoIP Settings</td> <td>→ <a href="#">page 126</a></td> </tr> <tr> <td>Security Settings</td> <td>→ <a href="#">page 127</a></td> </tr> <tr> <td>OpenVPN Settings</td> <td>→ <a href="#">page 128</a></td> </tr> </table>	LAN Settings	→ <a href="#">page 117</a>	Server and Phone Systems	→ <a href="#">page 123</a>	QoS Settings	→ <a href="#">page 125</a>	VoIP Settings	→ <a href="#">page 126</a>	Security Settings	→ <a href="#">page 127</a>	OpenVPN Settings	→ <a href="#">page 128</a>						
LAN Settings	→ <a href="#">page 117</a>																			
Server and Phone Systems	→ <a href="#">page 123</a>																			
QoS Settings	→ <a href="#">page 125</a>																			
VoIP Settings	→ <a href="#">page 126</a>																			
Security Settings	→ <a href="#">page 127</a>																			
OpenVPN Settings	→ <a href="#">page 128</a>																			
	Telephony *	<table border="1"> <tr> <td>Connections</td> <td>→ <a href="#">page 132</a></td> </tr> <tr> <td>Audio</td> <td>→ <a href="#">page 136</a></td> </tr> <tr> <td>Ring Tones *</td> <td>→ <a href="#">page 137</a></td> </tr> <tr> <td>Call Divert *</td> <td>→ <a href="#">page 138</a></td> </tr> <tr> <td>Local Settings</td> <td>→ <a href="#">page 138</a></td> </tr> <tr> <td>Dialling Plans</td> <td>→ <a href="#">page 140</a></td> </tr> <tr> <td>Do Not Disturb *</td> <td>→ <a href="#">page 141</a></td> </tr> <tr> <td>Call Live Recording</td> <td>→ <a href="#">page 141</a></td> </tr> <tr> <td>Voice Mail Services</td> <td>→ <a href="#">page 142</a></td> </tr> </table>	Connections	→ <a href="#">page 132</a>	Audio	→ <a href="#">page 136</a>	Ring Tones *	→ <a href="#">page 137</a>	Call Divert *	→ <a href="#">page 138</a>	Local Settings	→ <a href="#">page 138</a>	Dialling Plans	→ <a href="#">page 140</a>	Do Not Disturb *	→ <a href="#">page 141</a>	Call Live Recording	→ <a href="#">page 141</a>	Voice Mail Services	→ <a href="#">page 142</a>
Connections	→ <a href="#">page 132</a>																			
Audio	→ <a href="#">page 136</a>																			
Ring Tones *	→ <a href="#">page 137</a>																			
Call Divert *	→ <a href="#">page 138</a>																			
Local Settings	→ <a href="#">page 138</a>																			
Dialling Plans	→ <a href="#">page 140</a>																			
Do Not Disturb *	→ <a href="#">page 141</a>																			
Call Live Recording	→ <a href="#">page 141</a>																			
Voice Mail Services	→ <a href="#">page 142</a>																			
	Messaging	<table border="1"> <tr> <td>E-mail</td> <td>→ <a href="#">page 142</a></td> </tr> <tr> <td>MWI Light</td> <td>→ <a href="#">page 144</a></td> </tr> </table>	E-mail	→ <a href="#">page 142</a>	MWI Light	→ <a href="#">page 144</a>														
E-mail	→ <a href="#">page 142</a>																			
MWI Light	→ <a href="#">page 144</a>																			
	Services	<table border="1"> <tr> <td>IP Info Services</td> <td>→ <a href="#">page 145</a></td> </tr> <tr> <td>Internet Radio</td> <td>→ <a href="#">page 148</a></td> </tr> <tr> <td>Door Interphone</td> <td>→ <a href="#">page 148</a></td> </tr> <tr> <td>Online Directory</td> <td>→ <a href="#">page 150</a></td> </tr> <tr> <td>LDAP</td> <td>→ <a href="#">page 151</a></td> </tr> </table>	IP Info Services	→ <a href="#">page 145</a>	Internet Radio	→ <a href="#">page 148</a>	Door Interphone	→ <a href="#">page 148</a>	Online Directory	→ <a href="#">page 150</a>	LDAP	→ <a href="#">page 151</a>								
IP Info Services	→ <a href="#">page 145</a>																			
Internet Radio	→ <a href="#">page 148</a>																			
Door Interphone	→ <a href="#">page 148</a>																			
Online Directory	→ <a href="#">page 150</a>																			
LDAP	→ <a href="#">page 151</a>																			

	Function Keys *	→ <a href="#">page 154</a>
System *	Date and Time	→ <a href="#">page 158</a>
	Security *	→ <a href="#">page 159</a>
	Display *	→ <a href="#">page 160</a>
	Local Contacts *	→ <a href="#">page 163</a>
	All Calls *	→ <a href="#">page 165</a>
	Upload Tones and Pictures *	→ <a href="#">page 166</a>
	Reboot and Reset	→ <a href="#">page 167</a>
	Save and Restore	→ <a href="#">page 167</a>
	Firmware Update	→ <a href="#">page 168</a>
Status	Device	→ <a href="#">page 170</a>
	System Log	→ <a href="#">page 170</a>
	SIP Protocol	→ <a href="#">page 171</a>
	PCAP Logging	→ <a href="#">page 171</a>
	Storage Allocation	→ <a href="#">page 171</a>

## Running the setup assistant

This assistant will help you to configure your phone. It will guide you through all the important steps involved in:

- Configuring your phone connections
- Configuring your e-mail account

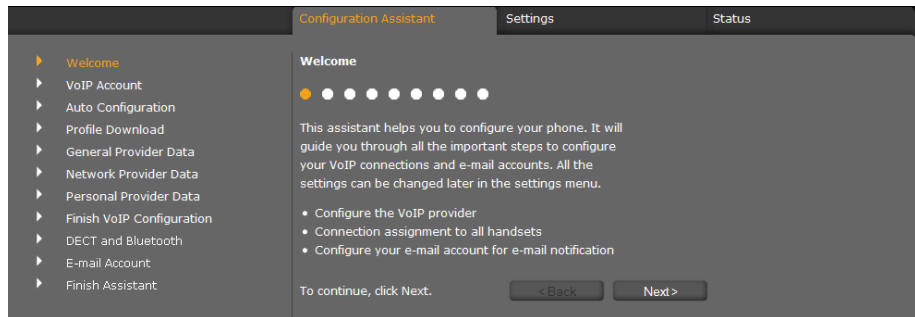

Afterwards, you will be able to change all the settings that you create using the setup assistant in the **Settings** tab (→ [page 116](#)).

When you have completed the fields on a screen, click on **Next >**.

If you want to go back a screen to change something, click on **< Back**. Use **Cancel** to close the setup assistant.

- ▶ Make sure that you have the registration data for your VoIP provider to hand before you begin the configuration.
- ▶ Click on **Next >** to begin the configuration.

## Configuring a VoIP account

You have the following options for configuring a VoIP account:

### Auto Configuration

Configuration is completed without you needing to enter any information. Your VoIP provider must permit this for your account.

### Profile Download

Your provider's default settings are used. You only have to enter your personal registration data.

### Manual configuration

You configure all the settings yourself.

## Automatic configuration

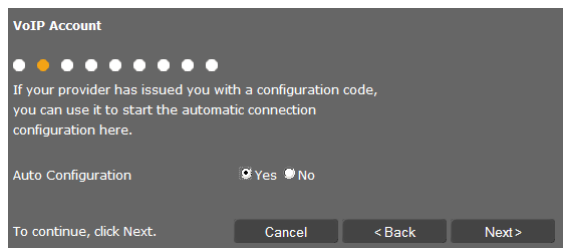

- ▶ Select **Yes** if your provider permits automatic configuration for your account and click on **Next >**.

The automatic configuration is now carried out. This may take a few minutes. Once the process is complete, the → **Completing configuration** screen will appear.

## Configuration via provider profile

If your provider does not enable automatic configuration, your Gigaset DE700 IP PRO offers a range of provider profiles that make it easy for you to configure your VoIP accounts. Each profile contains the most important configuration settings for the provider concerned.

- ▶ Click on **No** if automatic configuration is not permitted and then click on **Next >**.
- ▶ The **Auto Configuration** screen will guide you through the rest of the process. Click on **Next >**.

The **Profile Download** screen will appear.

- ▶ Click on **Next >** to start the configuration.
- ▶ Select your **Country** and click on **Next >**.
- ▶ Select your **Provider** and click on **Next >**.

The most important configuration settings will now be loaded.

The next step is for you to enter → **Personal provider data**.

## Web configurator – configuring the phone on a PC

### Configuration without provider profile

If your provider is not on the list, select **Other Provider**.

- ▶ Select the required settings for your VoIP account on the following screens. Your provider will supply you with this data.

### General provider data

#### Domain

Specify the last part of your SIP address (URI).

Example: Example: For the SIP address **987654321@provider.de** you would enter **provider.de**.

#### Proxy Server Address

The SIP proxy is your VoIP provider's gateway server. Enter the IP address or the DNS name of your SIP proxy server.

Example: **myprovider.com**.

#### Proxy Server Port

Enter the number of the communication port that the SIP proxy uses to send and receive signalling data (SIP port). Port 5060 is used by most VoIP providers.

#### Registration Server

Enter the IP address or the DNS name of your registrar server. The registrar is needed when the phone is registered. It assigns your SIP address (username@domain) to the public IP address/port number your phone uses to log in. With most VoIP providers, the registrar server is identical to the SIP server.

Example: **reg.myprovider.de**.

#### Registration Server Port

Enter the communication port used on the registrar. Port 5060 is used in most cases.

#### Registration Refresh Time [sec]

Enter the time intervals at which the phone should repeat the registration with the VoIP server (SIP proxy) (a request will be sent to establish a session). The repeat is required so that the phone's entry in the tables of the SIP proxy is retained and the phone can therefore be reached. The repeat will be carried out for all activated VoIP phone numbers. The default is 120 seconds.

If you enter 0 seconds, the registration will not be repeated periodically.

- ▶ Click on **Next >**.

## Network provider data

The phone needs to know its public address in order to receive caller voice data.

The SIP protocol recognises the following options:

- ◆ The phone requests the public address from a STUN server on the Internet (Simple Transversal of UDP over NAT). STUN can only be used with asymmetric NATs and non-blocking firewalls.
- ◆ The phone does not direct the connection request to the SIP proxy but to an outbound proxy on the Internet that supplies the data packets along with the public address.

The STUN server and outbound proxy are used alternately to work around the NAT/firewall in the router/gateway.

- ▶ Enter the required data for the STUN server **or** outbound proxy:

### STUN enabled

Select **Yes** if you want your phone to use STUN as soon as it is used on a router with asymmetric NAT.

### STUN Server Address

Enter the DNS name or the IP address of the STUN server on the Internet. If you have selected **Yes** in the **STUN enabled** field, then you must complete this field.

### STUN Server Port

Enter the number of the communication port on the STUN server.  
The default port is 3478.

### STUN Refresh Time [sec]

Enter the time intervals (seconds) at which the phone should repeat the registration with the STUN server. The repeat is required so that the phone's entry in the tables of the STUN server is retained. The repeat will be carried out for all activated VoIP phone numbers. Ask your VoIP provider for the STUN refresh time if necessary. Default setting: 30 seconds.

### NAT Refresh Time [sec]

Specify the intervals at which you want the phone to update its entry in the NAT routing table. Specify an interval in seconds that is a little shorter than the NAT session timeout. As a rule you should not change the default value for the NAT update. Default setting: 20 seconds.

### Outbound Proxy Mode

Specify when the outbound proxy should be used.

- |                      |  |
|----------------------|--|
| <b>Always</b>        | All signalling and voice data sent by the phone is sent to the outbound proxy.   |
| <b>Automatically</b> | Data sent by the phone is only sent to the outbound proxy when the phone is connected to a router with symmetric NAT or a blocking firewall. If the phone is behind an asymmetric NAT, the STUN server is used. If you have set <b>STUN enabled</b> to <b>No</b> , or if you have not entered a STUN server, the outbound proxy will be used in all cases. |
| <b>Never</b>         | The outbound proxy is not used.  |

If you leave the **Outbound Server Address** field empty, the phone does not respond to the selected mode and operates as if **Never** were selected.

## Web configurator – configuring the phone on a PC

### Outbound Server Address

Enter the DNS name or the IP address of your provider's outbound proxy. With many providers, the outbound proxy is identical to the SIP proxy.

### Outbound Proxy Port

Enter the number of the communication port used by the outbound proxy. The default port is 5060.

### Automatic Negotiation of DTMF Transmission

DTMF signalling is required, for example, for querying and controlling certain network mailboxes via digit codes or for remote operation of the local answering machine. Select whether the setting should be made automatically. If you select **No**, you must determine the setting for the DTMF transfer yourself.

### Send Settings for DTMF Transmission

To send DTMF signals via VoIP, you must define how the key codes are to be converted to DTMF signals and sent:

- Audio** As audible information in the voice channel, i.e., it is not known which key has been pressed.
- RFC 2833** As a value (= key pressed) in an RTP packet.
- SIP Info** As an "SIP Info" message.  
The value (= key pressed) is sent as an SIP data packet.

Ask your VoIP provider which type of DTMF transmission it supports.

- ▶ Click on **Next** >.



## Personal provider data

In both cases of manual configuration, with and without a provider profile, you now enter the personal registration data that you have received from your VoIP provider.

- ▶ Enter the following data:
  - **Authentication Name**
  - **Authentication Password**
  - **Username**
  - **Display Name**

You can also enter a name of your choice for this phone connection. This is advisable if you use multiple VoIP accounts.

- ▶ Enter a **Connection Name**.
- ▶ Click on **Next >** to finish configuring the VoIP account.

## Completing configuration

The data for the configured VoIP account is displayed.

- ▶ To change the settings, click on **< Back**.
- ▶ If you want to configure another VoIP account, check the relevant box. In this case, the Web configurator will return to the start screen when you press **Next >** ( → **Configuring a VoIP account**).
- ▶ Click on **Finish** to end the setup assistant.
- ▶ Click on **Next >** to
  - Configure another VoIP account
  - Configure an e-mail account

## Configuring an e-mail account

Your phone can notify you when new e-mail messages have been received on your incoming e-mail server. You can connect to the incoming e-mail server and display the sender, date/time of receipt, subject and body of the message for every e-mail message in the incoming e-mail list.

### Prerequisites:

- You have set up an e-mail account with an ISP.
  - The incoming e-mail server uses the POP3 protocol.
- ▶ Select **Yes** if you want to configure an e-mail account and click on **Next >**.

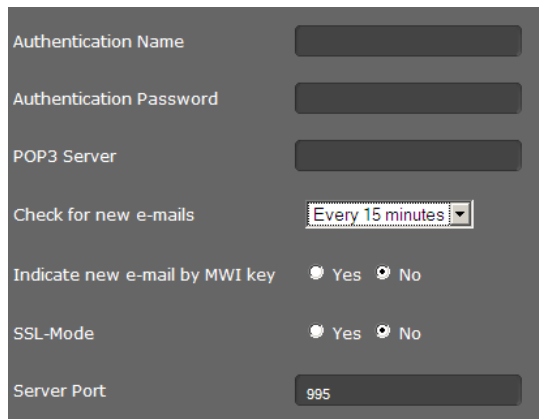

Authentication Name

Authentication Password

POP3 Server

Check for new e-mails

Indicate new e-mail by MWI key  Yes  No

SSL-Mode  Yes  No

Server Port

- ▶ Enter the data for your e-mail account:

- **Authentication Name**
- **Authentication Password**
- **POP3 Server**

You will have received this data from your provider when you set up your e-mail account.

- ▶ Select how often you want new e-mails to be retrieved. You can choose from values between **Every 15 minutes** and **Once per day**.
- ▶ Select whether new e-mails should be displayed via the Message Centre key  on your phone ( → [page 67](#)).
- ▶ Select whether e-mails should be transmitted via a **Security Connection (SSL)**. Indicate the **Server Port** for the secure connection. In this case you can only access the message via the display menu, not via the Message Centre key ( → [page 64](#)).
- ▶ Click on **Next >**.

---

### Note

You can configure additional settings for e-mail messages on the **Settings** tab ( → [page 142](#)).

---

## Closing the assistant

You have now successfully configured your phone using the Web configurator. The following data is displayed once again:

- The number of VoIP accounts configured
  - The name of the default account for outgoing calls
  - E-mail notification configured: **Yes** or **No**
- ▶ Click on **Finish** to close the assistant and apply the settings.
- ▶ Click on < **Back** if you want to make changes to your settings.

## Configuring phone settings via the Web configurator

---

The **Settings** menu of the Web configurator allows you to change settings that you have already made using the phone's display menu or the assistant, or that were the default settings when the phone was delivered. You also have further configuration options.

The menu offers the following functions:

◆ **Network and Connections** ( → [page 117](#))

Configure the settings for the local network, server and PABX, set up other VoIP accounts and create the security settings.

You can also set up your phone as an OpenVPN client in a virtual private network here.

◆ **Telephony** ( → [page 132](#))

Edit your configured VoIP accounts, optimise the quality of the voice connections, configure phone functions such as call divert and dialling plans and set up blacklists and voice mail services.

◆ **Messaging** ( → [page 142](#))

Configure settings for receiving e-mail and configure the Message Centre (MWI) for your device.

◆ **Services** ( → [page 145](#))

Select info services and Internet radio stations for your info centre, set up a door interphone and configure settings for using directories.

◆ **Function Keys** ( → [page 154](#))

Assign frequently used functions to the programmable keys on your phone.

◆ **System** ( → [page 158](#))

Change the basic settings on your phone, e.g., date/time or display settings. You can also restart the system or add new firmware.

## Network and connectors

All of the settings for connecting your phone to the local network must be correct to enable communication with other devices in the network and phone calls via the Internet.

If you use the Web configurator, your phone is already connected to the local network. You can use the **Network and Connections** menu to change and extend these settings. You can also configure additional VoIP accounts and create settings for phone connections:

- ◆ LAN settings ( → [page 117](#))
- ◆ Server and phone systems ( → [page 123](#))
- ◆ VoIP settings ( → [page 126](#))
- ◆ Security settings ( → [page 127](#))
- ◆ OpenVPN settings ( → [page 128](#))

### LAN settings

---

#### Warning

If an error occurs when you are changing the LAN settings, the PC connection to the phone may be cancelled and you will no longer have access to the Web configurator.

If this happens, you must re-establish phone access to the local network via the display menu ( → [page 94](#)).

---

Settings → Network and Connections → LAN Settings

#### Assigning the network address

##### Network Type

- ▶ Select the IP protocol that is used in your network (**IPv4** or **IPv6**).

You may be asked to configure additional settings depending on your selection.

## Configuring phone settings via the Web configurator

### IPv4 configuration

- ▶ Select **Dynamic** if your device receives the IP address via a DHCP server.
- ▶ Select **Static** if your device receives a fixed IP address.

If the **Dynamic** setting is selected, all further settings are configured automatically. They are displayed and cannot be changed.

If you selected **Static** as the address type, you must configure the following settings:

The screenshot shows a configuration form with the following fields and values:

Field	Value
IP Address Type	Static
IP Address	192 . 168 . 2 . 101
Subnet Mask	255 . 255 . 255 . 0
Standard Gateway	192 . 168 . 2 . 1
Preferred DNS Server	
Alternate DNS Server	

### IP Address

Enter an IP address for your phone. This IP address allows your phone to be reached by other subscribers in your local network (e.g., PC).

The IP address comprises four individual groups of numbers with decimal values from 0 to 255 that are separated by a dot, e.g., 192.168.2.1.

The following should be observed:

- The IP address must be included in the address block used by the router/gateway for the local network. The valid address block is defined by the IP address for the router/gateway and the subnet mask (see example).
- The IP address must be unique across the network, which means that it must not be used by another device connected to the router/gateway.
- The fixed IP address must not belong to the address block that is reserved for the DHCP server for the router/gateway.

Check the settings on the router or ask your network administrator.

#### Example:

Router IP address:	192.168.2.1
Network subnet mask	255.255.255.0
DHCP server address block	192.168.2.101 – 192.168.2.255
Possible IP addresses for the phone	192.168.2.2 – 192.168.2.100

### Subnet Mask

The subnet mask specifies how many parts of an IP address the network prefix must comprise.

For example, 255.255.255.0 means that the first three parts of an IP address must be the same for all devices in the network, while the last part is specific to each device. In subnet mask 255.255.0.0, only the first two parts are reserved for the network prefix. Enter the subnet mask that is used by your network.

### Standard Gateway

Enter the IP address for the standard gateway through which the local network is connected to the Internet. This is generally the local (private) IP address for your router/gateway (e.g., 192.168.2.1). Your phone requires this information to be able to access the Internet.

### Preferred DNS Server

Enter the IP address for the preferred DNS server. DNS (Domain Name System) allows you to assign public IP addresses to symbolic names. The DNS server is required to convert the DNS name into the IP address when a connection is being established to a server.

You can specify the IP address for your router/gateway here. This forwards address requests from the phone to its DNS server.

There is no default setting for a DNS server.

### Alternate DNS Server

Enter the IP address for the alternate DNS server that should be used in situations where the preferred DNS server cannot be reached.

## IPv6 configuration

### IP Address Type

- ▶ Select **Auto Configuration** if your device receives the IP address via a DHCP server.
- ▶ Select **Static** if your device receives a fixed IP address.

If the **Auto Configuration** setting is selected, all further settings are configured automatically. They are displayed here and cannot be changed.

If you selected **Static** as the address type, you must configure the following settings:

IP Address Type	<input type="text" value="Static"/>
IP Address	<input type="text"/>
Prefix Length	<input type="text" value="64"/>
Preferred DNS Serve	<input type="text"/>
Alternate DNS Server	<input type="text"/>

## Configuring phone settings via the Web configurator

### IP Address

Enter an IP address for your phone. This IP address allows your phone to be reached by other subscribers in your local network (e.g., PC).

The IP address comprises 128 bits and is represented by eight blocks of hexadecimal figures from 0 to FFFFFFFF that are separated by a colon, e.g., 2001:b021:189:0:205:5dff:fe6b:87.

The IP address comprises a prefix and an interface identifier. The length of the prefix (usually 64 bits) is determined by the **Prefix Length** value.

### Prefix Length

The prefix length stipulates how many bits of the IP address are used for the network prefix. Enter the prefix length that is used in your network.

### Preferred DNS Server

Enter the IP address for the preferred DNS server. DNS (Domain Name System) allows you to assign public IP addresses to symbolic names. The DNS server is required to convert the DNS name into the IP address when a connection is being established to a server.

You can specify the IP address for your router/gateway here. This forwards address requests from the phone to its DNS server.

There is no default setting for a DNS server.

### Alternate DNS Server

Enter the IP address for the alternate DNS server that should be used in situations where the preferred DNS server cannot be reached.



## VLAN tagging

A local network can be divided into logical subnetworks known as VLANs (VLAN = Virtual Local Area Network, Standard IEEE 802.1Q). Multiple VLANs share a physical network and its components, e.g., switches. Data packets from a VLAN are not forwarded to another VLAN. VLANs are often used to separate the data traffic of different services (Internet telephony, Internet TV etc.) and to define different priorities for the data traffic.

You can operate your phone and a PC connected to the PC port on your phone in two different VLANs. In this case, you enter the VLAN identifiers (VLAN tags) for your VLAN. Your network operator will supply you with this data.

---

### Warning

If you operate the PC in a different VLAN from the phone, you will no longer have direct access to the Web configurator of the phone from the PC.

---

► Select one of the following options for **Use VLAN Tagging**:

- No**                      If you are not using a VLAN (default).
- LAN Port only**        If you are operating the phone and PC in the same VLAN.
- LAN and PC Port**     If you are operating the phone and PC in different VLANs.

### VLAN Tagging

You should receive the tagging values of a virtual LAN from your provider. Wrong settings will require hardware reset.

Use VLAN Tagging      LAN and PC Port ▼

VLAN LAN Port

VLAN Identifier (1..4094)     

Voice Priority            1 ▼

Data Priority             0 ▼

VLAN PC Port

VLAN Identifier (1..4094)     

VLAN Priority            1 ▼

## Configuring phone settings via the Web configurator

- ▶ Enter the VLAN identifier for your virtual network in the **VLAN Identifier (1..4094)** field. When selecting **LAN and PC Port**, enter the different VLAN identifiers under **VLAN LAN Port** and **VLAN PC Port**.  
Value range: 1 – 4094

---

### Warning

If you enter the wrong value for **VLAN Identifier (1..4094)**, you will need to restore the phone to the default settings ( → [page 92](#)). You will then need to reinstate the phone's access to the local network ( → [page 94](#)).

---

- ▶ Select the required priorities for voice and data transmission for the LAN port from the **Voice Priority** and **Data Priority** menus.
- ▶ If you selected **LAN and PC Port**, select the **VLAN Priority** for the transmission of PC data as well.

## Prioritising VLANs

Data packets from VLANs can be prioritised. The priority determines whether the data traffic from a VLAN is given preferential treatment by the network components. You can define the priority for voice and data separately. In the case of a local network with a lot of data traffic, you can achieve better quality phone connections by giving a high priority to voice data. Using a high priority for data services you can achieve better quality for displaying info services such as webcam images or maps.

Range of values and assignment of values to service classes (according to IEEE 802.1p):

- 0 No priority (Best Effort)
- 1 Background services, e.g., news ticker (Background)
- 2 Not defined
- 3 General data services (Excellent Effort)
- 4 Control services, e.g., routing (Controlled Load)
- 5 Video
- 6 Voice data (Voice)
- 7 Top priority for network control software (Network Control)

---

### Note

Further options for optimising the voice quality are available under **QoS settings (Quality of Service)** → [page 125](#).

---

## Saving settings

- ▶ Click on **Save** to save your settings on the **LAN Settings** screen.

## Server and phone systems

If you operate a separate HTTP server or a phone system in your local network, use this screen to configure access to your phone.

**Settings** → **Network and Connections** → **Server and Phone Systems**

### Configure HTTP proxy

- ▶ Select whether you want to enable a separate proxy server in the network for your phone.
- ▶ If **Yes**, enter the IP address for the proxy server in the **Proxy Server Address** field.
- ▶ The default setting for the **Proxy Server Port** is 80. Change this if your server uses a different port.

### Own HTTP server settings

- ▶ If you operate your own HTTP server, enter the communication data.

#### HTTP Port

Enter the number for the port to be used for communication by the HTTP server. The default setting is 80.

#### HTTPS Port

Enter the number for the port to be used for secure connections by the HTTP server. The default setting is 443.

#### HTTP Connection Type

Select which connections can be established:

- HTTP**                      Unsecured connection
- HTTPS**                    Secure connection
- HTTP + HTTPS**          Both secure and unsecured connections

#### Automatic logout [min]

Enter the time (in minutes) after which an HTTP connection should automatically end if no entries are made.

## Phone Systems

If your phone is connected to a phone system, select what type of phone system it is.

### Connected with phone system (sample selection)

- Standard**                      The phone is connected to any phone system.
- Gigaset T500/300**              The phone is connected to a Gigaset T500 PRO or Gigaset T300 PRO.

**HiPath**

...

## Configuring phone settings via the Web configurator

### Call Manager

If your phone is connected to a Gigaset phone system:

- ▶ Select if you would like to automatically accept calls transferred by the phone system's call manager. You have the following options:
  - **via Headset**
  - **via Handsfree** or
  - **not at all (No)**

### Saving settings

- ▶ Click on **Save** to save your settings on the **Server and Phone Systems** screen.

## QoS settings (Quality of Service)

On this screen you can optimise the voice quality of your IP telephone.

The voice quality depends on the priority of the voice data in the IP network. Prioritising the VoIP data packets is done using the QoS protocol DiffServ (Differentiated Services). DiffServ defines a number of classes for the quality of service and, within these classes, various priority levels for which specific prioritisation procedures are defined.

You can specify different QoS values for SIP and RTP packets. SIP packets (Session Initiation Protocol) contain the signalling data, while RTP (Real-time Transport Protocol) is used for the voice transfer.

**Settings** → **Network and Connections** → **QoS Settings**

**VoIP Quality of Service (QoS)**

Type of Services / Differentiated Services

SIP ToS/Diffserv (0..63)

RTP ToS/Diffserv (0..63)

- ▶ Enter your chosen QoS values in the **SIP ToS/Diffserv (0..63)** and **RTP ToS/Diffserv (0..63)** fields. Value range: 0 - 63.

Common values for VoIP (default setting):

SIP	34	High service class for fast switching of the data flow (Expedited Flow)
RTP	46	Highest service class for fast forwarding of data packets (Expedited Forwarding)

---

### Warning

Do not change these values without consulting your network operator first. A higher value does not necessarily mean a higher priority. The value determines the service class, not the priority. The prioritisation procedure used in each case meets the requirements of this class and is not necessarily suitable for transferring voice data.

Detailed information on the DiffServ protocol can be found in [RFC 2474](#) and [RFC 3168](#).

---

### Saving settings

- ▶ Click on **Save** to save your settings on the **QoS Settings** screen.

### VoIP settings

On this screen you configure the ports for establishing VoIP connections.

Settings → Network and Connections → VoIP Settings

#### "Listen ports" for VoIP connections

"Listen ports" for VoIP connections

Use random ports  Yes  No

SIP port

RTP port

ICE enabled  Yes  No

- ▶ Select the ports on which your phone expects incoming VoIP connections.

#### Use random ports

- ▶ Select **Yes** if the phone should use any available ports for the SIP port and RTP port instead of fixed ports.

The use of random ports is advisable if you want multiple phones to be operated on the same router/gateway with NAT. The phones must then use different ports so that the NAT for the router/gateway is only able to forward incoming calls and voice data to one (the intended) phone.

- ▶ If you click on **No**, the phone uses the ports specified in **SIP port** and **RTP port**.

#### SIP port

Specify the local communication port that the phone should use to send and receive signalling data. Specify a number between 1024 and 49152. The default port number for SIP signalling is 5060.

#### RTP port

Specify the local communication port that the phone should use to receive voice data. Enter an even number between 1024 and 49152. The port number must not be the same as the port number in the SIP port field. If you enter an odd number, the next lowest even number will be selected automatically (e.g., if you enter 5003, then 5002 is set automatically). The default port number for voice transmission is 5004.

#### ICE enabled

Choose whether or not to use ICE (Interactive Connectivity Establishment). ICE is similar to STUN (→ [page 111](#)) a Session Initiation Protocol (SIP) method for overcoming NAT firewalls.

#### Saving settings

- ▶ Click on **Save** to save your settings on the VoIP Settings screen.

## Security settings

This screen is where you create security settings for your phone.

**Settings** → **Network and Connections** → **Security Settings**

### Remote management

- ▶ Select whether you want to **Allow access from other networks to the WEB configurator** (**Yes**) or not (**No**).

If you permit **Remote Management**, this increases the risk of unauthorised access to your device settings.

- ▶ Select the network protocol to be used for the communication:
  - **TLS** (Transport Level Security)
  - **UDP** (User Datagram Protocol)
  - **UDP** (Transmission Control Protocol)

### Security settings

On this screen you can download server certificates onto your phone, delete downloaded certificates and specify how invalid certificates should be handled.

Server certificates allow a server to be digitally identified via SSL (Secure Sockets Layer). Operating a server with SSL requires a server certificate both for one-way authentication (server to the client) and for two-way authentication (between client and server). A server certificate has to be downloaded onto your device so that the device can carry out authentication.

The **Server Certificates** and **CA Certificates** lists contain all downloaded certificates.

- ▶ Select a certificate from one of the lists.
- ▶ Click on **Remove** to delete the certificate from the list.
- ▶ Click on **Details** to display information about the certificate.

### Import a local certificate

In order for a certificate to be downloaded to your phone, it must be available in your network.

- ▶ Click on **Browse** to search for the file on your PC or in your network. Select the required file.
- ▶ Click on **Upload** to download the file onto the device.

---

#### Note

The connection to the handset may be interrupted when transferring or removing a certificate.

---

### Invalid Certificates

The list contains all invalid certificates.

- ▶ Select a certificate from the list.
- ▶ Click on **Accept** to accept the certificate anyway.
- ▶ Click on **Reject** to reject the certificate.

## Configuring phone settings via the Web configurator

### Secure Real Time Protocol (SRTP)

The Secure Real-Time Transport Protocol (SRTP) allows you to encrypt voice data transmitted using the Real-Time Transport Protocol (RTP).

- ▶ Activate or deactivate the **Secure Real Time Protocol (SRTP)**.
- ▶ Select whether you want to **Accept Non-SRTP Call** or not. If this function is activated, you also accept incoming calls from a number that does not use SRTP.
- ▶ In the **Pre-Shared Key for SRTP** field, enter the password for the encryption/authentication via SRTP.

### Saving settings

- ▶ Click on **Save** to save your settings on the **Security Settings** screen.

## OpenVPN settings

You can use OpenVPN to set up a virtual private network (VPN) to conduct secure communication over an encrypted connection. The security protocols are based on the OpenSSL protocols SSL (Secure Sockets Layer) and TLS (Transport Layer Security). OpenVPN creates a VPN tunnel in which remote access to devices and resources of the private network is only possible for authorised devices. Communication between devices in the VPN only takes place within this tunnel. Additional functions, such as STUN for bypassing NAT, for example, are not required.

You can configure your Gigaset DE700 IP PRO as an OpenVPN client.

**Prerequisite:** An OpenVPN network has been set up. You will require the address of the OpenVPN server and the authentication data (certificate and key).

**Settings** → **Network and Connections** → **OpenVPN Settings**

**OpenVPN Settings**

OpenVPN  On  Off

Interface

Protocol

Server Address

Server Port

LZO compression  Yes  No

- ▶ If you would like to configure your phone as an OpenVPN client, select the **On** option next to **OpenVPN**.



- ▶ Select which virtual driver to use from the **Interface** list.
  - TUN** For a routed IP tunnel (routing mode). TUN simulates a point-to-point network device and communicates via IP packets.
  - TAP** For an Ethernet IP tunnel (bridge mode). TUN simulates an Ethernet device and communicates via Ethernet frames.
- ▶ Select the transport protocol to be used for communication from the **Protocol** list. The options are **TCP** or **UDP**.
- ▶ Enter the IP address or domain name of the OpenVPN server in the **Server Address** field.
- ▶ Enter the port number for the tunnel in the **Server Port** field. The default setting is 1194.
- ▶ If the data of the virtual connection should be compressed, select the option **Yes** for **LZO compression**.

### Authentication

Authentication for devices that wish to join a VPN takes place using a certificate. The implementation of certificate-based authentication over the TLS protocol uses public/private key pairs or X.509 certificates. The server and user each possess an individual certificate (public/private). The OpenVPN server only allows connections signed by a known certification authority.

The following encryption protocols can also be used.

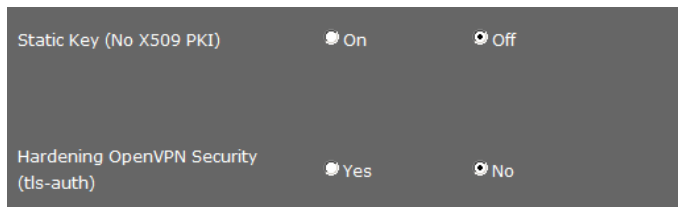

- ▶ Activate the required protocols:
  - Static Key (No X509 PKI)**

Simple encryption protocol (one client, one server). A static key is generated from the IP addresses of the server and client.

    - ▶ Enter the IP address of the OpenVPN server in the **Remote Tunnel IP** field.
    - ▶ Enter the IP address of your phone in the OpenVPN in the **Local Tunnel IP** field.
  - Hardening OpenVPN Security (tls-auth)**

In this encryption protocol, all data packets are provided with an additional signature (HMAC signature = Keyed-Hash Message Authentication Code).

## Configuring phone settings via the Web configurator

### DHCP relay

This function makes it possible for a DHCP server on the other side of the VPN tunnel to assign the IP address for the VPN to your telephone, rather than being assigned one from the IP address pool of the OpenVPN server. This simplifies administration of IP addresses in complex VPN structures, if, for example, all VPN networks need to belong to a single IP subnet.

OpenVPN Server DHCP relay mode  Yes  No

- ▶ Activate the **OpenVPN Server DHCP relay mode** function if you wish to allow a DHCP server on the other side of the VPN tunnel to assign the IP address for the VPN to your telephone.

### Saving settings

- ▶ Click on **Save** to save your settings.

### Loading certificate and key files

In the lower portion of the screen, you can load the certificates and keys for the OpenVPN connection in your telephone or delete certificates and keys that have already been loaded. You will require the **CA Certificates**, the **Client Certificate** and the **Client Key**.

You only require a key file for the **Static Key** or **TA Key (using TLS authentication)** if you are using one of these security protocols.

Certificate and key files must be made available by the OpenVPN server administrator.

#### Upload files

Please package the Root CA(ca.crt), client certificate and private key into a \*.tar file or upload them one by one.

\*.tar file

Browse...

Upload

### Loading a certificate

In order for a certificate to be downloaded to your phone, it must be available in your network. The files can be uploaded individually or together in the form of a tar archive.

- ▶ Select the file you want to upload from the left-hand side, or select **\*.tar file** if you have a tar archive.
- ▶ Click on **Browse** to search for the file on your PC or in your network and select the relevant file.
- ▶ Click on **Upload** to download the file onto the device.

File status		
Static Key		Remove
CA Certificates	/storage/opensvpn/ca.crt	Remove
Client Certificate	/storage/opensvpn/client.crt	Remove
Client Key	/storage/opensvpn/client.key	Remove
TA Key (using TLS authentication)		Remove

The certificates and keys loaded are shown.

- ▶ Click on **Remove** to remove a certificate or key from the list.

# Telephony

The **Telephony** menu provides the following setting options:

- ◆ **Connections** ( → [page 132](#))  
This is where you can configure your VoIP connections and establish new connections.
- ◆ **Voice quality (audio)** ( → [page 136](#))  
On this screen you can optimise the voice quality of your VoIP connections.
- ◆ **Ring Tones** ( → [page 137](#))  
This screen is only available in user mode. This is where you can configure the ringtones for your connections ( → [page 137](#)). In administrator mode, this setting can be found with the configuration data for the connection (**Telephony** → **Connections**).
- ◆ **Call divert** ( → [page 138](#))  
On this screen you can define options for call divert and activate or deactivate this function.
- ◆ **Dialling plans** ( → [page 140](#))  
The Dialling Plans screen is where you can define the use of area codes and VoIP connections for outgoing phone calls and enter the international and local area code for your phone connection.
- ◆ **Do Not Disturb (DND)** ( → [page 141](#))  
You can use the blacklists to block incoming calls from selected numbers and also to block all anonymous calls.
- ◆ **Call records** ( → [page 141](#))  
This is where you define where recordings of conversations are saved.
- ◆ **Voice mail services** ( → [page 142](#))  
On this screen you can configure your network mailbox.

## Connections

You can establish up to 12 telephony connections (VoIP accounts) for your phone, plus a connection for a mobile phone.

### Settings → Telephony → Connections

On this screen you can

- Set up a new connection via **Auto Configuration**
- See the status of the configured connections
- Activate or deactivate individual connections
- Define which of the connections are used by default for outgoing calls
- Change the configuration of connections or establish new connections
- Delete existing connections

## Setting up a new connection via Auto Configuration

- ▶ If you want to set up a new connection and your provider allows automatic configuration for the account, click on **Start**.

When the process is complete, the connection is displayed in the list.

**Auto Configuration**

**Start**

**VoIP Connections**

Name/Provider	Status	Active	Default Send Account
01. Account_001 sipgate	Enabled	<input checked="" type="checkbox"/>	<input checked="" type="radio"/>
02. IP2 Other Provider	Disabled	<input type="checkbox"/>	<input type="radio"/>

## Connections for the Gigaset DE700 IP PRO

The following information is shown for each configured connection:

**Name/ Provider** Name or number of the VoIP connection / Name of the VoIP provider

**Status** Status of the connection. The following statuses are possible:

<b>Registered</b>	The connection is registered with the provider.
<b>Not registered</b>	The connection is not registered with the provider.
<b>Registration failed</b>	An error occurred during registration.
<b>Server not accessible</b>	The registrar server specified during configuration is not available.
<b>Disabled</b>	The connection is disabled.

## Activating/deactivating connections

Only activated connections can be used for Internet telephony.

- ▶ To use a configured connection, select **Active**.

## Specifying a default line for outgoing calls

- ▶ Select **Default Send Account** for the connection that you want to use as the default line for your phone calls. Only one can be selected.

## Configuring phone settings via the Web configurator

### Establishing new connections or editing existing ones

- ▶ Click on **Edit** in the row of a configured connection to change its configuration.
- ▶ Click on **Edit** in a row without a configured connection to establish a new connection.

Only one connection can be configured at a time for mobile phones.

### Configuring the connections

To do this you need the relevant information about your provider for Internet telephony.

- ▶ In the **Connection Name or Number** field enter a name of your choice or the phone number for this connection.
- ▶ Click on **Start Profile Download** to load a provider profile.

An assistant opens to guide you through the next steps.

- ▶ Select your **Country** and in the next step your **Provider**.
- ▶ If your provider is not in the list, select **Other Provider**.
- ▶ Click on **Finish**.

The selected provider profile is loaded.

### Entering personal provider data

Now enter your personal login data that you received from your VoIP provider.

- ▶ Enter the following data:
  - **Authentication Name**
  - **Authentication Password**
  - **Username**
  - **Display Name**

## Advanced Settings

You can find further parameters for configuring your VoIP connection under **Advanced Settings**.

- ▶ Click on **Show** next to **Advanced Settings**.

For further information on configuration settings, please refer to the section **Configuring a VoIP account** on **page 108**.

You can also configure the following settings here:

### Counting missed and accepted calls

Missed and accepted calls for this VoIP account are recorded in the call lists for the phone if this function is activated ( → **page 46**).

- ▶ Open the **Advanced Settings** area.
- ▶ Select **Yes** for **Missed/accepted calls count**, if you wish to activate this function. Default setting: No

### Allowing or blocking Call Waiting

If you receive another incoming call during a call, this is indicated by Call Waiting by default. For each connection, it is possible to set whether or not Call Waiting is permitted.

- ▶ Open the **Advanced Settings** area.
- ▶ Select **No** for **Call Waiting** if you wish to deactivate this function. Default setting: Yes

### Setting the ring tone

You can set a ring tone for each connection.

- ▶ Open the **Advanced Settings** area.
- ▶ Select a **Melody**.
- ▶ Click on **Test** to play the selected melody.

### Saving settings

- ▶ Click on **Save** to save your settings for this connection.

### Deleting a connection

- ▶ Click on **Delete connection** to delete the displayed connection.

### Voice quality (audio)

The voice quality of your VoIP calls is determined by the codec used for the transmission. To increase the quality, more data must be transmitted. Depending on the bandwidth of your DSL connection, this can then lead to problems with the volume of data – especially if two VoIP calls are made simultaneously – so that the transmission no longer takes place smoothly. The following settings allow you to adjust your Gigaset to your individual DSL connection.

#### Settings → Telephony → Audio

You can set the following parameters for the voice quality:

The screenshot shows the 'Voice Quality' configuration page. At the top, 'Packed time for RTP packages [ms]' is set to 20. Below this, 'Voice Quality' has three radio button options: 'Optimised for high bandwidth' (selected), 'Optimised for low bandwidth', and 'Own Codec preference'. The 'Selected codecs' list on the left contains G.722, G.711 μ-law, G.711 a-law, G.726, iLbc, and G.729A. The 'Available codecs' list on the right is empty. Between the lists are buttons for '<Add', 'Remove>', 'Down', and 'Up'. At the bottom, 'Silence Suppression' is set to 'Yes'.

### Time interval for RTP packets

- ▶ Select the interval for sending RTP packets (20 or 30 ms).

RTP (RTP = Real-Time Transport Protocol) is a protocol for the continuous transmission of audiovisual data (streams) via IP-based networks.

### Voice quality

- ▶ Select the voice quality that matches the bandwidth of your DSL connection.
  - **Optimised for high bandwidth**
  - **Optimised for low bandwidth**
  - Select **Own Codec preference** if you want to determine the codecs yourself.

Both parties involved in a phone connection (caller/sender and recipient) must use the same voice codec. The voice codec is negotiated between the sender and the recipient when establishing a connection. You can influence the voice quality by selecting (bearing in mind the bandwidth of your Internet connection) the voice codecs your phone is to use, and specifying the order in which the codecs are to be suggested when a VoIP connection is established.

- ▶ Select the required codecs and define the sequence in which they should be used.



The following voice codecs are supported by your phone:

**G.722** The broadband voice codec G.722 works at the same bit rate as G.711 (64 kbit/s per voice connection) but at a higher sampling rate (16 kHz) and therefore provides excellent sound quality.

### **G.711 a law/G.711 $\mu$ law**

Excellent voice quality (comparable with ISDN). The required bandwidth is 64 kbit/s per voice connection.

**G.726** Good voice quality (inferior to that with G.711 but better than with G.729). Your phone supports G.726 with a transmission rate of 32 kbit/s per voice connection.

**iLbc** Average voice quality. The codec works with 30 ms or 20 ms blocks. The transmission rate is 13.33 kbit/s (30 ms blocks) or 15.2 kbit/s (20 ms blocks).

**G.729A** Average voice quality. The necessary bandwidth is less than or equal to 8 kbit/s per voice connection.

## Silence suppression

Silence suppression means that no data packets are sent during a pause in speaking. This means a lower data volume but call participants may interpret it as an interruption to the connection.

▶ Select **No** if you do not want silence suppression. Default setting: **Yes**

## Saving settings

▶ Click on **Save** to save your settings on the screen.

## Ring Tones

This menu option is only available in user mode. In administrator mode this function can be found under **Settings** → **Telephony** → **Connections** with the configuration data for the connection (→ [page 135](#)).

### **Settings** → **Telephony** → **Ring Tones**

You can set a ring tone for each of your connections.

▶ Select a **Melody**.

▶ Click on **Test** to play the selected melody.

## Saving settings

▶ Click on **Save** to save your settings on the screen.

---

### **Note**

You can download further ring tones to your phone from the PC (→ [page 166](#)).

---

## Configuring phone settings via the Web configurator

### Call divert

For each configured VoIP account you can automatically forward incoming calls to another phone number.

Settings → Telephony → Call Divert

Connection	When	Phone Number
IP 1	<input type="text" value="Off"/>	<input type="text"/>
IP 2	<input type="text" value="Off"/>	<input type="text"/>

► Specify for the VoIP account when a call should be diverted.

**Off** No call divert

**All Calls** Call divert for all incoming calls

**No Answer** Call divert if you do not answer the call

In the **Waiting time for no answer (value range: 1 - 600 sec)** field enter the time in seconds after which call divert is to be activated.

**When Busy** Call divert if you are currently speaking to another participant.

► Enter the **Phone Number** to which calls are to be forwarded.

► Click on **Save** to save your settings on the screen.

### Local settings

On this screen, you provide details about the location of your phone. These are used to determine the international and local area dialling codes as well as country-specific tones (e.g., dialling tone or ringback tone).

Settings → Telephony → Local Settings

Area Codes	
Country	<input type="text" value="Germany"/>
International	
Prefix	<input type="text" value="00"/>
Code Number	<input type="text" value="49"/>
Local	
Prefix	<input type="text" value="0"/>
Code Number	<input type="text"/>

### Selecting the country

The time zone is determined automatically based on the country you select.

- ▶ Select the **Country** in which you are using your phone from the list.

### Setting dialling codes

Depending on your country selection, the international and (if relevant for that country) national dialling codes are entered in the **Prefix** and **Code Number** fields automatically.

If your country is not offered in the list of countries enter the dialling code yourself. Save the complete area code (with international code) for the area in which you are using the phone. In general, you must always dial the area code for VoIP calls – even for local calls. To avoid having to dial the area code for local calls, your phone prefixes all VoIP calls in the local area with the area code entered, i.e., all numbers that do not begin with 0 – even when dialling numbers from the directory and other lists.

**Exceptions:** Numbers for which you have set dialling plans.

- ▶ Select **Other Country** from the end of the **Country** list.
- ▶ Enter the full prefix for the country in which you use your phone. Otherwise errors may occur with phone connections or during data exchange (e.g., between a fixed line network and a mobile network).

The prefix consists of the international prefix (**International: Prefix and Code Number**, e.g. 00 49 for Germany) and, if applicable, the prefix used for calls within the country (**Local: Prefix and Code Number**, e.g. 0 for national long-distance calls in Germany).

### Setting country-specific ringback and dialling tones

Tones, e.g. dialling tone, ringback tone, busy tone or call waiting tone, vary from one country or region to another. You can choose from various tone groups for your phone.

The **Tone Scheme** is automatically determined on the basis of the country selected above. You can change the setting.

- ▶ Select the country or region whose tone scheme should be used for your phone.

### Saving settings

- ▶ Click on **Save** to save your settings on the screen.

### Dialling plans

You can use dialling plans to define which phone numbers should be called using which configured VoIP account and whether an area code should be dialled first.

**Settings → Telephony → Dialling Plans**

Phone Number	Use Area Codes	Connection	Comment	Active
<input type="text"/>	<input type="checkbox"/>	<input type="text" value="IP3"/>	<input type="text"/>	<input type="button" value="Delete"/> <input type="checkbox"/>
<input type="text"/>	<input type="checkbox"/>	<input type="text" value="IP7"/>	<input type="text"/>	<input type="button" value="Delete"/> <input type="checkbox"/>
<input type="text"/>	<input type="checkbox"/>	<input type="text" value="IP5"/>	<input type="text"/>	<input type="button" value="Add"/> <input type="checkbox"/>

- ▶ Enter the **Phone Number** that the dialling plan is to apply to.
- ▶ Select **Use Area Codes** if you want to call this number with an area code.
- ▶ Select the connection that should be used to call this phone number.
- ▶ Enter a name for this dialling plan in the **Comment** field.
- ▶ Click on **Add** to add the rule to the list.
- ▶ Click on **Delete** to delete a rule from the list.
- ▶ Select **Active** if you want to activate the rule.

### Access Code

The prefix is automatically added to numbers during dialling.

- ▶ Define when it should be used:
  - **None** (if you do not use an access code)
  - With numbers from **Directory & Call lists**
  - With **All**

### Saving settings

- ▶ Click on **Save** to save your settings on the **Dialling Plans** screen.

## Do Not Disturb (DND)

Block individual phone numbers and/or all anonymous calls. You will then be unavailable for these calls; your phone will not ring.

Settings → Telephony → Do Not Disturb

- ▶ Select **Yes** to activate the **Do Not Disturb** function.
- ▶ Enter the **Name** and **Phone Number** for the call.
- ▶ Click on **Add** to save the entry to the do not disturb list.
- ▶ Click on **Delete** to delete an entry.
- ▶ Click on **Delete all** to delete all entries.
- ▶ Activate the **Block anonymous caller** option to block all anonymous calls.
- ▶ Click on **Save** to save your settings on this screen.

## Call records

On this screen you define where call records should be saved.

You can start call records with the  REC key (→ [page 38](#)). You can play recorded calls back via the display menu (→ [page 63](#)).

Call records of up to 30 minutes are saved on the phone's internal memory. If your network has a server, you can also save call records there.

Settings → Telephony → Call Live Recording

- ▶ Select where recorded calls should be saved:
  - **at server**: The recording is saved on the SIP server.
  - **at phone**
- ▶ Click on **Save** to save the settings.

### Voice mail services

Some VoIP providers offer answer machines on the network – network mailboxes. These accept incoming calls on the corresponding VoIP phone number. You can access voice mails on the network mailbox via the display menu ( → [page 61](#)) or the Message Centre ( → [page 67](#))

To record all calls, set up a network mailbox for each of your VoIP accounts.

**Settings** → **Telephony** → **Voice Mail Services**

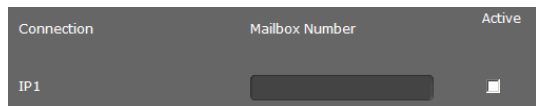

- ▶ Enter the **Mailbox Number** for the VoIP connection and activate the network mailbox.
- ▶ Click on **Save** to save the settings.

### Messaging

The **Messaging** menu provides the following setting options:

#### ◆ **E-mail**

This is where you enter the data for your e-mail account so that you can receive your e-mails on the phone.

#### ◆ **MWI light** ( → [page 144](#))

On this screen you can configure the behaviour of the Message Centre key (MWI = Message Waiting Indication).

### E-mail

Your phone will notify you when new e-mail messages have been received on your incoming e-mail server. You can use your phone to connect to the incoming e-mail server and display the sender, date/time of receipt, subject and body of the message for every e-mail message in the incoming e-mail list.

#### **Prerequisites:**

- ◆ You have set up an e-mail account with an ISP.
- ◆ The incoming e-mail server uses the POP3 protocol.
- ◆ You set up the name of the incoming e-mail server and your personal registration data (account name, password).

If you have already entered the data in the setup assistant, you can change it here.

## Settings → Messaging → E-mail

Authentication Name

Authentication Password

POP3 Server

Check for new e-mails

Delete deleted e-mails from server  Yes  No

Security Connection (SSL)  Yes  No

Server Port

- ▶ Enter the data for your e-mail account that you received from your provider when you set up your e-mail account:
  - **Authentication Name**
  - **Authentication Password**
  - **POP3 Server**
- ▶ Select from the **Check for new e-mail** list to specify how often you want new e-mails to be retrieved. You can choose from various values between **Every 15 minutes** and **Once per day**.
- ▶ Select whether e-mails that you delete on your phone ( → [page 66](#)) should also be deleted on the server. **Default setting:** They are only deleted on the phone.
- ▶ Select whether e-mails should be transmitted via a **Security Connection (SSL)**. If **Yes**, indicate the **Server Port** for the secure connection. In this case you can only access the message via the display menu, not via the Message Centre key ( → [page 64](#)).
- ▶ Click on **Save** to save the settings.

### MWI light

The Message Centre allows you to access your voice mails, missed calls, e-mails and missed alarms at the press of a key (☒) (→ [page 67](#)). This key flashes if a new message has been received. You can switch the flashing on or off for every message type. (MWI = Message Waiting Indication.)

#### Settings → Messaging → MWI Light

Missed Calls	<input checked="" type="radio"/> Yes <input type="radio"/> No
E-Mail	<input checked="" type="radio"/> Yes <input type="radio"/> No
Voice Mail	<input checked="" type="radio"/> Yes <input type="radio"/> No
Missed Alarm	<input checked="" type="radio"/> Yes <input type="radio"/> No
MWI notification	<input checked="" type="radio"/> silent <input type="radio"/> beep

- ▶ Select the message type for which the receipt of a new message should be indicated by a flashing Message Centre key.
  - **Missed Calls**
  - **E-mail**
  - **Voice Mail**
  - **Missed Alarms**
- ▶ Select whether the **MWI notification** (the receipt of a new message) should also be indicated by a beep (**beep**) or only by flashing (**silent**).
- ▶ Click on **Save** to save the settings.



## Services

The **Services** menu offers the following functions:

- ◆ Selecting info services and configuring for the screensaver
- ◆ Activating internet radio and selecting stations ( → [page 148](#))
- ◆ Setting up door interphones ( → [page 149](#))
- ◆ Assigning an online directory ( → [page 150](#))
- ◆ Assigning and configuring an LDAP directory ( → [page 151](#))

### Info services

Information services from an info server can be shown on the phone's display. On this screen you can activate this function and select the info services.

You can call up info services on the phone using the Info Centre key  ( → [page 72](#)), or you can use them as a screensaver ( → [page 89](#)).

**Settings** → **Services** → **IP Info Services**

- ▶ Click on **Yes** next to **Activate Info Services** to allow info services for your phone.

### Selecting an info service for the screensaver

You can select a service from the **News**, **Weather** or **Webcam** category for the screensaver or enter an **XML site**.

First, you should arrange the info services from the **News**, **Weather** and **Webcam** categories at the bottom of the page.

If you wish to offer info services from an XML site, you must provide these in an XML file. The structure of the XML file and the permitted XML tags for an XML site have been described in a specification. You can find this at:

<http://wiki.gigaset.com>.

If you have selected info services, set here which info service should be used as a screensaver.



Please select one info service for screensaver.

News

Weather

Webcam

XML site

Save

- ▶ Select **News**, **Weather**, **Webcam** or **XML site**. Only one can be selected.
- ▶ Select the desired provider for news, the region for weather reports or the webcam from the neighbouring drop-down lists. If you wish to display an XML page, enter the full file path.

## Configuring phone settings via the Web configurator

- ▶ Click on **Save** to save your setting.

### Note

The screensaver is activated via

- ◆ the display menu **Settings** → **Display** → **Screensaver** ( → [page 89](#)) or
- ◆ the Web configurator menu **Settings** → **System** → **Display** ( → [page 160](#)).

## Selecting an info service

### News

You can enter the data for RSS feeds directly or search for RSS feeds in a specific category in a specific country.

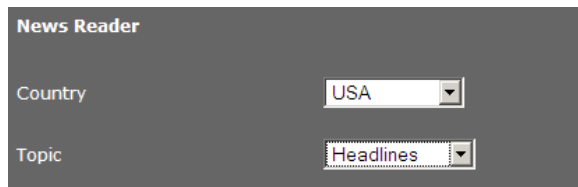

**News Reader**

Country: USA

Topic: Headlines

- ▶ First select the **Country** of the provider of the required RSS feed.
- ▶ Select the news category: **Headlines, Entertainment, Computer, sen, Business, Science and Technology.**

All the RSS feeds that have been found for the selected country and category are shown under **Library of RSS feed providers.**

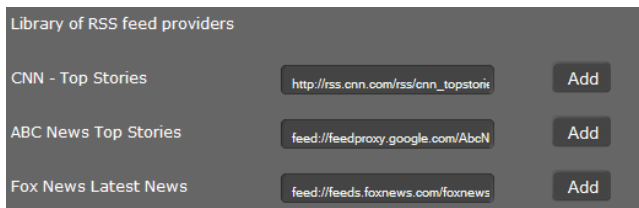

Library of RSS feed providers

CNN - Top Stories	<a href="http://rss.cnn.com/rss/cnn_topstories">http://rss.cnn.com/rss/cnn_topstories</a>	Add
ABC News Top Stories	<a href="feed://feedproxy.google.com/AbcN">feed://feedproxy.google.com/AbcN</a>	Add
Fox News Latest News	<a href="feed://feeds.foxnews.com/foxnews">feed://feeds.foxnews.com/foxnews</a>	Add

- ▶ Click **Add** next to the desired RSS feed.

The services that you have already selected are listed under **Current selection.**

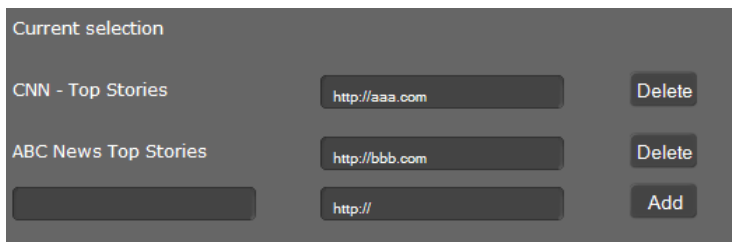

Current selection

CNN - Top Stories	<a href="http://aaa.com">http://aaa.com</a>	Delete
ABC News Top Stories	<a href="http://bbb.com">http://bbb.com</a>	Delete
	<a href="http://">http://</a>	Add

## Configuring phone settings via the Web configurator

- ▶ If you know the name and URL of a desired service, enter them in the empty fields and click on **Add**.
- ▶ Click on **Delete** if you want to remove a news service from the current selection list.
- ▶ Click on **Save** to save your setting.

### Selecting a weather service

Weather services that have already been configured are shown.

The screenshot shows a configuration window titled "Weather". It contains a list of cities: "New York" and "Paris". To the right of each city name is a "Delete" button. Below the list is a search input field containing the text "Paris". To the right of the search field is a "Search" button. Below the search field is a dropdown menu showing "Paris, Île-de-France, France". To the right of the dropdown menu is an "Add" button. At the bottom of the window is a "Save" button.

- ▶ Enter the name of a city or location and click on **Search**.
- ▶ Select your choice from the list of cities found and click on **Add**.
- ▶ Click on **Delete** to remove an entry from the list.
- ▶ Click on **Save** to save your setting.

### Selecting a webcam

Webcams that have already been configured are shown.

The screenshot shows a configuration window titled "Webcam". It contains two input fields: "Name of Webcam" with the text "Webcam 1" and "IP adress of Webcam (URL)" with the text "http://". To the right of the second input field is an "Add" button. Below the input fields is a "Save" button.

- ▶ Enter a name and the URL for the webcam.  
If access to the webcam is password protected, enter the access data in the following format:  
`http://USER:PASSWORD@IP-address-of-the-webcam/image.jpg`
- ▶ Click on **Add**.
- ▶ Click on **Delete** to remove an entry from the list.
- ▶ Click on **Save** to save your setting.

### Internet radio

On this screen you can activate the **Internet Radio** function and select the stations for the Internet radio.

**Settings** → **Services** → **Internet Radio**

▶ Click on **Yes** next to **Activate Internet Radio** to allow Internet radio for your phone.

The stations listed here are available for selection if you access the Internet radio function in the phone's display menu ( → **page 74**). You can add new stations or delete existing ones from the list.

Name of Station	IP address of Broadcast Station (URL)	
Radio 538	<input type="text" value="http://www.einslive.de/multimedia/1"/>	<input type="button" value="Delete"/>
Sky Radio	<input type="text" value="http://217.196.35.12/asx/skyradio"/>	<input type="button" value="Delete"/>
<input type="text"/>	<input type="text" value="http://"/>	<input type="button" value="Add"/>

▶ Enter the name and the Internet address (URL) for the required station in the empty fields at the end of the list and click on **Add**.

▶ Click on **Delete** if you want to remove a station from the list.

### Saving settings

▶ Click on **Save** to save your settings on the **Internet Radio** screen.

## Door interphone

You can operate one or more door interphones with video surveillance using the phone. The pictures from the camera(s) are shown on the phone's display ( → [page 77](#)). Enter the data for the door interphone on this page.

---

### Note

The door interphone can also be set up for your phone using the Gigaset phone system. If automatic configuration is permitted, configuration is carried out automatically on your phone.

---

### Settings → Services → Door Interphone

Name	SIP ID	DTMF code	Camera (URL)	Reload Rate	
Camera 1			http://	500	Add

- ▶ Enter a name and the SIP ID for the camera.
- ▶ Enter the code for the door opener in the **DTMF code** field. This MFV code is required to operate the door opener from the phone. The MFV code can be found in the description of your door interphone.
- ▶ Enter the URL of the camera in the **Camera (URL)** field.
- ▶ Set how often the image should be refreshed in ms in the **Reload Rate** field. Minimum time: 200 ms.
- ▶ Click on **Add** to add a camera to the list.
- ▶ Click on **Delete** if you want to remove a camera from the list.
- ▶ Click on **Save** to save your settings.

### Online directory

If you want to use an online directory (→ [page 57](#)), select the provider on this screen which supplies the directory on the Internet. Also specify which service you want to use.

**Settings → Services → Online Directory**

The available provider directories are displayed.

Provider	Select	Automatic look-up
EDSA Herold Business Data	<input type="checkbox"/>	<input type="radio"/>
tel.search.ch	<input type="checkbox"/>	<input type="radio"/>
Klicktel (GER)	<input type="checkbox"/>	<input type="radio"/>
EDSA De Gule Sider	<input type="checkbox"/>	<input type="radio"/>
Telefoongids (NDL)	<input type="checkbox"/>	<input type="radio"/>
Eniro	<input type="checkbox"/>	<input type="radio"/>

- ▶ Select the providers whose online directories you want to use by selecting the check boxes under **Select**.
- ▶ If you select the **Automatic look-up** option, when a call comes in the online service automatically looks up the name of the caller in the online directory. This function must be available for the provider directory.

### Configuring an additional provider

- ▶ To use the online services of another provider, enter the access data under **Settings for additional provider**:
  - **Provider Name**
  - **Server Address**
  - **Username**
  - **Password**

- ▶ Activate the service(s) you wish to use:
    - **White Pages**  
A public directory supplied on the Internet by the provider entered above
    - **Yellow Pages**  
Yellow pages supplied on the Internet by the provider entered above
- You can activate one or both services.



The screenshot shows a dark-themed interface. At the top, there is a text input field with the placeholder text "Name of directory". Below this, there is a checkbox labeled "Enable 'White Pages'", which is currently unchecked.

- ▶ Enter a name for each of the selected services in the **Name of directory** field. This is the name under which the directory will be displayed on your device ( → [page 57](#)).
- ▶ Select whether you allow **Automatic look-up**.

### Saving settings

- ▶ Click on **Save** to save your settings on the **Online Directory** screen.

## LDAP directory

If your corporate network provides a directory via an LDAP server, you can access this on your phone (LDAP = Lightweight Directory Access Protocol). You can set up the function on this screen. You will need information about the configuration of the LDAP server to do this.

### Settings → Services → LDAP



- ▶ Enter a name in the **Name of directory**. This is the name under which the directory will be displayed on your device ( → [page 56](#)).
- ▶ Enter all the data for your LDAP server and the directory.

### Attributes

A range of attributes are defined in the LDAP database for a directory entry, e.g. surname, first name, telephone number, address, company, etc. The quantity of all attributes, which can be saved in one entry, is saved in the relevant LDAP server scheme. In order to be able to access attributes or define search filters, you must know the attributes and their designation in the LDAP server. The majority of attribute designations are standardised, however specific attributes can also be defined.

## Configuring phone settings via the Web configurator

The Gigaset DE700 IP PRO supports the following attributes:

Attribute name	Name in the phone	Meaning
cn sn	Name with which the entry is listed (cn = common name, sn = surname)	
company or o	<b>Company</b>	Company name
telephoneNumber		Office number
mobile		Mobile number
homePhone		Private number
mail	<b>E-mail</b>	E-mail address
postalAddress	<b>Street</b>	Street
postalCode	<b>ZIP</b>	Post code
l (location)	<b>City</b>	City or town
c (country)	<b>Country</b>	Country

### LDAP Name Attributes

Defines which information should be delivered as the search result for the search by name, e.g., surname only, surname and first name etc.

### LDAP Number Attributes

Defines which telephone numbers are made available for an entry from the database, e.g. the office number (telephoneNumber), the mobile number (mobile).

### Filter

Using the filter, you can define criteria against which specific entries can be searched in the LDAP database. One filter consists of one or more search criteria. A search criterion contains the query for an LDAP attribute, e. g. sn=%. The percent symbol (%) is a placeholder for the user entry.

#### LDAP Name Filter

The name filter decides which attribute is used for the search.

Example: (sn=%)

The percent symbol (%) is replaced by the name or part of the name entered by the user. If a user enters the letter "A" for example, all entries in which the attribute **sn** begins with "A" are searched for in the LDAP database. If the user then enters a "b", entries are searched in which the **sn** attribute begins with "Ab".



## LDAP Number Filter

The number filter stipulates the criteria for the automatic completion of telephone numbers.

Example: `((telephoneNumber=%)(mobile=%))`

The percent symbol (%) is then replaced by the part of the telephone number entered by the user. When dialling, if a user enters the numbers "123" for example, all telephone numbers (office and mobile) that begin with "123" are searched for in the LDAP database. The telephone number is completed with the addition of information from the database.

Multiple criteria can be connected using logical AND (&) and/or OR (|) operators. The logical operators "&" and "|" are placed before the search criteria. The search criterion must be placed in brackets and the whole expression must be terminated with a bracket again. AND and OR operations can also be combined.

### Examples:

AND operation: `(& (givenName=%) (mail=%))`

Searches for entries in which the first name **and** mail address begin with the letters entered by the user.

OR operation: `(| (cn=%) (sn=%))`

Searches for entries in which the common name **or** surname begin with the letters entered by the user.

Combined operation: `((& (givenName=%) (mail=%))(& (sn=%) (mail=%)))`

Searches for entries in which the first name **and** mail address **or** the surname **and** mail address begin with the letters entered by the user.

## Other parameters

### LDAP Display Name

Defines how the search result is displayed on the handset. Here, you can enter combinations of different name and number attributes and special characters. For the attribute value to be shown for the required attribute, the attribute name must be preceded by a percent symbol (%).

#### Example

Entry data on the LDAP server:

<b>cn</b>	Administrator	<b>telephoneNumber</b>	0891234567890
<b>sn</b>	Black	<b>mobile</b>	012398765432
...		<b>homePhone</b>	09876543123

Attribute definition in the web UI:

**LDAP Name Attributes**      cn sn

**LDAP Number Attributes**    mobile telephoneNumber homePhone

**LDAP Display Name**          %sn, %cn; %telephoneNumber / %homePhone / %mobile

The entry is shown on the handset as follows:

Black, Administrator; 0891234567890 / 09876543123 / 012398765432

## Configuring phone settings via the Web configurator

### Server Address

IP address for the LDAP server in your network.

### Server Port

Port number that is used to provide the LDAP service. Default setting: 389

### LDAP Search Base

Range in the hierarchical LDAP database where the search begins. All areas have defined designations.

### Username

Access ID for the LDAP server.

### Password

Password for the access ID to the LDAP server.

### Max. Hits

Maximum number of search results to be displayed. Default setting: 50

- ▶ Select **Yes for LDAP lookup for incoming calls** if a search should be made for a caller in the LDAP directory instead of in the local directory.

## Saving settings

- ▶ Click on **Save** to save your settings on this screen.

## Function keys

On this screen you can set up the key light, decide on the assignment of the directory key and programme the function keys.

### Settings → Function Keys

Keys

Key Light

Always on

On in use

Off

Directory Key

Local Directory

Program Keys

Keys	Key setting
PK1	Line

Edit

## Activating/deactivating the key light

- ▶ Select if and when the **Key Light** should be activated. This is the backlight for all keys, not just the function keys.

Possible settings: **Off**, **Always on**, **On in use**

## Assigning the directory key

You can use the directory key **☎** (navigation key **⌂**) to open the **local** directory by default (→ [page 50](#)). You can change this setting.

- ▶ Select which directory you want to access with the **Directory Key**:
  - **Local Directory** (→ [page 50](#)),
  - **LDAP** (company directory → [page 56](#)).

## Programmable keys

Your Gigaset DE700 IP PRO allows you to assign frequently used functions or phone numbers to up to 14 keys so that you can access them with one key press. You can increase the number of function keys by connecting extension modules (→ [page 17](#)). These are displayed under **Additional Program Keys**.

All available function keys are shown with **Key setting**.

- ▶ Click on **Edit** to assign a number or function to a **Key**. The window for programming the selected key will open.

Key	PK1
Function Select	Line
Connection Name	IP1

- ▶ Select the required function from the **Function Select** list.

### Line

Assigns a specific connection to the function key. You can use the key to make a call via this connection or to answer an incoming call for this connection. The key flashes if a call comes in and lights up if the line is busy.

- ▶ Select the required connection. All configured connections are displayed for you to choose from (→ [page 132](#)).

### Shared Line

Assigns the VoIP account for a "split line" to the function key. This means that several users share the same VoIP account. The key can be used to make a call via the shared account or to answer an incoming call. It will be configured on all extensions for the group. The keys will flash on all extensions if a call comes in and light up if the line on any extension is busy.

This function is only available if your telephone is connected to a Gigaset T500 PRO or Gigaset T300 PRO phone system and the number has been assigned to a group.

- ▶ Select the required connection and enter the **Phone Number** of the "split line" that has been assigned to the group's phone system.

## Configuring phone settings via the Web configurator

### Park + Orbit

This function key is used to "park" a call. The participant hears the hold music. This function key allows you to transfer calls within a group, which share a common line. It will be configured on all extensions for the group. The "Park + Orbit" keys on all extensions flash if a call has been "parked" on an extension. The call can be picked up on any extension by pressing the key.

This function is only available if your telephone is connected to a Gigaset phone system and the number has been assigned to a group. The function key can also be assigned using the phone system.

- ▶ Select the required connection and enter the **Phone Number** of the shared line.

### Speed Dial

Assigns the speed dial for a phone number to the function key.

- ▶ Select the required connection and enter the **Phone Number** that should be selected using this function key.

### BLF

A function key that is configured as BLF (Busy Lamp Field) indicates the status of a shared line. It will be configured on all extensions for the group. The keys will flash on all extensions if a call comes in and light up if the line on any extension is busy.

You can accept an incoming call if you have set the **Directed Call Pickup Code**.

This function is only available if your telephone is connected to a Gigaset phone system and the number has been assigned to a group. The function key can also be assigned using the phone system.

- ▶ Enter the **Phone Number** for the shared line.
- ▶ If you wish you accept calls with the key, enter the **Directed Call Pickup Code**. For a Gigaset phone system this code is \*8.

### XML-Content

On a function key of this type you can store a function that has been defined in an XML file.

- ▶ Enter the full path of the XML file in the text field.

All permitted functions and XML tags have been described in a specification. You can find this at: <http://wiki.gigaset.com>.

### Call Divert

Assigns a call divert to the function key.

- ▶ Select the connection for which the call divert should apply and enter the **Phone Number** to which the calls should be diverted.

The call divert set up here applies to all calls. To configure different call divert rules, use the screen

**Settings** → **Telephony** → **Call Divert** (→ **page 138**).

### DTMF

Assigns a number to the function key that is dialled using DTMF. This is required, for example, for querying and controlling certain network mailboxes via digit codes or for remote operation of the local answering machine.

- ▶ Enter the **Phone Number** that should be dialled using DTMF signalling.

### Menu - Next call anonymous

Opens the **Select Services** → **Next Call anonymous** function in the telephone's display menu (→ [page 38](#)) to dial a call without transmitting the number.

### Menu - Call Divert

Opens the **Select Services** → **Call Divert** function in the telephone's display menu (→ [page 43](#)) to activate/deactivate or set up a call divert.

### Menu - Resource Directory

Opens the **Additional Features** → **Resource Directory** menu in the telephone's display menu to select **Screensavers**, **Caller Pictures** and **Sounds** (→ [page 100](#)).

### Menu - Internet Radio

Opens the **Additional Features** → **Internet Radio** menu in the telephone's display menu to select an Internet radio station (→ [page 74](#)).

### None

Nothing assigned.

- ▶ Click on **Save** to accept the key assignment.

You will now be returned to the **Function Keys** screen, where you can programme more keys.

### Saving settings

- ▶ Click on **Save** to save the settings on this screen.

---

### Note

If your telephone is connected to a Gigaset T500 PRO or Gigaset T300 PRO phone system function keys assignments can also be downloaded to the phone's keys from the phone system, if automatic configuration is permitted.

The following phone system function keys are transferred to the telephone:

#### **Speed Dial, Call Divert, BLF, Park + Orbit**

In this way, various functions of the keys that can be configured on the phone system can be referred to. Further information on this can be found in the user guide for the phone system.

---

### System settings

You can create the following settings in the **System** menu:

- ◆ Define the date and time or time server
- ◆ Security – Change passwords for administrator and user identification ( → [page 159](#))
- ◆ Display – Set the idle display, screensaver and brightness for the display ( → [page 160](#))
- ◆ Load ring tones and pictures ( → [page 166](#))
- ◆ Restart the device and restore factory settings ( → [page 167](#))
- ◆ Save and restore telephone data ( → [page 167](#))
- ◆ Perform and configure a firmware update ( → [page 168](#))

### Date and time

On this screen you can specify a time server or enter the date and time manually.

**Settings** → **System** → **Date and Time**

#### Defining the time server

- ▶ Select **Yes** for **Automatic adjustment of system time with time server**.

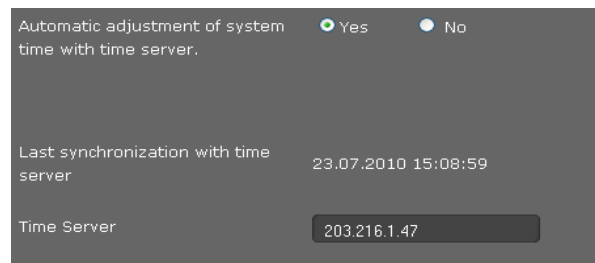

Automatic adjustment of system time with time server.  Yes  No

Last synchronization with time server 23.07.2010 15:08:59

Time Server

- ▶ Enter the IP address of the required server in the **Time Server** field.

The most recent synchronisation carried out with the time server is shown.

#### Entering the date and time manually

- ▶ Select **No** for **Automatic adjustment of system time with time server**.

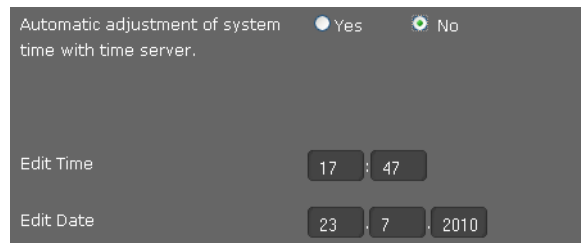

Automatic adjustment of system time with time server.  Yes  No

Edit Time  :

Edit Date  .  .

- ▶ Enter the **date and time**:
  - **Time format**: ss:mm
  - **Date format**: dd.mm.yyyy
- ▶ Click on **Save** to save the settings.

Even if you have changed the date format in the **System** → **Display** menu, enter the date here in the format **mm.dd.yyyy** (→ [page 161](#)).

### Setting the time zone

- ▶ Select your **Time Zone** from the list.
- ▶ Activate the **Automatically adjust clock to summer time changes** option if necessary.

### Saving settings

- ▶ Click on **Save** to save the settings on this screen.

## Security

Access to the Web configurator and administration functions on the phone is password-protected for security purposes.

Default settings:	User type	Password
	Administrator on Web configurator	admin
	User on Web configurator	user
	Administration on phone	admin

### Settings → System → Security

On this screen you can change the passwords for administrator and use. For security reasons, you should always do this after getting started with your device and then at regular intervals.

- ▶ Enter new passwords:
  - Web Configurator** For access to the Web configurator in user mode
  - Web Configurator (Administrator)** For access to the Web configurator in administrator mode
  - Phone PIN** For access to administrator functions on the phone
- ▶ For security reasons, the passwords are not displayed. Select the option **Password visible**, to display the passwords in plain text.

### Saving settings

- ▶ Click on **Save** to save the settings on this screen.

## Display

On this screen you can configure a range of settings for your phone display.

Settings → System → Display

### Display screen in idle status

In idle status, the display shows either the **Idle Display** or a **Screensaver**. The difference is that the **Idle Display** only covers the lower part of the display; the display icons are still visible in the upper part. The **Screensaver** covers the full screen.

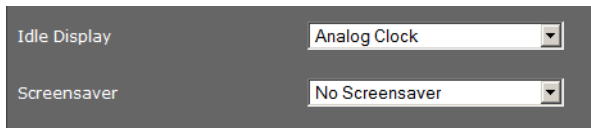

Idle Display: Analog Clock

Screensaver: No Screensaver

- ▶ Choose the required **Idle Display** or **Screensaver** from the list. If **No Screensaver** is set, your choice applies for **Idle Display**.

Possible displays:

**Idle Display:** Time Zones, Analog Clock, Digital Clock, Calendar, Pictures

**Screensaver:** No Screensaver, Analog Clock, Digital Clock, Calendar, Pictures, Info Service

- ▶ If you have selected the **Pictures** option, you must now choose one or more pictures. Multiple pictures are shown in sequence as a slide show. All pictures in the phone's resource directory are available to choose from. You can download your own pictures from the PC to your phone (→ [page 166](#)).
- ▶ If you have selected **Info Service** as a **Screensaver**, the info service that you have defined on the **IP Info Services** screen will be activated as the screensaver (→ [page 148](#)).

### Displaying a contact location in a map

If the address of a caller or contact is known in the directory, this can be shown in a map on the display.

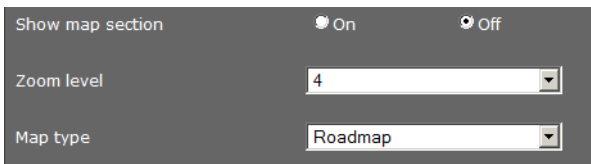

Show map section: On

Zoom level: 4

Map type: Roadmap

- ▶ Select **On** for **Show map section** if you want to activate the function.
- ▶ Select the **Zoom level** for the map display.
- ▶ Select the type of **Map type**. You can select from the standard display types: **Roadmap**, **Terrain** and **Hybrid**.



## Setting the display brightness

You can set the display brightness at seven levels and turn the display off completely at specific times, e.g., at night. These measures help to optimise the power consumption of your device.

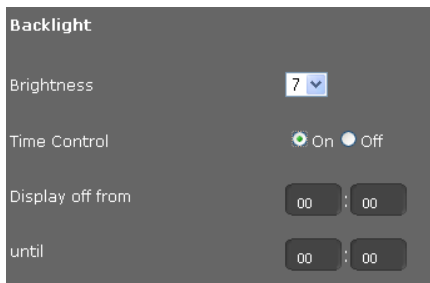

- ▶ Select the **Brightness** of the display from 1 to 7. 1 = dark ... 7 = very bright.
- ▶ Select **On** for **Time Control** if you want to deactivate the display.
- ▶ Enter the start and end of the period when the display should be switched off.

## Defining the format for the display screen

- ▶ Select your required setting:

<b>Device Language</b>	Language for the display screens
<b>Web Interface Language</b>	Language for the Web configurator
<b>Date Format</b>	The format that the date is shown in:
	<b>dd.mm.yyyy</b> e.g. 03.12.2010 for 3 December 2010
	<b>mm.dd.yyyy</b> e.g. 02.17.2010 for 17 February 2010
<b>24-hour clock</b>	<b>On</b> The time is displayed in 24 hour format, e.g. 18:15
	<b>Off</b> The time is displayed in 12 hour format, e.g. 6:15 PM
<b>Sort Criteria Directory</b>	Select whether your local directory should be sorted by first names or surnames.

## Configuring phone settings via the Web configurator

### Changing the main menu

You can adjust the main menu of the phone to your requirements. To this end you should prepare the desired menu in an XML file. The XML file can either be made available over the network or can be downloaded in XML file format directly to the phone.

---

#### Note

All permitted XML tags have been described in a specification. You can find this at: <http://wiki.gigaset.com>.

---

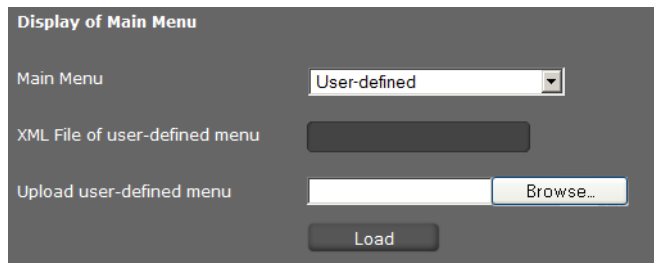

The screenshot shows a configuration interface with a dark grey background. At the top left, the title "Display of Main Menu" is displayed. Below it, there are four main sections: 1. "Main Menu" with a dropdown menu currently showing "User-defined". 2. "XML File of user-defined menu" with a dark grey rectangular input field. 3. "Upload user-defined menu" with a light grey rectangular input field and a "Browse..." button to its right. 4. A "Load" button centered at the bottom of the form.

If you want to change the main menu:

- ▶ Select **User-defined** from the list **Main Menu** if you have an XML file with the alternative menu.  
Enter the full path of the XML file in the **XML File of user-defined menu** field.
- ▶ Select **User-defined by upload file** from the list **Main Menu** if an alternative menu is available as a file.  
Click on **Browse** next to **Upload user-defined menu**. Navigate to the storage location of the menu file in the file system on the PC and select the required file.
- ▶ Click on **Load** to download the alternative menu onto the telephone.

### Saving settings

- ▶ Click on **Save** to save the settings on this screen.

## Private contacts

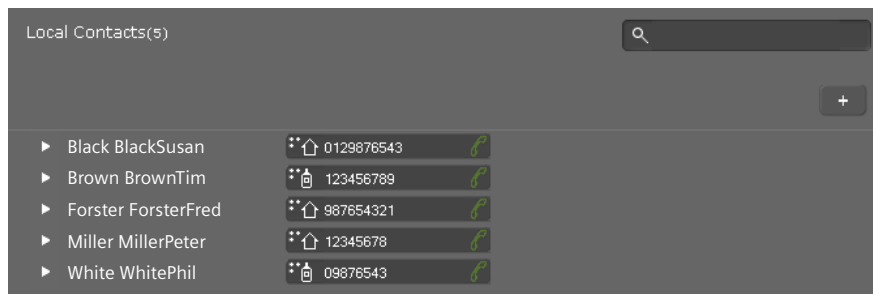

On this screen you manage your local directory. All functions described here are also available in the telephone's display menu (→ [page 50](#)).

Settings → System → Local Contacts



The entries in your local directory are displayed in alphabetical order with the name of the contact and the number set as the standard number.

### Dialling a number from the directory

- ▶ Click the telephone symbol  next to the number. The number is dialled using the phone's speakerphone mode.
- ▶ To end the call or end dialling click on .

### Searching an entry

- ▶ Enter a name or part of a name in the search field in the upper-right corner and click on the magnifying glass icon . All entries beginning with the character string entered are displayed,

## Configuring phone settings via the Web configurator

### Creating a new entry

- ▶ Click on the  button to create a new entry.

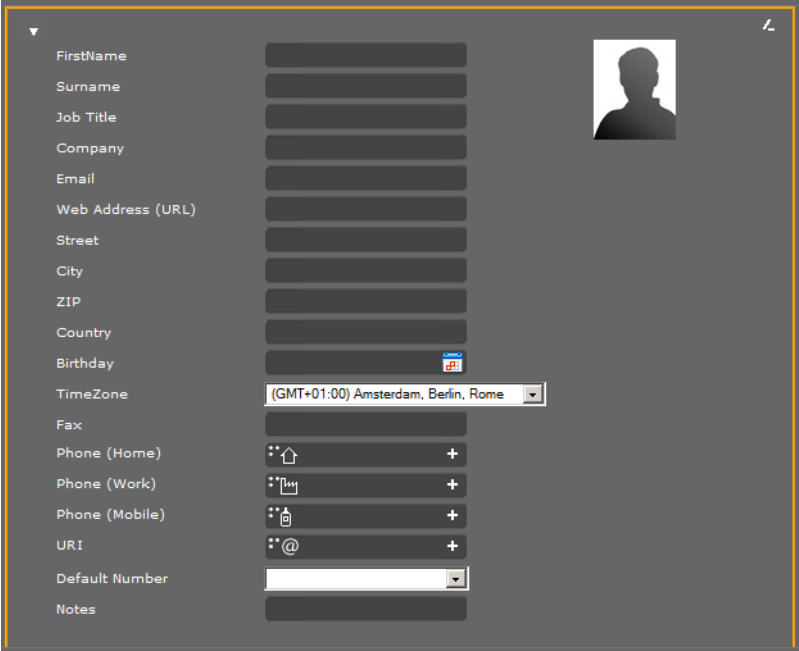

- ▶ Enter the data for the contact. The fields contain all options for the local directory on the telephone (→ [page 51](#)).
- ▶ Click on  to save the entry.

### Displaying an entry

- ▶ Click on the arrow ▶ before the name to display an entry in full.
- ▶ Click on the arrow ▼ in the upper-left to hide the entry details and return to the list.

### Editing an entry

- ▶ Click on  to edit the entry.

### Deleting an entry

- ▶ Click on  and then  to delete the entry.

## All calls

On this screen you can manage your call lists. All functions described here are also available in the telephone's display menu ( → [page 46](#)).

Calls(6)							
▲ Date	Time	Line	Caller			Duration	
10.03.2011	16:03	1	→	Black Susan	**🏠 089878970987	00:02:50	✕
28.03.2011	10:55	1	←	Tim Brown	**🏠 08912121212@sipgate	00:01:04	✕
05.04.2011	15:22	1	→	Forster Fred	**🏠 68070085	00:00:00	✕
05.04.2011	15:22	1	→	unknown	**🏠 68000000	00:00:50	✕
05.04.2011	15:23	1	→	White Phil	**🏠 09876543	00:00:00	✕
05.04.2011	15:35	1	↔	01222222222	**🏠 01222222222@sipga	00:00:40	✕

<b>Date/Time</b>	Time of the call/conference call. Use ▼ ▲ to sort the list in ascending/descending order according to date.
<b>Line</b>	VoIP account used to make the call.
→	Outgoing call
←	Accepted call
↔	Missed call
<b>Caller</b>	Name (if known) and number of the caller. 📞 Call the caller.
	📞 End the call/conference call with this participant.
<b>Duration</b>	Time spent connected to this participant.
✕	Delete entry.

### Loading ring tones and pictures

You can download ring tones and pictures from the PC to the device's resource directory. The data on the PC must be in the following formats:

Type	Format	Size
Sounds	mp3	max. 2 MB
Pictures	JPG	
– Picture	320 x 240 pixels	max. 250 KB
– Vcard picture (CLIP)	64 x 78 pixels	max. 250 KB

Settings → System → Upload Tones and Pictures

#### Loading ringtones

- ▶ Click on **Browse** next to **Ringtone file**. Navigate to the storage location of the sound files in the file system on the PC and select the required file.
- ▶ Enter a **Name** for the ringtone and click on **Store**.

The available ringtones are listed.

---

#### Note

You can change the ringtone for a connection directly on the telephone ( → [page 82](#)) or using the Web configurator (user mode → [page 137](#), administrator mode → [page 135](#)).

---

#### Loading pictures

You can download pictures for the display and Vcard pictures from the PC to the device's resource directory in the same way.

- ▶ Click on **Browse** next to **Image File**. Navigate to the storage location of the picture files in the file system on the PC and select the required file.
- ▶ Enter a **Name** for the picture and click on **Store**.

The remaining free storage capacity of the resource directory is displayed under **Free storage [kB]**.

## Rebooting the system and restoring factory settings

You may have to reboot your phone in certain operational situations, for instance to save changes you have made.

**Settings → System → Reboot and Reset**

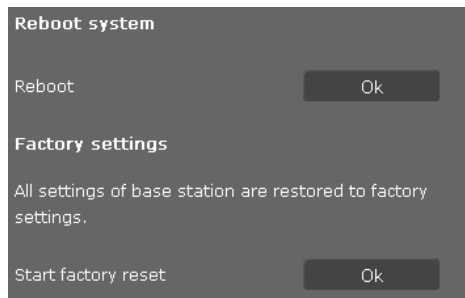

▶ Click on **OK** next to **Reboot** to reboot the system.

All phone settings can be reset to the **Factory settings**. This deletes all settings, lists and directory entries!

▶ Click on **OK** next to **Start factory reset** to reset the phone to factory condition.

## Saving and restoring telephone data

You can save data from your phone onto your PC and, if necessary, restore it back onto the phone.

**Settings → System → Save and Restore**

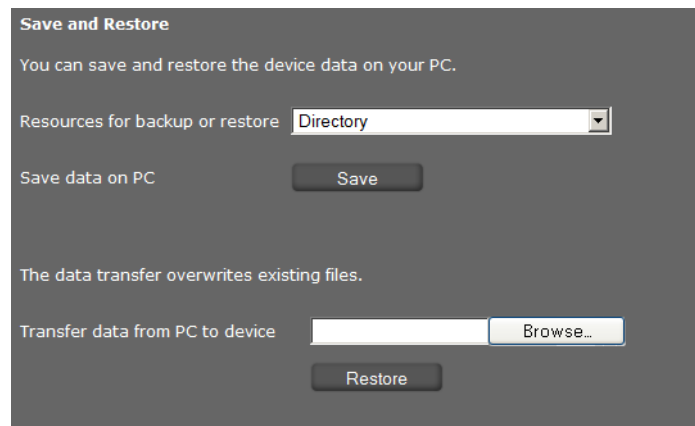

## Configuring phone settings via the Web configurator

### Transferring data from to PC

- ▶ Select which data you want to save:
  - **Directory**
  - **Vcard pictures**
  - **Ring Tones**
  - **Pictures**
  - **Call Records**
  - **Phone settings (Configfile)** (configuration file)
- ▶ Click **Save** to save the selected data to the PC and choose a storage location.

### Transferring data from PC to phone

- ▶ Use the **Browse** button to select the file you want from your PC's file system, or enter the complete path name of the file in the **Transfer data from PC to device** field.
- ▶ Click on **Restore**.

## Updating firmware

Firmware updates are available from the Gigaset website [www.gigaset.com](http://www.gigaset.com) so you can ensure your phone is always up to date. You can find the current version of your firmware on the **Device** status screen ([page 170](#)). You can update your phone automatically or manually. Your provider for Internet telephony can also deliver updates for the phone firmware and/or for the profile of your VoIP account.

Any PC connected to the phone will not be able to access the local network and the Internet during the firmware update.

**Settings** → **System** → **Firmware Update**

### Updating firmware automatically

Data server: gigaset.com/chagall

Automatic check for software updates:  Yes  No

Automatic check for profile updates:  Yes  No

When the firmware update is started, the device checks if the requirements for a successful firmware download are fulfilled. A successful update results in a short message text.

Update firmware

- ▶ Select **Yes** for **Automatic check for software updates** and /or **Automatic check for profile updates**.
- ▶ Enter the Web address for the automatic update search in the **Data server** field.
- ▶ Click on **Update firmware** to start the search and to load the new firmware.



## Updating manually

- ▶ Download the new firmware from the Internet onto your PC and then open the firmware update screen.



- ▶ Select **No** for **Automatic check for software updates** and /or **Automatic check for profile updates**.
- ▶ Click on **Browse** and select the file from the file system on your PC.
- ▶ Click on **Load** to start the update process.

When the firmware update is started, the device first checks whether the prerequisites are in place for successfully downloading the firmware. A successful update is indicated by an advisory message.

## Saving settings

- ▶ Click on **Save** to save your settings on the screen.

## Checking the status of the phone

---

You will find information about the status of the phone and diagnostic information in the **Status** menu.

### Device

**Status** → **Device**

This screen shows general information about your phone.

#### IP configuration

**IP Address** The phone's current IP address within the local network.

**MAC Address LAN** The phone's device address.

**MAC ID** The device identifier. This consists of the MAC address and a four character provider identifier. This identifier is used for the automatic configuration.

#### Software

**Firmware Version** Version of the firmware currently loaded on the phone. You can download updates of the firmware to your phone (→ [page 168](#)).

#### VoIP status

List of all configured VoIP connections with the **Name**, **Status** and which connection is configured as the **Default Send Account**.

#### Date and time

Current **Time** and **Date** in the device and the date of the most recent synchronisation with the time server.

### System log

**Status** → **System Log**

System events e.g., system start, assigning an IP address etc., are recorded in the system log. This screen shows the system log. The events are displayed with the **Date**, **Time** and **Message**. This information may be useful in the event of problems involving Customer Care.

- ▶ Click on **Reload** to update the display.
- ▶ Click on **Delete all entries** all entries to delete the entries.

## SIP logging

### Status → SIP Protocol

SIP logging stores information about the set-up and disconnection of phone connections and about registering your phone.

This information is useful for diagnosing errors and can be of use to Customer Care for problem solving.

- ▶ Click on **Reload** to update the display.
- ▶ Click on **Delete all entries** all entries to delete the entries.

## PCAP logging

### Status → PCAP Logging

On this screen you can create a PCAP log file and save it for analysis at a later stage. PCAP (Packet Capture) analyses the data traffic in the network at the phone-Ethernet interface. This recording is carried out for diagnostic purposes and should only be made if requested by service personnel.

- ▶ Click on **Start**. Every incoming or outgoing data packet to or from your phone is recorded.
- ▶ Click on **Stop** to stop recording.
- ▶ To save the PCAP file (pcapdump.pcap), click on **Store** and select a directory in the file system on your PC where the file should be stored.

---

### Notes

- ◆ The information is recorded in a ring buffer that has limited storage capacity. If the buffer is full, the first packets will be overwritten and lost. You should therefore attempt to record scenarios that are as short as possible.
  - ◆ This logging uses a lot of memory and CPU power and can negatively affect how the phone behaves (e.g. slowing the display screen, distorting the ring tone etc.)
- 

## Checking storage allocation

### Status → Storage Allocation

This shows you how much storage capacity is still available on your phone.

## Service (Customer Care)

---

You have questions? You can find help quickly in this User Manual and at [www.gigaset.com/pro](http://www.gigaset.com/pro). If you have further queries regarding your Gigaset Professional phone system please contact the dealer you bought your phone system from.

### Questions and answers

If you have any queries about the use of your telephone, visit our website at [www.gigaset.com/pro](http://www.gigaset.com/pro) for assistance.

# Protecting our environment

## Our environmental mission statement

We, Gigaset Communications GmbH, bear social responsibility and are actively committed to a better world. Our ideas, technologies and actions serve people, society and the environment. The aim of our global activity is to secure sustainable life resources for humanity. We are committed to taking responsibility for our products throughout their entire life cycle. The environmental impact of products, including their manufacture, procurement, distribution, use, service and disposal, is evaluated early on, during product and process design.

Further information on environmentally friendly products and processes is available on the Internet at [www.gigaset.com](http://www.gigaset.com).

## Environmental management system



Gigaset Communications GmbH is certified according to the international standards ISO 14001 and ISO 9001.

**ISO 14001 (Environment):** Certified since September 2007 by TÜV SÜD Management Service GmbH.

**ISO 9001 (Quality):** Certified since 17/02/1994 by TÜV SÜD Management Service GmbH.

## Disposal

All electrical and electronic products should be disposed of separately from the municipal waste stream via designated collection facilities appointed by the government or the local authorities.



This crossed-out wheeled bin symbol on the product means the product is covered by the European Directive 2002/96/EC.

The correct disposal and separate collection of your old appliance will help prevent potential negative consequences for the environment and human health. It is a precondition for reuse and recycling of used electrical and electronic equipment.

For more detailed information about disposal of your old appliance, please contact your local council refuse centre or the original supplier of the product.

## Appendix

---

### Caring for your telephone

Wipe the unit with a **damp cloth** or an **antistatic cloth**. Do not use solvents or microfibre cloths. **Never** use a dry cloth; this can cause static.

### Contact with liquid

If the device comes into contact with liquid:

- 1 Unplug the power supply .**
- 2** Allow the liquid to drain from the device.
- 3** Pat all parts dry. Place the device (the keypad facing down) in a dry, warm place **for at least 72 hours (not in a microwave, oven etc.)**.
- 4** Do not switch on the device again until it is completely dry.

When it has fully dried out, you will normally be able to use it again.

In rare cases, contact with chemical substances can cause changes to the telephone's exterior. Due to the wide variety of chemical products available on the market, it was not possible to test all substances.

### Authorisation

Voice over IP telephony is possible via the LAN interface (IEEE 802.3). Depending on your telecommunication network interface, an additional modem could be necessary. For further information please contact your Internet provider.

This device is intended for use worldwide. Use outside the European Economic Area (with the exception of Switzerland) is subject to national approval.

Country-specific requirements have been taken into consideration.

We, Gigaset Communications GmbH, declare that this device meets the essential requirements and other relevant regulations laid down in Directive 1999/5/EC.

A copy of the 1999/5/EC Declaration of Conformity is available at this Internet address:  
[www.gigaset.com/docs](http://www.gigaset.com/docs)

 **0682**

### Using insert strips























The phone is supplied with insert strips for the function keys. If you require more blank insert strips for the function keys, they are available as a PDF file on the product CD supplied.

## Using Gigaset QuickSync – additional functions for the PC interface

You can synchronise your handset directory with Outlook. The **Gigaset QuickSync** program must be installed on your computer to do so. The program is provided on the product CD.

### Key combinations for phone system functions

To access the functions of Gigaset T300 PRO/Gigaset T500 PRO phone systems the following key combinations are available:

		+ Phone number	Marking calls as private.
		+ Group ID	Logging the user into the group.
		+ Group ID	Logging the user out of the group.
		+ Speed dial	Calling a number using speed dial.
		+ Login ID	Logging on to the phone.
		+ Login ID	Logging out of the phone.
			Logging all users out of the phone.
		+ Int. phone number	Picking up a call for the user with this phone number.
			Randomly picking up a call.
		+ Voicemail box ID	Checking for voicemail.
		+ Number	Establishing a call via a line with corresponding line prefix.

### During a call



Call2Go: Transferring a call to your other phones.

**Note:** Only available from Gigaset T300 PRO/Gigaset T500 PRO software version 5 upwards.



Recording a call and sending as voicemail.



+ Phone number Transferring a call with inquiry function.

## Appendix

### Additional service features

* 0 1 1	+ Target phone number	Activating the general redirect function for all calls (Always) to one target phone number.
* 0 1 0		Deactivating the redirect function.
* 0 2 1	+ Target phone number	Activating the redirect function for all calls to the target phone number when busy.
* 0 2 0		Deactivating the redirect function for all calls when busy.
* 0 3 1	+ Target phone number	Activating the redirect function for all calls to the target phone number on timeout (no response).
* 0 3 0		Deactivating the redirect function for all calls on timeout.
* 0 7 1		Activating the callback function when the line is busy.
* 0 7 0		Deactivating the callback function when the line is busy.
* 0 8	+00 to 99 (waiting ID)	Placing a held caller in a call queue or taking a caller from the queue.
* 0 9 1		Activating the Do-Not-Disturb (DND) function for all phones.
* 0 9 0		Deactivating the Do-Not-Disturb (DND) function for all phones.

### Managing conference calls

*		Accessing the control options language menu.
* 1		Activating and deactivating mute (microphone).
* 2		Requesting to speak if the moderator has activated the mute function.
* 3		Moderator: Blocking and unblocking conference calls.
* 4	(... 4) 8	Gradually reducing the handset volume. (8 TUV) = save.
* 6	(... 6) 8	Gradually increasing the handset volume. (8 TUV) = save.
* 7	(... 7) 8	Gradually reducing the microphone volume. (8 TUV) = save.
* 9	(... 9) 8	Gradually increasing the microphone volume. (8 TUV) = save.



## Specifications

LAN	2 port LAN switch: 10 Mbit, 100 Mbit, 1Gbit
Headset connections	corded
Power supply	100–240 V, ~50/60 Hz
Power over Ethernet	PoE, IEEE 802.3af, class 3
Power consumption (standby)	4.6 W
Environmental conditions in operation	±0°C to +45°C, 10% to 95% relative humidity
Language codecs	G.711 $\mu$ -law/a-law, G.722, G.726, G.729AB, iLbc
Quality of Service (QoS)	RSVP/DiffServ (RFC2474, RFC2475)
VoIP protocols	SIP (RFC3261, RFC2543), RTP
VoIP security	SRTP (RFC3711), TLS (RFC2246), SIPS
Internet protocols	IPv4 (RFC0791), IPv6(RFC2460)
Further protocols	STUN, ICE, TCP, DHCP

# Open Source Software

---

## General

Your Gigaset device includes Open Source software that is subject to various license conditions. With regard to Open Source software, the granting of usage rights that go beyond the operation of the device in the form manufactured by Gigaset Communications GmbH is governed by the relevant license conditions of the Open Source software.

## Information on license rights and copyright

Your Gigaset device includes Open Source software that is subject to the GNU General Public License (GPL) / the GNU Lesser General Public License (LGPL). The corresponding license conditions are shown at the end of this section, in their original version. The appropriate source code can be downloaded from the internet at <http://www.gigaset.com/opensource/>. The appropriate source code can also be requested from Gigaset Communications GmbH within three years of purchasing the product. Please use the contact details provided at [www.gigaset.com/service](http://www.gigaset.com/service).

## License texts

### GNU General Public Licence (GPL)

Version 2, June 1991

Copyright (C) 1989, 1991 Free Software Foundation, Inc.  
59 Temple Place, Suite 330, Boston, MA 02111-1307 USA

Everyone is permitted to copy and distribute verbatim copies of this licence document, but changing it is not allowed.

#### Preamble

The licences for most software are designed to take away your freedom to share and change it. By contrast, the GNU General Public Licence is intended to guarantee your freedom to share and change free software – to make sure the software is free for all its users. This General Public Licence applies to most of the Free Software Foundation's software and to any other program where the authors commit to using it. (Some other Free Software Foundation software is covered by the GNU Lesser General Public Licence instead.) You can apply it to your programs, too.

When we speak of free software, we are referring to freedom, not price. Our General Public Licences are designed to make sure that you have the freedom to distribute copies of free software (and charge for this service if you wish), that you receive source code or can get it if you want it, that you can change the software or use pieces of it in new free programs, and that you know you can do these things.

To protect your rights, we need to impose restrictions that forbid anyone to deny you these rights or to ask you to surrender the rights. These restrictions translate into certain responsibilities for you if you distribute copies of the software, or if you modify it.

For example, if you distribute copies of such a program, whether gratis or for a fee, you must give the recipients all the rights that you have. You must make sure that they, too, receive or can get the source code. And you must show them these terms so they know their rights.

We protect your rights with two steps: (1) copyright the software, and (2) offer you this licence which gives you legal permission to copy, distribute and/or modify the software.

Also, for each author's protection and ours, we want to make certain that everyone understands that there is no warranty for this free software. If the software is modified by someone else and passed on, we want its recipients to know that what they have is not the original, so that any problems introduced by others will not reflect on the original authors' reputations.

Finally, any free program is threatened constantly by software patents. We wish to avoid the danger that redistributors of a free program will individually obtain patent licences, in effect making the program proprietary. To prevent this, we have made it clear that any patent must be licensed for everyone's free use or not licensed at all. The precise terms and conditions for copying, distribution and modification follow.

## GNU GENERAL PUBLIC LICENCE

### TERMS AND CONDITIONS FOR COPYING, DISTRIBUTION AND MODIFICATION

0. This Licence applies to any program or other work which contains a notice placed by the copyright holder saying it may be distributed under the terms of this General Public Licence. The "Program", below, refers to any such program or work, and a "work based on the Program" means either the Program or any derivative work under copyright law: that is to say, a work containing the Program or a portion of it, either verbatim or with modifications and/or translated into another language. (Hereinafter, translation is included without limitation in the term "modification".) Each licensee is addressed as "you".

Activities other than copying, distribution and modification are not covered by this Licence; they are outside its scope. The act of running the Program is not restricted, and the output from the Program is covered only if its contents constitute a work based on the Program (independent of having been made by running the Program). Whether that is true depends on what the Program does.

1. You may copy and distribute verbatim copies of the Program's source code as you receive it, in any medium, provided that you conspicuously and appropriately publish on each copy an appropriate copyright notice and disclaimer of warranty, keep intact all the notices that refer to this Licence and to the absence of any warranty, and give any other recipients of the Program a copy of this Licence along with the Program.

You may charge a fee for the physical act of transferring a copy, and you may, at your discretion, offer warranty protection in exchange for a fee.

## Open Source Software

2. You may modify your copy or copies of the Program or any portion of it, thus forming a work based on the Program, and copy and distribute such modifications or work under the terms of Section 1 above, provided that you also meet all of these conditions:

- a) You must cause the modified files to carry prominent notices stating that you changed the files and the date of any change.
- b) You must cause any work that you distribute or publish, that in whole or in part contains or is derived from the Program or any part thereof, to be licensed as a whole at no charge to all third parties under the terms of this Licence.
- c) If the modified program normally reads commands interactively when run, you must cause it, when running is commenced for such interactive use in the most ordinary way, to print or display an announcement including an appropriate copyright notice and a notice that there is no warranty (or else, saying that you provide a warranty) and that users may redistribute the program under these conditions, and telling the user how to view a copy of this Licence. (Exception: if the Program itself is interactive but does not normally print such an announcement, your work based on the Program is not required to print an announcement.)

These requirements apply to the modified work as a whole. If identifiable sections of that work are not derived from the Program, and can be reasonably considered independent and separate works in themselves, then this Licence, and its terms, do not apply to those sections when you distribute them as separate works. But when you distribute the same sections as part of a whole which is a work based on the Program, the distribution of the whole must be on the terms of this Licence, in which the permissions for other licensees extend to the entire whole, and thus to each and every part regardless of who wrote it. Thus, it is not the intent of this section to claim rights or contest your rights to work written entirely by you; rather, the intent is to exercise the right to control the distribution of derivative or collective works based on the Program.

In addition, mere aggregation of another work not based on the Program with the Program (or with a work based on the Program) on a volume of a storage or distribution medium does not bring the other work under the scope of this Licence.

3. You may copy and distribute the Program (or a work based on it, under Section 2) in object code or executable form under the terms of Sections 1 and 2 above, provided that you also do one of the following:

- a) Accompany it with the complete corresponding machine-readable source code, which must be distributed under the terms of Sections 1 and 2 above on a medium customarily used for software interchange; or,
- b) Accompany it with a written offer, valid for at least three years, to give any third party, for a charge no more than your cost of physically performing source distribution, a complete machine-readable copy of the corresponding source code, to be distributed under the terms of Sections 1 and 2 above on a medium customarily used for software interchange; or,
- c) Accompany it with the information you received as to the offer to distribute corresponding source code. (This alternative is allowed only for non-commercial distribution and only if you received the program in object code or executable form with such an offer, in accordance with sub-section b above.)

The source code for a work means the preferred form of the work for making modifications to it. For an executable work, complete source code means all the source code for all modules it contains, plus any associated interface definition files, plus the scripts used to control compilation and installation of the executable. However, as a special exception, the source code distributed need not include anything that is normally distributed (in either source or binary form) with the major components (compiler, kernel and so on) of the operating system on which the executable runs, unless that component itself accompanies the executable.

If distribution of executable or object code is made by offering access to copy from a designated place, then offering equivalent access to copy the source code from the same place counts as distribution of the source code, even though third parties are not compelled to copy the source along with the object code.

4. You may not copy, modify, sub-license or distribute the Program except as expressly provided under this Licence. Any attempt otherwise to copy, modify, sub-license or distribute the Program is void, and will automatically terminate your rights under this Licence. However, parties who have received copies, or rights, from you under this Licence will not have their licences terminated so long as such parties remain in full compliance.

5. You are not required to accept this Licence, since you have not signed it. However, nothing else grants you permission to modify or distribute the Program or its derivative works. These actions are prohibited by law if you do not accept this Licence. Therefore, by modifying or distributing the Program (or any work based on the Program), you indicate your acceptance of this Licence to do so, and all its terms and conditions for copying, distributing or modifying the Program or works based on it.

6. Each time you redistribute the Program (or any work based on the Program), the recipient automatically receives a licence from the original licensor to copy, distribute or modify the Program subject to these terms and conditions. You may not impose any further restrictions on the recipients' exercise of the rights granted herein. You are not responsible for enforcing compliance by third parties to this Licence.

7. If, as a consequence of a court judgment or allegation of patent infringement or for any other reason (not limited to patent issues), conditions are imposed on you (whether by court order, agreement or otherwise) that contradict the conditions of this Licence, they do not excuse you from the conditions of this Licence. If you cannot distribute so as to satisfy simultaneously your obligations under this Licence and any other pertinent obligations, then as a consequence you may not distribute the Program at all. For example, if a patent licence would not permit royalty-free redistribution of the Program by all those who receive copies directly or indirectly through you, then the only way you could satisfy both it and this Licence would be to refrain entirely from distribution of the Program.

If any portion of this section is held invalid or unenforceable under any particular circumstance, the remainder of the section is intended to apply and the section as a whole is intended to apply in other circumstances.

## Open Source Software

It is not the purpose of this section to induce you to infringe any patents or other property right claims or to contest validity of any such claims; this section has the sole purpose of protecting the integrity of the free software distribution system, which is implemented by public licence practices. Many people have made generous contributions to the wide range of software distributed through that system in reliance on consistent application of that system; it is up to the author/donor to decide if he or she is willing to distribute software through any other system and a licensee cannot impose that choice.

This section is intended to make thoroughly clear what is believed to be a consequence of the rest of this Licence.

8. If the distribution and/or use of the Program are restricted in certain countries either by patents or by copyrighted interfaces, the original copyright holder who places the Program under this Licence may add an explicit geographical distribution limitation excluding those countries, so that distribution is permitted only in or among countries not thus excluded. In such a case, this Licence incorporates the limitation as if written in the body of this Licence.

9. The Free Software Foundation may publish revised and/or new versions of the General Public Licence from time to time. Such new versions will be similar in spirit to the present version, but may differ in detail to address new problems or concerns.

Each version is given a distinguishing version number. If the Program specifies a version number of this Licence which applies to it and "any later version", you have the option of following the terms and conditions either of that version or of any later version published by the Free Software Foundation. If the Program does not specify a version number of this Licence, you may choose any version ever published by the Free Software Foundation.

10. If you wish to incorporate parts of the Program into other free programs for which the distribution conditions are different, write to the author to ask for permission. For software which is copyrighted by the Free Software Foundation, write to the Free Software Foundation; we sometimes make exceptions for this. Our decision will be guided by the two goals of preserving the free status of all derivatives of our free software and of promoting the sharing and reuse of software generally.

### **NO WARRANTY**

11. BECAUSE THE PROGRAM IS LICENSED FREE OF CHARGE, THERE IS NO WARRANTY FOR THE PROGRAM, TO THE EXTENT PERMITTED BY APPLICABLE LAW. EXCEPT WHEN OTHERWISE STATED IN WRITING THE COPYRIGHT HOLDERS AND/OR OTHER PARTIES PROVIDE THE PROGRAM "AS IS" WITHOUT WARRANTY OF ANY KIND, EITHER EXPRESSED OR IMPLIED, INCLUDING, BUT NOT LIMITED TO, THE IMPLIED WARRANTIES OF MERCHANTABILITY AND FITNESS FOR A PARTICULAR PURPOSE. THE ENTIRE RISK AS TO THE QUALITY AND PERFORMANCE OF THE PROGRAM IS WITH YOU. SHOULD THE PROGRAM PROVE DEFECTIVE, YOU ASSUME THE COST OF ALL NECESSARY SERVICING, REPAIR OR CORRECTION.

12. IN NO EVENT UNLESS REQUIRED BY APPLICABLE LAW OR AGREED TO IN WRITING WILL ANY COPYRIGHT HOLDER, OR ANY OTHER PARTY WHO MAY MODIFY AND/OR REDISTRIBUTE THE PROGRAM AS PERMITTED ABOVE, BE LIABLE TO YOU FOR DAMAGES, INCLUDING ANY GENERAL, SPECIAL, INCIDENTAL OR CONSEQUENTIAL DAMAGES ARISING OUT OF THE USE OR INABILITY TO USE THE PROGRAM (INCLUDING BUT NOT LIMITED TO LOSS OF DATA OR DATA BEING RENDERED INACCURATE OR LOSSES SUSTAINED BY YOU OR THIRD PARTIES OR A FAILURE OF THE PROGRAM TO OPERATE WITH ANY OTHER PROGRAMS), EVEN IF SUCH HOLDER OR OTHER PARTY HAS BEEN ADVISED OF THE POSSIBILITY OF SUCH DAMAGES.

## END OF TERMS AND CONDITIONS

### How to apply these terms to your new programs

If you develop a new program, and you want it to be of the greatest possible use to the public, the best way to achieve this is to make it free software which everyone can redistribute and change under these terms.

To do so, attach the following notices to the program. It is safest to attach them to the start of each source file to most effectively convey the exclusion of warranty; and each file should have at least the "copyright" line and a pointer to where the full notice is found.

```
<one line to give the program's name and a brief idea of what it does.>
```

```
Copyright (C) <year> <name of author>
```

```
This program is free software; you can redistribute it and/or modify it under the terms of the GNU General Public Licence as published by the Free Software Foundation; either version 2 of the Licence, or (at your option) any later version.
```

```
This program is distributed in the hope that it will be useful, but WITHOUT ANY WARRANTY; without even the implied warranty of MERCHANTABILITY or FITNESS FOR A PARTICULAR PURPOSE. See the GNU General Public Licence for more details.
```

You should have received a copy of the GNU General Public Licence along with this program; if not, write to the Free Software Foundation, Inc., 59 Temple Place, Suite 330, Boston, MA 02111-1307 USA

Also add information on how to contact you by electronic and paper mail.

If the program is interactive, make it output a short notice like this when it starts in an interactive mode:

```
Gnomovision version 69, Copyright (C) <year> <name of author>
```

```
Gnomovision comes with ABSOLUTELY NO WARRANTY; for details type 'show w'. This is free software, and you are welcome to redistribute it under certain conditions; type 'show c' for details.
```

The hypothetical commands 'show w' and 'show c' should show the appropriate parts of the General Public Licence. Of course, the commands you use may be called something other than 'show w' and 'show c'; they could even be mouse-clicks or menu items – whatever suits your program.

## Open Source Software

You should also get your employer (if you work as a programmer) or your school, if any, to sign a "copyright disclaimer" for the program, if necessary.

Here is a sample; alter the names:

<p>Yoyodyne, Inc., hereby disclaims all copyright interest in the program 'Gnomovision' (which makes passes at compilers) written by James Hacker. &lt;signature of Ty Coon&gt;, 1 April 1989, Ty Coon, President of Vice</p>
---

This General Public Licence does not permit you to incorporate your program into proprietary programs. If your program is a subroutine library, you may consider it more useful to permit linking of proprietary applications with the library. If this is what you want to do, use the GNU Lesser General Public Licence instead of this Licence.



# Accessories

---

## Extension module each with 14 additional programmable keys

For Gigaset DE900 IP PRO: ZY900 PRO      Product number: S30852-S2210-R701

For Gigaset DE700 IP PRO: ZY700 PRO      Product number: S30852-S2211-R701

# Glossary

---

## A

### ADSL

Asymmetric Digital Subscriber Line  
Special form of **DSL**.

### ALG

Application Layer Gateway  
NAT control mechanism of a router.

Many routers with integrated NAT use ALG. ALG lets the data packets in a VoIP connection pass and adds the public IP address of the secure private network.

The router's ALG should be deactivated if the VoIP provider offers a STUN server or an outbound proxy.

See also: **Firewall, NAT, Outbound proxy, STUN**.

### Authentication

Restriction of access to a network/service by using an ID and password to log in.

### Automatic redial

Several attempts to call are made automatically when the line is busy. The number is adjustable.

## B

### Block dialling

Enter the complete phone number, and correct it if necessary. Then pick up the receiver or press the speaker key to dial the phone number.

### Broadband Internet access

See **DSL**.

### Buddy

Subscriber with whom you exchange brief messages on the Internet in real time (chatting).

See also: **Instant messaging**.

**C****Call divert****CD**

Automatic diversion (CD) of a call to a different telephone number. There are three kinds of call divert:

- CDU, Call Divert Unconditional
- CDB, Call Divert Busy
- CDNR, Call Divert No Reply

**Call swap**

Call swap allows you to switch between two callers or between a conference and an individual caller without allowing the waiting caller to listen to the call.

**Call waiting**

= CW. VoIP provider feature. A beep during a call indicates that another caller is waiting. You can accept or reject the second call. You can activate/deactivate the feature.

**CD****Call divert**

See **Call divert**.

**Chatting**

Form of communication on the Internet. During a chat, brief messages are exchanged between the communicating parties in real time. Chatting in this sense is understood to be a written form of communication.

**Client**

Application that requests a service from a server.

**CLIP****Calling Line Identification Presentation**

Telephony feature. The number of the caller is transferred to the called party's phone display (if the caller activates this feature). The called party's phone must be compatible with CLIP and the feature must be enabled on the phone port.

**Codec****Coder/decoder**

Codec is a procedure that digitalises and compresses analogue voice before it is sent via the Internet, and decodes – i.e., translates into analogue voice – digital data when voice packets are received. There are different codecs, with differing degrees of compression, for instance.

Both parties involved in the telephone connection (caller/sender and recipient) must use the same codec. This is negotiated between the sender and the recipient when establishing a connection.

## Glossary

The choice of codec is a compromise between voice quality, transmission speed and the necessary bandwidth. A high level of compression, for example, means that the bandwidth required for each voice connection is low. However, it also means that the time needed to compress/decompress the data is greater, which increases execution time for data in the network and thus impairs voice quality. The time required increases the delay between the sender speaking and the recipient hearing what has been said.

### COLP/COLR

Connected Line Identification Presentation/Restriction

Feature provided by a VoIP connection for outgoing calls.

COLP displays the phone number accepting the call on the calling party's display unit.

The number of the party accepting the call is different to the dialled number, e.g., if the call is diverted or transferred.

The called party can use COLR (Connected Line Identification Restriction) to prevent the number from appearing on the calling party's display.

### Consultation call

You are on a call. With a consultation call, you interrupt the conversation briefly to establish a second connection to another participant. If you end the connection to this participant immediately, then this was a consultation call. If you switch to and fro between the first and second participants, it is called **call swapping**.

### CW

Call waiting

See **Call waiting**.

### D

#### DHCP

Dynamic Host Configuration Protocol

Internet protocol that regulates the automatic assignment of **IP addresses** to **network subscribers**. The protocol is made available in the network by a server. A DHCP server can, for example, be a router.

The phone contains a DHCP client. A router that contains a DHCP server can assign the IP addresses for the phone automatically from a defined address block. This dynamic assignment means that several **network subscribers** can share one IP address, although they use it alternately and not simultaneously.

With some routers you can specify that the IP address for the phone is never changed.

#### Displayed name

VoIP provider feature. You can specify any name that is to be shown to the other party during a call instead of your phone number.

#### DMZ (Demilitarised Zone)

DMZ describes a part of a network that is outside the firewall.

A DMZ is set up, as it were, between a network you want to protect (e.g., a LAN) and a non-secure network (e.g., the Internet). A DMZ permits unrestricted access from the Internet to only one or a few network components, while the other network components remain secure behind the firewall.

## DNS

### Domain Name System

Hierarchical system that permits the assignment of **IP addresses** to **domain names** that are easier to remember. This assignment has to be managed by a local DNS server in each (W)LAN. The local DNS server determines the IP address, if necessary by enquiring about superordinate DNS servers and other local DNS servers on the Internet.

You can specify the IP address of the primary/secondary DNS server.

See also: **DynDNS**.

### Domain name

Name of one (several) Web server(s) on the Internet (e.g., www.gigaset.com). The domain name is assigned to the relevant IP address by DNS.

## DSCP

### Differentiated Service Code Point

See **Quality of Service (QoS)**.

## DSL

### Digital Subscriber Line

Data transfer technology which allows Internet access over conventional phone lines. Prerequisites: DSL modem and the appropriate service offered by the Internet provider.

## DSLAM

### Digital Subscriber Line Access Multiplexer

The DSLAM is a switch cabinet in an exchange at which all subscriber connectors converge.

## DTMF

### Dual Tone Multi-Frequency

Another description for dual tone multi-frequency dialling (DTMF).

## Dynamic IP Address

A dynamic IP address is assigned to a network component automatically via **DHCP**. The dynamic IP address for a network component can change every time it registers or at certain time intervals.

See also: **Fixed IP address**.

## DynDNS

### Dynamic DNS

**DNS** is used to assign domain names and IP addresses. For **dynamic IP addresses** this service is now enhanced with Dynamic DNS. This permits the use of a network component with a dynamic IP address as a **server** on the **Internet**. DynDNS ensures that a service can always be addressed on the Internet under the same **domain name** regardless of the current IP address.

## Glossary

### E

#### ECT

##### Explicit Call Transfer

Participant A calls participant B. The participant puts the connection on hold and calls participant C. Rather than connect everyone in a three-party conference, A now transfers participant B to C and hangs up.

#### EEPROM

##### Electrically Erasable Programmable Read-Only Memory

Memory building block in your phone with fixed data (e.g., default and customised settings) and data saved automatically (e.g., call list entries).

#### Ethernet network

Wired **LAN**.

Ethernet uses a base band cable for data transmission with a transmission rate of 10 or 100 Mbps or 1 Gbps.

### F

#### Firewall

You can use a firewall to protect your network against unauthorised external access. This involves combining various measures and technologies (hardware and/or software) to control the flow of data between a private network you wish to protect and an unprotected network (e.g., the Internet).

See also: **NAT**.

#### Firmware

Device software in which basic information is saved for the functioning of a device. To correct errors or update the device software, a new version of the firmware can be loaded into the device's memory (firmware update).

#### Fixed IP address

A fixed IP address is assigned to a network component manually during network configuration. Unlike a **dynamic IP address**, a fixed IP address never changes.

#### Flat rate

System of billing for an Internet connection. The Internet service provider charges a set monthly fee. There are no additional charges for the duration of the connection or number of connections.

#### Fragmentation

Data packets that are too big are split into smaller packets (fragments) before they are transferred. They are put together again when they reach the recipient (defragmented).

#### Full duplex

Data transmission is a mode in which data can be sent and received at the same time.

**G****G.711 a law, G.711  $\mu$  law**

Standard for a **codec**.

G.711 delivers a very good voice quality that corresponds to that in the ISDN fixed line. As there is little compression, the necessary bandwidth is around 64 kbit/s per voice connection, but the delay caused by coding/decoding is only approx. 0.125 ms.

"a law" describes the European standard and " $\mu$  law" describes the North American/Japanese equivalent.

**G.722**

Standard for a **codec**.

G.722 is a **broadband** language codec with a bandwidth of 50 Hz to 7 kHz, a net transmission rate of 64 kbit/s per language connection and integrated speech pause recognition and comfort noise generation (silence suppression).

G.722 delivers very good voice quality. A higher sampling rate provides clearer and better voice quality than other codecs and enables a speech tone in High Definition Sound Performance (HDSP).

**G.726**

Standard for a **codec**.

G.726 delivers a good voice quality. It is inferior to the quality with codec **G.711** but better than with **G.729**.

**G.729A/B**

Standard for a **codec**.

The voice quality is more likely to be lower with G.729A/B. As a result of the high level of compression, the necessary bandwidth is only around 8 kbit/s per voice connection, but the delay is around 15 ms.

**Gateway**

Connects two different **networks**, e.g., a router as an Internet gateway.

For phone calls from **VoIP** to the telephone network, a gateway has to be connected to the IP network and the telephone network (gateway/VoIP provider). It forwards calls from VoIP to the telephone network as required.

**Gateway provider**

See **SIP provider**.

**Global IP address**

See **IP address**.

**GSM**

Global System for Mobile Communication

Originally, a European standard for mobile networks. GSM can now be described as a worldwide standard. However, in the USA and Japan, national standards were previously more frequently supported.

## Glossary

### H

#### Headset

Combination of microphone and headphone. A headset makes using speaker mode more convenient. Headsets that can be connected to the telephone via a cable are available.

#### HTTP proxy

Server via which **network subscribers** can process their Internet traffic.

#### Hub

Connects several **network subscribers** in one **infrastructure network**. All data sent to the hub by one network subscriber is forwarded to all network subscribers.

See also: **Gateway, Router**.

### I

#### IEEE

Institute of Electrical and Electronics Engineers

International body that defines standards in electronics and electrical engineering, concerned in particular with the standardisation of LAN technology, transmission protocols, data transfer rate and wiring.

#### Infrastructure network

Network with central structure: All **network subscribers** communicate via a central **router**.

#### Instant messaging

Service that uses a client program to allow chatting in real time, i.e., to send brief messages to other subscribers on the Internet.

#### Internet

Global **WAN**. A series of protocols known as TCP/IP have been defined for exchanging data.

All **network subscribers** are identifiable by an **IP address**. **DNS** assigns a **domain name** to the **IP address**.

Important services on the Internet include the World Wide Web (WWW), e-mail, file transfer and discussion forums.

#### Internet service provider

Enables access to the Internet for a fee.

#### Internet telephony

Voice over IP.

#### IP (Internet Protocol)

TCP/IP protocol on the **Internet**. IP is responsible for the addressing of subscribers in a **network** using **IP addresses**, and routes data from a sender to the recipient. IP determines the paths (routing) along which the data packets travel.

There are standard IPv4 and IPv6 protocols; the essential difference is the structure of the IP addresses.



**IP address**

A unique address for a network component within a network based on the TCP/IP protocols (e.g., LAN, Internet). On the **Internet**, domain names are usually assigned instead of IP addresses. **DNS** assigns the corresponding IP address to the domain name.

The IPv4 IP address has four parts (decimal numbers between 0 and 255) separated by full stops (e.g., 230.94.233.2).

The IP address is made up of the network number and the number of the **network subscriber** (e.g., phone). Depending on the subnet mask, the first, second or third part makes up the network number and the rest of the IP address addresses the network component. The network number of all the components in any one network must be identical.

IP addresses can be assigned automatically with DHCP (dynamic IP addresses) or manually (static IP addresses).

See also: **DHCP**.

**IP pool range**

Range of IP addresses that the DHCP server can use to assign dynamic IP addresses.

**L****LAN****Local Area Network**

Network with a restricted physical range. A LAN can be wireless (WLAN) and/or wired (Ethernet).

**LDAP****Lightweight Directory Access Protocol**

Service for managing directories across a network.

LDAP is used to store and access information about individuals who are part of an organisation (e.g., employees).

**Local IP address**

The local or private IP address is the address for a network component in the local network (LAN). The network operator can assign any address he or she wants. Devices that act as a link from a local network to the Internet (gateway or router) have a public and a private IP address.

See also **IP address**.

**Local SIP port**

See **SIP port/Local SIP port**.

## Glossary

### M

#### MAC address

Media Access Control address

Hardware address by means of which each network device (e.g., network card, switch, phone) can be uniquely identified worldwide. It consists of six parts (hexadecimal numbers) separated by a "-" (e.g., 00-90-65-44-00-3A).

The MAC address is assigned by the manufacturer and cannot be changed.

#### Mbps

Million bits per second

Unit of the transmission speed in a network.

#### MRU

Maximum Receive Unit

Defines the maximum user data volume within a data packet.

#### MTU

Maximum Transmission Unit

Defines the maximum length of a data packet that can be carried over the network at a time.

#### Music on hold

Music is played while you are making a **consultation call** or **call swapping**. The waiting participant hears music while on hold.

### N

#### NAT

Network Address Translation

Method for converting (private) **IP addresses** to one or more (public) IP addresses. With NAT, the IP addresses of **network subscribers** (e.g., VoIP phones) in a **LAN** can be hidden behind a joint IP address for the **router** in the **Internet**.

VoIP telephones behind a NAT router cannot be reached by VoIP servers (on account of the private IP address). To "bypass" NAT it is possible to either use **ALG** in the router, **STUN** in the VoIP telephone or an **outbound proxy** for the VoIP provider.

If an outbound proxy is made available you must allow for this in the VoIP settings for your phone.

#### Network

Group of devices. Devices can be connected in either wired or wireless mode.

Networks can also differ in range and structure:

- Range: Local networks (**LAN**) or wide-area networks (**WAN**)
- Structure: **Infrastructure network** or ad hoc network

#### Network subscriber

Devices and PCs that are connected to each other in a network, e.g., servers, PCs and phones.

## O

**Outbound proxy**

Alternative NAT control mechanism to STUN and ALG.

Outbound proxies are implemented by the VoIP provider in firewall/NAT environments as an alternative to a **SIP proxy server**. They control data traffic through the firewall.

Outbound proxy and STUN servers should not be used simultaneously.

See also: **STUN** and **NAT**.

## P

**PIN**

Personal Identification Number

Protects against unauthorised use. When the PIN is activated, a number combination has to be entered to access a protected area.

**Port**

Data is exchanged between two applications in a **network** across a port.

**Port forwarding**

The **Internet** gateway (e.g., your router) forwards data packets from the Internet to the **port** that the data is intended for. This allows servers in the **LAN** to offer services on the Internet without you needing a public IP address.

**Port number**

Indicates a specific application of a **network subscriber**. Depending on the setting in the **LAN**, the port number is permanently assigned or else it is newly assigned with each access.

The combination of **IP address/port** number identifies the recipient or sender of a data packet within a network.

**Prepare dialling**

See **Block dialling**.

**Private IP address**

See **Public IP address**.

**Protocol**

Describes the agreements for communicating within a **network**. It contains rules for opening, administering and closing a connection, about data formats, time frames and possible error handling.

**Proxy/Proxy server**

Computer program that controls the exchange of data between **client** and **server** in computer networks. If the phone sends a query to the VoIP server, the proxy acts as a server towards the phone and as a client towards the server. A proxy is addressed via the **IP address/domain name** and **port**.

**Public IP address**

The public IP address is the address for a network component on the Internet. It is assigned by the Internet service provider. Devices that act as a link from a local network to the Internet (gateway, router) have a public and a local IP address.

See also: **IP address**, **NAT**.

## Glossary

### Q

#### Quality of Service (QoS)

Describes the Quality of Service in communication networks. Differentiations are made between various Quality of Service classes.

QoS influences the flow of data packets on the Internet, e.g., by prioritising data packets, reserving bandwidth and optimising data packets.

In VoIP networks, QoS influences the voice quality. If the whole infrastructure (router, network server etc.) has QoS, the voice quality is better, i.e., fewer delays, less echoing, less crackling.

### R

#### RAM

##### Random Access Memory

Memory in which you have reading and storage rights. Items such as melodies and screen pictures are saved in the RAM after you have loaded them onto the phone via the Web configurator.

#### Registrar

The registrar manages the **network subscribers'** current IP addresses. When you register with your VoIP provider, your current IP address is saved on the registrar. This means you can also be reached when on the move.

#### ROM

##### Read Only Memory

A type of memory that can only be read.

#### Router

Routes data packets within a network and between different networks via the quickest route. Can connect **Ethernet networks** and WLAN. Can be the **gateway** to the Internet.

#### Routing

Routing is the transfer of data packets to another subscriber in your network. On their way to the recipient, the data packets are sent from one router to the next until they reach their destination.

If data packets were not forwarded in this way, a network like the Internet would not be possible. Routing connects the individual networks to this global system.

A router is a part of this system; it transfers data packets both within a local network and from one network to the next. Transfer of data from one network to another is performed on the basis of a common protocol.

#### RSS feed

##### Really Simple Syndication (also Rich Site Summary)

Provision of data in RSS format. RSS is an Internet service that summarises an Internet page in a short paragraph and includes a link to the original page. Users can subscribe to an RSS feed and receive automatically updated information.

**RTCP**

## Real-Time Control Protocol

Is used to control the RTP protocol. The RTCP protocol is a control protocol and therefore knows which of the transferred RTP sessions belong together.

**RTCP port**

(Local) **port** by means of which voice data packets are sent and received for VoIP.

**RTP**

## Real-Time Transport Protocol

Global standard for transferring audio and video data. Often used in conjunction with UDP. In this case, RTP packets are embedded in UDP packets.

**S****Server**

Makes a service available to other **network subscribers (clients)**. The term can indicate a computer/PC or an application. A server is addressed via the **IP address/domain name and port**.

**SIP (Session Initiation Protocol)**

Signalling protocol independent of voice communication. Used for establishing and ending a call. It is also possible to define parameters for voice transmission.

**SIP address**

See **URI**.

**SIP port/Local SIP port**

(Local) **port** by means of which SIP signalling data is sent and received for VoIP.

**SIP provider**

See **VoIP provider**.

**SIP proxy server**

IP address of your VoIP provider's gateway server.

**Static IP address**

See **Fixed IP address**.

**STUN**

## Simple Transversal of UDP over NAT

NAT control mechanism.

STUN is a data protocol for VoIP telephones. STUN replaces the private IP address in the VoIP telephone data packets with the public address of the secure private network. To control data transfer, a STUN server is also required on the Internet. STUN cannot be implemented with symmetric NATs.

See also: **ALG, Firewall, NAT, Outbound proxy**.

**Subnet**

Segment of a **network**.

## Glossary

### Subnet mask

**IP addresses** consist of a fixed line network number and a variable subscriber number. The network number is identical for all **network subscribers**. The size of the network number part is determined in the subnet mask. In the subnet mask 255.255.255.0, for example, the first three parts of the IP address are the network number and the last part is the subscriber number.

### Symmetric NAT

A symmetric NAT assigns different external IP addresses and port numbers to the same internal IP addresses and port numbers – depending on the external target address.

## T

### TCP

Transmission Control Protocol

**Transport protocol.** Session-based transmission protocol: it sets up, monitors and terminates a connection between sender and recipient for transporting data.

### TLS

Transport Layer Security

Protocol for encrypting data transmissions on the Internet. TLS is a superordinate **transport protocol**.

### Transmission rate

Speed at which data is transmitted in the **WAN** or **LAN**. The transmission rate is measured in data units per unit of time (Mbit/s).

### Transport protocol

Controls data transport between two communication partners (applications).

See also: **UDP, TCP, TLS**.

## U

### UDP

User Datagram Protocol

**Transport protocol.** Unlike **TCP**, **UDP** is a non session-based protocol. UDP does not establish a fixed connection. The recipient is solely responsible for making sure the data is received. The sender is not notified about whether it is received or not.

### URI

Uniform Resource Identifier

Character sequence for identifying resources (e.g., e-mail recipient, www.gigaset.com, files).

On the **Internet**, URIs are used as a unique identification for resources. URIs are also described as SIP addresses.

URIs can be entered in the phone as a number. By dialling a URI, you can call an Internet subscriber with VoIP equipment.

**URL**

Universal Resource Locator

Globally unique address of a domain on the **Internet**.

A URL is a subtype of the **URI**. URLs identify a resource by its location on the **Internet**. For historical reasons the term is often used as a synonym for URI.

**User ID**

See **User identification**.

**User identification**

Name/number combination for access, e.g., to your VoIP account.

**V****Voice codec**

See **Codec**.

**VoIP**

Voice over Internet Protocol

Calls are no longer established and transmitted via the telephone network, but via the **Internet** (or other IP networks).

**VoIP provider**

A VoIP, SIP or **gateway provider** is an Internet service provider that provides a **gateway** for Internet telephony. As the phone works with the SIP standard, your provider must support the SIP standard.

The provider routes calls from VoIP to the telephone network (analogue, ISDN and mobile) and vice versa.

**W****WAN**

Wide Area Network

Wide-area network that is unrestricted in terms of area (e.g., **Internet**).

# Index

---

## A

- Acknowledge tones .....84
- Activating DTMF using a function key. 157
- Adjusting the volume .....36
- Advisory tone
  - confirmation.....84
  - key press.....84
- Advisory tones
  - activating/deactivating.....84
- Alarm clock function .....70
  - activating/deactivating.....70
  - ringer.....71
  - volume.....71
- Anonymous calling.....38
- Appointment
  - deleting from calendar .....68
  - displaying in calendar .....68
- Attributes
  - LDAP database ..... 151
- Audio quality ..... 136
- Authentication
  - OpenVPN ..... 129
- Authorisation ..... 174
- Automatic configuration
  - of VoIP accounts ..... 109

## B

- Backlight
  - brightness.....91
  - deactivating.....91
- Birthday
  - displaying in calendar .....68
  - showing on display .....69
- BLF
  - assigning a function key ..... 156
- BLF (Busy Lamp Field) ..... 156

## C

- CA certificates ..... 127
  - OpenVPN ..... 130
- Calendar
  - deleting appointments.....68
  - icons.....68
  - opening.....68

## Calendar

- showing on display.....86

## Call

- accepting via receiver ..... 35, 77
- anonymous.....38
- in call list .....46
- incoming.....35
- missed .....46
- outgoing.....31
- rejecting ..... 35, 77
- transferring.....42
- two-way recording .....38
- Call divert .....43, 138, 156
  - no answer..... 43, 44
  - when busy ..... 43, 44
- Call duration.....31
- Call list .....46
  - all calls .....46
  - deleting.....49
  - deleting an entry.....49
  - dialling a number ..... 34, 48
  - in Web configurator ..... 165
  - missed calls.....46
  - opening..... 33, 46
  - outgoing calls .....46
  - redial .....33
  - saved information.....47
  - transferring entry to directory.....49
- Call manager ..... 124
- Call records .....38
  - deleting.....64
  - duration.....63
  - playing back via the display menu...63
- Call records key ..... 3, 38
- Call swap .....40
- Call transfer.....42
  - blind .....42
  - secure.....42
- Call Waiting
  - blocking ..... 135
- Call waiting.....39
  - accepting call.....39
  - activating/deactivating.....40
  - rejecting call.....39



- Caller
  - name on display .....35
  - picture on display .....35
- Caller picture .....35
  - in directory entry .....52
  - in resource directory ..... 102
- Calling Line Identification ..... 38, 47
  - withholding for all calls .....38
  - withholding once .....38
- Caring for your telephone..... 172, 174
- Certificate
  - importing ..... 127, 130
  - invalid ..... 127
  - OpenVPN ..... 129
- Characters
  - correcting .....23
  - upper, lower case .....23
- Checking the capacity of the
  - resource directory ..... 104
- Client certificate ..... 130
- Client key..... 130
- CLIP (Calling Line Identification Presentation) .....47
- CLIR (Calling Line Identification Restriction) .....38
- Codec
  - G.711 a law ..... 137
  - G.711  $\mu$  law ..... 137
  - G.722 ..... 137
  - G.726 ..... 137
  - G.729 ..... 137
- Codec preference ..... 136
- Conference call .....41
  - adding callers on hold .....41
  - adding new participants..... 41
- Conference key ..... 4, 41
- Configuring an e-mail account ..... 114
- Confirmation tone.....84
- Connecting
  - extension module.....17
  - network cable .....14
  - PC .....15
  - power adapter.....16
  - receiver .....13
- Connecting a PC .....15
- Connecting the network cable .....14
- Connection frame for extension module 17
- Consultation call .....39
- Consultation key ..... 3, 39
- Contact with liquid ..... 174
- Contents .....11
- Correcting
  - incorrectly entered characters.....23
  - incorrectly entered digit .....32
- Counting accepted calls ..... 135
- Counting missed calls ..... 135
- Country ..... 139
- Counts for missed and accepted calls . 135
- D**
- Data
  - memory..... 100
- Date
  - setting via display menu.....81
- Deactivating the microphone .....37
- Default number in directory entry .....54
- Deleting a digit .....32
- Determining prefix length ..... 120
- DHCP .....93
- DHCP relay ..... 130
- Diagnostic information
  - PCAP logging..... 171
  - SIP logging ..... 171
  - system log..... 170
- Dialling a number
  - cancelling .....32
  - from call list (display).....34
  - from directory (display).....32
  - from the call list (Web configurator) 165
  - via function key .....33
- Dialling code ..... 139
- Dialling plans ..... 140
- Dialling see Dialling a number
- DiffServ (Differentiated Services) ..... 125
- Directories.....50
- Directory
  - accessing via key..... 155
  - map .....78
  - transferring from PC to phone..... 168
  - transferring to PC ..... 168
- Directory entry.....51
  - caller picture .....52
  - changing default number.....54
  - creating .....52

## Index

- Directory entry
    - deleting .....55
    - displaying ..... 51, 52, 78
    - editing .....54
    - entering numbers.....53
  - Directory key
    - programming..... 155
  - Directory, LDAP ..... 56, 151
    - dialling a number .....56
    - searching for an entry .....56
  - Directory, local .....50
    - deleting.....55
    - entry.....51
    - opening.....51
  - Directory, net .....57
    - displaying entry details.....60
    - opening.....57
    - personal .....57
    - public.....57
    - refining search.....60
    - search results .....59
    - searching for a name .....59
    - searching for a number.....58
    - transferring entry to directory.....60
  - Directory, online ..... 150
    - selecting a provider ..... 150
  - Display ..... 22, 160
    - backlight.....91
    - brightness..... 161
    - Calling Line Identification.....35
    - display formats ..... 161
    - during call.....36
    - in idle status..... 22, 84
    - menu tree .....29
    - returning to idle status .....26
    - setting the language .....92
    - settings .....84
    - time-controlled deactivation..... 161
  - Display format, LDAP ..... 153
  - Display functions..... 22, 160
  - Display icons.....4
  - Display in idle status.....22
    - displaying calendar .....86
    - displaying picture.....88
    - displaying time zones .....85
    - returning.....26
  - Display keys ..... 3, 22
  - Display menu .....29
    - illustration in the user guide .....27
  - Disposal..... 173
  - DND (Do Not Disturb) see Do Not Disturb
  - DNS server
    - alternate ..... 96, 97, 119, 120
    - preferred ..... 96, 97, 119, 120
  - Do Not Disturb.....37
  - Do Not Disturb (DND) ..... 141
  - Do Not Disturb key ..... 3, 37
  - Door interphone .....77
    - video cameras .....76
  - Door interphone video camera
    - configuring..... 149
    - displaying pictures .....76
  - Door opener .....77
  - DSL router .....9
- ## E
- E-mail
    - deleting .....66
    - displaying messages ..... 142
    - displaying new messages..... 114, 143
      - in Message Centre .....67
    - messages whilst making a connection66
    - notification .....64
    - opening incoming e-mail list.....65
    - reading .....66
    - settings ..... 142
    - spam protection .....65
    - troubleshooting .....66
    - via secure connection (SSL) .... 114, 143
  - E-mail account
    - configuring..... 114
  - E-mail icon .....64
    - new message.....65
    - read message.....65
  - E-mail server.....10
  - Encryption..... 128
  - End key ..... 3, 32
  - Ending call
    - by hanging up .....35
    - with end call key .....35
  - Entering special characters.....24
  - Entering standard gateway.....95
  - Entering text.....23

Entry mode .....	23
Environment .....	173
Error tone .....	84
Ethernet .....	9, 93
Ethernet cable .....	15
Extension module .....	17
connection frame .....	17

## F

Factory settings .....	92, 167
restoring .....	167
File server .....	10
Filter, LDAP .....	152
Firmware update	
automatic .....	168
manual .....	169
Firmware updates .....	168
Firmware version .....	170
Function key	
accessing menu function .....	157
BLF .....	156
call divert .....	156
connection .....	155
DTMF .....	157
Park + Orbit .....	156
speed dial .....	156
split line .....	155
XML data .....	156
Function keys .....	4
additional .....	17
programming .....	154, 155

## G

G.722 .....	2
Getting started .....	18
Gigabit switch .....	9
Gigaset QuickSync .....	175
Gigaset T500 .....	123
GNU General Public Licence (GPL) .....	178
GNU General Public License (GPL)	
English .....	178
GNU Lesser General Public License_ (LGPL),	
English .....	178
GPL .....	178

## H

Headset	
adjusting the volume .....	36
calling via .....	31
Headset key .....	3
HTTP server	
operating .....	123

## I

ICE (Interactive Connectivity	
Establishment) .....	126
Idle display	
showing slide show .....	87
Idle status (display) .....	26
Incoming e-mail list .....	65
Incoming e-mail server .....	64, 114, 142
Info service .....	72
for screensaver .....	145
XML site .....	145
Info services	
activating .....	145
closing .....	76
configuring .....	145
door interphone .....	76
Internet radio .....	74
News .....	73
selecting for screensaver .....	145
weather report .....	74, 147
webcam .....	75
Information Centre .....	72
Information Centre key .....	3, 72, 79
Insert strips .....	174
Installation wizard .....	18
Internet radio	
activating .....	74
selecting stations .....	75, 148
Internet service	
as screensaver .....	89
Internet telephony	
configuring .....	20, 108
IP address .....	93
auto-configuration .....	96, 119
dynamic .....	94, 118
finding .....	105
IPv4 .....	95, 118
IPv6 .....	97, 120

## Index

- IP address
  - prefix ..... 97, 120
  - static ..... 93, 94, 96, 118, 119
- IP protocol ..... 93, 94, 117
- IPv4 ..... 93
- IPv6 ..... 93
- K**
- Kensington lock ..... 16
- Key
  - call records ..... 3, 38
  - conference ..... 4, 41
  - consultation ..... 3, 39
  - display ..... 3
  - Do Not Disturb ..... 3, 37
  - end ..... 3
  - headset ..... 3
  - Information Centre ..... 3, 72, 79
  - Message Centre ..... 3, 33, 67
  - mute ..... 3, 37
  - navigation ..... 3, 24
  - programmable ..... 4
  - speaker ..... 3, 37
  - transfer ..... 4, 42
  - volume ..... 3, 36
- Key shortcuts for phone
  - system functions ..... 175
- L**
- LAN port ..... 15
- LAN settings ..... 94, 117
- Language
  - for the display ..... 161
  - for the Web configurator ..... 161
- LDAP
  - display format ..... 153
  - display name ..... 153
  - name attributes ..... 152
  - number attributes ..... 152
  - number filter ..... 153
  - search area ..... 154
  - server address ..... 154
  - server port ..... 154
- LDAP (Lightweight Directory Access Protocol) ..... 151
- LDAP (Lightweight Directory Access Protocol) ..... 56
- LDAP attributes ..... 151
- LDAP contacts
  - in display ..... 56, 151
- LDAP filter ..... 152
- LDAP server ..... 151
- LEDs see Light Emitting Diodes
- Licence, GPL ..... 178
- License
  - GPL ..... 178
  - LGPL ..... 178
- Light Emitting Diodes ..... 4
- List
  - accepted calls ..... 46
  - all calls ..... 46
  - missed calls ..... 46
  - redial ..... 46
  - scrolling through ..... 26
- Local contacts
  - in display menu ..... 50
- Local directory
  - creating entry in Web configurator . 164
  - in Web configurator ..... 163
- LZO compression ..... 129
- M**
- Main menu ..... 25
  - customising individually ..... 162
- Making calls ..... 31
- Managing the calendar ..... 68
- Map
  - activating display ..... 160
  - displaying ..... 78
  - for directory entry ..... 78
- Medical equipment ..... 8
- Memory keys ..... 33
- Menu ..... 25
  - navigation ..... 25
  - settings ..... 116
  - start tone ..... 84
  - using ..... 25
- Menu tree
  - display ..... 29
  - Web configurator ..... 106
- Message Centre ..... 33, 67
  - icons ..... 67
  - opening ..... 67
  - opening message list ..... 67

Message Centre key ..... 3, 67  
 Messages  
   call records .....63  
   e-mails .....64  
   voice.....61  
 Messaging  
   voice..... 142  
 Missed alarm  
   deleting from list .....69  
   in Message Centre .....67  
 Missed call  
   in call list .....46  
   in Message Centre .....67  
 Move cursor .....23  
 Mute key ..... 3, 37  
 Mute see Muting  
 Muting .....37  
 MWI (Message Waiting Indication) . 61, 144

## N

NAS system.....10  
 NAT ..... 111  
 Navigation key..... 3, 24  
 Network  
   setting up for the first time.....19  
   setting up via display menu.....93  
   setting up via Web configurator.... 117  
   wired .....93  
 Network configuration  
   default setting .....19  
 Network mailbox..... 61, 142  
   new message .....61  
 Network provider data..... 111  
 Network type .....94  
 News  
   display as screensaver ..... 145  
 Notification of incoming e-mail.....64  
 Number  
   dialling from call list .....48  
   dialling from LDAP directory .....56  
   dialling from the directory ..... 163  
   entering via keypad .....31  
   searching in directory ..... 163  
   selecting from the directory.....55  
   showing on display .....35  
   transferring to local directory .....32  
 Number filter, LDAP ..... 153

## O

On hold .....39  
 Online directory see  
   Directory, online  
 Open listening .....37  
 OpenSSL ..... 128  
 OpenVPN..... 128  
   authentication ..... 129  
   certificates ..... 130  
   DHCP relay ..... 130  
   hardened security..... 129  
   static key ..... 129  
 OpenVPN client ..... 128  
 Operating the telephone  
   via display menu .....22  
 Outbound proxy ..... 111  
   mode ..... 111  
 Outbound server  
   address ..... 112

## P

Park + Orbit  
   assigning a function key ..... 156  
 Password  
   displaying in readable form ..... 159  
 Password for Web configurator ..... 159  
 PCAP log file ..... 171  
 Phone  
   factory settings ..... 167  
   rebooting ..... 167  
 Phone system.....9  
   type ..... 123  
 Pictures  
   for callers in directory entry  
     (display menu) .....52  
   for display in idle status.....88  
   for slide show.....87  
   in resource directory ..... 100  
 PoE (Power over Ethernet) ..... 9, 15  
 Power adapter .....8  
   connecting .....16  
 Prefix of the IP address..... 97, 120  
 Priority of voice data.....98, 122, 125  
 Private contacts ..... 163  
 Programmable keys ..... 155  
 Protection against theft.....16  
 Provider profile ..... 109

<b>Index</b>	
Provisioning file .....	20
<b>Q</b>	
QoS (Quality of Service) .....	125
Questions and answers .....	172
<b>R</b>	
Reboot .....	167
Rebooting .....	167
Receiver	
adjusting the volume .....	36
connecting .....	13
Redial list .....	33, 46
Registration server	
port .....	110
Reset .....	92
Resource directory .....	100
caller pictures .....	102
checking capacity .....	104
file formats .....	100
pictures for screensaver .....	101
sounds for ringers .....	103
Restoring the default settings .....	92
Ringback .....	34
activating/deactivating function .....	34
Ringer .....	81
adjusting the volume while phone	
is ringing .....	36
alternative volume .....	82
deactivating .....	35
for alarm clock function .....	71
setting melody .....	82
silencing for anonymous calls .....	83
sound in resource directory .....	103
volume for appointments .....	81
volume for incoming calls .....	81
RSS feed .....	89
RSS feeds .....	73
RTP (Realtime Transport Protocol) .....	125
<b>S</b>	
Safety precautions .....	8
Screensaver .....	89
Internet service .....	89
pictures in resource directory .....	101
selecting .....	89
selecting an info service .....	145
Screensaver see Screensaver	
Security settings	
server certificates .....	127, 130
Server certificates .....	127, 130
Setting a ring tone	
in user mode .....	137
Setting language	
for Web configurator .....	105
Setting the language .....	92
setting up for the first time .....	18
Setting the ring tone	
administrator mode .....	135
Setting up the device via the display .....	18
Settings	
configuring via Web configurator .....	116
information .....	80
Settings via display menu	
advisory tones .....	84
date and time .....	80
display backlight .....	91
display in idle status .....	84
display language .....	92
ringers .....	81
screensaver .....	89
Setup assistant .....	108
closing .....	115
Silence suppression .....	137
SIP address .....	110
SIP logging .....	171
SIP provider .....	10
Slide show .....	87
Sound	
in resource directory .....	100, 103
Spam protection .....	65
Speaker	
activating/deactivating .....	37
Speaker key .....	3, 31, 37
Speaker mode	
adjusting the volume .....	36
Specifications .....	36, 177
Speed dial .....	156
Split line	
assigning function key .....	155
defining for function key .....	155
using .....	33
SRTP (Secure Real-Time Protocol) .....	128

SSL (Secure Sockets Layer) . . . . . 128  
 Standard gateway . . . . . 95, 119  
 Standard VoIP account . . . . . 31  
 Static key . . . . . 129  
 Stations for Internet radio . . . . . 75  
 Status . . . . . 170  
 Storage allocation . . . . . 171  
 Storage capacity  
   displaying in Web configurator . . . . . 171  
 STUN  
   refresh time . . . . . 111  
 STUN server . . . . . 111  
 Subnet mask . . . . . 95, 119  
 System log . . . . . 170  
 System settings . . . . . 158  
   date and time . . . . . 158  
   security . . . . . 159  
**T**  
 TAP driver . . . . . 129  
 Telephone PIN  
   changing . . . . . 159  
 Telephone settings  
   in display menu . . . . . 80  
   in Web configurator . . . . . 116  
 Telephone system  
   operating in the network . . . . . 123  
 Telephony . . . . . 132  
 Text editor . . . . . 23  
 Time  
   setting . . . . . 81  
   showing on display . . . . . 86  
 Time server . . . . . 80  
 Time zone . . . . . 139  
   setting . . . . . 18  
   showing on display . . . . . 85  
 TLS (Transport Layer Security) . . . . . 128  
 TLS-auth . . . . . 129  
 Tone scheme . . . . . 139  
 Transfer key . . . . . 4, 42  
 Troubleshooting . . . . . 172  
   e-mail . . . . . 66  
 TUN driver . . . . . 129

**U**

Usage scenario  
   professional environment with phone  
     system . . . . . 9  
   without phone system . . . . . 10  
 User interface  
   display . . . . . 22  
 User mode  
   available functions . . . . . 106

**V**

vCard . . . . . 50  
 Virtual driver . . . . . 129  
 Virtual Private Network . . . . . 128  
 VLAN (Virtual Local Area Network) . . . . . 97  
 VLAN (Virtual Local Area Network) . . . . . 121  
 VLAN priority . . . . . 98, 122  
 VLAN tagging . . . . . 97, 121  
 Voice mail . . . . . 61, 142  
   ending playback . . . . . 62  
   in Message Centre . . . . . 67  
   playing . . . . . 61, 62  
 Voice quality . . . . . 125, 136  
 VoIP account  
   automatic configuration . . . . . 109  
   configuration via provider profile . . . . . 109  
   DTMF transfer . . . . . 112  
   entering registration data . . . . . 113, 134  
   manual configuration . . . . . 110  
   personal provider data . . . . . 113, 134  
   selecting . . . . . 31  
   setting up . . . . . 108  
   standard . . . . . 31  
 VoIP status . . . . . 170  
 Volume for ringer . . . . . 81  
   alternative . . . . . 82  
 Volume key . . . . . 3, 36  
 VPN . . . . . 128  
 VPN (Virtual Private Network) . . . . . 128  
 VPN tunnel . . . . . 128

## Index

### W

Weather	
display as screensaver .....	145
Weather report .....	74
Web address	
in directory .....	53
Web configurator .....	105
accessing .....	105
changing password .....	159
login screen .....	105
menu structure .....	106
selecting language .....	105
settings .....	116
setup assistant .....	108
starting .....	105
Webcam	
configuring for info service .....	147
display as screensaver .....	145
displaying as info service .....	75
Workgroup server .....	10

### X

XML function .....	156
XML site	
display as screensaver .....	145
specification .....	145
XML site as info service .....	145



Issued by

Gigaset Communications GmbH  
Frankenstr. 2a, D-46395 Bocholt

© Gigaset Communications GmbH 2012

Subject to availability.

All rights reserved. Rights of modifications reserved.

[www.gigaset.com](http://www.gigaset.com)

**A31008-M2211-R101-5-7619**