

INTERNATIONAL SALESMANUAL

SCHOCK

COLOUR YOUR LIFE

NEWS
NEWS

HANDMADE IN GERMANY

SCHOCK

SCHOCK

HANDMADE IN GERMANY

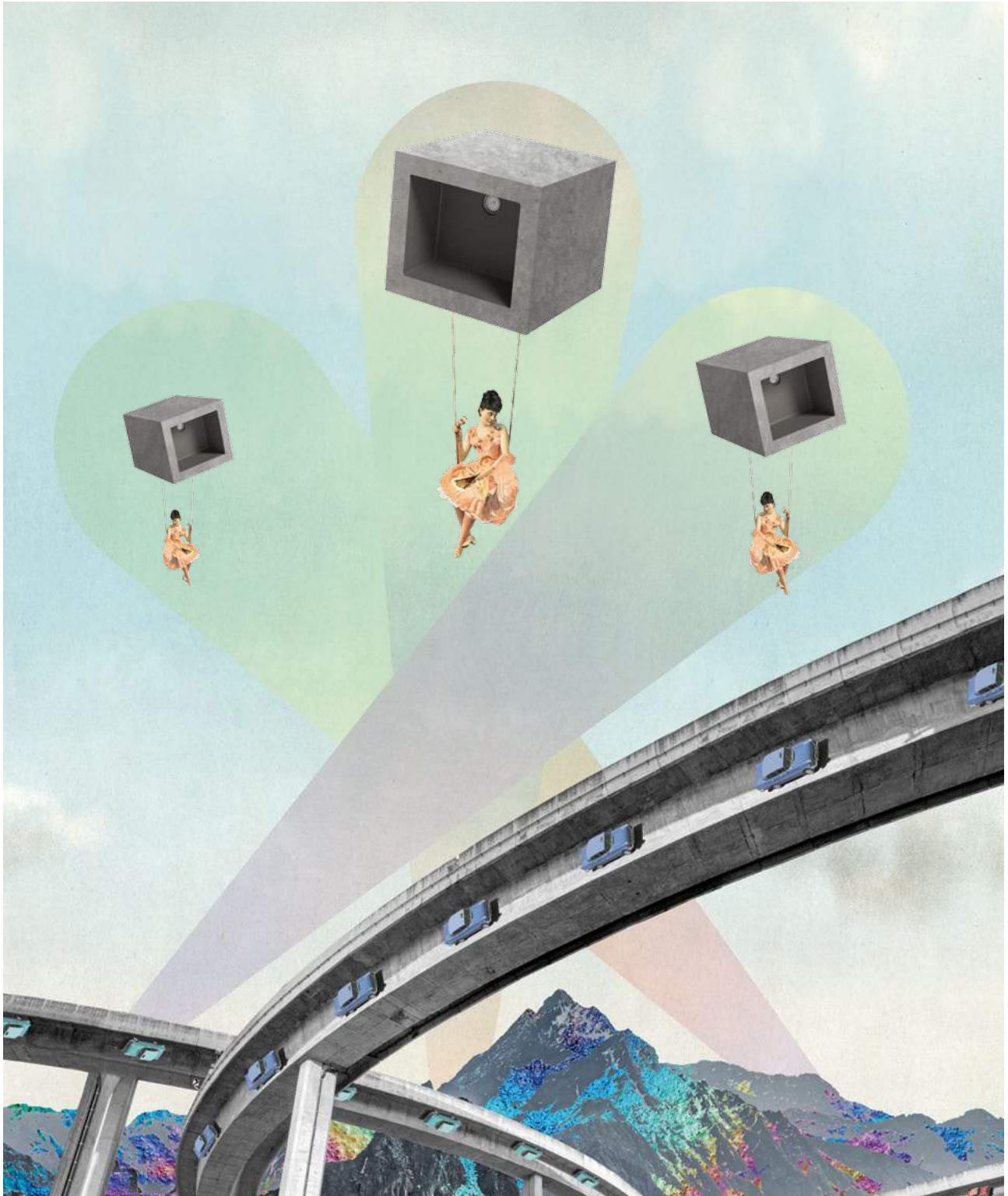

SINKS & MIXER TAPS
NEWS 2017

WELCOME 2
SERVICE 4
THE COMPANY 6
SOCIAL RESPONSIBILITY 12
WORLD OF MATERIALS 14

FEATURES & NEWS 24
PREPSTATION 42

COLOUR BRING YOUR LIFE

Dear customers,

We invite you to join us and immerse yourselves in the colourful world of the SCHOCK sink.

Come and get to know our new products and innovations. Find out about how sinks can be employed as food prep assistants, how good SCHOCK looks in grey and how we are growing our portfolio optimally.

As a sink pioneer with outstanding product innovations that revolutionize the market we are keen to demonstrate once more that change is our status quo.

Your management team

Sven-Michael Funck and Ralf Boberg





SERVICE



High-grade products need the right kind of love and attention. So we have put together all the right hints and tips for you. You can find the answers to your specific questions in our care videos and FAQs located in our online Care Center at www.schock.de/care

Practical - The SCHOCK spare parts shop

Looking for SCHOCK spare parts or care products? Browse our spare parts shop for complementary parts to go with our assortment of sinks and mixer taps. Order what you need online wherever it suits you best - from your computer at home or on the road with your smartphone or tablet.

Visit the spare parts shop at www.schock.de/en/shop



Movie material - The SCHOCK service videos

What special features does my SCHOCK product have? How do I install it right? And what tools will I need to use? Answers to all these questions can be found in the service videos from SCHOCK. The video clips present our products, spare parts and care products, provide you with technical information and supply installation instructions. All of the videos are available to view on our website and on the SCHOCK Germany YouTube channel.

Visit the Youtube channel [SCHOCK Germany](https://www.youtube.com/channel/SCHOCKGermany)



THE COMPANY



ABOUT US
 OUR CORPORATE IDENTITY
 SOCIAL RESPONSIBILITY

SCHOCK

VISION



ABOUT US We invented the quartz composite sink in 1979. And we've been constantly reinventing it and ourselves ever since. The result is more than 240 sink models in as many as 43 colours. We have more than 90 patents and 60% of sinks made around the world are produced on the basis of our methods. But there's one thing we kept to ourselves: the special combination of our products themselves - handmade in Germany - and our international trend scouting activities. We don't follow a strategy, we follow our intuition. And what that means for us in figures is: 50% growth, 25% global market share, 100% pioneering spirit. We know that the road ahead of us is long: It will continue to take us out of our comfort zone and thrust us headlong into the world of colour. With new and unseen ideas and good old, tried-and-trusted craftsmanship.

CHANGE IS OUR PERMANENT STATE Since our company's inception in 1924 we have only ever been satisfied when we're not yet satisfied. What we want is to set the standards to which the global market aspires and to keep testing them constantly. We want to be top dog and challenger all in one. That's because we think that moving with the times is not enough: it's better to be ahead of the curve. The machinery and materials we've used in doing this have changed time and again over the course of the last 90 years. But the tools have remained the same. These are: curiosity, dedication, courage, an international context and a passion for what we're doing - and what we still have scope to do in the future. This encompasses both international success and commitment to our local region. For instance by partnering with regional suppliers, schools and workshops for the disabled or by creating jobs and apprenticeships.

Headquarters, Regen

HANDMADE IN GERMANY



TRUST



SOCIAL RESPONSIBILITY We work according to standards that are anything but standard. That goes for our manufacturing of premium, environmentally sound sinks and recyclable packaging materials and likewise for our demands in terms of energy-efficient and environmentally friendly production. We have achieved raw materials efficiency of 90%, for instance, halved our water consumption since 2007 and made sure that we recycle 95% of the water we use. Certification through ISO 14001 and EMAS (the European Commission's certification scheme) serve to underline our desire for healthy growth. That is why we produce exclusively in Germany, as the only manufacturer of quartz composite sinks to do so. And yet we still like to think beyond boundaries - e.g. about school projects in Africa like Ohole Ambassadors. Because we want to make life not only that little more colourful but perhaps also that little bit easier.

ISO
14001



UM
WELT
PAKT
BAYERN



WORLD OF MATERIALS



PRODUCT BENEFITS
 CRISTADUR® EXTREME
 CRISTADUR® NATURE
 CARBON

16

18

20

22

SCHOCK

PRODUCT BENEFITS

SCHOCK sinks are up to 80% natural quartz sand. CRISTADUR® and CRISTALITE+® have been specially developed for the demands of the kitchen. The rigours of everyday use vanish with hardly a trace.

SCHOCK INVENTED THE quartz composite SINK

Even after more than 35 years, 60% of all quartz composite sinks made in the world today are manufactured using SCHOCK methods – that's 2 million quartz composite sinks a year.

SCHOCK PREMIUM DESIGN

SCHOCK's material technology enables the realisation of exceptional designs. Premium sinks from SCHOCK have won numerous design awards over the years.

SCHOCK MATERIAL TECHNOLOGY

Since the invention of the quartz composite sink, SCHOCK materials have been continually refined and set new standards. This innovative spirit is reflected in more than 90 patents.

PROHYGIENIC21 - THE HYGIENE STANDARD

The patented surface quality of CRISTALITE+ and CRISTADUR® ensure optimum safety when handling fresh food.

SCHOCK DIRT-REPELLENT EFFECT

The material's fine structure means dirt that could be a breeding ground for bacteria finds it impossible to stick to the surface.



Dirt-repellent effect

The dirt simply runs off.



Odour-free

Leaves the surface free of smells. LGA 5421357



Heat-proof

Not temperature sensitive. DIN 13310



Food-safe

Absolutely safe material. LGA 5631024



ProHygienic 21

Guaranteed, patented surface quality from SCHOCK.



Impact-resistant

Tough and resistant material. DIN EN438-2

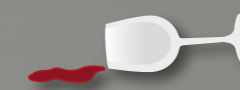

Stain-resistant

Food stains cannot stick. LGA 1103



Made to last

Extremely durable. DIN 13310

CRISTADUR® EXTREME

Developing extremely hard-wearing materials demands extreme test methods. Like all SCHOCK products, the new CRISTADUR® EXTREME sinks naturally went through extensive internal and external testing. Heat resistance, impact resistance, durability and many more aspects had all been tested. Nevertheless, SCHOCK decided to conduct two more, very special endurance tests.

THE ICE-HOCKEY CHALLENGE

Achieving four times greater impact resistance in the bottom of the sink called for an impact load far in excess of anything tested under lab conditions. So SCHOCK called up the local ice hockey team, ERC Red Dragons Regen, and dared them to “bombard” and try to destroy the new CRISTADUR® EXTREME model, the Greenwich N-100. Having pucks forcefully shot at over 100 km/h against the bottom of the sink made this test a real challenge for SCHOCK’s new fibreglass technology.

See it for yourself:



www.schock.de/eishockey

THE OFF-ROAD SINK DERBY

The cross-linkage within the CRISTADUR® EXTREME material significantly reduces the risk of transport breakage for the heavy SCHOCK sinks, making it possible to develop smaller and more environmentally friendly packaging. Or even to do without packaging entirely? That was something SCHOCK was keen to know, so they arranged a sink derby: an old tank training track in the Bavarian Forest saw the sinks sent hurtling downhill, being “transported” without any packaging whatsoever.

See more here:



www.schock.de/spuelenkisten

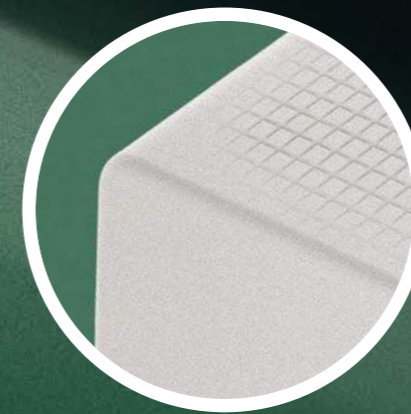

Fibreglass reinforcement
in the bottom of the sink

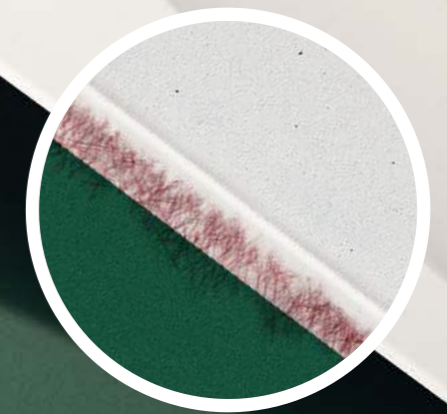

Organic fibres
cross-link the material



CRISTADUR® NATURE

For the production of the CRISTADUR® NATURE colours Kaiserstein and Rockenstein, SCHOCK employs a refined version of its manufacturing formula. An innovative crystalline quartz mixture is used to create the natural granite structure. And what's really special about it is that the quartz crystals are left completely uncoloured.

Granite in its rough, million year old, pristine colouring is an alluring sight and fits just perfectly into the trend of bringing regional materials back into contemporary kitchens. The colours Rockenstein and Kaiserstein show off the beauty of Bavarian granite. And CRISTADUR®

NATURE features a natural surface with the feel of real granite. Naturally, the surface still boasts the material's typical qualities, being food-safe, poreless and much more besides. The new natural colours are available with selected CRISTADUR® models.



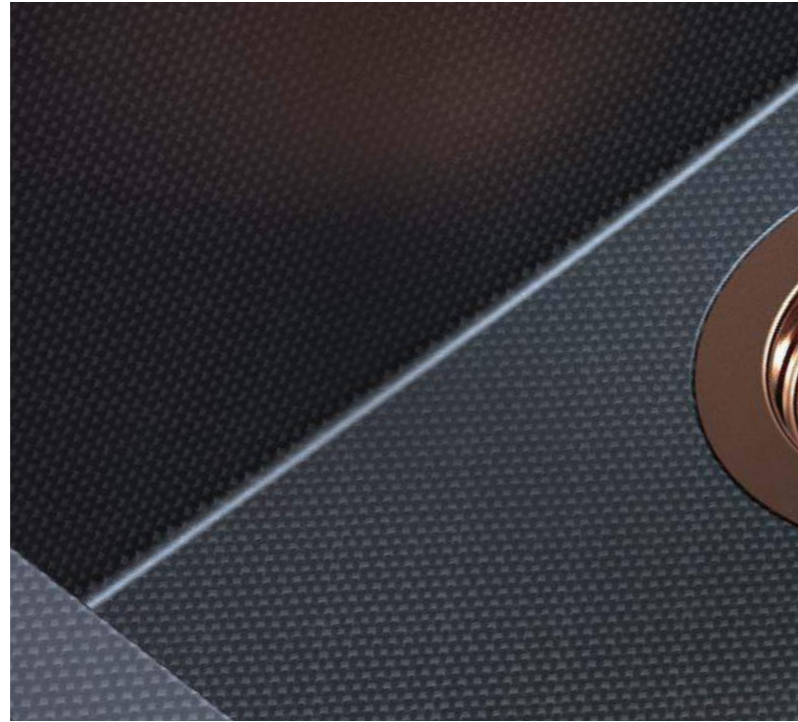

THE ULTIMATE MATERIAL

SCHOCK is employing a revolutionary, patent pending method to produce the first sinks to be made of a carbon/quartz composite. Carbon is an integral part of technological progress. It's very strong and able to absorb a great deal of energy, making it the leading material of the 21st century. The new series of Carbon sinks with the N-100S and N-100 models enables those who acquire one to be part of the technological revolution and install something in their kitchen that is pretty much one of a kind. The material stands out even in an exclusive environment. Homeowners and their guests alike will love it - the ultimate sink for the exclusive kitchen.

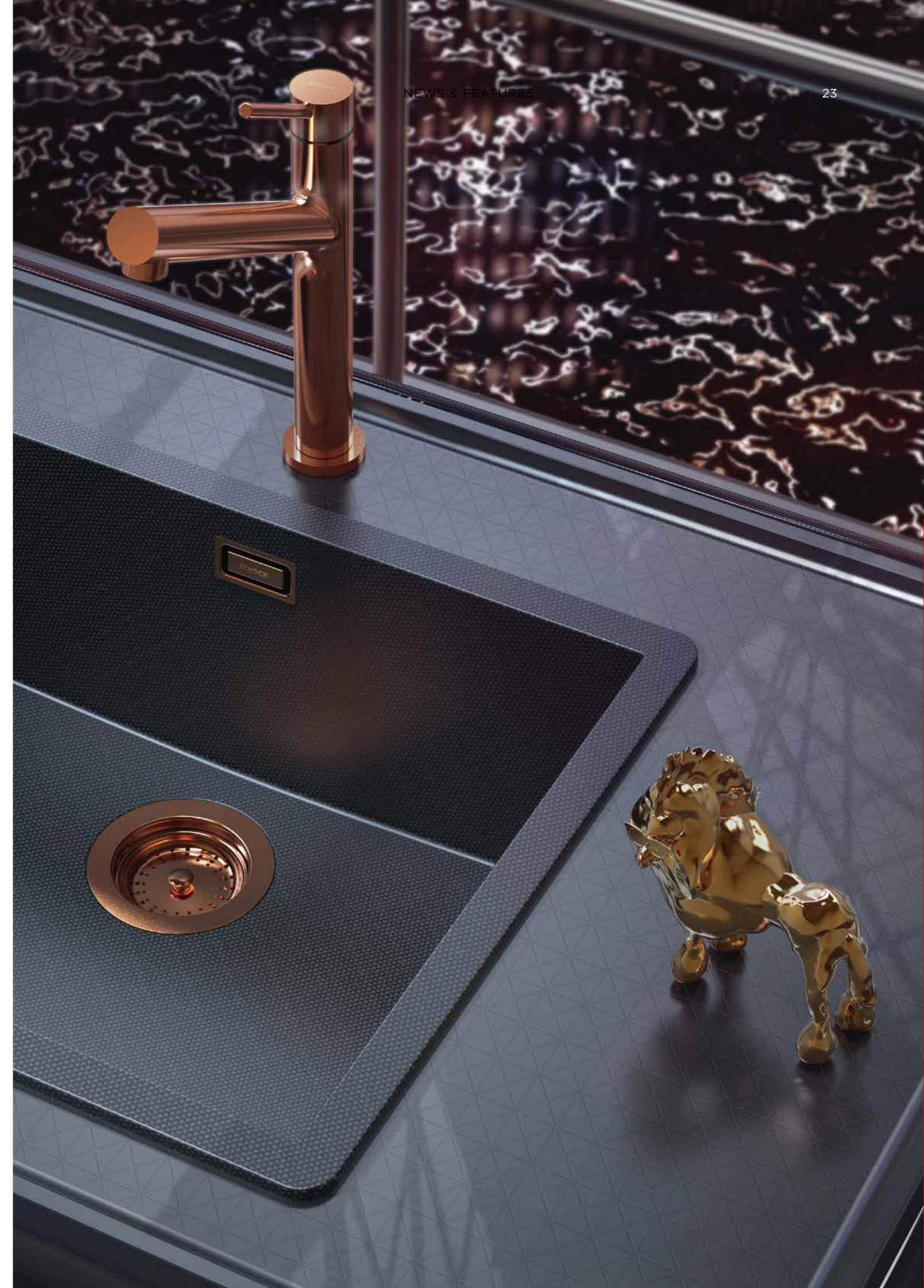

FEATURES & NEWS



IN THE FAST LANE

Asphalt and Silverstone - two new names in the SCHOCK portfolio that speak for themselves. The two new shades of grey hold associations with high-powered vehicles speeding along scorching highways. The CRISTALITE®-colour Asphalt, just like the road surface that bears its name, lends itself well to becoming your constant companion - not on the motorway but in the busiest room of the house, the kitchen, where it is a perfect match for the elementary aesthetic of the contemporary kitchen.

The second shade of grey, Silverstone, is evocative of speed, sophisticated technology and a premiumness reflecting that of the high-grade material CRISTADUR® itself, whose colour repertoire it is now joining. These new colour themes see SCHOCK once more targeting the urban interior design trend and heading for life in the fast lane.

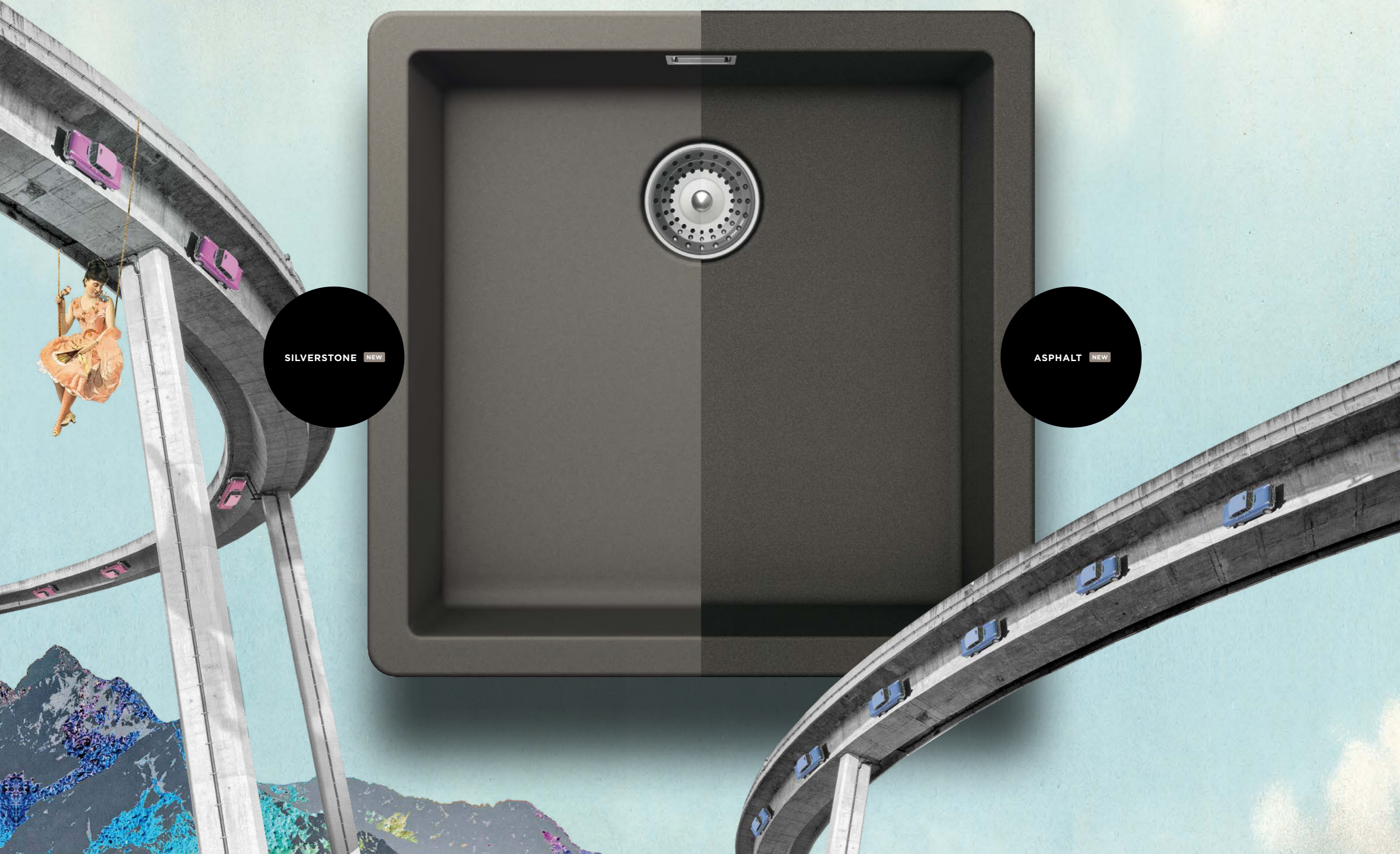

SILVERSTONE NEW

ASPHALT NEW

THAT PERFECT PARTNER LOOK

Finding a perfect match is not only important on an interpersonal level - styling accessories in matching materials is becoming increasingly imperative in the modern kitchen, too. In the quest for perfection, SCHOCK offers the possibility to install mixer taps with matching trim. Available with selected sink models, solid stainless steel taps can be teamed with an overflow, basket strainer

and control knob for the pop-up waste finished in the exact same material, bringing a touch of cool chic into the kitchen. Another highlight is the shimmering metallic black aesthetic of the Dion and Neilos designer taps in combination with a PVD-coated trim we call Gunmetal. These options enable us to craft a dangerously good alliance of materials and accessories in the sink unit.

NEW DION in GUNMETAL

VISIBLE PARTS
IN GUNMETAL

NEW





WEMBLEY

CURVES ALL
ROUND



RADI(C)AL TREND

WEMBLEY

Swimming against the tide has always been one of our strengths. Which is why we are reinventing ourselves anew this year with another unusual sink design. The excitingly large radii in the sweeping lines of these models see us using curves to striking effect. You might even say that we managed to square the circle! The flowing forms of the Wembley D-100 and D-150 show off the silky-smooth CRISTADUR® surface to best effect in any one of the ten different colours available. With confident style, a premium wooden chopping board picks up on the soft lines of the new design. The new range offers total flexibility for all installation variants, being available for undermount, flush-mounted or inset installation in the worktop. Our latest innovation brings a unique look into the kitchen: instead of sharp corners we are showcasing unconventional radii with this sink, our design choices highlighting a new and curvy emphasis.



DRESSED BY SCHOCK

THE NEW SC-RANGE



CONFIDENTLY STYLISH



SCHOCK is like a perfect designer in many respects. The quartz composite sink's inventor is, after all, extraordinary, attention-grabbing and chic. Fashion design and architecture are not the only disciplines where different materials are teamed in confidently styled combinations. Our patented cladding technology enables us to ensure that the finish on the new SC- mixer tap range matches the many different colours of our sinks to perfection and allows us to create harmonious masterpieces within the contemporary kitchen setting. Offering five modern mixer taps in varying designs from simple to

professional and variable styles with fixed or pull-out spout, the inventor of the quartz composite sink demonstrates exceptionally good taste once more. Tone on tone with SCHOCK sinks, the SC-500 range is encased in solid CRISTADUR® or CRISTALITE® in as many as 28 different colours. Available in tapered sleeves, different sizes and a variety of spout shapes, the new SC range takes style into the heart of the kitchen, where it adapts to the room's design and creates an individual look.





THE JUNGLE TEST



MONO D-100XS

Welcome to the jungle – the kitchen jungle! If you're going to stay on top of the challenges in this environment you'll need functional support. The new Mono D-100XS was developed as the Tarzan of the kitchen, ready to lead Jane, a.k.a. the single-person or family household, out of the jungle. There is a range of smart accessories on offer: besides a perfectly sized rack that not only helps with drying the dishes but also serves as a place to put down hot pans, the new model also comes with an optional wooden chopping board. This can function as a traditional chopping board which can be placed flat on the sink and used to prepare fresh food. But

the practical, fold-out handles also turn the chopping board into a tray you can use to carry freshly made meals straight out of the jungle and onto the table – or as Tarzan might say, „me Mono D-100XS, you perfect dinner“. Available in three variants for inset, undermount and flush-mounted installation, the compact model integrates flexibly into a huge range of worktops. And with the tap ledge at the side rather than at the back, the sink can even be positioned in front of a window – Tarzan needs his freedom, after all.



PREPSTATION

A NEW KITCHEN DIMENSION



ADD MORE WOW! TO YOUR KITCHEN



GASTRONORM-SIZED MULTIFUNCTIONAL BOWL FOR USE IN THE STEAM COOKER OR FOR MORE CONVENIENT PREPARATION OF FRESH FOODS

PREMIUM-QUALITY WOODEN CHOPPING BOARD AS ADDITIONAL WORK SURFACE IN THE HUB OF THE KITCHEN

SPACE-MAXIMISING DRAINING BOARD FOR THE PREPARATION OF FRUIT, VEGETABLES, FISH OR MEAT

CONOS PRO MIXER TAP WITH ADDITIONAL PULL-OUT SIDE SPRAY FOR TWICE THE IMPACT OVER THE ENTIRE SINK AREA

LARGE BOWL FOR THE PREPARATION OF DELICATE FOODS

INTEGRATED RACK TAILORED TO HOLD GASTRONORM-SIZED STEAMER ACCESSORIES

SCHOCK takes the kitchen sink to a whole new level with this prep station. Representing a real revolution in the kitchen, the novel sink concept assists you throughout the entire process of food preparation,

right from step one, guaranteeing an uncompromisingly enjoyable cooking experience on a professional level in your home. The accessories turn the prep station into a full service provider in the hub of your kitchen. These

include steamer accessories tailored to fit perfectly and a wooden or plastic chopping board to rest on the draining board. The new model is reversible and suitable for inset, flush-mounted or undermount installation

in cabinets starting at 120 cm wide. Available in ten modern colours and built of CRISTADUR® material, it teams the widest possible choice of combination options with different high-grade surface materials.



FOOD-ENTHUSIAST THE PREPSTATION AS A SOUS-CHEF

Paying homage to good food and functional design, the prep station extends the work area of every kitchen virtuoso whose love of good food begins with its preparation. Many steps in the preparation and cooking process come together in the novel, Gastronorm-standard sink. For example, you can prepare legumes in the small basin and fresh fruit and vegetables, meat or fish on the adjacent draining board and work surface at the same time. While the small bowl is practically positioned to take the peelings, you can wash food in the large basin, where the tailored-to-fit steamer accessories will come in handy. The Cronos Pro mixer tap, which is similar to the mixer taps used in professional kitchens, extends your range of action. To get your ingredients ready for the cooking pot or the frying pan, you can chop or slice them directly on the integrated work surface or place the wooden or plastic chopping board on top. The prep station makes a real statement in a premium kitchen – form and function united in an innovative sink concept, turning cooking in good company into a true highlight.



LEGEND

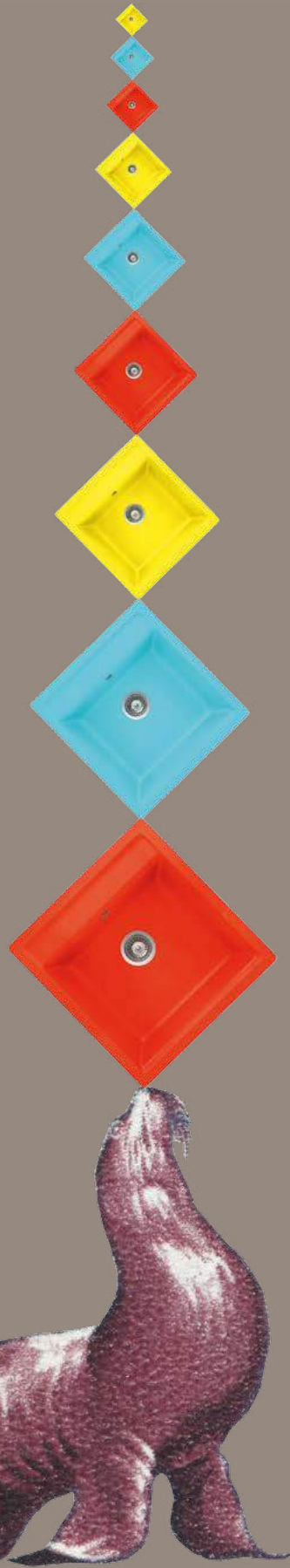

Installation



Topmount



Undermount



Flushmount



Module

Hygiene Protection System



proHygienic 21

Fits Cabinet (cm/inch)



Cabinet



Corner unit size

Cut-out size (cm/inch)



Depth (cm/inch)



19 cm / 7.5 inch



12 cm / 4.7 inch and 19 cm / 7.5 inch

Handing



Bowl left



Bowl right



Reversible



Fixed

Nature



Special surface



Fibreglass reinforcement

Available only for CRISTADUR®

Mixer taps

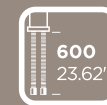

Length of supply hoses



Swivel range



Quarter turn valve



Pull-out



Pull-out spray head



Low pressure

Material



Patented technology

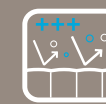

Dirt repellent effect



Silky-smooth surface



Enhanced classic granite

SINKS
SINKS

HANDMADE IN GERMANY

SCHOCK

COLOU SINK

COLOUR RANGE
SINKS

HANDMADE IN GERMANY

SCHOCK

CRISTADUR® The SCHOCK premium material is truly captivating with its extremely fine and smooth structure and lovely shimmering surface, which provides nowhere for grime to take hold – the dirt simply runs off. So it's not just the way they look but also how easy they are to clean that makes these models a luxury that becomes any kitchen.

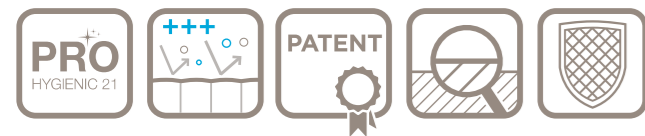

	CRISTADUR®										NATURE		CRISTALITE®														
	Puro	Vintage	Bronze	Stone	Magnolia	Carbonium	Magma	Polaris	Rouge	Indigo	Silverstone	Kaiserstein	Rockenstein	Onyx	Nero	Alpina	Croma	Moonstone	Sabbia	Superwhite	Terra	Inox		Crema	Everest	Asphalt	Concrete
ALIVE MADISON			●	●	●		●	○			●			●	●	○	●	●	○	●	●	●	●	●	●	●	●
ASH IMPULSE			●	●	●		●	○			●			●	●	○	●	●	○	●	●	●	●	●	●	●	●
CAMPUS														●	●	○	●	●	○	●	●	●	●	●	●	●	●
CITY														●	●	○	●	●	○	●	●	●	●	●	●	●	●
CLASSIC														●	●	○	●	●	○	●	●	●	●	●	●	●	●
EDO CREST			●	●	●		●	○	●*		●	●	●	●	●	○	●	●	○	●	●	●	●	●	●	●	●
ELEMENT														●	●	○	●	●	○	●	●	●	●	●	●	●	●
EURO														●	●	○	●	●	○	●	●	●	●	●	●	●	●
FORMHAUS														●	●	○	●	●	○	●	●	●	●	●	●	●	●
GALAXY GEMO	●	●	●	●	●	●	●	○	●	●	●	●	●	●	●	○	●	●	○	●	●	●	●	●	●	●	●
GENIUS														●	●	○	●	●	○	●	●	●	●	●	●	●	●
GRANDO			●	●	●	●	●	○						●	●	○	●	●	○	●	●	●	●	●	●	●	●
GREENWICH BROOKLYN	●	●	●	●	●	●	●	○	●	●	●	●	●	●	●	○	●	●	○	●	●	●	●	●	●	●	●
HORIZONT EDEN	●	●	●	●	●	●	●	○	●	●	●	●	●	●	●	○	●	●	○	●	●	●	●	●	●	●	●
INSPIRE INSPIRATION			●	●	●		●	○			●			●	●	○	●	●	○	●	●	●	●	●	●	●	●
KYOTO	●	●	●	●	●	●	●	○	●	●	●	●	●	●	●	○	●	●	○	●	●	●	●	●	●	●	●
LITHOS														●	●	○	●	●	○	●	●	●	●	●	●	●	●
LOTUS	●	●	●	●	●	●	●	○	●	●	●	●	●	●	●	○	●	●	○	●	●	●	●	●	●	●	●
MANHATTAN														●	●	○	●	●	○	●	●	●	●	●	●	●	●
MONO NEMO	●	●	●	●	●	●	●	○	●	●	●	●	●	●	●	○	●	●	○	●	●	●	●	●	●	●	●
MONTANO VIRTUS			●	●	●		●	○	●	●	●	●	●	●	●	○	●	●	○	●	●	●	●	●	●	●	●
PREPSTATION	●	●	●	●	●	●	●	○	●	●	●	●	●	●	●	○	●	●	○	●	●	●	●	●	●	●	●
RONDA														●	●	○	●	●	○	●	●	●	●	●	●	●	●
SIGNUS PRIMUS	●	●	●	●	●	●	●	○	●	●	●	●	●	●	●	○	●	●	○	●	●	●	●	●	●	●	●
SOHO QUADRO	●		●	●	●	●	●	○	●	●	●	●	●	●	●	○	●	●	○	●	●	●	●	●	●	●	●
SOLIDO														●	●	○	●	●	○	●	●	●	●	●	●	●	●
SUPRA	●	●	●	●	●	●	●	○	●	●	●	●	●	●	●	○	●	●	○	●	●	●	●	●	●	●	●
TYPOS														●	●	○	●	●	○	●	●	●	●	●	●	●	●
VALLEY MAXIM			●	●	●		●	○	●					●	●	○	●	●	○	●	●	●	●	●	●	●	●
VENUS														●	●	○	●	●	○	●	●	●	●	●	●	●	●
VIOLA														●	●	○	●	●	○	●	●	●	●	●	●	●	●
WATERFALL	●	●	●	●	●	●	●	○	●	●	●	●	●	●	●	○	●	●	○	●	●	●	●	●	●	●	●
WEMBLEY	●	●	●	●	●	●	●	○	●	●	●	●	●	●	●	○	●	●	○	●	●	●	●	●	●	●	●

*1) Indigo is available for Mono D-200, D-100L, D-100 and D-100S. 2) Rouge is available for Edo N-175, Edo N-175Y

CRISTALITE® The on-trend material from SCHOCK is a popular classic around the globe and has recently been optimised once more in the course of a multi-year R&D effort: the slightly rough, stony surface of CRISTALITE® is now even tougher than before and embodies the enduring pleasure of cooking.

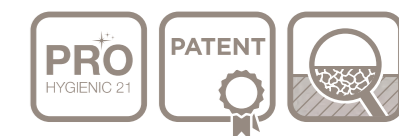

OVERVIEW OVERVIEW

OVERVIEW

OVERVIEW
CRISTADUR®
SINKS

HANDMADE IN GERMANY

SCHOCK

SCHOCK

40



HORIZONTAL | EDEN D-100S



HORIZONTAL | EDEN D-100

45



GREENWICH | BROOKLYN N-100S



KYOTO D-100



MONO | NEMO D-100S



MONO | NEMO R-100



SIGNUS | PRIMUS D-100S



SIGNUS | PRIMUS D-100



WATERFALL D-100

50



GREENWICH | BROOKLYN N-100



LOTUS D-100



MONO | NEMO D-100



MONO | NEMO N-100S



SOHO | QUADRO N-100S



WATERFALL D-100



WEMBLEY D-100

OVERVIEW CRISTADUR® SINKS

60



GALAXY | GEMO N-100



GREENWICH | BROOKLYN N-100L



HORIZONTAL | EDEN D-150



KYOTO D-100L



KYOTO D-150



LOTUS D-150



MONO | NEMO D-100XS



MONO | NEMO D-100L



MONO | NEMO D-150

80



MONO | NEMO N-100



SIGNUS | PRIMUS D-100L



SIGNUS | PRIMUS D-150



SOHO | QUADRO N-100



SOHO | QUADRO N-150



WATERFALL D-150



WEMBLEY D-150



GALAXY | GEMO N-100Y



GALAXY | GEMO N-100L



GALAXY | GEMO N-100LY



HORIZONTAL | EDEN D-200



INSPIRE | INSPIRATION N-175



INSPIRE | INSPIRATION N-175Y



INSPIRE | INSPIRATION N-200



INSPIRE | INSPIRATION N-200Y



KYOTO D-200



LOTUS C-150



MONO | NEMO D-175



MONO | NEMO D-200



SIGNUS | PRIMUS D-175

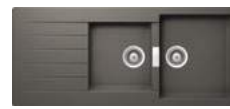

SIGNUS | PRIMUS D-200



SIGNUS | PRIMUS N-100XL



SIGNUS | PRIMUS C-150



VALLEY | MAXIM N-100



VALLEY | MAXIM N-100Y

SCHOCK

90



WATERFALL D-200



WEMBLEY D-200



ALIVE | MADISON N-200



ALIVE | MADISON N-200Y



ASH | IMPULSE N-175



ASH | IMPULSE N-200



EDO | CREST N-175



EDO | CREST N-175Y



EDO | CREST N-200



ALIVE | MADISON N-175



ALIVE | MADISON N-175Y



ALIVE | MADISON N-200Y



ASH | IMPULSE N-200



EDDO | CREST N-175



EDDO | CREST N-200



EDDO | CREST N-200Y



EDDO | CREST N-200Y



EDDO | CREST N-200



EDDO | CREST N-200Y



SUPRA N-175



GRANDO M-100



HORIZONTAL | EDEN N-200



MONO | NEMO N-200



MONO | NEMO N-200



MONTANO | VIRTUS N-100XL



MONTANO | VIRTUS N-100XLY



SIGNUS | PRIMUS N-100XLY

corner unit



LOTUS C-150



SIGNUS | PRIMUS C-150

OVERVIEW OVERVIEW

OVERVIEW
CRISTALITE⁺[®]
SINKS

HANDMADE IN GERMANY

SCHOCK

SCHOCK

CARBON N-100S

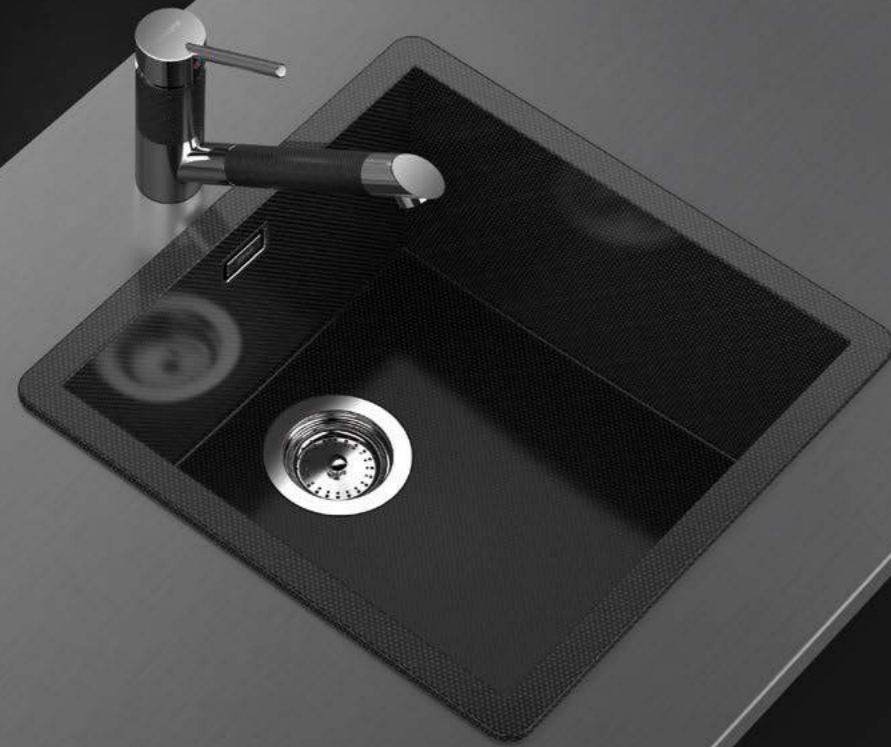

CARBON

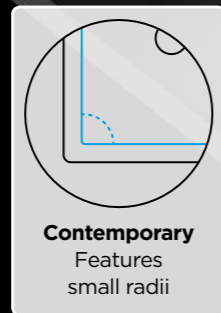

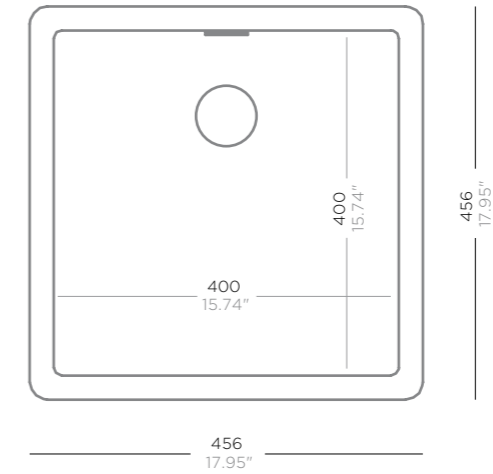

SCHOCK

CARBON N-100S



Article no.

-  **CAR N100S A**
-  **CAR N100S U**
-  **CAR N100S FB**

Accessories

- Manual drain kit **629309SET**
- Standard automatic drain kit **629307**
- Premium automatic drain kit **629307PD**
- Comfotouch **629830**
- Waste cap **628152**

Cut-out size



Carbon materials

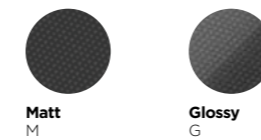

SCHOCK

CARBON N-100



CARBON

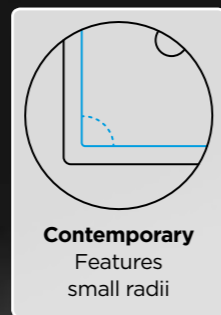

Contemporary
Features
small radii

SCHOCK

CARBON N-100

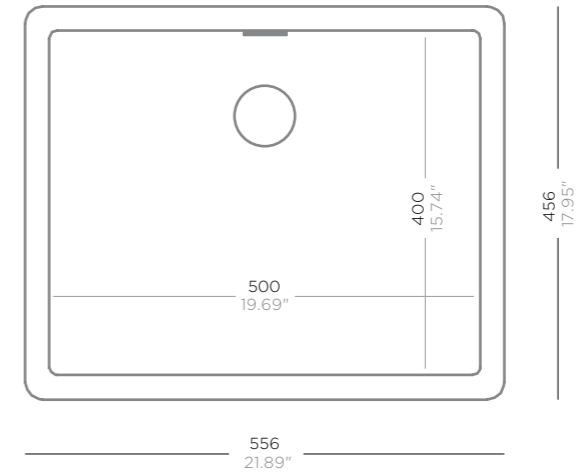

CARBON

Article no.

 **CAR N100 A**

 **CAR N100 U**

 **CAR N100 FB**

Accessories

Manual drain kit **629309SET**
Standard automatic drain kit **629307**

Premium automatic drain kit **629307PD**
Comfotouch **629830**

Waste cap **628152**

Cut-out size



Carbon materials

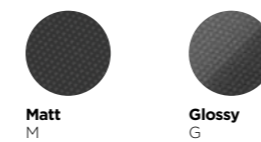

Matt
M

Glossy
G

SCHOCK

CARBON N-100XL



CARBON

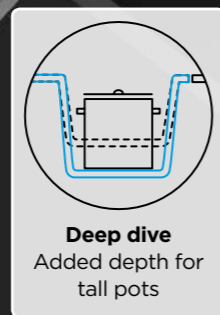
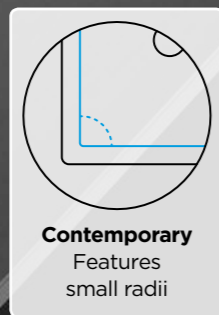

SCHOCK

CARBON N-100XL

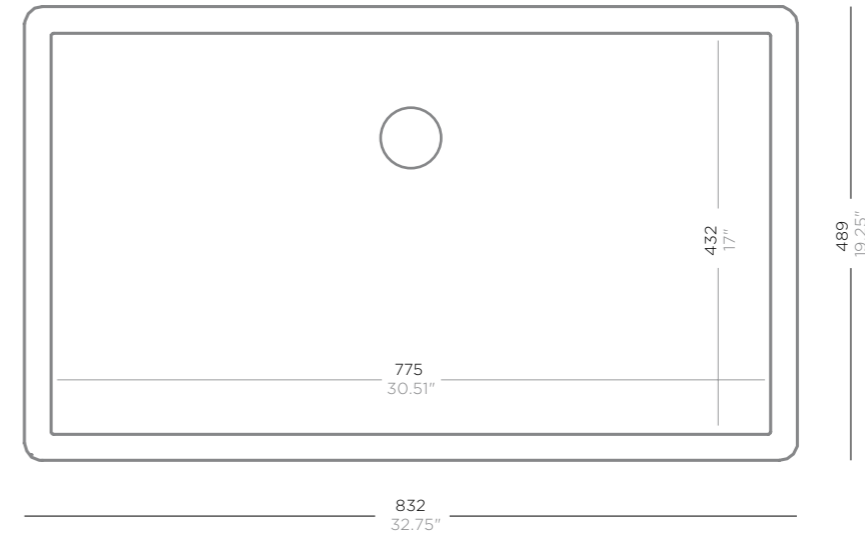

Article no.

CAR N100XL A

CAR N100XL U

Accessories

Manual drain kit **629320SET**
Standard automatic drain kit **629308**

Premium automatic drain kit **629308PD**
Comfotouch **629830**

Waste cap **628152**

Cut-out size



Carbon materials

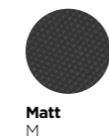

SCHOCK

ALIVE | MADISON N-175



ALIVE | MADISON

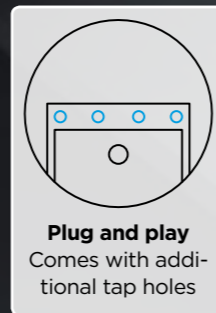
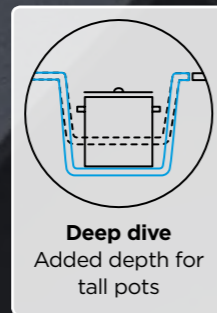
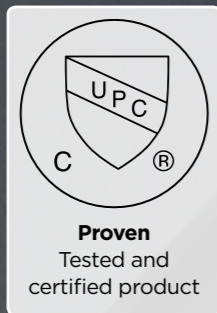

SCHOCK

ALIVE | MADISON N-175

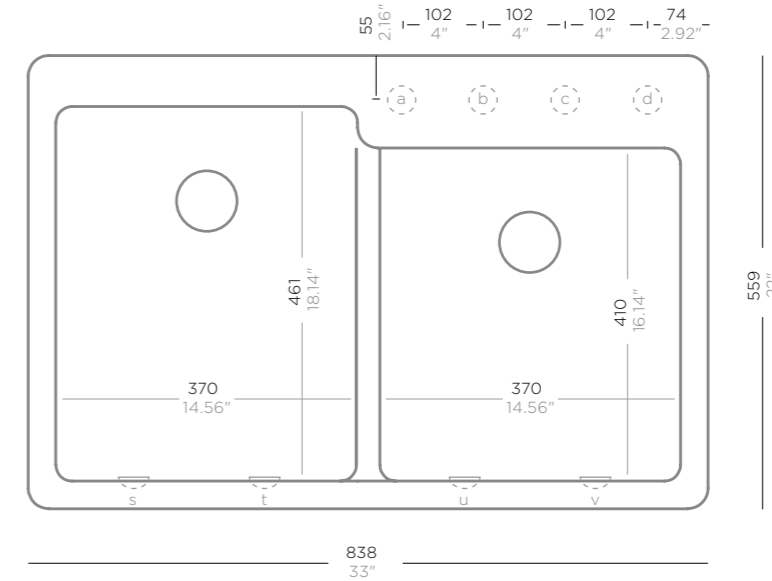

Article no.

 **ALI N175 A**
 **MDN N175 A**

 **ALI N175 U**
 **MDN N175 U**

Accessories

 Manual drain kit 629325	 Pro Care 629099
 Standard automatic drain kit 629326	 Comfotouch 629830
 Premium automatic drain kit 629326PD	 Waste cap 628152
 LED-light 629024	 DurCare 629094
 Easy Care 629018	 Magic Sponge 629023
 Easy Care Brightener 629019	

Cut-out size



Colour range

This product is available in the standard colour range as listed in the appendix.

SCHOCK

ALIVE | MADISON N-175Y



ALIVE | MADISON

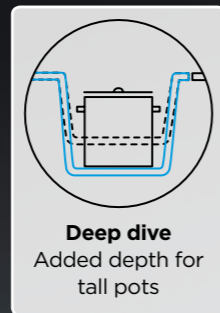
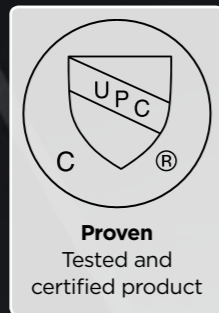

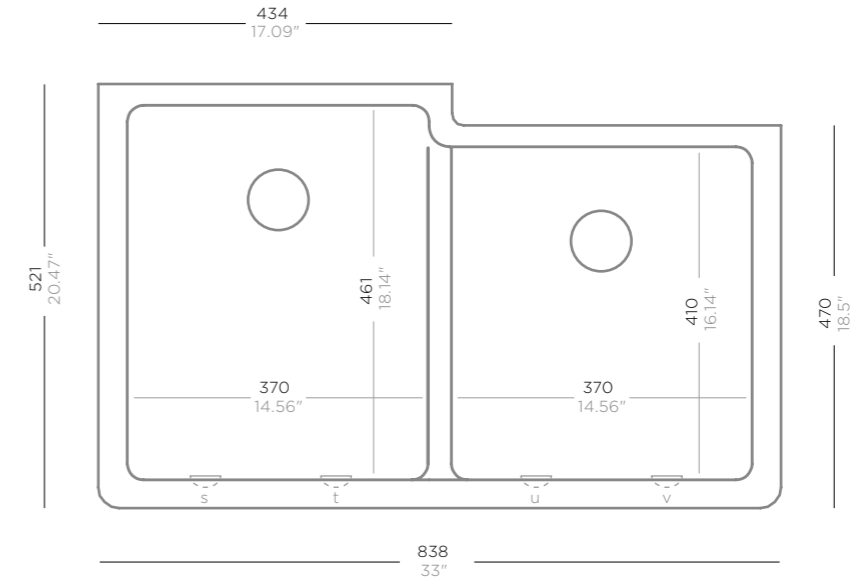

SCHOCK

ALIVE | MADISON N-175Y



Article no.

 **ALI N175Y U** 
MDN N175Y U 

Accessories

Manual drain kit 629325	Pro Care 629099
Standard automatic drain kit 629326	Comfotouch 629830
Premium automatic drain kit 629326PD	Waste cap 628152
LED-light 629024	DurCare 629094
Easy Care 629018	Magic Sponge 629023
Easy Care Brightener 629019	

Cut-out size

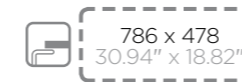

Colour range

This product is available in the standard colour range as listed in the appendix.

SCHOCK

ALIVE | MADISON N-200



ALIVE | MADISON

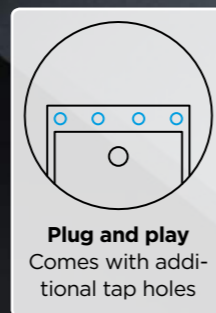
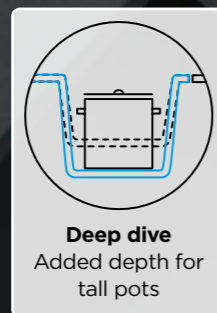
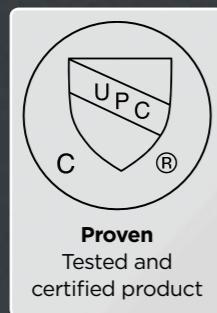





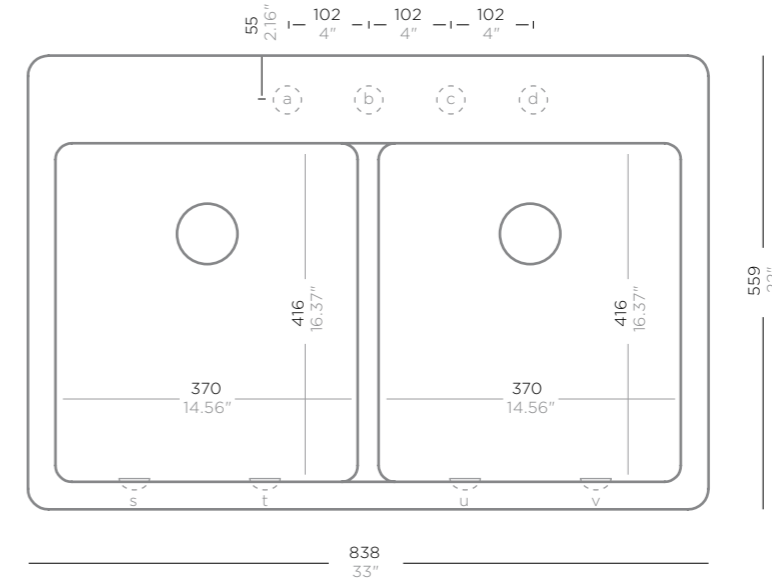







SCHOCK

ALIVE | MADISON N-200



Article no.

Accessories

	ALI N200 A		Manual drain kit	629325		Pro Care	629099
	MDN N200 A		Standard automatic drain kit	629326		Comfotouch	629830
	ALI N200 U		Premium automatic drain kit	629326PD		Waste cap	628152
	MDN N200 U		LED-light	629024		DurCare	629094
			Easy Care	629018		Magic Sponge	629023
			Easy Care Brightener	629019			

Cut-out size



Colour range

This product is available in the standard colour range as listed in the appendix.

SCHOCK

ALIVE | MADISON N-200Y



ALIVE | MADISON

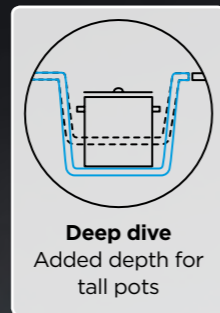
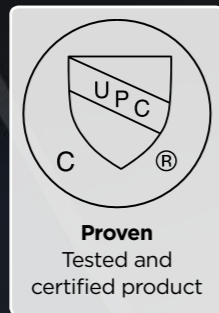

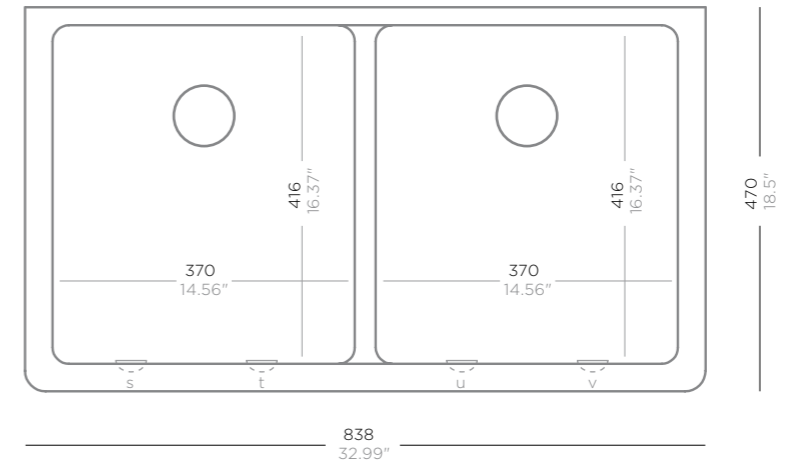

SCHOCK

ALIVE | MADISON N-200Y



Article no.

 **ALI N200Y U** 
MDN N200Y U 

Accessories

Manual drain kit	629325	Pro Care	629099
Standard automatic drain kit	629326	Comfotouch	629830
Premium automatic drain kit	629326PD	Waste cap	628152
LED-light	629024	DurCare	629094
Easy Care	629018	Magic Sponge	629023
Easy Care Brightener	629019		

Cut-out size



Colour range

This product is available in the standard colour range as listed in the appendix.

SCHOCK

ASH | IMPULSE N-175



ASH | IMPULSE

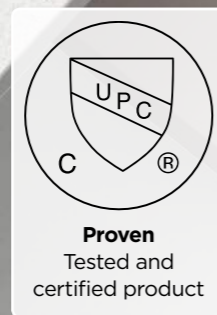

SCHOCK



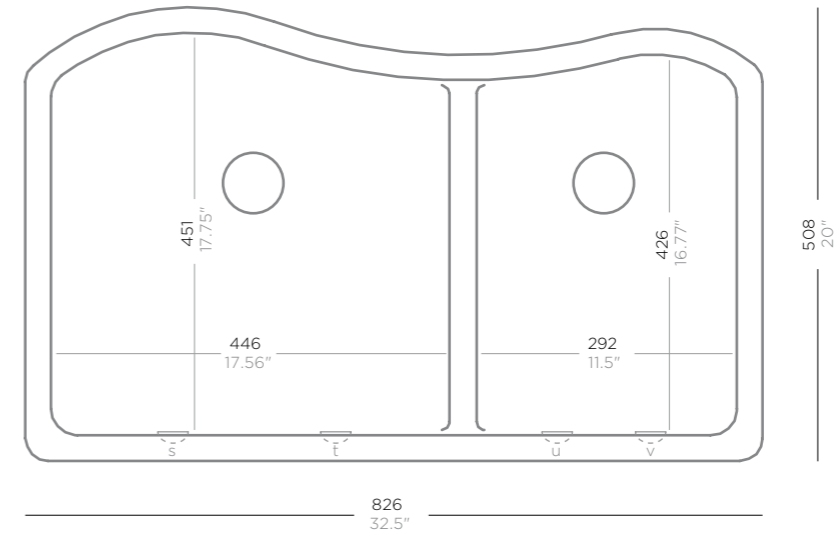







ASH | IMPULSE N-175



Article no.

 **ASH N175 U**
IMP N175 U

Accessories

-  **629325** Manual drain kit
-  **629326** Standard automatic drain kit
-  **629326PD** Premium automatic drain kit
-  **629018** Easy Care
-  **629019** Easy Care Brightener
-  **629099** Pro Care
-  **629830** Comfotouch
-  **628152** Waste cap
-  **629094** DurCare
-  **629023** Magic Sponge

Cut-out size

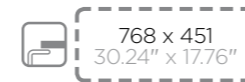

Colour range

This product is available in the standard colour range as listed in the appendix.

SCHOCK

ASH | IMPULSE N-200



ASH | IMPULSE

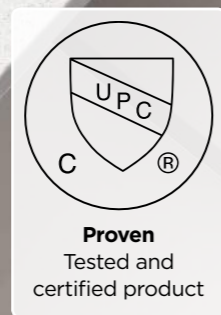

SCHOCK

ASH | IMPULSE N-200

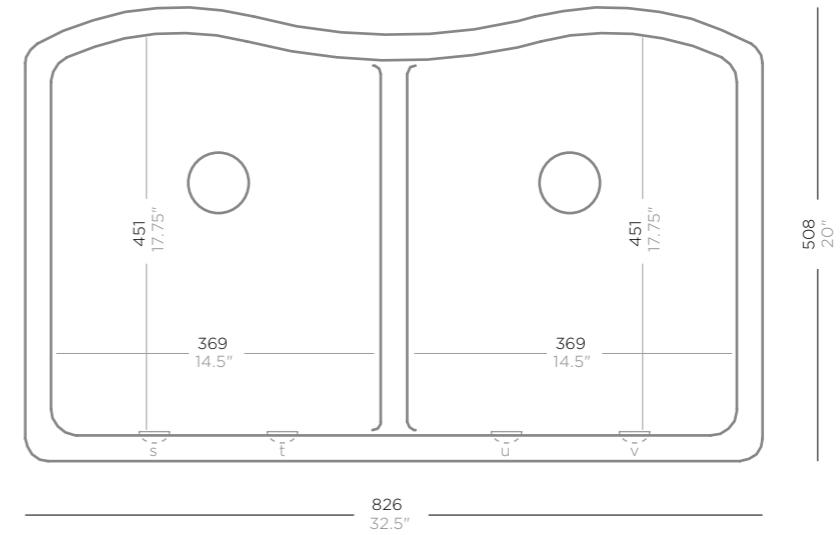

Article no.

- ASH N200 U
- IMP N200 U

Accessories

- Manual drain kit **629325**
- Standard automatic drain kit **629326**
- Premium automatic drain kit **629326PD**
- Easy Care **629018**
- Easy Care Brightener **629019**
- Pro Care **629099**
- Comfotouch **629830**
- Waste cap **628152**
- DurCare **629094**
- Magic Sponge **629023**

Cut-out size

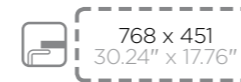

Colour range

This product is available in the standard colour range as listed in the appendix.

SCHOCK

CAMPUS D-100L



CAMPUS

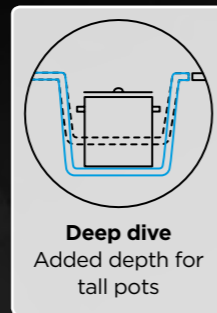



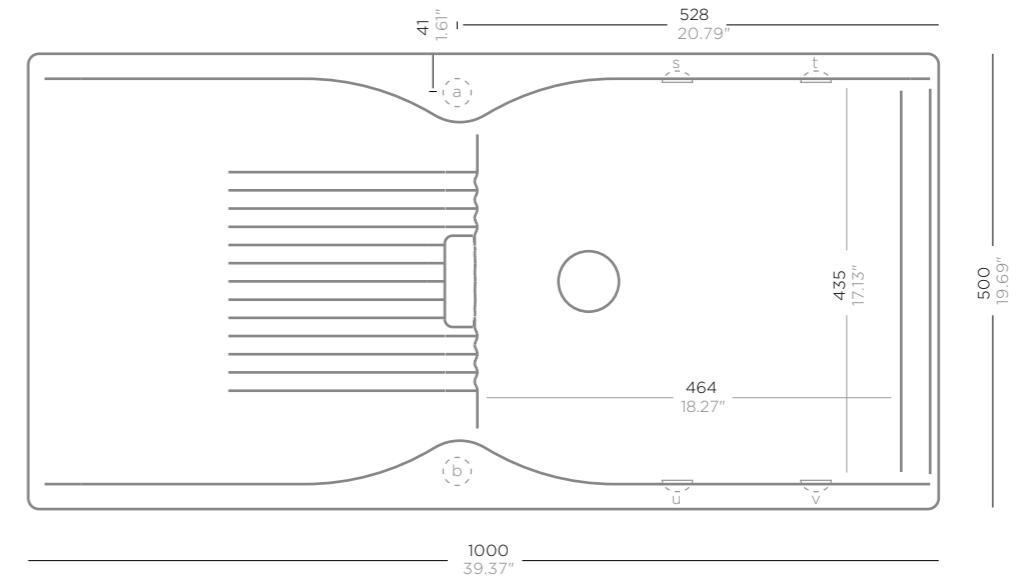

SCHOCK

CAMPUS D-100L



Article no.

Accessories

	CAM D100L A 	Manual drain kit 629358	Wire basket 629149
		Standard automatic drain kit 629359	LED-light 629024
	CAM D100L U 	Glass chopping board 629036A/U	Easy Care 629018
		Glass chopping board, white 629045A/U	Easy Care Brightener 629019
		Glass chopping board, black 629046A/U	Pro Care 629099
		Chopping board, bamboo 629044	Comfotouch 629830

Cut-out size



Colour range

This product is available in the standard colour range as listed in the appendix.

SCHOCK

CAMPUS N-175XL



CAMPUS



Eye catcher
Patented over-flow design



Go big
Extra volume for large pots

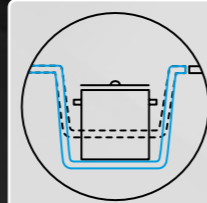

Deep dive
Added depth for tall pots

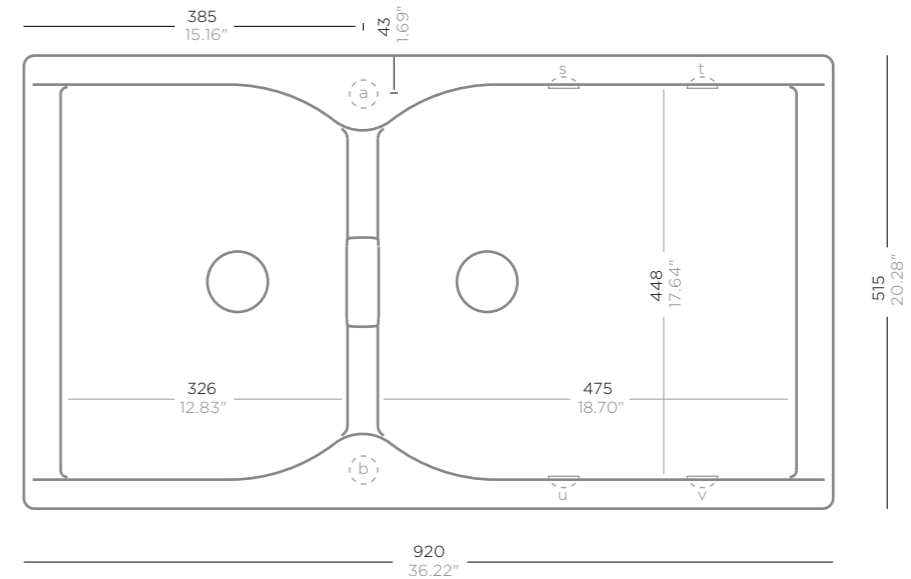

SCHOCK

CAMPUS N-175XL



Article no.

Accessories

<p> CAM N175XL A CTD</p> <p> CAM N175XL U CTD</p>	<p>Manual drain kit 629355</p> <p>Standard automatic drain kit 629356</p> <p>Wire basket 629149</p> <p>LED-light 629024</p> <p>Easy Care 629018</p> <p>Easy Care Brightener 629019</p>	<p>Pro Care 629099</p> <p>Comfotouch 629830</p> <p>Waste cap 628152</p> <p>Magic Sponge 629023</p> <p>Diamond drill SB light 629095</p>
---	--	--

Cut-out size

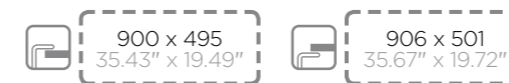

Colour range

This product is available in the standard colour range as listed in the appendix.

SCHOCK

CAMPUS N-200



CAMPUS

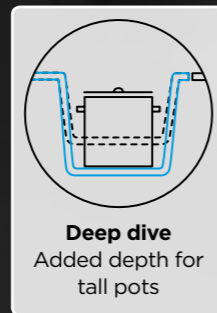



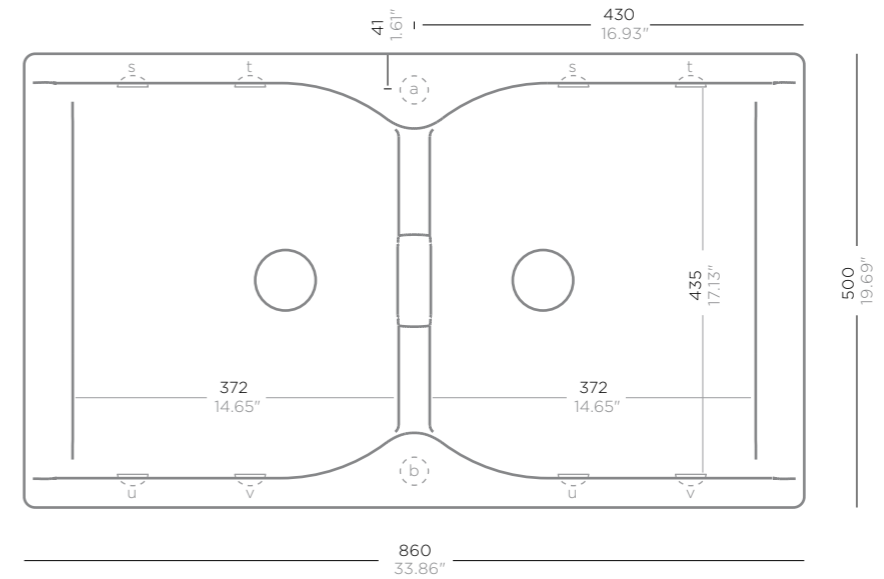

SCHOCK

CAMPUS N-200



Article no.

Accessories

	CAM N200 A		Manual drain kit 629355	Wire basket 629147
			Standard automatic drain kit 629356	LED-light 629024
	CAM N200 U		Glass chopping board 629036A/U	Easy Care 629018
			Glass chopping board, white 629045A/U	Easy Care Brightener 629019
			Glass chopping board, black 629046A/U	Pro Care 629099
			Chopping board, bamboo 629044	Comfotouch 629830

Cut-out size



Colour range

This product is available in the standard colour range as listed in the appendix.

SCHOCK

CITY D-100

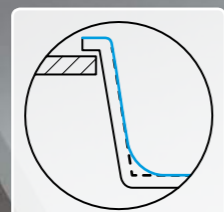

Looking slim
Lightweight
design

SCHOCK

CITY D-100

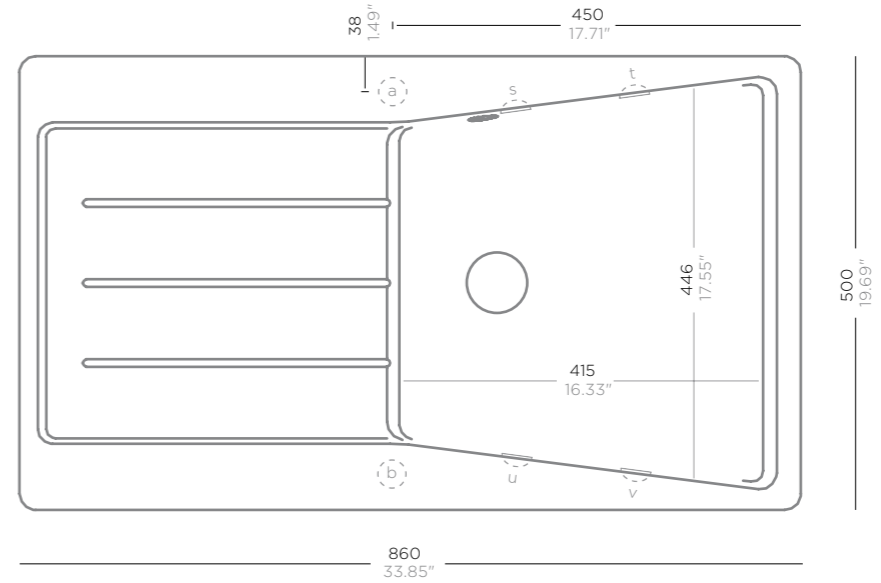

Article no.

 **CIT D100 A**

 **CIT D100 U**

Accessories

- | | |
|---|--|
|  Manual drain kit 629353 | LED-light 629024 |
| Standard automatic drain kit 629352 | Easy Care 629018 |
|  Glass chopping board 629036A/U | Easy Care Brightener 629019 |
| Glass chopping board, white 629045A/U | Pro Care 629099 |
| Glass chopping board, black 629046A/U | Comfotouch 629830 |
| Chopping board, bamboo 629044 | Waste cap 628152 |

Cut-out size



Colour range

This product is available in the standard colour range as listed in the appendix.

SCHOCK

CITY D-100L

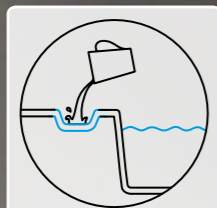

On standby
Extra drain when
washing up

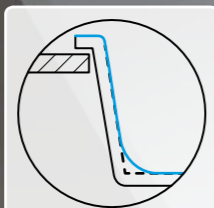

Looking slim
Lightweight
design

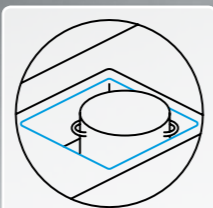

Go big
Extra volume
for large pots

SCHOCK

CITY D-100L

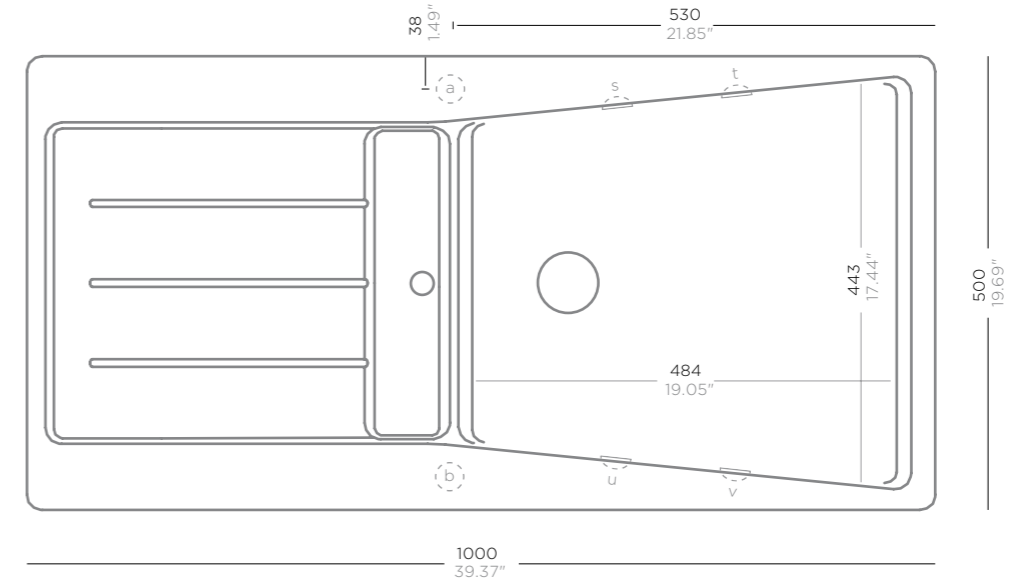

Article no.



CIT D100L A



Manual drain kit **629382**
Standard automatic drain kit **629383**



CIT D100L U



Glass chopping board **629036A/U**
Glass chopping board, white **629045A/U**

Glass chopping board, black **629046A/U**
Chopping board, bamboo **629044**

LED-light **629024**
Easy Care **629018**
Easy Care Brightener **629019**
Pro Care **629099**
Comfotouch **629830**
Waste cap **628152**

Cut-out size



960 x 480
37.8" x 18.9"



968 x 486
38.1" x 19.1"

Colour range

This product is available in the standard colour range as listed in the appendix.

SCHOCK

CITY D-150

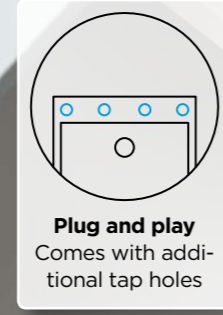
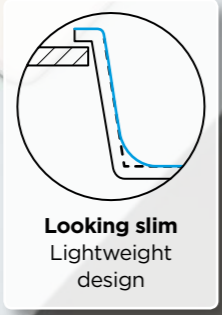





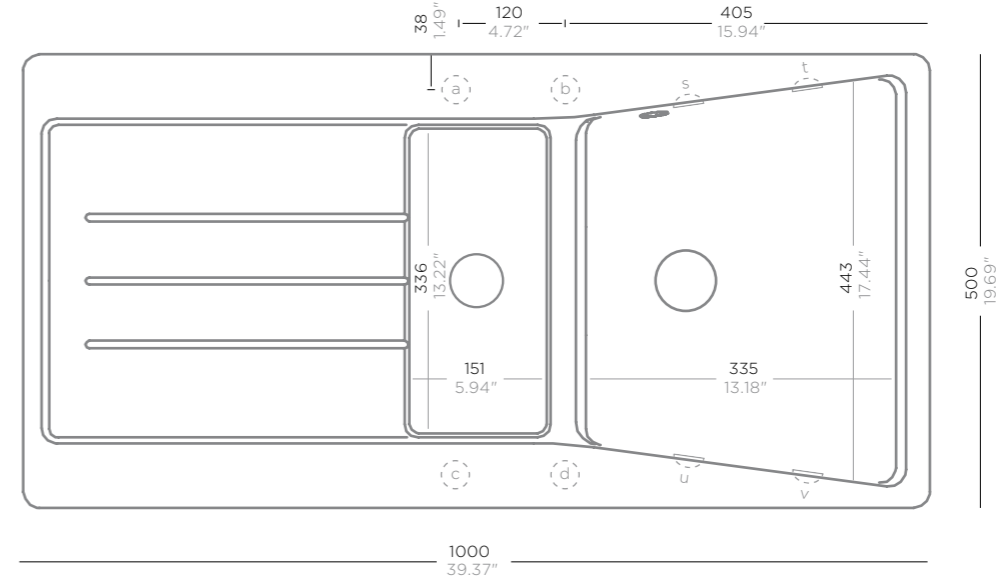









SCHOCK

CITY D-150



Article no.

Accessories

	CIT D150 A	 Manual drain kit 629304	 Strainer bowl 629029
		 Standard automatic drain kit 629305	 LED-light 629024
	CIT D150 U	 Glass chopping board 629036A/U	 Easy Care 629018
		 Glass chopping board, white 629045A/U	 Easy Care Brightener 629019
		 Glass chopping board, black 629046A/U	 Pro Care 629099
		 Chopping board, bamboo 629044	 Comfotouch 629830

Cut-out size



Colour range

This product is available in the standard colour range as listed in the appendix.

SCHOCK

CITY D-200



CITY



Looking slim
Lightweight
design

SCHOCK

CITY D-200

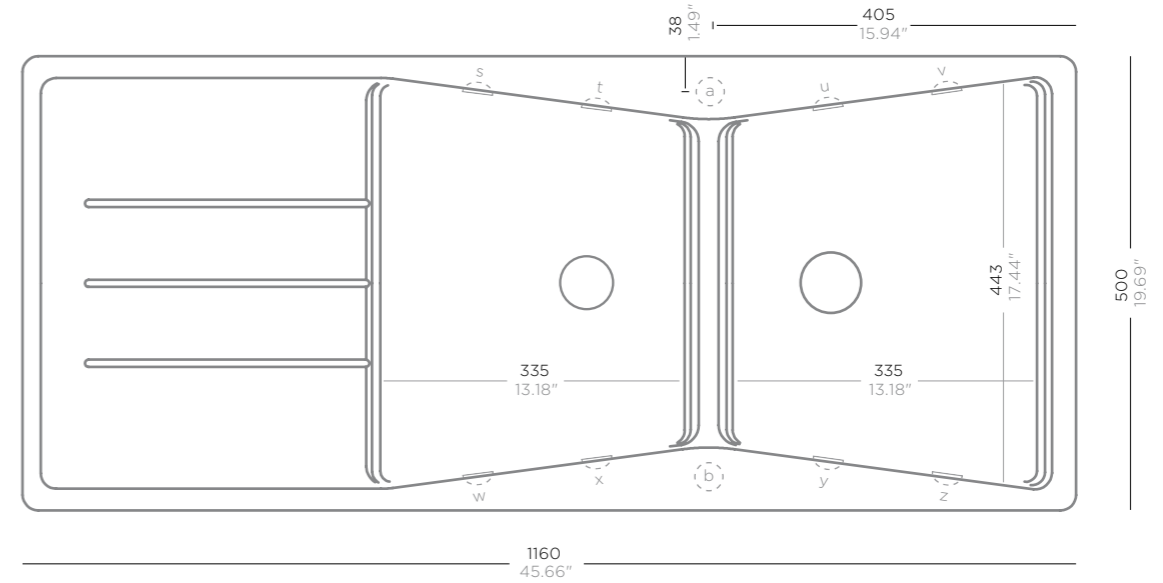

Article no.

 **CIT D200 A**

Accessories

 Manual drain kit **629304**
Standard automatic drain kit **629305**

LED-light **629024**
Easy Care **629018**

 **CIT D200 U**

 Glass chopping board **629036A/U**
Glass chopping board, white **629045A/U**

Easy Care Brightener **629019**
Pro Care **629099**

Glass chopping board, black **629046A/U**
Chopping board, bamboo **629044**

Comfotouch **629830**
Waste cap **628152**

Cut-out size

 1140 x 480
44.88" x 18.9"

 1146 x 486
45.12" x 19.13"

Colour range

This product is available in the standard colour range as listed in the appendix.

SCHOCK

CLASSIC N-150

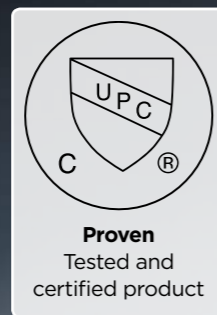



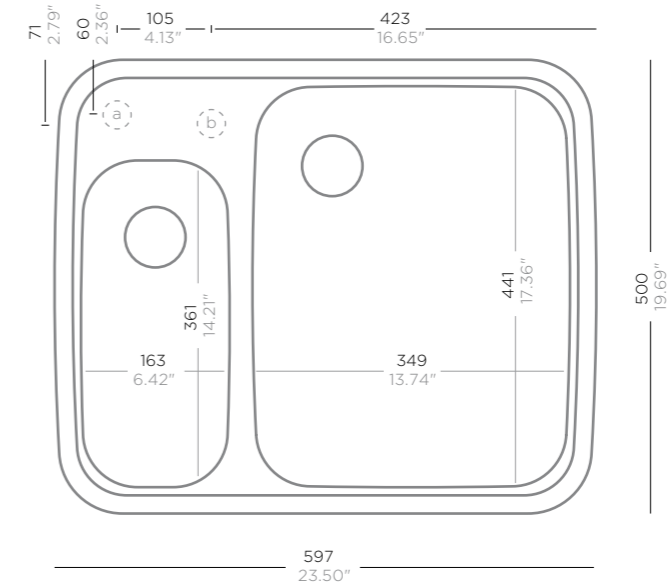

SCHOCK

CLASSIC N-150



Article no.

Accessories

<p> CLA N150 A </p> <p> CLA N150 U* </p>	<p>Manual drain kit 629374</p> <p>Standard automatic drain kit 629321</p> <p>Glass chopping board 629036A/U</p> <p>Glass chopping board, white 629045A/U</p> <p>Glass chopping board, black 629046A/U</p> <p>Chopping board, bamboo 629044</p>	<p>Strainer bowl (acryl) 629072/48</p> <p>Easy Care 629018</p> <p>Easy Care Brightener 629019</p> <p>Pro Care 629099</p> <p>Comfotouch 629830</p> <p>Waste cap 628152</p>
--	--	---

Cut-out size



Colour range

This product is available in the standard colour range as listed in the appendix.

* Please note that the undermount version requires a cabinet the next size up.

SCHOCK

CLASSIC N-150Y



CLASSIC

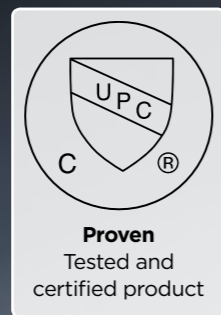

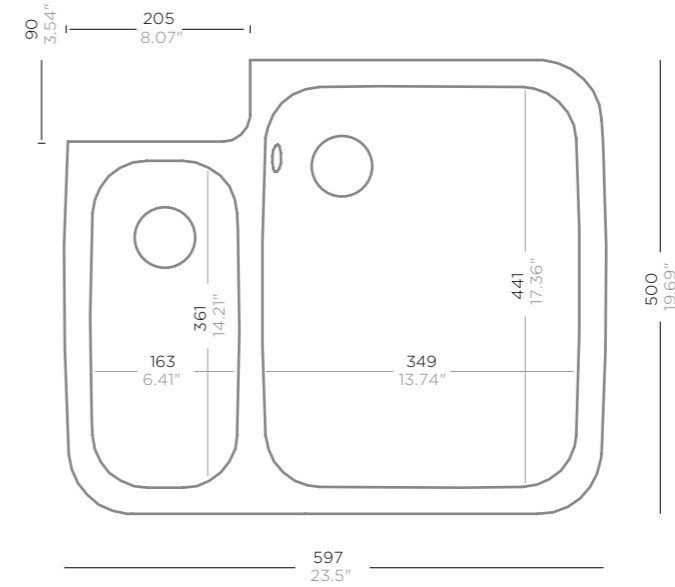

SCHOCK

CLASSIC N-150Y



CLASSIC

Article no.

 **CLA N150Y U** 

Accessories

- Manual drain kit **629374**
- Standard automatic drain kit **629321**
- Glass chopping board **629036U**
- Glass chopping board, white **629045U**
- Glass chopping board, black **629046U**
- Chopping board, bamboo **629044**
- Strainer bowl (acryl) **629072/48**
- Easy Care **629018**
- Easy Care Brightener **629019**
- Pro Care **629099**
- Comfotouch **629830**
- Waste cap **628152**

Cut-out size

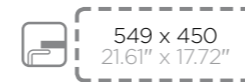

Colour range

This product is available in the standard colour range as listed in the appendix.

SCHOCK

CLASSIC R-100



CLASSIC

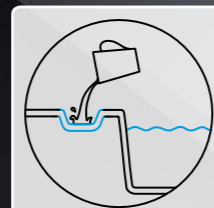

On standby
Extra drain when
washing up

SCHOCK

CLASSIC R-100

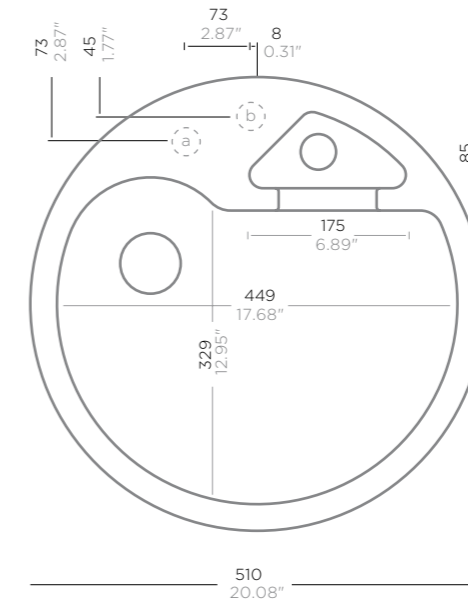

Article no.

Accessories



CLA R100 A



Manual drain kit **629344**
Standard automatic drain kit **629343**

Waste cap **628152**
Magic Sponge **629023**



CLA R100 U



Easy Care **629018**
Easy Care Brightener **629019**

Diamond drill SB light **629095**

Pro Care **629099**
Comfotouch **629830**

Cut-out size



Ø 490
Ø 19.29"



Ø 490
Ø 19.29"

Colour range

This product is available in the standard colour range as listed in the appendix.

SCHOCK

EDO | CREST N-175



EDO | CREST

Proven
Tested and certified product

Versatile
Fits even large trays

Plug and play
Comes with additional tap holes

SCHOCK

EDO | CREST N-175

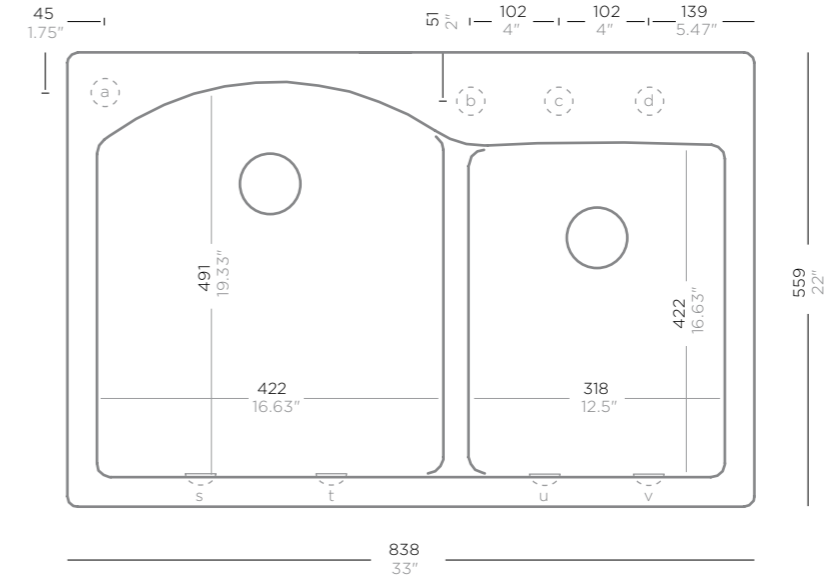

EDO | CREST



Article no.

EDO N175 A
CRE N175 A

Accessories

- Manual drain kit **629861**
- Easy Care **629018**
- Easy Care Brightener **629019**
- Pro Care **629099**
- Comfotouch **629830**
- Waste cap **628152**
- DurCare **629094**
- Magic Sponge **629023**

Cut-out size

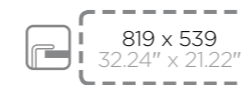

Colour range

This product is available in the standard colour range as listed in the appendix.

SCHOCK

EDO | CREST N-175Y



EDO | CREST

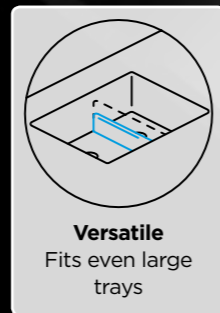
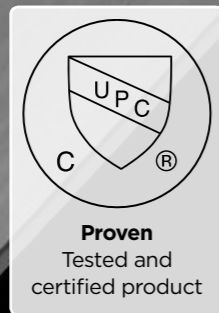

SCHOCK

EDO | CREST N-175Y

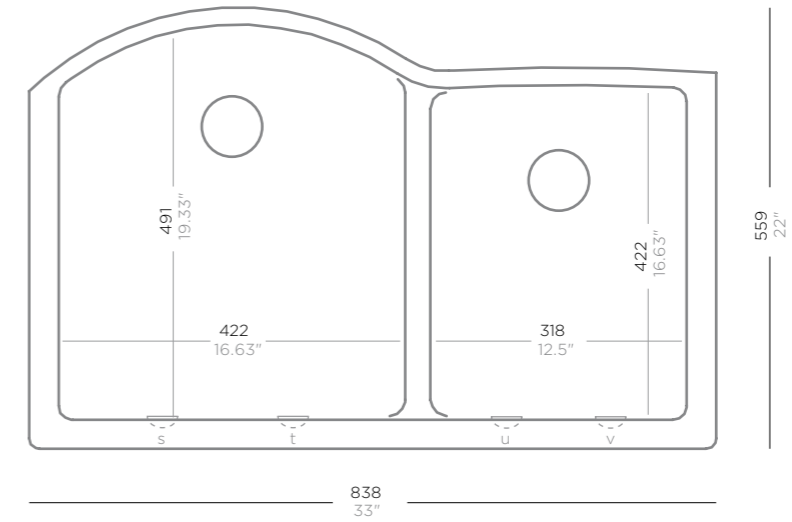

Article no.

 **EDO N175Y U**
CRE N175Y U

Accessories

- Manual drain kit **629861**
- Easy Care **629018**
- Easy Care Brightener **629019**
- Pro Care **629099**
- Comfotouch **629830**
- Waste cap **628152**
- DurCare **629094**
- Magic Sponge **629023**

Cut-out size



Colour range

This product is available in the standard colour range as listed in the appendix.

SCHOCK

EDO | CREST N-200



EDO | CREST

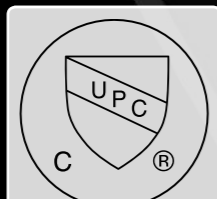

Proven
Tested and certified product

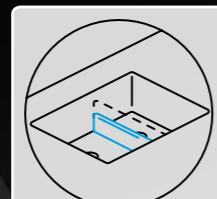

Versatile
Fits even large trays

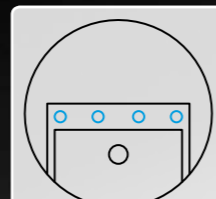

Plug and play
Comes with additional tap holes

SCHOCK

EDO | CREST N-200

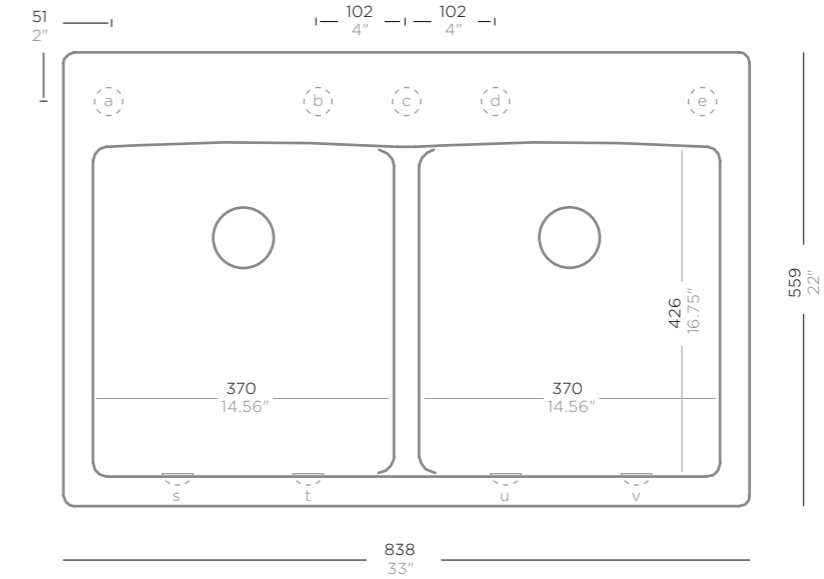

EDO | CREST



Article no.

- EDO N200 A
- CRE N200 A

Accessories

- Manual drain kit **629861**
- Easy Care **629018**
- Easy Care Brightener **629019**
- Pro Care **629099**
- Comfotouch **629830**
- Waste cap **628152**
- DurCare **629094**
- Magic Sponge **629023**

Cut-out size

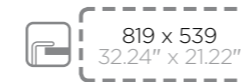

Colour range

This product is available in the standard colour range as listed in the appendix.

SCHOCK

EDO | CREST N-200Y



EDO | CREST

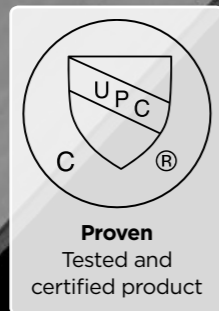

Proven
Tested and certified product

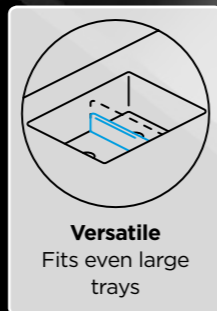

Versatile
Fits even large trays

SCHOCK

EDO | CREST N-200Y

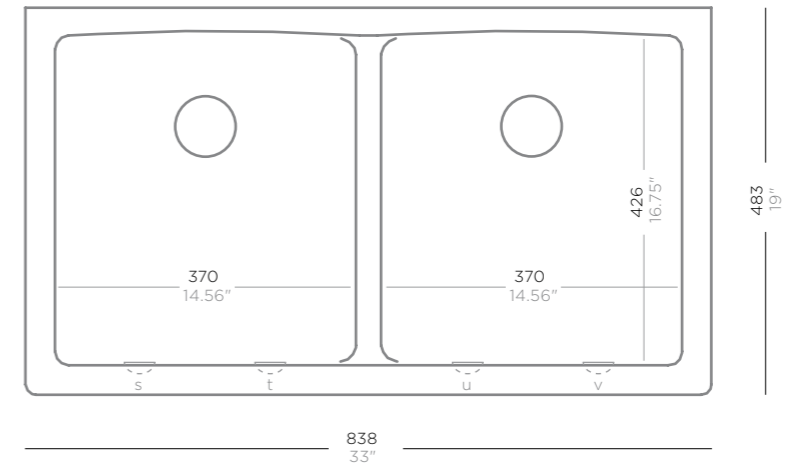

Article no.

EDO N200Y U **CRE N200Y U**

Accessories

- Manual drain kit **629861**
- Easy Care **629018**
- Easy Care Brightener **629019**
- Pro Care **629099**
- Comfotouch **629830**
- Waste cap **628152**
- DurCare **629094**
- Magic Sponge **629023**

Cut-out size



Colour range

This product is available in the standard colour range as listed in the appendix.

SCHOCK

ELEMENT D-100S



ELEMENT

SCHOCK

ELEMENT D-100S

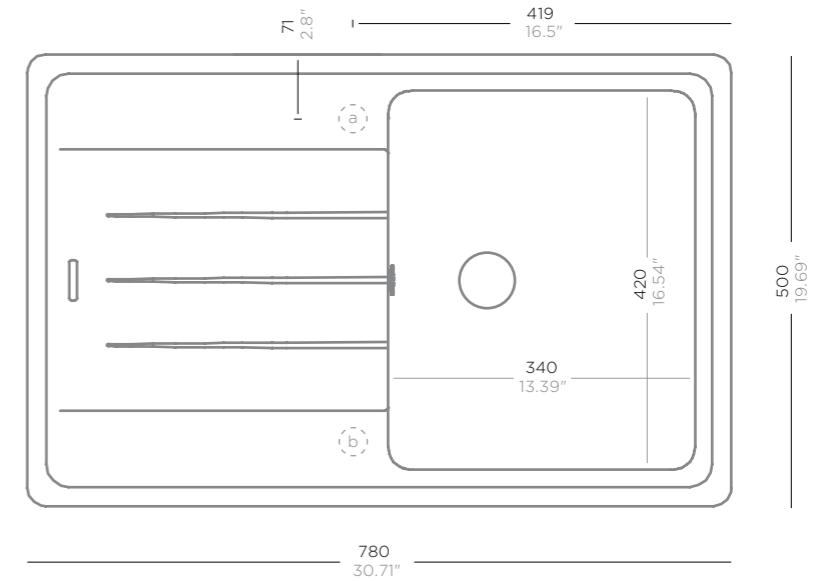

Article no.

ELE D100S A CTD

ELE D100S U CTD

Accessories

Manual drain kit 629870	Comfotouch 629830
Standard automatic drain kit 629871	Waste cap 628152
LED-light 629024	DurCare 629094
Easy Care 629018	Magic Sponge 629023
Easy Care Brightener 629019	Diamond drill SB light 629095
Pro Care 629099	

Cut-out size



Colour range

This product is available in the standard colour range as listed in the appendix.

SCHOCK

ELEMENT D-100L



ELEMENT

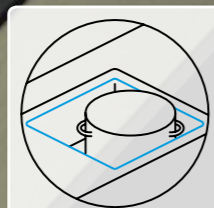

Go big
Extra volume
for large pots



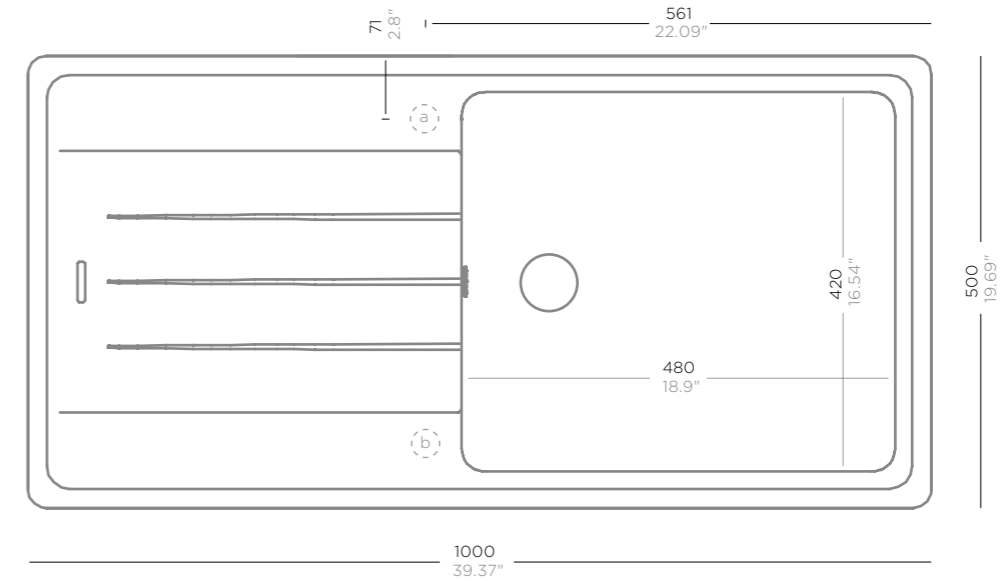

SCHOCK

ELEMENT D-100L



Article no.

Accessories

	ELE D100L A	 Manual drain kit 629870	Comfotouch 629830
		Standard automatic drain kit 629871	Waste cap 628152
	ELE D100L U	 LED-light 629024	DurCare 629094
		Easy Care 629018	Magic Sponge 629023
		Easy Care Brightener 629019	Diamond drill SB light 629095
		Pro Care 629099	

Cut-out size



Colour range

This product is available in the standard colour range as listed in the appendix.

SCHOCK

ELEMENT D-150



SCHOCK

ELEMENT D-150

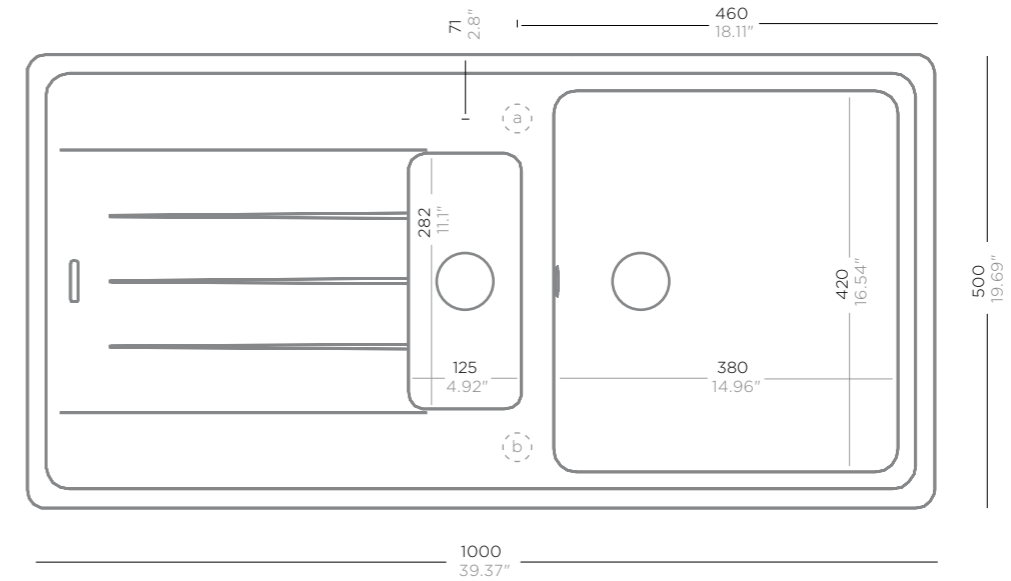

ELEMENT











Article no.

 **ELE D150 A**

 **ELE D150 U**

Accessories

 Manual drain kit	629880	 Comfotouch	629830
 Standard automatic drain kit	629881	 Waste cap	628152
 LED-light	629024	 DurCare	629094
 Easy Care	629018	 Magic Sponge	629023
 Easy Care Brightener	629019	 Diamond drill SB light	629095
 Pro Care	629099		

Cut-out size



Colour range

This product is available in the standard colour range as listed in the appendix.

SCHOCK

ELEMENT D-200



ELEMENT

SCHOCK

ELEMENT D-200

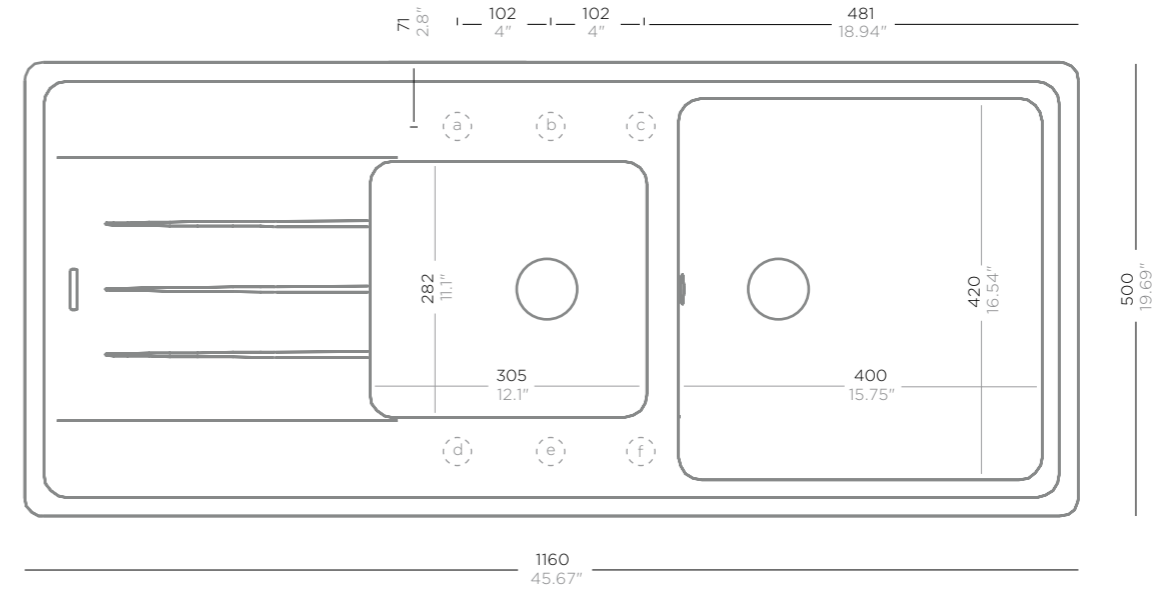

Article no.

 **ELE D200 A**

 Manual drain kit **629874**
Standard automatic drain kit **629875**

Comfotouch **629830**
Waste cap **628152**

 **ELE D200 U**

 LED-light **629024**
Easy Care **629018**
Easy Care Brightener **629019**
Pro Care **629099**

DurCare **629094**
Magic Sponge **629023**

Diamond drill SB light **629095**

Cut-out size

 1140 x 480
44.88" x 18.9"

 1144 x 484
45.04" x 19.06"

Colour range

This product is available in the standard colour range as listed in the appendix.

SCHOCK

ELEMENT N-200



ELEMENT

SCHOCK

ELEMENT N-200

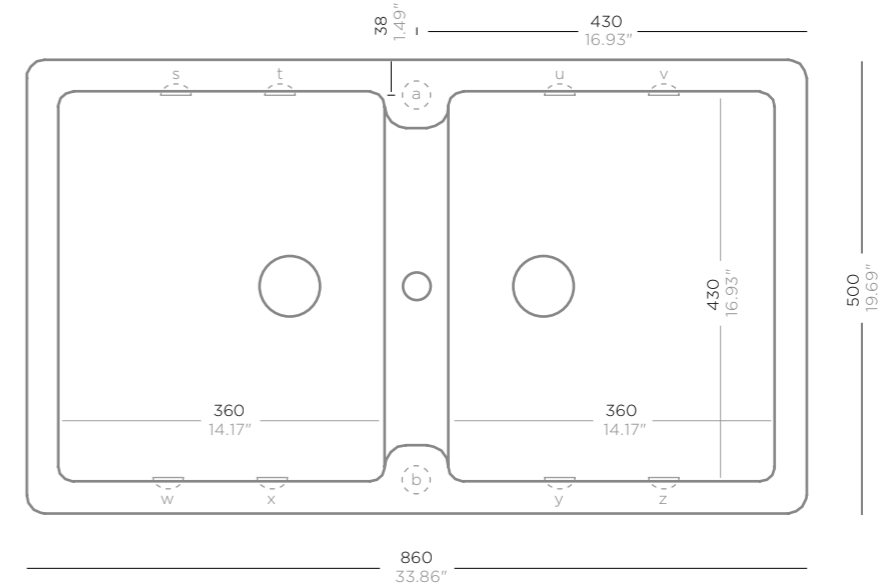

Article no.

ELE N200 A

ELE N200 U

Accessories

Manual drain kit **629878**
Standard automatic drain kit **629879**

Glass chopping board **629036A/U**
Glass chopping board, white **629045A/U**

Glass chopping board, black **629046A/U**
Chopping board, bamboo **629044**

Wire basket **629171**
LED-light **629024**

Easy Care **629018**
Easy Care Brightener **629019**

Pro Care **629099**
Comfotouch **629830**

Cut-out size

840 x 480
33.07" x 18.9"

846 x 486
33.31" x 19.13"

Colour range

This product is available in the standard colour range as listed in the appendix.

SCHOCK

EURO N-100



EURO

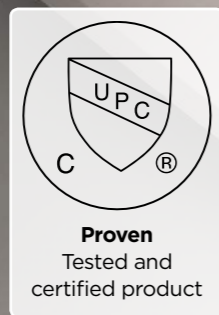

SCHOCK

EURO N-100

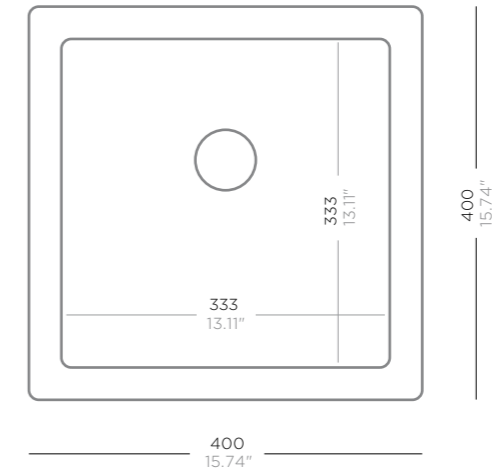







EURO

Article no.

 **EUR N100 A**

 **EUR N100 U**

Accessories

-  Manual drain kit **629314**
-  Standard automatic drain kit **629313**
-  Easy Care **629018**
-  Easy Care Brightener **629019**
-  Pro Care **629099**
-  Comfotouch **629830**
- Waste cap **628152**
- Magic Sponge **629023**
- Diamond drill SB light **629095**

Cut-out size



Colour range

This product is available in the standard colour range as listed in the appendix.

SCHOCK

EURO R-100



EURO

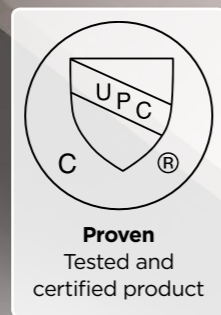

SCHOCK

EURO R-100

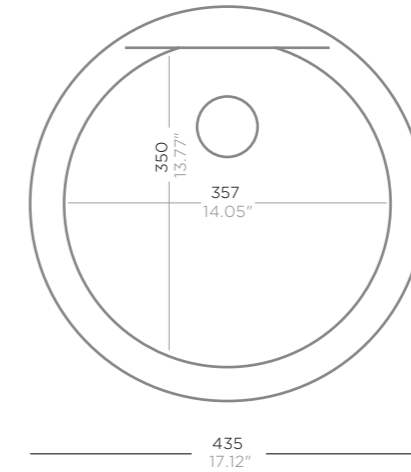

Article no.

 **EUR R100 A**



Manual drain kit **629112**
Standard automatic drain kit **629220**

Waste cap **628152**
Magic Sponge **629023**

 **EUR R100 U**



Easy Care **629018**
Easy Care Brightener **629019**

Diamond drill SB light **629095**

Pro Care **629099**
Comfotouch **629830**

Cut-out size



Colour range

This product is available in the standard colour range as listed in the appendix.

SCHOCK

FORMHAUS D-100S



FORMHAUS

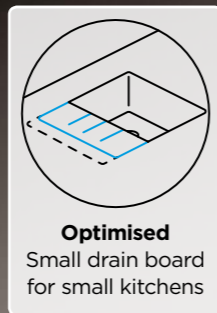
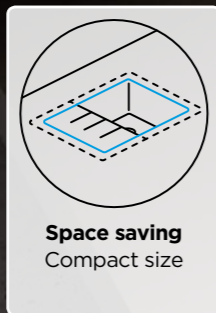

SCHOCK

FORMHAUS D-100S

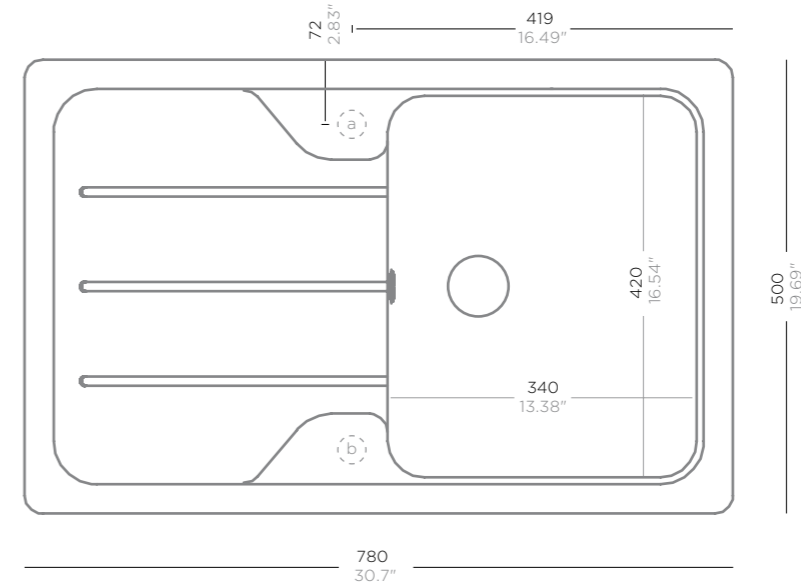

Article no.



FOM D100S A CTB

Accessories

- | | | | |
|------------------------------------|----------------|----------------------------|---------------|
| Manual drain kit | 629870 | Easy Care Brightener | 629019 |
| Standard automatic drain kit | 629871 | Pro Care | 629099 |
| Glass chopping board | 629036A | Comfotouch | 629830 |
| Chopping board, bamboo | 629044 | Waste cap | 628152 |
| LED-light | 629024 | Magic Sponge | 629023 |
| Easy Care | 629018 | | |

Cut-out size

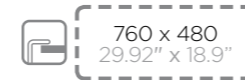

Colour range

This product is available in the standard colour range as listed in the appendix.

SCHOCK

FORMHAUS D-100



FORMHAUS

SCHOCK

FORMHAUS D-100

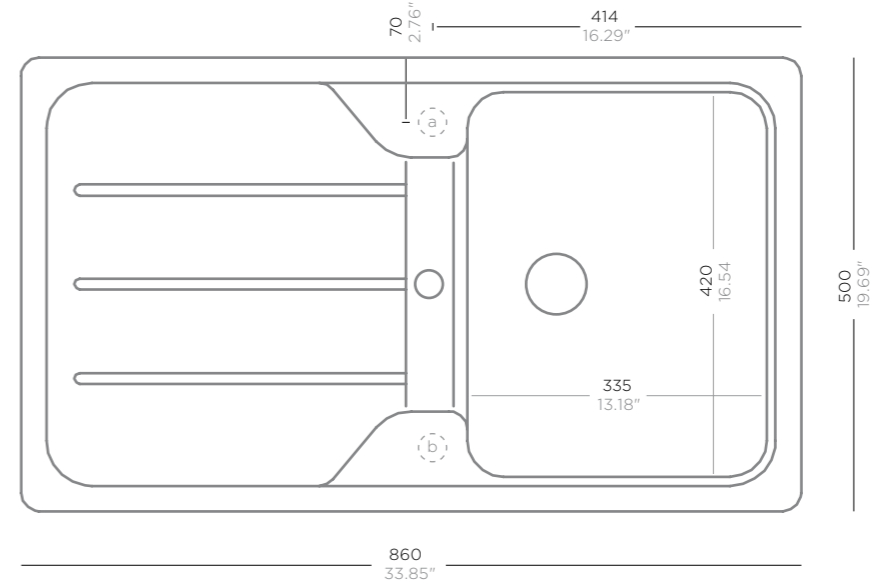

Article no.

 **FOM D100 A** 

Accessories

- | | |
|--|--|
| Manual drain kit 629872 | Easy Care Brightener 629019 |
| Standard automatic drain kit 629873 | Pro Care 629099 |
| Glass chopping board 629036A | Comfotouch 629830 |
| Chopping board, bamboo 629044 | Waste cap 628152 |
| LED-light 629024 | Magic Sponge 629023 |
| Easy Care 629018 | |

Cut-out size

 **840 x 480**
33.07" x 18.9"

Colour range

This product is available in the standard colour range as listed in the appendix.

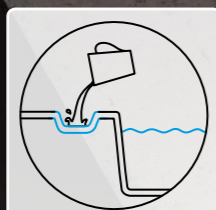

On standby
Extra drain when
washing up

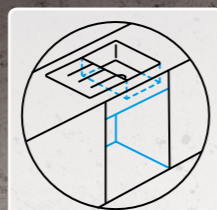

Unobtrusive
Needs less space
in the cabinet

SCHOCK

FORMHAUS D-100L



FORMHAUS



SCHOCK

FORMHAUS D-100L

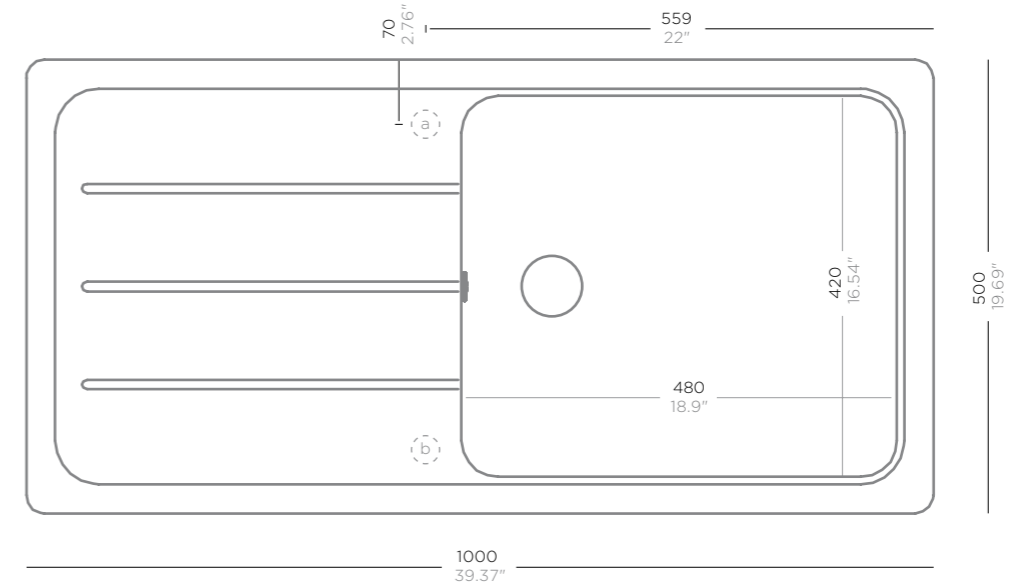

Article no.



FOM D100L A

Accessories

- Manual drain kit **629870**
- Standard automatic drain kit **629871**
- Glass chopping board **629036A**
- Chopping board, bamboo **629044**
- LED-light **629024**
- Easy Care **629018**
- Easy Care Brightener **629019**
- Pro Care **629099**
- Comfotouch **629830**
- Waste cap **628152**
- Magic Sponge **629023**

Cut-out size



Colour range

This product is available in the standard colour range as listed in the appendix.

SCHOCK

FORMHAUS D-150L



FORMHAUS

SCHOCK

FORMHAUS D-150L

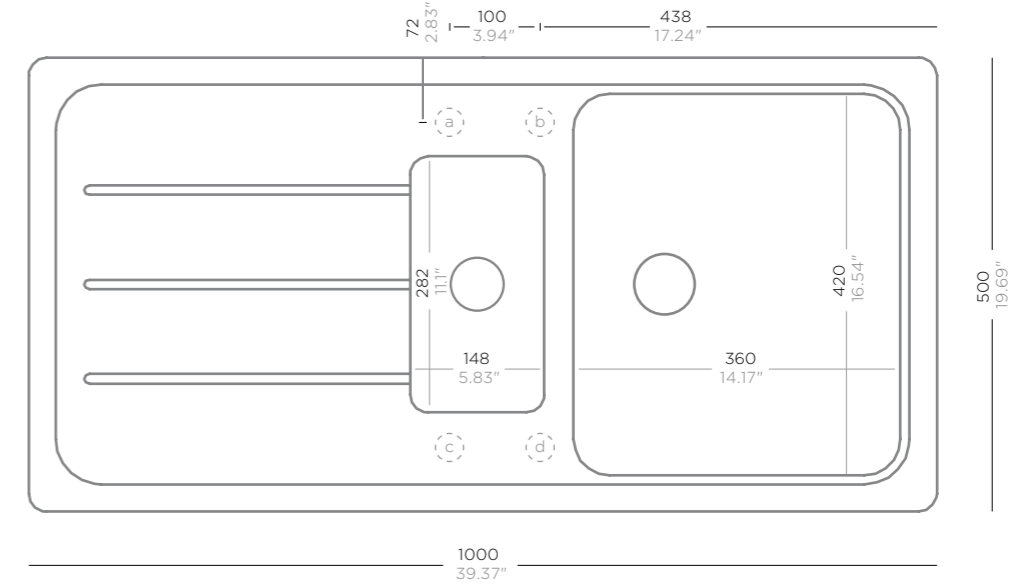

Article no.



FOM D150L A CTB

Accessories

Manual drain kit	629876	Comfotouch	629830
Standard automatic drain kit	629877	Waste cap	628152
LED-light	629024	DurCare	629094
Easy Care	629018	Magic Sponge	629023
Easy Care Brightener	629019	Diamond drill SB light	629095
Pro Care	629099		

Cut-out size



Colour range

This product is available in the standard colour range as listed in the appendix.

SCHOCK

FORMHAUS D-200

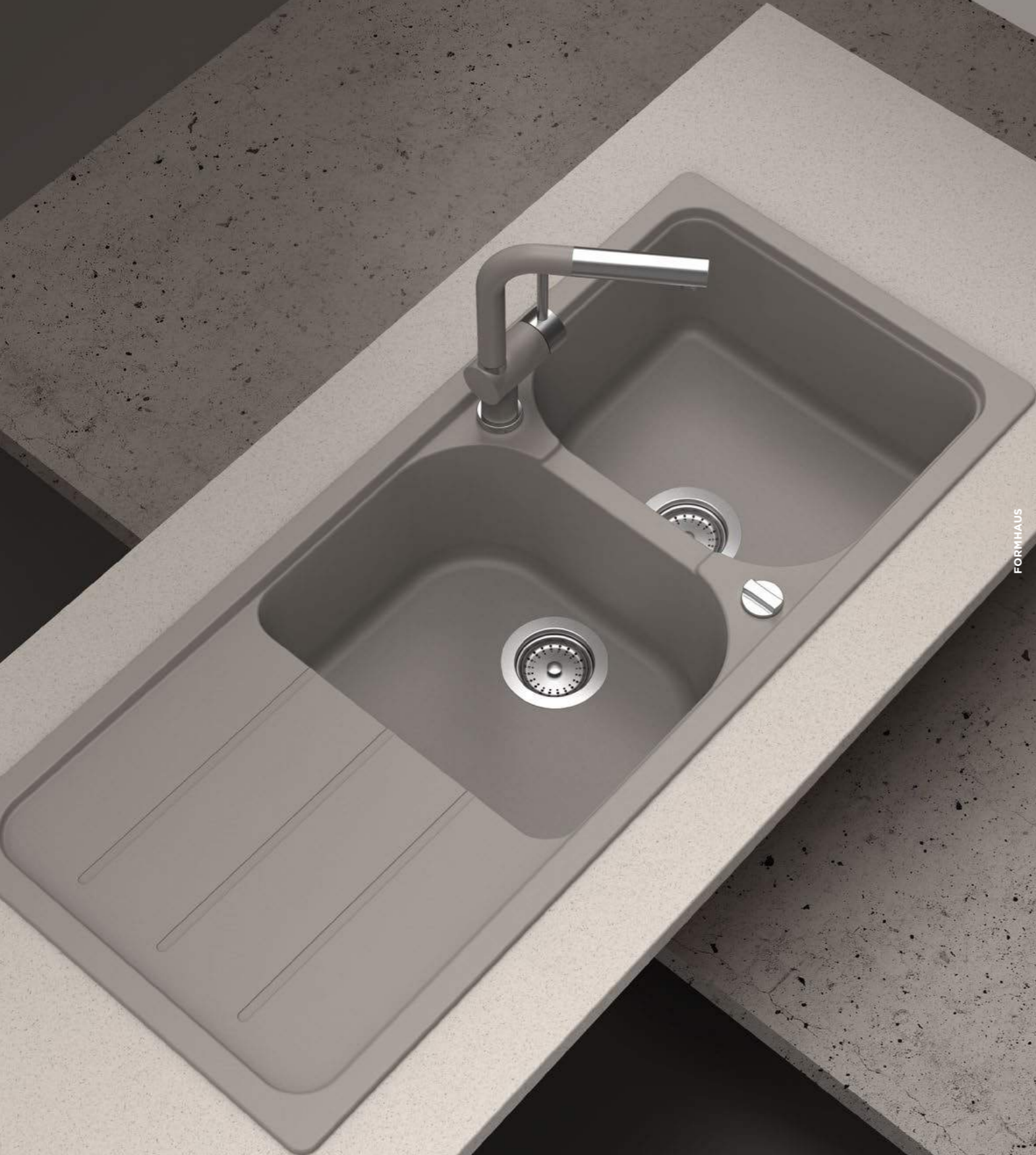

FORMHAUS

SCHOCK

FORMHAUS D-200

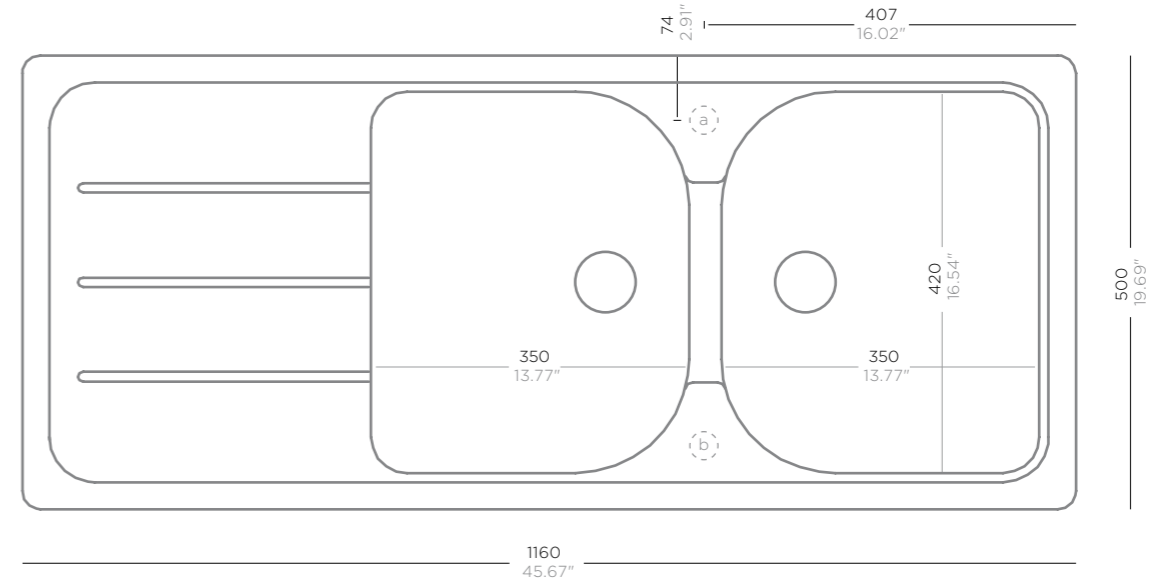

Article no.

 **FOM D200 A** 

Accessories

- | | | | |
|------------------------------------|---------------|------------------------------|---------------|
| Manual drain kit | 629874 | Comfotouch | 629830 |
| Standard automatic drain kit | 629875 | Waste cap | 628152 |
| LED-light | 629024 | DurCare | 629094 |
| Easy Care | 629018 | Magic Sponge | 629023 |
| Easy Care Brightener | 629019 | Diamond drill SB light | 629095 |
| Pro Care | 629099 | | |

Cut-out size

 **1140 x 480**
44.88" x 18.9"

Colour range

This product is available in the standard colour range as listed in the appendix.

SCHOCK

FORMHAUS N-200S



FORMHAUS

SCHOCK

FORMHAUS N-200S

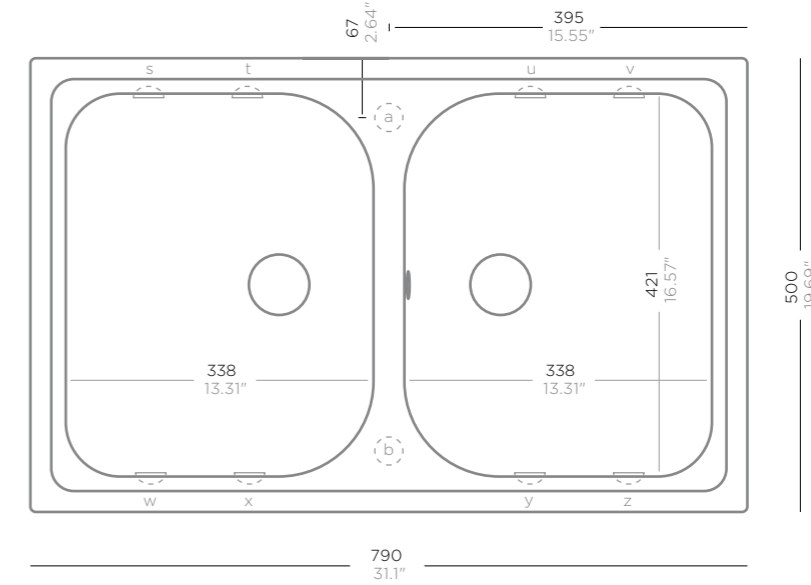

Article no.



FOM N200S A CTB

Accessories

Manual drain kit **629874**
Standard automatic drain kit **629875**

Easy Care **629018**
Easy Care Brightener **629019**



FOM N200S U CTB

Glass chopping board **629036A/U**
Glass chopping board, white **629045A/U**

Pro Care **629099**
Comfotouch **629830**

Glass chopping board, black **629046A/U**
Chopping board, bamboo **629044**

Waste cap **628152**

Cut-out size



770 x 480
30.31" x 18.9"



775 x 485
30.51" x 19.09"

Colour range

This product is available in the standard colour range as listed in the appendix.

SCHOCK

FORMHAUS N-200



FORMHAUS

SCHOCK

FORMHAUS N-200

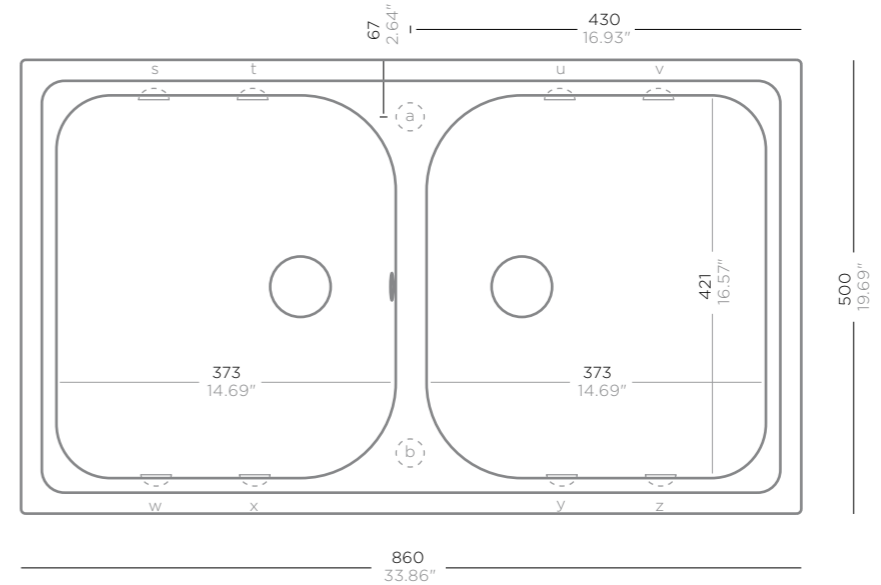

Article no.

FOM N200 A

Accessories

- Manual drain kit **629874**
- Standard automatic drain kit **629875**
- Glass chopping board **629036A/U**
- Glass chopping board, white **629045A/U**
- Glass chopping board, black **629046A/U**
- Chopping board, bamboo **629044**
- Easy Care **629018**
- Easy Care Brightener **629019**
- Pro Care **629099**
- Comfotouch **629830**
- Waste cap **628152**
- DurCare **629094**

Cut-out size



Colour range

This product is available in the standard colour range as listed in the appendix.

SCHOCK

GALAXY | GEMO N-100



GALAXY | GEMO

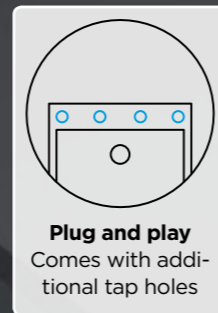
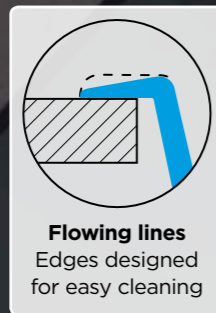
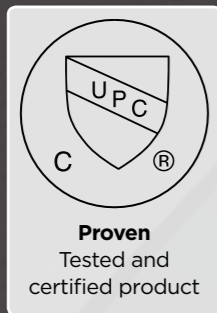





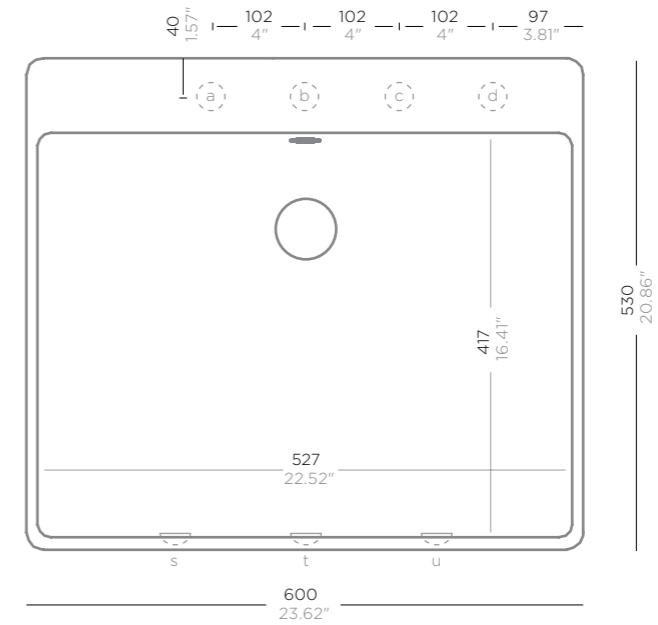



SCHOCK

GALAXY | GEMO N-100



Article no.

Accessories

	GAX N100 A		Manual drain kit	629323		Bottom grid	629122/GAXN100
	GEM N100 A		Standard automatic drain kit	629324		LED-light	629024
	GAX N100 U		Premium automatic drain kit	629324PD		Easy Care	629018
	GEM N100 U		Visible parts in Copper	629324COP		Easy Care Brightener	629019
			Visible parts in Gunmetal	629324GUM		Pro Care	629099
			Visible parts stainless steel	629324EDM		Comfotouch	629830

Cut-out size



Colour range

This product is available in the standard colour range as listed in the appendix.

* Please note that the undermount version requires a cabinet the next size up.

SCHOCK

GALAXY | GEMO N-100Y



GALAXY | GEMO

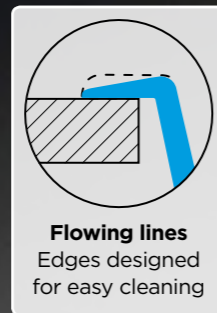
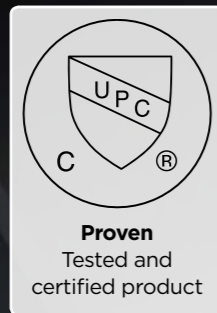

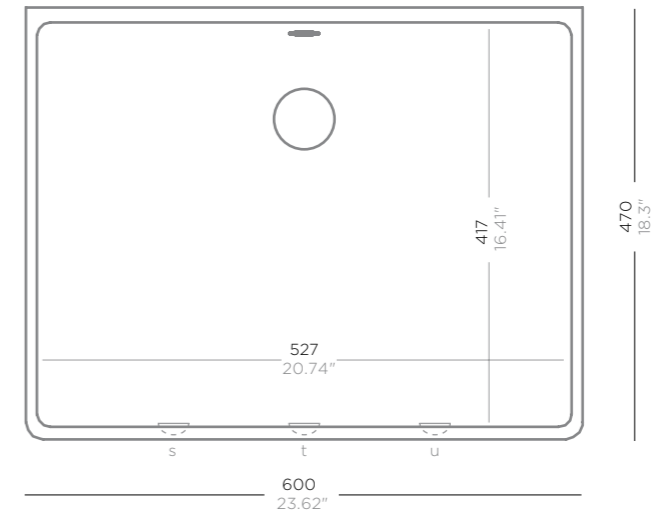

SCHOCK

GALAXY | GEMO N-100Y



Article no.

-  **GAX N100Y U** 
-  **GEM N100Y U** 

Accessories

- Manual drain kit **629323**
- Standard automatic drain kit **629324**
- Premium automatic drain kit **629324PD**
- Visible parts in Copper **629324COP**
- Visible parts in Gunmetal **629324GUM**
- Visible parts stainless steel **629324EDM**
- Bottom grid **629122/GAXN100**
- LED-light **629024**
- Easy Care **629018**
- Easy Care Brightener **629019**
- Pro Care **629099**
- Comfotouch **629830**

Cut-out size



Colour range

This product is available in the standard colour range as listed in the appendix.

SCHOCK

GALAXY | GEMO N-100L



GALAXY | GEMO

Flowing lines
Edges designed for easy cleaning

Go big
Extra volume for large pots

Plug and play
Comes with additional tap holes

SCHOCK

GALAXY | GEMO N-100L

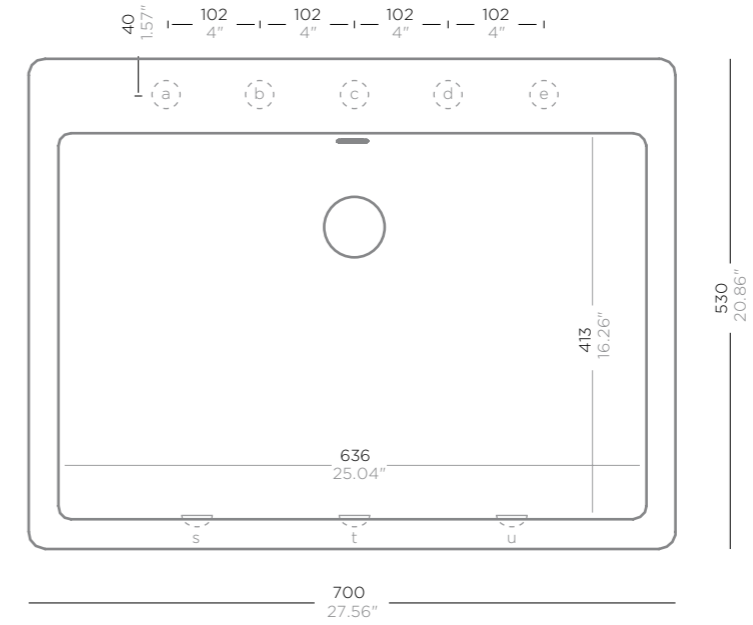

Article no.

GAX N100L A

Accessories

- | | |
|---|--|
| Manual drain kit 629323 | Easy Care Brightener 629019 |
| Standard automatic drain kit 629324 | Pro Care 629099 |
| Premium automatic drain kit 629324PD | Comfotouch 629830 |
| Visible parts in Copper 629324COP | Waste cap 628152 |
| LED-light 629024 | DurCare 629094 |
| Easy Care 629018 | Magic Sponge 629023 |

Cut-out size

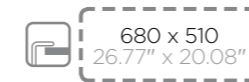

Colour range

This product is available in the standard colour range as listed in the appendix.

SCHOCK

GALAXY | GEMO N-100LY



GALAXY | GEMO



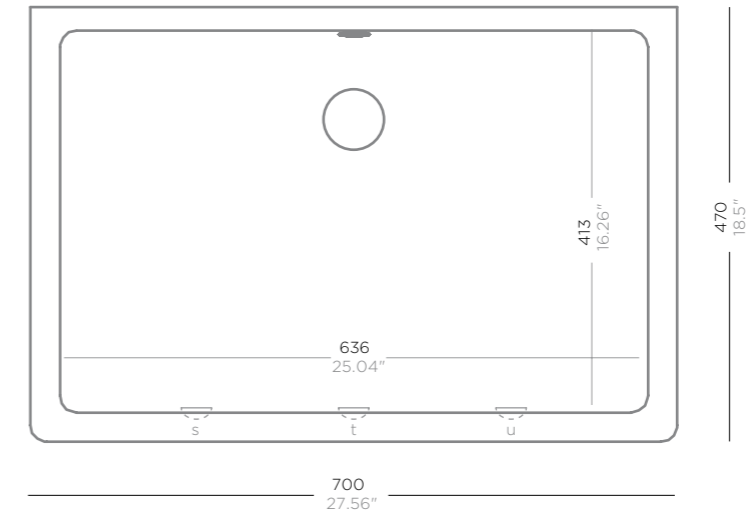

SCHOCK

GALAXY | GEMO N-100LY



Article no.

 **GAX N100LY U** 

Accessories

- | | |
|---|--|
| Manual drain kit 629323 | Easy Care Brightener 629019 |
| Standard automatic drain kit 629324 | Pro Care 629099 |
| Premium automatic drain kit 629324PD | Comfotouch 629830 |
| Visible parts in Copper 629324COP | Waste cap 628152 |
| LED-light 629024 | DurCare 629094 |
| Easy Care 629018 | Magic Sponge 629023 |

Cut-out size



Colour range

This product is available in the standard colour range as listed in the appendix.

SCHOCK

GENIUS D-100S



GENIUS

SCHOCK

GENIUS D-100S

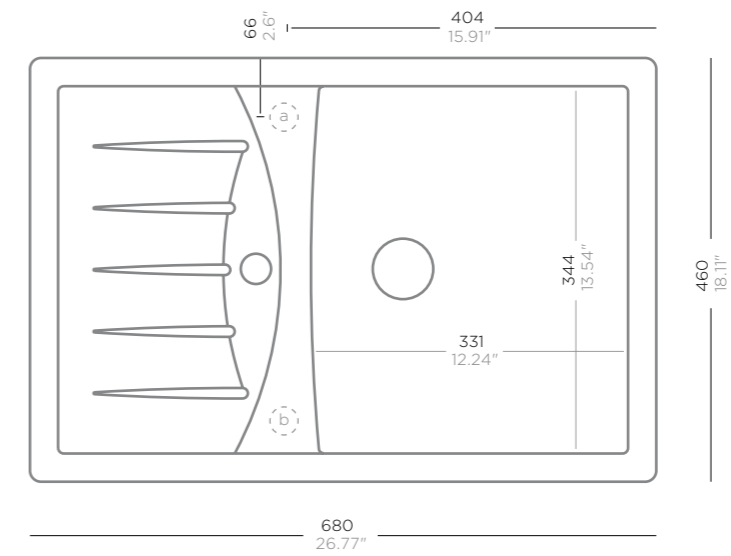

Article no.



GEN D100S A



Accessories

Manual drain kit **629382**
Standard automatic drain kit **629383**

Waste cap **628152**
Magic Sponge **629023**



GEN D100S U



Easy Care **629018**
Easy Care Brightener **629019**

Diamond drill SB light **629095**

Pro Care **629099**
Comfotouch **629830**

Cut-out size



Colour range

This product is available in the standard colour range as listed in the appendix.

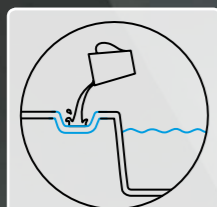

On standby
Extra drain when
washing up

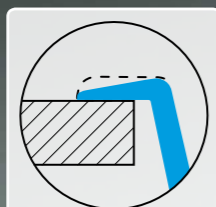

Flowing lines
Edges designed
for easy cleaning

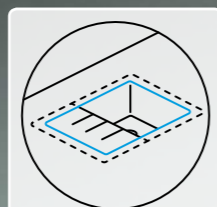

Space saving
Compact size

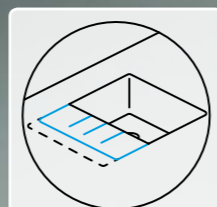

Optimised
Small drain board
for small kitchens

SCHOCK

GENIUS D-100



GENIUS

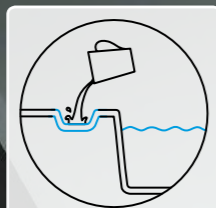

On standby
Extra drain when washing up

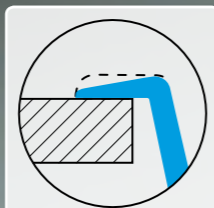

Flowing lines
Edges designed for easy cleaning



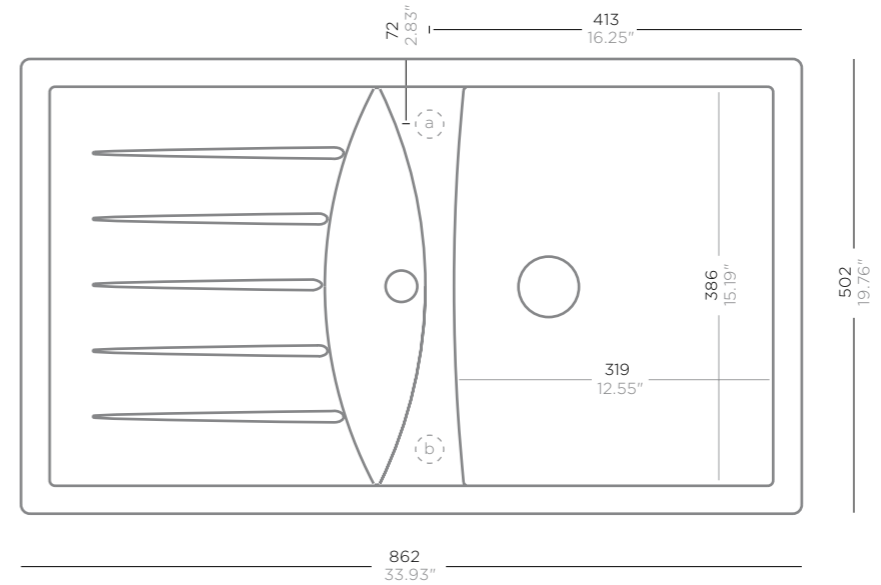

SCHOCK

GENIUS D-100



Article no.

Accessories

	GEN D100 A		Manual drain kit 629382	Wire basket 629194
			Standard automatic drain kit 629383	Easy Care 629018
	GEN D100 U		Glass chopping board 629036A/U	Easy Care Brightener 629019
			Glass chopping board, white 629045A/U	Pro Care 629099
			Glass chopping board, black 629046A/U	Comfotouch 629830
			Chopping board, bamboo 629044	Waste cap 628152

Cut-out size



Colour range

This product is available in the standard colour range as listed in the appendix.

SCHOCK

GENIUS D-150



GENIUS

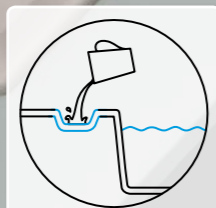

On standby
Extra drain when washing up

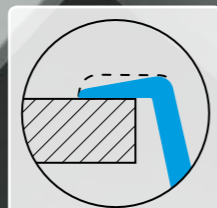

Flowing lines
Edges designed for easy cleaning





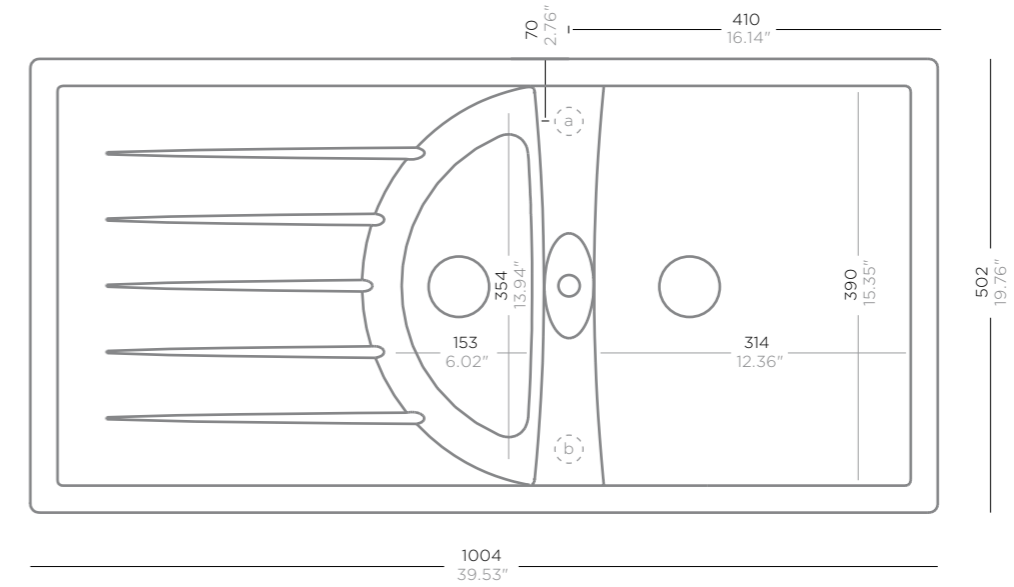









SCHOCK

GENIUS D-150



Article no.

Accessories

	GEN D150 A	 Manual drain kit 629300	 Strainer bowl 629042
		 Standard automatic drain kit 629301	 Wire basket 629194
	GEN D150 U	 Glass chopping board 629036A/U	 Easy Care 629018
		 Glass chopping board, white 629045A/U	 Easy Care Brightener 629019
		 Glass chopping board, black 629046A/U	 Pro Care 629099
		 Chopping board, bamboo 629044	 Comfotouch 629830

Cut-out size



Colour range

This product is available in the standard colour range as listed in the appendix.

SCHOCK

GENIUS D-200

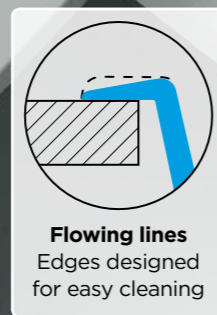
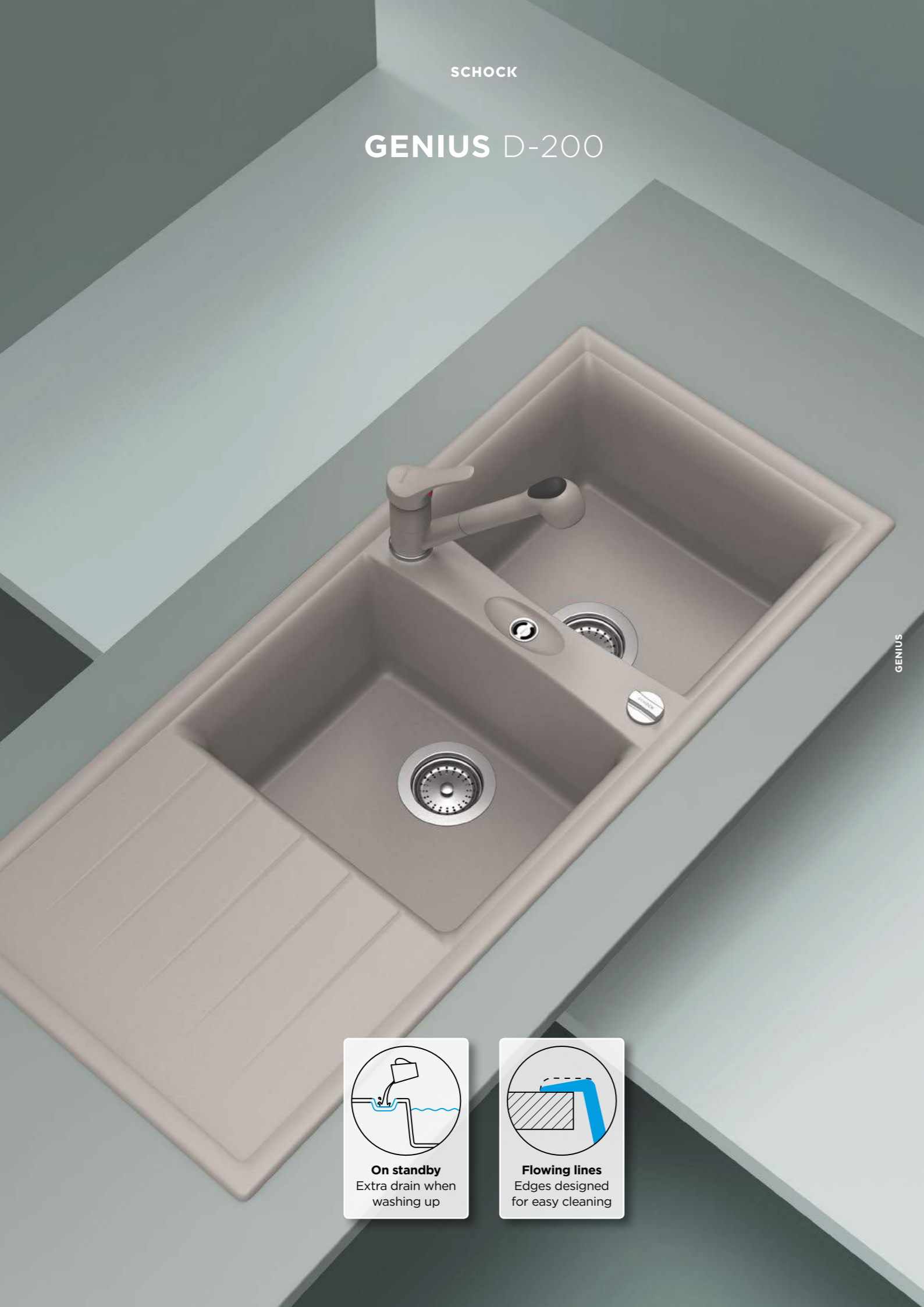

SCHOCK

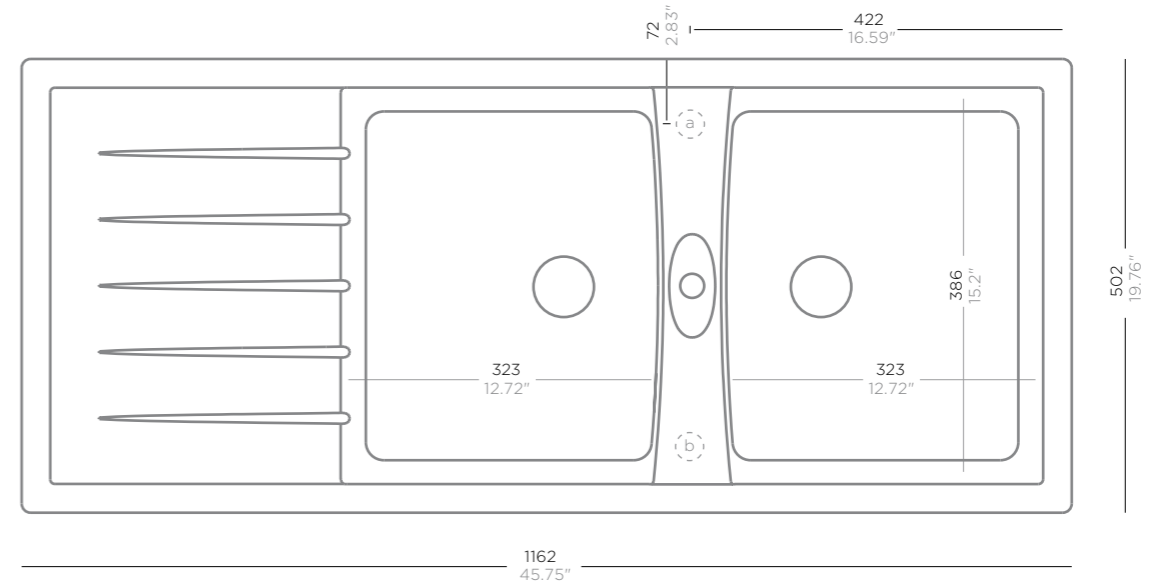

GENIUS D-200





Article no.

 **GEN D200 A**

Accessories

 Manual drain kit **629300** Wire basket **629194**
 Standard automatic drain kit **629301** Easy Care **629018**

 **GEN D200 U**

 Glass chopping board **629036A/U** Easy Care Brightener **629019**
 Glass chopping board, white **629045A/U** Pro Care **629099**

Glass chopping board, black **629046A/U** Comfotouch **629830**
 Chopping board, bamboo **629044** Waste cap **628152**

Cut-out size



Colour range

This product is available in the standard colour range as listed in the appendix.

SCHOCK

GENIUS C-150



GENIUS

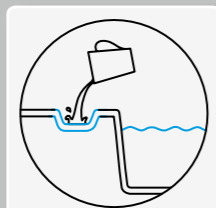

On standby
Extra drain when washing up



Flowing lines
Edges designed for easy cleaning

SCHOCK

GENIUS C-150

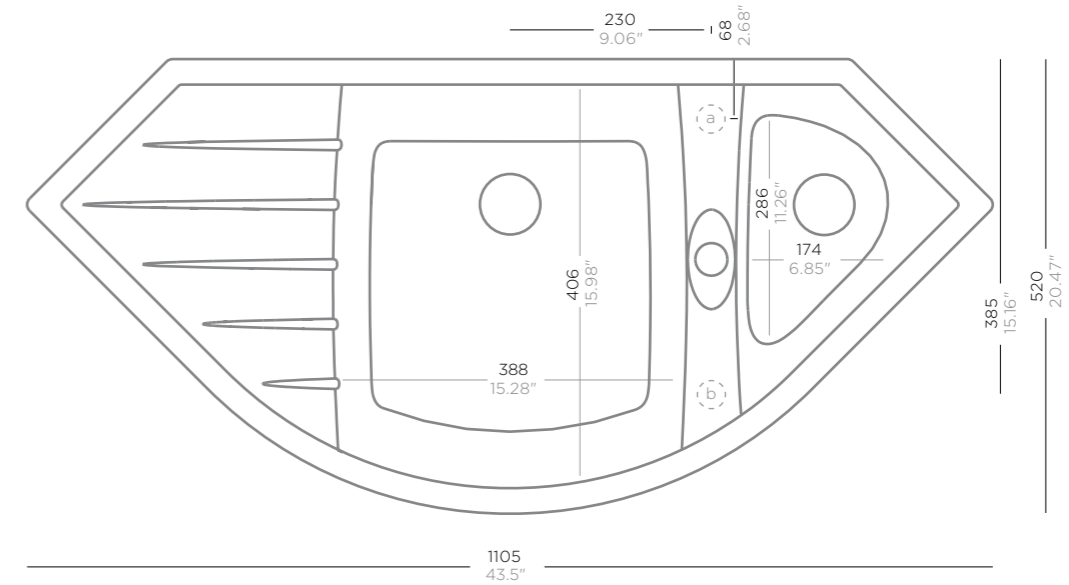





GENIUS



Article no.

Accessories

	GEN C150 A		Manual drain kit 629350	Comfotouch 629830
			Standard automatic drain kit 629351	Waste cap 628152
	GEN C150 U		Chopping board, wood 629211	Magic Sponge 629023
			Easy Care 629018	Diamond drill SB light 629095
			Easy Care Brightener 629019	
			Pro Care 629099	

Cut-out size



Colour range

This product is available in the standard colour range as listed in the appendix.

SCHOCK

GRANDO M-100



GRANDO

GRANDO

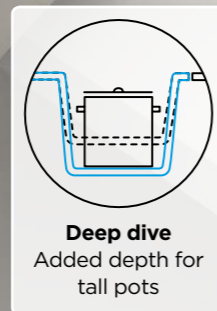

SCHOCK

GRANDO M-100

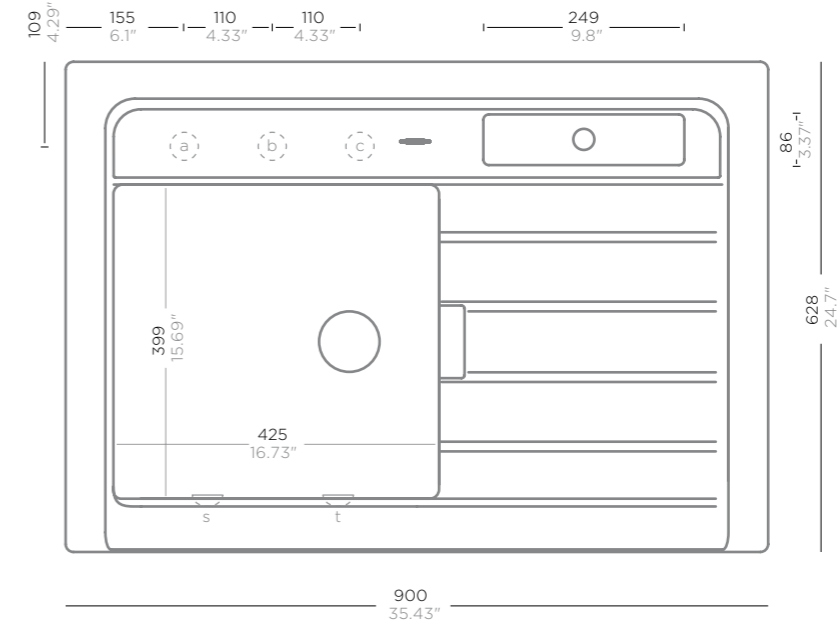

Article no.

GRA M100 M

Accessories

- Premium automatic drain kit **629306PD**
- Glass chopping board, black **629028**
- LED-light **629024**
- Indutherm **629100**
- Easy Care **629018**
- Easy Care Brightener **629019**
- Pro Care **629099**
- Comfotouch **629830**
- Waste cap **628152**
- DurCare **629094**
- Magic Sponge **629023**

Cut-out size



Colour range

This product is available in the standard colour range as listed in the appendix.

SCHOCK

GREENWICH | BROOKLYN N-100S



GREENWICH | BROOKLYN

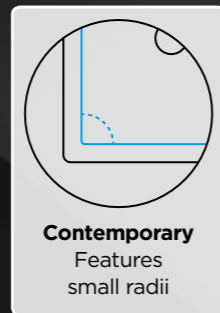
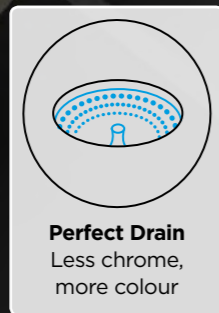

SCHOCK



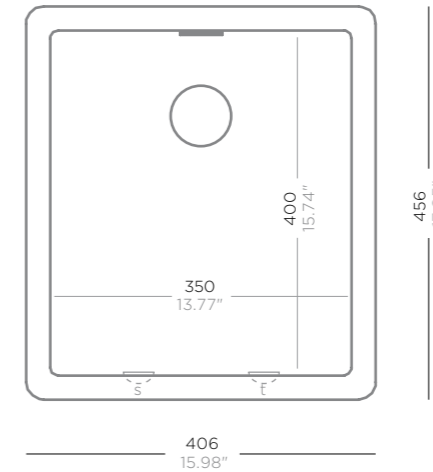







GREENWICH | BROOKLYN N-100S



GREENWICH | BROOKLYN

Article no.

Accessories

	GRE N100S A 	Manual drain kit	629322	Easy Care	629018
	BYK N100S A 	Standard automatic drain kit	629392	Easy Care Brightener	629019
	GRE N100S U 	Premium automatic drain kit	629392PD	Pro Care	629099
	BYK N100S U 	Visible parts in Copper	629392COP	Comfotouch	629830
	GRE N100S FB 	Strainer bowl	629111	Waste cap	628152
		LED-light	629024	DurCare	629094

Cut-out size



Colour range

This product is available in the standart colour range as listed in the appendix.

SCHOCK

GREENWICH | BROOKLYN N-100



GREENWICH | BROOKLYN

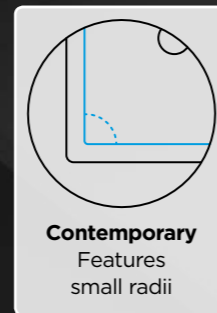
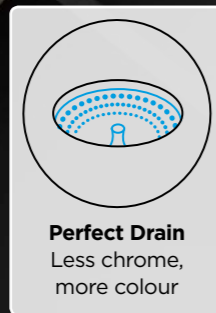





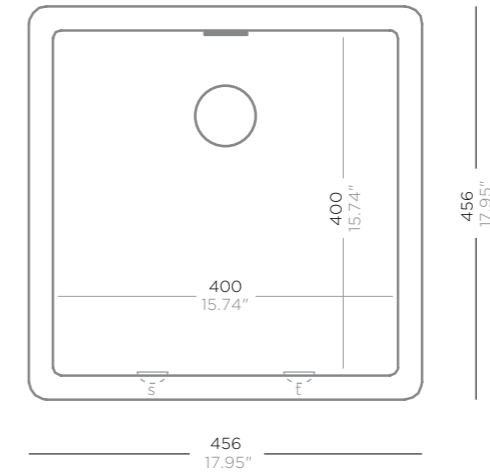





SCHOCK

GREENWICH | BROOKLYN N-100



Article no.

Accessories

	GRE N100 A		Manual drain kit	629322	Easy Care	629018
	BYK N100 A		Standard automatic drain kit	629392	Easy Care Brightener	629019
	GRE N100 U		Premium automatic drain kit	629392PD	Pro Care	629099
	BYK N100 U		Visible parts in Copper	629392COP	Comfotouch	629830
	GRE N100 FB		Strainer bowl	629111	Waste cap	628152
			LED-light	629024	DurCare	629094

Cut-out size



Colour range

This product is available in the standart colour range as listed in the appendix.

SCHOCK

GREENWICH | BROOKLYN N-100L



GREENWICH | BROOKLYN

Perfect Drain
Less chrome,
more colour

Contemporary
Features
small radii

Go big
Extra volume
for large pots

SCHOCK

GREENWICH | BROOKLYN N-100L

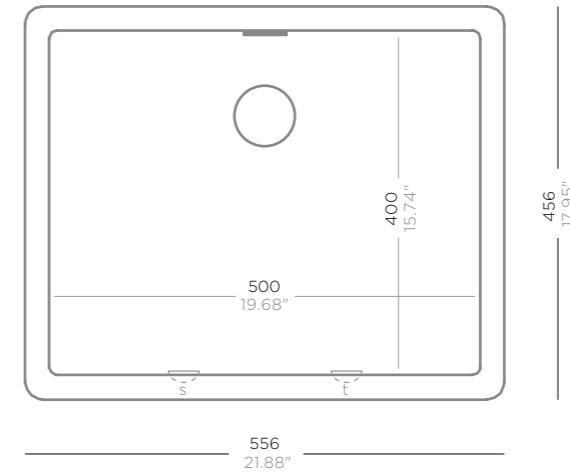

GREENWICH | BROOKLYN

Article no.

Accessories

	GRE N100L A		Manual drain kit	629322	Easy Care	629018
	BYK N100L A		Standard automatic drain kit	629392	Easy Care Brightener	629019
	GRE N100L U		Premium automatic drain kit	629392PD	Pro Care	629099
	BYK N100L U		Visible parts in Copper	629392COP	Comfotouch	629830
	GRE N100L FB		Strainer bowl	629111	Waste cap	628152
			LED-light	629024	DurCare	629094

Cut-out size



Colour range

This product is available in the standart colour range as listed in the appendix.

SCHOCK

GREENWICH | BROOKLYN N-175



GREENWICH | BROOKLYN

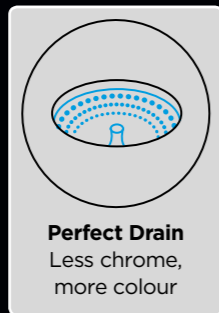



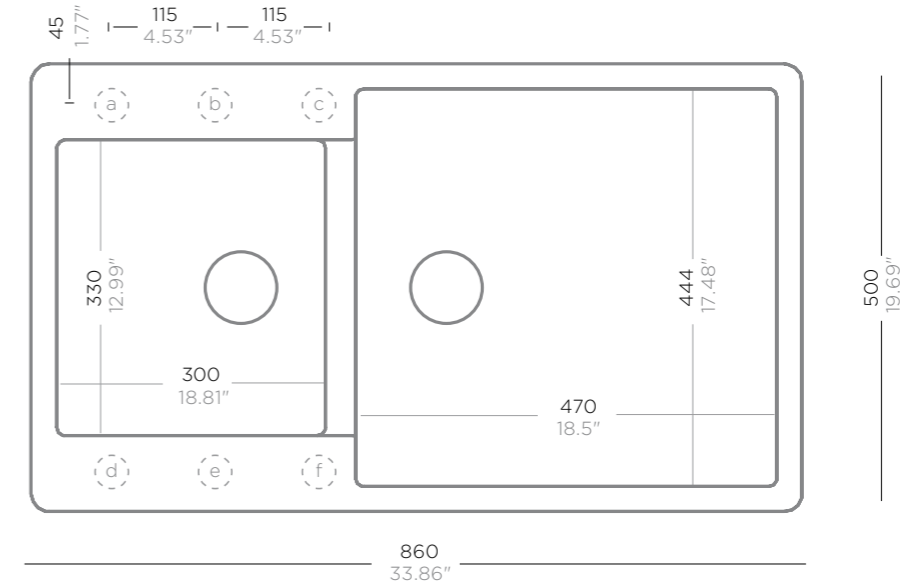

SCHOCK

GREENWICH | BROOKLYN N-175



Article no.

Accessories

	BYK N175 A		Manual drain kit 629621	Comfotouch 629830
			Standard automatic drain kit 629622	DurCare 629094
	BYK N175 U		LED-light 629024	Magic Sponge 629023
			Easy Care 629018	Diamond drill SB light 629095
			Easy Care Brightener 629019	
			Pro Care 629099	

Cut-out size



Colour range

This product is available in the standard colour range as listed in the appendix.

SCHOCK

HORIZONT | EDEN D-100S



HORIZONT | EDEN

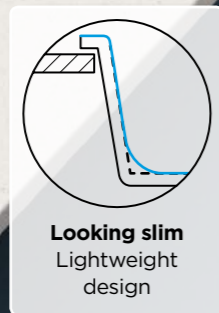

Looking slim
Lightweight design

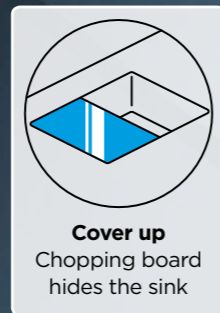

Cover up
Chopping board hides the sink





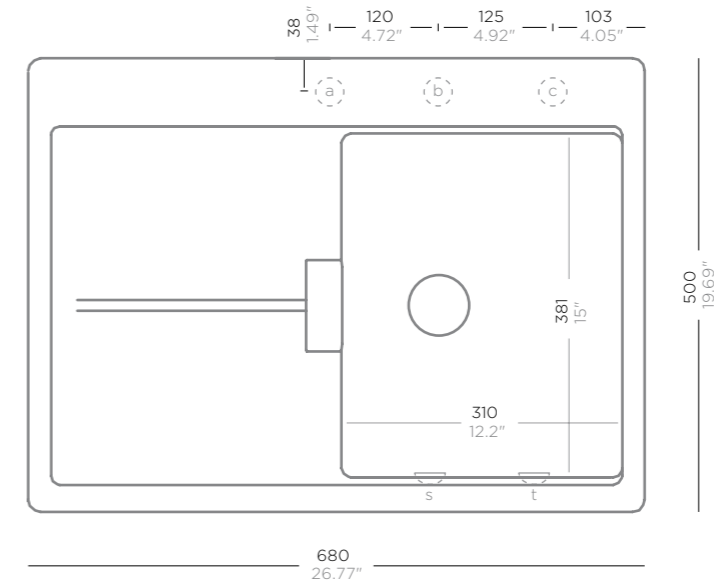





SCHOCK

HORIZONT | EDEN D-100S



Article no.

Accessories

 HON D100S A 	Manual drain kit 629395	LED-light 629024
 EDE D100S A 	Standard automatic drain kit 629368	Easy Care 629018
 HON D100S U 	Premium automatic drain kit 629368PD	Easy Care Brightener 629019
 EDE D100S U 	Visible parts in Copper 629368COP	Pro Care 629099
 HON D100S FB 	Glass chopping board, black 629076	Comfotouch 629830
	Strainer bowl 629051	Waste cap 628152

Cut-out size

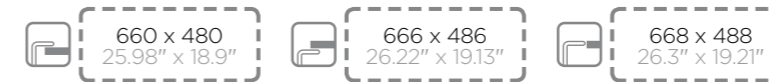

Colour range

This product is available in the standard colour range as listed in the appendix.

SCHOCK

HORIZONT | EDEN D-100



HORIZONT | EDEN

HORIZONT | EDEN

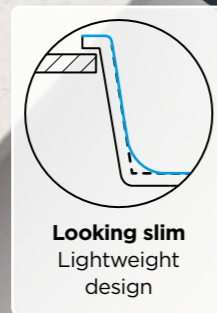
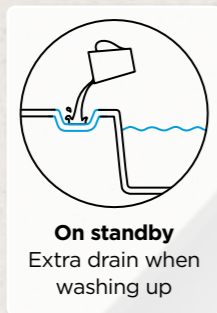





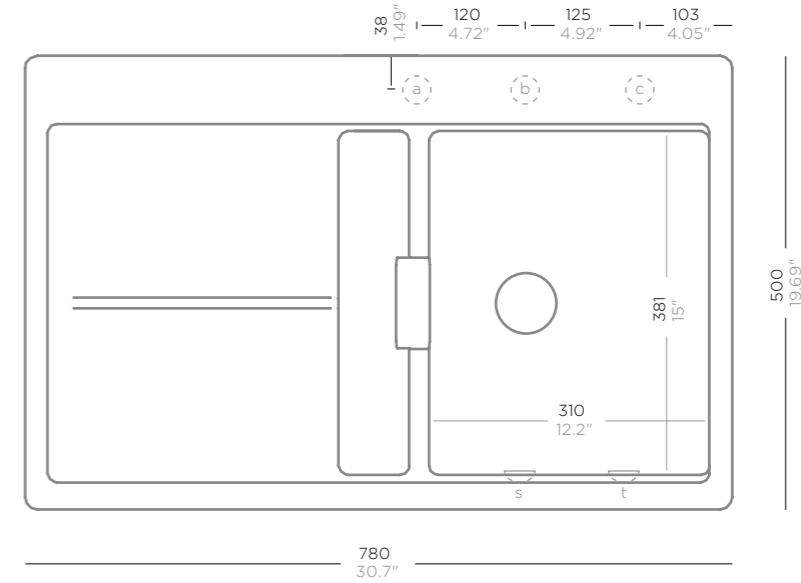











SCHOCK

HORIZONT | EDEN D-100



Article no.

Accessories

	HON D100 A		Manual drain kit	629370		LED-light	629024
	EDE D100 A		Standard automatic drain kit	629371		Indutherm	629100
	HON D100 U		Premium automatic drain kit	629371PD		Easy Care	629018
	EDE D100 U		Visible parts in Copper	629371COP		Easy Care Brightener	629019
	HON D100 FB		Glass chopping board, black	629076		Pro Care	629099
			Strainer bowl	629051		Comfotouch	629830

Cut-out size

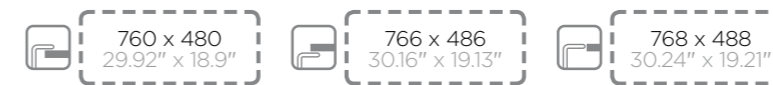

Colour range

This product is available in the standard colour range as listed in the appendix.

SCHOCK

HORIZONT | EDEN D-150



HORIZONT | EDEN

HORIZONT | EDEN

Looking slim
Lightweight design

Eye catcher
Patented over-flow design

Plug and play
Comes with additional tap holes

Spacious
Big dishes? Big drain board!

Cover up
Chopping board hides the sink

SCHOCK

HORIZONT | EDEN D-150

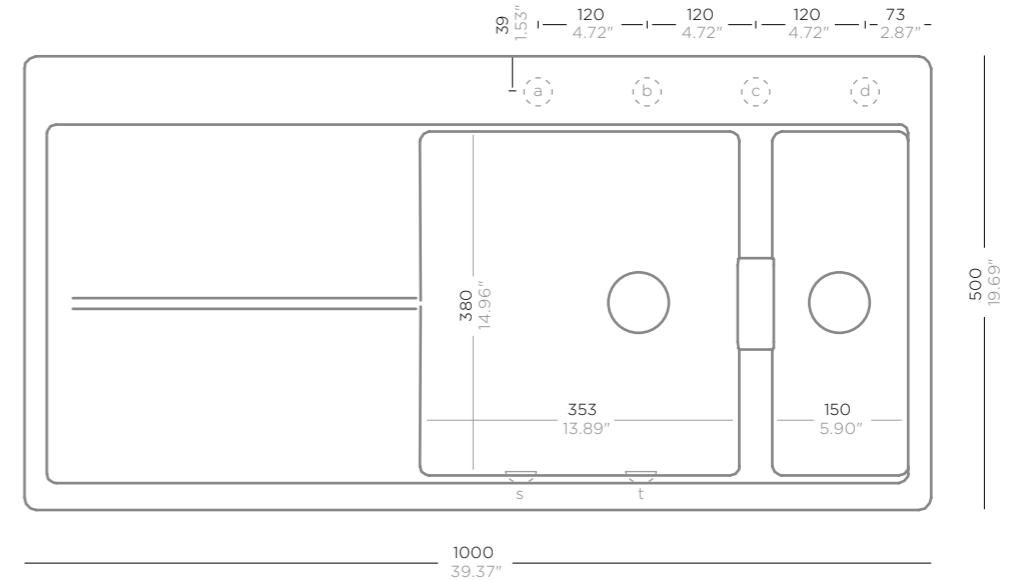

Article no.	Accessories
HON D150 A EDE D150 A	Manual drain kit 629372 Standard automatic drain kit 629373 LED-light 629024 Indutherm 629100
HON D150 U EDE D150 U	Premium automatic drain kit 629373PD Chopping board, black 629064+629075 Easy Care 629018 Easy Care Brightener 629019
HON D150 FB	Chopping board, green .. 629064/1+629075/1 Strainer bowl 629051 Pro Care 629099 Comfotouch 629830

Cut-out size		
980 x 480 38.58" x 18.9"	986 x 486 38.82" x 19.13"	988 x 488 38.9" x 19.21"

Colour range

This product is available in the standard colour range as listed in the appendix.

SCHOCK

HORIZONT | EDEN D-200



HORIZONT | EDEN

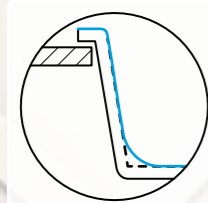

Looking slim
Lightweight design

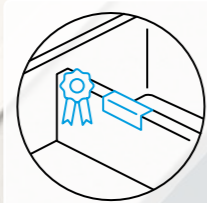

Eye catcher
Patented over-flow design

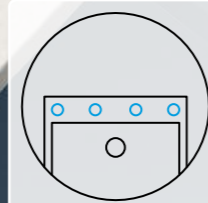

Plug and play
Comes with additional tap holes

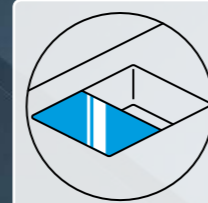

Cover up
Chopping board hides the sink





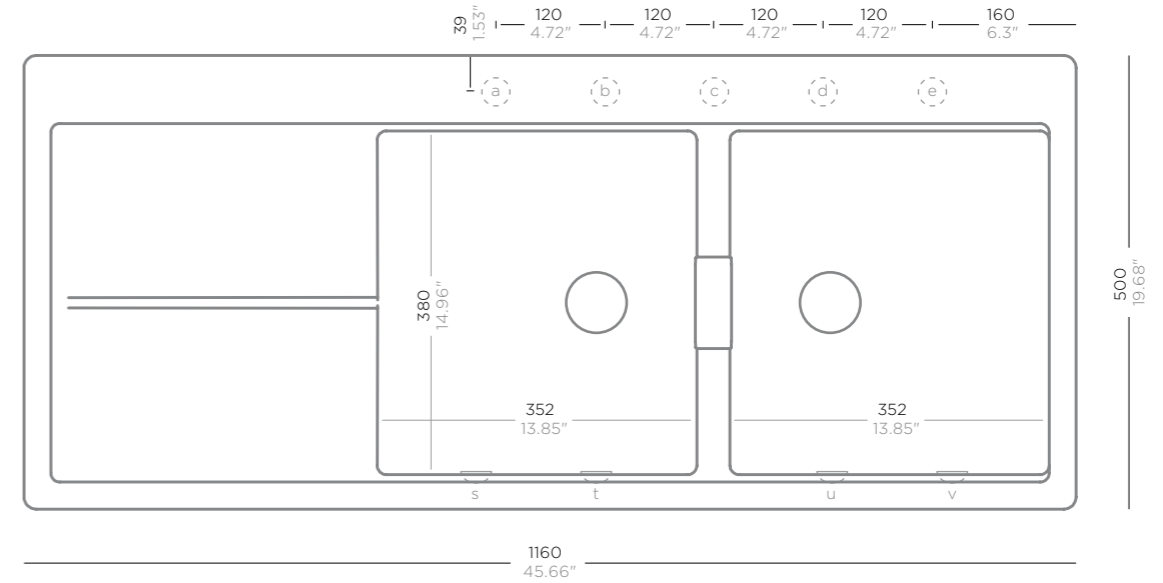

SCHOCK

HORIZONT | EDEN D-200





Article no.

Accessories

 HON D200 A 	Manual drain kit 629372	Indutherm 629100
	Standard automatic drain kit 629373	Easy Care 629018
 HON D200 U 	Premium automatic drain kit 629373PD	Easy Care Brightener 629019
	Glass chopping board, black 629076	Pro Care 629099
 HON D200 FB 	Strainer bowl 629051	Comfotouch 629830
	LED-light 629024	Waste cap 628152

Cut-out size

 1140 x 480 44.88" x 18.9"	 1146 x 486 45.12" x 19.13"	 1148 x 488 45.2" x 19.21"
--	---	--

Colour range

This product is available in the standard colour range as listed in the appendix.

SCHOCK

HORIZONT | EDEN N-200



HORIZONT | EDEN

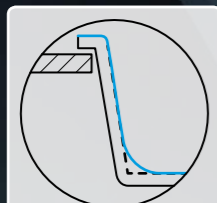

Looking slim
Lightweight design

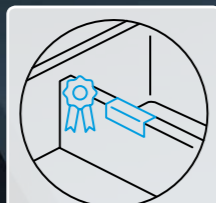

Eye catcher
Patented over-flow design

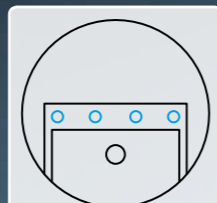

Plug and play
Comes with additional tap holes

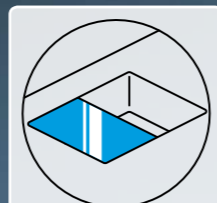

Cover up
Chopping board hides the sink





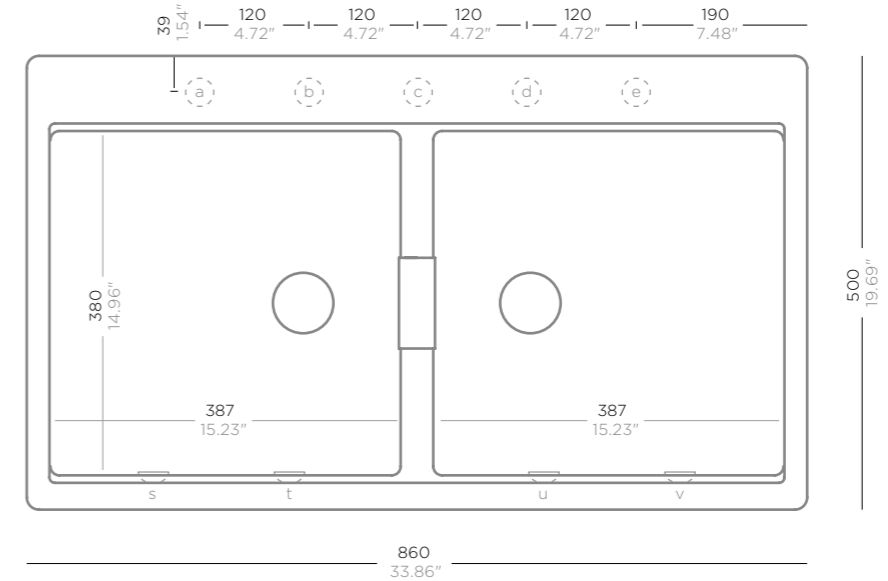

SCHOCK

HORIZONT | EDEN N-200



Article no.

Accessories

 HON N200 A 	Manual drain kit 629372	LED-light 629024
	Standard automatic drain kit 629373	Easy Care 629018
 HON N200 U 	Premium automatic drain kit 629373PD	Easy Care Brightener 629019
	Glass chopping board, small, black 629064	Pro Care 629099
 HON N200 FB 	Glass chopping board, small, green . 629064/1	Comfotouch 629830
	Strainer bowl 629051	Waste cap 628152

Cut-out size



Colour range

This product is available in the standard colour range as listed in the appendix.

SCHOCK

INSPIRE | INSPIRATION N-175



INSPIRE | INSPIRATION

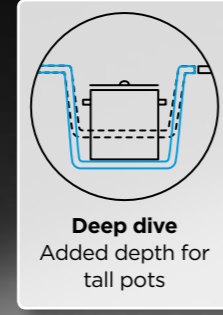
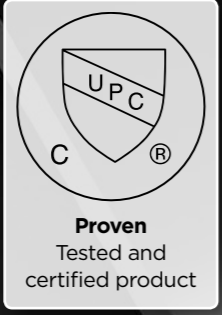

SCHOCK

INSPIRE | INSPIRATION N-175

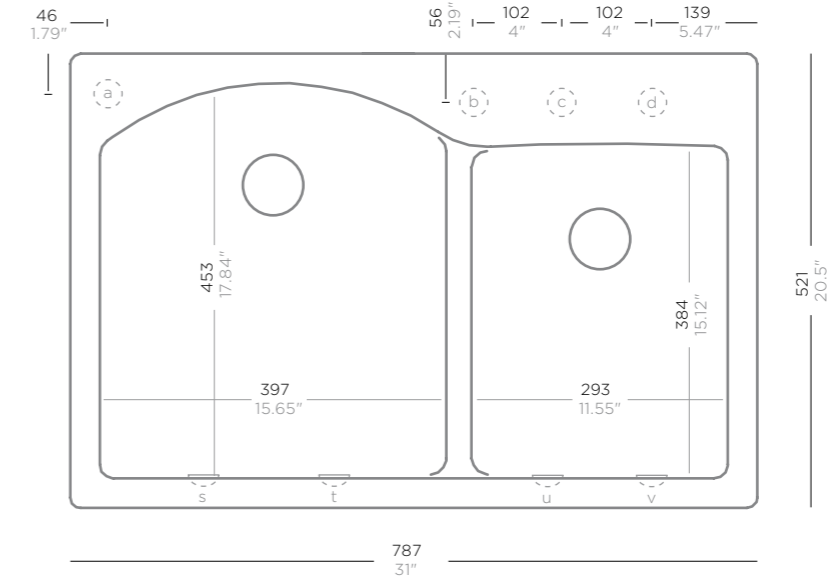

Article no.

INP N175 A
 INS N175 A

INP N175 U
 INS N175 U

Accessories

- Manual drain kit **629321**
- Standard automatic drain kit **629326**
- Premium automatic drain kit **629326PD**
- Wire basket **629121**
- Easy Care **629018**
- Easy Care Brightener **629019**
- Pro Care **629099**
- Comfotouch **629830**
- Waste cap **628152**
- DurCare **629094**
- Magic Sponge **629023**

Cut-out size



Colour range

This product is available in the standard colour range as listed in the appendix.

SCHOCK

INSPIRE | INSPIRATION N-175Y



INSPIRE | INSPIRATION

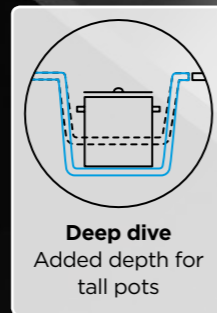
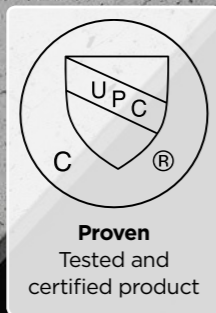

SCHOCK

INSPIRE | INSPIRATION N-175Y

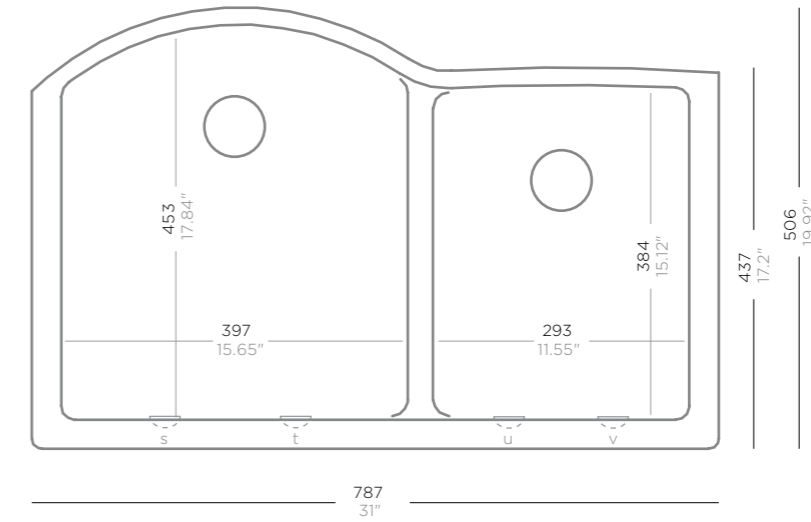

Article no.

INP N175Y U
 INS N175Y U

Accessories

- Manual drain kit **629321**
- Standard automatic drain kit **629326**
- Premium automatic drain kit **629326PD**
- Wire basket **629121**
- Easy Care **629018**
- Easy Care Brightener **629019**
- Pro Care **629099**
- Comfotouch **629830**
- Waste cap **628152**
- DurCare **629094**
- Magic Sponge **629023**

Cut-out size

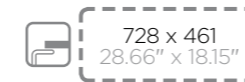

Colour range

This product is available in the standard colour range as listed in the appendix.

SCHOCK

INSPIRE | INSPIRATION N-200



INSPIRE | INSPIRATION

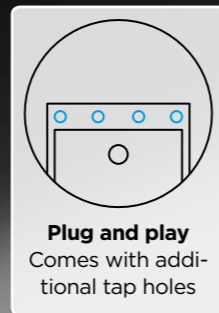
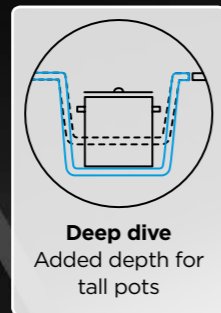
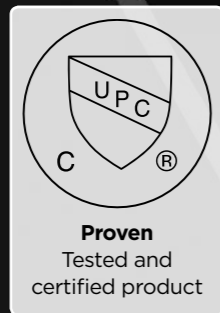





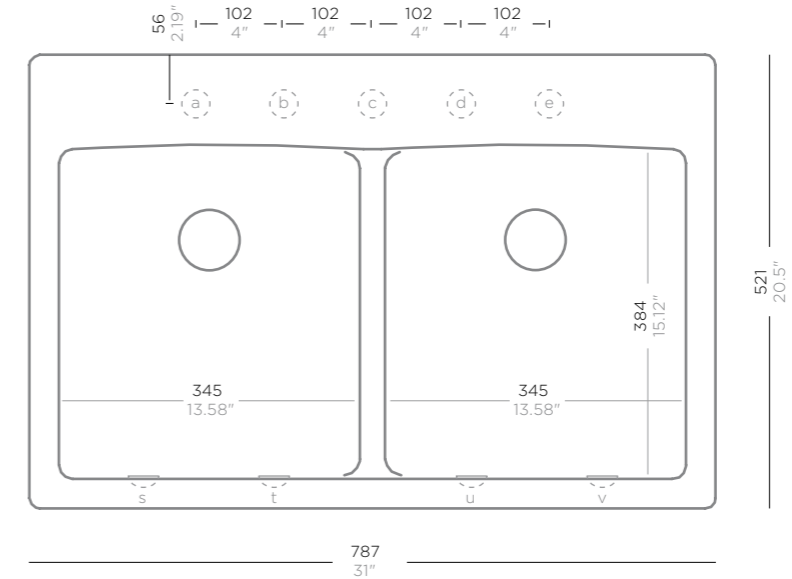







SCHOCK

INSPIRE | INSPIRATION N-200



Article no.

Accessories

	INP N200 A		Manual drain kit	629321		Comfotouch	629830
	INS N200 A		Standard automatic drain kit	629326		Waste cap	628152
	INP N200 U		Premium automatic drain kit	629326PD		DurCare	629094
	INS N200 U		Easy Care	629018		Magic Sponge	629023
			Easy Care Brightener	629019			
			Pro Care	629099			

Cut-out size



Colour range

This product is available in the standard colour range as listed in the appendix.

SCHOCK

INSPIRE | INSPIRATION N-200Y



INSPIRE | INSPIRATION

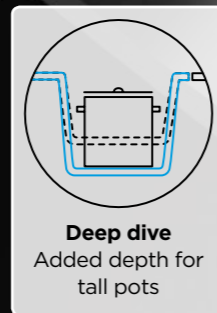
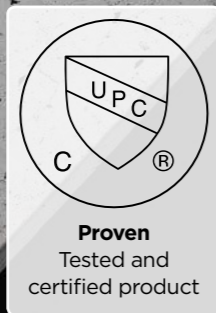

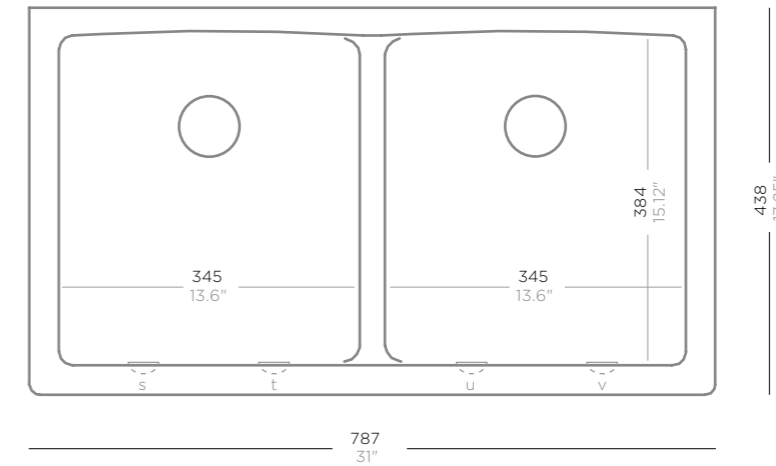

SCHOCK

INSPIRE | INSPIRATION N-200Y



Article no.

-  **INP N200Y U** 
-  **INS N200Y U** 

Accessories

- Manual drain kit **629321**
- Standard automatic drain kit **629326**
- Premium automatic drain kit **629326PD**
- Easy Care **629018**
- Easy Care Brightener **629019**
- Pro Care **629099**
- Comfotouch **629830**
- Waste cap **628152**
- DurCare **629094**
- Magic Sponge **629023**

Cut-out size

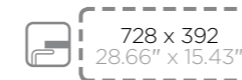

Colour range

This product is available in the standard colour range as listed in the appendix.

SCHOCK

KYOTO D-100

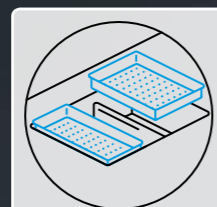

For true chefs
Perfect with
a steamer

SCHOCK

KYOTO D-100

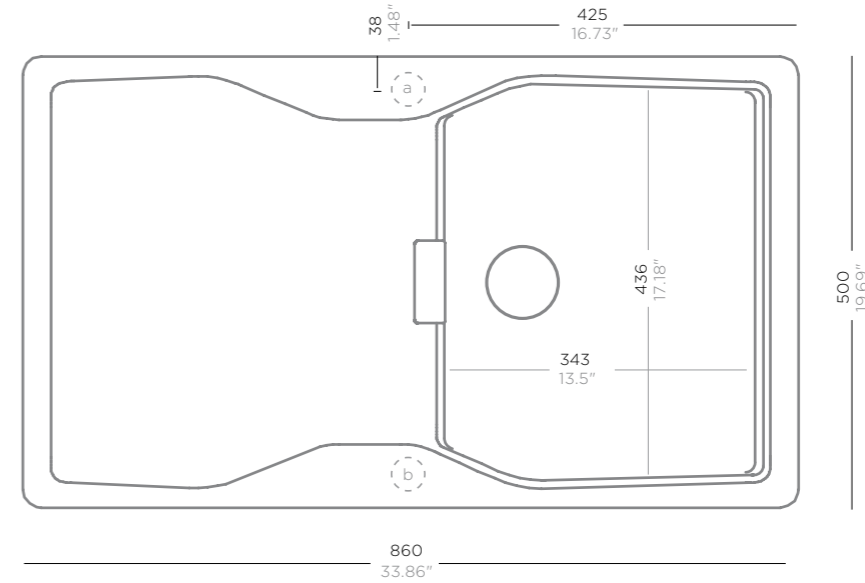

Article no.

 **KYO D100 A** 

Accessories

- | | |
|---|---|
| Manual drain kit 629337 | Glass chopping board 629036A/U |
| Standard automatic drain kit 629338 | Chopping board, bamboo 629044 |
| Premium automatic drain kit 629338PD | Strainer bowl 629062 |
| Glass chopping board black 629046 | Drain pan 629063 |
| Glass chopping board white 629045 | Drain bowl 629060 |
| Strainer bowl 629061 | Comfotouch 629830 |

Cut-out size

 **840 x 480**
33.07" x 18.9"

Colour range

This product is available in the standard colour range as listed in the appendix.

SCHOCK

KYOTO D-100L



For true chefs
Perfect with a steamer

Deep dive
Added depth for tall pots

SCHOCK

KYOTO D-100L

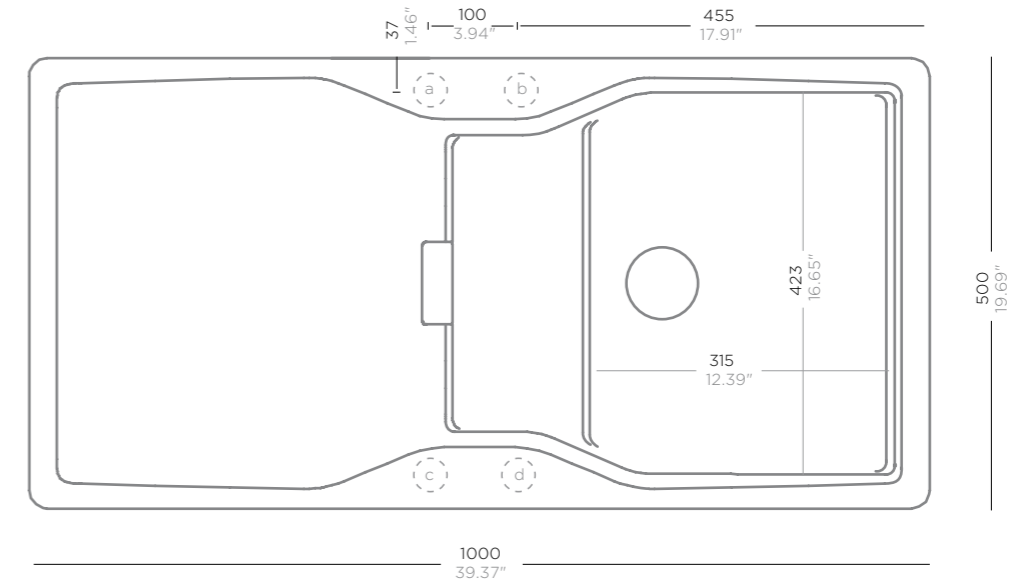

Article no.

KYO D100L A

Accessories

- Manual drain kit **629337**
- Standard automatic drain kit **629338**
- Premium automatic drain kit **629338PD**
- Glass chopping board black **629046**
- Glass chopping board white **629045**
- Strainer bowl **629061**
- Glass chopping board **629036A/U**
- Chopping board, bamboo **629044**
- Strainer bowl **629062**
- Drain pan **629063**
- Drain bowl **629060**
- Comfotouch **629830**

Cut-out size

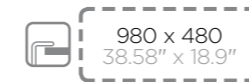

Colour range

This product is available in the standard colour range as listed in the appendix.

SCHOCK

KYOTO D-150



KYOTO

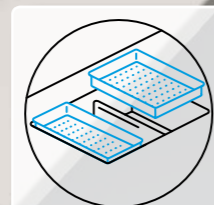

For true chefs
Perfect with
a steamer

SCHOCK

KYOTO D-150

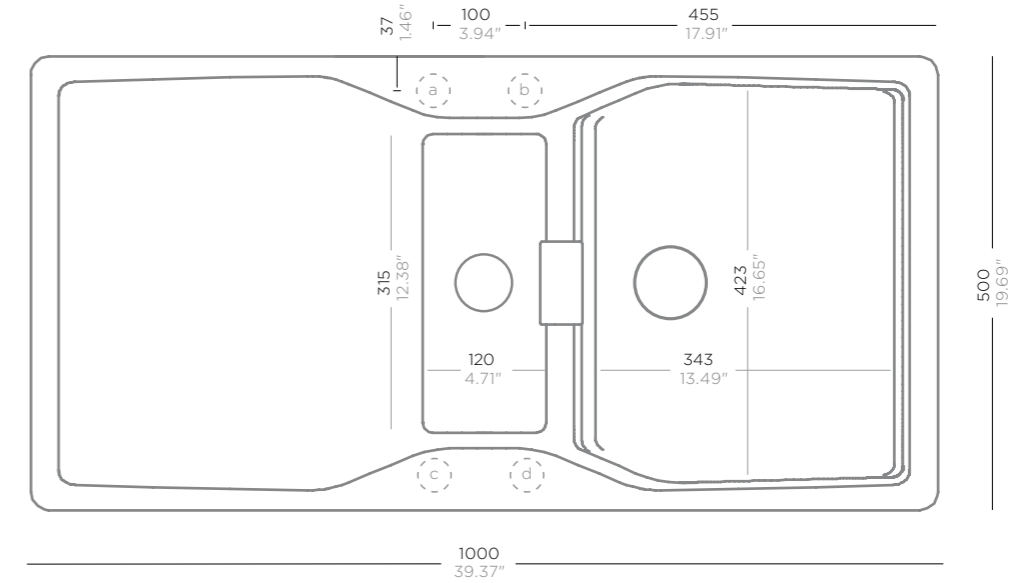

KYOTO



Article no.

 **KYO D150 A** 

Accessories

- | | |
|---|---|
| Manual drain kit 629339 | Glass chopping board 629036A/U |
| Standard automatic drain kit 629340 | Chopping board, bamboo 629044 |
| Premium automatic drain kit 629340PD | Strainer bowl 629062 |
| Glass chopping board black 629046 | Drain pan 629063 |
| Glass chopping board white 629045 | Drain bowl 629060 |
| Strainer bowl 629061 | Comfotouch 629830 |

Cut-out size

 980 x 480
38.58" x 18.9"

Colour range

This product is available in the standard colour range as listed in the appendix.

SCHOCK

KYOTO D-200

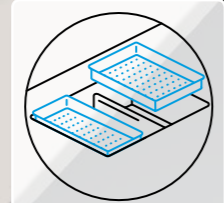

For true chefs
Perfect with
a steamer

SCHOCK

KYOTO D-200

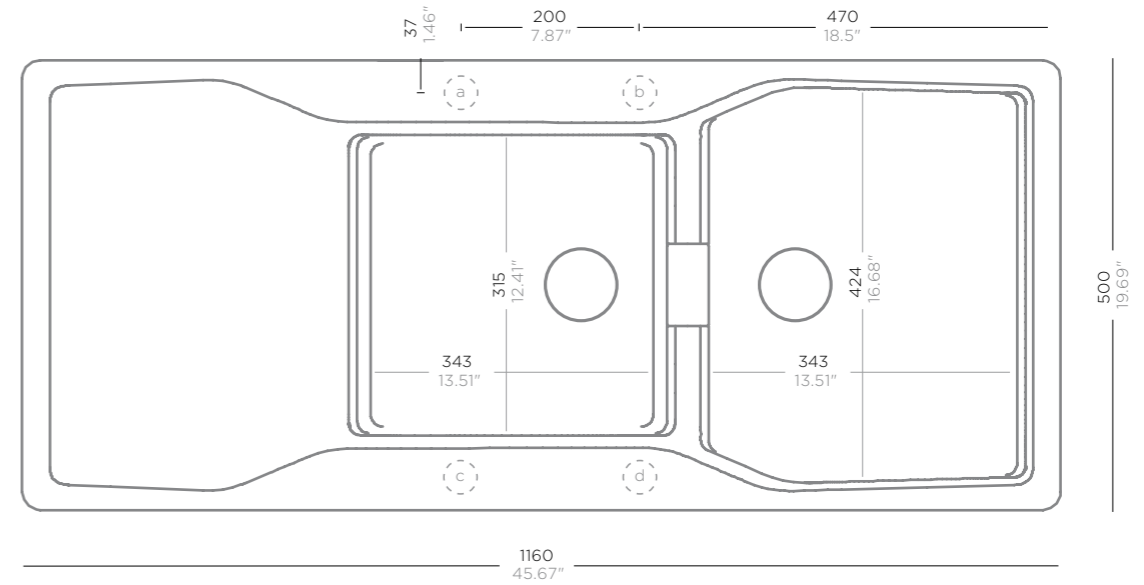

KYOTO



Article no.

 **KYO D200 A** 

Accessories

- | | |
|---|---|
| Manual drain kit 629341 | Glass chopping board 629036A/U |
| Standard automatic drain kit 629342 | Chopping board, bamboo 629044 |
| Premium automatic drain kit 629342PD | Strainer bowl 629062 |
| Glass chopping board black 629046 | Drain pan 629063 |
| Glass chopping board white 629045 | Drain bowl 629060 |
| Strainer bowl 629061 | Comfotouch 629830 |

Cut-out size

 1140 x 480
44.88" x 18.9"

Colour range

This product is available in the standard colour range as listed in the appendix.

SCHOCK

LITHOS D-100



LITHOS

SCHOCK

LITHOS D-100

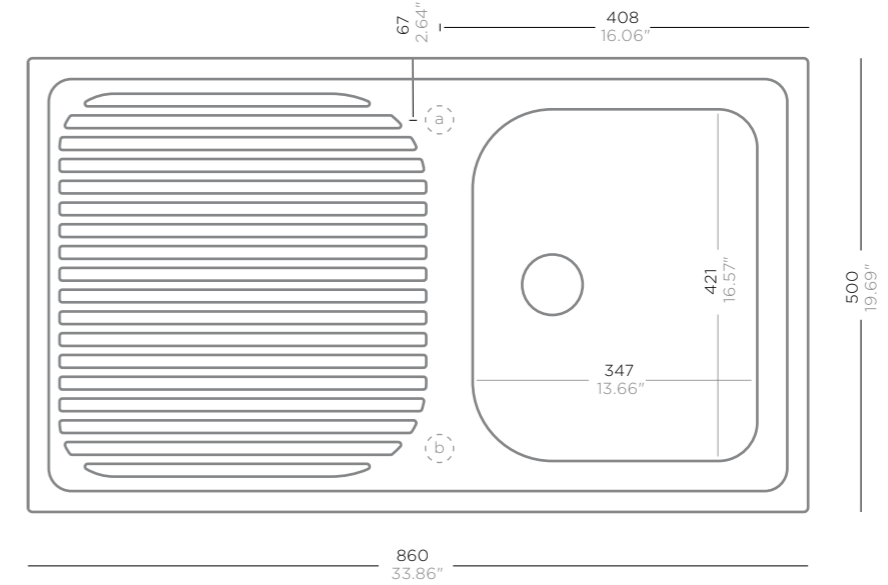

Article no.

LIT D100 A

LIT D100 U

Accessories

Manual drain kit **629870**
Standard automatic drain kit **629871**

Glass chopping board **629036A/U**
Glass chopping board, white **629045A/U**

Glass chopping board, black **629046A/U**
Chopping board, bamboo **629044**

Easy Care **629018**
Easy Care Brightener **629019**

Pro Care **629099**
Comfotouch **629830**

Waste cap **628152**

Cut-out size

840 x 480
33.07" x 18.9"

845 x 485
33.27" x 19.09"

Colour range

This product is available in the standard colour range as listed in the appendix.

SCHOCK

LITHOS D-100L



SCHOCK

LITHOS D-100L

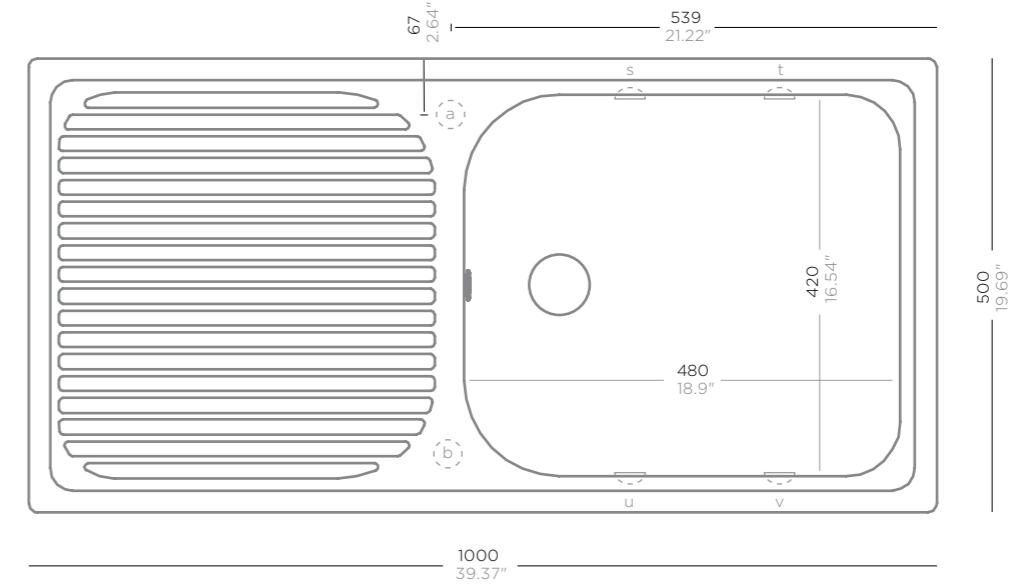

Article no.

LIT D100L A

Accessories

Manual drain kit **629870** Easy Care **629018**
 Standard automatic drain kit **629871** Easy Care Brightener **629019**

LIT D100L U

Glass chopping board **629036A/U** Pro Care **629099**
 Glass chopping board, white **629045A/U** Comfotouch **629830**

Glass chopping board, black **629046A/U** Waste cap **628152**
 Chopping board, bamboo **629044**

Cut-out size



Colour range

This product is available in the standard colour range as listed in the appendix.

SCHOCK

LITHOS D-150



LITHOS

SCHOCK

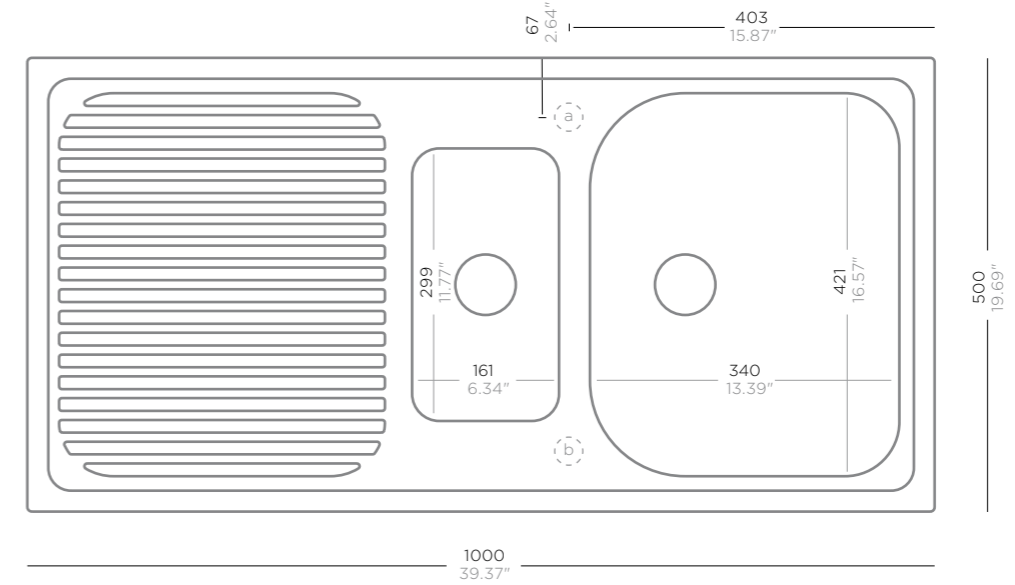

LITHOS D-150





Article no.

 **LIT D150 A**

Accessories

 Manual drain kit **629874** Strainer bowl (acryl) **629124/48**
 Standard automatic drain kit **629875** Easy Care **629018**

 **LIT D150 U**

 Glass chopping board **629036A/U** Easy Care Brightener **629019**
 Glass chopping board, white **629045A/U** Pro Care **629099**

Glass chopping board, black **629046A/U** Comfotouch **629830**
 Chopping board, bamboo **629044** Waste cap **628152**

Cut-out size



Colour range

This product is available in the standard colour range as listed in the appendix.

SCHOCK

LITHOS D-200



LITHOS

SCHOCK

LITHOS D-200

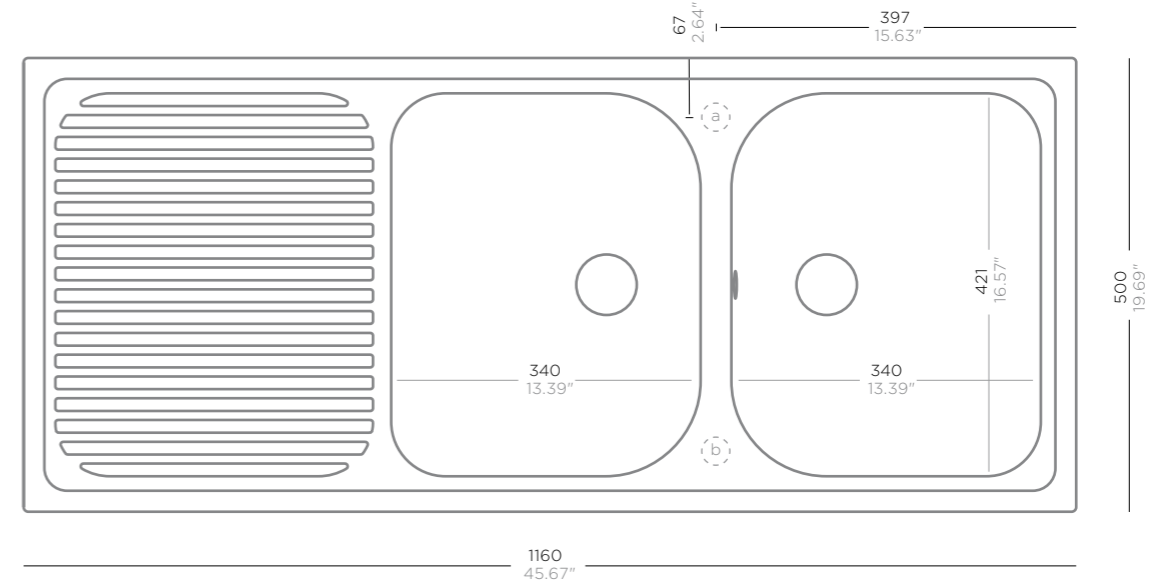

LITHOS













Article no.

 **LIT D200 A**

 **LIT D200 U**

Accessories

-  Manual drain kit **629874**
-  Standard automatic drain kit **629875**
-  Glass chopping board **629036A/U**
-  Glass chopping board, white **629045A/U**
-  Glass chopping board, black **629046A/U**
-  Chopping board, bamboo **629044**
-  Easy Care **629018**
-  Easy Care Brightener **629019**
-  Pro Care **629099**
-  Comfotouch **629830**
-  Waste cap **628152**

Cut-out size



Colour range

This product is available in the standard colour range as listed in the appendix.

SCHOCK

LITHOS N-200S



LITHOS



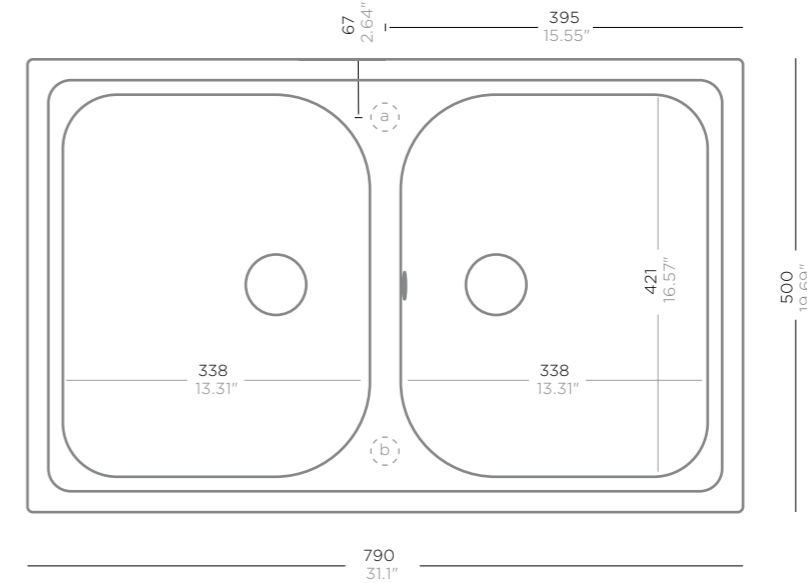

SCHOCK

LITHOS N-200S



Article no.

Accessories

	LIT N200S A		Manual drain kit	629874	Easy Care	629018
			Standard automatic drain kit	629875	Easy Care Brightener	629019
	LIT N200S U		Glass chopping board	629036A/U	Pro Care	629099
			Glass chopping board, white	629045A/U	Comfotouch	629830
			Glass chopping board, black	629046A/U	Waste cap	628152
			Chopping board, bamboo	629044		

Cut-out size



Colour range

This product is available in the standard colour range as listed in the appendix as well as in the special colours shown below:



SCHOCK

LITHOS N-200



SCHOCK

LITHOS N-200

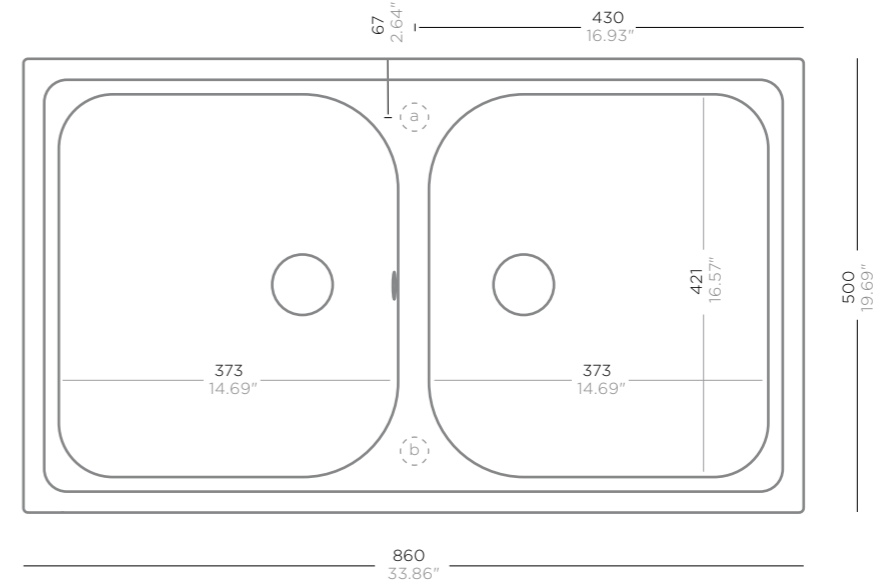

Article no.

LIT N200 A

LIT N200 U

Accessories

- Manual drain kit **629874**
- Standard automatic drain kit **629875**
- Glass chopping board **629036A/U**
- Glass chopping board, white **629045A/U**
- Glass chopping board, black **629046A/U**
- Chopping board, bamboo **629044**
- Easy Care **629018**
- Easy Care Brightener **629019**
- Pro Care **629099**
- Comfotouch **629830**
- Waste cap **628152**
- DurCare **629094**

Cut-out size



Colour range

This product is available in the standard colour range as listed in the appendix.

SCHOCK

LOTUS D-100



LOTUS

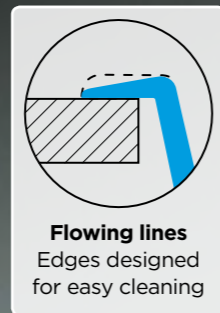
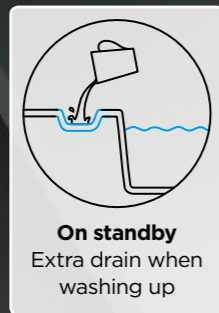

SCHOCK

LOTUS D-100

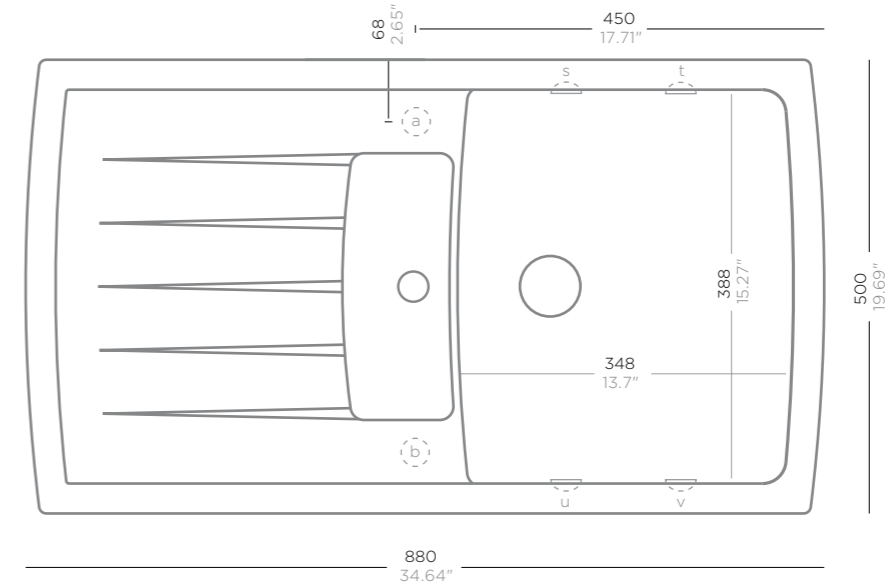















LOTUS



Article no.

Accessories

<p> LOT D100 A</p> <p> LOT D100 U</p>	<p> Manual drain kit 629382</p> <p> Standard automatic drain kit 629383</p> <p> Premium automatic drain kit 629383PD</p> <p> Visible parts in Copper 629383COP</p> <p> Glass chopping board 629036A/U</p> <p> Glass chopping board, white 629045A/U</p>	<p> Glass chopping board, black 629046A/U</p> <p> Wire basket 629194</p> <p> LED-light 629024</p> <p> Easy Care 629018</p> <p> Easy Care Brightener 629019</p> <p> Pro Care 629099</p>
---	---	--

Cut-out size



Colour range

This product is available in the standard colour range as listed in the appendix.

SCHOCK

LOTUS D-150

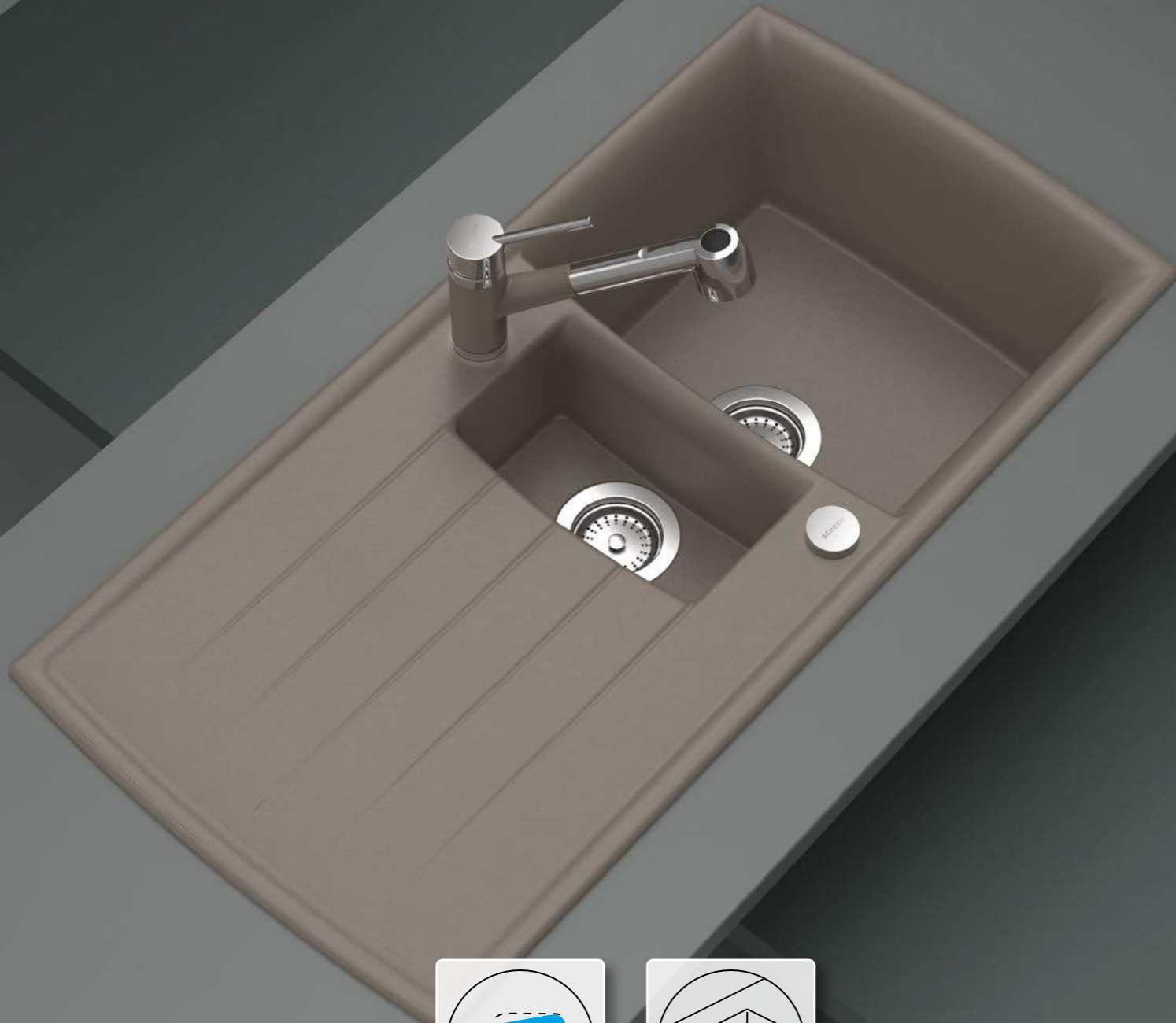

LOTUS

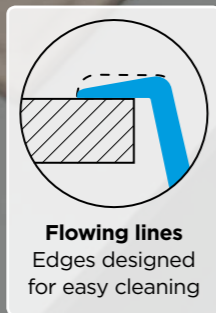





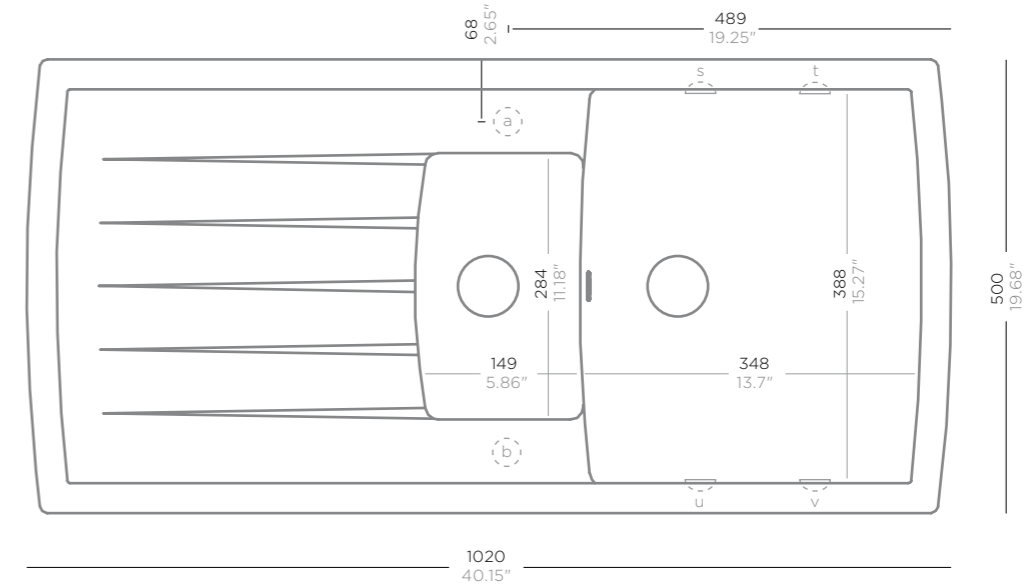









SCHOCK

LOTUS D-150



Article no.

Accessories

<p> LOT D150 A</p> <p> LOT D150 U</p>	<p> Manual drain kit 629304</p> <p> Standard automatic drain kit 629305</p> <p> Premium automatic drain kit 629305PD</p> <p> Visible parts in Copper 629305COP</p> <p> Glass chopping board 629036A/U</p> <p> Glass chopping board, white 629045A/U</p>	<p> Glass chopping board, black 629046A/U</p> <p> Strainer bowl 629056</p> <p> Wire basket 629194</p> <p> LED-light 629024</p> <p> Easy Care 629018</p> <p> Easy Care Brightener 629019</p>
---	---	---

Cut-out size



Colour range

This product is available in the standard colour range as listed in the appendix.

SCHOCK

LOTUS C-150



LOTUS

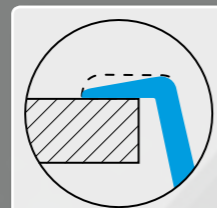

Flowing lines
Edges designed
for easy cleaning



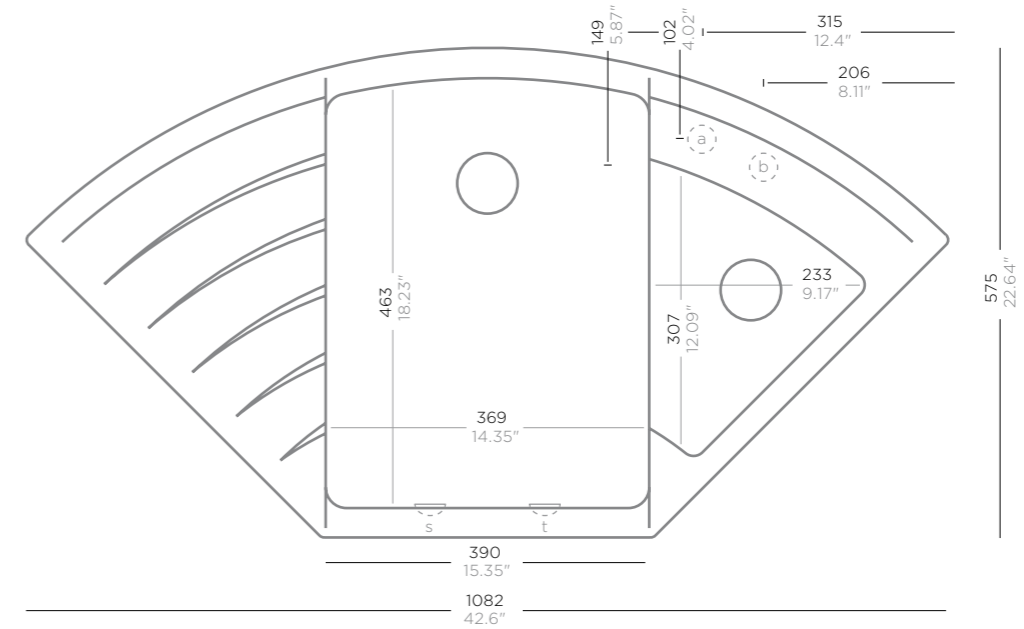

SCHOCK

LOTUS C-150



Article no.

Accessories

	LOT C150 A		Manual drain kit 629348	LED-light 629024
			Standard automatic drain kit 629349	Easy Care 629018
	LOT C150 U		Premium automatic drain kit 629349PD	Easy Care Brightener 629019
			Visible parts in Copper 629305COP	Pro Care 629099
			Strainer bowl 629057	Comfotouch 629830
			Wire basket 629196	Waste cap 628152

Cut-out size



Colour range

This product is available in the standard colour range as listed in the appendix.

SCHOCK

MANHATTAN D-100XS



MANHATTAN

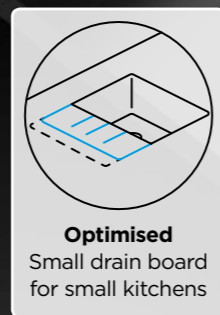
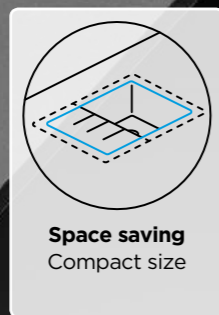

SCHOCK

MANHATTAN D-100XS

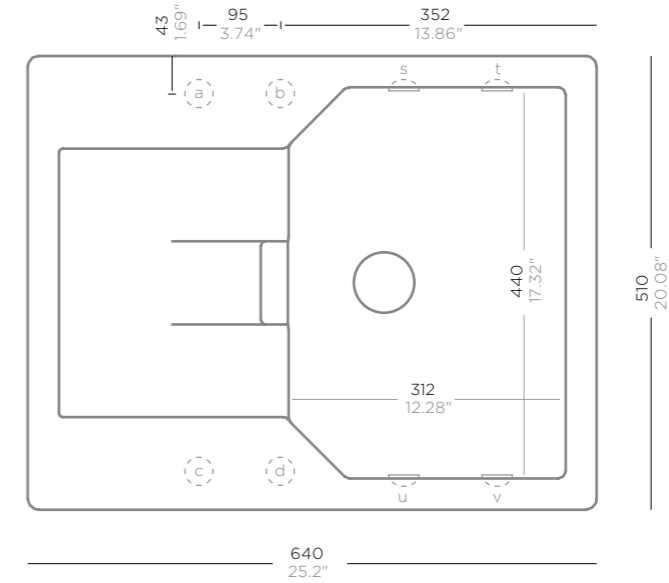

Article no.

MAN D100X A CTB

MAN D100X U CTB

Accessories

- Manual drain kit **629395**
- Standard automatic drain kit **629368**
- Glass chopping board, white **629059**
- Glass chopping board, black **629050**
- Chopping board, bamboo **629052**
- Easy Care **629018**
- Easy Care Brightener **629019**
- Pro Care **629099**
- Comfotouch **629830**
- Waste cap **628152**
- Magic Sponge **629023**

Cut-out size



Colour range

This product is available in the standard colour range as listed in the appendix.

SCHOCK

MANHATTAN D-100S



MANHATTAN

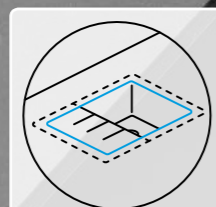

Space saving
Compact size

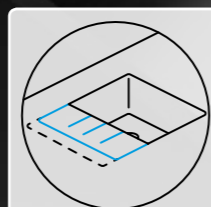

Optimised
Small drain board
for small kitchens



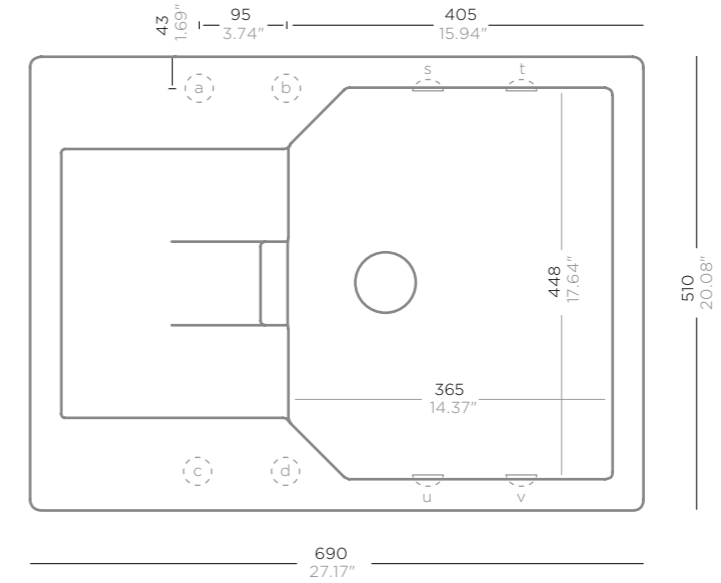

SCHOCK

MANHATTAN D-100S



Article no.

Accessories

	MAN D100S A 	Manual drain kit 629395	Easy Care Brightener 629019
		Standard automatic drain kit 629368	Pro Care 629099
	MAN D100S U 	Glass chopping board, white 629059	Comfotouch 629830
		Glass chopping board, black 629050	Waste cap 628152
		Chopping board, bamboo 629052	Magic Sponge 629023
		Easy Care 629018	

Cut-out size



Colour range

This product is available in the standard colour range as listed in the appendix.

SCHOCK

MANHATTAN D-100L

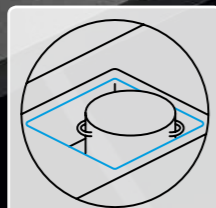

Go big
Extra volume
for large pots



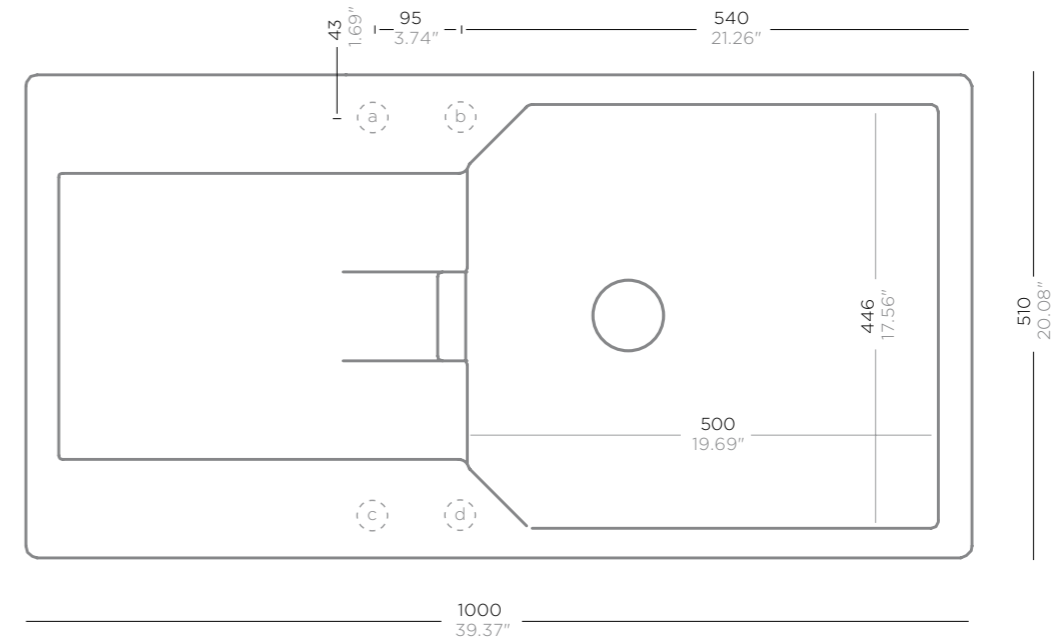

SCHOCK

MANHATTAN D-100L



Article no.

Accessories

	MAN D100L A 	Manual drain kit 629395	Easy Care Brightener 629019
		Standard automatic drain kit 629368	Pro Care 629099
	MAN D100L U 	Glass chopping board, white 629059	Comfotouch 629830
		Glass chopping board, black 629050	Waste cap 628152
		Chopping board, bamboo 629052	Magic Sponge 629023
		Easy Care 629018	

Cut-out size

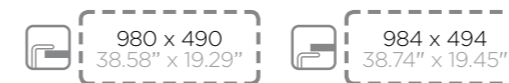

Colour range

This product is available in the standard colour range as listed in the appendix.

SCHOCK

MANHATTAN D-150S



SCHOCK

MANHATTAN D-150S

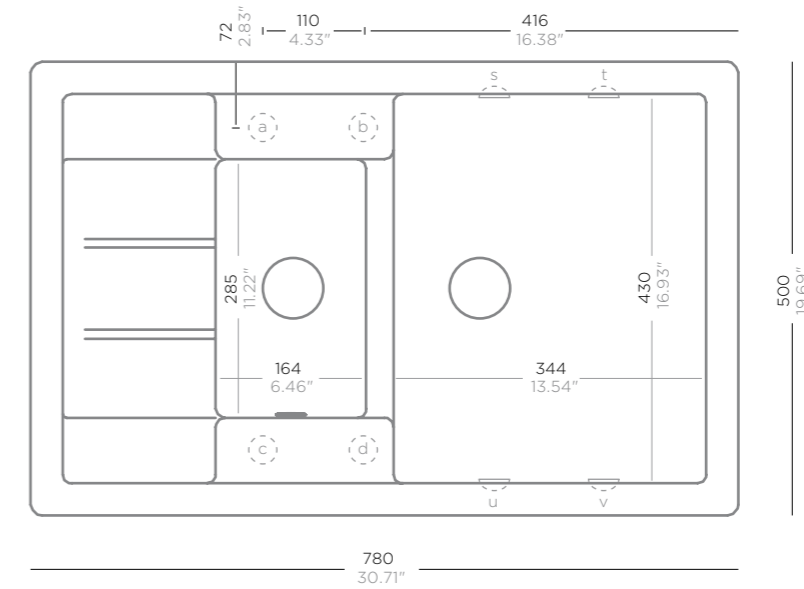

MANHATTAN



Article no.



MAN D150S A



Accessories

Manual drain kit **629906**
Standard automatic drain kit **629907**

LED-light **629024**
Easy Care **629018**



MAN D150S U



Glass chopping board **629036A/U**
Glass chopping board, white **629045A/U**

Easy Care Brightener **629019**
Pro Care **629099**

Glass chopping board, black **629046A/U**
Chopping board, bamboo **629044**

Comfotouch **629830**
Waste cap **628152**

Cut-out size



760 x 480
29.92" x 18.9"



764 x 484
30.08" x 19.06"

Colour range

This product is available in the standard colour range as listed in the appendix.

SCHOCK

MANHATTAN D-150



MANHATTAN

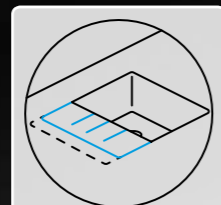

Optimised
Small drain board
for small kitchens

SCHOCK

MANHATTAN D-150

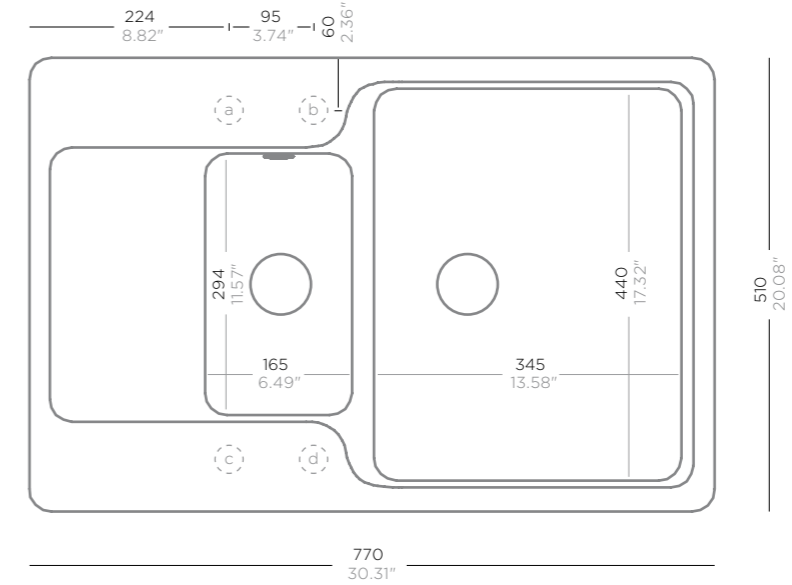

Article no.



MAN D150 A



Manual drain kit **629304**
Standard automatic drain kit **629305**



MAN D150 U



Glass chopping board, white **629059**
Glass chopping board, black **629050**

LED-light **629024**
Easy Care **629018**

Accessories

Easy Care Brightener **629019**
Pro Care **629099**

Comfotouch **629830**
Waste cap **628152**

DurCare **629094**
Magic Sponge **629023**

Cut-out size



Colour range

This product is available in the standard colour range as listed in the appendix.

SCHOCK

MANHATTAN D-150L



MANHATTAN

SCHOCK

MANHATTAN D-150L

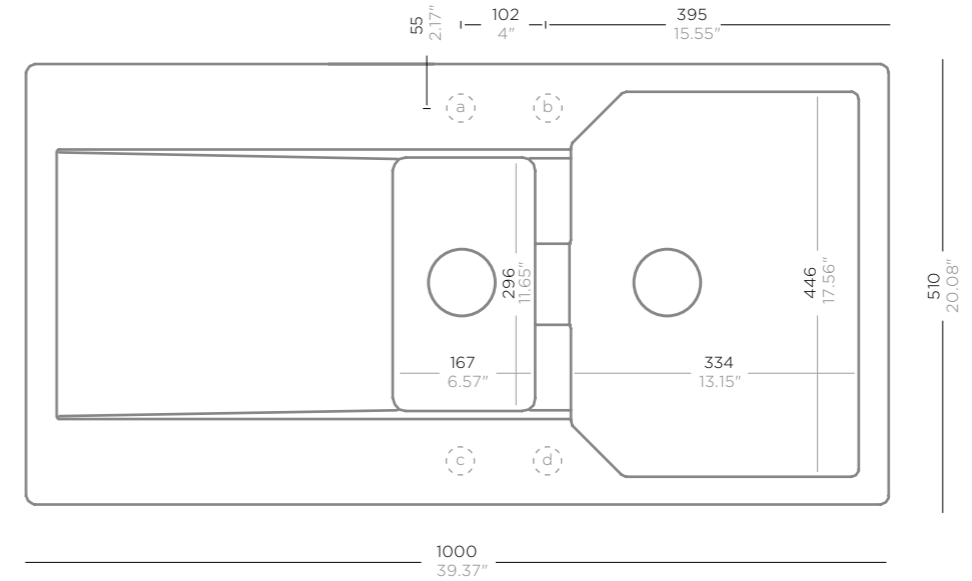

Article no.



MAN D150L A



Accessories

- Manual drain kit **629616**
- Standard automatic drain kit **629615**
- LED-light **629024**
- Easy Care **629018**
- Easy Care Brightener **629019**
- Pro Care **629099**
- Comfotouch **629830**
- Waste cap **628152**
- DurCare **629094**
- Magic Sponge **629023**
- Diamond drill SB light **629095**

Cut-out size



Colour range

This product is available in the standard colour range as listed in the appendix.

SCHOCK

MANHATTAN D-200



SCHOCK

MANHATTAN D-200

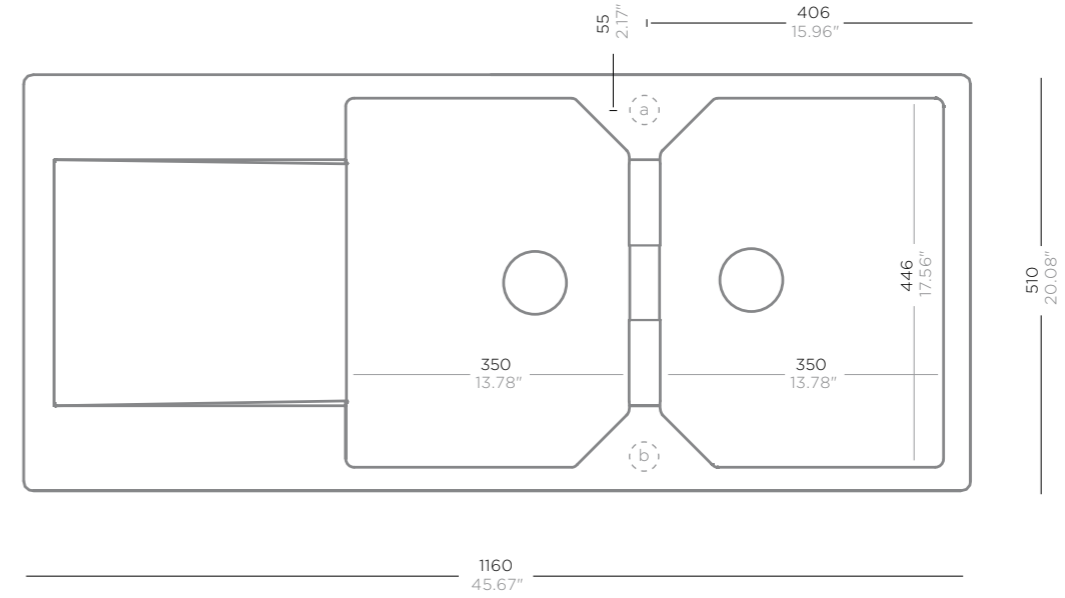

MANHATTAN



Article no.



MAN D200 A



Manual drain kit **629616**
Standard automatic drain kit **629615**



MAN D200 U



LED-light **629024**
Easy Care **629018**
Easy Care Brightener **629019**
Pro Care **629099**

Comfotouch **629830**
Waste cap **628152**

DurCare **629094**
Magic Sponge **629023**

Diamond drill SB light **629095**

Cut-out size



1140 x 490
44.88" x 19.29"



1144 x 494
45.04" x 19.45"

Colour range

This product is available in the standard colour range as listed in the appendix.

SCHOCK

MANHATTAN N-150



MANHATTAN

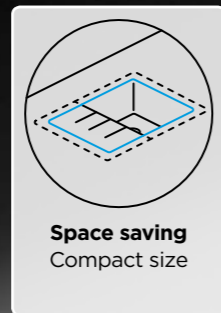

SCHOCK

MANHATTAN N-150

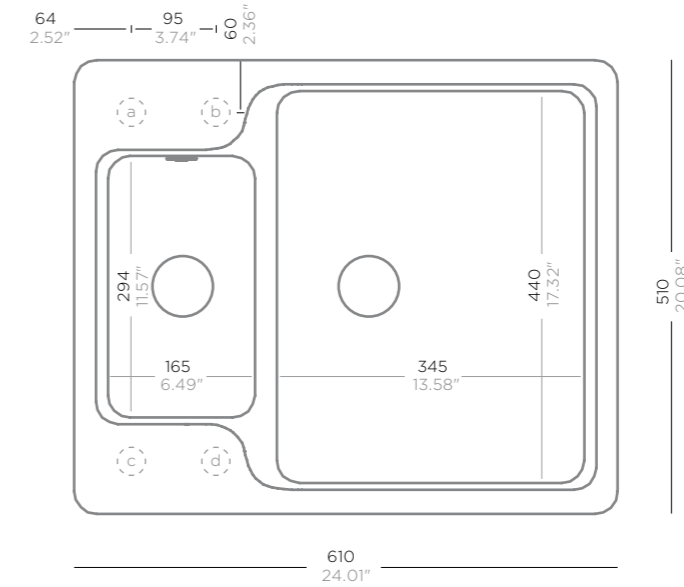

Article no.



MAN N150 A



Accessories

Manual drain kit **629395**
Standard automatic drain kit **629305**

Easy Care Brightener **629019**
Pro Care **629099**



MAN N150 U



Glass chopping board, white **629059**
Glass chopping board, black **629050**

LED-light **629024**
Easy Care **629018**

Comfotouch **629830**
Waste cap **628152**

DurCare **629094**
Magic Sponge **629023**

Cut-out size



590 x 490
23.23" x 19.29"



594 x 494
23.39" x 19.45"

Colour range

This product is available in the standard colour range as listed in the appendix.

SCHOCK

MANHATTAN R-100



MANHATTAN

MANHATTAN

SCHOCK

MANHATTAN R-100

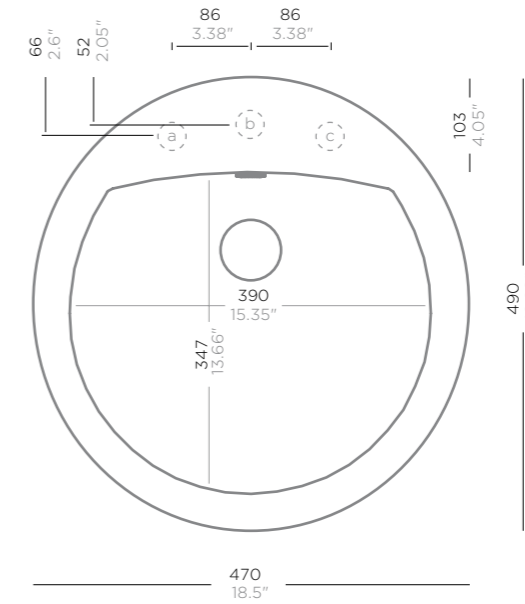

Article no.



MAN R100 A



Manual drain kit **629314**
 Standard automatic drain kit **629313**



MAN R100 U



Easy Care **629018**
 Easy Care Brightener **629019**
 Pro Care **629099**
 Comfotouch **629830**

Waste cap **628152**
 Magic Sponge **629023**

Diamond drill SB light **629095**

Cut-out size



Please use dxf data!



Please use dxf data!

Colour range

This product is available in the standard colour range as listed in the appendix.

SCHOCK

MONO | NEMO D-100XS



MONO | NEMO

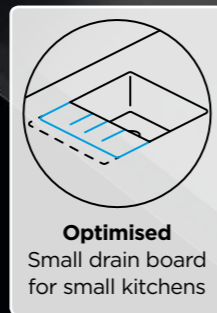

SCHOCK

MONO | NEMO D-100XS

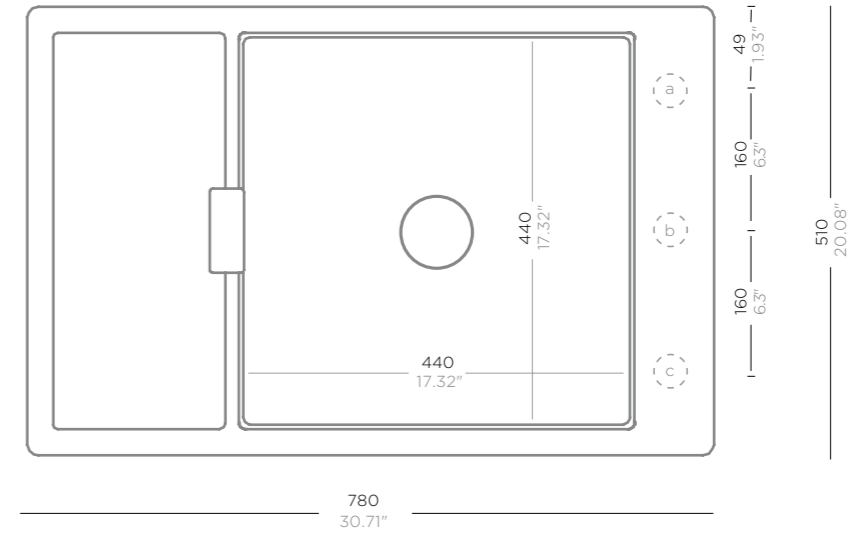

Article no.



MON D100XS A

Accessories

Manual drain kit **629384**
Standard automatic drain kit **629385**

Visible parts in Copper **629385COP**
Visible parts in Gunmetal **629385GUM**



MON D100XS U

Premium automatic drain kit **629385PD**
Wooden chopping board **629133**

Visible parts stainless steel **629385EDM**
LED-light **629024**



MON D100XS FB

Grid **629138**
Strainer bowl **629131**

Easy Care **629018**
Easy Care Brightener **629019**

Cut-out size



760 x 490
29.92" x 19.29"



764 x 494
30.08" x 19.45"



771 x 501
30.35" x 19.72"

Colour range

This product is available in the standard colour range as listed in the appendix.

SCHOCK

MONO | NEMO D-100S



MONO | NEMO

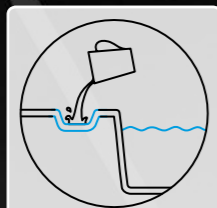

On standby
Extra drain when washing up

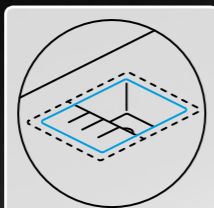

Space saving
Compact size

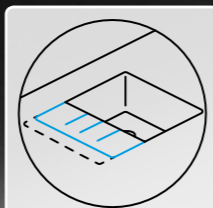

Optimised
Small drain board for small kitchens

SCHOCK

MONO | NEMO D-100S

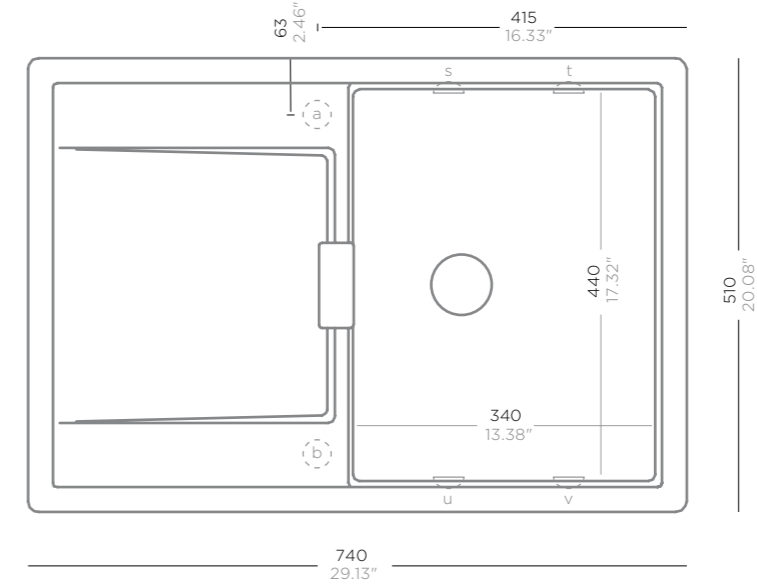

Article no.

MON D100S A

Accessories

Manual drain kit **629384** Glass chopping board, white **629059**
Standard automatic drain kit **629385** Glass chopping board, black **629050**

MON D100S U

Premium automatic drain kit **629385PD** LED-light **629024**
Visible parts in Copper **629385COP** Easy Care **629018**

MON D100S FB

Visible parts in Gunmetal **629385GUM** Easy Care Brightener **629019**
Visible parts stainless steel **629385EDM** Pro Care **629099**

Cut-out size



Colour range

This product is available in the standard colour range as listed in the appendix as well as in the special colours shown below:



* Only available for topmount installation

SCHOCK

MONO | NEMO D-100



MONO | NEMO





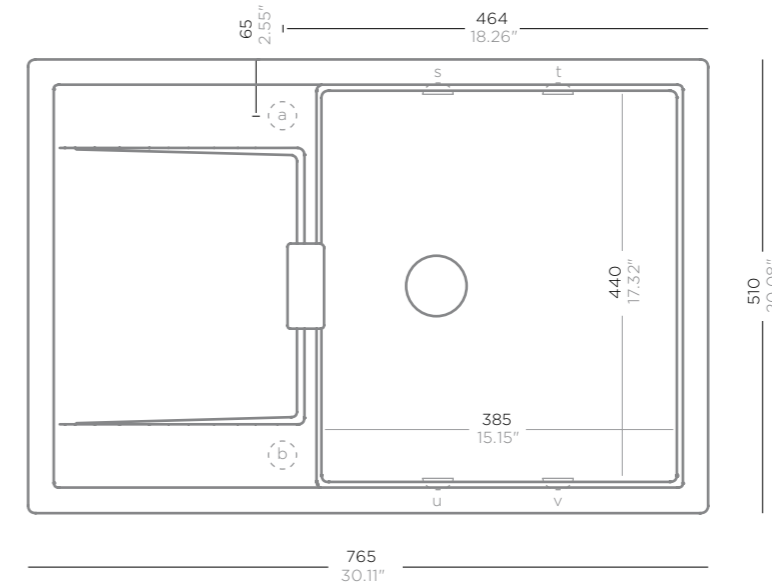









SCHOCK

MONO | NEMO D-100



Article no.

Accessories

	MON D100 A	 Manual drain kit 629384	 Easy Care 629018
		 Standard automatic drain kit 629385	 Easy Care Brightener 629019
	MON D100 U	 Premium automatic drain kit 629385PD	 Pro Care 629099
		 Glass chopping board, white 629059	 Comfotouch 629830
	MON D100 FB	 Glass chopping board, black 629050	 Waste cap 628152
		 LED-light 629024	 DurCare 629094

Cut-out size



Colour range

This product is available in the standard colour range as listed in the appendix.

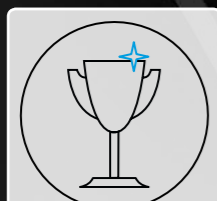

Distinguished
Award-winning
design

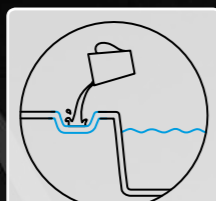

On standby
Extra drain when
washing up

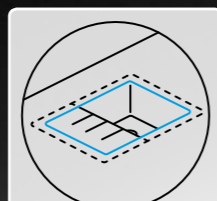

Space saving
Compact size

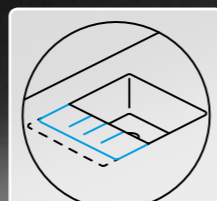

Optimised
Small drain board
for small kitchens

SCHOCK

MONO | NEMO D-100L



MONO | NEMO







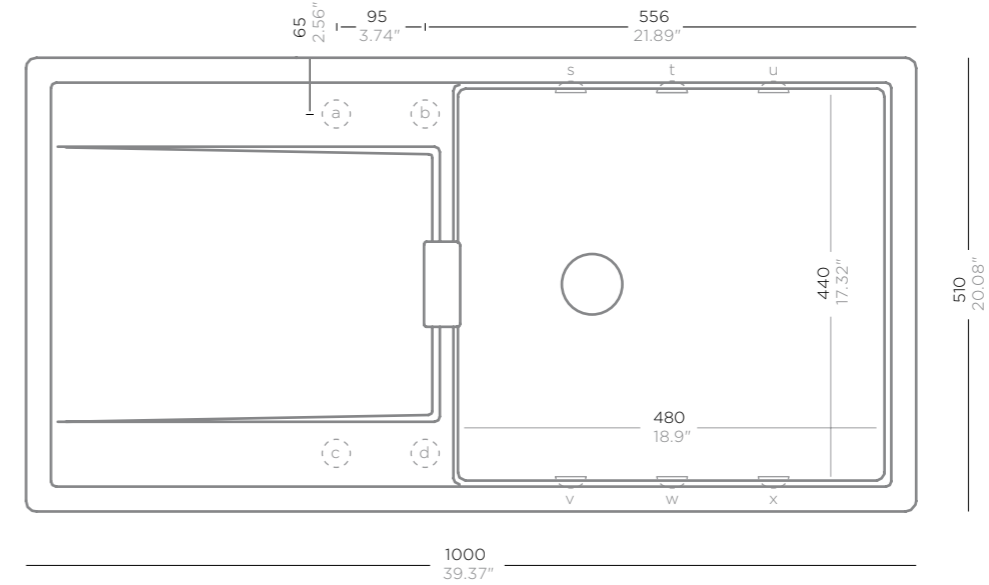

SCHOCK

MONO | NEMO D-100L



Article no.

Accessories

	MON D100L A 	Manual drain kit 629384	Glass chopping board, white 629059
		Standard automatic drain kit 629385	Glass chopping board, black 629050
	MON D100L U 	Premium automatic drain kit 629385PD	LED-light 629024
		Visible parts in Copper 629385COP	Easy Care 629018
	MON D100L FB 	Visible parts in Gunmetal 629385GUM	Easy Care Brightener 629019
		Visible parts stainless steel 629385EDM	Pro Care 629099

Cut-out size

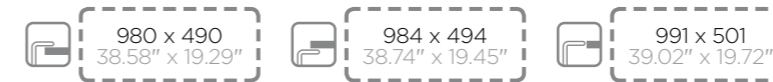

Colour range

This product is available in the standard colour range as listed in the appendix as well as in the special colours shown below:



Indigo
78

SCHOCK

MONO | NEMO D-150



MONO | NEMO

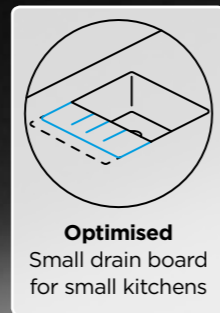





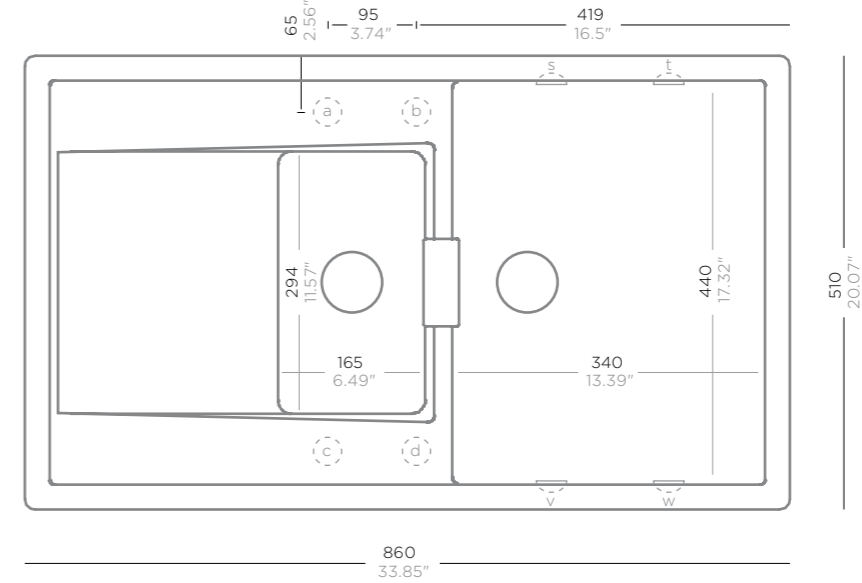

SCHOCK

MONO | NEMO D-150



Article no.

Accessories

	MON D150 A		Manual drain kit 629389	LED-light 629024
			Standard automatic drain kit 629388	Easy Care 629018
	MON D150 U		Premium automatic drain kit 629388PD	Easy Care Brightener 629019
			Visible parts in Copper 629388COP	Pro Care 629099
	MON D150 FB		Glass chopping board, white * 629059	Comfotouch 629830
			Glass chopping board, black * 629050	Waste cap 628152

Cut-out size



Colour range

This product is available in the standard colour range as listed in the appendix.

* Only available for topmount installation

SCHOCK

MONO | NEMO D-175



MONO | NEMO

MONO | NEMO





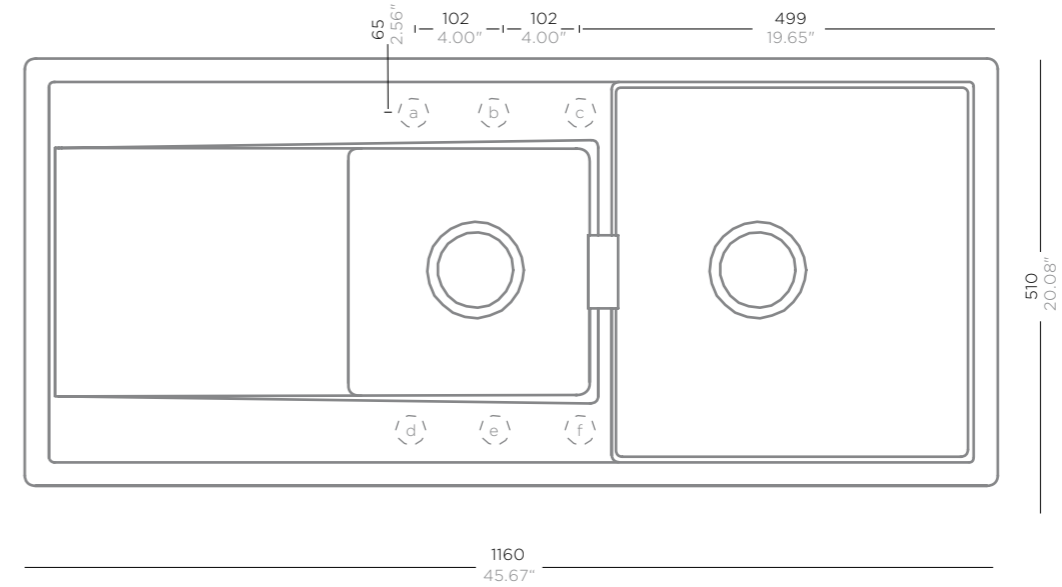

SCHOCK

MONO | NEMO D-175



Article no.

Accessories

	MON D175 A		Manual drain kit	629389	Glass chopping board, black	629050
			Standard automatic drain kit	629389	Glass chopping board, white	629059
	MON D175 U		Premium automatic drain kit	629388PD	LED-light	629024
			Visible parts in Copper	629388COP	Easy Care	629018
	MON D175 FB		Visible parts in Gunmetal	629388GUM	Easy Care Brightener	629019
			Visible parts stainless steel	629388EDM	Pro Care	629099

Cut-out size



Colour range

This product is available in the standard colour range as listed in the appendix.

SCHOCK

MONO | NEMO D-200



MONO | NEMO

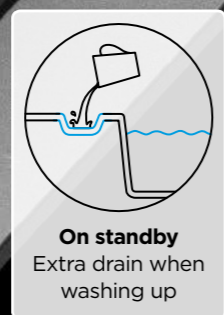





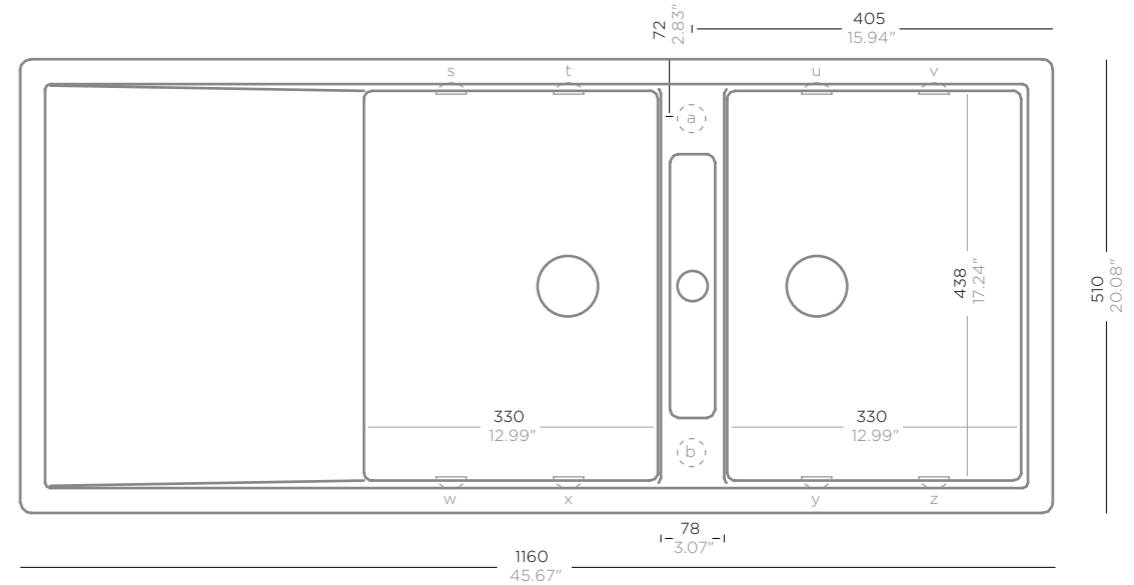



SCHOCK

MONO | NEMO D-200



Article no.

Accessories

	MON D200 A		Manual drain kit	629300	Easy Care	629018
			Standard automatic drain kit	629301	Easy Care Brightener	629019
	MON D200 U		Premium automatic drain kit	629301PD	Pro Care	629099
			Glass chopping board, white	629059	Comfotouch	629830
	MON D200 FB		Glass chopping board, black	629050	Waste cap	628152
			LED-light	629024	DurCare	629094

Cut-out size



Colour range

This product is available in the standard colour range as listed in the appendix.

SCHOCK

MONO | NEMO N-100S



MONO | NEMO

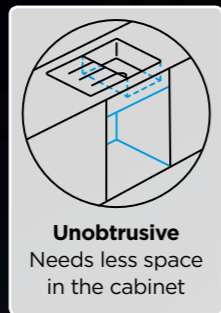





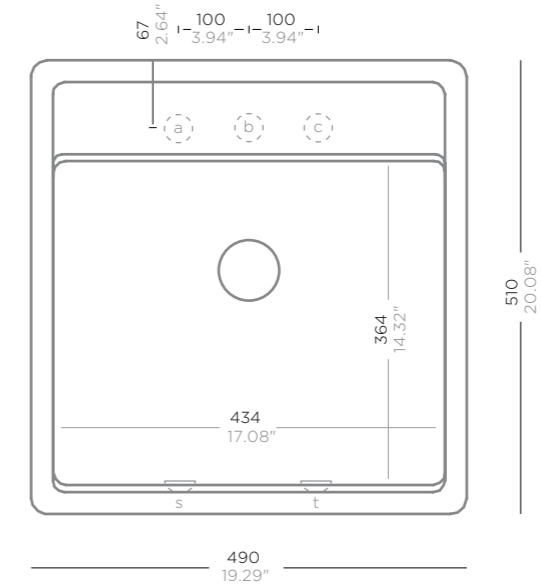



SCHOCK

MONO | NEMO N-100S



Article no.

Accessories

	MON N100S A 	Manual drain kit	629314	Easy Care	629018
	NEM N100S A 	Standard automatic drain kit	629313	Easy Care Brightener	629019
	MON N100S U 	Premium automatic drain kit	629313PD	Pro Care	629099
	NEM N100S U 	Glass chopping board, black	629015/N	Comfotouch	629830
		Strainer bowl	629017	Waste cap	628152
		LED-light	629024		

Cut-out size



Colour range

This product is available in the standard colour range as listed in the appendix as well as in the special colours shown below:



SCHOCK

MONO | NEMO N-100



MONO | NEMO

Plug and play
Comes with additional tap holes

Space saving
Compact size

Unobtrusive
Needs less space in the cabinet

SCHOCK

MONO | NEMO N-100

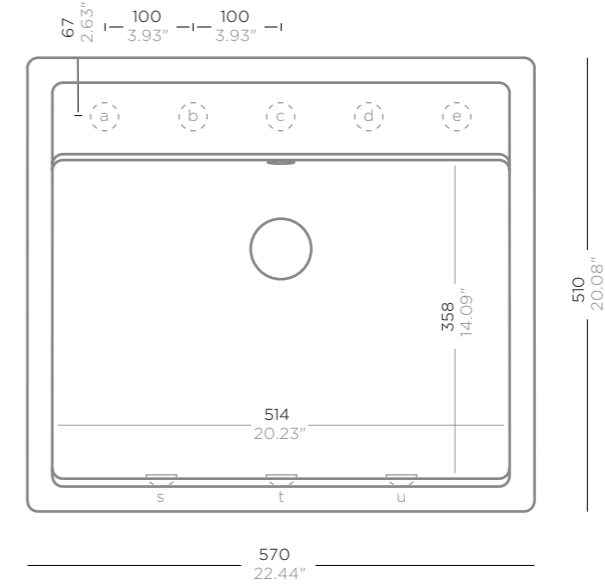

MONO | NEMO

Article no.

Accessories

	MON N100 A		Manual drain kit	629314	Glass chopping board, black	629015/N
	NEM N100 A		Standard automatic drain kit	629313	Strainer bowl	629017
	MON N100 U		Premium automatic drain kit	629313PD	LED-light	629024
	NEM N100 U		Visible parts in Copper	629313COP	Easy Care	629018
	MON N100 FB		Visible parts in Gunmetal	629313GUM	Easy Care Brightener	629019
			Visible parts stainless steel	629313EDM	Pro Care	629099

Cut-out size



Colour range

This product is available in the standard colour range as listed in the appendix as well as in the special colours shown below:

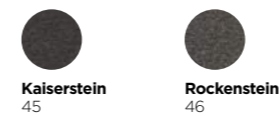

SCHOCK

MONO | NEMO N-200



MONO | NEMO

SCHOCK

MONO | NEMO N-200

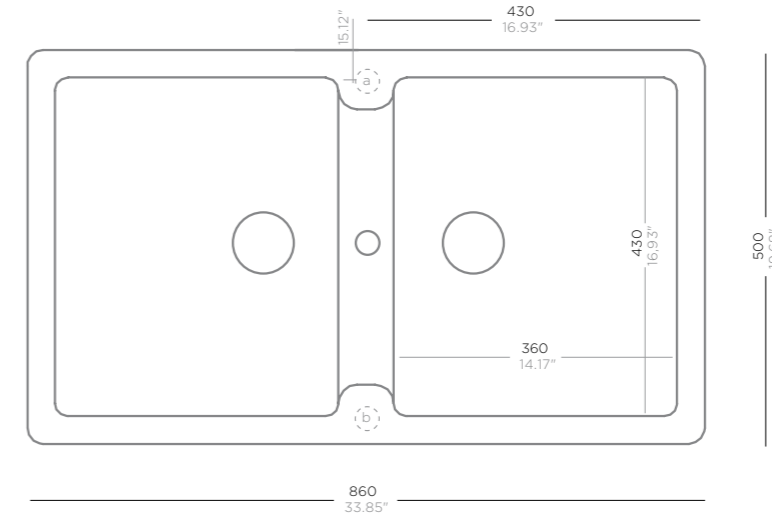

Article no.



MON N200 A



Manual drain kit **629300**
Standard automatic drain kit **629301**



MON N200 U



Premium automatic drain kit **629301PD**
Glass chopping board **629036A/U**

Glass chopping board, black **629046A/U**
Glass chopping board, white **629045A/U**

Accessories

Chopping board, bamboo **629044**
LED-light **629024**

Easy Care **629018**
Easy Care Brightener **629019**

Pro Care **629099**
Comfotouch **629830**

Cut-out size



840 x 480
33.07" x 18.9"



846 x 486
33.31" x 19.13"

Colour range

This product is available in the standard colour range as listed in the appendix.

SCHOCK

MONO | NEMO R-100



MONO | NEMO

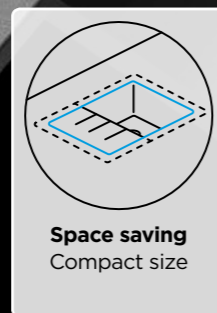

SCHOCK

MONO | NEMO R-100

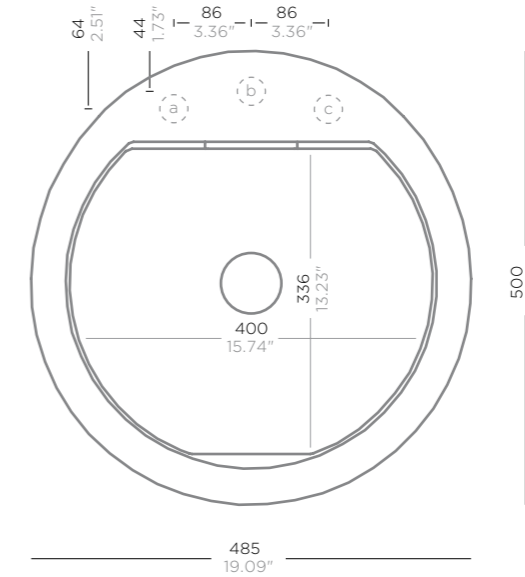

Article no.



MON R100 A



Manual drain kit **629327**
Standard automatic drain kit **629329**



MON R100 U



Premium automatic drain kit **629329PD**
Visible parts in Copper **629329COP**



MON R100 FB



Easy Care **629018**
Easy Care Brightener **629019**

Accessories

Pro Care **629099**
Comfotouch **629830**

Waste cap **628152**
Magic Sponge **629023**

Cut-out size



Please use dxf data!



Please use dxf data!



Please use dxf data!

Colour range

This product is available in the standard colour range as listed in the appendix.

SCHOCK

MONTANO | VIRTUS N-100XL



MONTANO | VIRTUS

MONTANO | VIRTUS

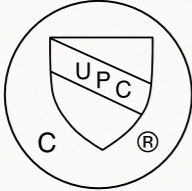

Proven
Tested and certified product

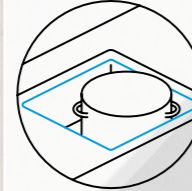

Go big
Extra volume for large pots

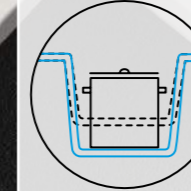

Deep dive
Added depth for tall pots

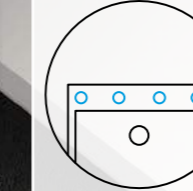

Plug and play
Comes with additional tap holes



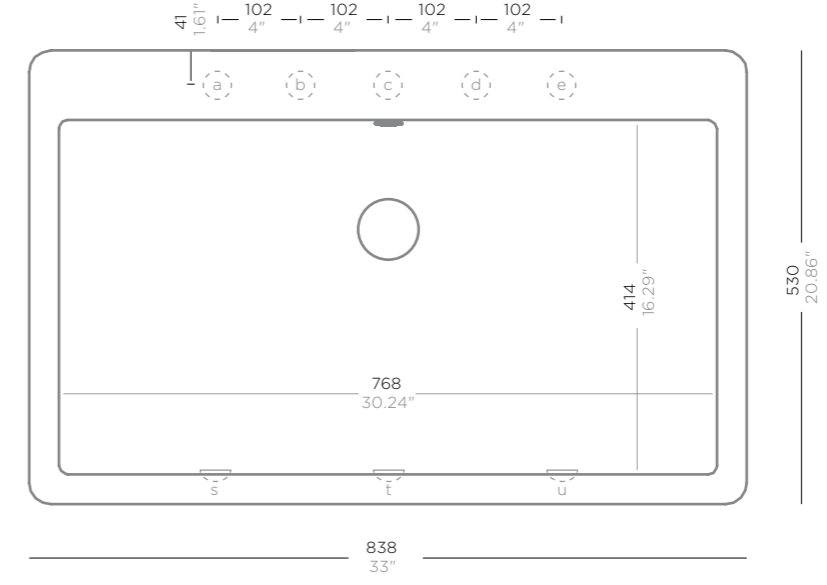

SCHOCK

MONTANO | VIRTUS N-100XL



Article no.

Accessories

<p> MOT N100XL A CD</p> <p> VIT N100XL A CTB</p>	<p>Manual drain kit 629323</p> <p>Standard automatic drain kit 629324</p>	<p>Easy Care Brightener 629019</p> <p>Pro Care 629099</p>
<p> MOT N100XL U CD</p> <p> VIT N100XL U CTB</p>	<p>Bottom grid 629122/MOTN100</p> <p>Wire basket 629120</p>	<p>Comfotouch 629830</p> <p>Waste cap 628152</p>
	<p>LED-light 629024</p> <p>Easy Care 629018</p>	<p>DurCare 629094</p> <p>Magic Sponge 629023</p>

Cut-out size



Colour range

This product is available in the standard colour range as listed in the appendix.

SCHOCK

MONTANO | VIRTUS N-100XLY



MONTANO | VIRTUS

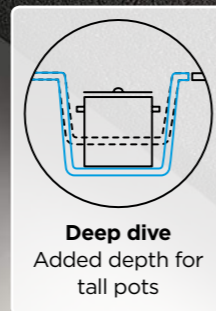
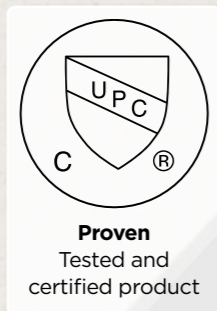

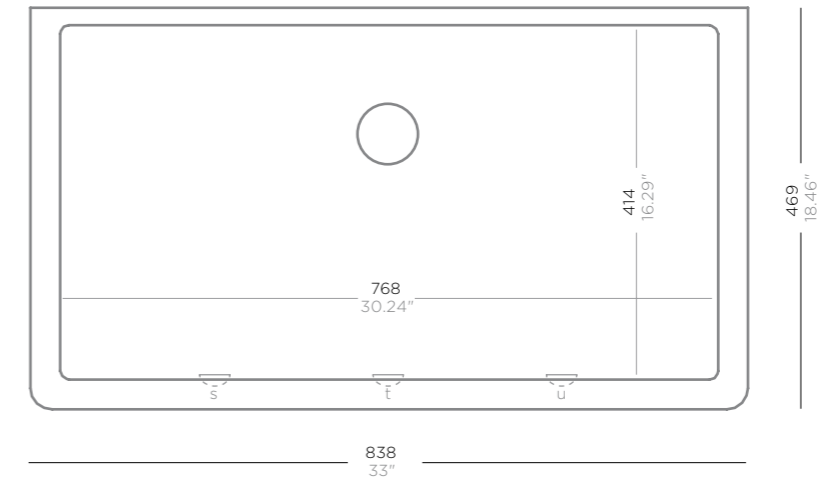

SCHOCK

MONTANO | VIRTUS N-100XLY



Article no.

MOT N100XLY U 
VIT N100XLY U 

Accessories

Manual drain kit	629323	Easy Care Brightener	629019
Standard automatic drain kit	629324	Pro Care	629099
Bottom grid	629122/MOTN100	Comfotouch	629830
Wire basket	629120	Waste cap	628152
LED-light	629024	DurCare	629094
Easy Care	629018	Magic Sponge	629023

Cut-out size



Colour range

This product is available in the standard colour range as listed in the appendix.

SCHOCK

PREPSTATION D-150

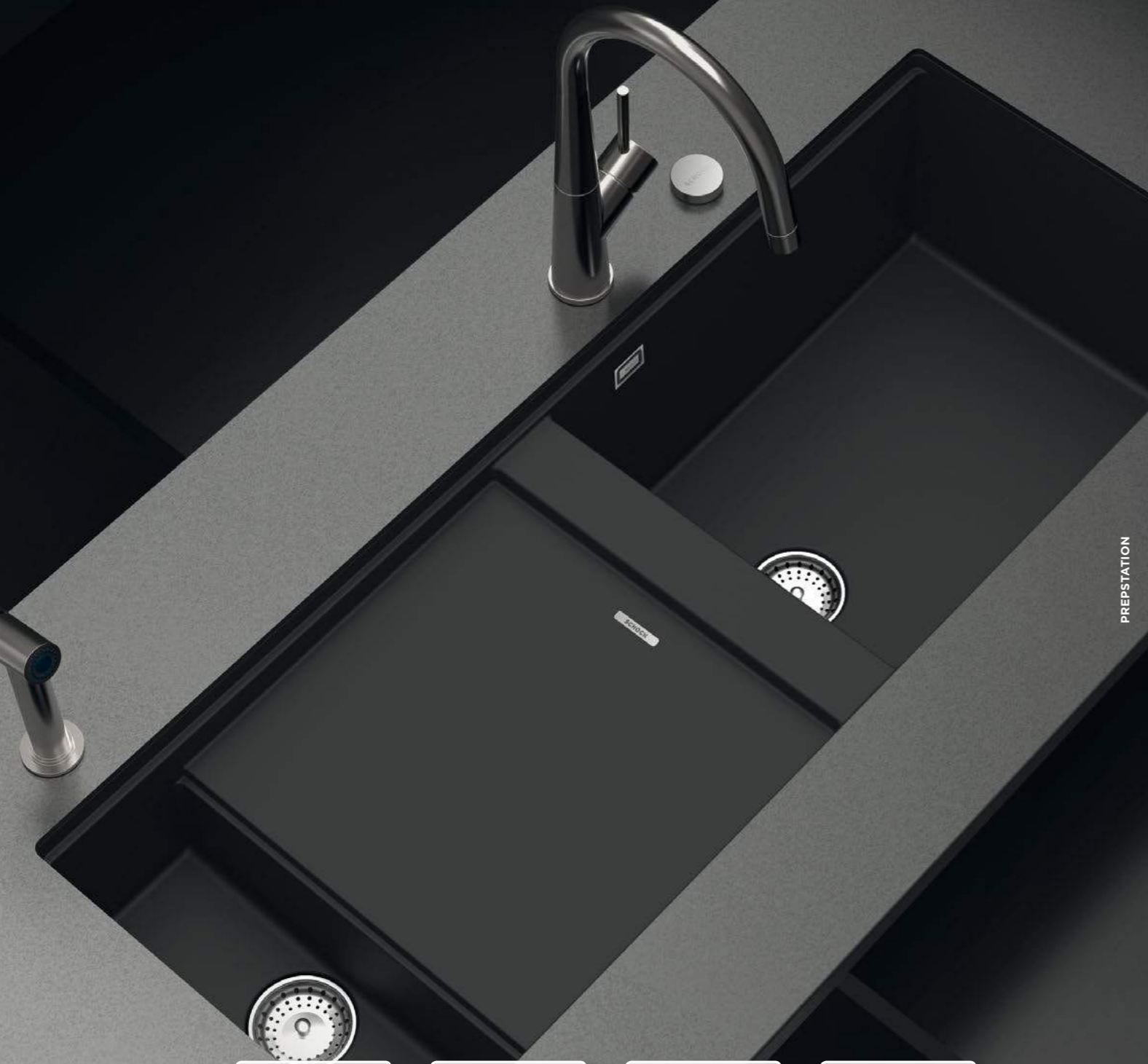

PREPSTATION

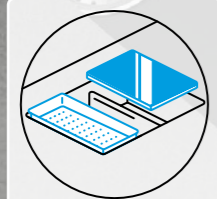

Kitchen aid
Functional accessories

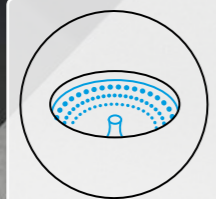

Perfect Drain
Less chrome, more colour

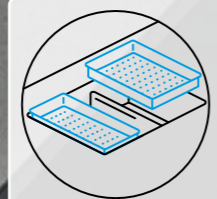

For true chefs
Perfect with a steamer

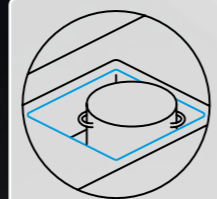

Go big
Extra volume for large pots





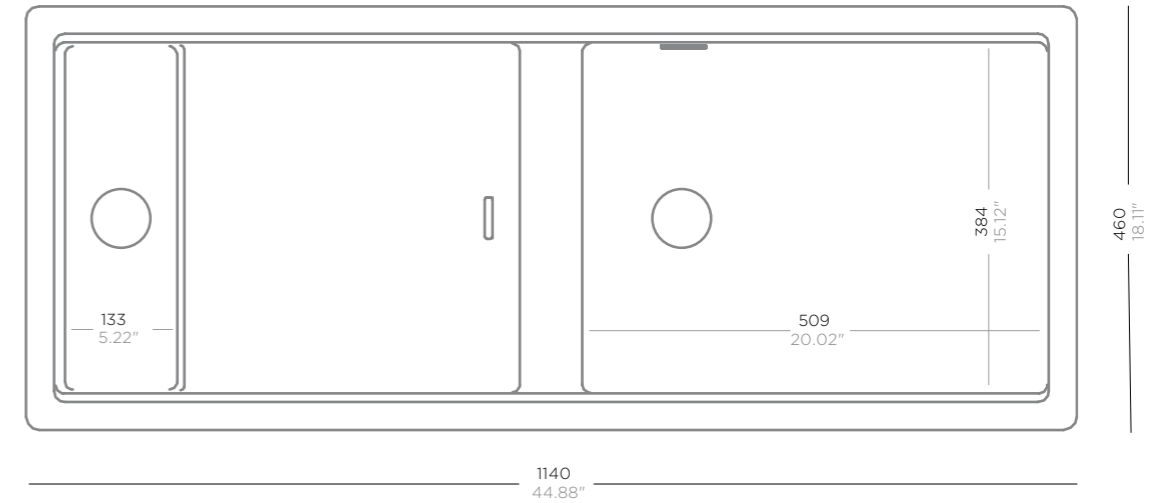

SCHOCK

PREPSTATION D-150



Article no.

Accessories

	PRP D150 A	 Manual drain kit 629619	Strainer bowl 629061
		Standard automatic drain kit 629620	Strainer bowl 629063
	PRP D150 U	 Premium automatic drain kit 629620PD	Visible parts stainless steel 629620EDM
		Wooden chopping board 629137	LED-light 629120
	PRP D150 FB	 PE chopping board, white 629135	Easy Care 629024
		Carrier 629136	Easy Care Brightener 629018

Cut-out size

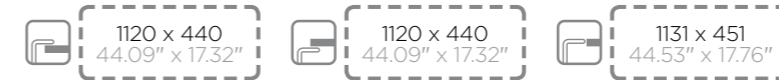

Colour range

This product is available in the standard colour range as listed in the appendix.

SCHOCK

RONDA D-100S



RONDA

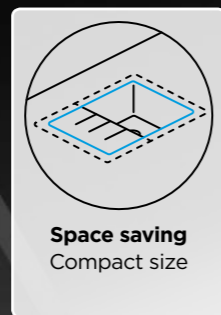

SCHOCK

RONDA D-100S

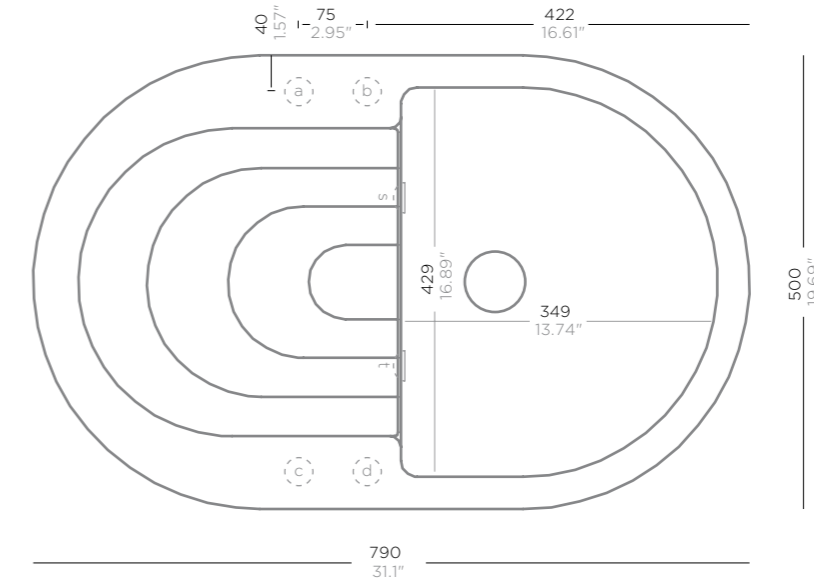

Article no.



RON D100S A CTB

Accessories

- | | | | |
|------------------------------------|---------------|------------------------------|---------------|
| Manual drain kit | 629314 | Comfotouch | 629830 |
| Standard automatic drain kit | 629313 | Waste cap | 628152 |
| LED-light | 629024 | Magic Sponge | 629023 |
| Easy Care | 629018 | Diamond drill SB light | 629095 |
| Easy Care Brightener | 629019 | | |
| Pro Care | 629099 | | |

Cut-out size



Colour range

This product is available in the standard colour range as listed in the appendix.

SCHOCK

RONDA D-100



RONDA

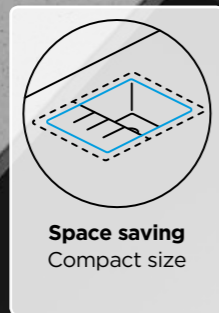

SCHOCK

RONDA D-100

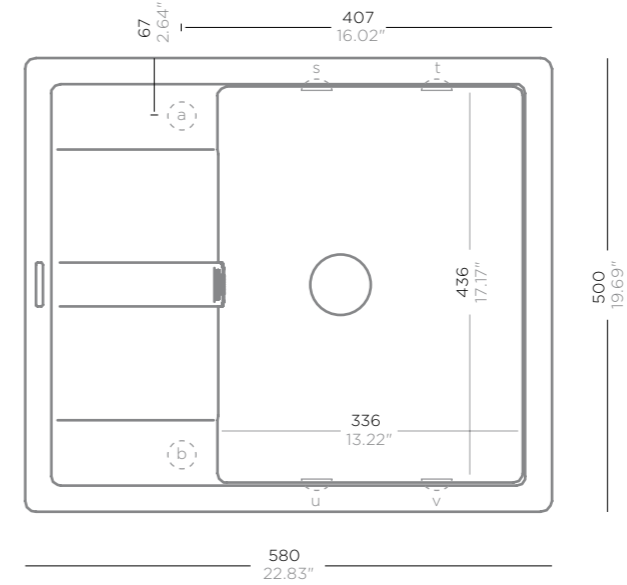

Article no.



RON D100 A



Manual drain kit **629314**
Standard automatic drain kit **629313**



RON D100 U



Glass chopping board **629036A/U**
Glass chopping board, white **629045A/U**
Glass chopping board, black **629046A/U**
Chopping board, bamboo **629044**

Easy Care **629018**
Easy Care Brightener **629019**

Pro Care **629099**
Comfotouch **629830**

Waste cap **628152**

Cut-out size



560 x 480
22.05" x 18.9"



564 x 484
22.2" x 19.06"

Colour range

This product is available in the standard colour range as listed in the appendix.

SCHOCK

RONDA D-100L



RONDA

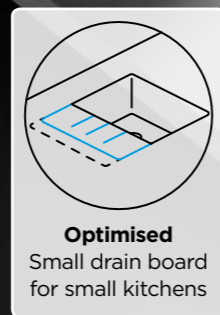
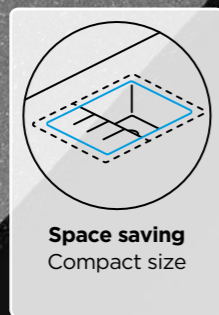

SCHOCK

RONDA D-100L

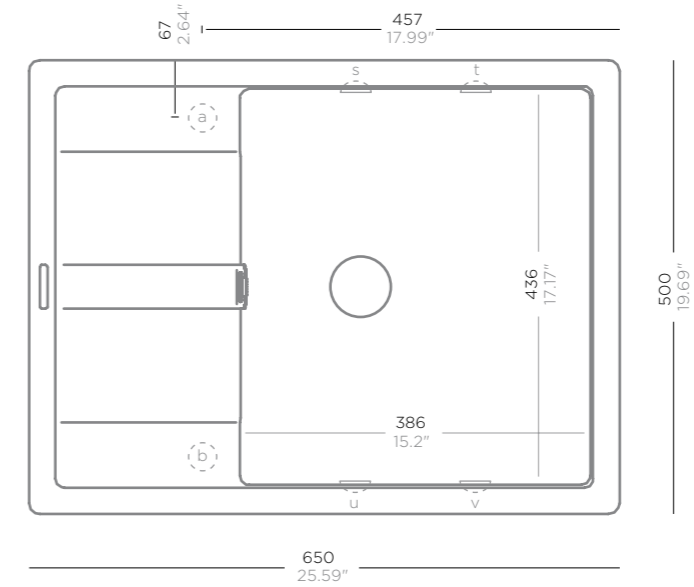

Article no.



RON D100L A



Accessories

Manual drain kit **629314**
Standard automatic drain kit **629313**

LED-light **629024**
Easy Care **629018**



RON D100L U



Glass chopping board **629036A/U**
Glass chopping board, white **629045A/U**

Easy Care Brightener **629019**
Pro Care **629099**

Glass chopping board, black **629046A/U**
Chopping board, bamboo **629044**

Comfotouch **629830**
Waste cap **628152**

Cut-out size

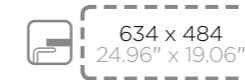

Colour range

This product is available in the standard colour range as listed in the appendix as well as in the special colours shown below:



SCHOCK

SIGNUS | PRIMUS D-100S



SIGNUS | PRIMUS

On standby
Extra drain when washing up

Standardised
Follows industry standards

Spacious
Big dishes?
Big drain board!



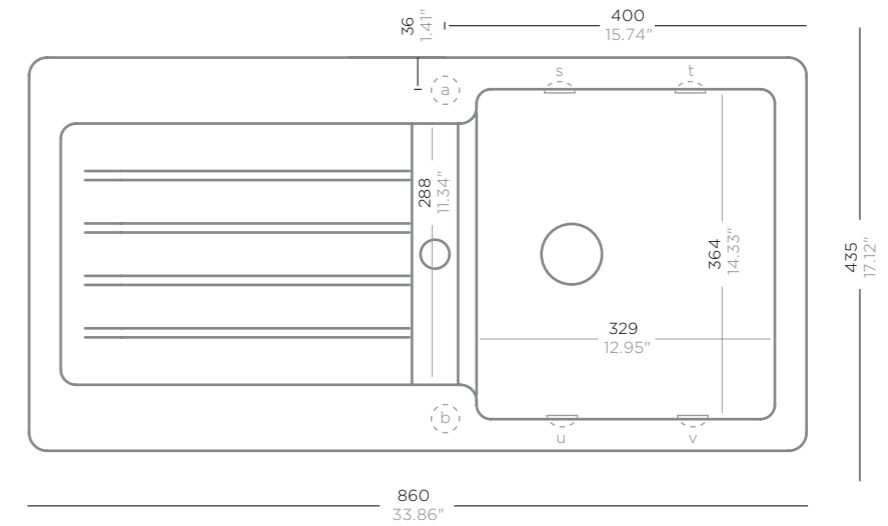

SCHOCK

SIGNUS | PRIMUS D-100S



Article no.

Accessories

	SIG D100S A		Manual drain kit 629382	Easy Care 629018
			Standard automatic drain kit 629383	Easy Care Brightener 629019
	SIG D100S U		Premium automatic drain kit 629383PD	Pro Care 629099
			Visible parts in Copper 629383COP	Comfotouch 629830
			LED-light 629024	Waste cap 628152
			Indutherm 629100	DurCare 629094

Cut-out size



Colour range

This product is available in the standard colour range as listed in the appendix as well as in the special colours shown below:



SCHOCK

SIGNUS | PRIMUS D-100

SIGNUS | PRIMUS

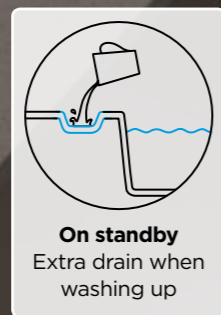

SCHOCK

SIGNUS | PRIMUS D-100

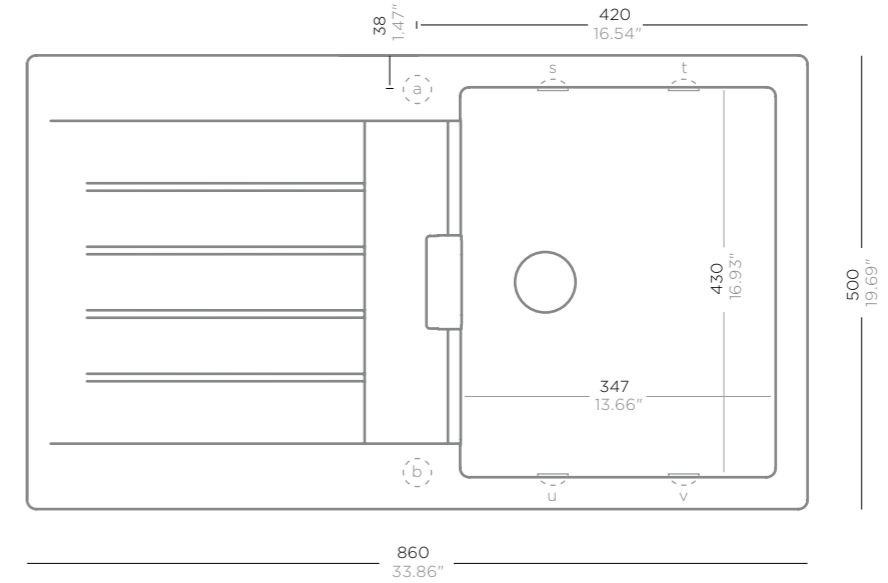

Article no.

Accessories

SIG D100 A	Manual drain kit 629370	Glass chopping board, black .. 629046A/U/FB
PRI D100 A	Standard automatic drain kit 629371	Wire basket 629171
SIG D100 U	Premium automatic drain kit 629371PD	LED-light 629024
PRI D100 U	Visible parts in Copper 629371COP	Indutherm 629100
SIG D100 FB	Glass chopping board 629036A/U	Easy Care 629018
	Glass chopping board, white .. 629045A/U/FB	Easy Care Brightener 629019

Cut-out size



Colour range

This product is available in the standard colour range as listed in the appendix as well as in the special colours shown below:



SCHOCK

SIGNUS | PRIMUS D-100L

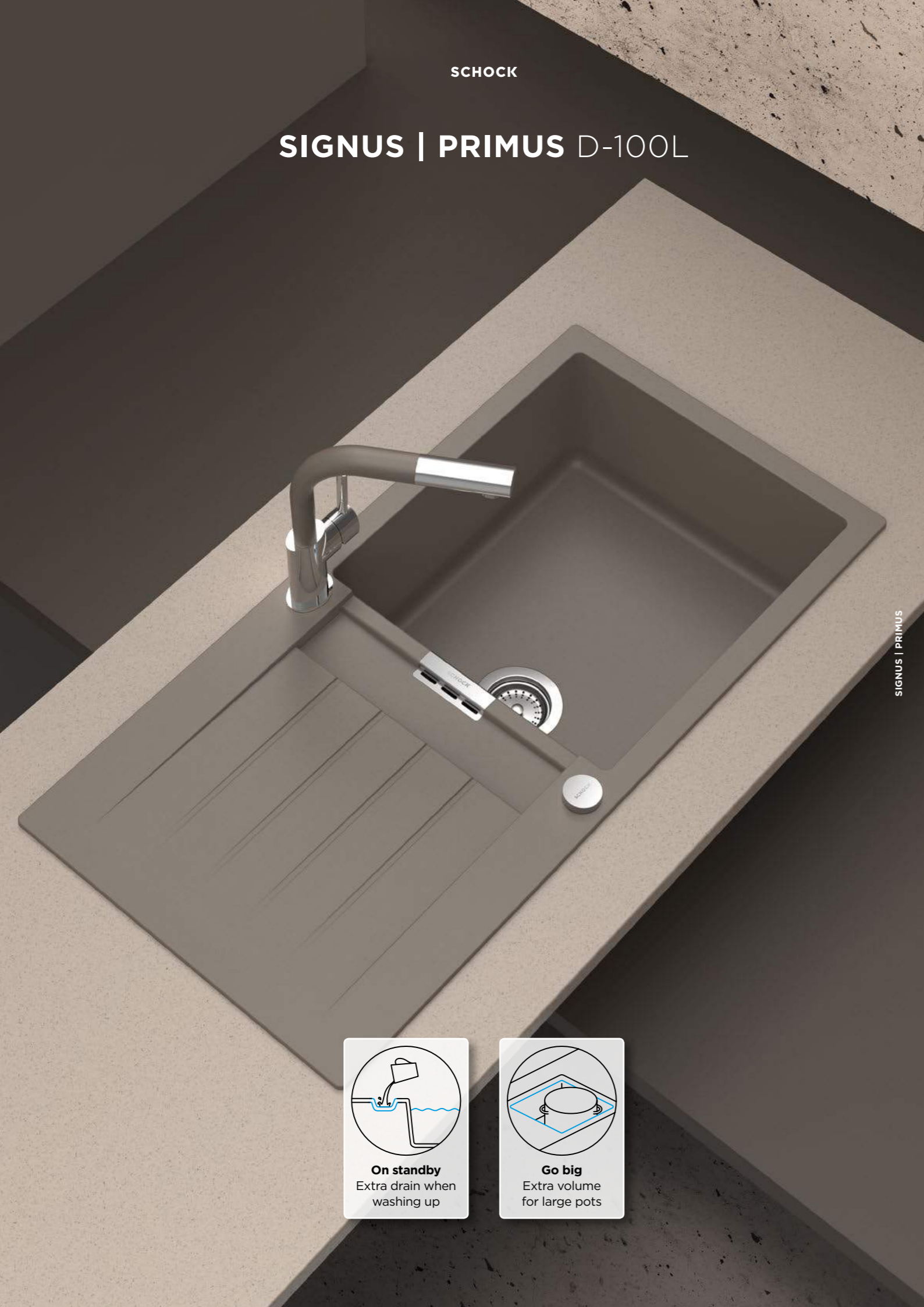

SIGNUS | PRIMUS





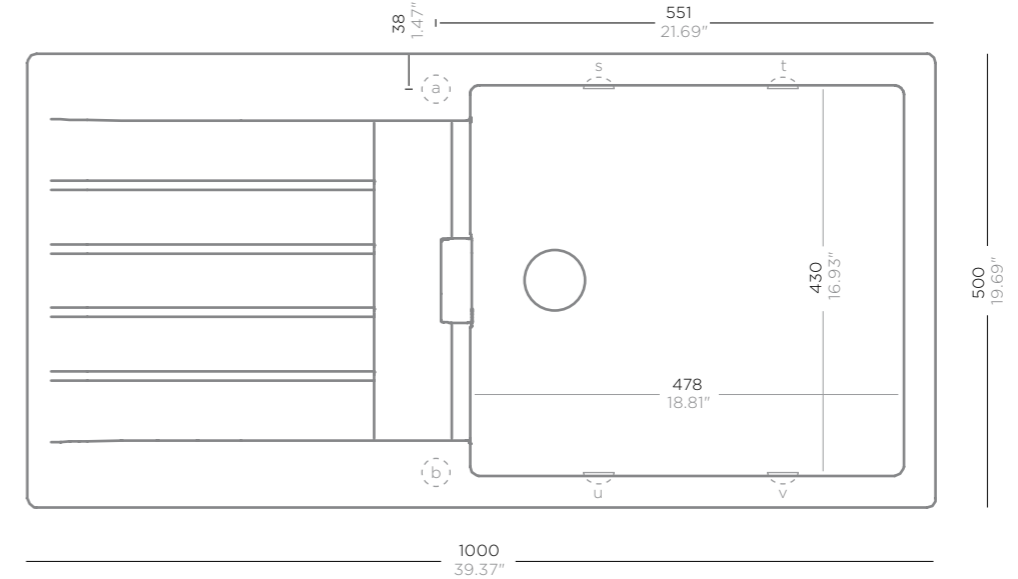



SCHOCK

SIGNUS | PRIMUS D-100L



Article no.

Accessories

	SIG D100L A		Manual drain kit	629370	Glass chopping board, black ..	629046A/U/FB
	PRI D100L A		Standard automatic drain kit	629371	Wire basket	629171
	SIG D100L U		Premium automatic drain kit	629371PD	LED-light	629024
	PRI D100L U		Visible parts in Copper	629371COP	Indutherm	629100
	SIG D100L FB		Glass chopping board	629036A/U	Easy Care	629018
			Glass chopping board, white ..	629045A/U/FB	Easy Care Brightener	629019

Cut-out size



Colour range

This product is available in the standard colour range as listed in the appendix as well as in the special colours shown below:



SCHOCK

SIGNUS | PRIMUS D-150



SIGNUS | PRIMUS







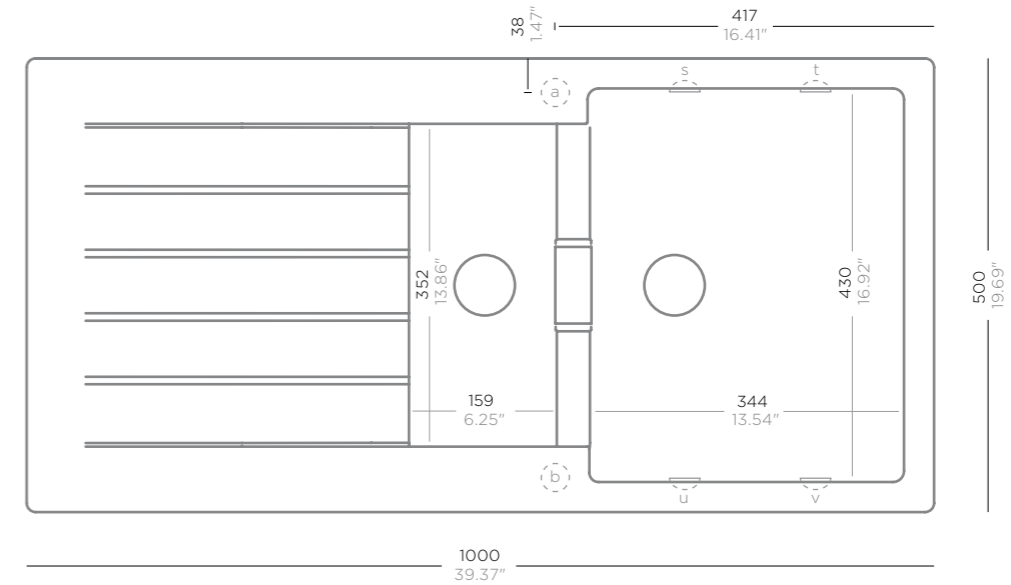











SCHOCK

SIGNUS | PRIMUS D-150



Article no.

Accessories

	SIG D150 A		Manual drain kit	629372		Strainer bowl	629043
	PRI D150 A		Standard automatic drain kit	629373		Wire basket	629171
	SIG D150 U		Premium automatic drain kit	629373PD		LED-light	629024
	PRI D150 U		Glass chopping board	629036A/U		Indutherm	629100
	SIG D150 FB		Glass chopping board, white ..	629045A/U/FB		Easy Care	629018
			Glass chopping board, black ..	629046A/U/FB		Easy Care Brightener	629019

Cut-out size



Colour range

This product is available in the standard colour range as listed in the appendix as well as in the special colours shown below:



SCHOCK

SIGNUS | PRIMUS D-175



SIGNUS | PRIMUS

Eye catcher
Patented over-flow design

Go big
Extra volume for large pots

Perfect Drain
Less chrome, more colour

SCHOCK

SIGNUS | PRIMUS D-175

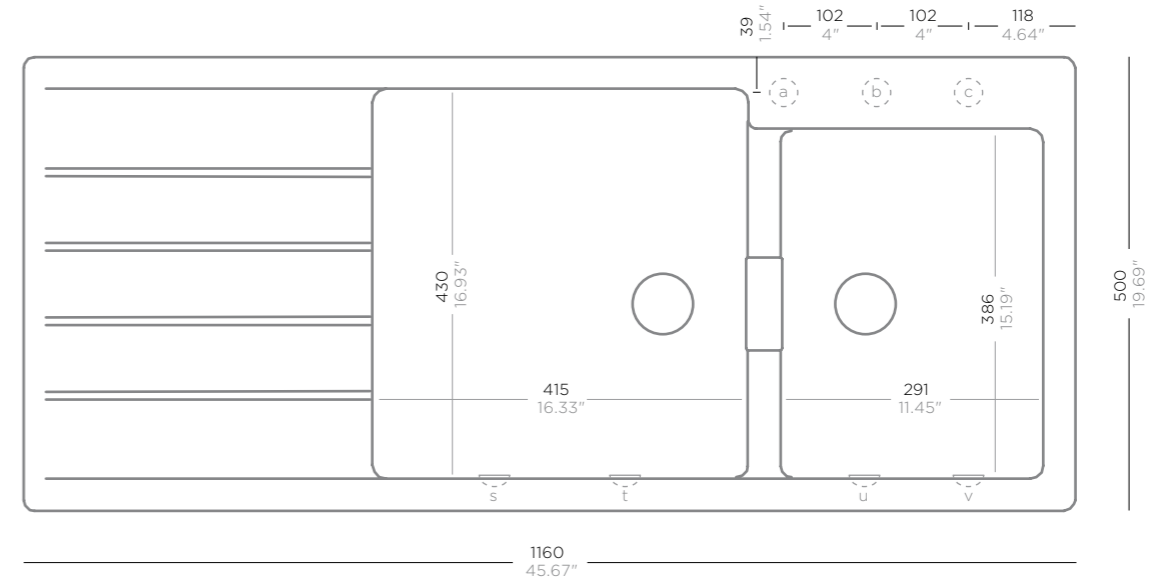

Article no.	Accessories
SIG D175 A	Manual drain kit 629345SET Standard automatic drain kit 629347
SIG D175 U	Premium automatic drain kit 629347PD Glass chopping board 629036A/U
SIG D175 FB	Glass chopping board, white .. 629045A/U/FB Glass chopping board, black .. 629046A/U/FB
	LED-light 629024 Easy Care 629018 Easy Care Brightener 629019 Pro Care 629099 Comfotouch 629830 Waste cap 628152

Cut-out size		
1140 x 480 44.88" x 18.9"	1146 x 486 45.12" x 19.13"	1150 x 490 45.28" x 19.29"

Colour range

This product is available in the standard colour range as listed in the appendix.

SCHOCK

SIGNUS | PRIMUS D-200

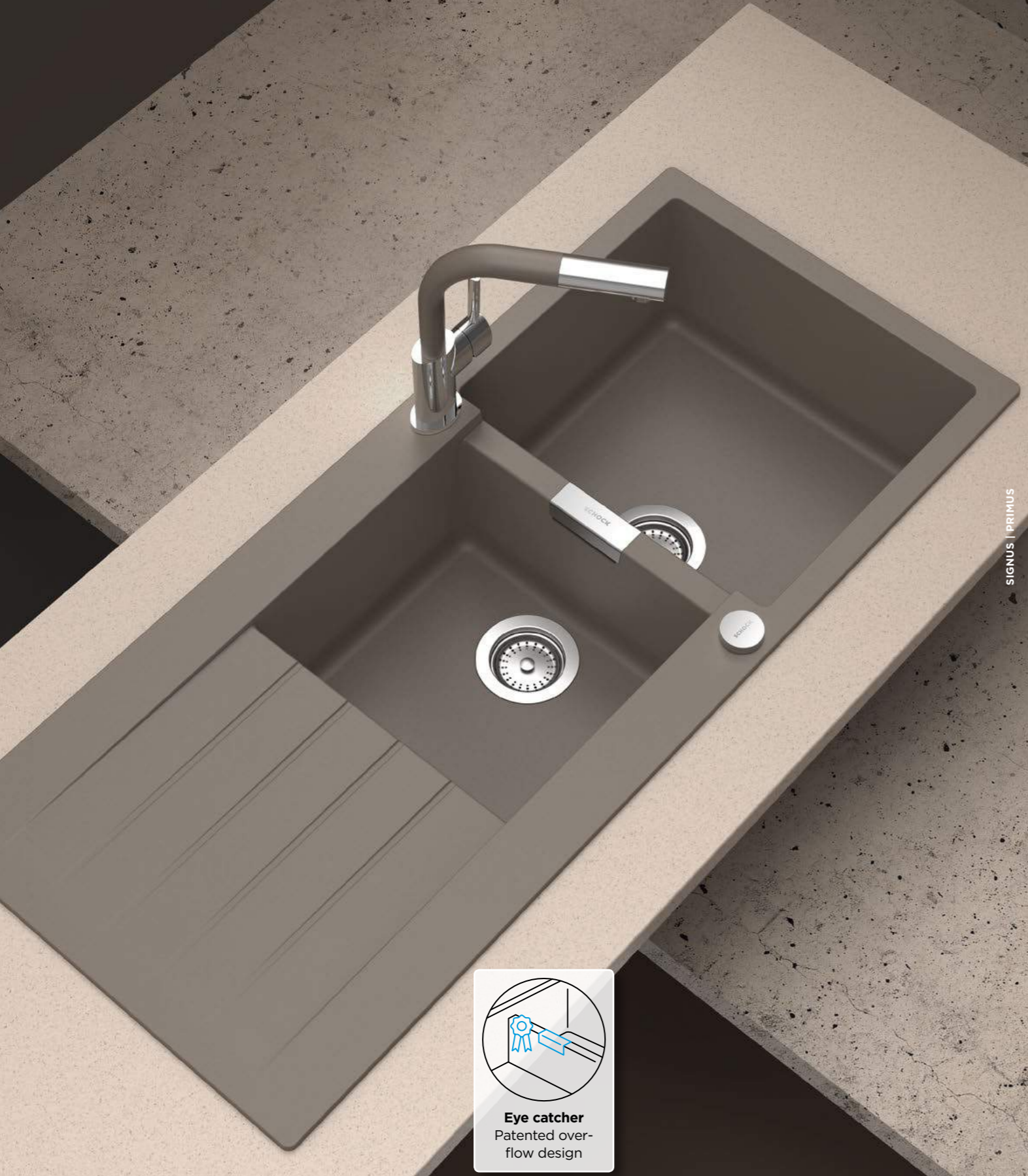

SIGNUS | PRIMUS

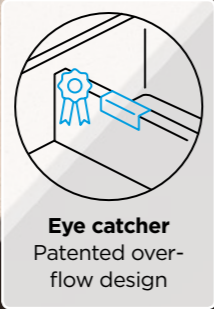

SCHOCK

SIGNUS | PRIMUS D-200

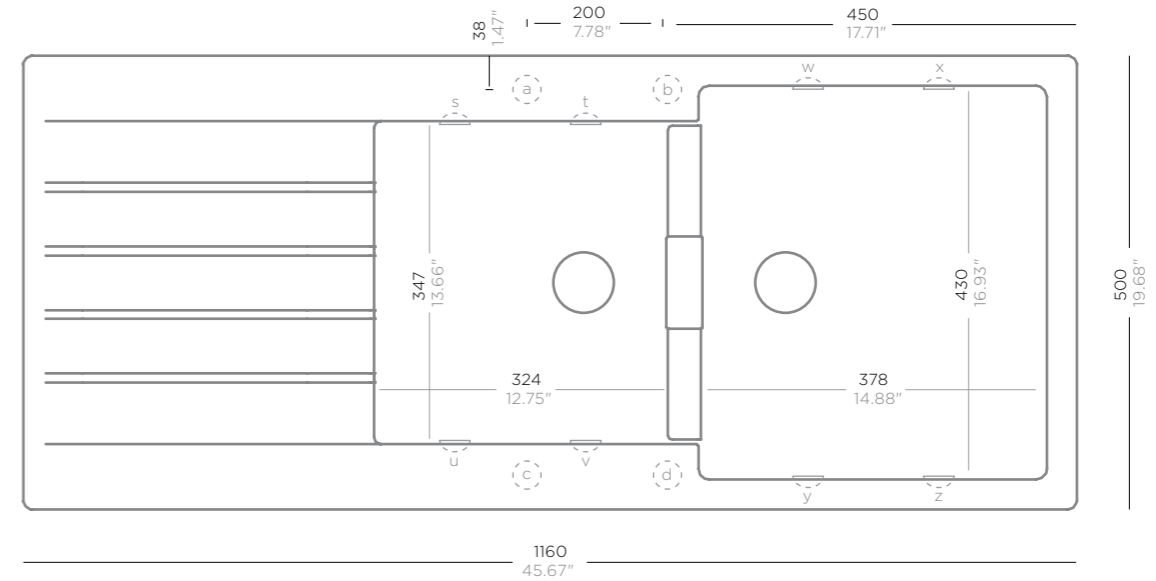

Article no.	Accessories
SIG D200 A PRI D200 A	Manual drain kit 629372 Standard automatic drain kit 629373 Wire basket 629171 LED-light 629024
SIG D200 U PRI D200 U	Premium automatic drain kit 629373PD Glass chopping board 629036A/U Indutherm 629100 Easy Care 629018
SIG D200 FB	Glass chopping board, white .. 629045A/U/FB Glass chopping board, black .. 629046A/U/FB Easy Care Brightener 629019 Pro Care 629099

Cut-out size

1140 x 480 44.88" x 18.9"	1146 x 486 45.12" x 19.13"	1153 x 493 45.39" x 19.41"
------------------------------	-------------------------------	-------------------------------

Colour range

This product is available in the standard colour range as listed in the appendix as well as in the special colours shown below:

Kaiserstein 45	Rockenstein 46	Rouge 81
--------------------------	--------------------------	--------------------

SCHOCK

SIGNUS | PRIMUS N-100XL



SIGNUS | PRIMUS







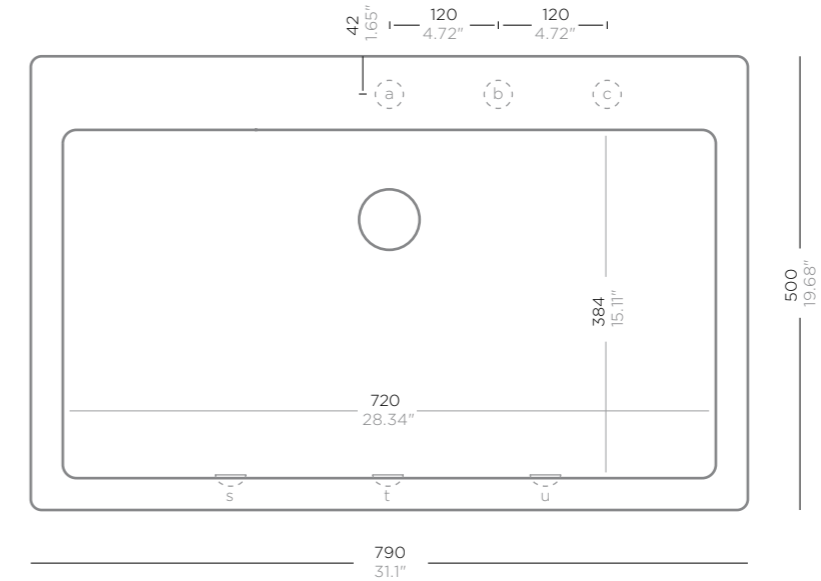

SCHOCK

SIGNUS | PRIMUS N-100XL



Article no.

Accessories

	SIG N100XL A 	Manual drain kit 629309SET	Wire basket 629171
	PRI N100XL A 	Standard automatic drain kit 629307	LED-light 629024
	SIG N100XL U* 	Premium automatic drain kit 629307PD	Easy Care 629018
	PRI N100XL U* 	Glass chopping board 629036A/U	Easy Care Brightener 629019
		Glass chopping board, white 629045A/U	Pro Care 629099
		Glass chopping board, black 629046A/U	Comfotouch 629830

Cut-out size



Colour range

This product is available in the standard colour range as listed in the appendix.

* Please note that the undermount version requires a cabinet the next size up.

SCHOCK

SIGNUS | PRIMUS N-100XLY



SIGNUS | PRIMUS



Go big
Extra volume
for large pots

SCHOCK

SIGNUS | PRIMUS N-100XLY

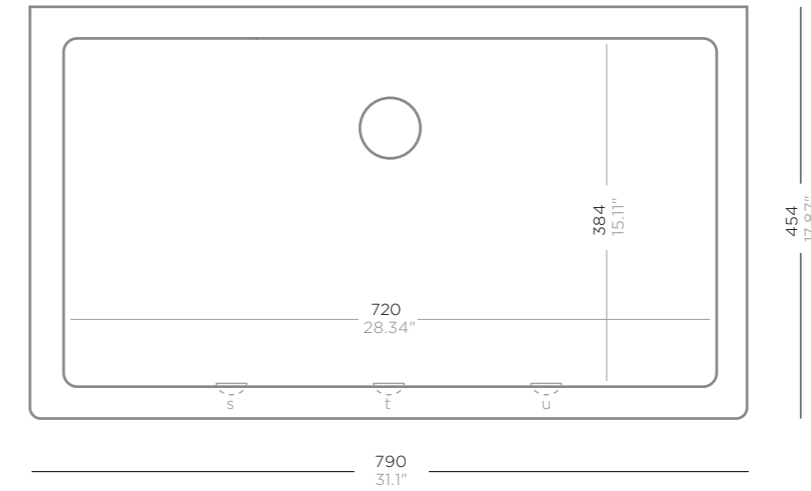

Article no.

SIG N100XLY U **PRI N100XLY U**

Accessories

- Manual drain kit **629309SET**
- Standard automatic drain kit **629307**
- Premium automatic drain kit **629307PD**
- Glass chopping board **629036U**
- Glass chopping board, white **629045U**
- Glass chopping board, black **629046U**
- Wire basket **629171**
- LED-light **629024**
- Easy Care **629018**
- Easy Care Brightener **629019**
- Pro Care **629099**
- Comfotouch **629830**

Cut-out size



Colour range

This product is available in the standard colour range as listed in the appendix.

SCHOCK

SIGNUS | PRIMUS N-175



SIGNUS | PRIMUS

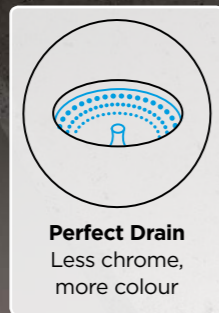

SCHOCK

SIGNUS | PRIMUS N-175

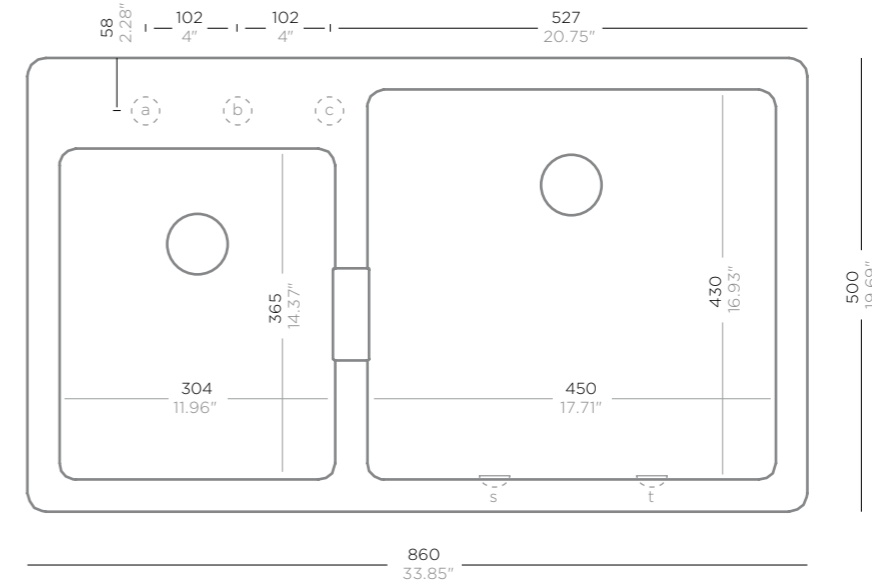

Article no.

Accessories

SIG N175 A		Manual drain kit 629345SET	LED-light 629024
		Standard automatic drain kit 629347	Easy Care 629018
SIG N175 U		Premium automatic drain kit 629347PD	Easy Care Brightener 629019
		Glass chopping board 629036A/U	Pro Care 629099
		Glass chopping board, white 629045A/U	Comfotouch 629830
		Glass chopping board, black 629046A/U	Waste cap 628152

Cut-out size



Colour range

This product is available in the standard colour range as listed in the appendix.

SCHOCK

SIGNUS | PRIMUS N-200



SIGNUS | PRIMUS



Eye catcher
Patented over-flow design





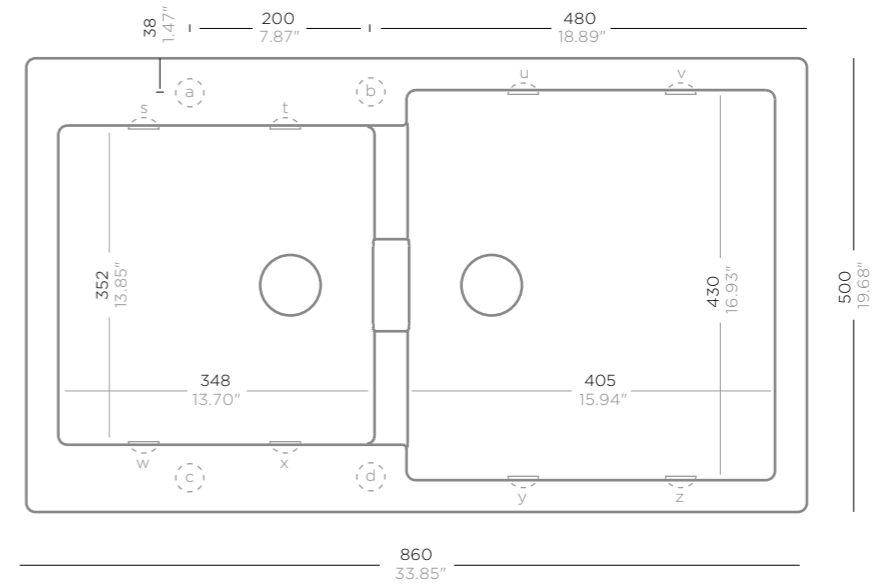











SCHOCK

SIGNUS | PRIMUS N-200



Article no.

Accessories

	SIG N200 A		Manual drain kit	629372		Wire basket	629171
	PRI N200 A		Standard automatic drain kit	629373		LED-light	629024
	SIG N200 U		Premium automatic drain kit	629373PD		Easy Care	629018
	PRI N200 U		Glass chopping board	629036A/U		Easy Care Brightener	629019
	SIG N200 FB		Glass chopping board, white ..	629045A/U/FB		Pro Care	629099
			Glass chopping board, black ..	629046A/U/FB		Comfotouch	629830

Cut-out size

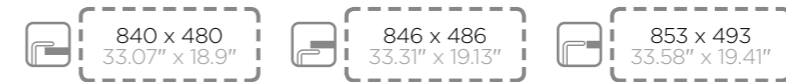

Colour range

This product is available in the standard colour range as listed in the appendix.

SCHOCK

SIGNUS | PRIMUS C-150



SIGNUS | PRIMUS





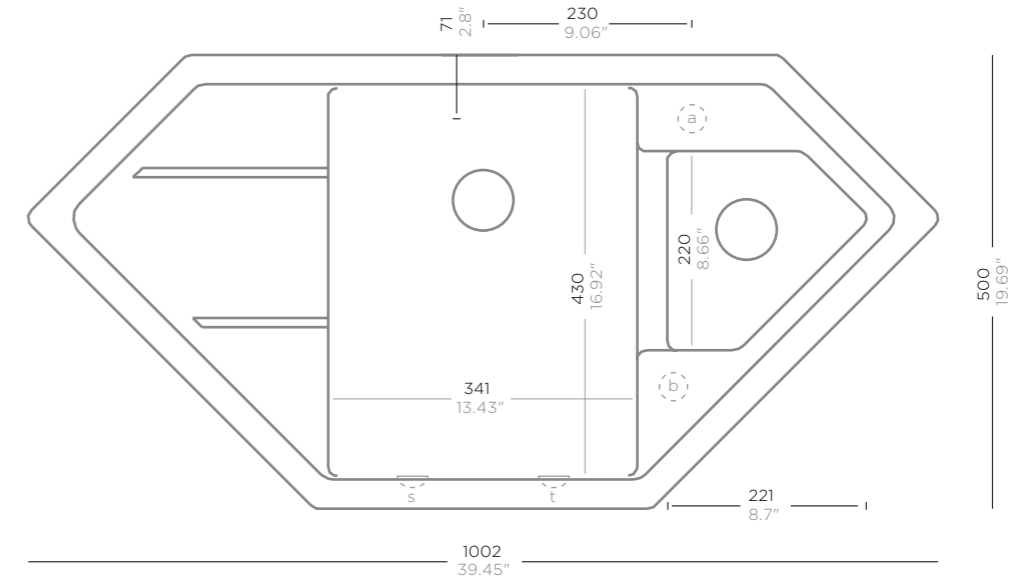









SCHOCK

SIGNUS | PRIMUS C-150



Article no.

Accessories

	SIG C150 A		Manual drain kit	629304		Glass chopping board, black ..	629046A/U/FB
	PRI C150 A		Standard automatic drain kit	629305		Strainer bowl	629109
	SIG C150 U		Premium automatic drain kit	629305PD		Wire basket	629170
	PRI C150 U		Visible parts in Copper	629305COP		LED-light	629024
	SIG C150 FB		Glass chopping board	629036A/U		Easy Care	629018
			Glass chopping board, white ..	629045A/U/FB		Easy Care Brightener	629019

Cut-out size



Colour range

This product is available in the standard colour range as listed in the appendix as well as in the special colours shown below:



SCHOCK

SIGNUS | PRIMUS C-200



SIGNUS | PRIMUS

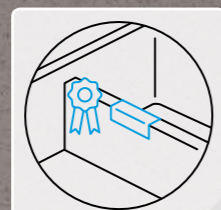

Eye catcher
Patented over-
flow design

SCHOCK

SIGNUS | PRIMUS C-200

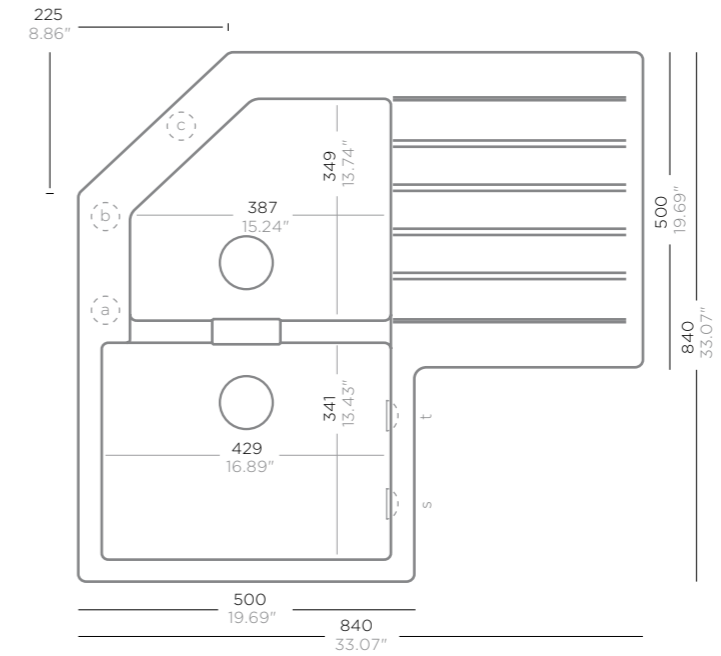

Article no.

PRI C200 A

PRI C200 U

Accessories

- Manual drain kit **629372**
- Standard automatic drain kit **629373**
- Glass chopping board **629036A/U**
- Glass chopping board, white **629045A/U**
- Glass chopping board, black **629046A/U**
- Chopping board, bamboo **629044**
- Wire basket **629171**
- LED-light **629024**
- Easy Care **629018**
- Easy Care Brightener **629019**
- Pro Care **629099**
- Comfotouch **629830**

Cut-out size



Colour range

This product is available in the standard colour range as listed in the appendix.

SCHOCK

SOHO | QUADRO N-100S



SOHO | QUADRO

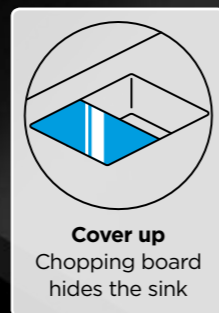
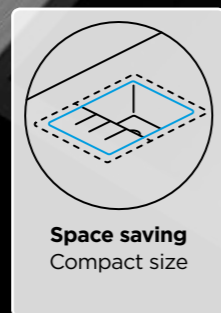





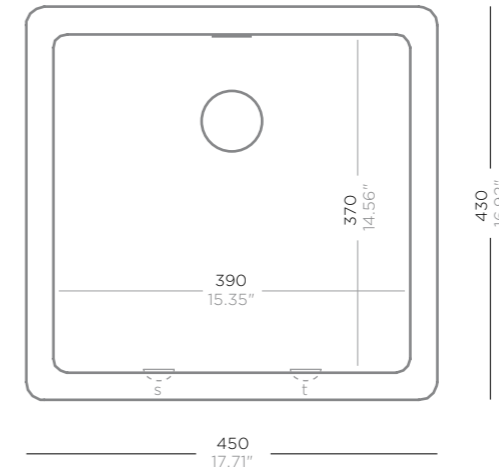



SCHOCK

SOHO | QUADRO N-100S



Article no.

Accessories

	SOH N100S A		Manual drain kit	629309SET	Comfotouch	629830
	QUA N100S A		Standard automatic drain kit	629307	Waste cap	628152
	SOH N100S U		Premium automatic drain kit	629307PD	DurCare	629094
	QUA N100S U		Easy Care	629018	Magic Sponge	629023
			Easy Care Brightener	629019		
			Pro Care	629099		

Cut-out size



Colour range

This product is available in the standard colour range as listed in the appendix.

* Please note that the rectangular overflow pictured is only available with the Soho range.

SCHOCK

SOHO | QUADRO N-100



SOHO | QUADRO

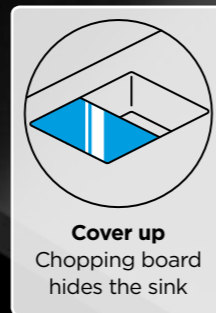
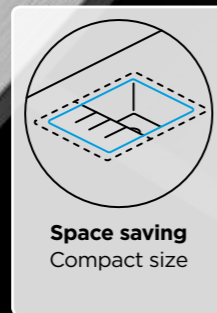
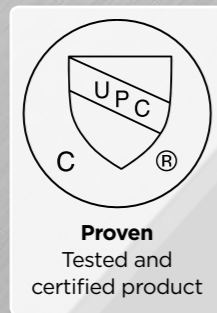





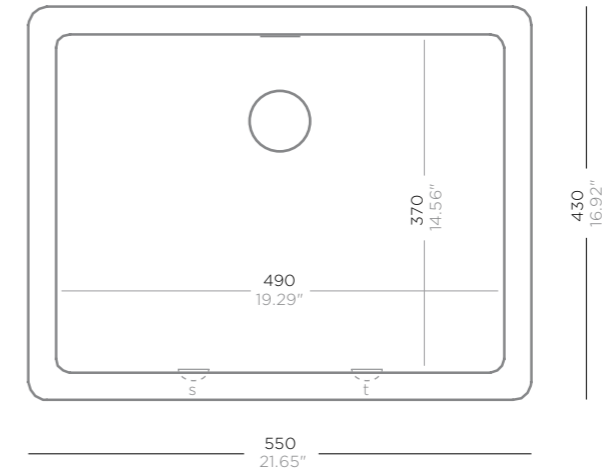



SCHOCK

SOHO | QUADRO N-100



Article no.

Accessories

	SOH N100 A		Manual drain kit	629309SET	Pro Care	629099
	QUA N100 A		Standard automatic drain kit	629307	Comfotouch	629830
	SOH N100 U		Premium automatic drain kit	629307PD	Waste cap	628152
	QUA N100 U		Glass chopping board, 12 mm, black *..	629077	DurCare	629094
			Easy Care	629018	Magic Sponge	629023
			Easy Care Brightener	629019		

Cut-out size



Colour range

This product is available in the standard colour range as listed in the appendix.

* For undermount version with 12 mm thick countertop

** Please note that the rectangular overflow pictured is only available with the Soho range.

SCHOCK

SOHO | QUADRO N-150



SOHO | QUADRO

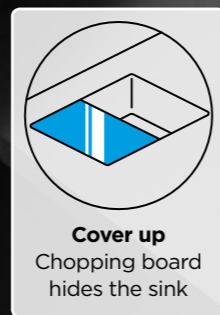
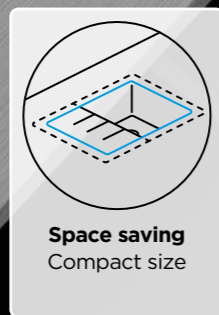

SCHOCK

SOHO | QUADRO N-150

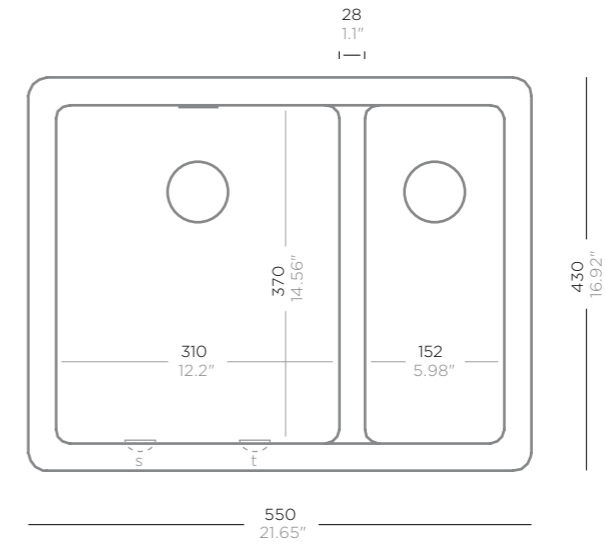

Article no.

SOH N150 A
 QUA N150 A

Manual drain kit **629320SET**
Standard automatic drain kit **629308**

SOH N150 U
 QUA N150 U

Premium automatic drain kit **629308PD**
Glass chopping board, 12 mm, black *.. **629077**

Easy Care **629018**
Easy Care Brightener **629019**

Pro Care **629099**
Comfotouch **629830**

Waste cap **628152**
DurCare **629094**

Magic Sponge **629023**

Cut-out size



Colour range

This product is available in the standard colour range as listed in the appendix.

* For undermount version with 12 mm thick countertop

** Please note that the rectangular overflow pictured is only available with the Soho range.

SCHOCK

SOLIDO N-050



SOLIDO

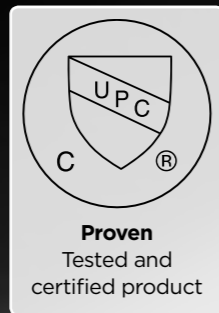

Proven
Tested and certified product

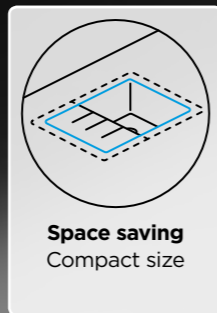

Space saving
Compact size

SCHOCK

SOLIDO N-050

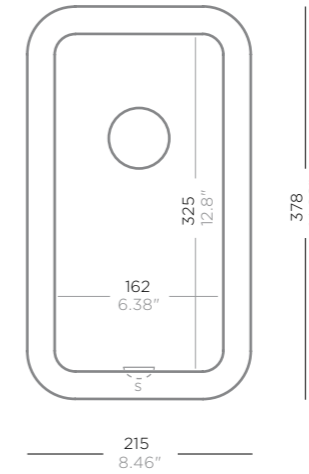

SOLIDO

Article no.

 **SOL N050 U** 

Accessories

- | | |
|--|--|
| Manual drain kit 629314 | Comfotouch 629830 |
| Standard automatic drain kit 629313 | Waste cap 628152 |
| LED-light 629024 | Magic Sponge 629023 |
| Easy Care 629018 | Diamond drill SB light 629095 |
| Easy Care Brightener 629019 | |
| Pro Care 629099 | |

Cut-out size



Colour range

This product is available in the standard colour range as listed in the appendix.

SCHOCK

SOLIDO N-075



SOLIDO

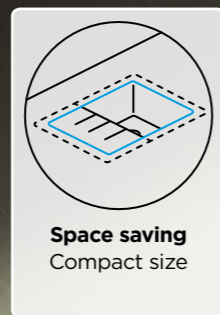
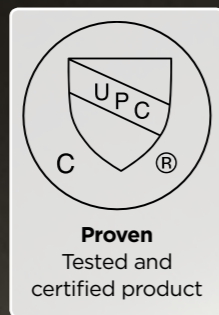

SCHOCK

SOLIDO N-075

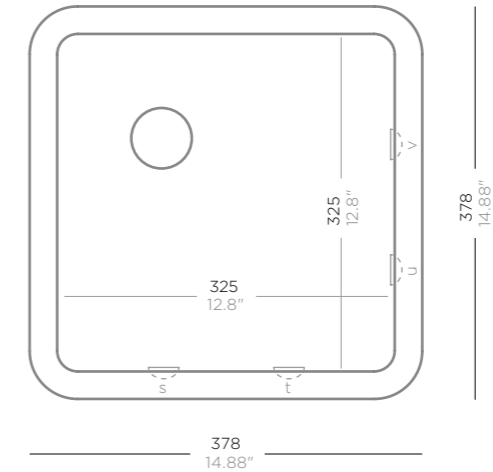

Article no.

 **SOL N075 U** 

Accessories

- Manual drain kit **8940013**
- Standard automatic drain kit **8940012**
- LED-light **629024**
- Easy Care **629018**
- Easy Care Brightener **629019**
- Pro Care **629099**
- Comfotouch **629830**
- Waste cap **628152**
- Magic Sponge **629023**
- Diamond drill SB light **629095**

Cut-out size



Colour range

This product is available in the standard colour range as listed in the appendix.

SCHOCK

SOLIDO N-100



SOLIDO

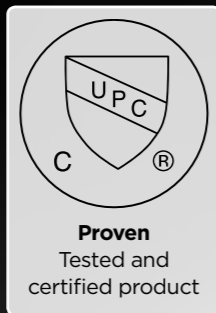

SCHOCK

SOLIDO N-100

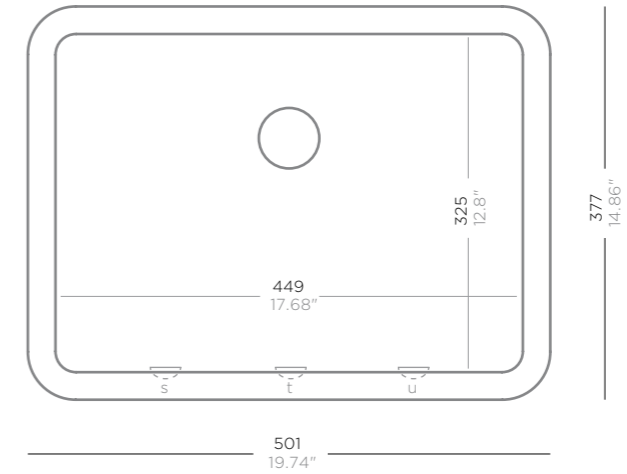

Article no.

 **SOL N100 U** 

Accessories

- Manual drain kit **8940013**
- Standard automatic drain kit **8940012**
- LED-light **629024**
- Easy Care **629018**
- Easy Care Brightener **629019**
- Pro Care **629099**
- Comfotouch **629830**
- Waste cap **628152**
- Magic Sponge **629023**
- Diamond drill SB light **629095**

Cut-out size

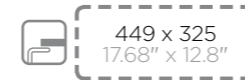

Colour range

This product is available in the standard colour range as listed in the appendix.

SCHOCK

SOLIDO N-175



SOLIDO

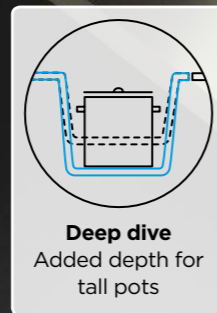
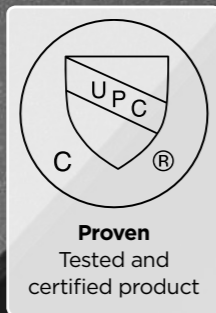

SCHOCK

SOLIDO N-175

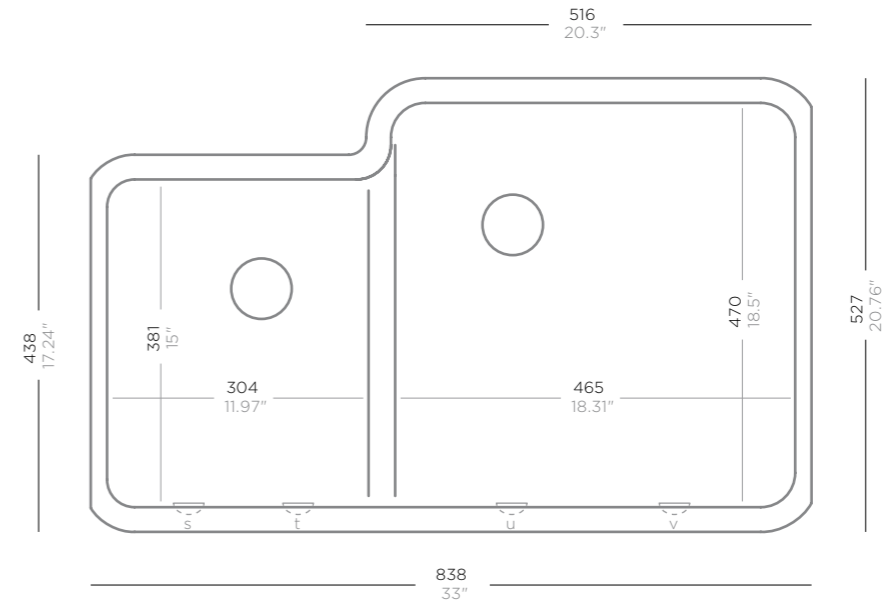

Article no.

 **SOL N175 U** 

Accessories

- | | |
|--|--|
| Manual drain kit 629325 | Comfotouch 629830 |
| Standard automatic drain kit 629326 | Waste cap 628152 |
| LED-light 629024 | Magic Sponge 629023 |
| Easy Care 629018 | Diamond drill SB light 629095 |
| Easy Care Brightener 629019 | |
| Pro Care 629099 | |

Cut-out size

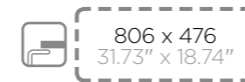

Colour range

This product is available in the standard colour range as listed in the appendix.

SCHOCK

SOLIDO N-200



SOLIDO

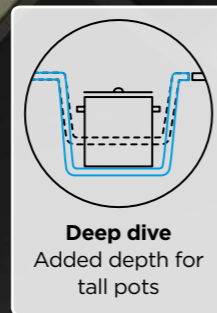
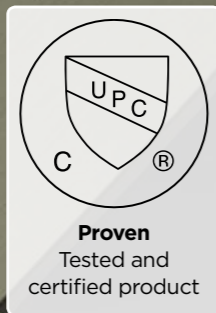

SCHOCK

SOLIDO N-200

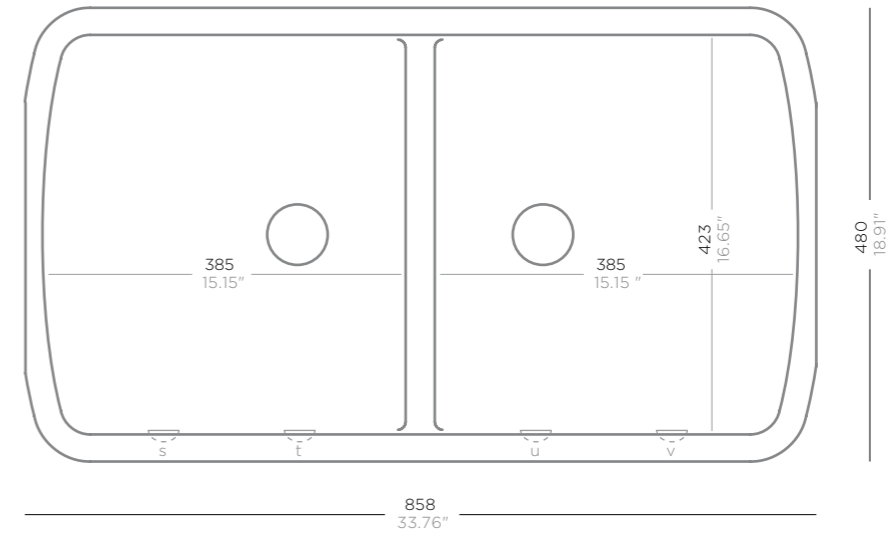

Article no.

SOL N200 U

Accessories

- Manual drain kit **629325**
- Standard automatic drain kit **629326**
- LED-light **629024**
- Easy Care **629018**
- Easy Care Brightener **629019**
- Pro Care **629099**
- Comfotouch **629830**
- Waste cap **628152**
- Magic Sponge **629023**
- Diamond drill SB light **629095**

Cut-out size

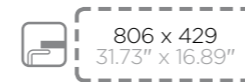

Colour range

This product is available in the standard colour range as listed in the appendix.

SCHOCK

SUPRA N-175

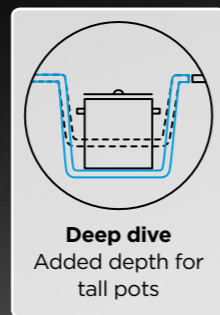

SCHOCK

SUPRA N-175

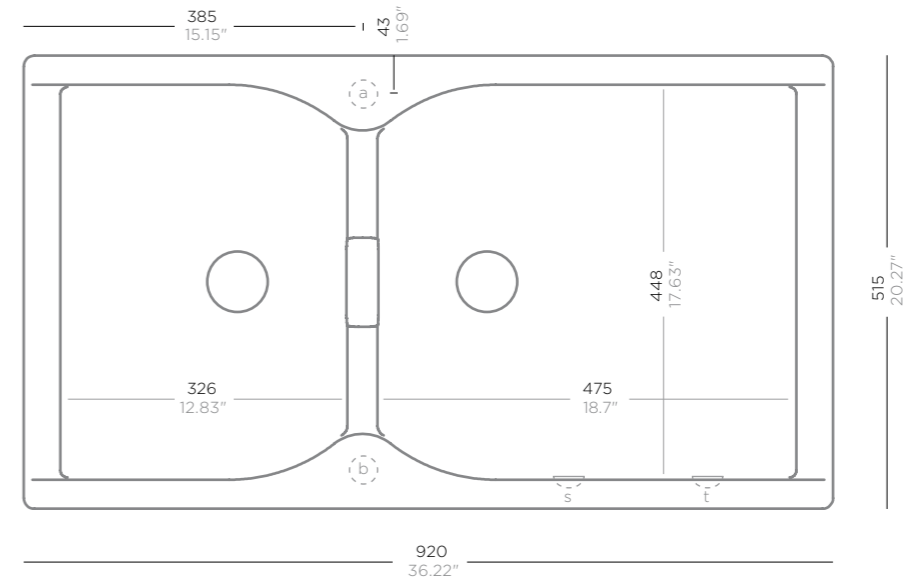







SUPRA



Article no.

Accessories

	SUP N175 A		Manual drain kit	629355	Easy Care Brightener	629019
			Standard automatic drain kit	629356	Pro Care	629099
	SUP N175 U		Premium automatic drain kit	629356PD	Comfotouch	629830
			Wire basket	629149	Waste cap	628152
			LED-light	629024	DurCare	629094
			Easy Care	629018	Magic Sponge	629023

Cut-out size



Colour range

This product is available in the standard colour range as listed in the appendix.

SCHOCK

TYPOS D-100S



TYPOS

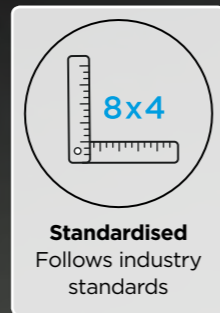
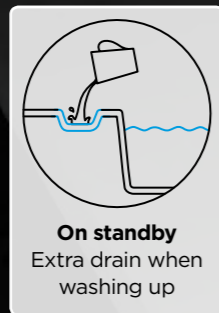



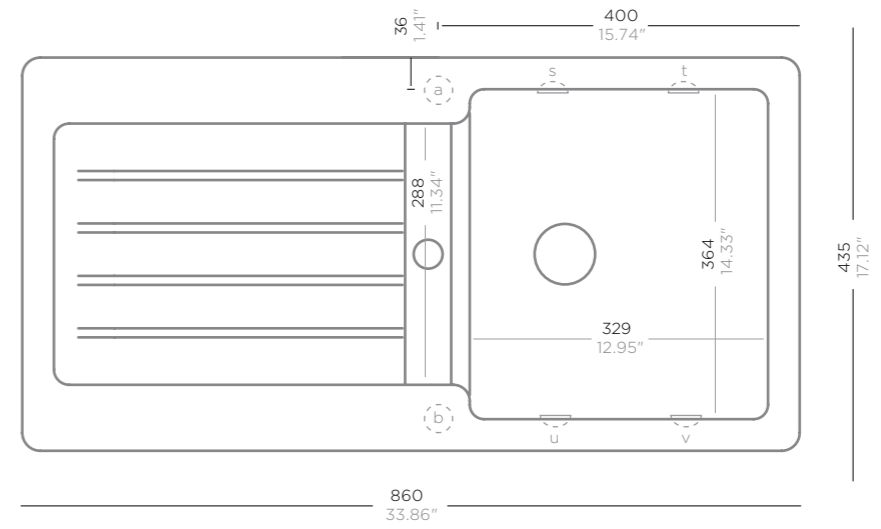

SCHOCK

TYPOS D-100S



Article no.

Accessories

	TYP D100S A	 Manual drain kit 629872	Comfotouch 629830
		Standard automatic drain kit 629873	Waste cap 628152
	TYP D100S U	 LED-light 629024	Magic Sponge 629023
		Easy Care 629018	Diamond drill SB light 629095
		Easy Care Brightener 629019	
		Pro Care 629099	

Cut-out size



Colour range

This product is available in the standard colour range as listed in the appendix as well as in the special colours shown below:



SCHOCK

TYPOS D-100



TYPOS

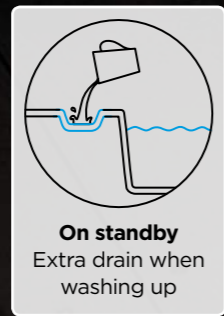



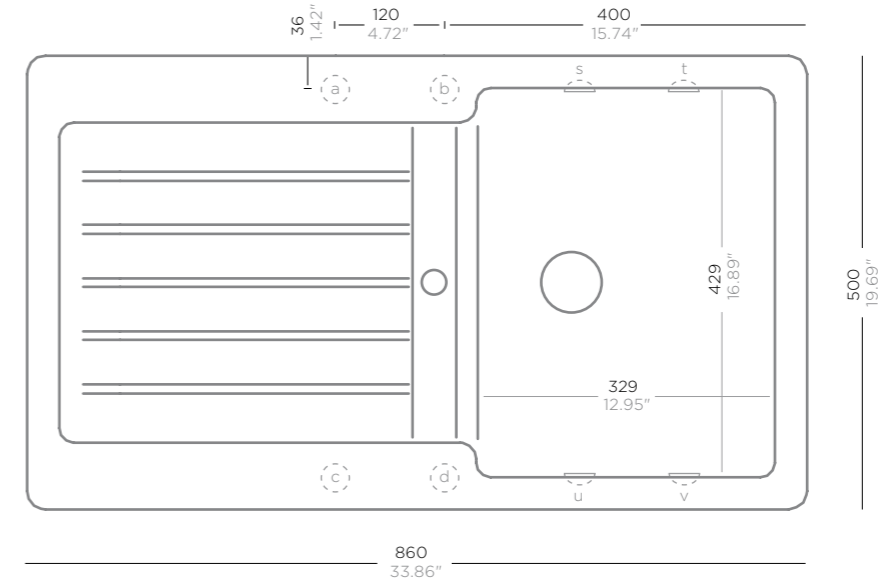

SCHOCK

TYPOS D-100



Article no.

Accessories

	TYP D100 A	 Manual drain kit 629872	Wire basket 629171
		Standard automatic drain kit 629873	LED-light 629024
	TYP D100 U	 Glass chopping board 629036A/U	Easy Care 629018
		Glass chopping board, white 629045A/U	Easy Care Brightener 629019
		Glass chopping board, black 629046A/U	Pro Care 629099
		Chopping board, bamboo 629044	Comfotouch 629830

Cut-out size



Colour range

This product is available in the standard colour range as listed in the appendix as well as in the special colours shown below:



SCHOCK

TYPOS D-100L



TYPOS

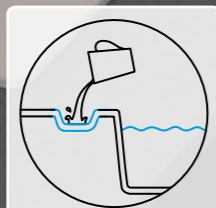

On standby
Extra drain when washing up

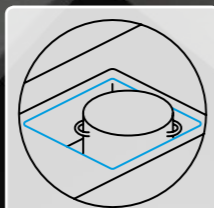

Go big
Extra volume for large pots

SCHOCK

TYPOS D-100L

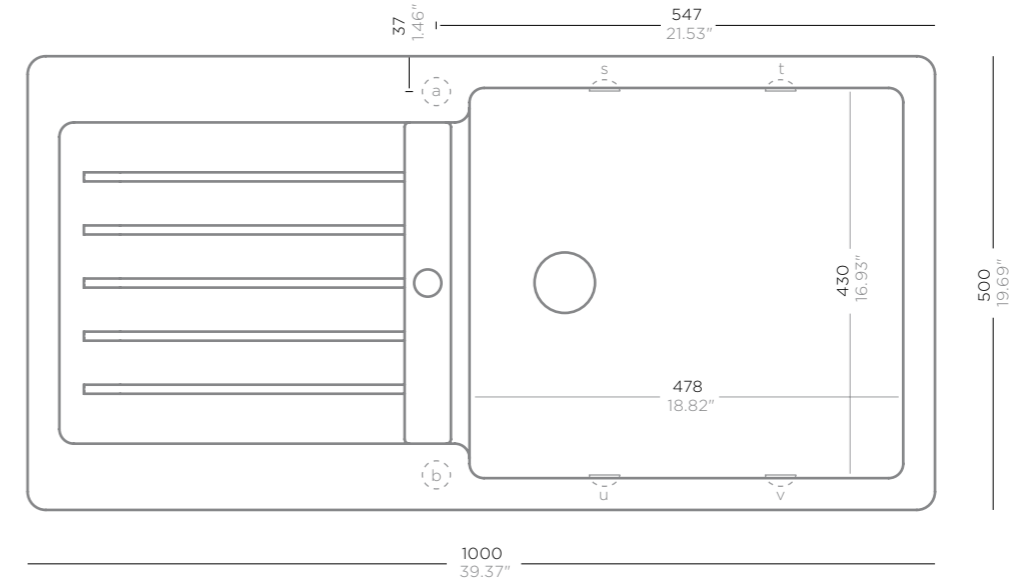

Article no.



TYP D100L A



Manual drain kit **629872**
Standard automatic drain kit **629873**



TYP D100L U



Glass chopping board **629036A/U**
Glass chopping board, white **629045A/U**

Glass chopping board, black **629046A/U**
Chopping board, bamboo **629044**

Accessories

Wire basket **629171**
LED-light **629024**

Easy Care **629018**
Easy Care Brightener **629019**

Pro Care **629099**
Comfotouch **629830**

Cut-out size



980 x 480
38.58" x 18.9"



986 x 486
38.82" x 19.13"

Colour range

This product is available in the standard colour range as listed in the appendix as well as in the special colours shown below:



Superwhite
01



Inox
12



Crema
14



Everest
26



Terra
38



Basalt
41



Concrete
42



Mocha
63

SCHOCK

TYPOS D-150S

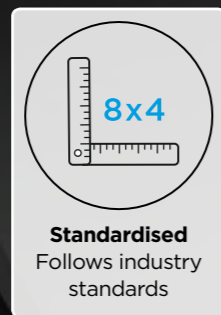

TYPOS



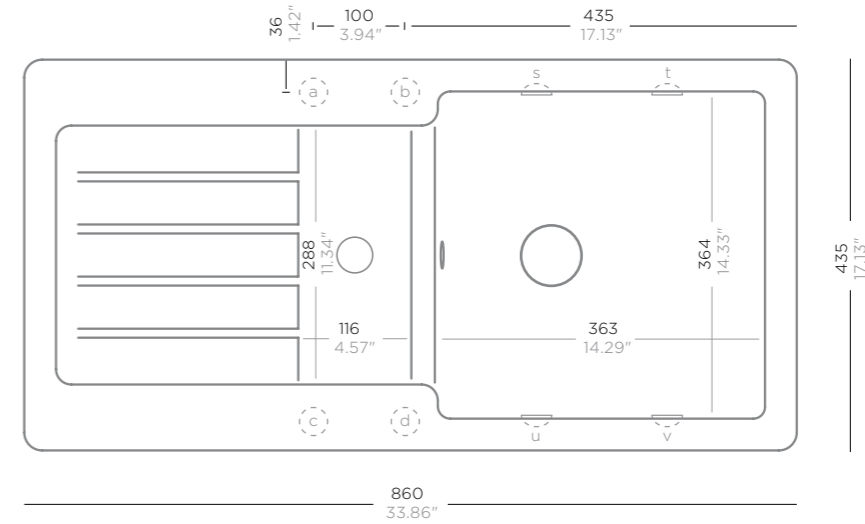

SCHOCK

TYPOS D-150S



Article no.

Accessories

	TYP D150S A	 Manual drain kit 629880	Comfotouch 629830
		Standard automatic drain kit 629881	Waste cap 628152
	TYP D150S U	 LED-light 629024	Magic Sponge 629023
		Easy Care 629018	Diamond drill SB light 629095
		Easy Care Brightener 629019	
		Pro Care 629099	

Cut-out size



Colour range

This product is available in the standard colour range as listed in the appendix as well as in the special colours shown below:



SCHOCK

TYPOS D-150



TYPOS

SCHOCK

TYPOS D-150

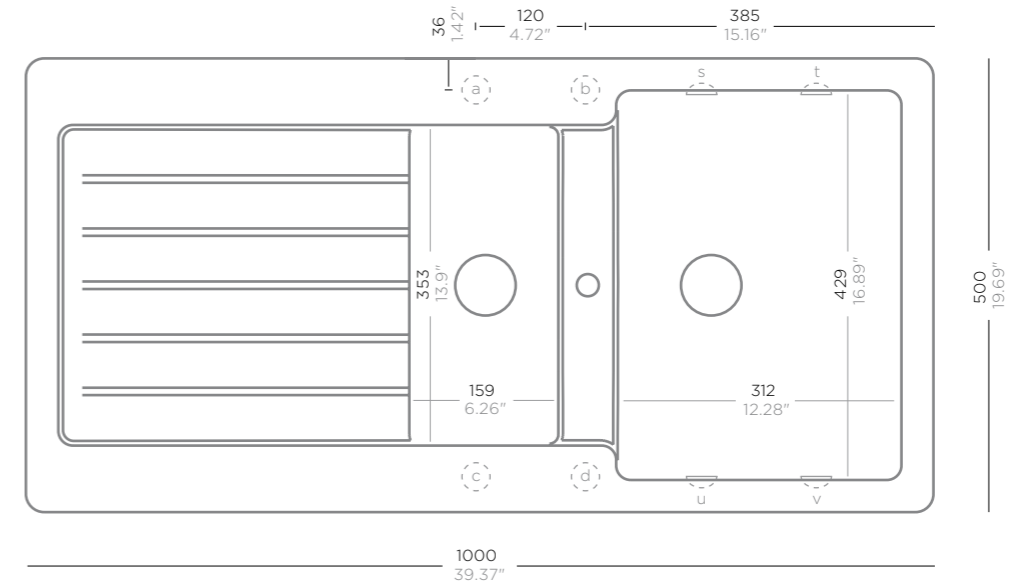

Article no.

TYP D150 A

TYP D150 U

Accessories

- Manual drain kit **629878**
- Standard automatic drain kit **629879**
- Glass chopping board **629036A/U**
- Glass chopping board, white **629045A/U**
- Glass chopping board, black **629046A/U**
- Chopping board, bamboo **629044**
- Strainer bowl **629043**
- LED-light **629024**
- Easy Care **629018**
- Easy Care Brightener **629019**
- Pro Care **629099**
- Comfotouch **629830**

Cut-out size



Colour range

This product is available in the standard colour range as listed in the appendix as well as in the special colours shown below:



SCHOCK

TYPOS D-200



TYPOS

SCHOCK

TYPOS D-200

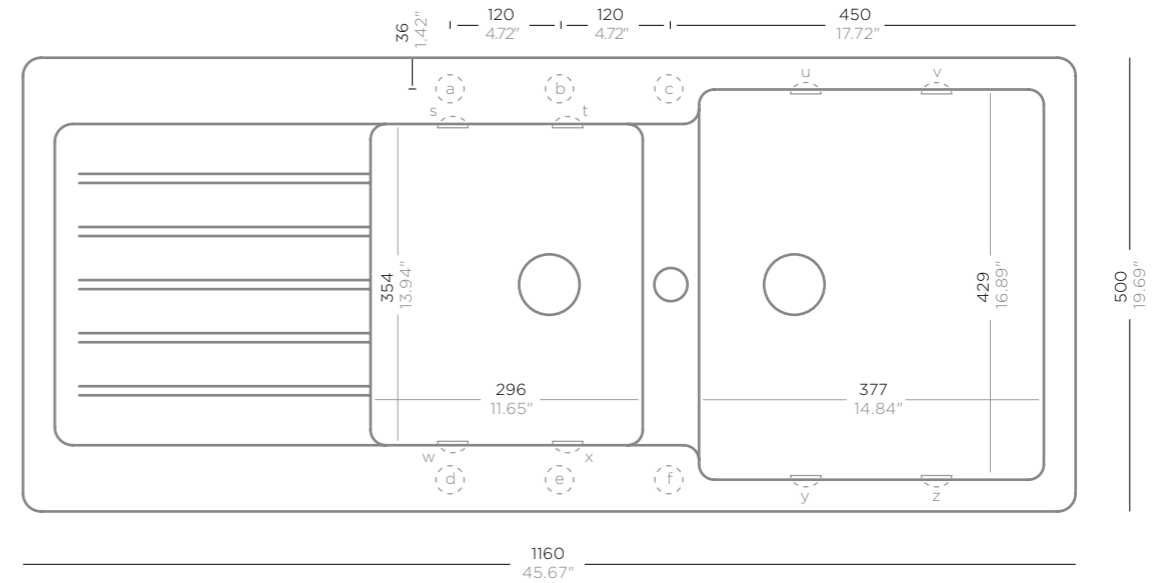

Article no.

TYP D200 A

Accessories

Manual drain kit **629878** Wire basket **629171**
 Standard automatic drain kit **629879** LED-light **629024**

TYP D200 U

Glass chopping board **629036A/U** Easy Care **629018**
 Glass chopping board, white **629045A/U** Easy Care Brightener **629019**

Glass chopping board, black **629046A/U** Pro Care **629099**
 Chopping board, bamboo **629044** Comfotouch **629830**

Cut-out size



Colour range

This product is available in the standard colour range as listed in the appendix as well as in the special colours shown below:

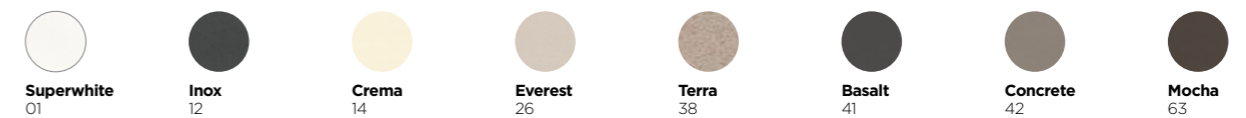

SCHOCK

TYPOS N-200



TYPOS

SCHOCK

TYPOS N-200

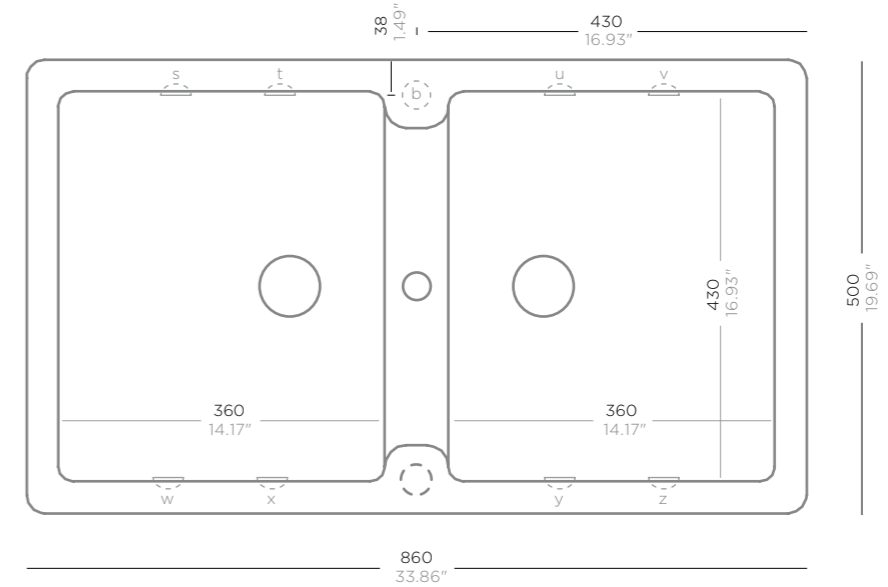













Article no.

TYP N200 A

TYP N200 U

Accessories

- | | | | |
|---|--|---|--|
|  | Manual drain kit 629878 |  | Wire basket 629171 |
|  | Standard automatic drain kit 629879 |  | LED-light 629024 |
|  | Glass chopping board 629036A/U |  | Easy Care 629018 |
|  | Glass chopping board, white 629045A/U |  | Easy Care Brightener 629019 |
|  | Glass chopping board, black 629046A/U |  | Pro Care 629099 |
|  | Chopping board, bamboo 629044 |  | Comfotouch 629830 |

Cut-out size



Colour range

This product is available in the standard colour range as listed in the appendix.

SCHOCK

TYPOS C-150



TYPOS

SCHOCK



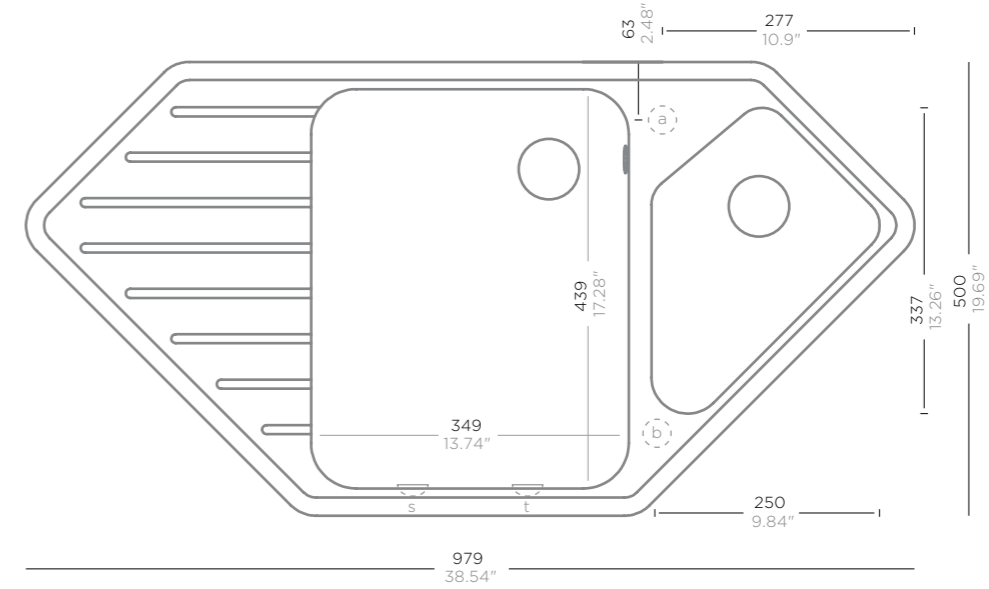









TYPOS C-150



Article no.

-  **TYP C150 A**
-  **TYP C150 U**

Accessories

-  Manual drain kit **629874**
-  Standard automatic drain kit **629875**
-  Glass chopping board **629036A/U**
-  Glass chopping board, white **629045A/U**
-  Glass chopping board, black **629046A/U**
-  Chopping board, bamboo **629044**
-  Strainer bowl **629244**
-  Wire basket **629170**
-  LED-light **629024**
-  Easy Care **629018**
-  Easy Care Brightener **629019**
-  Pro Care **629099**

Cut-out size



Colour range

This product is available in the standard colour range as listed in the appendix as well as in the special colours shown below:



Terra
38

SCHOCK

VALLEY | MAXIM N-100



VALLEY | MAXIM

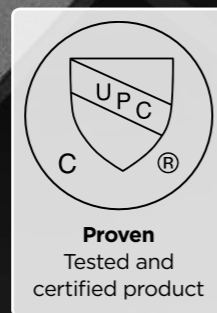

SCHOCK

VALLEY | MAXIM N-100

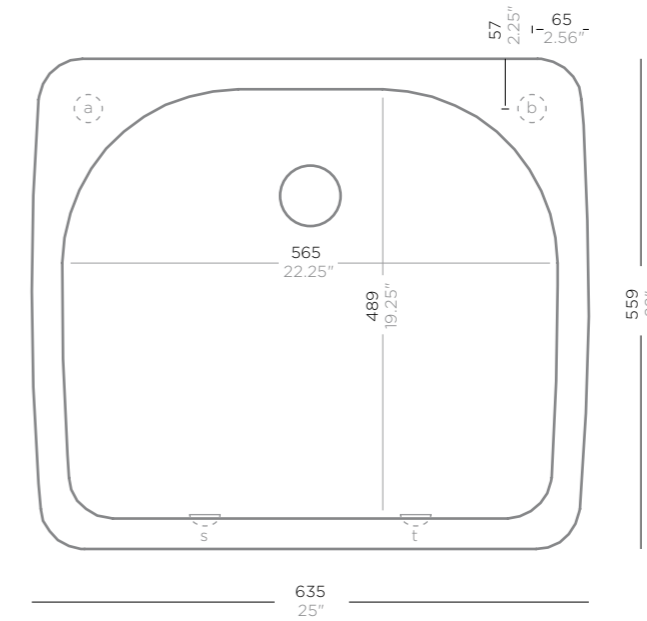

Article no.

 **VAL N100 A**
MAX N100 A

 **CD**
 **CTB**

Accessories

- Manual drain kit **629323**
- Easy Care **629018**
- Easy Care Brightener **629019**
- Pro Care **629099**
- Comfotouch **629830**
- Waste cap **628152**
- DurCare **629094**
- Magic Sponge **629023**

Cut-out size



Colour range

This product is available in the standard colour range as listed in the appendix.

SCHOCK

VALLEY | MAXIM N-100Y



VALLEY | MAXIM

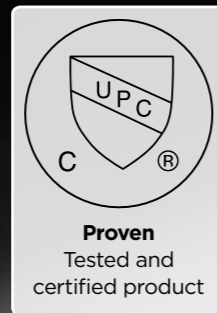

SCHOCK

VALLEY | MAXIM N-100Y

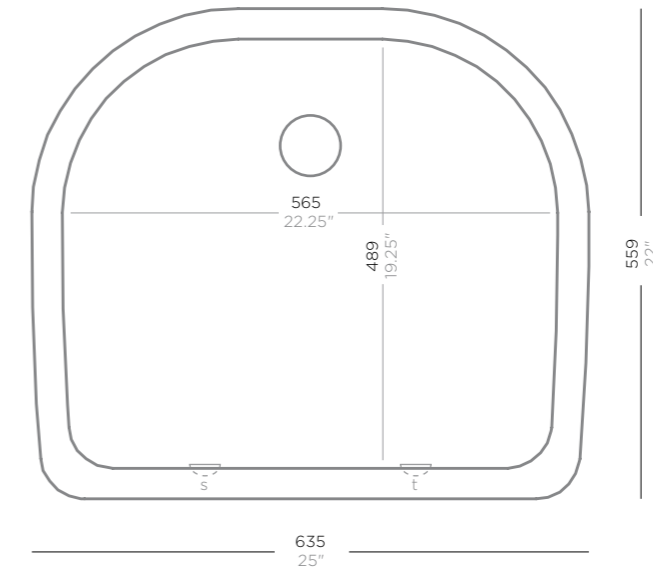

Article no.

- VAL N100Y U**
- MAX N100Y U**

Accessories

- Manual drain kit **629323**
- Easy Care **629018**
- Easy Care Brightener **629019**
- Pro Care **629099**
- Comfotouch **629830**
- Waste cap **628152**
- DurCare **629094**
- Magic Sponge **629023**

Cut-out size



Colour range

This product is available in the standard colour range as listed in the appendix.

SCHOCK

VENUS D-100



VENUS



SCHOCK

VENUS D-100

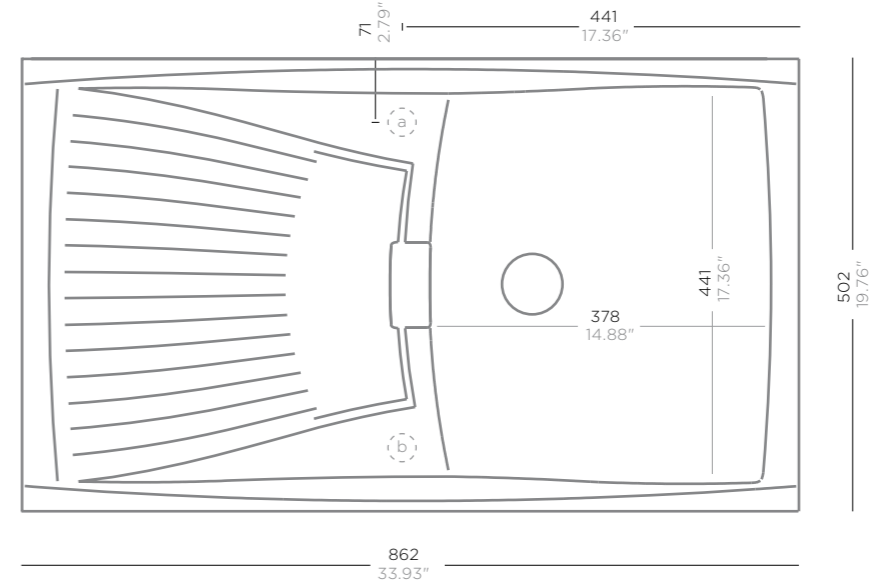

Article no.



VEN D100 A



Accessories

- | | |
|--|--|
| Manual drain kit 629376 | Waste cap 628152 |
| Standard automatic drain kit 629377 | Magic Sponge 629023 |
| Easy Care 629018 | Diamond drill SB light 629095 |
| Easy Care Brightener 629019 | |
| Pro Care 629099 | |
| Comfotouch 629830 | |

Cut-out size



Colour range

This product is available in the standard colour range as listed in the appendix.

SCHOCK

VENUS D-150



VENUS

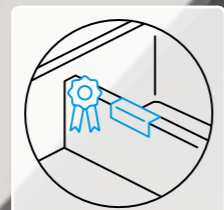

Eye catcher
Patented over-
flow design

SCHOCK

VENUS D-150

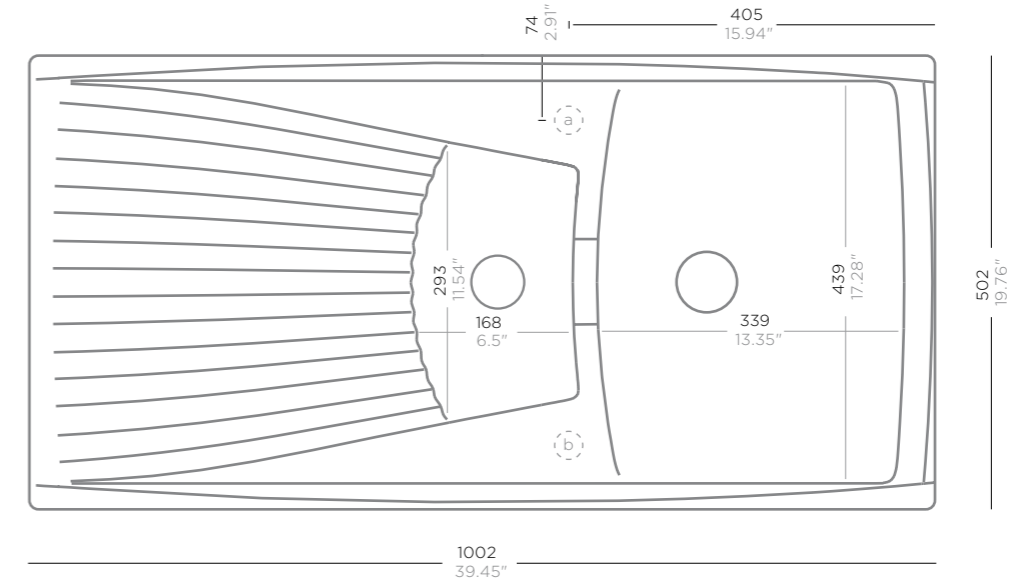

Article no.

 **VEN D150 A** 

Accessories

- Manual drain kit **629378**
- Standard automatic drain kit **629379**
- Easy Care **629018**
- Easy Care Brightener **629019**
- Pro Care **629099**
- Comfotouch **629830**
- Waste cap **628152**
- Magic Sponge **629023**
- Diamond drill SB light **629095**

Cut-out size

 980 x 480
38.58" x 18.9"

Colour range

This product is available in the standard colour range as listed in the appendix.

SCHOCK

VENUS D-200

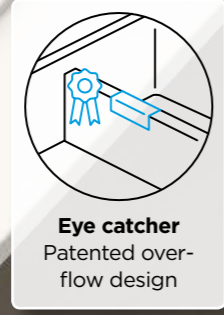

SCHOCK

VENUS D-200

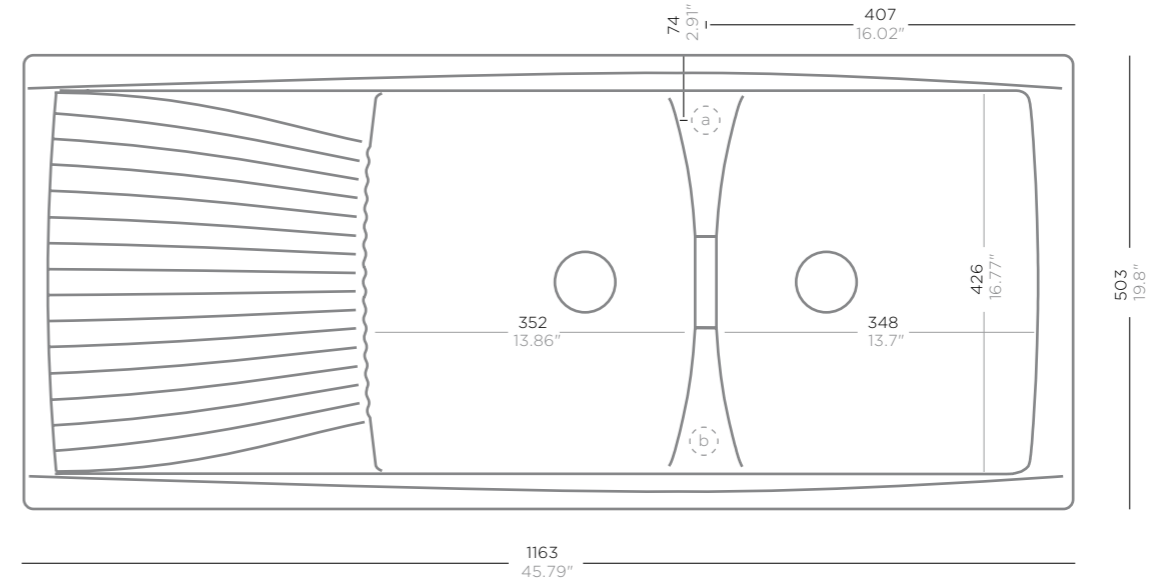

VENUS



Article no.

 **VEN D200 A** 

Accessories

- Manual drain kit **629380**
- Standard automatic drain kit **629381**
- Easy Care **629018**
- Easy Care Brightener **629019**
- Pro Care **629099**
- Comfotouch **629830**
- Waste cap **628152**
- Magic Sponge **629023**
- Diamond drill SB light **629095**

Cut-out size



Colour range

This product is available in the standard colour range as listed in the appendix.

SCHOCK

VENUS N-200

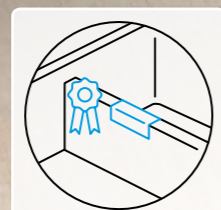

Eye catcher
Patented over-
flow design

SCHOCK

VENUS N-200

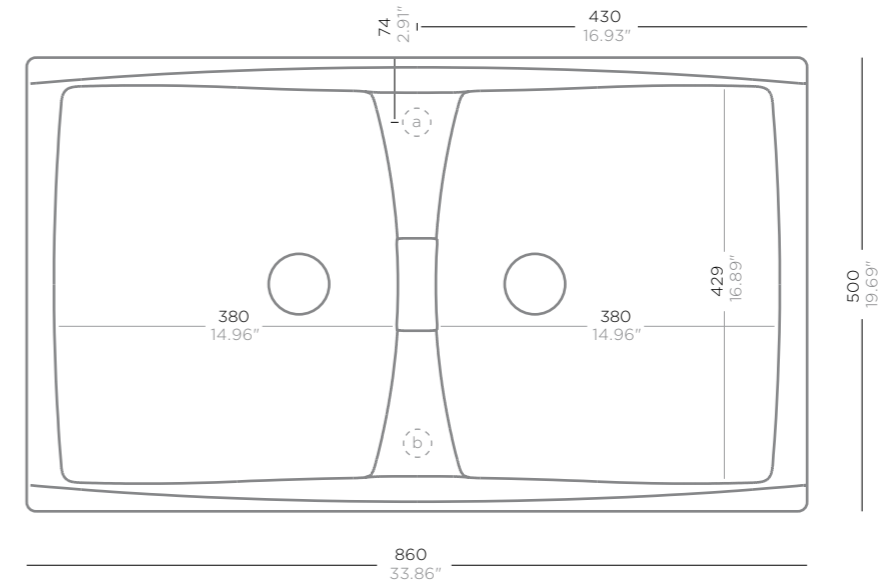

Article no.

 **VEN N200 A** 

Accessories

- | | | | |
|------------------------------------|---------------|------------------------------|---------------|
| Manual drain kit | 629380 | Waste cap | 628152 |
| Standard automatic drain kit | 629381 | Magic Sponge | 629023 |
| Easy Care | 629018 | Diamond drill SB light | 629095 |
| Easy Care Brightener | 629019 | | |
| Pro Care | 629099 | | |
| Comfotouch | 629830 | | |

Cut-out size

 **840 x 480**
33.07" x 18.9"

Colour range

This product is available in the standard colour range as listed in the appendix.

SCHOCK

VIOLA D-100S



VIOLA

SCHOCK

VIOLA D-100S

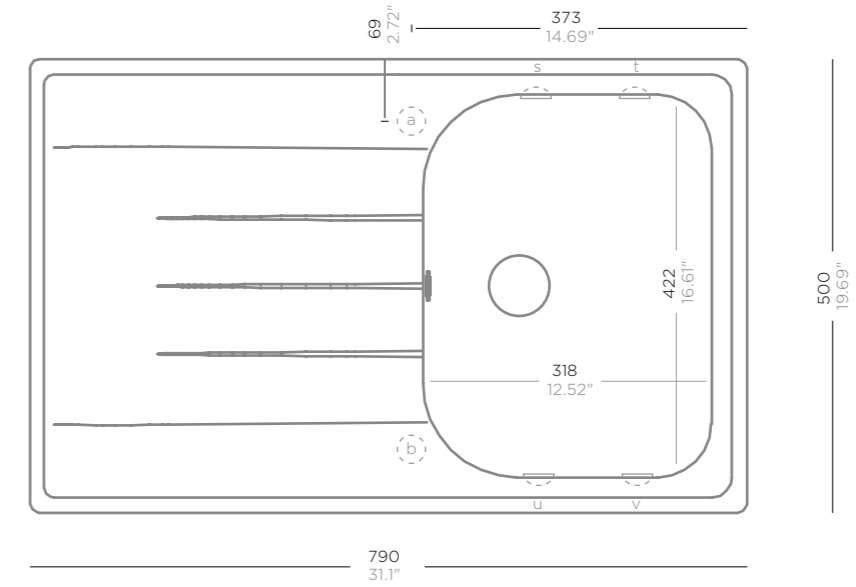

Article no.

VIO D100S A

VIO D100S U

Accessories

- Manual drain kit** **629870**
 Easy Care **629018**
- Standard automatic drain kit** **629871**
 Easy Care Brightener **629019**
- Glass chopping board** **629036A/U**
 Pro Care **629099**
- Glass chopping board, white** **629045A/U**
 Comfotouch **629830**
- Glass chopping board, black** **629046A/U**
 Waste cap **628152**
- Chopping board, bamboo** **629044**
 DurCare **629094**

Cut-out size



Colour range

This product is available in the standard colour range as listed in the appendix.

SCHOCK

VIOLA D-100



SCHOCK

VIOLA D-100

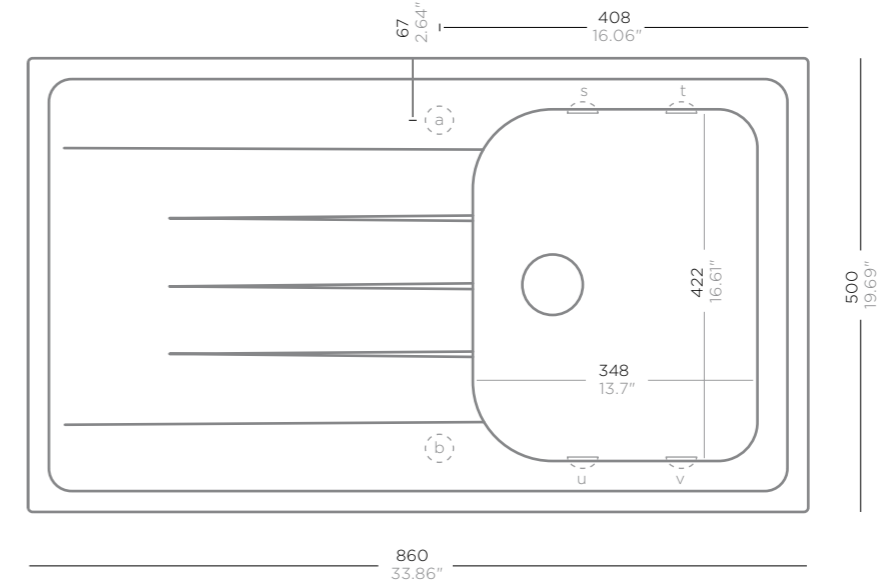

Article no.

VIO D100 A

VIO D100 U

Accessories

Manual drain kit **629870**

Standard automatic drain kit **629871**

Glass chopping board **629036A/U**

Glass chopping board, white **629045A/U**

Glass chopping board, black **629046A/U**

Chopping board, bamboo **629044**

LED-light **629024**

Easy Care **629018**

Easy Care Brightener **629019**

Pro Care **629099**

Comfotouch **629830**

Waste cap **628152**

Cut-out size

840 x 480
33.07" x 18.9"

845 x 481
33.27" x 18.94"

Colour range

This product is available in the standard colour range as listed in the appendix.

SCHOCK

VIOLA D-100L



VIOLA

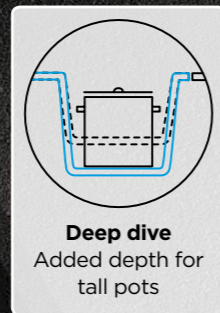

SCHOCK

VIOLA D-100L

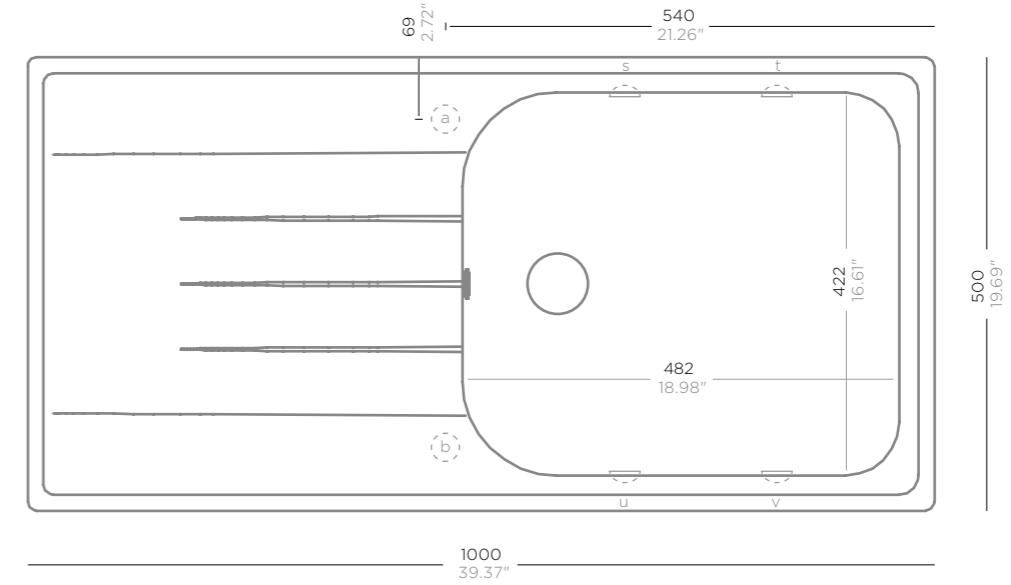

VIOLA



Article no.



VIO D100L A



Manual drain kit **629870**
Standard automatic drain kit **629871**



VIO D100L U



Glass chopping board **629036A/U**
Glass chopping board, white **629045A/U**

Glass chopping board, black **629046A/U**
Chopping board, bamboo **629044**

LED-light **629024**
Easy Care **629018**
Easy Care Brightener **629019**
Pro Care **629099**
Comfotouch **629830**
Waste cap **628152**

Cut-out size



Colour range

This product is available in the standard colour range as listed in the appendix.

SCHOCK

VIOLA D-150



SCHOCK

VIOLA D-150

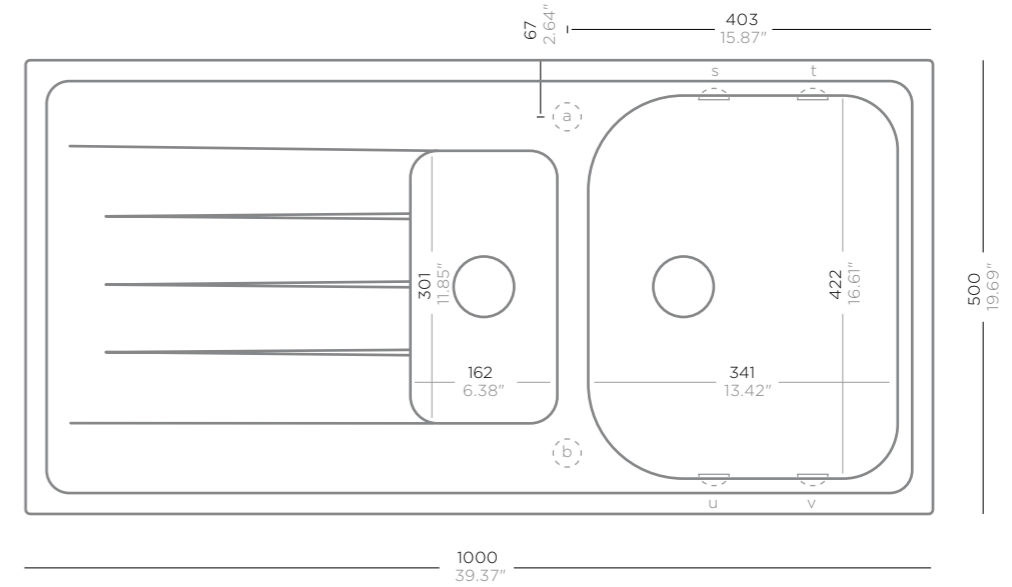





VIOLA



Article no.

Accessories

 VIO D150 A		Manual drain kit 629874	LED-light 629024
		Standard automatic drain kit 629875	Easy Care 629018
 VIO D150 U		Glass chopping board 629036A/U	Easy Care Brightener 629019
		Glass chopping board, white 629045A/U	Pro Care 629099
		Glass chopping board, black 629046A/U	Comfotouch 629830
		Chopping board, bamboo 629044	Waste cap 628152

Cut-out size



Colour range

This product is available in the standard colour range as listed in the appendix.

SCHOCK

VIOLA D-200



VIOLA

SCHOCK

VIOLA D-200

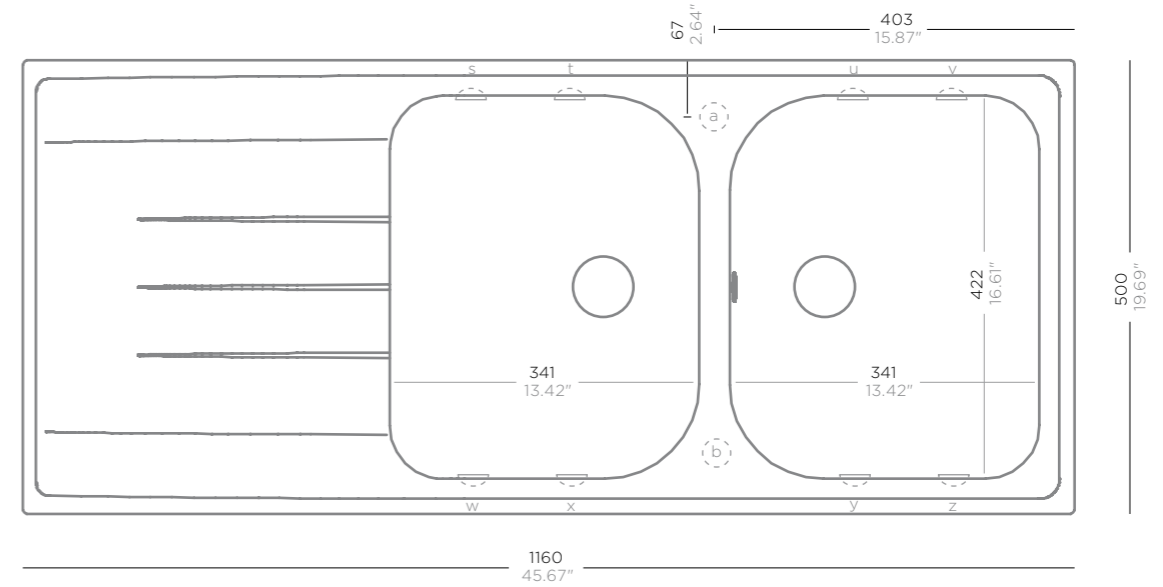

Article no.



VIO D200 A



Manual drain kit **629874**
 Standard automatic drain kit **629875**



VIO D200 U



Glass chopping board **629036A/U**
 Glass chopping board, white **629045A/U**

Glass chopping board, black **629046A/U**
 Chopping board, bamboo **629044**

LED-light **629024**
 Easy Care **629018**

Easy Care Brightener **629019**
 Pro Care **629099**

Comfotouch **629830**
 Waste cap **628152**

Cut-out size



1140 x 480
 44.88" x 18.9"



1145 x 481
 45.08" x 18.94"

Colour range

This product is available in the standard colour range as listed in the appendix.

SCHOCK

WATERFALL D-100



WATERFALL



On standby
Extra drain when washing up

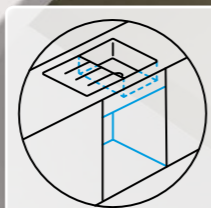

Unobtrusive
Needs less space in the cabinet





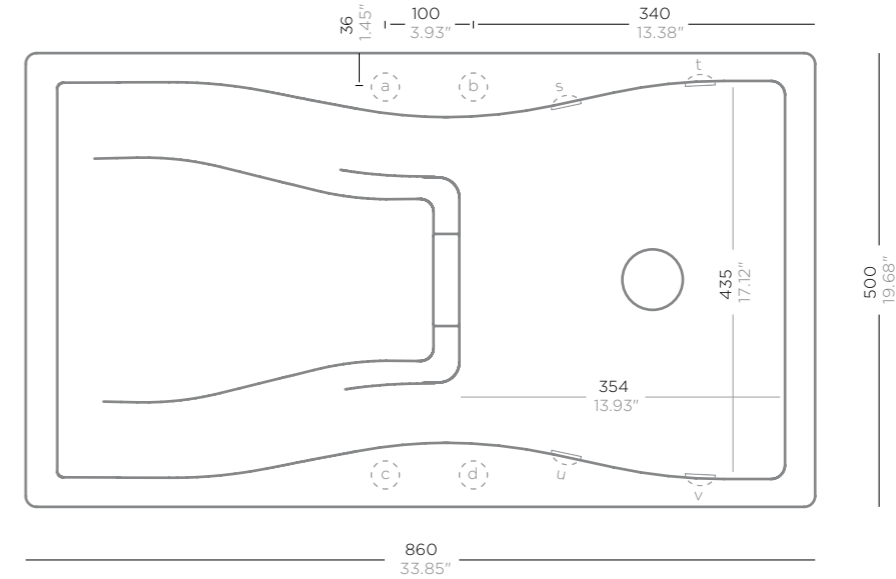



SCHOCK

WATERFALL D-100



Article no.

Accessories

	WAT D100 A		Manual drain kit 629370	Glass chopping board, black .. 629046A/U/FB
			Standard automatic drain kit 629371	LED-light 629024
	WAT D100 U		Premium automatic drain kit 629371PD	Indutherm 629100
			Visible parts in Copper 629371COP	Easy Care 629018
	WAT D100 FB		Glass chopping board 629036A/U	Easy Care Brightener 629019
			Glass chopping board, white .. 629045A/U/FB	Pro Care 629099

Cut-out size



Colour range

This product is available in the standard colour range as listed in the appendix.

SCHOCK

WATERFALL D-150



WATERFALL

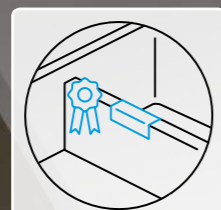

Eye catcher
Patented over-
flow design





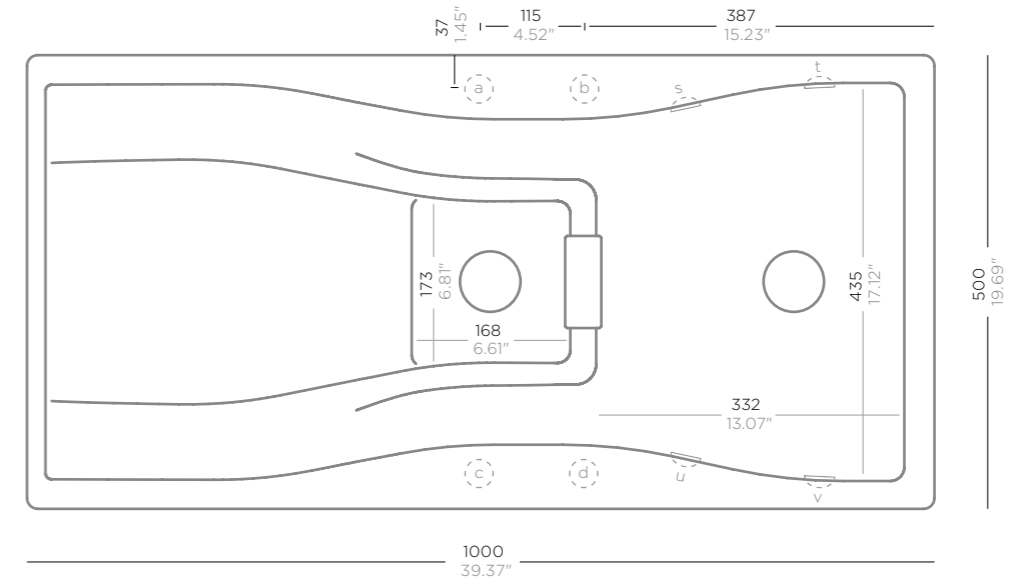



SCHOCK

WATERFALL D-150



Article no.

Accessories

	WAT D150 A		Manual drain kit 629365	Glass chopping board, black .. 629046A/U/FB
			Standard automatic drain kit 629366	Strainer bowl, white/green 629049
	WAT D150 U		Premium automatic drain kit 629366PD	LED-light 629024
			Visible parts in Copper 629366COP	Indutherm 629100
	WAT D150 FB		Glass chopping board 629036A/U	Easy Care 629018
			Glass chopping board, white .. 629045A/U/FB	Easy Care Brightener 629019

Cut-out size

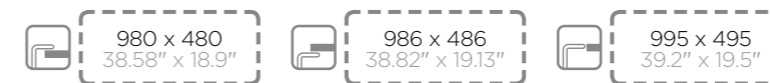

Colour range

This product is available in the standard colour range as listed in the appendix.

SCHOCK

WATERFALL D-200

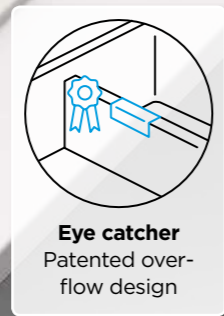

Eye catcher
Patented over-flow design

SCHOCK

WATERFALL D-200

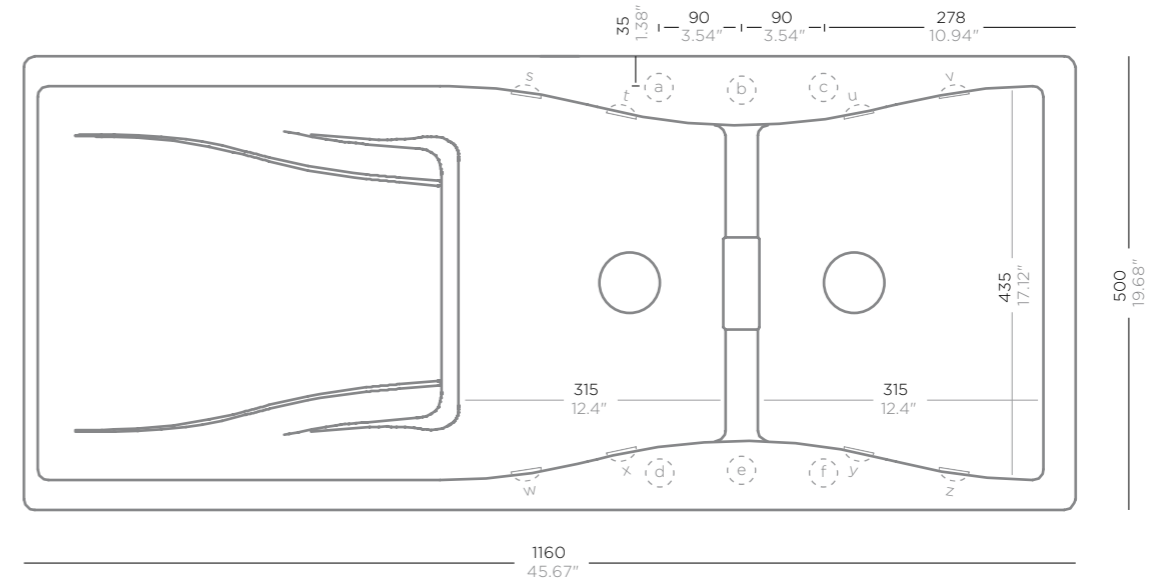









WATERFALL





Article no.

Accessories

	WAT D200 A		Manual drain kit	629365	LED-light	629024
			Standard automatic drain kit	629366	Indutherm	629100
	WAT D200 U		Premium automatic drain kit	629366PD	Easy Care	629018
			Glass chopping board	629036A/U	Easy Care Brightener	629019
	WAT D200 FB		Glass chopping board, white ..	629045A/U/FB	Pro Care	629099
			Glass chopping board, black ..	629046A/U/FB	Comfotouch	629830

Cut-out size

	1140 x 480 44.88" x 18.9"		1146 x 486 45.12" x 19.13"		1153 x 493 45.39" x 19.41"
---	------------------------------	---	-------------------------------	---	-------------------------------

Colour range

This product is available in the standard colour range as listed in the appendix.

SCHOCK

WEMBLEY D-100



Kitchen aid
Functional accessories

Curves all round
Design emphasis on large radii

Perfect Drain
Less chrome, more colour

SCHOCK



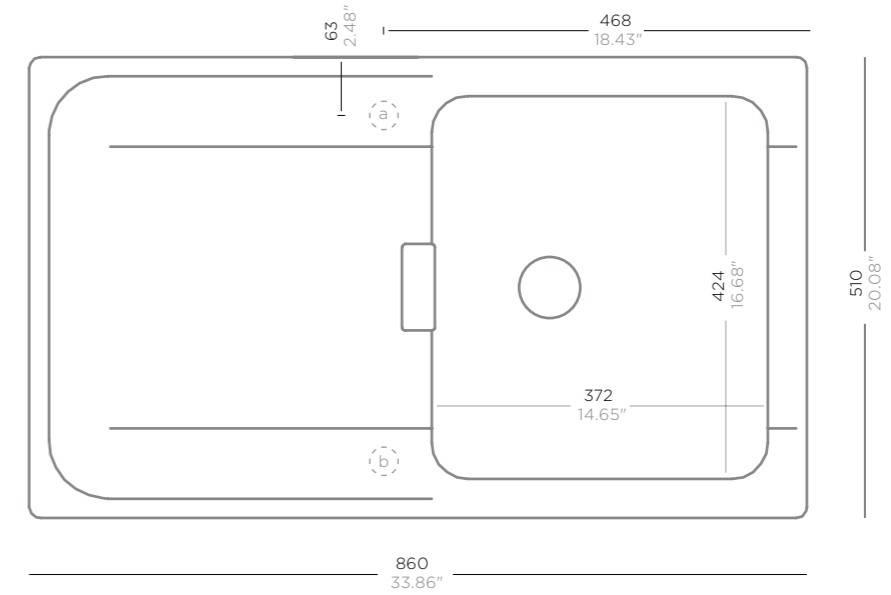



WEMBLEY D-100



WEMBLEY

Article no.

Accessories

 WEM D100 A 	Manual drain kit 629613 Standard automatic drain kit 629614	Chopping board, wood 629134 LED-light 629024
 WEM D100 U 	Premium automatic drain kit 629614PD Visible parts in Copper 629614COP	Easy Care 629018 Easy Care Brightener 629019
 WEM D100 FB 	Visible parts in Gunmetal 629614GUM Visible parts stainless steel 629614EDM	Pro Care 629099 Comfotouch 629830

Cut-out size



Colour range

This product is available in the standard colour range as listed in the appendix.

SCHOCK

WEMBLEY D-150



Kitchen aid
Functional accessories

Curves all round
Design emphasis on large radii

Perfect Drain
Less chrome, more colour

SCHOCK

WEMBLEY D-150

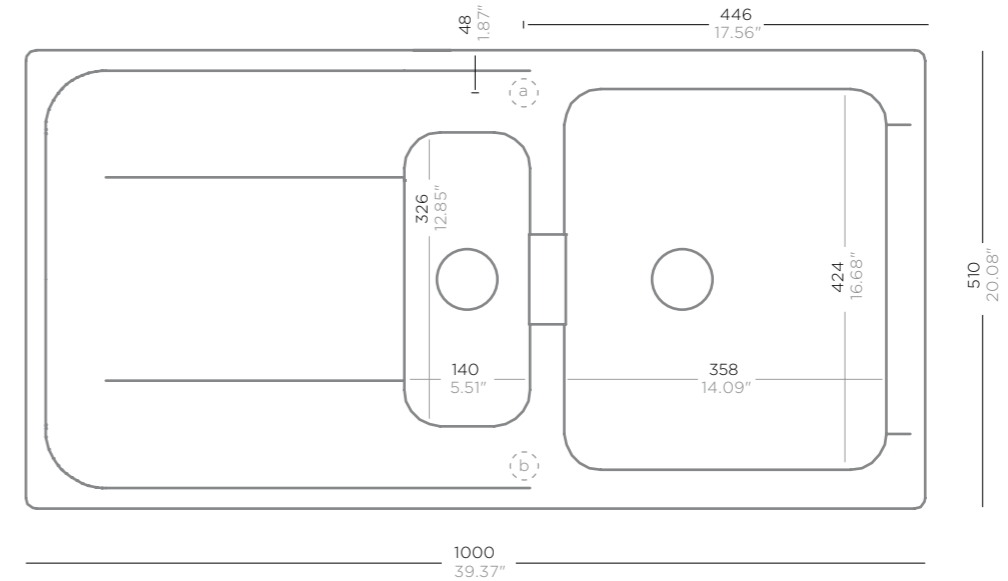

WEMBLEY



Article no.

Accessories

	WEM D150 A		Manual drain kit 629617	Chopping board, wood 629134
			Standard automatic drain kit 629618	Strainer bowl 629132
	WEM D150 U		Premium automatic drain kit 629618PD	LED-light 629024
			Visible parts in Copper 629618COP	Easy Care 629018
	WEM D150 FB		Visible parts in Gunmetal 629618GUM	Easy Care Brightener 629019
			Visible parts stainless steel 629618EDM	Pro Care 629099

Cut-out size

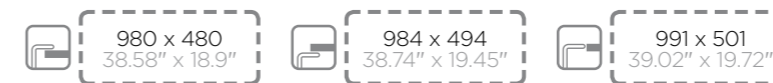

Colour range

This product is available in the standard colour range as listed in the appendix.

SCHOCK

WEMBLEY D-200



Kitchen aid
Functional accessories

Curves all round
Design emphasis on large radii

Perfect Drain
Less chrome, more colour

SCHOCK

WEMBLEY D-200

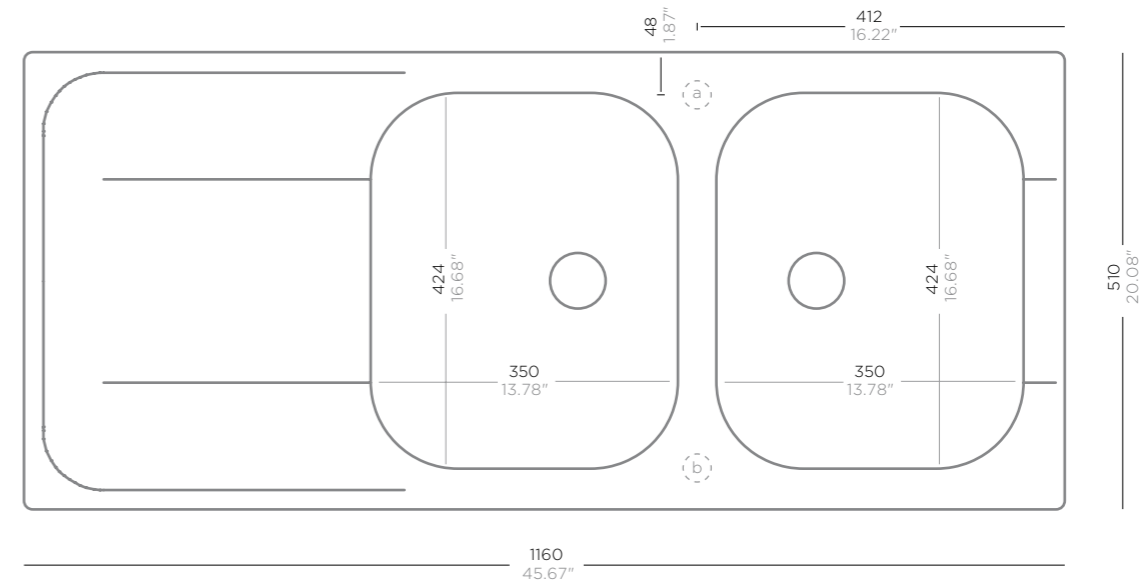

WEMBLEY



Article no.

Accessories

	WEM D200 A		Manual drain kit 629617	Chopping board, wood 629134
			Standard automatic drain kit 629618	LED-light 629024
	WEM D200 U		Premium automatic drain kit 629618PD	Easy Care 629018
			Visible parts in Copper 629618COP	Easy Care Brightener 629019
	WEM D200 FB		Visible parts in Gunmetal 629618GUM	Pro Care 629099
			Visible parts stainless steel 629618EDM	Comfotouch 629830

Cut-out size



Colour range

This product is available in the standard colour range as listed in the appendix.

MIXER MIXER
MIXER TAPS

HANDMADE IN GERMANY

SCHOCK

CRISTADUR® The SCHÖCK premium material is truly captivating with its extremely fine and smooth structure and lovely shimmering surface, which provides nowhere for grime to take hold - the dirt simply runs off. So it's not just the way they look but also how easy they are to clean that makes these models a luxury that becomes any kitchen.

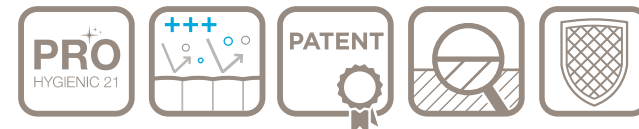

	CRISTADUR®														NATURE		CRISTALITE®													SPECIAL COLOUR
	Puro	Vintage	Bronze	Stone	Magnolia	Carbonium	Magma	Polaris	Rouge	Indigo	Silverstone	Kaiserstein	Rockenstein	Onyx	Nero	Alpina	Croma	Moonstone	Sabbia	Superwhite	Terra	Inox	Crema	Everest	Asphalt	Concrete	Mocha	Gunmetal		
ARCADA	●	●	●	●	●	●	●	○						●	●	○	●	●	●	○			●	●	●	●	●			
ARES														●	●	○	●	●	●	○										
COSMO														●	●	○	●	●	●	○				●			●	●		
DION	●	●	●	●	●	●	●	○						●	●	○	●	●	●	○								●		
FONOS														●	●	○	●	●	●	○							●	●		
KAVUS														●	●	○	●	●	●	○							●	●		
LEVA														●	●	○	●	●	●	○		●	●	●	●	●	●	●		
NAPOS														●	●	○	●	●	●	○							●	●		
NEILOS														●	●	○	●	●	●	○								●		
NEOS														●	●	○	●	●	●	○		●	●	●	●	●	●	●		
NIMBUS	●	●	●	●	●	●	●	○						●	●	○	●	●	●	○							●	●		
PIA														●	●	○	●	●	●	○				●						
PIEGA	●	●	●	●	●	●	●	○						●	●	○	●	●	●	○										
PILA	●	●	●	●	●	●	●	○						●	●	○	●	●	●	○										
PLUTOS	●	●	●	●	●	●	●	○	●	●				●	●	○	●	●	●	○							●	●		
SC-50	●	●	●	●	●	●	●	○	●	●		●	●	●	●	○	●	●	●	○		●	●	●	●	●	●	●		
SC-90	●	●	●	●	●	●	●	○	●	●		●	●	●	●	○	●	●	●	○		●	●	●	●	●	●	●		
SC-200	●	●	●	●	●	●	●	○	●	●		●	●	●	●	○	●	●	●	○		●	●	●	●	●	●	●		
SC-300	●	●	●	●	●	●	●	○	●	●		●	●	●	●	○	●	●	●	○		●	●	●	●	●	●	●		
SC-510	●	●	●	●	●	●	●	○	●	●	●	●	●	●	●	○	●	●	●	○	●	●	●	●	●	●	●	●		
SC-520	●	●	●	●	●	●	●	○	●	●	●	●	●	●	●	○	●	●	●	○	●	●	●	●	●	●	●	●		
SC-530	●	●	●	●	●	●	●	○	●	●	●	●	●	●	●	○	●	●	●	○	●	●	●	●	●	●	●	●		
SC-540	●	●	●	●	●	●	●	○	●	●	●	●	●	●	●	○	●	●	●	○	●	●	●	●	●	●	●	●		
SC-550	●	●	●	●	●	●	●	○	●	●	●	●	●	●	●	○	●	●	●	○	●	●	●	●	●	●	●	●		
SIMI														●	●	○	●	●	●	○		●	●	●	●	●	●	●		
SONO														●	●	○	●	●	●	○		●	●	●	●	●	●	●		
VITUS														●	●	○	●	●	●	○		●	●	●	●	●	●	●		
WELLUS	●	●	●	●	●	●	●	○						●	●	○	●	●	●	○		●	●	●	●	●	●	●		

CRISTALITE® The on-trend material from SCHÖCK is a popular classic around the globe and has recently been optimised once more in the course of a multi-year R&D effort: the slightly rough, stony surface of CRISTALITE® is now even tougher than before and embodies the enduring pleasure of cooking.

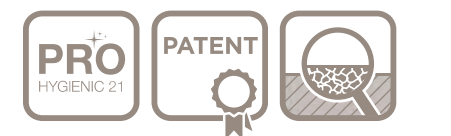



ONLINESHOP



**SCHOCK spare parts for sinks and mixer taps,
as well as care products can be found in the spare parts shop.**

Visit the spare parts shop using
the QR code or go to www.schock.de/shop

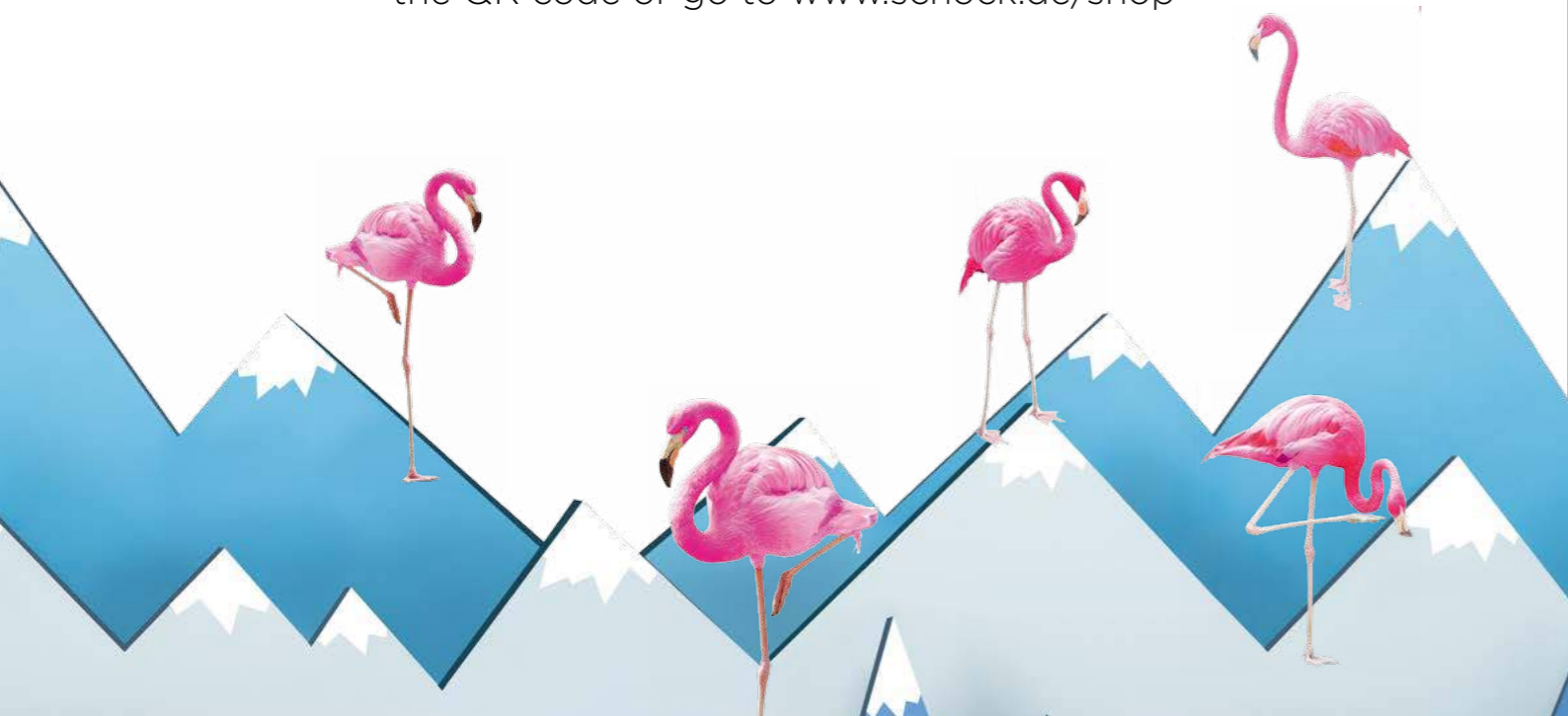

OVERVIEW MIXER TAPS & SOAP DISPENSERS

OVERVIEW
MIXER TAPS &
SOAP DISPENSERS

SCHOCK

SCHOCK

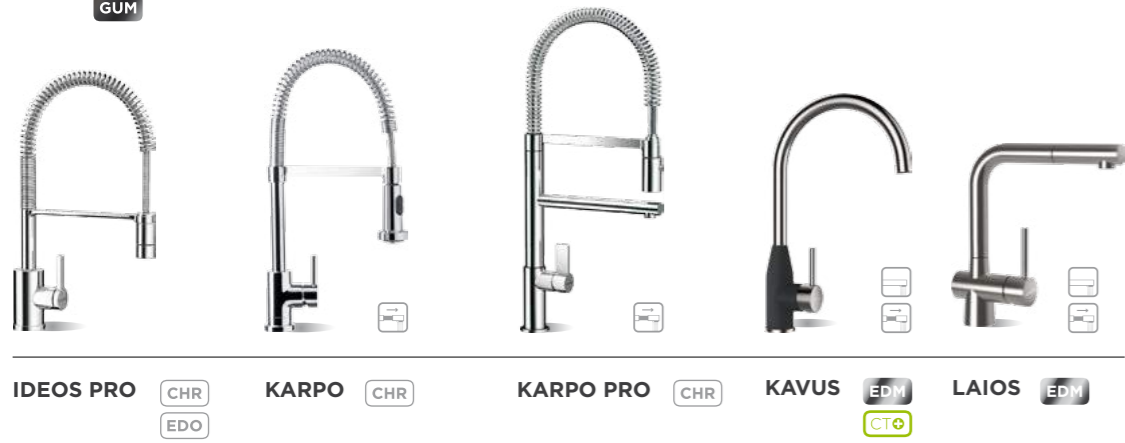
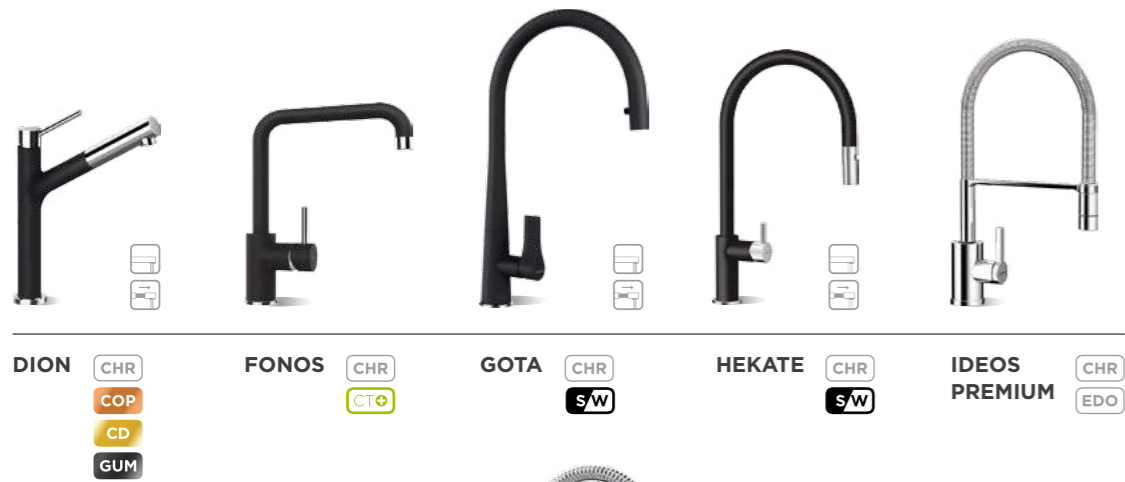

SCHOCK

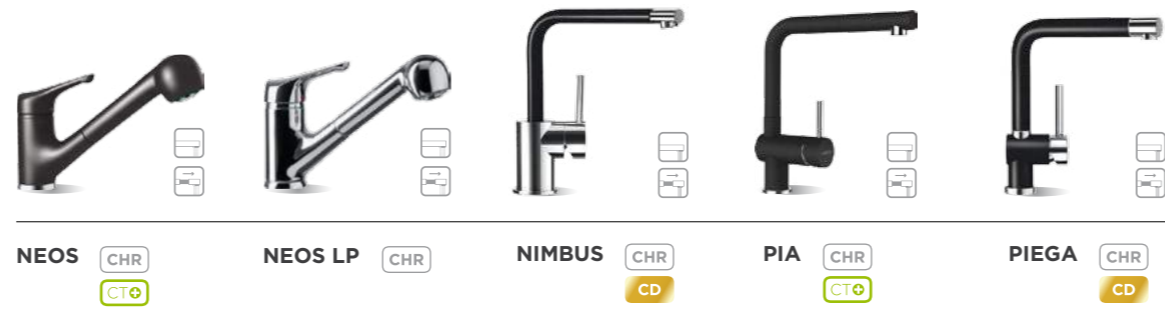

SCHOCK

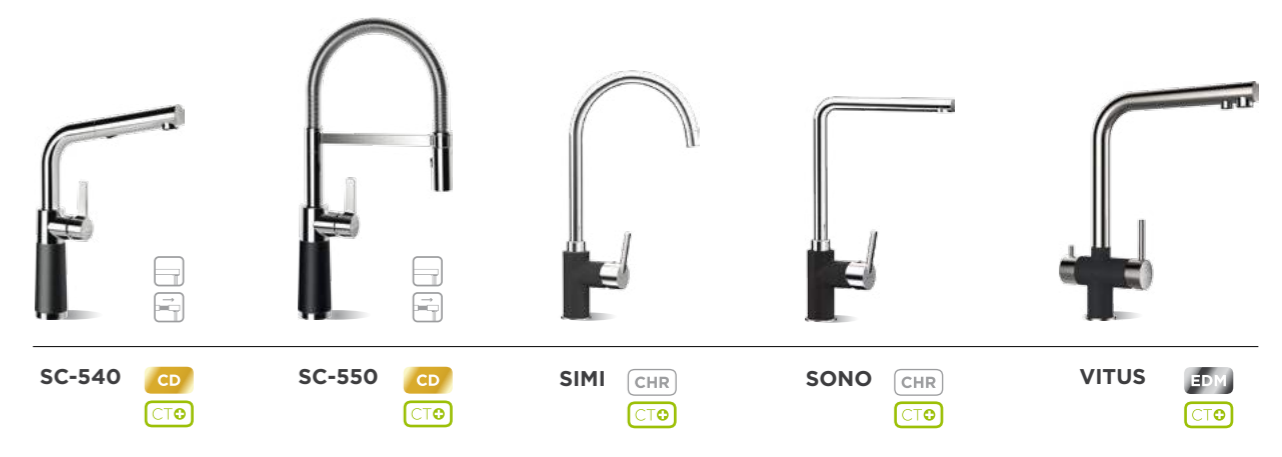

SOAP DISPENSERS



CHR Chrome **EDO** Stainless steel look **COP** Copper **CAB** Carbon **GUM** Gunmetal

EDM Solid stainless steel **SW** Black or white **CD** CRISTADUR® **CT** CRISTALITE®

SCHOCK

SCHOCK ALTOS



SCHOCK ALTOS

SCHOCK

SCHOCK ALTOS

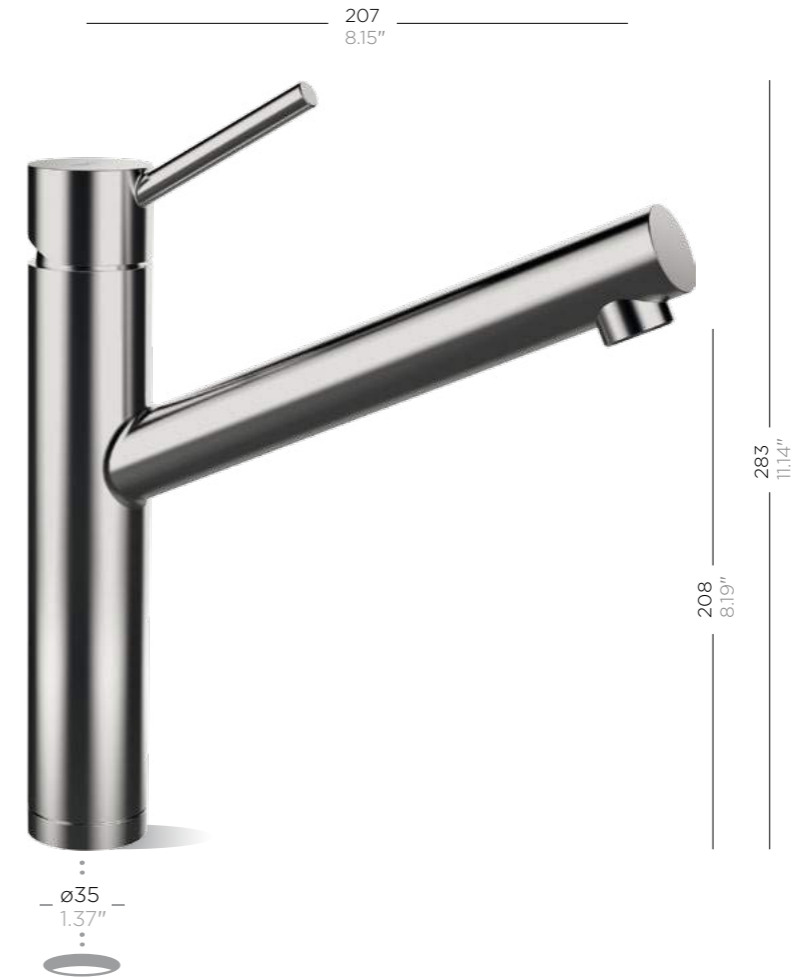

Video



www.schock.de/en/easy-altos

Materials



Solide Stainless Steel
EDM

Article no.

529000 + Code

SCHOCK

SCHOCK ALTOS

PULL-OUT



SCHOCK ALTOS PULL-OUT



Get more done
Ergonomic
design

SCHOCK

SCHOCK ALTOS

PULL-OUT



SCHOCK ALTOS PULL-OUT

Video



www.schock.de/en/easy-altos

Materials



Solide Stainless Steel
EDM

Article no.

529120 + Code

SCHOCK

SCHOCK ALTOS LP



SCHOCK ALTOS LP



Stainless steel
Long lasting and
hygienic

SCHOCK

SCHOCK ALTOS LP

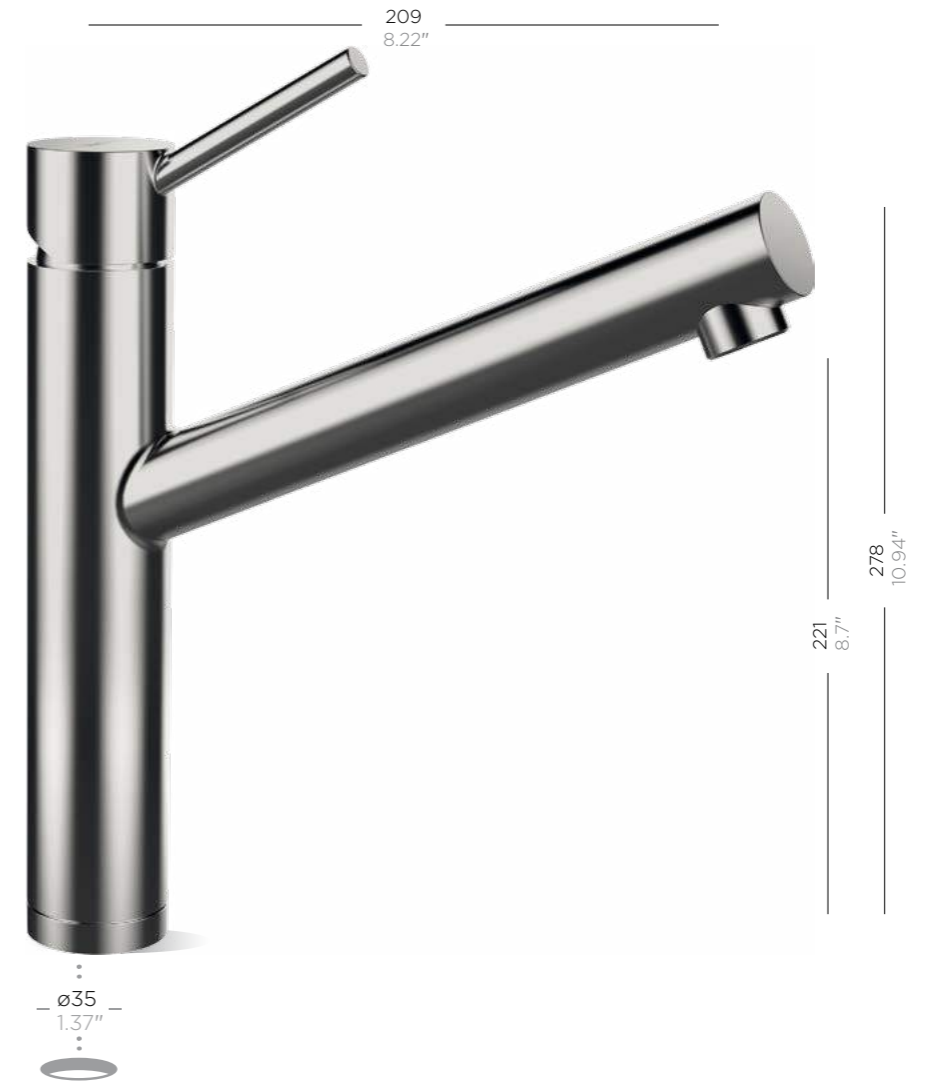

Video



www.schock.de/en/easy-altoslp

Materials



Solide Stainless Steel
EDM

Article no.

529003 + Code

SCHOCK

SCHOCK ALTOS LP

PULL-OUT



SCHOCK ALTOS LP PULL-OUT



Get more done
Ergonomic design



Stainless steel
Long lasting and hygienic

SCHOCK

SCHOCK ALTOS LP

PULL-OUT



Video



www.schock.de/en/easy-altoslp

Materials



Solide Stainless Steel
EDM

Article no.

529123 + Code

SCHOCK

SCHOCK ALTOS S



SCHOCK ALTOS S

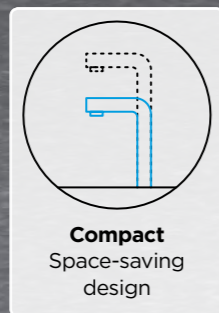

SCHOCK

SCHOCK ALTOS S



Video



www.schock.de/en/easy-altos

Materials



Solide Stainless Steel
EDM

Article no.

530000 + Code

SCHOCK

SCHOCK ALTOS S

PULL-OUT



SCHOCK ALTOS S PULL-OUT



Get more done
Ergonomic design



Stainless steel
Long lasting and hygienic

SCHOCK

SCHOCK ALTOS S

PULL-OUT



Video



www.schock.de/en/easy-altoss

Materials



Solide Stainless Steel
EDM

Article no.

530120 + Code

SCHOCK

SCHOCK ALTOS W



SCHOCK ALTOS W

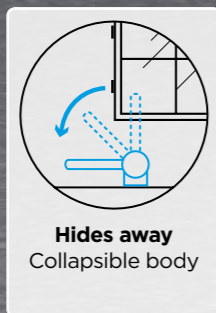

Hides away
Collapsible body



Stainless steel
Long lasting and
hygienic

SCHOCK

SCHOCK ALTOS W



Video



www.schock.de/en/easy-altosw

Materials



Solide Stainless Steel
EDM

Article no.

529005 + Code

SCHOCK

SCHOCK ALTOS W

PULL-OUT



SCHOCK ALTOS W PULL-OUT



Hides away
Collapsible body



Stainless steel
Long lasting and
hygienic

SCHOCK

SCHOCK ALTOS W

PULL-OUT



Video



www.schock.de/en/easy-altosw

Materials



Solide Stainless Steel
EDM

Article no.

529125 + Code

SCHOCK

SCHOCK **ARCADA**



SCHOCK **ARCADA**



Aqua vida
Separate spout
for drinking water

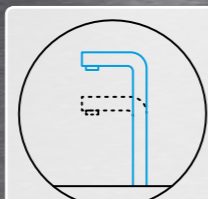

Standing tall
High spout
position

SCHOCK

SCHOCK **ARCADA**



SCHOCK **ARCADA**

Video



www.schock.de/en/easy-arcada

Materials



Chrome
CHR

Article no.

562000 + Code

Colour range

This mixer tap is available in the colours listed in the appendix.

SCHOCK

SCHOCK ARES



SCHOCK ARES

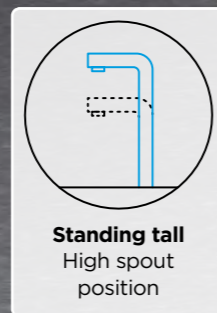

SCHOCK

SCHOCK ARES



SCHOCK ARES

Video



www.schock.de/en/easy-ares

Materials



**Stainless Steel
Brushed**
BR



**Stainless Steel
Polished**
PL

Article no.

561000 + Code

Colour range

This mixer tap is available in the colours listed in the appendix.

SCHOCK

SCHOCK CONOS



SCHOCK CONOS

SCHOCK CONOS

SCHOCK

SCHOCK CONOS

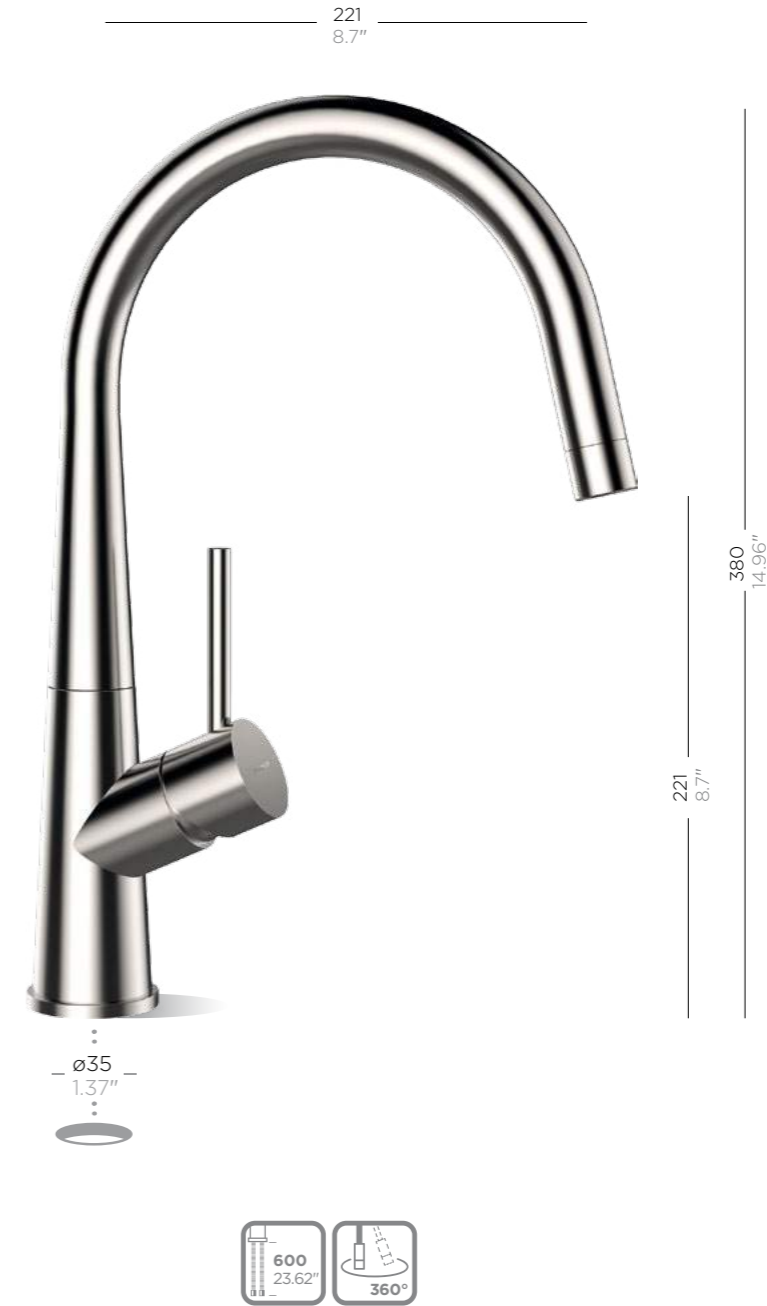

Video



www.schock.de/en/easy-conos

Materials



Solide Stainless Steel
EDM

Article no.

528000 + Code

SCHOCK

SCHOCK CONOS

PULL-OUT



SCHOCK CONOS PULL-OUT



Get more done
Ergonomic design



Stainless steel
Long lasting and hygienic

SCHOCK

SCHOCK CONOS

PULL-OUT



Video



www.schock.de/en/easy-conos

Materials



Solide Stainless Steel
EDM

Article no.

528120 + Code

SCHOCK

SCHOCK CONOS PRO



SCHOCK CONOS PRO

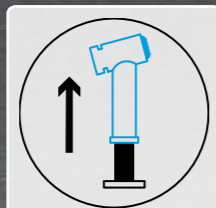

Twice the impact
Sidespray for added flexibility



Stainless steel
Long lasting and hygienic

SCHOCK

SCHOCK CONOS PRO



Video



www.schock.de/en/easy-conospro

Materials



Solide Stainless Steel
EDM

Article no.

528006 + Code

SCHOCK

SCHOCK COSMO



SCHOCK COSMO

Compact
Space-saving design

Save time
Cartridge with fast water flow

SCHOCK

SCHOCK COSMO

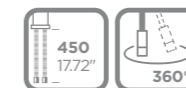

Video



www.schock.de/en/easy-cosmo

Materials



Chrome
CHR

Article no.

525001 + Code

Colour range

This mixer tap is available in the colours listed in the appendix.

SCHOCK

SCHOCK COSMO

PULL-OUT



SCHOCK COSMO PULL-OUT

Compact
Space-saving design

Get more done
Ergonomic design

SCHOCK

SCHOCK COSMO

PULL-OUT



Video



www.schock.de/en/easy-cosmo

Materials



Chrome
CHR

Article no.

525121 + Code

Colour range

This mixer tap is available in the colours listed in the appendix.

SCHOCK

SCHOCK DIKE

PULL-OUT



SCHOCK DIKE PULL-OUT

Compact
Space-saving design

Select
Spout with spray and jet function

SCHOCK

SCHOCK DIKE

PULL-OUT



SCHOCK DIKE PULL-OUT

Video



www.schock.de/en/easy-dike

Materials



Chrome
CHR

Article no.

502120 + Code

SCHOCK

SCHOCK **DION**



SCHOCK **DION**

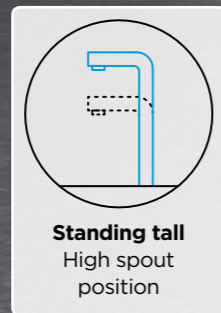

Standing tall
High spout
position

SCHOCK

SCHOCK **DION**



Video



www.schock.de/en/easy-dion

Materials



Chrome
CHR

Copper
COP

Article no.

510000 + Code

Colour range

This mixer tap is available in the colours listed in the appendix.

SCHOCK

SCHOCK **DION**

PULL-OUT



SCHOCK **DION** PULL-OUT

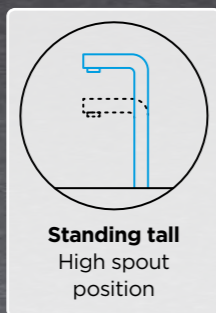

Standing tall
High spout position



Get more done
Ergonomic design

SCHOCK

SCHOCK **DION**

PULL-OUT



Video



www.schock.de/en/easy-dion

Materials



Chrome
CHR

Copper
COP

Article no.

510120 + Code

Colour range

This mixer tap is available in the colours listed in the appendix.

SCHOCK

SCHOCK FONOS

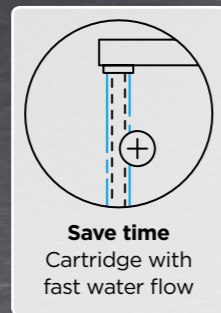

Save time
Cartridge with
fast water flow

SCHOCK FONOS

SCHOCK FONOS

SCHOCK

SCHOCK FONOS



Video



www.schock.de/en/easy-fonos

Materials



Chrome
CHR

Article no.

538000 + Code

Colour range

This mixer tap is available in the colours listed in the appendix.

SCHOCK

SCHOCK GOTA



SCHOCK GOTA

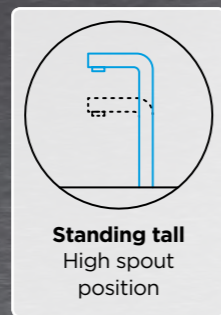

Standing tall
High spout
position

SCHOCK

SCHOCK GOTA



Video



www.schock.de/en/easy-gota

Materials



Chrome
CHR

Black
S

White
W

Article no.

521000 + Code

SCHOCK

SCHOCK **GOTA**

PULL-OUT



SCHOCK **GOTA** PULL-OUT

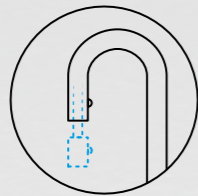

Well concealed
Hidden pull-out
function

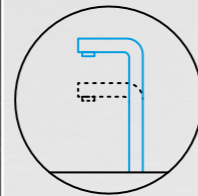

Standing tall
High spout
position



Get more done
Ergonomic
design

SCHOCK

SCHOCK **GOTA**

PULL-OUT

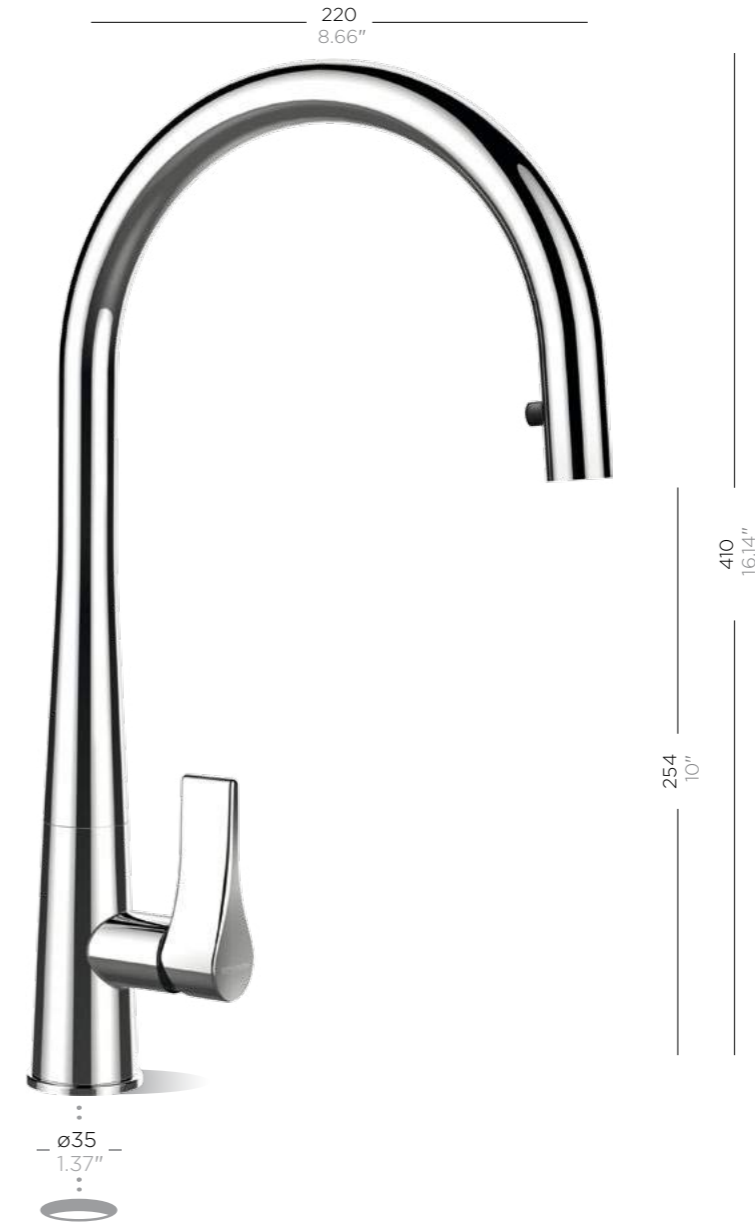

SCHOCK **GOTA** PULL-OUT



Video



www.schock.de/en/easy-gota

Materials



Chrome
CHR



Black
S



White
W

Article no.

521120 + Code

SCHOCK

SCHOCK HEKATE



SCHOCK HEKATE



Enjoy every drop
Water-saving feature



Safe by design
Built-in temperature limiter

SCHOCK

SCHOCK HEKATE



SCHOCK HEKATE

Video



www.schock.de/en/easy-hekate

Materials



Article no.

549000 + Code

SCHOCK

SCHOCK HEKATE

PULL-OUT



SCHOCK HEKATE PULL-OUT



Enjoy every drop
Water-saving feature

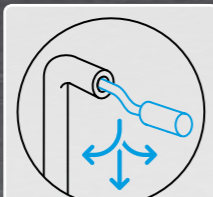

Get more done
Ergonomic design



Safe by design
Built-in temperature limiter



Select
Spout with spray and jet function

SCHOCK

SCHOCK HEKATE

PULL-OUT



SCHOCK HEKATE PULL-OUT

Video



www.schock.de/en/easy-hekate

Materials



Article no.

549120 + Code

SCHOCK

SCHOCK IDEOS PREMIUM



SCHOCK IDEOS PREMIUM



Peaceful
Ultra-quiet water jet

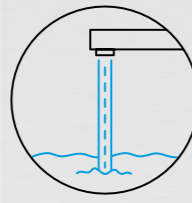

Stay dry
Splash-free water jet

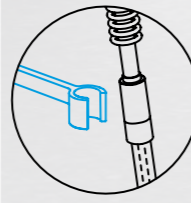

Freedom
Unhookable, flexible spout



Hassle free
Easy-clean Pull-out hose

SCHOCK

SCHOCK IDEOS PREMIUM



SCHOCK IDEOS PREMIUM



Video



www.schock.de/en/easy-ideospremium

Materials



Chrome
CHR

Stainless steel look
EDO

Article no.

581000 + Code

SCHOCK

SCHOCK IDEOS PRO



SCHOCK IDEOS PRO

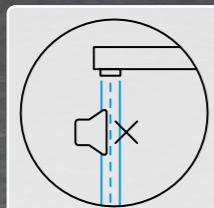

Peaceful
Ultra-quiet
water jet

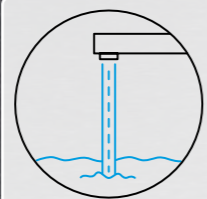

Stay dry
Splash-free
water jet

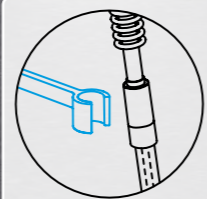

Freedom
Unhookable,
flexible spout

SCHOCK

SCHOCK IDEOS PRO



Video



www.schock.de/en/easy-ideospro

Materials



Chrome
CHR

Stainless steel look
EDO

Article no.

578000 + Code

SCHOCK

SCHOCK KARPO

PULL-OUT



SCHOCK KARPO PULL-OUT

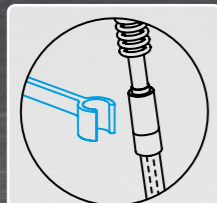

Freedom
Unhookable,
flexible spout

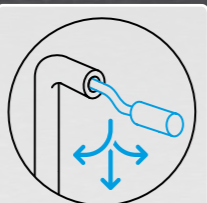

Get more done
Ergonomic
design



Select
Spout with spray
and jet function



Safe by design
Built-in temper-
ature limiter

SCHOCK

SCHOCK KARPO

PULL-OUT



SCHOCK KARPO PULL-OUT

Video



www.schock.de/en/easy-karpo

Materials



Chrome
CHR

Article no.

593120 + Code

SCHOCK

SCHOCK KARPO PRO

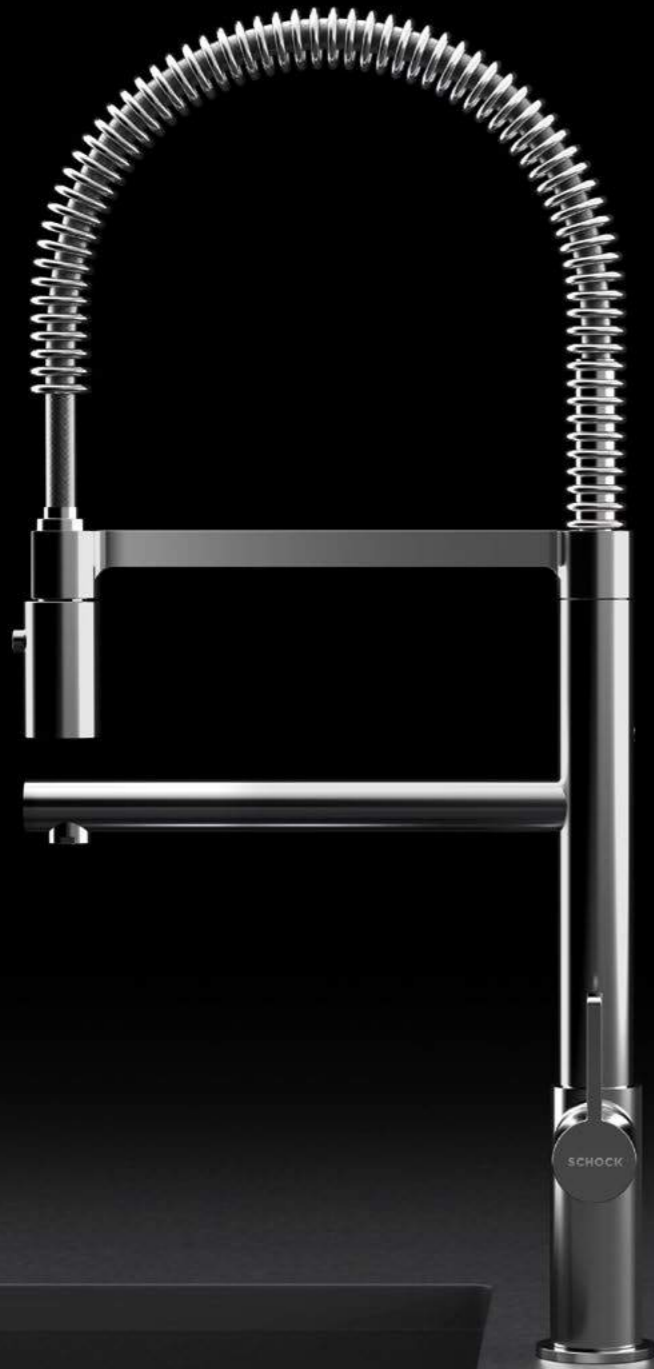

SCHOCK KARPO PRO

SCHOCK KARPO PRO

SCHOCK

SCHOCK KARPO PRO

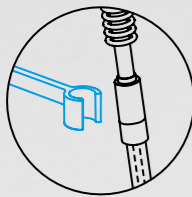
Freedom
Unhookable,
flexible spout



Enjoy every drop
Water-saving
feature



Select
Spout with spray
and jet function



Get more done
Ergonomic
design



Safe by design
Built-in tempe-
rature limiter

Video



www.schock.de/en/easy-karpopro

Materials



Chrome
CHR

Article no.

593200 + Code

SCHOCK

SCHOCK KAVUS



SCHOCK KAVUS



Stainless steel
Long lasting and
hygienic

SCHOCK

SCHOCK KAVUS



SCHOCK KAVUS

Video



www.schock.de/en/easy-kavus

Materials



**Stainless Steel
Brushed**
BR

Article no.

559000 + Code

Colour range

This mixer tap is available in the colours listed in the appendix.

SCHOCK

SCHOCK LAIOS



SCHOCK LAIOS

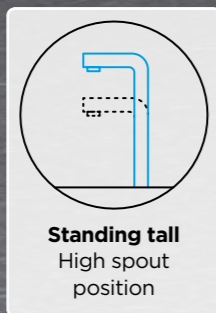

Standing tall
High spout position



Stainless steel
Long lasting and hygienic

SCHOCK

SCHOCK LAIOS



SCHOCK LAIOS

Video



www.schock.de/en/easy-laios

Materials



Solide Stainless Steel
EDM

Article no.

517000 + Code

SCHOCK

SCHOCK LAIOS

PULL-OUT



SCHOCK LAIOS PULL-OUT

Standing tall
High spout position

Get more done
Ergonomic design

Stainless steel
Long lasting and hygienic

SCHOCK

SCHOCK LAIOS

PULL-OUT



Video



www.schock.de/en/easy-laios

Materials



Solide Stainless Steel
EDM

Article no.

517120 + Code

SCHOCK

SCHOCK LEVA



SCHOCK LEVA

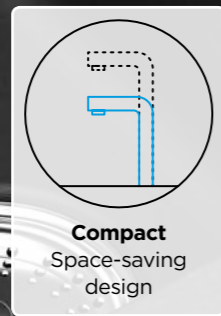

Compact
Space-saving
design

SCHOCK

SCHOCK LEVA



Video



www.schock.de/en/easy-leva

Materials



Chrome
CHR

Article no.

511000 + Code

Colour range

This mixer tap is available in the colours listed in the appendix.

SCHOCK

SCHOCK LEVA

PULL-OUT



SCHOCK LEVA PULL-OUT

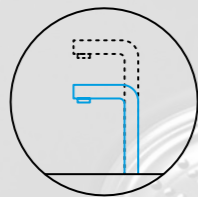

Compact
Space-saving design



Get more done
Ergonomic design

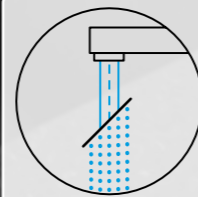

Select
Spout with spray and jet function

SCHOCK

SCHOCK LEVA

PULL-OUT



Video



www.schock.de/en/easy-leva

Materials



Chrome
CHR

Article no.

511120 + Code

Colour range

This mixer tap is available in the colours listed in the appendix.

SCHOCK

SCHOCK MAIA

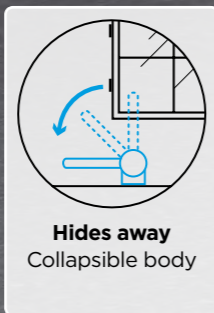

SCHOCK MAIA

SCHOCK

SCHOCK MAIA



Video



www.schock.de/en/easy-maia

Materials



Chrome
CHR

Article no.

527000 + Code

SCHOCK

SCHOCK MERA



SCHOCK MERA

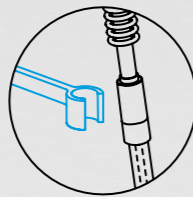

Freedom
Unhookable,
flexible spout



Hassle free
Easy-clean
Pull-out hose

SCHOCK

SCHOCK MERA



Video



www.schock.de/en/easy-mera

Materials



Chrome
CHR

Article no.

512000 + Code

SCHOCK

SCHOCK NAPOS



SCHOCK NAPOS



SCHOCK

SCHOCK NAPOS



Video



www.schock.de/en/easy-napos

Materials



Chrome
CHR

Article no.

539000 + Code

Colour range

This mixer tap is available in the colours listed in the appendix.

SCHOCK

SCHOCK NAPOS

PULL-OUT



SCHOCK NAPOS PULL-OUT

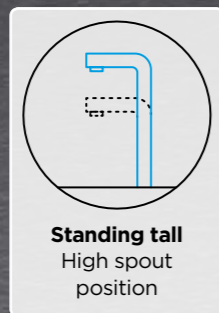

Standing tall
High spout
position



Get more done
Ergonomic
design

SCHOCK

SCHOCK NAPOS

PULL-OUT



Video



www.schock.de/en/easy-napos

Materials



Chrome
CHR

Article no.

539120 + Code

Colour range

This mixer tap is available in the colours listed in the appendix.

SCHOCK

SCHOCK NEILOS



SCHOCK NEILOS

SCHOCK

SCHOCK NEILOS



Video



www.schock.de/en/easy-neilos

Materials



Chrome
CHR

Gunmetal
GUN

Article no.

572001 + Code

SCHOCK

SCHOCK NEOS

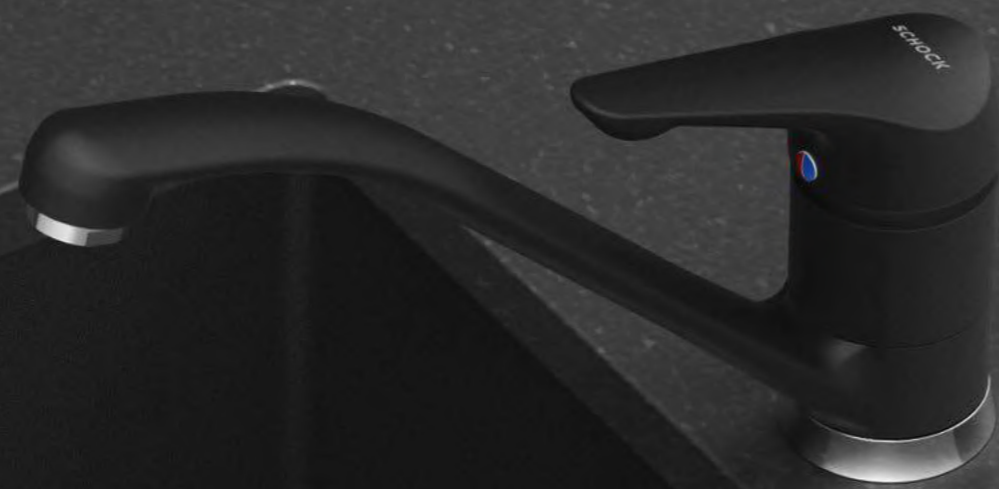

SCHOCK NEOS



Enjoy every drop
Water-saving feature

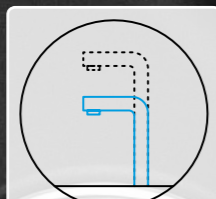

Compact
Space-saving design

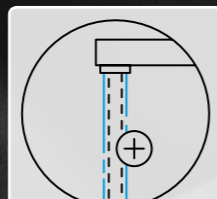

Save time
Cartridge with fast water flow



Safe by design
Built-in temperature limiter

SCHOCK

SCHOCK NEOS



Video



www.schock.de/en/easy-neos

Materials



Chrome
CHR

Article no.

542000 + Code

Colour range

This mixer tap is available in the colours listed in the appendix.

SCHOCK

SCHOCK NEOS

PULL-OUT

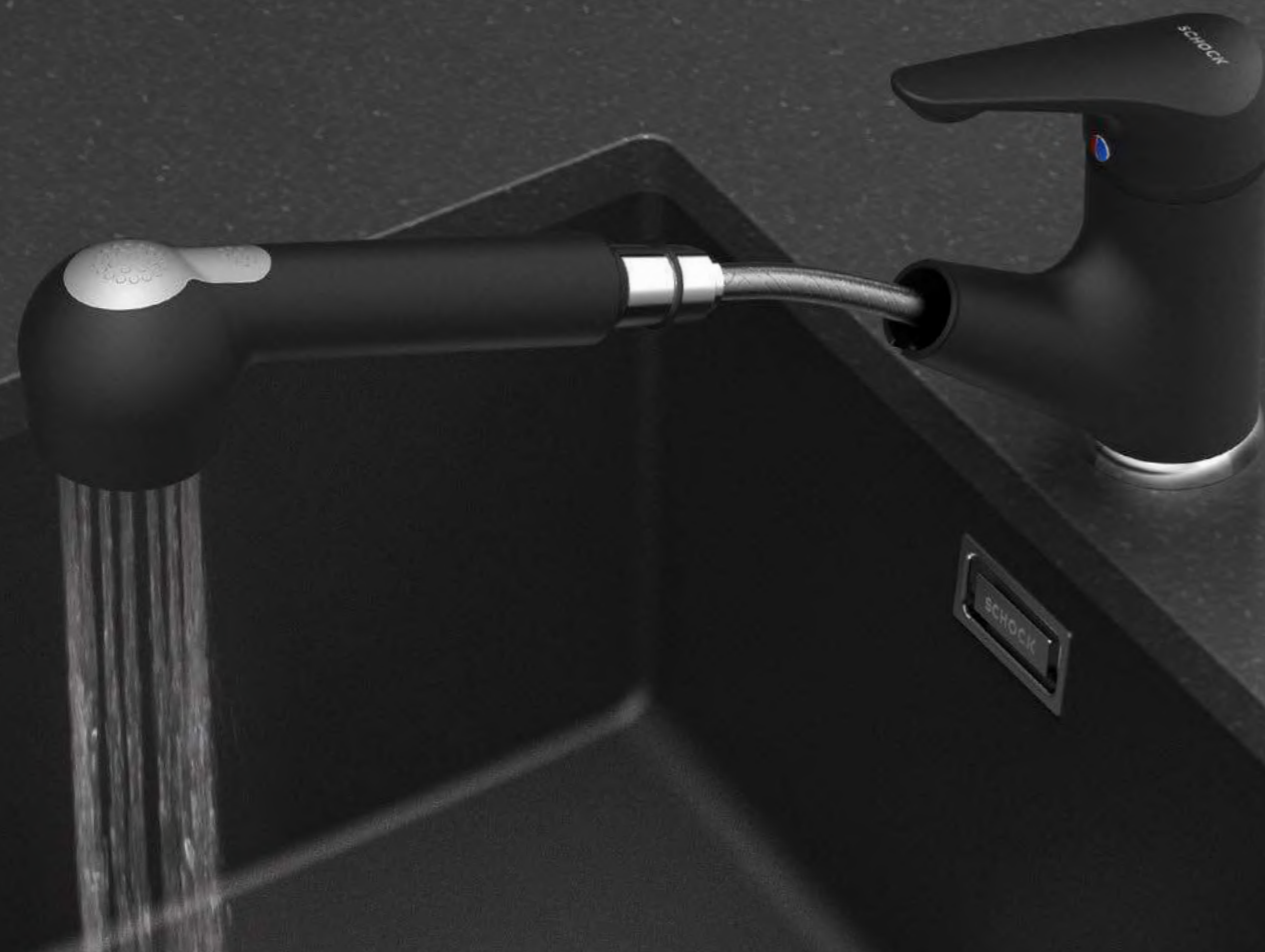

SCHOCK NEOS PULL-OUT

SCHOCK NEOS PULL-OUT

Enjoy every drop
Water-saving feature

Compact
Space-saving design

Get more done
Ergonomic design

Select
Spout with spray and jet function

Safe by design
Built-in temperature limiter

SCHOCK

SCHOCK NEOS

PULL-OUT



Video



www.schock.de/en/easy-neos

Materials



Chrome
CHR

Article no.

542120 + Code

Colour range

This mixer tap is available in the colours listed in the appendix.

SCHOCK

SCHOCK NEOS LP



SCHOCK NEOS LP



Enjoy every drop
Water-saving feature

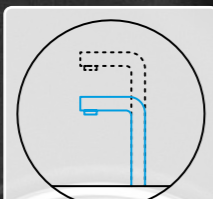

Compact
Space-saving design

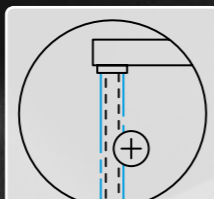

Save time
Cartridge with fast water flow



Safe by design
Built-in temperature limiter

SCHOCK

SCHOCK NEOS LP



SCHOCK NEOS LP

Video



www.schock.de/en/easy-neoslp

Materials



Chrome
CHR

Article no.

542003 + Code

SCHOCK

SCHOCK NEOS LP

PULL-OUT



SCHOCK NEOS LP PULL-OUT

SCHOCK NEOS LP PULL-OUT



Enjoy every drop
Water-saving feature

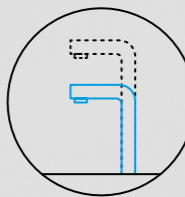

Compact
Space-saving design

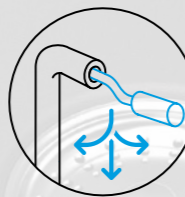

Get more done
Ergonomic design



Select
Spout with spray and jet function



Safe by design
Built-in temperature limiter

SCHOCK

SCHOCK NEOS LP

PULL-OUT



Video



www.schock.de/en/easy-neoslp

Materials



Chrome
CHR

Article no.

542123 + Code

SCHOCK

SCHOCK NIMBUS



SCHOCK NIMBUS

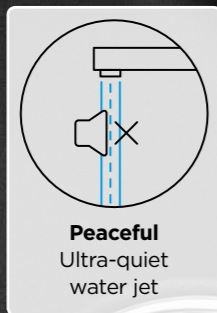

Peaceful
Ultra-quiet
water jet



Stay dry
Splash-free
water jet



Standing tall
High spout
position

SCHOCK

SCHOCK NIMBUS



Video



www.schock.de/en/easy-nimbus

Materials



Chrome
CHR

Article no.

523000 + Code

Colour range

This mixer tap is available in the colours listed in the appendix.

SCHOCK

SCHOCK NIMBUS

PULL-OUT



SCHOCK NIMBUS PULL-OUT

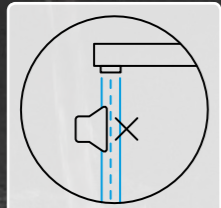

Peaceful
Ultra-quiet
water jet

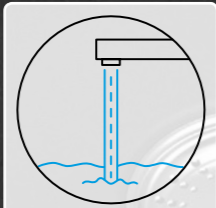

Stay dry
Splash-free
water jet

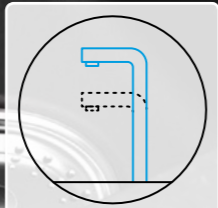

Standing tall
High spout
position



Get more done
Ergonomic
design

SCHOCK

SCHOCK NIMBUS

PULL-OUT



Video



www.schock.de/en/easy-nimbus

Materials



Chrome
CHR

Article no.

523120 + Code

Colour range

This mixer tap is available in the colours listed in the appendix.

SCHOCK

SCHOCK PIA



SCHOCK PIA

SCHOCK

SCHOCK PIA



Video



www.schock.de/en/easy-pia

Materials



Chrome
CHR

Article no.

537000 + Code

Colour range

This mixer tap is available in the colours listed in the appendix.

SCHOCK

SCHOCK PIA

PULL-OUT

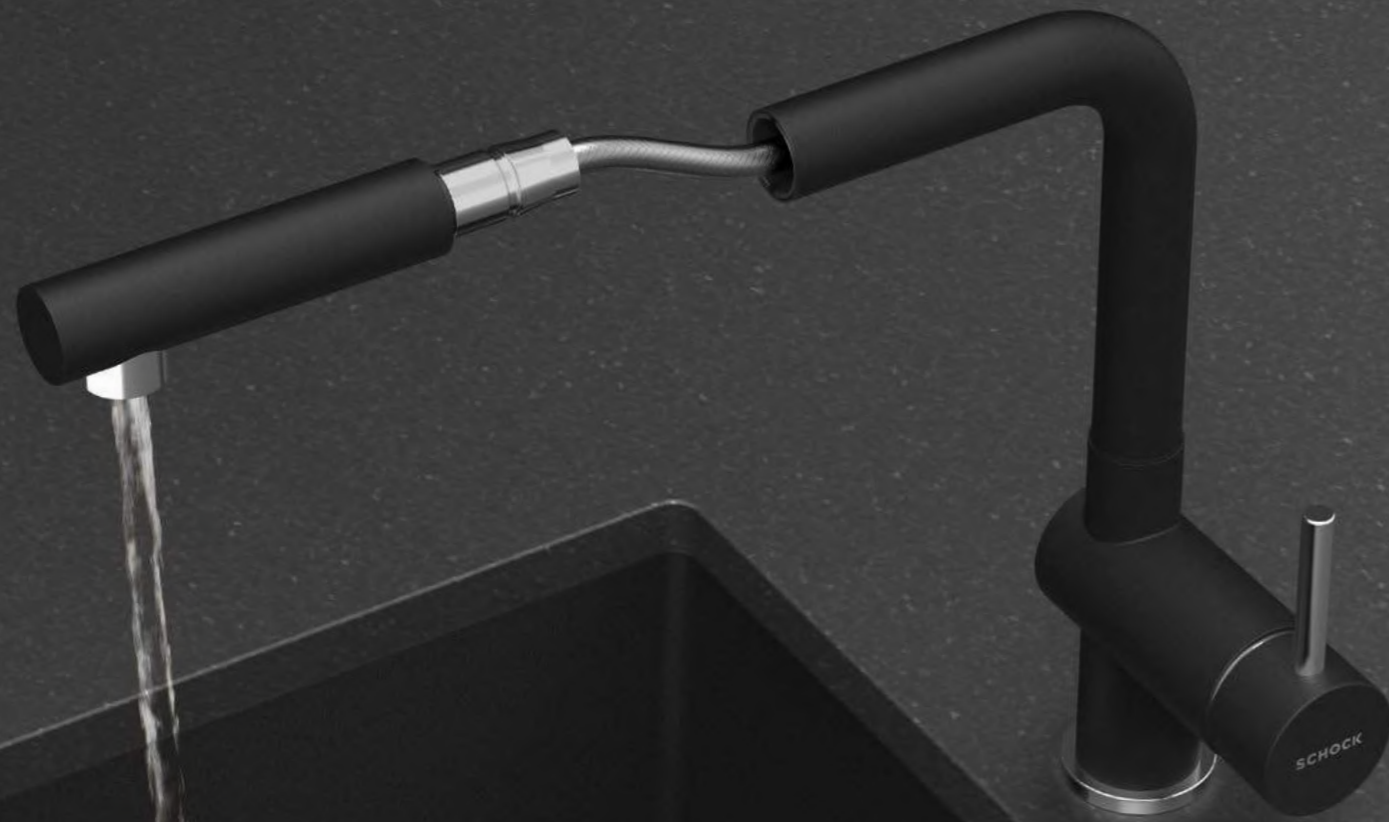

SCHOCK PIA PULL-OUT



SCHOCK

SCHOCK PIA

PULL-OUT



SCHOCK PIA PULL-OUT

Video



www.schock.de/en/easy-pia

Materials



Chrome
CHR

Article no.

537120 + Code

Colour range

This mixer tap is available in the colours listed in the appendix.

SCHOCK

SCHOCK PIEGA



SCHOCK PIEGA

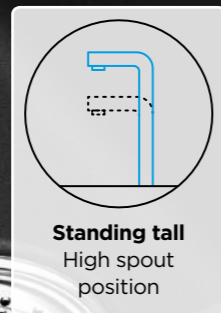

Standing tall
High spout
position

SCHOCK

SCHOCK PIEGA



Video



www.schock.de/en/easy-piega

Materials



Chrome
CHR

Article no.

547000 + Code

Colour range

This mixer tap is available in the colours listed in the appendix.

SCHOCK

SCHOCK PIEGA

PULL-OUT



SCHOCK PIEGA PULL-OUT

Standing tall
High spout position

Get more done
Ergonomic design

SCHOCK

SCHOCK PIEGA

PULL-OUT



Video



www.schock.de/en/easy-piega

Materials



Chrome
CHR

Article no.

547120 + Code

Colour range

This mixer tap is available in the colours listed in the appendix.

SCHOCK

SCHOCK PILA

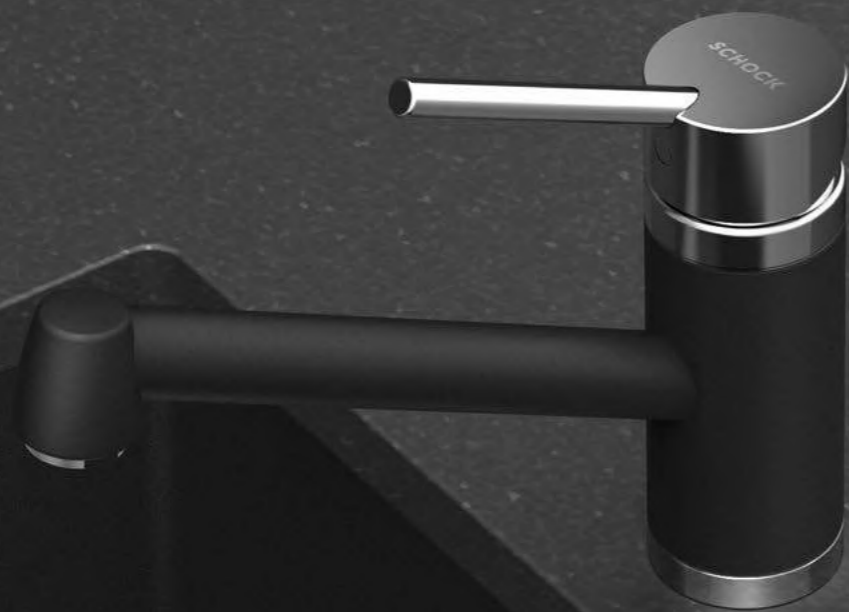

SCHOCK PILA

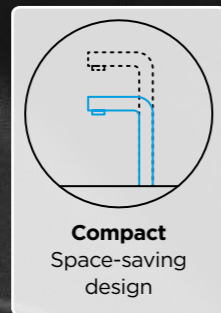

Compact
Space-saving
design

SCHOCK

SCHOCK PILA



Video



www.schock.de/en/easy-pila

Materials



Chrome
CHR

Article no.

541000 + Code

Colour range

This mixer tap is available in the colours listed in the appendix.

SCHOCK

SCHOCK PILA

PULL-OUT



SCHOCK PILA PULL-OUT

Compact
Space-saving design

Get more done
Ergonomic design

Select
Spout with spray and jet function

SCHOCK

SCHOCK PILA

PULL-OUT



Video



www.schock.de/en/easy-pila

Materials



Chrome
CHR

Article no.

541120 + Code

Colour range

This mixer tap is available in the colours listed in the appendix.

SCHOCK

SCHOCK PILA LP



SCHOCK PILA LP

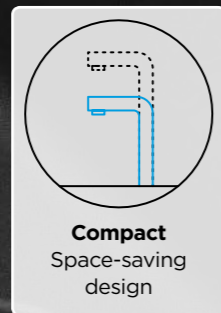

Compact
Space-saving
design

SCHOCK

SCHOCK PILA LP



Video



www.schock.de/en/easy-pilalp

Materials



Chrome
CHR

Article no.

541003 + Code

SCHOCK

SCHOCK PILA LP

PULL-OUT



SCHOCK PILA LP PULL-OUT

SCHOCK PILA LP PULL-OUT

Compact
Space-saving design

Get more done
Ergonomic design

Select
Spout with spray and jet function

SCHOCK

SCHOCK PILA LP

PULL-OUT



Video



www.schock.de/en/easy-pilalp

Materials



Chrome
CHR

Article no.

541123 + Code

SCHOCK

SCHOCK PLUTOS

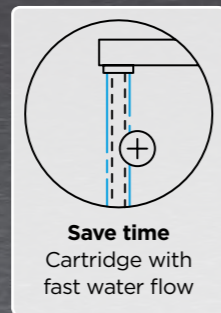

Save time
Cartridge with
fast water flow

SCHOCK PLUTOS

SCHOCK

SCHOCK PLUTOS



Video



www.schock.de/en/easy-plutos

Materials



Chrome
CHR

Article no.

589000 + Code

Colour range

This mixer tap is available in the colours listed in the appendix.

SCHOCK

SCHOCK PLUTOS

PULL-OUT



SCHOCK PLUTOS PULL-OUT



Get more done
Ergonomic design

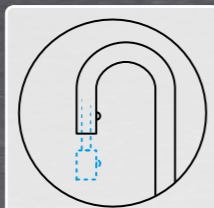

Well concealed
Hidden pull-out function

SCHOCK

SCHOCK PLUTOS

PULL-OUT



SCHOCK PLUTOS PULL-OUT

Video



www.schock.de/en/easy-plutos

Materials



Chrome
CHR

Article no.

589120 + Code

Colour range

This mixer tap is available in the colours listed in the appendix.

SCHOCK

SCHOCK SC50

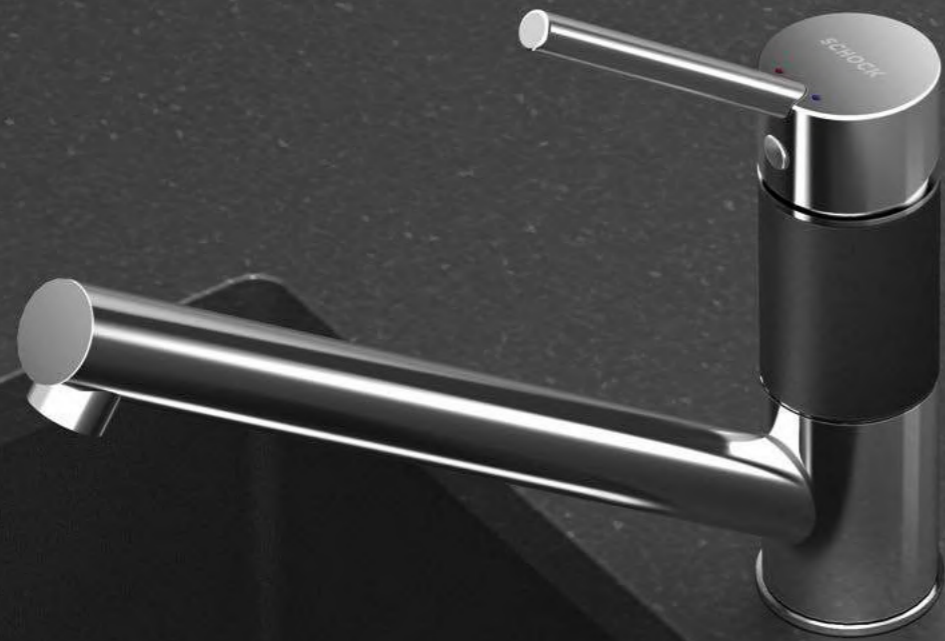

SCHOCK SC50

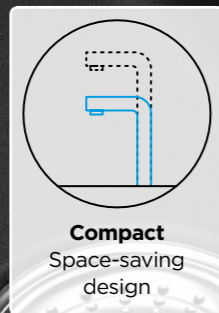

Compact
Space-saving
design

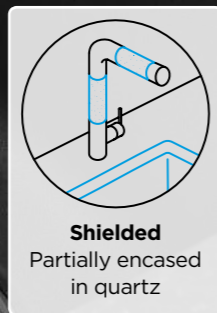

Shielded
Partially encased
in quartz

SCHOCK

SCHOCK SC50



Video



www.schock.de/en/easy-sc50

Additional CRISTALITE® colours



Pink
64



Peppermint Green
65



Ocean Blue
67



Sunflower
68



Bright Orange
69

Article no.

503000 + Code

Colour range

This mixer tap is available in the colours listed in the appendix.

SCHOCK

SCHOCK SC50

PULL-OUT



SCHOCK SC50 PULL-OUT

Compact
Space-saving design

Get more done
Ergonomic design

Shielded
Partially encased in quartz

SCHOCK

SCHOCK SC50

PULL-OUT







SCHOCK SC50 PULL-OUT

Video



www.schock.de/en/easy-sc50

Additional CRISTALITE® colours

-  **Pink**
64
-  **Peppermint Green**
65
-  **Ocean Blue**
67
-  **Sunflower**
68
-  **Bright Orange**
69

Article no.

503120 + Code

Colour range

This mixer tap is available in the colours listed in the appendix.

SCHOCK

SCHOCK SC90



SCHOCK SC90



Enjoy every drop
Water-saving feature

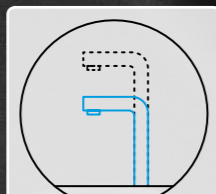

Compact
Space-saving design

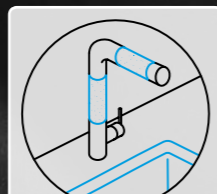

Shielded
Partially encased in quartz



Safe by design
Built-in temperature limiter

SCHOCK

SCHOCK SC90

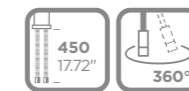

Video



www.schock.de/en/easy-sc90

Additional CRISTALITE® colours



Pink
64



Peppermint Green
65



Ocean Blue
67



Sunflower
68



Bright Orange
69

Article no.

598000 + Code

Colour range

This mixer tap is available in the colours listed in the appendix.

SCHOCK

SCHOCK SC200

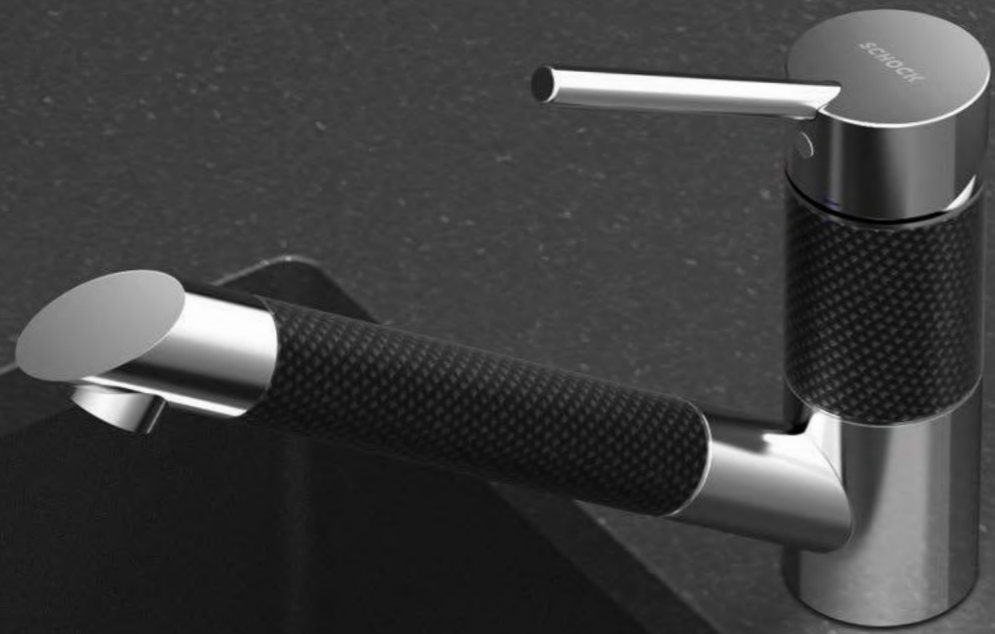

SCHOCK SC200

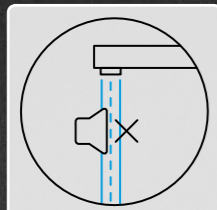

Peaceful
Ultra-quiet
water jet

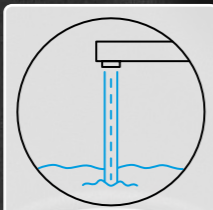

Stay dry
Splash-free
water jet

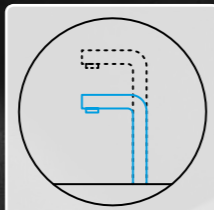

Compact
Space-saving
design

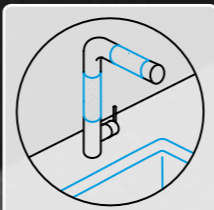

Shielded
Partially encased
in quartz

SCHOCK

SCHOCK SC200



Video



www.schock.de/en/easy-sc200

Additional Carbon materials

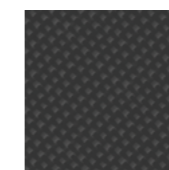

Matt
M

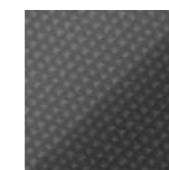

Glossy
G

Article no.

592000 + Code

Colour range

This mixer tap is available in the colours listed in the appendix.

SCHOCK

SCHOCK SC200

PULL-OUT

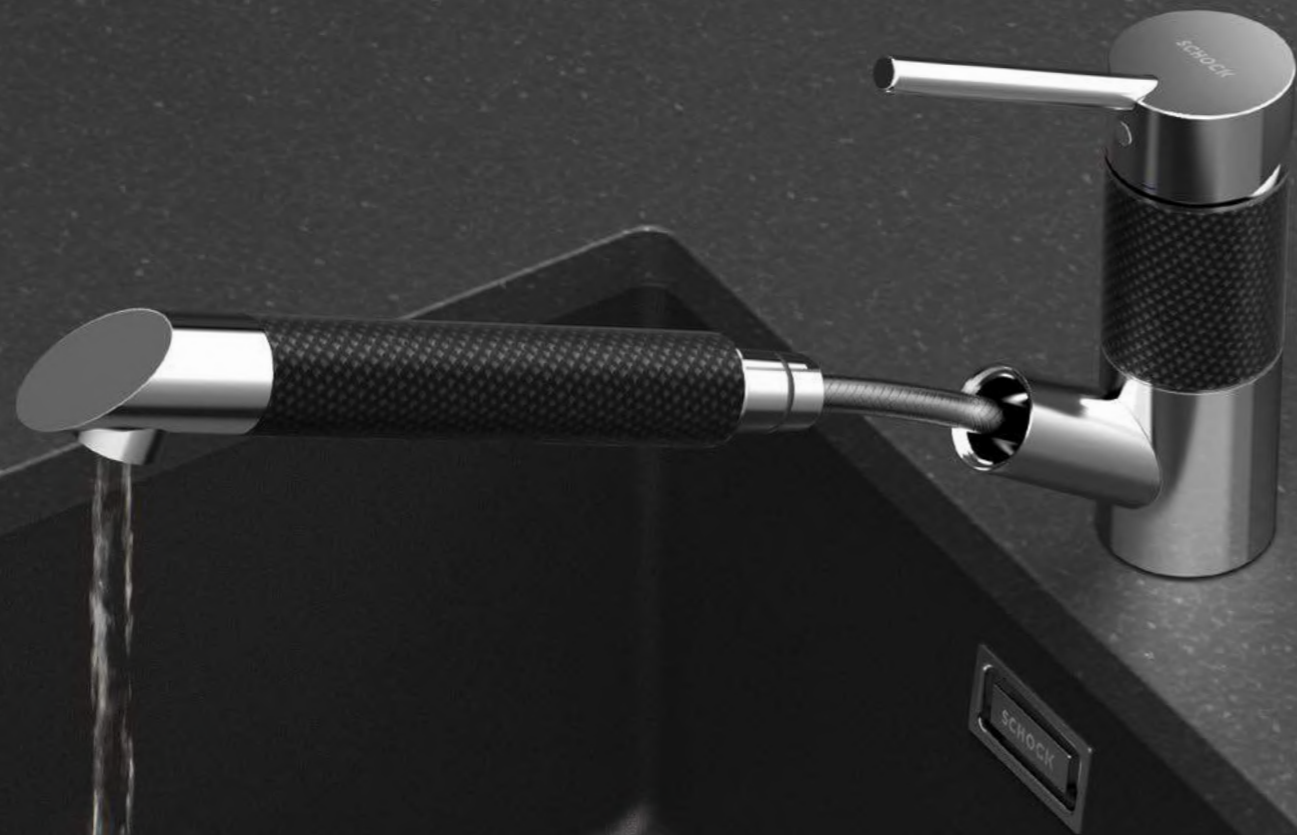

SCHOCK SC200 PULL-OUT

SCHOCK SC200 PULL-OUT

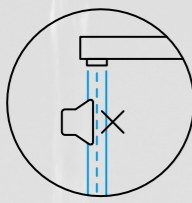

Peaceful
Ultra-quiet water jet



Stay dry
Splash-free water jet



Compact
Space-saving design



Get more done
Ergonomic design

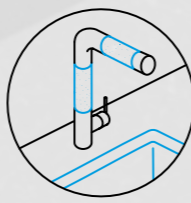

Shielded
Partially encased in quartz

SCHOCK

SCHOCK SC200

PULL-OUT



Video



www.schock.de/en/easy-sc200

Additional Carbon materials

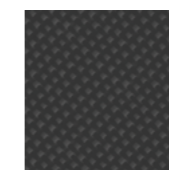

Matt
M

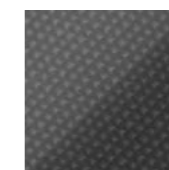

Glossy
G

Article no.

592120 + Code

Colour range

This mixer tap is available in the colours listed in the appendix.

SCHOCK

SCHOCK SC300



SCHOCK SC300



Enjoy every drop
Water-saving feature

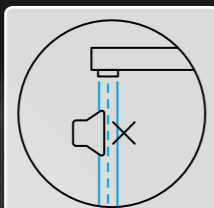

Peaceful
Ultra-quiet water jet

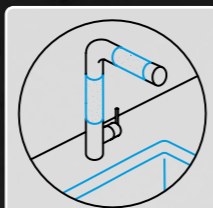

Shielded
Partially encased in quartz

SCHOCK

SCHOCK SC300



Video



www.schock.de/en/easy-sc300

Article no.

597000 + Code

Colour range

Please see taps color range

SCHOCK

SCHOCK SC300

PULL-OUT



SCHOCK SC300 PULL-OUT



Enjoy every drop
Water-saving feature

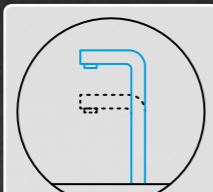

Standing tall
High spout position

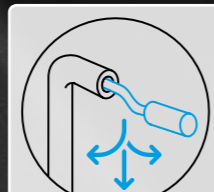

Get more done
Ergonomic design

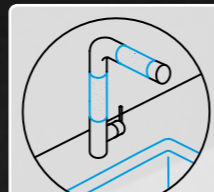

Shielded
Partially encased in quartz

SCHOCK

SCHOCK SC300

PULL-OUT



SCHOCK SC300 PULL-OUT

Video



www.schock.de/en/easy-sc300

Article no.

597120 + Code

Colour range

This mixer tap is available in the colours listed in the appendix.

SCHOCK

SCHOCK SC-510



SCHOCK SC-510

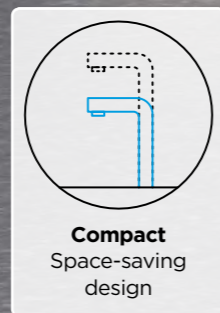
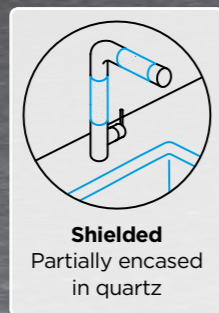

SCHOCK

SCHOCK SC-510



Video



www.schock.de/en/easy-sc510

Additional CRISTALITE® Colours



Pink
64



Peppermint Green
65



Ocean Blue
67



Sunflower
68



Bright Orange
69

Article no.

554000 + Code

Colour range

This mixer tap is available in the colours listed in the appendix.

SCHOCK

SCHOCK SC-510

PULL-OUT

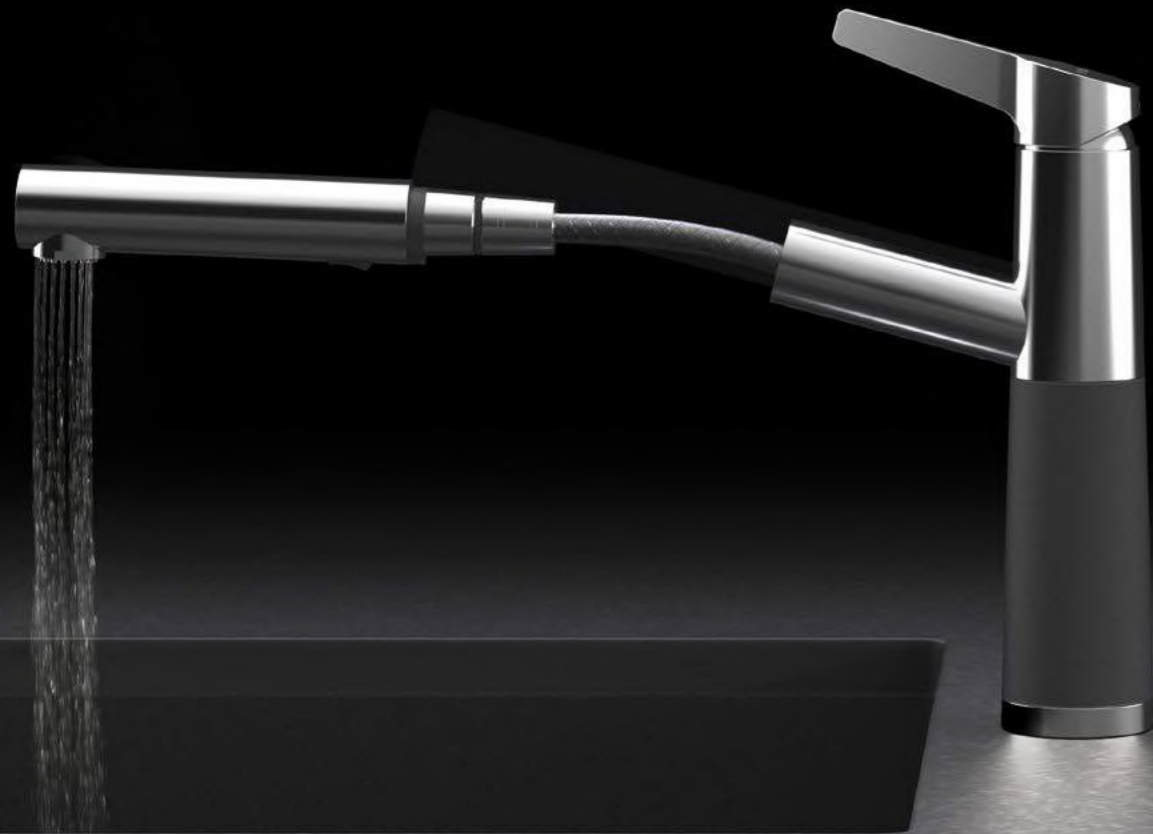

SCHOCK SC-510 PULL-OUT

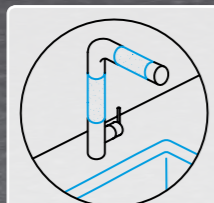

Shielded
Partially encased
in quartz

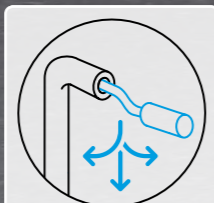

Get more done
Ergonomic
design



Select
Spout with spray
and jet function

SCHOCK

SCHOCK SC-510

PULL-OUT



SCHOCK SC-510 PULL-OUT

Video



www.schock.de/en/easy-sc510

Additional CRISTALITE® Colours

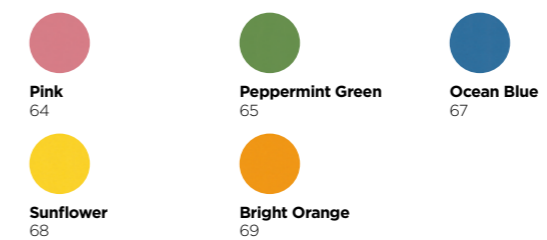

Article no.

554120 + Code

Colour range

This mixer tap is available in the colours listed in the appendix.

SCHOCK

SCHOCK SC-520



SCHOCK SC-520

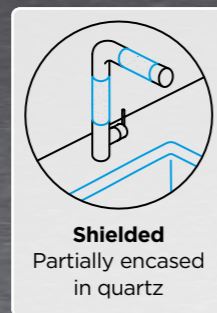

Shielded
Partially encased
in quartz

SCHOCK

SCHOCK SC-520



Video



www.schock.de/en/easy-sc520

Additional CRISTALITE® Colours



Pink
64



Peppermint Green
65



Ocean Blue
67



Sunflower
68



Bright Orange
69

Article no.

555000 + Code

Colour range

This mixer tap is available in the colours listed in the appendix.

SCHOCK

SCHOCK SC-520

PULL-OUT



SCHOCK SC-520 PULL-OUT

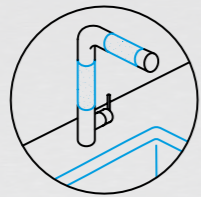

Shielded
Partially encased
in quartz



Get more done
Ergonomic
design



Select
Spout with spray
and jet function

SCHOCK

SCHOCK SC-520

PULL-OUT







SCHOCK SC-520 PULL-OUT

Video



www.schock.de/en/easy-sc520

Additional CRISTALITE® Colours

		
Pink 64	Peppermint Green 65	Ocean Blue 67
		
Sunflower 68	Bright Orange 69	

Article no.

555120 + Code

Colour range

This mixer tap is available in the colours listed in the appendix.

SCHOCK

SCHOCK SC-530



SCHOCK SC-530

SCHOCK SC-530

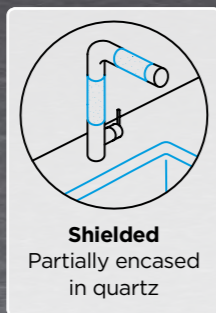

Shielded
Partially encased
in quartz

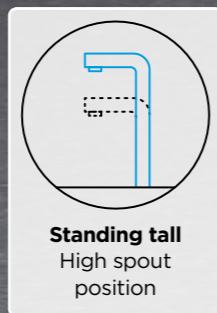

Standing tall
High spout
position

SCHOCK

SCHOCK SC-530



Video



www.schock.de/en/easy-sc530

Additional CRISTALITE® Colours

- 
Pink
64
- 
Peppermint Green
65
- 
Ocean Blue
67
- 
Sunflower
68
- 
Bright Orange
69

Article no.

556000 + Code

Colour range

This mixer tap is available in the colours listed in the appendix.

SCHOCK

SCHOCK SC-530

PULL-OUT



SCHOCK SC-530 PULL-OUT

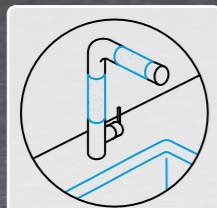

Shielded
Partially encased
in quartz

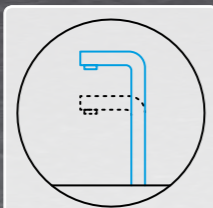

Standing tall
High spout
position



Get more done
Ergonomic
design

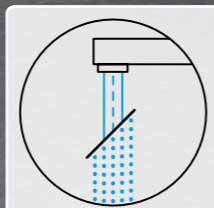

Select
Spout with spray
and jet function

SCHOCK

SCHOCK SC-530

PULL-OUT







SCHOCK SC-530 PULL-OUT

Video



www.schock.de/en/easy-sc530

Additional CRISTALITE® Colours

-  **Pink**
64
-  **Peppermint Green**
65
-  **Ocean Blue**
67
-  **Sunflower**
68
-  **Bright Orange**
69

Article no.

556120 + Code

Colour range

This mixer tap is available in the colours listed in the appendix.

SCHOCK

SCHOCK SC-540



SCHOCK SC-540

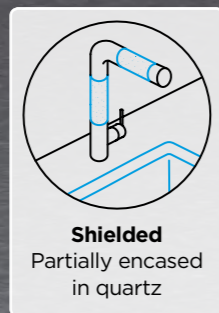

Shielded
Partially encased
in quartz

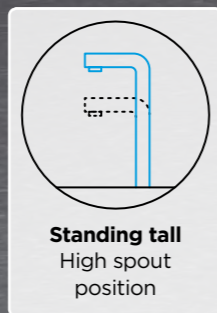

Standing tall
High spout
position

SCHOCK

SCHOCK SC-540







SCHOCK SC-540

Video



www.schock.de/en/easy-sc540

Additional CRISTALITE® Colours

- 
Pink
64
- 
Peppermint Green
65
- 
Ocean Blue
67
- 
Sunflower
68
- 
Bright Orange
69

Article no.

557000 + Code

Colour range

This mixer tap is available in the colours listed in the appendix.

SCHOCK

SCHOCK SC-540

PULL-OUT



SCHOCK SC-540 PULL-OUT

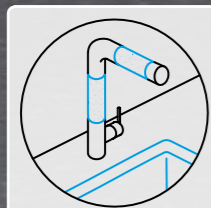

Shielded
Partially encased
in quartz

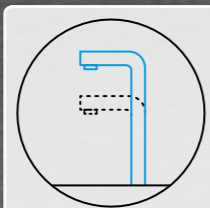

Standing tall
High spout
position



Get more done
Ergonomic
design

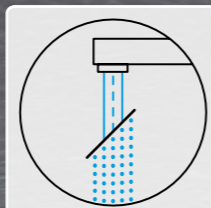

Select
Spout with spray
and jet function

SCHOCK

SCHOCK SC-540

PULL-OUT



323
12.7"
270
10.62"



Video



www.schock.de/en/easy-sc540

Additional CRISTALITE® Colours



Pink
64



Peppermint Green
65



Ocean Blue
67



Sunflower
68



Bright Orange
69

Article no.

557120 + Code

Colour range

This mixer tap is available in the colours listed in the appendix.

SCHOCK

SCHOCK SC-550



SCHOCK SC-550

SCHOCK SC-550

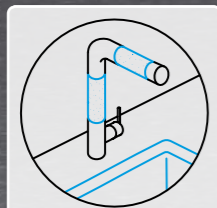

Shielded
Partially encased
in quartz

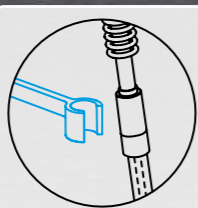

Freedom
Unhookable,
flexible spout

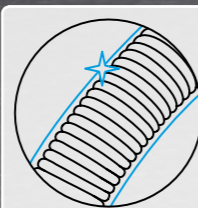

Hassle free
Easy-clean
Pull-out hose

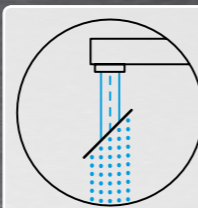

Select
Spout with spray
and jet function

SCHOCK

SCHOCK SC-550



Video



www.schock.de/en/easy-sc550

Additional CRISTALITE® Colours



Pink
64



Peppermint Green
65



Ocean Blue
67



Sunflower
68



Bright Orange
69

Article no.

558000 + Code

Colour range

This mixer tap is available in the colours listed in the appendix.

SCHOCK

SCHOCK SIMI



SCHOCK SIMI



Standing tall
High spout position

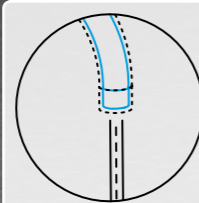

Graceful
Delicate design



Choice
Left or right-handed design

SCHOCK

SCHOCK SIMI



Video



www.schock.de/en/easy-simi

Materials



Chrome
CHR

Stainless Steel Look
EDO

Article no.

505000 + Code

Colour range

This mixer tap is available in the colours listed in the appendix.

SCHOCK

SCHOCK SONO

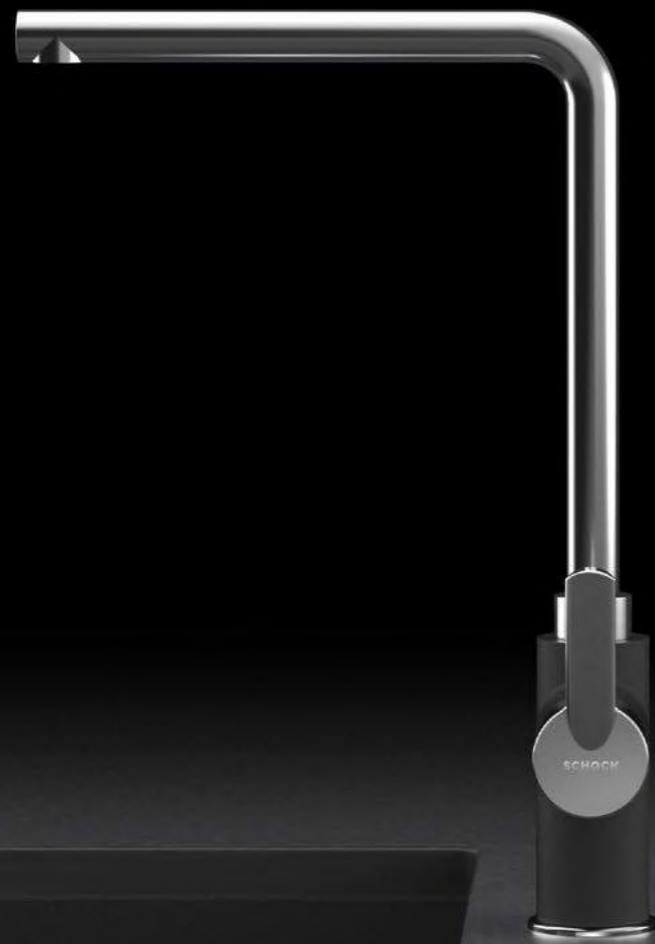

SCHOCK SONO



Standing tall
High spout position

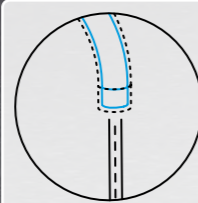

Graceful
Delicate design



Choice
Left or right-handed design

SCHOCK

SCHOCK SONO



SCHOCK SONO

Video



www.schock.de/en/easy-sono

Materials



Chrome
CHR



Stainless Steel Look
EDO

Article no.

504000 + Code

Colour range

This mixer tap is available in the colours listed in the appendix.

SCHOCK

SCHOCK VITUS



SCHOCK VITUS



SCHOCK

SCHOCK VITUS



Video



www.schock.de/en/easy_vitus

Materials



**Stainless Steel
Brushed
BR**

Article no.

560000 + Code

Colour range

This mixer tap is available in the colours listed in the appendix.

SCHOCK

SCHOCK WELLUS



SCHOCK WELLUS



Aqua vida
Separate spout
for drinking water

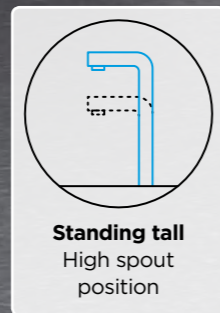

Standing tall
High spout
position

SCHOCK

SCHOCK WELLUS



Video



www.schock.de/en/easy-wellus

Materials



Chrome
CHR

Article no.

570001 + Code

Colour range

This mixer tap is available in the colours listed in the appendix.

SCHOCK

SCHOCK AMUR



SCHOCK AMUR

SCHOCK

SCHOCK AMUR

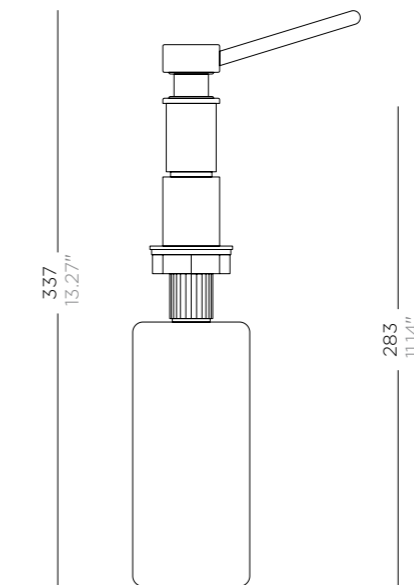

Materials



Chrome
CHR

Article no.

629014 + Code

SCHOCK

SCHOCK CHIO



SCHOCK CHIO

SCHOCK

SCHOCK CHIO

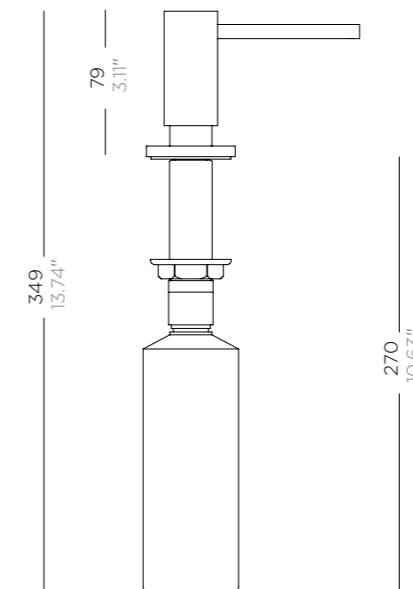

Materials



Chrome
CHR

Stainless steel look
EDO

Article no.

629165 + Code

SCHOCK

SCHOCK CHIO S



SCHOCK CHIO S

SCHOCK

SCHOCK CHIO S

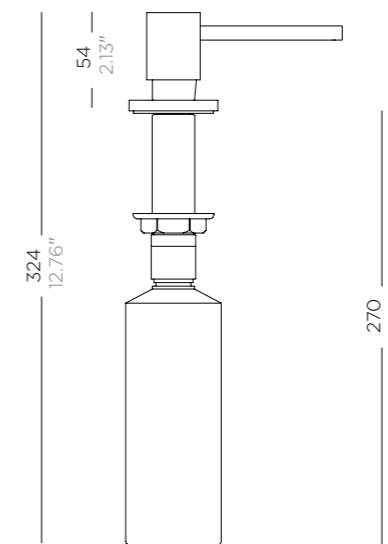

Materials



Chrome
CHR

Stainless steel look
EDO

Article no.

629164 + Code

SCHOCK

SCHOCK LADON

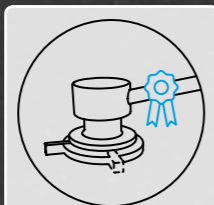

A clever idea
Soap dispenser
and pop-up in 1

SCHOCK LADON

SCHOCK

SCHOCK LADON

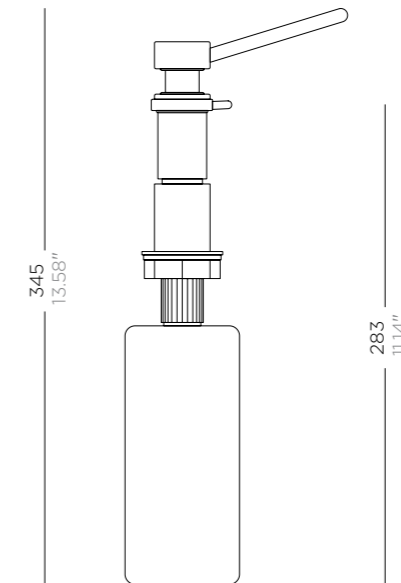

SCHOCK LADON

Materials



Chrome
CHR

Article no.

629016 + Code

SCHOCK

SCHOCK PUCK



SCHOCK PUCK

SCHOCK

SCHOCK PUCK

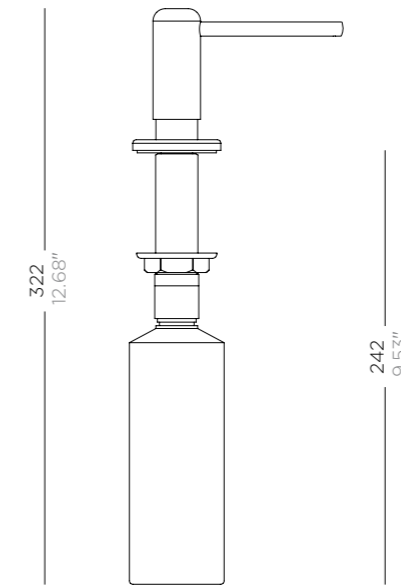

Materials



Chrome
CHR

Stainless steel look
EDO

Article no.

629025 + Code

SCHOCK

SCHOCK SAMO



SCHOCK SAMO

SCHOCK

SCHOCK SAMO

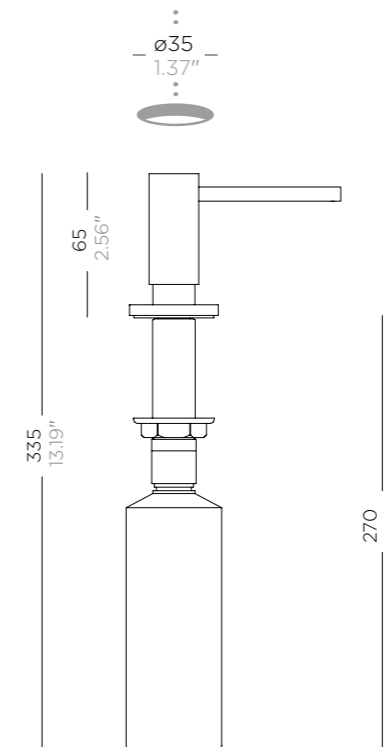

Materials



Chrome
CHR

Stainless steel look
EDO

Article no.

629167 + Code

SCHOCK

SCHOCK SAMO S



SCHOCK SAMO S

SCHOCK

SCHOCK SAMO S

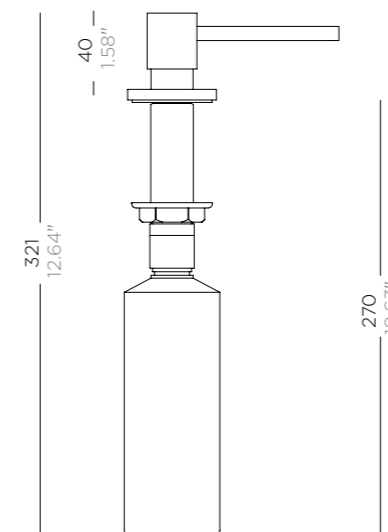

Materials



Chrome
CHR

Stainless steel look
EDO

Article no.

629166 + Code

SCHOCK

SCHOCK SANI



SCHOCK SANI

SCHOCK

SCHOCK SANI

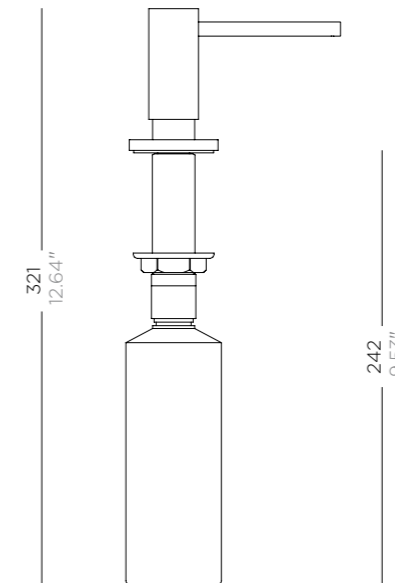

Materials



Chrome
CHR

Stainless steel look
EDO

Article no.

629026 + Code









ACCES
ACCESSORIES





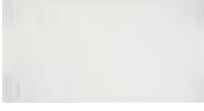



HANDMADE IN GERMANY

SCHOCK

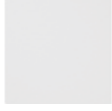
SCHOCK





ZUBEHÖR

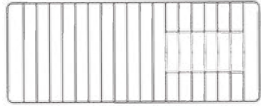
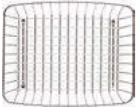
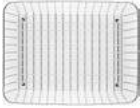
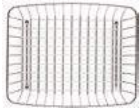

CHOPPING BOARDS	INFORMATION	ADDITIONAL INFORMATION	ORDER NO.
	Glass chopping board	422 x 353	629028
	Large all-purpose chopping board with a modern polka dot pattern	Inset, 542 x 300 x 5 Undermount, 515 x 300 x 5	629036 629036U
	Chopping board in sturdy bamboo	540 x 300 x 25	629044
	Chic white chopping board with a light abstract pattern	528 x 275 x 4 515 x 275 x 4 515 x 275 x 4	629045 629045U 629045FB
	Chic white chopping board with a light abstract pattern	For Inset installation	629059
	Chic black glass chopping board with a grey abstract pattern	Inset, 528 x 275 x 4 Undermount, 515 x 275 x 4 Flusch-mount, 515 x 275 x 4	629046 629046U 629046FB
	Chic black glass chopping board with a grey abstract pattern	For Inset installation	629050
	Chopping board in sturdy bamboo	290 x 210 x 18	629052
	Glass chopping board in black for inset sinks	small, 408 x 394 x 4 big, 537 x 394 x 4	629064 629075

CHOPPING BOARDS	INFORMATION	ADDITIONAL INFORMATION	ORDER NO.
	Glass chopping board in black	394 x 318 x 4	629076
	Wooden chopping board with fold-out handles can also be used as a tray	Special design for Mono D-100XS 473 x 186 x 17	629133
	Chopping board in light wood	530 x 300 x 23	629134
	Plastic chopping board in professional quality	394 x 394 x 16	629135
	Chopping board in light wood	394 x 394 x 16	629137
	Exclusive premium chopping board in SCHOCK design		629174
	Chopping board in light maple wood with handle	505 x 403	629211
	Big glass chopping board	383 x 255	629015/N
	Glass chopping boards in white with an abstract line pattern in green	small, 408 x 394 x 4 big, 537 x 394 x 4	629064/1 629075/1

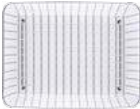
SCHOCK









ZUBEHÖR

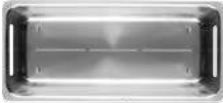





DISH RACKS AND HOLDER	INFORMATION	ADDITIONAL INFORMATION	ORDER NO.
	Multifunctional holder for steamer containers Gastro-norm GN 2/3	394 x 316	629136
	Practical rack for multifunctional use	Special design for Mono D-100XS 473 x 186 x 17	629138
	Practical dish rack		629147
	Practical dish rack		629149
	Practical dish rack		629161
	Practical dish rack	420 x 325 x 160	629170
	Practical dish rack	415 x 320 x 155	629171
	Practical dish rack	385 x 315 x 140	629172
	Practical dish rack	395 x 315 x 170	629194

DISH RACKS AND HOLDER	INFORMATION	ADDITIONAL INFORMATION	ORDER NO.
	Practical dish rack	475 x 350 x 155	629196
	Practical dish rack	400 x 380 x 165	629212

SCHOCK





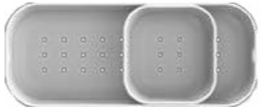

ZUBEHÖR





MULTIFUNKTIONAL STRAINER BOWL	INFORMATION	ADDITIONAL INFORMATION	ORDER NO.
	Multifunctional strainer bowl in stainless steel	368 x 185 x 110	629017
	Multifunctional strainer bowl in stainless steel	345 x 164 x 107	629029
	Multifunctional strainer bowl in stainless steel		629041
	Multifunctional strainer bowl in stainless steel		629042
	Multifunctional strainer bowl in stainless steel	345 x 188 x 110	629043
	Multifunctional strainer bowl in stainless steel		629047
	Multifunctional white strainer bowl	230 x 230 x 118	629049
	Multifunctional green strainer bowl	230 x 230 x 118	629049G
	Multifunctional strainer bowl in stainless steel	394 x 146 x 105	629051

MULTIFUNKTIONAL STRAINER BOWL	INFORMATION	ADDITIONAL INFORMATION	ORDER NO.
	Multifunctional strainer bowl in stainless steel	295 x 188 x 111	629056
	Multifunctional strainer bowl in stainless steel	365 x 263 x 112	629057
	Steamer container Gastronorm GN 2/8	324 x 130 x 65	629061
	Steamer container Gastronorm GN 2/3	353 x 324 x 65	629063
	Acryl strainer bowl in grey transparent		629072/48
	Multifunctional strainer bowl in stainless steel	394 x 146 x 105	629109
	Multifunctional strainer bowl in smoky grey acrylic	303 x 163 x 115	629124/48
	Plastic multifunctional strainer bowl in black	Small bowl 125 x 117 x 94 Big bowl 318 x 132 x 97	629132S
	Plastic multifunctional strainer bowl in white	Small bowl 125 x 117 x 94 Big bowl 318 x 132 x 97	629132W

SCHOCK

ZUBEHÖR

EXTRAS	INFORMATION	ADDITIONAL INFORMATION	ORDER NO.
	Wastecap Elegant chrome trim to cover the basket strainer		628152
	Pre-drilled hole for control knob and mixer tap See drawing for position		629004
	SB Pro diamond drill Exclusive drill with diamond particles suitable for multiple use		629007
	Indutherm Patented heated draining board to warm up plates or help the dishes dry quicker		629100
	Electric control knob Basket strainer opens and closes automatically at the touch of a button		629830
	Electric control knob, round Basket strainer opens and closes automatically at the touch of a button		629830R
	SF-100 coarse particle filter for added protection for the cartridge and aerator		629883
	LED light Modern, energy-efficient LED light to illuminate the bowl	for the left-hand bowl for the right-hand bowl	629024 629024L 629024R

CLEAN AND CARE	INFORMATION	ADDITIONAL INFORMATION	ORDER NO.
	Easy Care Set Cleans and cares for all sinks to protect against limescale deposits and dirty residues.	Contents: Easy Care Descaler 250 ml, Easy Care Balm 250 ml, 3 eraser sponges, instructions for use	621918
	Easy Care Brightener Bleaching effect to remove all organic stains thanks to a highly effective activated chlorine formula.	Suitable for selected colours. Contents: 250 ml bottle, instructions for use	629019
	Eraser sponge Easily removes metal scuffs	Contents: Set contains 3 sponges	629023
	DurCare Set Removes and then seals deeper spots of damage, especially in the bottom of CRISTADUR® sinks.	Contents: DurCare Precleaner, DurCare Balm, eraser sponge, 2 soft cloths, instructions for use	629094
	ProCare Set Can be used to refresh and intensify the colour and repair minor damage to SCHOCK sinks.	The paste also protects against fresh soiling. Contents: ProCare paste (1x30 ml), 2 soft cloths, instructions for use	629099



Visible parts in Copper



Visible parts in Gunmetal



Visible parts in stainless steel

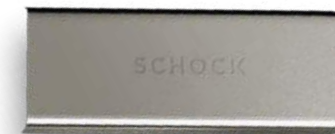

VISIBLE PARTS

ADDITIONAL INFORMATION

ORDER NO.

Visible parts consisting of a knob to operate the pop-up waste, two drain cups and an overflow faceplate

in Copper
in Gunmetal
in stainless steel

629305COP
629305GUM
629305EDM

Visible parts consisting of a knob to operate the pop-up waste, a drain cup and an overflow faceplate

in Copper
in Gunmetal
in stainless steel

629307COP
629307GUM
629307EDM

Visible parts consisting of a knob to operate the pop-up waste, a drain cup and an overflow faceplate

in Copper
in Gunmetal
in stainless steel

629313COP
629313GUM
629313EDM

Visible parts consisting of a knob to operate the pop-up waste, a drain cup and an overflow faceplate

in Copper
in Gunmetal
in stainless steel

629324COP
629324GUM
629324EDM

Visible parts consisting of a knob to operate the pop-up waste, two drain cups and an overflow faceplate

in Copper
in Gunmetal
in stainless steel

629349COP
629349GUM
629349EDM

Visible parts consisting of a knob to operate the pop-up waste, two drain cups and an overflow faceplate

in Copper
in Gunmetal
in stainless steel

629366COP
629366GUM
629366EDM

Visible parts consisting of a knob to operate the pop-up waste, a drain cup and an overflow faceplate

in Copper
in Gunmetal
in stainless steel

629368COP
629368GUM
629368EDM

Visible parts consisting of a knob to operate the pop-up waste, a drain cup and an overflow faceplate

in Copper
in Gunmetal
in stainless steel

629371COP
629371GUM
629371EDM

Visible parts consisting of a knob to operate the pop-up waste, two drain cups and an overflow faceplate

in Copper
in Gunmetal
in stainless steel

629373COP
629373GUM
629373EDM

VISIBLE PARTS

ADDITIONAL INFORMATION

ORDER NO.

Visible parts consisting of a knob to operate the pop-up waste, a drain cup and an overflow faceplate

in Copper
in Gunmetal
in stainless steel

629383COP
629383GUM
629383EDM

Visible parts consisting of a knob to operate the pop-up waste, a drain cup and an overflow faceplate

in Copper
in Gunmetal
in stainless steel

629385COP
629385GUM
629385EDM

Visible parts consisting of a knob to operate the pop-up waste, two drain cups and an overflow faceplate

in Copper
in Gunmetal
in stainless steel

629388COP
629388GUM
629388EDM

Visible parts consisting of a knob to operate the pop-up waste, a drain cup and an overflow faceplate

in Copper
in Gunmetal
in stainless steel

629392COP
629392GUM
629392EDM

Visible parts consisting of a knob to operate the pop-up waste, a drain cup and an overflow faceplate

in Copper
in Gunmetal
in stainless steel

629857COP
629857GUM
629857EDM

Visible parts consisting of a knob to operate the pop-up waste, two drain cups and an overflow faceplate

in Copper
in Gunmetal
in stainless steel

629886COP
629886GUM
629886EDM

Visible parts consisting of a knob to operate the pop-up waste, two drain cups and an overflow faceplate

in Copper
in Gunmetal
in stainless steel

629886COP
629886GUM
629886EDM

Visible parts consisting of a knob to operate the pop-up waste, a drain cup and an overflow faceplate

in stainless steel

629620EDM

SCHOCK

Delivery period Within one week if in stock.
We reserve the right to defer delivery in the event of production delays.

Minimum order value For orders with a net value of €50 or less, we shall impose a flat-rate shipping charge of €6.90.

Delivery Free delivery ex works (from Regen) within Germany for orders with a net value of €50 or more.

Warranty Sinks in CRISTALITE®/CRISTADUR®

2 years*, improper use voids the warranty.

Any installation of undermount sinks in countertops made of laminate/wood is at the customer's own risk.

Sink accessories:

2 years*, improper use voids the warranty.

Mixer taps:

2 years*, improper use voids the warranty.

Complaints Colours may vary due to the high proportion of natural raw materials used. This is not a fault and does not constitute cause for complaint. SCHOCK shall not pay the costs of any duplicate journey or installation if the customer fails to check the product and notify us of any defects with the period specified in the General Terms and Conditions of Supply and Payment.

In the event of breakage of one of our sinks, SCHOCK shall only deliver a replacement for free if the damage is notified to SCHOCK within 4 days of delivery and the sink is given back to the haulage company to take away. SCHOCK shall not be obliged to recover the product.

Recovery/return of goods SCHOCK shall pay the costs of recovering or returning the goods in the event of defective products or wrong deliveries only by prior arrangement and only if the goods are available for collection at all times after the date of complaint with a copy of the invoice or delivery note enclosed. Otherwise the customer shall be obliged to return the goods to the Regen plant at the customer's own expense.

If the goods cannot be taken upon collection, SCHOCK shall be entitled to invoice the costs incurred; at the same time payment of the invoice for the goods shall become due. Freight and shipping costs for the return of goods ordered in error or for any other reason not attributable to SCHOCK shall be paid by the purchaser.

For return deliveries not made under notices of defects or warranty claims, we are entitled to invoice the purchaser 30% of the value of the goods. This does not apply to failed or wrong deliveries occurring as a result of our own error.

Separate section on trademark rights: In the absence of any other written agreement between us and the purchaser, all goods purchased from us may only be marketed under the respective SCHOCK product name. This particularly applies in the event of products from SCHOCK GmbH being publicised by the purchaser or publicised within the scope of auctions, advertising or other offers.

*in accordance with SCHOCK's General Terms and Conditions as available at www.schock.de

This price list supersedes all earlier price lists and offers.
We reserve the right to make technical modifications.
Schock assumes no liability for misprints.

SCHOCK