

# Veriton X4230G(VX4230G) Lifecycle Extension Guide

Disassembly Procedure .....	3
Troubleshooting.....	15
Exploded Diagrams.....	18
FRU (Field Replaceable Unit) List.....	20
To update your software .....	21
To remove your personal data .....	21

# Disassembly Procedure

---

## Safety Guidelines

---

This chapter contains step by step procedures on how to remove and de-install components from the computer. Use the following safety guidelines to ensure your personal safety. Each procedure included in this chapter assumes that you are preparing your computer for recycling and disposal. **By performing any of these procedures you acknowledge that any remaining warranty applicable to your computer will be voided. Before you start any of the procedures in this chapter, make sure to read the following safety guidelines and the respective instructions within the chapter.**

### CAUTION!

- Turn off your computer and disconnect all power sources before opening the computer cover or panels.
- To avoid electrostatic discharge, ground yourself by using a wrist grounding strap or by periodically touching an unpainted metal surface at the same time as touching a connector on the back of the computer.
- Take off any metal objects on your arms or fingers such as bracelets, rings or watches and make sure your hands are completely dry. Even if your unit is unplugged, there may still be some remaining electric charge.
- If a component does not come out easily, do not forcefully remove it. Instead, check that you are removing it correctly and that no wires or other parts are in the way.
- When you disconnect a cable, pull on its connector or on its pull-tab, not on the cable itself. Some cables have connectors with locking tabs; if you are disconnecting this type of cable, press in on the locking tabs before you disconnect the cable.

## Recommended Equipment

---

The following equipment are recommended to do the following maintenance procedures:

- Wrist grounding strap and conductive mat
- Flat screwdriver
- Philips screwdriver
- Polydrive screwdriver
- Plastic tweezers
- Flat plastic pry

## **WEEE Annex VII Component**

---

These components are classified as requiring selective treatment.

## **Pre-disassembly Instructions**

---

Do the following prior to starting any maintenance procedures:

1. Place the system on a stable work surface.
2. Remove AC power cord from the system and peripherals
3. Remove all cables from the system.

### **⇒ NOTE:**

Make sure the system is completely powered off.

## Chassis Door Removal

---

1. Remove the chassis door
  - 1.1 Remove the 2 screws



- 1.2 Remove the left side cover



## ODD Removal

---

### 2. Remove the Slim ODD

#### 2.1 Disconnect the ODD SATA cable and ODD power-cable



#### 2.2 Press the tail of ODD to pushing it out of chassis

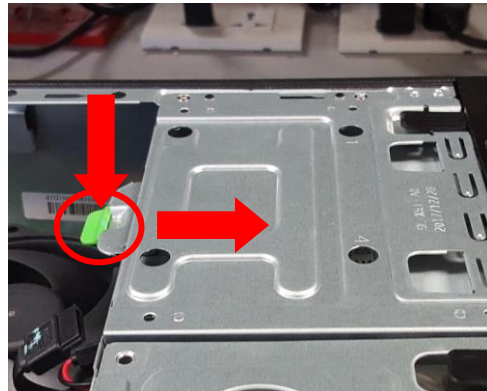

#### 2.3 Remove the ODD

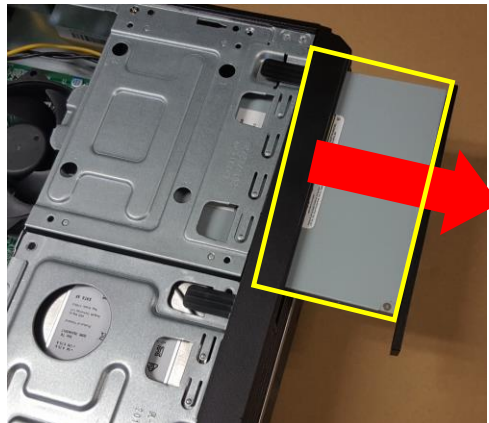

**NOTE:** ODD has been highlighted with the yellow circle as above image shows. WEEE Annex VII component.

## 3.5" HDD Removal

---

### 3. Remove 3.5" HDD

#### 3.1 Disconnect SATA cable and power cable from HDD

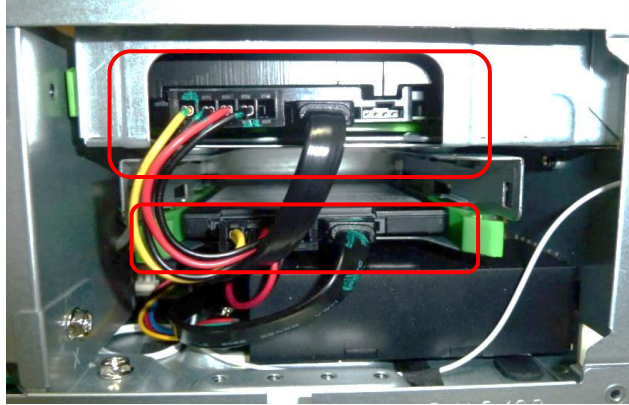

#### 3.2 Remove two screws fastening HDD cage



#### 3.3 Press the ODD cage down and pull it out



3.4 Pull green rack out from HDD cage

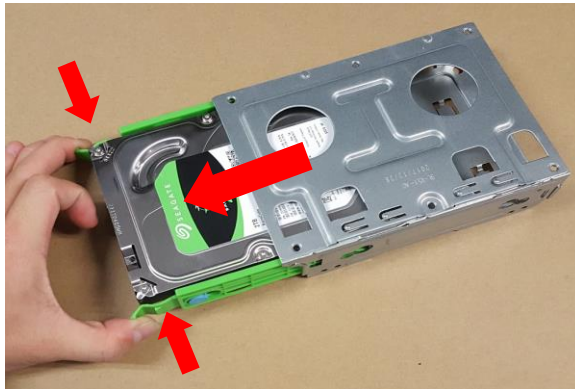

3.5 Remove HDD from green rack



**NOTE:** HDD has been highlighted with the yellow circle as above image shows. WEEE Annex VII component.



## 2.5" SSD Removal

---

### 4. Remove 2.5" SSD

4.1 Remove four screw and take out the metal bracket

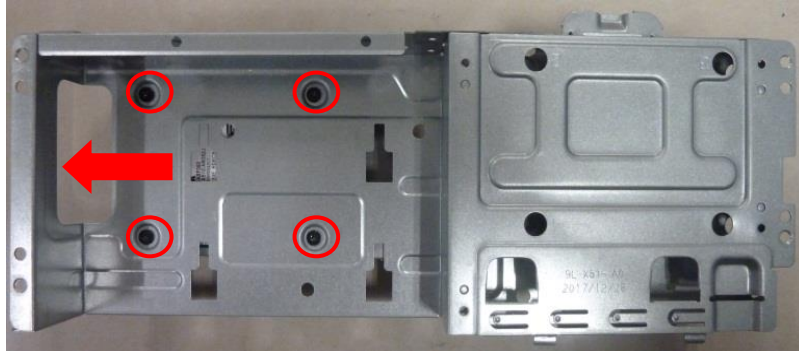

4.2 Remove the green tool-less from metal bracket

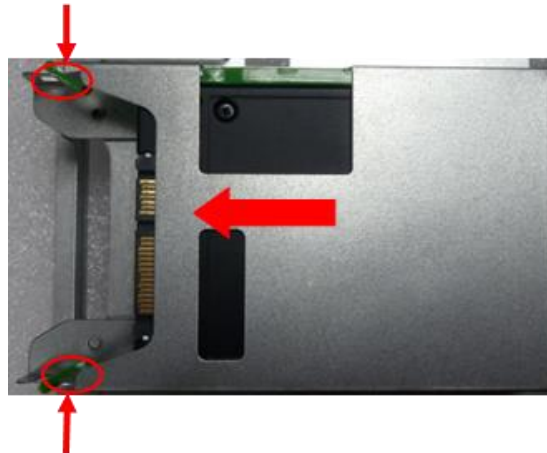

4.3 Remove the 2.5" SSD



**NOTE:** SSD has been highlighted with the yellow circle as above image shows. WEEE Annex VII component.

## VGA card Removal

---

### 5. Remove VGA Card

#### 5.1 Remove a screw and open the PCI bracket

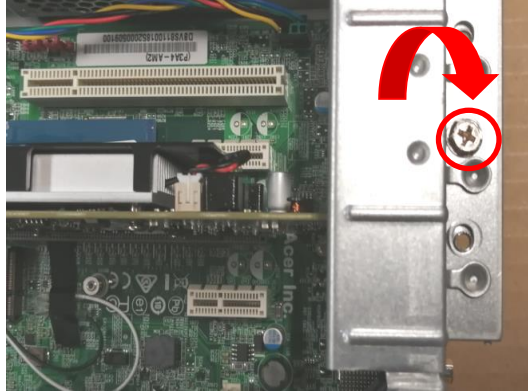

#### 5.2 Press the PCI slot latch down and lift up the VGA card

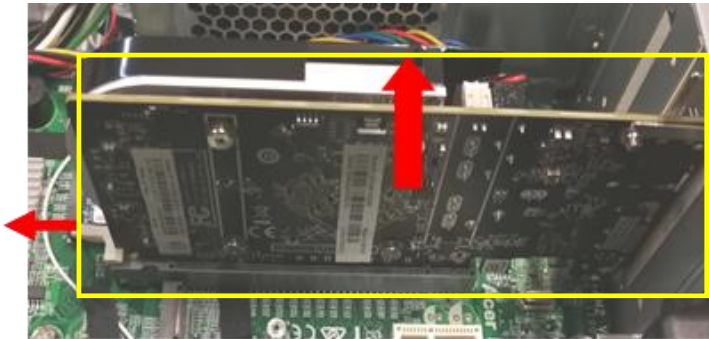

**NOTE:** VGA card has been highlighted with the yellow circle as above image shows. WEEE Annex VII component.

## PSU Removal

---

### 6. Remove internal PSU

6.1 Cut the cable tie and disconnect the 4pin ATX\_12V and 6pin ATX\_ power cables form MB

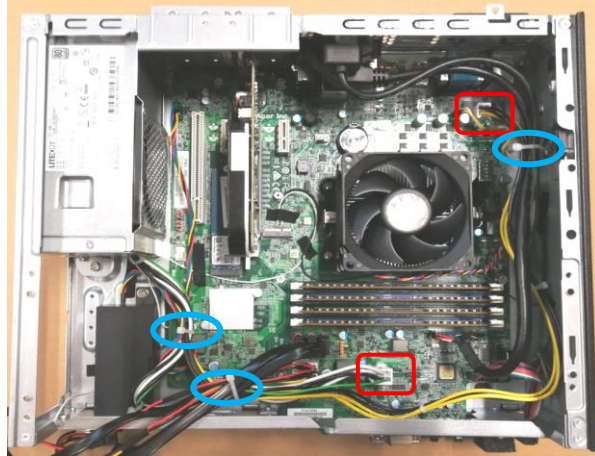

6.2 Remove four screw fastening PSU and pull it out from chassis

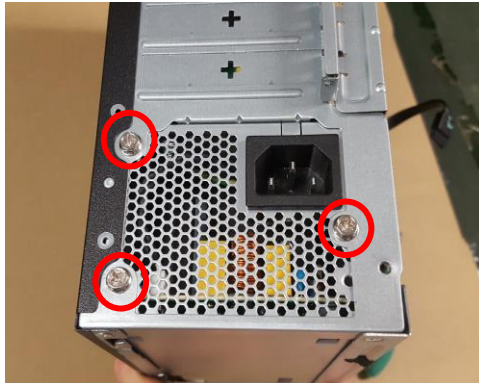

6.3 Push the latch then take out the PSU

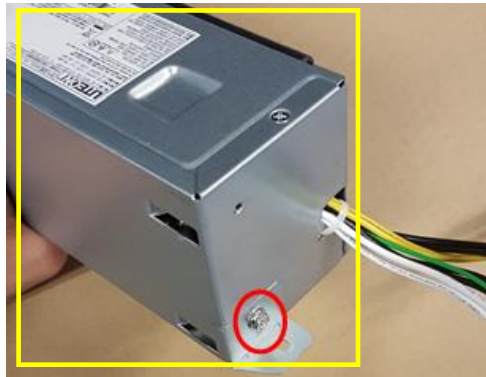

**NOTE:** PSU MB/PSU FAN/PSU CAPACITOR have been highlighted with the yellow circle as above image shows. WFFF Annex VII component.

## MotherBoard, MEM, CPU, Cooler, WLAN, SSD, RTC Battery Removal

### 7. Remove the Main Board

#### 7.1 Remove the acetic acid tape antenna from MB

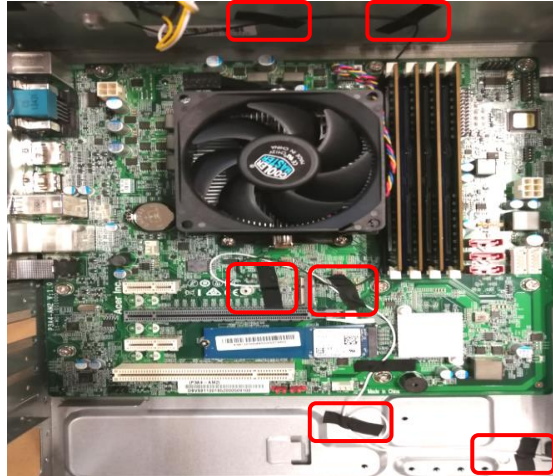

#### 7.2 Disconnect SATA and SATA-power cables from MB

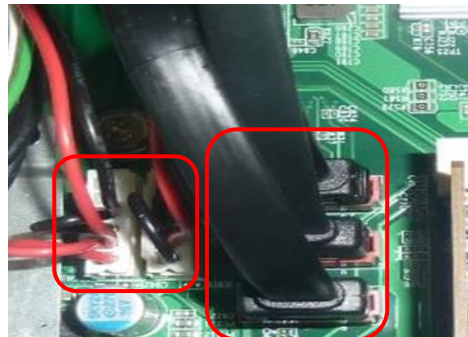

#### 7.3 Disconnect front panel cables from MB

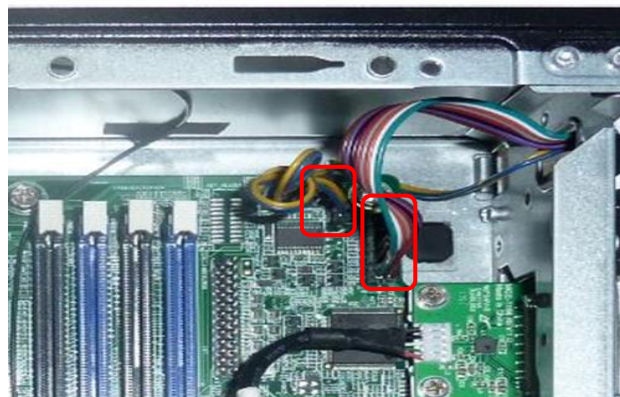



7.4 Remove the eight screws from MB

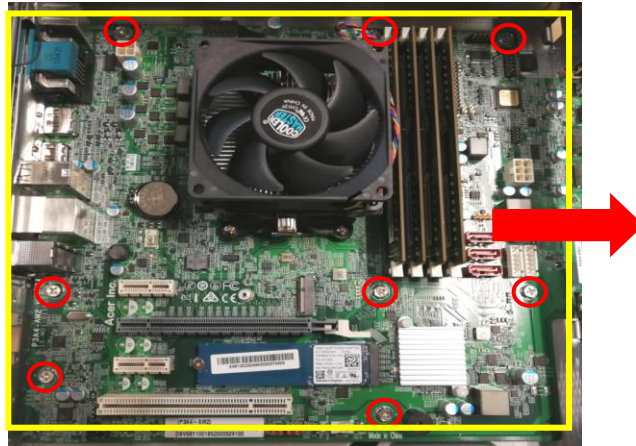

**NOTE:** Circuit boards >10 cm<sup>2</sup> has been highlighted with the yellow rectangle as above image shows. WEEE Annex VII component. Please detach the Circuit boards and follow local regulations for disposal.

7.5 Release the two latch show bellow then remove the Memory

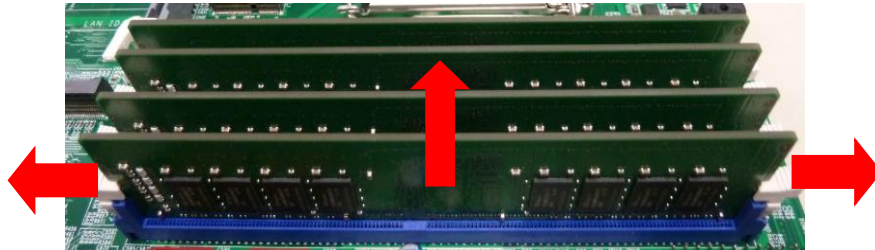

**NOTE:** MEMORY has been highlighted with the yellow circle as above image shows. WEEE Annex VII component.

7.6 Disconnect fan power cable from MB then remove CPU cooler



**NOTE:** CPU cooler has been highlighted with the yellow circle as above image shows. WEEE Annex VII component.

### 7.7 Remove the CPU

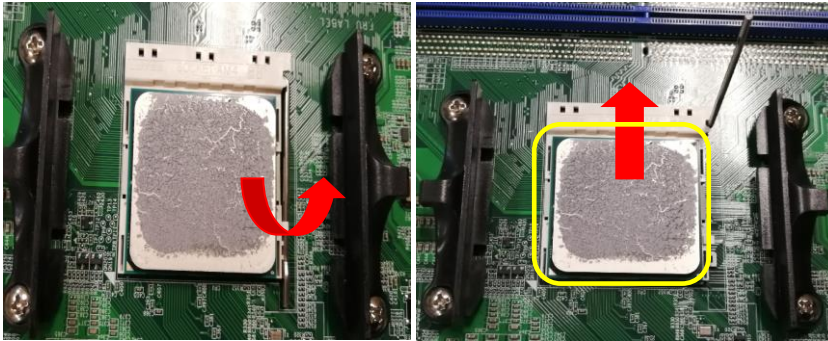

**NOTE:** CPU has been highlighted with the yellow circle as above image shows. WEEE Annex VII component.

### 7.8 Remove a screw fastening the M.2 SSD and pull it out of slot



**NOTE:** SSD has been highlighted with the yellow circle as above image shows. WEEE Annex VII component.

### 7.9 Remove the battery

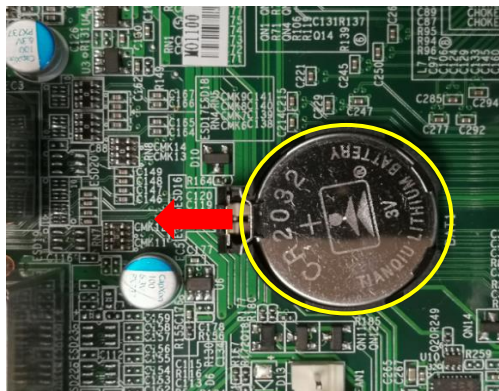

**NOTE:** RTC battery has been highlighted with the yellow circle as above image shows. WEEE Annex VII component.

# Troubleshooting

---

This chapter provides troubleshooting information for the Veriton X4230G Service Guide

- Power-On Self-Test (POST)
- POST Error Messages List

## Power-On Self-Test (POST)

---

Each time you turn on the system, the Power-on Self Test (POST) is initiated. Several items are tested during POST, but for the most part transparent to the user.

The Power-On Self Test (POST) is a BIOS procedure that boots the system, initializes and diagnoses the system components, and controls the operation of the power-on password option. If POST discovers errors in system operations at power-on, it displays error messages on screen, generates a check point code at port 80h or even halts the system if the error is fatal.

The main components on the main board that must be diagnosed and/or initialized by POST to ensure system functionality are as follows:

- Microprocessor with built-in numeric co-processor and cache memory subsystem
- Direct Memory Access (DMA) controller
- Interrupt system
- Three programmable timers
- ROM subsystem
- RAM subsystem
- CMOS RAM subsystem and real time clock/calendar with battery backup
- Onboard parallel interface controller
- Embedded hard disk interface and one diskette drive interface
- Keyboard and auxiliary device controllers
- I/O ports
  - One parallel port
  - One PS/2-compatible mouse port
  - One PS/2-compatible keyboard port

## POST Error Messages List

If you cannot run the diagnostics program tests but did receive a POST error message, use "POST Error Messages List" to diagnose system problems. If you did not receive any error message, look for a description of your error symptoms in "Error Symptoms List".

If you are unable to correct the problem by using the "BIOS Messages List" table and "Error Symptoms List" table, go to "Undetermined Problems".

To diagnose a problem, first find the BIOS error messages in the left column. If directed to a check procedure, replace the FRU indicated in the check procedure. If no check procedure is indicated, the first Action/FRU listed in right column is the most likely cause.

BIOS Messages	Action/FRU
BIOS ROM checksum error - System halted	The checksum of the BIOS code in the BIOS chip is incorrect, indicating the BIOS code may have become corrupt. Contact your system dealer to replace the BIOS.
CMOS Battery Failed	The CMOS battery is no longer functional. Contact your system dealer for a replacement the BIOS.
CMOS Checksum Error- defaults loaded	Checksum of CMOS is incorrect, so the system loads the default equipment configuration. A checksum error may indicate that CMOS has become corrupt. A weak battery may have caused this error. Check the battery and replace if necessary.
CPU at run	Displays the running speed of CPU.
Display switch is set incorrectly	The display switch on the motherboard can be set to either monochrome or color. This message indicates the switch is set to a different setting than indicated in Setup. Determine which setting is correct, and then either turn off the system and change the jumper, or enter Setup and change the Video selection.
Press ESC to skip memory test	The user may press Esc to skip the full memory test.
HARD DISK initializing - Please wait a	Some hard drives require extra time to initialize.
HARD DISK INSTALL FAILURE	Cannot find or initialize the hard drive controller or the drive. Make sure the controller is installed correctly. If no hard drives are installed, be sure the Hard Drive Selection in Setup is set to NONE.
Hard disk(s) diagnosis fail	The system may run specific disk diagnostic Routines. This message appears if one or more hard disks return an error when the diagnostics run.
Keyboard Error Or No Keyboard Present	Cannot initialize the keyboard. Make sure the keyboard is attached correctly and no keys are pressed during POST. To purposely configure the system without a keyboard, set the error halt condition in Setup to HALT ON ALL, BUT KEYBOARD. The BIOS then ignores the missing keyboard during POST.
Keyboard is locked out - Unlock the key	This message usually indicates that one or more keys have been pressed during the keyboard tests. Be sure no objects are resting on the keyboard.



BIOS Messages	Action/FRU
Memory Test:	This message displays during a full memory test, counting down the memory areas being tested.
Memory test fail	If POST detects an error during memory testing, additional information appears giving specifics about the type and location of the memory error.
Override enabled - Defaults loaded	If the system cannot boot using the current CMOS configuration, the BIOS can override the current configuration with a set of BIOS defaults designed for the most stable, minimal-performance system operations.
Press TAB to show POST screen	System OEMs may replace the Phoenix Technologies Award BIOS POST display with their own proprietary display. Including this message in the OEM display permits the operator to switch between the OEM display and the default POST display.
Primary master hard disk fail	POST detects an error in the primary master hard drive.
Primary slave hard disk fail	POST detects an error in the secondary master hard drive.
Secondary master hard disk fail	POST detects an error in the primary slave hard drive.
Secondary slave hard disk fail	POST detects an error in the secondary slave hard drive.

# Exploded Diagrams

---

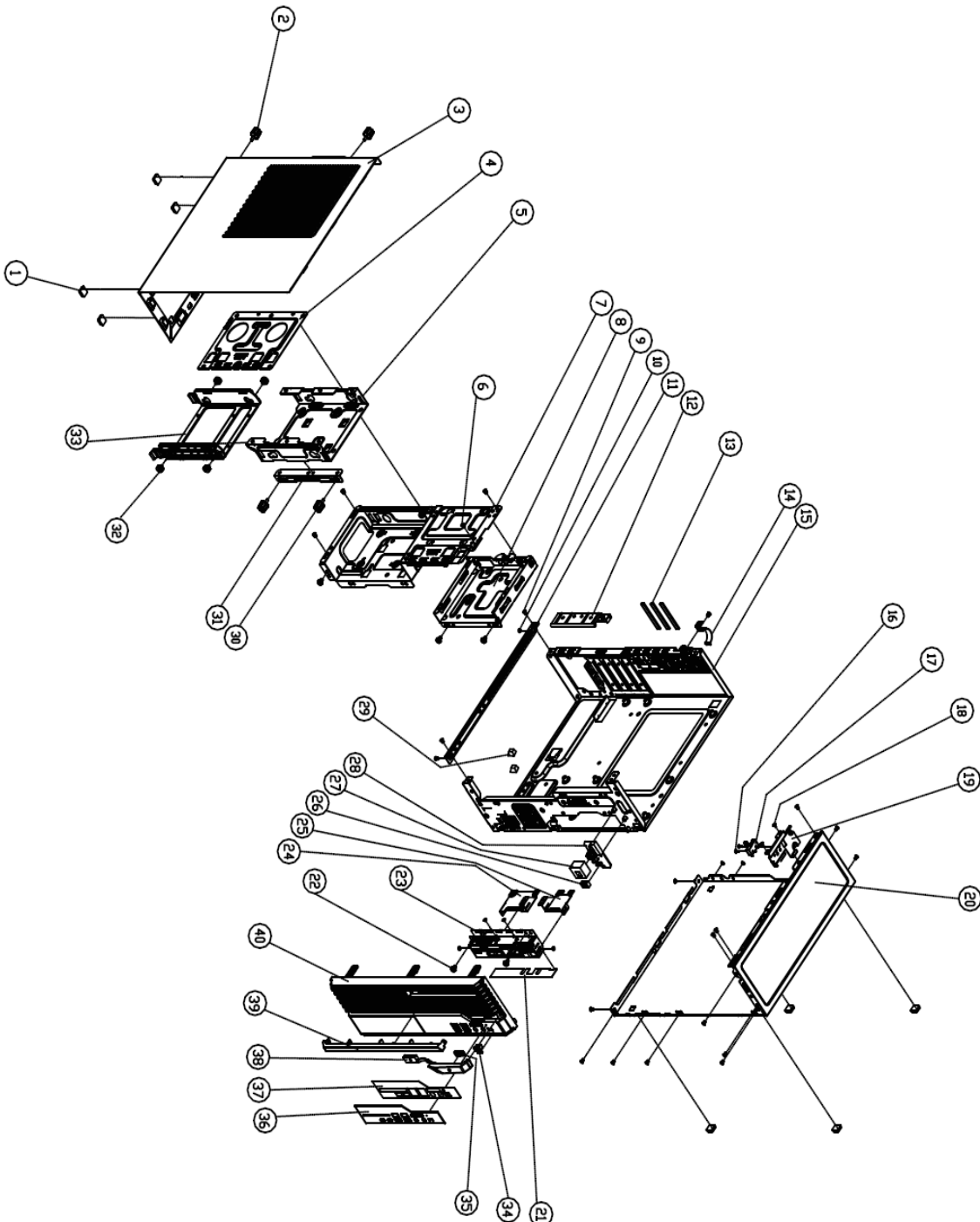

Figure 1 System Exploded Diagram

Item	Description	Item	Description
1	Rubber foot	26	LED sponge
2	Black Screw	27	Power sponge
3	Side Cover L	28	Power switch PCB
4	HDD Bracket	29	MB Rubber
5	HDD Top cover	30	#6-32*5 Screw
6	#6-32*5 Screw	31	HDD support Bracket
7	HDD support Bracket	32	HDD Rubber
8	ODD Bracket	33	HDD tool-less
9	Rivet-1	34	HDD lens
10	Rivet-2	35	Power lens
11	X5.1 Side bkt	36	IO Cover
12	PCI Cover	37	ADHESIVE for IO Cover
13	Gasket	38	Power button
14	Metal Cable Clip	39	VX logo strip
15	MB Bracket	40	VX Front Bezel
16	M2*8 Screw		
17	INTERNAL INTRUSION ALARM		
18	M2*5 Screw		
19	INTRUSION Bracket		
20	Bottom Bracket		
21	FIO Mylar		
22	#6-32*5 Screw		
23	FIO Bracket		
24	SM Bracket		
25	SD Bracket		

## **FRU (Field Replaceable Unit) List**

---

Please contact your local service center to find out how to obtain the part or replace your device

## To update your software

---







Microsoft keeps pushing the latest Windows operation system to each unit. Acer post the latest software on website. Please visit

<https://www.acer.com/ac/en/US/content/drivers>

<https://www.acer.com/ac/en/CA/content/drivers>

## To remove your personal data

---

- Option 1: Select **Start**  > **Settings**  > **Update & Security**  > **Recovery**. Under **Reset this PC**, select **Get started**. [Open Recovery settings](#).
- Option 2: Restart your PC to get to the sign-in screen, then press and hold down the **Shift key** while you select the **Power**  icon > **Restart** in the lower-right corner of the screen. After your computer restarts, select **Troubleshoot** > **Reset this PC**.
- Option 3: Select **Start** , then press and hold down the **Shift key** while you select the **Power**  icon > **Restart** to restart your computer into Recovery Mode. After your computer restarts, select **Troubleshoot** > **Reset this PC**.