

ISSN 0387-7906

# KAWASAKI TECHNICAL REVIEW

## Special Issue on Distributed Power Generation System

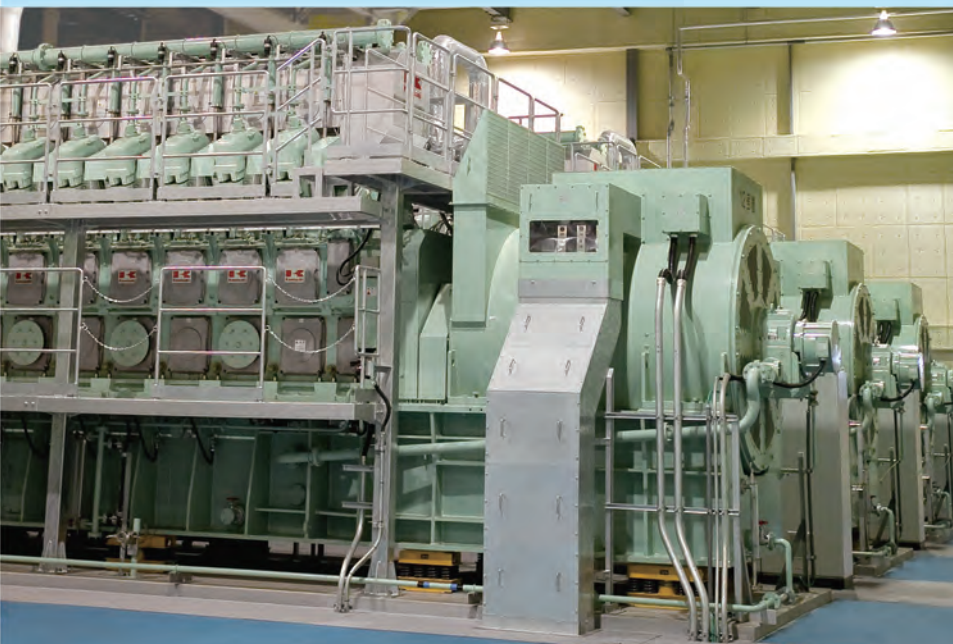
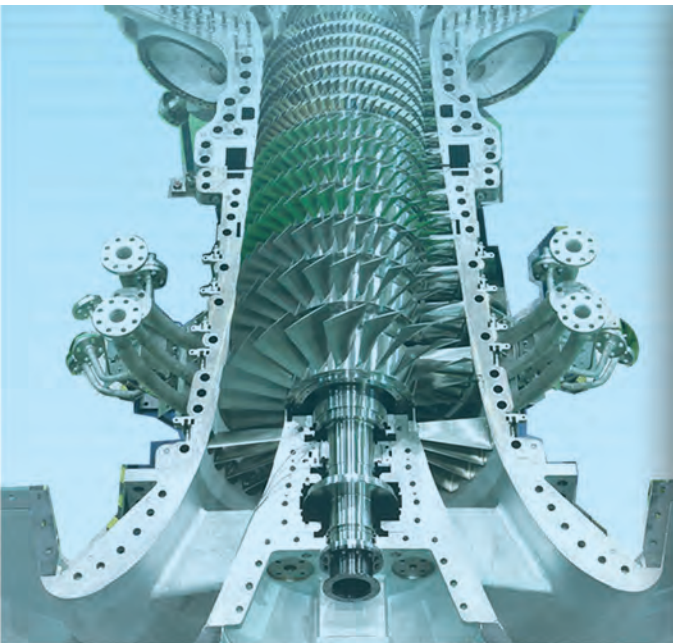

Solutions to Energy Needs Today and Tomorrow

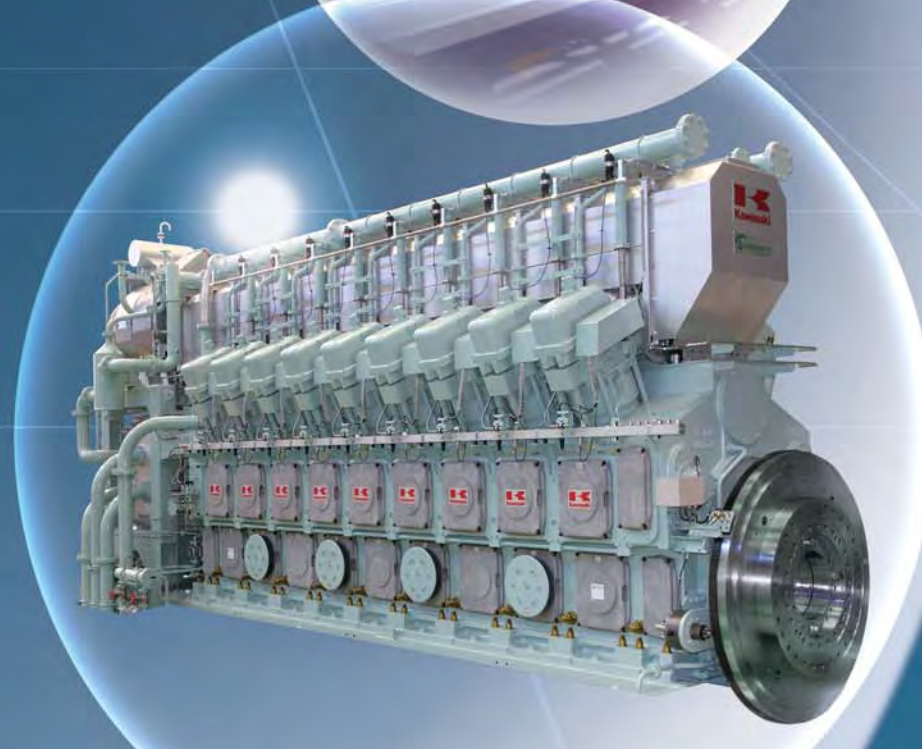
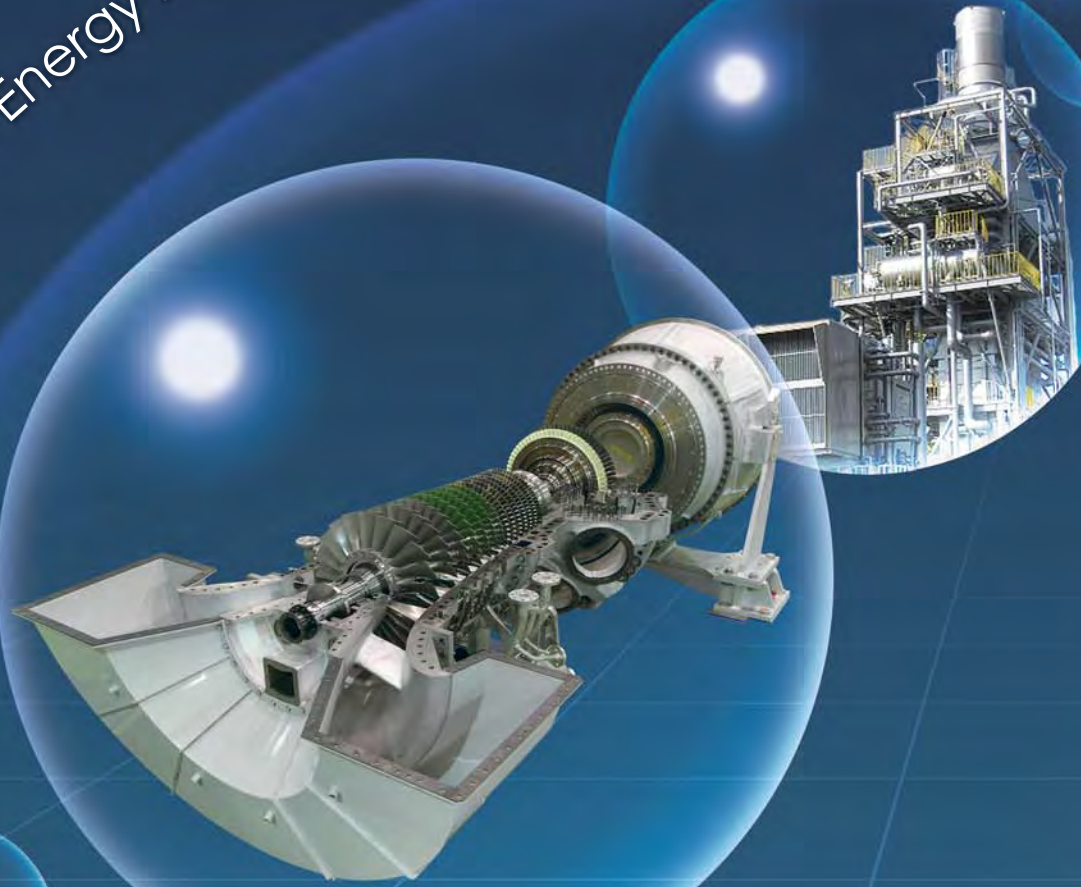



# KAWASAKI TECHNICAL REVIEW

## No.173 CONTENTS

---

### Lead Article

---

- Current status and future prospects of the distributed power generation system business ..... 1
- Kawasaki responds to a great variety of energy needs with its system solutions ..... 3

### Technical Description

---

- Distributed power generation systems that meet energy needs —Cogeneration system solutions ..... 9
- Standby gas turbine generator set for stable supply of electric power ..... 15
- Gas turbine cogeneration system for energy conservation and better power supply security ..... 21
- Gas engine with world highest generating efficiency —Green gas engine ..... 27
- Highly efficient 30 MW class gas turbine, L30A ..... 33
- Modification of 8 MW class gas turbine, M7A-03 ..... 39
- 1.7 MW class high efficiency and low emission gas turbine, M1A-17 ..... 45
- DLE combustion technology for enhancing environmental performance ..... 51
- Lean methane- fueled gas turbine generator set ..... 57
- 250 kW turbine generator based on organic rankine cycle with effective use of low temperature heat source —Green binary turbine ..... 63

### Product Introduction

---

- Kawasaki-MAN 48/60 4-stroke diesel engine for stationary power generating plant ..... 69
- Diverse applications of industrial steam turbines ..... 71
- Gas turbine cogeneration system for supercomputer "K" ..... 73
- Hybrid type absorption chiller, Sigma Ace Gene-Link 1.43 series (TZJ) ..... 75

A Conversation with the President of the Gas Turbine & Machinery Company

# Current status and future prospects of the distributed power generation system business



**Joji Iki**

Senior Vice President  
President, Gas Turbine & Machinery Company

## Particular attention remains focused on the supply of electric power. Are changes seen in customer needs?

In the past, electric power was supplied stably from centralized power generation facilities. Since the Great East Japan Earthquake in March 2011, however, the advantages of distributed power generation have been re-evaluated. In addition, with the development of shale gas advancing in the United States and elsewhere, natural gas, a clean fuel, is drawing greater attention. Backed by this, needs are rising for distributed power generation systems using our gas turbines and gas engines.

Moreover, for the purpose of utilizing resources effectively and preventing global warming, attention is being focused on systems that thoroughly use exhaust heat and those promoting the use of renewable energy.

And, with increasingly greater importance being focused on security, safety, and disaster preparedness, customer inquiries in this connection have increased.

## What are the features of Kawasaki's power generation system solutions?

We have various types of energy engines that form the core of distributed power generation systems and the know-how for designing systems to effectively utilize them, and we are capable of providing system solutions with which customers can enjoy the maximum benefit.

Based on "heat-oriented" gas turbines which have high overall efficiency and are suitable for long, continuous operation and "electricity-oriented" gas engines that follow load variation accurately and have high power generation efficiencies, we have a lineup

of heat recovery steam generators that use waste heat effectively, as well as absorption chillers, steam turbines and binary turbines that are combined with these gas turbines and gas engines to provide customers with the best systems for their needs.

Our products have as their foundation over a century of experience with marine engines and over a half century of experience with aviation and transportation engines. Transportation engines, for example, must be small-sized and lightweight, operate at high efficiencies over a wide range, and be highly reliable. We are experienced in addressing these requirements, and possess very advanced technologies. Energy engines are manufactured on the basis of sophisticated design technologies covering the fields of aerodynamics, combustion, structure, strength, materials, control, electric power conversion, and the like, as well as high-precision manufacturing technologies. We refine our technologies through constant efforts and the close linkage between the company in charge and the Corporate Technology Division, and are advancing our products and ability to make system proposals.

---

## What are the more recent topics?

We launch new power generation systems and energy-related products on the market one after another.

In August 2012, Nihon Techno's Sodegaura Green Power Plant, which has an output of 110 MW from 14 green gas engines boasting the world's highest power generation efficiency, was commissioned and the plant now operates at a power generation efficiency of 49.5%. This is Japan's first power plant with an output greater than 100 MW composed of gas engines only, and the first new power generation facility built for a company other than general electricity utility after the Great East Japan Earthquake. We feel the start of a new era of electric power supply with this event.

As a new topic concerning green gas turbines, development work on the L30A, the largest model of ours, has been completed, and commercial operation

of the model started at the Aboshi Plant of Daicel Corporation in October 2012. With excellent power generation performance (world's highest class efficiency of 40%) and low NOx emission characteristics, our gas turbines have come to cover an extremely wide range of power generation capacity from 650 to 30,000 kW, thanks to the development of the above model.

Also deserving special mention as natural energy utilization systems are geothermal binary generator sets and solar absorption chillers that are now undergoing demonstration tests.

---

## Conclusion

The draft power supply structure for 2030, to be incorporated into Japan's basic energy plan, requires cogeneration to account for 15% of the country's electric energy structure, namely, to be increased by about five times the current scale. We will do our best so that distributed power generation systems can contribute to the fulfillment of this plan.

We will further improve and develop the performance and quality of green gas engines and green gas turbines, while also focusing on strengthening our ability to propose system solutions unique to us.

In terms of our activities overseas, we will make the most of our bases to grasp user needs and increase the sale of distributed power generation systems, with the aim of providing the best system for the intrinsic characteristics of the different regions.

To materialize a sustainable society, which is the greatest challenge to mankind, wider use of renewable energy is indispensable. Distributed power generation/cogeneration systems that use fossil fuels efficiently play an important role in using natural energy that is distributed thinly and widely, and fluctuates considerably. We at Kawasaki believe that it is our mission to support security and safety with emergency power generation, to use limited resources effectively via clean-fuel-based cogeneration systems and thorough use of waste heat, and to contribute thereby to the realization of a sustainable society.

# Kawasaki responds to a great variety of energy needs with its system solutions

## Toshiyuki Kuyama

Executive Officer

General Manager, Gas Turbine Division, Gas Turbine & Machinery Company



## Takeshi Ohata

Executive Officer

General Manager, Machinery Division, Gas Turbine & Machinery Company



## Preface

The Great East Japan Earthquake was one of the greatest earthquakes in the history of Japan, being accompanied by large-scale tsunamis that caused unheard-of damage. The accident at the Fukushima Daiichi Nuclear Power Plant of the Tokyo Electric Power Company and shutdown of thermal power plants forced the utility company to resort to rolling blackouts in its service areas. In addition, an unprecedented situation in which all nuclear power plants in Japan were brought to a shutdown has caused a shortage of electric power on a scale involving the entire nation in addition to the disaster-stricken areas. The exposure of the vulnerability in the steady supply of energy has forced Japan to re-evaluate its energy policy as an urgent challenge.

In the meantime, the world economy continues to advance, with energy consumption growing increasingly in emerging countries such as China and India. According to a report from the International Energy Agency (IEA), China will account for about one-fourth of the world's energy consumption in 2030, becoming the world's largest energy consumer. For the purpose of preventing global warming, countries have raised the reduction of greenhouse gas emissions as a strategy in their energy policies. In addition, the accident at the Fukushima Daiichi Nuclear Power Plant following the Great East Japan Earthquake has created a trend toward abandoning or reducing nuclear power generation, as restructuring is being urged with energy strategies around the world. At the same time, environmental problems have worsened, and a move is growing to use fossil gas fuels of lesser CO<sub>2</sub> emissions

than coal or petroleum. In the future, the importance of distributed power generation based on gas will further increase.

In August 2012, the Ministry of Economy, Trade and Industry established the Combined Heat and Power Promotion Office and a contact in charge of this matter in each Bureau of Economy, Trade and Industry. The Ministry says that the creation of a responsible office will reinforce administrative functions aimed at the accelerated introduction of cogeneration systems (energy systems supplying both heat and power, abridged to CHP\* in the following) with the aim of expanding the introduction of CHPs.

We have a rich assortment of generator sets such as gas turbines, gas engines, diesel engines, and steam turbines, as well as products for exhaust heat utilization such as heat recovery steam generators (HRSG) and absorption chillers. We also have a good track record of delivering them in the form of CHPs. This special issue of the Kawasaki Technical Review presents our system solutions and products related to distributed power generation systems that respond to a wide variety of customer needs.

\*CHP: Combined Heat and Power

## 1 Offering system solutions in response to customer needs

We respond to a variety of energy needs of customers with solutions that optimize life cycle costs and environmental performance.

For example, steam obtained from CHPs can be used

as a heat source for processes, painting, industrial ovens, paper drying processes in paper mills, hot water supply and space heating, while adding an absorption chiller to a system allows low-temperature exhaust heat to be used to produce chilled water that is used for general air conditioning or for inlet air cooling for increasing gas turbine power generating output in summer. And, if this low-temperature exhaust heat is recovered and used by a binary turbine, the thermal efficiency of the system can be improved. Furthermore, combining exhaust heat recovery steam with various types of steam turbines will allow variable heat-electricity systems that follow the seasonal and time zone variations in steam demand to be built. Combining various machines and devices in this way and using heat in a cascade configuration (multi-stage use) from high to low temperatures allow a high overall efficiency to be attained, which greatly contributes to energy conservation and CO<sub>2</sub> reduction.

To suggest such a solution to the customer, it is very important to be able to quickly present a system configuration that will maximize the benefit of investment, as well as a method of running that system. Since the ongoing acceleration of the introduction of CHPs is expected to be accompanied by the sophistication of system configurations arising from the diversification of customer needs, we will further strengthen our ability to propose solutions so that we can respond to customer needs quickly.

## 2 Standby gas turbine generator sets

We started developing industrial gas turbines using our own technologies in 1972, and since delivering Japan's

first all-made-in-Japan turbine generator set in 1977, we have manufactured and delivered a number of gas turbine generator sets. Making the most of the features of gas turbines, to note their light weight, small size, and high starting reliability, we have serialized all 21 models covering 150 to 4,800 kW class products. In addition, the 1974 revisions to the Fire Services Act made stricter the obligation for buildings and large-sized stores to install standby generator sets for times of emergency. Recognized for their advantages of a compact size, light weight, no need for cooling water, and low vibrations in comparison with emergency diesel generator sets, gas turbine generator sets have rapidly penetrated the market.

With financial and IT enterprises having established large-sized data processing centers in the recent years, gas turbine generator sets have become widespread as backup power supplies for such data processing centers (Fig. 1).

In the Great East Japan Earthquake, Kawasaki's gas turbine generator sets showed their 99.9% starting reliability, and contributed to support efforts in the disaster-stricken areas.

After the Great East Japan Earthquake, users requested extended operation as a measure to cover the power shortage. Additionally, dual fuel specifications, in which liquid fuel is used for starting under a power service interruption and then gas fuel takes over, have been increasingly requested. Moreover, requests for mobile power supply vehicles have grown as they can demonstrate their capabilities as emergency power supplies in a disaster or a large-scale service interruption or as temporary power supplies used during wiring construction work or inspections.



Fig. 1 3,500 kVA standby gas turbine generator set for data processing center



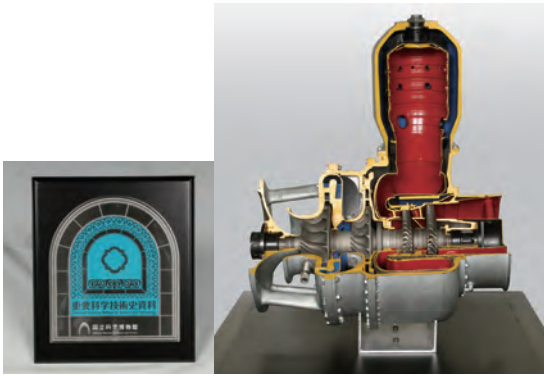

Fig. 2 Forerunner of gas turbines that became widely used as emergency generators (Essential Historical Materials for Science and Technology)

Since we entered the emergency power supply market in 1977, our gas turbine sales achieved a landmark as the 10,000th unit was delivered in February 2011. In September 2011, the 150 kW class S1A-01 gas turbine developed by us in 1975 was registered as the “forerunner of gas turbines that became widely used as emergency generators” and placed amongst the Essential Historical Materials for Science and Technology (Future Technology Heritage) at the National Museum of Nature and Science (Tokyo) (Fig. 2).

### 3 Industrial gas turbine generator sets

In response to society’s energy conservation needs, we, making the most of the experience acquired through emergency generator sets, developed a CHP composed of

a gas turbine and a HRSG, delivering the first CHP unit of this kind with a 1,000 kW output in 1984. Furthermore, we made in-roads into the market of combined cycle power generation that improves the power generation efficiency by combining a gas turbine with a steam turbine. Following this, we developed and put on the market increasingly larger gas turbines one after another, such as the M7A (7 MW class) and L20A (18 MW class). Following this, we developed a still larger model in the L30A (30 MW class), with operation of the first commercial unit started in October 2012 (Fig. 3). This has helped us serialize a wide variety of models with an output range of 650 to 30,000 kW.

In the past, the introduction of CHPs aimed at energy conservation or the reduction of greenhouse gas emissions in most cases. Since the Great East Japan Earthquake, however, a move has begun to study the introduction of CHPs from the viewpoint of business continuity in preparation against the risks of power shortages and service interruptions.

From the viewpoint of protecting the global environment, the needs for clean exhaust gas properties (reduction in CO<sub>2</sub> emissions and NO<sub>x</sub> emissions) have grown. We have already commercialized a gas turbine with an NO<sub>x</sub> emission level of 15 ppm (density equivalent at O<sub>2</sub> = 15%), with a similar product with an NO<sub>x</sub> emission level of less than 10 ppm having been developed and now under a demonstrative operation. In addition, we are engaged in developing combustion systems capable of running on a variety of fuels such as low-calorie gas, hydrogen, and by-product gas.

In terms of after-sales services, we have built a remote monitoring system called “Technonet” using a gas turbine



Fig. 3 30 MW class PUC300 cogeneration facility

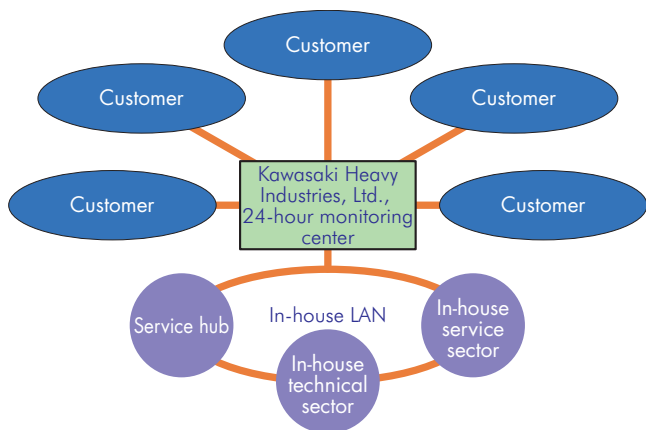

Fig. 4 Technonet system (Conceptual diagram)

developed by us and our own telecommunications network, to grasp the state of operation of each customer 24 hours a day. This allows us to provide preventive maintenance, operational support, instant response to potential nonconformance, and quick specific services (Fig. 4).

#### 4 Lean methane-fueled gas turbines

Coal is widely used as a power generation and industrial fuel and as a raw material for steelmaking. The demand for coal is increasing rapidly in emerging countries like China and India, mainly for power generation.

On the other hand, mining coal releases methane gas contained in coal layers. With a greenhouse effect about 21 times that of CO<sub>2</sub>, methane gas causes, after CO<sub>2</sub>, the second greatest environmental load on the global environment. Among the kinds of coal methane, in particular, ventilation air methane (VAM), which has a dilute methane content of less than 1%, has no way of being used and is currently being released into the atmosphere.



Fig. 5 Lean methane-fueled gas turbine generator set

Yet, we have developed a gas turbine running on lean methane such as VAM (Fig. 5). We will sell gas turbines of that type to coal producing countries to contribute to the prevention of global warming.

#### 5 Diesel generator sets

We have a long history as a diesel engine manufacturer, and since entering into a technical tie-up with the German firm MAN in 1911, we have provided a number of excellent engines for use in merchant ships, warships and land facilities. And, in 2011, we feted our 100th anniversary of technical tie-ups with MAN.

The Kawasaki-MAN 4-stroke diesel engine comes in L and V types that are light in weight, small in size, and high in power. These engines are capable of extended operation on heavy oil without major maintenance and are designed for simple maintenance and servicing, and, therefore, are used widely as main marine engines and in power generating plants.

These MAN-type engines and S.E.M.T. Pielstick PA6CL type 4-stroke engines, completed in 1993, are used in land-based power generation. We have a history of delivering utility-use generator sets for remote islands, emergency generator sets for nuclear power plants, and industrial generator sets, all of which have been given a favorable reception (Fig. 6).



Fig. 6 Diesel generator set destined for the Okinawa Electric Power Company



Fig. 7 7.8 MW Kawasaki green gas engine

## 6 Gas engines

We developed the world's highest performing gas engine with an 8 MW class generating output (Fig. 7). In 2007, we completed an 18-cylinder demonstrative machine and achieved the world's highest generating efficiency of 48.5%, and, at the same time, it materialized the world's highest level of environmental performance in terms of NOx emissions (density of 200 ppm or less at O<sub>2</sub> = 0%) . This gas engine is characterized not only by the optimized combustion chamber shape but also by its ability to control the incident of knocking and the cycle efficiency obtained through individual control of cylinders. Its overall efficiency reached about 85% when built into a CHP using exhaust heat. In the course of engaging in the development of various products, we installed a gas engine generator set with an output of 5 MW at our Kobe Works, equipped it with a variable nozzle turbocharger and succeeded in increasing the generating efficiency to 49.0% in 2010. An order for the first unit was received in February 2011. Recently, needs have been growing rapidly in Japan for small- and medium-sized power plants and captive power plants for the purpose of steady supply of electric power. We received an order from Central Motor Co., Ltd. (now Toyota Motor East Japan, Inc.) for a gas engine for its Miyagi plant in July 2011, and another order in September 2011 from a new electric utility company, Nihon Techno Co., Ltd., for the construction of Japan's first gas engine power plant composed of 14 gas engines with a total power generating capacity of 110,000 kW. The project is called the "Nihon Techno's Sodegaura Green Power Project." Both power plants have started full commercial operation.

Nihon Techno's Sodegaura Green Power Plant is operated at a generating efficiency of 49.5% and applies

low-viscosity lubricant and other measures. In the meantime, overseas inquiries have increased rapidly due to an increase in electric power demand resulting from economic development. In December 2011, we received an order for two gas engines to be installed in a Singapore LNG terminal, the first order from overseas. Orders for more than 30 gas engines have been received from both Japan and foreign countries.

We started developing marine gas engines and land-use gas engine of the world's highest power generation efficiency. This is the first attempt in Japan to develop marine gas engines fired exclusively by gas for use as main engines that can deliver a large output (2 MW or more). Another feature of this engine is its compliance with the International Maritime Organization (IMO)'s Tier III regulations without relying on a DeNOx system. We will develop not only technologies to minimize knocking due to load fluctuations but also technologies that are applicable both to direct propulsion systems, by which engine output is used to drive the propeller directly, and to indirect propulsion systems, by which engine output is used to drive a propulsion motor and then drive a propeller (electric propulsion).

We will complete a demonstrative (six-cylindrical) marine engine with an output of about 2.5 MW and obtain ship classification in fiscal 2013, and then successively put on the market engines with an output range of 2 to 8 MW (5 to 18 cylinders).

## 7 Generator-use steam turbines

Land-use steam turbines are classified into those for power generation and those for mechanical drive. We have serialized a reduction geared type (models RP and RC) and a direct coupling type (models DP and SC) for power

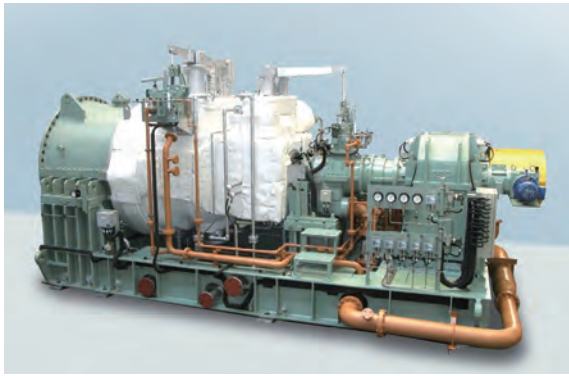

Fig. 8 Generator-use steam turbine

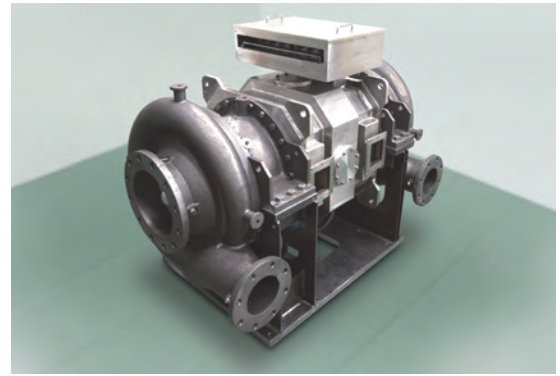

Fig. 9 Green binary turbine

generation use, and HP and HC models for mechanical drive use (Fig. 8). Their output range extends from 1,000 kW to 150,000 kW.

For power generation use, in particular, we have an extensive track record in the field of steam plants such as exhaust heat recovery plants using exhaust heat from plants, refuse incineration plants, biomass power generation plants, and geothermal power plants, in addition to conventional in-house power generation plants consisting of fossil fuel-fired boilers, turbines, and generators. At the same time, we produce high-efficiency turbines with axial flow exhaust that are suitable for combined cycle power generation plants as they aim at the effective use of energy in combination with gas turbines.

## 8 Top pressure recovery turbines

A top pressure recovery turbine is a machine that recovers the pressure energy of blast furnace gas produced by a blast furnace in a steel plant in the form of electric energy. Top pressure recovery generator sets allow blast furnace gas to be used effectively and exhibit a high energy-saving effect. In addition, they are equipped with environmental functions for reducing fluid noise from blast furnace gas flow and removing dust. For this reason, they are installed in all large-scale blast furnaces in Japan.

Our top pressure recovery turbines do not adopt conventional governor valves to regulate blast furnace gas pressure, but variable stator blades by which the pressure is controlled by freely changing the angle of the inlet stator blades. For this reason, low-noise, high-efficiency power generation is allowed even under conditions in which the quantity and pressure of the gas passing through the turbine varies. As the top-ranking manufacturer of top pressure recovery generator sets, we have a track record of delivering about 50 units both in Japan and foreign countries, including the Republic of Korea, Taiwan, the United States, China and Brazil. In addition, inquiries for replacement projects in Japan are brisk.

## 9 Binary turbines

Binary power generation is an electricity-producing energy-saving system, by which energy is taken from a low-temperature heat source by means of a low-boiling-point medium to drive a turbine generator set. Binary power generation produces electric power by effectively using waste hot water (80°C to 120°C) or exhaust gas that was not used in the past, geothermal heat, or hot spring water, thus contributing to a reduction in CO<sub>2</sub> emissions. The green binary turbine (Fig. 9), whose manufacture and sale started in June 2010, materializes excellent environmental performance and high cost-effectiveness owing to technologies accumulated with CFC turbine generator sets, similar systems, and by adopting a new low-boiling-point medium.

Jointly with Kyushu Electric Power Co., Inc., furthermore, the demonstration tests on a geothermal binary generator set (250 kW) will be started on the premises of the electric power company's Yamagawa Geothermal Power Station, to confirm and verify heat recovery technologies, cost-effectiveness, durability, and similar factors under geothermal conditions.

## Closing

Today's trends toward the abandonment or reduction of nuclear power plants, expanded use of renewable energy, global environment conservation, introduction of CHPs, and expanded use of distributed power generation have spurred intensive reviews of energy policies the world over.

With the aim of contributing to the preservation of the global environment and the stable supply of electricity, we will continue improving our technologies and proposing to customers efficient practical energy systems and energy-related equipment that meet their diversified energy needs.

# Distributed power generation systems that meet energy needs

## — Cogeneration system solutions

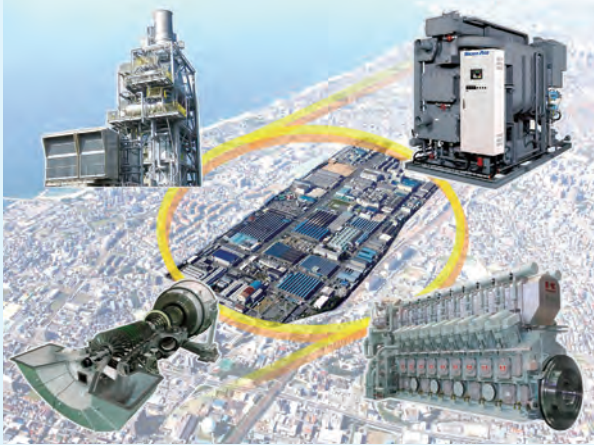

After the Great East Japan Earthquake, growing interest in energy has been motivated not only by energy conservation but also by power supply security, as Japan’s energy and environment policies now mention the widespread use of cogeneration. To promote the introduction of cogeneration, we are making an effort to strengthen our ability to make proposals to customers about the configuration of the cogeneration system best suited to their demands for electric power, heat, air conditioning and the like, and about the manner of operating such a system. This article presents our approaches to cogeneration system solutions intended to maximize the customer’s benefit.

### Preface

Cogeneration has been introduced mainly for the purposes of energy conservation, energy cost reduction, and greenhouse gas reduction. However, power shortages and concerns over the risks of power service interruptions after the Great East Japan Earthquake have created new needs such as “the reinforcement of power supply security.”

With the government reviewing the energy basic plan, the Innovative Strategy for Energy and the Environment,

which determines the future strategy on energy and the environment of the Cabinet (Energy and the Environment Council held on September 14, 2012), urges that cogeneration be spread as far and wide as possible to promote the effective use of energy, and that the energy generated by cogeneration be increased from the current 30 billion kWh to 150 billion kWh in 2030, which would account for 15% of the electricity demand then (Fig. 1). As a measure for promoting this strategic option, a business environment will be developed in which the electricity

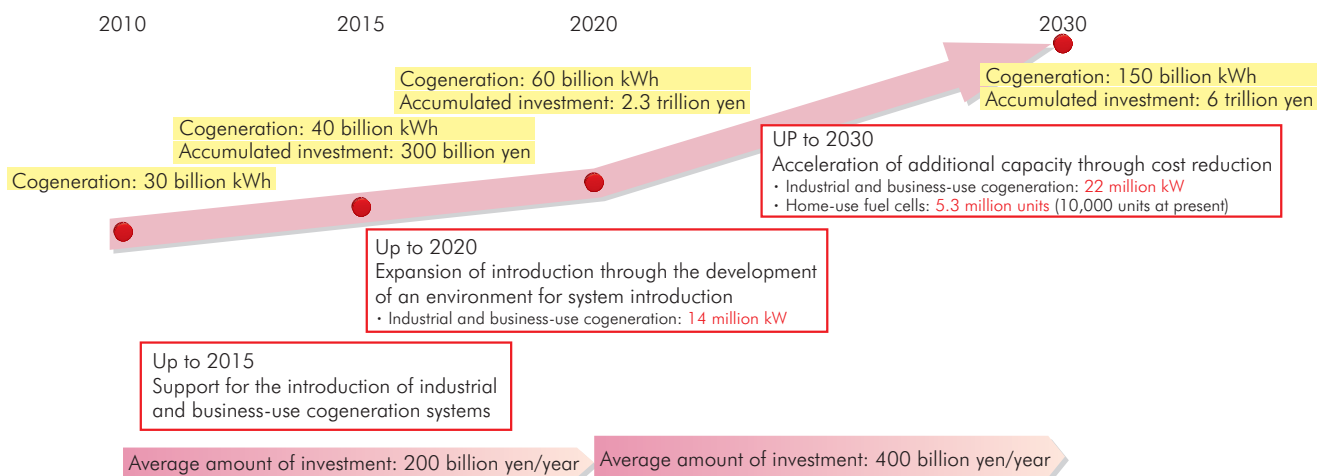

Note: The amount of investment in home-use fuel cell batteries is included both in energy conservation and cogeneration.

Source: Innovative Strategy for Energy and the Environment, National Policy Unit

Fig. 1 Expansion of introduction of cogeneration toward 2030

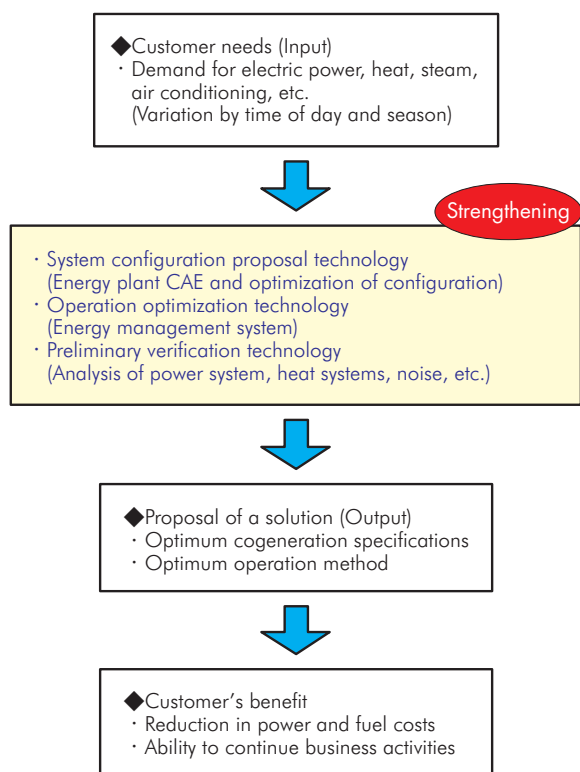

Fig. 2 Strengthening of ability to make proposals on introducing cogeneration

produced by cogeneration can be sold smoothly and measures for supporting the introduction of cogeneration will be reinforced.

Backed by such circumstances, we are strengthening (Fig. 2) our ability to propose cogeneration systems (Fig. 3), using a variety of energy supply machines (such as gas turbines, gas engines, boilers, and steam absorption chillers). In putting forward the suggestion to introduce cogeneration, it is particularly important to study the system configuration and the method of system operation so as to maximize the benefits of introducing such a system. In addition, selling the electricity from cogeneration or extending the range of utilization of waste heat from cogeneration requires that technologies verify beforehand how the variation in electricity and heat demand is followed (such as by power system analysis and steam system analysis). To achieve these goals, we are making efforts in the following ways.

## 1 Proposals on system configurations

In the early stages of cogeneration, too, we suggested to our customers the optimum system configuration based on energy plant computer aided engineering (energy plant CAE). However, since more complicated configurations are expected in the future due to the diversified needs of customers, it is necessary to strengthen our ability to propose system configurations.

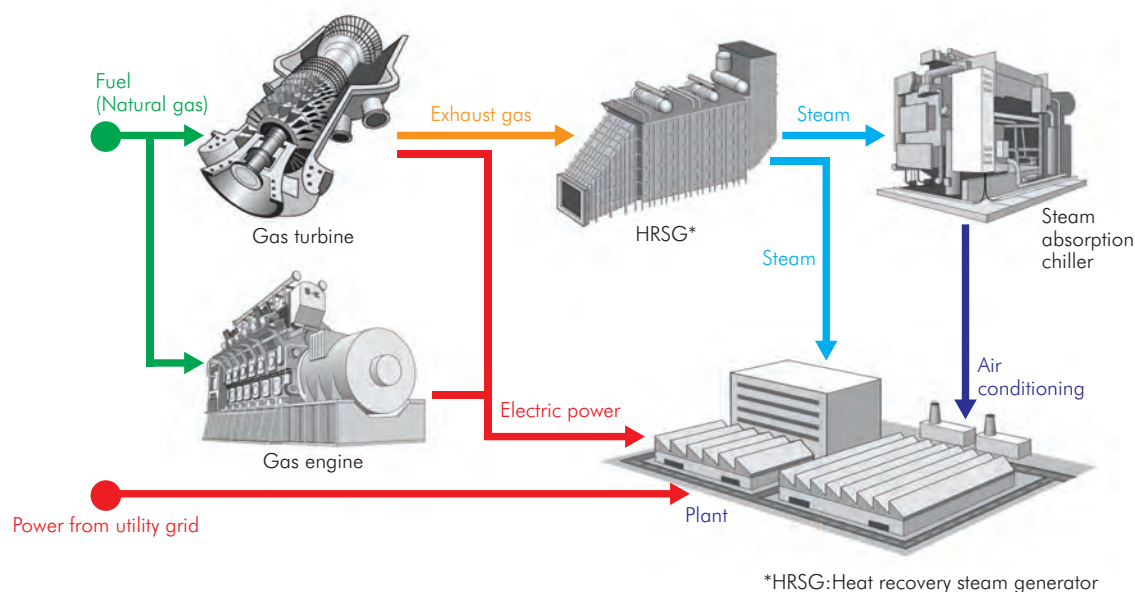

Fig. 3 Cogeneration system

# Technical Description

The “configuration optimization technology” that we are developing aims at proposing a system configuration that will provide the customer introducing cogeneration with a minimized life cycle cost (i.e., reductions in facility maintenance expenses and fuel expenses; Fig. 4).

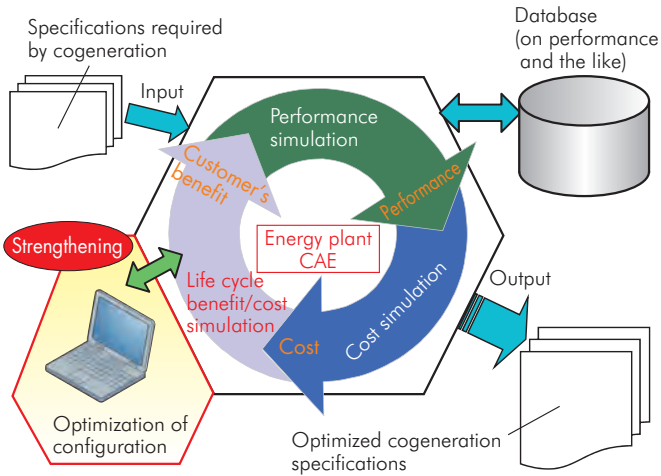

Fig. 4 Flow of proposal on cogeneration system configuration

Figure 5 shows an example of a study on fuel expenses using the configuration optimization technology. In this example, fuel consumption is simulated using plant demand patterns A and B for two different system configurations, ① and ②, in order to compare the integrated daily amounts. The following was learned. Under pattern A, in which the demand for heat is larger, configuration ①, which is equipped with more gas turbine cogeneration units thus exhibiting a higher overall efficiency inclusive of power generation and heat (steam), allows for lower fuel consumption. In contrast to the above, under pattern B, in which the same quantity of electricity is needed but the demand for heat is smaller, configuration ② with more gas engines of a higher power generation efficiency allows for lower fuel consumption.

We will focus our efforts on the combination of “energy plant CAE” and the “configuration optimization technology” so as to propose cogeneration system configurations more quickly and flexibly.

Configuration	Gas turbine cogeneration	Gas engine	Gas-fired boiler
① Gas turbine as the main component	3 units	1 unit	1 unit
② Gas engine as the main component	1 unit	3 units	3 units

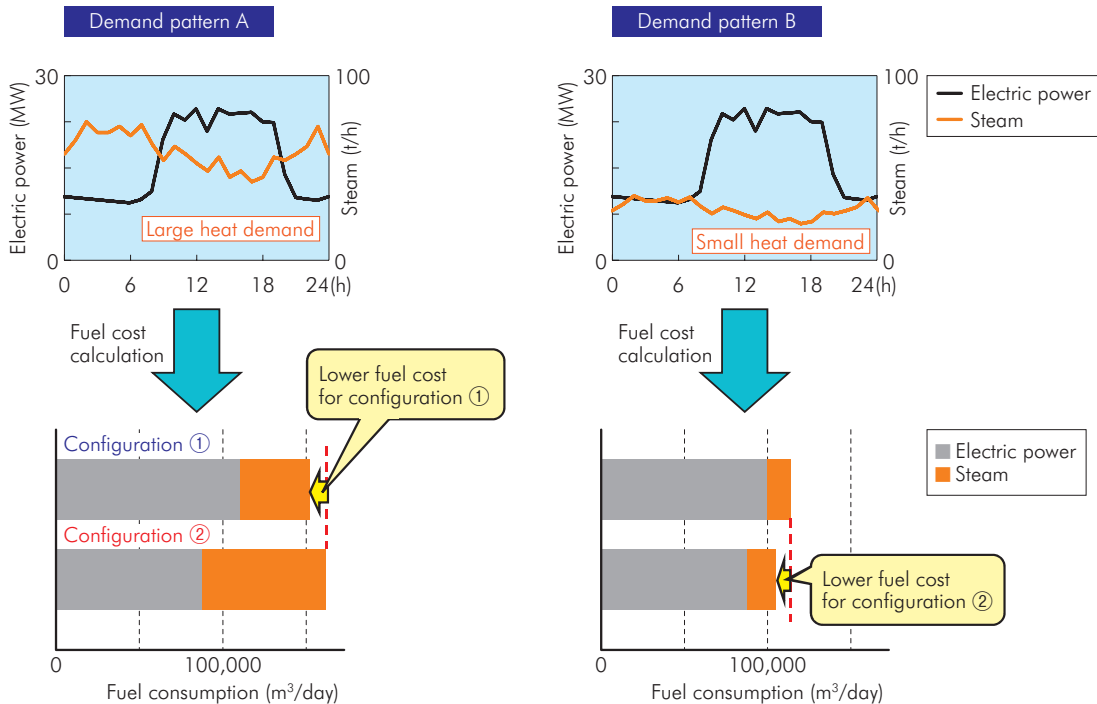

Fig. 5 Study on fuel cost based on configuration optimization technology

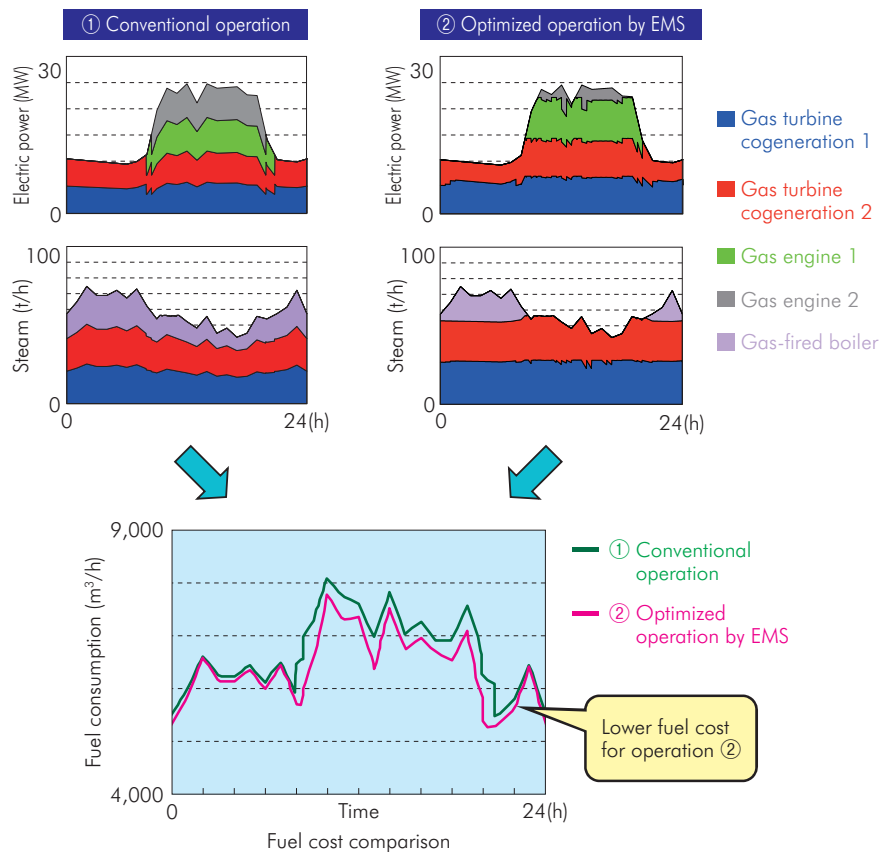

Fig. 6 EMS-based optimization of system operation

## 2 Optimization of operation

We have developed an energy management system (EMS) that optimizes the operation of cogeneration systems according to the variation in the customer's demand for electricity and heat. An EMS is a system that minimizes the fuel cost and the CO<sub>2</sub> emissions, while planning and implementing an energy distribution plan according to demand.

Figure 6 shows the results of a simulated case in which the system operation was optimized by EMS for the example cogeneration system configuration shown in Fig. 7. Under the existing operation pattern, it is common practice to keep the ratio of allotted output of individual units constant even if the demand for electricity or steam changes. In contrast, optimized operation based on EMS allows the ratio of allotted output to change from time to time so that the fuel cost is minimized. In other words, fuel consumption can be minimized by increasing the overall efficiency, inclusive of electricity and heat (steam), through an increase in the output allotment of the gas turbine cogeneration unit during the daytime when the demand for electricity and steam is high.

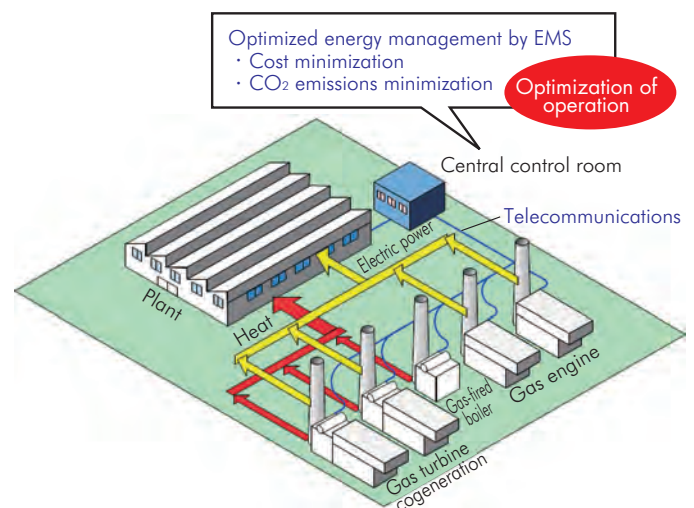

Fig. 7 Example configuration of cogeneration system

In this way, the EMS-based optimized operation can lower fuel consumption in comparison with the conventional operation mode, allowing the life cycle cost to the customer to be minimized.



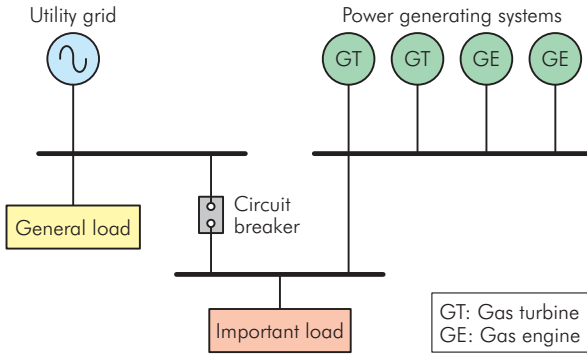

Fig. 8 Power system

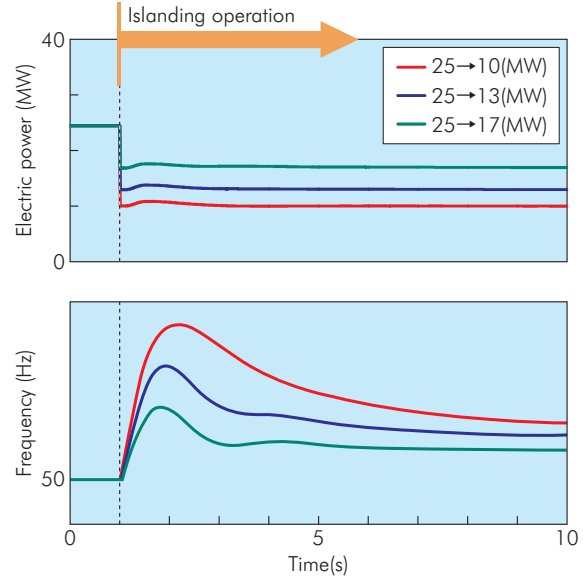

Fig. 9 Analysis of power system

### 3 Preliminary verification

In the planning and design stage following the proposal of a new cogeneration system configuration, it is necessary to verify, in advance, how the system follows electricity and steam load variations, the impact of faults in the utility grid, the behavior of electricity and steam at the time of equipment failure, and similar events. Among the technologies for verifying these factors, power system analysis, steam system analysis and noise analysis are presented in the following.

#### (1) Power system analysis

Power system analysis is a technology for verifying the ability of a power system to maintain the required quality of power supply under various circumstances such as

operation interconnected with a utility grid or islanding operation of a cogeneration system.

Figure 8 shows a power system diagram for the example cogeneration system configuration shown in Fig. 7, and Fig. 9 the result of the power system analysis. In this example, the behavior of the power grid frequency in the process of transition from grid-interconnected operation to islanding operation as a result of a fault in the utility grid, for example, is verified under various load conditions.

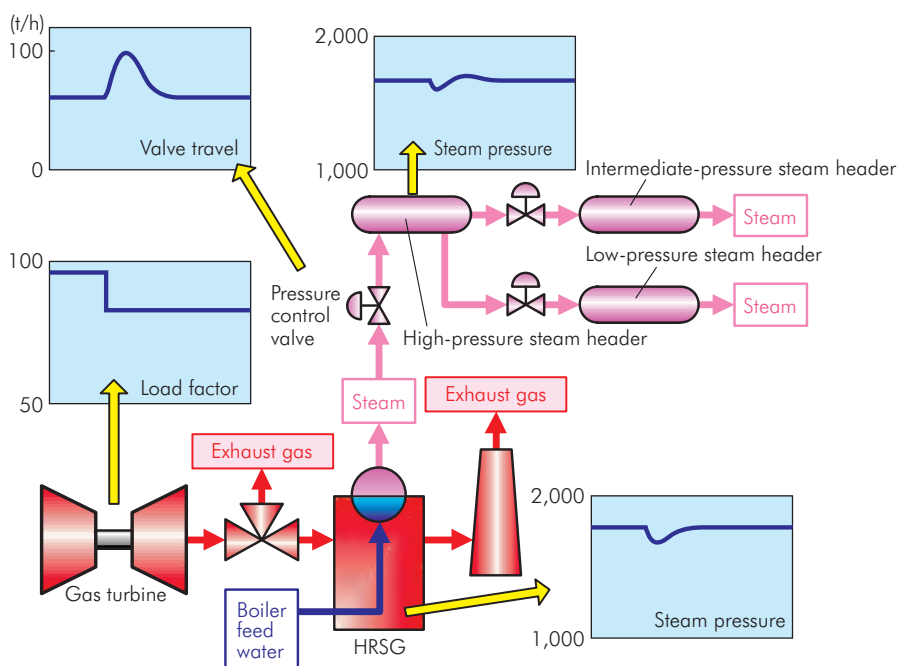

Fig. 10 Analysis of steam system

In this way, using power system analysis makes it possible to verify preliminarily the power (voltage, current, and frequency) behavior at the time of an accident or equipment failure, thereby increasing the possibility of continuing business activities on the customer side in an emergency.

### (2) Steam system analysis

Steam system analysis allows steam behavior to be verified preliminarily under various operating conditions of a cogeneration system, thereby providing suggestions as to the method of effective operation.

Figure 10 shows the steam system of a gas turbine cogeneration system and the result of a simulation test. Verified in this example are the behavior of the steam pressure at the HRSG (heat recovery steam generator) and at the high-pressure steam header, and the manipulation of the pressure control valve in response to a variation in loading from the gas turbine.

In this way, using steam system analysis makes it possible to optimize the use of steam or extend its scope of use, thereby increasing the benefit of introducing cogeneration on the customer side.

### (3) Noise analysis

With cogeneration facilities often installed near the boundaries of a customer's plant, it is necessary, in the planning stage, to ensure that the noise level at the premise boundaries is below the regulated level. With cogeneration facilities that contain a number of noise sources, optimization between the noise prevention performance of individual devices and machines, and the costs for this purpose is a particularly important issue.

We estimate the amount of noise at the boundaries using an environment noise analysis program that is based on accumulated data from noise sources, and examines noise prevention measures for individual devices and machines, and the necessity of installing noise barriers, before presenting overall noise prevention specifications.

## Concluding remarks

The nuclear accident at the Tokyo Electric Power Company's Fukushima Daiich Nuclear Power Station has cast great doubt on the way the conventional energy-based society exists, and thus greatly changed market needs for cogeneration. In response to this change, we will enhance our ability to make system solution proposals on the strengths of individual products such as gas turbines and gas engines, in order to meet diverse customer needs.



**Naoki Murakami**  
Program Management Department,  
Industrial Gas Turbine Center,  
Gas Turbine Division,  
Gas Turbine & Machinery Company



**Minoru Nakayasu**  
Project Management Department,  
Industrial Gas Turbine Center,  
Gas Turbine Division,  
Gas Turbine & Machinery Company



**Atsuhiko Inada**  
Project Management Department,  
Industrial Gas Turbine Center,  
Gas Turbine Division,  
Gas Turbine & Machinery Company



**Tomohiko Sugimoto**  
Power Generation Project Department,  
Machinery Division,  
Gas Turbine & Machinery Company



**Toru Yamazaki**  
Business Development Department,  
Solution Sales Center,  
Energy Solution Division,  
Gas Turbine & Machinery Company

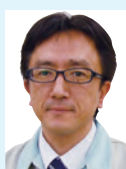

**Kaoru Koyano**  
System Integration Technology Department,  
System Technology Development Center,  
Corporation Technology Division



**So Kurosaka**  
Energy Solutions Section,  
System Technology Development Center,  
Corporation Technology Division



**Kazuo Tanaka**  
Energy Solutions Section,  
System Technology Development Center,  
Corporation Technology Division



**Kazushige Sugimoto**  
Energy Solutions Section,  
System Technology Development Center,  
Corporation Technology Division

# Standby gas turbine generator set for stable supply of electric power



After the Great East Japan Earthquake, the need for systems that can stably supply power in an emergency is openly evident. We internally develop, manufacture and sell power generation facilities powered by gas turbines for a wide variety of output ranges, as standby backup power supplies to be used by hospitals, communications facilities, IT-related datacenters and other facilities that need to run 24 hours a day.

This paper presents the features of our standby gas-turbine power generation facilities as well as their operating track records in disasters such as the Great East Japan Earthquake.

## Preface

The Great East Japan Earthquake that hit Japan in March 2011 caused immense damage over an extensive region covering one metropolis and 15 prefectures. In the areas where power service was interrupted, Kawasaki's standby gas turbine generator sets operated fully up to the time of service resumption or the exhaustion of fuel, proving their worth as standby equipment. Fig.1 shows the localities in which Kawasaki's standby generator sets operated during the power service interruption caused by the earthquake.

It is essential for a standby generator set to start up without fail in an emergency and to supply electric power. And, a gas turbine used as the prime mover must be characterized by high startup reliability and a short transient time from the startup to the start of power feeding. For this reason, the plain-structured simple open cycle single-shaft type gas turbine (Fig. 2) is the mainstream product, which is adopted by Kawasaki too. A gas turbine is self-air-cooled and does not need cooling water, allowing itself to be installed in space-restricted locations such as a rooftop or a basement. Fig. 3 shows a typical indoor installation of a gas turbine generator set. Like a routine gas turbine generator set, a standby gas turbine generator set must not only be high efficiency but also meet different characteristics requirements from those of a routine use set because of the different purpose of use.

Table 1 shows the main specifications of Kawasaki's standby gas turbine generator sets of the Kawasaki PU series.

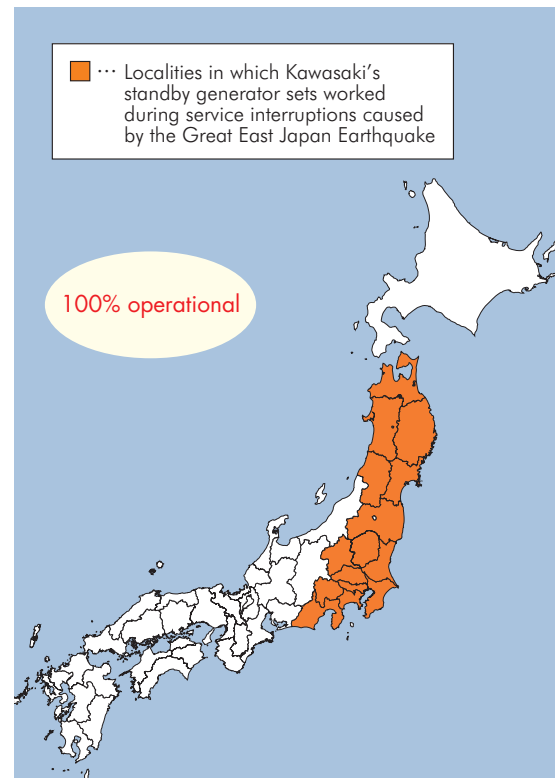

Fig. 1 Localities with working standby generator sets

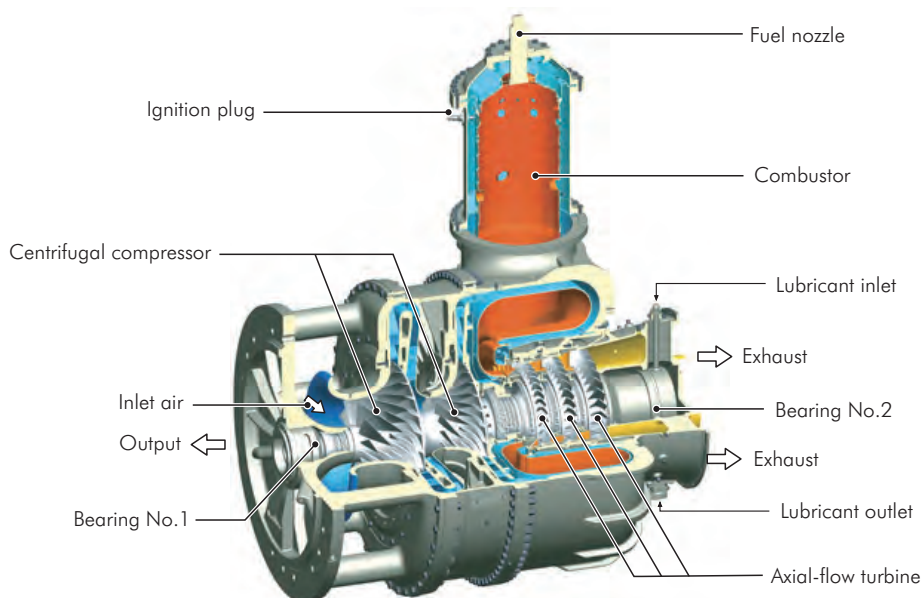

Fig. 2 Simple open cycle single-shaft type gas turbine

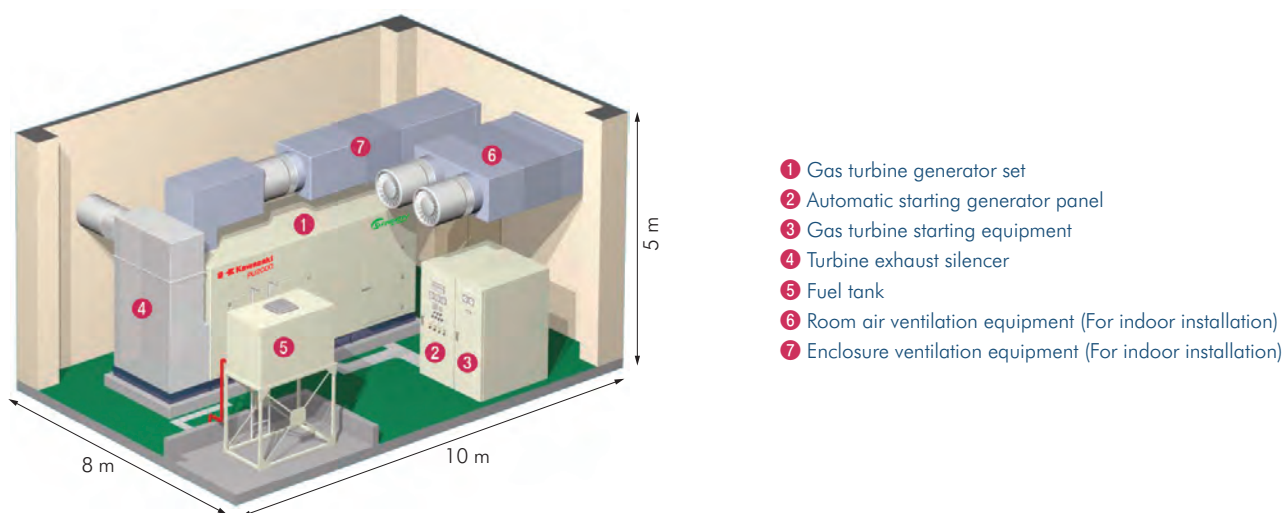

Fig. 3 Example configuration of gas turbine plant (2,000 kVA)

Table 1 Main specifications of Kawasaki PU series

Model	PU 200	PU 250	PU 250S	PU 300	PU 375	PU 500	PU 500S	PU 625	PU 750	PU 1000	PU 1250	PU 1500	PU 1750	PU 2000	PU 2500	PU 3000	PU 3500	PU 4000	PU 4500	PU 5000	PU 6000
Rated output (kVA)	187.5	225	250	300	375	437.5	500	625	750	1,000	1,250	1,500	1,750	2,000	2,500	3,000	3,500	4,000	4,500	5,000	6,000
Alternator	Standby use (40°C)																				
	Voltage (V)	200 ~ 6,600						400 ~ 6,600						3,300 ~ 6,600							
	Frequency (Hz)	50/60																			
	Number of poles(P)																				
	4																				
Gas turbine	S1A-01	S1A-02	S1A-03	S1A-06	S1T-02A	S1T-02	S1T-03	S2A-01A	S2A-01	M1A-01A	M1A-01	M1A-03	M1A-06	M1A-23	M1T-01S	M1T-03	M1T-06	M1T-23	M1T-23S	M1T-33A	M1T-33

## 1 Features of Kawasaki's standby gas turbine

### (1) Quick startup

After the occurrence of a service interruption, Kawasaki's gas turbine set is capable of feeding power within 40 seconds of starting up automatically.

Usually, the problem of a longer startup time occurs as a gas turbine becomes larger and increases output. With Kawasaki's gas turbines, however, the starting unit has been optimized through startup torque simulation. As a result, even a 6,000 kVA gas turbine is capable of starting up within 40 seconds.

### (2) Stable frequency characteristic

A single-shaft type gas turbine has a large equivalent moment of inertia because the compressor is driven and the rotational output is transmitted via the same turbine (main shaft) and because the speed of the main shaft rotating at a high speed (18,000 to 53,000 rpm) is reduced to that of the output shaft at 1,500/1,800 rpm. This leads

to minimal change in speed under instantaneous load fluctuation, yielding good rotational speed (frequency) characteristics. This provides a substantial advantage for a standby generator set susceptible to instantaneous overload.

### (3) Self-air-cooled type

A gas turbine employs a self-cooling system that uses air from the outlet of the compressor to cool the high temperature sections. This feature eliminates the need for cooling water and its accompanying equipment, hence the need to prepare against water supply interruptions and freezing in cold seasons. This is a useful feature for a standby generator unit that must be operated in a variety of environments.

### (4) Small size and lightweight

A gas turbine, as a rotary machine, is characterized by continuous fuel combustion and the capability of handling a large quantity of working fluid. Accordingly, a gas turbine unit can be made compact and lightweight.

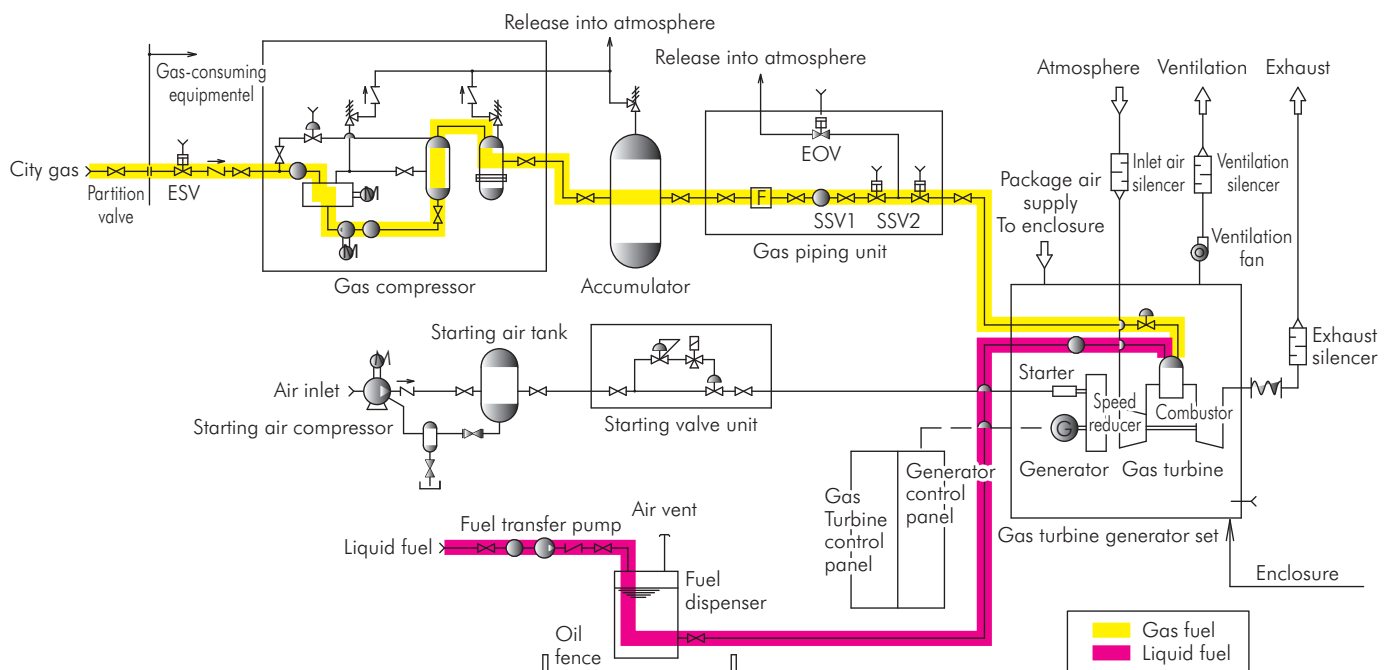

Fig. 4 Example system flow of dual fuel type gas turbine

### (5) Diverse fuel options

Standby generator sets are fueled mainly by liquid fuels such as fuel oil A, light oil or kerosene. The allowable temperature ranges of the fuels in the environment of installation are as follows.

- ① Fuel oil A :  $-10\sim 40^{\circ}\text{C}$
- ② Light oil Nos. 1 and 2:  $-10\sim 40^{\circ}\text{C}$
- ③ Light oil No. 3 :  $-15\sim 40^{\circ}\text{C}$
- ④ Kerosene :  $-25\sim 40^{\circ}\text{C}$

The startup reliability associated with the use of fuel oil A and light oil is improved by taking measures against filter clogging due to an increase in low temperature dynamic viscosity and other causes, that is, by heating the fuel dispensing tank, fuel piping, and the like.

Recently, We started supplying dual fuel systems that change over to gas fuel after the completion of startup with the aim of making turbine generator sets operate for a longer time.

## 2 Dual fuel system

Standby generator sets have been installed for supplying power for a relatively short period of time. For this reason, when they are required to operate for a long time as in planned service interruptions required as a result of the earthquake this time, how to supply fuel in a stable way becomes an important problem in operating these standby generator sets.

Most standby generator sets use liquid fuels such as fuel oil A, light oil, or kerosene, and fuel is stored in underground tanks and the like, which limits the quantity that can be stored. A dual fuel system is intended to allow both liquid and gas fuels to be used should the fuel supply be interrupted in an emergency.

For a gas turbine, changeover between liquid and gas fuel is easier. In a dual fuel specification system, a gas turbine standby generator set starts up on liquid fuel after the occurrence of a service interruption, uses electricity it generates to drive a gas compressor, and changes over from liquid fuel to gas fuel during operation. This allows the system to keep running on different fuels. These systems have established track records in routine-use generator sets, and modifications to the fuel system components, such as the fuel injection nozzles, have made the systems operational on standby generator sets Fig. 4 shows an example system flow of a dual fuel type gas turbine.

## 3 Mobile power unit

The “compactness, lightweight, and no need for cooling water” are ideal features for a mobile power unit in times of a disaster. The following report presents the gas-turbine-equipped mobile power unit of the Kawasaki MPU series, which adds mobility to the Kawasaki PU series gas turbine generator set that has been enjoying a high reputation and an almost overwhelming delivery track record in the fixed gas turbine market (Fig. 5).



Fig. 5 Mobile power unit

(i) Low vibration and low noise

Similar to a stationary system, a gas turbine is a rotary motion engine without a reciprocal motion section, thus nearly free of vibration. The major part of the noise generated is in the high frequency region that is easy to isolate and is isolated very effectively by means of a simple-structured sound isolation panel and a silencer. This allows a gas turbine standby generator set to be operated in an urban area or at night.

(ii) No need for cooling water

Being self-air-cooled, a gas turbine does not need cooling water. This is a very favorable attribute of a mobile power unit that is required to perform under a variety of operating conditions.

(iii) Resistance to coldness and high startup reliability

A gas turbine that does not need cooling water and is free of sliding parts is structurally resistant to coldness. Even cold climate versions do not need a large-scale heating system as is required by a diesel power vehicle. It can work on fuel oil A, light oil, or kerosene, and can be started up at temperatures as low as  $-25^{\circ}\text{C}$  without heating means. In addition, being capable of engaging full load operation without warming-up is an attraction peculiar to a gas turbine.

## 4 Track records of operation of standby gas turbine generator sets

### (1) Actual state of operation in the wake of the Great East Japan Earthquake

The Great East Japan Earthquake that hit Japan with a magnitude of 9.0 was the greatest earthquake in the history of seismic observation since 1990 and of a scale that was counted as one of the world's five greatest earthquakes. The disaster area covers one metropolis and 15 prefectures including the Tohoku and Kanto areas. Table 2 shows how the Kawasaki PU series standby gas turbine generator sets worked in the disaster area.

In the disaster area, 3,092 of Kawasaki's standby gas turbine generator sets, Kawasaki PU series products, were deployed, while 1,035 were deployed in areas where service interruptions due to the earthquake occurred. Except one unit that had not undergone maintenance, all of the units mentioned above operated normally, proving that the units had high startup reliability.

In the implementation of planned power service interruptions in and around the Kanto area after the earthquake, all generator sets in the areas in question worked normally.

Table 2 Operation of Kawasaki PU series in disaster area

Prefecture.	Number of deployed sets		State of operation	
	Disaster areas	Service interruption areas	In operation	Not in operation
Aomori	57	50	50	
Iwate	50	50	50	
Miyagi	134	119	119	
Akita	32	28	28	
Yamagata	73	67	66	1 (Insufficient maintenance)
Fukushima	64	41	41	
Niigata	89	0	0	
Tokyo	1,277	49	49	
Kanagawa	363	175	175	
Saitama	216	125	125	
Chiba	233	91	91	
Ibaraki	125	76	76	
Tochigi	65	43	43	
Gunma	106	90	90	
Yamanashi	28	13	13	
Shizuoka	180	18	18	
Total	3,092	1,035	1,034	1

## (2) Actual state of operation of generator sets in the wake of past disasters

In the Great Hanshin-Awaji Earthquake of January 1995, diesel-engine-based generator sets could not operate because of water supply interruption. On the other hand, many of self-air-cooled gas turbine generator sets did, with Kawasaki's standby gas turbine generator sets exhibiting a working rate of 95.9%. Many of the sets that did not work had not been serviced regularly since their installation, and this was the reason why they did not operate in an emergency. Under these circumstances, the occurrence of the earthquake provided an opportunity for recognizing the importance of regular inspections and servicing. As a result of this lesson, a working rate of 100% was attained with standby gas turbine generator sets in the great blackout of the metropolitan area in August 2006, the 2007 Noto Peninsular Earthquake, the 2007 Chuetsu Offshore Earthquake, and the 2008 Iwate-Miyagi Inland Earthquake.

## Concluding remarks

Recently, a move toward strengthening power supply security has been visible as a result of the implementation of planned service interruptions by power utilities and power shortages. From the viewpoint of business continuity planning (BCP) as well, awareness has been growing of the importance of standby gas turbine generator sets with a dual fuel system that are capable of feeding electricity to disaster-preparedness loads and security loads in an emergency. It is expected that cases where these systems are adopted will increase in the future.

The mobile power unit with a small gas turbine excels in mobility and is useful as a backup system for supporting social infrastructure. The gas turbine to be mounted in the unit is selected from a variety of viewpoints, but high efficiency, high reliability, and low environmental loading are required of it invariably. In response to these requirements, we will continue its efforts to improve the quality of gas turbines, spread their use, and build up a periodic maintenance service system essential to the assured operation of gas turbines in an emergency.



**Yuusuke Inoue**

Project Management Department,  
Industrial Gas Turbine Center,  
Gas Turbine Division,  
Gas Turbine & Machinery Company



**Tomo Naito**

Project Management Department,  
Industrial Gas Turbine Center,  
Gas Turbine Division,  
Gas Turbine & Machinery Company



**Sadayuki Kurasawa**

Customer Support Department,  
Industrial Gas Turbine Center,  
Gas Turbine Division,  
Gas Turbine & Machinery Company



# Gas turbine cogeneration system for energy conservation and better power supply security



*Cogeneration is capable of contributing greatly to energy conservation, energy cost reduction, and greenhouse gas emission reduction. Moreover, new demands, such as the need to “improve power supply security,” have emerged from the Great East Japan Earthquake. Under these circumstances, we are striving to provide gas turbine cogeneration that responds to this change in market needs.*

## Preface

Cogeneration has been introduced mainly for the purposes of energy conservation, energy cost reduction, and greenhouse gas reduction. However, power shortages and concerns over power service interruptions after the Great East Japan Earthquake have created new needs such as “the reinforcement of power supply security.” Table 1 shows typical reasons for introducing cogeneration systems among our list of received orders.

- ① Reinforcement of power supply security
- ② Reduction in energy costs
- ③ Conservation of electric energy

Responding to such changes in market needs, we are constructively engaged in providing high efficiency, high reliability gas turbine cogeneration.

## 1 Market trend for cogeneration

### (1) Japan

At present, the current basic energy plan is undergoing a radical review, following the impact of the Great East Japan Earthquake and the subsequent accident at a nuclear power plant in March 2011. In laying out a new basic energy plan, the Ministry of Economy, Trade and Industry released a plurality of “energy mix options.” The release by the Ministry refers to the following matters as basic courses for an energy mix.

- Efficient utilization of fossil fuels as implemented by a shift to natural gas with the maximum possible consideration given to environmental load; (Clean use of fossil fuels)

Table 1 Major orders received after the Earthquake and reasons for introducing cogeneration systems

Case of introduction	Reason for introduction
Site A	Stable supply of electricity in summer and winter, and electricity conservation
Site B	Reinforcement of power supply security for the plant in the wake of the shutdown of nuclear power plants
Site C	Securing of power supply for safeguarding medical equipment (Reinforcement of power supply security)
Site D	Relocation to the Kyushu region of some functions of the plant in the Kanto region for the purpose of stable supply of electricity to production facilities
Site E	Stable supply of electricity and energy costs reduction as measures against an increase in electricity charges

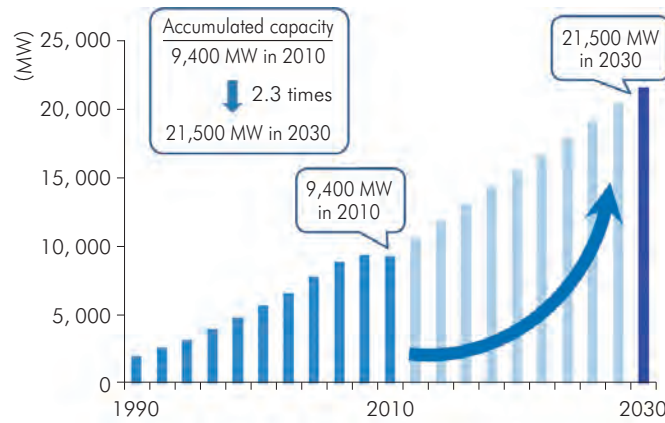

Fig. 1 Anticipated introduction of cogeneration systems (Note: Fuel cells excluded from data for 2030.)

- The importance of the expansion of clean use of fossil fuels as well as of the expansion of use of cogeneration systems (including fuel cells) that integrate the use of electricity and heat from the viewpoint of accelerating the effective use of waste heat and the widespread use of distributed power supplies; the necessity to this end of immediately materializing a policy aiming at the expansion of the introduction and development of a framework to efficiently use surplus power in grids.

The individual cases described in the “energy mix options” proposed on the basis of the above basic courses assume that the power generating capacity from cogeneration will increase from the current 9,400 MW to 21,500 MW, which will cover 15% of the power demand in 2030 (Fig. 1).

## (2) Foreign countries

The International Energy Agency (IEA), in its report entitled “Cogeneration: Evaluating the Benefits of Greater Global

Investment<sup>1)</sup>,” defines cogeneration as “low-cost and reliable technology that is capable of contributing to solving the problems of global climate change and increasing power demand.” The Agency also estimates, in its “Accelerated Combined Heat and Power (CHP) Scenario,” an increase in the introduction of cogeneration in various countries between 2015 and 2030 (Fig. 2).

## 2 Gas turbine cogeneration

Cogeneration can be defined as an energy system in which a prime mover such as a gas turbine is driven by a kind of primary energy (fuel) to obtain electric power and to simultaneously extract heat in the exhaust gas and cooling water of the prime mover in the form of steam or hot water in order to use the heat for space air conditioning, hot water supply, process heating, and similar purposes.

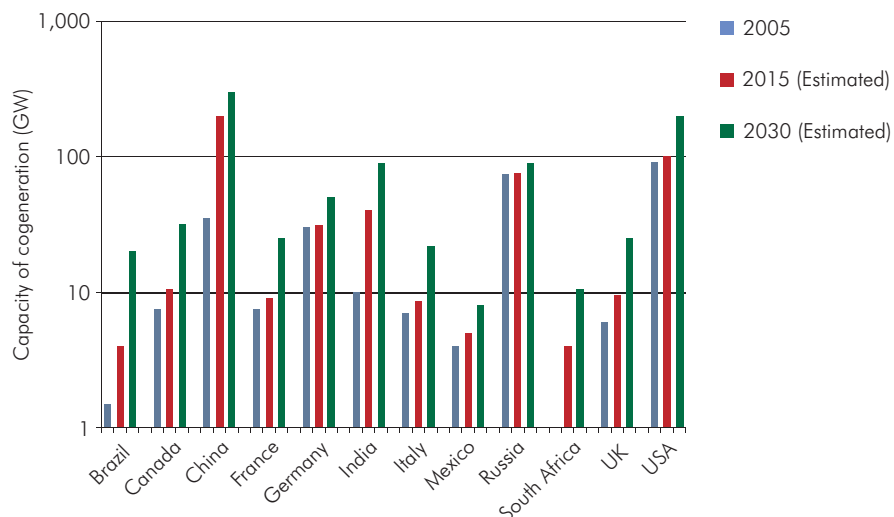

Fig. 2 Introduced cogeneration systems by country (IEA estimate)<sup>1)</sup>

Table 2 Lineup of Kawasaki gas turbine cogeneration products

Model	Generating end output (kW)	Generating end efficiency/ Overall efficiency (%)
PUC07D	650	24.4 / 75.0
PUC15D	1,455	24.1 / 82.0
PUC17D	1,660	26.5 / 84.2
PUC30D	2,865	23.9 / 81.9
PUC60D	5,250	28.9 / 83.1
PUC70D	6,500	30.0 / 81.0
PUC80D	7,290	32.7 / 84.3
PUC180D	17,530	33.5 / 81.9
PUC300D	28,350	38.8 / 83.1

We have an extensive lineup of products with outputs ranging from 600 to 30,000 kW, driven by gas turbines developed on its own efforts (Table 2).

The features behind our products are as follows.

- ① Integrated system from the development of engines to their after-sales services
- ② Extensive track record (517 units delivered with an accumulated capacity of 1,000 MW or more)
- ③ Capability of running on diverse fuels (City gas, liquid fuel, etc.)
- ④ Availability not only in normal time but also as standby power supply in disasters (Limited to model PUC30, inclusive)
- ⑤ Around-the-clock after-sales service system

## 3 Market needs for cogeneration and examples of cogeneration introduction

### (1) Reinforcement of power supply security

Figure 3 shows the outline of the PUCS500 50 MW class combined cycle generator set, composed of two 17 MW class L20A gas turbines and a 16 MW class steam turbine, that was delivered to Summit Mihama Power Corporation. Using clean city gas, the combined cycle generator set supplies electricity to seven companies in the food processing complex in Mihama Ward, Chiba Prefecture

#### ■ Plant performance

Gas turbine generating output : Approx. 34,000 kW  
 Steam turbine generating output: Approx. 16,000 kW  
 Quantity of steam supplied : Approx. 65 t/h



(a) Appearance

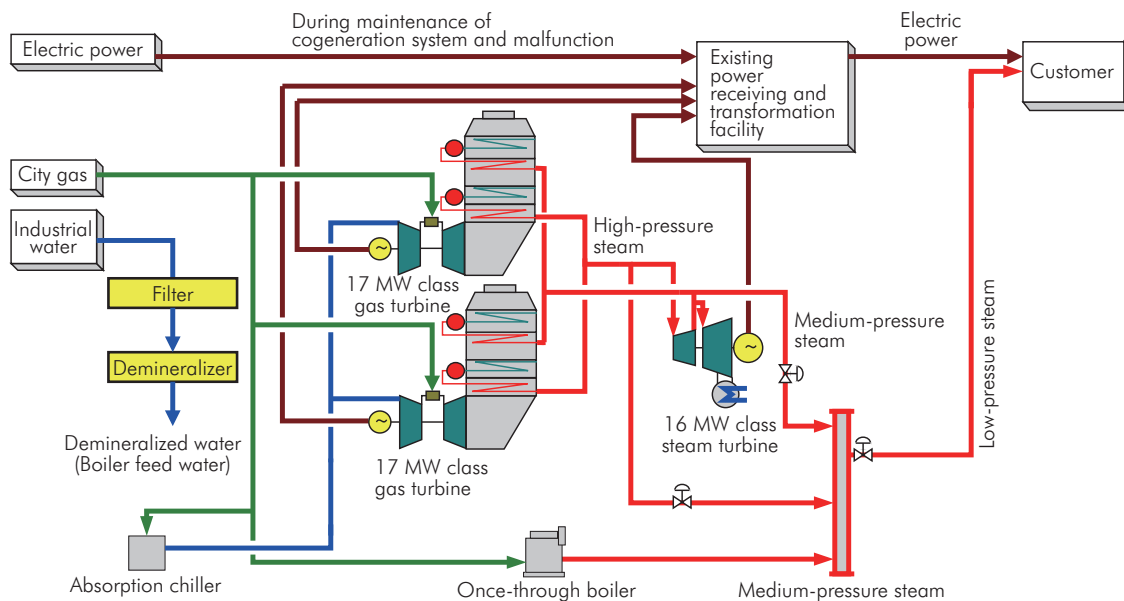

(b) Facility flow

Fig. 3 50 MW class combined cycle power generation plant PUCS500 delivered to Summit Mihama Power Corporation

and steam to four companies there. In addition, the utility company sells surplus power to bulk customers in the Greater Tokyo Metropolitan area via its subsidiary, Summit Energy Corporation.

One of the important features of the generator set is, instead of the common practice of the conventional combined heat and power supply business characterized by in-house consumption on a one-company-one-plant basis, the combination of a business supplying electricity and steam to two or more plants within an industrial complex via the electric power retail business, and the forming of an unprecedented new business structure as a 50 MW class power station. Distributed power generation can exert its full potential under such a business structure if it cannot make the most of its advantages in reducing costs and environmental load when introduced to a single plant.

During planned power service interruptions after the Great East Japan Earthquake, this generator set ensured a stable supply of electricity and steam to the companies in the food processing complex, thus helping those companies continue stable supply of their products. This in turn helped Kawasaki discover a different need for cogeneration than that of the past. A system that allows electric power and exhaust heat energy to be used efficiently on a regional basis can be said a small-scale example of a “smart energy network.”

## (2) Energy conservation and reduction in energy costs

Figure 4 shows an outline of the PUC180D gas turbine cogeneration unit, equipped with a reheating device and delivered to a factory in Shizuoka Prefecture. With the existing heavy-oil-fired boiler out of service and a natural-gas-fired gas turbine cogeneration unit working together with the customer’s own waste heat reuse facility, a yearly reduction in crude oil consumption of about 19,000 kL was attained, contributing to a 34% energy-savings by the entire plant.

## (3) Electric power conservation

The energy center of our Akashi Works is composed of a PUCS250 combined cycle generator set made up of a L20A gas turbine and a steam turbine, the PUC80D turbine cogeneration generator set, and a PUC17D mono-generation generator set. These are installed with the main objective of reducing plant electricity and steam costs, and conducting long-hour demonstration tests of model plants and newly developed gas turbine engines (Fig. 5).

In response to a request from Kansai Electric Power Co., Inc. for power conservation beginning in 2011 (in winter and in summer), these generator sets are operated to the maximum to reduce purchased power, and when a surplus occurs under this operating condition, it is sent back (transmitted) to the power utility by reversing power flow.

### ■ Plant performance

Gas turbine generator output: Approx. 17,000 kW  
Quantity of steam supplied : Approx. 51 t/h



Fig. 4 PUC180D gas turbine cogeneration system

### ■ Plant performance

Generator set No. 4 (L20A) : 18,000 kW  
Generator set No. 6 (Steam turbine): 6,700 kW  
Generator set No. 7 (PUC80D) : 8,100 kW  
Generator set No. 8 (PUC17D) : 1,800 kW



Fig. 5 Akashi Works Energy Center

## 4 Technological readiness to the market needs after the Great East Japan Earthquake

### (1) Dual fuel

“Dual fuel” is a specification by which an engine can run on either liquid or gas fuel. An engine with this capability can be operated for a long time if gas fuel can be supplied through gas conduits when a disaster or the like makes it difficult to procure liquid fuel. Also capable of starting up even under a service interruption, gas turbines made to dual fuel specification can be used as a standby power supply in an emergency. Many of them have been introduced for hospital and private building use (Fig. 6).



Fig. 6 Gas turbine of dual-fuel specification

### (2) Isolated operation

Isolated operation refers to a mode of operation in which a cogeneration system parallels off the generator set from an interconnected commercial power supply to independently supply power to important loads, should an abnormality such as an instantaneous voltage drop occur in the interconnected commercial power supply. After the Great East Japan Earthquake, we executed a number of electrical construction projects to convert existing cogeneration systems to ones capable of isolated operation.

Figure 7 shows an example of measures against instantaneous voltage drops using a high-speed circuit breaker. When an instantaneous voltage drop occurs, the high-speed circuit breaker, using semiconductor switches, allows the bus-connected circuit breaker (52B) to be paralleled off, with power feeding to important loads continued.

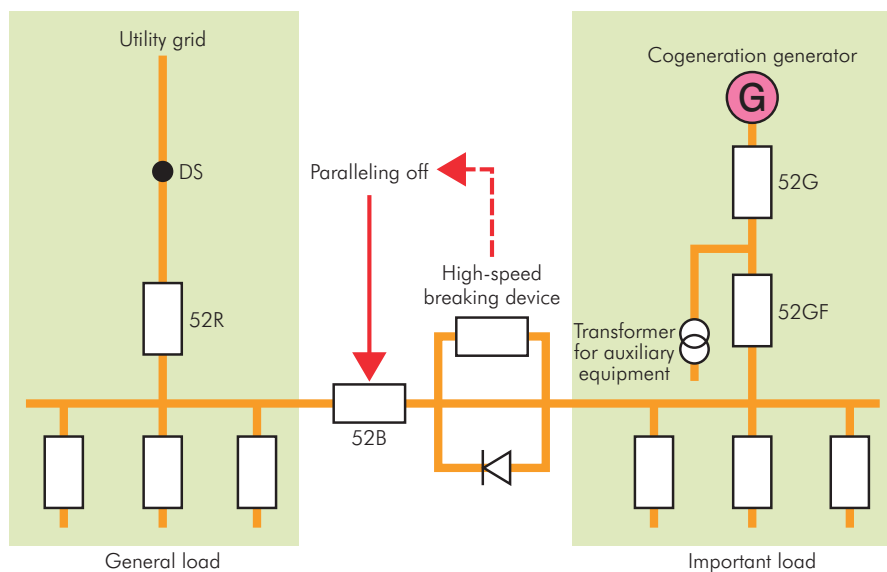

Fig. 7 Measure against instantaneous voltage drop using high-speed circuit breaker

### (3) Power conservation by means of absorption chillers

Using steam generated by exhaust heat from a cogeneration system to make space-cooling cold water in an absorption chiller reduces electricity equivalent to that consumed by a turbo refrigerator.

Figure 8 shows the effect of the reduction in electricity achieved by an absorption chiller. To obtain a space-cooling capacity of about 500 USRT, an absorption chiller consumes about 2 t/h of steam, while a turbo refrigerator consumes about 260 kW of electricity.

For this reason, steam generated by 2 t/h of exhaust heat from a cogeneration system provides space-cooling equivalent to 500 USRT and simultaneously achieves about a 260 kW reduction in received power or peak cut.

### Concluding remarks

With business environments relating to energy changing greatly day by day, we at Kawasaki hope to immediately catch wind of these changes in order to provide products that match market needs, thus contributing to society.

### Reference

- 1) IEA, Combined Heat and Power, 2008.



**Minoru Nakayasu**  
Project Management Department,  
Industrial Gas Turbine Center,  
Gas Turbine Division,  
Gas Turbine & Machinery Company



**Daisuke Hasegawa**  
Project Management Department,  
Industrial Gas Turbine Center,  
Gas Turbine Division,  
Gas Turbine & Machinery Company



**Yuji Yamade**  
Construction Department,  
Industrial Gas Turbine Center,  
Gas Turbine Division,  
Gas Turbine & Machinery Company

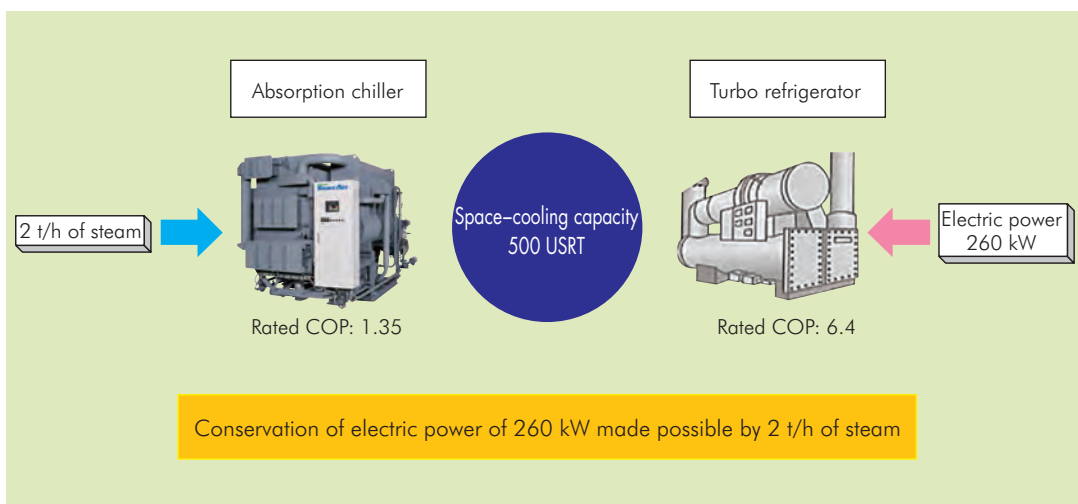

Fig. 8 Example of electricity conservation by means of absorption chiller

# Gas engine with world highest generating efficiency – Green gas engine



*Since 2007, we have supplied green gas engines as high-efficiency gas engines. They exhibit the world's highest class of power generation efficiency, as development efforts have been devoted to further improving power generation efficiency. The results obtained from these efforts have been utilized in the market, being used at the Kobe Power Center of our Kobe Works and Japan's largest 110 MW class large-scale gas engine power generation plants.*

## Preface

After the Great East Japan Earthquake of 2011, uncertainty about the supply of utility power has activated the market of in-house power generation facilities including emergency backup facilities, as well as the market of distributed power generations. In particular, clean high-efficiency gas engines are attracting the attention of the market.

Having developed high-efficiency green gas engines (KG series) in 2007 and having added the KG-V series products of improved efficiency in 2010, we continue maintaining the world's highest power generating efficiency. We also have addressed the strengthening of supply chains and production capacity to respond to the needs of the market, establishing a setup for producing 4 units per month.

Supported by high power generation efficiency and high environmental performance, this green gas engine has seen an increase in orders with 28 units delivered to

customers in Japan and other countries in 2011.

Given the market situation, we continue focusing its effort on improving performance characteristics of the green gas engine with the aim of further strengthening its market superiority in terms of power generation efficiency.

## 1 Overview

### (1) Product lineup

From the start of development, the green gas engine attained a power generation efficiency of 48.5%, standing at the world's highest level among gas engines of the same class in terms of the power generation efficiency. In this product lineup, 2 types of engine are available by output, a 5,000 kW class 12-cylinder engine (KG-12) and a 7,500 kW class 18-cylinder engine (KG-18).

In 2010, the product lineup was enriched with a more efficient KG-V series, with 4 models made available (Table 1).

Table 1 Green gas engine product lineup

Model		KG-12	KG-18	KG-12-V	KG-18-V
Cylinder diameter (mm)		300		300	
Revolutions (min <sup>-1</sup> )	50 Hz	750		750	
	60 Hz	720		720	
Electric output (kW)	50 Hz	5,200	7,800	5,200	7,800
	60 Hz	5,000	7,500	5,000	7,500
Efficiency at generator terminal (%)		48.5		49	
NOx (ppm) (Converted at 0% O <sub>2</sub> )		200		200	
Operating range		30-100% load		30-100% load	

## (2) Features

The green gas engine is characterized by the following features.

- Power generation efficiency is 49%, the world's top level performance.
- With an NOx (nitrogen oxides) value being as low as 200 ppm or less, the engine stands at the top level in terms of environmental performance also.
- The engine is capable of maintaining a power generation efficiency of as high as 45% under 50% partial loading.
- The engine can reach the 100%-load state within 10 minutes of startup, and is capable of running in a wide load range of 30 to 100% loading. This allows the engine to be operated in a flexible manner.

## 2 Approaches to the improvement of the power generation efficiency

We have been continuing development work on the green gas engine, even after its introduction onto the market, to maintain the engine's power generation efficiency at the world's highest level. This chapter presents our approaches to the improvement of the power generation efficiency.

### (1) Adoption of a variable turbine nozzle area (VTA) turbocharger

In 2010, the Kobe Power Center was established with a 12-cylinder engine adopted as the power supply facility for our Kobe Works. The Kobe Power Center is used not only to supply power to the Works but also as a setting for improving power generation efficiency. This is where we developed a number of engines with a variety of turbocharger specifications. Different from the conventional practice of controlling the intake pressure via an exhaust bypass valve, the green gas engine adopts a variable turbine nozzle area (VTA) in the turbocharger itself to

control engine intake pressure. This has increased power generation efficiency from the 48.5% of the conventional structure to 49.0%. Fig. 1 shows the difference in the turbocharger system between the standard specification (referred to as the KG model) and the high-efficiency one (referred to as the KG-V model). In the conventional KG model, an exhaust bypass valve is provided to release part of the exhaust energy so as to control the intake pressure. In the new KG-V model, on the other hand, the exhaust bypass valve was abolished and a variable nozzle is installed on the turbocharger instead to control engine intake pressure. The adoption of a variable nozzle has allowed the pressure in the exhaust cylinder before the turbocharger to be lowered. Efficiency has also been improved by increasing pumping work in the intake and exhaust strokes.

The engine in which a VTA-type turbocharger is adopted has been undergoing demonstration tests at the Kobe Power Center since 2010, and it has been confirmed to exhibit stable performance throughout the year.

### (2) Adoption of a new lubricant

Recent performance improvements in gas-engine-use lubricants have made it possible to ensure viscosity of low viscosity lubricants in engines at high temperature.

The adoption of a low viscosity lubricant allows the mechanical loss of an engine to be reduced, promising an increase in power generation efficiency. To verify the compatibility of low viscosity lubricants with gas engines, we replaced a conventional high viscosity lubricant with a low viscosity lubricant at its Kobe Power Center and conducted verifications. Oiled with low viscosity lubricants, engines were run over 1,000 hours to verify the power generation efficiency and the reliability of mechanical sliding parts such as bearings.

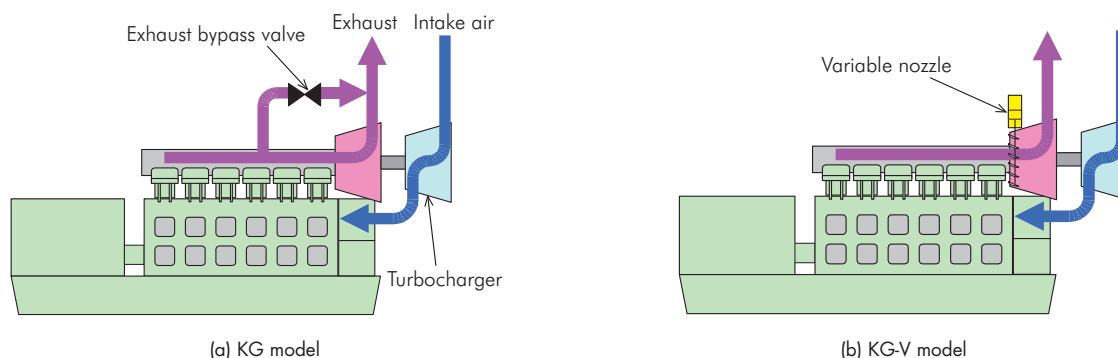

Fig. 1 Turbocharger system



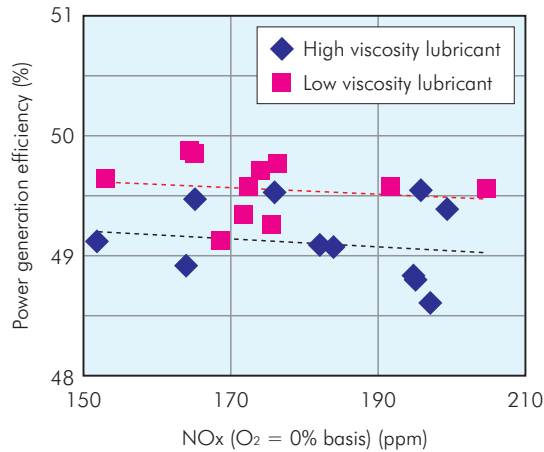

Fig. 2 Improvement in efficiency through use of different lubricant

The power generation efficiency increased by about 0.5 points over cases where conventional high viscosity lubricant was used. And, the overhaul after the test showed no problems with the reliability of bearings and other similar parts. Fig. 2 shows the results of the efficiency improvements from the change of lubricant. Currently, low viscosity lubricants are offered as options for conventional models.

### (3) Changing intake air temperature

In the past, gas engines were used mainly for cogeneration, and, accordingly, facilities were planned so that heat performance supply was compatible with electricity supply performance. However, recent changes in the market needs have resulted in an increase in inquiries for projects focusing on power generation performance only. In response to such interest from the market, we started developing engines with more emphasis placed on power generation efficiency than on the utilization of heat.

For the purpose of heat utilization, in the past, cooling water from the engine was set at a high temperature so that the heat recovery rate in the form of hot water was increased. Since it was not necessary this time to raise the temperature of the extracted cooling water, performance was improved as a result of re-examining the cooling system and, thereby, lowering the intake air temperature.

The efficiency of a gas engine is improved by advancing the ignition timing, because this results in an increase in pressure during combustion. However, advancing the ignition timing too early results in the frequent occurrence of knocking, which hinders engine operation. In the current development work, lowering the intake air temperature made it possible to ensure a margin for knocking as it hindered any increase in efficiency. As a result, this allowed the ignition timing to be advanced, which translated as an improvement in power generation efficiency. Operation on

actual engines confirmed an improvement in power generation efficiency of about 0.2 points.

By combining the efficiency improvement measures described in items (1) to (3) above, the green gas engine achieves a power generation efficiency of 49.8%

Figure 3 shows the progress in the improvement of power generation efficiency of green gas engines.

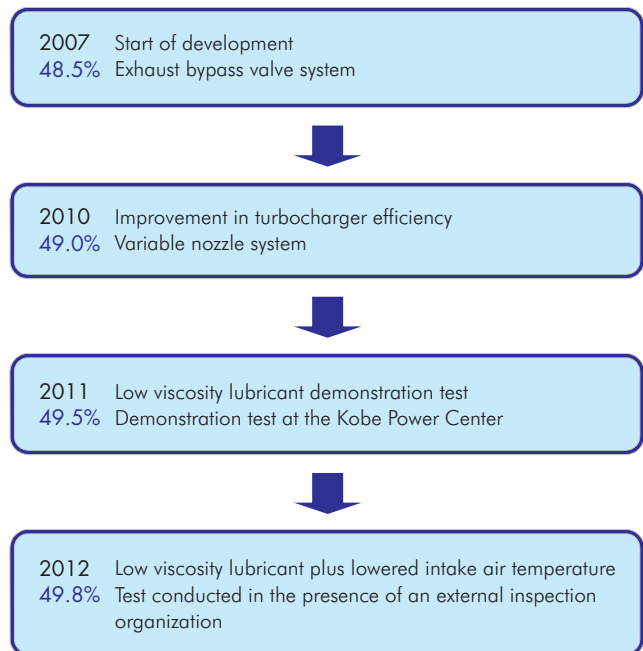

Fig. 3 Progress in improvement of power generation efficiency

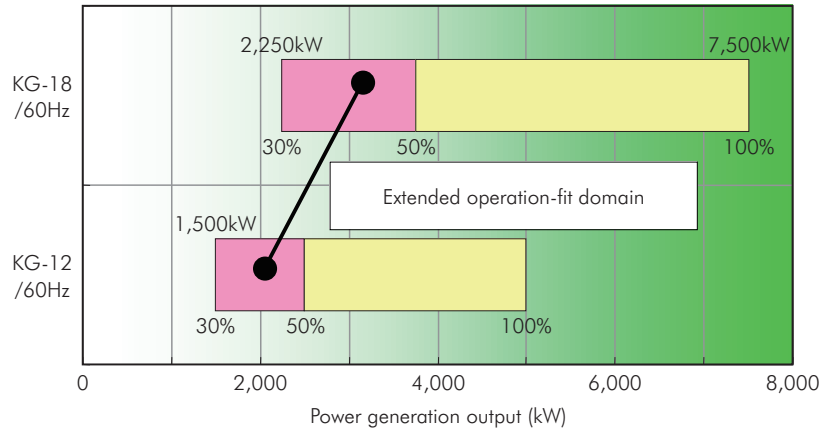

Fig. 4 Operation-fit domain for green gas engines

### 3 Improvement in operability

For many gas engines, the lower limit load at which they can be operated at a continuous rate is about 50%, and for this reason, gas engines have been generally viewed as having a smaller operability range in spite of their higher power generation efficiency. We have been making an effort to widen the operability of green gas engines with the aim of making them easy-to-handle power generating sets not only in terms of power generation efficiency but also practical operation. At the Kobe Power Center, green gas engines were operated under low loading for a long time to verify the range of engine operation.

Generally, long-hour low-load operation of a gas engine causes combustion residue in the combustion chamber,

which in turn becomes a major factor of knocking and thereby impairs the reliability of operation. The long-hour low-load operation test of green gas engines at the Kobe Power Center, on the other hand, demonstrated the scarcity of combustion residue in the combustion chamber, verifying the excellence of combustion performance of green gas engines.

The long-hour operation, furthermore, confirmed that the operational lower limit for green gas engines can be set at 30%, a lower setting than that of conventional gas engines. Fig. 4 shows the range of power generation output in which engines are allowed to operate at a continuous rate in 60 Hz areas. The operation test also confirmed that the power generation efficiency at low load does not decrease much (Fig. 5).

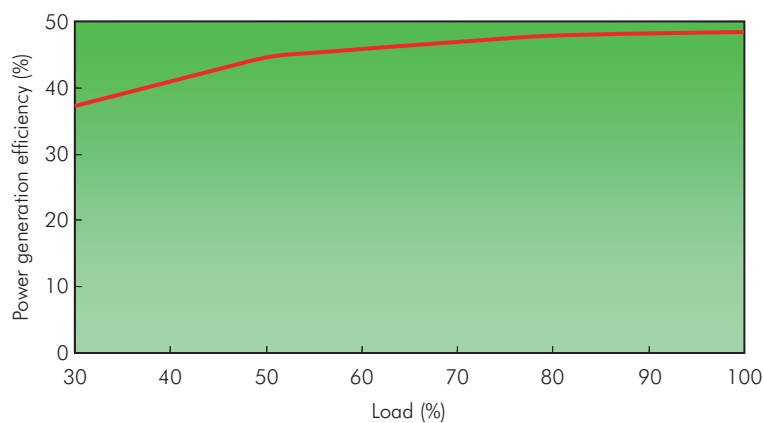

Fig. 5 Power generation efficiency under partial load

## 4 Effort in strengthening the production system

Concurrently with the improvement of performance of green gas engines, we have been making an effort, since 2011, to strengthen the production system in response to the ever-increasing needs of the market. In particular, production facilities were reinforced as represented by the introduction of large machine tools such as planomillers, and simultaneously, assembly lines and factory test-run facilities were improved (Fig. 6). As a result, the production capacity reached 4 units per month in 2012.

Figure 7 shows the entire view of the test-run site for green gas engines. This testing facility is equipped with a 10,000 kW dry loading unit, allowing a variety of load tests to be conducted with an engine and a generator combined.

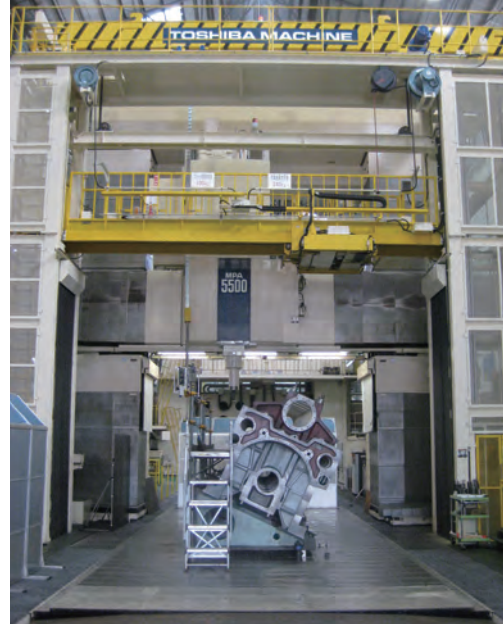

Table displacement (m)	13.0
Maximum carrying mass of the table (t)	200
Gate width (m)	5.5
Gate height (m)	6.1

Fig. 6 Large-scale planomiller



Fig. 7 Factory test facility

## Concluding remarks

Green gas engines were developed on the basis of Kawasaki's more than 100 years of history with reciprocating engines and its state-of-the-art control technology cultivated through the development and manufacture of various equipment and plants.

We received an order from Nihon Techno Co., Ltd. for a 110 MW class power station, Sodegaura Green Power, which is ranked one of the largest gas engine power stations in Japan (Fig. 8). Adopting a VTA turbocharger, whose performance was demonstrated by the efficiency improvement this time, and the first low viscosity lubricant in the industry, this power station is operated at a power generation efficiency of 49.5%.

We hope to contribute to building an affluent society by providing high efficiency, less environment-loading green gas engines.



**Tomohiko Sugimoto**

Power Generation Project Department,  
Machinery Division,  
Gas Turbine & Machinery Company



**Yoshishige Sakai**

Power Generation Project Department,  
Machinery Division,  
Gas Turbine & Machinery Company



**Takashi Hattori**

Power Generation Project Department,  
Machinery Division,  
Gas Turbine & Machinery Company



**Takashi Horie**

Power Generation Project Department,  
Machinery Division,  
Gas Turbine & Machinery Company



**Yosuke Nonaka**

Diesel Engine Department,  
Machinery Division,  
Gas Turbine & Machinery Company



Fig. 8 110 MW class power station delivered to Nihon Techno Co., Ltd.

# Highly efficient 30 MW class gas turbine, L30A

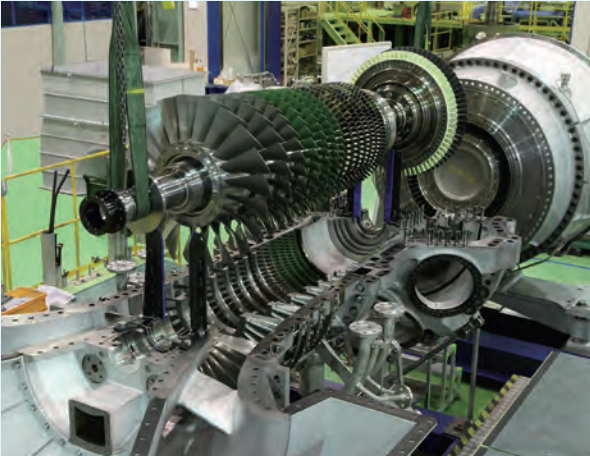

*From the viewpoint of reducing environmental loads and being aware of a growing demand for distributed power generation and an economy-driven need for high-efficiency power generation, we have developed the L30A gas turbine that boasts the world's highest efficiency in the 30 MW class. This paper describes the design concepts, basic structure, general design, and other features of the engine.*

## Preface

Amid society's mounting awareness of electricity conservation, the demand for distributed power generation is increasing with the aim of obtaining a stable supply of electric power. Because of this and economic considerations such as the reduction in running costs, high efficient power generation is coming to the forefront. In addition, expectations are growing in less environment-

loading renewable energy and energy conservation from the viewpoint of preventing global warming and CO<sub>2</sub> emissions. Under these circumstances, combined heat and power plants (CHP/CCPP) using high-efficiency, environment-friendly industrial gas turbines are attracting the greatest attention in the fields of energy conservation.

We have developed the L30A, a new highly efficient 30 MW class gas turbine, in response to such requests from society.

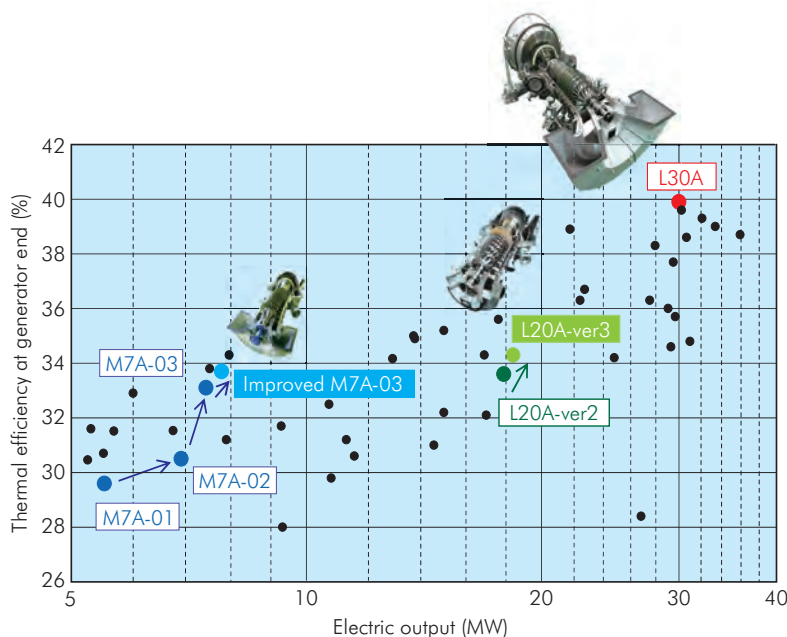

Fig. 1 Performance trend of 5-35 MW class industrial gas turbine

## 1 Overview

Figure 1 shows the performance characteristics of 5 to 35 MW class industrial gas turbines. With one of the development targets set at an efficiency of 40% or more, the world's highest in the 20 to 35 MW class gas turbines, which are the most needed, and with the petroleum and gas markets and turbines for mechanical drive units in sight, we started development of the two-shaft L30A gas turbine in 2007<sup>1)</sup>.

Table 1 shows the main specifications of the L30A and Fig. 2 gives an overview of it.

The L30A gas generator module adopts a multistage axial-flow compressor, a multi-can combustor, and a horizontal split casing structure that were employed in products of our proven M7A and L20A series. For the power turbine module, a ring structure that resists deformation and allows for greater efficiency was designed after proven two-shaft type gas turbines — our small-sized gas turbine, the M1F series, and the Super Marine Gas Turbine (SMGT) developed under a national project.

Table 1 L30A main specifications

Type	Simple open cycle, two-shaft
Output (MW)	30.9
Thermal efficiency (%)	41.3
Compressor	Axial flow 14-stage
Combustor	8-can
Gas generator turbine	Axial flow 2-stage
Power turbine	Axial flow 3-stage
Gas generator revolutions (min <sup>-1</sup> )	9,330
Power turbine revolutions (min <sup>-1</sup> )	5,600
Mass flow rate (kg/s)	86.5
Pressure ratio	24.5
Exhaust gas temperature (°C)	470

ISO conditions (at power turbine shaft end; Fuel: natural gas)

## 2 Features

### (1) World's highest efficiency in 30 MW class gas turbines

With the aim of achieving the world's highest efficiency among gas turbines of the same class, the L30A employed a design philosophy of increased compressor pressure ratio, improved element efficiencies, and state-of-the-art turbine cooling technology. In our existing gas turbines, the pressure ratio of a compressor used to be about 18, but the L30A achieves 24.5, which dramatically surpasses conventional characteristics. For the compressor, a blade profile optimization tool was applied and, at the same time, inter-stage matching was adjusted via Computational Fluid Dynamics (CFD) across all stages. For the turbine, Kawasaki's patented technologies for film cooling and conjugate heat transfer and flow (CHT flow) analysis were applied to grasp detailed temperature distributions on turbine blades to improve the design accuracy.

### (2) Low emissions

Along with the CO<sub>2</sub> emissions reduced through an increase in engine efficiency, the dry low NO<sub>x</sub> combustor that had produced satisfactory results in the M7A and L20A series (third generation) was adopted as design concepts<sup>2)</sup>. With a pre-mixing lean-burn type fuel nozzle, three kinds of burners are used to enable Dry Low Emission (DLE) operations across a wide range.

### (3) Ease of maintenance

Inspection holes are provided at suitable locations so that all flow path faces can be inspected without disassembly. As in existing Kawasaki models, the high-temperature section of the gas generator module is structured as a horizontally split casing and a multi-can combustor with the aim of shortening the maintenance time for periodic replacement. In addition, a modular structure design enables easy and fast replacement work in overhauls.

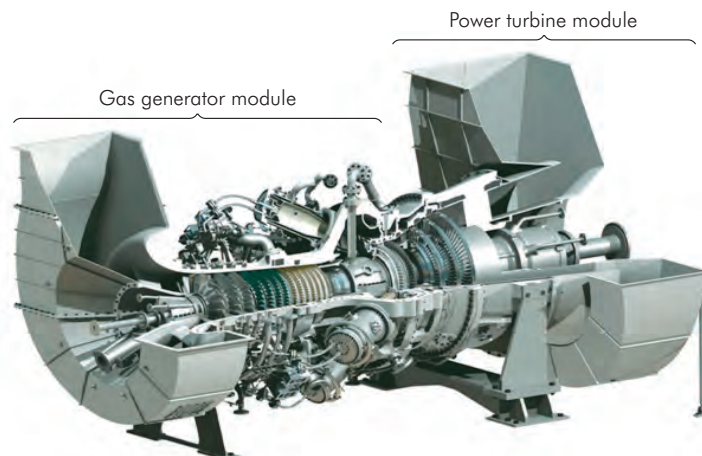

Fig. 2 L30A gas turbine

Table 2 Failure modes and effects analysis of L30A

Item (Critical parts)	Failure modes	Assessment in each validation phase				
		Design	Manufacture or assembly	Engine test		Rig test
				Short-term	Long-term	
245 (Number of cases)	6,473	4,300	1,866	4,095	4,071	170
Gas generator 1st stage rotor blade	Creep rupture	CHT flow analysis	Flow rate test	Pyrometer measurement	Metallurgical inspection	Pre-swirl nozzle rig test
Axial-flow compressor	Inter-stage mismatching or surge	Multi-stage 3D-CFD	Blade tip clearance measurement	Wall static pressure measurement	—	Scale compressor rig test
DLE combustor	Exceeded allowable emissions	3D-CFD	(Checking of ease of assembly)	NOx measurement		Actual scale rig test

### 3 Development process

Prior to the start of the engine development, we conducted Failure Mode and Effects Analysis (FMEA) to predict problems such as potential accidents and failure risks in the design stage. Table 2 lists representative failure modes of a higher probability of occurrence. Detailed analyses and rig tests were conducted in advance to assess their possibilities.

#### (1) Advanced analysis

##### (i) Conjugate heat transfer and flow analysis

With the aim of enabling turbine rotor blades to reach an allowable metal temperature and thereby meet the design creep strength, the flow outside the blade from the combustor and the flow of cooling air inside the blade were computed simultaneously. On the basis of these calculations, CHT flow analysis was conducted on the rotor blade to optimize the arrangement of cooling holes and the shape of the cooling passage.

##### (ii) Non-linear vibration response analysis

All rotor blades of the power turbine have a tip-shroud, with a vibration damping structure based on a Z-shaped

notch. For this reason, vibration response analysis that took into consideration frictional force and damping at the notch contact section was conducted to identify vibrations during operation. It was found that the blades had a sufficient margin of strength for vibrations including higher harmonics modes and random vibrations.

#### (2) Rig tests

##### (i) Compressor tests

Before the engine test, a 63%-scale compressor rig test was conducted (Fig. 3). Using a rig test facility, the compressor characteristics such as the startup behavior, inter-stage matching, compressor map, and variable stator blade schedules were checked and optimized to reduce the risk of failures<sup>3)</sup>.

##### (ii) Combustor tests

Actual-scale rig tests under the same pressure and temperature conditions as for the engine in operation were conducted in the test facility at RWTH Aachen. Combustion characteristics such as the ignition performance, emissions and durability based on the measurement of the liner wall temperature were checked. This also reduced the risk of failure before the engine test.

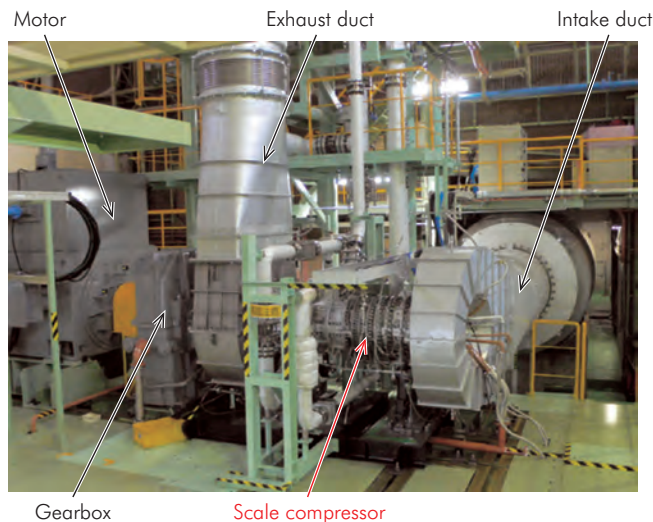

Fig. 3 Scaled-compressor rig test facility

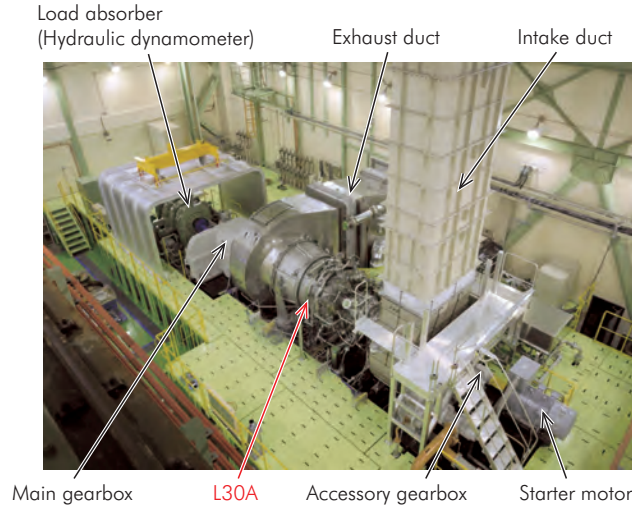

Fig. 4 L30A test facility

**(3) Establishing special production processes**

We have established conditions for various special processes such as how to cast and coat rotor blades, and electron beam welding, and have developed systems that allow these conditions to be applied to the production of parts beginning with the first unit.

**4 Results of operation tests**

We have constructed a new operation test facility for the L30A in our Akashi Works and, at the same time, built a new satellite for the natural gas storage tank. Fig. 4 shows the layout of the operation test facility for the L30A.

The in-house validation tests were conducted roughly in four stages.

**(1) Startup test and load input test**

Figure 5 shows a typical trend graph from startup to the maximum load condition in the early phase of development. The engine startup process was completed without problems after adjustments of the fuel schedule and so forth. It was further confirmed, by monitoring the engine running state during the load input period, that the engine exhibited stable operating characteristics up to the time when the maximum load condition was reached.

**(2) Performance tests**

The performance characteristics of the L30A are obtained by converting pieces of test data measured during the engine operation into ISO-based values using our own performance calculation system. Fig. 6 plots the performance characteristics of the L30A along with its

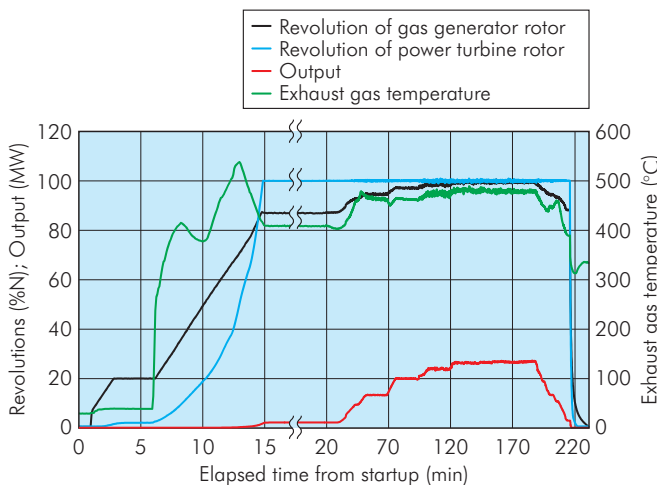

Fig. 5 Typical trend graph from startup to full load

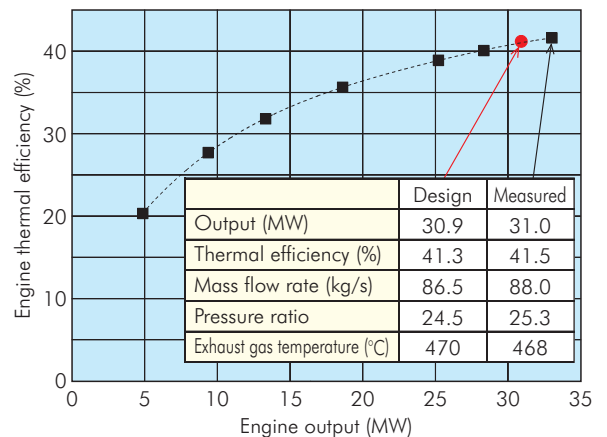

Fig. 6 L30A performance test results



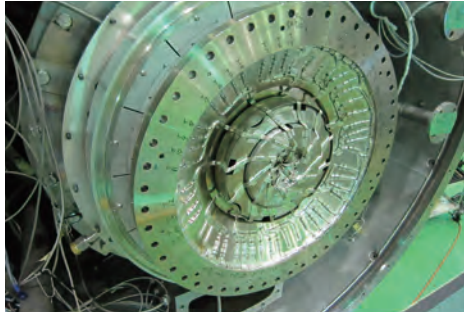

Fig. 7 Telemetry system for power turbine and vibration measurement test results

design values. The target for the engine thermal efficiency against the engine output was achieved.

### (3) Durability confirmation tests

Using a telemetry system with multiple channels, blade vibrations in the compressor and the turbine were measured to prevent the rotor blades from resonating and breaking in operation (Fig. 7). At the same time, tip-timing blade vibration measurements were also conducted and both measurements verified that all the blades were within the allowance in terms of vibration.

Since turbine blades are exposed to a high-temperature atmosphere while in operation, the blade metal temperature was directly measured by means of an infrared radiation measurement system (pyrometer)<sup>4)</sup>. Measurement data was used to confirm that no problems existed with the durability of the rotor blades and to assess the compatibility with the CHT flow analysis verified beforehand, with the usefulness of both techniques confirmed.

In addition, clearance and other items were measured and the initial clearance for assembly was determined on

the basis of the measurement data for the purpose of engine restarting, and so on.

### (4) DLE combustor tests

The combustor is composed of three burners (pilot burner, main burner, and supplemental burner). During the operation in the DLE mode, the pilot burner plays the roll of maintaining the minimum flame. And, as the load increases, the ratio of the fuel for the supplemental burner is increased, with a low NOx level maintained in this way.

The test results of a combustor installed on an engine showed that, as in the preliminary rig tests that were conducted in advance, the NOx value in exhaust gas attained the target of the world's lowest level of 15 ppm or less (15% O<sub>2</sub>) for 50-100% loads.

## 5 Combined heat and power generation using the L30A unit

As an example of application, the performance characteristics of a plant that introduced the L30A unit in a cogeneration system were calculated. Table 3 shows that

Table 3 Specifications of L30A combined heat & power plant

Electric power output (MW)	28.4
Steam production (t/h)	46.2 Saturated steam (Pressure: 0.83 MPaG; Temperature: 177°C)
LHV thermal efficiency (%)	38.8
Total LHV thermal efficiency (%)	83.1
Intake air temperature (°C)	15
Intake/Exhaust loss (kPa)	0.98/3.43
Fuel	Natural gas (Lower heating value = 40.6 MJ/Nm <sup>3</sup> )



Fig. 8 Panoramic view of L30A package PUC300D and CHP plant

the cogeneration system is capable of generating 28 MW of electric power and 46 t/h of saturated steam, and that the overall thermal efficiency reaches 83.1%.

Recently, it was decided to operate commercially the first combined heat and power plant of this type in a chemical plant in Western Japan, with the on-site demonstration tests started in October 2012. Fig. 8 depicts the L30A package, named as the PUC300D, along with the entire view of the CHP plant.

## Concluding remarks

The development and application to power generation of the L30A, a gas turbine boasting the world's highest efficiency among 30 MW class gas turbines, has been completed. And, commercial operation of L30A units has been started, thereby contributing to CO<sub>2</sub> emissions reduction and energy conservation. We will continue development efforts for applications in mechanical drive units aimed at the petroleum and gas markets, with efforts directed at increasing sales of the L30A, which contributes to environmental conservation with its high performance.

## References

- 1) R. Tanaka, K. Take, M. Ryu, A. Matsuoka, and A. Okuto: "Verification Test of Newly Developed High Efficient 30MW Class Gas Turbine, The Kawasaki L30A," ACGT Paper ACGT2012-7138 (2012)
- 2) T. Oda, M. Ogata, K. Matsumoto, S. Aoki, A. Horikawa, and K. Hirano: "DLE combustion technology for enhancing the environmental performance," Kawasaki Technical Review, No.173, pp. 51-56 (2013)
- 3) T. Ikeguchi, A. Matsuoka, Y. Sakai, Y. Sakano, and K. Yoshiura: "Design and Development of a 14-stage Axial Compressor for Industrial Gas Turbine," ASME Paper GT2012-68524 (2012)
- 4) T. Taniguchi, R. Tanaka, Y. Shinoda, M. Ryu, N. Moritz, and K. Kusterer: "Application of an Optical Pyrometer for Newly Developed Industrial Gas Turbine," ASME Paper GT2012-68679 (2012)



### Takuya Ikeguchi

Gas Turbine Development Department,  
Engineering Center  
Gas Turbine Division,  
Gas Turbine & Machinery Company



### Akinori Matsuoka

Gas Turbine Development Department,  
Engineering Center  
Gas Turbine Division,  
Gas Turbine & Machinery Company



### Ryoza Tanaka

Gas Turbine Development Department,  
Engineering Center  
Gas Turbine Division,  
Gas Turbine & Machinery Company



### Atsushi Okuto

Gas Turbine Development Department,  
Engineering Center  
Gas Turbine Division,  
Gas Turbine & Machinery Company



### Koji Terauchi

Gas Turbine Development Department,  
Engineering Center  
Gas Turbine Division,  
Gas Turbine & Machinery Company



### Yusuke Sakai

Gas Turbine Development Department,  
Engineering Center  
Gas Turbine Division,  
Gas Turbine & Machinery Company



### Daisuke Kariya

Mechanical System Research Department,  
Technical Institute,  
Corporate Technology Division



### Masanori Ryu

Gas Turbine Development Department,  
Engineering Center  
Gas Turbine Division,  
Gas Turbine & Machinery Company



### Koji Take

Engineering Center,  
Gas Turbine Division,  
Gas Turbine & Machinery Company

# Modification of 8 MW class gas turbine, M7A-03

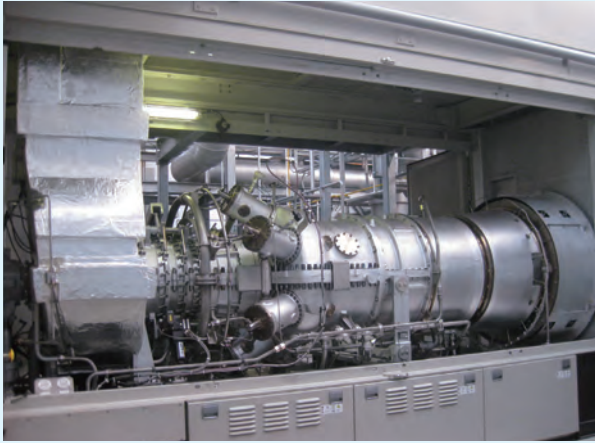

Over 30 orders have been received for our 8 MW class high-efficiency gas turbine, the M7A-03, which first appeared on the market in 2007. Those units are running smoothly with an accumulated equivalent operating time of more than 200,000 hours. To respond to the need for further performance enhancement, continuous efforts have been directed at improving performance of the M7A-03. This paper presents our approach to performance improvement with the M7A-03.

## Preface

In addition to the interest drawn from increased environmental awareness, gas turbine-based cogeneration systems are considered to be increasingly important hardware as distributed power supplies. The gas turbines that form the core of such cogeneration systems are required from an environmental viewpoint to have environment-friendly exhaust gas characteristics (CO<sub>2</sub> and NO<sub>x</sub> emissions reduction) based on the use of natural gas and high efficiencies from an economic perspective.

The M7A-03 is a low-environment-loading, high-efficiency gas turbine, and is the latest model of Kawasaki's M7A series, which has an impressive track record of more than 100 units delivered. We continue the effort for performance enhancement of the M7A-03 in response to the needs described above.

## 1 Overview of the M7A-03

We internally developed the M7A-01<sup>1)</sup> gas turbine (6 MW class) and equipped it with a full-scale axial flow compressor, putting it on the market in 1994. Following this, We developed the M7A-02 gas turbine (7 MW class) in which transonic compressor technology was applied to increase output power through an increase in the intake air flow volume and pressure ratio, with sales started in 1998. Aiming at scaling up the M7A while maintaining its basic structure, we applied the latest technology in developing a high-efficiency gas turbine in the L20A<sup>2)</sup> (18 MW class) Sales were launched in 2000.

The M7A-03<sup>3)</sup> which retrofitted the M7A-02 with the latest technologies of the L20A to improve performance characteristics, has been on the market since 2007. Fig. 1 shows the M7A-03, and Table 1 presents its specifications.

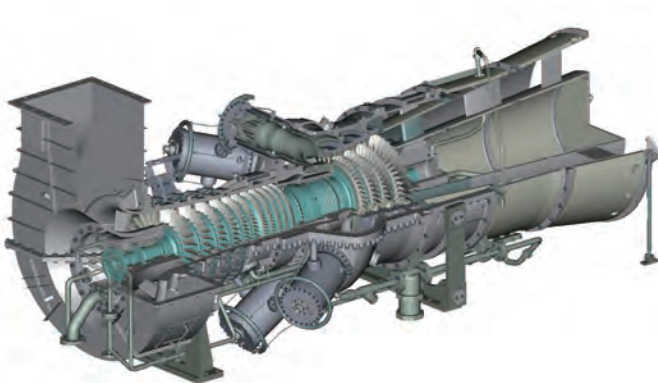

Fig. 1 Overview of M7A-03 gas turbine

Table 1 M7A main specifications

Structure	Open cycle, Single shaft
Compressor	Axial flow, 11 stages
Combustor	Can-type, 6 cans
Turbine	Axial flow, 4 stages
Number of revolutions (min <sup>-1</sup> )	13,790
Bearing specification	Journal bearings, Thrust bearing



(a) Unit for Japanese use



(b) Unit intended for use in Europe

Fig. 2 M7A-03 gas turbine generator package

## 2 Operational track record of the M7A-03

We have received orders from both Japan and abroad for over 30 cogeneration facilities equipped with the M7A-03 gas turbine. The total working time is over 150,000 hr in terms of the actual operating time and over 200,000 hr in terms of the equivalent operating time. Fig. 2 shows an example of a typical gas turbine generator package.

In terms of the combustion scheme, most of the delivered gas turbines are equipped with Dry Low (NOx) Emission (DLE) combustors to meet environment requirements. Three gas turbines equipped with an ultra-low (NOx) DLE combustor with an NOx emission density

of 15 ppm (15% O<sub>2</sub> conversion) continue running without a problem. On the other hand, in regions such as Southeast Asia where infrastructure for natural gas is unreliable, gas turbines equipped with a dual fuel combustor that can be fired temporarily on liquid fuel are used.

With the M7A-03 having roughly the same basic structure as the M7A-02, the M7A-03 can replace the M7A-02 installed on a generator package. Fig. 3 shows how the generated output changes as a result of a replacing the M7A-02 with the M7A-03. By replacing the M7A-02 with the M7A-03, the generated output can be increased by 700 kW without other substantial modifications.

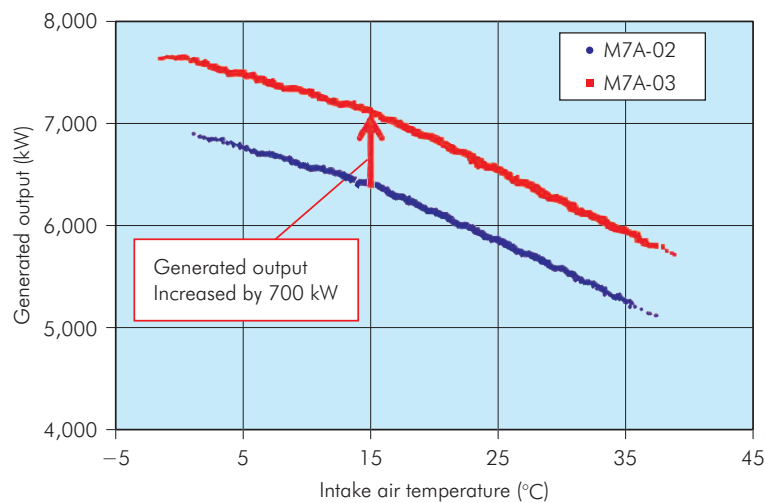

Fig. 3 Benefits of output power by switching to M7A-03

## 3 Efforts for higher performance

In response to market requirements for higher efficiency, we have continued efforts toward higher performance. Some of those efforts are presented below.

### (1) Improvement of element efficiencies and reduction in ineffective air

In the development of the M7A-03<sup>3</sup>, a substantial increase in performance was attained by improving the efficiencies of each element such as the compressor and turbine, and reducing air that was not effectively used to produce power. By the way, we continue efforts to improve these factors to achieve even higher performance.

#### (i) Reduction in pressure loss in the inlet collector

The passage through which air is taken from the outside of the generator set and channeled to the gas turbine inlet is

shaped as a collector. An improperly shaped inlet collector causes distorted flow at the compressor inlet resulting in increased pressure loss. In addition, this inlet flow distortion affects the element efficiency of the compressor and blade vibration characteristics.

A modification was made to make the flow at the compressor inlet uniform. Fig. 4 shows the shape before and after the modification, and Fig. 5 shows the results of CFD analysis on the outlet of the inlet collector (namely, the compressor inlet). The modification has brought about a reduction in pressure loss of about 10%.

#### (ii) Reduction in the tip clearance of the turbine

The gap between the turbine rotor blades and turbine shroud, is called the "tip clearance." Because it governs the quantity of working fluid bypassed to the face and the back of a blade, this tip clearance affects the element efficacy of the turbine greatly.

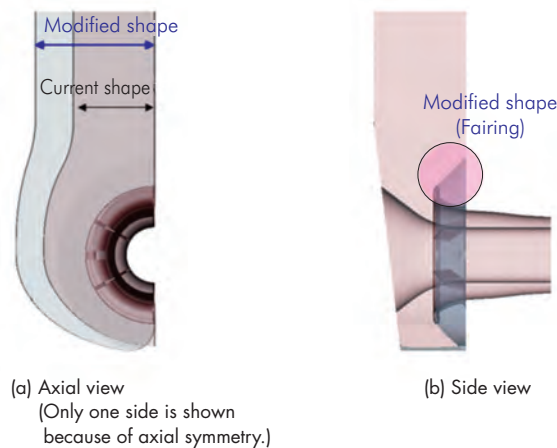

Fig. 4 Modified inlet collector profile

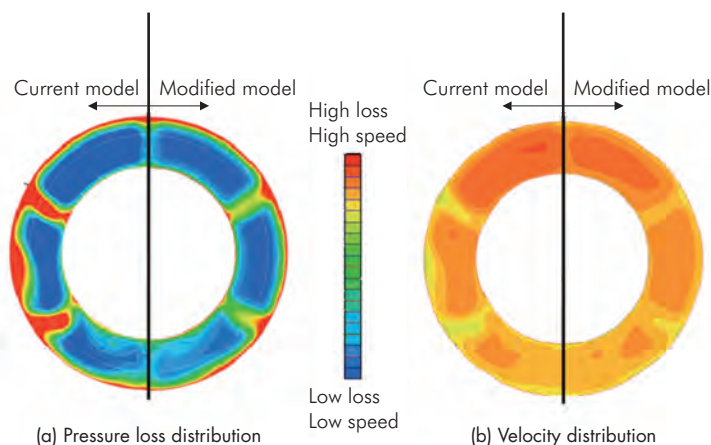

Fig. 5 Results of CFD analysis at collector outlet (Cross-section downstream of bellmouth)

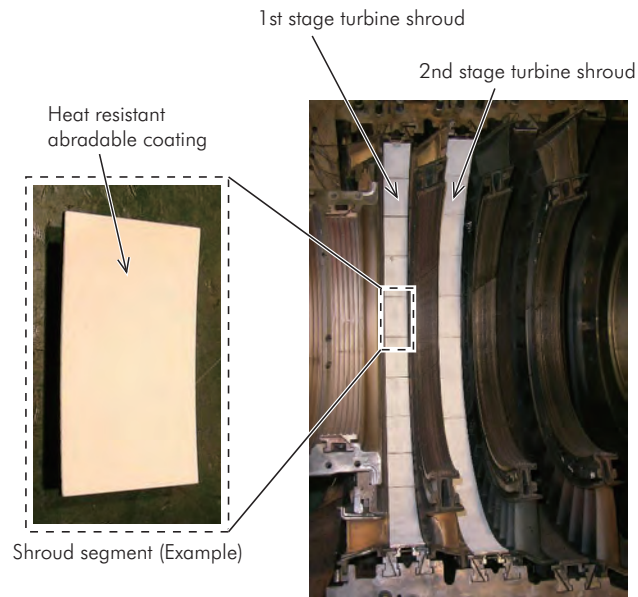

Fig. 6 Heat-resistance and abradable coating

The tip clearance becomes the smallest in a transient operation such as start up. The clearance in nominal operation is determined so as to prevent the rotor blades and stationary shroud from being damaged by hard rubbing in a transient operation.

With the aim of making the clearance during normal operation still smaller, a heat-resistant abradable coating that is easily worn by contact with rotating metal is applied to the shroud so that any possible contact of the rotor blade with the shroud during transient operation does not result in serious damage. Fig. 6 shows a shroud with the heat-resistant abradable coating.

(iii) Reduction in ineffective air

Pressure at the outlet of the compressor in a gas turbine is very high. For this reason, if gaps are present in spaces of high compressed air, air leaks will occur and compressed air cannot be used effectively. But, it is difficult to eliminate gaps completely because of processing tolerances and the differences in thermal expansion during operation.

With the aim of minimizing gaps that occur during operation and thereby reducing leaking air, heat-resistant plastic cord seals were inserted into the gaps. Fig. 7 shows how a cord seal is inserted.

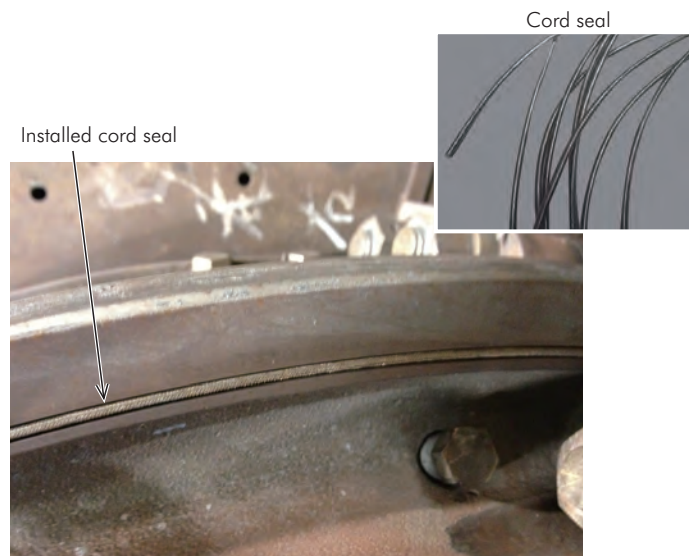

Fig. 7 Gap minimization by applying cord seal

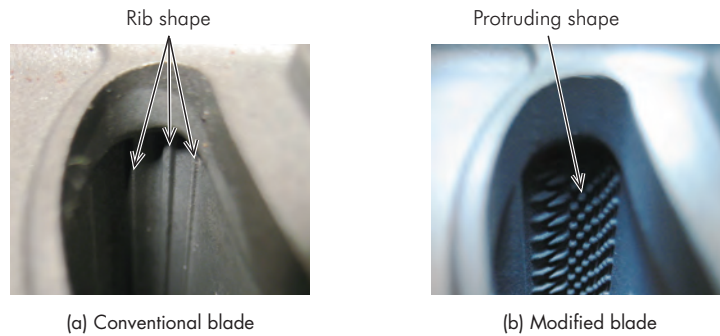

Fig. 8 Cooling structure on leading edge

## (2) Re-examining the heat cycle

The ways of increasing performance in terms of the heat cycle characteristics of a gas turbine include increasing the pressure ratio and raising the gas temperature at the turbine inlet. The former requires the compressor be redesigned and hence a substantial change in the structure. For this reason, the latter means of raising the gas temperature at the turbine inlet was adopted to attain higher performance.

An increase in the temperature of turbine parts affects the life of hot section parts and consequently the reliability of gas turbine. What becomes important to ensure reliability is cooling technology for the hot parts when the turbine inlet temperature (TIT) is raised, and temperature measuring technology to verify the effect of the former.

### (i) Cooling technology

With compressed air from the compressor outlet used to cool turbine blades, saving this cooling air minimizes compression work, contributing to an improvement in performance of the gas turbine. Also, when the TIT is raised, improving the cooling performance of blades is important to maintain, with a minimal increase in cooling air volume, the turbine blades at about the same temperature as when the TIT is not raised.

In order to improve the blade cooling performance at the highest thermally loaded leading edge of the 1st stage turbine stationary blades, which are exposed to the highest gas temperature, the leading edge cooling structure was changed from the conventional rib structure to a protruding structure that increased the heat transfer area on the cooling side. Fig. 8 shows the difference in the cooling structures.

### (ii) Temperature measuring technology

Among the rotor blades of the M7A-03, the 1st and 2nd stage blades adopt a cooling structure. The temperature of the blade material is one of the very important factors in assessing the life of turbine blades. But, it is difficult to accurately estimate temperatures over the entire cooling blade at the time of design, and for this reason, it is extremely important to measure temperatures across the blade on an actual machine in operation.

To retain the reliability of blades in terms of strength, the basic structure of the cooling blade was kept identical to that of a conventional blade. On the basis of this idea, the objective was set not to allow the temperature of the blade material to rise as a result of an increase in the cooling air to the blade if the TIT rises. In the design phase, studies were conducted to maintain the temperature of the

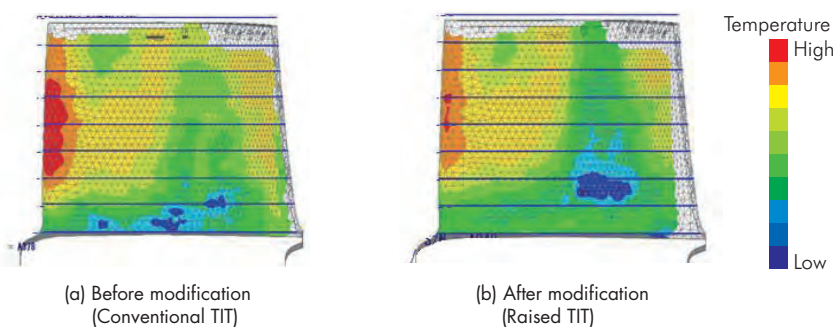

Fig. 9 1st blade surface temperature measured by pyrometer (Blade pressure side)

turbine blade material with a minimum increase in cooling air volume in consideration of the effect on engine performance.

To verify the appropriateness of the increase in cooling air volume based on this design, the temperature of blade materials on an actual machine was measured. To measure the temperature of the rotary blades, an infrared radiation temperature measurement system (pyrometer)<sup>4)</sup> that had a proven track record was used. Fig. 9 shows the results of measurements on the 1st stage turbine rotor blades. This confirms that the temperature of the material of the turbine blades is held below the same temperature of conventional blades even if the gas temperature at the inlet rises.

## 4 Performance of the modified model

The modified model is being subjected to field tests at our Akashi Works No.7 power plant to verify the reliability of each of the modifications since June 2012. Table 2 shows the performance of the improved M7A-03 to which the current modifications have been applied.

### Concluding remarks

We have received brisk orders for the M7A-03 since the first unit was marketed in 2007, and continues favorable operation.

The improved M7A-03, which aims at still higher performance, has been undergoing field tests at the energy center of Kawasaki's Akashi Works since June 2012.

We will do its best to continue making improvements with the aim of providing its customers with gas turbines of higher performance and reliability.

Table 2 Performance of improved M7A-03

	Modified	Conventional
Output, generator end (kW)	7,780	7,420
Efficiency, generator end (%)	33.5	33
Exhaust gas temperature (°C)	523	510
Pressure ratio	15.6	15.6
Air flow rate (kg/s)	27	27

No inlet and exhaust duct loss; fuel: methane (100% CH<sub>4</sub>)



#### Hiroshi Taki

Industrial Gas Turbine Engineering Department,  
Engineering Center,  
Gas Turbine Division,  
Gas Turbine & Machinery Company



#### Sakiko Shiga

Industrial Gas Turbine Engineering Department,  
Engineering Center,  
Gas Turbine Division,  
Gas Turbine & Machinery Company



#### Tetsuo Ukita

Industrial Gas Turbine Engineering Department,  
Engineering Center,  
Gas Turbine Division,  
Gas Turbine & Machinery Company



#### Makoto Gouda

Solution Engineering Department,  
Energy Solution Division,  
Gas Turbine & Machinery Company

### References

- 1) T. Sugimoto, K. Ikegawa, S. Kajita, W. Karasawa, T. Kojima, and K. Nagai: "Development of a 6MW-Class High-Efficiency Gas Turbine M7A-01," ASME 94-GT-066 (1994)
- 2) T. Sugimoto, K. Nagai, M. Ryu, R. Tanaka, T. Kimura, and T. Nagatomo: "Development of a 20MW-Class High-Efficiency Gas Turbine L20A," ASME GT2002-30255 (2002)
- 3) K. Tanimura, N. Murakami, A. Matsuoka, K. Ishida, H. Kato, T. Sakai, T. Taniguchi, and H. Taki: "Development of an 8MW-Class High-Efficiency Gas Turbine, M7A-03," ASME GT2007-28361 (2007)
- 4) T. Taniguchi, K. Sanbonsugi, Y. Ozaki, and A. Norimoto: "Temperature Measurement of High Speed Rotating Turbine Blades Using a Pyrometer," ASME GT2006-90247 (2006)



# 1.7 MW class high efficiency and low emission gas turbine, M1A-17

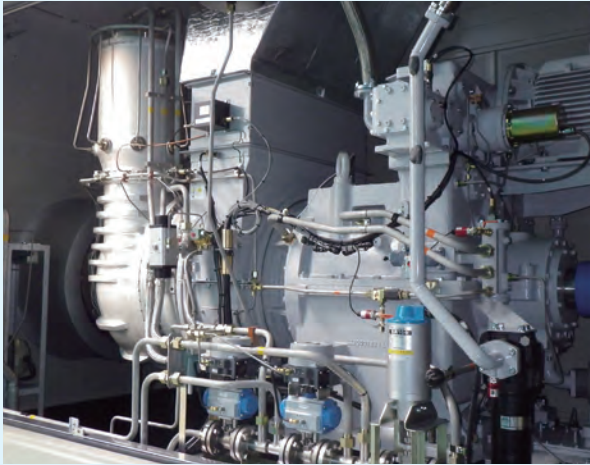

We have been developing and manufacturing power generation-use gas turbines for a long time ever since pioneering the manufacture and sale of the first such unit in Japan. Based on this rich experience, we developed a new 1.7 MW class power generation-use gas turbine, the M1A-17, with latest analysis technology. Its generating-end efficiency is of the world's highest class at 26.0%, while NOx emissions are 52.5 ppm converted on an O<sub>2</sub>=0% basis (15 ppm converted on an O<sub>2</sub>=15% basis), also the world's highest performance achieved. The field test machine started operation in a power generation facility at our plant in April 2010, and marketed units started operation all over the world, including Japan, in 2012.

## Preface

Recently, the importance of distributed power sources has increased from the viewpoint of ensuring power supply against the loss of power and power service interruptions in disasters. In addition, regulations on exhaust gas are increasingly stricter from the viewpoint of global environment preservation. A reduction in NOx emissions from power generation-use gas turbines is also demanded.

Since successfully developing Japan's first domestically built industrial gas turbine in 1972, we have put various models of gas turbines on the market. Fig. 1 shows the lineup of our industrial gas turbines. The M1A-13,

developed in the latter half of the 1980s, boasts a track record of deliveries of about 400 units for continuous generating power use both in Japan and overseas.

Developed on the base of the proven M1A-13, the M1A-17<sup>1)</sup> not only integrates the development history and basic technologies of Kawasaki but also is endowed with a substantial improvement in efficiency and exhaust gas performance while still preserving the reliability of the M1A-13. The M1A-17 has exhibited a generating-end efficiency of 26.0% and an overall thermal efficiency of 80% with the boiler included, achieving the top-level performance indexes of this class.

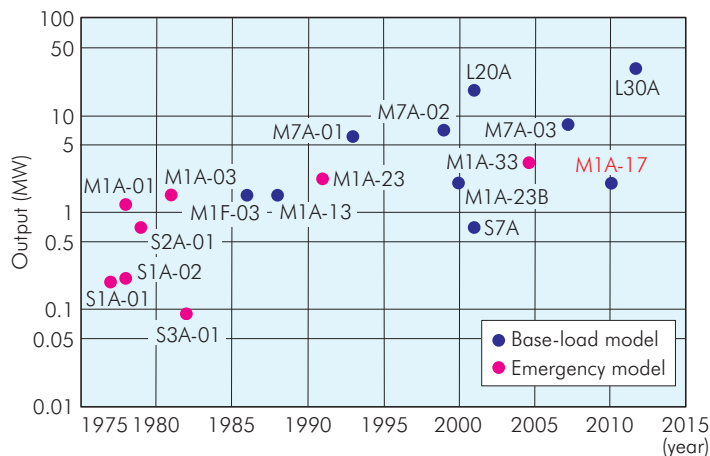

Fig. 1 Lineup of industrial gas turbines

## 1 Overview of the M1A-17

The M1A-17 is composed of a two-stage centrifugal compressor, a three-stage axial flow turbine, and a single can-type combustor as its main components. The model can be equipped with a diffusion combustor or a dry low emission (DLE) combustor; the model equipped with a DLE combustor is distinguished as the M1A-17D. Fig. 2 shows a cut model of the M1A-17D and Table 1 the main characteristics and cogeneration performance data. The features of the M1A-17 are described below.

### (1) High efficiency

Thanks to measures to improve the efficiencies of individual elements described hereafter, the M1A-17 has achieved the world's top level of generating-end efficiency at 26.0%. And, since the exhaust gas temperature is on the same level as that of conventional machines, it has attained a high overall thermal efficiency of 80% as a cogeneration system that produces, in addition to electricity, steam by using the exhaust gas.

### (2) Low emission

The DLE combustor incorporates Kawasaki's proven system used in the M7A, inheriting the high reliability of the model. Equipped with a DLE combustor, the M1A-17 has achieved the world's top-level of low NO<sub>x</sub> performance at 15 ppm (O<sub>2</sub>=15%).

### (3) High reliability

The basic structures of the rotor and casing of the M1A-17 are the same as those of the highly reliable M1A-13. To carry on the overall system reliability from the predecessor model, the same number of revolutions and the same bearings as the M1A-13 have been adopted; the peripheral devices were proven on other models.

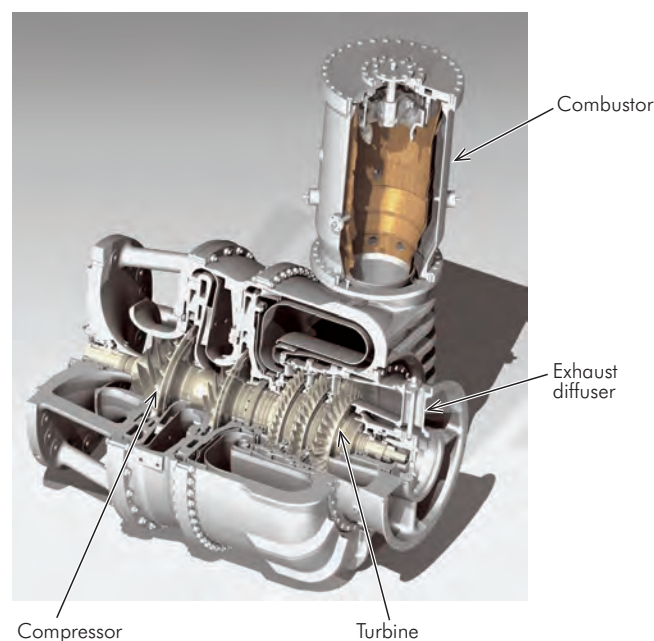

Fig. 2 Cut model of M1A-17D gas turbine

Table 1 Main specifications and performances of M1A-13D and M1A-17D

Model	M1A-13D	M1A-17D
Type	Simple open cycle, single-shaft type	
Compressor	Two-stage centrifugal type	
Turbine	Three-stage axial flow type	
Combustor	Single-can-type (DLE)	
Generating-end output (kW)	1,450	1,630
Fuel consumption (m <sup>3</sup> N/h)	617	629
Quantity of steam supplied (kg/h)	5,100	5,000
Generating-end efficiency (%)	23.6	26.0
Heat recovery efficiency (%)	56.1	54.1
Overall thermal efficiency (%)	79.7	80.1
NO <sub>x</sub> value (ppm, O <sub>2</sub> =15%) (Operating range)	NO <sub>x</sub> <25 (85~100%)	NO <sub>x</sub> <15 (70~100%)
CO value (ppm, O <sub>2</sub> =15%) (Operating range)	NO <sub>x</sub> <50 (85~100%)	NO <sub>x</sub> <80 (70~100%)

<Conditions for calculating performance values>  
 Intake temperature: 15°C  
 Atmospheric pressure: 101.3 kPa (At 0 m elevation)  
 Intake/Exhaust pressure loss: 0.98/2.45 kPa  
 Fuel: Methane 100%

Generator efficiency: 95%  
 Measures for NO<sub>x</sub>: Lean premixed combustion  
 Heat recovery steam generator: Steam pressure 0.83 MPaG;  
 Water supply temperature: 80°C

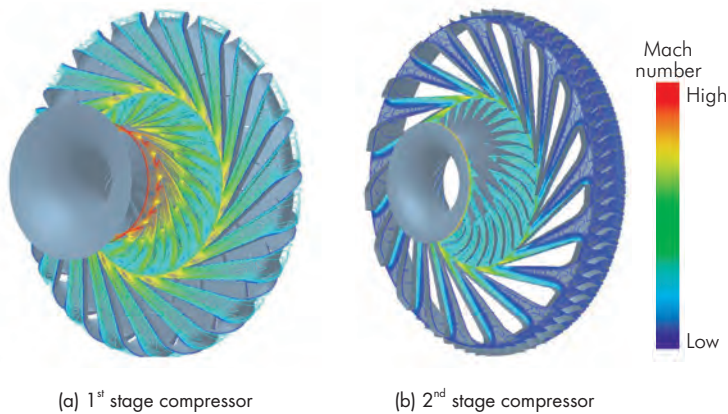

Fig. 3 CFD results of compressor internal flows

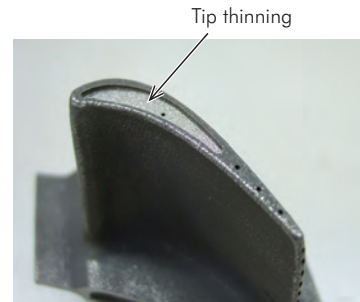

Fig. 4 Tip thinning structure

## 2 Design improvements of individual elements

### (1) Compressor

This model adopts a two-stage centrifugal compressor. In the past, the application of CFD analysis was limited to the design of impellers, which are rotating bodies. This time, however, CFD analysis was applied to parts on the stationary side to carry out an integrated analysis of rotating and stationary bodies for the purpose of optimizing the passage shape so as to prevent reverse flow in the passages of stationary bodies. Fig. 3 shows examples from an analysis of internal flow in the first and the second stage. Using this analysis technology has made it possible to maximize the efficiency of centrifugal compressors.

### (2) Turbine

The turbine is a three-stage axial flow type and provided with cooling blades in the first stage. In designing this turbine, a tip\* thinning structure (Fig. 4) was adopted as a structural feature for reducing leak loss, while a low expansion material was adopted for the turbine casing as a material feature for minimizing the tip clearance\*\* in rated operation. This helped reduce leaking from the blade tips, allowing more fluid energy to be recovered by the turbine. In terms of aerodynamics, the latest CFD tools were used to separately analyze the individual stages, and then all stages were analyzed with the aim of optimizing the passage shape and distribution of work between the stages. Fig. 5 shows the result of the CFD analysis on all stages.

\* Tip: Tip of turbine blade

\*\* Tip clearance: Clearance between the tip of blade and the turbine shroud that covers the blade

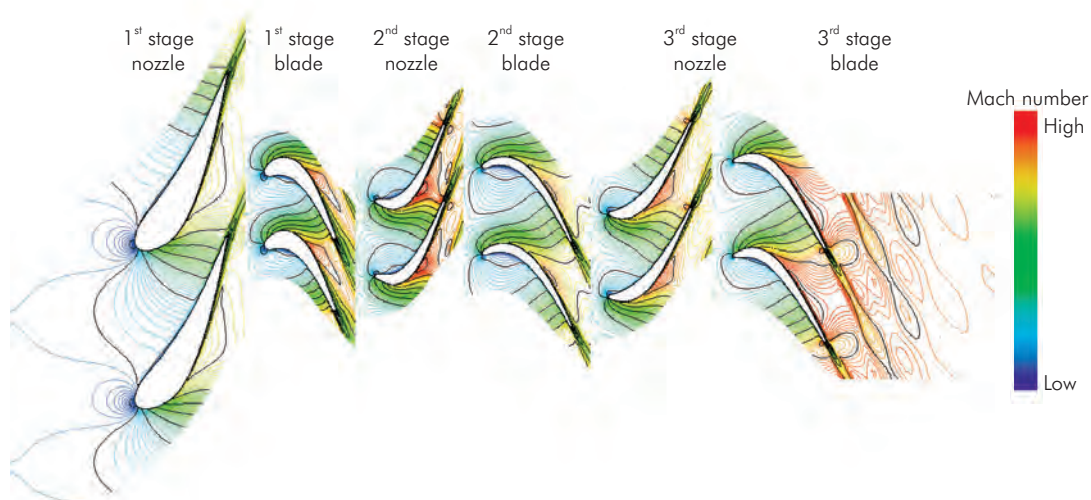

Fig. 5 CFD results of all turbine stages

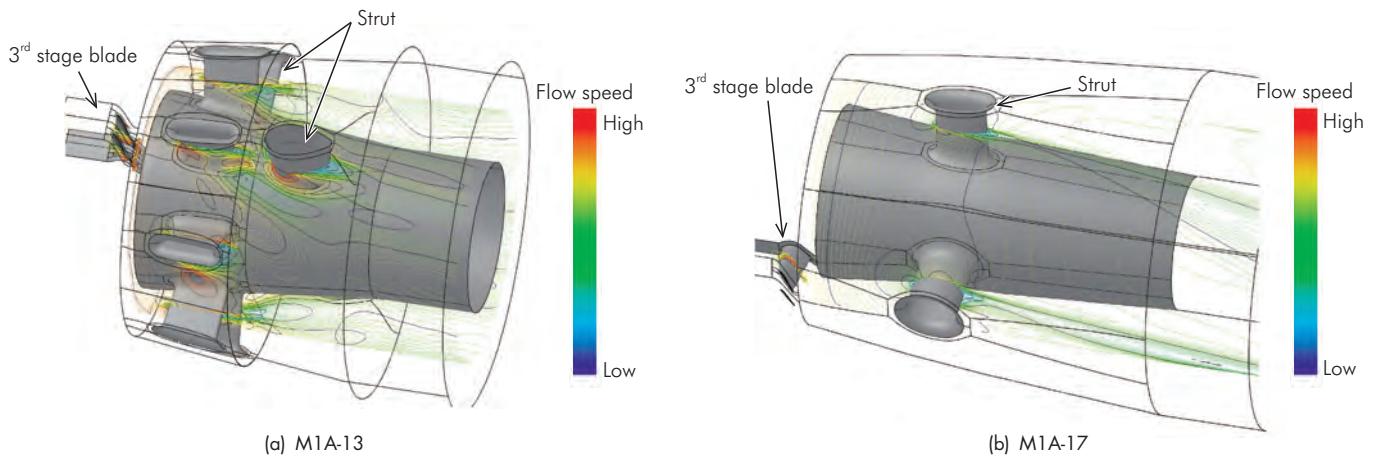

Fig. 6 CFD results of exhaust diffuser

### (3) Exhaust diffuser

The exhaust diffuser is used to discharge exhaust gas while expanding the flow passage to reduce the flow speed and recover static pressure. Struts are provided in the flow passage to hold bearing parts and others arrayed on the inside diameter side. Since the struts are provided in the exhaust gas passage, their shape, number, and arrangement affect the performance of the exhaust diffuser greatly. In the M1A-17, CFD-based flow analysis was used to study the arrangement and shape of the struts, while the pressure loss was reduced by minimizing the reverse flow domain. Fig. 6 shows examples from the CFD-based analysis of the exhaust diffuser used in the M1A-13 and M1A-17. The illustration shows a smaller

separation of flow and areas of reverse flow in the M1A-17 than in the M1A-13, which comes as a result of reducing the number of struts and other measures.

### (4) DLE combustor

The combustor is based on lean premixed and a supplemental combustion method, both of which have been proven with our products. The combustor has three burners: a pilot burner, a main burner, and supplemental burners (Fig. 7). The pilot burner is used mostly for ignition and low load, while the main burner and the supplemental burners are used at low NOx operation. Keeping the fuel concentration distribution as homogeneous as possible in the combustion zone is effective towards reducing

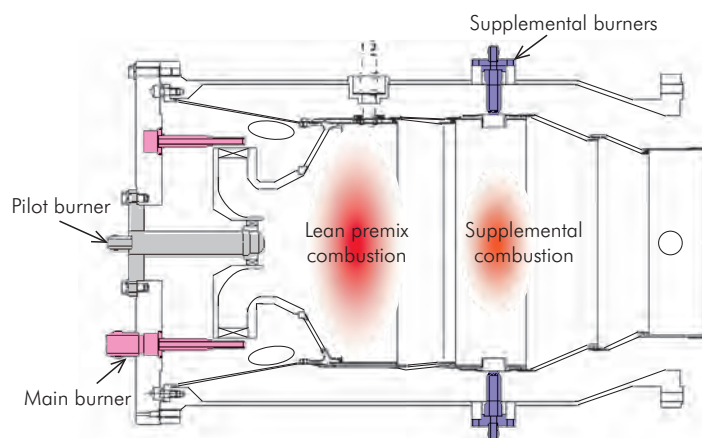

Fig. 7 Dry Low Emission combustor

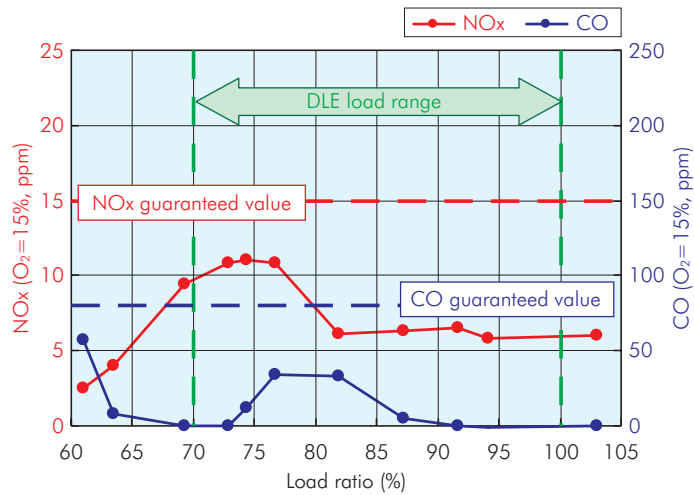

Fig. 8 NOx emission characteristics



Fig. 9 Electric power plant at Akashi Works

emissions. For this purpose, CFD analysis was used to optimize the shape of the burner and flow passage so that air and fuel are mixed efficiently in the burner section. In combustor unit tests and engine tests, an NOx value no greater than 15 ppm (O<sub>2</sub>=15%) was attained, thus improving NOx exhaust performance by about 50% in comparison with the M1A-13D. Fig. 8 shows the NOx exhaust characteristics.

### 3 Field test

To determine the reliability of the M1A-17D, a field test was started at a power station in one of our plants in April 2010 (Fig. 9). The turbine is operated with the DLE combustor. Operation exceeded 8,000 hours in August 2012 and continues smoothly without problems.

Table 2 M1A-17D track record of deliveries

Delivered to	Country name	Fuel	Waste heat utilization
Energy supply company A	Switzerland	Natural gas	Boiler
Energy supply company B	USA	Natural gas	Boiler
Chemicals manufacturing company	Germany	Natural gas	Boiler
Food processing company A, No.1 unit	Germany	Natural gas	Boiler
Food processing company A, No.2 unit	Germany	Natural gas	Boiler
Metal manufacturing company	Germany	Natural gas	Boiler
Paper manufacturing company	Japan	City gas	Boiler
Construction materials manufacturing company A, No.1 unit	Japan	City gas	Drying oven
Construction materials manufacturing company A, No.2 unit	Japan	City gas	Drying oven
Construction materials manufacturing company B	Japan	City gas	Drying oven



Fig. 10 M1A-17D package (Switzerland)

## 4 Mass-production units

The M1A-17 was put on the market in April 2010. Since the first mass-produced unit was commissioned in April 2012, 10 units have been shipped as of June 2012. Table 2 shows the track record of deliveries, and Fig. 10 the package of the first mass-produced unit destined for Switzerland.

### Concluding remarks

Carrying on the reliability proven in its predecessor machines, the M1A-17 incorporates state-of-the-art performance-enhancing technologies and substantially improves thermal efficiency through an improvement in efficiency performance of individual elements. The turbine also has realized a low emissions level of the world's top class. We will continue demonstrating the reliability of its products in field tests, as well as striving for further improvement with the aim of contributing to the effective use of energy and the reduction in environmental loading.



#### Yasufumi Hosokawa

Industrial Gas Turbine Engineering Department,  
Engineering Center,  
Gas Turbine Division,  
Gas Turbine & Machinery Company



#### Makoto Gouda

Solution Engineering Department,  
Energy Solution Division,  
Gas Turbine & Machinery Company



#### Yoshihiro Yamasaki

Industrial Gas Turbine Engineering Department,  
Engineering Center,  
Gas Turbine Division,  
Gas Turbine & Machinery Company



#### Yoshiaki Kusumoto

Industrial Gas Turbine Engineering Department,  
Engineering Center,  
Gas Turbine Division,  
Gas Turbine & Machinery Company



#### Daisuke Uemura

Industrial Gas Turbine Engineering Department,  
Engineering Center,  
Gas Turbine Division,  
Gas Turbine & Machinery Company



#### Naoki Kanazawa

Technology Department,  
Engineering Center,  
Gas Turbine Division,  
Gas Turbine & Machinery Company



#### Atsushi Norimoto

Quality Assurance Department,  
Gas Turbine Division,  
Gas Turbine & Machinery Company

## Reference

- 1) Y. Hosokawa, M. Gouda, Y. Yamasaki, and A. Norimoto: "Development of 1.7 MW Class High Efficiency Gas Turbine, M1A-17," Asian Congress on Gas Turbines, 2012.

# DLE combustion technology for enhancing environmental performance

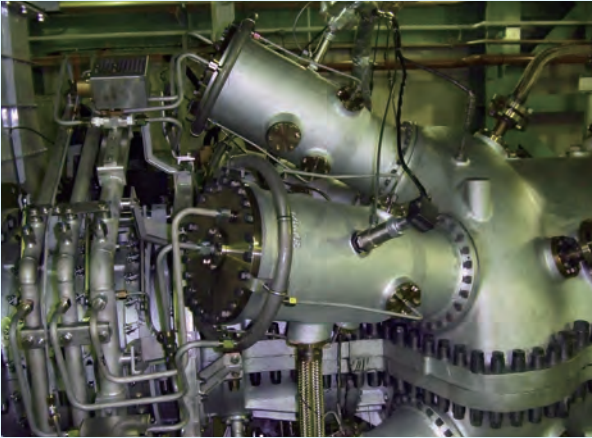

*With a product lineup of 0.7 to 30 MW class gas turbines, we are engaged in the development of combustors and working to commercialize them with the aim of assuring the world's top class emission performance in all models. This paper describes the development and demonstration of Kawasaki's DLE (Dry Low Emissions) combustion technologies.*

## Preface

As a result of rising environmental awareness, environmental regulations on gas turbine power generation systems have become stricter year by year, with this trend expected to continue. In response to stricter regulations, gas turbine manufacturers are accelerating the development of low-emission combustors. We have developed a lineup of various normal-use gas turbines of 0.7 to 30 MW class, for all of which we have developed and are commercializing low-emission combustors.

This paper presents some examples of our low-emission combustors and the world's highest level of guaranteed emission performance that they achieved.

## 1 Emissions of gas turbines and mechanisms to reduce them

Major emissions exhausted from gas turbine combustors are carbon dioxide (CO<sub>2</sub>), nitrogen oxides (NO<sub>x</sub>), and carbon monoxide (CO). The reduction in CO<sub>2</sub> should be achieved through performance improvements of the gas turbine main body; this paper describes the reduction in NO<sub>x</sub> and CO through the improvement in combustion. The major causes of NO<sub>x</sub> emissions are categorized into the following three by generation mechanism: "thermal NO<sub>x</sub>" that is generated in the high-temperature range, "prompt NO<sub>x</sub>" that is generated on a fuel rich flame front, and "fuel NO<sub>x</sub>" that is generated by the oxidation of nitrogen contents in fuel molecules. For the use of gas turbine generator sets, "thermal NO<sub>x</sub>" governs the NO<sub>x</sub> emissions, and the key is

how to reduce them (hereinafter, "NO<sub>x</sub>" refers to thermal NO<sub>x</sub>). On the other hand, CO is an intermediate product occurring as a result of the combustion of hydrocarbon fuel on the verge of being further oxidized into CO<sub>2</sub>, and can be decreased by raising the flame temperature or lengthening the staying time in a high temperature range.

The production of NO<sub>x</sub> increases rapidly as the flame temperature rises. On the contrary, CO increases suddenly as the flame temperature falls. For this reason, if a high temperature range exists even partially as shown in Fig. 1,

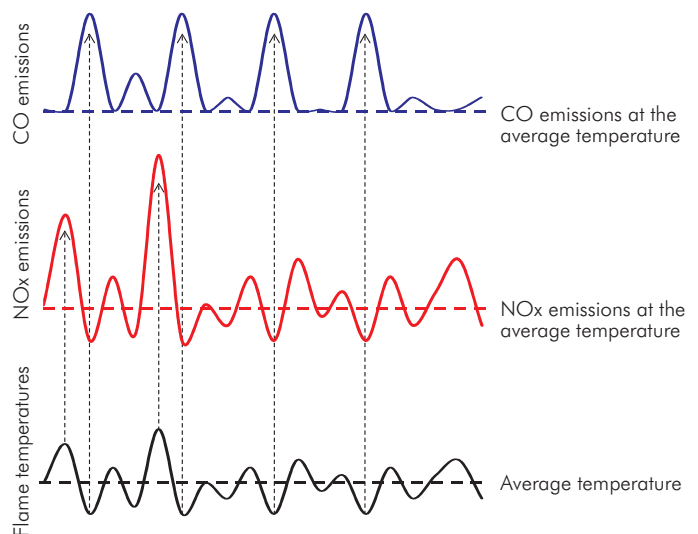

Fig. 1 Relationship between NO<sub>x</sub> and CO formations and flame temperature distribution

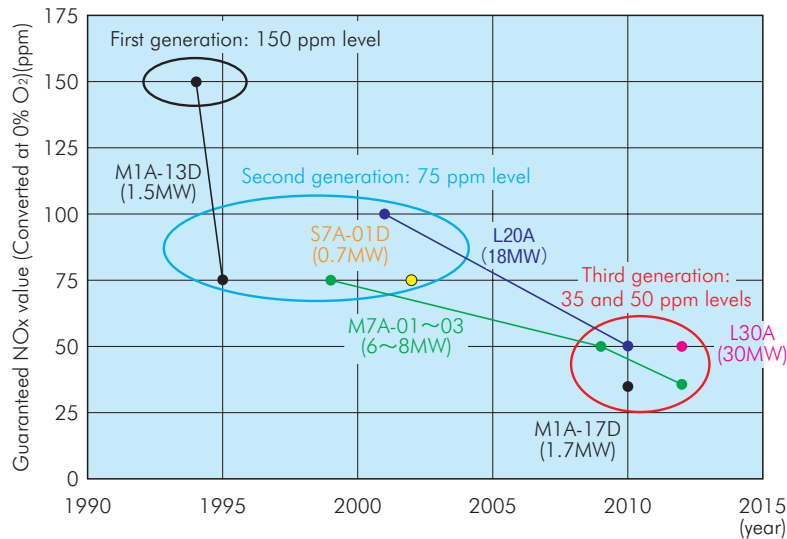

Fig. 2 History of Kawasaki DLE combustion technologies

a large quantity of NOx is produced in that range while a large quantity of CO is produced in a low temperature range, if any.

To reduce NOx, it is important to lower the average flame temperature and homogenize the fuel concentration distribution so as to smooth out the flame temperature on the one hand and to keep a balance with CO emissions on the other.

## 2 Development of low-emission combustors by Kawasaki

### (1) History of our DLE combustion technology

With gas turbine combustors, a technique of water or steam injection into a diffusion combustor was originally adopted to reduce NOx. In the 1990s, however, Dry Low Emissions (DLE) combustion technology that reduced NOx without water or steam injection was developed. We, too, developed and started commercialization of DLE combustion technology in the mid 1990s<sup>1)</sup>. We have since continued efforts to extend this technology to all models of normal-use gas turbines and lower the guaranteed NOx level. Fig. 2 shows a history of our DLE combustion technology. The first generation DLE combustion technology guaranteed NOx emissions on a 150 ppm (converted at 0% O<sub>2</sub>) level, with the guarantee lowered to the 75 ppm level by the second generation. The present DLE combustion technology is the third generation, and we guarantee a 50 or 35 ppm value, the world's top level.

### (2) Features of Kawasaki's DLE combustors

Lean premixed combustion system DLE combustors adopted by gas turbine manufacturers are capable of controlling NOx emission by controlling the flame temperature uniformly and at a low value by first mixing air and fuel, and then firing the mixture. In this system, on the other hand, the range in which fuel burns stably is limited, and, therefore, the operating range is limited from the viewpoint of compatibility with CO exhaust. With our DLE combustor, the operating range where low NOx emission is compatible with combustion stability can be extended if the combustion state of the main burner, in which lean premixed combustion is carried out, is maintained in a low NOx and stable state, and if the variation in fuel consumption by engine output is smoothed out by the amount of combustion of the supplemental burner.

Figure 3 shows a schematic diagram of our DLE combustor (M7A-03, third generation DLE combustor). Our

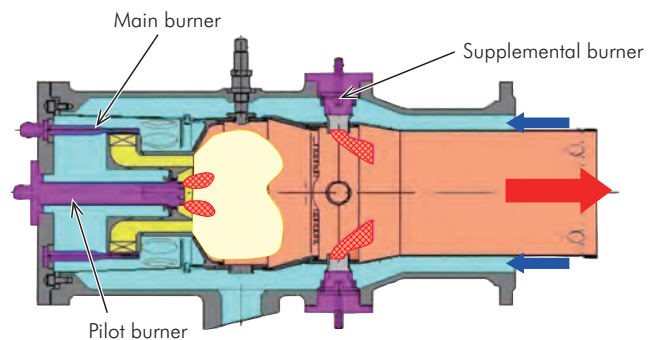

Fig. 3 Schematic diagram of third-generation DLE combustor for M7A-03



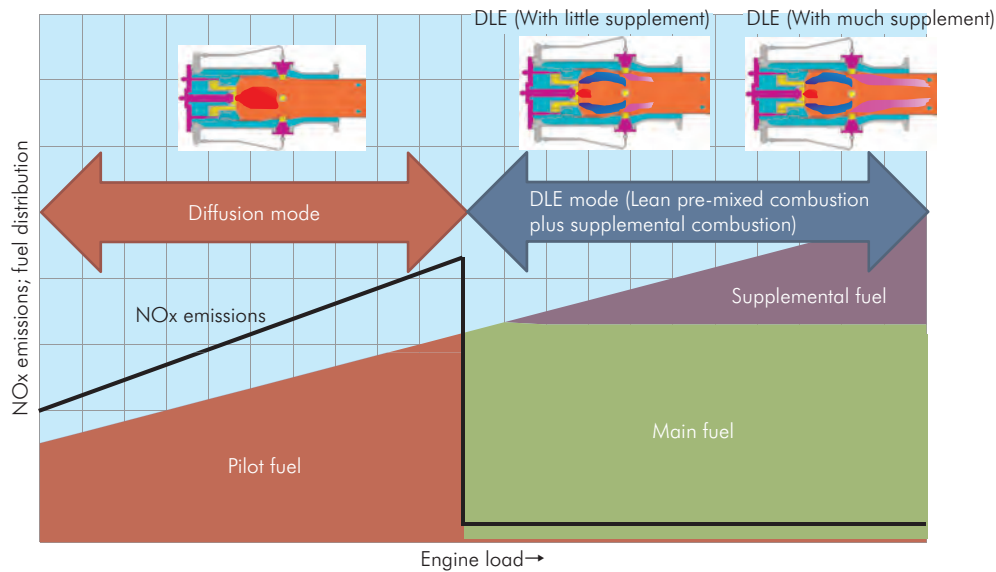

Fig. 4 Conceptual diagram of burner control and NOx emission using Kawasaki DLE combustion technology

DLE combustor is composed of a three-burner system that includes a pilot burner to be used in starting or during low loading, other than the above mentioned capabilities. Fig. 4 shows a conceptual diagram of burner control (fuel distribution control) and NOx emission.

### (3) Development of DLE combustors

In developing DLE combustors, shapes are adjusted by computational fluid dynamics (CFD) analysis, flow measurement, rig combustion tests, and similar means,

and shapes are confirmed by engine tests. If problems are found, the same process is repeated, with the optimization work being continued until the final mass-production shape is obtained.

(i) CFD analysis

To cut back NOx, it is necessary to make the fuel concentration distribution uniform. Fig. 5 shows examples from CFD-based analyses of air-fuel mixing carried out to improve the concentration distribution. Fig.5 (a) shows a second generation DLE combustor and Fig. 5 (b) a third

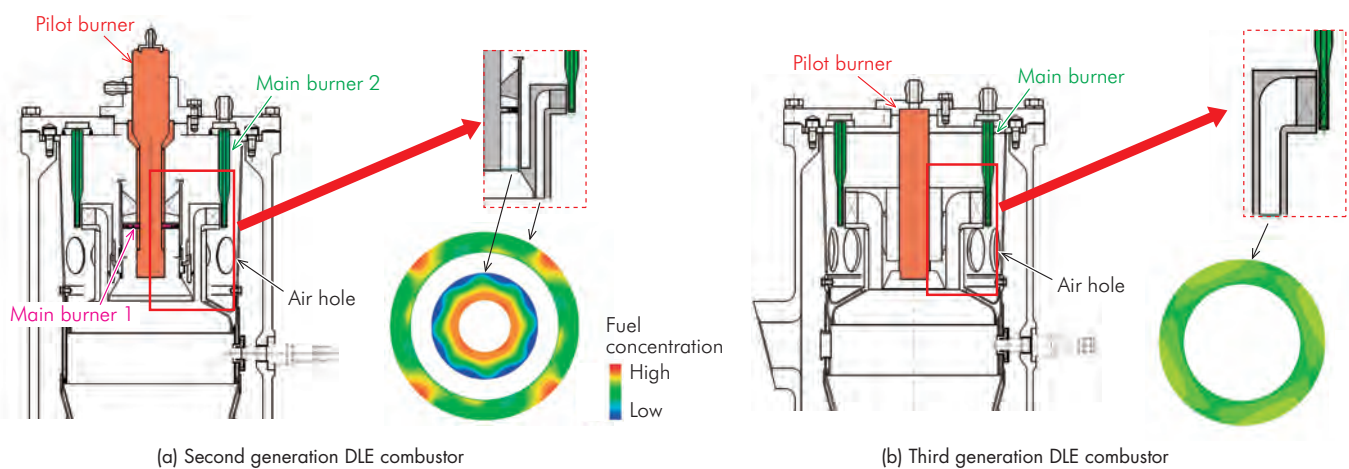

Fig. 5 Fuel concentration distribution at outlet of main burner



(a) Overall view



(b) Combustor outlet

Fig. 6 Acryl combustor for PIV measurement

generation DLE combustor. The illustration shown on the left of each figure is the cross-section of the entire main burner and pilot burner, while the illustration on the right shows the result of CFD analysis on the concentration distribution and the positions at which the concentration distribution was assessed. The illustrations show that, in the third generation DLE combustor, the optimization of the position at which the fuel is injected into the air flowing into the main burner results in a more uniform concentration distribution.

(ii) Flow measurement

As an example of a method for measuring the flow inside a

combustor, Particle Image Velocimetry (PIV) is presented here. PIV is a technique in which fine particles are added to a fluid and the velocity field of the fluid is investigated by measuring the velocity of the particles with laser light. Fig. 6 shows an acrylic combustor used in PIV measurement. In this case, measurement is made from the side while laser light is radiated from the outlet side of the combustor. Fig. 7 shows an image obtained by letting oil mist flow (fine particles) in the combustor and visualizing the flow with the Mie-Scattering scattered light from the oil mist, while Fig. 8 is a velocity vector diagram obtained by PIV measurement of the area inside the red dotted-line frame.

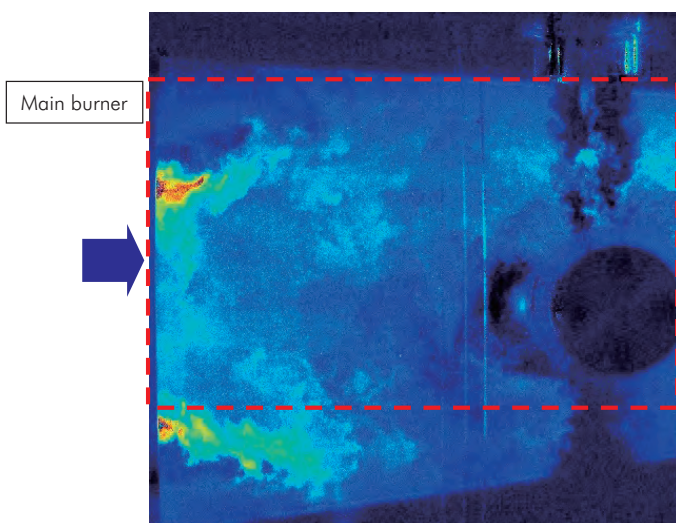

Fig. 7 Image of internal flow of combustor visualized with oil mist

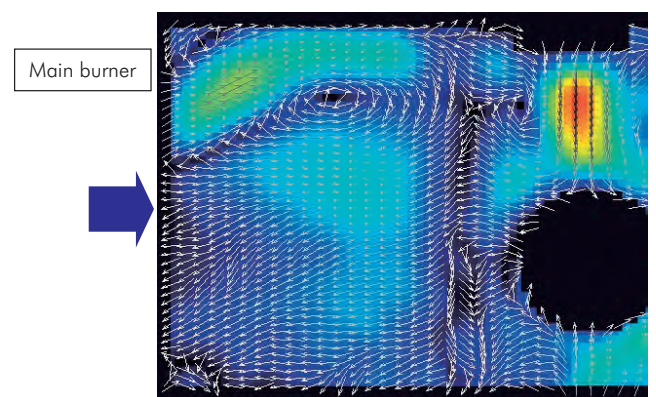

Fig. 8 Result of PIV measurement (Velocity vector)

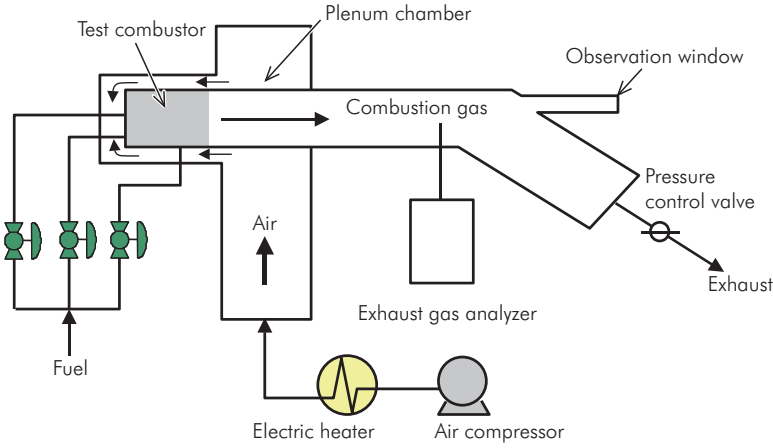

Fig. 9 System diagram of combustion test facility

### (iii) Rig combustion test

We have installed five combustion test facilities for gas turbine combustors, using different facilities for different purposes. Fig. 9 shows the system diagram of a typical combustion facility. To simulate the conditions at the inlet of the combustor of an engine, air is compressed, with its temperature raised, to specified conditions and then fed to the combustor. With its flow rate controlled in a different system, the fuel is fed into the combustor. High-temperature combustion gas generated in the combustor is cooled and then discharged into the atmosphere.

In the rig combustion test, combustion performance characteristics such as ignition performance and emission, and liner wall temperature, which is associated with the durability of the combustor, are measured and used as a basis for improving design prior to engine tests. During the test, the condition of the flame is observed constantly

through an observation window provided downstream of the combustor. Fig. 10 shows an image of a flame photographed from downstream of the combustor. Observation of the flame is an extremely important means for understanding the state of combustion. The rig combustion test allows fuel conditions and air conditions to be varied independently of each other, which in turn allows data to be obtained under a wide range of conditions. For example, carrying out an engine test under intake conditions of  $-20^{\circ}\text{C}$  or  $+50^{\circ}\text{C}$  is difficult. But, it is possible in a rig test to simulate the conditions at the combustor inlet.

### (iv) Engine test

Figure 11 shows the result of an engine test using our M7A-03 third generation DLE combustor. The illustration shows that a reduction in NOx is compatible with a reduction in CO in a load factor range of 50 to 100%.



Fig. 10 Image of flame as observed from downstream of combustor

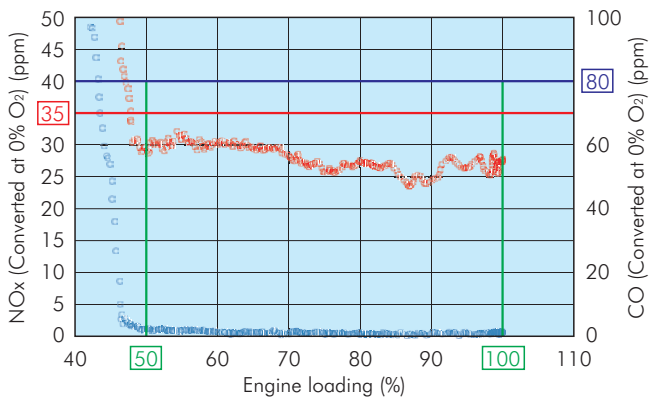

Fig. 11 NOx and CO emissions from engine



Fig. 12 Power generation plant (PUC80D) with M7A-03

### 3 Operation of a state-of-the-art third generation DLE combustion system

A demonstration facility was installed and has been operating on the premises of our works to serve the final stage of development work. As an example of installation of the third generation DLE combustion system, the power generation plant (PUC80D) with M7A-03 operated at our Akashi Works is shown in Fig.12. This combustor is operated with an NO<sub>x</sub> concentration level of 35 ppm or less (converted at 0% O<sub>2</sub>).

#### Concluding remarks

Today is characterized by stricter environmental regulations and higher awareness of environmental preservation. We will continue developing combustion technology that can materialize environmental performance of the world's highest level and offer it to the market.

#### Reference

- 1) S. Kajita, et al.: "Advanced Development of a Second-Generation Dry Low-NO<sub>x</sub> Combustor for 1.5 MW Gas Turbine," ASME 96-GT-49, 1996.



#### Takeo Oda

Technology Department,  
Engineering Center,  
Gas Turbine Division,  
Gas Turbine & Machinery Company



#### Masahiro Ogata

Industrial Gas Turbine Engineering Department,  
Engineering Center,  
Gas Turbine Division,  
Gas Turbine & Machinery Company



#### Kiyoshi Matsumoto

Industrial Gas Turbine Engineering Department,  
Engineering Center,  
Gas Turbine Division,  
Gas Turbine & Machinery Company



#### Shigeki Aoki

Industrial Gas Turbine Engineering Department,  
Engineering Center,  
Gas Turbine Division,  
Gas Turbine & Machinery Company



#### Atsushi Horikawa

Thermal System Research Department,  
Technical Institute,  
Corporate Technology Division



#### Kohshi Hirano

Thermal System Research Department,  
Technical Institute,  
Corporate Technology Division

# Lean methane- fueled gas turbine generator set



*We developed, for the first time in the world, a lean methane- fueled gas turbine generator set in which ventilation air methane (VAM) obtained during the excavation of coal is used as fuel. Aiming at the reduction of greenhouse gases through large volume treatment of unused lean methane gas, which is emitted into the atmosphere from coal mines and landfill etc. around the world, and simultaneously aiming at its effective use for power generation, we are accelerating the commercialization of this system.*

## Preface

Methane gas is one of the greenhouse gases defined in the Kyoto Protocol. Its greenhouse effect is about 21 times that of carbon dioxide (CO<sub>2</sub>), second to CO<sub>2</sub> in terms of environmental loading. In addition, approx. 6% of the total amount of discharged methane gas is emitted into the atmosphere from coal mines (Fig. 1).

Coal beds contain methane gas produced in the process of coal formation. It is released as coal is mined. Of the released methane gas, Coal Mine Methane (CMM) that contains 30% or more methane is used for power

generation and the like. But, CMM that contains 1 to 30% methane and Ventilation Air Methane (VAM) that contains less than 1% methane are discharged into the atmosphere because there are no ways to utilize them. This VAM occupies 60 to 80% of methane gas discharged in the process of mining coal, and consequently its discharge into the atmosphere constitutes not only a waste of energy but also a cause of global warming (Fig. 2).

Against this backdrop, we are engaged in the development of gas turbines that are capable of generating electricity by using lean methane gas such as VAM as fuel.

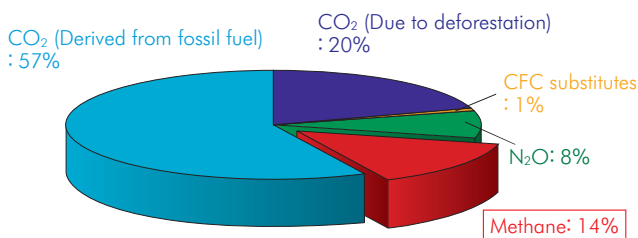

(a) Greenhouse gas emissions of entire world (CO<sub>2</sub> equivalent), 2007

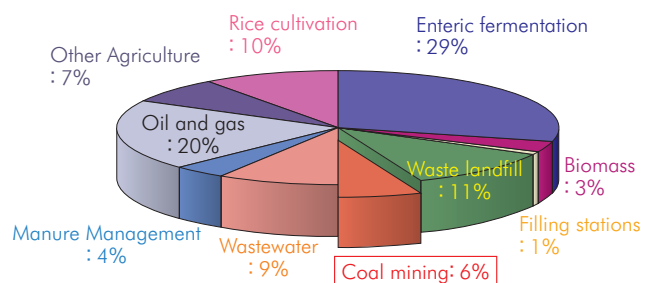

(b) Methane emission sources of entire world, 2010

Fig. 1 Greenhouse gas emissions and sources around the world

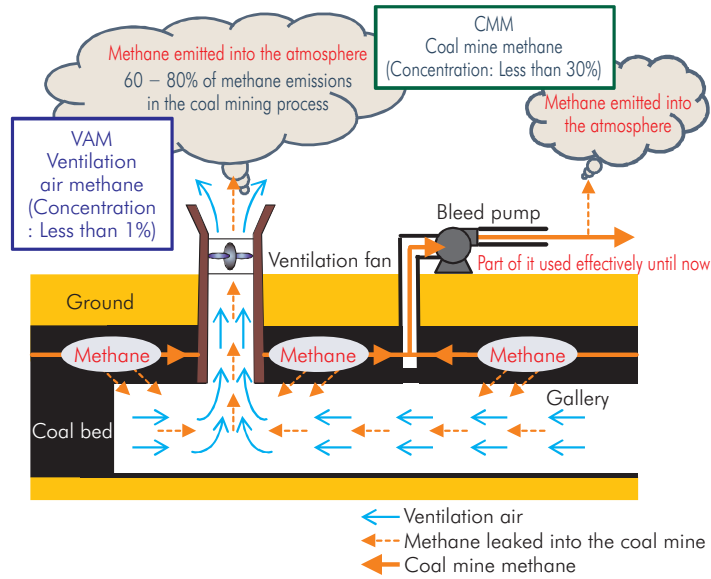

Fig. 2 Methane emitted into the atmosphere from coal mines

## 1 Unused lean methane treatment system

### (1) Concept and configuration

Figure 3 shows the concept behind the unused lean methane treatment system proposed by us<sup>1)</sup>.

Composed of a catalyst combustion-type “gas turbine

generator set” and a catalyst combustion-type “lean methane purifying unit” that operates on the waste heat from the gas turbine, this system is capable of simultaneously processing ultra-lean methane gas like VAM that cannot be processed by ordinary means, and generating power. Fig. 4 shows the system configuration and Table 1 the design performance characteristics.

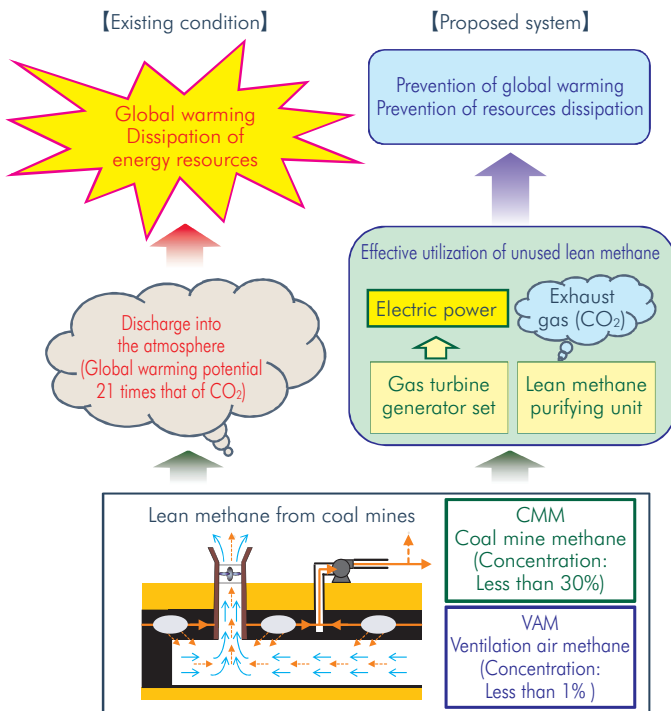

Fig. 3 Concept behind treatment system for unused lean methane

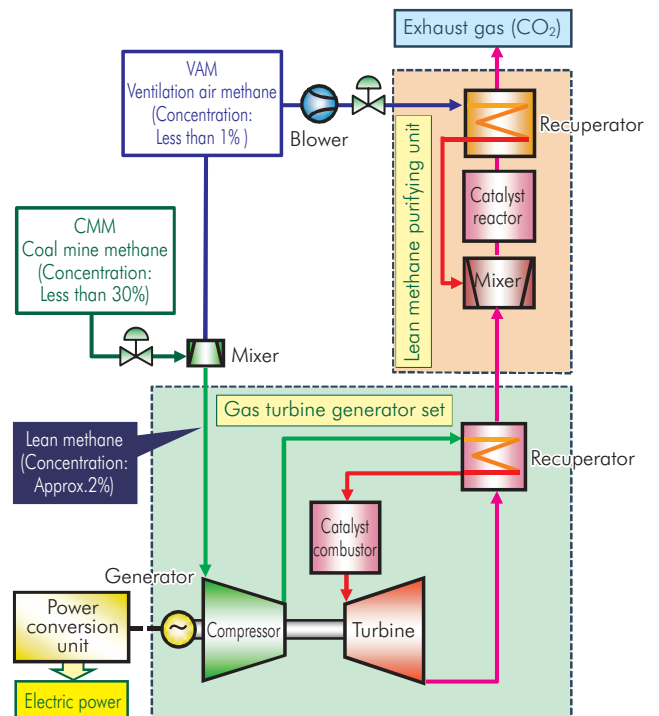

Fig. 4 Configuration of system

Table 1 Design performance of system

Generator unit	Generator end output (kW)* <sup>1)</sup>	800
	Quantity of VAM and CMM treated (Nm <sup>3</sup> /h)	22,000
	Reduction in greenhouse gas (t-CO <sub>2</sub> /year)* <sup>2)</sup> * <sup>3)</sup>	48,000
Purifying unit	Quantity of VAM treated (Nm <sup>3</sup> /h)	38,000
	Reduction in greenhouse gas (t-CO <sub>2</sub> /year)* <sup>2)</sup> * <sup>3)</sup>	20,000
Total reduction in greenhouse gas (t-CO <sub>2</sub> /year)* <sup>3)</sup>		68,000

\*<sup>1)</sup> Output under conditions of 15°C, 1 atm, and 0 m elevation

\*<sup>2)</sup> Methane concentration supposed to be 0.5% for VAM and 30% for CMM

\*<sup>3)</sup> For one-year operation at an availability factor of 97%

## (2) Principle

In the catalyst combustion “gas turbine generator set”, a mixture of a large amount of VAM that is discharged unused into the atmosphere and CMM (with a methane concentration of 2%) is drawn in as engine intake, compressed, and heated to the catalyst reaction starting temperature by a recuperator, and then is burned in the catalyst combustor. The high-temperature high-pressure gas thus obtained is used to rotate the turbine, thereby driving the generator.

The high-temperature exhaust gas from the generator set has still a high level of energy, and by using this energy, the catalyst combustion type “lean methane purifying unit” oxidizes the VAM. Through this process, greenhouse gas emissions are further reduced. The lean methane purifying unit is composed of an exhaust mixer, a catalyst reactor, and a heat exchanger. The VAM, which is supplied by means of a blower, is pre-heated by heat exchange between the heat exchanger and exhaust gas. The pre-heated VAM is mixed evenly with the exhaust gas from the generator set in the exhaust mixer and sent to the catalyst reactor, and the methane content in the gaseous mixture is oxidized by catalyst reaction. After this, the exhaust gas from the catalyst reactor is discharged into the atmosphere through the heat exchanger.

## (3) Features

The features of this system are described here.

- VAM and low-concentration CMM, for which no means of utilization has been available, can be used for power generation; this allows the consumption of good-quality fuels (natural gas, oil, and coal) to be reduced.
- This system reduces greenhouse gas emissions while generating power.
- This system does not produce nitrogen oxides (NO<sub>x</sub>).
- The use of lean methane (approx. 2%) outside the flammable range (5 – 15%) increases safety.
- The system can be finished into a compact transportable size.

## 2 Outline of the applicable technologies

Table 2 shows the equipment specifications of a gas turbine generator set. In addition, an outline of the technologies applicable to each element is given below.

### (1) Gas turbine

Forming the core of this system, the catalyst combustion gas turbine is optimized to meet the catalyst combustion and regeneration cycle specifications on the basis of the M1A-01 1,000 kW class gas turbines developed and marketed by us.

Table 2 Equipment specifications of gas turbine generator set

Section	Item	Type and specification
Gas turbine	Type	Regenerative cycle, single-shaft type
	Compressor	Two-stage centrifugal type
	Combustor	Single-can catalyst combustor
	Turbine	Three-stage axial type (All stages not cooled)
Engine equipment	Starting combustor	Single-can diffusion combustor
	Recuperator	Plate fin type
	Reduction gearbox	Two-stage planetary type
Power electronics equipment	Generator	Induction generator (Serving also as the starter)
	Power conversion unit	Inverter-Converter type

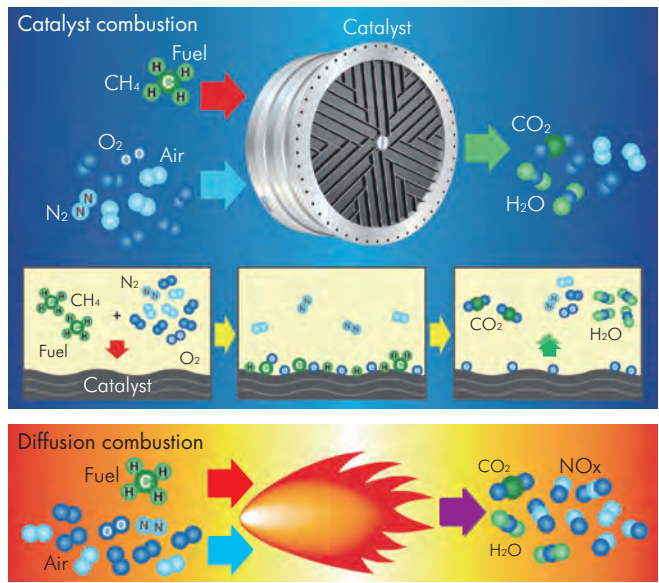

Fig. 5 Comparison between catalyst combustion and normal (diffusion) combustion

## (2) Catalyst combustor

The “catalyst combustion technology” indispensable to the system adsorbs oxygen in the air and methane into the catalyst surface and burns (oxidizing) them by means of the strong oxidizing action of the catalyst. This system allows ultra-lean methane gas, which cannot be burned in normal flame combustion, to be burned at low temperatures without generating nitrogen oxides (NO<sub>x</sub>), a cause of atmospheric pollution, at all. In contrast to this, a normal combustor not only needs a mixture gas in a flammable concentration range (5 – 15%) but also produces a large amount of NO<sub>x</sub> because the mixture gas of air and fuel burns with a flame at a high temperature. Fig. 5 shows a comparison between catalyst combustion

and normal combustion (diffusion combustion) in a conceptual illustration.

We are the world’s only manufacturer that has commercialized catalyst combustion type gas turbines, in the form of the M1A-13X ultra-low NO<sub>x</sub> gas turbines, by converting catalyst combustion technology for development (Fig. 6).

## (3) Recuperator

The recuperator requires high temperature efficiency and durability as well as a compact size. With these requirements taken into consideration, a plate fin type recuperator, which had been proven with Kawasaki’s S7A 600 kW class regenerative gas turbines, was adopted (Fig. 7).

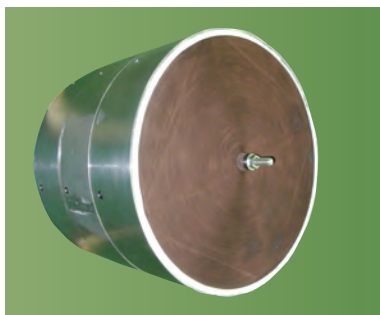

Fig. 6 Catalyst combustor core

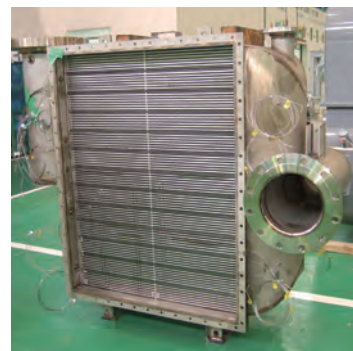

Fig. 7 Plate-fin-type recuperator



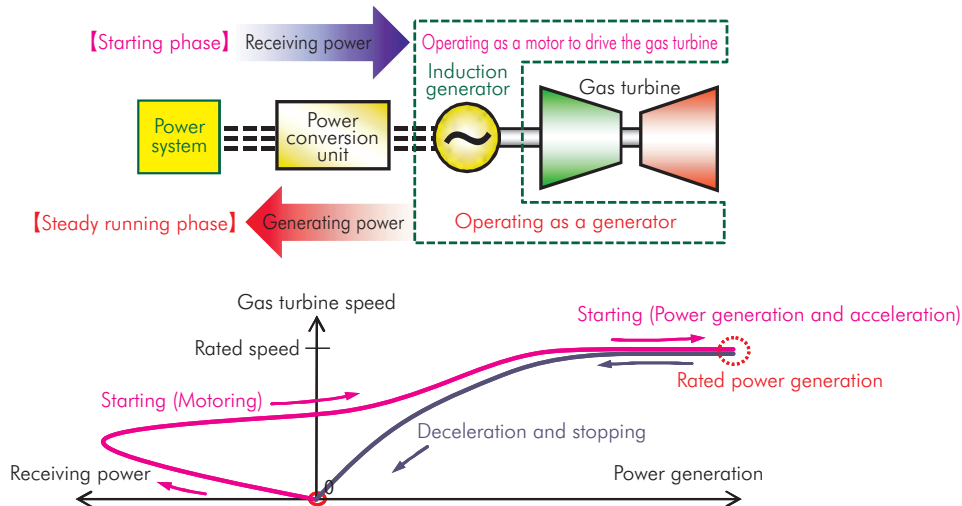

Fig. 8 Image of equipment operation in starting phase and steady running phase

#### (4) Power conversion unit

When igniting the catalyst combustor in the starting phase, this system must shift to a warming-up state and power generation at a slow gas turbine speed. For this reason, an induction generator with variable speed control using a power conversion unit developed by us is used. Fig. 8 shows a conceptual view of operation of the devices in starting phase and in steady running phase.

#### (5) Control technology

In addition to ordinary control sequences, control logic for starting and stopping and controlling methane concentration variation were newly designed. This has made it possible to materialize a system that takes into consideration stability when starting and stopping, and the protection and safety of equipment, such as the catalyst, against the variation in methane concentration in VAM and CMM.



Fig. 9 Demonstration test unit

### 3 In-house demonstration test

#### (1) Demonstration test unit

The demonstration test was conducted in-house using a demonstration test unit (Fig. 9) and a demonstration test facility (Fig. 10). With no VAM-like lean methane available in the in-house demonstration test, air was taken in and Fuel gas was injected into the mixer to simulate lean methane.

#### (2) Result of the demonstration test

The starting, loading, and other tests conducted confirmed that the system is capable of operating stably under automatic control in all stages from startup to loaded operation, and that the desired performance characteristics (reduction in greenhouse gas: 48,000 t-CO<sub>2</sub>/year; rated output: 800 kW) can be obtained. Fig. 11 shows an example of test results.

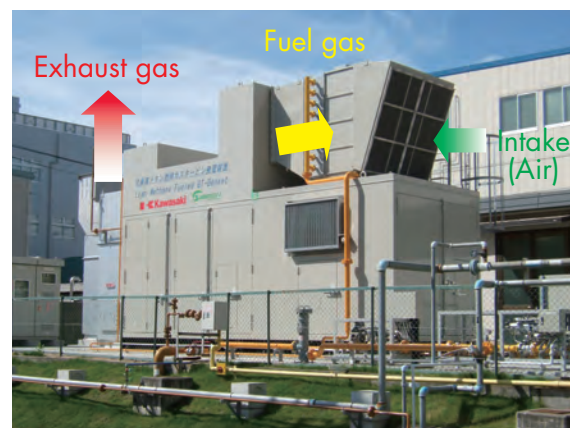

Fig. 10 Demonstration test facility

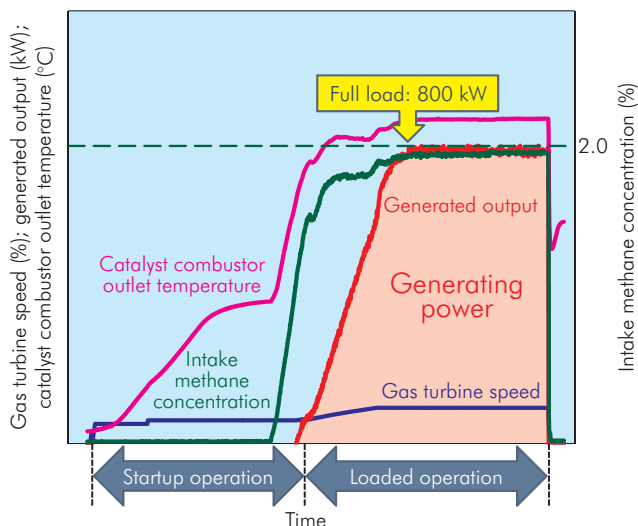

Fig. 11 Example of results of demonstration tests

## Concluding remarks

We will verify the reliability and durability of “lean methane-fueled gas turbine generator sets,” and then put them into mass-production. After this step, we plan to sell them to coal mines in Australia and China where VAM emissions are large and to waste landfill sites in the United States and other countries where lean methane gas is emitted in great amounts.

This product will aid the fight against global warming by processing lean methane gas emitted into the atmosphere (greenhouse gas) and utilizing it for power generation, thus contributing to the future of the global environment.

## Reference

- 1) Patent No. 2009258561 (PCT/JP2009/060595): Lean fuel sucking gas turbine system



### Yoshihiro Yamasaki

Industrial Gas Turbine Engineering Department,  
Engineering Center,  
Gas Turbine Division,  
Gas Turbine & Machinery Company



### Daisuke Uemura

Industrial Gas Turbine Engineering Department,  
Engineering Center,  
Gas Turbine Division,  
Gas Turbine & Machinery Company



### Yasushi Douura

Industrial Gas Turbine Engineering Department,  
Engineering Center,  
Gas Turbine Division,  
Gas Turbine & Machinery Company



### Yasufumi Hosokawa

Industrial Gas Turbine Engineering Department,  
Engineering Center,  
Gas Turbine Division,  
Gas Turbine & Machinery Company



### Katsunori Tanaka

Project Management Department,  
Industrial Gas Turbine Center,  
Gas Turbine Division,  
Gas Turbine & Machinery Company



### Tsuyoshi Satou

Project Engineering Department,  
Industrial Gas Turbine Center,  
Gas Turbine Division,  
Gas Turbine & Machinery Company



### So Kurosaka

Energy Solutions Section,  
System Technology Development Center,  
Corporate Technology Division



### Kazuya Matsuo

Electromechanical System Department,  
System Technology Development Center,  
Corporate Technology Division



### Atsushi Horikawa

Thermal System Research Department,  
Technical Institute,  
Corporate Technology Division

# 250 kW turbine generator based on organic rankine cycle with effective use of low temperature heat source — Green binary turbine



We have developed a “green binary turbine” that uses low-boiling-point alternative CFCs as the working fluid with the aim of recovering distributed waste heat that exists in unused condition (80-120°C).

After a demonstration that used a waste hot water source from a gas engine at the in-house power station of our Kobe plant, we are pushing ahead with the development of products compatible with diversified heat sources by conducting geothermal power generation verification tests jointly with Kyushu Electric Power Corporation and participating in advanced waste heat utilization projects using low-temperature steam such as waste incineration plants.

## Preface

With the aim of recovering unused waste heat (80-120°C) from distributed sources such as waste hot water from plants, power stations and city incinerators, we developed a green binary turbine as a simplified version of a Rankine cycle-based, 250 kW class, small binary generator set that uses alternative CFCs, a low-boiling-point substance, as the working fluid. Since it was installed in an in-house power station at our Kobe Works, the Kobe Power Center, the turbine has been operating smoothly. Having an overall power station efficiency of over 50% when combined with Kawasaki’s green gas engine, it exhibits unparalleled efficiency among small-scale power stations.

The small-sized binary generator set presented in this article is based on the knowledge obtained from 2 to 4 MW class binary generator sets that were developed and manufactured by us in the early 1980s with a CFC gas working fluid (CFC-11, not produced now as a result of regulations). A turbine generator integrates a turbine and a generator by means of the latest power electronics, and is downsized through the adoption of high-speed rotation. It also has perfectly seals the working fluid circuit to prevent the medium from leaking outside the system.

## 1 Overview

### (1) Main specifications

Table 1 shows the main specifications of the green binary turbine and the heat exchanger installed at the Kobe Power Center.

Table 1 Main specifications

Item	Specification
Cycle	Rankine cycle
Working fluid	Alternative CFCs
Generator terminal end output (kW)	250
Turbine type	Transverse single-stage double impeller type
Generator type	Permanent magnet three-phase AC high-frequency synchronous generator
Generator capacity (kVA)	250 (Power factor 1.0)
Rotational speed (min <sup>-1</sup> )	Approx. 9,000 (Variable speed type)
Evaporator	Falling film shell & fin tube type
(Heat source)	Inlet temperature (°C) 98* <sup>1)</sup>
Circulating hot water	Flow rate (t/h) 180* <sup>1)</sup>
Condenser type	Shell & fin tube type
(Cooling source)	Temperature (°C) 20* <sup>1)</sup>
Circulating cooling water	Flow rate (t/h) 480* <sup>1)</sup>
Reduction in CO <sub>2</sub>	Approx. 550 t-CO <sub>2</sub> /year* <sup>2)</sup>

\*<sup>1)</sup> Rated conditions: Hot water and cooling water conditions necessary for the generation of 250 kW of electric power

\*<sup>2)</sup> Generating output minus auxiliary equipment power in the package

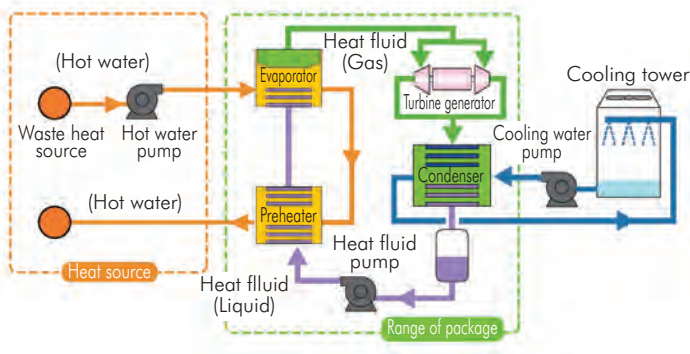

Fig. 1 Cycle composition

## (2) Cycle composition

Figure 1 shows the basic composition of the working fluid cycle. A package including a turbine generator and the medium system devices such as an evaporator and a condenser form the basic composition, with the hot water system and the cooling water system placed outside the package. Since various heat sources are available, it is necessary to design systems outside the package accordingly.

The medium first passes through the preheater in the state of a liquid and is heated, and then is changed into saturated vapor by the evaporator. After generating 250 kW of power in the turbine generator, the saturated vapor is condensed into liquid by the condenser. With no leakage of medium from the turbine generator and component equipment, a perfectly sealed cycle is materialized.

The adoption of a water cooling system on the condenser improves the cycle efficiency because the effective heat drop between the main medium vapor and the turbine exhaust is larger than in the case where an air-cooled condenser is adopted.

## 2 Features

### (1) Turbine generator

Figure 2 shows the cross-sectional profile of the turbine generator. The structure integrates the turbine and the generator and inserts a thin cylindrical can between the rotor and the stator of the generator to prevent medium leakage.

The double-flow structure, in which the impeller is attached to both ends of the generator rotor, allows an impeller of smaller diameter to be adopted than in the case of a single-flow structure, making high-speed rotation possible and thereby downsizing the generator. The direct shaft-coupling of the turbine and the generator does not necessitate the use of a reduction gear that is commonly used.

A can is adopted after testing compatibility with the medium, and pressure/running heat cycle tests to make sure that there are no problems with its strength or medium leakage.

The vapor of the medium is used to cool the generator rotor section. In common practice, a fan is attached to the shaft to cool both the rotor and the stator. In this case, however, cooling by means of an air-cooling fan cannot be provided because the rotor section is inside the can. For this reason, a blower fan is installed outside to cool just the generator stator section.

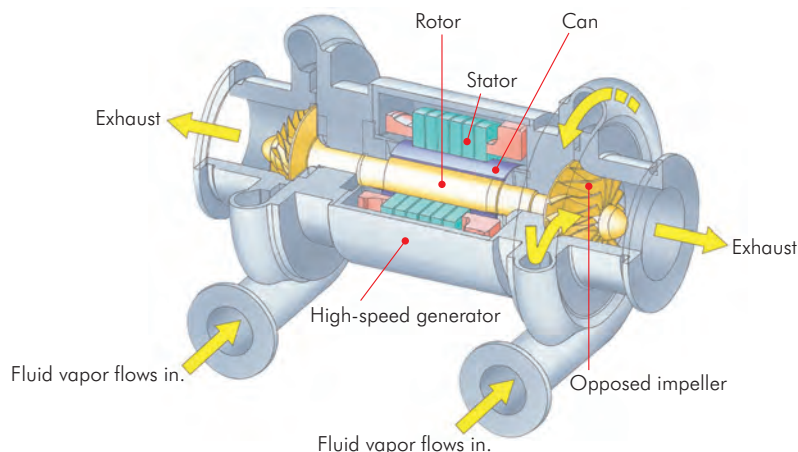

Fig. 2 Turbine cut model

The shape of the impeller and the shape of the generator cooling flow passage are optimized, through analysis based on computational fluid dynamics (CFD), to meet the characteristic of the medium employed.

## (2) Heat exchanger

Adopting a falling film evaporator eliminates the necessity of filling the barrel side of the evaporator with medium so as to immerse the entire tube bank, minimizing the inventory of relatively expensive medium. We successfully developed the falling film evaporator and made it relatively compact by applying absorption chiller technology owned by a group company and by fully grasping the characteristics of heat transfer in evaporation through heat transfer analysis.

The condenser adopts an array of cooling tubes and structure proven in past 2 to 4 MW class binary generator sets.

## (3) Medium

Having been assessed comprehensively in terms of environment-friendliness, safety, thermophysical properties, ease of handling, availability, regulations, and similar factors, alternative CFCs were selected. They are excellent in environment-friendliness (ozone depletion potential: 0; global warming potential: relatively low), free of toxicity and corrosiveness, and non-flammable, have smaller latent/sensible heat ratios, and are liquid at normal temperatures and atmospheric pressure.

## (4) Electric system and control system

Figure 3 shows the configuration of the electrical and control systems.

The binary control panel consists of a converter that turns AC power of a frequency of approx. 450 Hz from the generator into DC and controls the generator rotational speed, an inverter for system interconnection that turns DC into AC of the frequency of the power system, functions for monitoring, controlling, and protecting the entire facility and a control unit for internally controlling the automatic start/stop sequence. In addition, the panel is integrated with the operating system.

Moreover, the panel supports input and output exchanges with remote monitoring equipment and a host computer.

## (5) Partial load characteristics

In a binary generator set, the temperature of the heat source is low and cooling is provided at a level equal to the ambient temperature, which leaves little range for using temperature differential. When the air temperature is high as in summer, the difference in temperature is even smaller and the turbine exhaust pressure rises, resulting in considerable deviation from the design point. In such case, operating the system at the rated rotational speed (approx. 9,000 min<sup>-1</sup>) causes the turbine efficiency to lower considerably. However, thanks to the capability of the power conversion unit that controls the rotational speed of the turbine generator independent of the power system

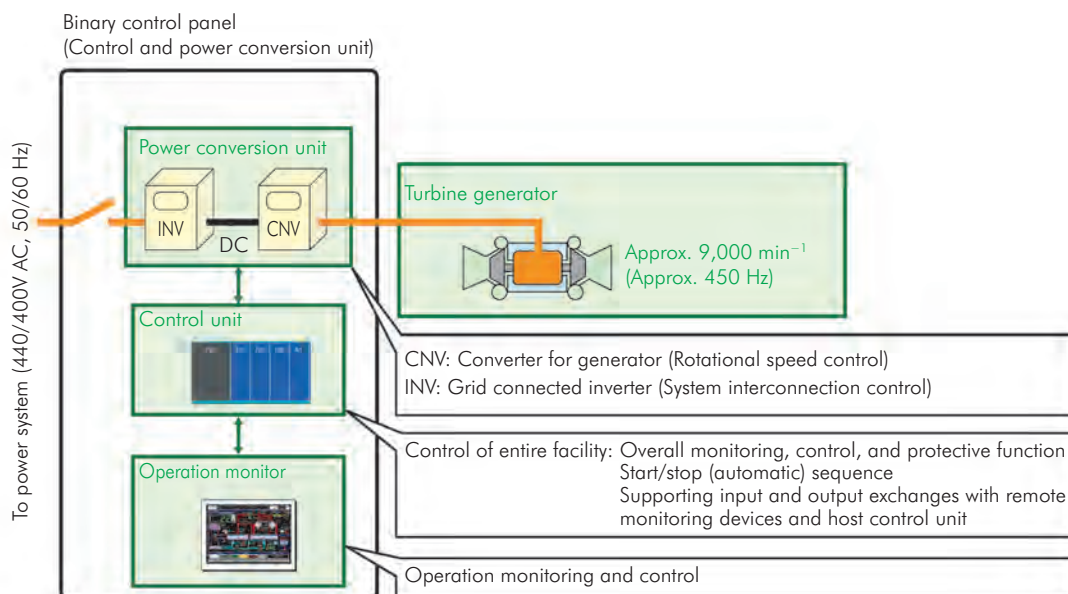

Fig. 3 Diagram of electric and control systems

frequency, it is possible to operate the generator at a high partial loading efficiency by lowering the rotational speed to approx. 7,000 min<sup>-1</sup>.

### 3 Examples of applications

#### (1) Application to gas engines

Figure 4 shows the binary organic Rankine cycle combined with the green gas engine, KG-12-V 5000 kW, at Kawasaki's Kobe Power Center, and Fig. 5 an example layout of the above.

The temperature at the hot water outlet after heat has been used in the evaporator and preheater is adjusted to the temperature of the cooling water supplied to the jacket of the gas engine. Using the jacket cooling heat and exhaust gas heat from the gas engine, hot water of a

temperature of 98°C and a flow rate of 180 t/h is obtained to generate 250 kW of electric power (at the generator end).

The green gas engine has achieved the world's highest efficiency of 49% in standalone operation, and when combined with the green binary turbine, has achieved an overall power station efficiency of over 50%.

#### (2) Application to geothermal power generation

Although this unit was developed as a generator set that uses a low-temperature heat source, we are engaged in verification tests of a geothermal small-scale binary generator set in cooperation with Kyushu Electric Power Co., Inc. with the aim of confirming the applicability of this system to geothermal power generation utilizing renewable energy.

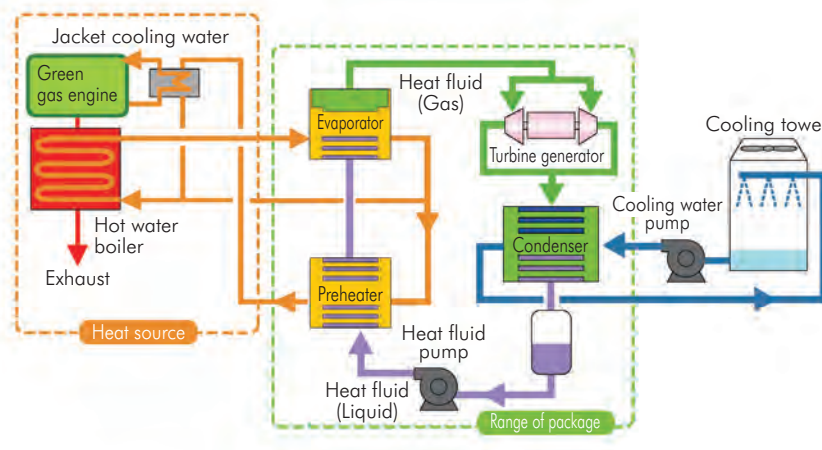

Fig. 4 Composition of binary cycle at Kobe Power Center

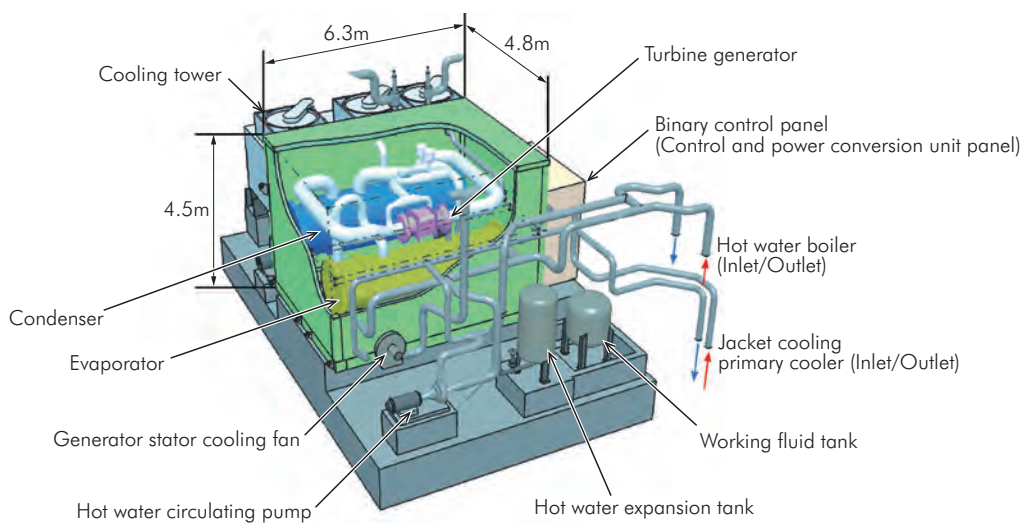

Fig. 5 Example of layout and configuration

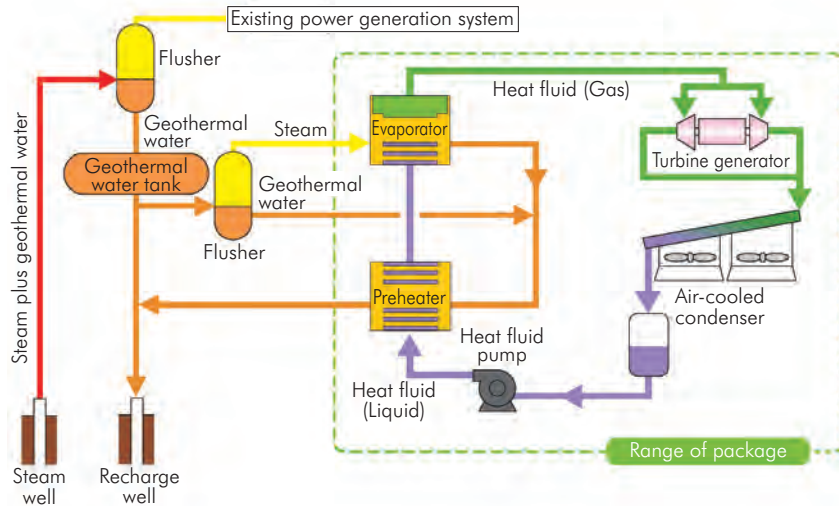

Fig. 6 Composition of cycle in verification test for small-scale geothermal binary power generation

Figure 6 shows the cycle composition of the verification test facility. With conventional geothermal power generation based on steam turbines, only steam is used for power generation although steam and hot water are erupted from the steam well. In this verification test, part of the hot water to be returned to the recharge well is used for binary power generation.

This facility will be installed at the Yamagawa Geothermal Power Station in Ibusuki City, Kagoshima Prefecture, Japan. This facility will be used to assess technologies for heat recovery from geothermal fluid, measures to prevent the growth of scale, measures to prevent corrosion, facility performance, cost effectiveness, and other items by the end of fiscal 2013.

### (3) Utilization of waste heat from a city incinerator

The city incinerator of the Environment Bureau of Osaka City produces steam by using the heat generated in garbage incineration, and effectively uses it for power generation, hot water supply and space heating in the plant. The “project for advanced utilization of urban waste heat from city incinerators, etc.” a joint demonstration project involving Osaka Gas Co., Ltd., Osaka City, Osaka Prefecture, and Kawasaki, has selected the Taisho Plant as the site for verification tests. The aim of the project is to achieve a 25% improvement in the overall energy efficiency by binary power generation, transport unused heat to the nearby community by a heat storage transfer system, and utilize the power generation and delivery of unused heat via an energy management system (EMS).

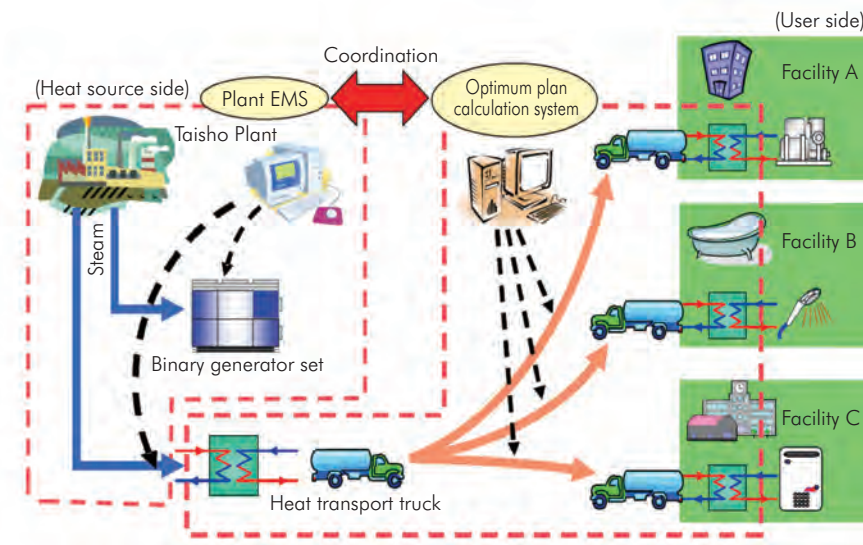

Fig. 7 System configuration for “Waste Heat Utilization from City Incinerators, Etc.” project

Figure 7 shows the configuration of the overall system of the project. As the major facilities and systems, a binary generator set and a plant energy management system (EMS) will be provided by Kawasaki and a heat storage transfer system by Osaka Gas Co., Ltd.

① Binary generator set

The heat source is the exhaust heat from the steam turbine installed at the plant. In the past, the temperature was too low to be used for power generation, but power generation has been made possible by using a binary generator set that is capable of using low-temperature heat effectively.

② Heat storage transfer system

The system is capable of storing heat from garbage incineration in a heat storage tank, from which heat can be transferred and supplied to users in the community.

③ Plant energy management system (EMS)

This system optimizes the heat distribution between its conversion from incineration into electricity (power generation) and straight-up use (heat transport) according to how heat is used in the nearby community.

According to the plan of the project, practical operation will be started after trial-runs in fiscal 2012. Technological verifications will be continued up to the end of fiscal 2013.

## Concluding remarks

The green binary turbine was developed as a power generation unit to recover heat from dispersed unused low-temperature heat sources, such as exhaust gas, exhaust steam, waste hot water, and geothermal hot water. A number of visitors have come to the Kobe Power Center, where the first unit is installed, making the authors realize that this product is anticipated as an energy-saving appliance.

But when compared with existing generator sets and other energy-saving appliances, the profitability of this product for the customer is still lower because of the utilization of low-temperature heat.

On the other hand, we believe, the application of the feed-in tariff system (FIT), intended for renewable energy, to geothermal power generation will improve the profitability and the accumulation of track records in geothermal power generation through the joint research with Kyushu Electric Power Co., Inc. will build on the momentum for the widespread use of this product in the field of geothermal power generation.

We will widen the application of this product to various dispersed low-temperature waste heat sources and develop the present product into one that will meet needs of a wide variety of users.



**Kazuhiko Mizoguchi**

Turbine Department,  
Machinery Division,  
Gas Turbine & Machinery Company



**Hajime Shimizu**

Turbine Department,  
Machinery Division,  
Gas Turbine & Machinery Company



**Hirokazu Suzuki**

Turbine Department,  
Machinery Division,  
Gas Turbine & Machinery Company



**Naoki Miyake**

Turbine Department,  
Machinery Division,  
Gas Turbine & Machinery Company



**Yuko Konno**

Turbine Department,  
Machinery Division,  
Gas Turbine & Machinery Company



**Seiji Yamashita**

Thermal System Research Department,  
Technical Institute,  
Corporate Technology Division



**Masahi Sawada**

Electromechanical System Department,  
System Technology Development Center,  
Corporate Technology Division



# Kawasaki-MAN 48/60 4-stroke diesel engine for stationary power generating plant



*In 2011, we delivered land-use generator sets to the Ishigaki Daini Power Station of the Okinawa Electric Power Company. The facility is composed of a new model Kawasaki-MAN 18V48/60 diesel engine as the main engine, which boasts an output of 18 MW, the first ever in Japan and ranking one of the world's largest. (The largest output in Japan in the past was 10 MW.) The facility is in operation and performing well.*

*This paper introduces the Kawasaki-MAN 48/46 diesel engine.*

## Preface

Since 1955 when its first emergency power generation set was delivered to Kawasaki Steel Corporation (currently JFE Steel Corporation), we have been delivering diesel generator sets for normal and emergency uses for about 60 years. The total number of diesel generator sets delivered is 111, with a total output amounting to 226.1 MW. In the past 20 years or so, we have delivered 10 land-use diesel generator sets to Japan's electric power utilities.

The current market of reciprocal engine generator sets demands higher output, higher efficiency, and higher environmental performance, with gas engine generator sets of low environment loading attracting attention. However, isolated islands where infrastructure for gas facilities has not been developed still need diesel power generation.

In 2011, we delivered to the Okinawa Electric Power Company a land-use power generation set powered by a new type of diesel engine, which is also of the world's

largest class with a power generation output of 18 MW, in the Kawasaki-MAN 18V48/60.

The 18V48/60 are highly reliable engines with which MAN has registered a solid track record. By constantly raising engine performance, MAN has responded to the market requirements of high efficiency and high environment performance.

Table 1 shows the major characteristics of the Kawasaki-MAN 48/60 diesel engines.

## 1 Construction

Figure 1 shows an outline of the Kawasaki-MAN 48/60 diesel engines.

Air supply is pressurized in an axial flow turbine type exhaust gas turbocharger, passes through the A train and B train air coolers (controlled to the optimum air supply temperature through two-stage cooling of warm water and

Table 1 Main specifications

Type	In-Line	Vee		
Number of cylinders	9	12	14	18
Engine output (kW)	9,450	12,600	14,700	18,900
Number of revolutions (min <sup>-1</sup> )	500/514			
Frequency (Hz)	50/60			
Cylinder diameter/stroke (mm)	480/600			
Heat rate (kJ/kWh)*	7,558	7,473		
(Thermal efficiency) (%)	(47.6)	(48.2)		

\* Heat rate under the following conditions:  
 ( • ISO3046/1-2002 conditions      • Without engine driven pump )  
 ( • Exhaust emission: WB2007/2008      • Tolerance: +5% )  
 ( • Engine end )

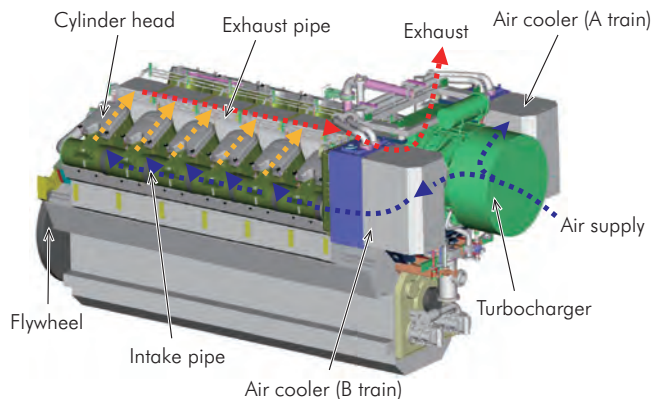

Fig. 1 Outline of the Kawasaki-MAN 48/60 diesel engine

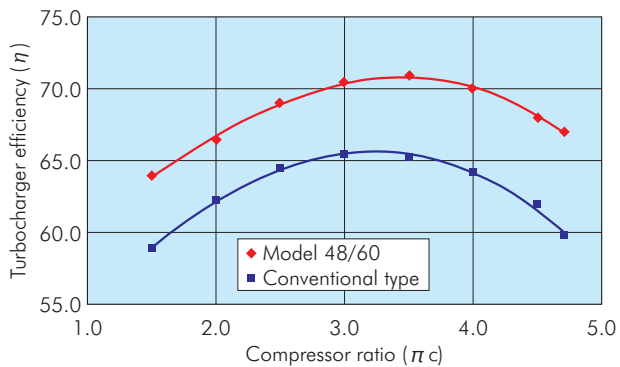

Fig. 2 Turbocharger efficiency

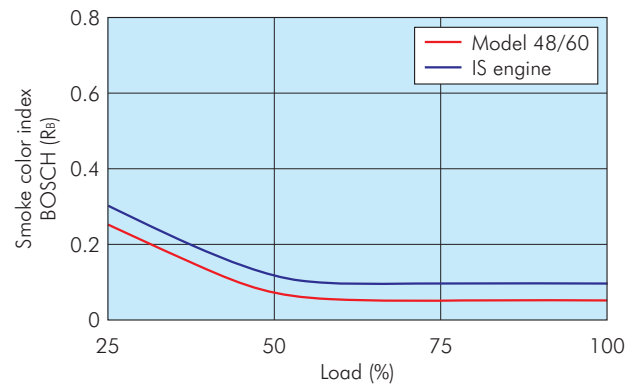

Fig. 3 Smoke index

cold water), and are supplied to individual cylinders. The fuel oil, injected into the cylinder combustion chamber at high pressure under the control of the electric speed governor, is diffused and burned in the combustion chamber. The exhaust gas from the fuel is discharged into a single exhaust pipe, passes through the turbocharger turbine chamber, and is discharged into the atmosphere.

The main features of the component parts of the Vee are as follows.

(i) Cylinder head

The shape of the intake duct and exhaust duct have been optimized and the combustion surface smoothed to improve air flow, which improves the mixture of fuel and air, and the combustion efficiency, and reduces fuel residue.

(ii) Fuel injection system

With the aim of improving combustion conditions, the fuel injection timing has been optimized and the maximum fuel injection pressure increased from the conventional value of 80 MPa to 160 MPa.

(iii) Turbocharger

A high-efficiency large-scale turbocharger has replaced two turbochargers used on conventional models. Fig. 2 compares efficiency against a conventional turbocharger.

## 2 Features

This engine is provided with the following features owing to an optimized design.

(i) Higher output

In terms of the average effective pressure used in comparing per-cylinder output values, this engine exhibits a 47% higher output than conventional 10 MW class engines, achieving the target of an increase in output. An increase in output accompanies an increase in cylinder internal pressure, however the optimized design of the cylinder head ensures safety and reliability.

(ii) Higher efficiency

The optimized design of the combustion chamber, fuel injection and turbocharger has made it possible to increase

the thermal efficiency of this engine to 48.2% from the 45.5% of conventional 10 MW class engines.

(iii) Improvement in smoke

The improvement in combustion conditions and the installation of a high-efficiency turbocharger have resulted in an improvement in smoke. Fig. 3 shows the smoke color index for smoke from engines.

When the smoke color index is  $0.3R_b$  (Bosch index) or smaller, the smoke reflects good exhaust emissions that cannot be confirmed visually. MAN-type engines have shown satisfactory exhaust emissions under 25% or higher loading as Invisible Smoke (IS) engines; the engine presented here exhibits a further improvement in this respect. In addition, intake air temperature control raises the intake air temperature under low loading, reducing black smoke that accompanies low loading operation.

(iv) Easy maintenance and servicing workability

The cylinder head, intake pipe, and control lever casing are assembled in an integrated structure on each cylinder, while a spherical bearing of a new structure is adopted in the control lever device. Both measures contribute to a reduction in servicing time.

## Postscript

The future will bring a variety of needs such as further enhanced efficiency and fuel diversification. To respond to such needs, we will make an effort to improve MAN-type engines and contribute to society through the supply of diesel power generation of higher efficiency and less environmental loading.

Seiichi Ohsaki / Michio Fukushima

### Contact information

Power Generation Project Department,  
Machinery Division,  
Gas Turbine & Machinery Company  
Tel: +81-78-682-5344 Fax: +81-78-682-5530

# Diverse applications of industrial steam turbines



*Unlike fossil-fired plants, some power generation facilities using steam turbines, like those using biomass or waste heat recovery, are low in environmental load. And, some others that use exhaust steam from steam turbines or extract steam from intermediate stages for use in plants are intended to improve the total energy efficiency of entire plants. Including geothermal power generation that has attracted attention recently, steam turbines are utilized in various power generation facilities.*

## Preface

Steam turbines are important facilities that have been used as prime movers for power generating facilities the world over since long ago.

Steam turbines used for power generation are classified roughly into those for utility use and those for industrial use as in-house power generation at plants.

One of the features of industrial steam turbines is an infinite variety of specification requirements. Although steam turbines are custom-made, we design and make them with our own technologies, and the flexibility shown to such requirements has been highly evaluated.

In addition, a steam turbine can be used with any kind of heat source that generates steam; it can even use exhaust steam. And, it can be used with a variety of plants, though the turbine is destined for a generic-sounding power generation purpose. The following paper gives some characteristic examples of use of steam turbines.

## 1 For thermal power plants

The most basic system for driving a steam turbine is to use steam generated by heat obtained by burning fuel. Fig. 1 shows, as a typical example a flow diagram.

Steam produced in the boiler drives the steam turbine, turns into water in the condenser, and is fed to the boiler again. In this process, the higher the exhaust vacuum of the steam turbine is (the lower the exhaust pressure is), the higher the generated output is. However, the heat taken away by the cooling water in the condenser for this purpose is dumped. To address this problem, steam is extracted from an intermediate stage and used to preheat water supplied to the boiler, thereby increasing the heat

efficiency of the entire plant.

In industrial steam turbines, extracted steam is not only used to preheat boiler feed water but is also used in processes to manufacture products.

And it is possible, not to reduce the exhaust pressure of the steam turbine to a vacuum but to discharge steam at high pressure and temperature for use as is and in its entirety. We offer steam turbines that meet individual needs for electricity or heat (in the form of steam), thereby contributing to high-efficiency utilization of energy.

Furthermore, fuels to be burned to produce steam are not limited to fossil fuels. Steam turbines are extensively applied to plants that burn wood chips used tires, and bagasse, attracting attention from the viewpoint of biomass power generation that reduces loading on the environment.

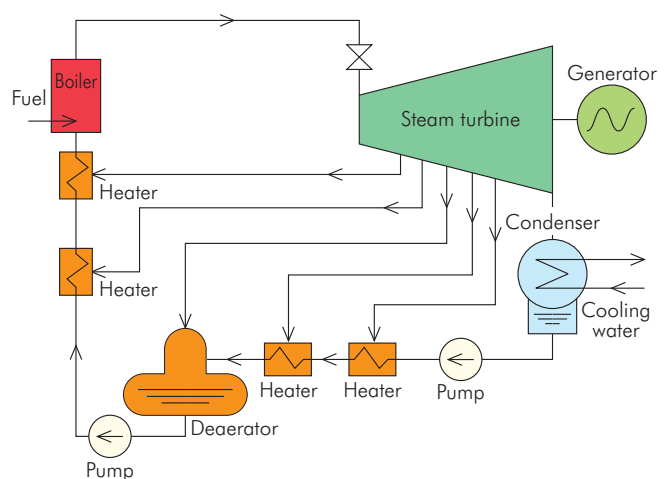

Fig. 1 Flow diagram of thermal power plant

## 2 For waste heat recovery power plants

A method of driving a steam turbine without burning fuel is available in which waste heat from a plant is used to produce steam. This method needs no fuel to generate electricity, thus is advantageous both in terms of reducing environmental loading and cost-effectiveness.

Major examples of this kind of application are steam turbine generator sets that use heat produced in coke dry quenching facilities or cement firing facilities.

Some systems characterized by steam turbine generator sets utilize relatively low temperature heat in the intermediate stages of the steam turbines (induction steam) for power generation purposes. Fig. 2 shows an example of the flow diagram. In addition to the main steam taken from the inlet, relatively low temperature heat is recovered from two stages for use in power generation and to effectively use energy.

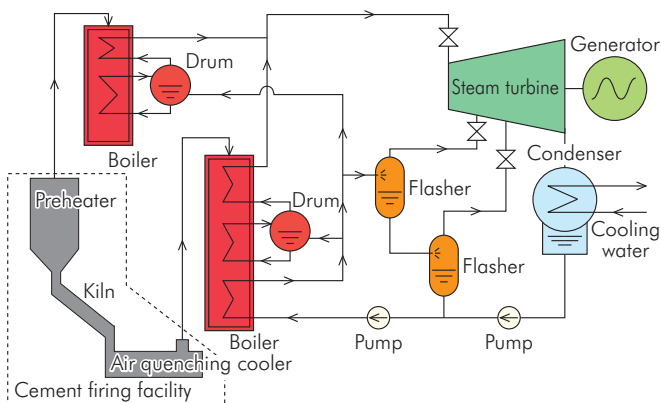

Fig. 2 Flow diagram of waste heat recovery power plant



Fig. 3 Geothermal power generation facility

## 3 For geothermal power plants

One of power generation systems attracting attention these days is geothermal power generation. Fig. 3 shows the appearance of a geothermal power generation facility. A geothermal power generation facility produces electric power by using steam or hot water heated by geothermal heat to drive a steam turbine. The major differences from common steam turbine generator sets are the use of saturated vapor of relatively low pressure and the poor quality of steam.

The use of low-pressure steam necessitates a steam turbine with a large structure compared with its output, while the use of saturated vapor necessitates measures against erosion that starts from the turbine inlet. In common steam turbines, steam from water of controlled quality is used, but in geothermal power generation, steam gushing from the ground is used without any treatment, which requires measures specific to geothermal power generation such as consideration for acid resistance.

Having accumulated knowledge through after-sales servicing in addition to the experience of implementing various measures before shipment since the delivery of the first unit in 1975, we are confident that we can contribute to the widespread use of geothermal power generation.

### Postscript

We have a lineup of products developed from the company's history of designing and manufacturing steam turbines, such as top pressure recovery turbines that use the pressure of blast furnace gas and binary power generating turbines that use hot springs or waste gas/hot water of relatively low temperature from plants. They all contribute to a reduction in environment load.

We believe it our mission to continue making proposals for products that meet the needs of individual customers, and deliver products of high reliability.

Takumi Kirimura

#### Contact information

Solution Sales Center,  
Energy Solution Division,  
Gas Turbine & Machinery Company  
Tel: +81-3-3435-2267 Fax: +81-3-3435-2022

# Gas turbine cogeneration system for supercomputer “K”



*We have introduced a 6 MW class gas turbine cogeneration system, as part of the electrical facilities for the “K” at the RIKEN Advanced Institute for Computational Science. It is our first experience to apply a cogeneration system to protect power supplies at a data-processing center. In this article, we report the features of this combined heat and power.*

## Preface

The “K” supercomputer was ranked No. 1 amongst the world’s top 500 supercomputers in June and November 2011. We delivered a combined heat and power (CHP), consisting of two 6 MW class gas turbines, as part of the electrical facility for the “K.”

The CHP introduced into the “K” facility not only serves the purpose of reducing contracted demand by means of peak shaving and energy-saving but also protects the power supply to the supercomputer. This is the first time that we have applied a CHP for the purpose of protecting the power supply of a data-processing center.

In this article, we report our contribution to the power supply of the “K” via the power supply protection system for the “K” and the energy-saving measure.

## 1 Overview of the CHP unit

Figure 1 shows the appearance of the CHP unit. It is made up of two 6 MW class gas turbines and two heat recovery steam generators (HRSG), with city gas 13A used as the fuel. The generator is connected to important loads such as the hard disk device of the “K” and laboratory loads, being operated constantly with utility power supply in a system interconnection configuration. These loads are protected against service interruptions and instantaneous voltage drops. In addition, gas turbine exhaust gas is used to produce chilled water for the computer by means of a steam absorption chiller.

## 2 Features

### (1) Power supply protection system

The system of measures that protect the “K” facilities against service interruptions and instantaneous voltage drops (called “measures against instantaneous voltage drop” in the following) is aimed at the protection of important domains such as large-scale storage units that store the results of computation and research buildings for which the protection of research data is needed.

A commonly practiced measure against instantaneous voltage drop for facilities such as a data-processing center is a storage-battery-based UPS unit. In the case of this facility, however, the power requirement for the important domains to be covered was estimated to be 6,500 kW, therefore a storage-battery-based UPS facility posed problems in an increase in initial costs, the need to acquire an installation site, and an increase in the maintenance expenses. To protect file servers, which are important devices, from instantaneous voltage drops, it is necessary



Fig. 1 Appearance of CHP unit

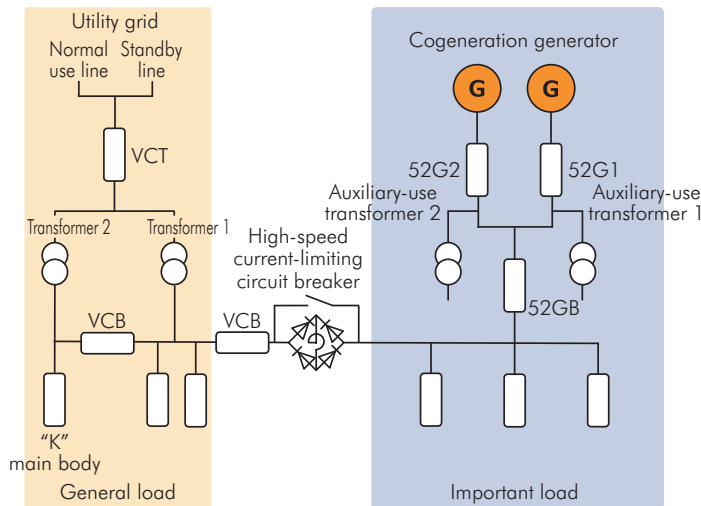

Fig. 2 Schematic diagram of protective measures against instantaneous voltage drops

to maintain the voltage of the generator bus within 80% should an instantaneous voltage drop occur and to complete cut-off from the power system within 20 ms. In response to this necessity, a system of measures against an instantaneous voltage drop incorporating a high-speed current-limiting circuit breaker was devised. Fig. 2 shows the diagram of the system configuration.

In comparison with existing measures, this system allows important units such as file servers to be protected while containing the installation and maintenance expenses for the backup power supply and reducing the installation space.

## (2) Introduction of energy-saving technology for an eco-supercomputer facility

One of concepts for the facilities of the "K" supercomputer is an "eco-supercomputer." Kawasaki's CHP uses a power generation system consisting of gas turbines and steam absorption chillers that runs on gas turbine exhaust gas, thus contributing to a reduction in environmental load from the computer system and facilities in the building in which the supercomputer is installed. Fig. 3 shows the flow from the heat source.

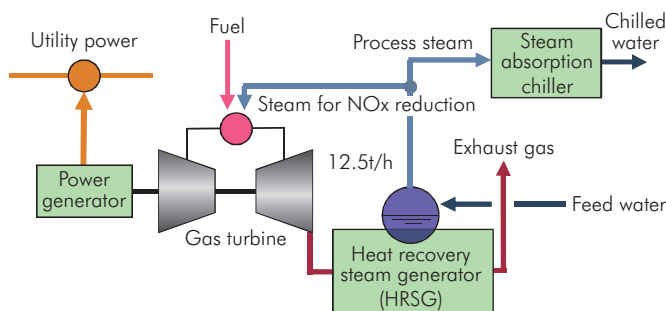

Fig. 3 Facility flow of CHP

## (3) Operating track record

### (i) Operating track record

The CHP has a power generation efficiency of approx. 30%, a heat recovery efficiency of approx. 45%, and an overall efficiency of approx. 75%, thus operating efficiently in compliance with computer loading.

### (ii) Power Usage Efficiency

Power Usage Efficiency (PUE) is a criterion by which to assess the energy conservation capability of an entire computer processing center.

$$PUE = \frac{\text{Energy consumption in entire building}}{\text{Energy consumption of computer}}$$

This definition shows that the closer to 1 that PUE is, the smaller the electricity consumed by the building facilities, excluding the computer. In other words, the better the energy conservation of the facility is.

The "PUE target values to be attained in 2011," made public by the U.S. Environment Protection Agency, are 1.7 for the standard value, 1.3 for the best value to be attained, and 1.2 for epoch-making technology.

According to the track record obtained with the "K" supercomputer to date, the system has operated at a value of approx. 1.3, the best value to be attained, because the CHP has been running very efficiently.

## Postscript

Kawasaki's CHP introduced into the facilities of the "K" has proven that it adds, to the advantages of existing CHPs, new advantages such as the elimination of expenses for the installation of backup power supplies and a reduction in installation space. With these points evaluated highly, the electrical facilities for the "K" were awarded an Institute of Electrical Installation Engineers of Japan Promotion Prize (for facilities, technical fields.) (The prize was jointly awarded to the RIKEN Advanced Institute for Computer Science, Nikken Sekkei Ltd., Kinden Corporation, Kyudenko Corporation, and Sanki Engineering Co., Ltd.)

As a final note, the authors sincerely thank the RIKEN Advanced Institute for Computer Science and those who provided us with cooperation in a variety of ways in the task of delivering this facility.

Daisuke Tomofuji / Masahiro Kogasaka

### Contact information

Project Management Department,  
Industrial Gas Turbine Center,  
Gas Turbine Division,  
Gas Turbine & Machinery Company  
Tel: +81-78-921-5184 Fax: +81-78-921-5196

# Hybrid type absorption chiller, Sigma Ace Gene-Link 1.43 series (TZJ)



Waste heat utilization is attracting attention as technology that can contribute to saving energy, reducing CO<sub>2</sub> emissions and protecting global environment. We developed our first waste heat utilization type absorption chiller in 1959. We developed the first hybrid type absorption chiller named the Gene Link in 1998, and since then we have been enjoying a good reputation from the market. A hybrid type absorption chiller can operate with waste hot water alone at partial cooling load, and is equipped with fuel combustion equipment as a backup of waste heat. We newly developed a hybrid type absorption chiller (TZJ model) that can reduce fuel consumption rate by 8% compared with conventional models.

## Preface

Currently, social demand is increasing for a reduction of CO<sub>2</sub> emissions as a preventive measure to global warming. A hybrid type absorption chiller can utilize waste heat such as hot water from combined heat and power (CHP) and operate without fossil fuels at partial cooling load.

As a result, the chiller can contribute substantially to reductions in fuel consumption and CO<sub>2</sub> emissions.

The TZJ combines our unique technology of a fuel-fired type chiller and a waste heat utilization type chiller.

## 1 Overview

Table 1 shows the main specifications of the TZJ and Fig. 1 shows its cycle flow in cooling operation.

The TZJ realizes high energy-saving efficiency by adding waste heat recovery technology to a fuel-fired absorption chiller "Sigma Ace 1.43 Series" (TZG).

Three major gas supply companies in Japan approved the TZJ as a Green Type Absorption Chiller which represents high efficiency partial load characteristics and reduction of environmental load.

## 2 Features

### (1) 30 % reduction in fuel consumption in rated operation

In order to improve efficiency in not only rated operation but also partial load operation, we adopted high efficiency heat transfer tube to evaporator, absorber and condenser, and we optimized solution circulation. As a result, in the

case of rated operation with hot inlet water, a 30% energy reduction can be realized by the TZJ compared with operation without hot inlet water.

### (2) High efficiency partial load characteristics

The TZJ is equipped with an inverter control system for each solution pump in order to optimize solution circulation and improve efficiency at partial load.

Cooling operation with hot inlet water alone can be realized up to a 50% cooling load by optimum solution circulation.

### (3) Various gas engines can be combined to the TZJ

The heat recovery rate of the TZJ is 20% more than that of conventional models. The TZJ is adaptable to various types

Table 1 Main specifications

Item		TZJ
COP (Cooling mode) (LHV)	Operation with hot inlet water	2.06
	Operation without hot inlet water	1.43
COP (Heating mode)	(Operation without hot inlet water)	0.86
Chilled water	Inlet/Outlet temperature (°C)	15.0 → 7.0
	Flow rate (m <sup>3</sup> /h·RT)	0.378
Cooling water	Inlet/Outlet temperature (°C)	32.0 → 37.6
	Flow rate (m <sup>3</sup> /h·RT)	1.00
Waste hot water	Inlet/Outlet temperature (°C)	90.0 → 80.0
	Flow rate (m <sup>3</sup> /h·RT)	0.115
Energy reduction rate in rated operation with hot inlet water (%)		30
Maximum cooling load with hot inlet water alone (%)		50

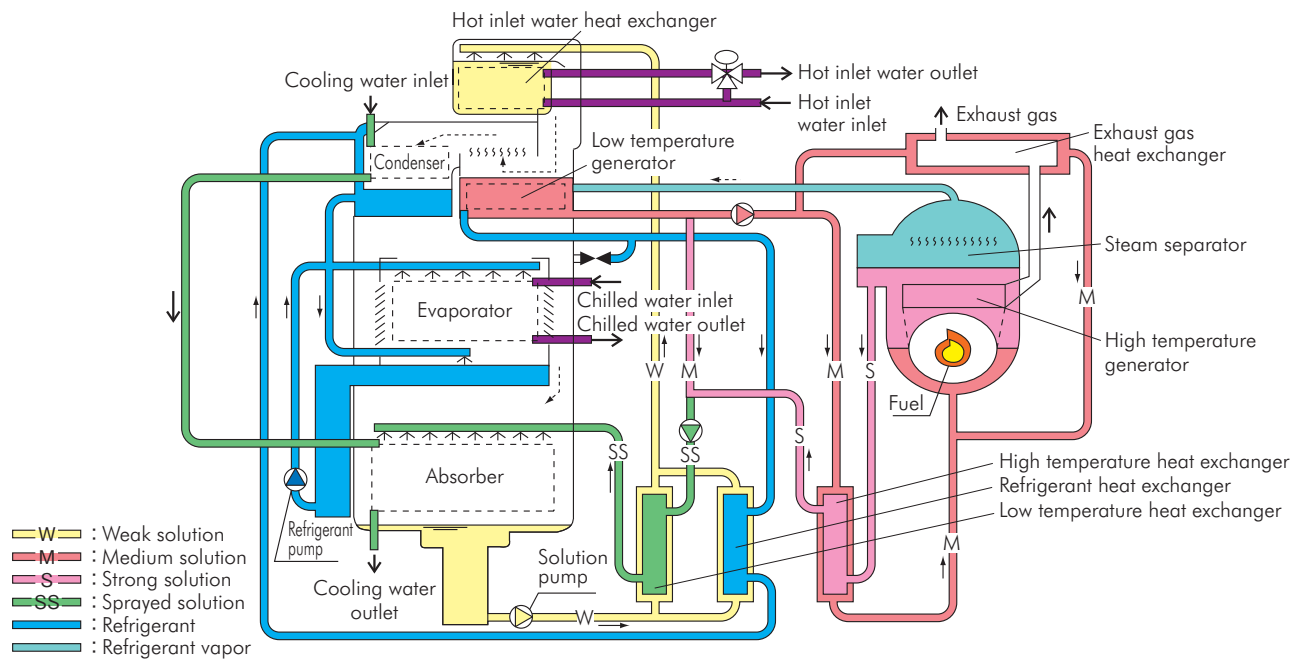

Fig. 1 Cycle flow (Cooling)

of gas engines unlike conventional models. For example, it has become possible to select the most appropriate model even for a CHP system where power demand is bigger than cooling demand.

## Postscript

Currently, CHP projects are increasing in Japan in response to the needs for distributed power supply. The TZJ has many special features as mentioned in section 2 above and is suitable for CHP systems.

We newly developed a flagship chiller named Efficio to succeed to our main brand Sigma Ace. We release Efficio (Fig. 2) to Japanese market from April, 2013 and to overseas market in the latter part of 2014. Direct-fired type of Efficio has three best characteristic:

- COP at rated operation
- IPLV (Integrated Part Load Volume)
- System efficiency, i.e. total energy consumption as an air conditioning system is most effective in double effect absorption chillers.

In particular, COP at rated operation is the world's highest value of 1.51 in double effect direct-fired absorption chillers. Direct-fired type of Efficio has three products lineup, NZ model (COP 1.51, LHV), NU model (1.39) and NE model (1.33) and cooling capacity range of three models is from 80RT to 1000RT. NZ model is the highest COP machine and NU model is the highest IPLV machine of double effect absorption chillers in the world.

We release direct-fired type first. Waste heat recovery type such as hybrid chiller and steam-driven type will

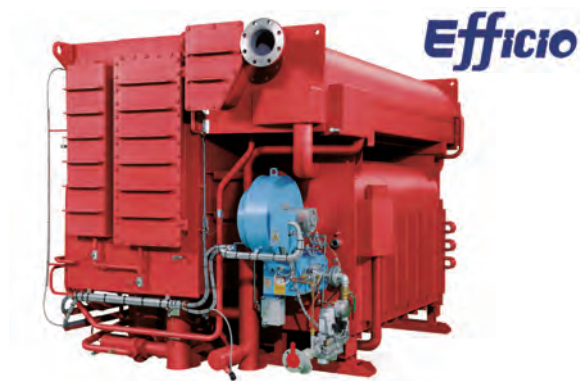

Fig. 2 Overview of Efficio

follow based on unique technology of direct-fired type.

Finally, we are convinced that all of our products will contribute to energy-saving and the global environment. We will focus our efforts on the development of highly efficient and highly reliable absorption chillers.

**Daisuke Tanaka**

### Contact information

Chiller-Heater Engineering Department,  
Engineering Office,  
Kawasaki Thermal Engineering Co., Ltd.  
Tel: +81-77-564-4111 Fax: +81-77-564-4353



# Kawasaki Heavy Industries Group

## Main Products and Production Bases by Business Segment

Business Segment	Main Products	Main Production Bases
Ship & Offshore structure	<ul style="list-style-type: none"> <li>LNG carriers, LPG carriers, crude oil carriers, bulk carriers, container ships, car carriers, high-speed vessels, submarines, ships for government and municipal offices, offshore structures</li> </ul>	Kobe Works (Kobe) Sakaide Works (Sakaide, Kagawa Prefecture) Nantong COSCO KHI Ship Engineering Co., Ltd. (China)* Dalian COSCO KHI Ship Engineering Co., Ltd. (China)*
Rolling Stock	<ul style="list-style-type: none"> <li>Train cars, integrated transit systems, monorail cars, platform screen door systems</li> <li>GigaceII™ (nickel metal-hydride battery)</li> </ul>	Hyogo Works (Kobe) Harima Works (Harima-cho, Hyogo Prefecture) Kawasaki Motors Manufacturing Corp., U.S.A. (U.S.A.) Kawasaki Rail Car, Inc. (U.S.A.)
	<ul style="list-style-type: none"> <li>Rotary snowplows, dual mode vehicles (DMV)</li> <li>Rail cars, heavy lift cars</li> </ul>	Nichijo Manufacturing Co., Ltd. Head Office (Main Plant) (Sapporo, Hokkaido) Nichijo Manufacturing Co., Ltd. Akebono Plant (Sapporo, Hokkaido)
Aerospace	<ul style="list-style-type: none"> <li>Aircraft (fixed-wing aircraft and helicopters), missiles, electronic equipment, space systems and peripheral equipment, simulators</li> </ul>	Gifu Works (Kakamigahara, Gifu Prefecture) Nagoya Works 1 (Yatomi, Aichi Prefecture) Nagoya Works 2 (Tobishima-mura, Aichi Prefecture)
	<ul style="list-style-type: none"> <li>Aircraft components, rocket components, space equipment, target systems</li> <li>Aircraft servicing, remodeling</li> </ul>	NIPPI Corporation Aerospace Division (Yokohama) and Aircraft Maintenance Division (Yamato, Kanagawa Prefecture)
Gas Turbines & Machinery	<ul style="list-style-type: none"> <li>Gas turbine engines for aircraft and ships, peripheral equipment</li> <li>Gas turbine generators, gas turbine cogeneration systems</li> </ul>	Akashi Works (Akashi, Hyogo Prefecture) Seishin Works (Kobe)
	<ul style="list-style-type: none"> <li>Steam turbines for ground and maritime applications, diesel engines, gas engines, large decelerators</li> <li>Marine propulsion systems (side thrusters, steerable thrusters)</li> <li>Natural gas compression modules, air blowers and other aerodynamic machinery</li> </ul>	Kobe Works (Kobe) Harima Works (Harima-cho, Hyogo Prefecture) Wuhan Kawasaki Marine Machinery Co., Ltd. (China)
	<ul style="list-style-type: none"> <li>Air conditioning equipment, general-purpose boilers</li> </ul>	Kawasaki Thermal Engineering Co., Ltd. Shiga Works (Kusatsu, Shiga Prefecture)
Plant & Infrastructure Engineering	<ul style="list-style-type: none"> <li>Cement, chemical, conveyers, and other industrial plant systems</li> <li>Flue gas desulphurization and denitrification plants</li> <li>Industrial boilers for land and marine use</li> <li>Waste treatment facility</li> <li>LNG tank and other storage facilities</li> <li>Shield machines, tunnel boring machines</li> </ul>	Harima Works (Harima-cho, Hyogo Prefecture) Shanghai COSCO Kawasaki Heavy Industries Steel Structure Co., Ltd. (China)* Anhui Conch Kawasaki Equipment Manufacturing Co., Ltd. (China)* Anhui Conch Kawasaki Energy Conservation Equipment Manufacturing Co., Ltd. (China)*
	<ul style="list-style-type: none"> <li>Crushers, processing equipment for recycling</li> </ul>	EarthTechnica Co., Ltd. Yachiyo Works (Yachiyo, Chiba Prefecture)
Motorcycle & Engine	<ul style="list-style-type: none"> <li>Motorcycles, ATVs (all-terrain vehicles), utility vehicles, Jet Ski® watercraft</li> <li>General-purpose gasoline engines</li> </ul>	Akashi Works (Akashi, Hyogo Prefecture) Kakogawa Works (Kakogawa, Hyogo Prefecture) Kawasaki Motors Manufacturing Corp., U.S.A. (U.S.A.) Kawasaki Motores do Brasil Ltda. (Brazil) Kawasaki Motors Enterprise (Thailand) Co., Ltd. (Thailand) Kawasaki Motors (Phils.) Corporation (Philippines) P.T. Kawasaki Motor Indonesia (Indonesia) Changzhou Kawasaki and Kwang Yang Engine Co., Ltd. (China)*
Precision Machinery	<ul style="list-style-type: none"> <li>Hydraulic equipment for construction machines, hydraulic equipment and systems for industrial machines</li> <li>Marine application machines, deck cranes and other marine deck equipment</li> <li>Industrial robots</li> </ul>	Akashi Works (Akashi, Hyogo Prefecture) Nishi-Kobe Works (Kobe) Kawasaki Precision Machinery (U.K.) Ltd. (U.K.) Kawasaki Precision Machinery (Suzhou) Ltd. (China) Flutek, Ltd. (Korea)
Other	<ul style="list-style-type: none"> <li>Wheel loaders, snowdozers, load haul dumps, concrete paving equipment, and other construction machinery</li> </ul>	KCM Corporation(Main Plant) (Inami-cho, Hyogo Prefecture) KCMA Corporation (U.S.A.)

\*Affiliated company-equity method

---

## Domestic Offices, Works & Technical Units

---

### Kawasaki Heavy Industries, Ltd.

#### Tokyo Head Office

1-14-5, Kaigan, Minato-ku,  
Tokyo 105-8315, Japan  
Phone: 81-3-3435-2111 Fax: 81-3-3436-3037

#### Kobe Head Office

Kobe Crystal Tower, 1-3, Higashikawasaki-cho 1-chome, Chuo-ku, Kobe,  
Hyogo 650-8680, Japan  
Phone: 81-78-371-9530 Fax: 81-78-371-9568

#### Corporate Technology Division

1-1, Kawasaki-cho, Akashi, Hyogo 673-8666, Japan  
Phone: 81-78-921-1611 Fax: 81-78-921-1867

#### Sapporo Office

8-3 Square Kita Bldg., 32, Kitahachijo-nishi 3-chome, Kita-ku, Sapporo,  
Hokkaido 060-0808, Japan  
Phone: 81-11-727-3131 Fax: 81-11-727-3132

#### Sendai Office

Tokyo Tatemono Sendai Bldg., 6-35, Chuo 1-chome, Aoba-ku, Sendai,  
Miyagi 980-0021, Japan  
Phone: 81-22-261-3611 Fax: 81-22-265-2736

#### Nagoya Office

JR Central Towers, 1-4, Meieki 1-chome, Nakamura-ku, Nagoya, Aichi  
450-6041, Japan  
Phone: 81-52-388-2211 Fax: 81-52-388-2210

#### Osaka Office

Furukawa Osaka Bldg., 1-29, Dojimahama 2-chome, Kita-ku, Osaka City,  
Osaka 530-0004, Japan  
Phone: 81-6-6344-1271 Fax: 81-6-6348-8289

#### Hiroshima Office

12F, Hiroshima Business Tower Bldg., 3-33, Hacchobori, Naka-ku,  
Hiroshima City, Hiroshima 730-0013, Japan  
Phone: 81-82-222-3668 Fax: 81-82-222-2229

#### Fukuoka Office

Hakata-ekimae Daiichi Seimei Bldg., 4-1, Hakataekimae 1-chome,  
Hakata-ku, Fukuoka City, Fukuoka 812-0011, Japan  
Phone: 81-92-432-9550 Fax: 81-92-432-9566

#### Okinawa Office

Kokuba Bldg., 21-1, Kumoji 3-chome, Naha, Okinawa 900-0015, Japan  
Phone: 81-98-867-0252 Fax: 81-98-864-2606

#### Gifu Works

1, Kawasaki-cho, Kakamigahara, Gifu 504-8710, Japan  
Phone: 81-58-382-5712 Fax: 81-58-382-2981

#### Nagoya Works 1

11, Kusunoki 3-chome, Yatomi, Aichi 498-0066, Japan  
Phone: 81-567-68-5117 Fax: 81-567-68-5090

#### Nagoya Works 2

7-4, Kanaoka, Tobishima-mura, Ama-gun, Aichi 490-1445, Japan  
Phone: 81-567-55-0800 Fax: 81-567-55-0803

#### Kobe Works

1-1, Higashikawasaki-cho 3-chome, Chuo-ku, Kobe, Hyogo 650-8670, Japan  
Phone: 81-78-682-5001 Fax: 81-78-682-5503

#### Hyogo Works

1-18, Wadayama-dori 2-chome, Hyogo-ku, Kobe, Hyogo 652-0884, Japan  
Phone: 81-78-682-3111 Fax: 81-78-671-5784

#### Seishin Works

8-1, Takatsukadai 2-chome, Nishi-ku, Kobe, Hyogo 651-2271, Japan  
Phone: 81-78-992-1911 Fax: 81-78-992-1910

#### Nishi-Kobe Works

234, Matsumoto, Hasetani-cho, Nishi-ku, Kobe, Hyogo 651-2239, Japan  
Phone: 81-78-991-1133 Fax: 81-78-991-3186

#### Akashi Works

1-1, Kawasaki-cho, Akashi, Hyogo 673-8666, Japan  
Phone: 81-78-921-1301 Fax: 81-78-924-8654

#### Kakogawa Works

170, Yamanoue Mukohara, Hiraoka-cho, Kakogawa, Hyogo 675-0112,  
Japan  
Phone: 81-79-427-0292 Fax: 81-79-427-0556

#### Harima Works

8, Niijima, Harima-cho, Kako-gun, Hyogo 675-0155, Japan  
Phone: 81-79-435-2131 Fax: 81-79-435-2132

#### Sakaide Works

1, Kawasaki-cho, Sakaide, Kagawa 762-8507, Japan  
Phone: 81-877-46-1473 Fax: 81-877-46-7006

---

## Overseas Offices

---

#### Beijing Office

Room No.2602, China World Tower 1, China World Trade Center, No.1,  
Jian Guo Men Wai Avenue, Beijing 100004, People's Republic of China  
Phone: 86-10-6505-1350 Fax: 86-10-6505-1351

#### Taipei Office

15th Floor, Fu-Key Bldg., 99 Jen-Ai Road, Section 2, Taipei, Taiwan  
Phone: 886-2-2322-1752 Fax: 886-2-2322-5009

#### Delhi Office

5th Floor, Meridien Commercial Tower, 8 Windsor Place, Janpath,  
New Delhi, 100 001, India  
Phone: 91-11-4358-3531 Fax: 91-11-4358-3532

#### Moscow Office

Office 1206, Entrance 3, Krasnopresnenskaya nab. 12, 123610,  
Moscow, Russian Federation  
Phone: 7-495-258-2115 Fax: 7-495-258-2116

---

## Overseas Affiliated Companies

---

#### Kawasaki Heavy Industries (U.S.A.), Inc.

60 East 42nd Street, Suite 2501, New York, NY 10165, U.S.A.  
Phone: 1-212-759-4950 Fax: 1-212-759-6421

#### Kawasaki Heavy Industries (U.S.A.), Inc. Houston Branch

333 Clay Street, Suite 4310, Houston, TX 77002-4109, U.S.A.  
Phone: 1-713-654-8981 Fax: 1-713-654-8187

#### Kawasaki do Brasil Indústria e Comércio Ltda.

Avenida Paulista, 542-6 Andar, Bela Vista, 01310-000, São Paulo, S.P., Brazil  
Phone: 55-11-3289-2388 Fax: 55-11-3289-2788

#### Kawasaki Heavy Industries (U.K.) Ltd.

4th Floor, 3 St. Helen's Place, London EC3A 6AB, U.K.  
Phone: 44-20-7588-5222 Fax: 44-20-7588-5333

#### Kawasaki Heavy Industries Management (Shanghai), Ltd.

10th Floor, Chong Hing Finance Center, 288 Nanjing Road West,  
Huangpu District, Shanghai 200003, People's Republic of China  
Phone: 86-21-3366-3100 Fax: 86-21-3366-3108

#### Kawasaki Heavy Industries (Singapore) Pte. Ltd.

6 Battery Road, #23-01, Singapore 049909  
Phone: 65-6225-5133~4 Fax: 65-6224-9029

#### Kawasaki Heavy Industries Middle East FZE

Dubai Airport Free Zone, Bldg. 6W, Block-A, Office No.709,  
P.O. Box 54878, Dubai, U.A.E.  
Phone: 971-4-214-6730 Fax: 971-4-214-6729

## **Kawasaki Technical Review No.173**

July 2013

---

**Edited and Published by :** Corporate Technology Division, Kawasaki Heavy Industries, Ltd.  
1-1, Kawasaki-cho, Akashi, Hyogo 673-8666, Japan  
URL: [www.khi.co.jp](http://www.khi.co.jp)

**Publisher :** Minoru Makimura, Senior Vice President  
General Manager, Corporate Technology Division

**Chief editor :** Eiichi Harada, General Manager, Corporate Technology Planning Center  
Corporate Technology Division

**Designed and Printed by :** SEIKODO CO., LTD.  
4-12, Tenma 3-chome, Kita-ku, Osaka City, Osaka 530-0043, Japan  
URL: [www.seikodo-kk.co.jp](http://www.seikodo-kk.co.jp)

---

**Copyright © 2013 Kawasaki Heavy Industries, Ltd.**

All right reserved. No part of this publication may be reproduced, stored in retrieval system or transmitted, in any form or by any means, electronic, mechanical, photocopying, recording, or otherwise, without permission in writing from the publisher.



**Kawasaki Heavy Industries, Ltd.**

[www.khi.co.jp](http://www.khi.co.jp)

