

Anatomy of facial nerve

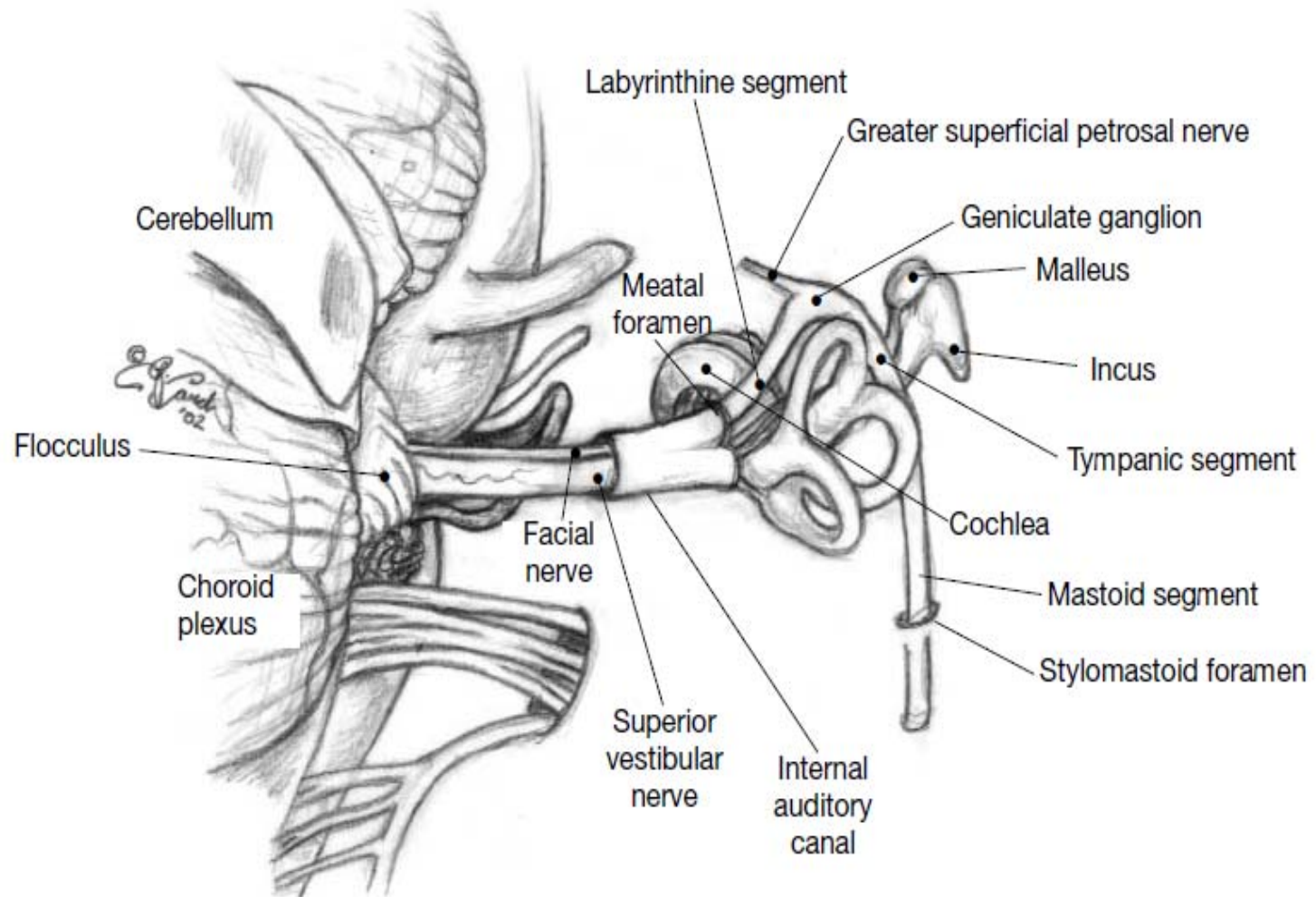

Embryology of the facial nerve

Weeks 0-4

- 3rd wk : facioacoustic (acousticofacial) primordium
- 4th wk : chorda tympani nerve exits rostrally and courses ventrally to the first pharyngeal pouch to enter the mandibular arch

Weeks 5-6

- The greater superficial petrosal nerve (GSPN) is appreciable
- The chorda tympani nerve enters the mandibular arch and terminates just proximal to the submandibular ganglion, near a branch of the trigeminal nerve

Week 7 :

- The chorda tympani and lingual nerve unite proximal to the submandibular gland
- The parotid gland begins to develop .The temporal, zygomatic, and upper buccal branches are superficial to the parotid primordium

Week 8 :

- Beginning of the fallopian canal

Weeks 10-15 :

- The vertical portion of the facial nerve begins in the middle ear, and its overall relationship to external and middle ear structures is far more anterior than in the adult.



Week 16 to birth:

- the fallopian canal develops
- In late fetal life, the fallopian canal is closed by bone in most areas, except in the anterior cranial portion, where it remains open to form the facial hiatus along the floor of the middle cranial fossa.
- 25-55 %of fallopian canals are dehiscant, with the most common location adjacent to the oval window.

The Anatomy Of Facial Nerve

- Broadly divided into 3 parts
 - Intracranial Portion
 - Intratemporal Portion
 - Extratemporal Portion

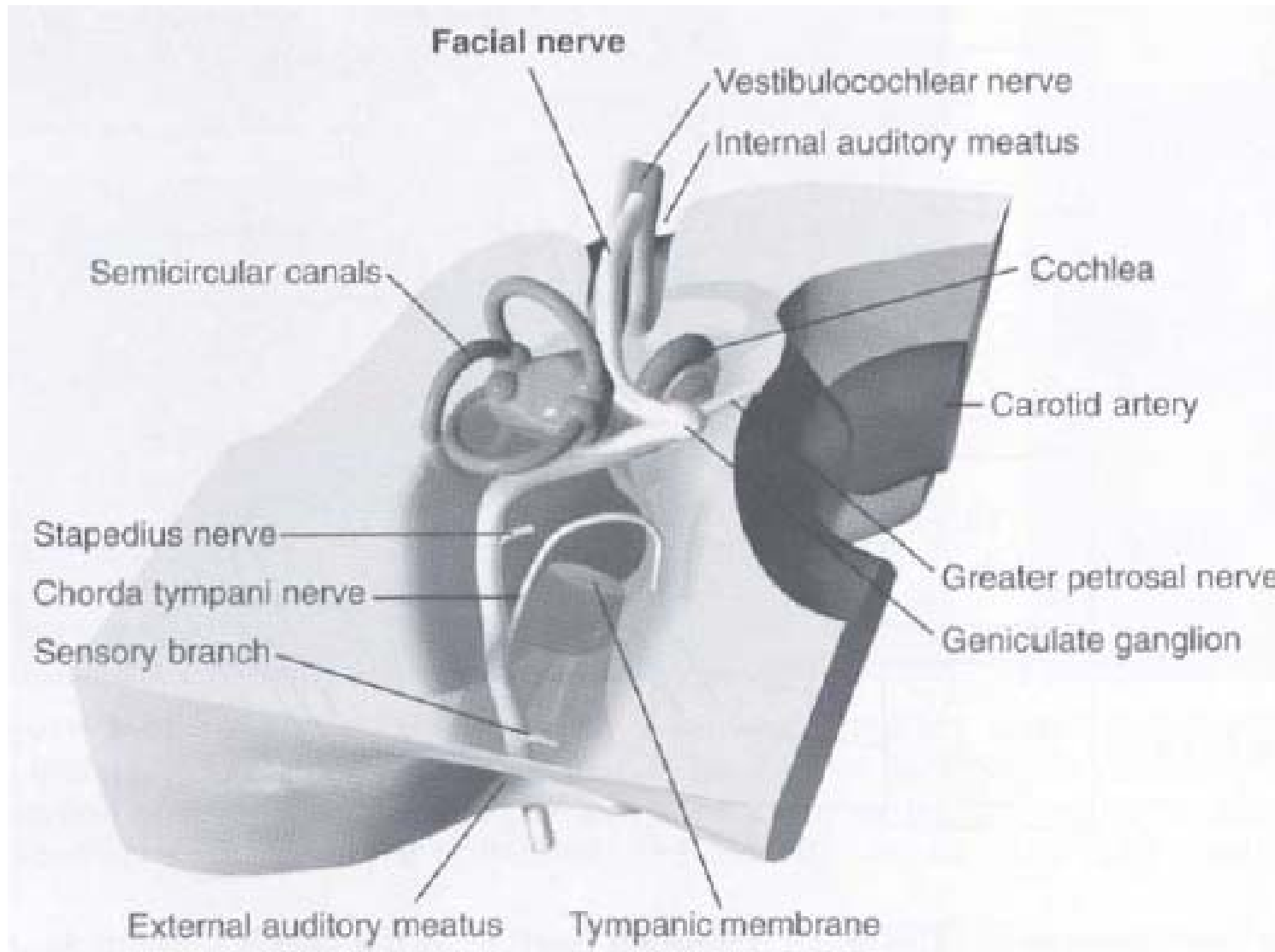



- **2 roots:**

- Motor root :moderate in size

- Sensory root (Nervus intermedius of wrisberg)

- Very slender & lies posterior to motor root.

Facial nerve: sensory root

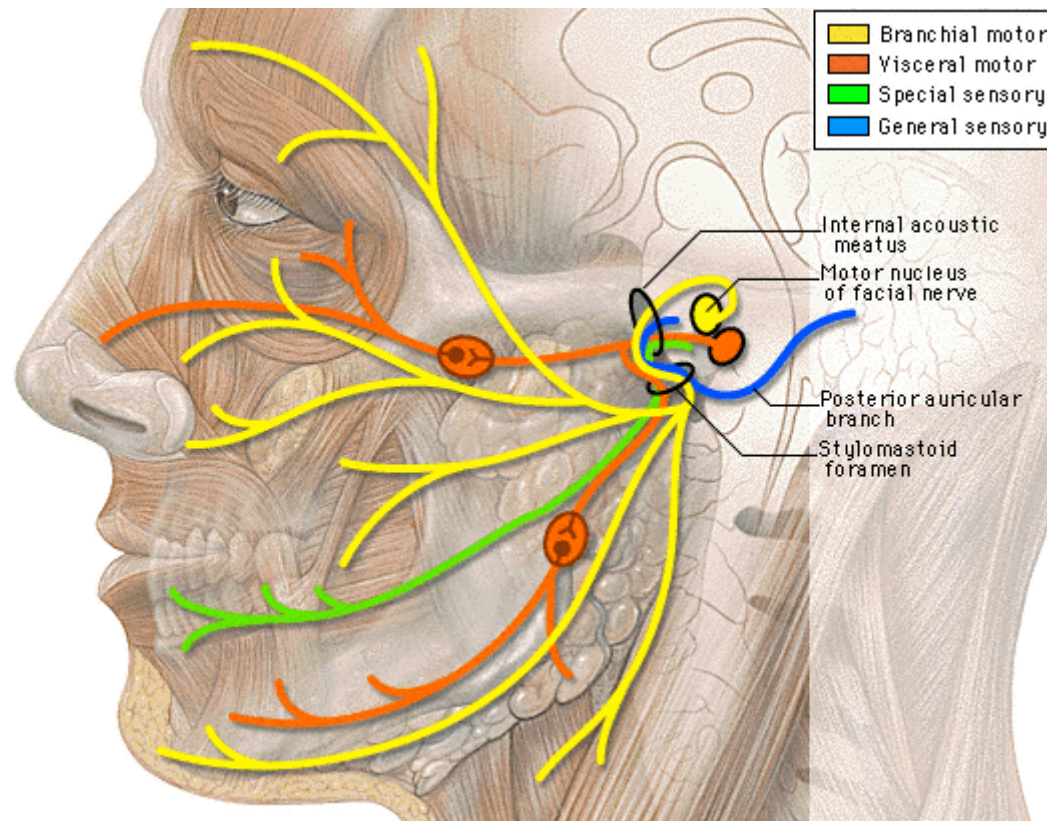

- Special Visceral Efferent/Branchial Motor
- General Visceral Efferent/Parasympathetic
- General Sensory afferent
- Special Visceral Afferent/Taste

Special sensory afferent

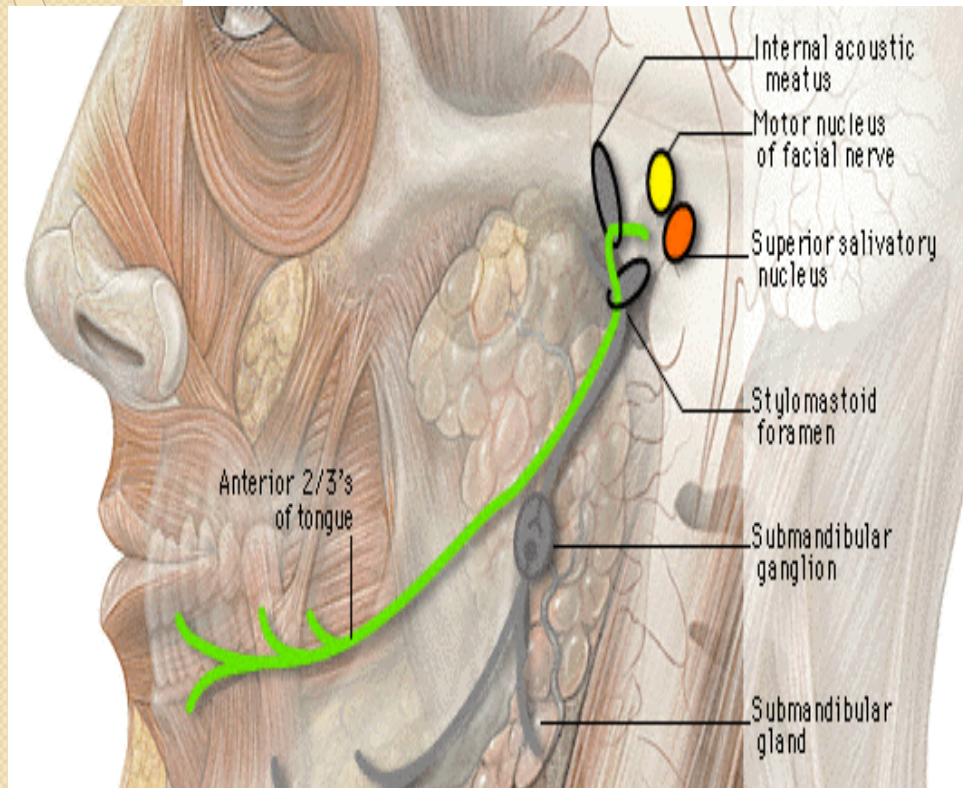

- Origin : Unipolar neurons in geniculate ganglia
- Central : Nucleus of Tractus Solitarius
- Peripheral : Chorda tympani nv & lingual nv to ant 2/3rd tongue



General sensory afferent

- Deep sensibility of face

General Visceral Efferent

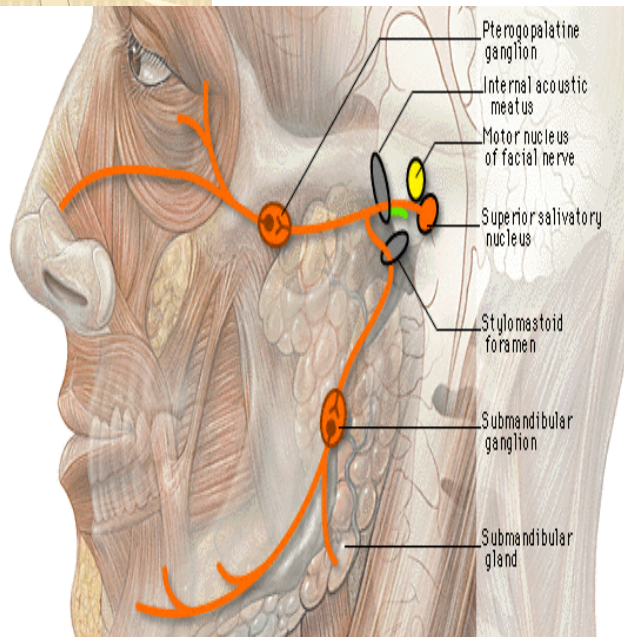

Origin : Sup salivatory nucleus
Para sympathetic secretomotor fibres

(SSN)GSPN – PterygopalatineGanglia
- Lacrimal & Palatine Gland

(ISN)LSPN- Otic Ganglia – Parotid
Gland

Chorda Tympani – Sunmandibular &
Sublingual Gland

Segment	Location	Length mm
Supranuclear	Cerebral cortex	
Brain stem	Brain stem to IAC	24
Meatal segment	IAM to fundus	5-12
Labyrinthine segment	Fundus of IAC to first genu	3-4
Tympanic segment	Geniculate ganglion to pyramidal eminence	8-11
Mastoid segment	Pyramidal process to stylomastoid foramen	10-14
Extratemporal segment	Stylomastoid foramen to pes anserinus	15-20

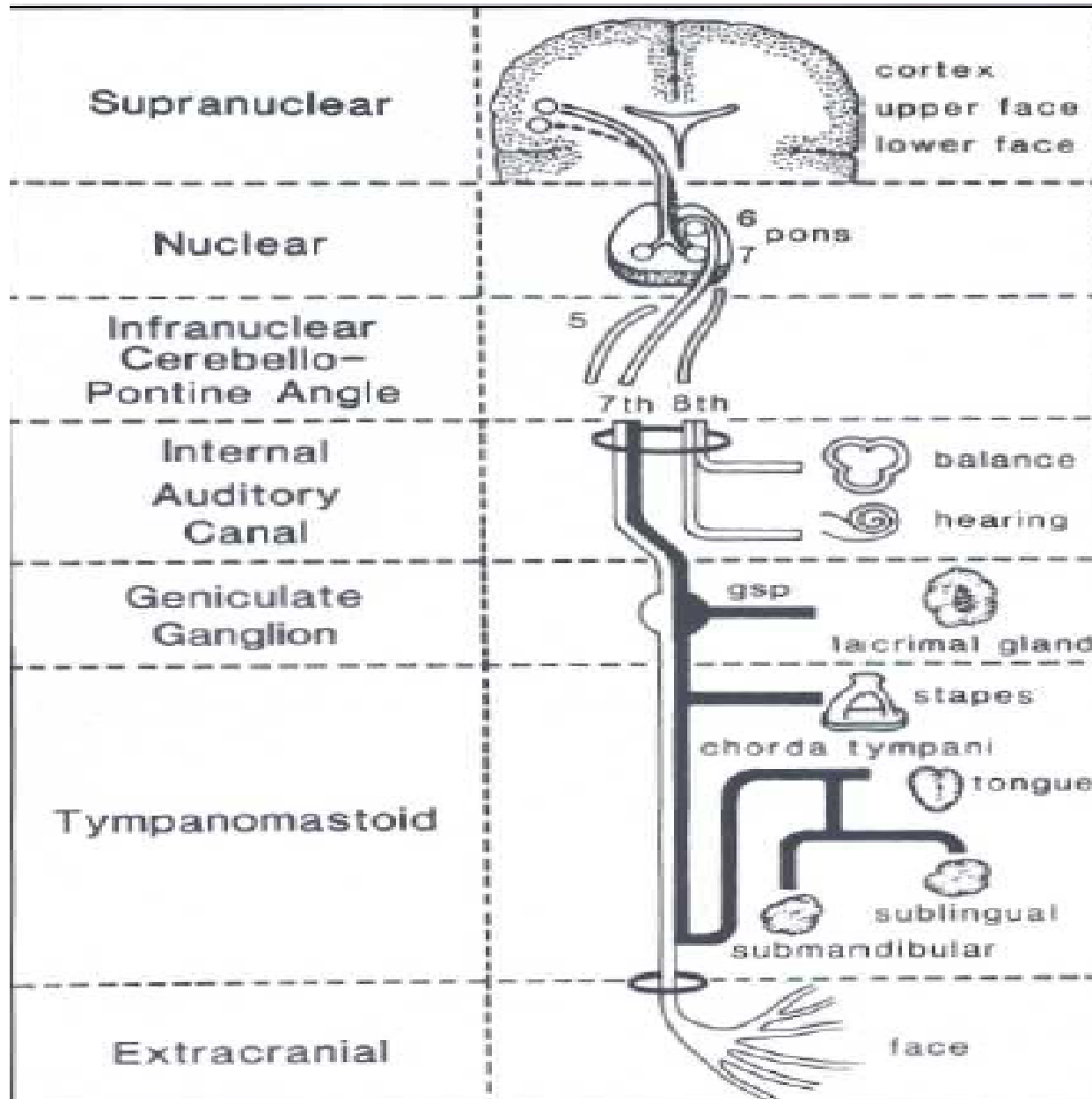

Intracranial Portion Of Facial nerve

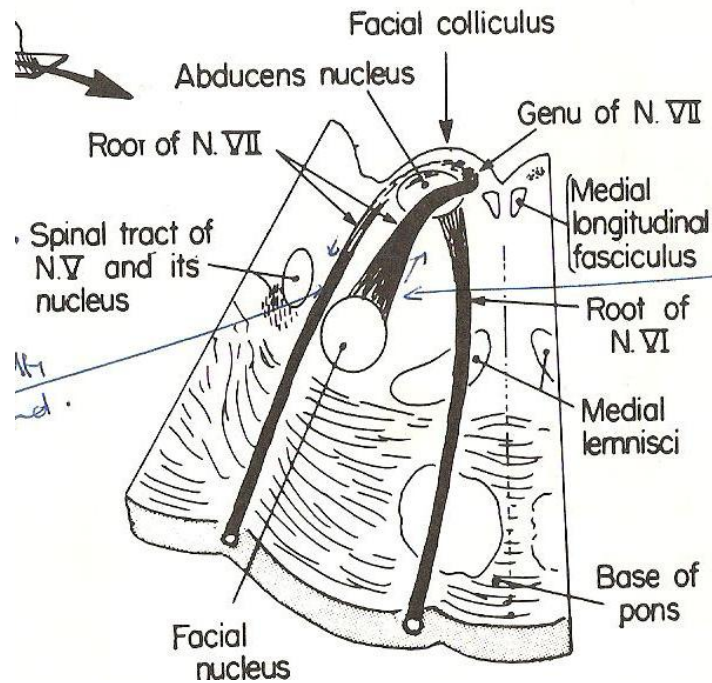
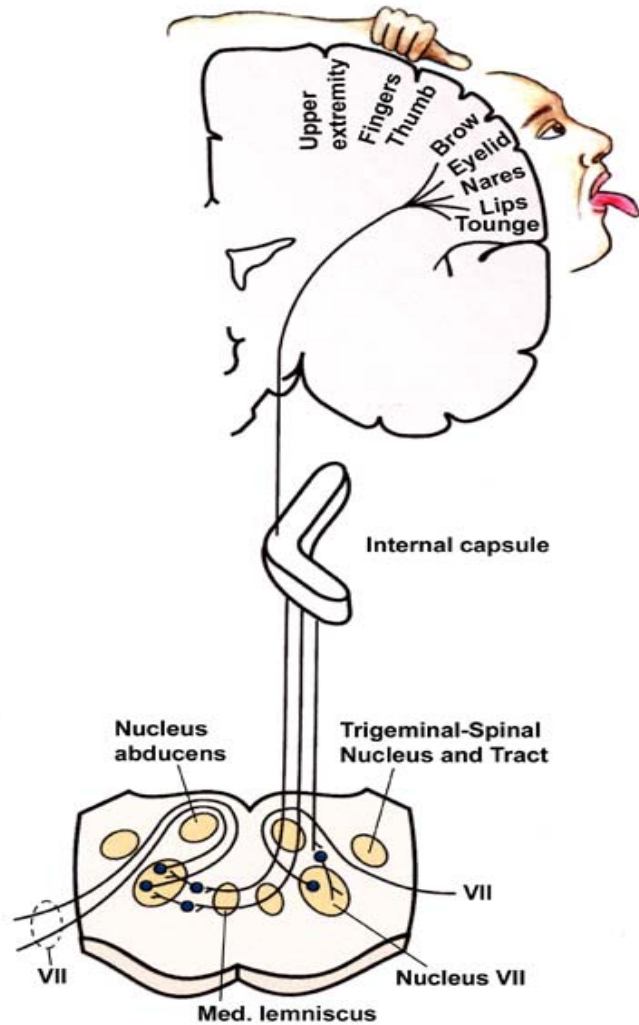

- Facial nv & nerve of intermedius lie above & slightly ant to vestibulocochlear nv
- Distance between exit & entrance in IAC :23-24 mm

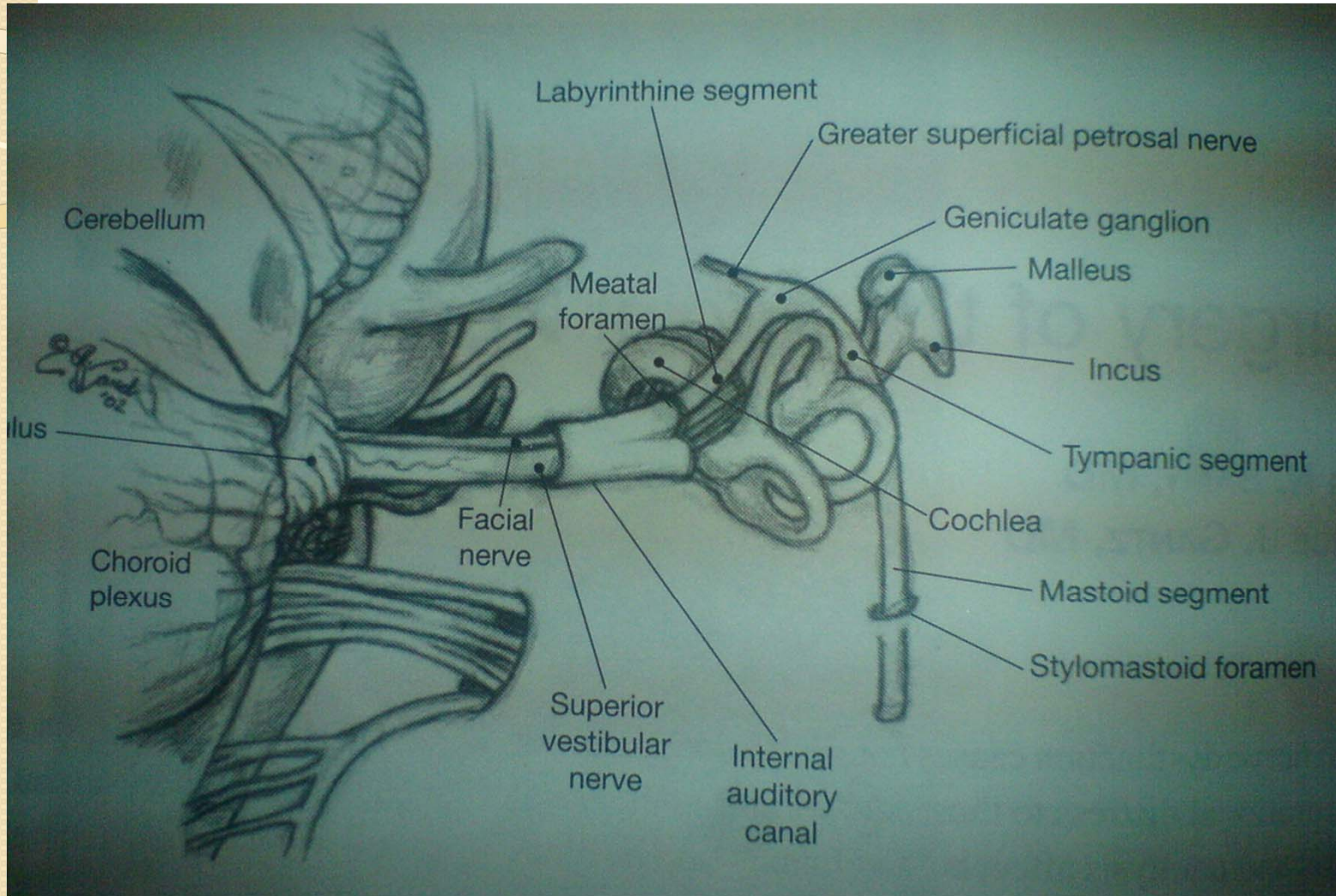

Intratemporal portion of Facial nerve

- fallopian canal (after Gabriel Fallopius).
- Divided into 4 segments:
 - Meatal
 - Labyrinthine
 - Tympanic, horizontal
 - Mastoid, vertical

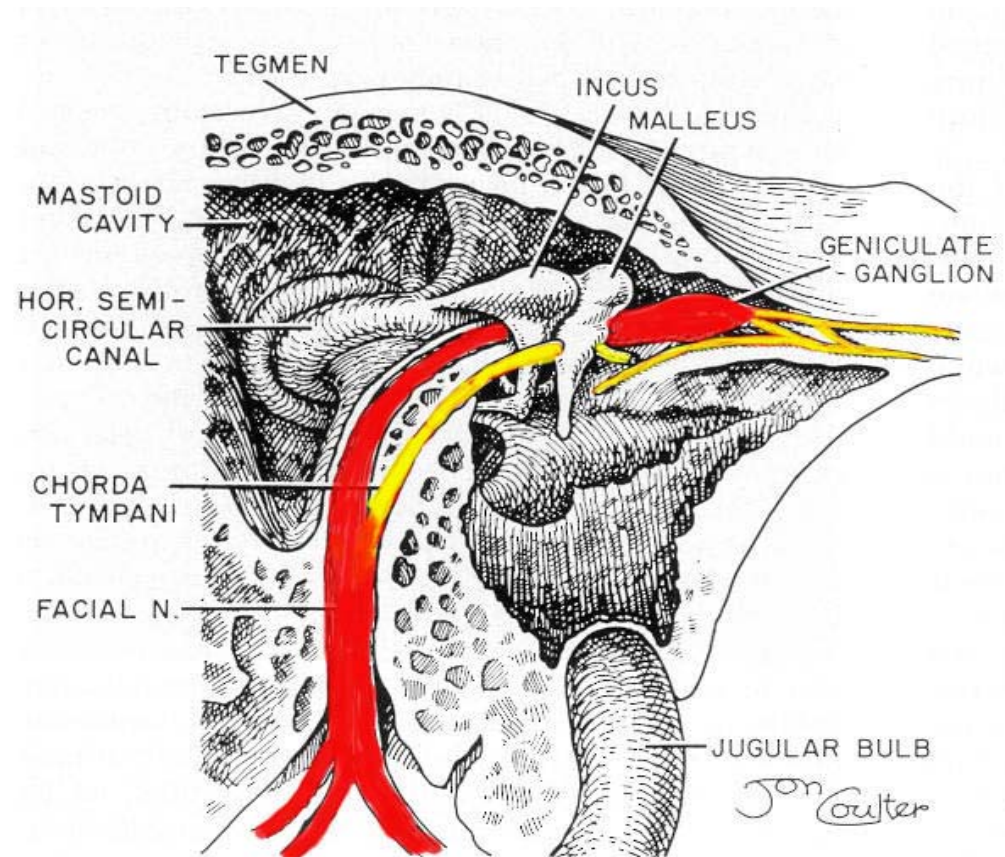

Meatal Segment (5-12 mm)

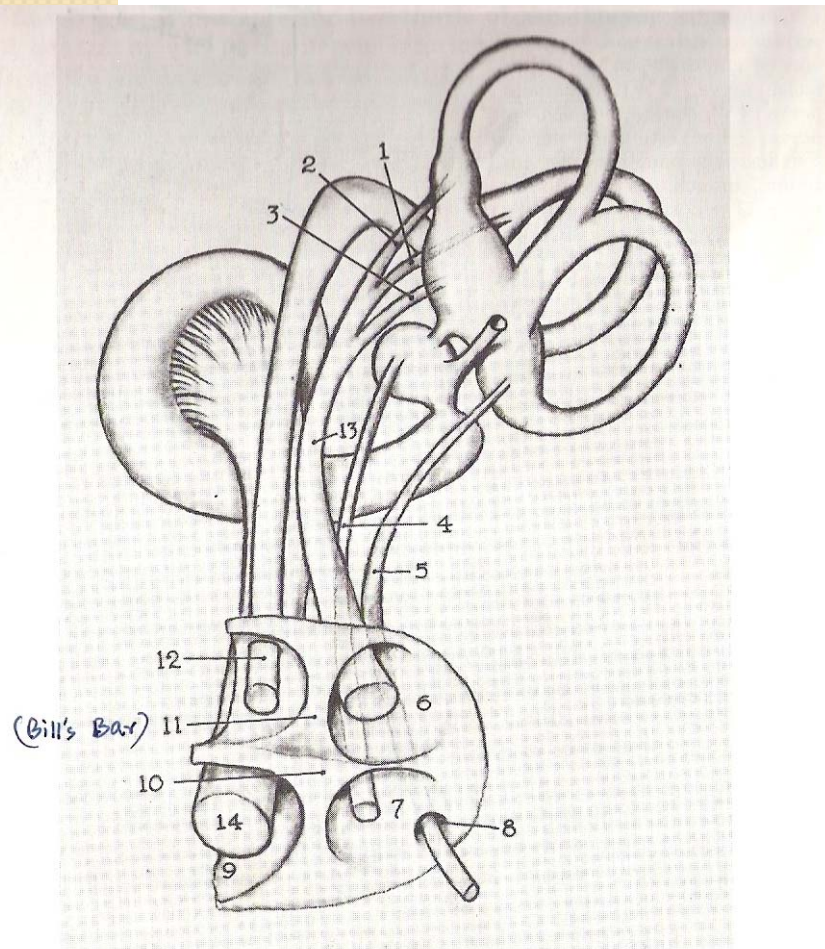
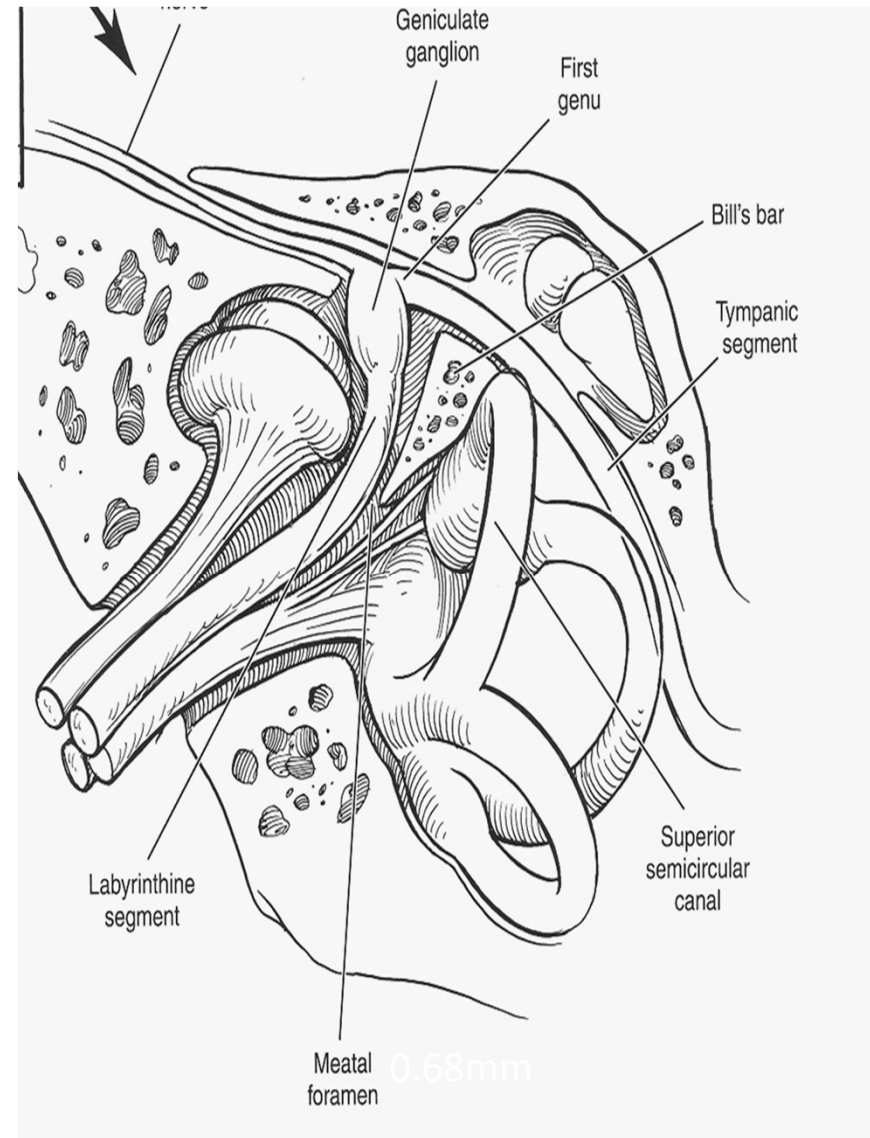
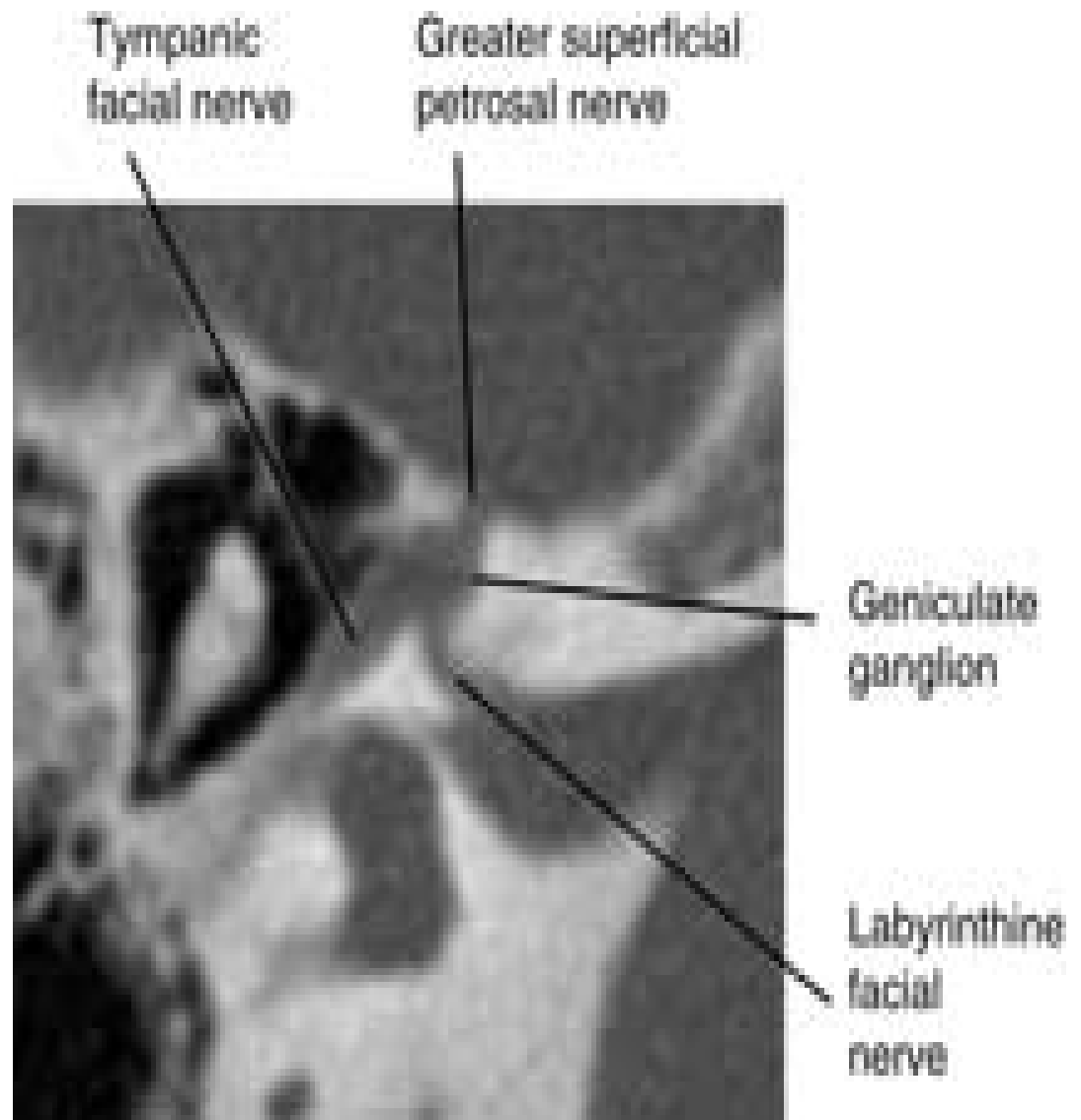
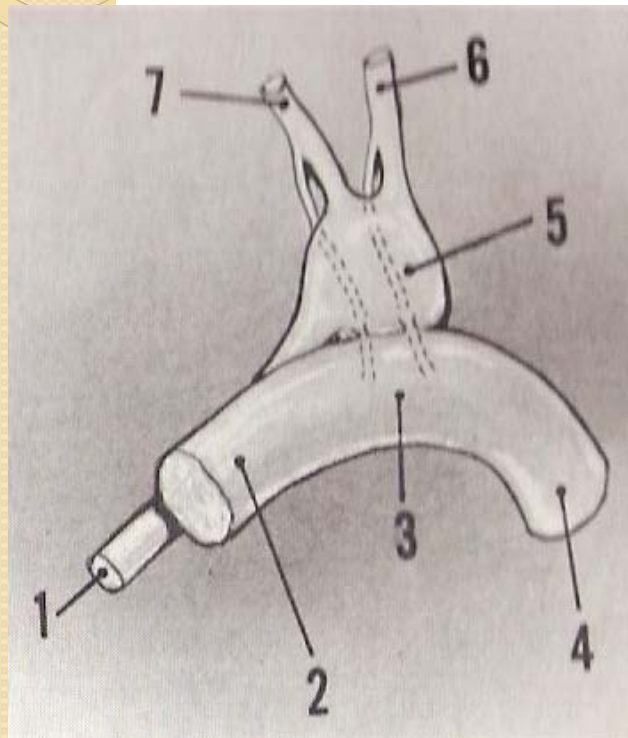
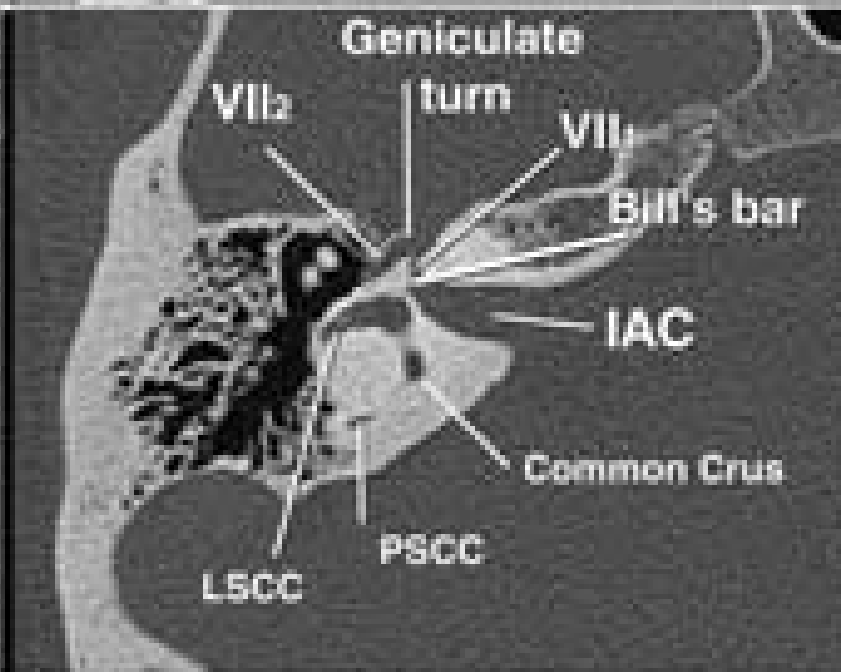
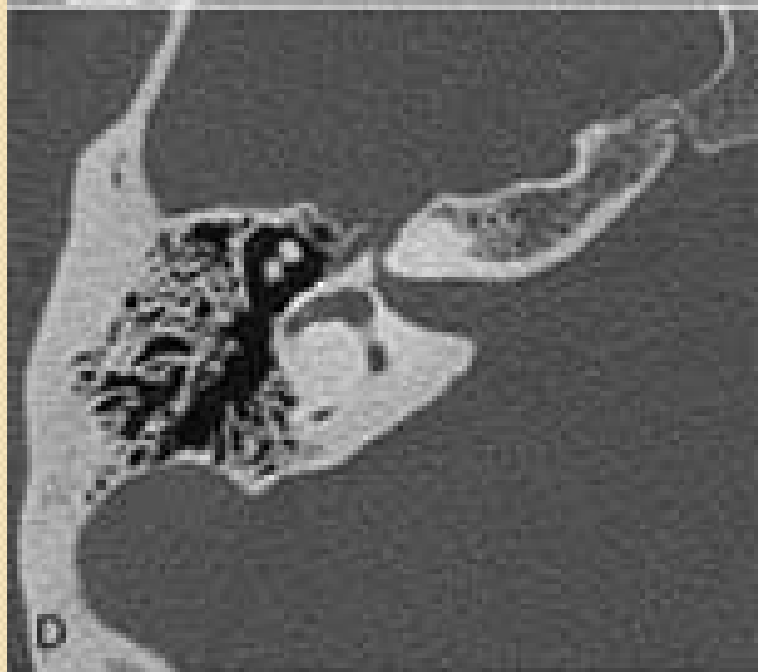
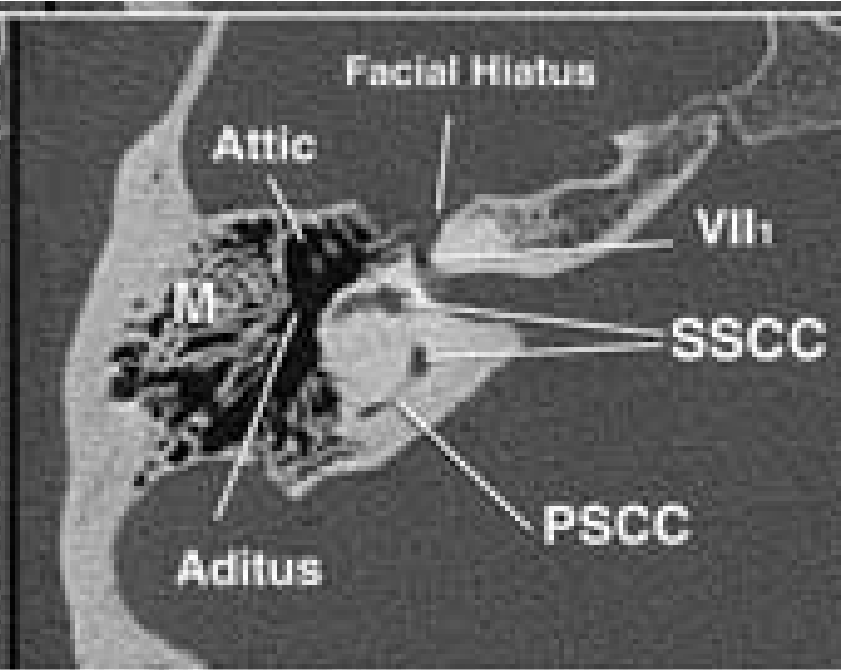

Figure 4. Fundus of internal auditory canal and distribution of eighth nerve to membranous labyrinth. 1 = external ampullary nerve, 2 = superior ampullary nerve, 3 = utricular nerve, 4 = saccular nerve, 5 = posterior ampullary nerve, 6 = superior vestibular fossa, 7 = inferior vestibular fossa, 8 = singular foramen of Morgagni, 9 = cochlear fossa, 10 = falciform crest, 11 = vertical crest, 12 = facial nerve, 13 = superior vestibular nerve, 14 = cochlear nerve.







labyrinthine segment:

- Size -3-5 mm , 0.68 mm
- Lies beneath the middle cranial fossa
- Direction
- Meninges

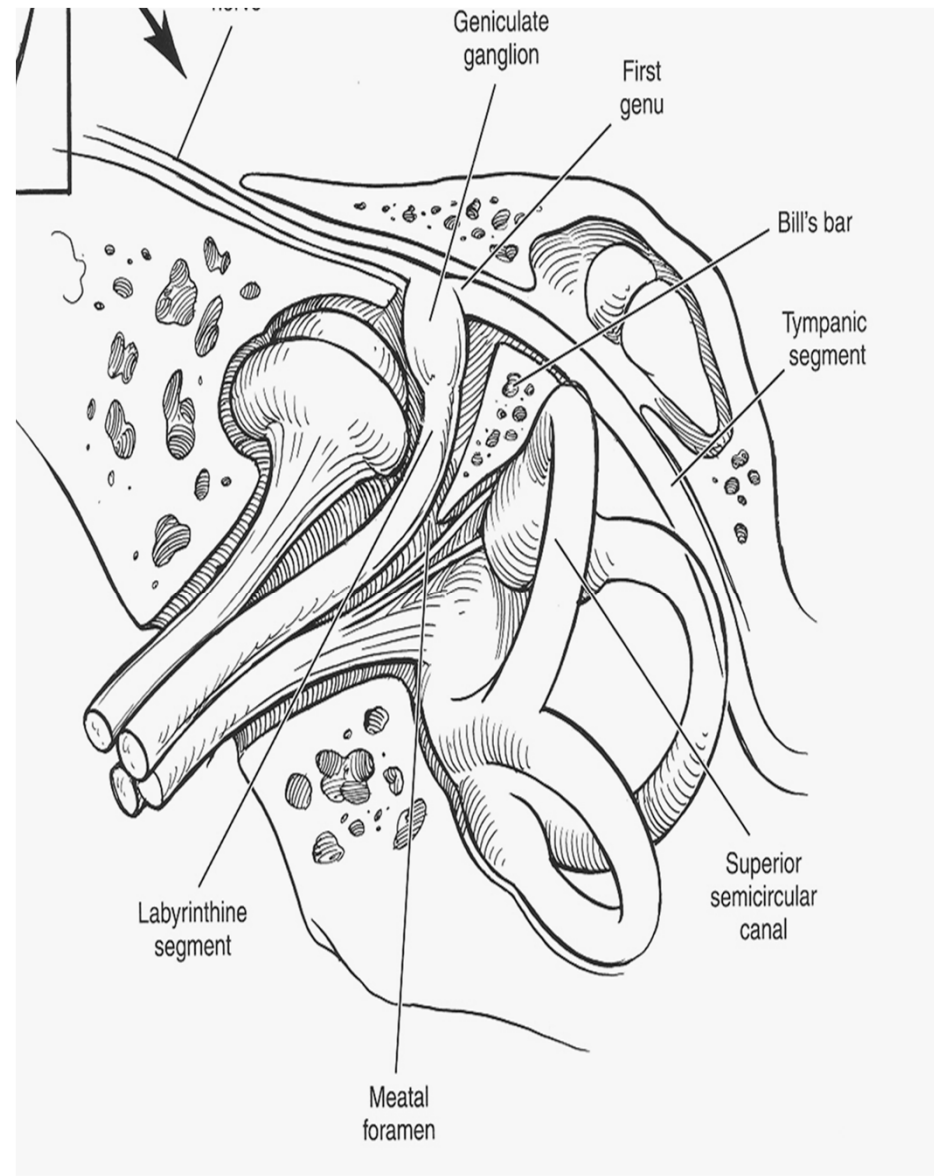

labyrinthine segment:

- - meningeal cover
- - narrow constriction (0.68mm)
- - 132 deg bend
- Slight constriction from vertical crest, thick periosteum
- Only segment of the facial nerve that lacks anastomosing arterial cascades : embolic phenomena, low-flow states, or vascular compression

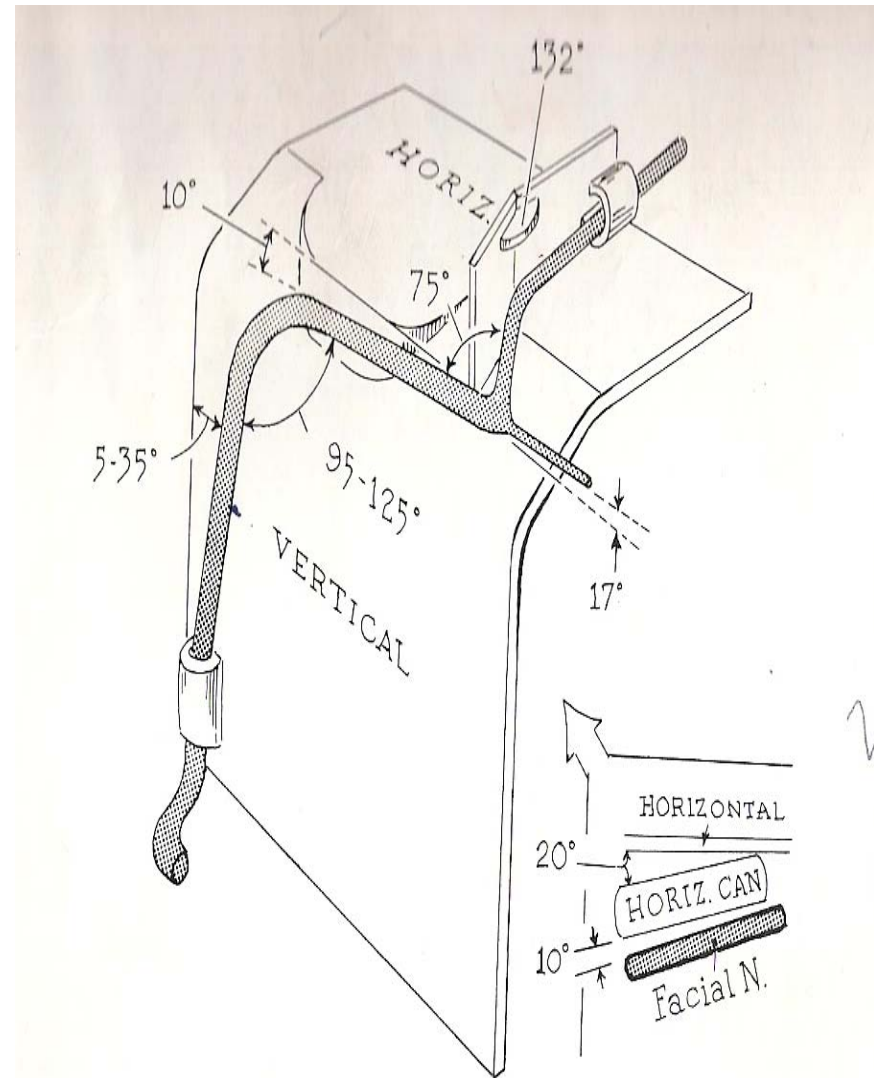

Geniculate ganglion:

- Forming an acute angle of variable degree but usually not less than 75° .
- 1st genu
- Cog
- The geniculate ganglion is formed by the junction of the nervus intermedius and the facial nerve into a common trunk

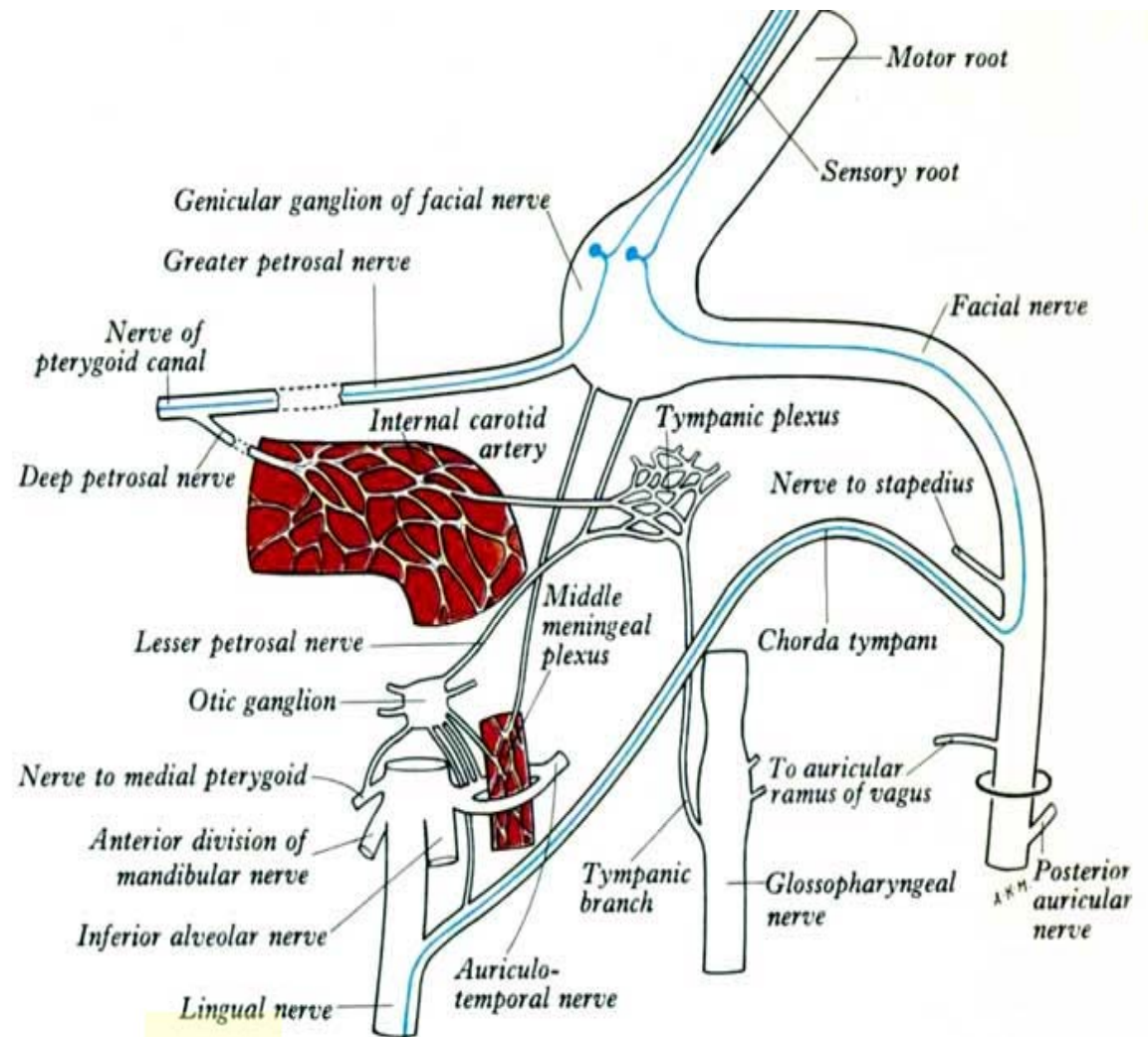

Tympanic or horizontal segment (8-11 mm) :

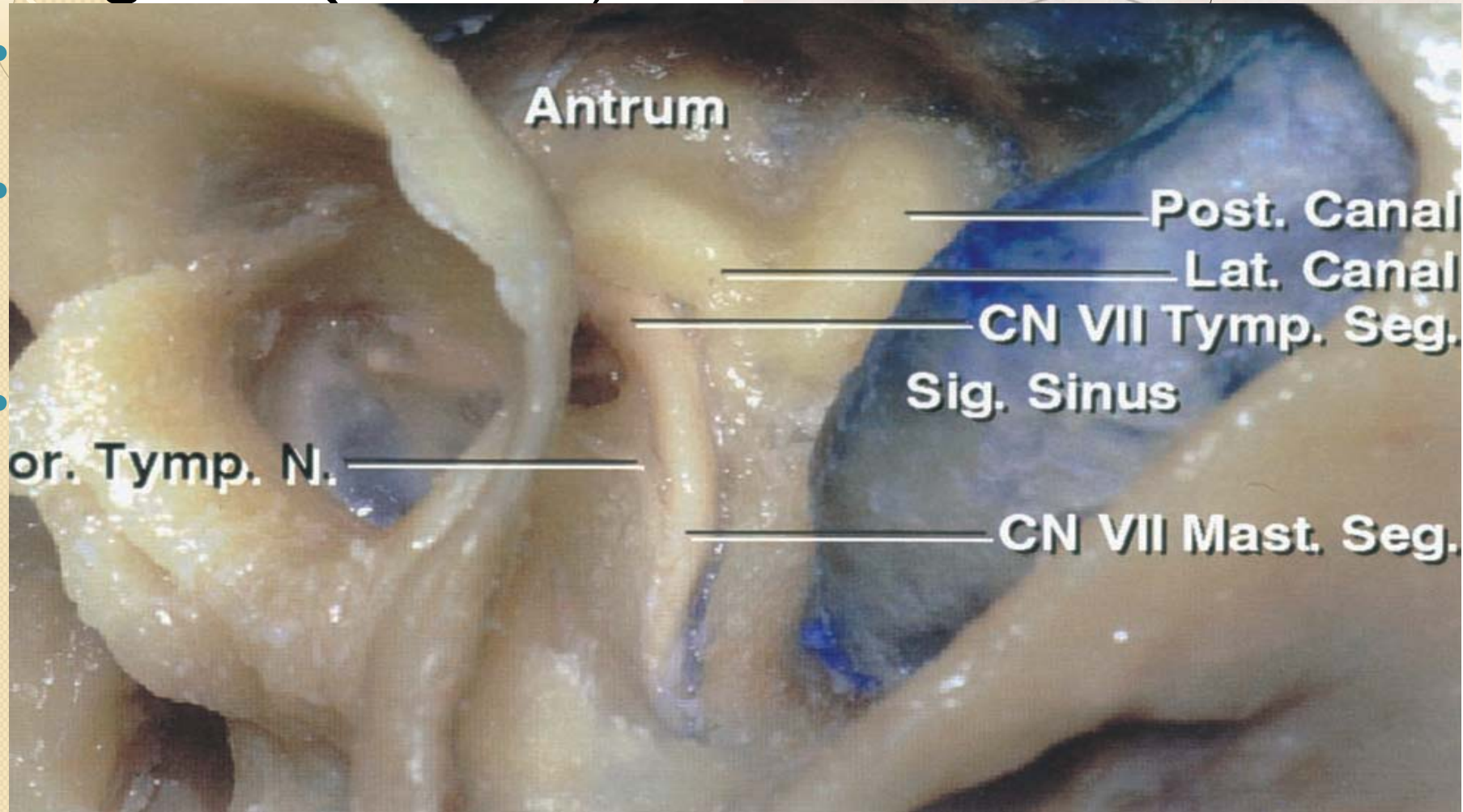

D

Epitymp. Recess

Incus

Short Proc.

Stapes

Eust. Tube

Malleus

Lat. Cana

Incus
Long. Proc

Stapedial M

CN VII Mast. Seg.

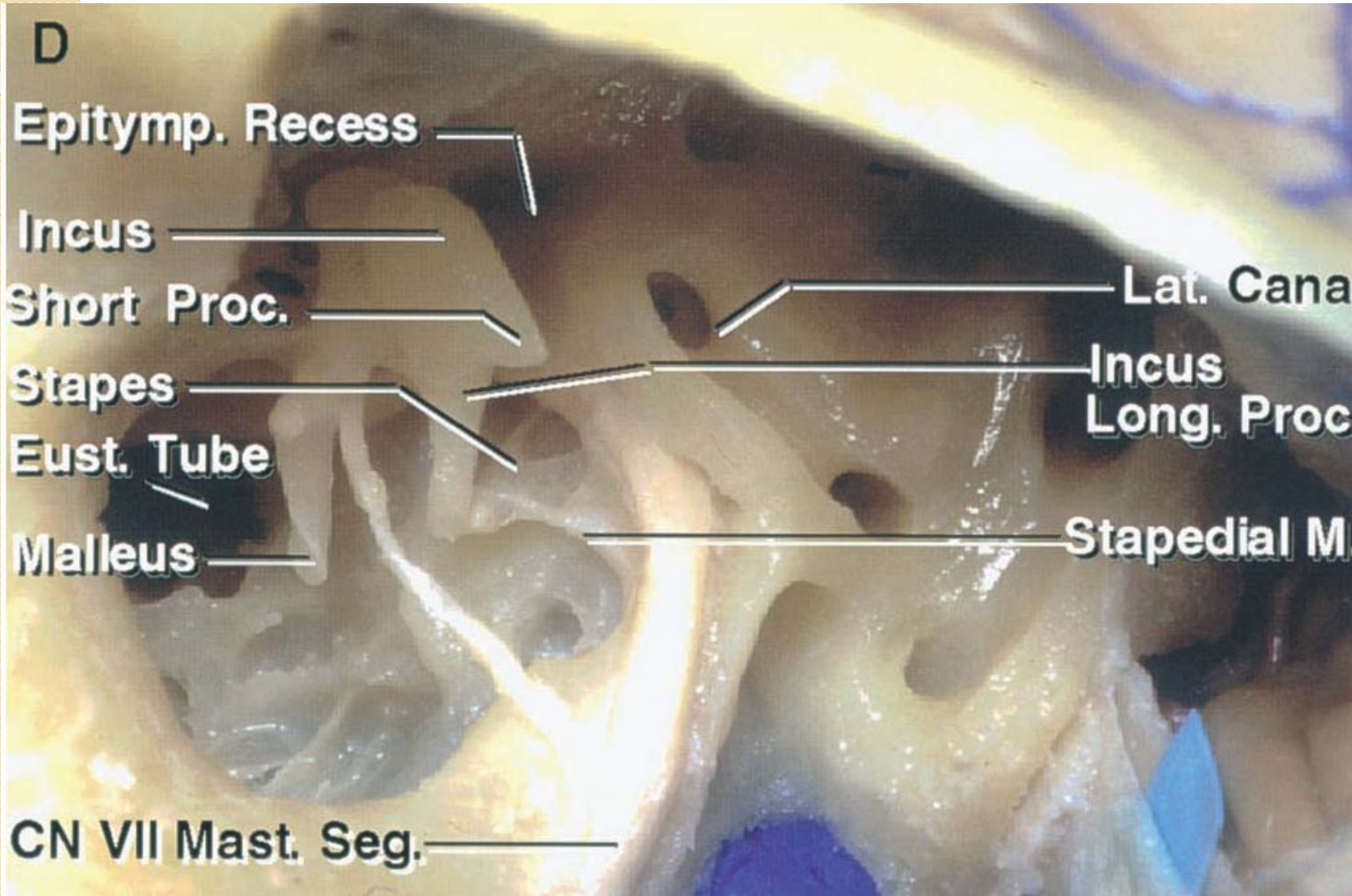

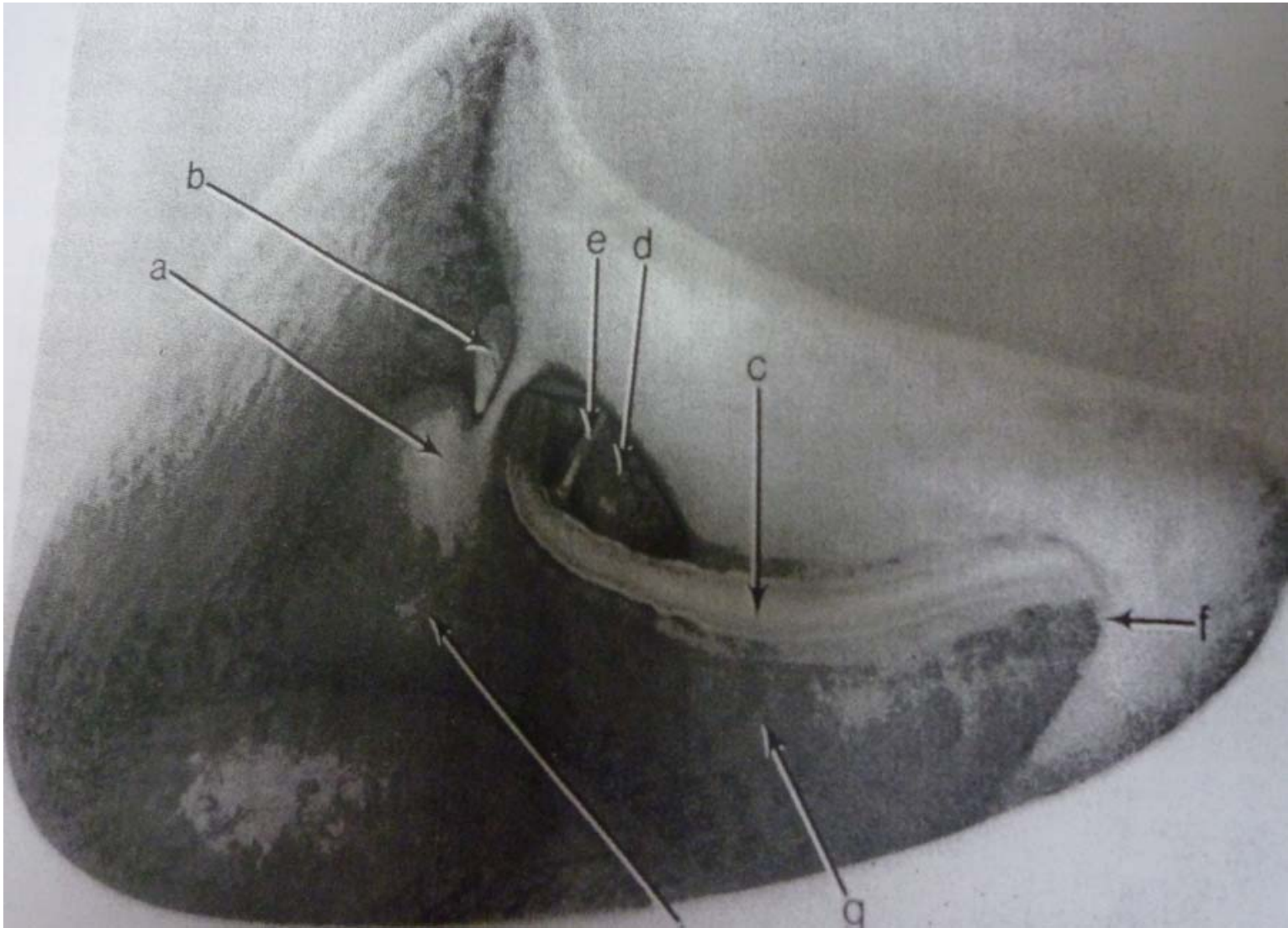

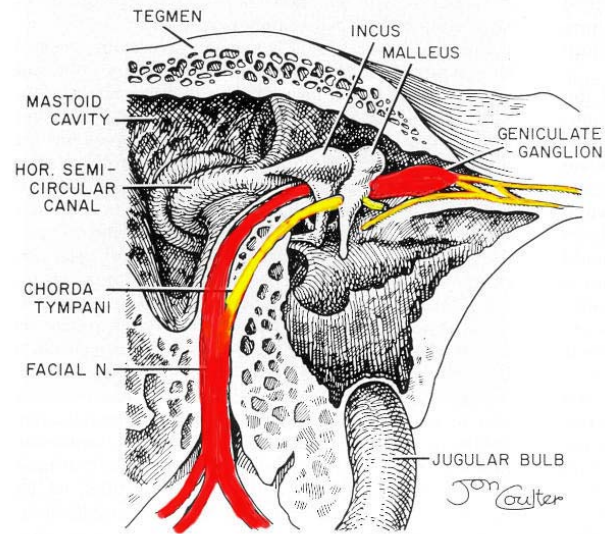
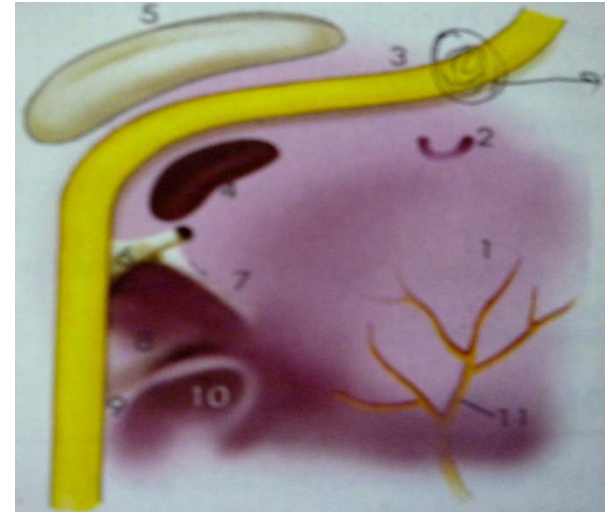
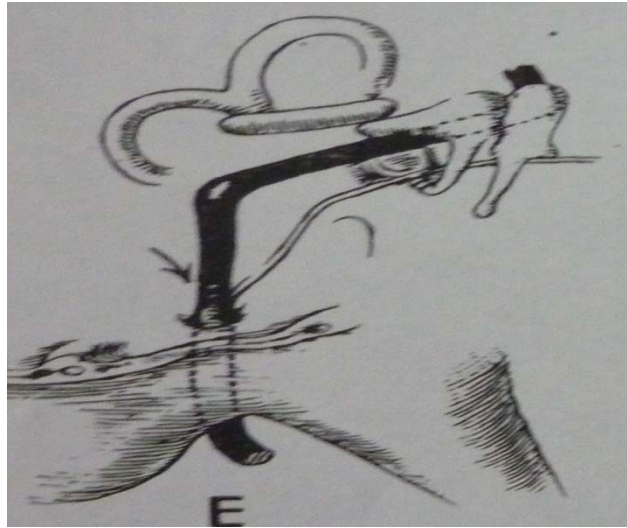
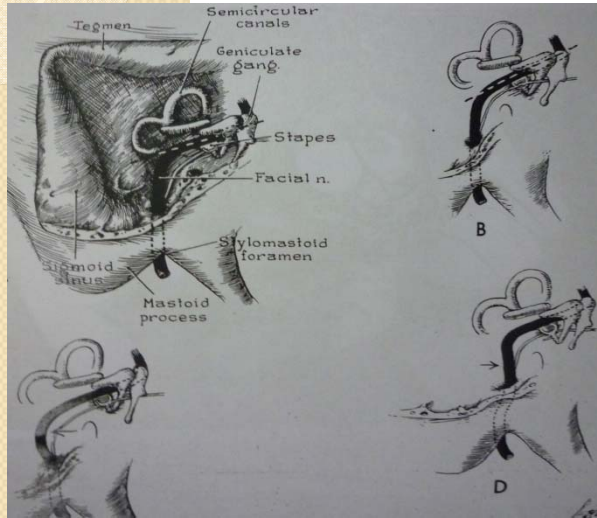

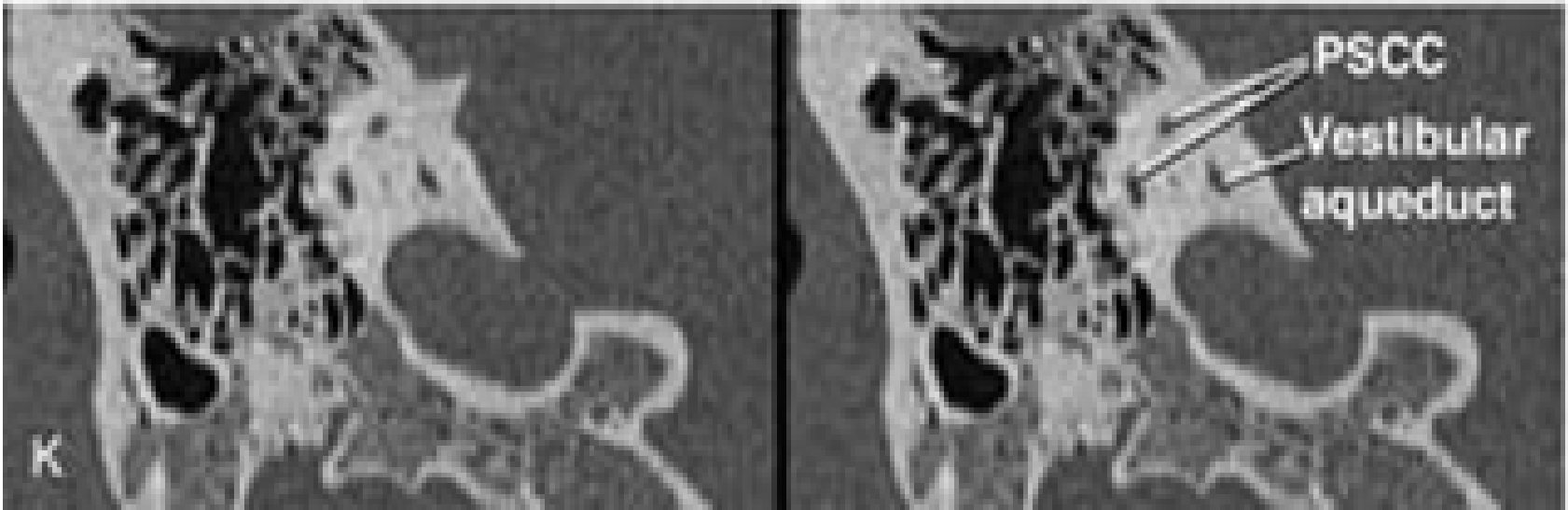
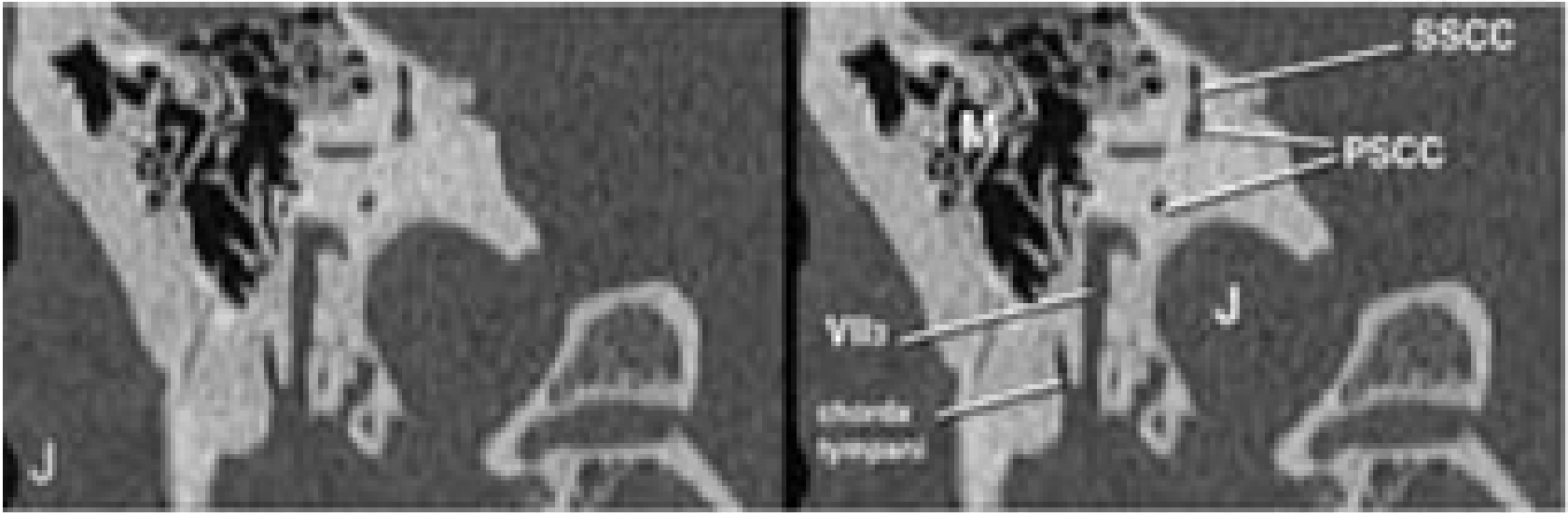

Mastoid (Vertical) segment of facial canal

- 15-20 mm
- Course
- Angulation
- 3 branches

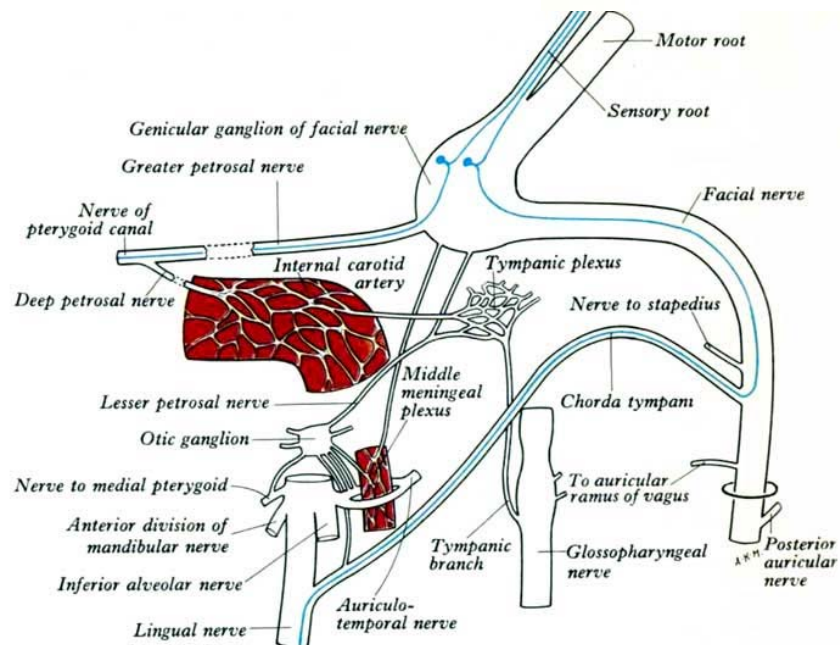
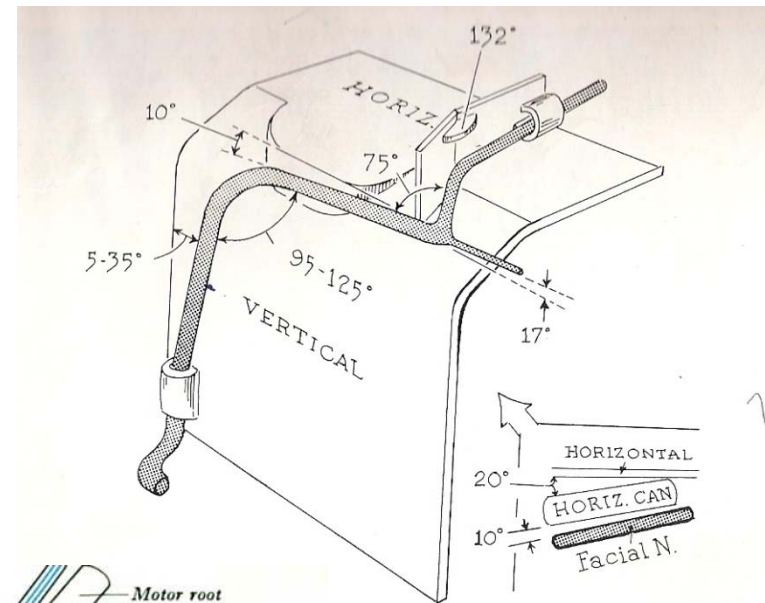

Chorda tympani nerve

- Terminal branch of the nervus intermedius
- Course

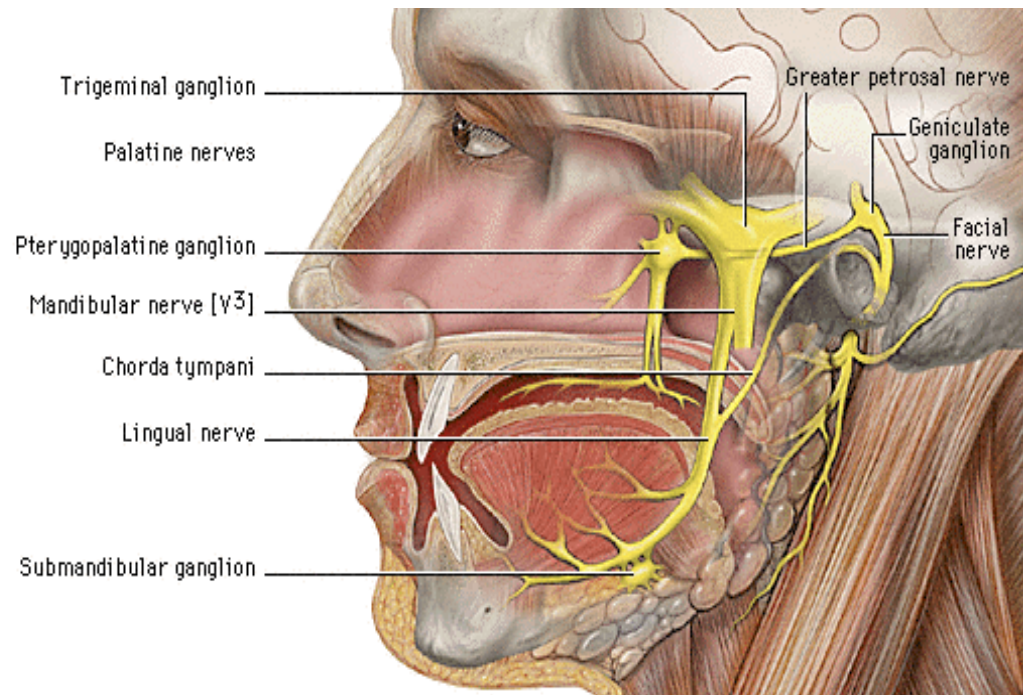
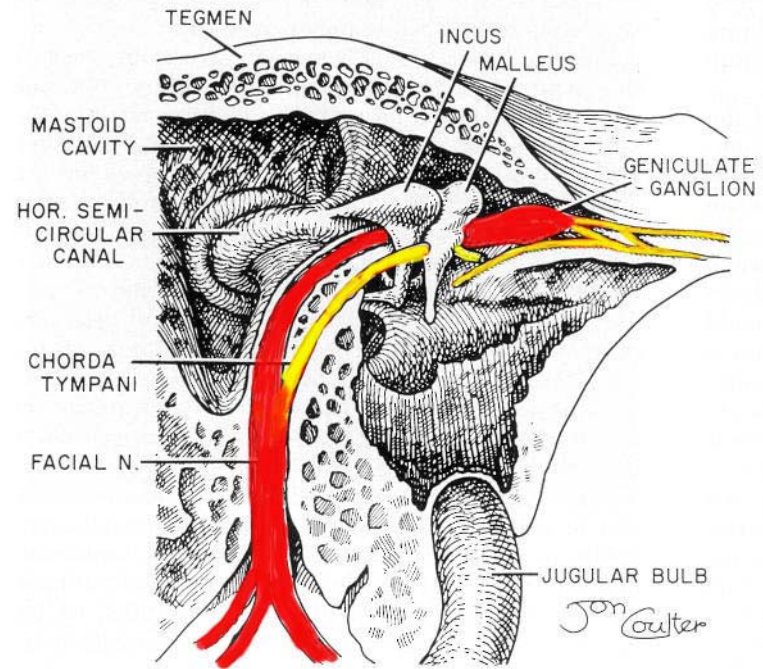

- Exits the fallopian canal via the stylomastoid foramen.
- Stylomastoid foramen opens at base of petrosa between the mastoid process and styloid.
- Once it exit the fallopian canal at the stylomastoid foramen, it gives off several rami before it divides into its main branches

Extratemporal Facial Nerve

Branches of Facial Nerve

1. Ansa of Haller (inconstant)
2. Posterior auricular branch
3. Stylohyoid branch
4. Posterior belly of digastric branch
5. Pes anserinus

Extratemporal Facial Nerve

- Runs anteriorly in the substance of parotid gland, crosses the ECA & divides at the posterior border of ramus of mandible into 2 primary branches:

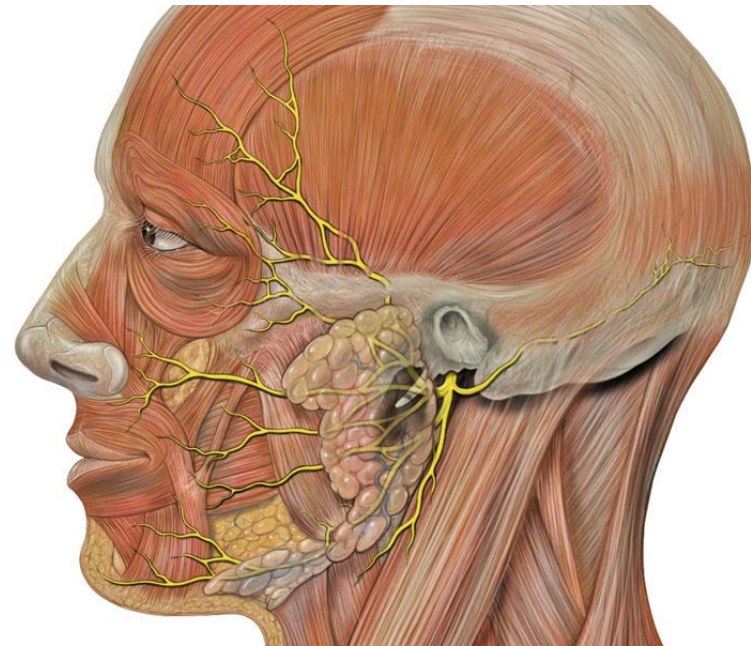

Sup : Temporozygomatic
Inf : Cervicofacial

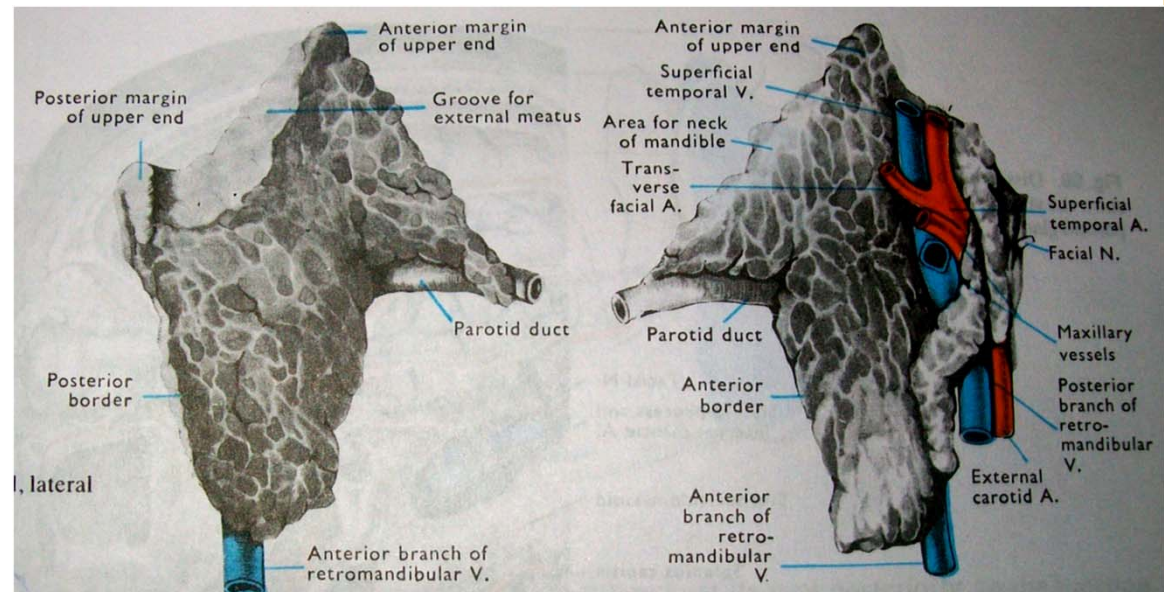

- After the main point of division, 5 major branches of the facial nerve exist:
- Temporal (i.e., frontal), zygomatic, buccal, marginal mandibular, and cervical.

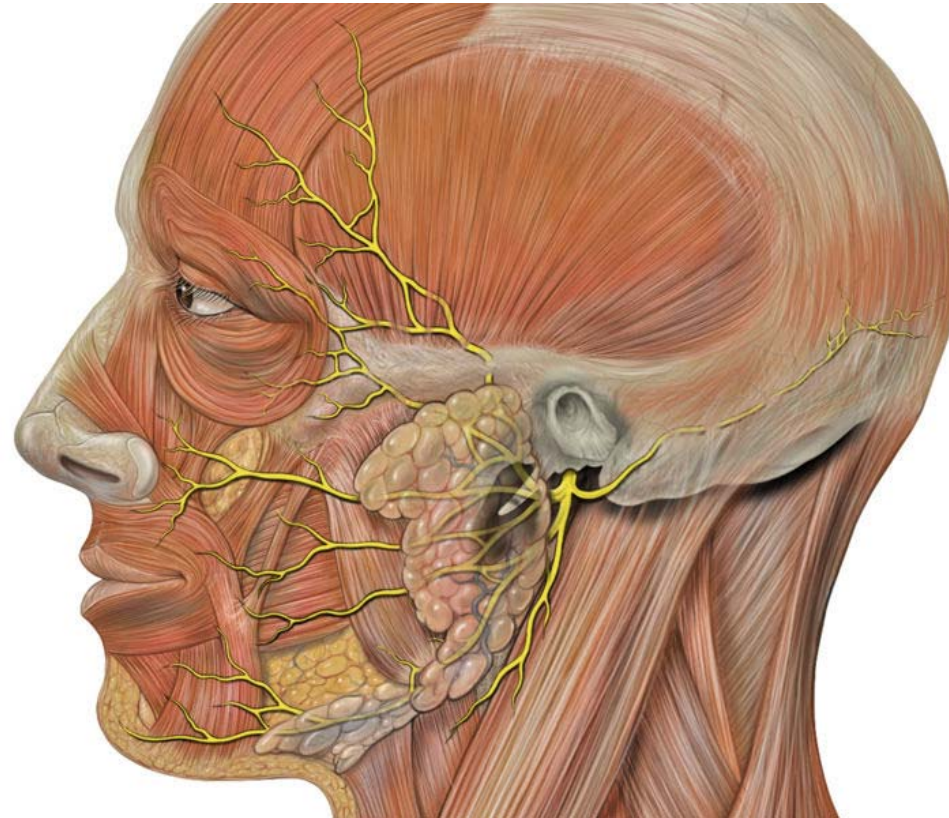

Surgical landmarks for the extratemporal facial nerve

- Tragal pointer
- Styloid process
- Posterior belly of digastric
- Peripheral branches
- Stylomastoid foramen
- Tympanomastoid suture
- Vaginomastoid angle
- Post auricular muscle branch

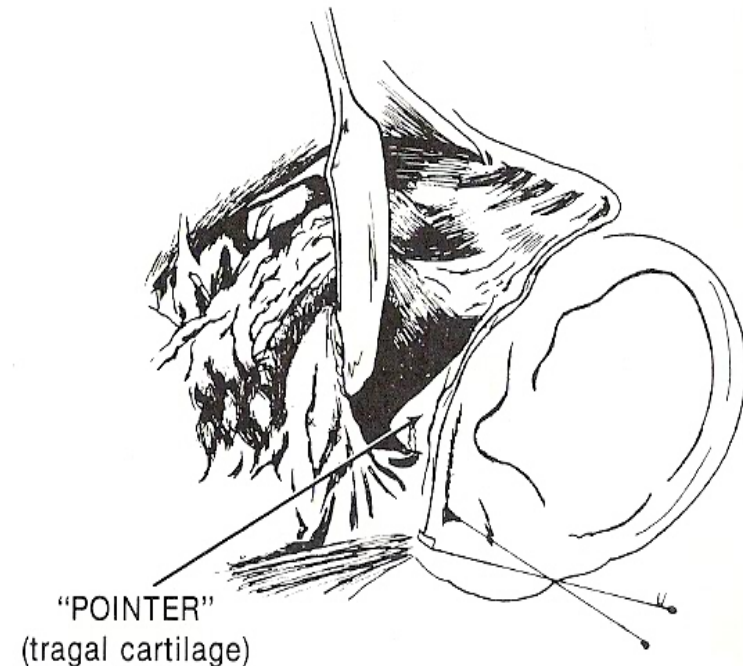

- Frontal branch
- Ramus mandibularis
(post facial vein)
- Buccal branch

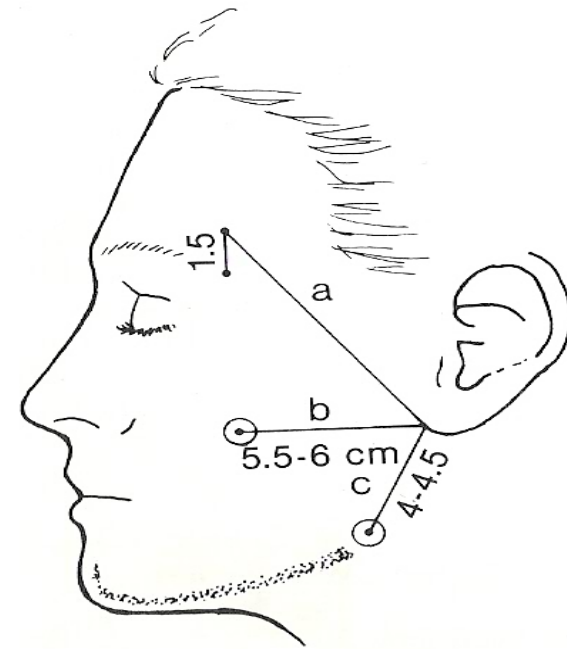

Vascular supply of the facial nerve

- The cortical motor area : Rolandic branch
- Pons : anterior inferior cerebellar artery (AICA)
- Superficial petrosal artery
- Posterior auricular artery

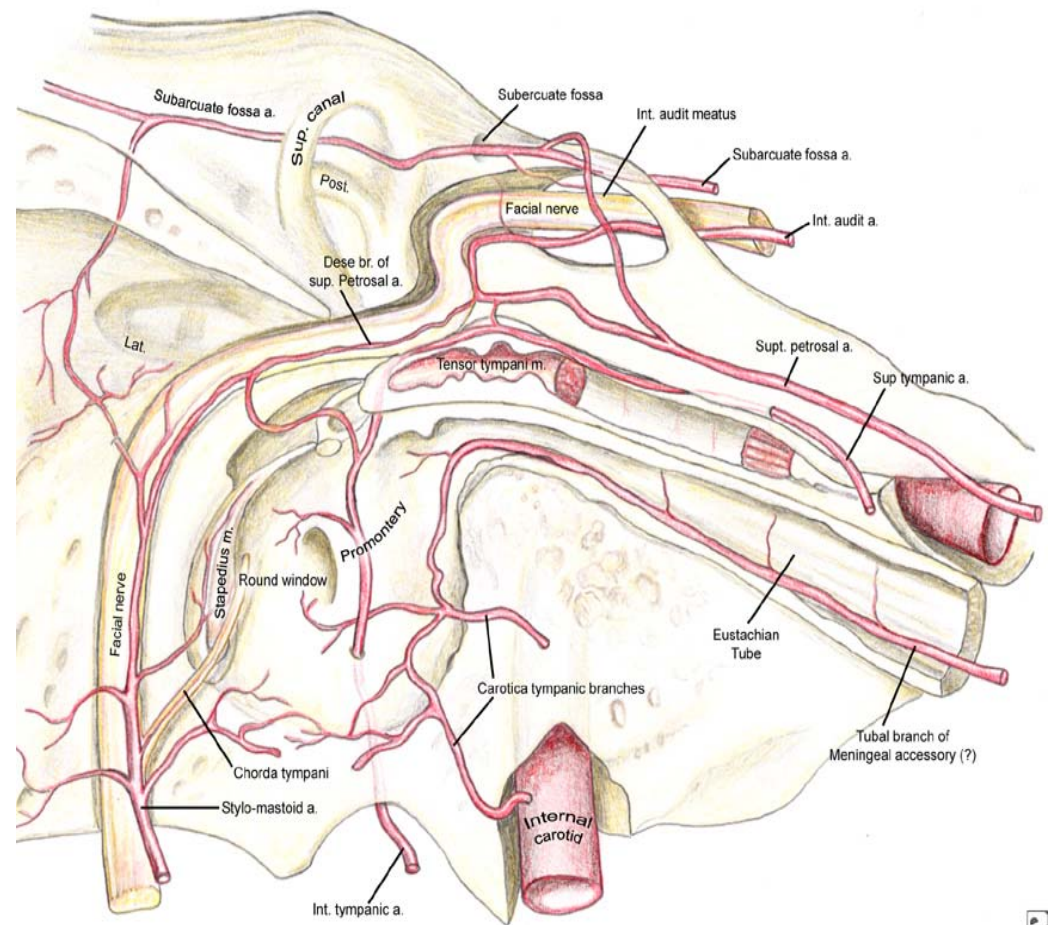



Thank U