



Capital Electric
A Sonepar Company



**SOUTH CAROLINA
& GEORGIA**

SMARTBUYS

SEPTEMBER-OCTOBER 2021

New product features and promotions!



1165450

**NEW!! Klein Tools
AEPJS1 Wireless
Jobsite Speaker**
[1165450]

More Klein Tools, page 36



1662828

**NEW!! Signify GC90-SCT-G2-SM-5-10-BZ 90W LED
Garage & Canopy Fixture, CCT Selectable 30K-40K-
50K, Surface Mount, 120-347V, Bronze** [1662828]

More Signify products, page 12



1262584

**BRK 7020BSL (1038335) Smoke
Alarm And Strobe Light Wire In with
10 Yr Sealed Lith Battery** [1262584]

BRK, pages 22 - 24



**Milwaukee M12
Heated Toughshell
Jacket Kits L-2X
(Black)**

**Milwaukee
jackets,
page 38**



*Not all products available at all locations. Capital Electric is not responsible for misprints or typos. Prices valid
September 1 - October 31, 2021 unless otherwise noted. Prices and offers are subject to change or cancellation
without notice. Speak to your Capital Electric salesperson for more details. Shop online 24/7 at capitalelectricsupply.com!*

The electrical distributor of choice

GIVE IT A TRY WITH SMART BUYS!

Barcodes included for all products.

**SCAN TO ORDER
IN SECONDS**

Our mobile app is designed to save you time and boost productivity. The quick-scan feature easily reads product labels for efficient ordering and eliminates manual entry errors in just three steps!

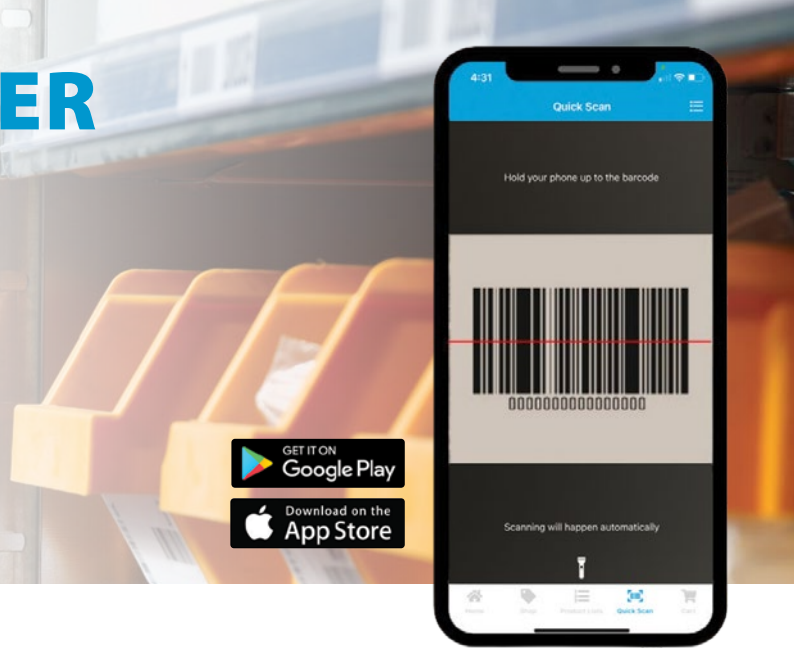

1

PRINT



We print individual labels to place on bins or shelving and build a label booklet for easy access from anywhere.

2

SCAN



Scan from various locations, including storerooms, jobsites, service vans, and more.

3

ORDER



Eliminate manual entry to avoid errors. Easily add to a cart and place your order.

More app benefits include: Search products, view pricing and availability, order quoted material, view frequently purchased products, order from product lists, view spec sheets, and scan UPC labels.

Download the app today!

For questions, contact Digital Support at digitalsupport@capitalelectricsupply.com or call 804-588-4867. You can also visit us at capitalelectricsupply.com!

LTR-P Professional Series

1.5W, 12VDC and 24VDC LED Tape Specification Sheet

GM Lighting®

NEW PRODUCTS!

PRODUCT OVERVIEW

GM's Professional Series Flexible LED Tape combines style and technology with reliability. Designed for professional installations that demand a high level of quality, the LTR-P Series includes a wide array of key features and is available in 16'-4" (5M) and 100' (30M) reels.

FEATURES

- 12VDC or 24VDC models
- 2400K, 2700K, 3000K, 3500K, 4000K and 5000K color temps
- Dry location
- Remote control with GM's LUXcontrol™ App and controllers
- 120 LEDs per meter
- Cuttable every 2"
- Custom lengths available - consult factory
- Premium diodes
- 120° viewing angle
- Dimmable
- 3M adhesive back
- Maximum run on a given lead is 32'-8" (12V) and 60' (24V)
- Includes Sure-Tite connectors

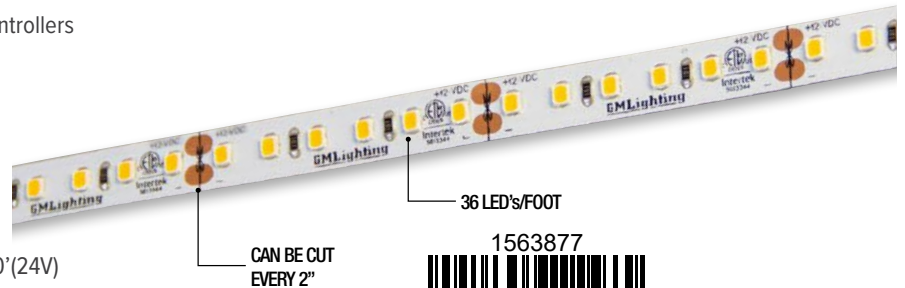

36 LED's/FOOT

1563877



NEW!! GM Lighting LTR-P-12V-1.5W-30K-16 16' LED Tape 1.5W 3000K [1563877]

Wet Location, 24VDC 1.5W / 3.0W / 5.8W LED Tape Specification Sheet

PRODUCT OVERVIEW

GM's Professional Outdoor Series Flexible LED Tape combines style and technology with reliability for wet location. Designed for professional installations that demand a high level of quality, the LTR-P Series boasts a wide array of key features and is available in 16'-4" (5M) reels or custom cuts. Do not submerge in water.

FEATURES

- 24VDC
- 2400K, 2700K, 3000K, 3500K, 4000K and 5000K as well as Amber, Red, Green, Blue color temps
- Remote control with GM's LUXcontrol™ App and controllers (requires NEMA box - by others)
- LM80 / IP65
- 120 LEDs per meter
- Cuttable every 2"
- Wet location
- Optical clear UV protected silicone sheath
- Premium diodes
- 120° viewing angle
- Dimmable
- Maximum run on a given lead is 60' (1.5W), 32'-8" (3.0W), 16'-4" (5.8W)
- Custom lengths available - consult factory

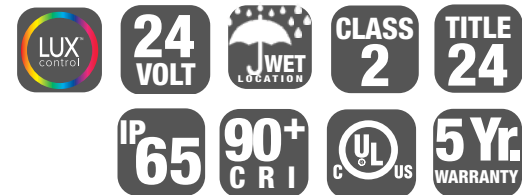

36 LED's/FOOT

1582143



NEW!! GM Lighting LTR-P-WP-24V-1.5W-30K-16 16' Wet Location LED Tape 1.5W 3000K [1582143]

NEW PRODUCTS!



TWX LED

Innovative Glass Wall Packs



1656273



NEW!! Lithonia Lighting TWX1-LED-ALO-40K-MVOLT-DDBTXD 36W LED WALL PACK LUMEN SELECTABLE 4000K 120/277V [1656273]



1655909



NEW!! Lithonia Lighting TWX2-LED-ALO-40K-MVOLT-DDBTXD 54W LED Wall Pack Lumen Selectable 4000K 120/277V [1655909]

1653599



NEW!! Lithonia Lighting TWX2-LED-ALO-50K-MVOLT-DDBTXD 54W LED Wall Pack Lumen Selectable 5000K 120/277V [1653599]



1654960



NEW!! Lithonia Lighting TWX3-LED-ALO-40K-MVOLT-DDBTXD 108W LED Wall Pack Lumen Selectable 4000K 120/277V [1654960]

1656166



NEW!! Lithonia Lighting TWX3-LED-ALO-50K-MVOLT-DDBTXD 108W LED WALL PACK LUMEN SELECTABLE 5000K 120/277V [1656166]



NEW PRODUCTS!

Contractor Select™

EXRG

Lithonia Lighting Basics™

LED Exit



† Exit Signs Certified in the CA Title 20 Appliance Efficiency Database.



1668333



NEW!! Lithonia Lighting EXRG-EL-M6
Switchable Red/Green LED Exit Sign
W/Battery Back Up [1668333]

NEW PRODUCTS!

Contractor Select™

ECRG

Lithonia Lighting Basics™

Emergency Light/Exit Combo



† Exit Signs Certified in the CA Title 20 Appliance Efficiency Database.



1673851



NEW!! Lithonia Lighting ECRG-RD-M6
Switchable Red/Green LED Exit/
Emergency Combo Sign [1673851]

SMARTBUYS

Pricing valid September 1 - October 31, 2021



Not all products available at all locations. Please speak to your Capital Electric Sales Representative for more information. Capital Electric is not responsible for misprints or typos. Prices are subject to change without notice.

NEW PRODUCTS!

SMARTBUYS

Pricing valid September 1 - October 31, 2021



1691476



NEW!! Sylvania WRAP2A/S044UNVD8SC7/48U/WH (62178) 44W LED SURFACE WRAP FIXTURE COLOR SELECT 3500/4000/500K [1691476]

- Diffuse acrylic lens delivers smooth, even illumination
- CCT selectable (3500K, 4000K or 5000K color temperature)
- Lumen selectable (22, 28, 34 or 44 watt) or dedicated 22W and 68W versions available for rebate and high wattage opportunities
- Innovative lens design eliminates LED pixilation and light-leaks on all sides of the fixture while still enabling simple, toolless removal of the lens during installation
- Internally mounted motion/daylight sensor and battery back up options increase the versatility of this product line
- DLC Premium listing maximizes rebate opportunities
- Up to 130 LPW
- CRI >80
- Energy savings up to 43%
- Optional 8W battery back-up on 4' products provides
- 1000 lumens for 90 minutes

1208784



NEW!! Sylvania LED42T8FA8L96FGP840BF (41196) 8FT T8 LED BAL- LAST BYPASS LAMP SINGLE PIN 4000K [1208784]

1675320



NEW!! Sylvania LED42T8FA8L96FGP850BF (41197) 8FT T8 LED BAL- LAST BYPASS LAMP SINGLE PIN 5000K [1675320]

1703211



NEW!! Sylvania LED42T8R17DL96FGP840BF (41200) 8FT T8 LED BALLAST BYPASS LAMP HIGH OUTPUT END 4000K [1703211]

1703212



NEW!! Sylvania LED42T8R17DL96FGP850BF (41201) 8FT T8 LED BALLAST BYPASS LAMP HIGH OUTPUT END 5000K [1703212]

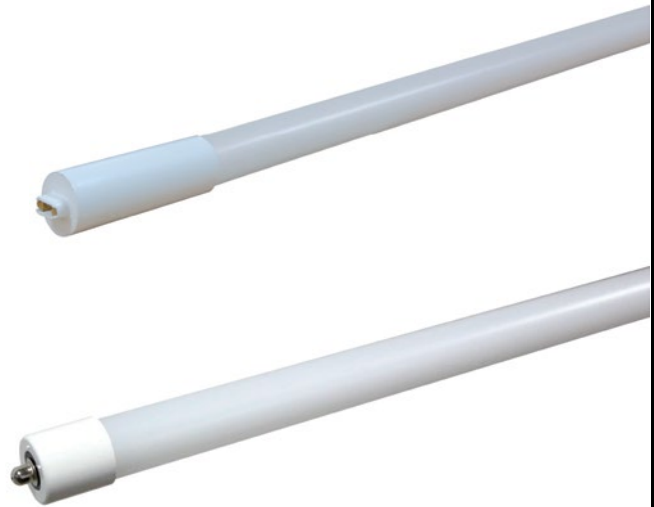

LEDlescent T8HO Ballast-Free lamps are an energy saving alternative, designed to replace traditional fluorescent T8/T12 lamps by bypassing the existing ballast. These LED T8 lamps contain no mercury, provide instant light and a uniform light distribution. Engineered to operate directly on 120-277V, these lamps minimize labor and recycling costs. These lamps can be used with occupancy and vacancy sensors for enhanced energy savings. When installing the LEDlescent T8 lamps, the UL rating of the existing fixture is not voided (even when it is electrically modified) since our LEDlescent T8 lamp is UL Classified (as a luminaire conversion retrofit kit) under UL standard 1598C. UL1598C is the standard covering LED retrofits intended for an existing UL rated fixture. Since the user is retrofitting with a UL1598C classified LED kit, the installer must follow the installation instructions included with the lamps for the modified fixture to retain its UL rating.

SYLVANIA Luminaires

NEW PRODUCTS!

UltraLED™ Mini Wallpack

Application

The UltraLED Mini Wallpack luminaires are environmentally preferable LED alternatives to traditional HID luminaires, offering up to 70% in energy savings. Ideal in place of traditional luminaires, or as new installations, the Mini wall pack series is offered in several wattages/lumen packages for illuminating building exteriors, outdoor corridors, walkways, and stairwells.

Benefits and Features

- CCT Selectable (3000K, 4000K, or 5000K) enabled through switch located inside fixture
- IP65 rated body with aluminum backplate and polycarbonate lens offers easy mounting, reducing installation and maintenance costs
- High color rendering and DLC Premium listing ensure energy efficiency and provide uniform and even lighting
- Photosensor included provides additional energy savings
- Up to 130 LPW
- Selectable CCT of 3000, 4000, or 5000K
- CRI >80
- Offered in 15, 20 and 30 watts
- Non-cutoff distribution
- Energy savings up to 70%

Electrical

- 120-277VAC
- Power Factor >90%
- THD <20%
- 0-10V dimmable

Rated Life

- 150,000 hours (L₇₀)

Warranty

- 5-year

Ambient Operating Range

- -40°F to +104°F (-40°C to +40°C)



Wattage Comparison

Traditional Source	Traditional System Wattage	LED System Wattage	Energy Savings
23W CFL	23	15	35%
35W HPS	45	15	67%
42W CFL	46	15	67%
50W HPS	62	20	33%
50W MH	62	20	68%
100W Incandescent	100	30	68%
150W Incandescent	150	30	70%

Certifications and Listings

- cULus
- RoHS
- FCC
- DLC Premium
- IP65

Installation

- Luminaire mounts to recessed outlet box or can be surface mounted

1685755



NEW!! Sylvania MWLPAKN1A/015UNVDSC2/BZ/P 15W LED Mini Wallpack Color Select Bronze [1685755]

1685756



NEW!! Sylvania MWLPAKN1A/020UNVDSC2/BZ/P 20W LED Mini Wallpack Color Select Bronze [1685756]



LEDLUM093 11-20



NEW PRODUCTS!



Fail-Safe

GAW Germicidal Air Wall Mount

- Able to be used in occupied spaces
- Designed to use the latest in Germicidal UV source technology
- Compact 2ft length
- Large area of coverage
- Horizontal distribution keeps GUV in upper air
- UL 1598 Listed
- Minimum Ceiling Height of 9'
- Minimum Mounting Height 8'3" to bottom of the fixtures
- Professional layouts can be completed by Cooper Lighting Solutions upon request

1629745



NEW!! Cooper Lighting Solutions
GAW-2-1GUV20W-UNV-R1-W [1629745]



Fail-Safe

GAC Germicidal Air Ceiling Mount

- Able to be used in occupied spaces
- Designed to use the latest in Germicidal UV source technology
- Compact 2ft length
- Large area of coverage
- Horizontal distribution keeps GUV in upper air
- UL 1598 Listed
- Minimum ceiling height of 9'
- Minimum recommended spacing is 12' on center and 6' from nearest wall
- Professional layouts can be completed by Cooper Lighting Solutions upon request

1629748



NEW!! Cooper Lighting Solutions
22GAC-4GUV9W-UNV-R1-W [1629748]

Pure protection against bacteria and viruses using the power of light



Trusted

35 years experience in UV-C disinfection and strong application expertise.



Effective

Proven effectiveness against bacteria, mold, mildew, and viruses.



Continuous

Can be used in occupied spaces.



Versatile

Can be used in numerous applications.

SMARTBUYS

Pricing valid September 1 - October 31, 2021



Top Product Features

- Selectable CCT: 2700K, 3000K, 3500K or 3000K, 4000K, 5000K
- Smooth splay
- Direct mount – does not require recessed housing or junction box
- Dimmable down to 10%
- Perfect for new construction or remodel work



HALO

LT3 Direct Mount

3" LED Direct Mount Module
500 Lumen Series

Typical Applications
Residential

1679492

NEW!! Cooper Lighting Solutions
 LT3059FS231EWHDMR [1679492]



HALO

LT4 Direct Mount

4" LED Direct Mount Module
600 Lumen Series

Typical Applications
Residential

1679491

NEW!! Cooper Lighting Solutions
 LT4069FS231EWHDMR [1679491]



HALO

LT6 Direct Mount

6" LED Direct Mount Module
800 Lumen Series

Typical Applications
Residential

1679490

NEW!! Cooper Lighting Solutions
 LT6089FS231EWHDMR [1679490]

NEW PRODUCTS!



Lumark

LAS

Area / Site Luminaire

Typical Applications

Outdoor • Parking Lots • Walkways • Building Areas

Quick Facts

- 10-position lumen selectable across 2 housing sizes
- Lumen packages range from 4,900 - 34,000 lumens (30W - 250W)
- Replaces up to 450W and 1,000W HID equivalent
- Efficacies up to 135 lumens per watt at maximum output
- Energy and maintenance savings up to 79% versus HID solutions

Product Certifications



Product Features



1633220



NEW!! Cooper Lighting Solutions LAS45S-T4 152W LED Area Light W/Slipfitter 120/277V [1633220]

1635609



NEW!! Cooper Lighting Solutions LAS100S-T4 250W LED Area Light W/Slipfitter 120/277V [1635609]

SMART BUYS

Pricing valid September 1 - October 31, 2021



Ideal Retrofit Ventilation Solution



FV-0511VFL1 [1697108]



FV-0511VF1 [1697956]
FV-0511VFC1 [1709135]



- Easy room-side installation.
- Now with DC motor for powerful CFM output to overcome 0.375" static pressure and effectively remove unhealthy air, regardless of complicated duct runs, to reduce callbacks and to meet codes.
- Pick-a-Flow™ high speed options of 50, 80 and 110 CFM to properly ventilate various room sizes, all in one fan.
- 5-5/8" deep housing fits in 2x6 ceiling joist.
- Virtually silent operation, as quiet as <0.3 sones.
- Quick and easy installation with included Flex-Z-Fast™ bracket. Also includes 4" to 3" plastic duct adapter with backdraft damper for better air tightness and to accommodate existing 3" ducting often found in retrofit applications.
- 6-year warranty.
- Available in fan only, and fan/dimmable LED light & nightlight, and fan/condensation sensor for hands-free operation and automatic moisture control.

Panasonic fans are whisper-quiet and UL-listed for tub/shower enclosures when used with GFCI protected circuit. LED-lighted model includes 10W dimmable LED chip panel with <1W LED nightlight for warm, long-lasting, energy-efficient illumination; 3000K, 90 CRI, 70 lumens per watt.

For over two decades, Panasonic has delivered innovative ventilation solutions that have set new standards for performance, energy efficiency, and quiet operation.

NEW PRODUCTS!

Signify



1662824



NEW!! Stonco by Signify SL20-SCT-G1-8-BK 20W LED Security Light, CCT Selectable 30K-40K-50K, 120-277V, Motion & Daylight Sensor, Black [1662824]



1662831



NEW!! Day-Brite by Signify NWL440L8CST-UNV-DIM-OCC 4ft LED Wraparound Fixture, 4000 Lumens, Color Selectable 3000K-3500K-4000K, 80 CRI, Occupancy Sensor [1662831]



1662827



NEW!! Stonco by Signify GC60-SCT-G2-SM-5-10-BZ 60W LED Garage & Canopy Fixture, CCT Selectable 30K-40K-50K, Surface Mount, 120-347V, Bronze [1662827]

1662828



NEW!! Signify GC90-SCT-G2-SM-5-10-BZ 90W LED Garage & Canopy Fixture, CCT Selectable 30K-40K-50K, Surface Mount, 120-347V, Bronze [1662828]

SMART BUYS

Pricing valid September 1 - October 31, 2021

 **Capital Electric**
A Sonepar Company

WE PROTECT



We protect the most hazardous environments

For product solutions that span virtually every aspect of safety and security, turn to Federal Signal. You'll discover the world's most extensive product line of hazardous location, explosion-proof and safe area products designed to meet or exceed UL, ATEX, IECEx and other global certifications.

 **FEDERAL SIGNAL**
Safety and Security Systems
Protecting people and our planet

HUBBELL®
Wiring Device-Kellems

WATERTIGHT WIRING DEVICES

For the Most Demanding Environments.



The Watertight Wiring Devices line can stand up to regular facility wash-downs, survive mud and standing water, and withstand severe weather exposure.

Typical Applications

- Food Processing
- Water Treatment
- Agriculture
- Outdoor Entertainment
- Amusement Parks
- Factories



HUBBELL®
Wiring Systems





Most Connected Smart Lighting Control

Caséta works with more smart home devices than any other smart lighting control brand.

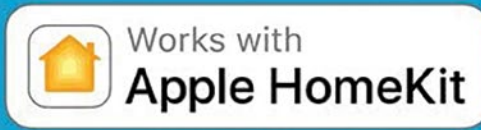

1056335



Lutron P-BDG-PKG1W CASETA SMART DIMMER KIT WITH BRIDGE [1056335]

Caseta by Lutron Starter Kit with Smart Bridge, In-wall Dimmer (1), Claro Wallplate (1), Pico Remote (1); 150 W CFL & LED, 600 W Inc/Hal, 120V



NEW PRODUCTS!



1664204



NEW!! Lutron PD-150UT-BL Caseta Outdoor Smart Plug, Weatherproof, Black [1664204]

SMARTBUYS

Pricing valid September 1 - October 31, 2021



Not all products available at all locations. Please speak to your Capital Electric Sales Representative for more information. Capital Electric is not responsible for misprints or typos. Prices are subject to change without notice.



NEW PRODUCTS!



1494141



NEW!! Lutron STCL-153PH-WH Sunnata LED+ Touch Dimmer, for LED, CFL, Incandescent & Halogen Lamps, White [1494141]



702672



NEW!! Lutron MS-OPS2-WH Maestro PIR Occupancy Sensor Switch 2A 120V [702672]



1622538



NEW!! Lutron RCL-153PNLH-WH Dalia Rotary Dimmer LED/CFL/INC/HAL 1P/3W [1622538]



SIGN HERO 360
DOUBLE-SIDED LED SIGN TUBE

Why our customers love it:

Quick and easy installation: No external driver/ballast needed

Versatile: Perfect for retrofits or new installations

Consistent lighting: No hot spots at 6" from the face of the sign and 360° illumination

Built to last: Plastic and aluminum construction

LED LAMPS | FIXTURES | DRIVERS | LED RETROFIT KITS | BALLASTS

See your Capital Electric Sales Representative for more information.

See your Capital Electric Sales Representative for more information.

FLUKE®

Fluke infrared windows limited time offer

Save time on infrared inspections,
outfit your facility today

- Safely and easily perform thermal scans without opening up a panel
- No need to lock-out tag-out, simply open the IR window and perform your inspection

Get up to
**30%
off**



Offer valid July 5, 2021
through December 31, 2021

**By Special Order Only*

Ordering information

IR Window models	Fluke part number	Description	MSRP	Promo price
FLK-050-CLKT	3460346	2 IN (50MM) C-RANGE IR WINDOW	\$207.99	\$142.99
FLK-075-CLKT	3460387	3 IN (75MM) C-RANGE IR WINDOW	\$311.99	\$211.99
FLK-100-CLKT	3460439	4 IN (100MM) C-RANGE IR WINDOW	\$415.99	\$315.99
FLUKE-CV200	4326955	2 IN (50 MM) IR WINDOW	\$259.99	\$194.99
FLUKE-CV300	4326962	3 IN (75 MM) IR WINDOW	\$383.99	\$263.99
FLUKE-CV301	4338164	3 IN (75MM) IR WINDOW	\$384.99	\$284.99
FLUKE-CV400	4326996	4 IN (100 MM) IR WINDOW	\$519.99	\$419.99
FLUKE-CV401	4338173	4 IN (100MM) IR WINDOW	\$545.99	\$445.99

©2021 Fluke Corporation. 06/2021 210583-en

NEW PRODUCTS!



RAB®

1652117



NEW!! RAB DSK4R79FA120WS 4" Round Surface Mount LED Trim w/Color Select [1652117]

1653293



NEW!! RAB DSK6R119FA120WS 6" Round Surface Mount LED Trim w/Color Select [1653293]

Features:

- Low profile back-lit design
- Durable thermoplastic housing with frosted lens
- New construction or retrofit applications
- Installs on standard junction boxes
- Suitable for wet locations
- Suitable for use in closets when installed in accordance with NEC guidelines
- Dimmable down to 5% on compatible dimmers
- 5-Year, Limited Warranty

SMARTBUYS

Pricing valid September 1 - October 31, 2021





Electrical safety has many rewards.

Including electronics, tools, camping, tailgating and fishing gear

When you purchase Square D Safety Switches you not only get the **industry's longest lasting, most durable switches** and the **highest standards in safety, reliability, efficiency and innovation**, but the benefits that come with being a part of our **Contractor Rewards Program**.



Easily earn points by uploading your receipt via the **mySchneider app** and redeem your points for a variety of great rewards.

See your Capital Electric Sales Representative for more information.











Wiser Energy System

Residential Energy Monitoring

Wiser Energy™ System from Square D, is an integral part of any smart home. It helps you keep tabs on your home by notifying you when devices are on or off and monitors energy usage in real time, for a safer and more efficient home.

Adding Wiser Energy to your electrical panel will allow you to make your home safer, greener and more efficient

-  Easy to use intuitive mobile app from Sense
-  Always learning and self identifies devices in your home
-  Set custom alerts for devices in your home such as when the garage door opens, the sump pump turns on, or when the dryer's done
-  Displays energy consumption by appliance, i.e. refrigerator or pool pump, air conditioner or electric hot water heater
-  24/7 real-time view of energy consumption and production (Solar)
-  Set budgets to manage your energy expenditures before you get a bill
-  Simple installation into new or existing electrical panel, by certified electrician

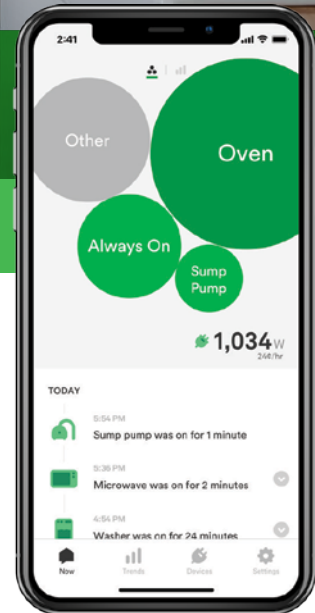

Works with a growing list of smart devices like Alexa®, Google Home™, Philips Hue, Wemo® Insight™ and Kasa™ smart plugs.

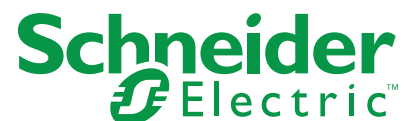

See your Capital Electric Sales Representative for more information.

NEW TEST & MEASUREMENT PRODUCTS

TightSight® Clamp Meters



61-775
1000A AC/DC Clamp Meter
TightSight™ w/Backlight



61-765
660A AC/DC Clamp Meter
TightSight™ w/Backlight



61-757
600A AC/DC Clamp Meter
TightSight™ w/Backlight & Flashlight



61-747
400A AC/DC Clamp Meter
TightSight™ w/Backlight & Flashlight



61-415
200A AC/DC Split-Jaw™ Clam Meter
TightSight™ w/Backlight & Flashlight

Conventional Clamp Meters



61-737
400A AC Clamp Meter
4000 Count & Flashlight



61-405
200A AC Clamp Split-Jaw™ Meter
w/Backlight & Flashlight

THE ELECTRICIAN'S
CHAMPION™ **IDEAL**®

See your Capital Electric Sales Representative for more information.

NEW TEST & MEASUREMENT PRODUCTS

Multimeters



61-357

1000V Auto Range TRMS Multimeter
6000 Count Display w/ NCVT, Temp,
Bar Graph & LoZ



61-337

600V Auto Range Multimeter
w/ NCVT & Temp



61-327

600V Manual Range Multimeter
w/NCVT

Non-Contact Voltage Testers



61-647

Single Range
50 to 1000V AC
NCVT w/Flashlight



61-627

Single Range
50 to 600V AC
NCVT

Dual Laser Infrared Thermometer



Dual Laser
Targeting

61-847

Dual Laser Targeting
12:1 Infrared Thermometer

Receptacle Tester



61-517

120V AC GFCI Receptacle/Voltage Tester

THE ELECTRICIAN'S
CHAMPION™ **IDEAL**®

See your Capital Electric Sales Representative for more information.

NEW PRODUCTS!

KICHLER®

Kichler 56" 3 Blade Industrial Style Ceiling Fan



1301915



NEW!! Kichler 330025WH 56" 3 Blade Industrial Style Ceiling Fan White

[1301915]



1217286



NEW!! Kichler 330025SBK 56" 3 Blade Industrial Style Ceiling Fan Black

[1217286]

SMARTBUYS

Pricing valid September 1 - October 31, 2021



1019321



BRK 9120LBL First Alert Hardwired Ionization Smoke Alarm - 10 Year Lithium Battery Backup with Locked Battery Drawer [1019321]



1262584



BRK 7020BSL (1038335) Smoke Alarm And Strobe Light Wire In with 10 Yr Sealed Lith Battery [1262584]

INSTALL IT DONE

10 YEAR 10



10-Year
Battery



10-Year
Sensor



10-Year
Warranty

BRK[®]

THE PROFESSIONAL STANDARD

TRUSTED, RELIABLE PROTECTION SINCE 1958

See your Capital Electric Sales
Representative for more information.



1019321 Mfg# 9120LBL
Hardwired Smoke Alarm
with 10-Year Battery Backup



Conforms to
UL STD 217

1038335 Mfg# 7020BSL
Hardwired Smoke Alarm
with LED Strobe and
10-Year Battery Backup



Conforms to
UL STD 217 &
UL STD 2034

© 2021 BRK Brands, Inc. All rights reserved. Distributed by BRK Brands, Inc., Aurora, Illinois 60504. BRK Brands, Inc. is a subsidiary of Honeywell International Inc. (NYSE: HON).

UL 217 8TH EDITION UPDATE



WHAT IS UL 217 8TH EDITION?

An update to the UL standard will go into effect ~~June 30, 2021~~ for all manufacturers of smoke and combination smoke and carbon monoxide alarms.

Alarms produced after this date must be compliant to the performance requirements as specified in the UL 217 8th edition Standard for Safety for Single and Multiple Station Smoke Alarms. The implementation date applies to the date of manufacture and does not prohibit the continued sell through of any inventory on hand at our BRK distribution center or in stock at electrical distributor locations at the time of the transition. Alarms manufactured prior to the transition date can continue to be installed in compliance with local building code requirements and job site specifications.

UPDATE TO UL STANDARD DELAYED UNTIL JUNE 30, 2022

WHY AN UPDATE?

Research by fire industry experts found that fire dynamics in a home have changed over the last several decades. According to UL, newer synthetic materials in the home, more open layouts and lighter construction materials all burn hotter and faster. This research led the industry experts and UL to create new performance requirements for certain types of flammable material fires, such as polyurethane foam.

According to the National Fire Protection Association (NFPA), nuisance alarms are a leading reason for disconnected smoke alarms. To enable manufacturers to produce more responsive alarms that do not cause nuisance alarms during cooking, UL conducted a research project to develop data on smoke characteristics during normal cooking events. This research led to new test requirements for nuisance alarm tests.

EFFECTIVE DATE CONFIRMED - JUNE 30, 2022 PER UL BULLETIN

UL 217 8th Edition Affects all smoke and combination alarms



NEW TEST PARAMETERS:

- 1 Responsive to changes in home and finish materials
- 2 More stringent nuisance alarm criteria
- 3 More than 200 technical changes to the standard

UL and the UL logo are trademarks of UL LLC © 2020.

ESCAPE TIMES IN HOME FIRES HAS DECREASED OVER THE LAST 40 YEARS

APPROX.
17 MIN
1978

Natural materials and furnishing

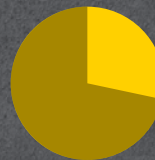

APPROX.
3 MIN
2018

Synthetic materials and open floor plans

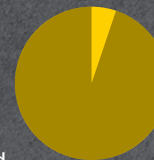

Source: Smart Smoke Alarms and New UL Testing Standards. Presentation to International Fire Chiefs Association (IFCA) October 11, 2019, ifca.org



PRECISION DETECTION TECHNOLOGY

Precision Detection is First Alert's advanced sensing technology that will be used for all smoke and combination alarms in that comply with UL 217 8th edition revised smoke alarm standards.

Early Warning



There have been significant changes in home furnishing and finish materials over the past 30 years. Most modern-day household furniture are made from synthetic materials, which burns faster. First Alert Precision Detection technology gives you more time to escape in the event of an emergency as they detect smoke faster and provide early warning.

Less Cooking Nuisance



First Alert Precision Detection technology smoke alarms will help distinguish between nuisance alarms and a fire emergency. Three of every five home fire deaths resulted from fires in homes with no working smoke alarms and the #1 reason why people disable smoke alarms is due to nuisance cooking alarms. (UL)



Legrand Cablofil Cable Trays

The Cablofil Wiremesh Cable Tray concept is based upon performance, safety and economy; three qualities which make Cablofil Wiremesh Cable Tray system preferred by installers. Cablofil adapts to the most complex configurations, and its structure gives maximum strength for minimum weight. The ease of creating fittings, carried out on site, as well as the wide range of unique and universal accessories gives complete freedom in routing combined with exceptionally fast installation.

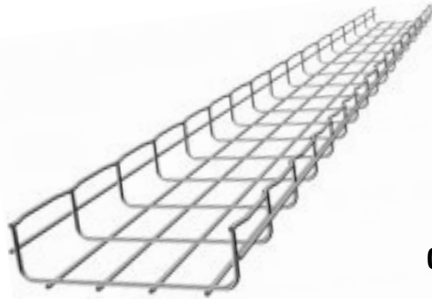

96225

**Cablofil Legrand
CF54/200EZ
Cable Tray** [96225]

322154

**Cablofil Legrand
CF54/150EZ
Cable Tray** [322154]

96583

**Cablofil Legrand
CF54/300EZ
Cable Tray** [96583]



94440

**Cablofil Legrand
CF105/300EZ
Cable Tray** [94440]

95190

**Cablofil Legrand
CF105/450EZ
Cable Tray** [95190]

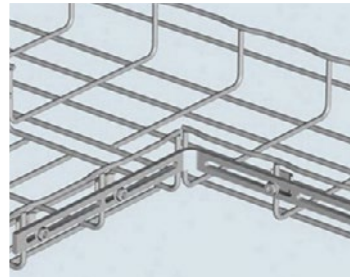

99642

**Cablofil Legrand
EZT90EZ
90° Bend and T Kit** [99642]

Flexible VFD Cable

- 600V to 2kV
- Oil Res I & 2
- XLPE Insulation
- NFPA 79 Compliant
- Sun Res & Direct Burial Approved



EMC Shielding Glands & Grounding Kits Available



Not all products available at all locations. Please speak to your Capital Electric Sales Representative for more information. Capital Electric is not responsible for misprints or typos. Prices are subject to change without notice.

Non-Metallic Mounting Bases

for Meters, AC Disconnects, Timers, Generator Inlet Boxes, and more



Arlington's one-piece, non-metallic Mounting Bases provide a smooth, flat mounting surface for most electric meters, including the largest sizes – as well as a variety of other products such as disconnects, timers, inlet boxes and more.

Designed for easy use, squared-off corners provide 'gangability' so installers can create a custom-sized mounting base for the product they're installing.

Available in a variety of sizes, our mounting bases install on siding and other surfaces. They work on any siding type, and install before or after the siding goes up.

They also help meet the NEC 2020 code requiring an outside disconnect for AC and other service.

Sizes (inches)

- **MM7** 5x7 **NEW!**
- **MM10** 7x10
for meters, disconnects, time clocks, pool panels, cable TV boxes, etc
- **MM18** 17-5/8 x 15-7/8
- **MM23** 23 x 17-5/8
for meters, as shipped and gangable, to accommodate most meter sizes

- UV-rated plastic for long outdoor life
- Paintable, textured surface

Pre-formed J-channel covers cut ends of siding



Mounts Meters...



Cable TV boxes...



Time clocks...



Disconnects...



Vents and more



Arlington®

NEW PRODUCTS!



NEW!! Arlington VB1 Vapor Barrier Cover [1583901]

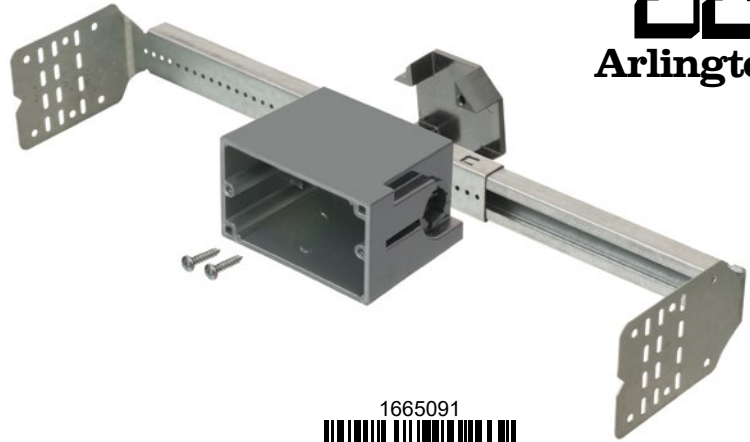

NEW!! Arlington SL1B18 SliderBar 1G box kit [1665091]

Minerallac[®]
Company

Cully



Minerallac Cully 39515 6-32 WALL PLT SC KIT [211205]



Minerallac Cully 39536 1/4-20 COMBO RHMS KIT [280692]



Minerallac Cully 39525 6-32 RHMS SCREW KIT [946126]



Minerallac Cully 39541 6-32 FH MACHINE SCREW KIT [314130]



Minerallac Cully 39526 8-32 COMBO RHMS KIT [130758]

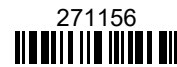

Minerallac Cully 62006 1/4IN TAPCON KIT [271156]



851690

**3M SF202AF Securefit
 Gray Anti-Fog Lens
 20/Case Protective
 Eyewear** [851690]



SMARTBUYS

Pricing valid September 1 - October 31, 2021



578993

**3M Industrial Safety
 11228-00000-100 Clear
 Temple Uncoated Lens
 Protective Eyewear** [578993]

3M Comfort Grip Gloves offer a comfortable alternative to the traditional cotton and leather work glove. The gloves are designed to offer a comfortable, breathable fit and are perfectly suited for applications where hand flexibility and dexterity are needed. The coated palm provides gripping ability in wet or oily applications. The Comfort Grip Cut Resistant gloves are an excellent choice for applications when working with sharp tools or edges. The 3M Comfort Grip Winter Gloves helps keep hands warm in colder climates.



898758

**3M CGXL-GU
 General Use Extra
 Large Comfort Grip
 Gloves** [898758]



30373

**3M 8428-12 Cold Shrink Connector
 Insulators** [30373]

16263

**3M 8427-12 Cold Shrink Connector
 Insulators** [16263]

22199

**3M 8426-9 Cold Shrink Connector
 Insulators** [22199]

878555

**3M CGL-CR Cut
 Resistant Large
 Comfort Grip Gloves**
 [878555]



60077

**3M MPP+7X7 Fire Barrier
 Moldable Putty Pad,
 Red, 7" x 7"**
 [60077]



33476

**3M CP-25WBPLUS-10.10Z
 Fire Barrier Sealant, Red,
 10.1 fl.oz Cartridge** [33476]

MACTM BLOCK

Splice & Tap Connectors



- Splice or tap up to 8 conductors
- Variable conductor sizes per port
- Conductor range: 6-18 AWG, 6-14 FLEX
- Connector rated for 90°C, 300 volts
- Insulated cover rated to 105°C
- Certified for power and grounding
- Retrofit aluminum to copper connections
- Widest conductor range in the industry
- Runs on average 35°F cooler than leading twist-on connectors
- Secureness strength 2.5 times higher than that of leading twist-ons

See your Capital Electric Sales Representative for more information.

ILSCO[®]

PRODUCT LAUNCH

Plugload Controllable Receptacles

Half & Dual Controllable Decorator Receptacles

PASS & SEYMOUR



Product Features & Benefits

.032 inch thick, brass, triple-wipe power contacts for lasting retention.

Two drive screws anchor strap to back body and face where abrupt removal torque is strongest.

Can be used to control loads using WattStopper® DLM and other building control systems.

Also available: Half-controlled version, that features a factory-broken split-circuit tab, allowing for half of the receptacle to be controlled.



26352CD-GRY

Auto-ground clip assures positive ground.

Controlled receptacle marking is NEMA-approved and compliant with 2014 NEC®.

Corrosion-resistant, plated steel strap locked into face and back body to resist pulling away from face/body assembly.

Tri-drive steel terminal screws. Internal screw-pressure-plate back and side wire capability. Two back wire holes for more wiring flexibility.



PASS & SEYMOUR®
 Specification Grade Weather-Resistant USB Charging Receptacles
 15 & 20A, Tamper-Resistant

Spec and install the toughest outdoor USB charging receptacle in the industry

WRTR15USBAC6, WRTR20USBAC6

Features & Benefits

Posted terminal screws and external back-wire pressure plates for more productive and reliable terminations.

AC USB receptacles available in 15 and 20A, 125V Specification Grade and Hospital Grade.

- Complies with Section 406.9 of the National Electrical Code for weather resistance. Multiple color options available.*
- Efficient power supply meets the Department of Energy (DoE) Level VI no-load power requirement of 100mW max for external power supplies.

*Must be installed with a weatherproof cover. It is recommended that these devices are installed in a wall box measuring at least 3" x 2" x 2-1/2" to ensure proper NEC Article 314 box fill requirements. For retrofit applications a Weatherproof extension ring may be required on boxes with less depth than 2-1/2".



WRTR20USBAC6LA

Available with (1) USB Type-A & (1) USB Type-C port or (2) USB Type-C ports to charge the latest mobile devices.

Reinforced nylon USB Type-A ports to withstand abuse over the life of the product.

Type-A and Type-C ports carry a minimum rating of 10,000 insertions.

AC USB receptacles are tamper-resistant to meet NEC. Patented shutter system - now with black "invisi-shutters" for an invisible effect preferred by end-users - helps prevent improper insertion of foreign objects.

Stainless steel auto-ground clips assure positive ground.



3rd Party Compliance



cULus Listed, UL Listed
 Complies with test requirements UL 498, UL 1310, Federal Specification WC-596,
 CSA C22.2 No. 42, CSA C22.2 No. 223

See your Capital Electric Sales Representative for more information.



1258895



iTOOLco GRD01 Ground Rod Dawg [1258895] Item not in stock - special order only.



1609758



iTOOLco AJ01 All Jack [1609758]



1229533



iTOOLco C6K-2 6K Cable Puller [1229533]



1476459



iTOOLco CM3K 3000LB Cordless Puller [1476459]

iTOOLco. **SMARTBUYS**

Pricing valid September 1 - October 31, 2021





1679098



Ridgid 64058 STRUTSLAYR™ Strut Shear Head

[1679098] Item not in stock - special order only.

The RIDGID® STRUTSLAYR™ delivers fab shop quality, burr-free strut channel cuts on the jobsite in 5 seconds or less. Compatible with RIDGID 32kN press tools*, the STRUTSLAYR strut cutter offers a clean, consistent cut with a simple pull of a trigger: no grinding or sawing sparks! *Press tools are not included. Not compatible with RIDGID 320-E or CT-400.

Increased Efficiency - Clean, consistent cuts in 5 seconds or less

Safe Operation - No grinding or sawing sparks

Portable - Easy to move around the job site and mounts to RIDGID TRISTANDs

Built-in Measuring Guide - Allows accuracy on the job site



1672393



Ridgid 67063 Press Tool [1672393] Item not in stock - special order only.

The RIDGID RP 350 features a brushless motor that is capable of over 100,000 press cycles and requires no scheduled maintenance. Get access to hard-to-reach locations with endless 360° swivel. With the most advanced LED interface and lighting, the RP 350 has been upgraded from top to bottom. It's also the only press tool in the industry compatible with all RIDGID Standard Series jaws, rings, actuators, and attachments.

Durable - Brushless motor capable of over 100,000 press cycles

Relentless - No scheduled maintenance

Agile - Endless 360° head swivel for reaching tight spaces

Smart - Bluetooth connectivity and advanced upgraded color-coded light indicators for easy operation

Bright - Robust LED lighting for low-light applications

SMARTBUYS

Pricing valid September 1 - October 31, 2021





c **UL** US
LISTED

G10 TUGGER™

10,000 lb. Puller

Hands Down Faster. Period.



Up to **2X FASTER***



1578682



Greenlee G10 (52087817)

[1578682] Item not in stock - special order only.

1578684



Greenlee G10-C G10 TUGGER with Chain Mount (52087818)

[1578684] Item not in stock - special order only.

1578683



Greenlee G10-F G10 TUGGER with Floor Mount (52087819)

[1578683] Item not in stock - special order only.

1578685



Greenlee G10-MVB G10 TUGGER with Mobile VersiBoom™ including 2-1/2", 3" and 4" Adapters

[1578685] Item not in stock - special order only.

G10 TUGGER™

10,000 lb. Puller

Hands Down Faster. Period.

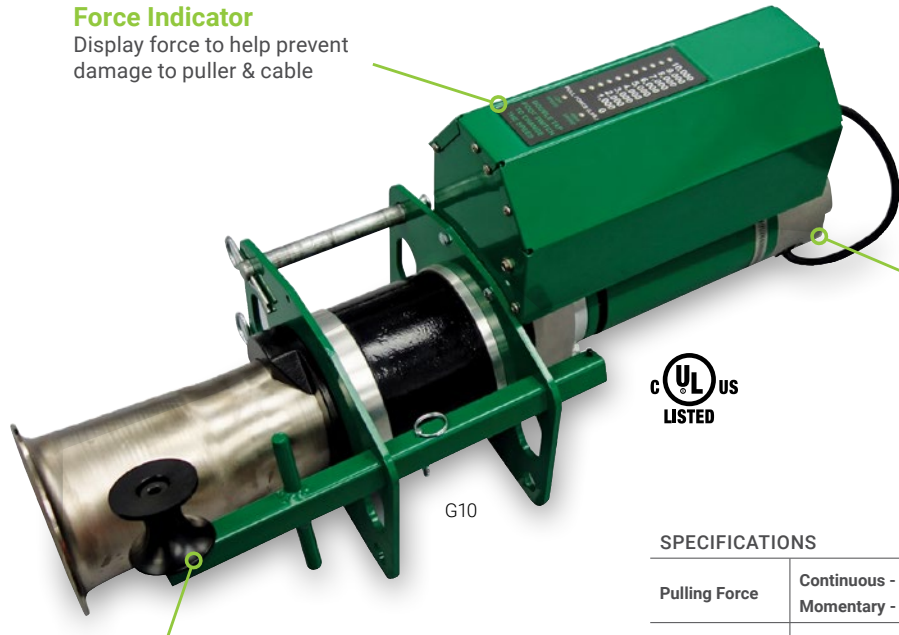

Force Indicator
Display force to help prevent damage to puller & cable

Right-Angle Sheave
Keeps operators out of direct line of pulls



Multi-Purpose Foot Switch
Control speed and start/stop operation with foot switch

New Specialized Dual-Speed Motor
Allows for faster pulls up to 10,000 lb.
Increases the productivity and reduces the risk of injury & strain



SPECIFICATIONS

Pulling Force	Continuous - 0 lb. to 8,000 lb. (0 kN to 28.9 kN)
	Momentary - 8,000 lb. to 10,000 lb. (35.6 kN to 44.5 kN)
Rope Size	7/8" Diameter Double-Braided, Polyester Composite, Rated at 32,000 lb. (143 kN) Recommended Rope - 34137
Motor	120 VAC, 60 Hz, Single Phase, 20 Amps
Capstan Speed with No Load	High Speed - 22.4 ft/min (6.8 m/min)
	Low Speed - 13.5 ft/min (4.1 m/min)
Weight (G10 Tugger Only)	100 lb. (45.4 kg)

Various Mount Systems Available*

Chain Mount



Floor Mount



Boom Mount



*Rope not included

See your Capital Electric Sales Representative for more information.

Professional. Nothing Less.™

Not all products available at all locations. Please speak to your Capital Electric Sales Representative for more information. Capital Electric is not responsible for misprints or typos. Prices are subject to change without notice.

NEW PRODUCTS!

KLEIN TOOLS®



1165450



NEW!! Klein Tools AEPJS1
Wireless Jobsite Speaker
[1165450]



1525981



Klein Tools AEPJS2
Bluetooth Speaker with
Magnetic Strap [1525981]



1692894



NEW!! Klein Tools AEPJS3
Bluetooth Jobsite Speaker with
Magnet and Hook [1692894]



1681117



NEW!! Klein Tools 56411
Rechargeable Waterproof
LED Pocket Light with
Lanyard [1681117]



1681115



NEW!! Klein Tools 56413
Rechargeable 2-Color LED
Flashlight with Holster [1681115]



1681114



NEW!! Klein Tools 56412
Rechargeable LED
Flashlight with Worklight
[1681114]



1681116



NEW!! Klein Tools 56414
Rechargeable 2-Color LED
Headlamp with Adjustable Strap
[1681116]

SMARTBUYS

Pricing valid September 1 - October 31, 2021



Discover Kraloy Water-Tight Junction Box Connections

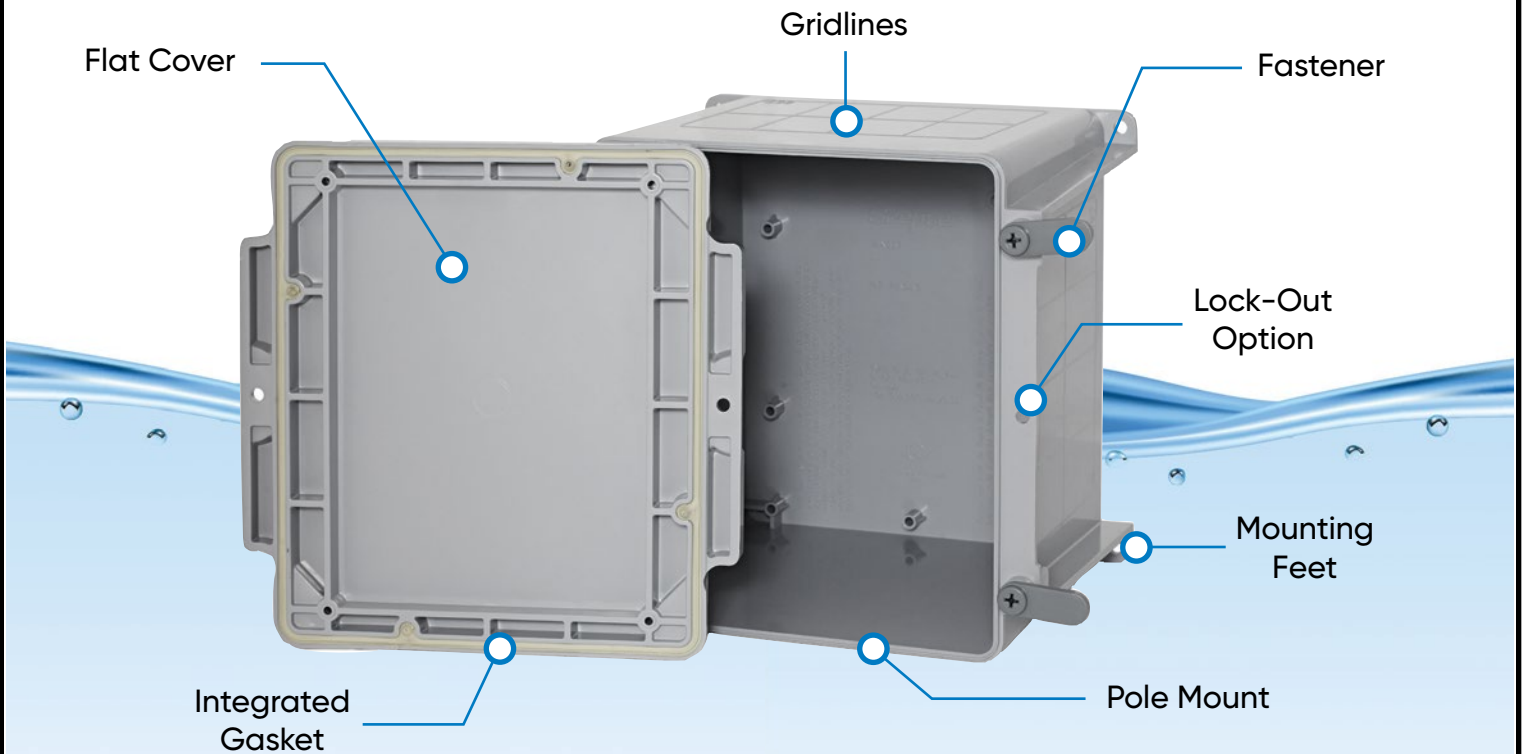

The Kraloy® JBox® is ideally suited for indoor and outdoor use and made to perform in the most demanding environments. Made of PVC, it is extremely durable and resistant to impact in a wide range of temperatures and not adversely affected by water and chemicals. Built for corrosive environments, the Kraloy JBox is entirely non-metallic, eliminating corrosion concerns with screws and other metal parts.

To ensure optimal water-tightness for PVC Conduit connection to PVC junction boxes (JB, JBX or JBXH), Kraloy suggests two possible solutions:

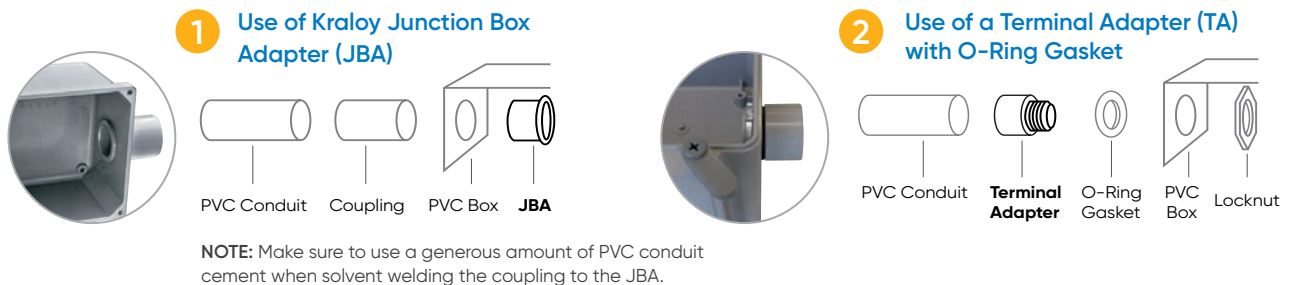

Products are manufactured by IPEX Electrical Inc. and distributed by Kraloy, a division of Multi Fittings Corp. Kraloy® is a trademark of Multi Fittings Corp.



See your Capital Electric Sales Representative for more information.



1644267

Milwaukee 204B-21L M12 Heated Toughshell Jacket Kit L (BLACK) [1644267]



1644268

Milwaukee 204B-21XL M12 Heated Toughshell Jacket Kit XL (BLACK) [1644268]



1644265

Milwaukee 204B-212X M12 Heated Toughshell Jacket Kit 2X (BLACK) [1644265]



1644282

Milwaukee 224C-21L M12 Heated Quietshell Jacket Kit L (Realtree Camo) [1644282]



1644283

Milwaukee 224C-21XL M12 Heated Quietshell Jacket Kit XL (Realtree Camo) [1644283]



1644279

Milwaukee 224C-212X M12 Heated Quietshell Jacket Kit 2X (Realtree Camo) [1644279]



1318247

Milwaukee 203B-21L M12 Heated Axis Jacket Kit L Black [1318247]



1318250

Milwaukee 203B-21XL M12 Heated Axis Jacket Kit XL Black [1318250]



1318282

Milwaukee 302B-21M M12 Heated Hoodie Kit M Black [1318282]



1318281

Milwaukee 302B-21L M12 Heated Hoodie Kit L Black [1318281]



1318284

Milwaukee 302B-21XL M12 Heated Hoodie Kit XL Black [1318284]



1318279

Milwaukee 302B-212X M12 Heated Hoodie Kit 2X Black [1318279]



1318280

Milwaukee 302B-213X M12 Heated Hoodie Kit 3X Black [1318280]



****WHILE SUPPLIES LAST, NO BACKORDERS****

FOLLOW US



FACEBOOK

@CapitalElecSply



LINKEDIN

Capital Electric



TWITTER

@CapitalElecSply



INSTAGRAM

@capitalelecsply

WE ARE SOCIAL

INDUSTRIAL

Customers We Serve



INDUSTRIAL MANUFACTURING



ORIGINAL EQUIPMENT
MANUFACTURERS OF ALL TYPES (OEM)



INDUSTRIAL CONTRACTORS



SYSTEM INTEGRATORS



UTILITIES



SCHOOLS AND HIGHER
EDUCATION



WATER AND WASTE FACILITIES



HOSPITALS AND HEALTH CARE



GOVERNMENT

The electrical distributor of choice

INDUSTRIAL

Automation & Control



Our team of sales, engineering and technical support strive to solve your most difficult problems each and every day. We cover all aspects from Automation trouble shooting, design applications, software, and programming to MRO materials supply chain, Vendor Managed Inventory and all things in between.

Here are some of the services we provide -

AUTOMATION SOLUTIONS:

Design Engineering Services including System Control Panel Design, PLC Software Development, and Machine Safety Audit, just to name a few.

ON-SITE ENGINEERING SERVICES:

VFD commission, Trouble Shooting, PLC Programming assistance, Start up, & Technical Training...

REPAIR SERVICE:

AC & DC Motors - Servo Motors - Industrial Electronic - Hydraulics & Pneumatics - and much more. Extended warranty, fast turnaround, and free evaluation on all items....

TRAINING & PRODUCT DEMONSTRATION:

In house and on-site training to include CEC credits. We develop and build working models for your unique application to ensure form, fit and function prior to installation.

TECH SUPPORT HOTLINE (800) 220-8221:

Speak directly to an engineer with any technical questions about any product or manufacturer.

VENDOR MANAGED INVENTORY (VMI):

Store room and job site inventory management - detailed consumption reporting & trends - Storage Containers, Bins & Job Boxes.

DIGITAL SOLUTIONS:

Order online, anytime using capitalelectricsupply.com or download the app. Our digital solution includes working with ARIBA, Jagger, and SAP (Punchout or Portal Based).

KITTING & ASSEMBLY:

Improve productivity with our cost-effective specialty kitting and assembly services.

QUALITY & COMPLIANCE:

Committed to fulfilling your requirements, our trained associates work directly with the manufacturer to facilitate and manage quality and compliance documentation.

We offer Technical Support and Applications on the following:

- Sensors
- Control Devices
- Motor Starters
- Soft Starts
- Drives
- PLC's
- HMI's
- Software
- Motion Controls
- RFID Systems
- Wireless Radios
- Control Panel Devices
- Machine Safety Applications
- Specialty Products
- EcoStruxure Building, Plant & Machine
- AOA & IoT

Enjoying the new products and promotions in Smart Buys?

Visit our website for even
more offers not seen here!

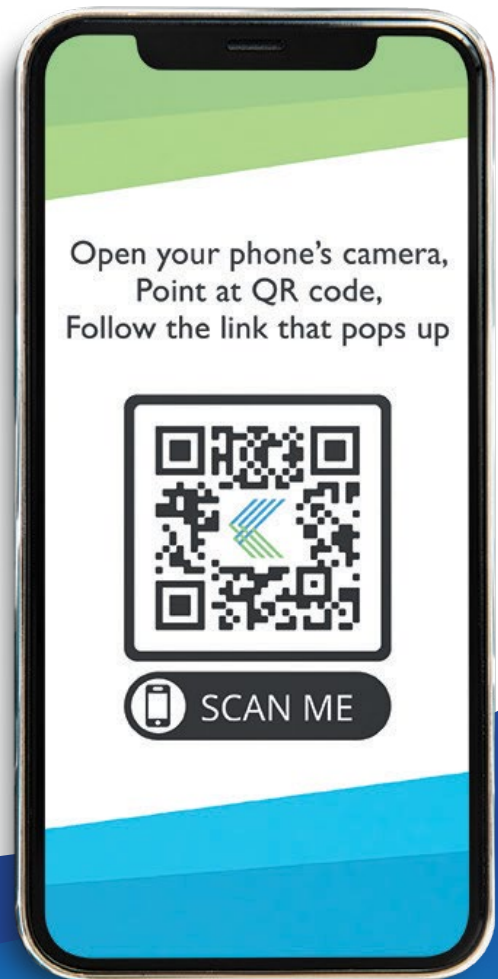

SMART BUYS

MANUFACTURER'S INDEX

3M.....	28	Klein Tools	1, 36
Arlington	26, 27	Kraloy.....	37
BRK	1, 22-24	Lithonia Lighting/Acuity.....	4, 5
Cablofil Legrand.....	25	Lutron	14, 15
Cooper Lighting Solutions	8-10	Milwaukee.....	1, 38
Federal Signal.....	13	Minerallac Cully	27
Fluke.....	16	Panasonic.....	11
GM Lighting	3	Pass & Seymour Legrand.....	30, 31
Greenlee.....	34, 35	RAB	17
Hubbell Wiring Systems.....	13	Ridgid	33
Ideal.....	20, 21	SAB	25
ILSCO.....	29	Schneider/Square D	18, 19
iTOOLco	32	Signify.....	1, 12
Keystone.....	15	Sylvania	6, 7
Kichler.....	22		



capitalelectricsupply.com