

SIEMENS



Issued by
Gigaset Communications GmbH
Schlavenhorst 66, D-46395 Bocholt
Gigaset Communications GmbH is a trademark licensee of Siemens AG

© Gigaset Communications GmbH 2008
All rights reserved.
Subject to availability. Rights of modifications reserved.

www.gigaset.com

Gigaset E45

Gigaset

Handset at a glance

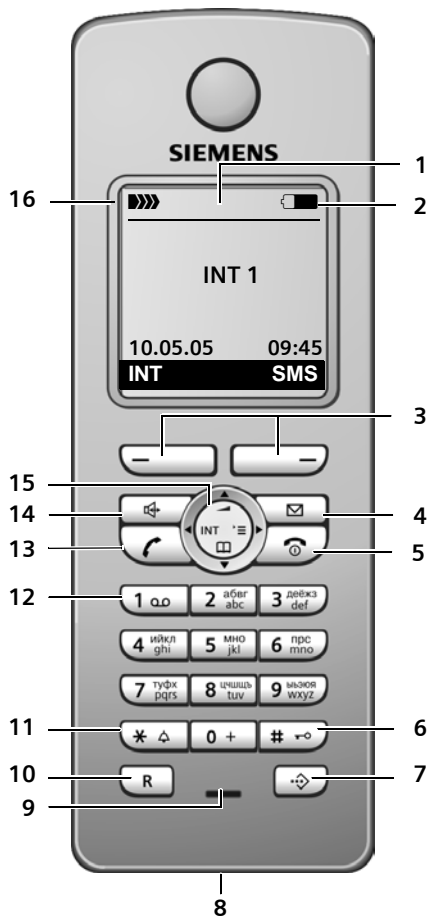

- 1 **Display** in idle status
- 2 **Battery pack charge status**
 - ▬ (flat to full)
 - ▬ flashes: battery pack almost flat
 - ▬ flashes: battery pack charging
- 3 **Display keys** (page 9)
- 4 **Message key**
 Access to calls and message lists (depending on the base station)
 Flashes: new message or new call.
- 5 **End call key, On/Off key**
 End call, cancel function, go back one menu level (press briefly), back to idle status (press and hold), activate/deactivate handset (press and hold in idle status)
- 6 **Hash key**
 Key lock on/off (press and hold in idle status),
 Toggle between upper/lower case and digits
- 7 **Call-by-call list key**
 Open call-by-call list
- 8 **Connection socket** for headset
- 9 **Microphone**
- 10 **Recall key**
 - Confer (Flash)
 - Insert a dialling pause (press and hold)
- 11 **Star key**
 Ringtones on/off (press and hold),
 Open table of special characters
- 12 **Key 1**
 Select answering machine/network mailbox (press and hold)
- 13 **Talk key**
 Answer a call, open last number redial list (press briefly), start dialling (press and hold)
- 14 **Handsfree key**
 Switch between earpiece and handsfree mode
 Lights up: handsfree activated
 Flashes: incoming call
- 15 **Control key** (page 8)
- 16 **Signal strength**
 - ▬▬▬▬▬▬▬▬▬▬▬▬▬▬▬▬ (high to low)
 - ▬▬▬▬▬▬▬▬▬▬▬▬▬▬▬▬ flashes: no reception

Note:
 Illustration of a handset on a base station with SMS functionality.

Contents

Handset at a glance 1

Safety precautions 3

Gigaset E45 – a handset with many extras 4

First Steps 4

Pack contents 4

Setting up the handset for use 4

Making calls 7

Making an external call 7

Ending a call 7

Answering a call 7

Handsfree operation 7

Muting 8

Making internal calls 8

Operating the handset 8

Switching the handset on/off 8

Activating/deactivating the keypad lock 8

Control key 8

Display keys 9

Returning to idle status 9

Menu guidance 9

Correcting incorrect entries 10

Using the directory and lists ... 10

Directory and call-by-call list 10

Last number redial list 12

Opening lists with the message key . 13

Using a handset as a room monitor 13

Activating the room monitor and entering the number to be called ... 13

Handset settings 14

Changing the display language 14

Setting the display 14

Setting the screen picture 14

Setting display illumination 15

Activating/deactivating auto answer . 15

Adjusting the loudspeaker volume .. 15

Changing ringtones 16

Activating/deactivating advisory tones 17

Setting the alarm clock 17

Restoring the handset default settings 18

Appendix 18

Care 18

Contact with liquid 18

Questions and answers 18

Service (Customer Care) 19

Specifications 19

Notes on the operating instructions 20

Symbols used 20

Example: menu input 20

Example: multiple line input 21

Writing and editing a text message .. 22

Accessories 23

Index 24

Safety precautions

Caution:

Read the safety precautions and the user guide before use. Explain their contents to your children, and the potential hazards associated with using the phone.



Use only the mains adapter supplied, as indicated on the underside of the charging cradle.



Fit only the **recommended rechargeable battery pack** (page 19)! I.e. do not use any other battery type or non-rechargeable batteries as this could result in significant health risks and personal injury.



The operation of medical appliances may be affected. Be aware of the technical conditions in your particular environment (e.g. doctor's surgery).



The handset may cause an unpleasant humming noise in hearing aids.



Do not install the charging cradle in bathrooms or shower rooms. The charging cradle is not watertight (page 18).



Do not use your phone in environments with a potential explosion hazard (e.g. auto paint shops).



If you give your Gigaset to someone else, make sure you also give them the user guide.



Dispose of the batteries and phone in accordance with environmental regulations.

Note:

Not all of the functions described in this manual are available in all countries.

Gigaset E45 – a handset with many extras

Your Gigaset E45 not only lets you store up to 150 telephone numbers (page 10) - your Gigaset E45 can do much, much more:

- ◆ You can designate important people as VIPs so you can tell important calls from the "tone" (page 11).
- ◆ You can store anniversaries (page 12) in your phone and it will remind you of them in advance.
- ◆ Select frequently used phone numbers at the press of a **single** key (page 11).

Have fun using your new Gigaset E45!

First Steps

Pack contents

- ◆ one Gigaset E45 handset,
- ◆ one charging cradle (incl. mains adapter),
- ◆ one battery pack,
- ◆ one battery cover,
- ◆ one lock ring,
- ◆ one belt clip,
- ◆ one headset socket cover,
- ◆ one user guide.

Setting up the handset for use

Connecting up the charging cradle and mounting it on the wall (if required) is described at the end of these instructions.

Fitting the battery pack

Caution:

Use only the rechargeable battery pack recommended by Gigaset Communications GmbH * (page 19). I.e. on no account may a conventional (non-rechargeable) battery pack or other type of battery be used, as this may cause significant damage to health and property e.g. the outer casing of the battery or battery pack could be destroyed or the battery pack could explode. The phone could also malfunction or be damaged as a result of using batteries that are not of the recommended type.

* Gigaset Communications GmbH is a trademark licensee of Siemens AG.

- ▶ Fit the plug into the socket.
- ▶ Insert the battery pack.
- ▶ Place the cords in the cord routing.

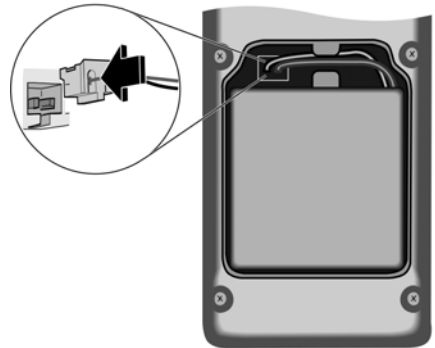

Closing the battery cover

- ▶ Hold the battery cover at a slight angle and introduce the two lower lugs into the casing first. Then close the cover so that it clicks into place.

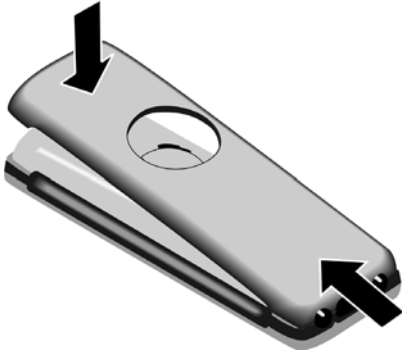

Locking the battery cover

Insert the catches on the lock ring or belt clip into the notches in the casing and make sure that the arrow markings on the casing are aligned with those on the bottom of the ring. Turn the lock ring or belt clip clockwise to the end stop. When both holes are horizontally aligned with the upper edge of the handset the lock ring is closed.

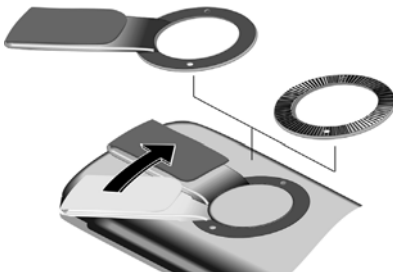

Opening the battery cover

Position both thumbs on the lock ring and at the same time turn the lock ring or belt clip anticlockwise and remove.

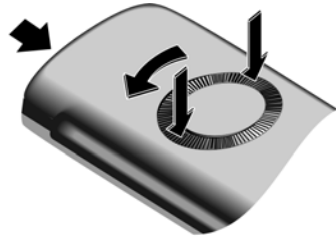

- ▶ Insert a coin into the cavity at the top of the battery cover and twist it until the cover opens.

Registering your phone

Before you can use your Gigaset E45 you must register it to a base station. It can be registered to a maximum of four base stations. The actual registration procedure will depend on the type of base station.

Automatic registration Gigaset E45 to Gigaset E450

Important: The handset must not already be registered to any base station.

Registering the handset to the Gigaset E450 base station occurs automatically. (On the E455 base station you register your handset manually, see page 6.)

- ▶ Place the handset in the base with its **display facing forward**.

Registration takes around 1 minute. During this process, **Regstr.Procedure** appears in the display and the name of the base station flashes e.g. **Base 1**. When the handset has registered, its screen displays its internal number, e.g. **INT 2** for internal number 2. The handset is assigned the lowest available internal number (1-6). If all internal numbers 1-6 have been assigned, number 6 is overwritten, provided the handset with the internal number 6 is in idle status.

Notes:

- Automatic registration is not possible when the base station on which you wish to register the handset is being used to make a call.
- Each key press interrupts the automatic registration.
- If automatic registration does not work, you will have to register the handset manually.

Manual registration of the Gigaset E45

If the handset does not activate automatically when the battery pack is fitted, you must first charge the battery pack.

You must activate manual registration of the handset at both the handset and the base station.

After it has registered, the handset returns to idle status. The handset's internal number is shown in the display e.g. INT 1. If not, repeat the procedure.

1. On the handset



→ → **Handset** → **Register H/Set**



Select base station, e.g. **Base 1**, and press **OK**.



Enter the system PIN of the base station (the default is 0000) and press **OK**. The screen will display, e.g. **Base 1**.

2. On the base station

Within 60 secs. press and **hold** the registration/paging key on the base station (page 1) (approx. 3 secs.).

Headset socket

You can connect the following types of headset (with jack connector): HAMA Plantronics M40, MX100 and MX150.

If you do not connect a headset, please insert the cover supplied for the headset socket to guarantee the unit is still splash proof.

Charging the battery pack

- ▶ Plug the mains adapter of the charging cradle into a mains power socket.
- ▶ Place the handset in the cradle with its display facing forward.

To charge the battery pack, leave the handset in the charging cradle. If the handset is activated, the flashing battery icon in the top right of the display indicates that the battery pack is being charged. During handset operation, the battery icon indicates the charge status of the battery pack (page 1).

Initial charging and discharging of the battery pack

The correct charge status can only be displayed if the battery pack is first fully charged **and** discharged.

- ▶ To do this, leave the handset in the charging cradle **continuously** for **ten** hours. Your handset need not be switched on for it to charge.
- ▶ Afterwards, remove the handset from the charging cradle and do not put it back again until the battery pack is fully discharged.

Notes:

- The handset should only be placed in a base station or charging cradle that is designed for it.
- When the handset is in the cradle, it charges even if it is switched off.
- If the handset has switched itself off because the battery pack is flat and it is then placed in the cradle, it will switch itself on automatically.
- After the first battery charge **and** discharge you may replace your handset in the charging cradle after every call.

Please remember:

- ◆ Always repeat the charging and discharging procedure if you remove the battery pack from the handset and insert it again.

- ◆ The battery pack may warm up as it is charging. This is not dangerous.
- ◆ After a time the charge capacity of the battery pack will decrease for technical reasons.

Setting the date and time

If you have not yet set the date and time, press the display key **Time** to open the input field.

To change the time, open the input field via:





 →  → **Date/Time**

▶ Change multiple line input:

Date:

Enter day, month and year in 6-digit format.

Time:

Enter hours and minutes with 4 digits, e.g.     for 07:15 a.m.

Save

Press the display key.

Changing the base station

If your handset is registered to more than one base station, you can set it to a particular base station or to the base station that has the best reception (**Best Base**).



 →  → **Handset** → **Select Base**

 Select one of the registered base stations or **Best Base** and press **OK**.



Making calls

Making an external call

External calls are calls using the public telephone network.

  Enter the number and press the talk key.

Or:

  Press and **hold** the talk key  and then enter the number.

You can cancel the dialling operation with the end call key .

You are shown the duration of the call while the call is in progress.

Notes:

- Dialling using the directory, call-by-call list (page 1, page 10) or last number redial list (page 12) saves time re-entering numbers and network provider access codes ("call-by-call numbers").



Ending a call

 Press the end call key.

Answering a call

The handset indicates an incoming call in three ways: by ringing, by a display on the screen and by the flashing handsfree key .

You can accept the call by:

- ▶ Pressing the talk key .
- ▶ Pressing the handsfree key .

If the handset is in the charging cradle and the **Auto Answer** function is activated (page 15), the handset will take a call automatically when you lift it out of the cradle.

If the ringtone is intrusive, press the display key **Silence**. You can take the call so long as it is displayed on the screen.



Handsfree operation

In handsfree mode instead of holding the handset to your ear you can put it down e.g. on the table in front of you to allow others to participate in the call.

Operating the handset

Activating/deactivating handsfree

Activating while dialling

  Enter the number and press the handsfree key.



- ▶ You should inform your caller before you use the handsfree function so that they know someone else is listening.

Switching between earpiece and handsfree mode

 Press the handsfree key.

During a call and when listening to the answering machine (depending on the base station), switch handsfree on or off.

If you wish to place the handset in the charging cradle during a call:

- ▶ Press and hold the handsfree key  while placing the handset in the base station. If handsfree key  does not light up, press the key again.

For how to adjust the volume, see page 15.

Muting

You can deactivate the microphone in your handset during an external call. The other party hears a wait melody.

 Press the control key on the left to mute the handset.

 Press the display key to reactivate the microphone.

Making internal calls

Internal calls to other handsets registered on the same base station are free.

Calling a specific handset

 Initiate internal call.

 Enter the number of the handset.

Or:

 Initiate internal call.

 Select handset.

 Press the talk key.

Calling all handsets ("group call")

 Initiate internal call.

 Press the star key. All handsets are called.

Ending a call

 Press the end call key.

Operating the handset

Switching the handset on/off

 Press and **hold** the end call key. You will hear the confirmation beep.

Activating/deactivating the keypad lock

 Press and **hold** the hash key.

You will hear the confirmation beep. The icon  appears in the display when the keypad lock is activated.

The keypad lock is deactivated automatically if someone calls you. It is re-activated when the call is finished.





Control key







In the following information the side of the control key (top, bottom, right, left) you have to press in each operating situation is shown in black (e.g.  for "press the right of the control key").

The control key has a number of different functions:





When the handset is in idle status

-  Open the directory.
-  Open main menu.
-  Open list of handsets.
-  Set the ringtones on the handset (page 16).



In the main menu and in input fields

You can use the control key to move the cursor up , down , right  or left .

In lists and submenus

-  /  Scroll up/down line by line.
-  Open submenu or confirm selection.
-  Go back one menu level, or cancel.

During an external call

-  Open the directory.
-  Initiate an internal consultation call.
-  Adjust loudspeaker volume for earpiece and handsfree mode.

Display keys

The function of the display keys changes depending on the particular operating situation. Example:

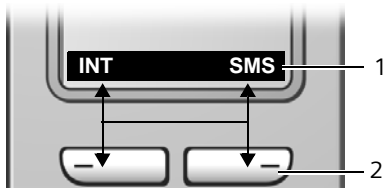







- 1 Current display key functions are shown in the bottom display line.
- 2 Display keys

Press the display key below to launch the function.

The most important display symbols are:

-  Open the main menu.

-  Open a context-dependent menu.
-  Delete key: backspace deletes one character at a time.
-  Go back one menu level or cancel operation.
-  Copy number into directory.
-  On bases with built-in answering machines: forward external call to answering machine.
-  Open the last number redial list (depending on the base station).

Returning to idle status

You can revert to idle status from anywhere in the menu as follows:

- ▶ Press and **hold** the end call key .

Or:

- ▶ Do not press any key: after 2 minutes the display will **automatically** revert to idle status.

Changes that you have not confirmed or saved by pressing **OK**, **Yes**, **Save**, **Send** or **Save Entry OK** will be lost.

An example of the display in idle status is shown on page 1.

Menu guidance

Your telephone's functions are accessed using a menu that has a number of levels.

Main menu (first menu level)

- ▶ Press  with the handset in idle status to open the main menu.

The main menu functions are shown in the display as a list with icon and name.

Accessing a function, i.e. opening the corresponding submenu (next menu level):

- ▶ Navigate to the function using the control key . Press the display key **OK**.

Using the directory and lists

Submenus

The functions in the submenus are displayed as lists.

To access a function:

- ▶ Scroll to the function with the control key  and press **OK**.

Or:

- ▶ Enter the corresponding digit combination.

A **short** press on the end call key  returns you to the previous menu level / cancels the operation.

Correcting incorrect entries

You can correct wrong characters in the text by navigating to the wrong input using the control key. You can then:

- ◆ press **<C** to delete the character to the left of the cursor,
- ◆ insert characters to the left of the cursor,
- ◆ overwrite the character (flashing) when entering the time and date etc.
- ◆ **You will find examples of symbols used, menu entries and multiple line input in the appendix to this user guide, page 20.**

Using the directory and lists

You can store a maximum of 150 entries in the directory and call-by-call list (the actual number depends on the size of the individual entries).

You create the directory and call-by-call list for your own individual handset. You can, however, send lists/entries to other handsets or the base station (page 11).

Directory and call-by-call list

In the **directory**, you can store numbers and the associated names.

- ▶ With the handset in idle status, open the directory by pressing the  key.

The **call-by-call list** is used to store the access codes for network providers (so-called "call-by-call numbers").

- ▶ Open the call-by-call list in idle status by pressing the  key.

Length of entries

Number: max. 32 digits

Name: max. 16 characters

Note:

For quick access to a number from the directory or the call-by-call list (quick dial), you can assign the number to a key.

Storing a number in the directory

 → **New Entry**

- ▶ Change multiple line input:

Number :

Enter number.

Name :

Enter name.

Annivers.:

Enter anniversary if required (page 12).

Speed Dial:

Select key for quick dial.

- ▶ Save changes.

Storing a number in the call-by-call list

 → **New Entry**

- ▶ Change multiple line input:



Number :

Enter number.



Name :

Enter name.





Selecting entries in the directory and call-by-call list

 /  Open directory or call-by-call list.

You have the following options:

- ◆ Use  to scroll through the entries until the required name is selected.
- ◆ Enter the first character of the name, or scroll to the entry with  if required.

Dialling with the directory/call-by-call list

 /  →  (select entry)
 Press the talk key. The number is dialled.

Managing entries in the directory/call-by-call lists

 /  →  (select entry)

Viewing an entry



View Press the display key.
The entry is displayed.
Back with **OK**.

Editing entries

View **Edit** Press display keys one after the other.

- ▶ Carry out changes and save.

Using other functions

 /  →  (select entry)
 → **Options** (open menu)

The following functions can be selected with :

Display Number

Edit or add to a stored number. Then dial or call up further functions by pressing **Options**.

Edit Entry

Edit selected entry.

Delete Entry

Delete selected entry.

VIP Entry (directory only)

Mark a directory entry as **VIP** (Very Important Person) and assign it a particular ringtone. You can then identify VIP calls by their ringtones.

Requirement: caller display ("CLIP")

Copy Entry

Send a single entry to a handset (page 11).

Delete List

Delete **all** entries in the directory/call-by-call list.

Copy List (depending on the receiving handset)

Send complete list to a handset (page 11).

Available Memory

Display the available entries in the directory and call-by-call list (page 10).



Using quick dial keys

- ▶ Press and **hold** the required quick dial key.

Sending the directory/call-by-call list to another handset

Requirements:

- ◆ The sending and receiving handsets must both be registered to the same base station.
- ◆ The other handset and base station can send and receive directory entries. Please read the relevant user guide for further information.

 /  →  (select entry)
 → **Options** (open menu) → **Copy Entry**
 / **Copy List**



Enter the internal number of the receiving handset. You see **Copying entry**.

Yes / **No** Press the display key.

A successful transfer is confirmed by a message and confirmation tone on the receiving handset.



Using the directory and lists

Please remember:

- ◆ Entries with identical numbers are not overwritten on the receiving handset.
- ◆ The transfer is cancelled if the phone rings or if the memory of the receiving handset is full.

Storing anniversaries in the directory

You can store an anniversary for every number in the directory, and specify a time when you will receive a reminder call on the anniversary.

 →  (Select entry; page 11)

View **Edit** Press display keys one after the other.

 Scroll to the **Annivers.:** line.

Edit Press the display key.

► Change multiple line input:

Date:

Enter the day/month in 4-digit format.

Time:

Enter the hour/minute for the reminder call in 4-digit format.

Prompt:



Select the type of signal for the reminder and press **OK**.

► Save changes (page 21).

Note:

Reminder calls require a time stamp. If you select a visual signal, then a time stamp is not required and is automatically set to 00.00.

Deleting anniversaries

 →  (Select entry; page 11)

View **Edit** Press display keys one after the other.

 Scroll to the **Annivers.:** line.

Edit **Delete** **Save**

Press display keys one after the other.

Reminder call on an anniversary

A reminder call is signalled on the handset using the selected ringtone.

Silence Press the display key to stop the reminder call.

Last number redial list

The last number redial list contains the ten numbers last dialled with the handset (max. 32 numbers). If one of the numbers is in the directory, then the corresponding name will be displayed.

Manual last number redial

 Press the key **briefly**.

 Select entry.

 Press the talk key again. The number is dialled.

When a name is displayed, you can display the corresponding phone number by pressing the display key **View**.

Managing entries in the last number redial list

 Press the key **briefly**.

 Select entry.

Options Open the menu.

The following functions can be selected with :

Display Number (as in the directory, page 11)

Copy to Directory

Copy an entry to the directory (page 10).

Delete Entry (as in the directory, page 11)

Delete List (as in the directory, page 11)

Opening lists with the message key

An advisory tone sounds as soon as a **new entry** appears on a list. The  key flashes (it goes off when the key is pressed). In idle status, the display shows an icon for the new message.

If you press the  key, you access the lists which contain new messages.

Using a handset as a room monitor

If the room monitor is activated, a previously stored destination number is called as soon as a set noise level is reached. You can store an internal or external number in your handset as the destination number.

The room monitor call to an external number stops after approx. 90 seconds. The room monitor call to an internal number (handset) stops after approx. 3 minutes (depending on the base station). While the room monitor is activated, all keys are locked except the end call key. The handset's speaker is muted.

When the room monitor is activated, incoming calls to the handset are indicated **without a ringtone** and are only shown on the screen. The display and keypad are not illuminated and advisory tones are also turned off.

If you accept an incoming call, the room monitor mode is suspended for the duration of the call, but the function **remains** activated.

If you switch off the handset, the room monitor mode is deactivated. You must reactivate the function after switching on the handset again.

Caution!

- You should always check the operation of the room monitor before use. For example, test its sensitivity. Check the connection if you are diverting the room monitor to an outside number.
- When the function is switched on, the handset's operating time is severely reduced. If necessary, place the handset in the charging cradle. This ensures that the battery pack does not run down.
- Ideally the handset should be positioned 1 to 2 metres away from the baby. The microphone must be directed towards the baby.
- The connection to which the room monitor is diverted must not be blocked by an activated answering machine.

Activating the room monitor and entering the number to be called

 →  → Room Monitor

▶ Change multiple line input:

Room M.:

Select **On** to activate.

Call to:

Press the display key **Edit** and enter destination number.

External number: select number from the directory or enter directly. Only the **last 4 digits** are displayed.

Internal number: delete any stored external number. **INT**  (select handset or **Call All**, if all registered handsets are to be called) **OK**.

Store number with **Save Entry** **OK**.





Level:

Set noise level sensitivity (**Low** or **High**).





▶ Save changes (page 21).

The function is now activated. With , you can move directly to settings.

Changing previously set external destination number



-  →  → Room Monitor
-  Scroll to the **Call to:** line.
-  Press the display key.
-  Delete existing number.
- ▶ Enter number as described in "Activating the room monitor and entering the number to be called" (page 13).
- ▶ Save changes (page 21).

Changing previously set internal destination number

-  →  → Room Monitor
-  Scroll to the **Call to:** line.
-  Press the display key.
-  Press the display key to confirm the prompt.
- ▶ Enter number as described in "Activating the room monitor and entering the number to be called" (page 13).
- ▶ Save changes (page 21).

Deactivating the room monitor remotely

Requirements: The phone must support touch tone dialling and the room monitor is set for an external destination number.

- ▶ Take the call from the room monitor and press keys  .
- The room monitor function will deactivate after the call ends. There will be no further room monitor calls. The other room monitor settings on the handset (e.g. no ring-tone) will however remain activated until you press the display key  on the handset.













To reactivate the room function with the same phone number:

- ▶ Turn on the activation again and save with  (page 13).

Handset settings











Changing the display language

You can view the display texts in different languages.

-  →  → Handset → Language
- The current language is indicated by .
-  Select a language and press .
-  Press and **hold** (idle status).
- If you accidentally choose a language you do not understand:
-     Press keys one after the other.
-  Select the correct language and press .

Setting the display

You have a choice of four colour schemes and several different contrasts.

-  →  → Display
- Colour Scheme**
-  Select and press .
-  Select a colour scheme and press  ( = current colour).
-  Press **briefly**.
- Contrast**
-  Select contrast.
-  Press the display key.
-  Press and **hold** (idle status).

Setting the screen picture

You can display a screen picture (picture or digital clock) when the handset is in idle status. This will replace the idle status display. It may conceal the date, time and name.

The screen picture is not displayed in certain situations, e.g. during a call or when the handset has been deregistered.

If a screen picture has been activated, the menu item **Screen Picture** is marked with



→ → **Display** → **Screen Picture**

The current setting is displayed.

▶ Change multiple line input:

Activation:

Select **On** (screen picture is displayed) or **Off** (no screen picture).

Selection:

Change screen picture if necessary (see below).

▶ Save changes (page 21).

If the screen picture conceals the display, press the end call key briefly to show the idle display with time and date.

Changing the screen picture

→ → **Display** → **Screen Picture**

Scroll to the **Selection** line.

View Press the display key. The active screen picture is displayed

Select **picture/Clock** and press **OK**.

▶ Save changes.

Setting display illumination

Depending on whether or not the handset is in the charging cradle you can set different levels of display illumination. If the charging cradle is switched on, the display is permanently dimmed.

→ → **Display** → **Backlight**

The current setting is displayed.

▶ Change multiple line input:

In Charger

Select **On** or **Off**.

without Charger

Select **On** or **Off**.

Save Press the display key.

Press and **hold** (idle status).

Note:

When the display illumination is switched on, the standby time of the handset is reduced to approx. 30 hours.

Activating/deactivating auto answer

If you have activated this function, when you get a call you can simply lift the handset out of the charging cradle without having to press the talk key .

→ → **Handset**

Auto Answer

Select and press **OK** (= on).

Press and **hold** (idle status).

Adjusting the loudspeaker volume

You can set the loudspeaker volume for handsfree speaking to five different levels and the earpiece volume to three different levels. You can only make these adjustments during an external call.

The handsfree volume can only be adjusted when this function is set.

You are conducting an external call.

Open menu.

Select volume.

Save Press display key if necessary to save the setting permanently.

Handset settings

If  is assigned a different function:



Options Open menu.

Volume Select and press **OK**.

Configure setting (see above).

Changing ringtones

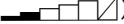
◆ Volume:

You can choose between five volumes (1–5; e.g. volume 2 = ) and the "Crescendo" ring (6; volume increases with each ring = .

◆ Ringtones:

You can choose between 15 different melodies.

You can configure the following functions with different ringtones:

◆ **Ext. Calls** : For external calls

◆ **Internal Calls** : For internal calls

◆ **All**: The same for all functions

Settings for individual functions

Set the volume and melody depending on the type of signalling required.

 →  → **Audio Settings** → **Ringer Settings**

 Setting, e.g. select **Ext. Calls** and press **OK**.

▶ Change multiple line input:

 Set volume (1–6).



 Scroll to the next line.

 Select melody.

Save Press the display key to save the setting.

In idle status, you can also open the menu **Ringer Settings** by pressing  briefly.

Settings for all functions to ring the same

 →  → **Audio Settings** → **Ringer Settings** → **All**

▶ Set volume and ringtone (see "Settings for individual functions").

Yes Press the display key to confirm the prompt.

 Press and **hold** (idle status).

Activating/deactivating the ringtone

Before answering a call or while your handset is in idle status, it is possible for you to cancel the ringtone permanently or for the current call. The ringtone cannot be re-activated while an external call is in progress.

Deactivating the ringtone permanently

 Press the star key and hold until you can no longer hear the ringtone.

The  icon appears in the display.

Re-activating the ringtone

 Press and **hold** the star key.

Deactivating the ringtone for the current call

Silence Press the display key.

Activating/deactivating the alert tone

In place of the ringer tone you can activate an alert tone. When you get a call, you will hear a **short tone** ("Beep") instead of the ringtone.

 Press and **hold** the star key and **within 3 seconds**:

Beep on Press the display key. A call is now signalled by **one** brief alert tone. You will now see  in the display.

Activating/deactivating advisory tones

Your handset uses 'advisory tones' to tell you about different activities and statuses. The following advisory tones can be activated and deactivated independently of each other:

- ◆ **Key beep:** Each key press is acknowledged.
- ◆ **Acknowledged tones:**
 - **Confirmation tone** (rising tone sequence): at the end of the entry/setting and when an SMS or a new entry arrives in the answering machine list (depending on base) or the calls list
 - **Error beep** (descending tone sequence): when you make an incorrect entry
 - **Menu end tone:** when scrolling at the end of a menu
- ◆ **Battery low beep:** the battery pack requires charging.

 →  → **Audio Settings** → **Advisory Tones**

▶ Change multiple line input:

Key Tones:

Select **On** or **Off** .

Confirm.:

Select **On** or **Off** .

Battery:

Select **On**, **Off** or **In Call**. The battery tone is activated/deactivated or only sounds during a call.



▶ Save changes (page 21).

You cannot deactivate the confirmation tone for placing the handset in the charging cradle.

Setting the alarm clock

Requirement: the date and time have already been set (page 7).

Activating/deactivating the alarm clock and setting the wake-up time

 → 

▶ Change multiple line input:

Alarm Clock:

Select **On** or **Off** .

Time:

Enter the wake-up time in 4-digit format.

Melody:

Select melody.

Volume:

Set the volume (1-6).

▶ Save changes (page 21).

You will see the  icon.

A wake-up call with the selected ringer melody is signalled on the handset. The wake up call sounds for 60 seconds. The display shows **Alarm Clock** . If no key is pressed the wake-up call is repeated twice at five minute intervals and then switched off.

During a call, the wake-up call is signalled by a short tone.

Deactivating the wake-up call/repeating after a pause (slumber mode)

Requirement: A wake-up call is sounding.

Off

Press the display key. The wake-up call is deactivated.

or

Snooze

Press the display key or any key. The wake-up call is deactivated and then repeated after 5 minutes. After the second repetition the wake-up call is deactivated completely.

Restoring the handset default settings

You can reset any individual settings and changes that you have made. This will not affect entries in the directory, call-by-call list or calls list, nor the handset's registration to the base station.

 →  → **Handset** → **Reset Handset**

Yes Press the display key.

 Press and **hold** (idle status).

Cancel the restoring process by pressing  or the display key **No**.

Appendix

Care

- ▶ Wipe the charging cradle and the handset with a **damp** cloth (do not use solvent) or an antistatic cloth.

Never use a dry cloth. This can cause static.

Contact with liquid

Your handset is splash proof.

If it comes into contact with water, knock the water out of the microphone opening and remove any water on the handset with an absorbent cloth. Your handset is ready for use.

If your handset comes into contact with a larger amount of liquid take the following steps:

1. **Do not switch the handset on under any circumstances!**
2. Remove the battery pack immediately.
3. Remove the headset socket cover.
4. Hold the handset horizontally with the open battery compartment facing down.
5. Hold the handset vertically. Tilt the



handset backwards and forwards slightly, giving it a gentle shake each time.

6. Dab all parts dry and then leave the handset for **at least 72 hours** with the battery compartment open and the keypad facing down in a dry, warm place (not: microwave, oven or similar).

When it has fully dried out, you will normally be able to use it again.

Questions and answers

If you have any queries about the use of your telephone, you can contact us at any time at www.gigaset.com/customercare. The table below contains a list of common problems and possible solutions.

<p>The display is blank.</p> <ol style="list-style-type: none"> 1. The handset is not switched on. <ul style="list-style-type: none"> ▶ Press and hold the end call key . 2. The battery pack is flat. <ul style="list-style-type: none"> ▶ Charge/replace the battery pack (page 4).
<p>The handset does not respond to a key press.</p> <p>The keypad lock is activated.</p> <ul style="list-style-type: none"> ▶ Press and hold the hash key  (page 8).
<p>"Base station x" is flashing in the display.</p> <ol style="list-style-type: none"> 1. The handset is outside the range of the base station. <ul style="list-style-type: none"> ▶ Reduce the distance between handset/base station. 2. The handset has been de-registered. <ul style="list-style-type: none"> ▶ Register the handset (page 5).
<p>Base Search is flashing in the display.</p> <p>Handset is set for Best Base and no base station is within range.</p> <ul style="list-style-type: none"> ▶ Reduce the distance between handset/base station.
<p>Handset does not ring.</p> <p>The ringtone is switched off.</p> <ul style="list-style-type: none"> ▶ Activate the ringtone (page 16).

The other party cannot hear you.

You have pressed the  (INT) key. The handset is "muted".

- ▶ Switch on the microphone again (page 8).

You hear an error tone when keying an input
(a descending sequence of tones).

Action has failed/invalid input.

- ▶ Repeat the operation.
Watch the display and refer to the operating instructions if necessary.

Service (Customer Care)

We offer you support that is fast and tailored to your specific needs!

Our Online Support on the Internet can be reached any time from anywhere.

www.gigaset.com/customer-care

It provides you with 24/7 support for all our products. It also provides a list of FAQs and answers plus user guides and current software updates (if available for the product) for you to download.

You will also find frequently asked questions and answers in the appendix of this user guide.

For fast and dependable assistance with any repairs or guarantee/warranty claims, contact our Service Centre.

Russia 8 (495) 228 1312

Please have your proof of purchase ready when calling.

Replacement or repair services are not offered in countries where our product is not sold by authorised dealers.

Authorisation

This device is intended for use within the European Economic Area and Switzerland. If used in other countries, it must first be approved nationally in the country in question.

Replacement or repair services are not offered in countries where our product is not sold by authorised dealers.

We, Gigaset Communications GmbH, declare that this device meets the essential requirements and other relevant regulations laid down in Directive 1999/5/EC.

A copy of the 1999/5/EC Declaration of Conformity is available at this Internet address:

www.gigaset.com/docs.

CE 0682

Certificate N^o
POCC DE. M105. B00708
valid until 29.04.2011.

Postal address of manufacturer:
Gigaset Communications GmbH
Hofmannstrasse 61,
81379, Munich,
Germany.

Specifications**Recommended battery pack**

(Valid at the time of going to press)

Nickel-metal-hydride (NiMH):

V30145-K1310-X382

The handset is supplied with the recommended battery pack.

Handset operating times/charging times

Capacity	620 mAh
Standby time	Approx. 160 hours (6 days)
Calling time	Approx. 12 hours
Charging time	approx. 6 hours

The operating and charging times apply only when using the recommended battery pack.

Note:

When the display illumination is switched on, the standby time of the handset is reduced to approx. 30 hours.

General specifications

Handset dimensions	143 x 51 x 25 mm (L x W x H)
Weight of handset with battery pack	133 g

Notes on the operating instructions

This section explains the meaning of certain symbols and typographical conventions that are used in this user guide.

Symbols used

Copy Entry / Copy List (example)

Select one of the two menu functions specified.



Save

Enter digits or letters.

The display keys' current functions are shown reverse highlighted in the bottom display line.



Press the top or the bottom of the control key: scroll up or down.



Press the right or left of the control key: e.g. select setting.





/ 0+ / *△ etc.

Press the corresponding key on the handset.

Example: menu input

In the user guides, the steps you need to perform are shown in abbreviated form. This is illustrated below using the example of "Contrast". The things you have to do are explained in the boxes.

 →  → Display

- ▶ With the handset in idle status, press on the right of the control key to open the main menu.
- ▶ Select the  icon using the control key - press the control key at the top or bottom.

In the display header, **Settings** is displayed.

- ▶ Press the display key **OK** to confirm the function **Settings**.

The **Settings** submenu is displayed.

- ▶ Press the bottom of the control key repeatedly until **Display** is selected.
- ▶ Press the display key **OK** to confirm the selection.

Contrast Select and press **OK**.

- ▶ Press the bottom of the control key repeatedly until **Contrast** is selected.
- ▶ Press the display key **OK** to confirm the selection.

 Select contrast and press **OK**.

- ▶ Press right or left on the control key to select the contrast.
- ▶ Press the display key **Save** to confirm the selection.

 Press and **hold** (idle status).

- ▶ Press and hold the end call key until the handset returns to idle status.

Example: multiple line input

There are many situations in which you can change the settings of a display or enter data in several lines.

In this user guide symbols are used to guide you step by step through multiple line input. This is illustrated below using the example of "Setting the date and time". The things you have to do are explained in the boxes.

You will see the following display (example):

Date/Time	
Date:	[10.06.05]
Time:	11:11
	Save

Date:

Enter day, month and year in 6-digit format.

The second line is marked with [] to show it is active.

- ▶ Enter the date using the digit keys.

Time:

Enter hours/minutes in 4-digit format.

- ▶ Press the  key.

The fourth line is marked with [] to show it is active.

- ▶ Enter the date using the digit keys.

- ▶ Save changes.

- ▶ Press the display key **Save**.
- ▶ Then press and **hold** the  key.

The handset changes to idle status.

Writing and editing a text message

The following rules apply when writing a text message:

- ◆ Control the cursor with
- ◆ Characters are added to the left of the cursor.
- ◆ Press the star key to show the table of special characters.
- ◆ The first letter of the name of directory entries is automatically capitalised, followed by lower case letters.

Entering special characters

You can call up the table of special characters when writing an SMS using the key. Select the required character and insert it with **Insert**.

Writing an SMS/name (without predictive text)

Requirement:

Your base station must support SMS.

Press and **hold** the hash key to switch from "Abc" mode to "123" and from "123" to "abc" and from "abc" to "Abc" (upper case: 1st letter upper case, all others lower case). Press the hash key **before** entering the letter.

The following applies when writing an SMS:

- ◆ The display shows whether upper case, lower case or digits is selected. "Abc", "abc" or "123" appears at the top right of the display.
- ◆ When you press a key and **hold** it, the characters of that key appear in the **bottom display line** and are highlighted one after the other. When you release the key the highlighted character is inserted into the input field.

Writing SMS (with predictive text)

Requirement:

Your base station must support SMS.

EATONI predictive text helps you when you are writing text messages.

Each key between and is assigned several letters and characters. These appear in a selection line immediately under the text panel (above the display keys) as soon as you press a key. The letter you are most likely looking for is shown in reversed highlights and is at the beginning of the selection line. It is copied into the text panel.

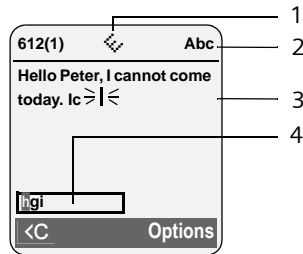

- 1 EATONI is activated
- 2 Upper/lower case or digits
- 3 SMS text
- 4 Selection line

If this letter is the one you want, confirm it by pressing the next key. If it is not the one you want, **briefly** press the hash key repeatedly until the required letter is reverse-highlighted on the display line and copied into the text panel.

If you press and **hold** the hash key you switch from "Abc" mode to "123" and from "123" to "abc" and from "abc" to "Abc".

Deactivating/activating predictive text

Requirement: You are writing a text message.

Options Press the display key.

Predictive Text

Select and press **OK** (= on).



Press the end call key **briefly** to return to the text panel. Enter the text.

Order of directory entries

The directory entries are usually sorted in alphabetical order. Spaces and digits take first priority. The sort order is as follows:

1. Space
2. Digits (0–9)
3. Letters (alphabetical)
4. Other characters

To get round the alphabetical order of the entries, insert a space or a digit in front of the name. These entries will then move to the beginning of the directory. Names which you have preceded with an asterisk will move to the end of the directory.

Accessories

All accessories and batteries are available from your mobile phone retailer.

The Online Shop also has the latest product information.



Only use original accessories. This will avoid possible health risks and damage, and also ensure that all the relevant regulations are complied with.

Index

A

Acknowledge tones	17
Activating	
advisory tones	17
call acceptance	15
handset	8
keypad lock	8
room monitor	13
Adjusting	
loud speaker volume	15
Advisory tones	17
Alarm clock	
setting	17
Alert tone	16
Anniversary	12
storing in directory	12
Answering a call	7
Authorisation	19
Auto answer	7, 15

B

Base station	
changing	7
Battery icon	6
Battery pack	
charging	6
inserting	4
recommended battery pack	19
Battery tone	17
Best base station	7

C

Call	
ending	7
external	7
internal	8
Call acceptance	15
Call duration	7
Call-by-call list	10
key	1
Call-by-Call numbers	10
Calls list	12
Cancelling (operation)	9
Care, phone	18
Changing	
destination number	14
display language	14

ringtone	16
Character set, see Special characters	22
Charge status display	6
Confirmation beep	17
Control key	1, 8
Correcting incorrect input	10
Customer Care	19

D

Deactivating	
handset	8
keypad lock	8
Default settings	
handset	18
Delete key	9
Deleting	
characters	10
Dialling pause	
entering	1
Digital clock	14
Directory	10
managing entries	11
opening	9
order of entries	23
saving entry	10
sending entry/list to handset	11
storing anniversary	12
Display	
changing display language	14
contrast	14
display keys	1, 9
illumination	15
in idle status	9
memory	11
screen picture	14
setting	14
wrong language	14

E

Earpiece mode	8
Earpiece volume	15
EATONI (predictive text)	22
End call key	1, 7
Ending a call	7
Entering special characters	22
Error beep	17
Example	
menu input	20
multiple line entry	21

- F**
Fast access
 assigning key 1 1
- G**
Group call 8
- H**
Handset
 activating/deactivating 8
 advisory tones 17
 changing to best reception 7
 changing to different base station. . . 7
 contact with liquid 18
 display illumination 15
 display language 14
 idle status 9
 list. 9
 loudspeaker volume. 15
 muting 8
 operating and charging times 20
 registering 5
 registering on another base station. . 7
 restoring default settings 18
 screen picture 14
 using room monitor 13
Handset charging times. 20
Handset operating time. 20
 in room monitor mode. 13
Handsfree
 key 1
Handsfree talking 7
Hash key. 1, 8
Headset socket 6
Hearing aids 3
- I**
Icon
 alarm clock 17
 ringtone 16
Idle status (display) 9
Idle status, returning to 9
Incorrect input (correction) 10
Internal call. 8
- K**
Key 1 (fast access) 1
Key click. 17
Keypad lock 8
Keys
 assigning directory entry 10
 call-by-call key. 1
 cancel key. 9
 control key 1, 8
 delete key. 9
 display keys. 1, 9
 end call key. 1, 7
 fast access 1
 handsfree key 1
 hash key. 1, 8
 menu key 9
 message key 1
 On/Off key 1
 quick dial 10
 recall key 1
 star key. 1, 16
 talk key. 1, 7
- L**
Language, display. 14
Last number redial list 12
Last number redial, manual 12
Liquid 18
List
 call-by-call list 10
 calls list 12
 handsets. 9
 last number redial list 12
Lock
 activating/deactivating keypad lock . 8
Loudspeaker volume. 15
- M**
Mains adapter 3
Making calls
 answering a call 7
 external 7
 internal. 8
Manual last number redial 12
Medical appliances. 3
Memory
 directory. 11

Index

- Menu
 - back one menu level 9
 - end tone 17
 - key 9
 - open 9
- Menu input 20
- Message key 1
 - opening lists 13
- Microphone 1
- Multiple line entry 21
- Muting handset. 8
- N**
- Network provider (number list) 10
- Number
 - as destination for room monitor . . . 13
 - saving in directory 10
- Number list (network provider) 10
- O**
- On/Off key 1
- Open
 - menu 9
- Opening
 - directory 9
- Order of entries in directory. 23
- P**
- Pack contents 4
- Phoning
 - internal 8
- Predictive text 22
- Q**
- Quick dial 10, 11
- R**
- Recall key 1
- Registering (handset) 5
- Reminder call 12
- Reset 18
- Ringtone
 - changing 16
 - setting melody. 16
 - setting volume. 16
- Room monitor. 13
 - activating 13
 - entering destination number 13
 - sensitivity 13
- S**
- Safety precautions 3
- Screen picture 14
- Searching in directory. 11
- Sending
 - directory entry to handset 11
- Service. 19
- Setting
 - alarm clock 17
 - date 7
 - display illumination 15
 - display language 14
 - loud speaker volume 15
 - ringtone volume 16
 - screen picture 14
 - time 7
 - volume, melody 16
- Setting melody. 16
- Setting the date 7
- Setting the time 7
- Settings, see Setting
- Signal beep, see Advisory tones
- Slumber mode 17
- Sound
 - ringtone 16
- Specifications. 19, 20
- Star key 1, 16
- T**
- Talk key 1, 7
- Text
 - writing, editing 22
- Troubleshooting 18
- V**
- VIP. 11
- Volume
 - earpiece 15
 - handset loudspeaker 15
 - loudspeaker 15
 - ringtone 16
 - setting 16
- W**
- Wait melody. 8
- Warning beep, see Advisory tones
- Writing. 22

