

Gigaset S685 IP



SIEMENS

Important information about the user guide

This user guide applies to Gigaset S685 IP devices that were manufactured from **September 2009** onwards. These devices contain a label inside the battery compartment on the handset stating "Gigaset S68H **S2**". The label can be found on the bottom of the battery compartment.

If "S2" is missing from the label, the device was manufactured before September 2009, in which case this user guide is not valid. In this case, please download the updated version of the user guide from the Internet. In conjunction with the user guide found on the CD supplied with your device, this updated version describes all of the possible functions relating to your device.

The handset at a glance



- 6 **Hash key**
Keypad lock on/off (press and hold, → [Page 36](#))
Switch between upper/lower case letters and digits for text input (→ [Page 239](#))
- 7 **Call-by-call list key** (not for VoIP)
Open call-by-call list
- 8 **Microphone**
- 9 **Recall key**
Fixed line network:
Enter flash (press briefly)
Insert a pause (press and hold)
VoIP: enter flash (adjustable, → [Page 208](#))
- 10 **Star key**
Idle status: ringers on/off (press and hold)
Fixed line network: switch between dial pulsing/tone dialling
Editor: open special characters table
- 11 **Key 1** (press and hold)
Call network mailbox or answering machine
- 12 **Connection socket for headset** (→ [Page 31](#))
- 13 **Talk key**
Accept call, open redial list (press briefly in idle status), select connection type and start dialling (press briefly/press and hold after entering the number, → [Page 44](#))
- 14 **Speaker key**
Change between earpiece/speaker mode
Lights up: speaker activated
Flashes: incoming call
- 15 **Control key** (→ [Page 33](#))
- 16 **Eco mode activated** (→ [Page 133](#))
- 17 **Signal strength**
▀▀▀▀▀▀ (low to high)
▢▀▀▀▀▀▀ flashes: no reception
- 18 **Gigaset S68H handset: Bluetooth activated** (→ [Page 146](#))
- 19 **Answering machine icon**
Answering machine switched on;
Flashes: Answering machine is recording a message or is being operated by another internal party

Handset keys

- 1 Display in idle status (example)
- 2 **Charge status of the batteries**
▢▢▢▢▢▢ (1/3 charged to fully charged)
▢▢▢▢▢▢ flashes: battery almost flat
▢▢▢▢▢▢ flashes: battery charging
- 3 **Display keys** (→ [Page 34](#))
- 4 **Message key**
Opens calls and message lists
Flashes: new message, new call or new firmware/new provider profile available
- 5 **End call key, On/Off key**
End call, cancel function, go back one menu level (press briefly), back to idle status (press and hold), activate/deactivate handset (press and hold in idle status)

Overview of display icons



Charge status of the batteries (flat to full)

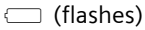

Batteries almost empty



Charging



Reception signal strength between the base station and the handset (high to low)

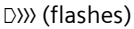

No reception signal between the base station and the handset



Eco mode activated



Bluetooth mode activated



in header:

Base station answering machine is activated.

Flashes:

Answering machine is recording a message or is being operated

Otherwise:

New message on a network mailbox or the local answering machine



Incoming call (ringer icon)



New call in the calls list



New message in SMS-, messenger- or e-mail list



Keypad lock activated



Ringer deactivated



Alert tone activated



Alarm clock set

The base station at a glance



Base station key

1 Paging key

Lights up:

LAN connection active (phone is connected to router)

Flashes:

Data transfer to LAN connection

Press **briefly**:

Start paging (→ [Page 140](#)), display IP address on handset

Press and **hold**:

Set base station to registration mode (→ [Page 138](#))

Contents

Overview of display icons	2
The base station at a glance	2
Safety precautions	8
Gigaset S685 IP – more than just making calls	9
VoIP – making calls via the Internet	10
Gigaset HDSP – telephony with brilliant sound quality	11
First steps	12
Check the pack contents	12
Setting up the handset for use	14
Installing the base station	18
Connecting the base station	19
Adjusting the settings for VoIP telephony	22
Belt clip and headset	31
How to proceed	32
Operating the handset	33
Control key	33
Display keys	34
Keys on the keypad	34
Correcting incorrect entries	34
Menu guidance	35
Reverting to idle status	36
Activating/deactivating the handset	36
Activating/deactivating the keypad lock	36
Illustration of operating steps in the user guide	37
Menu trees	39
Phone menu	39
Web configurator menu	43
Making calls with VoIP and the fixed line network	44
Making an external call	44
Ending a call	48
Accepting a call	48
Calling Line Identification	49
Speaker	53
Deactivating handset's microphone	53
Muting the handset	54
VoIP telephony via Gigaset.net	55
Opening the Gigaset.net directory	56
Search for subscribers in the Gigaset.net directory	57
Entering, editing and deleting own entry	59
Calling a Gigaset.net subscriber	59

Making calls via network services	60
Anonymous calling – withholding caller ID	60
Further network services in the fixed line network	61
Further network services for VoIP	63
Using lists	66
Redial list	66
Opening lists with the message key	67
Using directories and the call-by-call list	71
Handset directory/call-by-call list	71
Using online directories	78
Making cost-effective calls	82
SMS (text messages)	83
Writing/sending an SMS	85
Receiving an SMS	88
Notification by SMS	91
SMS mailboxes	92
Setting SMS centre and the send line	93
SMS info services	95
SMS on a PABX	96
Activating/deactivating first ringer muting	96
Activating/deactivating the SMS function	96
SMS troubleshooting	97
E-mail messages	98
Opening the inbox	98
Reading e-mail messages	100
View e-mail sender's address	101
Delete the e-mail message	101
Messenger	102
Establishing a connection, going online	103
Changing/checking your personal status, going offline	104
Opening the buddy list	106
Receiving messages	108
Writing and sending messages	110
Calling a buddy	111
Self-help with errors	112
Info Center – with the handset always online	113
Starting Info Center, selecting info services	113
Registration for personalised info services	114
Operating the Info Center	115
Displaying information from the Internet as a screensaver	117

Operating the base station answering machine	118
Operation via the handset	119
Activating/deactivating call screening	124
Setting up the answering machine	125
Configuring the answering machine for fast access	126
Operating when on the move (remote operation)	127
Using the network mailbox	129
Activating/deactivating the network mailbox, entering numbers	129
Configuring the (network) mailbox for fast access	130
Listening to messages on the network mailbox	131
ECO DECT: reducing the power consumption and transmission power of the base station	133
Setting an appointment (calendar)	134
Saving an appointment	134
Managing appointments	135
Deactivating or accepting an appointment reminder	135
Displaying missed appointments, anniversaries	136
Setting the alarm clock	137
Activating/deactivating the alarm clock and setting the wake-up time ...	137
Deactivating the wake-up call/repeating after a pause (snooze mode) ...	137
Using several handsets	138
Registering handsets	138
De-registering handsets	139
Locating a handset ("paging")	140
Changing the base station	140
Changing a handset's internal number	140
Changing the name of a handset	141
Making internal calls	141
Using a handset as a room monitor	144
Gigaset S68H handset: using Bluetooth devices	146
Activating/deactivating Bluetooth mode	146
Registering Bluetooth devices	147
Editing the list of known (trusted) devices	148
Rejecting/accepting an unregistered Bluetooth device	149
Changing the Bluetooth name of the handset	149
Handset settings	150
Changing the display language	150
Setting the display	151
Setting the screensaver	151
Setting the display backlight	152
Quick access to functions and numbers	153
Activating/deactivating auto answer	155
Changing the speaker/earpiece volume	155

- Changing ringers 156
- Activating/deactivating advisory tones 157
- Resource directory 158
- Setting your own area code 160
- Restoring the handset default settings 160
- Setting the base station via the handset 161**
- Protecting against unauthorised access 161
- Restoring the base station to the factory settings 162
- Activating/deactivating music on hold 163
- Activating/deactivating repeater mode 163
- Setting default line 164
- Updating the base station firmware 164
- Making VoIP settings 166**
- Using the connection assistant 166
- Changing settings without the connection assistant 166
- Setting the phone's IP address in LAN 168
- Activating/deactivating the display of VoIP status messages 170
- Checking the base station MAC address 170
- Operating the base station on the PABX 171**
- Setting recall 171
- Setting the access code (outside line code) 171
- Setting pauses 172
- Switching temporarily to tone dialling (DTMF) 172
- Web configurator – setting the phone using a PC 173**
- Connecting the PC with the telephone's Web configurator 174
- Logging in, setting the Web configurator language 175
- Logging off 176
- Structure of the Web pages 176
- Menu bar 177
- Navigation area 177
- Working area 178
- Buttons 179
- Opening Web pages 179
- Setting phone with Web configurator 180
- IP Configuration 181
- Configuring telephone connections 184
- Optimising voice quality for VoIP connections 195
- Setting the telephone's default line 199
- Activating the fixed line network connection as an alternative connection 200
- Assigning send and receive numbers to handsets 200
- Assigning receive numbers to the answering machine 202
- Activating Call Forwarding for VoIP connections 202
- Entering your own area code, activating/deactivating an automatic area code for VoIP 203

Defining dialling plans – cost control	204
Activating/deactivating network mailbox, entering numbers	207
Setting DTMF signalling for VoIP	208
Defining recall key functions for VoIP (hook flash)	208
Configuring call forwarding via VoIP	209
Defining local communication ports for VoIP	210
Saving messenger access data	211
Making e-mail settings	213
Configuring info services/activating idle display	214
Selecting and registering online directories for access	215
Changing internal handset numbers and names	216
Loading and deleting handset directories to/from the PC	217
Activating VoIP status message display	219
Starting a firmware update	220
Activating/deactivating the automatic version check	221
Copying the date/time from time server	222
Querying the phone status	223
Service (Customer Care)	224
Questions and answers	225
VoIP status codes	230
Checking service information	233
Authorisation	234
Environment	235
Our environmental mission statement	235
Appendix	236
Care	236
Contact with liquid	236
Specifications	236
Writing and editing text	238
Additional functions via the PC interface	241
Gigaset S685 IP – free software	242
Accessories	250
Glossary	253
Mounting the charging cradle to the wall	280
Mounting the base station to the wall	280

Safety precautions

Warning

Read the safety precautions and the user guide before use.

Explain their content and the potential hazards associated with using the telephone to your children.



Only use the mains adapter supplied, as indicated on the underside of the base station or charging cradle.



Only use the **recommended, rechargeable batteries** (→ [Page 236](#)), i.e. never use a conventional (non-rechargeable) battery or other battery types as this could result in significant health risks and personal injury.



The operation of medical appliances may be affected. Be aware of the technical conditions in your particular environment, e.g. doctor's surgery.



Do not hold the rear of the handset to your ear when it is ringing or when speaker mode is activated. Otherwise you risk serious and permanent damage to your hearing.

The handset may cause an unpleasant humming noise in hearing aids.



Do not install the base station or charging cradle in bathrooms or shower rooms. The handset, base station and charging cradle are not splashproof (→ [Page 236](#)).



Do not use the phone in environments with a potential explosion hazard, e.g. paint shops.



If you give your Gigaset to someone else, make sure you also give them the user guide.



Please remove faulty base stations from use or have them repaired by our Service department, as they could interfere with other wireless services.

Warning

When the keypad lock is active, you cannot call emergency numbers.

Please note

Not all of the functions described in this user guide are available in all countries.

Gigaset S685 IP – more than just making calls

You can use your phone to make calls both via the fixed line network and also (cost effectively) via the Internet (VoIP) **without a PC**.

Your phone can do much more besides:

- ◆ Make calls with brilliant sound quality (**High Definition Sound Performance HDSP**, → [Page 11](#)) – for internal calls or calls via VoIP.
- ◆ A simple **press of a key** each time you make a call indicates whether you want to call via the fixed line network or the Internet (→ [Page 44](#)).
- ◆ Register up to **six** handsets on your base station. With your base station, you can simultaneously conduct two calls via VoIP and one call via the fixed line network.
- ◆ **Multiline:** Create up to six VoIP accounts with different VoIP providers. Together with your fixed line number and the Gigaset.net number, your phone can then be reached via up to **eight different phone numbers**.
- ◆ Assign each handset its own VoIP number as a send and receive number. If a member of your family is called on their VoIP number, only their handset will ring (→ [Page 200](#)).
- ◆ You can also use the VoIP accounts with different providers for cost control purposes. When dialling, specify the VoIP connection/the VoIP account you want to use for its lower rates (→ [Page 46](#)).
- ◆ Setting dialling plans for phone numbers or area codes enables you to automate the selection of the most cost-effective VoIP connection (→ [Page 204](#)).
- ◆ Set the answering machine to specify the phone numbers for which the answering machine is to accept calls (→ [Page 202](#)).
- ◆ Use Gigaset.net for VoIP calls. Connect your phone to the mains power supply and the Internet, and enjoy free phone calls on Gigaset.net – without making any further settings (→ [Page 55](#)).
- ◆ Configure the phone connection for VoIP without a PC. Your phone's connection assistant downloads general data about your VoIP provider from the Internet and guides you through entering your personal data (VoIP/SIP account). This makes it easy for you to start using VoIP (→ [Page 22](#)).
- ◆ If necessary, make any further VoIP settings on a PC. The phone features a Web interface (**Web configurator**) that can be accessed via your PC's Web browser (→ [Page 173](#)).
- ◆ Use **instant messaging** on your handset. Go online and see which of your messenger contacts (buddies) are also online. Exchange SMS messages with your buddies or simply give them a call (→ [Page 102](#)). A free messenger account is already set up for you on the Gigaset.net Jabber server (→ [Page 212](#)).

VoIP – making calls via the Internet

- ◆ Obtain information about new **e-mail** messages in your mailbox from your phone **without using a PC** (→ **Page 98**). Use your handset to delete old e-mail messages from your mailbox.
- ◆ Make sure your phone is always up-to-date. Keep yourself informed about **firmware updates** on the Internet and download them onto your phone (→ **Page 164**).
- ◆ Reduce your telephone's transmission power, by activating Eco Mode (→ **Page 133**).
- ◆ Use Bluetooth™ on the Gigaset S68H handset to communicate wirelessly with other Bluetooth devices (e.g. headset, PDA, → **Page 146**).

Your Gigaset S685 IP has a protected operating system that offers **increased security against viruses** from the Internet.

Have fun using your new phone!

VoIP – making calls via the Internet

With VoIP (**V**oice **o**ver **I**nternet **P**rotocol), your calls are not made via a fixed connection as with the telephone network, but rather they are transmitted via the Internet in the form of data packets.

You can take advantage of all the benefits of VoIP with your phone:

- ◆ You can make cost-effective calls in high voice quality with callers on the Internet, the fixed line network or the mobile phone network.
- ◆ VoIP providers will give you personal numbers, with which you can be reached from the Internet, the fixed line network and any mobile phone network.

To be able to use VoIP, you need the following:

- ◆ A broadband Internet connection (e.g. DSL) with flat rate (recommended) or volume-based price.
- ◆ Internet access, i.e. you need a router that will connect your phone to the Internet.

You can find a list of recommended routers on the Internet at:

www.gigaset.com/customer-care

From here, go to the FAQ page and select your Gigaset IP telephone. Search for "Router", for example.

- ◆ Access the services of a VoIP provider. Open up to six accounts with **different** VoIP providers.

Gigaset HDSP – telephony with brilliant sound quality



Your Gigaset IP telephone supports the broadband codec G.722. With your base station and the corresponding handset, you can thus make calls via VoIP with brilliant sound quality (High Definition Sound Performance).

If you register further broadband-capable handsets (e.g. Gigaset S67H, S68H or SL37H) with your base station, internal calls between these handsets will also be conducted via broadband. Preconditions for broadband connections to your base station are:

◆ **For internal calls:**

Both handsets are broadband-capable, i.e. both support codec G.722.

◆ **For external calls via VoIP:**

- You make the call from a broadband-capable handset.
- You have selected codec G.722 for outgoing calls (→ [Page 195](#)).
- Your VoIP provider supports broadband connections.
- The recipient's phone supports codec G.722 and accepts the establishment of a broadband connection.

Please note

The VoIP service [Gigaset.net](#) (→ [Page 55](#)) supports broadband connections.

First steps

Check the pack contents

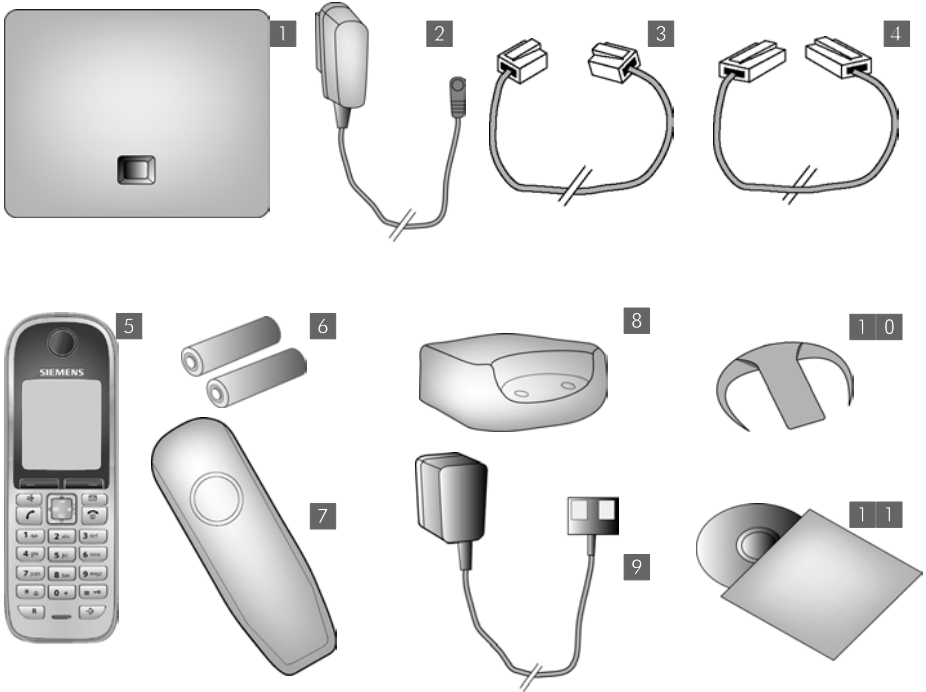

- 1 one Gigaset S685 IP base station
- 2 one mains adapter for connecting the base station to the mains power supply
- 3 one phone cord for connecting the base station to the fixed line network
- 4 one Ethernet (LAN) cable for connecting the base station to the router (LAN/Internet)
- 5 one Gigaset S68H handset
- 6 two batteries for the handset (uncharged)
- 7 one battery cover for the handset
- 8 one handset charging cradle
- 9 one mains adapter for connecting the charging cradle to the mains power supply
- 10 one belt clip for the handset
- 11 one quick guide and a CD containing this user guide

Firmware updates

This user guide describes the basic functions of the firmware version 182.

Whenever there are new or improved functions for your Gigaset S685, base station firmware updates will be made available for you to download to your telephone (→ **Page 164**). If this results in operational changes to your phone, a new version of this user guide or the necessary amendments will be published on the Internet at www.gigaset.com.

Select the product "Gigaset S685 IP" to open the relevant product page for your phone, where you will find a link to the user guide.

For information on how to find out the current firmware version on your base station, please see **Page 223** (using the Web configurator) or **Page 233** (during an external call).

Setting up the handset for use



The display is protected by a plastic film.
Please remove the protective film!

Inserting the batteries and closing the battery cover

Warning

Only use the rechargeable batteries (→ [Page 236](#)) recommended by Gigaset Communications GmbH*, i.e. never use a conventional (non-rechargeable) battery or other battery types as this could result in significant health risks and personal injury. For example, the outer casing of the batteries could be damaged or the batteries could explode. The phone could also malfunction or be damaged as a result of using batteries that are not of the recommended type.

- ▶ Insert the batteries the right way round.
The polarity is indicated in/on the battery compartment.

The handset switches on automatically.
You will hear a confirmation tone.

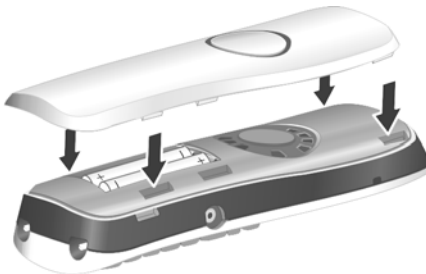

- ▶ First align the notches on the side of the battery cover with the lugs on the inside of the casing.
- ▶ Then press the cover until it clicks into place.

- ▶ If you need to open the battery cover again, for instance to replace the batteries, remove the belt clip (if fitted), place your fingertip in the cavity on the casing and pull the battery cover upwards.

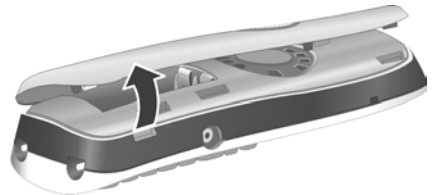

* Gigaset Communications GmbH is a trademark licensee of Siemens AG

Connecting the charging cradle

The charging cradle is designed to be operated in enclosed, dry areas at temperatures ranging from +5°C to +45°C.

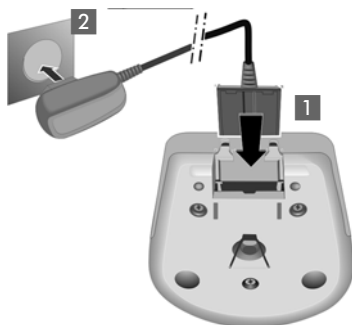

- ▶ Connect the flat plug from the mains adapter **1**.
- ▶ Plug the mains adapter into the plug socket **2**.

If you need to disconnect the plug from the charging cradle, press the release button **1** and disconnect the plug **2**.

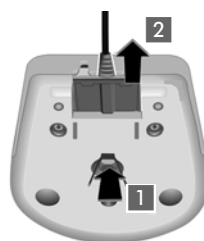

- ▶ To charge the batteries, leave the handset in the charging cradle.

Please note

- ◆ Only place the handset in the charging cradle that is intended for it.
- ◆ If the handset has turned itself off because the batteries are flat and is then placed in the charging cradle, it will turn itself on automatically.

For information on how to attach the charging cradle to the wall, → [Page 280](#).

Should you have any questions or problems → [Page 225](#).

Initial charging and discharging of the batteries

- ▶ Place the handset in the charging cradle and wait until the batteries are fully charged (approx. **10** hours).

If the handset is activated, the flashing battery icon  in the top right of the display indicates that the batteries are being charged.



- ▶ Remove the handset from the charging cradle and do not replace it until the batteries are fully discharged.

The charge status is displayed in the idle display.

 (flat to full).

 flashes, the batteries are almost flat.

After the first battery charge **and** discharge, you may place your handset in the charging cradle after every call.

Warning

- ◆ Always repeat the charging and discharging procedure if you remove the batteries from the handset and reinsert them.
- ◆ The batteries may warm up during charging. This is not dangerous.
- ◆ After a while, the charge capacity of the batteries will decrease for technical reasons.

Setting the date and time

The date and time must be set in order to have the correct time for incoming calls and to be able to use the alarm clock and calendar.

Please note

The address of a time server on the Internet is stored on your telephone. The date and time are taken from this time server provided that the base station is connected to the Internet and synchronisation with the time server is activated (→ [Page 222](#)). Manual settings are overwritten in this case.

If the date and time on the phone have not yet been set, the **Time** display key will appear.

Setting up manually:



- ▶ Press the key below **Time** on the display (= right display key).

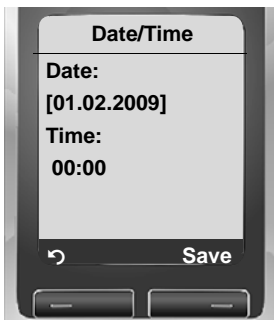





The following is displayed for a multiple line input. Each active line is marked [...].

- ▶ Overwrite the date that is currently being displayed: Enter the day, month and year in an 8-digit format with the keypad, e.g., for 01/02/2009.

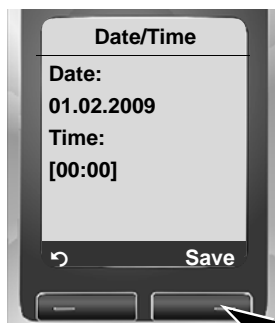

- ▶ Press down on the control key , to scroll to the time entry line.



- ▶ Overwrite the time that is currently being displayed: Enter the hours and minutes in a 4-digit format with the keypad, e.g.     for 07:15 am. If necessary, use the control key to swap between fields.
- ▶ Press down on the right display key **Save**, to store the date and time settings.

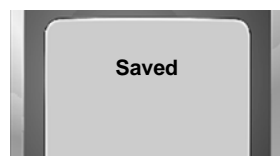

The display shows Saved.
You will hear a confirmation tone.

The date and time are shown in the handset's idle display (→ [Page 1](#)).

Registering the handset to the base station

Your handset is registered to the base station by default.

For information on how to register additional handsets with the base station and make free internal calls, → [Page 138](#).

Installing the base station

The base station is designed for use in closed, dry rooms with a temperature range of +5°C to +45°C.

- ▶ Install the base station in a central location in your flat or house.

— **Please note** —

Pay attention to the range of the base station.

This is up to 300 m in unobstructed outdoor areas and up to 50 m inside buildings. The range is reduced when Eco mode is activated (→ [Page 133](#)).

The phone's feet do not usually leave any marks on surfaces. However, due to the multitude of different varnishes and polishes used on today's furnishings, the occurrence of marks on the surfaces cannot be completely ruled out.

For information on how to mount the base station on the wall, → [Page 280](#).

— **Warning** —

- ◆ Never expose the telephone to any of the following: heat sources, direct sunlight or other electrical appliances.
 - ◆ Protect your Gigaset from moisture, dust, corrosive liquids and vapours.
-

Connecting the base station

In order to be able to make calls with your phone via the fixed line network and via VoIP, you must connect the base station to the fixed line network and the Internet, → **Figure 1**.

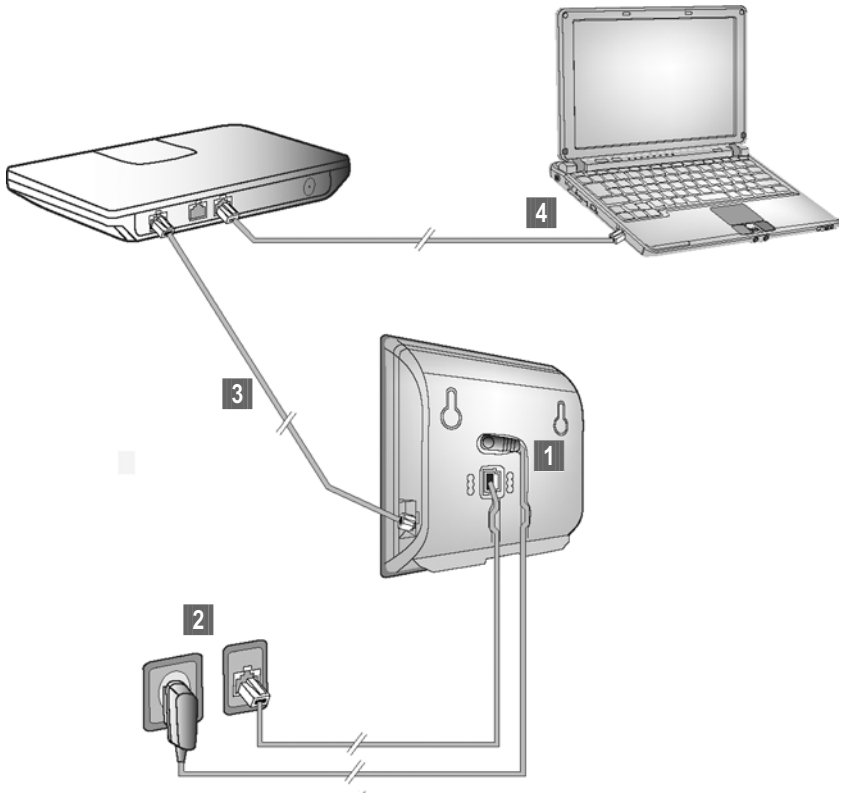
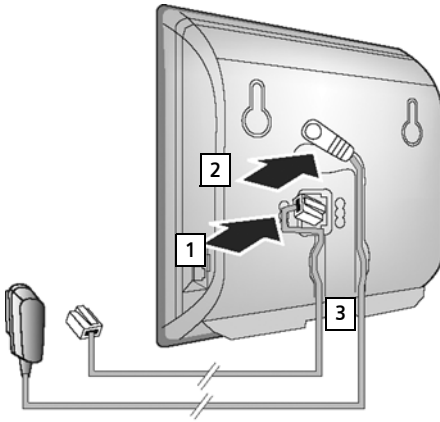

Figure 1 Connecting the phone to the fixed line network and the Internet

Follow the steps in the order given below:

- 1 Connect the phone cord and power lead to the base station.
- 2 Connect the base station to the fixed line network and the mains power supply.
- 3 To connect the base station to the Internet, first connect the base station to the router (connection via router and modem or via router with integrated modem).
- 4 Connect the PC and router (optional) – for advanced configuration of the base station (→ **Page 173**).

1. Connect the phone cord and power lead to the base station



- 1** Insert the phone cord into the lower connection socket at the rear of the base station.
- 2** Insert the power lead of the mains adapter into the upper connection socket at the rear of the base station.
- 3** Push both cables into the appropriate cable channels.

2. Connect the base station to the fixed line network and the mains power supply

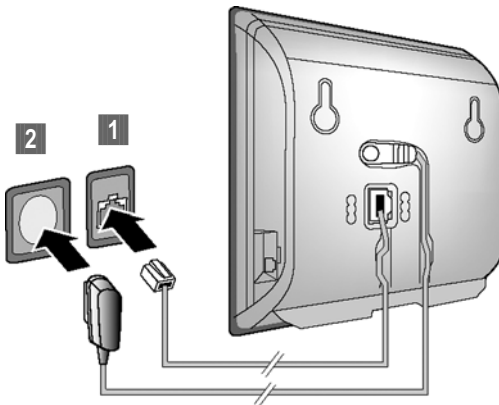

- 1** Insert the phone cord into the fixed line network connection socket.
- 2** **Then** insert the mains adapter into the mains socket.

Warning

- ◆ Keep the mains adapter **plugged in at all times** for operation, as the phone does not work without a mains connection.
- ◆ Only use the mains adapter and phone cord **supplied**. Pin connections on telephone cables can vary (pin connections → [Page 238](#)).

You can now use your phone to make calls via the fixed line network and can be reached on your fixed line number.

Your answering machine is set with a default announcement in answer and record mode (→ [Page 118](#)).

3. Connecting the base station with the router (Internet)

For Internet access you need a router connected to the Internet via a modem (this may be integrated in the router).

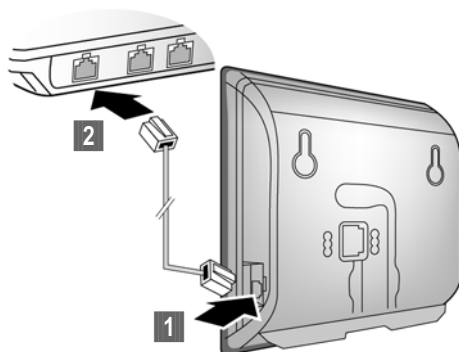

- 1** Connect an Ethernet cable plug into the LAN socket at the side of the base station.
- 2** Then insert the second Ethernet cable plug into a LAN socket on the router.

As soon as the cable connecting the phone and router is plugged in and the router is switched on, the key lights up on the front of the base station (paging key).

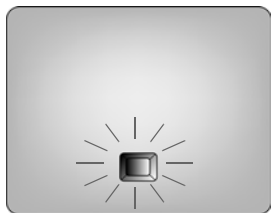

You can now establish VoIP connections within Gigaset.net (→ [Page 55](#)).

Adjusting the settings for VoIP telephony

Before you can use the Internet (VoIP) to phone any other numbers on the Internet, the fixed line network or the mobile phone network, you need the services of a VoIP provider who supports the VoIP SIP standard.

Precondition: You have registered with such a VoIP provider (e.g. via your PC) and set up at least one VoIP account.

To be able to use VoIP, you now need to enter the access data for your VoIP account. You will receive all the necessary data from your VoIP provider. This will include:

Either:

- ◆ Your user name (if requested by the VoIP provider), this is the user identification (Caller ID) for your account, which is often identical to your phone number
- ◆ Your authentication name or login ID
- ◆ The (login) password registered with the VoIP provider
- ◆ General settings for your VoIP provider (server addresses etc.)

Or:

- ◆ An auto-configuration code (Activation Code)

Your Gigaset phone's connection assistant can help you make these entries.

Starting the connection assistant

Precondition: The base station is connected to the mains power supply and a router. Your router is connected to the Internet (→ [Page 21](#)).

Tip:

Leave VoIP activated as the default line for your telephone (default setting → [Page 164](#)). The telephone then attempts to establish a connection directly to your VoIP provider's server after the connection assistant is closed. If incorrect/incomplete information means that the connection cannot be established, messages will be displayed (→ [Page 29](#)).

— Please note —

Your phone is preconfigured for dynamic assignment of the IP address. In order for your router to "recognise" the phone, dynamic IP address assignment must also be activated on the router, i.e. the router's DHCP server must be activated.

If the DHCP server cannot or should not be activated, you must first assign a fixed IP address to the phone. For information on how to do this, → [Page 168](#).



As soon as the handset battery is sufficiently charged, the message key (envelope icon) on the handset will flash (approx. 20 minutes after you have put the handset in the charging cradle).

- ▶ Press the message key (envelope icon).

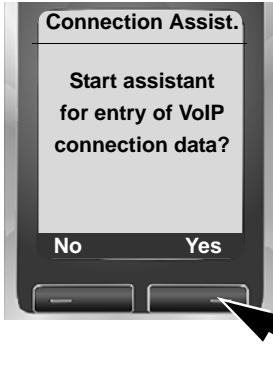

You will see the following display.

- ▶ Press the key under **Yes** on the display screen.

You will be prompted to enter your phone's system PIN.

— New firmware available is shown in the display ... —

New/improved firmware is available for your phone on the Internet. First carry out an automatic update of the firmware (→ [Page 164](#)). Once the update has completed (after approx. 3 minutes), the idle display of the handset appears again and the message key (envelope icon) flashes. If you press (envelope icon), the display shown in the picture above appears and you can start the connection assistant.

— Please note —

To protect your phone and its system settings from unauthorised access, please define a 4-digit number code (system PIN) known only to yourself. These must also be entered before you can register/de-register handsets, or alter the VoIP or LAN settings of your phone.

The default system PIN is 0000 (4 x zero). For how to change the PIN, → [Page 161](#).

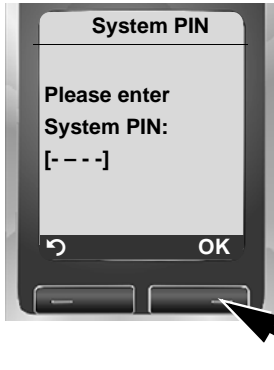

The active line is marked [----].

- ▶ Enter your phone's current system PIN using the keypad.
- ▶ Press the key below **OK** on the display screen.

The connection assistant is launched.

Please note

- ◆ You can also call up the connection assistant at any time via the menu (→ [Page 166](#)).
 - ◆ The connection assistant will also start automatically if you try to establish a connection via the Internet before you have made the necessary settings.
Precondition: You have **not** activated the fixed line network connection as a replacement connection (Web configurator, → [Page 200](#)):
-

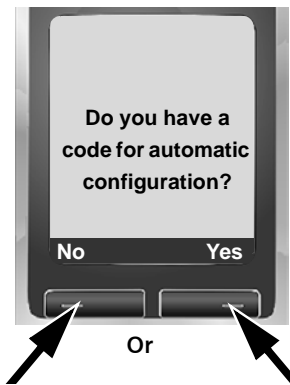

Your VoIP provider has supplied you with an **authentication name/ password** and, where applicable, a user name:

- ▶ Press the key below **No** on the display screen.
- ▶ For further information, please see "[Downloading VoIP provider data](#)" → [Page 25](#).

You have received an **auto-configuration code** (Activation Code) from your VoIP provider:

- ▶ Press the key below **Yes** on the display screen.
- ▶ For further information, please see "[Entering an auto-configuration code](#)".

Entering an auto-configuration code



- ▶ Enter your auto-configuration code using the keypad (max. 32 characters).
- ▶ Press the key below **OK** on the display screen.

All data necessary for VoIP telephony is loaded directly from the Internet to your phone.

When all the data has been successfully loaded onto your phone, *Saved* appears on the display.

- ▶ For further information, please see "[Completing the VoIP settings](#)",
→ [Page 28](#).

Downloading VoIP provider data

The connection assistant establishes a connection with the Gigaset configuration server on the Internet. Various profiles with general access data for different VoIP providers can be downloaded here.

After a brief period you will see the following display:



A list of countries is loaded.



- ▶ Press up or down on the control key repeatedly ...



... until the country in which you are using the phone is selected on the display.

- ▶ Press the key below **OK** on the display screen to confirm your selection.

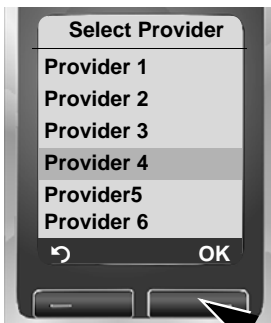

A list of the VoIP providers is displayed, for which a profile with the general access data is available on the configuration server.

- ▶ Press the top or bottom of the control key  repeatedly until your VoIP provider appears on the display.
- ▶ Press the key below **OK** on the display screen to confirm your selection.

The general access data for your VoIP provider will be downloaded and saved on the phone.

— You have not been able to download your provider's data —

If the data for your VoIP provider is not available for download, press the  display key twice. You can then carry out the following steps with the connection assistant.

You must then make the settings needed for the VoIP provider using the Web configurator (→ [Page 186](#)).

Your VoIP provider will supply you with this data.

Entering user data for your first VoIP account

You will now be prompted to enter your personal access data for your VoIP accounts.

The following are provider-dependent:

◆ Username, Authent. Name , Authent. Password

Or:

◆ Authent. Name , Authent. Password

____ Take care ... _____

... when entering access data, as it is case sensitive.

To switch between upper and lower case and digits, press the **[↔]** key (several times if necessary). You can see briefly in the display whether upper case, lower case or digit input is selected.

Characters entered erroneously can be deleted using the left display key below **[KC]**. The character to the left of the cursor will be deleted.

You can navigate within the input field using the control key **[↔]** (left/right).



If your VoIP provider does not require a user name, this step can be skipped.

- ▶ Using the keypad, enter the user name that you received from your VoIP provider.
- ▶ Press the key under **OK** on the display screen.



- ▶ Using the keypad, enter the authentication name that you received from your VoIP provider.
- ▶ Press the key under **OK** on the display screen.



- ▶ Use the keypad to enter your password.
- ▶ Press the key under **OK** on the display screen.

If you have made all the required entries, the message "Connection data complete" will appear on the display.

Completing the VoIP settings

After the entries have been completed, the handset reverts to idle status.

If all the settings are correct and if the phone can establish a connection to the VoIP server, the internal name of the handset will be displayed: (example)



Now you can use your phone to make calls via the fixed line network and the Internet! Callers can reach you on your fixed line number and your VoIP number.

Please note





- ◆ To ensure that you can always be reached via the Internet, the router must be permanently connected to the Internet.
 - ◆ If you have launched the connection assistant via the menu, you will initially have to press and hold the end call key  once the entry is complete, for the handset to return to idle status.
 - ◆ If you try to make a call via a VoIP connection that is not configured correctly, the following VoIP status message will appear in the display:
IP configuration error: xxx (xxx = VoIP status code). The various status codes and their respective meanings can be found on [Page 230](#).
-

You have set up several VoIP accounts ...

You can enter five additional VoIP accounts (VoIP phone numbers) via the Web configurator at a later stage (→ [Page 184](#)). Your phone (together with your fixed line number) can then be reached on up to seven different phone numbers. You can assign the phone numbers to the individual handsets that are registered with the base station as send and receive numbers (→ [Page 200](#)).

Icons on the idle display

The following is displayed:

- ◆ the internal number, e.g. INT 1.
- ◆ the strength of the reception signal between base station and handset:
 - good to poor: 
 - no reception:  flashes
- ◆ battery charge status:
 -  (flat to full)
 -  flashes: batteries almost flat
 -  flashes: charging

No connection to the Internet/VoIP server

If one of the following messages is displayed instead of the internal name after the connection assistant is closed, errors have occurred:

- ◆ Server not accessible!
- ◆ Registration at provider failed!

Below you will find possible causes and measures you can take.

Server not accessible!

The phone has no connection to the Internet.

- ▶ Check the cable connection between the base station and the router (the LED on the base station must light up) and the connection between the router and the Internet connection.
- ▶ Check whether the phone is connected to the LAN.
 - It may not have been possible to dynamically assign an IP address to the phone

or

- You have assigned a static IP address to the phone that has either already been assigned to another LAN subscriber or does not belong to the router's address block.
 - ▶ Press the paging key on the base station. The IP address appears on the handset display.
 - ▶ Press the talk key on the handset to end paging call.
 - ▶ Start the Web configurator with the IP address.
 - ▶ If no connection can be established, change the settings on the router (activate DHCP server) or the phone's IP address.

Registration at provider failed!

- ◆ Your personal data for registering with the VoIP provider may have been entered incompletely or incorrectly.
 - ▶ Check your entries for Username, Authent. Name and Authent. Password. Particularly check your use of upper and lower case.
To do this, open the following menu on the handset:
☐ → ☒ → Telephony → VoIP (Enter system PIN) → Provider Registr. (→ **Page 167**)
- ◆ The server address for the VoIP server has not yet been entered, or has been entered incorrectly.
 - ▶ Start the Web configurator.
 - ▶ Open the following Web page: Settings → Telephony → Connections.
 - ▶ Click the Edit key next to the first VoIP connection.
 - ▶ Edit the server address where necessary.

Please note

If port forwarding is activated on your router for the ports (→ **Page 210**) that have been registered as the SIP and RTP ports, it is advisable to deactivate DHCP and assign the phone a static IP address (otherwise you may not be able to hear the other party during VoIP calls):

- ◆ Assigning an IP address via the handset menu:

☐ → ☒ → Base → Local Network

Or

- ◆ Assigning an IP address via the Web configurator:
 - ▶ Open the following Web page: Settings → IP Configuration.
 - ▶ Select IP address type.

Please note that the IP address and subnet mask depend on the router's address block.

You must also enter the standard gateway and DNS server. The IP address for the router is generally entered here.

Belt clip and headset

By using a belt clip and headset (optional), you can easily make your handset a constant companion both inside the building and in its immediate vicinity.

Attaching the belt clip

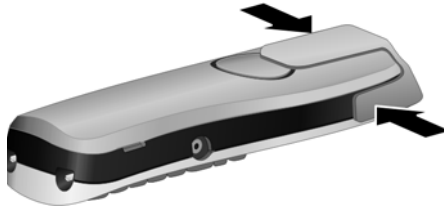

There are notches for attaching the belt clip on both sides of the handset at the top and at the same height as the display.

- ▶ Press the belt clip onto the back of the handset so that the protrusions on the belt clip engage with the notches.

Connection socket for headset

You can connect various headset types (with 2.5 mm jack connector), including HAMA Plantronics M40, MX100 and MX150.

A compatibility list of tested headsets is available on the Internet at:

www.plantronics.com/productfinder

How to proceed

Now you have successfully started your Gigaset, you will probably want to adapt it to your personal requirements. Use the following guide to quickly locate the most important subjects.

If you are unfamiliar with menu-driven devices such as other Gigaset telephones you should first read the section entitled "**Operating the handset**" → [Page 33](#).

Information on is located here.
Making calls via VoIP or the fixed line network	▶ Page 44
Setting the ringer and volume	▶ Page 156
Setting the earpiece volume	▶ Page 155
Setting Eco Mode	▶ Page 133
Preparing the telephone for SMS reception	▶ Page 83
Operating the telephone on a PABX	▶ Page 171
Registering existing Gigaset handsets to a base station	▶ Page 138
Transferring directory entries from existing Gigaset handsets to new handset(s)	▶ Page 74
Using online directories	▶ Page 78
Entering additional VoIP accounts	▶ Page 184

If you have any questions about using your phone, please read the tips on troubleshooting (→ [Page 225](#)) or contact our Customer Care team (→ [Page 225](#)).

Operating the handset

Control key





In this user guide the side/position of the control key (top, bottom, right, left) you have to press in each operating situation is shown in black.

Example:  for "press up on the control key".







The control key has a number of different functions:



When the handset is in idle status

-  Press briefly to open the handset directory.
Press and hold to open the list of available online directories.
-  Open the main menu.
-  Open the list of handsets.
-  Call up the menu for setting the handset's call volume
(→ [Page 155](#)), ringers (→ [Page 156](#)) and advisory tones
(→ [Page 157](#)).



In the main menu and in input fields

You can use the control key to move the cursor **up** , **down** , **right**  or **left** .

In lists and submenus

-  /  Scroll up/down line by line.

During an external call

-  Press briefly to open the handset directory.
-  Initiate an internal consultation call
-  Adjust the handset volume for earpiece and speaker mode.

Display keys

The functions of the display keys change depending on the particular operating situation. Each of the current functions is shown in the bottom display line. Example:

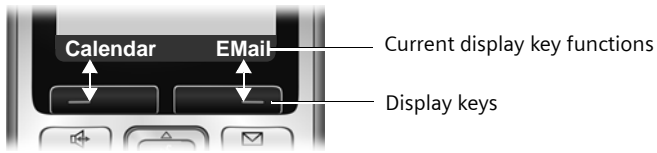

You can define your own display key functions when the handset is in idle status (→ [Page 153](#)). If a display key has not yet been given a function, **?** is displayed above the key.

Important display key functions include:

Options	Open a situation-dependent menu (context menu).
OK	Confirm selection.
Save	Store entry.
<C	Delete key: deletes one character at a time from right to left.
↶	Go back one menu level or cancel operation.
+☎	Copy number into directory.
☎	Divert external call to answering machine.

Keys on the keypad

/ / etc.

Press the matching key on the handset.



Enter digits or letters.

Correcting incorrect entries

You can correct incorrect characters in the input fields by navigating to the incorrect entry using the control key. You can then:

- ◆ Delete the character to the left of the cursor with the display key **<C**.
- ◆ Insert new characters to the left of the cursor.
- ◆ Overwrite the highlighted flashing character, e.g. when entering date and time or IP addresses.

Menu guidance

Your telephone's functions are accessed using a menu that has a number of levels.



Main menu (first menu level)

- ▶ With the handset in idle status, press on the right of the control key  to open the main menu.

The main menu functions are shown in the display with icons. The icon for the selected function is shown enlarged, and the name of the associated function appears in the display's header.

Accessing a function, i.e. opening the corresponding submenu (next menu level):

- ▶ Use the control key / to select the required function and press the display key **OK**.

Briefly press the display key  or the end call key  to revert back to idle status.



Submenus

The functions in the submenus are displayed as lists.

To access a function:

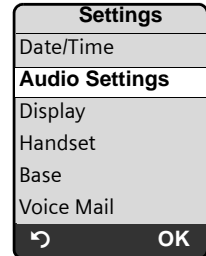

- ▶ Scroll to the required function using control key . The function is selected if it is marked with a bar and shown in bold. Select display key **OK**, to confirm your selection and open the next menu level if necessary.



This operating step is illustrated below:

Audio Settings

Select and press **OK**.

To return to the previous menu level or cancel the operation, briefly press the display key  or the end call key .

Reverting to idle status

You can revert to idle status from anywhere in the menu as follows:

- ▶ Press and **hold** the end call key .

Or:

- ▶ Do not press any key: after 2 minutes the display will **automatically** revert to idle status.

Changes that you have not confirmed or saved by pressing **OK**, **Yes**, **Save**, **Send** or **Save Entry** **OK** will be lost.

You can find an example of the display in idle status on [Page 1](#).

Activating/deactivating the handset



With the phone in idle status, press and **hold** the end call key to switch off the handset. You will hear the confirmation tone.

Press and **hold** the end call key again to switch the handset on.

Activating/deactivating the keypad lock

The keypad lock prevents any inadvertent use of the phone.



Press and **hold** the hash key. You will hear the confirmation tone.

The  icon appears in the display when the keypad lock is activated.

The keypad lock deactivates automatically when you receive a call and activates again after the call.

Please note

The handset displays an advisory message if you press a key by accident while the keypad lock is on. To deactivate the keypad lock, press and **hold** the hash key .

Illustration of operating steps in the user guide

The operating steps are shown in abbreviated form in the user guide.

Example of "Activating/deactivating auto answer":

The display



 →  → Handset → Auto Answer (= on)

means:



- ▶ With the handset in idle status, press on the right of the control key  to open the main menu.



- ▶ Use the control key to select the icon . For example, press once on the left of the control key . Settings is shown in the header.





- ▶ To open the submenu, press the right display key .

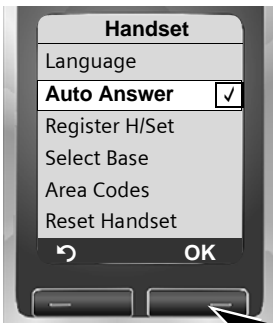

▶ Press the bottom of the control key  repeatedly until the menu item **Handset** is selected.

▶ To open the submenu, press the right display key **OK**.



▶ Press the bottom of the control key  repeatedly until the menu item **Auto Answer** is selected.

The icon after **Auto Answer** tells you whether auto answer is currently activated or deactivated:

= on

= off

▶ To change the setting, press the right display key **OK**.



▶ Press and hold the end call key  to return the handset to idle status.

Menu trees

Phone menu

Open the main menu on your phone by clicking on the right of the control key when the handset is in idle status: .



There are two ways to select a function:

Using number combinations ("shortcut")

- ▶ Enter the number combination that is in front of the function in the menu tree.

Example:  **8** tuv **4** gpi **1** oo for 'Set handset language'.

Scrolling through the menus

- ▶ In the main menu: using the control key   (press top/bottom or left/right), navigate to the function and press **OK**.
- ▶ In the submenus: using the control key  (press top/bottom), scroll to the function and press **OK**.

Messaging

An SMS mailbox (general or private) activated without a PIN → [Page 83](#)

1-1	SMS	1-1-1	New SMS	→ Page 85
		1-1-2	Incoming (0)	→ Page 88
		1-1-3	Outgoing (0)	→ Page 87

An SMS mailbox activated with a PIN or 2-3 mailboxes

1-1	SMS	1-1-1	Mailbox	1-1-1-1	New SMS	→ Page 85
				1-1-1-2	Incoming (0)	→ Page 88
				1-1-1-3	Outgoing (0)	→ Page 87
		1-1-2	Mailbox 1 to 1- 1-4 Mailbox 3	1-1-2-1	New SMS	→ Page 85
				1-1-2-2	Incoming (0)	→ Page 88
				1-1-2-3	Outgoing (0)	→ Page 87
		1-1-5	SMS Service	→ Page 95		

Menu trees

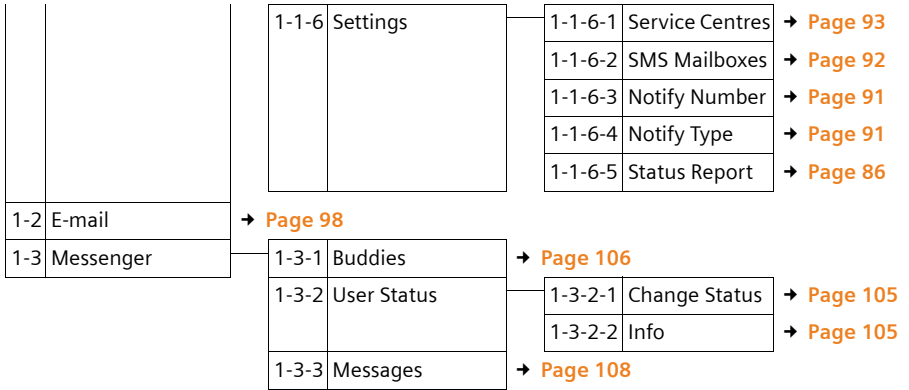

 Info Center → Page 113

 Calls List → Page 68

 Add. Feature

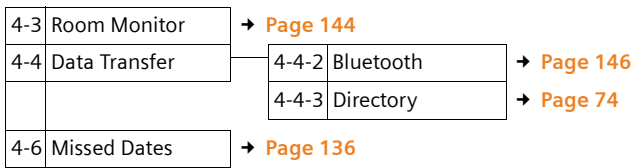

 Alarm Clock → Page 137

 Calendar → Page 134

 Resource Dir.



 Settings

8-1	Date/Time	→ Page 16			
8-2	Audio Settings	8-2-1	Handset Volume		
		8-2-2	Ringer Settings		
			8-2-2-1	Ext. Calls	
			8-2-2-2	Internal Calls	
8-2-2-3	Appointments				
8-2-2-4	All	→ Page 156			
8-2-3	Advisory Tones	→ Page 157			
8-3	Display	8-3-1	Screen Saver		
		8-3-2	Colour Scheme		
		8-3-3	Contrast		
		8-3-4	Lighting		
		→ Page 151			
		→ Page 151			
		→ Page 151			
		→ Page 152			
8-4	Handset	8-4-1	Language		
		8-4-2	Auto Answer		
		8-4-3	Register H/Set		
		8-4-4	Select Base		
		8-4-5	Area Codes		
		8-4-6	Reset Handset		
		→ Page 150			
		→ Page 155			
		→ Page 138			
		→ Page 140			
		→ Page 160			
		→ Page 160			
8-5	Base	8-5-1	Calls List Type		
			8-5-1-1	Missed Calls	
		8-5-1-2	All Calls	→ Page 68	
		8-5-2	Music on hold	→ Page 163	
		8-5-3	System PIN	→ Page 161	
		8-5-4	Base Reset	→ Page 162	
		8-5-5	Add. Features	8-5-5-1	Repeater Mode
				8-5-5-2	Access Code
				8-5-5-4	Eco Mode
				→ Page 163	
		→ Page 171			
		→ Page 133			
8-5-6	Local Network	→ Page 168			
8-5-8	Firmware Update	→ Page 164			

Menu trees

8-6	Voice Mail	8-6-1	Local AM	8-6-1-1	Ans Machine	→ Page 119
				8-6-1-2	Call Screening	→ Page 124
				8-6-1-3	Announcements	→ Page 120
				8-6-1-4	Message Length	→ Page 125
				8-6-1-5	Record Quality	→ Page 126
				8-6-1-6	Ring Delay	→ Page 125
		8-6-2	Network AM(s)	8-6-2-1	Net AM Fxd. In.	→ Page 129
				8-6-2-2	Net AM IP1	
				:		(dependent on the number of configured VoIP phone numbers and receive numbers on the handset)
				8-6-2-7	Net AM IP6	
		8-6-3	Set Key 1	Local AM		→ Page 126
				Net AM Fxd. In.		
Net AM IP1						
:				(dependent on the number of configured VoIP phone numbers and receive numbers on the handset)		
		Net AM IP6				
8-7	Telephony	8-7-8	Sel. Services	8-7-8-1	VoIP	→ Page 63
				8-7-8-2	Fixed Line	→ Page 61
				8-7-8-3	Ringback Off	→ Page 63
				8-7-8-4	Always anon.	→ Page 60
				8-7-8-5	Next Call	→ Page 60
		8-7-1	Default Line	8-7-1-1	VoIP	→ Page 164
				8-7-1-2	Fixed Line	
		8-7-2	Connection Assist.			→ Page 166
		8-7-6	Fixed Line	8-7-6-2	Recall	→ Page 171
		8-7-7	VoIP	Enter system PIN	Show Stat. on HS	→ Page 170
Select Provider	→ Page 166					
Provider Registr.	→ Page 167					

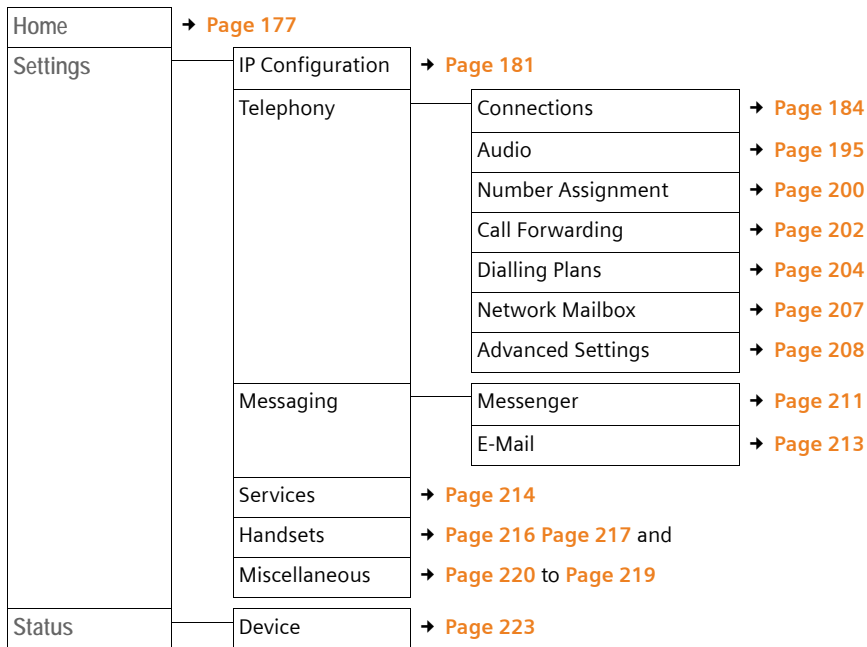

Web configurator menu



Making calls with VoIP and the fixed line network

Making an external call

External calls are calls made via the public telephone network (fixed line network) or via the Internet (VoIP). You generally decide which connection you want to use for a specific call when you dial the number. You have the following options:

- ◆ Select the connection type with the talk key  (briefly press/press and hold ) , → [Page 44](#).
- ◆ Select the connection type via the display key, by assigning VoIP or the fixed line network to your left display key, → [Page 45](#)
- ◆ Select a special connection via your line suffix, → [Page 46](#).



Please note

- ◆ You can conduct up to three separate external calls via your base station (using different handsets): two calls via VoIP and one via the fixed line network.
- ◆ You can define dialling plans for certain numbers or area codes by determining the connection and therefore the billing method to be used (cost control → [Page 204](#)) when these numbers are dialled.
- ◆ Dialling with the directory (→ [Page 71](#)), quick dial keys (→ [Page 153](#)) or redial list (→ [Page 66](#)) saves you from repeatedly keying in phone numbers. You can modify or add to these numbers on a call-by-call basis.
- ◆ If you use VoIP to make a call to the fixed line network, you may also have to dial the area code for local calls (depending on the VoIP provider). You can save yourself the time of dialling your own area code each time by entering the area code in the configuration (→ [Page 203](#)) and activating the Predial area code for local calls through VoIP option (→ [Page 203](#)).



Use the talk key to select the type of connection and make the call

By briefly pressing or pressing and holding the talk key , you can determine the type of connection for the call you want to make (fixed line network or VoIP).

Precondition: You enter the number without a line suffix (→ [Page 46](#)) and have not defined any dialling plans for this number.

  Enter number (without suffix) or IP address and **briefly press/press and hold** the talk key.

A default line is set on your phone (fixed line network or VoIP → [Page 164/ Page 199](#)).

- ▶ **Briefly** press the talk key  if you want to make a call via this default line.
- ▶ Press and **hold** the talk key  if you want to make the call via the other connection type.

If you have assigned a number of VoIP numbers to your phone, you can define which VoIP number (VoIP account) is used for external calls from each specific handset (handset send number, → [Page 200](#)).

— Please note —

- ◆ If you are using a GAP compatible handset other than the Gigaset handsets A58H, S67H, S68H, SL37H, S45, C47H and C45, every call will be made via the default line, even if you press and hold the talk key.
 - ◆ You have activated the Automatic Fallback to Fixed Line option with the Web configurator (→ [Page 200](#)):
If the attempt to establish a connection via VoIP fails, an attempt is made automatically to establish the connection via the fixed line network.
-

Selecting the connection type using display keys and making a call

Precondition: The display keys on your handset have been assigned **Fxd.Ln.** and/or **IP** (→ [Page 153](#)).

Fxd.Ln. / **IP** Press the display key to select the connection type.



Enter the number or select from the directory.

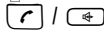

Press the talk or speaker key.

The number will always be called via the selected connection type.

Exception:

If you have activated the "Automatic Fallback to Fixed Line" option (Web configurator, → [Page 200](#)) and the attempt to establish a connection via VoIP fails, an attempt is made automatically to establish the connection via the fixed line network.

— Please note —

If you have pressed the display key **IP** before dialling and ...

- ◆ ... dialled the number with suffix #1 to #6, your call will be made via the VoIP account assigned to the suffix. The number will not be dialled if the suffix is invalid (e.g. no VoIP connection assigned).
- ◆ ... dialled the number without a suffix or with the suffix #0, your call will be made via the handset's VoIP send number.

Do not enter a suffix if you have pressed the display key **Fxd.Ln.** prior to dialling. Otherwise the suffix will be dialled together with the number via the fixed line network. This may cause errors!

Selecting and calling a connection via its line suffix

You can configure up to six VoIP numbers on your phone in addition to the fixed line network number and the Gigaset.net number. A (line) suffix is assigned to each number (line) of your phone:

- ◆ the fixed line network number has the suffix #0
- ◆ VoIP numbers have the suffixes #1 to #6 (→ [Page 185](#))
- ◆ and the Gigaset.net number has the suffix #9

When dialling, you can use this line suffix to specify the connection via which you would like to call or be charged.



Enter the number of the party you wish to call.



Add the suffix of the connection (your phone number) from which the call is to be made and charged to.



Press the talk key.

The connection is always made via the line with the assigned suffix, regardless of whether you press the talk key  **briefly** or press and **hold**.

Example



If you enter the number 1234567890#1 and press the talk key , the number 1234567890 will be dialled via the first VoIP connection in the configuration.

Please note

- ◆ If you specify a suffix for which no VoIP connection is configured in your base station, the VoIP status code 0x33 will be displayed. The number will not be dialled.
 - ◆ You have activated the *Automatic Fallback to Fixed Line* option with the Web configurator (→ [Page 200](#)):
If the attempt to establish a connection via VoIP fails, an attempt is made automatically to establish the connection via the fixed line network.
-

Entering an IP address (provider-dependent)

You can also dial an IP address instead of a phone number using VoIP.

- ▶ Press the star key  to separate the sections of the IP address (e.g. 149*246*122*28).
- ▶ If necessary press the hash key  to attach the SIP port number of the person you are calling to the IP address (e.g. 149*246*122*28#5060).

You **cannot** dial IP addresses using a line suffix.

If your VoIP provider does not support the choice of IP addresses, each part of the address will be interpreted as a normal phone number.

Cancelling the dialling operation

You can cancel the dialling operation with the end call key .

Gigaset S68H: Continuing a call on a Bluetooth headset

Precondition: Bluetooth is activated; a connection has been established between the Bluetooth headset and the handset (→ [Page 146](#)).

Press the talk key on the Bluetooth headset; it may take up to 5 seconds to establish a connection to the handset.

For further details about your headset, see the user guide issued with it.

Dialling emergency numbers – defining dialling plans

You can use the Web configurator to block certain numbers or to define which of your numbers (fixed line network, VoIP) should be used to call specific numbers (Dialling Plans, → [Page 204](#)).

If you enter a number that has a defined dialling plan, the call will be made via the line defined in the dialling plan – regardless of whether the talk key is pressed briefly or pressed and held. Any automatic area code will **not** be prefixed to the number.

Emergency numbers

Dialling plans for emergency numbers (e.g. the **local** emergency service number) are preset for certain countries. Emergency calls are then always made via the fixed line network.

You cannot delete or deactivate these dialling plans. However, you can change the connection through which each emergency number should be called (e.g. if the phone is not connected to the fixed line network). You must make sure that the VoIP provider for the selected connection supports emergency calls. If the VoIP connection is deleted from the configuration, the emergency call can no longer be made.

If your phone does not have default dialling plans for emergency calls, you should define the rules yourself (→ [Page 204](#)). Assign them to a connection that you know supports emergency calls. Calls to emergency numbers are always supported by fixed line networks.

Please note: If no rules are defined for emergency numbers and you have programmed an automatic local area code (→ [Page 203](#)), the code will be prefixed to emergency numbers as soon as they are dialled via a VoIP connection.

Please note

Emergency numbers cannot be dialled if the keypad lock is activated. Before dialling, press **and hold** the hash key () to release the keypad lock.

Ending a call



Press the end call key.

Accepting a call

The handset indicates an incoming call in three ways: by ringing, by a display on the screen and by the flashing speaker key

Please note

Only calls to receive numbers assigned to your handset will be signalled (→ [Page 200](#)). This following applies:

- ◆ If the phone number is not assigned to a handset or an answering machine as a receive number, all calls to this number are signalled on all handsets. If the phone number is not assigned to a handset, but is assigned to the answering machine, the call is not signalled on any handset and is accepted by the answering machine.
 - ◆ If you have not assigned receive numbers to the answering machine or any of the registered handsets, calls to all connections will be signalled on all handsets.
 - ◆ Calls to your IP address will be signalled on all handsets.
-

You can accept the call by:

- ▶ Pressing the talk key
- ▶ Pressing the speaker key
- ▶ Pressing the display key to forward the call to the answering machine (→ [Page 123](#)).

If the handset is in the charging cradle and the **Auto Answer** function is activated (→ [Page 155](#)), the handset will automatically accept a call when you lift it out of the cradle.

To deactivate the ringer, press the **Silence** display key. You can accept the call so long as it is displayed on the screen.

Please note

You can reject VoIP calls by pressing the end call key . The caller receives an appropriate message (provider-dependent).

Pressing the end call key on an incoming call from the fixed line network will cancel the ringer (same as **Silence**).

Gigaset S68H: Accepting calls to a Bluetooth handset

Precondition: Bluetooth is activated; a connection has been established between the Bluetooth headset and the handset (→ [Page 146](#)).

Only when the headset rings: Press the talk key on the headset. It may take up to 5 seconds to establish a connection to the handset.

For further details about your headset, see the user guide issued with it.

Calling Line Identification

When you receive a call from the Internet, the caller's number or the name they have specified is displayed on the screen.

When you receive a call from the fixed line network, the caller's number is displayed on the screen if the following conditions are met:

- ◆ Your fixed line network provider supports CLIP, CLI:
 - CLI (Calling Line Identification): the caller's number is transmitted
 - CLIP (Calling Line Identification Presentation): the caller's number is displayed
- ◆ You have requested CLIP from your network provider.
- ◆ The caller has requested CLI from the network provider.

If the phone number is identified and the caller's number is saved in your handset's local directory, the name will be displayed from the directory. If a caller picture is allocated to the name, this will also appear in the display.

If the caller's number is not saved in the local directory the caller's surname and first name will be displayed from the currently installed online directory.

Precondition: You have activated this option (Web configurator → [Page 215](#)).

Call display

You can use the display to determine whether the call is for your fixed line network number or one of your VoIP numbers.

Calls to your fixed line number

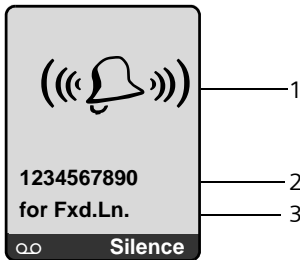

1 Ringer icon or the caller picture assigned to the caller (→ [Page 72](#))

2 Number or name of caller

3 Receive number displayed: The name is displayed that you have assigned to your fixed line network number (→ [Page 193](#)).

Calls to your VoIP number

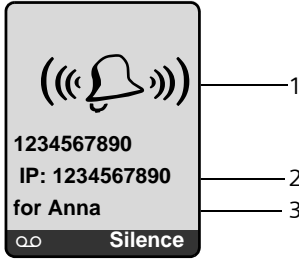

- 1 Ringer icon or the caller picture assigned to the caller (→ [Page 72](#))
- 2 Number or name of caller
- 3 Receive number: indicates which of your VoIP phone numbers the caller has dialed. You assign the names when you enter the VoIP phone numbers into the phone (→ [Page 186](#)). For calls from Gigaset.net, for Gigaset.net is displayed.

Adopting the name from the online directory

You can display the name under which the caller is saved in the online directory.

Preconditions:

- ◆ The provider of the online directory you have set for your telephone (→ [Page 215](#)) supports this function.
- ◆ You have activated the "display caller name" function via the Web configurator (→ [Page 215](#)).
- ◆ The caller has authorised Calling Line Identification and has not suppressed the function.
- ◆ Your telephone is connected to the Internet.
- ◆ The caller's number is not saved in the handset's local directory.

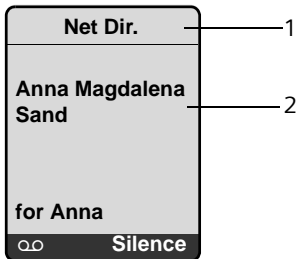

- 1 Name of the currently active online directory from which the name was obtained
- 2 Name of the caller, possibly over a number of lines
The number is displayed if the caller's name is in neither the local directory nor the online directory.

Display when Calling Line Identification is suppressed

The number or name of the caller is not displayed if the caller has suppressed Calling Line Identification:

- ◆ VoIP: The caller has activated the "anonymous calling" function.
- ◆ Fixed line network: The caller has activated the "anonymous calling" function or has suppressed Calling Line Identification from his fixed line network provider.

The following is displayed in place of the number:

- ◆ With a call to one of your VoIP phone numbers, the display is provider-dependent (examples):

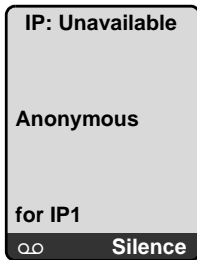

or

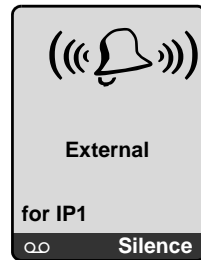

- ◆ For calls to your fixed line network numbers:
 - If no number is transmitted:

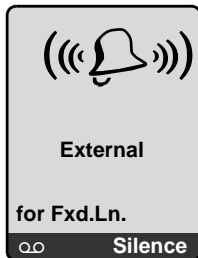

- If the caller has withheld Calling Line Identification:

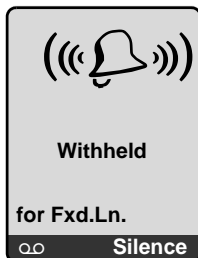

- If the caller has not arranged Calling Line Identification:

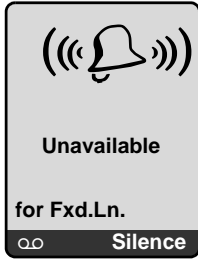

VoIP: Displaying the called party's phone number (COLP)

Preconditions:

- ◆ Your VoIP provider supports COLP (**C**onnected **L**ine **I**dentification **P**resentation). You may have to ask your provider to activate COLP (contact your VoIP provider for more information).
- ◆ The called party has not activated COLR (**C**onnected **L**ine **I**dentification **R**estriction).

For outgoing VoIP calls, the phone number of the connection on which the call is received is displayed on the handset.

The displayed number may differ from the number you have dialled. Examples:

- ◆ The called party has activated call forwarding.
- ◆ The call is answered by another connection within a PABX system.

If there is an entry in the directory for this phone number, the corresponding name will be displayed.

— Please note —

- ◆ The number of the connection you have reached (or the assigned name) will also be displayed instead of the called number during call swapping, conference calls and consultation calls.
 - ◆ When the phone number is copied to the directory (**Options** → **Copy to Directory**) and the redial list, the dialled number (not the displayed number) is copied.
-

Speaker

In speaker mode, instead of holding the handset to your ear you can put it down, for example on the table in front of you. This allows others to participate in the call.

Activating/deactivating the speaker

Activating while dialling





Enter number and press **briefly**/press and **hold** the speaker key to select the connection type (→ [Page 44](#)).

- ▶ You should inform your caller before you use the speaker function so that they know someone else is listening.

Switching between earpiece and speaker mode

- ▶ Press the speaker key  to activate/deactivate the speaker during a call and when listening to the answering machine.

If you wish to place the handset in the charging cradle during a call:

- ▶ Press and hold the speaker key  while placing the handset in the charging cradle.
- ▶ If the speaker key  does not light up, press the key again.

For instructions on how to adjust the handset volume, → [Page 155](#).

Deactivating handset's microphone

You can deactivate your handset's microphone during an external call (including during a conference or when call swapping). The other party cannot hear you, but you can still hear them.

Turning off the microphone

Mute

Press the display key to deactivate the handset.

Your handset's microphone is deactivated. The display shows **Microphone is off**.

Switch the microphone back on.

On

Press the display key to switch the microphone back on.

— Please note the following: _____

The microphone is **activated automatically** under the following circumstances:

- ◆ During an external call (the microphone is deactivated), you establish a second connection by accepting a waiting call or successfully carrying out an external/internal consultation call. The microphone is turned on. If you return to the first caller, the microphone remains **activated**.
(If you reject a waiting call or you can connect to a consultation call, the microphone remains deactivated.)
 - ◆ If you deactivated the microphone while call swapping, it is reactivated for both connections, as soon as they are connected to the other caller.
 - ◆ If you have deactivated the microphone during a conference call, the microphone is reactivated when you terminate the conference call by selecting **Options** → End Conference (call swapping).
-

Muting the handset

You can mute your handset during an external call. The other party cannot hear you, Likewise, you can no longer hear the other party. Your caller will hear music on hold, if activated (→ [Page 163](#)).

Muting the handset



Press left on the control key to mute the handset.

Cancelling muting



Press the display key or the end call key to cancel the muting.

VoIP telephony via Gigaset.net

You can use **Gigaset.net** to make free phone calls via the Internet **directly** to other Gigaset.net users, without having to set up an account with a VoIP provider or make any further settings. You simply have to connect your phone to the power supply and the Internet connection and, if necessary, enter yourself in the Gigaset.net online directory under a name of your choice (→ [Page 56/ Page 59](#)).

Gigaset.net is a VoIP service provided by Gigaset Communications GmbH to which all users of a Gigaset VoIP device can subscribe.

You can call other subscribers to Gigaset.net **free of charge**, i.e. there are no telephone charges other than the costs for your Internet connection. Connections to/from other networks are not possible.

Please note

Gigaset.net supports broadband telephony: Gigaset.net calls that you make from your Gigaset S685 IP (base station and handset) with a different broadband-capable terminal have excellent sound quality.

Every Gigaset VoIP device is assigned a Gigaset.net phone number by default (→ [Page 233](#)).

All registered subscribers are included in the Gigaset.net directory, which you are able to access.

An echo service is available on the phone number **12341#9** (English) for you to check your VoIP connection.

After an announcement, the echo service sends back the voice data you have received immediately in the form of an echo.

Exclusion of liability

Gigaset.net is a voluntary service provided by Gigaset Communications GmbH with no liability or guarantee for the availability of the network. This service can be terminated at any time with a notice period of three months.

Please note

If you do not use your Gigaset.net connection for six weeks, it is automatically deactivated. You cannot be reached for calls from Gigaset.net.

The connection is reactivated:

- ◆ As soon as you start a search in the Gigaset.net directory or
 - ◆ Make a call via Gigaset.net (dial a number with #9 at the end) or
 - ◆ Activate the connection via the Web configurator (→ [Page 194](#)).
-

Opening the Gigaset.net directory

Your handset is in idle status.



Press and **hold**.



If necessary, select **Gigaset.net** from the list of available online directories and press **OK**.

Or:

- ▶ Open the directory with the key.
- ▶ Select **Gigaset.net** from the directory and press the talk key . A connection to the Gigaset.net directory is established.

— Please note —

- ◆ The **Gigaset.net** directory entry is transferred to a handset when it is registered with the base station. Provided the handset can send and receive directory entries.
- ◆ Calls to the Gigaset.net directory are always **free of charge**.
- ◆ You can also open the Gigaset.net directory by dialling **1188#9** (phone number of the Gigaset.net directory) and pressing the talk key .

If a connection cannot be established with the Gigaset.net directory, an error message will be sent and the handset will go into idle status.

After opening the Gigaset.net directory for the first time

When opening the Gigaset.net directory for the first time you can use the Gigaset.net assistant to create an entry in the Gigaset.net directory for your phone.

The following appears in the handset's display:

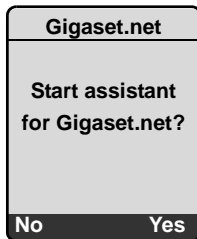

- ▶ Press the display key **Yes** to start the assistant.

— Please note: —

If you press **No** the assistant will be cancelled and will no longer be launched. You must then create your entry as described on [Page 59](#).



- ▶ Using the keypad, enter the name that you would like to be listed under in the Gigaset.net directory. The name may contain a maximum of 25 characters.
- ▶ Press the right-hand display key **OK**.

If there is already an entry under this name, you will receive a message to this effect and you will be asked to enter a name again.

If an entry was created successfully in the Gigaset.net directory, the message "Your user name is succesfully added to Gigaset.net!" is displayed.

— You have not been able to enter a name ... —

If the attempt to create the entry fails you can create it via the Gigaset.net directory ("**Entering, editing and deleting own entry**", → [Page 59](#))

Search for subscribers in the Gigaset.net directory

Once the connection to the Gigaset.net directory has been established, you will be asked to enter a name that you want to search for.

Nickname search:

Enter the name or part of a name (max. 25 characters).

Options Press the display key.

Start search Select and press **OK**.

If the search has been successful, a hit list will be displayed of all the names that begin with the specified character string.

Example:

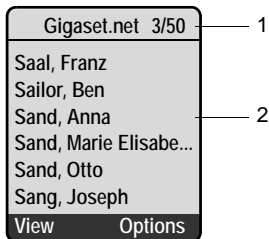

1. 3/50: Entry number/number of hits
2. Name of an entry, possibly abbreviated

You can scroll through the hit list with .

If it has **not** been possible to find a **matching** entry, a corresponding message is displayed. You have the following options:

▶ Press the display key **New** to start a new search.



Or

▶ Press the display key **Change** to change the search criteria. The previously entered name is copied and can be edited.

If there are **too many matching** entries in the Gigaset.net directory, the message **Too many results found!** is displayed instead of a hit list.

▶ Press the display key **Refine** to start a refined search. The previously entered name is copied and can be edited/expanded.

Calling subscribers

  Select the subscriber from the hit list and press the talk key.

Viewing the subscriber's number

 Select the subscriber from the hit list.

View Press the display key.

The display shows the Gigaset.net number and the subscriber's name, whereby the name may appear over a number of lines.

— Please note —

- ◆ Connections to Gigaset.net are always established via the Internet irrespective of which default line is set on your phone. Pressing and holding  or pressing it briefly has no effect.
 - ◆ You can open the Gigaset.net directory and establish connections, even if you have not entered yourself in the Gigaset.net directory.
-

Using other functions

Precondition: The hit list is displayed.

 (Select entry) → **Options**

The following functions can be selected with .

Copy to Directory

Copy the number to the handset directory. The number and name (abbreviated if necessary, max. 16 characters) are copied to the directory.

▶ Edit and save entry where appropriate (→ [Page 72](#)).

The hit list is displayed again.

New search

Start a search with a new name (→ [Page 57](#)).

Own information

See "[Entering, editing and deleting own entry](#)" on [Page 59](#).

— Please note —

If you select a Gigaset.net number from the local directory, the connection is automatically established via Gigaset.net (Internet).

Entering, editing and deleting own entry

You have the following options:

- ◆ Edit the name of your entry in the Gigaset.net directory
- ◆ Delete your entry from the Gigaset.net directory
- ◆ If you did not specify a name when you first opened the Gigaset.net directory (→ [Page 56](#)) or have deleted your name:
Determine a name and enter it in the directory.

Viewing own entry

You are connected to the Gigaset.net directory:

- ▶ Select **Options** → Own information and press **OK**.

Your Gigaset.net number and, where applicable, your currently entered name are displayed.

Entering/editing a name

Edit

Press the display key.



Edit name or enter new name (max. 25 characters) and press **OK**.
You can delete the name with **⏪**.

If there is no existing entry with this name in the Gigaset.net directory, the name is saved. A message to this effect is displayed. The handset switches to idle status.

If there is an existing entry with this name, or the entered name contains impermissible characters, you will be requested to enter a different name.

— Please note —

If you delete the name, your entry will be deleted from the directory. You are no longer "visible" to other Gigaset.net subscribers. However, you can still be reached via your Gigaset.net number. For information on how to display the number, → [Page 233](#).

Calling a Gigaset.net subscriber

You can call a Gigaset.net subscriber directly via the Gigaset.net directory (see above) or via their Gigaset.net number:



Enter the Gigaset.net number (including the #9) or select from the handset directory.



Press the talk key.

Every number ending with #9 is dialled via Gigaset.net.

Making calls via network services

Network services are functions made available by your fixed line network or VoIP provider.

Anonymous calling – withholding caller ID

Phone number identification can be withheld (CLIR = Calling Line Identification Restriction). Your phone number will not be displayed when making outgoing calls. You are calling anonymously.

Preconditions:

- ◆ For anonymous calls via your fixed line network connection, you need to have requested the relevant service (feature) from your fixed line network provider.
- ◆ Anonymous calls are only possible via VoIP connections through providers that support the "anonymous calling" function. You may have to ask your VoIP provider to activate this function.

Activating/deactivating "anonymous calling" for all calls

Withholding caller ID can be activated/deactivated permanently for all your phone's connections (fixed line network and VoIP).

When this function is activated, the phone number will be withheld both for fixed line network calls and for calls via a VoIP connection. Withholding caller ID is activated for all registered handsets.

 →  → Telephony → Sel. Services

Always anon.

Select and press **OK** ( = on).

Activating/deactivating "anonymous calling" for the next call

You can change the setting for withholding caller ID for the next call.

 →  → Telephony → Sel. Services → Next Call

Anonymous:

Select Yes / No to activate/deactivate withholding caller ID and press **Dial**.



Send

If necessary, enter the phone number with line suffix.

Press the display key. The phone number is dialled. If you have not specified a line suffix, the number will be dialled via the default line.

Further network services in the fixed line network

The following network services can only be used for making calls via the fixed line network. You will need to request them from your fixed line network provider.

▶ **If you require assistance, please contact your network provider.**

Settings for all calls

If you have completed one of the following procedures, a code is sent.

▶ After confirmation from the telephone network, press the end call key .

You can set the following features:

General call forwarding (call divert)

 →  → Telephony → Sel. Services → Fixed Line → Call Divert

▶ Change multiple line input:

When

Select All Calls / No Answer / When Busy.

All Calls: Calls are forwarded immediately, i.e. calls to your fixed line network number are no longer signalled on your phone.

No Answer: Calls are forwarded if no one accepts the call within several rings.

When Busy: Calls are forwarded when your line is busy.

Call No.

Press the display key **Edit**. Enter the number to which the call is to be forwarded, and press **Save**. You can enter a fixed line, VoIP or mobile number.

Status

Activate/deactivate call forwarding.

▶ Press the display key **Send**.

▶ Press the end call key  after the announcement from the telephone network.

Activating/deactivating call waiting

If call waiting is activated, a caller on the fixed line network will hear the ringing tone if you are already conducting a phone conversation using your fixed line connection. This call is announced acoustically and visually on your handset screen.

Calls on the VoIP connection are not shown as call waiting. They are signalled on other registered handsets. If no other handset is available, the caller will hear the busy tone.

Accepting/rejecting a waiting call, → [Page 62](#).

 →  → Telephony → Sel. Services → Fixed Line → Call Waiting

Status Activate/deactivate.

▶ Press the display key **Send**.

▶ Press the end call key  after the announcement from the telephone network.

— Please note —

The setting does not affect the procedure for call waiting on the VoIP connection. For information on how to activate/deactivate call waiting for the VoIP connection, → [Page 64](#).

Functions during a call

Initiating ringback

You hear the busy tone.

Options → Ringback



Press the end call key.

Consultation call

During a call:

Options → External Call





Enter a number or copy it from the directory and press **OK**.

The number will be dialled via the fixed line connection.

— Please note —

After a few seconds, the number selected for a consultation call is saved in the redial list.

You have the following options:

- ◆ Call swapping:
 - ▶ Use  to swap between the participants.
 - ▶ End call with active participant: **Options** → End Active Call.
- ◆ Conference call:
 - ▶ Call both participants: **Options** → Conference.
 - ▶ End the conference call (call swapping): **Options** → End Conference.
 - ▶ End call with both participants: press the end call key .

Accepting a waiting call

Precondition: Call waiting is activated (→ [Page 61](#)).

Options → Accept Call Wait

You have the option of call swapping or holding a conference call.

— Please note —

- ◆ Without CLIP, a waiting call is only announced with a signal tone.
 - ◆ If the first call was an internal call, the internal connection is ended.
 - ◆ An internal, waiting call is shown on the display. You can neither accept the internal call nor reject it.
-

Rejecting a waiting call

Options → Reject Call Wait

Functions after a call

Cancelling ringback

 →  → Telephony → Sel. Services → Ringback Off

If you have cancelled the ringback, a code is sent.

- ▶ After confirmation from the telephone network, press the end call key .

Further network services for VoIP

You can use the following network services to make calls via the VoIP connection.

Settings for all calls

General call forwarding (call divert)

Precondition: The VoIP provider supports call forwarding.

 →  → Telephony → Sel. Services → VoIP → Call Divert

The display shows a list of configured and activated VoIP phone numbers and the Gigaset.net number of your telephone. Numbers for which call forwarding is activated are marked with .

- ▶ Select the phone number for which you want to activate or deactivate call forwarding, and press **OK**.
- ▶ Change multiple line input:

When

Select All Calls / No Answer / When Busy.

All Calls: Calls are forwarded immediately, i.e. calls for this VoIP phone number are no longer signalled on your phone.

No Answer: Calls are forwarded if no one accepts the call within several rings.

When Busy: Calls are forwarded when your line is busy.

Call No.

Press the display key **Edit**. Enter the number to which the call is to be forwarded, and press **Save**. You can state a fixed line network, VoIP or mobile number for forwarding calls from a VoIP number.

You must specify another Gigaset.net number for call forwarding from your Gigaset.net number.

Status

Activate/deactivate call forwarding.

- ▶ Press the display key **Save**.

Please note

Forwarding VoIP phone numbers can result in additional costs. Please consult your VoIP provider.

Activating/deactivating call waiting

Precondition: Your phone will permit two parallel VoIP connections (→ Allow 1 VoIP call only on [Page 196](#)).

If call waiting is activated, a caller on one of your VoIP connections will hear the ringing tone if you are already on a call using this VoIP connection. This call is announced acoustically and visually on your handset screen.

Calls on the fixed line connection are not signalled as call waiting. They are signalled on other registered handsets to which the fixed line number has been allocated as a receive number. If no other handset is available, the caller will hear the busy tone.

Accepting/rejecting a waiting call, → [Page 65](#).

 →  → Telephony → Sel. Services → VoIP → Call Waiting

Status Activate/deactivate.

▶ Press the display key **Save**.

— Please note —

The setting applies to all VoIP phone numbers. It does not affect the procedure for call waiting on the fixed line network. For information on how to activate/deactivate call waiting for the fixed line connection, → [Page 61](#).



Functions during a call

Precondition: Your phone will permit two parallel VoIP connections (→ Allow 1 VoIP call only on [Page 196](#)).

Consultation call

During a call:

Options → External Call

  Enter the number or copy from the directory and **press and release/press and hold** the talk key .

The number must be dialled via VoIP.

— Please note —

After a few seconds, the number selected for a consultation call is saved in the redial list.

If the participant ends the consultation call, press **End** to return to the first call.

If the participant does not answer, press  to return to the first call.

If the participant answers, you have the following options:

◆ Call swapping:

- ▶ Use  to swap between the participants.
- ▶ End call with active participant: **Options** End Active Call.

◆ Conference call:

- ▶ Call both participants: **Options** → Conference.
- ▶ End the conference call (call swapping): **Options** → End Conference.
- ▶ End call with both participants: press the end call key .

◆ Transferring (provider dependent):

Precondition:



- You are call swapping and you phoned the currently active participant yourself.
- You are connected to an external participant whom you have called yourself and start an external consultation call.
 - ▶ You can also end the call before the second participant answers.
 - ▶ To connect the two external participants:

Options Call Transfer

If the call transfer was successful, a message will appear to this effect. The handset will then switch to idle.

If the call transfer was not successful, the party that was previously waiting will call you back automatically.

— Please note —

You can configure your telephone so that you can also connect the participants by pressing the  key or the end call key  (→ [Page 208](#)).

Accepting a waiting call

Precondition: Call waiting is activated (→ [Page 64](#)).

Options → Accept Call Wait

You have the option of call swapping or holding a conference call.

— Please note —

- ◆ If the first call was an internal call, the internal connection is ended.
 - ◆ An internal, waiting call is shown on the display. You can neither accept the internal call nor reject it.
-

Rejecting a waiting call**Options** → Reject Call Wait

Using lists



The options are:

- ◆ Redial list
- ◆ E-mail, SMS and messenger list
- ◆ Calls list
- ◆ Answering machine list
- ◆ Network mailbox

Redial list



The redial list contains the 20 numbers last dialled with the handset (max. 32 digits). If one of the numbers is in the directory, the corresponding name will be displayed.

Dialling from the redial list

-  Press the key **briefly**.
-  Select an entry.
-  Briefly press/press and hold the talk key. The number is dialled using the selected connection type (→ [Page 44](#)).

When a name is displayed, you can display the corresponding phone number by pressing the **View** display key.

Managing entries in the redial list

-  Press the key **briefly**.
-  Select an entry.
- Options** Open menu.

The following functions can be selected with :

Copy to Directory

Copying a displayed number to the directory (→ [Page 76](#)).

Automatic Redial

The selected number is automatically dialled at fixed intervals (at least every 20 seconds). The speaker key flashes and "open listening" is activated.

- Party answers: press the talk key . The function is ended.
- Party does not answer: the call is terminated after approx. 30 seconds. The function is ended after pressing any key or after ten unsuccessful attempts.

Display Number

(As in the directory, → [Page 74](#))

Delete Entry

Delete selected entry.

Delete List



Delete complete list.

Opening lists with the message key

You can use the message key  to open the following lists:

- ◆ Answering machine list
- ◆ Network mailbox, → [Page 129](#)
A separate list is displayed for each network mailbox.
Precondition: Its number is saved in the base station, it is switched on (→ [Page 129](#), [Page 207](#)) and the corresponding VoIP/fixed line network number is assigned to the handset as a receive number.
- ◆ SMS list, → [Page 88](#)
If **several** mailboxes are set up (→ [Page 92](#)), several lists will be displayed, if required.
- ◆ E-mail inbox, → [Page 98](#)
This is only shown if new messages have arrived in the mailbox from the incoming e-mail server.
- ◆ Calls list
- ◆ Messenger message list, → [Page 108](#)
The list is only shown on the handset that is online.

An advisory tone sounds as soon as a **new message** arrives in a list. The  key flashes (it stops when the key is pressed). In idle status, the display shows an icon for the new message:

Icon	New message...
	... in one of your network mailboxes or ... in the answering machine list
	... in the calls list
	... in the SMS, messenger or e-mail list

The number of new entries is shown beneath the corresponding icon.

List selection

Pressing the  key will only display lists that contain messages and also the network mailbox lists **Net AM ...**

Lists with new messages are shown first and identified in bold. The number of messages received are shown in brackets.

If a list contains no new messages, the number of old messages will be shown. Exception: (0) is displayed for **Net AM ...** network mailboxes.

Example:

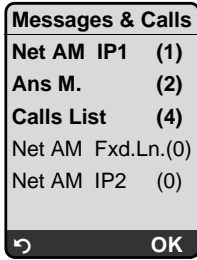

▶ Select a list with  and press **OK**.

Calls list

Depending on the type of list set, the calls list contains

- ◆ Received calls (marked with )
- ◆ Missed calls



The numbers of the last 30 calls are saved.

Multiple calls from the same number will be stored once in the list of missed calls (the latest call). The number of calls from this number is shown in brackets after the entry.

Multiple calls from the same number are stored several times in the list of answered calls.

The list of missed calls does not contain calls that were answered and calls that were recorded by the answering machine.

Please note

- ◆ Only calls to the receive numbers assigned to your handset are stored in the calls list (→ [Page 200](#)).
If no receive numbers are assigned, all calls will be stored in the calls list for all handsets.
 - ◆ You can also call up the calls list via the menu:  → .
 - ◆ Missed calls are not stored in the calls list if they were accepted on another phone registered with the same VoIP access data.
-

Setting the calls list type

 →  → Base → Calls List Type

Missed Calls / All Calls

Select and press **OK** ( = on).

 Press and **hold** (idle status).

The calls list entries are retained when you change the list type.

List entry in the calls list

New messages are displayed at the top.

Example of list entries:



- ◆ List type in header: Missed Calls, All Calls
- ◆ Status of entry
 - Bold:** New entry
- ◆ Number or name of caller
 - The number is always saved in the list with the area code.
 - You can add the caller's number to the directory → [Page 76](#).
- ◆ Call date and time (if set, → [Page 16](#)).

Managing calls list entries

Pressing the display key **Delete** deletes the highlighted entry.

After pressing the display key **Options** you can select more functions with :

Copy to Directory

Copying a displayed number to the directory.

Information

If a URI was received and stored for a VoIP call, this will be shown. The URI is dialled if you press the talk key . The URI is not entered on the redial list.

Delete List

Delete complete list.

After exiting the calls list, all entries are set to "old" status and are no longer shown in bold.

Selecting from the calls list

 → Calls List (2)

 Select entry.

 Briefly press/press and hold the talk key. The number is dialled using the selected connection type (→ [Page 44](#)).

Answering machine list

The answering machine list **Ans M.** is only displayed on handsets that have at least one receive number in common with the answering machine.

You can use the answering machine list to listen to the messages stored on the base station's answering machine.

The first new message received is displayed at the top of the answering machine list. Playback starts when the list is opened.

New messages are placed after old messages when they have been played back.

All messages are played back irrespective of the associated receive number.

Old messages are played back if the list does not contain any new messages.

List entry in the answering machine list

Example of list entries:



- ◆ Status of entry

Bold: New entry

- ◆ Number or name of caller

You can add the caller's number to the directory (→ [Page 76](#)).

- ◆ Call date and time (if set, → [Page 16](#)).

How to manage the messages in the answering machine list, → [Page 121](#).

Dialling numbers from the answering machine list

 → **Ans M. (2)**

 Select entry.

 Briefly press/press and hold the talk key. The number is dialled using the selected connection type (→ [Page 44](#)).

Using directories and the call-by-call list

The options are:

- ◆ the handset directory
- ◆ die handset's call-by-call list
- ◆ where applicable, public online directories (country and provider-specific),
→ [Page 78](#)

Handset directory/call-by-call list

You can store up to 250 entries on your handset's directory and call-by-call list (the total number of entries depends on the size of the individual entries).

You create the directory and call-by-call list for your own individual handset. However, you can send the lists or individual entries to other handsets (→ [Page 74](#)).

Please note

For quick access to a number from the directory or the call-by-call list (using quick dial keys), you can assign the number to a key (→ [Page 74](#)).

Local handset directory

In the local **directory**, you can save

- ◆ Up to three numbers and associated first names and surnames,
 - ◆ VIP designation and VIP ringer (optional)
 - ◆ E-mail address (optional)
 - ◆ Caller pictures (optional)
 - ◆ Anniversaries with reminder
- ▶ With the handset in idle status, open the directory by pressing the  key.

Length of the entries (directory)

3 numbers: each max. 32 digits

First name and last name: each up to 16 characters

E-mail address: max. 60 characters

Please note

Some VoIP providers do not support local calls for calls to the fixed line network. In this case, always enter the fixed line number with the area code in your directory. Alternatively, you can also use the Web configurator to define an area code, which is automatically prefixed to all numbers that are dialled via VoIP without an area code (→ [Page 203](#)).

Call-by-call list

The **call-by-call list** is used to store access codes for network providers (called "call-by-call numbers"), that can be put ahead of the numbers when dialling via the fixed line network.

- ▶ Open the call-by-call list in idle status by pressing the  key.

Length of the entries

Number: max. 32 digits

Name: max. 16 characters

Storing a number in the directory

 → New Entry

- ▶ Change multiple line input:

First Name / Surname:

Enter a name in at least one of the fields.

Phone / Phone (Office) / Phone (Mobile)

Enter a number in at least one of the fields.

E-mail

Enter e-mail address.

Annivers.

Select On or Off.

With setting On:

Enter Anniversary (Date) and Annivers. (Time) (→ [Page 76](#)) and select reminder type: Annivers. (Signal).

Caller Picture

Precondition: Calling Line Identification (CLIP).

If required, select a picture to be displayed when the caller calls.

The options are:

- Caller pictures that are supplied with the handset.
- Any additional images on the Gigaset S68H that you have loaded from your PC to your handset (→ [Page 241](#)).

The pictures are saved in the resource directory of the handset (→ [Page 158](#)).

Save Press the display key to save the changes.

— Please note —

- ◆ For information on how to enter IP addresses, → [Page 46](#).
- ◆ If you want to dial a number using a certain line connection each time, you can add the relevant line suffix to the number in question (→ [Page 46](#)).
- ◆ You can use the Web configurator to save the directory to a file on your PC, where it can be edited and then sent back to the handset (→ [Page 217](#)). Or you can transfer Outlook contacts from the PC to the handset's directory.

Storing a number in the call-by-call list

 → New Entry

▶ Change multiple line input:

Number :

Enter the number.



Name:

Enter name.

Selecting entries in the directory and call-by-call list

 /  Open the directory or call-by-call list.

You have the following options:

- ◆ Use  to scroll to the entry until the required name is selected.
- ◆ Enter the first character of the name (in the directory: first character of the surname or of the first name if **only** the first name has been entered), or scroll to the entry using .

Dialling with the directory/call-by-call list



 /  →  (Select entry; → [Page 73](#))

 Briefly press/press and hold the talk key. The number is dialled using the selected connection type (→ [Page 44](#)).

— Please note —

You can only dial IP addresses via VoIP.

Managing directory/call-by-call list entries

 /  →  (Select entry; → [Page 73](#))

Viewing entries



View Press the display key. The entry is displayed.
Go back with **OK**.

Editing entries

View **Edit** Press the display keys one after the other.

▶ Carry out changes and save.

Using other functions

 /  →  (Select entry; → [Page 73](#))

Options Open menu.

The following functions can be selected with :

Display Number

Change or add to a saved number and then dial it (press talk key .

Edit Entry

Edit selected entry.

Delete Entry

Delete selected entry.

VIP Entry (directory only)

Mark a directory entry as **VIP** (Very Important Person) and assign it a specific ringer. You can then identify VIP calls by the ringer.

Precondition: Calling Line Identification (→ [Page 49](#)).

Copy Entry

Send a single entry to a handset (→ [Page 74](#)).

Delete List

Delete **all** entries in the directory or in the call-by-call list.

Copy List

Send complete list to a handset (→ [Page 74](#)).

Available Memory

Display the available entries in the directory and call-by-call list.

Using quick dial keys

How to assign numbers to the digit keys on your handset, → [Page 153](#).

▶ Press and **hold** the required quick dial key.

If there is a valid line suffix at the end of the number in the directory (e.g. #1), the number will be dialled via the line belonging to the suffix (→ [Page 185](#)).

If no suffix is entered, the number will be dialled via the default line. Exception: A dialling plan has been defined for the number (→ [Page 204](#)).

Sending the directory/call-by-call list to another handset

Preconditions:

- ◆ The sending and receiving handsets must both be registered to the same base station.
- ◆ The other handset can send and receive directory entries.

 /  →  (Select entry; → [Page 73](#)) → **Options** → Copy Entry / Copy List
→ to Internal

 Select the internal number of the receiving handset and press **OK**.

A successful transfer is confirmed by a message and confirmation tone on the receiving handset.

You can transfer several individual entries one after the other by responding **Yes** to the Copy next entry? prompt.

— Please note —

You can also send the complete **directory** via data transfer, without opening the directory:

 →  → Data Transfer → Directory

Please note:

- ◆ Entries with identical numbers are not overwritten in the receiver handset.
- ◆ The transfer is cancelled if the phone rings or if the memory of the receiving handset is full.

Gigaset S68H: Transferring directory entries as a vCard via Bluetooth

In Bluetooth mode (→ [Page 146](#)), you can transfer directory entries in vCard format, e.g. to exchange entries with your mobile.

Preconditions:

- ◆ Your own area code is stored in the phone (→ [Page 160](#)).
- ◆ Bluetooth is activated (→ [Page 146](#)).
- ◆ The device that you want to send the entries to (e.g. mobile), is registered with the handset as a Bluetooth device (→ [Page 146](#)).

 →  (Select entry) → **Options** → Copy Entry / Copy List

vCard via Bluetooth

Select and press **OK**.

The Trusted Devices (→ [Page 148](#)) list is displayed.

 Select device and press **OK**.

Receiving a vCard with Bluetooth

If a device from the Trusted Devices (→ [Page 148](#)) list sends a vCard to your handset, this occurs automatically and you are informed about it via the display.

If the sending device does not appear in the list, you will be asked on the display to enter the device PIN for the sending device:

 If necessary, enter the PIN for the **sending** Bluetooth device and press **OK**.

The transferred vCard is available as a directory entry.

Copying a displayed number to the directory

Numbers displayed in a list, e.g. the calls list or the redial list, in an SMS or during a call can be copied to the directory.

A number is displayed:

Options → Copy to Directory

Or:

 Press the display key.

The directory is opened.

New Entry / Directory entry

Select and press **OK**.

 Select and press **OK**.



The number is copied to the relevant number field (Phone / Phone (Office) / Phone (Mobile)).

▶ Complete the entry if necessary, → [Page 72](#).

During the number transfer from the answering machine list, the message playback is interrupted.

Copying a number or e-mail address from the directory

In many operating situations, you can open the directory to copy a number or e-mail address, for example. Your handset need not be in idle status.



▶ Depending on the operating situation, open the directory with 
or .

 Select an entry (→ [Page 73](#)).

Saving an anniversary in the directory

You can save an anniversary for every number in the directory and specify a time when you will receive a reminder call on the anniversary.

Anniversaries are automatically recorded in the calendar (→ [Page 134](#)).

 →  (Select entry; → [Page 73](#))

View **Edit** Press the display keys one after the other.

 Scroll to the Annivers. line.

 Select On.

▶ Change multiple line input:

Anniversary (Date)

Enter day/month/year in 8-digit format.

Annivers. (Time)

Enter the hour/minute for the reminder call in 4-digit format.

Annivers. (Signal)



Select the type of signal for the reminder.

Save Press the display key to save the changes.

Please note

A time must be specified for reminder calls. If you select a visual signal, a time is not required and is automatically set to 00.00.

Deactivating anniversaries

 →  (Select entry; → [Page 73](#))

View **Edit** Press the display keys one after the other.

 Scroll to the **Annivers.** line.

 Select **Off**.

Save Press the display key.

Reminder call on an anniversary

A reminder call is signalled on the handset using the selected ring.

You have the following options:

SMS Terminate reminder call and write an SMS.

Off Press the display key to acknowledge and end the reminder call.

Viewing missed anniversaries

In idle status, you are reminded of an elapsed and unacknowledged anniversary by the **one-off** display of **Appoint.**

▶ View appointment:

Appoint. Press the display key.

You now have the following options:

SMS Write an SMS.

Delete Delete reminder.

After deleting, press the display key  or **Go Back**:
Back in idle status, **Appoint.** is no longer displayed.

You can still view missed anniversaries afterwards (→ [Page 136](#)).

Using online directories

You can use online directories (= online directories and classified directories, e.g. "Yellow Pages") depending on your provider.

You can define which online directories you wish to use via the Web configurator (→ [Page 215](#)).

Exclusion of liability

Gigaset Communications GmbH assumes no guarantee or liability for the availability of this service. The service may be discontinued at any time.

Opening an online/classified directory

Precondition: The handset is idle and a VoIP connection is available.



Press and **hold**. This opens the list of online directories. Provider-specific names appear in the display.



Select directory (online directory or classified directory) from the list and press **OK**.

Or:

You can find the **Online Directory**, **Yellow Pages** entries for online directories in the local directories of the registered handsets. You can use these entries to access the online directories assigned to your handset (→ [Page 215](#)).

- ▶ Open the directory with the key.
- ▶ Select the **Online Directory** entry for the online directory or the **Yellow Pages** entry for the classified directory and press the talk key .

This establishes a connection to the online directory or the classified directory.

Please note

- ◆ The directory entries **Online Directory / Yellow Pages** are transferred to the handset when it is registered with the base station (→ [Page 138](#)).
Precondition: The handset can receive directory entries.
- ◆ You can also establish a connection to the online directory as follows:
 - ▶ When the handset is idle, dial 1#91 and then press the talk key .
 - ▶ To establish a connection to the classified directory, dial 2#91.
 - ▶ To establish a connection to the Gigaset.net directory, dial 1188#9.

Calls to the online directory are always free of charge.

Searching for an entry

Precondition: You have opened the online directory/classified directory.

- ▶ Making a multi-line entry:

Surname : (Online directory) /

Category/Name: (Classified directory)

Enter the name, part of a name or the business type (max. 30 characters).

City : Enter the name of the town/city in which the party you are searching for lives (max. 30 characters).

If you have already completed a search, the last names of the towns/cities you entered are displayed (maximum of five).

You can enter a new name

or

Select the displayed name of the town/city with  and confirm with **OK**.

Number: Enter the number (max. 30 characters).

- ▶ Press the display key **Search** to start the search.

You must make an entry in either **Surname** : or **Category/Name**: **and** in **City** : or in **Number**. Searching by number is only possible if supported by the online directory you have selected. For information on how to enter text, → [Page 238](#).

A list of found towns/cities will be displayed if the search returns more than one result:



Select the town/city.

If the name of a town/city is longer than one line, it is abbreviated.

Select **View** to view the complete name.

If no matching town/city is found: Press **Edit** if you want to change the search criteria. The entries for **Category/Name** and **City** are adopted and can be changed.

OK Press the display key to continue the search.

A corresponding message will appear on the display if no subscriber is found to match the search criteria. You have the following options:

- ▶ Press the display key **New** to start a new search.

Or

- ▶ Press the display key **Edit** to change the search criteria. The stated name and town/city are adopted and can be changed.

No hits will be displayed if the list of hits is too large. A message to this effect is displayed.

- ▶ Press the display key **Refine** to start a refined search (→ [Page 81](#)).

Or

- ▶ Provider-dependent: You can view the list if the number of hits is shown on the display. Press the display key **View**.

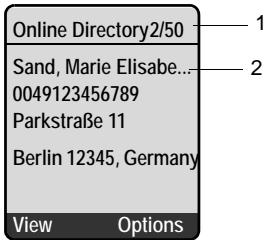

Search result (hit list)

The search result is shown as a list on the display. Example:



1. 2/50: Consecutive number/total number of hits (only the consecutive number is displayed if the total number of hits >99)
2. Four lines with subscriber's name, business type, telephone number and address (possibly abridged). If a fixed line number is not available, the mobile phone number (if available) is displayed.

You have the following options:

- ▶ You can scroll through the hit list with .
- ▶ Press the display key **View**. Displays the unabridged details of the entry (name, business type where applicable, address, telephone numbers). You can scroll through the entry with .

You have the following additional options via **Options**:

Refine search

Refine search criteria and restrict list (→ [Page 81](#)).

New search Start a new search.

Copy to Directory

Transfer the entry number to the handset's directory (→ [Page 76](#)).
The surname is transferred to the name field of the directory.



Calling subscribers

Precondition: A hit list is displayed.

- ▶ Select the entry and press the talk key .

If the entry only contains one phone number, this is the one that is dialled.

A list of numbers appears if there is more than one number.

- ▶ Select the number with  and press the talk key  once again.

Start detailed search

You can use the search options available in the detailed search (first name and/or street) to limit the number of hits returned by a previous search.

Precondition: A search result is displayed (hit list with multiple entries or a message indicating too many hits).

Refine Press the display key.

Or

Options → Refine search
Select and press **OK**.

The search criteria from the previous search are adopted and entered in the corresponding fields.

Surname : (Online directory) /

Category/Name: (Classified directory)

If necessary, change name/business type or extend partial name.

City : If necessary, change the name of the town/city.

Street: If necessary, change the name of the street (max. 30 chars.).

First name: (only in the online directory)

If necessary, enter the first name (max. 30 characters).

Search Start detailed search.





Making cost-effective calls

Using the Internet (VoIP) is the preferred cost-effective way of making calls. You can also use your phone's cost control function for calls to fixed line or mobile phone networks. Open accounts with various VoIP providers who offer favourable rates for calls to other networks. In the phone configuration, define the best VoIP connections (account), e.g. for specific regional, national and mobile network prefixes, to be used when calls are made (Dialling Plans, → [Page 204](#)). Or define the VoIP connection to be used when dialling the number (dialling with line suffix, → [Page 46](#)).

If you are using your fixed line network phone, choose a network provider who offers particularly favourable rates (call-by-call). You can manage call-by-call numbers in the call-by-call list.

Linking call-by-call numbers with a number

You can prefix a network provider's number ("chaining") to numbers dialled via a fixed line network.

-  Open call-by-call list.
-  Select entry (call-by-call number).
- Options** Press the display key.
- Display Number** Select and press **OK**.
-   Enter number or dial number from the directory (→ [Page 76](#)).
-  Briefly press/press and hold the talk key so that the number is dialled via the fixed line network. Both numbers are dialled.

— Please note —

You can also dial "chained" numbers via a fixed line network by adding the line suffix #0 (for the fixed line network) to the end of the number. Alternatively, you can define appropriate rules for call-by-call numbers (→ [Page 204](#)).

Displaying the call duration

The duration of each call appears in the display for calls made via a fixed line network and VoIP

- ◆ during the conversation,
- ◆ until about three seconds after the call has ended if you do not replace the handset in the charging cradle.

— Please note —

The actual duration of the call can vary from that shown by a few seconds.

SMS (text messages)

You can use your telephone to send and receive SMS messages via the fixed line network and VoIP.

You must specify the line via which SMS are sent. You can receive SMS messages (abbreviated: SMS) via all of your telephone's connections (with the exception of Gigaset.net).

Your telephone is delivered ready to send SMS messages as soon as the phone is connected to the fixed line network. If you do not change any of the settings, the SMS messages are sent via the fixed line network.

Preconditions:

- ◆ Calling Line Identification is enabled for the VoIP connections/fixed line network, via which you wish to send/receive SMS messages. It must not be withheld, → [Page 60](#).
- ◆ Your fixed line network/VoIP provider supports the SMS service (information on this is available from your provider).
- ◆ You are registered with your service provider to send and receive SMS messages.

SMS messages are exchanged between SMS centres operated by service providers. You must enter the SMS centre through which you wish to send and receive SMS messages into your phone. You can receive SMS messages from **every** SMS centre that is entered, provided you have registered with your service provider. Generally, all you have to do is send one SMS via the service provider SMS centre.

Your SMS messages are sent via the **Service Centr.** that is entered as the **active send service centre**. However, you can activate any other SMS centre as the active send service centre to send a current message (→ [Page 93](#)).

Determine via which of the connections (fixed line, VoIP) the SMS should be sent with the settings of the SMS send centre (→ [Page 93](#)).

Please note

If no SMS service centre is entered on your phone, the SMS menu only consists of the entry **Settings**.

To write and send an SMS:

- ▶ Enter an SMS service centre (→ [Page 93](#)).
-

Information on writing an SMS can be found in the appendix:

- ◆ For how to enter text, → [Page 238](#).
- ◆ Writing using the predictive text tool EATONI, → [Page 240](#).

Rules

- ◆ For more than 160 characters, the SMS will be sent as a **linked** SMS (up to four SMS messages each containing 152 or 153 characters, depending on the length of the linking information).

The following will be shown on the top right in the header when an SMS is being written (example):

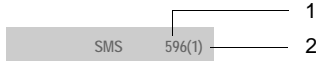

- 1 Maximum number of characters you can still write or attach.
- 2 Number of SMS messages that need to be linked for the text written so far.

Please note

Linking SMS messages usually incurs higher charges.

Entering Cyrillic and Arabic characters

The number of characters per SMS is reduced, if you select an input language that uses Cyrillic or Arabic characters to write an SMS (→ [Page 241](#)). If the SMS contains more than 70 characters, it is sent as a linked SMS. A linked SMS can be made up of up to four SMS with 67 lines each.

Please note:

- ◆ Each incoming SMS is signalled by a single ring (ringer as for external calls). If you accept such a "call", the SMS will be lost. To prevent this ring, suppress the first ringer for all external calls (→ [Page 96](#)).
- ◆ If your phone is connected to a PABX, → [Page 96](#).
- ◆ To receive SMS messages you must be registered with your service provider.

Writing/sending an SMS

Writing an SMS

 →  → SMS

Mailbox 2 Select mailbox if necessary and press **OK** (→ [Page 92](#)).



Enter mailbox PIN if necessary and press **OK**.

New SMS Select and press **OK**.



Write an SMS.

Please note

- ◆ Entering text with and without EATONI predictive text is described from [Page 239](#).
 - ◆ EATONI is activated as a default setting. For information on how to activate/deactivate EATONI, → [Page 240](#).
-

Sending an SMS

Options Press the display key.

Send Select and press **OK**.

Then:

SMS Select and press **OK**.





Select number with area code (even if you are in that area) from the directory or call-by-call list, or enter number manually. For sending SMS to an SMS mailbox: add the mailbox ID to the **end** of the number.

Send Press the display key.

The SMS is sent via the send line entered (→ [Page 93](#)).

Please note

- ◆ If you are interrupted by an external call while writing an SMS, the text is automatically saved in the draft message list.
 - ◆ You will not be able to open the SMS menu, while the SMS menu is open on another handset registered to the base station. When pressing  →  → SMS → **OK**, an error tone sounds.
 - ◆ If the memory is full the process is cancelled. An appropriate message appears in the display. Delete SMS messages you no longer require.
-

Using other functions

Precondition: You are writing an SMS.

Options Open menu.

The following functions can be selected with :

Send

Send an SMS.

Save

Save an SMS in the draft message list (→ [Page 87](#)).

Insert E-mail Adr.

Add an e-mail address to the message text.

Predictive Text

Activate/deactivate predictive text EATONI (→ [Page 240](#)).

Select Language

For EATONI: select the language in which you wish to write the text and press **OK**.

SMS status report

Precondition: Your network provider supports this feature.

If you have activated the status report, you will receive an SMS with a confirmation message after sending.

Activating/deactivating the status report

 →  → SMS → Settings

Status Report

Select and press **OK** ( = on).

Reading/deleting the status report

▶ Open the incoming message list (→ [Page 89](#)) and then:

 Select SMS with State OK or State not OK status.

Read Press the display key.

Or:

Options Press the display key.

Delete Entry Select and press **OK**.

Draft message list

You can save an SMS in the draft message list, and edit and send it later.

Saving an SMS in the draft message list

► You are writing an SMS (→ [Page 85](#)).

Options Press the display key.

Save Select and press **OK**.

— Please note —

After saving, the SMS editor will be displayed again with your SMS. You can continue writing the text and save it again. The SMS that was saved previously will be overwritten.

Opening the draft message list

 →  → SMS → (Mailbox, mailbox PIN)

Outgoing (3) Select and press **OK**. The number of SMS messages in the list will be shown in brackets (e.g. (3)).

The first list entry is displayed, e.g.

1234567890
15.01.09 09:45

Reading or deleting SMS messages

► Open the draft message list and then:

 Select SMS.

Read Press the display key. The entry will be displayed. Scroll line by line using .

Or:

Options Open menu.

Delete Entry Press **OK**. The selected SMS message is deleted.

You can use **Options** → Delete all to delete every SMS in the draft message list.

Writing/changing an SMS

► You are reading an SMS in the draft message list.

Options Open menu.

You have the following options:

New SMS

Write a new SMS and then send (→ [Page 85](#)) or save it.

Edit

Edit the text of the saved SMS and then send it (→ [Page 85](#)).

Character Set

Text is shown in the selected character set.

Sending SMS messages to an e-mail address

If your service provider supports the SMS to e-mail feature, you can also send your SMS messages to e-mail addresses.

The e-mail address must be at the beginning of the text. You must send the SMS to the e-mail service of your SMS send centre.

 →  → SMS → (Mailbox, mailbox PIN) → New SMS

 / 

Load the e-mail address from the directory or enter it directly. End the entry with a space or colon (depending on the service provider).



Enter the SMS text.

 Options

Press the display key.

Send

Select and press **OK**.

E-mail

Select and press **OK**. If the number of the e-mail service is not entered (→ [Page 93](#)), enter the number of the e-mail service.

 Send

Press the display key. The SMS is sent via the set send line (→ [Page 93](#)).

Receiving an SMS

All SMS messages received are stored in an incoming message list, regardless of the number to which they are addressed. Linked SMS messages are displayed as **one** message. If this is too long (it consists of too many linked individual SMS messages) or if it was not fully transmitted, it will be split into several individual SMS messages.

Since an SMS remains in the list even after it has been read, you should **regularly delete SMS messages from the list**.



The display tells you if the SMS memory is full.

▶ Delete SMS messages you no longer require (→ [Page 89](#)).

Incoming message list

The incoming message list contains:

- ◆ All received SMS messages, starting with the most recent.
- ◆ SMS messages that could not be sent due to an error.
- ◆ SMS status messages, if the status report is activated (→ [Page 86](#)).

New SMS messages are signalled on all Gigaset S68H handsets by the  icon in the display, the flashing message key  and an advisory tone.

Please note

Every SMS addressed to one of your numbers (VoIP or fixed line network) is displayed on all registered handsets with SMS functionality – even if the addressed number is not assigned to the handset as a receive number.

Opening the incoming message list with the key



Press.

Select a mailbox if necessary and enter the mailbox PIN.

The incoming message list is displayed as follows (example):

SMS:	(2)	1
		2

1 **Bold:** number of new entries

Regular: number of read entries

2 Name of mailbox, here: general mailbox

Open list with **OK**.

An entry in the list is displayed e.g. as follows:

1234567890	1
15.12.08 09:45	2

1 Number of the sender or name of the directory entry

2 **SMS status:**

Bold: new unread SMS messages

Regular: old read SMS messages

Opening the incoming message box via the SMS menu



Reading or deleting individual SMS messages

- ▶ Open the incoming message box.
- ▶ Continue as described in "**Reading or deleting SMS messages**",
→ [Page 87](#).

After you have read a new SMS, it is given the status "Old" (it is no longer shown in bold).

Changing the character set

- ▶ Read the SMS (→ [Page 89](#)):

If you cannot see any text or symbols, the SMS may have been written with a different character set.



Press the display key.

Character Set

Select and press **OK**.



Select character set and press **OK**.

Text is shown in the selected character set.

Deleting the incoming message list

All **new and old** SMS messages in the list are deleted.

- ▶ Open the incoming message box.



Open menu.

Delete all Select, press **OK** and confirm with **Yes**. The list is cleared.

Replying to or forwarding text messages

▶ Read the SMS (→ [Page 89](#)):

Options Press the display key.

You have the following options:

Reply

Write and send a reply SMS directly (→ [Page 85](#)).

Edit

Edit the text in the SMS and then send it (→ [Page 85](#)).

Forwarding an SMS

▶ You are reading an SMS (→ [Page 89](#)):

Options Press the display key.

Forward Select and press **OK**. For further information, → [Page 85](#).

Copying the number to the directory

Copying the sender's number

▶ Open the incoming message list and select SMS (→ [Page 88](#)).

Options Press the display key. For further information, → [Page 76](#).

— Please note —

- ◆ You can create a special directory for SMS messages within your main directory by putting a star (*) before the names.
 - ◆ An attached mailbox identifier is added to the directory. It must be deleted for 'normal calls'.
-

Dialling numbers from SMS texts/transferring to the directory

▶ Read the SMS (→ [Page 89](#)) and scroll to the telephone number.

The digits are reverse-highlighted.



Briefly press/press and hold the talk key to dial the number.

Or:



Press the display key to transfer the number to the directory.
For further information, → [Page 76](#).

— Please note —

- ◆ The + symbol is not transferred for international area codes.
 - ▶ You should then enter '00' at the start of the number.
 - ◆ If an SMS contains several numbers, the next number will be highlighted if you scroll down until the first number disappears from the display.
-

If you wish to use the number to send an SMS:

- ▶ Save the number with the local area code (dialling code) in the directory.

Notification by SMS

You can have yourself notified about missed calls and new messages on the answering machine.

Precondition: For missed calls, the caller's number (CLI) must have been transmitted.

Notification is sent to your mobile phone or another phone with SMS functionality.

You only need to save the phone number to which the notification should be sent (notification number) and set the notification type.

— Please note —

Your network provider will usually charge for SMS notifications.

Saving the notification number

 →  → SMS → Settings → Notify Number



Enter the number (including area code) to which the SMS is to be sent.

Save

Press the display key.



Press and **hold** (idle status).

— Warning —

Do **not** enter one of your own numbers for the notification of missed calls. This can lead to chargeable endless looping.

Setting the notification type

 →  → SMS → Settings → Notify Type

▶ Change multiple line input if necessary:

Missed Calls

Select On if you require SMS notification.

Ans Machine

Select On if you require SMS notification.

Save

Press the display key to save the changes.

SMS mailboxes

The **general mailbox** is the default setting. Anyone can access this mailbox and it cannot be protected by a PIN. You can additionally set up three **personal mailboxes** and protect these with a **PIN**. Each mailbox is identified by a name and a "mailbox ID" (a kind of extension number).

Please note:

- ◆ If you operate a number of devices (base stations) with SMS functionality on a single phone line, then each SMS mailbox ID may only occur once. In this case you must also change the preset ID of the general mailbox ("0").
- ◆ You can only use personal mailboxes if your service provider supports this function. You can tell whether this is the case by the addition of a star (*) to the number of a (preset) SMS centre.
- ◆ If you have forgotten your mailbox PIN, you can reset it by restoring the base station's default settings. This will **delete all SMS messages from all mailboxes**.

Setting up and changing a personal mailbox

Setting up a personal mailbox

 →  → SMS → Settings → SMS Mailboxes

 Select mailbox, e.g. Mailbox 2 and press **OK**.

▶ Change multiple line input:

On/Off

Activate or deactivate mailbox.

ID

Select mailbox ID (0–9). You can only select the available numbers.

Protection

Activate/deactivate PIN protection.

PIN

If necessary, enter 4-digit PIN.

▶ Press the display key **Save** to save the changes.

Active mailboxes are marked with in the mailbox list. They are shown in the SMS list and can, if necessary, be displayed by pressing the message key .

Deactivating a mailbox

▶ Set On/Off to Off. Confirm message with **Yes** if necessary.

All SMS messages saved in this mailbox will be deleted.

Deactivating PIN protection

▶ Set Protection to Off.

The mailbox PIN is reset to "0000".

Changing the name of a mailbox

 →  → SMS → Settings → SMS Mailboxes →  (Select mailbox)

Edit Press the display key.

 Enter new name.

Save Press the display key.

 Press and **hold** (idle status).

Changing a mailbox's PIN and ID

 →  → SMS → Settings → SMS Mailboxes →  (Select mailbox)

 Enter mailbox PIN if necessary and press **OK**.

▶ Set ID, Protection and PIN (→ [Page 92](#)).

Sending an SMS to a personal mailbox

To send an SMS to a personal mailbox, the sender must know your ID and enter it after your number.

▶ You can send your SMS contact an SMS via your personal mailbox.

Your SMS contact will then receive your SMS number with current ID and can save it in their directory. If the ID is invalid, the SMS will not be delivered.

Setting SMS centre and the send line

Entering/changing SMS centre, setting the send line

_____ Before applying ... _____

... and **before deleting** preset numbers you should find out about the services and special functions offered by your service provider.

 →  → SMS → Settings → Service Centres

 Select SMS centre (e.g. Service Centr. 1) and press **OK**.

▶ Change multiple line input:

Active Send

Select **Yes** if SMS messages are to be sent via the SMS centre. For the SMS centres 2 to 4, the setting only applies to the next SMS.

SMS

Press the display key **Edit**. Enter the number of the SMS service and insert a star if your service provider supports personal mailboxes. Press the display key **Save**.

E-mail

Press the display key **Edit**. Enter the number of the e-mail service. Press the display key **Save**.

Send Line

Send line that should be used when sending SMS via this SMS centre.
The fixed line network is preset by default.

Press the display key **Edit**. A list of your phone's connections will be displayed. You can select from your fixed line network connection and all VoIP connections that you have configured. The standard names for the connections are displayed. IP1 to IP6, Fxd. In.

Select the VoIP connection or the fixed line connection and press **OK**.

- ▶ Press the display key **Save** to save the changes.

Please note

- ◆ Ask your SMS service provider for details on how to enter service numbers if you wish to use personal mailboxes (precondition: your service provider supports this function).
 - ◆ If you have selected a VoIP connection as a send line and this is deleted from the configuration, the first VoIP connection in the configuration will be used.
 - ◆ If you have selected a VoIP connection and the attempt to transfer the SMS messages fails, the SMS with error status is stored in the incoming message list. Even if you have activated the option **Automatic Fallback to Fixed Line** (→ **Page 200**), your phone does not attempt to send the SMS messages via the fixed line network.
-

Sending an SMS via another SMS centre

- ▶ Activate the SMS centre (2 to 4) as the active send service centre.
- ▶ Send the SMS.

This setting only applies to the next SMS to be sent. Thereafter, the setting returns to **Service Centr. 1**.

SMS info services

You can have your service provider send you specific information by SMS (e.g. weather forecast or the lottery numbers). A total of up to 10 info services can be saved. You can obtain information about the info services available and their costs from your service provider.

Setting up/ordering an info service

Ordering an info service

 →  → SMS → SMS Service

 Select info service.

Send Press the display key.

Setting up an info service

- ▶ Select an empty entry for an info service, deleting an existing entry if necessary. Then:

Edit Press the display key.

 If necessary, enter code, designation and destination number.

Save Press the display key.

Editing the entry of an info service

- ▶ Select info service (→ **Page 95**). Then:

Options Open menu.

Edit Entry Select and press **OK**.

 If necessary, change the code, designation or destination number.

Save Press the display key.

Deleting an info service

- ▶ Select info service (→ **Page 95**). Then:

Options Open menu.









Delete Entry Select and press **OK**.

SMS on a PABX

- ◆ You can only receive an SMS when the **Calling Line Identification** is **forwarded** to the extension of the PABX (**CLIP**). The CLIP evaluation of the phone number for the SMS centre takes place in your **Gigaset**.
- ◆ Depending on your PABX, you may have to add the access code (external line prefix) before the number of the SMS centre.
If in doubt, test your PABX, e.g. by sending an SMS to your own number: once with and once without the access code.
- ◆ When you send SMS messages, your sender number may be sent without your extension number. In this case the recipient cannot reply to you directly.

Sending and receiving SMS messages **on ISDN PABXs** is only possible via the MSN number assigned to your base station.









Activating/deactivating first ringer muting

-  Open menu.
-     
Press keys.
-  Make the first ringer audible.
- Or:
-  Suppress the first ringer.
-  Press and **hold** (idle status).

Activating/deactivating the SMS function

If you deactivate the SMS function, you cannot send or receive any SMS messages with your phone.

The settings you have made for sending and receiving SMS messages (e.g. the numbers of the SMS centres) and the entries in the incoming and draft message lists are saved even after deactivation.

-  Open menu.
-     
Enter the digits.
-  Deactivate the SMS function.
- Or:
-  Activate the SMS function (default setting).

SMS troubleshooting

Error codes when sending

E0	Calling Line Identification permanently withheld (CLIR) or Calling Line Identification not activated.
FE	Error occurred during SMS transfer.
FD	Connection to SMS centre failed; see self-help.

Self-help with errors



The following table lists error situations and possible causes and provides notes on troubleshooting.

<p>You cannot send messages.</p> <ol style="list-style-type: none"> You have not requested/activated the CLIP service (Calling Line Identification Presentation). <ul style="list-style-type: none"> Ask your provider to enable this feature. SMS transmission has been interrupted (e.g. by a call). <ul style="list-style-type: none"> Re-send the SMS. Feature is not supported by the VoIP/fixed line network provider. No number or an invalid number is entered for the SMS centre set as the active send service centre. <ul style="list-style-type: none"> Enter the number (→ Page 93).
<p>You receive an incomplete SMS.</p> <ol style="list-style-type: none"> Your phone's memory is full. <ul style="list-style-type: none"> Delete old SMS messages (→ Page 89). The SMS provider has not yet sent the remainder of the message.
<p>You have stopped receiving SMS messages.</p> <ol style="list-style-type: none"> You have changed the ID of your mailbox. <ul style="list-style-type: none"> Give your SMS contacts your new ID or undo the change (→ Page 93). You have not activated your mailbox. <ul style="list-style-type: none"> Activate your mailbox (→ Page 93). All calls are forwarded if When All Calls is activated for the addressed line (fixed line network/VoIP number) or if "immediately" is activated. <ul style="list-style-type: none"> Change the call forwarding setting.
<p>The SMS is played back.</p> <ol style="list-style-type: none"> The "display call number" service is not activated. <ul style="list-style-type: none"> Ask your service provider to activate this function (chargeable). Your mobile phone operator and SMS service provider have not agreed on a co-operation. <ul style="list-style-type: none"> Obtain information from your SMS service provider. Your phone has been recorded by your SMS provider as having no SMS functionality, i.e. you are no longer registered with the provider. <ul style="list-style-type: none"> To reregister your phone, send an SMS via the SMS centre of the SMS service provider.



E-mail messages

Your phone will notify you when new e-mail messages have been received on your incoming e-mail server. You can display the text (unstructured) contained in the e-mail messages on the handset.

You can set your phone to periodically connect to your incoming e-mail server and check whether you have new e-mail.

Any new e-mail messages that have been received are displayed on all Gigaset S68H handsets that have been registered: you will hear an advisory tone, the message key  will flash and the  icon will be displayed in the idle display.

— Please note —

The  icon is also displayed when there are new SMS or messenger messages. If there are new e-mail messages, the E-mail: list is displayed after pressing the message key .

You can use your phone to connect to the incoming e-mail server and display the sender, date and time of receipt, subject and message for every e-mail message in the inbox (→ [Page 98](#)).

Preconditions:

- ◆ You have set up an e-mail account with an ISP.
- ◆ The incoming e-mail server uses the POP3 protocol.
- ◆ You have stored the name of the incoming e-mail server and your personal access data (account name, password) in the phone (→ [Page 213](#)).

Opening the inbox

 →  → E-mail

Or if new e-mail messages have been received (the message key  is flashing):

 → E-mail:

The telephone establishes a connection to the incoming e-mail server. A list of e-mail messages that are stored there will be displayed.

The sequence in which the e-mail messages are displayed is dependent on your POP3 server. Generally speaking, the new unread messages appear before old messages that have been read.

The following details are displayed for each e-mail: name or e-mail address of the sender (one line, abbreviated if necessary) and date and time (date and time will only display correct values if sender and recipient are located in the same time zone).

Example display:

E-mail Inbox	
Susi Sorglos	
15.12.08	12:20
Louise Miller	
14.12.08	11:15
Anna Sand	
14.12.08	10:45
View	Delete

1 E-mail address or name transmitted by the sender (abbreviated if necessary)
Bold: New message.

All e-mail messages that were not present in the incoming e-mail server when the inbox was last opened are identified as "new". All other e-mails are not marked, regardless of whether or not they have been read.

2 Date and time of receipt of e-mail message

If the inbox on the incoming e-mail server is empty, No entries will appear in the display.

Please note

Many e-mail providers operate standard spam protection measures. E-mail messages classified as spam are stored in a separate folder and are therefore not shown in the inbox.

Some e-mail providers allow you to deactivate spam protection or show spam e-mails in the inbox.

Other e-mail providers may send a message to the inbox when a new spam e-mail is received. This is to inform you that a suspected spam e-mail has been received.

Date and sender of this mail are repeatedly updated, so that it is always displayed as a new message.

Messages when establishing a connection

The following problems may occur when connecting to the incoming e-mail server. The messages are displayed in the handset's display for a few seconds.

Server not accessible!

The connection to the incoming e-mail server could not be established.

This may have the following causes:

- Incorrect entry for name of incoming e-mail server (→ [Page 213](#)).
- Temporary problems with the incoming e-mail server (server is down or is not connected to the Internet).
 - ▶ Check settings.
 - ▶ Try again later.

Currently not possible!

The resources your phone requires to make the connection are busy, e.g.:

- Two VoIP connections have already been made.
 - ▶ Try again later.

E-mail messages

Logon at mail server failed!

Error when logging in to the incoming e-mail server. This may have the following cause:

- Incorrect entries for name of incoming e-mail server, user name and/or password.
- ▶ Check settings (→ [Page 213](#)).

Mailbox parameters incomplete!

Incomplete entries for name of incoming e-mail server, user name and/or password.

- ▶ Check settings and complete if necessary (→ [Page 213](#)).

Reading e-mail messages

Precondition: You have opened the inbox (→ [Page 98](#)).



Select e-mail entry.



Press the display key.

The subject and text of the e-mail message are displayed. Any attachments to the e-mail are not displayed.

Example display:

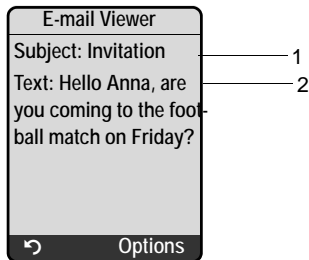

1 Subject of the e-mail message. A maximum of 120 characters are displayed.

2 Text of the e-mail message (abbreviated if necessary).

A maximum of the first 640 characters of the subject and message text are displayed in total (Subject + Text + "Subject:" + "Text:" = 640 characters).



Press the display key to return to the inbox.

— Please note —

- ◆ If the e-mail message contains more than just text, a brief message to this effect is displayed. The Subject of the message is then displayed.
- ◆ If the subject and/or message text are in HTML format, they may be displayed differently to how they appear on the PC e-mail client.

View e-mail sender's address

Precondition: You have opened the e-mail message to read (→ [Page 100](#)).

Options Press the display key.

From Select and press **OK**.

The sender's e-mail address is displayed in full (if necessary over several lines).

↶ Press the display key to return to the inbox.

Example:



Delete the e-mail message

You have opened the inbox (→ [Page 98](#)):

⇩ Select e-mail entry.

Delete Press the display key.

Or:

You have opened the e-mail message to read (→ [Page 100](#)) or request the e-mail sender's address to be displayed (→ [Page 101](#)):

Options Press the display key.

Delete E-mail

Select and press **OK**.

The e-mail is deleted from the incoming e-mail server.

Messenger

The messenger on your phone makes **instant messaging** possible (immediate message transfer, chatting). The phone supports the XMPP messenger (Jabber).

Instant messaging refers to communication between "friends" on the Internet. Subscribers exchange short messages, which are forwarded immediately. This gives rise to a flowing "conversation" similar to chatting.

The precondition for this form of communication is that both subscribers have a connection to the **messenger server** from the same instant messaging provider. Therefore, both subscribers must be "**online**". The messenger server forwards the messages to the recipient.

The subscribers to instant messaging are called **buddies**.

Most messenger servers allow you to create what are known as **buddy lists**. You can store the buddies you want to chat to in the buddy list.

The messenger server informs you as soon as one of your buddies comes online or goes offline. **Offline** means that the buddy has disconnected from the messenger server.

In addition to this, each buddy can determine their own (communication) **status (state of presence, → Page 105)**, from which buddies can tell whether they are in the mood to chat or wish to remain undisturbed.

The messenger on your phone provides you with the following options:

- ◆ Go **online** (→ **Page 103**).
- ◆ Display the list of your contacts (**buddies**) on the handset that you previously created on the PC. This will indicate for each buddy whether they are available (**online**) and ready to chat (**state of presence, → Page 105**).
- ◆ Exchange messages with your buddies. Your handset notifies you about new messages with a flashing message key  and a beep.
- ◆ Call your buddies directly from your buddy list (→ **Page 111**).

Preconditions for instant messaging:

- ◆ You have registered with an instant messaging provider via the Web browser on your PC and (optionally) agreed a Web name (nickname).
- ◆ You have created a buddy list via the messenger client on the PC.
- ◆ You have saved the messenger server address and your access data for the messenger server (user ID, password) in the phone using the Web configurator (→ **Page 211**). The phone needs the data to establish a connection with the messenger server.

Please note

If your instant messaging provider doesn't support the phone's messenger client, then you can open an account with an open Jabber server and use the Web configurator to enter its address in your phone. Many of these Jabber servers offer gateways to other messenger servers (e.g. AOL, ICQ, MSN, Yahoo!).

You can find a list of Jabber servers and an overview of the gateways to other messenger servers on the Internet at: <http://www.jabber.org>.

You can find information on setting up a Jabber account with connections from ICQ, MSN or Yahoo on the Internet, e.g. at: <http://web.swissjabber.ch>.

Establishing a connection, going online

When you go online, your buddy list will be displayed on the handset and you will receive messages from your buddies.

Only one of the handsets connected to the base station can connect to the messenger server. You can then only "chat" on this handset.

An external call will interrupt the "chat", but you will still be online. You can continue your chat after you end or reject the call.

Precondition: You have saved the messenger server address and your access data for the messenger server (user ID and password) in the phone using the Web configurator (→ [Page 211](#)).

 →  → Messenger

Yes Press the display key to confirm the prompt.

The phone attempts to establish a connection. You are informed about the status of the connection by messages on the display.

If the connection can be established, you are Online. The display will show the submenu for your messenger. You can open your buddy list, send and receive messages and call your buddies.

The following is displayed when the handset is in idle status.

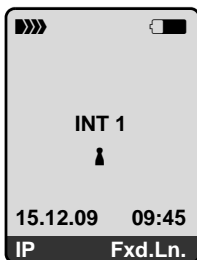

You remain online until you set your status to Offline (→ [Page 104](#)) or the connection to the messenger server is terminated (→ [Page 112](#)).

You also remain online if you press the end call key .

If the connection cannot be established, you will receive an appropriate message. Please try again later (→ [Page 112](#)).

— Please note —

You can also assign the messenger to one of the display keys on your handset (→ [Page 153](#)). The connection is established when you press the display key.

Lost connection

If your phone loses its connection to the messenger server, the display key  will flash on the handset that had been connected to the messenger. In idle status it will display "Messenger connection failed!". All messages that you had previously received, as well as any message you were currently writing, will be saved.

Reconnecting:



Press the message key.

Yes

Press the display key to confirm the prompt.

The phone will attempt to reconnect. You are informed about the status of the connection by messages on the display.

If you reply to the request with **No**, the phone will behave as during regular disconnection. All messenger messages will be deleted. The phone is offline.

Changing/checking your personal status, going offline

You want to log off (go offline) or let your buddies know whether you wish to chat or would prefer to remain undisturbed.

You have the following options:

Offline

You log off from the messenger server. The messenger server informs your buddies that you are no longer available.

The handset switches to idle status. You can neither send nor receive messages.

Online

(Setting after successful connection)

You are logged on to the messenger server and can send and receive messages.

Ready for chat

You are **Online** and can send and receive messages.

You invite your buddies to "chat" with you.

Away / Extended Away / Do not disturb

You are **Online** and can send and receive messages. You inform your buddies that you currently cannot/do not wish to "chat", i.e. will not reply to their messages immediately.

Invisible

You are **Online** and can send and receive messages.



However, the messenger server indicates to your buddies that you are **Offline**.

— Please note —

All status settings apart from **Offline** only inform other buddies about your communication status. Whether this information is passed on to your buddies depends on the provider.

Changing status

 →  → Messenger → User Status → Change Status

 Select status and press **OK** ( = on).

 Press **and hold** if necessary (idle status).

Disconnecting, going offline

▶ Select **Offline** status, and respond **Yes** to the security prompt.

The connection to the messenger server will be terminated. The handset returns to idle status. New messenger messages are no longer sent to you. The messenger message list is deleted. The buddy list is no longer available.

— Please note —

Whether messages directed to you are deleted or stored in the messenger server depends on the provider. Stored messages are sent to you when you go online again.

Checking your status and user ID

 →  → Messenger → User Status → Info

If you are online, the following information may be displayed (depending on your provider):

- ◆ Your Web name (nickname, abbreviated if necessary)
- ◆ Your current status
- ◆ Your user ID (format: userid@provider-domain; abbreviated if necessary)

Opening the buddy list

Precondition: You are **Online** and have already created a buddy list (using the PC) on your provider's messenger server.

 →  → Messenger → Buddies

Only the first 20 (maximum) buddies on the buddy list will be read by the messenger server and displayed on the handset. The number depends on the available memory space.

The buddies that are displayed depend on which buddies were transferred from the messenger server first.

Please note

You can also receive and respond to messages from buddies who are not on the list displayed on the handset.



Example:



The Web names (nicknames) of your buddies are displayed on the list. If they do not have a Web name, the user ID is displayed.

If the name of a buddy is longer than one line, it will be abbreviated. You can navigate in the list with the control key .

The buddies appear on the list in the following order. Their status (→ **Page 104**) is identifiable by the colour of the  icon next to the buddies:

- 1** Buddies with **Online** status or **Ready for chat** in alphabetical order. The  icon is **green**.
- 2** Buddies with **Away**, **Extended Away** or **Do not disturb** status in alphabetical order. The  icon is **orange**.
- 3** Buddies with **Offline** or **Invisible** status in alphabetical order. The  icon is **red**.

Please note

The buddy list will remain open until you exit it (press and release or press and hold .

The handset will not automatically return to idle status.

Changes in the status of buddies

You have opened the buddy list and one of the buddies changes their status. The following distinctions are made:

- ◆ A buddy changes to status **Online / Ready for chat**:
You are informed via a message on the display. The buddy list is updated.
- ◆ In the event of another status change, the buddy list is updated. No message is displayed.

Please note

If the buddy changes to **Offline** status, your messages are no longer sent to them. Whether the messenger server stores the messages until the buddy is **Online** again or deletes them depends on the provider.

Requesting information about buddies

You have opened the buddy list (→ [Page 106](#)).



Select buddy.



Press the display key.

The display depends on the provider.

Example:

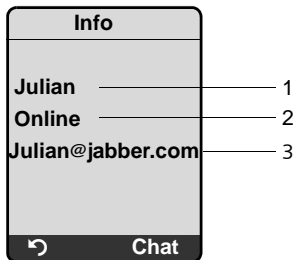

1 Web name (nickname, abbreviated if necessary)

2 Status

3 User ID (format: userid@provider-domain; abbreviated if necessary). (Resource names are not displayed)

Press to return to your buddy list. Press **Chat** if you want to "chat" with the buddy.

Chatting to buddies

You want to "chat" to a buddy, i.e. send a message.

Precondition: You have opened the buddy list (→ [Page 106](#)) and selected a buddy with .

- ▶ Press the display key **Chat**. The text editor is opened.
- ▶ Write and send your message (→ [Page 110](#)).

The buddy list is shown again.

Receiving messages

Precondition: You are online.

Newly arrived buddy or info messages (→ [Page 109](#)) are indicated by a flashing message key  and a beep, even if you are in a messenger menu or text editor.

The messages are stored in the Messenger: list.

— Please note —

The Messenger list is only displayed if you are online.

Opening the message list using the key

The message key flashes.



- ▶ Press the message key .
- ▶ Select **Messenger: (2)** list if required and press **OK**. The number in brackets indicates the number of new messages.

— Please note —

If you are in the messenger menu or one of its submenus/text editors and you press the flashing message key , this will open the Messenger list directly.

To open the message list from the menu:

When the handset is in idle status:

-  →  → Messenger → Messages
- Select and press **OK**.

Message list

The messages on the list are sorted chronologically, with the oldest message at the head of the list.

Example of a list display:

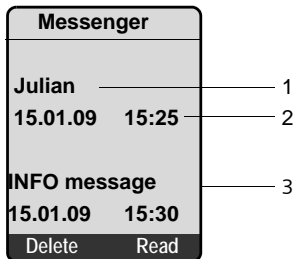

- 1 Sender's Web name/user ID
- Bold:** new/unread message
- 2 Date and time of message
- 3 Message from the messenger server (→ [Page 109](#))

If the memory is full and new messages arrive, the oldest message(s) will be overwritten. If there are no old (read) messages, the oldest new (unread) messages will be overwritten.

Message types

In instant messaging, a distinction is made between the following types of message:

- ◆ **Buddy messages** are the "instant messages" you receive from other buddies. You can answer the messages.
- ◆ **Info messages** are special information from the provider. They are forwarded to you, but you cannot reply to them.

Example: With some messaging providers you receive an info message when another subscriber tries to add you to their buddy list. You are prompted to check the messages on the messenger client on your PC.

Via the messenger client on your PC you can agree to the action or refuse permission. Without your agreement, the other subscriber cannot add you to their buddy list.

Reading messages

Precondition: You have opened the message list and selected a message with .

- ▶ Press the display key **Read**.

The message is opened for you to read.

You have the following options:

Delete Delete a message from the list. You will return to the message list.

Or:

Answer (for buddy messages only)
Reply to message. The text editor is opened. You can write a reply (→ "**Writing and sending messages**" on **Page 110**).

Or:

 Back to the message list.

Delete message

Precondition: You have opened the message list and selected a message with .

- ▶ Press the display key **Delete**.

Writing and sending messages

Precondition:

- ◆ You are reading a buddy's message and press the display key **Answer** or
- ◆ You have pressed the display key **Chat** in the buddy list or the buddy profiles.

A text editor is opened.

- ▶ Use the handset keys to enter a message (max. 612 characters).
- ▶ Select **☰** → **Send** and press **OK**.

The message is sent to the buddy.

Please note

- ◆ Entering text with and without EATONI predictive text is described from [Page 239](#).
 - ◆ EATONI is activated as a default setting. For information on how to activate/deactivate EATONI, → [Page 240](#).
-

If the messenger server is unable to send the message to the buddy, a notification message will be displayed.

- ▶ Confirm the message by clicking **OK**.

The text-editor will re-open with your message. You can then retry sending the message.

Interruption while writing

If you receive a call/SMS while you are writing a message or the connection to the messenger server is interrupted, the text editor is terminated. Your message is stored temporarily until ...

- ◆ ... you start up a chat with the same buddy (→ [Page 107](#)). The text editor is opened with the stored text. You can finish writing the message and send it.
- ◆ ... you wish to write a message to another buddy. The stored text is deleted. The text editor is empty.
- ◆ ... you go offline. The text is deleted.

Menu options for the text editor

Within the text editor, **☰** offers the following options:

Send

Send message to buddy.

Delete Text

Delete the whole text.

Predictive Text

Activate/deactivate predictive text, → [Page 240](#).

Select Language

For predictive text: select the language in which you wish to write the text and press **OK**.

Calling a buddy

You can call a buddy directly.

Precondition: The messenger server supports calls using vCard and your buddy's vCard contains a phone number.

Preconditions:

- ◆ You have opened the buddy list and selected a buddy
or
- ◆ You have opened a buddy's profile
or
- ◆ You have opened the **Messenger:** list and selected a buddy
or
- ◆ You are reading a message from a buddy

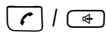

Press and **release/hold** the talk or speaker key.

The phone will try to establish a VoIP/fixed line connection.

The first number that is found on the vCard will be dialed.

Ending a call



Press the end call key.

Self-help with errors

While establishing a connection to the messenger server, during connection and when sending messages the following errors may occur.

What to do when the connection is lost

If the connection to the messenger server is interrupted, an appropriate message is shown in the display. You are **Offline**.

If you are in a submenu of the messenger, the handset switches to the messenger menu.

- ▶ Try to re-establish the connection (→ **Page 103**).

Errors when sending

If it is not possible to send a message, a distinction is made between the following situations:

- ◆ The connection to the messenger server is interrupted:
 - A message is shown in the display to indicate that the connection to the messenger server has been interrupted.
 - The message is stored temporarily (→ **Page 110**).
 - ▶ Try to re-establish the connection (→ **Page 103**) and send the message again.
- ◆ The server is unable to send the message:
 - A message is shown in the display to indicate that the message could not be sent. If, for example, the buddy is not available, the message you have sent will also be displayed.
 - The message is stored temporarily (→ **Page 110**).
 - ▶ If necessary, check the buddy's user ID and send the message again later.

Info Center – with the handset always online

You can use your handset to retrieve online content from the Internet, i.e. request info services that are provided specifically for the handset. The info services available are constantly updated. A preselection has already been made for your handset, but you can change these settings and add new services. Visit the Gigaset.net page www.gigaset.net on the Internet and compile your personal info services.

Customising info services

- ▶ On the PC, open the **Settings** → **Services** page of the Web configurator.
- ▶ Click the gigaset.net/myaccount link.

Or:

- ▶ Enter the following address in the address field of your PC's web browser: www.gigaset.net
- ▶ Enter your Gigaset.net user ID and password on the Gigaset.net page. You will find your user ID and password on the Web configurator page "Settings → Services", → **Page 214**).

In both cases a Web page is opened on which you can compile your info services.

Starting Info Center, selecting info services

 → Info Center

The menu of your Info Center, i.e. a list of available info services is displayed. You can navigate between the info services.

Example:

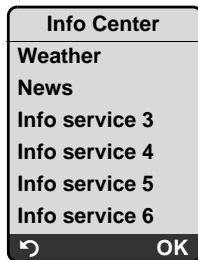

 Select the info service and press **OK**.

To access certain info services (personalised services), it is necessary to register with a user name and password. In this case, enter your access data as described in the section "**Registration for personalised info services**" on **Page 114**.

Messages when loading requested information

The information is loaded from the Internet. Wait a few seconds until the information is displayed. The display shows *Please wait*.

If the information for an info service cannot be displayed, one of the following messages appears:

Requested page cannot be reached!

Possible causes of this are:

- ◆ Time limit exceeded (timeout) when loading the information, or
 - ◆ the Internet server for the info services cannot be accessed.
- ▶ Check your Internet connection and repeat the request at a later time.

Coding error on requested page!

The content of the requested info service is coded in a format which the handset cannot display.

Unable to show requested page!

General error when loading the info service.

Authorization failed!

Registration has failed. Possible causes of this are:

- ◆ You have not entered your registration data correctly.
 - ▶ Reselect the info service and repeat the registration process.
Please remember that data is case sensitive.
- ◆ You are not entitled to access this info service.

Registration for personalised info services

If a special registration with user name and password is required to access an info service, the following is displayed after the service has been called up:



Authorization
Authent. Name:
Authent. Password:
 Save

Authent. Name Enter the user name supplied by the provider of the info service.

Authent. Password Enter the password associated with this user name.

Save Press the display key to send the registration data.

If registration was successful, the requested info service is displayed.

If registration failed, a message to this effect appears on the display
 → **Messages when loading requested information, Page 114.**



— Please note —

Please remember that registration data is case sensitive. To enter text
 → **Page 238.**

Operating the Info Center

Depending on the type of info service requested, you can carry out the following actions:

Scrolling within an info service

- ▶ You can use  to scroll downwards within an info service, and  to scroll up (back).

Skipping back to the previous page

- ▶ Press the left display key .

Skipping back to the Info Center menu

- ▶ Press the end call key  briefly.

You want to go offline:



Press and **hold** the end call key , the handset returns to idle status.

Selecting a hyperlink

Hyperlink to further information:



If the page contains a hyperlink to further information, this is indicated by the  icon.

If a page is opened using hyperlinks, the first hyperlink is highlighted.

- ▶ Using the control keys ( and/or ) as required, you can navigate to the hyperlink that you would like to select. The hyperlink is then highlighted by bars.
- ▶ Press the right display key **Link**, to open the relevant page.

Hyperlink to a phone number:

If a hyperlink contains a phone number, you can copy the number to the local directory or call the number directly (Click-2-Call functionality).

- ▶ Select the hyperlink using the  and/or  keys, as required.
- ▶ You can identify a hyperlink of this type by the fact that **Call** is shown above the right display key.
- ▶ Press **DIR** if you want to copy the phone number to your handset's local directory.

Or:

- ▶ Press **Call** to call the stored number.

Depending on the provider, if you press **Call**,

- ◆ the number is either dialled directly or
- ◆ appears first in the display, in which case you must first confirm the number before it is dialled.

Example:

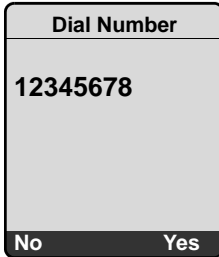

- ▶ If you press **Yes**, the number is dialled.



Or:

- ▶ If you press **No**, the page is displayed again with the hyperlink. The number will **not** be dialled.



Entering text

- ▶ If necessary, use  to navigate to the line containing the field into which you want to enter text. The cursor flashes in the text field.
- ▶ Enter your text using the handset keys (For information on entering text see → the appendix to the user guide belonging to your phone).
- ▶ If necessary, navigate to other text fields to complete them or make a selection (see below).
- ▶ Press the right display key to complete the entry and send the data.

Making selections

- ▶ If necessary, use  to navigate to the line, in which you would like to make a selection.
- ▶ Press left or right on the control key several times to make the desired selection.
- ▶ Use  to navigate to other selection fields and make your selection as described above.
- ▶ Press the left display key to complete the selection and send the data.

Setting options

- ▶ Use  to navigate to the line containing the option. The line is highlighted.
- ▶ Activate or deactivate the option via the control key  (press right) or the left display key (e.g. **OK**).
- ▶ If necessary, navigate to other options or text fields to set or complete them.
- ▶ Press the left display key (e.g. **Send**) to complete the entry and send the data.

Displaying information from the Internet as a screensaver

You can configure your handset to display a customised information feed (e.g. weather reports, newsfeeds) in the device's idle display.

To do this, you must switch on the screensaver **Clock** on your handset (→ [Page 151](#)) and activate the display of info services via the Web configurator (→ [Page 214](#)).

— Please note —

For details of how to select information, → [Page 214](#). The weather report is preset.

The text information appears on the display approx. 10 seconds after the handset returns to idle status.

Depending on the information feed selected, a display key appears on the right of the screensaver (e.g. **More**),

- ▶ Press the right display key to call up further information.
- ▶ Press and hold the end call key  to return to idle status.

Operating the base station answering machine

You can operate the answering machine that is integrated in the base station via the handset or via remote operation (other phone/mobile phone). You can record your own announcement message or advisory message via the handset.

— Please note —

Connections to the answering machine (internal and external) are not established using broadband.

Receive numbers

You can use your phone's Web configurator to set which of your phone numbers your answering machine is to accept as soon as it is switched on (→ [Page 202](#)). You can assign your phone any number of phone numbers as receive numbers (VoIP, fixed line network, Gigaset.net).

All calls accepted by the answering machine are stored in sequence in the answering machine independently of the receive number and displayed in the same answering machine list.

Any registered handset to which at least one receive number from the answering machine has been assigned as a send or receive number can access the answering machine list (→ [Page 200](#)).

After a new phone number is configured (a new VoIP account), it is first assigned to the answering machine as a receive number.

Parallel calls

If a caller is connected to the answering machine and a second call for the answering machine comes in on a different line (fixed line network or VoIP), the second caller hears the ringing tone. The answering machine will answer the second call if:

- ◆ the connection with the first caller has ended and
- ◆ the ring delay period for the answering machine to answer a call (→ [Page 125](#)) has expired.

Announce only/answer and record mode

You can use the answering machine in two different modes.

- ◆ In **Ans. & Record** mode, the caller hears the announcement and can then leave a message.
- ◆ In **Announce Only** mode, the caller hears your announcement but cannot leave a message.

Operation via the handset

The handset loudspeaker activates **automatically** if you receive an acoustic prompt or message while operating. You can switch it off with the speaker key .

Activating/deactivating the answering machine

 →  → Voice Mail → Local AM → Ans Machine ( = on)

When the answering machine is activated, the remaining memory time is announced. If the time has not yet been set (→ [Page 16](#)), an appropriate announcement is made. The ∞ icon appears in the display.

The answering machine accepts calls for all the receive numbers assigned to it (→ [Page 202](#)).

In answer and record mode



If the memory is full, the answering machine automatically switches to announce only mode.

- ▶ Delete old messages.

The answering machine reverts automatically to answer and record mode.

Selecting announcement mode

You can choose between Ans. & Record and Announce Only.

 →  → Voice Mail → Local AM → Announcements → Set Ans. Mode → Ans. & Record / Announce Only ( = on)

 Press and **hold** (idle status).

The selected mode is saved even after the answering machine is deactivated.

The selection process will be cancelled if the message memory is already full when you change to Ans. & Record mode. You will be requested to delete old messages. The answering machine stays in Announce Only mode.

- ▶ Delete old messages.

Only after messages have been deleted can you switch the answering machine to answer and record mode.

Setting "Ans Mode Time" in "Answer & Record" or "Announce Only" mode

You can use the Ans Mode Time setting to change over the announcement mode for a specific period.

Example: Ans. & Record mode is set. If you activate Ans Mode Time and set the time period From 18:00, Until 08:00, the answering machine will switch to Announce Only mode every day at 18:00 (if it is switched on). It will switch back to Ans. & Record mode at 08:00 the next day.

 →  → Voice Mail → Local AM → Announcements → Set Ans. Mode → Ans Mode Time ( = on)

- ▶ Change multiple line input:

From

Enter hours/minutes for the start of the period in 4-digit format.

Until

Enter hours/minutes for the end of the period in 4-digit format.

Activation

Select On or Off.

- ▶ Save changes with **Save**.

If the messages memory is full and **Activation On** has been selected, saving is interrupted and you will receive an instruction to delete old messages.

- ▶ Delete old messages and repeat the setting.

As soon as you change the announcement mode (→ **Page 119**), the **Ans Mode Time** function is automatically deactivated. You may have to reactivate it if required.

If you do not enter a time for **From / Until**, **Ans Mode Time** will still be activated but the machine will not switch to announcement mode.

Recording announcement/announce only



Pre-recorded announcements are stored in your telephone for both announcement modes. The pre-recorded announcements are used if there is no personal announcement for the mode concerned.

 →  → Voice Mail → Local AM → Announcements → Record Announce / Record Anc Only

OK Press the display key to start the recording.

When the recording starts, the handset changes to speaker mode. You hear the ready tone (short tone).

- ▶ Now speak your announcement (at least 3 secs.).

Use  or  to cancel recording and **OK** to restart the recording process.

The recording is cancelled if the answering machine memory is full.



- ▶ Delete old messages and repeat recording if required.

Stop recording:

End Press the display key.

After recording, the announcement is played back for you to check.

You can re-record the announcement with **New**.



You can cancel playback by pressing  or .

Please note:

- ◆ Recording ends automatically if the maximum recording time of 170 seconds is exceeded or there is a break in speech for more than 2 seconds.
- ◆ If you cancel the recording, the previously recorded announcement will be deleted. The pre-recorded announcement will be used again.
- ◆ The recording is cancelled if the answering machine memory is full.
 - ▶ Delete old messages and repeat recording if required.

- ◆ If an external call is received during a recording for one of the handset's receive numbers, the recording is interrupted and the call is signalled on the handset.

Playing back announcements

 →  → Voice Mail → Local AM → Announcements → Play Announcement / Play Anc Only

If you have not recorded a personal announcement, the relevant pre-recorded announcement is played.

Record a new announcement while playing back the announcement:

New Press the display key. For further information, → [Page 120](#).

Deleting announcements/announce only

 →  → Voice Mail → Local AM → Announcements → Del Announcement / Del Anc Only

Yes Press the display key to confirm the prompt.

 Press and **hold** (idle status).

Once you have deleted your announcement, the relevant pre-recorded announcement will be used again. You cannot delete the pre-recorded announcements.

Playing back messages

New messages that have not yet been heard are indicated by the ∞ icon in the display and by the  key flashing on the handset.

You can start to play back the messages in two ways:

- ◆ Open the answering machine list with the message key.
- ◆ If the answering machine is set for fast access (→ [Page 126](#)): press and **hold** key .

Please note

All messages are played back irrespective of their receive number.

Listening to messages via the answering machine list

Precondition: At least one of your handset's send/receive numbers matches the receive number of a stored message.

The date and time of each message is logged in the answering machine list (provided it has been set, → [Page 16](#)) and displayed during the playback. If Calling Line Identification is activated, the caller's number is displayed. If the caller's number is saved in the directory, their name is displayed.

 Press the message key.

Ans M. Select and press **OK**.

An announcement informs you if there are new or old messages.

If there are new messages, playback begins with the first new message. If the message has been saved with the date and time, you will hear an appropriate announcement before playback begins. All messages are played back irrespective of the receive number.

After the last new message you will hear the end tone and an announcement about how much recording time remains.

You can listen to old messages if there are no more new messages. If necessary begin playback again, as described above.

Listening to messages via key



Preconditions: The answering machine has been set to fast access (→ [Page 126](#)). At least one of your handset's send/receive numbers matches the receive number of a stored message (→ [Page 202](#)).



▶ Press and **hold** key .



The stored messages are now played back.

Pausing and controlling playback

During message playback:

 Pause playback. Press  again to resume.

 or  Skip to the previous message.

 or  Skip to the next message.

2 x  Skip to next-but-one message.

If playback is interrupted for over a minute, the answering machine returns to idle status.

Marking a message as "new"

A previously played back "old" message is displayed as a "new" message again.

During message playback or pause:

 Press the star key.

Or:

 Open menu.

Mark as New

Select and press .

Playback of the current message is cancelled. Playback of next message starts, if applicable.

The  key on the handset flashes.

Copying the phone number of a message to the directory

See "[Copying a displayed number to the directory](#)", → [Page 76](#).

Deleting messages

You can either delete all old messages together or individually.

Deleting all old messages

During playback or pause:

Options Press the display key.

Del All Old Msgs

Select and press **OK**.

Yes Press the display key to confirm the prompt.

All old messages are deleted irrespective of the receive number.

Deleting individual old messages

During playback or pause:

Delete / **[0+]**

Press the display key or **[0+]** key.

— Please note —

You can delete a new message as soon as playback has started.

Picking up a call from the answering machine

You can pick up a call while the answering machine is recording or is being operated via remote operation:

[hook] / **Accept**

Press the talk or display key.

Recording stops and you can speak to the caller.

If 3 seconds of the call have already been recorded when you pick it up, the call will be displayed as a new message. The **[msg]** key on the handset flashes.

Diverting an external call to the answering machine

You can forward an incoming external call to the answering machine.

Preconditions: There is sufficient free memory space. One of your handset's send/receive numbers matches a receive number of the answering machine.

An external call is signalled on the handset:

[00] Press the display key.

The answering machine immediately starts in recording mode and records the call. The set time for ring delay (→ **Page 125**) is ignored.

The display key **[00]** will not be displayed if the memory is full.

Activating/deactivating two-way record

You can record an **external** call with the answering machine.

Precondition: You are conducting an external call. At least one of the handset's send/receive numbers is assigned to the answering machine as a receive number (→ [Page 202](#)).

- ▶ Inform the caller that the call is being recorded.

Options Press the display key.

Two Way Record

Select and press **OK**.

Two-way record is indicated on the display by an advisory text and is added to the answering machine list as a new message.

End Press the display key to stop two-way record.

The maximum recording time depends on the memory available on the answering machine. If the memory is full, you will hear an end tone and the recording is aborted. The conversation recorded up to the end tone is then allocated to the answering machine list as a new message.

— Please note —

You can activate two-way recording for conference calls and call swapping with two external callers when making calls via a fixed line network.

Activating/deactivating call screening

During recording of a message you can screen a call via the handset loud-speaker.

Precondition: The number called is assigned to the handset as a receive number (→ [Page 200](#)).

Permanently activating/deactivating call screening

 →  → Voice Mail → Local AM

Call Screening

Select and press **OK** ( = on)



Press and **hold** (idle status).

Deactivating call screening for the current recording

You can deactivate the Call Screening function for the current call during recording via the handset.



Briefly press the end call key.

Setting up the answering machine

The answering machine has already been preset at the factory. Make individual settings using the handset.

Ring delay/cost saving function for remote operation



You can set when you want the answering machine to accept a call.

The options are: 0 sec., after 10 sec., 20 sec. or 30 sec. and the cost-saving setting Auto.

In Auto mode, the following applies for ring delay:

- ◆ If there are no new messages, the answering machine answers a call after **20 seconds**.
- ◆ If new messages are present, the answering machine accepts a call after **10 seconds**.

When operating remotely you can tell after approx. 15 seconds that there are no new messages (otherwise the answering machine would already have accepted your call). There will be no call charges if you hang up now.

 →  → Voice Mail → Local AM → Ring Delay

 Select 0 sec. / 10 sec. / 20 sec. / 30 sec. / Auto.

Save Press the display key.

 Press and **hold** (idle status).

Please note:

You can configure your telephone so that the **first ring is suppressed** on all calls (→ [Page 96](#)). The time set for ring delay therefore does not indicate how long the phone rings before the answering machine accepts the call.

Setting the recording time

You can set the maximum recording time of a message. You can choose between: 30 Sec, 60 Sec, 120 Sec or Maximum.

 →  → Voice Mail → Local AM → Message Length

 Select the recording time.

Save Press the display key.

Setting the recording quality

Set the quality you require for your recordings. The options are: Long Play, High, Excellent. If the quality is higher, the maximum recording time is reduced.

 →  → Voice Mail → Local AM → Record Quality

 Select the recording quality.

Save Press the display key.

_____ Please note _____

Your announcements are always recorded in best quality.

Changing the language for voice prompt and pre-recorded announcement

 **8** tuv **5** ki **9** wyc **2** abc

Enter digits **and** press

1 so **OK** To set Swedish.

2 abc **OK** To set Danish.

3 def **OK** To set Norwegian.

4 ghi **OK** To set Finnish.

Configuring the answering machine for fast access

You can assign the local answering machine or one of your network mailboxes to key **1 so** for fast access (→ [Page 130](#)). This setting is handset-specific.

Configuring the local answering machine for fast access

Precondition: At least one of your handset's send/receive numbers matches a receive number of the answering machine.

 →  → Voice Mail → Set Key 1

Local AM Select and press **OK**.

 Press and **hold** (idle status).

Listening to messages on the answering machine

Precondition: The answering machine is set for fast access on the handset.

1 so Press and **hold**.

The messages are now played back. Speaker mode is activated. You will hear the answering machine announcement.

 If necessary, press the speaker key to switch it off.

Operating when on the move (remote operation)

You can check and activate your answering machine from any other telephone (hotel, pay phone etc.), or initiate ringback from the answering machine with an SMS.

Preconditions:

- ◆ You have set a system PIN other than 0000 (→ [Page 161](#)).
- ◆ The phone you are using for remote operation has tone dialling (DTMF), i.e. you hear different tones when you press the keys. Alternatively, you can use a code transmitter (available from your mobile phone retailer).

Please note

Remote operation via VoIP connections is possible as long as DTMF signals are transmitted (depending on the provider) as SIP info messages, audible signals in the voice channel (inband or audio) or as special RTP data packets (pursuant to RFC2833).

Calling the answering machine and playing back messages

Precondition: Your answering machine is activated.



Dial your own number that is assigned to the answering machine as a receive number.



When you hear your announcement, press  and enter the system PIN.

You will be informed whether any new messages have been recorded.

The messages are now played back. All messages are played back irrespective of their receive number. After the new messages, the old messages are played back. Finally, the remaining memory time is specified.

You can control message playback by means of the keypad.

Please note

The answering machine will terminate the connection under the following circumstances:

- ◆ An incorrect system PIN has been entered.
 - ◆ There are no messages in the answering machine.
 - ◆ After the remaining memory has been specified.
-

Operating the answering machine via the keypad

The following keys are used for operation:

- 1** Previous:
Go to the start of the current message. Press repeatedly to go to the previous messages.
- 2** Stop/resume:
Stop playback. Press again to resume.
If there is a pause lasting longer than one minute, the connection to the answering machine is terminated.
- 3** Next:
Skip to next message. Press several times to go to the following messages.
- *** New:
Mark current message as "new". Start playback of the following message.
- 0** Delete:
Delete current message.

Cancelling remote operation

- ▶ Press the end call key or replace the receiver.

Activating the answering machine

- ▶ Phone home and allow the phone to ring for around a minute. Use a phone number that has been assigned to the answering machine as a receive number.

You hear: "Please enter PIN".



Enter system PIN.

Your answering machine is activated in the set mode (→ [Page 119](#)). It tells you how much memory time is left.

The messages are now played back.

The answering machine cannot be deactivated remotely.

Using the network mailbox

Some fixed network providers and VoIP providers offer answering machines on the network – these are known as network mailboxes.

Each network mailbox accepts incoming calls made via the corresponding line (fixed line network or corresponding VoIP phone number). To record all calls, you should therefore set up network mailboxes for both the fixed line network and for each of your VoIP connections.

You need to have **requested** the network mailbox for your fixed line network connection from your fixed line network provider. You can store the phone number for the fixed line network mailbox in the base station.

You can activate/deactivate the network mailboxes for your VoIP connections using your handset or the Web configurator. To do this, you only require the network mailbox phone number.

Activating/deactivating the network mailbox, entering numbers

You can manage the network mailboxes on your handset that are assigned to a receive number on the handset.

 →  Settings → Voice Mail → Network AM(s)

The list of connections (VoIP and fixed line network) that are assigned to the handset as receive numbers is displayed. Net AM xxx where xxx is replaced by the standard name in the connection (IP1 to IP6, Fxd. In.).

 Select connection and press **OK**.

You have selected a VoIP connection:

▶ Change multiple line input:

Status

Select On to activate the network mailbox. Select Off to deactivate.

Call No.

The number that is currently stored for the network mailbox is displayed.

Enter or change the phone number for the network mailbox if necessary.

With some VoIP providers your network mailbox phone number will be downloaded together with the general VoIP provider data (→ [Page 187](#)), saved to your base station and displayed under Call No..

Save Press the display key.

You have selected the fixed line network connection:

Call No.

Enter or change the phone number for the network mailbox.

Save Press the display key.

You cannot activate/deactivate the network mailbox for the fixed line network connection via the handset. For how to activate/deactivate the network mailbox for the fixed line network connection please refer to the fixed line network provider's information.

— Please note —

For information on how to activate and deactivate network mailboxes via the Web configurator and to change their assigned numbers, → [Page 207](#).



Configuring the (network) mailbox for fast access

You can use fast access to make direct calls to a network mailbox or the integrated answering machine on the base station.

Assigning key 1 of the handset, changing assignments

The setting for fast access is handset-specific. You can assign a different mailbox to key  on each registered handset.

No mailbox is preconfigured for fast access in the default settings.



 Fast access is not yet set on the handset: Press and hold key .

Or:

 →  Settings → Voice Mail → Set Key 1

The list of connections (VoIP and fixed line network) that are assigned to the handset as receive numbers is displayed. Net AM xxx where xxx is replaced by the standard name in the connection (IP1 to IP6, Fxd. In.).

For the integrated answering machine of the base station, the entry Local AM is offered in the list (→ [Page 126](#)).

 Select entry and press **OK** ( = on).

When selecting a network mailbox:

If a number is already saved to the base station for the selected network mailbox, fast access is activated.

 Press and **hold** (idle status).

If no number has been saved for the network mailbox, a message is displayed to this effect.

You will be prompted to enter the number for the network mailbox.

 Jump to the Call No. line.

 Enter the number for the network mailbox.

Save Press the display key.

 Press and **hold** (idle status).

Fast access is automatically activated.

— Please note —

You can only assign fast access to **one** answering machine.

However, you can also call the network mailbox assigned to a handset's receive numbers directly via the message key (→ [Page 131](#)).

Calling the network mailbox

 Press and **hold**.

If you have set a network mailbox for fast access you will be connected straight to this network mailbox.

 If necessary, press the speaker key.

You will hear the network mailbox announcement.

If you have set the integrated answering machine on the base station for fast access, message playback begins (→ [Page 126](#)).

Listening to messages on the network mailbox

Under the message key , you will find a list for each network mailbox that fulfils the following requirements:

- ◆ The corresponding connections are allocated to the handset as receive numbers.
- ◆ The network mailbox phone number is saved on the base station.

You can call and check the network mailbox directly from the list.

When you press the message key , the following is displayed (example):

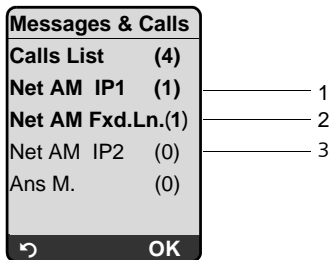

- 1 "Fxd. In. ", "IP1" etc. are the default names for the associated connections. The default names are always displayed irrespective of which connection name you specified when configuring via the Web configurator.
- 2 If there are new messages in the network mailbox, the list entry is shown in bold. The number of new messages is shown in brackets following the list entry.
- 3 If there are no new messages (0) is shown after the list entry for the network mailbox. The number of messages stored in the network mailbox is not displayed.

Displaying new messages in the handset's idle status

If a new message is present on one of the network mailboxes to which the handset is allocated via its receive number, or there is a new message on the integrated answering machine, the ∞ icon and the number of new messages are shown on the handset's idle display. The  message key flashes.

Calling the network mailbox and checking messages



Press the message key.

Net AM Fxd. In. / Net AM IP1 / ...

Select the network mailbox and press **OK**.

You are connected directly to the network mailbox and hear its announcement. Messages can generally be played back using your handset keypad (digit codes). Listen to the announcement.

— Please note —

- ◆ The network mailbox is automatically called via the corresponding connection. An area code predefined for your phone is **not** prefixed.
 - ◆ Network mailbox messages can generally be played back using your handset keypad (digit codes). You need to define how the digit codes for VoIP should be converted to DTMF signals and transmitted (→ [Page 208](#)).
- Ask your VoIP provider which type of DTMF transmission it supports.
-

ECO DECT: reducing the power consumption and transmission power of the base station

The base station of your phone is an ECO DECT base station, this means that:

- ◆ The base station uses less power because it is equipped with a power-saving mains adaptor.
- ◆ The reduction of the handset's transmission power is dependent on the handset's proximity to the base station.
- ◆ The base station can also be switched to *Eco Mode*. Eco mode reduces the transmission power and the power consumption of the base station further.

Eco Mode means:

80% reduction of the transmission power in standby operation and when making calls. *Eco Mode* is available when the handset(s) and the base station are close together, e.g. when the phone is being used in an office.

The setting can be made on the handset.

Activating/deactivating Eco Mode





Precondition: Repeater support must be deactivated.

 →  → Base → Add. Features

Eco Mode Select and press **OK** ( = on).

If Eco mode is activated, the  icon is displayed on the idle display (header).

The signal strength icon in the header of the idle display indicates whether the handset is connected to the base station.

    – reception good to poor
 (flashes) – no reception

Please note

- ◆ Activating *Eco Mode* reduces the range of the base station.
 - ◆ *Eco Mode* and any repeater support (→ [Page 163](#)) cancel each other out, i.e. both functions cannot be used at the same time.
-

Setting an appointment (calendar)

You can use your handset to remind yourself of up to 30 appointments.

Anniversaries entered in the directory (→ [Page 76](#)) are automatically recorded in the calendar.

Saving an appointment

If you have already saved 30 appointments, you must first delete an existing appointment.

Precondition: The date and time have already been set (→ [Page 16](#)).



→ Open the graphical calendar.

Days on which appointments have already been saved are highlighted in black.



Select day and press **OK**.

If appointments have already been saved for the day, the list of appointments will be displayed: select <New Entry> and press **OK**.

▶ Change multiple line input:

Appoint.

Select On or Off.

Date

Enter day/month/year in 8-digit format.

Time

Enter hours/minutes in 4-digit format.

Notes

Enter text (max. of 16 characters). The text appears as the appointment name in the list and will be displayed on the screen during the appointment reminder. If you do not enter any text, only the date and time of the appointment are displayed.

Save

Press the display key.

The list of appointments for the selected day is displayed. Activated appointments are highlighted with in the appointment list. The appointments in the list are sorted by time.



Press and **hold** (idle status).

Managing appointments



Select the day in the graphical calendar and press **OK** or . Days on which appointments have already been saved are highlighted in black in the calendar.



Select appointment for the day.

Options

Open menu.

Back with .

You have the following options:

View Entry

View selected appointment.

Options Open the menu for editing, deleting and activating/deactivating.

Edit Entry

Edit selected appointment.

Delete Entry

Delete selected appointment.

Activate / Deactivate

Activate/deactivate the selected appointment.

Delete List

Delete **all** appointments.

Deactivating or accepting an appointment reminder

An appointment reminder is signalled with the selected ringer (→ [Page 156](#)). The appointment reminder sounds for 60 seconds. The entered text, date and time are displayed.

During a call, the appointment reminder is signalled by a short tone.

Precondition: An appointment reminder is sounding.

▶ Press the display key **OFF** to switch off the appointment reminder.

Or:

▶ Press the display key **SMS** to write an SMS.

Displaying missed appointments, anniversaries



Missed appointments/anniversaries (→ [Page 76](#)) are displayed in the Missed Dates list if:

- ◆ You do not accept an appointment/anniversary.
- ◆ The appointment/anniversary was signalled during a phone call.
- ◆ The handset is deactivated at the time of the appointment/anniversary.
- ◆ Automatic redial was activated at the time of an appointment/anniversary (→ [Page 66](#)).

The most recent entry is at the head of the list.

If there is a new appointment/anniversary in the list, the display shows **Appoint.** . Pressing the display key will also open the Missed Dates list.

To open the list from the menu:

 →  → Missed Dates

Select appointment/anniversary.

Information about the appointment/anniversary is displayed.

A missed appointment is displayed with the appointment name and a missed anniversary is displayed with the last name and first name. The date and time will also be given.

Delete Delete appointment.

SMS Write an SMS.

 Press and **hold** (idle status).

If 10 entries are already stored in the list, the next appointment reminder will delete the oldest entry.

Setting the alarm clock

Precondition: The date and time have already been set (→ [Page 16](#)).

Activating/deactivating the alarm clock and setting the wake-up time



▶ Change multiple line input:

Activation

Select On or Off.

Time

Enter the wake-up time in 4-digit format.

Period:

Select Daily or Monday-Friday.

Volume:

Set the volume (1–6).

Melody:

Select melody.

▶ Press the display key **Save** to save the changes.

You will see the  icon.

A wake-up call with the selected ringer is signalled on the handset. The wake-up call sounds for 60 seconds.  is shown in the display. If no key is pressed, the wake-up call is repeated twice at five minute intervals and then switched off.

During a call, the wake-up call is only signalled by a short tone.

Deactivating the wake-up call/repeating after a pause (snooze mode)

Precondition: A wake-up call is sounding.

OFF

Press the display key. The wake-up call is deactivated.

or

Snooze

Press the display key or any key. The wake-up call is deactivated and then repeated after 5 minutes. After the second repetition the wake-up call is deactivated completely.

Using several handsets

Registering handsets

You can register up to six handsets to your base station.

You can register your Gigaset S68H handset on up to four base stations.

When you register a new Gigaset handset, the base station transfers the following entries to its local directory to enable you to use online directories on your new handset:

- ◆ Online Directory for the currently active online directory (→ [Page 215](#))
- ◆ Yellow Pages for the currently active online classified directory (→ [Page 215](#))
- ◆ Gigaset.net for the Gigaset.net directory

Precondition: The handset can send and receive directory entries (see handset user guide).

Successful registration is acknowledged with the message Data Transfer x entries received for this reason.

— Please note —



- ◆ If a number of handsets are registered on your base station, you can simultaneously make two calls via the Internet and one via the fixed line network. Up to two additional internal connections are also possible.
- ◆ Selecting the line via the talk key (→ [Page 44](#)) is not supported on GAP handsets. This means that if you enter a number without a line suffix and without defining a dialling plan for the phone number, it will be dialled via Default Line (→ [Page 164](#)).
- ◆ After registration, all the phone numbers for the phone will be assigned to the handset as receive numbers. It will use the fixed line network number and the first VoIP number as send numbers. For how to change the assignments, → [Page 200](#).

Registering another Gigaset S68H handset on the Gigaset S685 IP

Before you can use your handset, you must register it to the base station.

You must initiate handset registration on the handset and on the base station.

If the handset has been registered successfully, the handset returns to idle status. The handset's internal number is shown in the display e.g. Int 1. If not, repeat the procedure. Registration can take up to one minute.

- ▶ Select  →  → Handset → Register H/Set **on the handset**.
- ▶ Enter the system PIN of the base station (the default is 0000) and press **OK**. The display shows e.g. Base 1 and flashes.
- ▶ Within the next 60 seconds press and **hold** (for approx. 3 seconds) the registration/paging key (→ [Page 2](#)) **on the base station**.

The handset is assigned the lowest available internal number (1-6). If a number of handsets are registered on the base station, the internal number appears in the display after registration, e.g. INT 2. This means that the internal number 2 was assigned to the handset.

— Please note —

If six handsets are already registered to the base station, there are two options:

- ◆ The handset with the internal number 6 is in idle status: the handset you wish to register is assigned the number 6. The handset that was previously number 6 is de-registered.
 - ◆ The handset with the internal number 6 is being used: the handset you wish to register cannot be registered.
-

Registering other handsets on the Gigaset S685 IP

You can register other Gigaset handsets and handsets for other devices with GAP functionality as follows.





- ▶ Start the registration procedure **on the handset** in accordance with the handset's operating instructions.
- ▶ Press and hold (for approx. 3 seconds) the registration/paging key (→ **Page 2**) **on the base station**.

— Please note —

You can also make changes on the base station with a Gigaset S45 or C47H handset.

De-registering handsets

You can de-register any registered handset from any registered Gigaset S68H handset.

-  Open list of internal participants.
The handset you are currently using is highlighted with <
-  Select the handset to be de-registered.
- Options** Press the display key.
- De-reg. H/Set No.
Select and press **OK**.
-  Enter the base station system PIN (default setting: 0000).
- Yes** Press the display key to confirm the prompt.
-  Press and **hold** (idle status).

The handset is de-registered immediately, even if it is not in idle status.

Locating a handset ("paging")

You can locate your handset using the base station.

- ▶ **Briefly** press the registration/paging key on the base station (→ **Page 2**).
- ▶ All handsets will ring at the same time ("paging"), even if the ringers are switched off.

The current (local) IP address for the base station appears in the handset displays.

Ending paging

- ▶ **Briefly** press the registration/paging key on the base station (→ **Page 2**).

Or

- ▶ Press the talk key  or end call key  or display key **Silence** on any handset.

Changing the base station

If your handset is registered to more than one base station, you can set it to a particular base station or to the base station that has the best reception (Best Base).

 →  → Handset → Select Base

 Select one of the registered base stations or Best Base and press **OK**.

Changing a handset's internal number

A handset is **automatically** assigned the lowest free number when it is registered. In the list of internal participants, the handsets are sorted according to their internal number.

You can change the internal number of all registered handsets (1–6). Numbers 1-6 can only be assigned once each.

 Open the list of handsets. Your own handset is indicated by <.

Options Press the display key.

Edit H/Set No.

Select and press **OK**. The list of handsets and their internal numbers will be displayed.

The internal number for the first handset flashes.

 Select handset.

 Enter the new internal number (1–6). The handset's old number is overwritten.

  If necessary, select further handsets and change numbers.

After all the changes are completed:

Save Press the display key to save the input.





 Press and **hold** (idle status).

You will hear the error tone if an internal number has been allocated twice.

- ▶ Repeat the procedure with a free number.

Changing the name of a handset

The names "INT 1", "INT 2" etc. are assigned automatically at registration. You can change these names. The changed name is displayed in every handset's list.

-  Open the list of handsets. Your own handset is indicated by <.
-  Select handset.
- Edit** Press the display key.
-  Delete previous name if necessary.
-  Enter the new name (max. 10 characters).
- Save** Press the display key.
-  Press and **hold** (idle status).



Please note

If you delete the current handset name and then press **Save** without entering a new name, the handset will automatically be allocated the standard name "INT x" (x= internal number).



Making internal calls

Internal calls to other handsets registered on the same base station are free. They will always be made via broadband if both handsets are broadband-capable.



Calling a specific handset

-  Initiate internal call.
-  Enter the number of the handset.

Or:

-  Initiate internal call.
-  Select handset.
-  Press the talk key.

Calling all handsets ("group call")

-  Initiate internal call.
-  Press the star key. All handsets are called.

Ending a call

-  Press the end call key.

Please note

You can reject an internal call by pressing the end call key . Other handsets will continue to signal an internal "group call".

Transferring a call to another handset

You can forward (connect) an external call, made via the fixed line network or VoIP, to another handset.



Open the list of handsets.
The external participant hears hold music if activated
(→ [Page 163](#)).



Select handset or **Call All** and press **OK**.

When the internal participant answers:

▶ If necessary announce the external call.



Press the end call key.

The external call is transferred to the other handset.

If the internal participant does **not** answer or the line is busy, press the display key **End** to return to the external call.

When transferring a call you can also press the end call key  before the internal participant answers.

Then, if the internal participant does not answer or the line is busy, the call will automatically return to you (the display will show **Recall**).

Initiating internal consultation call, conference call

You are talking to an **external** participant (via fixed line network or VoIP) and can call an **internal** participant at the same time to hold a consultation call.



Open the list of handsets.
The external participant hears hold music if activated
(→ [Page 163](#)).



Select handset and press **OK**.

When an internal participant answers you can speak to them.

You have the following options:

Ending the consultation call



Press the display key.



You are reconnected with the external subscriber.

Initiating a conference call



Press the display key.

You are in a three-way conference call with the external participant and the internal participant.

If the internal participant who has been called ends the call (press end call key ) , you will be connected with the external participant. If you press end call key  , the external call will be transferred to the internal subscriber.

Accepting/rejecting call waiting during an internal call

If you receive an **external** call during an **internal** call, you will hear the call waiting tone (short tone). With Calling Line Identification, the caller's number will appear in the display.

Ending an internal call, accepting an external call

Accept Press the display key.

The internal call is **ended**. You are connected to the external caller.

Rejecting the external call

Reject Press the display key.

The call waiting tone is turned off. You remain connected with the internal participant. The ringer can still be heard on other registered handsets.

Using a handset as a room monitor

If the room monitor is activated, a previously stored destination number is called as soon as a set noise level is reached in the room.

You can save an internal or external number in your handset as the destination number.

The room monitor call to an external number is terminated after approximately 90 seconds. The room monitor call to an internal number (handset) stops after approx. 3 minutes (depending on the base station). During use as a room monitor, all keys are barred except for the end call key . The handset's loud-speaker is muted.

When the room monitor is activated, incoming calls to the handset are indicated **without a ringer** and are only shown on the screen. The display and keypad are not illuminated and advisory tones are also turned off.



If you accept an incoming call, the room monitor is suspended for the duration of the call, but the function **remains** activated.

If you deactivate then reactivate the handset, the room monitor remains activated.

Warning

- ◆ **You should always check the operation of the room monitor before use. For example, test its sensitivity. Check the connection if you are diverting the room monitor to an external number.**
 - ◆ When the function is switched on, the handset's operating time is considerably reduced. If necessary, place the handset in the charging cradle. This ensures that the batteries do not run down.
 - ◆ Ideally the handset should be positioned 1 to 2 metres away from the baby. The microphone must be directed towards the baby.
 - ◆ The connection to which the room monitor is diverted must not be blocked by an activated answering machine.
-

Activating the room monitor and entering the destination number

 →  → Room Monitor

▶ Change multiple line input:

Room M.





Select On to activate.

Call to

External number:

- ▶ Select the number from the directory (press display key ) or enter it manually. Only **the last 4 characters** are displayed.

Internal number:

- ▶ Press the display key  **Options**.
Select INT and press  **OK**.
- ▶ Use  to select the handset or Call All (if all registered handsets are to be called) and press  **OK**.

Level

Set noise level sensitivity (Low or High).

- ▶ Press the display key **Save** to save the changes.

The function is now activated.

You can use the **Options** display key to switch directly to the baby alarm settings.

Please note

- ◆ If you do not specify a line suffix (→ [Page 46](#)) and you do not define any dialling plans for the number (→ [Page 204](#)), an external number will be dialled via the set default line (VoIP or fixed line network).
 - ◆ The room monitor remains activated on the handset even it is switched off and on again.
-

Changing the set destination number

 →  → Room Monitor



 Scroll to the Call to line.

 Delete existing number.

- ▶ Enter number as described in "[Activating the room monitor and entering the destination number](#)" (→ [Page 144](#)).

Deactivating the room monitor remotely

Preconditions: The room monitor call is diverted to an external destination number. The telephone called supports tone dialling.

- ▶ Accept the call from the room monitor and press keys  .

Your base station sends a confirmation tone and ends the connection.

Please note

Remote deactivation via VoIP connections is possible as long as the DTMF signals are transmitted (depending on the provider) either as SIP info messages, audible signals in the voice channel (inband or audio) or as special RTP data packets (pursuant to RFC2833).

The room monitor function is deactivated on the handset. There will be no further room monitor calls. The other room monitor settings (e.g. no ringer) on the handset will remain activated until you press the display key **OFF** on the handset.

To reactivate the room monitor function with the same phone number:

- ▶ Turn on the activation again and save with **Save** (→ [Page 144](#)).

Gigaset S68H handset: using Bluetooth devices

Your Gigaset S68H handset can communicate wirelessly via Bluetooth™ with other devices using this technology.

Before you can use your Bluetooth devices, you must first activate Bluetooth and then register the devices to the handset.

You can register 1 Bluetooth headset to the handset. You can also register up to 5 data devices (PC, PDA) to send and receive directory entries as vCards or exchange data with the computer (→ [Page 238](#)).



In order to transfer phone numbers via Bluetooth, it is essential that area codes (international and local area codes) are saved on the phone (→ [Page 160](#)).

You will find a description of how to operate your Bluetooth devices in the user guides for these devices.

— Please note —

- ◆ You can only operate headsets on your handset that have the **headset profile**.
 - ◆ It can take up to 5 seconds to establish a connection between your handset and a Bluetooth headset. This applies both when a call is accepted using the headset or transferred to the headset, and when a number is dialled from the headset.
-

Activating/deactivating Bluetooth mode

 →  → Data Transfer → Bluetooth → Activation

Press **OK** to activate or deactivate Bluetooth mode ( = activated).

In idle status, the  icon on the handset shows that Bluetooth mode is activated:

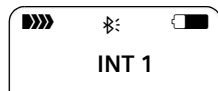

Registering Bluetooth devices

The distance between the handset in Bluetooth mode and the activated Bluetooth device (headset or data device) should be no more than 10 m.

Please note

- ◆ If you register a headset, any headset that is already registered will be overwritten.
- ◆ If you register a headset to your handset that is already registered to another device (e.g. to a mobile phone), the existing registration data may be overwritten by the new registration.

If you would like to operate a headset on both the mobile phone and on your handset, you should use a headset that supports several terminals.

 →  → Data Transfer → Bluetooth → Search Headset / Search Data Device

The search can take up to 30 seconds.

Once the device has been found, its name will be shown on the display.

Options Press the display key.

Trust Device Select and press **OK**.



Enter the PIN for the Bluetooth device you want to **register** and press **OK**.

The device is saved in the list of known devices.

Cancelling/repeating current search

To cancel search:

Cancel Press the display key.

Repeat search if necessary:

Options Select and press **OK**.

Repeat Search



Select and press **OK**.

Editing the list of known (trusted) devices

Opening the list

 →  → Data Transfer → Bluetooth → Trusted Devices

A corresponding icon appears next to each device name in the list displayed:

Icon	Meaning
	Bluetooth headset
	Bluetooth data device

Viewing entries

Open list →  (select entry)

Options Press the display key.

View Entry Select and press **OK**.
Device name and address are displayed.
Go back with **OK**.

De-registering Bluetooth devices

Open list →  (select entry)

Options Press the display key.

Delete Entry Select and press **OK**.

 Back: Press and **hold** key.

Please note

If you de-register an activated Bluetooth device, it may try to reconnect as an "unregistered device".

If you are using a headset and you complete the registration process by entering the PIN, the headset is saved in the device list as a data device and not as a headset. Therefore, initiate a new registration by searching for a headset.

Changing the name of a Bluetooth device

Open list →  (select entry)

Options Press the display key.

Rename Select and press **OK**.

 Change the name.

Save Press the display key.

 Back: Press and **hold** key.

Rejecting/accepting an unregistered Bluetooth device

If a Bluetooth device that is not registered in the list of known devices tries to connect with the handset, you will be prompted on the display to enter the PIN for the Bluetooth device (bonding).

◆ Reject

 Press the display key.

◆ Accept



Enter the PIN for the Bluetooth device you want to **accept** and press **OK**.

If you have accepted the device, you can use it temporarily (i.e. as long as it is within receiving range or until you deactivate the handset) or save it to the list of known devices.

Once the PIN has been confirmed, save to the list of known devices:

- Press display key **Yes**.
- Press display key **No**: use temporarily.

Changing the Bluetooth name of the handset

You can change the name of your handset used to identify it on the display of other Bluetooth devices.



 Press the display key.



Change the name.

 Press the display key.



Back: Press and **hold** key.

Handset settings

Your handset is preconfigured, but you can change the settings to suit your individual requirements.

Changing the display language

You can view the display texts in different languages.

 →  → Handset → Language

The current language is indicated by .

 Select a language and press **OK**.

 Press and **hold** (idle status).

If you accidentally choose a language you do not understand:

 **8** tuv **4** ght **1** aa

Press keys in sequence.

 Select the correct language and press **OK**.

— Parts of the menu are not displayed in the language selected ...

... and three or more handsets are registered on your base station. A language that is not one of the standard languages for the base station (= English, French, German, Italian, Spanish, Portuguese and Dutch) is set on at least three handsets.



Cause: Some display texts are only stored for the standard languages English, French, German, Italian, Spanish, Portuguese and Dutch on your base station. In addition, these display texts can be stored in the base station in two other languages or in another language for two different types of Gigaset handsets. When selecting the language on the handset, these texts are downloaded to the base station from the Internet. If another non-standard language is set on a third handset, then display texts appear in one of the standard languages on this handset.

The two non-standard languages registered to the handsets with the lowest internal numbers are saved on the base station.

If there is no further handset registered on the base station whose type and language setting correspond to an additionally loaded language, then the memory is freed up. If necessary, the language set for another registered handset is loaded onto the base station.

Setting the display

You have a choice of four colour schemes and several different contrasts.

 →  → Display

Colour Scheme

Select and press **OK**.



Select a colour scheme and press **OK** ( = current colour).



Press **briefly**.



Scroll to the Contrast line.

Contrast

Select and press **OK**.



Select contrast.

Save

Press the display key.



Press and **hold** (idle status).

Setting the screensaver

You can set a picture from the Resource Dir. (→ [Page 158](#)) to be displayed as a screensaver when the handset is in idle status. This will replace the idle status display. It may conceal the date, time and name.

The screensaver is not displayed in certain situations, e.g. during a call or if the handset is de-registered.

If a screensaver is activated, the Screen Saver menu option is marked with .

 →  → Display → Screen Saver

The current setting is displayed.

▶ Change multiple line input:

Activation

Select On (screensaver is displayed) or Off (no screensaver).

Selection:

If required, change the screensaver (see below).

▶ Press the display key **Save** to save the changes.

If the screensaver conceals the display, **briefly** press  to show the idle display with time and date.

Changing the screensaver

 →  → Display → Screen Saver



Scroll to the Selection line.

View

Press the display key. The active screensaver is displayed.



Select screensaver and press **Change**.

▶ Press the display key **Save** to save the changes.

Please note

- ◆ You have set the screensaver on your handset to **Clock** and have activated the display of info services via the Web configurator (→ [Page 214](#)), the display backlight in idle status is deactivated (→ [Setting the display backlight](#), → [Page 152](#)):

If the backlight is off and you want to make a call or change settings on the handset, you must repeat the first key press (e.g. press the control key  twice on the right to open the main menu). The first key press switches on the backlight; the info services text information is displayed.

- ◆ The screensaver is not displayed in certain situations, e.g. during a call or if the handset is de-registered.
-

Setting the display backlight

Depending on whether or not the handset is in the charging cradle, you can activate or deactivate the display backlight in idle status.

Regardless of the setting that you have made, the display lights up with full intensity after you have pressed a key on the handset or when the handset signals a call, appointment or anniversary or carries out a wake-up call.

If you do not make any further entries or there is no signalling, the backlight is dimmed after approx. 15 seconds (including during a call). If the handset is in room monitor mode, the backlight switches off after 15 seconds.

- ◆ If you have switched the display backlight on, the display is permanently dimmed in idle status.
- ◆ If you have switched the display backlight off, the display remains dimmed for 45 seconds before switching off.

Activating/deactivating the display backlight in idle status

 →  → **Display** → **Lighting**

The current setting is displayed.

- ▶ Change multiple line input:

In Charger

Select On or Off.

Outside Charger

Select On or Off.

Save Press the display key.

 Press and **hold** (idle status).

Please note

The handset's standby time can be significantly reduced if the display backlight (On) is activated.

Quick access to functions and numbers

You can assign the left display key and each of the digit keys **[0+]** and **[2-abc]** to **[9 wxyz]** to number or a function. The right display key has a function pre-selected by default. You can change the assignment.

The number is then dialled or the function started by simply pressing a key.

Assigning a digit key/left display key

Precondition: The digit key or the left display key has not yet been assigned a number or a function.

- ▶ Press the display key **[?]** or press and **hold** the digit key.

The list of possible key assignments is opened (see below).

- ▶ Select the function with the control key **[↕]** and press **OK**. The handset returns to idle status.

The following features are available:

Quick Dial / Call-by-Call

Assign key to a number from the directory or call-by-call list.

The directory or call-by-call list is opened.

- ▶ Select an entry and press **OK**.

If you delete or edit an entry in the directory or call-by-call list, this has no effect on the assignment to the digit/display key.

- ◆ **INT (INT)**
Opens the list of internal participants.
- ◆ **SMS (SMS)**
Opens the SMS submenu for writing, sending and reading SMS messages (→ [Page 85](#)):
✉ → SMS
- ◆ **SMS Service (SMS Info)**
Opens the menu for ordering an info service (→ [Page 95](#)):
✉ → SMS → SMS Service
- ◆ **Room Monitor (Room M.)**
Assign menu for setting and activating the room monitor to a key (→ [Page 144](#)).
- ◆ **Alarm Clock (Alarm)**
Assign menu for setting and activating the alarm clock to a key (→ [Page 137](#)).
- ◆ **Calendar (Calendar)**
Opens the calendar to enter new or view saved appointments: **[1]**
- ◆ **Withhold No. (Withhold)**
If you press the display key **Withhold**, your phone number will not be transmitted for the next call and will therefore not appear in the recipient's display.
If you press the display key **Withhold**, a number editor will be opened. Enter the phone number and press the display key **Send**.

The number is always dialled via the fixed line network. This function does not support dialling with a line suffix.

◆ **Bluetooth** (Bluetooth)

(Gigaset S68H only)

Assign the Bluetooth menu to a key:

 →  → Data Transfer → Bluetooth

◆ **E-mail** (EMail)

Opens the e-mail submenu for receiving and reading e-mail notifications (→ [Page 98](#)):

 → E-mail

◆ **Messenger** (Messgr.)

Opens the messenger submenu for chatting with friends on the Internet (→ [Page 102](#)):

 → Messenger

◆ **Fixed Line Call** (Fxd.Ln.)

Opens the pre-dialling option for making a call via the fixed line network.

◆ **IP Call** (IP)

Opens the pre-dialling option for making a call via VoIP.

If the display keys have been assigned a shortcut, the selected function or name of the phone number in the directory or call-by-call list is displayed (abbreviated if necessary) in the bottom display line via the relevant display key.

Starting the function, dialling the number

If the handset is in idle status, press and **hold** the digit key or press the display key **briefly**.

Depending on the key assignment:

- ◆ Numbers are dialled directly.
- ◆ The function menu is opened.

Changing key assignments

Display key

- ▶ Press and **hold** the left or right display key.

The list of possible key assignments is opened.

- ▶ Proceed as described when first assigning the key (→ [Page 153](#)).

Digit key



- ▶ Press the digit key **briefly**.

Change Press the display key. The list of possible key assignments is displayed.

- ▶ Proceed as described when first assigning the key (→ [Page 153](#)).

Activating/deactivating auto answer

If you activate this function, when you receive a call you can simply lift the handset out of the charging cradle without having to press the talk key .

 →  → Handset

Auto Answer

Select and press **OK** ( = on).



Press and **hold** (idle status).

Changing the speaker/earpiece volume

You can set the volume for the speaker to five different levels and the earpiece volume to three different levels.

When the handset is in idle status:



Press the control key at the top.

Handset Volume

Select and press **OK**.



Set the earpiece volume.



Scroll to the Handsfree Volume line.



Set the speaker volume.

Save

Press the display key if necessary to save the setting permanently.

Setting the volume during a call:



Press the control key.



Select volume.

Save

Press the display key if necessary to save the setting permanently.

The setting is automatically saved after approx. 3 seconds.

If  is assigned to another function, e.g. call swapping:

Options

Open menu.

Volume

Select and press **OK**.



Configure setting (see above).

— Please note —

You can also adjust the call volume via menu

 →  → Audio Settings → Handset Volume.

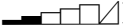
Changing ringers

- ◆ Volume:
You can choose between five volumes (1–5; e.g. volume 2 = ) and the "crescendo" ring (6; volume increases with each ring = ).
- ◆ Ringers:
You can select various ringers, melodies or any sound from the resource directory (→ [Page 158](#)).

You can set different ringers for the following functions:

- ◆ Ext. Calls: for external calls
- ◆ Internal Calls: for internal calls
- ◆ Appointments: for set appointments (→ [Page 134](#))
- ◆ All: the same ringer for all functions

Settings for individual functions

Set the volume and melody depending on the type of signalling required.

When the handset is in idle status:

 Press the control key at the top.

Ringer Settings

Select and press **OK**.

Ext. Calls / Internal Calls / Appointments

Select and press **OK**.

▶ Change multiple line input:

 Set volume (1–6).

 Scroll to the next line.

 Select ringer.

Save Press the display key to save the setting.

Same ringer for all functions

When the handset is in idle status:

 → Ringer Settings → All

▶ Set volume and ringer (see "[Settings for individual functions](#)").

Save Press the display key to confirm the prompt.

 Press and **hold** (idle status).

— Please note —

You can also adjust the ringers via the menu

 →  → Audio Settings → Ringer Settings.

Activating/deactivating the ringer

You can deactivate the ringer on your handset before you answer a call or when the handset is in idle status; the ringer can be deactivated permanently or just for the current call. The ringer cannot be re-activated while an external call is in progress.

Deactivating the ringer permanently



Press and **hold** the star key.

The  icon appears in the display.

Reactivating the ringer



Press and **hold** the star key.

Deactivating the ringer for the current call



Press the display key.

Activating/deactivating the alert tone

In place of the ringer you can activate an alert tone. When you get a call, you will hear a **short tone** ("Beep") instead of the ringer.



Press and **hold** the star key and **within 3 seconds**:



Press the display key. A call will now be signalled by **one** short alert tone.  appears in the display.

Activating/deactivating advisory tones

Your handset uses advisory tones to tell you about different activities and statuses. The following advisory tones can be activated/deactivated independently of each other:

- ◆ **Key tones:** every key press is confirmed.
- ◆ **Acknowledge tones:**
 - **Confirmation tone** (ascending tone sequence): at the end of an entry/setting and when an SMS or a new entry arrives in the calls list or answering machine list.
 - **Error tone** (descending tone sequence): when you make an incorrect entry
 - **Menu end tone:** when scrolling to the end of a menu
- ◆ **Battery tone:** the batteries need to be charged.

When the handset is in idle status:



Press the control key at the top.

Advisory Tones

Select and press **OK**.

Handset settings

- ▶ Change multiple line input:

Key Tones

Select On or Off.

Confirm.

Select On or Off.

Battery

Select On, Off or In Call. The battery warning tone is only activated/deactivated and only sounds during a call.

- ▶ Press the display key **Save** to save the changes.

You cannot deactivate the confirmation tone for placing the handset in the charging cradle.

— Please note —





You can also adjust the advisory tones via the menu

 →  → Audio Settings → Advisory Tones.

Resource directory

The resource directory on the handset manages sounds, which you can use as ringers, and pictures, which you can use as caller pictures or as screensavers. Precondition: Calling Line Identification (CLIP).



The resource directory can manage the following media types:

Icon	Sound	Format
	Ringers	Standard
	Monophonic	Standard
	Polyphonic	.mid
	Picture: Caller picture Screensaver	BMP 128 x 128 px or 128 x 66 px (px = pixels)

The icon is displayed in front of the name in the resource directory. Various mono and polyphonic sounds and pictures are preconfigured on your handset. You can listen to the available sounds and view the pictures. You can download your own pictures from a PC to the Gigaset S68H handset using Bluetooth connections and save them in the resource directory (→ [Page 241](#)).

The pre-configured pictures are labelled with . You cannot rename or delete them.

Playing back sounds/viewing caller pictures

 →  → Screensavers / Caller Pictures / Sounds (select entry)

Play / View Press the display key. Sounds are played back or pictures are displayed. Press the  key to switch between entries.

End /  Press the display key. Playback of the sound or display of the picture ends.

While you are playing back sounds, you can also interrupt playback with the  key.



Press and **hold** (idle status).

If you have saved a picture in an invalid data format, you will see an error message after selecting the entry. Cancel the operation with . Delete the picture with **Delete**.

Sounds: Setting the volume

During playback:

Volume Press the display key.



Set volume.

Save Press the display key.

Renaming/deleting a picture

You have selected an entry.

Options Open menu.

If a picture cannot be deleted () , these options are not available. Depending on the situation, you can select the following functions:

Delete Entry

The selected entry is deleted.

Delete List



All entries in the list that can be deleted are deleted.

Rename

Change the name (max. 16 characters) and press **Save**. The entry is stored with the new name.

Gigaset S68H: Checking the memory

You can check how much memory is available for screensavers and caller pictures.

 →  → Capacity



Back: Press the display key.

Setting your own area code

In order to transfer phone numbers via Bluetooth connections to the phone (Gigaset S68H handset) and to correctly manage entries in your directory, it is essential that your area code (international and local area code) is saved on the phone.

If necessary, these numbers are already preset.

 →  → Handset → Area Codes

Check that the (pre)set area code is correct.

▶ Change multiple line input:

 Select/change input field.

 Navigate in the input field.

 Delete number if necessary:
Press the display key.

 Enter number.

 Press the display key.

Example:

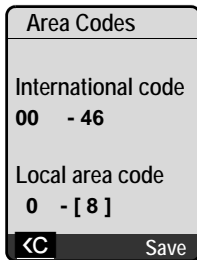

Please note



For how to enter your own area code using the Web configurator,
→ [Page 203](#).

Restoring the handset default settings

Each individual handset setting is reset, in particular the language, display, volume, ringers and alarm clock settings (→ from [Page 150](#)). The redial list is cleared.

Entries in the directory, the call-by-call list, the calls list, the SMS lists and the handset's registration to the base station as well as the content of the resource directory are retained.

 →  → Handset → Reset Handset

 Press the display key.
You can cancel the factory reset by pressing  or the display key .

 Press and **hold** (idle status).

Setting the base station via the handset

The base station settings are carried out using a registered Gigaset S68H handset.

Protecting against unauthorised access

Protect the system settings of the base station with a PIN known only to yourself. You have to enter the system PIN if, among other things, you register and de-register a handset, change VoIP settings or reset the phone to factory settings.

Changing the system PIN

You have to enter the system pin when, for example, you register a handset with the base station, change VoIP settings or start the Web configurator.

You can change the base station's 4-digit default system PIN ("0000") to a 4-digit system PIN known only to yourself.

 →  → Base → System PIN



Enter the current system PIN and press **OK**.



Enter new system PIN.



Scroll to the Re-enter PIN line.



Now re-enter the new system PIN and press **OK**.

For security reasons, "****" is displayed instead of the system PIN.



Press and **hold** (idle status).

Resetting the system PIN

If you have forgotten your system PIN, you can reset the base station to the original PIN **0000**. To do this, you must reset your base station using the key on the base station (→ [Resetting the base station using a key on the base station](#) on [Page 163](#)).

Please note that this will restore all other base station settings too (→ [Page 163](#)).

Restoring the base station to the factory settings

Resetting the base station via the menu

Each individual setting is reset, in particular:

- ◆ VoIP settings such as VoIP provider and account data and DTMF settings (→ [Page 166](#), [Page 184](#), [Page 208](#))
- ◆ Settings for the local network (→ [Page 168](#), [Page 181](#))
- ◆ Default line (→ [Page 164](#))
- ◆ The names of the handsets (→ [Page 141](#))
- ◆ SMS settings (e.g. SMS centres, → [Page 83](#))
- ◆ Eco Mode is deactivated (→ [Page 133](#))
- ◆ Settings for the connection to the PABX (→ [Page 171](#))
- ◆ Answering machine settings (→ [Page 125](#)), and own announcements are deleted

The following lists are deleted:

- ◆ SMS lists
- ◆ Calls list
- ◆ Answering machine lists

The following are **not** reset:

- ◆ Date and time
- ◆ System PIN
- ◆ SMS info services

The handsets are still registered.

 →  → Base → Base Reset



Enter the system PIN and press **OK**.

Yes

Press the display key to confirm.

Resetting the base station using a key on the base station

As with resetting the base station via the menu, all individual settings are reset. The **system PIN** will also be reset to "0000" and **all handsets** registered above and beyond the scope of delivery **will be de-registered**.

— Please note —

For how to reregister the handsets after resetting, where applicable,
→ [Page 138](#).

- ▶ Remove the cable connections from the base station to the router (→ [Page 21](#)) and fixed line network (→ [Page 20](#)).
- ▶ Remove the base station mains adapter from the socket (→ [Page 20](#)).
- ▶ **Press and hold** the registration/paging key (→ [Page 2](#)).
- ▶ Plug the mains adapter back into the power socket.
- ▶ Continue to press and hold the registration/paging key (at least 2 sec.).
- ▶ Release the registration/paging key. The base station has now been reset.

Activating/deactivating music on hold

 →  → Base

Music on hold

Select and press **OK** to activate or deactivate music on hold ( = on).

Activating/deactivating repeater mode

With a repeater you can increase the range and reception strength of your base station. You will need to activate repeater mode. This will terminate any calls being made via the base station at that time.

Preconditions:

- ◆ A repeater is registered with the base station.
- ◆ **Eco Mode** is switched off (→ [Page 133](#)).

 →  → Base → Add. Features

Repeater Mode

Select and press **OK** ( = on).

Yes Press the display key to confirm the security prompt.

— Please note —

Repeater support and Eco Mode (→ [Page 133](#)) cancel each other out, i.e. both functions cannot be used at the same time.

Setting default line

You can adjust the settings according to whether you want to make calls via VoIP or the fixed line network by default.

— Please note —



The default line is only relevant when dialling numbers that are not subject to dialling plans (→ [Page 204](#)) and are entered without a line suffix (→ [Page 46](#)).

 →  → Telephony → Default Line

VoIP / Fixed Line

Select and press **OK** ( = on).

When making calls:

- ▶ Press the talk key  **briefly** if you want to make the call via the default line.
- ▶ Press and **hold** the talk key  if you want to make the call via the other line type.

 For how to make the setting on the Web configurator, → [Page 199](#).

Updating the base station firmware

If necessary, you can update your base station firmware.

The firmware update is downloaded directly from the Internet by default. The relevant Web page is preconfigured in your phone.

Precondition:

The base station is in idle status, i.e.:

- ◆ No calls are being made via the fixed line network or VoIP.
- ◆ There is no internal connection between registered handsets or to GHC devices.
- ◆ No other handset has opened the base station menu.

Starting the firmware update manually

 →  → Base

Firmware Update

Select and press **OK**.



Enter the system PIN and press **OK**.

The base station establishes a connection to the Internet or to the local PC.

Yes

Press the display key to start the firmware update.

— Please note —

- ◆ The firmware update can last up to 3 minutes.
- ◆ When updating from the Internet, checks are made to ensure that no newer version of the firmware exists. If this is not the case, the operation is terminated and a message is issued to that effect.

Automatic firmware update

Your phone will check daily whether a newer firmware update is available via the Internet on the Gigaset configuration server. If this is the case, the message *New firmware available* is displayed when the handset is in idle status and the message key  flashes.



Press the message key.



Press the display key to confirm the prompt.

The firmware will be loaded onto your phone.

If you respond to the prompt with **No**, the handset changes to idle status. Your phone will then remind you at a later date about the firmware update (*New firmware available* will be displayed). You can also carry out the firmware update manually (→ [Page 164](#)).

Please note

If the telephone is not connected to the Internet at the time when the check for new firmware is to be carried out (e.g. because the router is deactivated), the check is carried out as soon as the phone is reconnected to the Internet.



You can deactivate the automatic version check via the Web configurator (→ [Page 221](#)).

Making VoIP settings

In order to be able to use VoIP, you must set a few parameters for your phone. You can make the following settings using your handset.

- ◆ Download the general access data for your VoIP provider from the Gigaset configuration server and store them on your phone.
- ◆ Enter your personal access data for your first VoIP account (first VoIP phone number). You can configure the access data for five further VoIP accounts via the phone's Web configurator.
- ◆ Set the phone's IP address in the LAN.

The connection assistant on your phone can help you make the settings.

-  You can set these and other parameters conveniently via the Web configurator on a PC connected to your local network (→ [Page 184](#)).

Using the connection assistant

The connection assistant starts automatically when you set the handset and base station up for the first time, or when you try to connect to the Internet before making the necessary settings.

You can also start the connection assistant via the menu:

 →  → Telephony

Connection Assist.

Select and press **OK**.



Enter the system PIN and press **OK**.

For how to enter VoIP settings using the connection assistant, → [Page 22](#).

Changing settings without the connection assistant

You can change your provider's VoIP settings and the VoIP user data via the menu without starting the connection assistant.

Downloading your VoIP provider's settings

The general settings for various VoIP providers are available to download on the Internet. The relevant Web page is preconfigured in your phone.

Precondition: Your phone is connected to the Internet.

 →  → Telephony → VoIP



Enter the system PIN and press **OK**.

Select Provider

Select and press **OK**.

The phone establishes a connection to the Internet.



Select country and press **OK**.



Select your VoIP provider and press **OK**.

Your VoIP provider data is downloaded and saved in your phone.

If only one provider is available, the countries and providers lists are not displayed. Only the name of this provider will then appear in the display. To start the download, confirm with **OK**.

-  If your VoIP provider is not included in the list, you need to enter or adjust the general VoIP settings manually via your phone's Web configurator, → [Page 186](#).

— Please note —

If an error occurs during the download, an error message will be displayed. You can find possible messages and measures in the table on [Page 225](#).

Automatic update for the VoIP provider settings

After the first download of the VoIP provider settings, your phone will check daily whether a newer version of the file for your VoIP provider is available via the Internet on the Gigaset configuration server. If this is the case, the message **New profile available** will be displayed when the handset is in idle status, and the message key  flashes.



Press the message key.



Press the display key to confirm the prompt.



Enter the system PIN and press **OK**.

The new data for your VoIP provider will be downloaded and saved on the phone.

If you answer the prompt with **No**, the handset returns to idle status. Your phone will remind you again later about the new profile (**New profile available** will be displayed again).

Entering/changing VoIP user data

You must complete the VoIP settings with your personal data. You will receive all necessary data from your VoIP provider.

— Please note —

When making these entries, please remember the VoIP user data is case sensitive. To enter text → [Page 238](#).



→  → Telephony → VoIP (enter system PIN) → Provider Registr.

- ▶ Change multiple line input:

Username:

Enter the user name (caller ID) for your VoIP provider account. Username is often identical to your Internet telephone number (the first part of your SIP address, → [Page 189](#)).

Authent. Name : / Authent. Password:

Enter the provider-dependent access data that has to be transferred by the phone to the SIP service at registration.

- ▶ Click **Save** to save the settings.

— Please note —

A previously set password is not displayed.

Setting the phone's IP address in LAN

The base station requires an IP address in order to be "recognised" by the LAN. The IP address can be assigned to the base station automatically (by the router) or manually.

- ◆ If performed **dynamically**, the router's DHCP server automatically assigns the base station an IP address. The base station's IP address can be changed according to router settings.
- ◆ If performed manually/**statically**, you assign the base station a static IP address. This may be necessary depending on your network configuration.

 For how to make the local network settings on the Web configurator, turn to [Page 181](#).

— Please note —

To assign the IP address dynamically, the DHCP server on the router must be activated. Please also read the user guide for your router.

 →  → Base → Local Network

 Enter the system PIN and press **OK**.

▶ Change multiple line input:

IP Address Type:

Select Static or Dynamic.

If you select *Static*, you must manually define the IP address and the subnet mask for the base station in the next lines, as well as the standard gateway and DNS server.

IP Address:

For IP Address Type = *Dynamic*:

The IP address that is currently assigned to the base station will be displayed. It cannot be amended.

For IP Address Type = *Static*:

Enter the IP address that is to be assigned to the base station (overwriting the current settings).

192.168.2.2 has been preset.

For information on the IP address, please see [Page 181](#) and the glossary on [Page 260](#).

Subnet Mask:

For IP Address Type = Dynamic:

The subnet mask that is currently assigned to the base station will be displayed. It cannot be amended.

For IP Address Type = Static:

Enter the subnet mask to be assigned to the base station (overwriting the current settings).

The default setting is 255.255.255.0

For information on the IP address, please see [Page 265](#) and the glossary on [Page 265](#).

DNS Server:

For IP Address Type = Static:

Enter the IP address for the preferred DNS server. The DNS server (Domain Name System) converts the symbolic name of a server (DNS name) into the public IP address for the server when the connection is made.

You can specify your router's IP address here. The router forwards phone address requests to its DNS server.

192.168.2.1 has been preset.

Default Gateway:

For IP Address Type = Static:

Enter the IP address for the standard gateway, by means of which the local network is connected to the Internet. This is generally the local (private) IP address for your router (e.g. 192.168.2.1). Your phone requires this information to be able to access the Internet.

192.168.2.1 has been preset.

- ▶ Click **Save** to save the settings.

Activating/deactivating the display of VoIP status messages

If the function is activated, a VoIP status code for your service provider is displayed.

Activate the function if, for example, you have problems with VoIP connections. You will receive a provider-specific status code, which supports the service when the problem is analysed. You will find a table with the possible status screens in the appendix (→ [Page 230](#)).

 →  → Telephony → VoIP

 Enter the system PIN and press **OK**.

Show Stat. on HS

Select and press **OK** ( = on).

 For how to make the setting on the Web configurator, → [Page 223](#).

Checking the base station MAC address

Depending on your network configuration, you may have to enter your base station MAC address, for example, into your router's access control list. You can check your base station MAC address:

The base station MAC address is displayed.

 Press and **hold** (idle status).



 For information on how to check your MAC address on the Web configurator, → [Page 223](#).

Operating the base station on the PABX

The following settings are only necessary when your PABX requires them; see the PABX user guide. The settings only concern fixed line network connections. You cannot send or receive SMS messages on PABXs that do not support Calling Line Identification.

Setting recall

You can set the recall option.

 →  → Telephony → Fixed Line → Recall

 Select recall and press **OK**.

The current setting is indicated by .

 Press and **hold** (idle status).

Setting the access code (outside line code)

Depending on your PABX, you must dial an access code before making external calls in order to obtain an external line. You can save this access code in your phone. For example, the access code is then automatically placed before the numbers selected from the call list.

 →  → Base → Add. Features

Access Code

 Select and press **OK**.

 Enter or change the access code (maximum three digits) and press **OK**.

 Press and **hold** (idle status).

If an access code is set, the following applies:

- ◆ The access code is added automatically when dialling from the Calls list and when dialling emergency numbers and SMS centre numbers.
- ◆ When dialling numbers manually and from the directory you must add the access code yourself.

Setting pauses

Changing pause after line seizure

You can set the length of the pause inserted between pressing the talk key  and sending the phone number.

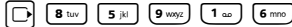

Enter a number for the length of the pause (1 = 1 sec.; 2 = 3 sec.; 3 = 7 sec.) and press **OK**.

Changing the pause after the recall key and access code

You can change the length of the pause if your PABX requires this (→ refer to the user guide for your PABX).



Enter a number for the length of the pause (1 = 1 sec.; 2 = 2 sec.; 3 = 3 sec.; 4 = 6 sec.) and press **OK**.

Switching temporarily to tone dialling (DTMF)

If your PABX still operates with dial pulsing (DP), but you need tone dialling for a connection (e.g. to listen to the network mailbox for your fixed line network connection), you must switch to tone dialling for the call.

Precondition: You are currently conducting an external call via the fixed line network or you have dialled an external fixed line network number or an external call is signalled.

Options Open menu.

Tone Dialling

Select and press **OK**.

Tone dialling is now activated **for this call only**.

Web configurator – setting the phone using a PC

The Web configurator is the Web interface for your phone. It allows you to select the settings for your phone's base station via your PC's Web browser.

The Web configurator on your phone provides you with the following options:

- ◆ Configure your phone access to the local network (IP address, gateway to the Internet).
- ◆ Configure your phone for VoIP. Assign up to six VoIP phone numbers to your telephone.
- ◆ Load new firmware onto the phone if necessary.
- ◆ Use Internet services: Enable access to an online directory, display text information on the handset (info services).
- ◆ Synchronise the telephone's date/time with a time server on the Internet.
- ◆ Copy contacts from the Outlook address book on your PC into the handset directories or back up your handsets' directories on your PC.
- ◆ Manage the names and internal numbers of registered handsets and your local directories
- ◆ Obtain information about your phone's status (firmware version, MAC address etc.).

Preconditions:

- ◆ A standard Web browser is installed on the PC, e.g. Internet Explorer version 6.0 or higher, or Firefox version 1.0.4 or higher.
- ◆ The phone and PC are connected with each other via a router.

Please note

- ◆ Depending on your VoIP provider, it is possible that you will be unable to change individual settings in the Web configurator.
 - ◆ The phone is **not** blocked while you select your settings in the Web configurator. You can also use your phone to make calls or change base station or handset settings on your handset at the same time.
 - ◆ While you are connected to the Web configurator, it is blocked to other users. It cannot be accessed by more than one user at any time.
-

Connecting the PC with the telephone's Web configurator

Precondition: The settings of an available firewall installed on your PC allow the PC and phone to communicate with each other.

There are two ways of connecting your PC to the base station Web configurator:

- ◆ via the (local) IP address of the base station
- ◆ via Gigaset config

Establishing a connection via the IP address:

- ▶ Establish the telephone's current IP address on the handset:

You can see the phone's current IP address in the handset display by **briefly** pressing the registration/paging key on the base station.

Your phone's IP address can change if you have activated dynamic IP address assignment (→ [Page 181](#)).

Warning

If one of the four parts of the IP address contains leading zeros (e.g. 002), these zeros must not be entered in the Web browser address field. Otherwise the Web browser will not be able to establish a connection to the Web configurator.

Example: The IP address 192.168.002.002 is displayed on the handset. 192.168.2.2 should be entered in the address field.

- ▶ Launch the Web browser on your PC.
- ▶ Enter **http://** and the telephone's current IP address (for example: `http://192.168.2.2`) into the address field of the Web browser.
- ▶ Press the return key.

A connection is established to the phone's Web configurator.

Establish a connection via Gigaset config:

Precondition: The router is connected to the Internet and your PC can access the Internet via the router.

- ▶ Launch the Web browser on your PC.
- ▶ Enter one of the following URLs into the Web browser's address field:
<http://www.gigaset-config.com>.
<http://www.gigaset-device.com>.
- ▶ Press the return key.

You will receive a message stating that the connection will be forwarded to your base station.

If several Gigaset VoIP phones can be reached via your Internet connection, you will be asked to which one of these phones you would like to be connected.

After successfully forwarding the connection, the **Login Web** page of the Web configurator will be displayed in the Web browser.

Please note

The connection between the PC and the Web configurator is a local connection (LAN connection). The Internet is only accessed to establish the connection.

Logging in, setting the Web configurator language

Once you have successfully established the connection, the Login Web page will be displayed in the Web browser.

You can select the language you want the menus and Web configurator dialogues to be displayed in. The language that is currently selected is displayed in the top field of the Web page.

- ▶ If necessary, click  to open the list of available languages.
- ▶ Select the language.
- ▶ Enter your phone's system PIN (default setting: 0000) in the bottom field of the Web page, to access the Web configurator functions.
- ▶ Select OK.

Once you have successfully logged in, a Home screen opens with general information on the Web configurator.

If you enter an incorrect system PIN, a corresponding message will be displayed. You will be prompted to re-enter the PIN.

If you enter an incorrect system PIN a second time, the PIN field will be blocked for a short time (greyed out). The duration of the block will double each time a PIN is subsequently entered incorrectly.

Please note

- ◆ If you have forgotten your system PIN, you must restore your device's factory settings. Please note that this will restore all other settings too (→ [Page 163](#)).
 - ◆ If you do not make any entries for a prolonged period (approx. 10 minutes), you are automatically logged off. The next time you try to add an entry or open a Web page, the Login Web page will be displayed. Enter the system PIN again to log in again.
 - ◆ Any entries that you did not save on the phone before automatic log-off will be lost.
-

Logging off

In the menu bar (→ **Page 177**) at the top right of every Web page in the Web configurator, you will see the Log Off command. Select Log Off to log off from the Web configurator.

Warning

Always use the Log Off command to end the connection to the Web configurator. If, for example, you close the Web browser without logging off beforehand, it is possible that access to the Web configurator will be blocked for a few minutes.

Structure of the Web pages

The Web pages contain the UI elements displayed in Figure 1.

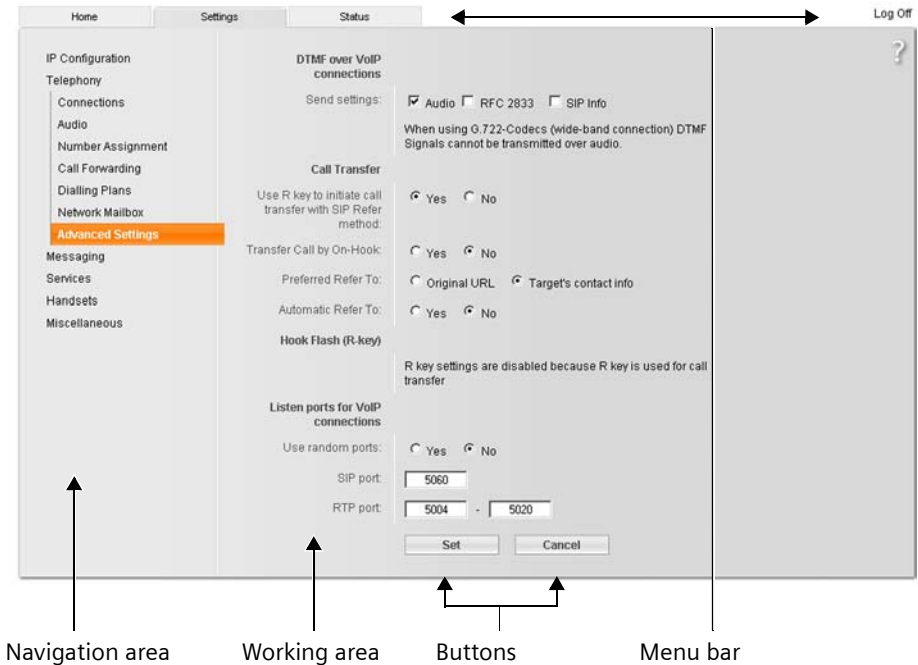

Figure 1 Example of the structure of a Web page

Menu bar

In the menu bar, the Web configurator menus are displayed in the form of tab pages.

The following menus are available:

- | | |
|----------|---|
| Home | The start screen is opened once you have registered with the Web configurator. It contains information on the Web configurator functions. |
| Settings | (→ Page 180)
This menu allows you to adjust the settings on your phone.
If you select the Settings menu, a list with this menu's functions is displayed in the navigation area (→ Page 177). |
| Status | (→ Page 223)
This menu provides you with information about your phone. |
| Log Off | You will find the Log Off function to the right of the menu bar on every Web page (→ Page 176). |

— Please note —

An overview of the Web configurator menu → [Page 43](#).

Navigation area

In the navigation area, the functions of the menu selected in the menu bar (→ [Page 177](#)) are listed.

If you select a function, the associated page opens in the working area with information and/or fields for your inputs.

If a function is assigned subfunctions, these are displayed with the function as soon as you select it. The relevant page for the first subfunction is displayed in the working area.

Working area

Depending on the function selected, information or dialogue boxes are displayed in the working area, which allow you to make or change your phone settings.

Making changes

Adjust the settings for entry fields, lists or options.

- ◆ There may be restrictions regarding the possible values for a field, e.g. the maximum number of characters, entering special characters or certain value ranges.
- ◆ To open a list, select . You can choose between default values.
- ◆ There are two kinds of options:
 - Options in a list, from which you can activate one or several options. Active, i.e. selected options are highlighted with , non-active options with . You can activate an option by selecting . The status of the other options in the list does not change. You can deactivate an option by selecting .
 - Alternative options. The active option in the list is highlighted with , and the non-active with . You can activate an option by selecting . The previously activated option is deactivated. You can only deactivate an option by activating another option.

Entering Cyrillic and Arabic characters

In the following section, the specified maximum number of characters permitted in a field refers to Latin characters and digits (1 character = 1 byte), i.e. 1 character means 1 byte.

Cyrillic and Arabic characters require 2 bytes each, i.e. with a field length of 16 characters, for example, you can enter a maximum of 8 Cyrillic or Arabic characters.

If you enter too many characters into a field, the entry will be rejected (not saved on the base station). The "old" field content (e.g. the standard settings) will remain in place and will be displayed again when the web page is updated. No warning/confirmation is given.

Applying changes

As soon as you have made your change on a page, activate the new setting on the phone by selecting **Set**.

If your input in a field does not comply with the rules for this field, an appropriate error message will be displayed. You can then repeat the input.

Warning

Changes that have not been saved on your phone are lost if you move to another Web page or if the Web configurator is logged off, e.g. due to exceeding the time limit (→ [Page 175](#)).

Buttons

Buttons are displayed in the bottom section of the working area.

Set Save entries on the phone.

Cancel Reject changes made on the Web page and reload the settings that are currently saved in your phone to the Web page.

Opening Web pages

A brief outline of the navigation to the individual Web configurator functions is given below.

Example

Setting DTMF signalling

Settings → Telephony → Advanced Settings

To open the Web page, carry out the following steps after registration:

- ▶ Select the **Settings** menu in the menu bar.
- ▶ Select the **Telephony** function in the navigation area.
The **Telephony** subfunctions are displayed in the navigation tree.
- ▶ Select the **Advanced Settings** subfunction.

The Web page from Figure 1 will be shown in the Web browser.

Setting phone with Web configurator

You can make the following settings using the Web configurator:

- ◆ Connect your phone to the local network (→ [Page 181](#)).
- ◆ Configuration for telephony:
 - Enter settings for the VoIP provider and configuring or activating/deactivating VoIP accounts (→ [Page 186](#)).
 - Specify the name of the fixed line network (→ [Page 193](#)).
 - Activate/deactivate the Gigaset.net connection (→ [Page 194](#)).
 - Activate/deactivate call forwarding for calls to your VoIP numbers or to your Gigaset.net number (→ [Page 202](#)).
 - Configure settings to improve voice quality for the VoIP connections (→ [Page 195](#)).
 - Define the default line for your telephone (fixed line network or VoIP) (→ [Page 199](#)).
 - Assign VoIP phone numbers to individual handsets as send/receive numbers (→ [Page 200](#)).
 - Determine fixed line network and VoIP phone numbers for which the answering machine of the base station should record calls (→ [Page 202](#)).
 - Define user-specific dialling plans for emergency numbers and for cost control purposes (→ [Page 204](#)).
 - Enter and activate/deactivate the network mailbox for each number assigned to the telephone (→ [Page 207](#)).
 - Define the type of DTMF signalling (e.g. for remote operation of a VoIP network mailbox) and the recall key function for VoIP (→ [Page 208](#)).
 - Enter settings for call forwarding via VoIP (call transfer, i.e. connecting two external callers to each other, → [Page 209](#)).
- ◆ Output of information from an IP info service on the handset (→ [Page 214](#))
- ◆ Select an online phone directory, activate/deactivate the caller name display from the online directory (→ [Page 215](#)).
- ◆ Synchronise date and time on the base station with a time server on the Internet (→ [Page 222](#)).
- ◆ Start firmware updates (→ [Page 220](#)).
- ◆ Manage registered handsets:
 - Change names and internal numbers of the registered handsets (→ [Page 216](#)).
 - Copy contacts from your PC's Outlook address book to the handset directories or save handset directories to your PC (→ [Page 217](#)).
 - Activate/deactivate the display of VoIP status messages on your handset (→ [Page 219](#)).

IP Configuration

Assigning the IP address

Select the necessary settings for operating your phone in your local network and to connect it to the Internet. For more detailed explanations of the individual components/terms, see the glossary (→ [Page 253](#)).

- ▶ Open the following Web page: [Settings](#) → [IP Configuration](#).
- ▶ In the [Address Assignment](#) area, select the IP address type.

Select [Obtained automatically](#) if you want your phone to be assigned a dynamic IP address by a DHCP server in your local network. No further settings are necessary for the local network.

Select [Static](#) if you would like to set up a static local IP address for your phone. A static IP address is, for example, useful if port forwarding or a DMZ is set up on the router for the phone.

The following fields are displayed when you select [IP address type = Static](#):

IP address Enter an IP address for your phone. This IP address allows your phone to be reached by other subscribers in your local network (e.g. PC).

192.168.2.2 has been preset.

Please note the following:

- ◆ The IP address must be from the address block for private use that is used in the router. This is generally in the range 192.168.0.1 – 192.168.255.254 with Subnet mask 255.255.255.0. The subnet mask determines that the first three parts of the IP address must be identical for all subscribers in your LAN.
- ◆ The static IP address must not belong to the address block (IP pool range) that is reserved for the DHCP server of the router. It must also not be used by another device on the router.

If necessary, check the settings on the router.

Subnet mask

Enter the subnet mask for your device's IP address. For addresses from the address block 192.168.0.1 – 192.168.255.254, the subnet mask 255.255.255.0 is generally used. This is preconfigured when the phone is supplied.

Default gateway

Enter the IP address for the standard gateway, by means of which the local network is connected to the Internet. This is generally the local (private) IP address for your router (e.g. 192.168.2.1). Your phone requires this information to be able to access the Internet.

192.168.2.1 has been preset.

Web configurator – setting the phone using a PC

Preferred DNS server

Enter the IP address for the preferred DNS server. DNS (Domain Name System) allows you to assign public IP addresses to symbolic names. The DNS server is required to convert the DNS name into the IP address when a connection is being established to a server.

You can specify your router's IP address here. The router forwards phone address requests to its DNS server.

192.168.2.1 has been preset.

Alternate DNS server (optional)

Enter the IP address for the alternative DNS server that should be used in situations where the preferred DNS server cannot be reached.

▶ Select **Set** to save the changes.

Or

▶ Select **Cancel** to reject the changes.

After you have changed the IP configuration the base station is rebooted. You will be logged off by the Web configurator. The **Login Web** page is displayed again after the reboot.

Allowing access from other networks

The default setting for your phone is set so that you can only access your phone's Web configurator via a PC that is in the same local network as your phone. The subnet mask of the PC must match that of the phone.

You can also allow access from PCs in other networks.

Warning

Expansion of access entitlement to other networks increases the risk of unauthorised access. It is therefore recommended that you deactivate remote access again if you no longer require it.

▶ Open the following Web page: **Settings** → **IP Configuration**.

Area: Remote Management

▶ Activate the **Yes** option to permit access from other networks.

To deactivate remote access, activate the **No** option. Access is then limited to PCs in your own local network.

Access to the Web configurator services from other networks is only possible if your router is set accordingly. The router must pass on the service requests from "outside" to Port 80 (default port) of the phone. Please also read the user guide for your router.

To establish a connection, the public IP address or the DNS name of the router and, where applicable, the port number on the router must be indicated in the Web browser of the remote PC.

Entering an HTTP proxy server (only when connected to an internal company network)

Direct connections between network participants and the Internet are often not permitted within internal company or organisation networks (intranet). In such cases, all HTTP calls from the network are "transferred" by a proxy server. The proxy server is a computer or program within the network.

If your phone is connected to such a network, you must store the address of this HTTP proxy server on the phone and activate handling of HTTP calls via the HTTP proxy server.

Only then will you be able to access, for example, the online and Gigaset.net directories or obtain weather information etc. in idle display (info services).

- ▶ Open the following Web page: **Settings** → **IP Configuration**.

Area: HTTP proxy

Enable proxy

Select the **Yes** option if your phone is to handle HTTP calls via your network's HTTP proxy server.

If you select **No**, the phone attempts to access the Internet directly.

Proxy server address

Enter the URL (→ **Page 266**) of the proxy server to which your phone is to send HTTP calls. The proxy server then creates the connection to the Internet.

Proxy server port

Specify the communication port used on the HTTP proxy server (number between 0 and 55000). It is mainly port 80 that is used.

- ▶ Now select **Set** to save your settings.

Configuring telephone connections

You can configure up to eight numbers on your phone: your fixed line network number, your Gigaset.net number and six VoIP numbers.

You need to set up a VoIP account with a VoIP provider for each VoIP phone number. You must save the access data for each account and for the relevant VoIP provider in the phone. You can assign a name to each connection (VoIP and fixed line network).

To configure the connections:

- ▶ Open the following Web page: Settings → Telephony → Connections.

A list (→ **Figure 2**) will be shown containing all the possible connections that you can configure, or have already configured, on your phone.

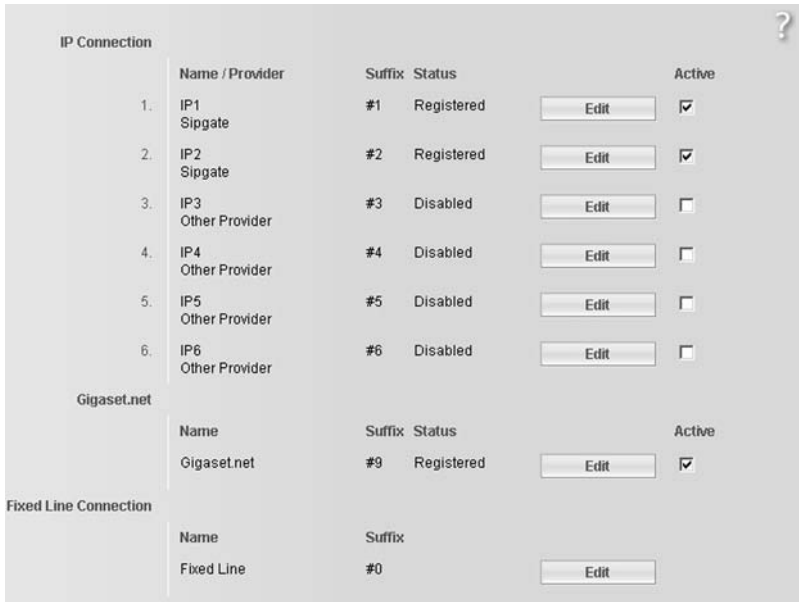

IP Connection					
	Name / Provider	Suffix	Status		Active
1.	IP1 Sipgate	#1	Registered	<input type="button" value="Edit"/>	<input checked="" type="checkbox"/>
2.	IP2 Sipgate	#2	Registered	<input type="button" value="Edit"/>	<input checked="" type="checkbox"/>
3.	IP3 Other Provider	#3	Disabled	<input type="button" value="Edit"/>	<input type="checkbox"/>
4.	IP4 Other Provider	#4	Disabled	<input type="button" value="Edit"/>	<input type="checkbox"/>
5.	IP5 Other Provider	#5	Disabled	<input type="button" value="Edit"/>	<input type="checkbox"/>
6.	IP6 Other Provider	#6	Disabled	<input type="button" value="Edit"/>	<input type="checkbox"/>
Gigaset.net					
	Name	Suffix	Status		Active
	Gigaset.net	#9	Registered	<input type="button" value="Edit"/>	<input checked="" type="checkbox"/>
Fixed Line Connection					
	Name	Suffix			
	Fixed Line	#0		<input type="button" value="Edit"/>	

Figure 2 List of possible connections

The list will show the following:

Name / Provider

Name of the connection. This will show the name that you have defined for the connection (→ **Page 186, Page 193**) or the default name (IP1 to IP6 for VoIP connections, Fixed Line for the fixed line network connection and Gigaset.net). VoIP connections also display the name of the VoIP provider with which you have opened the account. If the name is unknown the display will show Other Provider.

Suffix	<p>Line suffix that you have to add to the phone number of an outgoing call to allow the account assigned to the suffix to be used as the sending account.</p> <hr/> <p>Example</p> <p>If you dial 123456765#1, the connection will be made and billed through the first VoIP account, regardless of the VoIP number you have assigned to your handset as the send number and whether you briefly press/press and hold the talk key.</p> <p>If you dial 123456765#0, the connection will be made via the fixed line network.</p> <hr/>
Status	<p>The status of the connection will be shown for VoIP connections:</p> <p>Registered The connection is activated. The phone has been successfully registered. You can use the connection to make calls.</p> <p>Disabled The connection is deactivated. The phone is not registering with the corresponding account with the VoIP service. You cannot use the connection to make or receive calls.</p> <p>Registration failed / Server not accessible Your phone was unable to register with the VoIP service, e.g. because the VoIP access data is incorrect or incomplete or the phone is not connected to the Internet. You can find further information in the section "Questions and answers" → Page 225.</p> <hr/>
Active	<p>You can use the option in the Active column to activate (<input checked="" type="checkbox"/>) and deactivate (<input type="checkbox"/>) VoIP connections. If a connection is deactivated, the phone will not register for this connection. The connection can be activated/deactivated by clicking directly on the option. The change does not need to be saved.</p> <p>To configure a connection or to change the configuration of a connection:</p> <ul style="list-style-type: none"> ▶ Select Edit button next to the connection. <p>This will open a Web page where you can make the settings needed. More information is available</p> <ul style="list-style-type: none"> ◆ in the section "Configuring the VoIP connection", → Page 186 or ◆ in the section "Configuring the fixed line connection", → Page 193 or ◆ in the section "Configuring the Gigaset.net connection", → Page 194.

Configuring the VoIP connection

- ▶ Open the following Web page: **Settings** → **Telephony** → **Connections**.
- ▶ Select the **Edit** button next to the VoIP connection that you want to configure or the configuration you wish to change.

This will open a Web page where you can make the settings that your phone needs to access your provider's VoIP server.

The Web page always displays the following areas:

- ◆ IP Connection (→ **Page 186**)
- ◆ Auto Configuration (→ **Page 187**)
- ◆ Personal Provider Data (→ **Page 189**)

The areas

- ◆ General Provider Data (→ **Page 190**) and
- ◆ Network (→ **Page 191**)

can be shown and hidden by selecting the **Show Advanced Settings** and **Hide Advanced Settings** buttons.

You must enter the VoIP provider's general access data in these areas. You can download this data for many VoIP providers from the Internet (→ **"Area: Auto Configuration"**, **Page 187**).

- ▶ Make the settings on the Web page.
- ▶ Save them in the phone → **Page 193**.
- ▶ Activate the connection if necessary → **Page 193**.

Area: IP Connection

Connection Name or Number

Enter a name for the VoIP connection or the VoIP phone number (max. 16 characters). This name is used to display the connection on the handset and the Web configurator interface, e.g. during allocation of send and receive numbers (→ **Page 200**), for the call display (→ **Page 49**).

Area: Auto Configuration

The entire configuration process or a large part of the configuration for a VoIP connection is automated for many VoIP providers. You can download the necessary VoIP access data to your phone from the Internet.

You have the following options:

◆ Fully automated configuration

Preconditions:

- You have received an **auto configuration code** from your VoIP provider.
- The general access data for your VoIP provider is available for downloading.

You can download all the data required for VoIP access from the Internet:

- ▶ Enter the auto-configuration code you received from your VoIP provider in the **Auto Configuration** area in the **Auto Configuration Code** field (maximum 32 characters).
- ▶ Select the **Start Auto Configuration** button.

The telephone establishes a connection to the Internet and downloads all data required for the VoIP connection, i.e. the general provider information and your personal provider data (account data) are saved to your base station.

If you have already entered details on the Web page, this is deleted as soon as **Start Auto Configuration** is selected. The fields in the **Personal Provider Data** and **General Provider Data** areas and the server addresses in the **Network** area are overwritten by the downloaded data.

Generally, you should not have to enter any additional data on this Web page.

— Please note —

If the message **Download of settings not possible! File is corrupt!** appears, no data will be loaded onto the phone. Possible causes of this are:

- ◆ The incorrect code has been entered (e.g. upper/lower case rules have not been followed). If necessary, enter the code again.
 - ◆ The file that has been downloaded is invalid. Please consult your VoIP provider.
-

When the download is complete, the **Connections** list will be displayed.

- ▶ Activate the connection as described on **Page 193**.

You can then be reached on the corresponding VoIP phone number.

- ◆ Automatic configuration of general VoIP provider data

Precondition: You have received your account details from your VoIP provider (e.g. Authentication Name, Authentication password).

Profile files for the most important VoIP providers are available to download from the Internet via the Gigaset configuration server. The address for the server is stored in your phone (→ [Page 220](#)).

To load the data onto your telephone, proceed as follows:

- ▶ Select **Select VoIP Provider** in the Auto Configuration area. This will display information on the download procedure.

— Please note —

If you select the **Select VoIP Provider** button, any changes that have been made to the Web page will be saved and checked. Values may need to be corrected before the **Select VoIP Provider** operation is started.

The download procedure consists of several steps:

- ▶ Select the **Next** button.
- ▶ From the list, select the country for which the list of VoIP providers is to be loaded.
- ▶ Select the **Next** button.
- ▶ Select your VoIP provider from the list.
If your provider is not included in the list, select **Other Provider**. In this case you will have to enter the general provider data by hand (see "**Area: General Provider Data**" and "**Area: Network**" below).
- ▶ Select the **Finish** button.

— Please note —

If only one country is available, the country list will not be displayed. The provider list is then displayed immediately.

The details of the selected provider are loaded to your phone and saved under **General Provider Data** (→ [Page 190](#)) and **Network** (→ [Page 191](#)).

You cannot make any further entries in these areas.

The **Provider** field shows the name of the selected provider or **Other Provider**. A link to the provider's homepage is displayed where available.

To complete configuration of your VoIP connection, enter your account data in the **Personal Provider Data** area.

— Please note —

After the first download of the VoIP provider settings, your phone will check daily whether a newer version of the file for your VoIP provider is available via the Internet on the Gigaset configuration server (→ [Page 167](#)).

Area: Personal Provider Data

Enter the configuration data that is necessary for accessing your VoIP provider's SIP service. This data can be obtained from your VoIP provider.

The field names in this area (**Authentication Name** etc.) listed in the following are standard names and may change. If you have already downloaded the provider's general details ("Select VoIP Provider" button, see above), field entries will be replaced by provider-specific names to facilitate orientation (e.g. SIP-ID instead of **Authentication Name**).

Authentication Name

Specify the registration or authentication ID agreed with your VoIP provider (maximum 32 digits). The registration ID serves as the access ID that your phone must specify when registering with the SIP proxy/registrar server. The **Authentication Name** is mainly identical to the **Username**, i.e. to your Internet phone number.

Authentication password

Enter the password that you have agreed with your VoIP provider in the **Authentication password** field (maximum 32 characters). The phone needs the password when registering with the SIP proxy/registrar server.

Username Enter the caller ID for your VoIP provider account (maximum 32 characters). This ID is usually identical to the first part of your SIP address (URI, your Internet phone number).

Example

Example: If your SIP address is "987654321@provider.com", enter "987654321" as the **Username**.

Display name (optional)

Enter any name that should be shown in the other caller's display when you call them via the Internet (example: Anna Sand). All characters in the UTF8 character set (Unicode) are permitted. The name must not exceed 32 characters.

If you do not enter a name, your **Username** or your VoIP phone number will be displayed.

Ask your VoIP provider if this feature is supported.

Area: General Provider Data

If you have downloaded the general settings for the VoIP provider from the Gigaset configuration server (→ [Page 187](#)), then the fields in this area will be preset with the data from the download. Generally speaking, you do not need to configure any settings in this area.

Domain Specify the last part of your SIP address (URI) here (maximum 74 characters).

Example

For the SIP address "987654321@provider.com", enter "provider.com" in Domain.

Proxy server address

The SIP proxy is your VoIP provider's gateway server. Enter the IP address or the (fully-qualified) DNS name of your SIP proxy server (maximum 74 characters).
Example: myprovider.com.

Proxy server port

Enter the number of the communication port that the SIP proxy uses to send and receive signalling data (SIP port).

Port 5060 is used by most VoIP providers.

Registrar server

Enter the (fully-qualified) DNS name or the IP address of the registrar server (maximum 74 characters).

The registrar is needed when the phone is registered. It assigns the public IP address/port number to your SIP address (Username@Domain) that were used by the phone at registration. With most VoIP providers, the registrar server is identical to the SIP server. **Example:** reg.myprovider.com.

Registrar server port

Enter the communication port used in the registrar. It is mainly port 5060 that is used.

Registration refresh time

Enter the time intervals (in seconds) at which the phone should repeat the registration with the VoIP server (SIP proxy) (a request will be sent to establish a session). The repeat is required so that the entry of the phone in the tables of the SIP proxy is retained and the phone can therefore be reached. The repeat will be carried out for all activated VoIP phone numbers.

The default is 180 seconds.

If you enter 0 seconds, the registration will not be repeated periodically.

Area: Network

Please note

If you have downloaded the general settings for your VoIP provider from the Gigaset configuration server (→ [Page 188](#)), then some fields in this area will be preset with the data from the download (e.g. the settings for the STUN server and outbound proxy).

If your phone is connected to a router with NAT (Network Address Translation) and/or a firewall, you must select some settings in this area so that your phone can be reached from the Internet (i.e. can be addressed).

Through NAT, the IP addresses of subscribers in the LAN are concealed behind the public IP address of the router.

For incoming calls

If port forwarding is activated or a DMZ is set up for the phone on the router, no special settings are required for incoming calls.

If this is not the case, an entry in the NAT routing table (in the router) is necessary in order for the phone to be reached. This entry is created when the phone is registered with the SIP service. In the interest of security, this entry is automatically deleted at certain intervals (session timeout). The phone must therefore confirm its registration at certain intervals (→ [NAT refresh time on Page 192](#)) so that the entry stays in the routing table.

For outgoing calls

The phone needs its public address in order to receive caller voice data.

There are two possibilities:

- ◆ The phone requests the public address from a STUN server on the Internet (Simple Transversal of UDP over NAT). STUN can only be used with asymmetric NATs and non-blocking firewalls.
- ◆ The phone does not direct the connection request to the SIP proxy but to an outbound proxy on the Internet that supplies the data packets along with the public address.

The STUN server and outbound proxy are used alternatively to work around the NAT/firewall in the router.

STUN enabled

Select **Yes** if you want your phone to use STUN as soon as it is used on a router with asymmetric NAT.

STUN server

Enter the (fully-qualified) DNS name or the IP address of the STUN server on the Internet (maximum 74 characters).

If you selected **Yes** in the STUN enabled field, you must enter a STUN server here.

STUN port

Enter the number of the communication port on the STUN server. The default port is 3478.

Web configurator – setting the phone using a PC

STUN refresh time

Enter the time intervals at which the phone should repeat the registration with the STUN server. The repeat is required so that the entry of the phone in the tables of the STUN server is retained. The repeat will be carried out for all activated VoIP phone numbers.

Ask your VoIP provider for the STUN refresh time.

The default is 240 seconds.

If you enter 0 seconds, the registration will not be repeated periodically.

NAT refresh time

Specify the intervals at which you want the phone to update its entry in the NAT routing table. Specify an interval in seconds that is a little shorter than the NAT session timeout.

As a rule you should not need to change the preconfigured value for the NAT refresh time.

Outbound proxy mode

Specify when the outbound proxy should be used.

Always

All signalling and voice data sent by the phone is sent to the outbound proxy.

Auto

Data sent by the phone is only sent to the outbound proxy when the phone is connected to a router with symmetric NAT or blocking firewall. If the phone is behind an asymmetric NAT, the STUN server is used.

If you have set STUN enabled = No or have not entered a STUN server, the outbound proxy is always used.

Never

The outbound proxy is not used.

If you do not make an entry in the Outbound proxy field, the phone behaves independently of the selected mode, as with Never.

Outbound proxy

Enter the (fully qualified) DNS name or the IP address of your provider's outbound proxy (maximum 74 characters).

— Please note —

With many providers, the outbound proxy is identical to the SIP proxy.

Outbound proxy port

Enter the number of the communication port used by the outbound proxy.

The default port is 5060.

Saving settings on the phone

- ▶ Select **Set** to save the changes.

The **Connections** list will be shown after saving (→ [Figure 2 on Page 184](#)).

If you want to discard the changes:

- ▶ Select the **Cancel** button.

If all fields are to be reset to the default settings:

- ▶ Select the **Delete** button.

Fields without default settings are empty.

Please note

If you do not make any entries for a longer period, the connection to the Web configurator is automatically terminated. Unsaved entries are lost. If necessary, save intermittently. You can subsequently continue the entry and make changes if necessary.

Activating a new connection

If you have configured a new VoIP connection, you must also activate it.

In the **Connections** list:

- ▶ Activate the relevant option in the **Active** column (= activated).

Your phone will register itself with the VoIP provider using the relevant access data. Refresh the website (e.g. by pressing F5).

The **Status Registered** column will appear if registration was successful. You can now be reached on this VoIP phone number.

Please note

Once the new entry has been made, the VoIP phone number is assigned to each handset and the integrated answering machine as a receive number. For details on how to adjust the assignment, → [Page 200](#).

Configuring the fixed line connection

You can assign a name to your fixed line connection. This name is used to display the connection on the handset and the Web configurator interface, e.g. during allocation of send and receive numbers (→ [Page 200](#)), for the call display (→ [Page 49](#)).

- ▶ Open the following Web page: **Settings** → **Telephony** → **Connections**.
- ▶ Select the **Edit** button in the **Fixed Line Connection** area.
- ▶ Enter your fixed line network number or the name of your choice (max. 16 characters) for your fixed line connection in the **Connection Name or Number** field. The default is "Fixed Line".

Configuring the Gigaset.net connection

Your phone is assigned a Gigaset.net phone number by default. As soon as you have connected your phone to the Internet, you can make calls using the Gigaset.net and receive calls from other Gigaset.net subscribers, provided that your Gigaset.net connection has been activated. You can deactivate the Gigaset.net connection.

Activating/deactivating the Gigaset.net connection

- ▶ Open the following Web page: **Settings** → **Telephony** → **Connections**. The list of connections will be displayed (→ **Figure 2** on **Page 184**).
- ▶ In the **Gigaset.net** area: use the option in the **Active** column to activate () or deactivate () the Gigaset.net connection.

Please note

If you do not use your Gigaset.net connection for six weeks, it is automatically deactivated. You cannot be reached for calls from Gigaset.net.

The connection is reactivated:

- ◆ as soon as you start a search in the Gigaset.net directory (→ **Page 57**) or
 - ◆ make a call via Gigaset.net, i.e. dial a number ending in #9 (two attempts may be necessary) or
 - ◆ activate the connection via the Web configurator as described above.
-

Activating/deactivating the STUN server of the Gigaset.net connection

The Gigaset.net connection is preconfigured in your phone. The Gigaset.net uses a STUN server as standard. In the sent data packets, Gigaset.net replaces the private IP address of your phone with its public IP address.

If you operate your phone behind a router with symmetrical NAT, STUN cannot be used. Otherwise, when making Gigaset.net calls you will not be able to hear the caller.

In this case, deactivate STUN for the Gigaset.net connection.

- ▶ Open the following Web page: **Settings** → **Telephony** → **Connections**.
- ▶ Select **Edit** in the **Gigaset.net** area.

STUN enabled

Click **No** to deactivate STUN.

Select **Yes** if you want your phone to use STUN.

- ▶ Select **Set** to save the changes.

Optimising voice quality for VoIP connections

You can make general and connection-specific settings to improve the voice quality for VoIP telephony.

► Open the following Web page: **Settings** → **Telephony** → **Audio**.

The voice quality for VoIP connections is mainly determined by the **voice codec** used for transferring the data and the available **bandwidth** of your DSL connection.

In the case of the voice codec, the voice data is digitalised (coded/decoded) and compressed. A "better" codec (better voice quality) means more data needs to be transferred, i.e. perfect voice data transfer requires a DSL connection with a larger bandwidth.

The following voice codecs are supported by your phone:

G.722 Excellent voice quality. The **broadband** speech codec **G.722** works at the same bit rate as G.711 (64 kbit/s per speech connection) but with a higher sampling rate. This allows higher frequencies to be played back. The speech tone is therefore clearer and better than for the other codecs (High Definition Sound Performance).

Gigaset S67H, S68H, SL37H and A58H handsets, for example, are HDSP-compatible.

G.711 a law / G.711 μ law

Excellent voice quality (comparable with ISDN). The necessary bandwidth is 64 kbit/s per voice connection.

G.726 Good voice quality (inferior to that with G.711 but better than with G.729). Your phone supports G726 with a transmission rate of 32 kbit/s per voice connection.

G.729 Average voice quality. The necessary bandwidth is less than or equal to 8 kbit/s per voice connection.

Both parties involved in the telephone connection (caller/sender and receiver) must use the same voice codec. The voice codec is negotiated between the sender and the recipient when establishing a connection.

You can influence the voice quality by selecting (bearing in mind the bandwidth of your DSL connection) the voice codecs your phone is to use, and specifying the order in which the codecs are to be suggested when a VoIP connection is established.

Area: Settings for Bandwidth

The settings in this area influence all VoIP connections (VoIP phone numbers).

Allow 1 VoIP call only

You can usually make two VoIP calls at the same time on your phone. If, however, your DSL connection has a narrow bandwidth, there may be problems if two VoIP calls are made at the same time. The data is no longer transferred properly (long voice delay, data losses etc.).

- ▶ Select **Yes** after **Allow 1 VoIP call only** to prevent any further parallel VoIP phone connections being established.
- ▶ If you wish to permit two VoIP connections, select **No**.

Please note

If only one VoIP connection is permitted, the following VoIP network services will **no** longer be available:

- ◆ Call waiting
Call waiting is not displayed during a call via VoIP.
 - ◆ External consultation call from a VoIP call
 - ◆ Call swapping and initiating a conference call via VoIP
-

Voice Quality

Default settings for the codecs used are stored in your phone: one setting optimised for narrow and one for wide bandwidths.

- ▶ Activate one of the options **Optimized for low bandwidth / Optimized for high bandwidth** if you wish to accept a default setting for all VoIP connections. The settings are shown in the **Settings for Connections** area and cannot be changed.
- ▶ Activate the **Own Codec preference** option if you wish to select and set connection-specific voice codecs yourself (see "**Area: Settings for Connections**").

Area: Settings for Connections

In this area you can make specific settings for each of your VoIP phone numbers.

You can make the following settings for each VoIP phone number configured on your phone:

Volume for VoIP Calls

Depending on the VoIP provider, it is possible that the received voice/earpiece volume is too low or too high, so that adjusting the volume via the handset is not adequate.

Specify whether the received volume range is too high or too low. The following options are available:

Low

Voice/earpiece volume is too high. Activate this option to reduce the volume by 6 dB.

Normal

The voice/earpiece volume does not need to be raised/lowered.

High

Voice/earpiece volume is too low. Activate this option to increase the volume by 6 dB.

Voice codecs

Precondition: The **Own Codec preference** option is activated for the **Voice Quality** in the **Settings for Bandwidth** area.

Select the voice codecs your phone is to use, and specify the order in which the codecs are to be suggested when a VoIP connection is established via this VoIP phone number.

- ▶ Apply the voice codecs that your phone is to suggest for outgoing calls into the **Selected codecs** list.
To do this, in the **Available codecs** list select the voice codec that you want to apply (you can mark several entries using the Shift key or the Ctrl key). Select <Add.
- ▶ Move the voice codecs that you do not want the phone to use into the **Available codecs** list.
Select the voice codecs in the **Selected codecs** list (see above) and click the **Remove>** button.
- ▶ Sort the voice codecs in the **Selected codecs** list into the order in which they should be suggested to the receiving device when a connection is established. To do this, use the **Up** and **Down** buttons.

When establishing a VoIP connection, the phone suggests the 1st voice codec in the **Selected codecs** list to the receiving device to begin with. If the receiving device does not accept this voice codec (e.g. because it is not supported), the 2nd voice codec on the list is suggested, and so on.

If the receiving device does not accept any of the voice codecs in the **Selected codecs** list, the connection is **not** established. An appropriate message will be displayed on the handset.

If the phone always starts by trying to establish a broadband connection, put the G.722 codec at the top of the Selected codecs list.

— Please note —

- ◆ You should only deactivate codecs (put them in the Available codecs list) if there is a particular reason. The more codecs that are deactivated, the greater the danger that calls will not be able to be established due to unsuccessful codec negotiations. In particular you can only establish broadband connections if you permit the G.722 codec.
 - ◆ With incoming calls, all supported voice codecs are always permitted.
-

Area: Settings for Codecs

To save additional bandwidth and transmission capacity, on VoIP connections that use the G.729 codec you can suppress the transmission of voice packets in pauses ("Silence Suppression"). Then, instead of the background noises in your environment, your caller hears a synthetic noise generated in the receiver.

Please note: "Silence Suppression" can sometimes lead to deterioration in the voice quality.

- ▶ In the Enable Annex B for codec G.729 field, state whether the transmission of data packets during pauses should be suppressed when using the G.729 codec, (select Yes).

Saving settings on the phone

- ▶ Select Set to save the settings for the voice quality.

— Please note —

You should observe the following for good voice quality:

- ◆ When making calls using VoIP, avoid performing other Internet activities (e.g. surfing the Internet).
 - ◆ Please note that voice delays can occur depending on the codec used and the network capacity utilisation.
-

Voice quality and infrastructure

With your Gigaset S685 IP, you have the opportunity to make calls with good voice quality via VoIP.

However, your phone's performance with VoIP – and therefore the voice quality – also depends on the properties of the entire infrastructure.

The following VoIP provider components are just some of the things that can influence performance :

- ◆ Router
- ◆ DSLAM
- ◆ DSL transmission line and speed
- ◆ Connection paths over the Internet
- ◆ If applicable, other applications that also use the DSL connection

In VoIP networks, voice quality is affected by various things including the "quality of service" (QoS). If the entire infrastructure demonstrates QoS, voice quality is higher (fewer delays, less echoing, less crackling etc.).

If, for example, the router does not have QoS, then the voice quality is not as good. Please see the specialist documentation for further information.

Setting the telephone's default line

The default telephone line defines which line type (VoIP or fixed line network) will be used to dial numbers when you **briefly** press the  talk key. The default line is applied to all registered handsets.

- ▶ Open the following Web page: [Settings](#) → [Telephony](#) → [Number Assignment](#).

Area: Default Connection

- ▶ Select the default line for your phone. This can be done by selecting option VoIP or Fixed Line after Linetype for outgoing calls.
- ▶ Now select Set to activate your settings.

Please note

- ◆ The default line is only relevant when dialling numbers that are not subject to dialling plans and are entered without a line suffix.
 - ◆ You can change the settings for the default line via any registered handset (→ [Page 164](#)).
-

Activating the fixed line network connection as an alternative connection

You can activate the fixed line network connection on your phone as an alternative connection. If an attempt to establish a connection via VoIP then fails, an attempt is made automatically to establish the connection via the fixed line network.

An alternative connection would be used in the following cases:

- ◆ Your VoIP connections are busy
- ◆ The SIP server for the VoIP connection cannot be accessed
- ◆ The dialled VoIP connection has not (yet) been configured correctly (e.g. incorrect password)
- ◆ The base station does not have a connection to the Internet, e.g. because your router is deactivated or not connected to the Internet

Exceptions

- ◆ SMS messages that are to be sent via a VoIP connection are **not** sent via the fixed line network connection as an alternative. The SMS is stored in the incoming message list with an error status. Your handset's message key flashes.
- ◆ If a URI or IP address is dialled instead of a phone number, the connection cannot be created via the fixed line network.

-
- ▶ Open the following Web page: Settings → Telephony → Number Assignment.

Area: Default Connection

- ▶ If you want to activate the fixed line network connection as an alternative connection, click the **Yes** option after **Automatic Fallback to Fixed Line**. Select **No** to deactivate the function.
- ▶ Now select **Set** to activate your settings.

Assigning send and receive numbers to handsets

You can assign up to eight phone numbers on your phone: your fixed line network number, your Gigaset.net number and six VoIP numbers.

You can assign as many of these numbers as you like to each handset as receive numbers. Receive numbers determine which handset(s) will ring when a call is received.

You can assign one of your VoIP numbers to each handset as a (VoIP) send number. Send numbers define which VoIP account should be used in general to make and pay for outgoing VoIP calls. **Exceptions:**

- ◆ A phone number is dialled with a line suffix (→ [Page 185](#)) or
- ◆ A dialling plan has been defined for the phone number (→ [Page 204](#)).

The Gigaset.net number and fixed line network number are permanently assigned to each registered handset as send numbers.

Please note

A handset is assigned the following numbers after it is registered on the base station:

- ◆ Receive numbers: all phone numbers assigned to the phone (fixed line network, Gigaset.net and VoIP).
 - ◆ Send numbers: the fixed line network number and the VoIP phone number that you entered at the start of the phone configuration.
-

▶ Open the following Web page: **Settings** → **Telephony** → **Number Assignment**.

The display shows all registered handsets. A list is displayed for each handset showing the phone numbers that are configured and activated for the phone. The connection names are shown in the column **Connections**. The fixed line network connection is always at the end of the list.

▶ Define a VoIP phone number as the send number for each handset. To do this, click the option following the phone number in the **for outgoing calls** column. The previous assignment will automatically be deactivated.

Please note

The fixed line network number is permanently assigned to each handset as a send number. This assignment cannot be deactivated. It ensures that emergency numbers can be called from every handset.

The Gigaset.net number is also permanently assigned to each handset.

- ▶ Select the phone numbers for each handset (fixed line network, VoIP) that are to be assigned to the handset as receive numbers. To do this, click the option following the phone number in the **for incoming calls** column. Every handset can be assigned several phone numbers or no phone number (= assigned).
- ▶ Now select **Set** to save your settings.

Please note

- ◆ If a VoIP phone number that has been assigned to a handset as a send number is deleted, the handset will automatically be assigned the first configured VoIP phone number.
 - ◆ Calls made to a number that is not assigned to a handset as a receive number will not be signalled on any handset.
 - ◆ If you have not assigned receive numbers to any of the handsets, calls to all connections will be signalled on all handsets.
-

Assigning receive numbers to the answering machine

You can specify for which of your phone numbers your telephone's answering machine is to accept the calls. To do this, assign receive numbers to the answering machine.

— Please note —

- ◆ Once the new entry has been made, each VoIP phone number is assigned to the integrated answering machine as a receive number.
 - ◆ If no receive number is assigned to the answering machine, it will not accept any calls – even if it is activated.
 - ◆ For details on how to set and operate the answering machine, → [Page 118](#).
-
- ▶ Open the following Web page: [Settings](#) → [Telephony](#) → [Number Assignment](#).
 - ▶ In the [Answering machine](#) area, select the phone numbers (fixed line network, VoIP) for which the answering machine is to accept calls (if it is activated, → [Page 119](#)). To do this, click the option following the phone number in the [incoming calls](#) column. You can assign as many numbers as you wish to the answering machine (= assigned).
 - ▶ Now select [Set](#) to save your settings.

Activating Call Forwarding for VoIP connections

You can forward calls to your VoIP numbers and to your Gigaset.net number.

You can forward calls to your VoIP numbers to any external number (VoIP, fixed line or mobile network number). The forwarding is done via a VoIP connection.

You can forward calls to your Gigaset.net number within the Gigaset.net, i.e. to another Gigaset.net number.

You can define if and when calls to your Gigaset.net number and some of your VoIP numbers (VoIP account) should be forwarded to this VoIP number.

You can also use the handset to define call forwarding and activate/deactivate it, → [Page 63](#).

- ▶ Open the following Web page: [Settings](#) → [Telephony](#) → [Call Forwarding](#).

The display shows a list of all your configured VoIP connections and your Gigaset.net number.

Connections

Select the name you have assigned to the VoIP number, or select Gigaset.net.

When Select when a call to this VoIP number should be forwarded: [When busy](#) / [No reply](#) / [Always](#). Select [Off](#) to deactivate call forwarding.

Call number Enter the phone number to which the calls should be forwarded. Please note that you may have to enter the area code when forwarding to a fixed line network number in the same area (depending on your VoIP provider and the setting for the automatic area code → [Page 203](#)).

The settings only affect the phone number selected in [Connections](#).

Please note

For details on how to forward your fixed line network number → [Page 61](#).

Entering your own area code, activating/deactivating an automatic area code for VoIP

On the base station, save the complete code (with international code) for the area in which you are using the phone.

For VoIP calls you must generally always dial the area code – even for local calls. You can avoid having to dial the area code for local calls by setting your phone to prefix this code for all VoIP calls made in the same local area (→ option **Predial area code for local calls through VoIP**).

For calls made via VoIP, the area code entered is then prefixed to all numbers that do not begin with 0 – even when dialling numbers from the directory and other lists.

Exceptions: Phone numbers for which you have defined dialling plans and deactivated the Use Area Codes option (→ [Page 204](#)).

- ▶ Open the following Web page: **Settings** → **Telephony** → **Dialling Plans**.

Area: Area Codes

Make the following settings here:

- ▶ From the **Country** list, select the country in which you are using your phone. This way the country code and the prefix of the area code are automatically set (in **International Prefix / Area Code** and **Local Prefix** fields).
- ▶ In the **Local Area Code** field, enter the area code for your town without a prefix (maximum 8 figures 0–9, *, #, R, P, r, p), e.g. 131 (for Edinburgh).
- ▶ Select **Yes** after **Predial area code for local calls through VoIP** to activate the function.

Select **No** to deactivate the function. You will then need to enter the area code for local calls made via VoIP. Numbers in the directory must always contain the area code when dialling via VoIP.

- ▶ Select **Set** to save the settings.

Please note

- ◆ The area code will also be prefixed to VoIP calls made to emergency numbers if there are **no** defined dialling plans for these numbers.
 - ◆ The numbers of your network mailbox saved in the base station are **not** prefixed with an area code (→ [Page 207](#)).
-

Defining dialling plans – cost control

You can define dialling plans to reduce costs:

- ◆ You can define the connection (one of your VoIP accounts, the fixed line network) through which calls to specific numbers should be made and paid for. If you enter just a few digits (e.g. local area, national or mobile network code), any call to a number beginning with these digits will be made via the elected connection.
- ◆ You can block specific numbers, i.e. your phone will not establish a connection to these numbers (e.g. 09 numbers).

These dialling plans apply to all registered handsets. The settings for the default line (briefly press/press and hold ) and the send numbers of handsets do not apply to numbers governed by a dialling plan.

Please note

You can override dialling plans, with the exception of blocks, as follows:

- ◆ Dial the number with a line suffix (e.g. 123456789#3, → [Page 46](#)).
 - ◆ Before entering the number, define another connection type by pressing the **Fxd.Ln.** or **IP** display key (→ [Page 153](#)).
If, for example, you press **Fxd.Ln.**, the number will be dialled via the fixed line network, even if the dialling plan states that a VoIP connection should be used.
-

Tips:

- ◆ Compare the rates for long-distance calls (especially for international calls) offered by your fixed line network and VoIP providers, and determine which connection should be used specifically for these countries/locations, e.g. a dialling plan for the Phone Number "0033" would apply to every call made to France.
- ◆ Use dialling plans to define that numbers starting with a call-by-call number are always made via your fixed line network connection. To do so, enter the call-by-call number in the Phone Number field.

Defining dialling plans

- ▶ Open the following Web page: Settings → Telephony → Dialling Plans.

Area: Dialling Plans

Specify dialling plans for your phone. Enter the following information:

Phone Number

Enter the number or the first digits of the phone number (e.g. an area code) to which the dialling plan should apply (max. 15 digits).

Use Area Codes

Activate this option if the area code is to be added automatically for all calls via VoIP for the number in Phone Number or all phone numbers that begin with the digits in Phone Number (→ [Page 203](#)).

Connection Type

The list shows all the VoIP connections that you have configured as well as your fixed line network connection. It also displays the name assigned to each connection.

- ▶ From the list, select the connection via which the number or numbers that start with the specified sequence of digits should be dialled.

Or:

- ▶ Select **Block** if the number or numbers that start with the sequence of digits should be blocked.

The display will show **Not possible!** if an attempt is made to dial a blocked number.

Comment (optional)

You can enter a description of the dialling plan here (maximum of 20 characters).

- ▶ Select **Add**.

The dialling plan is activated immediately.

A new empty line for a new dialling plan will appear if your phone still has enough space to add further plans.

— Please note —

If dialling plans overlap, the one with the greatest concordance will apply.

Example:

There is a dialling plan for the number "02" and one for the number "023". If you dial "0231..." the second plan will apply; if you dial "0208..." the first plan will apply.

Example

- ◆ You want to block your phone for all 09 numbers.

Dialling plan:

Phone Number = 0190 Connection Type = Block

- ◆ All calls to the mobile phone network should be made via your VoIP connection with provider B.

Dialling plans:

Phone Number = 017 Connection Type = IP3, provider B
and the corresponding entries for "015" and "016".

Activating/deactivating dialling plans

- ▶ Select the option in the **Active** column to activate/deactivate the corresponding dialling plan (= activated).

A deactivated dialling plan will not take effect until it is reactivated.

Deleting dialling plans

- ▶ Select **Delete** next to the dialling plan you wish to delete.

The dialling plan is deleted from the list immediately. The space in the list is released.

Please note

Predefined dialling plans set as defaults (for emergency numbers) **cannot** be deactivated and **cannot** be deleted.

Emergency numbers

Dialling plans for emergency numbers (e.g. the **local** emergency service number) are preset for certain countries. The fixed line network is determined as the **Connection Type**.

These dialling plans cannot be deleted, deactivated or blocked. However, you can change the **Connection Type**.

This should only be changed if the phone is not connected to the fixed line network. If you choose a VoIP connection, please make sure the VoIP provider supports calls to emergency numbers. If the VoIP connection is deleted from the configuration, the emergency call can no longer be made.

If no emergency numbers are set by default, you should define dialling plans for emergency numbers yourself and assign them to a connection that you know that supports emergency calls. Deactivate the **Use Area Codes** option for these dialling plans. Calls to emergency numbers are always supported by fixed line networks.

Warning

- ◆ Emergency numbers cannot be dialled if the keypad lock is activated. Before dialling, press **and hold** the hash key (#*), to release the keypad lock.
 - ◆ If you have activated an automatic area code (→ [Page 203](#)) and if no dialling plan for emergency numbers is defined, the area code will also be prefixed to emergency calls made via VoIP.
-

Activating/deactivating network mailbox, entering numbers

Many fixed network providers and VoIP providers offer answering machines on the network – these are known as network mailboxes.

Each network mailbox accepts incoming calls made via the corresponding line (fixed line network or corresponding VoIP phone number).

You can enter the relevant network mailbox for each configured connection (VoIP, fixed line network) via the Web configurator. You can activate or deactivate the network mailbox for your VoIP connections.

- ▶ Open the following Web page: [Settings](#) → [Telephony](#) → [Network Mailbox](#).

A list with all possible connections is displayed on the Web page. The names of the connections are displayed in the [Connection](#) column.

Entering numbers

- ▶ Enter the network mailbox number in the [Call number](#) column after the desired connection.

With some VoIP providers your mailbox number will be downloaded together with the general VoIP provider data (→ [Page 188](#)), saved to your base station and displayed under [Call number](#).

- ▶ Now select [Set](#) to save your settings.

Activating/deactivating the network mailbox

- ▶ You can activate () and deactivate () individual network mailboxes using the option in the [Active](#) column. Activating/deactivating is carried out by selecting the appropriate option. The change does not need to be saved.

Please note

- ◆ You need to have **requested** the network mailbox for your fixed line network connection from your fixed line network provider.
 - ◆ For details on how to enter the network mailbox numbers and activate/deactivate network mailboxes, → [Page 129](#).
-

Setting DTMF signalling for VoIP

DTMF signalling is required, for example, for querying and controlling certain network mailboxes via digit codes or for remote operation of the local answering machine.

To send DTMF signals via VoIP you must first define how key codes should be converted into and sent as DTMF signals: as audible information via the speech channel or as a "SIP Info" message.

Ask your VoIP provider which type of DTMF transmission it supports.

- ▶ Open the following Web page: **Settings** → **Telephony** → **Advanced Settings**.

Area: DTMF over VoIP connections

Make the required settings for sending DTMF signals.

- ▶ Activate **Audio** or **RFC 2833**, if DTMF signals are to be transmitted acoustically (in voice packets).
- ▶ Activate **SIP Info** if DTMF signals are to be transmitted as code.
- ▶ Now select **Set** to save your settings.

— Please note —

- ◆ The settings for DTMF signalling apply to all VoIP connections (VoIP accounts).
 - ◆ DTMF signals cannot be transmitted in the audio path (**Audio**) on broadband connections (the G.722 codec is used).
-

Defining recall key functions for VoIP (hook flash)

Your VoIP provider may support special performance features. To make use of these features, your phone needs to send a specific signal (data packet) to the SIP server.. You can assign this "signal" to your phone's recall key.

If you press the recall key during a VoIP call the signal will be sent to the server.

Precondition:

- ◆ DTMF reminders via SIP info messages is activated, i.e. the option **SIP Info** on this Web page is activated (→ **Page 208**).
- ◆ The  key is not used for call forwarding, i.e. Use the **R** key to initiate call transfer with the **SIP Refer** method. = No is set for call forwarding (→ **Page 209**).

If one of these preconditions is not fulfilled, the field in the **Hook Flash (R-key)** area is hidden.

- ▶ Open the following Web page: **Settings** → **Telephony** → **Advanced Settings**.

Area: Hook Flash (R-key)

- ▶ In the **Application Type** fields (maximum 31 characters) and **Application Signal** fields (maximum 15 characters), enter the data that you have received from your VoIP provider.
- ▶ Now select **Set** to save your settings.

The setting for the recall key applies to all registered handsets.

Configuring call forwarding via VoIP

If you are swapping calls via VoIP connections, you can connect the two external callers (provider-dependent). You can configure settings for this type of call forwarding.

- ▶ Open the following Web page: Settings → Telephony → Advanced Settings.

Area: Call Transfer

- ▶ Make your settings for call forwarding via VoIP in the following fields:

Use the R key to initiate call transfer with the SIP Refer method.

If you activate the Yes option, the two external parties you are swapping between will be connected when you press the end call key . Your connections with the callers will be terminated.

Transfer Call by On-Hook

If you select Yes, the external parties you are swapping between will be connected when you press the end call key . Your connections with the callers will be terminated.

Preferred Refer To

Define the protocol (the contents of the "Refer To" information) that should be used with preference when forwarding calls:

Target's contact info

This protocol is recommended for "closed" networks (internal company and business networks).

Original URL

This protocol is recommended when the base station is connected to the Internet via a router with NAT.

Automatic Refer To

If you select Yes, the base station will automatically attempt to determine the best protocol.

If the base station cannot determine the best protocol, it will use the protocol defined in Preferred Refer To.

- ▶ Now select Set to save your settings.

Please note

For information on how to forward a call when you deactivate both Use the R key to initiate call transfer with the SIP Refer method. and Transfer Call by On-Hook, → [Page 65](#).

Defining local communication ports for VoIP

Specify which local communication ports (port numbers) the telephone is to use for VoIP telephony. The ports must not be used by any other subscriber in the LAN.

The following communication ports are used for VoIP telephony:

◆ SIP port

Communication port via which the phone receives (SIP) signalling data

◆ RTP port

Two consecutive RTP ports (consecutive port numbers) are required for each VoIP connection. Voice data is received via one port and control data via the other.

You can set port numbers or port number areas for SIP and RTP ports, or set your telephone so that it can use any number of free ports from a predefined range of port numbers.

▶ Open the following Web page: [Settings](#) → [Telephony](#) → [Advanced Settings](#).

Area: Listen ports for VoIP connections

Use random ports

Click **No** if you want the phone to use the ports specified in the fields **SIP port** and **RTP port**.

Click **Yes** if you do not want the phone to use fixed ports for **SIP port** and **RTP port**, but rather to use any free ports from predefined ranges of port numbers.

The use of random ports makes sense if you want several phones to be operated on the same router with NAT. The phones must then use different ports so that the router's NAT is only able to forward incoming calls and voice data to one (the intended) phone.

Use random ports = No

SIP port Specify the port number for the SIP port. Enter a number between 1024 and 49152 in the field.

The default port number for SIP signalling is 5060.

The port number specified must not be in the RTP port number range.

RTP port Specify a range of port numbers that are to be used as RTP ports. This range must be used in the LAN (router) for the phone.

Enter the lowest port number in the left-hand field and the highest number in the right-hand field (numbers between 1024 and 55000).

Size of the port number range:

The difference between the port numbers must be at least **6** if you permit two simultaneous VoIP calls on your phone. It must be at least **4** if you only permit one VoIP call (→ option **Allow 1 VoIP call only** on [Page 196](#)).

The lower of the port numbers in the range (in the left-hand field) must be an **even** number. If you enter an odd number, the next lowest even number will be selected automatically (e.g. if you enter 5003, then 5002 is set automatically).

The default port number for voice transmission is 5004.

Use random ports = Yes

- SIP port** Enter the port number range from which the SIP port is to be selected. Specify the lowest port number in the left-hand field and the highest number in the right-hand field (number between 1024 and 49152). This port number range must not overlap the range specified for RTP port. The default range is 5060 to 5076.
- RTP port** Specify a range of port numbers from which the RTP ports are to be selected. Specify the lowest port number in the range in the left-hand field and the highest number in the right-hand field. The default range is 5004 to 5020.
- ▶ Now select **Set** to save your settings.

Saving messenger access data

The messenger client in your base station enables **instant messaging** (immediate message transfer, chatting). The phone supports the XMPP messenger (Jabber).

In order for you to use your phone's messenger to "go online" and "chat" on the Internet, the access data of a messenger server must be saved on your phone.

Your phone is already registered with the Gigaset.net Jabber server. An account has been assigned to your phone. You can chat to other Gigaset.net subscribers via this account. To do this you need to create a buddy list on the PC (→ **"Setting up a Gigaset.net Jabber account"** on **Page 212**).

You can also register with another instant messaging provider that supports XMPP Messenger (Jabber). You must then save the messenger server address and your access data on your phone.

You can define a **Resource** name and a **Priority** for your phone. Both are required if you are logged in (online) with the messenger server with several devices (phone, desktop PC and laptop) at the same time using the same Jabber ID.

The **Resource** name is used to distinguish between these devices. The phone cannot log in to the messenger server if it does not have a resource name.

You should assign a **Priority** as each message will only be sent to one device for each Jabber ID. The **Priority** determines which of the devices receives the message.

Example

You are online using one of your phone's handsets and your PC both at the same time. You have assigned your phone (**Resource** name "phone") **Priority** 5 and your PC (**Resource** name "PC") **priority** 10. In this case, any message addressed to your Jabber ID will be sent to your phone.

- ▶ Open the following Web page: **Settings** → **Messaging** → **Messenger**.

- ▶ In the **Messenger Account** field, select whether you wish to use the Gigaset.net Jabber server or another provider's messenger server (Other).
The access data for Gigaset.net is already stored in the base station. It is displayed in **Jabber ID**, **Authentication password** and **Jabber server**. With this data you can also register with the Gigaset.net Jabber server through your PC.
- ▶ Enter the user ID (max. 50 characters) and password (max. 20 characters) that you used to register with the messenger server in the **Jabber ID** and **Authentication password** fields. If you have selected **Messenger Account = Gigaset.net**, the fields are preset with your Gigaset.net account.
- ▶ In the **Jabber server** field, enter the IP address or the DNS name of the messenger server with which you are registered for instant messaging.
Max. 74 alphanumeric characters.
If you have selected **Messenger Account = Gigaset.net**, the field is preconfigured with the name of the Gigaset.net server.
- ▶ Enter the number of the communication port on the Jabber server in the **Jabber server port** field. The default port is 5222.
If you have selected **Messenger Account = Gigaset.net**, the port number is preconfigured.
- ▶ Enter a resource name (max. 20 characters) in the **Resource** field.
The default is: phone.
- ▶ Enter the priority for your phone in the **Priority** field. Select a number between -128 (highest priority) and 127 (lowest priority) for the priority.
The default is: 5
- ▶ Select **Set**.

Setting up a Gigaset.net Jabber account

Your phone is already registered with the Gigaset.net Jabber server. An account has been assigned to your phone.

In order to chat with other Gigaset.net subscribers via this account, you must transfer the required Gigaset.net subscribers to a contact list (buddy list) on your PC. You can use any conventional Jabber client for this (e.g. PSI, Miranda; see e.g. <http://www.swissjabber.ch>).

Do the following so you can use your Gigaset.net Jabber account:

- ▶ Start the Web configurator, open the **Settings** → **Messaging** → **Messenger Web** page and select the **Messenger Account Gigaset.net** field. Your account data is displayed in **Jabber ID** and **Authentication password**. You will need these to create a buddy list via the Jabber client on the PC.
- ▶ Start your Jabber client on the PC.
- ▶ Enter your Gigaset.net Jabber ID on the Jabber client as a new account. The Jabber ID consists of your Gigaset.net number and "@jabber.gigaset.net"
Example: 12345678901#9@jabber.gigaset.net
- ▶ Then enter your **Authentication password**.

Please note

- ◆ Do **not** select the option "Create new account". Your Gigaset.net Jabber account has already been created in Gigaset.net.
- ◆ The option "SSL connection" must be **deactivated** in the Jabber client.

▶ Now you can enter Gigaset.net subscribers as contacts (buddies).

For the Jabber ID of each subscriber, enter the subscriber's Gigaset.net number with "@jabber.gigaset.net" (example: 2141524901#9@jabber.gigaset.net).

A request to "Add to contact list" will be sent to the subscriber.

If the subscriber accepts this request, they will be added to your buddy list. This updated buddy list will be displayed on the handset the next time the messenger is rebooted. To restart: If necessary, close your connection to the messenger server (→ [Page 105](#)) and then go back online (→ [Page 103](#)).

Please note

For details on how to use your handset to go online and chat with or call buddies, → [Page 102](#).

Making e-mail settings

You can use your phone to be notified about new e-mail messages on your incoming e-mail server and display the e-mail inbox and the text of the e-mail messages on the handset (→ [Page 98](#)).

You must store the address or DNS name of your incoming e-mail server and your personal access data in the phone and activate the e-mail check with the incoming e-mail server, so that the phone can establish a connection to the incoming e-mail server and connect to your mailbox.

- ▶ Open the following Web page: [Settings](#) → [Messaging](#) → [E-Mail](#).
- ▶ Enter the user name (account name) agreed with the Internet provider (max. 74 characters) in the [Authentication Name](#) field.
- ▶ Enter the password agreed with the provider for accessing the incoming e-mail server (max. 32 characters; case sensitive) in the [Authentication password](#) field.
- ▶ Enter the name of the incoming e-mail server (POP3 server) (max. 74 characters) in the [POP3 Server](#) field. Example: pop.theserver.com.
- ▶ Select from the [Check for new e-mail](#) list the time interval at which your phone should check whether new messages have arrived in your incoming e-mail server. Select [Never](#) to deactivate the request. Select one of the other values to activate the prompt for new e-mail messages.
- ▶ Select the [Set](#) button to save the settings in your phone.

Please note

For details on how you can display e-mail notifications on your handset and open e-mails to read, → [Page 98](#).

Configuring info services/activating idle display

You can configure your handset to display customised text information (e.g. weather reports, news feeds, E-bay messages, traffic reports) in the idle display. To do this you must set the **Clock** on the handset (→ **Page 151**).

Configuring info services

— Please note —

The weather report is preset. It is shown in the handset's idle display as soon as you set the **Clock** as a screensaver.

- ▶ Open the following Web page: **Settings** → **Services**.

Area: Info Services Configuration

- ▶ Click the link

www.gigaset.net/myaccount

The Web page for Gigaset.net info services is opened. You are already registered with your Gigaset.net user ID. Your Gigaset.net user ID and your password are registered in the **Info Services Configuration** area of the Web configurator **Services** page.

This will open a website where you can compile your info service.

- ▶ Define which information should be sent regularly to your handset.

Activating info service display

- ▶ Open the following Web page: **Settings** → **Services**.

Area: Activate Info Services

- ▶ Select **Yes / No** to activate or deactivate the display of text information.
- ▶ Select the **Set** button to save the settings in your phone.

If text information is available it is displayed (in idle display) on all registered Gigaset S67H/S68H, SL37H or C47H handsets for which the digital clock is set as the screensaver.

The text information overwrites the digital clock.

— Please note —

On the Gigaset A58H and C38H handsets you can activate/deactivate the info services by activating/deactivating the corresponding screensaver on the handset. The setting in the **Activate Info Services** area has no effect on how these handsets behave.

Selecting and registering online directories for access

You can use online directories (net directory and classified directory) on your handset. You can use your telephone's Web configurator to define which online directory you wish to use.

You can also elect to display the name under which the caller making an incoming call is saved in the online or Gigaset.net directory (Display of caller's name) – in the call display on the handset and in the caller list.

Precondition: This function is supported by the provider of the online directory.

- ▶ Open the following Web page: **Settings** → **Services**.
The settings are made in the **Online Directory** area.
- ▶ Select the provider whose online directory you wish to use from the **Provider** list. Select "none" if you do not wish to use an online directory.

The following fields are displayed depending on the **Provider** you select:

Display of caller's name

This is displayed if the provider supports transmission of the caller name from the online directory to the call display.

- ▶ Select **On** to update the display.

Authentication Name / Authentication password

These are displayed if you need to register with the provider to gain access to certain services:

- ◆ Some providers require you to register every time you want to access their online directory. They require registration with user name and password for access to the online directory. You will need to save this data to your base station.
- ◆ Other providers differentiate between standard and premium services. You can access standard services **without** entering user name and password. But you will have to register to use the premium services. You will need to save the access data in your base station to gain access to premium services.
- ▶ Enter the details you received from your provider in the **Authentication Name** (max. 74 characters) and **Authentication password** (max. 20 characters) fields.
- ▶ Select the **Set** button to save the settings in your phone.

Please note

- ◆ How to use online directories on handsets, → **Page 78**.
 - ◆ In the handset's list of online directories (press and **hold** ) , provider-specific names of the online directory are displayed. The standard names **Online Directory** and **Yellow Pages** are displayed in the local directory (irrespective of the chosen provider).
 - ◆ If you select "none" from the **Provider** list, the entries for online and classified directories will not be displayed in the handset's list of online directories. The local directory entries **Online Directory** and **Yellow Pages** are maintained but cannot be used to make any connections.
-

Changing internal handset numbers and names

Each handset is **automatically** assigned an internal number (1 to 6) and an internal name ("INT 1", "INT 2" etc.) when it registers with the base station (→ [Page 138](#)).

The internal numbers and names of all registered handsets can be changed.

— Please note —

For information on how to change internal names and numbers, → [Page 140](#).

- ▶ Open the following Web page: [Settings](#) → [Handsets](#).

In the Registered Handsets area

The names and internal numbers of all registered handsets are displayed.

- ▶ Select the handset whose number/name you want to change.
- ▶ **Changing numbers:** Select the internal number that you want to assign to the handset in the No. column of the handset. If a handset with this internal number already exists, you will also have to change the number allocation for this handset. The internal numbers 1-6 can only be assigned once each.
- ▶ **Changing names:** If necessary, change the name of the handset in the Name column. The name may contain up to 10 characters.
- ▶ If necessary, repeat the process for other handsets.
- ▶ Select **Set** to save the settings.

The changes are saved in the internal lists of all registered handsets. Handsets are sorted by their internal numbers in the internal list. The order of the handsets in the list can therefore be changed.

— Please note —

If an internal number has been entered twice, a message will appear. The internal numbers are not changed.

Loading and deleting handset directories to/from the PC

The Web configurator has the following options for editing the directories of the registered handsets.

- ◆ Store the handset directories on a PC. Entries are stored in vCard format in a vcf file on the PC. You can edit these files with an ASCII editor (e.g. Notepad/Editor in Windows Accessories) and load them onto any registered handset. You can also transfer directory entries to your PC address book (e.g. Outlook Express™ address book).
- ◆ Transfer contact details from your PC address book to handset directories. Export the contacts, e.g. with Outlook Express™ to vcf files (vCards) and transfer them to handset directories using the Web configurator.
- ◆ Delete the directory on the handset. If you have edited the directory file (vcf file) on the PC and would like to use this modified directory on the handset, you can delete the current directory from the handset first.

Tip: Back up the current directory on your PC before deleting it. You can then load it back onto the handset if the modified directory is affected by formatting errors and some, or all, of it cannot be loaded onto the handset.

Please note

- ◆ You can find information on the vCard format (vcf) on the Internet, e.g. under:
www.en.wikipedia.org/wiki/VCard or www.de.wikipedia.org/wiki/VCard
(You can set the display language at the bottom left-hand side in the navigation area of the Web page.)
 - ◆ If you want to transfer a handset directory (vcf file) saved on the PC that contains numerous entries to a Microsoft Outlook™ address book, please note the following:
Microsoft Outlook™ only ever transfers the first (directory) entry from the vcf file to its address book.
-

Preconditions:

- ◆ The handset can send and receive directory entries.
- ◆ The handset is activated and is in idle status.
- ▶ Open the following Web page: Settings → Handsets.

The names of all registered handsets are displayed in the Directory area.

- ▶ Select the handset for which you want to save or edit the directory. To do this, click the option in front of the handset.

Loading the directory file from the PC to the handset

- ▶ In the **Transfer directory to handset** area, specify the vcf file you want to load on to the handset (complete path name), or select **Browse...** and navigate your way to the file.
- ▶ Select **Transfer** button to start the transfer.

The display will show how many of the entries from the vcf file are being transferred to the directory.

Transfer rules

The directory entries from a vcf file that are loaded onto the handset will be added to the directory. If an entry already exists for a name, it will either be supplemented or a new entry for the name will be created. The process will not overwrite or delete any phone numbers.

Please note

Depending on your handset type, up to 3 entries with the same name will be created in the handset directory for each vCard – one entry per entered number.

Loading the directory from the handset to the PC

- ▶ Select **Save** in the **Handset Directory** area. A Windows dialogue box will be shown to save the file.
- ▶ Enter the directory on the PC (complete path name) in which the directory file is to be stored. Select **Save** or **OK**.

Deleting the directory

- ▶ Select **Delete** in the **Handset Directory** area.
- ▶ Confirm the security prompt **Telephone directory of the selected handset will be deleted. Continue?** with **OK**.

This deletes all the entries in the directory, including the entries for online directories.

Please note

For details on how to delete the directory on the handset, → [Page 74](#).

Directory file content (vcf file)

The following data (if available) is written into the vcf file for entry into the directory or transferred from a vcf file into the handset directory.

- ◆ Last name
- ◆ First name
- ◆ Number
- ◆ Number (office)
- ◆ Number (mobile)
- ◆ E-mail address
- ◆ Date (YYYY-MM-DD) and time of the reminder call (HH:MM) separated by a "T" (example: 2008-12-24T11:00).
- ◆ Identification as VIP (X-SIEMENS-VIP:1)

Other information that a vCard may contain is not entered into the handset directory.

Example for an entry in vCard format:

```
BEGIN:VCARD
VERSION:2.1
N:Smith;Anna
TEL;HOME:1234567890
TEL;WORK:0199123456
TEL;CELL:0771987654321
EMAIL:anna@smith.com
BDAY:2008-12-24T11:00
X-SIEMENS-VIP:1
END:VCARD
```

Activating VoIP status message display

You can display VoIP status messages on your handset when there are VoIP connection problems. These messages give you information on the status of a connection and contain a provider-specific status code that helps the service team when they are analysing the problem.

- ▶ Open the following Web page: Settings → Handsets.

Area: VoIP Status

- ▶ Select **Yes** after **Show VoIP status on handset** to activate the status message display.
If you select **No**, no VoIP status messages are displayed.
- ▶ Select **Set** to save the changes.

_____ Please note _____

A table with possible status codes and their meaning can be found in the appendix, → [Page 230](#).

Starting a firmware update

If necessary, you can load updates of the base station firmware onto your phone.

The server on which Gigaset Communications makes new firmware versions available for your base station is set by default. The URL of the Internet server is displayed in the *Data server* field.

You should only change this URL under exceptional circumstances (e.g. if requested to do so due to a malfunction). This address is also used to load provider information from the Internet. You should therefore make a note of the default URL before you overwrite it. Otherwise, you will only be able to reactivate the default URL by resetting the base station back to the default settings (→ [Page 162](#)).

— Please note —

- ◆ When updating from the Internet, checks are made to ensure that no **newer** version of the firmware exists. If this is not the case, the operation is terminated.
 - ◆ The firmware is only loaded from the Internet if you have not entered a local file in the *User defined firmware file* field prior to the update.
-

Preconditions:

- ◆ No calls are being made via the fixed line network or VoIP.
- ◆ There is no internal connection between registered handsets or to GHC devices.
- ◆ The base station menu is not open in any of the handsets.
- ▶ Open the following Web page: *Settings* → *Miscellaneous*.
- ▶ Select the *Update Firmware* button.

The firmware is updated. This process can take up to 3 minutes.

— Please note —

You can also start the firmware update on the handset (→ [Page 164](#)).

Firmware update from local firmware file

In exceptional circumstances you may receive, for example, a firmware file from Service that you can upload from your PC to your telephone (e.g. because the firmware update via the Internet did not work).

Precondition: A Web server is running on the local PC (e.g. Apache).

- ▶ First load the firmware file onto your PC.
- ▶ In the *User defined firmware file* field enter the IP address of the PC in your local network and the complete path and name of the firmware file on the PC (maximum 74 characters).
Example: 192.168.2.105/S675IP/FW_file.bin.
- ▶ Select **Set** to save the changes.
- ▶ Select the **Update Firmware** button to start the update.

This setting is automatically used for **this particular** firmware update. The URL in the *Data server* field is saved and used again for subsequent firmware updates. You will have to re-enter the IP address and file name if you need to carry out another update with a firmware file on your local PC.

Please note

If an error arises during a firmware update from a local PC, the most recent version of the firmware is automatically downloaded from the Internet.

Activating/deactivating the automatic version check

When the version check is activated, the phone checks on a daily basis whether the Gigaset configuration server has a new version of the phone firmware or provider profile (general provider data).

If a new version is available, a notification is sent to the handset and the message key flashes. You can then carry out an automatic update of the firmware (→ [Page 165](#)) or of the VoIP provider data.

- ▶ Open the following Web page: **Settings** → **Miscellaneous**.
- ▶ Select **Yes** after **Automatic check for software/profile updates** to activate the automatic version check.
Select **No** if you do not want a version check to be carried out.
- ▶ Select **Set** to save the changes.

Please note

If the telephone is not connected to the Internet at the time when the check for new versions is to be carried out (e.g. because the router is deactivated), the check is carried out as soon as the phone is reconnected to the Internet.

Copying the date/time from time server

The date and time are shown in the idle display of registered handsets. They are important, for example, for stating the correct time in the calls list and for the "anniversary", "appointments" and "alarm clock" functions.

There are two methods for updating the time and date on your base station: manually with one of the registered handsets (→ [Page 16](#)) or automatically by synchronisation with a time server on the Internet.

Activate/deactivate synchronisation with a time server as follows:

- ▶ Open the following Web page: Settings → Miscellaneous.
- ▶ In the Automatic adjustment of System Time with Time Server field, select Yes to activate synchronisation between base station and a time server. If you select No the base station will not adopt time settings from a time server. In this case you should set the time and date manually using a handset.
- ▶ The Last synchronisation with time server field shows the last time the base station compared the time and date settings with a time server.
- ▶ In the Time Server field, enter the Internet address or name of the time server from which the base station should adopt its time and date settings (maximum 74 characters). The time server "europe.pool.ntp.org" is set as default on the base station. You can overwrite the setting.
- ▶ From the Country list, select the country in which your base station is being operated.
- ▶ The Time Zone field shows the valid time zone for the Country. It shows the deviation between local time (not British Summer Time) and Greenwich Mean Time (GMT).
If a country is divided into various time zones, they will all appear in the list. Select the appropriate Time Zone for the base station from the list.
- ▶ The Automatically adjust clock to summer-time changes field will be displayed if your time zone differentiates between British Summer Time and standard time.

Select On if you want the time to change automatically to British Summer Time or standard time when British Summer Time begins and ends respectively.

Select Off if you do not want to change to British Summer Time.

Please note: If the date and time are updated by a time server that automatically switches between British Summer Time and standard time, you must always select Off here.

- ▶ Select the Set button to save the settings in your phone.

Once you have activated synchronisation, the time and date will be compared with a time server as soon as an Internet connection is established.

Synchronisation will usually occur once a day (at night) if synchronisation is activated. Any additional synchronisation will take place only after each new system start of the base station (e.g. after a firmware update or a power cut).

If you register a new handset on your base station it will assume the time and date of the base station without any additional synchronisation with the time server.

Date and time settings are transferred to every handset after synchronisation.

— Please note —

- ◆ The default time server "europe.pool.ntp.org" will remain stored in the base station even if you overwrite it. If you delete your time server from the **Time Server** field and synchronisation is still activated, the base station will continue to synchronise with the default time server. However, it will no longer appear in the **Time Server** field.
 - ◆ If you have entered your own time server in the **Time Server** field and the base station is unable to synchronise for ten consecutive attempts, the base station will synchronise with the default time server.
 - ◆ If you have deactivated synchronisation with a time server, and if the date and time are not set on any handset, then the base station will attempt to reference date and time settings from the CLIP information of an incoming call.
-

Querying the phone status

General information about your phone is displayed.

- ▶ In the menu list, select the **Status** tab.

The following information is displayed:

Area: IP Configuration

IP address The phone's current IP address within the local network. For details on assigning the IP address, → [Page 181](#).

MAC address

The phone's device address.

Area: Software

Firmware version

Version of the firmware currently downloaded. You can download updates of the firmware to your phone (→ [Page 164](#)). Firmware updates are available on the Internet.

EEPROM version

Version of your phone's EEPROM storage chip (→ [Page 257](#)).

Service (Customer Care)

You can get assistance easily when you have technical questions or questions about how to use your device by using our online support service on the Internet at:

www.qigaset.com/customer-care

This site can be accessed at any time wherever you are. It will give you 24/7 support for all our products. It also a list of FAQs and answers plus user guides for you to download. You will also find frequently asked questions and answers in the **Questions and Answers** section of this user guide in the appendix.

If the device needs to be repaired, please contact one of our Customer Care Centers:

Abu Dhabi97 12 62 23 800	Jordan00962 6 5625460/1/2
Argentina	0800-888-9878	Kuwait	00965-2464993
Australia	1300 780 878	Latvia	7 50 11 18
Austria .05 17 07 50 04 (0,065 Euro/Min.)		Lebanon	00961-1236110
Bahrain97 31 73 11 173	Luxembourg	00352 438 43399
Belgium	0 78 15 66 79	Malaysia603 77124304
Bosnia Herzegovina033 276 649	Malta	+353 21 4940 632
Brazil		Mexico .01800 999 4442738 (01800 999 Gigaset)	
Grande Capitais e Regiões Metropolitanas:		Netherlands	
Demais localidades:	(11) 4003 30200900-3333102 (0,25 Euro/min.)
.	0800 888 3020	New Zealand	0800 780 878
Bulgaria	02 873 94 88	Norway	22 70 84 00
Canada	866 247 8758	Oman	96 82 47 09 281
China	0 21 400 670 6007 (RMB 0.11)	Poland	0 801 140 160
Croatia	01 / 2456 555 (0,27 Kn)	Portugal	(351) 808 781 223
Czech Republic	233 032 727	Romania	+4.021.529.7114.
Denmark	35 25 86 00	Russia	8 (495) 228 1312
Dubai97 14 39 69 944	Serbia	0800 222 111
Egypt	202 7623441	Singapore	6735 9100
Finland09 23 11 34 25	Slovak Republic	
France	01 56 38 42 00 coût d'un appel national	02 59 68 22 66 (4,428 sk)
Germany01805 333 222	Slovenija	0 14 74 63 36
(0,14 Euro/Min. aus dem Festnetz der Deutschen Telekom.		South Africa	08 60 10 11 57
Für Anrufe aus den Mobilfunknetzen können abweichende Preise gelten)		Spain	902 103935
Greece	801 1000 500 (0,026 Euro)	Sweden	08 750 99 11
Hong Kong	2763 0203	Switzerland	
.	2389 7285	0848 212 000 (0,08 SFr./Min.)
Hungary	06 14 71 24 44 (27 Ft)	Taiwan	02 266 24343
India	Please refer to your	Thailand	02 722 1118
.	local warranty card	Turkey0216 459 98 59
Ireland	18 50 77 72 77	Ukraine	+380-44-451-71-72
Israel	1 700 700 727	United Arab Emirates	0 43 66 03 86
Italy	199.15.11.15	United Kingdom	0 84 53 67 08 12
		USA	1-866 247-8758
		(toll free)
		Vietnam	1900 545 416

Please address any questions about DSL access and VoIP access to the respective service provider.

Please have your record of purchase ready when calling.

Replacement or repair services are not offered in countries where our product is not sold by authorised dealers.

Questions and answers

If you have any questions about the use of your phone, you can contact us 24/7 at www.gigaset.com/customercare. The table below contains a list of common problems and possible solutions.

Please note

To support the service team, it can be helpful if you have the following information to hand:

- ◆ Version of firmware, EEPROM and your phone's MAC address
You can check this information with the Web configurator (→ [Page 223](#)).
For how to display the MAC address on your handset, → [Page 170](#).
- ◆ VoIP status code (→ [Page 230](#))
For problems with VoIP connections, you should set VoIP status messages to be displayed on your handset (→ [Page 167](#), [Page 219](#)). These messages contain a status code that helps when the problem is analysed.

Registration or connection problems with a Bluetooth headset.

- ▶ Reset the Bluetooth headset (see the user guide for your headset).
- ▶ Delete registration data from the handset when de-registering the device (→ [Page 148](#)).
- ▶ Repeat the registration process (→ [Page 147](#)).

The display is blank.

1. The handset is not switched on.
 - ▶ Press and **hold** the end call key .
2. The battery is flat.
 - ▶ Charge the battery or replace it (→ [Page 14](#)).

The keys of a handset do not respond when pressed.

The keypad lock is activated.

- ▶ Press and **hold** the hash key  (→ [Page 36](#)).

"Base X" flashes on the display.

1. The handset is out of range of the base station or the base station's range has decreased because Eco mode is active.
 - ▶ Move the handset closer to the base station.
 - ▶ Deactivate *Eco Mode* if necessary (→ [Page 133](#)).
2. The handset has been de-registered.
 - ▶ Register the handset (→ [Page 138](#)).
3. The base station is not switched on.
 - ▶ Check the base station's mains adapter (→ [Page 19](#)).
4. An update of the base station firmware is currently being conducted (→ [Page 164](#), [Page 220](#)).
 - ▶ Please wait until the update is complete.

<p>Base Search flashes on the display.</p> <p>The handset is set to Best Base and no base station is turned on or within range.</p> <ul style="list-style-type: none">▶ Move the handset closer to the base station.▶ Check the base station mains adapter.
<p>Handset does not ring.</p> <ol style="list-style-type: none">1. The ringer is deactivated.<ul style="list-style-type: none">▶ Activate the ringer (→ Page 157).2. Call forwarding set to All Calls.<ul style="list-style-type: none">▶ Deactivate call forwarding (fixed line network → Page 61; VoIP → Page 63/ Page 202).
<p>You cannot hear a ringer/dialling tone from the fixed line network.</p> <p>Base station's phone cord has been replaced.</p> <ul style="list-style-type: none">▶ When purchasing a new cord, ensure that it has the correct jack pin connections (→ Page 238).
<p>Error tone sounds after system PIN prompt.</p> <p>You have entered the wrong system PIN.</p> <ul style="list-style-type: none">▶ Re-enter system PIN. <p>Have you forgotten the system PIN?</p> <ul style="list-style-type: none">▶ Reset the base station to set the system PIN back to 0000 (→ Page 163).
<p>The other party cannot hear you.</p> <p>You have pressed the  key (INT) or the display key Mute. The handset is "muted".</p> <ul style="list-style-type: none">▶ Re-activating the microphone (→ Page 53/Page 54).
<p>When making calls from the fixed line network, the caller's phone number is not displayed although CLIP (→ Page 49) is set.</p> <p>Calling Line Identification is not enabled.</p> <ul style="list-style-type: none">▶ The caller should ask his network provider to enable Calling Line Identification (CLI).
<p>You hear an error tone when keying an input (a descending tone sequence).</p> <p>Action has failed/invalid input.</p> <ul style="list-style-type: none">▶ Repeat the operation. Watch the display and refer to the user guide if necessary.
<p>You cannot connect to the router and the phone is assigned a static IP address.</p> <ul style="list-style-type: none">▶ Check on the router whether the IP address is already being used by another device in the LAN or belongs to the block of IP addresses that is reserved on the router for dynamic address assignment.▶ If necessary, change the phone's IP address (→ Page 168).
<p>You have made a call via VoIP but cannot hear the other caller.</p> <p>Your phone is connected to a router with NAT/firewall.</p> <ul style="list-style-type: none">▶ Your STUN server (→ Page 191) or outbound proxy (→ Page 192) settings are incomplete or incorrect. Check the settings.▶ No outbound proxy is entered or the outbound proxy mode Never is activated (→ Page 192) and your phone is connected to a router with symmetric NAT or a blocking firewall.▶ Port forwarding is activated on your router, but no permanent IP address has been assigned to your phone.

You cannot make calls via VoIP. Server not accessible! is displayed.

- ▶ First wait a few minutes. This is often a short-term event that corrects itself after a short time.

If the message continues to be displayed, proceed as follows:

- ▶ Check whether your phone's Ethernet cable is correctly connected to the router.
- ▶ Check your router's cable connection to the Internet.
- ▶ Check whether the phone is connected to the LAN. Send a ping command, e.g. from your PC, to the phone (ping □ <local IP address of the phone>). It may be that no IP address could be assigned to the phone or a permanently set IP address is already assigned to another LAN subscriber. Check the settings on the router, you may have to activate the DHCP server.

You cannot make calls via VoIP. Either Registration at provider failed! or Registration failed is shown.

- ▶ First wait a few minutes. This is often a short-term event that corrects itself after a short time.

The message may still be displayed for the following reasons:

1. The personal VoIP access data (Username, Authent. Name and Authent. Password) you have entered may be incomplete or wrong.
 - ▶ Check your input. Particularly check your use of upper and lower case.
2. The general settings for your VoIP provider are incomplete or incorrect (incorrect server address).
 - ▶ Start the Web configurator and check the settings.

You cannot make calls via VoIP. IP configuration error: xxx appears in the display (xxx = VoIP status code).

You are trying to make a call via a VoIP connection that is not properly configured.

- ▶ Start the Web configurator and check the settings. Possible status codes and their meanings, → [Page 230](#).

The phone does not dial an entered number. The display shows Not possible!.

The number may be blocked (dialling plan).

- ▶ Open the Dialling Plans Web page of the Web configurator and delete or deactivate the block if necessary.

You cannot establish a connection to the phone with your PC's Web browser.

- ▶ When establishing a connection, check the phone's local IP address that has been entered. You can check the IP address on your handset.
- ▶ Check the LAN connections for the PC and phone.
- ▶ Check that your phone can be reached. Send a ping command, e.g. from your PC, to the phone (ping □ <local IP address of the phone>).
- ▶ You have tried to reach the phone via a secure http (https://...). Try again with http://....

You cannot be reached for calls from the Internet.

- ▶ There is no entry for your phone in your router's routing table. Check the settings for the NAT refresh time (→ [Page 192](#)).
- ▶ Your phone is not registered with the VoIP provider.
- ▶ You have entered the wrong user ID or an incorrect domain (→ [Page 189](#)).

No firmware update or VoIP profile download is carried out.

1. If **Currently not possible!** is displayed, the VoIP connections may be busy or a download/update is already being carried out.
 - ▶ Repeat the process at a later time.
2. If **File not readable!** is displayed, the firmware or profile file may be invalid.
 - ▶ Please only use firmware and downloads that are made available on the preconfigured Gigaset configuration server (→ **Page 220**) or at www.gigaset.com/customercare.
3. If **Server not accessible!** is displayed, the download server may not be accessible.
 - ▶ The server is currently not accessible. Repeat the process at a later time.
 - ▶ You have changed the preconfigured server address (→ **Page 220**). Correct the address. If necessary, reset the base station.
4. If **Transmission Error XXX** is displayed, an error has occurred during the transmission of the file. An HTTP error code is displayed for XXX.
 - ▶ Repeat the process. If the error occurs again, consult the Service department.
5. If **Check IP settings!** is displayed, your phone may not be connected to the Internet.
 - ▶ Check the cable connections between the phone and router and between the router and the Internet.
 - ▶ Check whether the phone is connected to the LAN, i.e. it can be reached at its IP address.

You cannot listen to or control a network mailbox.

VoIP:

Your VoIP provider does not support the type of DTMF signalling set up on your phone.

- ▶ Ask your VoIP provider which signalling it supports and change the settings on your phone (→ **Page 208**) if necessary.

Operating the base station within a PABX:

Your PABX is set for dial pulsing.

- ▶ Set your PABX to tone dialling.

No time is specified for a message in the calls list.

Date and time have not been set.

- ▶ Set date/time (→ **Page 16**) or
- ▶ Activate base station synchronisation with a time server on the Internet (→ **Page 222**).

The local answering machine announces "PIN is incorrect" during remote operation.

1. You have entered the wrong system PIN.
 - ▶ Enter the system PIN again.
2. The system PIN is still set to 0000.
 - ▶ Change the system PIN (→ **Page 161**).

The local answering machine is not recording any messages/has switched over to announce only.

Its memory is full.

- ▶ Delete old messages.
- ▶ Play back new messages and delete.

The local answering machine will not record a call or interrupts the recording.

1. An error tone sounds and the display shows **Not possible!**.
 - ▶ You are making the call via a broadband VoIP connection. A recording is not possible in this case. The attempt by the base station to establish a non-broadband connection instead has failed (rearranging the codec). If necessary, you or the other caller must change the setting for the codec used (→ [Page 195](#)).
2. The display shows **Delete messages**.
The answering machine's memory is full.
 - ▶ Use a different handset to delete messages from the answering machine and restart two-way recording.

Or:

 - ▶ Finish the call, delete old messages from the answering machine and re-establish the connection.

VoIP status codes

If you have problems with your VoIP connections, activate the **Show Stat. on HS** function (→ [Page 167](#), [Page 219](#)). You will then receive a VoIP status code that will support you during the problem analysis. Provide the code to the Service department during the problem analysis.

In the following tables you will find the meaning of the most important status codes and messages.

Status code	Meaning
0x31	IP configuration error: IP domain not entered.
0x33	IP configuration error: SIP user name (Authentication Name) not entered. This is shown, for example, when dialling with a line suffix, if no connection is configured for the suffix on the base station.
0x34	IP configuration error: SIP password (Authentication password) not entered.
0x300	The called party can be reached under several phone numbers. If the VoIP provider supports this, a list of the phone numbers is transmitted as well as the status code. The caller can select to which number he wants to make the connection.
0x301	Permanently redirected. The called party can no longer be reached under this number. The new number is transferred to the phone together with the status code, and the phone then no longer accesses the old number but dials the new address immediately.
0x302	Temporarily redirected. The phone is informed that the called party cannot be reached under the dialled number. The call is redirected for a limited period. The phone is also notified of the length of the redirection.
0x305	The query is sent to a different "proxy server", e.g. to balance incoming queries. The phone will make the same query once again to another proxy server. This is not a redirection of the address per se.
0x380	Other service: The query or call could not be transferred. But the phone is notified what other options there are to be able to connect the call.
0x400	Wrong call
0x401	Not authorised
0x403	The requested service is not supported by the VoIP provider.
0x404	Wrong phone number. No connection on this number. Example: In a local call you have not dialled the area code although your VoIP provider does not support local calls.
0x405	Method not permitted.
0x406	Not acceptable. The requested service cannot be provided.

Status code	Meaning
0x407	Proxy authentication required.
0x408	The party cannot be reached (e.g. account has been deleted).
0x410	The requested service is not available from the VoIP provider.
0x413	Message is too long.
0x414	URI is too long.
0x415	Query format is not supported.
0x416	URI is faulty.
0x420	Incorrect ending
0x421	Incorrect ending
0x423	The requested service is not supported by the VoIP provider.
0x480	The dialled number is temporarily unavailable.
0x481	The recipient is not available.
0x482	Double service query
0x483	Too many "jumps": The query was rejected because the service server (proxy) has decided that this query has already passed through too many service servers. The maximum number is defined beforehand by the original sender of the query.
0x484	Wrong number: In most cases this response means that you have simply omitted one or more digits in the phone number.
0x485	The URI dialled is not unique and cannot be processed by the VoIP provider.
0x486	The called party is busy.
0x487	General faults: The call was cancelled before a call was established. The status code confirms receipt of the interruption signal.
0x488	The server cannot process the query because the data entered in the media description is not compatible.
0x491	The server notifies that the query will be processed as soon as a previous query has been completed.
0x493	The server rejects the query because the phone cannot decrypt the message. The sender has used an encryption method that neither the server nor the receiver phone can decrypt.
0x500	The proxy or the receiving device has discovered a fault while executing the query. It is therefore impossible to execute the query. If this occurs, the caller or the phone displays the fault and repeats the query after a few seconds. The number of seconds after which the query can be repeated may be transmitted to the caller or phone by the receiving device.
0x501	The query cannot be processed by the recipient because the recipient does not have the functionality that the caller requires. If the recipient understands the query but does not process it because the sender does not have the necessary rights or the query is not permitted in the current context, status code 405 is transmitted instead of 501.

Status code	Meaning
0x502	In this case, the receiving device that transmits this error code is a proxy or a gateway and has received an invalid response from its gateway via which this query is to be processed.
0x503	The query can currently not be processed by the receiving device or the proxy because the server is either overloaded or is being serviced. If it is possible for the query to be repeated in the foreseeable future, the server informs the caller or the phone of this.
0x504	Time limit exceeded at the gateway.
0x505	The server rejects the query because the indicated version number of the SIP protocol does not at least concur with the version that is used by the server or the SIP device involved in this query.
0x515	The server rejects the query because the message exceeds the maximum permitted size.
0x600	The called party is busy.
0x603	The called party has rejected the call.
0x604	The called URI does not exist.
0x606	The communication settings are not acceptable.
0x701	The called party has hung up.
0x703	Connection cancelled because of time-out.
0x704	Connection cancelled because of a SIP error.
0x705	Wrong dialling tone
0x706	No connection established
0x751	Busy tone: No codec match between the calling and called party.
0x810	General socket layer error: User is not authorised.
0x811	General socket layer error: Wrong socket number
0x812	General socket layer error: Socket is not connected.
0x813	General socket layer error: Memory error
0x814	General socket layer error: Socket not available – check IP settings/connection problem/VoIP setting incorrect.
0x815	General socket layer error: Illegal application on the socket interface.

Checking service information

You may need the service information of your phone (base station and handset) for Customer Services.

Base station service information

Precondition: You are conducting an external call. The connection has been established for at least 8 seconds.

Options → Service Info

Confirm selection with **OK**.

The following information/functions can be selected with :

- 1: Serial number of the base station (RFPI)
- 2: Serial number of your handset (IPUI)
- 3: Informs the service employees of the base station settings (in hex diagram), e.g. the number of registered handsets, repeater mode. The last 4 digits indicate the number of operating hours (hexadecimal).
- 4: Variant (digits 1 to 2),
Version of the base station firmware (digits 3 to 5).
- 5: Gigaset.net number of your phone. With this number a service employee can call you over the Internet without you needing to be registered with a VoIP provider. This means that the employee can test online connections and VoIP telephony irrespective of the VoIP provider.
- 6: Base station device number. Contains further information for the service employees.

Unlock System

Confirm selection with **OK**.

A provider-specific device lock can, if necessary, be removed using the corresponding code.

Update Profile

Confirm selection with **OK**.

The current VoIP provider profile (general provider data of all configured VoIP connections) is automatically loaded onto your telephone. The general settings for all the VoIP connections are updated; profiles for these are available on the Gigaset server.

Handset service information

When the handset is in idle status:

Open the menu by pressing 

▶ Press the following keys one after the other:     

The information displayed on the handset includes:

- 1: Serial number (IPUI)
- 2: Number of operating hours
- 3: Variant (digits 1 to 2),
Version of the handset software (digits 3 to 5).

Authorisation

This device is intended for analogue phone lines in your network.

Voice over IP telephony is possible with an additional modem via the LAN interface.

Country-specific requirements have been taken into consideration.

We, Gigaset Communications GmbH, declare that this device meets the essential requirements and other relevant regulations laid down in Directive 1999/5/EC.

A copy of the 1999/5/EC Declaration of Conformity is available at this Internet address:

www.gigaset.com/docs.

 0682

Bluetooth  Qualified Design Identity

The Bluetooth QD ID for your Gigaset S68H is: B012741.

Environment

Our environmental mission statement

We, Gigaset Communications GmbH, bear social responsibility and are actively committed to a better world. Our ideas, technologies and actions serve people, society and the environment. The aim of our global activity is to secure sustainable life resources for humanity. We are committed to a responsibility for our products that comprises their entire life cycle. The environmental impact of products, including their manufacture, procurement, distribution, utilisation, service and disposal, are already evaluated during product and process design.

Further information on environmentally friendly products and processes is available on the Internet at www.gigaset.com.

Environmental management system



Gigaset Communications GmbH is certified pursuant to the international standards EN 14001 and ISO 9001.

ISO 14001 (Environment): certified since September 2007 by TÜV SÜD Management Service GmbH.

ISO 9001 (Quality): certified since 17/02/1994 by TÜV SÜD Management Service GmbH.

Ecological energy consumption

The use of ECO DECT (→ [Page 133](#)) saves energy and makes an active contribution towards protecting the environment.

Disposal

Batteries should not be disposed of in general household waste. Observe the local waste disposal regulations, details of which can be obtained from your local authority or the dealer you purchased the product from.

All electrical and electronic equipment must be disposed of separately from general household waste using the sites designated by local authorities.



If a product displays this symbol of a crossed-out rubbish bin, the product is subject to European Directive 2002/96/EC.

The appropriate disposal and separate collection of used equipment serve to prevent potential harm to the environment and to health. They are a precondition for the re-use and recycling of used electrical and electronic equipment.

For further information on disposing of your used equipment, please contact your local authority, your refuse collection service or the dealer you purchased the product from.

Appendix

Care

- ▶ Wipe down the base station and handset with a **damp** cloth (no solvents) or an antistatic cloth.

Never use a dry cloth as this can cause static.

Contact with liquid

If the handset should come into contact with liquid:

- ▶ **Switch the handset off and remove the batteries immediately.**
- ▶ Allow the liquid to drain from the handset.
- ▶ Pat all parts dry, then with the battery compartment open and the keypad facing down, place the handset in a dry, warm place **for at least 72 hours** (**not** in a microwave, oven etc.).
- ▶ **Do not switch on the handset again until it is completely dry.**

When it has fully dried out, you will normally be able to use it again.

Specifications

Recommended batteries

Technology:	Nickel-metal-hydride (NiMH)
Size:	AAA (Micro, HR03)
Voltage:	1.2 V
Capacity:	600–1200 mAh

We recommend the following battery types, because these are the only ones that guarantee the specified operating times, full functionality and long service life:

- ◆ Sanyo NiMH 800
- ◆ GP 850 mAh
- ◆ Yuasa Technologies AAA 800

The device is supplied with two recommended batteries.

Handset operating times/charging times

The operating time of your Gigaset depends on the capacity and age of the batteries and the way they are used. (All times are maximum possible times and apply when the display backlight is switched off).

	Capacity (mAh)			
	600	800	1000	1200
Standby time (hours)	130	175	220	265
Talktime (hours)	7	10	12	14
Operating time for 1.5 hrs of calls per day (hours)	70	90	115	135
Charging time, base station (hours)	6	9	11	13
Charging time, charging cradle (hours)	5	7	8	10

At the time of going to print, batteries up to 900 mAh were available and had been tested in the system. Due to the constant progression in battery development, the list of recommended batteries in the FAQ section of the Gigaset Customer Care pages is regularly updated:

www.gigaset.com/customercare

Base station power consumption

The power consumption for the base station is approx. 1.3 watt.

General specifications

Interfaces	Fixed line network, Ethernet
No. of channels	60 duplex channels
Radio frequency range	1880–11900 MHz
Duplex method	Time multiplex, 10 ms frame length
Channel grid	1728 kHz
Bit rate	1152 kbit/s
Modulation	GFSK
Language code	32 kbit/s
Transmission power	10 mW, average power per channel
Range	up to 300 m outdoors, up to 50 m indoors
Base station power supply	230 V ~/50 Hz
Environmental conditions in operation	+5°C to +45°C; 20% to 75% relative humidity
Codecs	G.711, G.726, G.729AB with VAD/CNG, G.722
Quality of Service	TOS, DiffServ
Protocols	DECT, GAP, SIP, RTP, DHCP, NAT Traversal (STUN), HTTP

Pin connections on the telephone jack

If you buy a replacement phone cord, make sure that the phone jack has the correct pin connections.

Correct phone jack pin connections

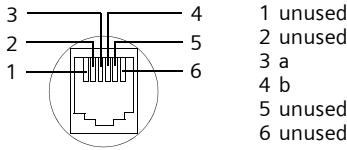

Writing and editing text

The following rules apply when writing text:

- ◆ Control the cursor with .
- ◆ Characters are inserted to the left of the cursor.
- ◆ Press the star key to display the table of special characters. (→ "Entering special characters".)
- ◆ The first letter of the name of directory entries is automatically capitalised, followed by lower case letters.

Entering special characters

- ▶ Press the star key .

A table is opened containing all the special characters. The cursor is positioned on the character "." (full stop).

␣	_	!	?	@	,	'	"	▣
()	;	:	█	-	+	&	%
*	=	<	>	/	€	£	\$	¥
[]	\$	↵	\	~	^	¿	¡
{	}	#						

- ▶ Navigate to the required character with the control key , . Example: to select * press 4 x and 1 x .
- ▶ Press the display key . The character is inserted into the text. Pressing again closes the table without inserting a character.

Writing a text/name (without predictive text)

Press the relevant key several times to enter letters/characters.

Standard characters

	1x	2x	3x	4x	5x	6x	7x	8x	9x	10x
1 sp	␣ ¹⁾	↵ ²⁾	1							
2 abc	a	b	c	2	ä	á	à	â	ã	ç
3 def	d	e	f	3	ë	é	è	ê		
4 ghi	g	h	i	4	ï	í	ì	î		
5 jkl	j	k	l	5						
6 mno	m	n	o	6	ö	ñ	ó	ò	ô	õ
7 pqrs	p	q	r	s	7	ß				
8 tuv	t	u	v	8	ü	ú	ù	û		
9 wxyz	w	x	y	z	9	ÿ	ý	æ	ø	å
0 +	.	,	?	!	0					

- 1) Space
- 2) Line break

When you press and **hold** a key, the characters of the corresponding key are displayed in the **bottom display line** and marked one after another. When you release the key the highlighted character is inserted into the input field.



Setting upper/lower case or digits

Press and **hold** the hash key (**#->**) before entering the character to switch from "Abc" mode to "123", from "123" to "abc" and from "abc" to "Abc" (upper case: 1st letter upper case, all others lower case).

The display shows whether upper case, lower case or digits is selected. The bottom right of the display (above the right display key) shows "Abc", "abc" or "123".

Writing a text/name (with predictive text)

The EATONI predictive text function helps you when you are writing messenger messages and SMS.

Each key between  and  is assigned several letters and characters (→ special characters, [Page 238](#)). These appear in a selection line immediately under the text panel (over the display keys) as soon as you press a key. The letter you are most likely looking for is reverse highlighted and is at the beginning of the selection line. It is copied to the text panel.

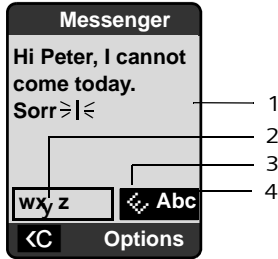

- 1 Message text
- 2 Selection line
- 3 EATONI is activated
- 4 Upper/lower case or digits

If this letter is the one you want, confirm it by pressing the next key. If it does not match the one you want, press the hash key  **briefly** until the letter you are looking for is reverse highlighted in the display line and then transferred to the text field.

If you press and **hold** the hash key  you switch from "Abc" mode to "123" and from "123" to "abc" and from "abc" to "Abc".

Activating/deactivating predictive text

- ▶ You are writing an SMS (→ [Page 85](#)) or a messenger message (→ [Page 110](#)).

 / 

Press the display key.

Predictive Text

Select and press **OK** ( = on).



Press the end call key **briefly** to return to the text field. Enter the text.

Setting input language

- ▶ You are writing an SMS (→ [Page 85](#)) or a messenger message (→ [Page 110](#)).

Options / 

Press the display key.

Select Language

Select and press **OK**.



Select input language and press **OK**.



Press the end call key **briefly** twice to return to the input field.

The input language setting only applies to the current message/SMS.

Order of directory entries

Directory entries are generally sorted alphabetically by surname. Spaces and digits take first priority. If only the first name was entered in the directory, this is incorporated into the sort order instead of the surname.

The sort order is as follows:

- 1 Space
- 2 Digits (0–9)
- 3 Letters (alphabetical)
- 4 Other characters

To get round the alphabetical order of the entries, insert a space or a digit in front of the first letter of the surname. These entries will then move to the beginning of the directory. Names that you have prefixed with a star will move to the end of the directory.

Additional functions via the PC interface

You can connect your Gigaset S68H handset to your computer using Bluetooth (→ [Page 146](#)). The computer must be equipped with a suitable dongle.

Your handset can communicate with a computer using the **Gigaset QuickSync** program (free download at www.gigaset.com/qigasets685).

You can

- ◆ access your handset's directory and synchronise it with Outlook, or copy contact details to the handset,
- ◆ download caller pictures (.bmp) from the computer to the handset,
- ◆ download pictures (.bmp) for the screensaver from the computer to the handset.

During the transfer of data between handset and PC, you will see **Data transfer in progress** on the display. During this time the keypad is disabled, and incoming calls will be ignored.

Gigaset S685 IP – free software

Your Gigaset S685 IP's firmware includes free software that is licensed under the GNU Lesser General Public License. This free software was developed by a third party and is protected by copyright. You will find the licence text in its original English version on the pages that follow.

The software is provided free of charge. You are authorised to use this free software in accordance with the above-mentioned licence conditions. In the event of contradictions between these licence conditions and the Gigaset Communications GmbH licence conditions that apply for the software, the above-mentioned licence conditions shall take precedence for the free software.

The GNU Lesser General Public License (LGPL) is supplied with this product. You can also download the licence conditions from the Internet:

- ◆ The **LGPL** is available on the Internet at:

<http://www.gnu.org/copyleft/lesser.html>

- ◆ The **source text, including copyright notices for free software**, is currently available on the Internet at:

<http://www.gigaset.com/developer>

For more information and Internet links to the source text of the free software, see the Online Support pages on the Internet at:

www.gigaset.com/customer-care

If it is not already supplied with the product, you can request the source text, including copyright notices, from Gigaset Communications GmbH. There is a charge to cover the cost of copying and postage. Please submit this request by e-mail or fax to the following address or fax number within 3 years of purchasing this product. Please state the exact device type plus the version number of the installed device software.

Small Parts Dispatch Bocholt

E-mail: kleinteileversand.com@gigaset.com

Fax: 0049 2871 / 91 30 29

Use of the free software contained in this product extending beyond the program sequence intended by Gigaset Communications GmbH is at the user's own risk – i.e. there shall be no claims for liability for defects against Gigaset Communications GmbH. The GNU Lesser General Public License contains notes regarding the author's liability for defects or that of other proprietors of the free software.

You shall have no right to assert a claim against Gigaset Communications GmbH based on liability for defects, if a defect in the product is or could be due to changes you have made to the programs or their configuration. Furthermore, you shall have no right to assert a claim against Gigaset Communications GmbH based on liability for defects if the free software violates the copyright of third parties.

Gigaset Communications GmbH shall not provide technical support for the software, including the free software included within it, if it has been changed.

GNU LESSER GENERAL PUBLIC LICENSE

Version 2.1, February 1999

Copyright (C) 1991, 1999 Free Software Foundation, Inc., 59 Temple Place, Suite 330, Boston, MA 02111-1307 USA

Everyone is permitted to copy and distribute verbatim copies of this license document, but changing it is not allowed.

[This is the first released version of the Lesser GPL. It also counts as the successor of the GNU Library Public License, version 2, hence the version number 2.1.]

Preamble

The licenses for most software are designed to take away your freedom to share and change it. By contrast, the GNU General Public Licenses are intended to guarantee your freedom to share and change free software--to make sure the software is free for all its users.

This license, the Lesser General Public License, applies to some specially designated software packages--typically libraries--of the Free Software Foundation and other authors who decide to use it. You can use it too, but we suggest you first think carefully about whether this license or the ordinary General Public License is the better strategy to use in any particular case, based on the explanations below.

When we speak of free software, we are referring to freedom of use, not price. Our General Public Licenses are designed to make sure that you have the freedom to distribute copies of free software (and charge for this service if you wish); that you receive source code or can get it if you want it; that you can change the software and use pieces of it in new free programs; and that you are informed that you can do these things.

To protect your rights, we need to make restrictions that forbid distributors to deny you these rights or to ask you to surrender these rights. These restrictions translate to certain responsibilities for you if you distribute copies of the library or if you modify it.

For example, if you distribute copies of the library, whether gratis or for a fee, you must give the recipients all the rights that we gave you. You must make sure that they, too, receive or can get the source code. If you link other code with the library, you must provide complete object files to the recipients, so that they can relink them with the library after making changes to the library and recompiling it. And you must show them these terms so they know their rights.

We protect your rights with a two-step method: (1) we copyright the library, and (2) we offer you this license, which gives you legal permission to copy, distribute and/or modify the library.

To protect each distributor, we want to make it very clear that there is no warranty for the free library. Also, if the library is modified by someone else and passed on, the recipients should know that what they have is not the original version, so that the original author's reputation will not be affected by problems that might be introduced by others.

Finally, software patents pose a constant threat to the existence of any free program. We wish to make sure that a company cannot effectively restrict the users of a free program by obtaining a restrictive license from a patent holder. Therefore, we insist that any patent license obtained for a version of the library must be consistent with the full freedom of use specified in this license.

Most GNU software, including some libraries, is covered by the ordinary GNU General Public License. This license, the GNU Lesser General Public License, applies to certain designated libraries, and is quite different from the ordinary General Public License. We use this license for certain libraries in order to permit linking those libraries into non-free programs.

When a program is linked with a library, whether statically or using a shared library, the combination of the two is legally speaking a combined work, a derivative of the original library. The ordinary General Public License therefore permits such linking only if the entire combination fits its criteria of freedom. The Lesser General Public License permits more lax criteria for linking other code with the library.

We call this license the "Lesser" General Public License because it does Less to protect the user's freedom than the ordinary General Public License. It also provides other free software developers Less of an advantage over competing non-free programs. These disadvantages are the reason we use the ordinary General Public License for many libraries. However, the Lesser license provides advantages in certain special circumstances.

For example, on rare occasions, there may be a special need to encourage the widest possible use of a certain library, so that it becomes a de-facto standard. To achieve this, non-free programs must be allowed to use the library. A more frequent case is that a free library does the same job as widely used non-free libraries. In this case, there is little to gain by limiting the free library to free software only, so we use the Lesser General Public License.

In other cases, permission to use a particular library in non-free programs enables a greater number of people to use a large body of free software. For example, permission to use the GNU C Library in non-free programs enables many more people to use the whole GNU operating system, as well as its variant, the GNU/Linux operating system.

Although the Lesser General Public License is Less protective of the users' freedom, it does ensure that the user of a program that is linked with the Library has the freedom and the wherewithal to run that program using a modified version of the Library.

The precise terms and conditions for copying, distribution and modification follow. Pay close attention to the difference between a "work based on the library" and a "work that uses the library". The former contains code derived from the library, whereas the latter must be combined with the library in order to run.

GNU LESSER GENERAL PUBLIC LICENSE TERMS AND CONDITIONS FOR COPYING, DISTRIBUTION AND MODIFICATION

0. This License Agreement applies to any software library or other program which contains a notice placed by the copyright holder or other authorized party saying it may be distributed under the terms of this Lesser General Public License (also called "this License"). Each licensee is addressed as "you".

A "library" means a collection of software functions and/or data prepared so as to be conveniently linked with application programs (which use some of those functions and data) to form executables.

The "Library", below, refers to any such software library or work which has been distributed under these terms. A "work based on the Library" means either the Library or any derivative work under copyright law: that is to say, a work containing the Library or a portion of it, either verbatim or with modifications and/or translated straightforwardly into another language. (Hereinafter, translation is included without limitation in the term "modification".)

"Source code" for a work means the preferred form of the work for making modifications to it. For a library, complete source code means all the source code for all modules it contains, plus any associated interface definition files, plus the scripts used to control compilation and installation of the library.

Activities other than copying, distribution and modification are not covered by this License; they are outside its scope. The act of running a program using the Library is not restricted, and output from such a program is covered only if its contents constitute a work based on the Library (independent of the use of the Library in a tool for writing it). Whether that is true depends on what the Library does and what the program that uses the Library does.

1. You may copy and distribute verbatim copies of the Library's complete source code as you receive it, in any medium, provided that you conspicuously and appropriately publish on each copy an appropriate copyright notice and disclaimer of warranty; keep intact all the notices that refer to this License and to the absence of any warranty; and distribute a copy of this License along with the Library.

You may charge a fee for the physical act of transferring a copy, and you may at your option offer warranty protection in exchange for a fee.

2. You may modify your copy or copies of the Library or any portion of it, thus forming a work based on the Library, and copy and distribute such modifications or work under the terms of Section 1 above, provided that you also meet all of these conditions:

- a) The modified work must itself be a software library.
- b) You must cause the files modified to carry prominent notices stating that you changed the files and the date of any change.
- c) You must cause the whole of the work to be licensed at no charge to all third parties under the terms of this License.
- d) If a facility in the modified Library refers to a function or a table of data to be supplied by an application program that uses the facility, other than as an argument passed when the facility is invoked, then you must make a good faith effort to ensure that, in the event an application does not supply such function or table, the facility still operates, and performs whatever part of its purpose remains meaningful.

(For example, a function in a library to compute square roots has a purpose that is entirely well-defined independent of the application. Therefore, Subsection 2d requires that any application-supplied function or table used by this function must be optional: if the application does not supply it, the square root function must still compute square roots.) These requirements apply to the modified work as a whole. If identifiable sections of that work are not derived from the Library, and can be reasonably considered independent and separate works in themselves, then this License, and its terms, do not apply to those sections when you distribute them as separate works. But when you distribute the same sections as part of a whole which is a work based on the Library, the distribution of the whole must be on the terms of this License, whose permissions for other licensees extend to the entire whole, and thus to each and every part regardless of who wrote it. Thus, it is not the intent of this section to claim rights or contest your rights to work written entirely by you; rather, the intent is to exercise the right to control the distribution of derivative or collective works based on the Library.

In addition, mere aggregation of another work not based on the Library with the Library (or with a work based on the Library) on a volume of a storage or distribution medium does not bring the other work under the scope of this License.

3. You may opt to apply the terms of the ordinary GNU General Public License instead of this License to a given copy of the Library. To do this, you must alter all the notices that refer to this License, so that they refer to the ordinary GNU General Public License, version 2, instead of to this License. (If a newer version than version 2 of the ordinary GNU General Public License has appeared, then you can specify that version instead if you wish.) Do not make any other change in these notices.

Once this change is made in a given copy, it is irreversible for that copy, so the ordinary GNU General Public License applies to all subsequent copies and derivative works made from that copy.

This option is useful when you wish to copy part of the code of the Library into a program that is not a library.

4. You may copy and distribute the Library (or a portion or derivative of it, under Section 2) in object code or executable form under the terms of Sections 1 and 2 above provided that you accompany it with the complete corresponding machine-readable source code, which must be distributed under the terms of Sections 1 and 2 above on a medium customarily used for software interchange.

If distribution of object code is made by offering access to copy from a designated place, then offering equivalent access to copy the source code from the same place satisfies the requirement to distribute the source code, even though third parties are not compelled to copy the source along with the object code.

5. A program that contains no derivative of any portion of the Library, but is designed to work with the Library by being compiled or linked with it, is called a "work that uses the Library". Such a work, in isolation, is not a derivative work of the Library, and therefore falls outside the scope of this License.

However, linking a "work that uses the Library" with the Library creates an executable that is a derivative of the Library (because it contains portions of the Library), rather than a "work that uses the library". The executable is therefore covered by this License.

Section 6 states terms for distribution of such executables.

When a "work that uses the Library" uses material from a header file that is part of the Library, the object code for the work may be a derivative work of the Library even though the source code is not.

Whether this is true is especially significant if the work can be linked without the Library, or if the work is itself a library. The threshold for this to be true is not precisely defined by law.

If such an object file uses only numerical parameters, data structure layouts and accessors, and small macros and small inline functions (ten lines or less in length), then the use of the object file is unrestricted, regardless of whether it is legally a derivative work. (Executables containing this object code plus portions of the Library will still fall under Section 6.)

Otherwise, if the work is a derivative of the Library, you may distribute the object code for the work under the terms of Section 6.

Any executables containing that work also fall under Section 6, whether or not they are linked directly with the Library itself.

6. As an exception to the Sections above, you may also combine or link a "work that uses the Library" with the Library to produce a work containing portions of the Library, and distribute that work under terms of your choice, provided that the terms permit modification of the work for the customer's own use and reverse engineering for debugging such modifications.

You must give prominent notice with each copy of the work that the Library is used in it and that the Library and its use are covered by this License. You must supply a copy of this License. If the work during execution displays copyright notices, you must include the copyright notice for the Library among them, as well as a reference directing the user to the copy of this License. Also, you must do one of these things:

a) Accompany the work with the complete corresponding machine-readable source code for the Library including whatever changes were used in the work (which must be distributed under Sections 1 and 2 above); and, if the work is an executable linked with the Library, with the complete machine-readable "work that uses the Library", as object code and/or source code, so that the user can modify the Library and then relink to produce a modified executable containing the modified Library. (It is understood that the user who changes the contents of definitions files in the Library will not necessarily be able to recompile the application to use the modified definitions.)

b) Use a suitable shared library mechanism for linking with the Library. A suitable mechanism is one that (1) uses at run time a copy of the library already present on the user's computer system, rather than copying library functions into the executable, and (2) will operate properly with a modified version of the library, if the user installs one, as long as the modified version is interface-compatible with the version that the work was made with.

c) Accompany the work with a written offer, valid for at least three years, to give the same user the materials specified in Subsection 6a, above, for a charge no more than the cost of performing this distribution.

d) If distribution of the work is made by offering access to copy from a designated place, offer equivalent access to copy the above specified materials from the same place.

e) Verify that the user has already received a copy of these materials or that you have already sent this user a copy.

For an executable, the required form of the "work that uses the Library" must include any data and utility programs needed for reproducing the executable from it. However, as a special exception, the materials to be distributed need not include anything that is normally distributed (in either source or binary form) with the major components (compiler, kernel, and so on) of the operating system on which the executable runs, unless that component itself accompanies the executable.

It may happen that this requirement contradicts the license restrictions of other proprietary libraries that do not normally accompany the operating system. Such a contradiction means you cannot use both them and the Library together in an executable that you distribute.

7. You may place library facilities that are a work based on the Library side-by-side in a single library together with other library facilities not covered by this License, and distribute such a combined library, provided that the separate distribution of the work based on the Library and of the other library facilities is otherwise permitted, and provided that you do these two things:

a) Accompany the combined library with a copy of the same work based on the Library, uncombined with any other library facilities. This must be distributed under the terms of the Sections above.

b) Give prominent notice with the combined library of the fact that part of it is a work based on the Library, and explaining where to find the accompanying uncombined form of the same work.

8. You may not copy, modify, sublicense, link with, or distribute the Library except as expressly provided under this License. Any attempt otherwise to copy, modify, sublicense, link with, or distribute the Library is void, and will automatically terminate your rights under this License. However, parties who have received copies, or rights, from you under this License will not have their licenses terminated so long as such parties remain in full compliance.

9. You are not required to accept this License, since you have not signed it. However, nothing else grants you permission to modify or distribute the Library or its derivative works. These actions are prohibited by law if you do not accept this License. Therefore, by modifying or distributing the Library (or any work based on the Library), you indicate your acceptance of this License to do so, and all its terms and conditions for copying, distributing or modifying the Library or works based on it.

10. Each time you redistribute the Library (or any work based on the Library), the recipient automatically receives a license from the original licensor to copy, distribute, link with or modify the Library subject to these terms and conditions. You may not impose any further restrictions on the recipients' exercise of the rights granted herein.

You are not responsible for enforcing compliance by third parties with this License.

11. If, as a consequence of a court judgment or allegation of patent infringement or for any other reason (not limited to patent issues), conditions are imposed on you (whether by court order, agreement or otherwise) that contradict the conditions of this License, they do not excuse you from the conditions of this License. If you cannot distribute so as to satisfy simultaneously your obligations under this License and any other pertinent obligations, then as a consequence you may not distribute the Library at all. For example, if a patent license would not permit royalty-free redistribution of the Library by all those who receive copies directly or indirectly through you, then the only way you could satisfy both it and this License would be to refrain entirely from distribution of the Library.

If any portion of this section is held invalid or unenforceable under any particular circumstance, the balance of the section is intended to apply, and the section as a whole is intended to apply in other circumstances.

It is not the purpose of this section to induce you to infringe any patents or other property right claims or to contest validity of any such claims; this section has the sole purpose of protecting the integrity of the free software distribution system which is implemented by public license practices. Many people have made generous contributions to the wide range of software distributed through that system in reliance on consistent application of that system; it is up to the author/donor to decide if he or she is willing to distribute software through any other system and a licensee cannot impose that choice.

This section is intended to make thoroughly clear what is believed to be a consequence of the rest of this License.

12. If the distribution and/or use of the Library is restricted in certain countries either by patents or by copyrighted interfaces, the original copyright holder who places the Library under this License may add an explicit geographical distribution limitation excluding those countries, so that distribution is permitted only in or among countries not thus excluded. In such case, this License incorporates the limitation as if written in the body of this License.

13. The Free Software Foundation may publish revised and/or new versions of the Lesser General Public License from time to time. Such new versions will be similar in spirit to the present version, but may differ in detail to address new problems or concerns.

Each version is given a distinguishing version number. If the Library specifies a version number of this License which applies to it and "any later version", you have the option of following the terms and conditions either of that version or of any later version published by the Free Software Foundation. If the Library does not specify a license version number, you may choose any version ever published by the Free Software Foundation.

14. If you wish to incorporate parts of the Library into other free programs whose distribution conditions are incompatible with these, write to the author to ask for permission. For software which is copyrighted by the Free Software Foundation, write to the Free Software Foundation; we sometimes make exceptions for this. Our decision will be guided by the two goals of preserving the free status of all derivatives of our free software and of promoting the sharing and reuse of software generally.

NO WARRANTY

15. BECAUSE THE LIBRARY IS LICENSED FREE OF CHARGE, THERE IS NO WARRANTY FOR THE LIBRARY, TO THE EXTENT PERMITTED BY APPLICABLE LAW.

EXCEPT WHEN OTHERWISE STATED IN WRITING THE COPYRIGHT HOLDERS AND/OR OTHER PARTIES PROVIDE THE LIBRARY "AS IS" WITHOUT WARRANTY OF ANY KIND, EITHER EXPRESSED OR IMPLIED, INCLUDING, BUT NOT LIMITED TO, THE IMPLIED WARRANTIES OF MERCHANTABILITY AND FITNESS FOR A PARTICULAR PURPOSE. THE ENTIRE RISK AS TO THE QUALITY AND PERFORMANCE OF THE LIBRARY IS WITH YOU. SHOULD THE LIBRARY PROVE DEFECTIVE, YOU ASSUME THE COST OF ALL NECESSARY SERVICING, REPAIR OR CORRECTION.

16. IN NO EVENT UNLESS REQUIRED BY APPLICABLE LAW OR AGREED TO IN WRITING WILL ANY COPYRIGHT HOLDER, OR ANY OTHER PARTY WHO MAY MODIFY AND/OR REDISTRIBUTE THE LIBRARY AS PERMITTED ABOVE, BE LIABLE TO YOU FOR DAMAGES, INCLUDING ANY GENERAL, SPECIAL, INCIDENTAL OR CONSEQUENTIAL DAMAGES ARISING OUT OF THE USE OR INABILITY TO USE THE LIBRARY (INCLUDING BUT NOT LIMITED TO LOSS OF DATA OR DATA BEING RENDERED INACCURATE OR LOSSES SUSTAINED BY YOU OR THIRD PARTIES OR A FAILURE OF THE LIBRARY TO OPERATE WITH ANY OTHER SOFTWARE), EVEN IF SUCH HOLDER OR OTHER PARTY HAS BEEN ADVISED OF THE POSSIBILITY OF SUCH DAMAGES.

END OF TERMS AND CONDITIONS

How to Apply These Terms to Your New Libraries

If you develop a new library, and you want it to be of the greatest possible use to the public, we recommend making it free software that everyone can redistribute and change. You can do so by permitting redistribution under these terms (or, alternatively, under the terms of the ordinary General Public License).

To apply these terms, attach the following notices to the library. It is safest to attach them to the start of each source file to most effectively convey the exclusion of warranty; and each file should have at least the "copyright" line and a pointer to where the full notice is found.

<one line to give the library's name and a brief idea of what it does.>
 Copyright (C) <year> <name of author>
 This library is free software; you can redistribute it and/or modify it under the terms of the GNU Lesser General Public License as published by the Free Software Foundation; either version 2.1 of the License, or (at your option) any later version.
 This library is distributed in the hope that it will be useful, but WITHOUT ANY WARRANTY; without even the implied warranty of MERCHANTABILITY or FITNESS FOR A PARTICULAR PURPOSE. See the GNU Lesser General Public License for more details.

You should have received a copy of the GNU Lesser General Public License along with this library; if not, write to the Free Software Foundation, Inc., 59 Temple Place, Suite 330, Boston, MA 02111-1307 USA

Also add information on how to contact you by electronic and paper mail.

You should also get your employer (if you work as a programmer) or your school, if any, to sign a "copyright disclaimer" for the library, if necessary. Here is a sample; alter the names:

Yoyodyne, Inc., hereby disclaims all copyright interest in the library `Frob' (a library for tweaking knobs) written by James Random Hacker. <signature of Ty Coon>, 1 April 1990
 Ty Coon, President of Vice

Accessories

Gigaset handsets

Upgrade your Gigaset to a cordless PABX:

Gigaset S67H or S68H handset

- ◆ HDSP ready
- ◆ Illuminated graphic colour display (65k colours)
- ◆ Illuminated keypad
- ◆ Speaker mode
- ◆ Polyphonic ringers
- ◆ Directory for around 250 entries
- ◆ Picture CLIP
- ◆ SMS (precondition: CLIP must be enabled)
- ◆ Headset socket
- ◆ Bluetooth (Gigaset S68H only)
- ◆ Room monitor

www.gigaset.com/gigasets67h

www.gigaset.com/gigasets68h



Gigaset SL37H handset

- ◆ HDSP ready
- ◆ Illuminated graphic colour display (65k colours)
- ◆ Illuminated keypad
- ◆ Speaker mode
- ◆ Polyphonic ringers
- ◆ Directory for around 250 entries
- ◆ Picture CLIP
- ◆ SMS (precondition: CLIP must be enabled)
- ◆ PC interface e.g. for managing directory entries, ringers and screensavers
- ◆ Headset socket
- ◆ Bluetooth
- ◆ Room monitor
- ◆ Walky-talky function

www.gigaset.com/gigasetsl37h



Gigaset A58H handset

- ◆ Illuminated graphic display
- ◆ Illuminated keypad
- ◆ Speaker mode
- ◆ Polyphonic ringers
- ◆ Directory for around 150 entries
- ◆ SMS (precondition: CLIP must be enabled)

www.gigaset.com/gigaseta58h

**Gigaset S45 handset**

- ◆ Illuminated colour display (4096 colours)
- ◆ Illuminated keypad
- ◆ Speaker mode
- ◆ Polyphonic ringers
- ◆ Directory for around 150 entries
- ◆ SMS (precondition: CLIP must be enabled)
- ◆ Headset socket
- ◆ Room monitor

www.gigaset.com/gigasets45

**Gigaset C47H handset**

- ◆ Illuminated graphic colour display (65k colours)
- ◆ Illuminated keypad
- ◆ Speaker mode
- ◆ Polyphonic ringers
- ◆ Directory for around 150 entries
- ◆ SMS (precondition: CLIP must be enabled)
- ◆ Headset socket
- ◆ Room monitor

www.gigaset.com/gigasetc47h



Accessories

Gigaset repeater

The Gigaset repeater can be used to increase the reception range of your Gigaset handset to the base station.

www.gigaset.com/gigasetrepeater



Gigaset HC450 – door intercom for cordless phones

- ◆ Use the intercom from your cordless phone – no need for a fixed home phone
- ◆ Intuitive user functions using the display keys (open door, switch on entry light)
- ◆ Simple to configure using the handset menu
- ◆ Forward to outside phone numbers (intercom feature)
- ◆ Simple to install and register with the Gigaset system
- ◆ Replaces existing call key – no further cable is needed
- ◆ Supports the existing doorbell and standard door opener
- ◆ Configuration options for the second ringer key (separate intercom call, activating entrance lighting, or function such as first ringer key)

www.gigaset.com/gigasethc450



All accessories are available from your phone retailer.



Only use original accessories. This will avoid possible health risks and personal injury, and also ensure that all the relevant regulations are complied with.

Glossary

A

ADSL Asymmetric Digital Subscriber Line
Special form of **DSL**.

ALG Application Layer Gateway
NAT control mechanism of a router.
Many routers with integrated NAT use ALG. ALG lets the data packets in a VoIP connection pass and adds the public IP address of the secure private network. The router's ALG should be deactivated if the VoIP provider offers a STUN server or an outbound proxy.
See also: **Firewall**, **NAT**, **Outbound proxy**, **STUN**.

Authentication

Restriction of access to a network/service by use of an ID and password to log in.

Automatic ringback

See **Ringback when the call is not answered**.

B

Block dialling

Enter the complete phone number, and correct it if necessary. Then pick up the handset or press the speaker key to dial the phone number.

Broadband Internet access

See **DSL**.

Buddy Subscriber with whom you exchange brief messages on the Internet in real time (chatting).

See also: **Instant messaging**.

C

Call forwarding (call divert) = CF

Automatic forwarding (CF) of a call to a different telephone number. There are three kinds of call forwarding:

- CFU, Call Forwarding Unconditional
- CFB, Call Forwarding Busy
- CFNR, Call Forwarding No Reply

Call swapping

Call swapping allows you to switch between two callers or between a conference call and an individual caller without allowing the waiting caller to listen to the call.

Call waiting = CW

VoIP provider feature. A beep during a call indicates that another caller is waiting. You can accept or reject the second call. You can activate/deactivate the feature.

CF Call Forwarding

See **Call forwarding (call divert) = CF**.

Chatting

Form of communication on the Internet. During a chat, brief messages are exchanged between the communicating parties in real time. Chatting in this sense is understood to be a written form of communication.

Client Application that requests a service from a server.

Codec Coder/decoder

Codec is a procedure that digitises and compresses analogue voice before it is sent via the Internet, and decodes – i.e. translates into analogue voice – digital data when voice packets are received. There are different codecs, with differing degrees of compression, for instance.

Both parties involved in the telephone connection (caller/sender and recipient) must use the same codec. This is negotiated between the sender and the recipient when establishing a connection.

The choice of codec is a compromise between voice quality, transmission speed and the necessary bandwidth. A high level of compression, for example, means that the bandwidth required for each voice connection is low. However, it also means that the time needed to compress/decompress the data is greater, which increases execution time for data in the network and thus impairs voice quality. The time required increases the delay between the sender speaking and the recipient hearing what has been said.

COLP/COLR

Connected Line Identification Presentation/Restriction

Service characteristic of a VoIP connection for outgoing calls.

COLP displays the phone number accepting the call on the calling party's display unit.

The number of the party accepting the call is different to the dialled number, e.g. if the call is forwarded or transferred.

The called party can use COLR (Connected Line Identification Restriction) to prevent the number from appearing on the calling party's display.

Consultation call

You are on a call. With a consultation call, you interrupt the conversation briefly to establish a second connection to another participant. If you terminate the connection to this participant immediately, then this was a consultation call. If you switch between the first and second participant, it is called **Call swapping**.

CW

Call Waiting

See **Call waiting**.

D

DHCP

Dynamic Host Configuration Protocol

Internet protocol that handles the automatic assignment of **IP addresses** to **Network subscriber**. The protocol is made available in the network by a server. A DHCP server can, for example, be a router.

The phone contains a DHCP client. A router that contains a DHCP server can assign the IP addresses for the phone automatically from a defined address block. The dynamic assignment means that several **Network subscribers** can share one IP address, although they can only use it alternatively and not simultaneously.

With some routers you can specify that the IP address for the phone is never changed.

Displayed name

VoIP provider feature. You can specify any name that is to be shown to the other party during a call instead of your phone number.

DMZ (Demilitarised Zone)

DMZ describes a part of a network that is outside the firewall.

A DMZ is set up, as it were, between a network you want to protect (e.g. a LAN) and a non-secure network (e.g. the Internet). A DMZ permits unrestricted access from the Internet to only one or a few network components, while the other network components remain secure behind the firewall.

Glossary

- DNS** Domain Name System
Hierarchical system that permits the assignment of **IP addresses** to **Domain names** that are easier to note. This assignment has to be managed by a local DNS server in each (W)LAN. The local DNS server determines the IP address, if necessary by enquiring about superordinate DNS servers and other local DNS servers on the Internet.
You can specify the IP address of the primary/secondary DNS server.
See also: **DynDNS**.
- Domain name**
Name of one (or several) Web server(s) on the Internet (e.g. gigaset.net). The domain name is assigned to the relevant IP address by DNS.
- DSCP** Differentiated Service Code Point
See **Quality of Service (QoS)**.
- DSL** Digital Subscriber Line
Data transfer technology that allows Internet access with, for e.g. **1.5 Mbps**, over a conventional telephone line. Preconditions: DSL modem and the appropriate service offered by the Internet provider.
- DSLAM** Digital Subscriber Line Access Multiplexer
The DSLAM is a switch cabinet in an exchange at which all subscriber connectors converge.
- DTMF** Dual Tone Multi-Frequency
Another description for dual tone multi-frequency dialling (DTMF).
- Dynamic IP address**
A dynamic IP address is assigned to a network component automatically via **DHCP**. The dynamic IP address for a network component can change every time it registers or at certain time intervals.
See also: **Static IP address**
- DynDNS** Dynamic DNS
Domain names and IP addresses are assigned via **DNS**. For **Dynamic IP addresses** this service is enhanced with "Dynamic DNS". This permits the use of a network component with a dynamic IP address as a **Server** on the **Internet**. DynDNS ensures that a service can always be addressed on the Internet under the same **Domain name** irrespective of the current IP address.

E

- ECT** Explicit Call Transfer
Participant A calls participant B. The participant puts the connection on hold and calls participant C. Rather than connect everyone in a three-party conference, A now transfers participant B to C and hangs up.
- EEPROM** Electrically Erasable Programmable Read Only Memory
Memory building block in your phone with fixed data (e.g. default and customised settings) and data saved automatically (e.g. entries to the list of callers).
- Ethernet network**
Wired **LAN**.

F

- Firewall** You can use a firewall to protect your network against unauthorised external access. This involves combining various measures and technologies (hard and/or software) to control the flow of data between a private network you wish to protect and an unprotected network (e.g. the Internet).
See also: **NAT**.
- Firmware** Device software in which basic information is saved for the functioning of a device. To correct errors or update the device software, a new version of the firmware can be loaded into the device's memory (firmware update).
- Flat rate** Billing system for an **Internet** connection. The Internet provider charges a set monthly fee. There are no additional charges for the duration of the connection or number of connections.
- Fragmentation**
Data packets that are too big are split into smaller packets (fragments) before they are transferred. They are put together again when they reach the recipient (defragmented).
- Full duplex** Data transmission is a mode in which data can be sent and received at the same time.

G

G.711 a law, G.711 μ law

Standard for a **Codec**.

G.711 delivers a very good voice quality that corresponds to that in the ISDN fixed line. As there is little compression, the necessary bandwidth is around 64 kbit/s per voice connection, but the delay caused by coding/decoding is only approx. 0.125 ms.

"a law" describes the European standard and " μ law" describes the North American/Japanese equivalent.

G.722

Standard for a **Codec**.

G.722 is a **broadband** language codec with a bandwidth of 50 Hz to 7 kHz, a net transfer rate of 64 kbit/s per language connection and integrated speech pause recognition and comfort noise generation (silence suppression).

G.722 delivers very good voice quality. A higher sampling rate provides clearer and better voice quality than other codecs and enables a speech tone in High Definition Sound Performance (HDSP).

G.726

Standard for a **Codec**.

G.726 delivers a good voice quality. It is inferior to the quality with codec **G.711** but better than with **G.729**.

G.729A/B

Standard for a **Codec**.

The voice quality is more likely to be lower with G.729A/B. As a result of the high level of compression, the necessary bandwidth is only around 8 kbit/s per voice connection, but the delay is around 15 ms.

Gateway

Connects two different **Networks**, e.g. a router as an Internet gateway.

For phone calls from **VoIP** to the telephone network, a gateway has to be connected to the IP network and the telephone network (gateway/VoIP provider). It forwards calls from VoIP to the telephone network as required.

Gateway provider

See **SIP provider**.

Global IP address

See **IP address**.

GSM

Global System for Mobile Communication

Originally, European standard for mobile networks. GSM can now be described as a worldwide standard. However, national standards in the USA and Japan had been more frequently supported up until now.

H

- Headset** Combination of microphone and headphone. A headset makes using speaker mode more convenient. There are headsets available that can be connected to the handset by a cable.
- HTTP proxy** Server via which the **Network subscribers** can process their Internet traffic.
- Hub** Uses one **Infrastructure network** to connect several **Network subscribers**. All data sent to the hub by one network subscriber is forwarded to all network subscribers.
See also: **Gateway**, **Router**.

I

- IEEE** Institute of Electrical and Electronics Engineers
International body that defines standards in electronics and electro-technology, concerned in particular with the standardisation of LAN technology, transmission protocols, data transfer rate and wiring.
- Infrastructure network**
Network with central structure: all **Network subscribers** communicate via a central **Router**.
- Instant messaging**
Service that uses a client program to allow chatting in real time, i.e. to send brief messages to other subscribers on the Internet.
- Internet** Global **WAN**. A series of protocols have been defined for exchanging data, known by the name TCP/IP.
All **Network subscriber** are identifiable via their **IP address**. **DNS** assigns a **Domain name** to the **IP address**.
Important services on the Internet include the World Wide Web (WWW), e-mail, file transfer and discussion forums.
- Internet service provider**
Enables access to the Internet for a fee.
- IP (Internet Protocol)**
TCP/IP protocol on the **Internet**. IP is responsible for addressing subscribers in a **Network** using **IP addresses** and routes data from the sender to the recipient. IP determines the paths (routing) along which the data packets travel.

Glossary

IP address A unique address for a network component within a network based on the TCP/IP protocols (e.g. LAN, Internet). On the **Internet**, domain names are usually assigned instead of IP addresses. **DNS** assigns the corresponding IP address to the domain name.

The IP address has four parts (decimal numbers between 0 and 255) separated by full stops (e.g. 230.94.233.2).

The IP address is made up of the network number and the number of the **Network subscriber** (e.g. phone). Depending on the **Subnet mask**, the front one, two or three parts make up the network number and the rest of the IP address addresses the network component. The network number of all the components in any one network must be identical.

IP addresses can be assigned automatically with DHCP (dynamic IP addresses) or manually (static IP addresses).

See also: **DHCP**.

IP pool range

Range of IP addresses that the DHCP server can use to assign dynamic IP addresses.

L

LAN Local Area Network

Network with a restricted physical range. A LAN can be wireless (WLAN) and/or wired.

Local IP address

The local or private IP address is the address for a network component in the local network (LAN). The network operator can assign any address he wants. Devices that act as a link from a local network to the Internet (gateway or router) have a public and a private IP address.

See also **IP address**.

Local SIP port

See **SIP port / Local SIP port**.

M

MAC address

Media Access Control Address

Hardware address by means of which each network device (e.g. network card, switch, phone) can be uniquely identified worldwide. It consists of 6 parts (hexadecimal numbers) separated by a "-" (e.g. 00-90-65-44-00-3A).

The MAC address is assigned by the manufacturer and cannot be changed.

Mbps Million bits per second

Unit of the transmission speed in a network.

MRU	Maximum Receive Unit Defines the maximum user data volume within a data packet.
MTU	Maximum Transmission Unit Defines the maximum length of a data packet that can be carried over the network at a time.

Music on hold

Music that is played while you are on a **Consultation call** or **Call swapping**. The waiting participant hears music while on hold.

N

NAT	Network Address Translation Method for converting (private) IP addresses to one or more (public) IP addresses. NAT enables the IP addresses of Network subscribers (e.g. VoIP telephones) in a LAN to be concealed behind a shared IP address for the Router on the Internet . VoIP telephones behind a NAT router cannot be reached by VoIP servers (on account of the private IP address). In order to "get around" NAT, it is possible to use (alternatively) ALG in the router, STUN in the VoIP telephone, or for the VoIP provider to use an Outbound proxy . If an outbound proxy is made available you must allow for this in the VoIP settings for your phone.
Network	Group of devices. Devices can be connected in either wired or wireless mode. Networks can also differ in range and structure: <ul style="list-style-type: none"> – Range: local networks (LAN) or wide-area networks (WAN) – Structure: Infrastructure network or ad-hoc network

Network subscriber

Devices and PCs that are connected to each other in a network, e.g. servers, PCs and phones.

O

Outbound proxy

Alternative NAT control mechanism to STUN and ALG.

Outbound proxies are implemented by the VoIP provider in firewall/NAT environments as an alternative to **SIP proxy server**. They control data traffic through the firewall.

Outbound proxy and STUN servers should not be used simultaneously.

See also: **STUN** and **NAT**.

P

Paging (handset search)

A base station function to locate registered handsets. The base station establishes a connection to every registered handset. The handsets start to ring. Paging is activated by briefly pressing the key on the base station and is deactivated by briefly pressing the same key again.

PIN

Personal Identification Number

Protects against unauthorised use. When the PIN is activated, a number combination has to be entered in order to access a protected area.

You can protect your base station configuration data with a system PIN (4-digit number combination).

Port

Data is exchanged between two applications in a **Network** via a port.

Port forwarding

The Internet gateway (e.g. your router) forwards data packets from the **Internet** that are directed to a certain **Port** to the port concerned. This allows servers in the **LAN** to offer services on the Internet without you needing a public IP address.

Port number

Indicates a specific application of **Network subscriber**. Depending on the setting in the **LAN**, the port number is permanently assigned or else it is newly assigned with each access.

The combination of **IP address/Port** number uniquely identifies the recipient or sender of a data packet within a network.

Pre-dialling See **Block dialling**.

Private IP address

See **Public IP address**.

Protocol

Describes the agreements for communicating within a **Network**. It contains rules for opening, administering and closing a connection, about data formats, time frames and possible error handling.

Proxy/Proxy server

Computer program that controls the exchange of data between **Client** and **Server** in computer networks. If the phone sends a query to the VoIP server, the proxy acts as a server towards the phone and as a client towards the server. A proxy is addressed via **IP address/Domain name** and **Port**.

Public IP address

The public IP address is the address for a network component on the Internet. It is assigned by the Internet Service Provider. Devices that act as a link from a local network to the Internet (gateway, router) have a public and a local IP address.

See also: **IP address, NAT**

Q

Quality of Service (QoS)

Describes the Quality of Service in communication networks. Differentiations are made between various Quality of Service classes.

QoS influences the flow of data packets on the Internet, e.g. by prioritising data packets, reserving bandwidth and data packet optimisation.

In VoIP networks, QoS influences the voice quality. If the whole infrastructure (router, network server etc.) has QoS, the voice quality is better, i.e. fewer delays, less echoing, less crackling.

R

RAM Random Access Memory

Memory in which you have reading and storage rights. Items such as melodies and screen pictures are saved in the RAM after you have loaded them onto the phone via the Web configurator.

Registrar The registrar manages the **Network subscribers'** current IP addresses. When you register with your VoIP provider, your current IP address is saved on the registrar. This means you can also be reached when on the move.

ROM Read Only Memory

A type of memory that can only be read.

Router Routes data packets within a network and between different networks via the quickest route. Can connect **Ethernet networks** and WLAN. Can be a **Gateway** to the Internet.

Routing Routing is the transfer of data packets to another subscriber in your network. On their way to the recipient, the data packets are sent from one router to the next until they reach their destination.

If data packets were not forwarded in this way, a network like the Internet would not be possible. Routing connects the individual networks to this global system.

A router is a part of this system; it transfers data packets both within a local network and from one network to the next. Transfer of data from one network to another is performed on the basis of a common protocol.

RTP Realtime Transport Protocol

Global standard for transferring audio and video data. Often used in conjunction with UDP. In this case, RTP packets are embedded in UDP packets.

RTP port (Local) **Port** that is used to send and receive voice data packets for VoIP.

Glossary

Ringback when the call is not answered

= CCNR (Completion of Calls on No Reply). If a participant does not respond when called, a caller can arrange an automatic ringback. As soon as the destination phone has completed a call and is free again, the caller is rung back. This feature must be supported by the exchange. The ringback request is automatically cancelled after about 2 hours (depending on the VoIP provider).

Ringback when the number is busy

= CCBS (Completion of Calls to Busy Subscriber). If a caller hears the busy tone, he or she can activate the ringback function. As soon as the connection is free the caller is rung back. As soon as the caller lifts the receiver the connection is made automatically.

S

Server Provides a service to other **Network subscribers (Clients)**. The term can indicate a computer/PC or an application. A server is addressed via **IP address/ Domain name** and **Port**.

SIP (Session Initiation Protocol)

Signalling protocol independent of voice communication. Used for establishing and ending a call. It is also possible to define parameters for voice transmission.

SIP address

See **URI**.

SIP port / Local SIP port

(Local) **Port** that is used to send and receive SIP signalling data for VoIP.

SIP provider

See **VoIP provider**.

SIP proxy server

IP address of your VoIP provider's gateway server.

Static IP address

A static IP address is assigned to a network component manually during network configuration. Unlike a **Dynamic IP address**, a static IP address does not change.

STUN Simple Transversal of UDP over NAT

NAT control mechanism.

STUN is a data protocol for VoIP telephones. STUN replaces the private IP address in the VoIP telephone data packets with the public address of the secure private network. To control data transfer, a STUN server is also required on the Internet. STUN cannot be implemented with symmetric NATs.

See also: **ALG, Firewall, NAT, Outbound proxy**.

Subnet Segment of a **Network**.

Subnet mask

IP addresses consist of a fixed network number and a variable subscriber number. The network number is identical for all **Network subscribers**. The size of the network number part is determined in the subnet mask. In the subnet mask 255.255.255.0, for example, the first three parts of the IP address are the network number and the last part the subscriber number.

Symmetric NAT

A symmetric NAT assigns different external IP addresses and port numbers to the same internal IP addresses and port numbers – depending on the external target address.

T

TCP Transmission Control Protocol

Transport protocol. Session-based transmission protocol: it sets up, monitors and terminates a connection between sender and recipient for transporting data.

TLS Transport Layer Security

Protocol for encrypting data transmissions on the Internet. TLS is a superordinated **Transport protocol**.

Transmission rate

Speed at which data is transmitted in the **WAN** or **LAN**. The transmission rate is measured in data units per unit of time (Mbit/s).

Transport protocol

Controls data transport between two communication partners (applications). See also: **UDP**, **TCP**, **TLS**.

U

UDP User Datagram Protocol

Transport protocol. Unlike **TCP**, **UDP** is a non session-based protocol. UDP does not establish a fixed connection. The data packets ("datagrams") are sent as a broadcast. The recipient is solely responsible for making sure the data is received. The sender is not notified about whether it is received or not.

URI Uniform Resource Identifier

Character sequence for identifying resources (e.g. e-mail recipient, `http://gigaset.com`, files).

On the **Internet**, URIs are used as a uniform identification for resources. URIs are also described as SIP addresses.

URIs can be entered in the phone as a number. By dialling a URI, you can call an Internet subscriber with VoIP equipment.

Glossary

URL Universal Resource Locator
Globally unique address of a domain on the **Internet**.
A URL is a subtype of **URI**. URLs identify a resource by its location on the **Internet**. For historical reasons the term is often used as a synonym for URI.

User ID See **User identification**.

User identification

Name/number combination for access, e.g. to your VoIP account.

V

Voice codec

See **Codec**.

VoIP

Voice over Internet Protocol

Telephone calls are no longer placed and transmitted over the telephone network but over the **Internet** (or other IP networks).

VoIP provider

A VoIP, SIP or **Gateway provider** is an Internet service provider that provides a **Gateway** for Internet telephony. As the phone works with the SIP standard, your provider must support the SIP standard.

The provider routes calls from VoIP to the telephone network (analogue, ISDN and mobile) and vice versa.

W

WAN

Wide Area Network

Wide-area network that is unrestricted in terms of area (e.g. **Internet**).

Index

A

Access code (PABX) 171
 Access protection 161
 Access to Web configurator
 from other networks 182
 Accessories 250
 Account name (e-mail) 213
 Acknowledge tones 157
 Activating
 advisory tones 157
 annex B for G.729 198
 answering machine 119
 answering machine from
 external location 128
 appointment 134
 auto answer 155
 handset 1, 36
 keypad lock 36
 muting ringer 96
 network mailbox 129, 207
 repeater mode 163
 room monitor 144
 speaker 53
 two-way recording 124
 withholding phone numbers 60
 Address assignment (IP address) 181
 ADSL 253
 Advisory tones 157
 Alarm clock 137
 Alert tone, activating/deactivating 157
 ALG 253
 Alternative DNS server
 (Web configurator) 182
 Anniversary
 deactivating 77
 displaying missed ones 136
 missed 77, 136
 saving 76
 Announce only mode (ans. mach.) 118
 Announcement (ans. mach.) 121
 Anonymous calling 60
 Answer and record mode
 (ans. mach.) 118
 Answering machine 118
 activating/deactivating 119
 assigning receive numbers 202

 deleting messages 123
 playing back messages 121
 recording announcement/
 notification 120
 remote operation 127
 scrolling back 122
 scrolling forward 122
 Answering machine list 70
 Application Layer Gateway (ALG) 253
 Application signal (recall key) 208
 Application type (recall key) 208
 Appointment call 135
 Appointments 134
 activating/deactivating 135
 deleting 135
 displaying missed ones 136
 managing 135
 Area code
 dialling automatically 203
 entering own 203
 setting own area code 160
 Area code pre-dialling
 activating/deactivating 203
 Assigning a key 153
 Assigning send number to handset 200
 Asymmetric Digital Subscriber Line 253
 Attaching the belt clip 31
 Audio (DTMF signalling) 208
 Authentication 253
 Authorisation 234
 Auto answer 48
 activating/deactivating 155
 Auto-configuration code 22, 187
 Automatic configuration
 of a VoIP connection 187
 Automatic redial 66
 Automatic version check 221
 Available codecs 197
 Away from computer (messenger) 104

B

Base selection 140
 Base station
 activating/deactivating Eco mode 133
 best base station 140
 changing system PIN 161
 checking service information 233
 connecting 19
 connecting with fixed line network 20
 connecting with mains power

- supply 20
- connecting with router 21
- operating on PABX 171
- power consumption 237
- reducing power consumption 133
- reducing transmission power 133
- restoring factory settings 162
- selecting 140
- setting 161
- setting default line 164, 199
- setting up. 18
- system PIN 161
- updating firmware 164, 220
- wall mounting 280

Battery

- charge status 2
- charging. 1, 15
- display 1, 15
- icon 1, 15
- inserting 14
- recommended batteries 236
- tone 157

Beep 157

Best base station 140

Birthday, see **Anniversary**

Block dialling 253

Bluetooth

- accepting a call. 48
- activating/deactivating 146
- changing device name 148, 149
- de-registering device 148
- list of known devices. 148
- registering device 147
- transferring directory (vCard) 75

Broadband connections 11

Broadband Internet access 253

Broadband voice codec 195, 258

Browser, operating. 115

Buddy 102, 253

- buddy messages. 109
- calling 111
- checking information 107
- list 102
- opening list 106
- status changes 107

Busy (messenger) 104

Buttons (Web configurator) 179

C

Calendar. 134

Call

- accepting 48
- accepting (Bluetooth). 48
- disconnecting (call swapping) 62, 64
- ending 48
- external. 51
- forwarding (VoIP) 65
- incoming. 2
- internal. 141
- number/name display 49
- picking up from ans. mach 123
- rejecting external. 143
- transferring (connecting) 142
- two-way recording. 124

Call acceptance. 125

- automatic 155

Call display 49

- fixed line network 49
- name from online directory 50, 215
- VoIP 50

Call duration display 82

Call forwarding 254

- fixed line network 61
- Gigaset.net 63, 202
- VoIP 65
- VoIP (handset). 63
- VoIP (Web configurator). 202

Call forwarding (call divert) 254

Call screening during recording 124

Call swapping 254

- disconnecting call 62, 64
- fixed line network 62
- VoIP 64

Call waiting 254, 255

- accepting/rejecting
 - (fixed line network). 62
- accepting/rejecting (VoIP). 65
- activating/deactivating
 - (fixed line network). 61
- activating/deactivating (VoIP) 64
- internal call 143

Call-by-call list. 71

- key 1

Call-by-call numbers 72, 82

Caller picture 49, 72, 158

Calling

- anonymously. 60
- entering IP address 46

- external 44
 - from classified directory 80
 - from online directory 80
 - Gigaset.net. 58, 59
 - internal 141
 - via VoIP/fixed line network 44
 - Calling Line Identification 49
 - Calling Line Identification
 - Presentation 49
 - Calls list. 68
 - Cancelling
 - dialling. 46
 - operation 34, 179
 - Care of the telephone 236
 - CF 254
 - CF, see Call forwarding
 - Changing
 - earpiece volume 155
 - internal number 140, 216
 - speaker volume 155
 - system PIN 161
 - to British summertime 222
 - Character set table, see
 - Special characters
 - Charge status display (battery) 1, 15
 - Charge status of the batteries. 2
 - Charging cradle
 - connecting 15, 280
 - wall mounting 280
 - Chatting 102, 254
 - with buddies 107
 - Checking EEPROM version 223
 - Checking service information 233
 - Classified directory. 78
 - CLI 49
 - Client 254
 - CLIP. 49
 - Codecs 254
 - available. 197
 - Colour scheme (display) 151
 - COLP 52, 255
 - COLR. 52, 255
 - Conference call 142
 - fixed line network. 62
 - VoIP. 64
 - Configuration
 - via PC. 173
 - VoIP connection (automatic) 187
 - Configuring
 - VoIP connection (handset) 167
 - VoIP connection (Web config.) 184
 - Confirmation tone. 157
 - Connected Line Identification
 - Presentation/Restriction 52, 255
 - Connecting
 - PC to the Web configurator. 174
 - phone to internal company
 - network 183
 - to the Web configurator. 174
 - Connection
 - activating (VoIP) 193
 - Internet (troubleshooting) 29
 - name/provider (Web config.) 184
 - selecting (line suffix) 44, 46
 - to Gigaset.net 194
 - to internal company network 183
 - to messenger server. 103
 - Connection assistant
 - starting (getting started) 22
 - Connection name
 - fixed line network 193
 - VoIP 186
 - Connection socket for headset. 1, 31
 - Connection type
 - selecting (display key) 44, 45
 - selecting (talk key). 44
 - Consultation call
 - ending 142
 - external (fixed line network) 62
 - external (VoIP). 64
 - internal 33, 142
 - Contrast (display) 151
 - Control key 1
 - functions. 33
 - Correcting incorrect entries 34
 - Cost control 9, 82
 - defining dialling plans 204
 - Cost saving function
 - (remote operation) 125
 - Customer Care 224
 - CW. 255
- ## D
- Data packets, fragmentation 257
 - Data server for firmware update 220
 - Date
 - set manually 16
 - transferring from time server 222
 - Deactivating
 - advisory tones. 157

Index

answering machine	119	editing via PC.	217
appointment	134	Gigaset.net	57
appointment reminder	135	loading from PC.	218
auto answer	155	opening	33, 78
handset	1, 36	order of entries	241
keypad lock	36	saving anniversary	76
muting ringer	96	saving entry	72
network mailbox.	129, 207	saving numbers from SMS text	90
repeater mode	163	searching for an entry	79
room monitor.	145	selecting entry.	73
speaker	53	sending entry/list to handset	74
two-way recording	124	storing SMS sender's number	90
withholding phone numbers.	60	transferring a vCard (Bluetooth)	75
Default settings, handset	160	transferring to/from PC.	217
Delete key	34	using to enter numbers	76
Deleting		Directory file	
announcement for ans. mach.	121	content (vCard format)	219
characters	34	Display	
e-mail	101	appointment/alarm activated	2
message.	123	call duration	82
Demilitarised Zone.	255	caller's number (CLI/CLIP).	49
De-registering		changing display language.	150
from Web configurator	176	charge status of the batteries	2
handset from base station.	139	colour scheme/contrast	151
Destination number		in idle status	1
room monitor.	144	incoming call.	2
Device (Bluetooth)		keypad lock	2
changing name	148, 149	lighting	152
de-registering.	148	memory (directory)	74
registering	147	memory (resource directory)	159
DHCP.	255, 256	missed appointment/anniversary	136
Dialling		name from online directory	50, 215
cancelling.	46	ringer deactivated	2
IP address.	46	screensaver	151
using quick dial.	74, 153	setting	151
with directory.	73	wrong language	150
Dialling plans	9, 82, 204	Display keys	1, 34
activating/deactivating	206	assigning a number/function	153
defining	205	change assignment	154
deleting	206	Displayed name (VoIP).	189, 255
for emergency numbers	206	Disposal	235
Differentiated Service Code Point	256	DMZ.	255
Digit key		DNS	256
assigning a number/function.	153	DNS server	
Digital Subscriber Line	256	alternative (Web configurator)	182
Digital Subscriber Line		preferred (handset)	169
Access Multiplexer.	256	preferred (Web configurator)	182
Directory	71	Do not disturb (messenger).	104
copying number	76	Domain	190
deleting (Web configurator)	218	Domain name.	256

- Domain Name System 256
- Draft message list (SMS) 87
- DSCP 256
- DSL 256
- DSLAM 256
- DTMF (tone dialling) 172
- DTMF-reminder for VoIP 208
- Dynamic DNS 256
- Dynamic Host Configuration Protocol 255
- Dynamic IP address 181, 256
- DynDNS 256
- E**
- Earpiece volume 155
- EATONI (predictive text) 240
- Echo service of Gigaset.net. 55
- ECO DECT 133
- Eco mode 133
- E-mail
 - account name 213
 - entering access data 213
 - incoming e-mail server 213
 - list 98
 - messages whilst making
 - a connection 99
 - notification 98
 - registration name/password 213
 - settings (Web config.) 213
 - SMS to an e-mail address 88
 - viewing the sender's address 101
- Emergency number
 - dialling 47
 - dialling plans for 206
 - when keypad lock is active 8
- End call key 1, 46, 48
- Ending, call 48
- Entering
 - access data (e-mail) 213
 - Arabic characters 84, 178
 - Cyrillic characters 84, 178
 - Cyrillic/Arabic characters 84, 178
 - flash 1
 - pause 1
 - user data (VoIP), with handset 27
- Error handling
 - messenger 112
- Error tone 157
- Ethernet network 257
- Example
 - menu input 37
- Explicit Call Transfer 257
- External call 255
 - accepting 48
 - forwarding to ans. mach. 123
- External consultation call
 - fixed line network 62
 - VoIP 64
- External line prefix (PABX) 171
- F**
- Factory settings
 - base station 162
- Fast access 130
 - answering machine 126
 - directory entries 74
- Firewall 257
- Firmware 257
 - automatic update 165, 221
 - checking version 223, 233
 - starting update (handset) 164
 - starting update (Web conf.) 220
 - updates 13
- Fixed line network
 - accepting/rejecting call waiting 62
 - activating/deactivating call waiting 61
 - anonymous calling 60
 - call forwarding (diverting) 61
 - call swapping 62
 - cancelling ringback 63
 - conference call 62
 - connection name 193
 - enter network mailbox 129
 - external consultation call 62
 - settings for calls 62
 - withholding phone numbers 60
- Fixed line network connection
 - creating settings 61
 - line suffix 185
- Flat rate 257
- Fragmentation of data packets 257
- Free software, licences 242
- Full duplex 257
- G**
- G.711 μ law 195
- G.711 a law 195
- G.722 11, 195
- G.722 broadband language codec 195
- G.726 195

Index

G.729 195
Gateway 258
Gateway provider 258
Gigaset config 174
Gigaset HDSP, see HDSP
Gigaset.net 55
 (de)activating the connection 194
 call forwarding 63, 202
 calling participant 58, 59
 changing/deleting own name 59
 directory 57
 Echo service 55
 entering name 56, 59
 Jabber server 212
 messaging 212
 searching for subscribers 57
Global IP address 258
Global System for
 Mobile Communication 258
GNU Lesser General Public License . . 242
Going online (messenger) 103
Group call 141
GSM 258

H

Handset
 activating/deactivating 1, 36
 activating/deactivating advisory
 tones 157
 assigning a receive number 200
 assigning a send number 200
 base station selection 140
 changing internal names 141, 216
 changing internal number 140, 216
 changing name 141, 216
 changing to a different base
 station 140
 changing to best reception 140
 checking service information 234
 contact with liquid 236
 de-registering 139
 display language 150
 display lighting 152
 earpiece volume 155
 idle status 36
 list 33, 216
 locating 140
 mode 53
 muting 54
 operating 33

 registering 17, 138
 resetting 160
 restoring to factory settings 160
 screensaver 151
 setting (individual) 150
 setting up 14
 speaker volume 155
 transferring a call 142
 using room monitor 144
 using several 138
 volume 33
Handset directory, see Directory
Handset operating time
 in room monitor mode 144
Hash key 1, 36
HDSP 9, 11, 195
Headset 1, 31, 259
Hearing aids 8
High Definition Sound Performance,
 see HDSP
HTTP proxy 183, 259
Hub 259

I

Icon
 alarm clock 137
 answering machine 119
 battery 15
 new message 121
 new messenger message 108
 new SMS 88
 ringer deactivated 157
Idle status
 back to 36
 display 1
IEEE 259
Inbox (e-mail)
 opening 98
Incoming e-mail server (e-mail) 213
Incoming message list
 opening (SMS) 88
Incorrect input (correction) 34
Info Center 113
Info messages (messenger) 109
Info services (SMS) 95, 214
 configuring 214
Infrastructure network 259
Input language (message) 241
Installing, base station 18
Instant messaging 102, 211, 259

preconditions 102
 Institute of Electrical and
 Electronics Engineers 259
 Interface language
 handset 150
 Web configurator 175
 Internal call 141
 call waiting 143
 Internal company network 183
 Internal consultation call 33, 142
 Internet 259
 no connection to 29
 Internet access (broadband) 253
 Internet protocol 259
 Internet Service Provider 259
 Intranet 183
 IP 259
 IP address 260
 assigning (handset) 168
 assigning (Web configurator) 181
 automatically obtaining one . 168, 181
 checking (handset) 168
 checking (Web configurator) 223
 dialling 46
 display on handset 2
 dynamic 256
 global 258
 local 260
 private 262
 public 262
 static 264
 IP address type 168, 181
 IP configuration
 handset 168
 Web configurator 181
 IP pool range 260

J

Jabber ID (messenger) 212
 Jabber server (messenger) 212
 Jabber server port (messenger) 212

K

Key 1 (fast access) 1, 126
 assigning 130
 Key tones 157
 Keypad lock 8, 36
 Keypad, change configuration 154
 Keys
 assigning directory entry 74

call-by-call 1
 cancel key 34
 control key 1, 33
 delete key 34
 display keys 1, 34
 end call key 1, 46, 48
 fast access 1, 126
 hash key 1, 36
 keypad lock 36
 message key 1, 67
 on/off key 1
 paging key (base station) 2
 quick dial 74
 recall key 1
 speaker key 1
 star key 1, 157
 talk key 1

L

LAN 260
 Language
 handset/display 150
 Web configurator 175
 LGPL 242
 Licences, free software 242
 Line suffix
 dialling with 44, 46
 display (Web configurator) 185
 Line type
 for outgoing calls 199
 Linking, see SMS
 Liquid 236
 List
 answering machine list 70
 calls list 68
 e-mail notifications 98
 handsets 33, 216
 known devices (Bluetooth) 148
 missed calls 68
 network mailbox 131
 redial list 66
 Local Area Network 260
 Local communication ports 210
 Local IP address 260
 Local network 181
 Local SIP port 264
 Lock (keypad lock) 36
 Login password (messenger) 212
 Lost connection
 messenger 104, 112

M

- MAC address 260
 - checking (handset) 170
 - checking (Web configurator) 223
- Mailbox
 - define for fast access 130
- Mailbox ID, see SMS
- Mailboxes, see SMS
- Main menu 35, 39
- Mains adapter 8
- Making calls
 - accepting a call 48
 - cost-effective calls 82
 - external (VoIP, fixed line network) 44
 - internal 141
- Maximum Receive Unit 261
- Maximum Transmission Unit 261
- Mbps. 260
- Media Access Control 260
- Medical appliances. 8
- Memory
 - directory 74
 - resource directory. 159
- Menu
 - end tone 157
 - going back one menu level 34
 - menu guidance 35
 - menu input 37
 - opening 33
 - phone overview 39
 - Web configurator overview 43
- Menu bar (Web configurator) 177
- Message
 - answering machine list 70
 - deleting (ans. mach.) 123
 - deleting (e-mail). 101
 - deleting (messenger) 109
 - marking as "new" (ans. mach.) 122
 - new message icon 121
 - playback via remote operation. 128
 - playing (network mailbox) 131
 - playing back (ans. mach.) 70, 121
 - receiving (messenger). 108
 - receiving (SMS) 88
 - writing/sending (messenger). 110
 - writing/sending (SMS) 85
- Message key 1
 - opening lists. 67
- Message list
 - answering machine 70, 121
 - e-mail 98
 - messenger. 108
 - network mailbox 131
 - SMS 88
- Messaging (Gigaset.net) 212
- Messenger 102
 - calling buddy. 111
 - change own status. 104
 - entering access data 211
 - error handling 112
 - errors when sending 112
 - lost connection 104, 112
 - message list. 108
 - priority 211
 - resource name. 211
- Messenger account 212
- Messenger message
 - deleting. 109
 - reading 109
 - receiving 108
 - writing/sending 110
- Messenger server 102
 - establishing a connection. 103
- Microphone 1
 - muting 54
- Million bits per second 260
- Missed
 - anniversary 136
 - appointment. 136
 - calls 68
- MRU. 261
- MTU. 261
- Music. 261
- Music on hold. 53, 54, 163, 261
- Muting
 - first ring 96
 - handset. 54
 - microphone. 53

N

- Name
 - changing name of the
 - handset 141, 216
 - displayed (VoIP). 255
 - fixed line network connection 193
 - of caller from online directory 50, 215
- NAT 261
 - symmetric. 265
 - updating 192

- Navigation area (Web config.) 177
 - Network 261
 - area 191
 - Ethernet 257
 - Network Address Translation 261
 - Network mailbox 129
 - activating/deactivating 129, 207
 - calling 131, 132
 - define for fast access 130
 - entering number 129, 207
 - list 131
 - Network MB, see Network mailbox
 - Network provider (numbers list) 72
 - Network services
 - fixed line network. 61
 - fixed line network and VoIP. 60
 - settings for fixed line network
 - calls. 61, 62
 - settings for VoIP calls 63, 64
 - VoIP. 63
 - Notification
 - incoming e-mail 98
 - via SMS 91
 - Number
 - as destination for room monitor . . 144
 - copying from an SMS text 90
 - copying from directory 76
 - copying to directory 76
 - displaying caller's number (CLIP) . . 49
 - entering network mailbox
 - number 129, 207
 - entering with directory 76
 - saving in the directory. 72
 - Number assignment. 201, 202
 - Numbers list, network provider. 72
- O**
- Offline (messenger). 102, 104
 - On/Off key 1
 - Online (messenger) 102, 104
 - Online directory. 78
 - Gigaset.net. 57
 - registering for access 215
 - select. 215
 - Opening the inbox. 98
 - Opening/closing the battery cover . . 14
 - Operating times of the handset . . . 237
 - Operation (preparing to use the
 - phone) 12
 - Order in directory. 241
 - Outbound proxy 192, 261
 - mode 192
 - port 192
 - Own area code
 - entering 203
 - setting 160
- P**
- PABX
 - access code (external line prefix) . 171
 - operating base station on PABX . . 171
 - pauses 172
 - setting recall 171
 - SMS 96
 - Pack contents 12
 - Paging 2, 140, 262
 - Pauses (PABX). 172
 - PC interface 241
 - Personal Identification Number . . . 262
 - Personal provider data. 189
 - Phone
 - configuring via PC 173
 - functions, overview 39
 - menu overview 39
 - protecting (PIN). 161
 - setting (Web configurator) 180
 - setting base station (on handset) . 161
 - setting up 12
 - Phone connection
 - configuring (handset) 166
 - Phone jack assignment 238
 - Phone status (Web configurator) . . 223
 - Picture
 - deleting. 159
 - renaming 159
 - Picture-CLIP, see Caller picture
 - PIN. 262
 - change system PIN. 161
 - changing. 161
 - Playback (ans. mach.) 70
 - remote operation. 128
 - Playing back
 - announcement (ans. mach.) 121
 - message (ans. mach.) 121
 - POP3 server 213
 - Port 262
 - Port forwarding. 262
 - Port number 262
 - Power consumption
 - of base station. 237

Index

reducing for the base station 133
Pre-dialling 262
Predictive text 240
Preferred DNS server
 entering (handset) 169
 entering (Web configurator) 182
Priority (messenger) 211
Private IP address 262
Problems and solutions 225
Protocol 262
Proxy 262
Proxy server 262
Proxy server address 190
Public IP address 262

Q

Quality of service 263
Questions and answers 225
Quick dial 71, 74, 153

R

RAM 263
Random Access Memory 263
Read Only Memory 263
Reading message (messenger) 109
Reading the subject (e-mail) 100, 101
Ready to chat (messenger) 104
Recall 142
Recall key 1
 function for VoIP 208
Receive number
 answering machine 118
 assigning to answering machine 202
 assigning to handset 200
 display on the handset 49, 50
Recording
 announcement/notification
 (answering machine) 120
 quality (ans. mach.) 126
 time (ans. mach.) 125
 two-way recording 124
Redial 66
Registering
 handset 17, 138
 with the Web configurator 175
Registrar 263
 server 190
 server port 190
Registration name
 e-mail 213

VoIP account 167, 189
Registration password
 e-mail 213
 VoIP account 27, 167, 189
Registration refresh time 190
Reminder call (anniversary) 77
Remote access to Web configurator 182
Remote management 182
Remote operation 127
Resetting
 base station 162
 handset 160
Resource directory 158
Resource name (messenger) 211
RFC 2833 (DTMF signalling) 208
Ringback
 cancelling (fixed line network) 63
 initiating (fixed line network) 62
 when busy 264
 when the call is not answered 264
Ringer
 activating/deactivating 157
 changing 156
 deactivating permanently 157
 muting 48
 muting first 96
 setting melody 156
 setting volume 156
Ringer icon 2
ROM 263
Room monitor 144
Router 263
 connecting base station 21
Routing 263
RTP 263
RTP port 210, 211, 263

S

Safety precautions 8
Scope of delivery 12
Screensaver 151
Searching
 for subscribers on Gigaset.net 57
 handset 140
 in directory 73
Selecting announcement mode
 (ans. mach.) 119
Send number
 selecting via line suffix 46
Sender's address (e-mail) 101

- Sensitivity (room monitor) 145
- Server 264
 - for firmware update 220
- Server port 190
- Service 224
- Setting
 - base station 161
 - date/time on handset 16
 - default line. 164, 199
 - handset 150
 - online directory 215
 - recall (PABX). 171
 - ringer. 156
 - screensaver 151
 - time zone. 222
- Settings for VoIP telephony. 186
- Shortcut (digit combination) 39
- Signal strength 1
- Signal tone, see Advisory tones
- Simple Transversal of UDP over NAT . 264
- SIP 264
- SIP address 264
- SIP Info (DTMF signalling). 208
- SIP port 210, 211, 264
- SIP provider 264
- SIP proxy server 264
- SMS 83
 - activating/deactivating function . . 96
 - changing mailbox. 93
 - deleting 87
 - diverting 90
 - draft message list 87
 - info services 95, 214
 - input language. 86, 241
 - linked. 84
 - mailbox ID 92
 - notification by SMS. 91
 - notification number 91
 - notification type. 91
 - PIN protection. 92
 - reading 87
 - receiving 88
 - replying to or diverting 90
 - rules 84
 - saving number 90
 - self help with error messages 97
 - sending to a personal mailbox. 93
 - sending to an e-mail address. 88
 - setting up a mailbox 92
 - status report. 86
 - troubleshooting. 97
 - writing/sending 85
- SMS centre
 - changing number 93
 - setting 93
- SMS to PABXs 96
- Snooze mode (alarm clock) 137
- Sound, see Ringer
- Speaker
 - activating/deactivating. 53
 - key 1
 - mode 53
- Special characters 238
- Specifications 236
- Standard gateway
 - entering (handset). 169
 - entering (Web configurator). 181
- Star key 1, 157
- Starting connection assistant
 - (menu) 166
- State of presence (messenger). 102, 104
 - setting own 104
- Static IP address 181, 264
- Status
 - buddy 102
 - changing own (messenger) 104
 - VoIP connection. 185
- Status codes
 - activating display (Web config.) . . 219
- Status codes (VoIP)
 - activating display (handset) 170
 - codes table 230
- Status report (SMS). 86
- Structure of IP address. 260
- STUN 264
- STUN port. 191
- STUN refresh time. 192
- STUN server 191
- Submenu 35
- Subnet 264
- Subnet mask. 265
 - defining (handset). 169
 - defining (Web configurator). 181
- Suffix 185
 - dialling with 44, 46
- Summer time
 - changing automatically to 222
- Suppressing
 - silence 198
 - speech pauses. 198

Index

speech pauses (VoIP) 198
Switching off
 call forwarding (fixed line network) . 61
 call forwarding (VoIP) 63
Switching on
 call forwarding (fixed line network) . 61
 call forwarding (VoIP) 63
Symmetric NAT 265
Synchronisation with time server . . . 222
System settings 161

T

Talk key 1
TCP 265
Telephone connection
 configuring (Web config.) 184
Telephone jack, pin connections . . . 238
Text information
 in idle display mode 214
Text message, see SMS
Time
 set manually 16
 transferring from time server . . . 222
Time server 222
TLS 265
Tone dialling 172
Transferring PC address book
 to directory 217
Transmission Control Protocol 265
Transmission power
 reducing for the base station 133
Transmission rate 265
Transport Layer Security 265
Transport protocol 265
Troubleshooting 225
 e-mail 99
 general (table) 225
 Internet connection 29
 SMS 97

U

UDP 265
Uniform Resource Identifier 265
Universal Resource Locator 266
Unknown 51
Unknown caller 52
URI 265
URL 266
Use random ports 210
User Datagram Protocol 265

User ID 266
User identification 266
User name (VoIP-Account) 167, 189

V

vCard format 219
vcf file 217
Version check, automatic 221
VIP (directory entry) 74
Voice over Internet Protocol 10, 266
Voice quality 195
Voice quality and infrastructure . . . 199
VoIP 266
 accepting/rejecting call waiting . . . 65
 activate/deactivate network
 mailbox 129
 activating/deactivating call waiting . 64
 activating/deactivating status
 message 170
 advantages 10
 anonymous calling 60
 assigning IP address 168
 call forwarding 63, 65
 call swapping 64
 completing settings 28
 conference call 64
 configuring account 186
 configuring account (first) 27
 connection name 186
 enter network mailbox 129
 external consultation call 64
 loading provider data 25, 166, 188
 making call settings 63
 network services 63
 phone number 29, 186
 preconditions 10
 settings (on handset) 166
 show called party's number 52
 starting connection assistant . . . 22, 166
 status codes (table) 230
 withholding phone numbers 60
VoIP connection
 activating/deactivating 185, 193
 automatic configuration 187
 configuring (handset) 166
 configuring (Web configurator) . . . 186
 line suffix 185
 name (Web configurator) 186
 name/provider (Web config.) 184
VoIP provider 266

- downloading data. 25, 166, 188
 - selecting (handset) 25, 166
 - selecting (Web configurator) 188
- VoIP status messages
 - activating display (handset) 170
 - activating display (Web config.) 219
 - status codes table 230
- VoIP telephony
 - settings (Web config.) 186
- VoIP user data
 - entering (connection assistant) 27
 - entering (handset) 167
 - entering (Web configurator) 189
- Volume
 - earpiece volume 33, 155
 - loudspeaker 155
 - ringer 156
 - speaker 33, 155
- W**
- Wall mounting
 - base station 280
 - charging cradle 280
- WAN 266
- Warning tone, see Advisory tones
- Weather forecasts, in idle display
 - mode 117, 214
- Web configurator 173
 - activating VoIP connection 185
 - alternative DNS server 182
 - assign receive number
 - to ans. mach. 202
 - assigning receive number 200, 202
 - assigning send number 200
 - checking EEPROM version 223
 - checking firmware version 223
 - checking IP address 223
 - checking MAC address 223
 - connecting with PC 174
 - creating e-mail settings 213
 - deactivating VoIP connection 185
 - defining IP address 181
 - defining standard gateway 181
 - de-registering 176
 - directory transfer 217
 - DTMF-reminder for VoIP 208
 - firmware update 220
 - interface language 175
 - IP configuration 181
 - local network 181
 - menu 43
 - messenger access data 211
 - name of a VoIP connection 186
 - name/provider of a connection 184
 - number assignment 201, 202
 - opening web page 179
 - phone status 223
 - preferred DNS server 182
 - remote access 182
 - selecting IP address type 181
 - setting phone 180
 - specifying dialling plans 204
 - status of a VoIP connection 185
 - structure of the web pages 176
 - subnet mask 181
- Web interface, see Web configurator
- Web page (Web configurator)
 - opening 179
 - structure 176
- Web server, see Web configurator
- Wide Area Network 266
- Withholding
 - number display 60
 - phone number display 60
- Working area (Web configurator) 178
- Writing
 - editing text 238
 - SMS 85

Mounting the charging cradle to the wall

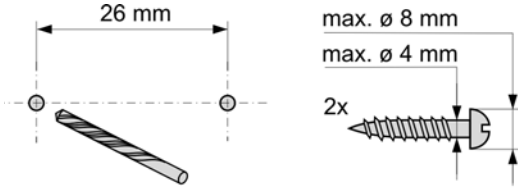

Mounting the base station to the wall

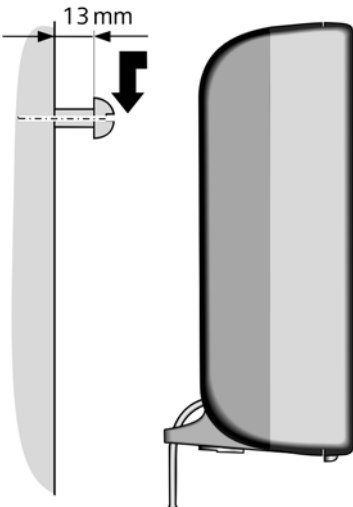
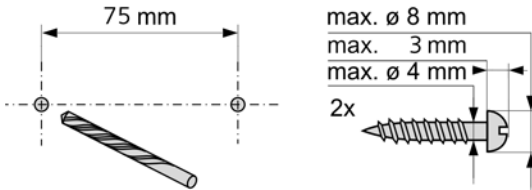



Issued by
Gigaset Communications GmbH
Schlavenhorst 66, D-46395 Bocholt
Gigaset Communications GmbH is a licensee of the Siemens trademark

© Gigaset Communications GmbH 2009
All rights reserved. Subject to availability.
Rights of modification reserved.

www.gigaset.com

