



SINCE 1939

# HALOGEN

POOL SUPPLIES AND EQUIPMENT  
RESIDENTIAL ♦ COMMERCIAL ♦ RECREATIONAL

CATALOG #97

# NON NON NON NON

# ALMOST EVERYTHING FOR YOUR POOL

**1.833.SWIM327** [www.halogensupply.com](http://www.halogensupply.com)

Halogen Supply Co. 4653 W. Lawrence Ave Chicago IL 60630-2588





Since 1939 Halogen has been leading the way in the Swimming Pool Industry. With one of the oldest catalogs in the industry, Halogen has continuously provided high-quality pool and spa products throughout

the United States. Serving Residential, Commercial, and Institutional facilities for over 80 years, we've built our reputation on providing excellent customer service, product expertise, and a huge inventory of in-stock items.

It is our intention that this catalog is used as a valuable resource to provide "almost everything for your pool." More valuable than this catalog is our knowledgeable sales staff, which averages over 25 years' experience. It's these quality people that give your purchases from Halogen "VALUE" you won't receive anywhere else. Whatever your swimming pool supply needs may be, please call toll free at 1-833-SWIM-327. We look forward to serving you.

Halogen Supply Co.

## CONDITIONS OF SALE

**PRICE INFORMATION**—All prices are F.O.B. Chicago unless otherwise stated. DUE TO MARKET CONDITIONS, PRICES ARE SUBJECT TO CHANGE WITHOUT NOTICE. Minimum billing \$10.00. All orders under \$10.00 are cash.

**TAXES**—All Illinois customers are subject to Illinois sales tax of 10.25% and all Michigan customers are subject to 6% sales tax. All tax exempt customers must provide us with proof of exemption in writing.

**SHIPPING**—All orders requiring shipping will be sent via Best Way at Halogen's discretion. All shipping charges plus a \$3.25 handling charge will be added to customers invoice.

**TRANSPORTATION CLAIMS**—All reasonable precautions are taken in packing goods for shipment, but we are unable to be responsible for goods damaged or lost in transit. Recovery claims must be filed with the common carrier by the purchaser within the time limit allowed by such a carrier, the loss or damage claim should be noted on the original copy of the freight bill by the receiver.

**RETURNS**—Merchandise returned for credit must be approved for return by a Halogen authorized representative and must be accompanied by proof of purchase and reason for return. All returns are subject to handling and restocking charges as determined by the product manufacturer and Halogen Supply Company, Inc.

**ORDERING**—Catalog numbers will expedite the shipment. Weights shown are approximate and a separate billing will be necessary where special packaging for export is required.

**TERMS**—Net 30 days where credit rating is satisfactory. A service charge of 1½% per month is charged on invoices over 30 days old.

## INDEX

Page	Description
1	New Products
<b>SECTION A • MAINTENANCE</b>	
2	Poles & Leaf Skimmers
3	Brushes, Scrubbers & Wysiwash Sanitizer
4	Vacuum Heads & Parts
5	Vacuum Hoses, Leaf Traps & Discharge Hose
6	Hayward Automatic Cleaners & Parts
7	Residential Automatic Cleaners & Parts
8	Dolphin Automatic Cleaners & Parts
9	Portable and Hand Held Vacuums
10	Olympic Pool Paint
11	Ramuc Pool Paint
12	Tiles, Grout, Caulk & Sealant
13	Sealers & Patching Material
<b>SECTION B • PUMPS, FILTERS, HEATERS &amp; PARTS</b>	
14	Pentair & Starite Pumps
15	Pentair Pumps & Motors
16	Commercial Pump Parts
17	Pump Parts
18	Replacement Pump Motors
19	Diatomaceous Earth Filters & Sand Filters
20	Cartridge Filters
21	Replacement Filter Cartridges
22	Filter Parts
23	Filter Valves & Valve Parts
24	Pentair Heaters
25	Raypak Heaters
26	Pentair, Coates & Jandy Heaters
27	Hayward Products
28	Heater Parts
29	Heater Parts
<b>SECTION C • PLUMBING SUPPLIES</b>	
30	Plumbing Valves
31	Specialty Tools & Winterizing Products
<b>SECTION D • LIGHTING AND WHITE GOODS</b>	
32	Pool Lights
33	Pool Lights & Replacement Bulbs
34	Cyclocac Pool Fittings & Skimmers
<b>SECTION E • DECK EQUIPMENT</b>	
35	Ladders, Rails & Accessories
36	SR Smith Residential
37	SR Smith Diving Boards, Towers, Starting Platforms & Life Guard Chairs
38	Paragon Dive Towers, Starting Platforms & Lifeguard Chairs
39	Competitor Racing Lanes , Reels & Pace Clocks
39	ADA Compliant Pool Access Lifts

## HOURS

**MONDAY THROUGH FRIDAY:** 8 A.M. to 5 P.M.

**SATURDAY:** 8 A.M. to NOON (Except December, January & February)

**WINTER HOURS:** 8 A.M. to 4 P.M. Monday through Friday

**CLOSED SUNDAYS**

Page	Description
<b>SECTION F • TEST KITS AND SUPPLIES</b>	
40	Taylor Specialty Kits & Reagents
41	Taylor Test Kits
42	Lamotte Test Kits & Accessories
43	Test Kits, Thermometers & Patio Clocks
<b>SECTION G • SAFETY EQUIPMENT</b>	
44	Signs & Safety Lines
45	Safety Equipment & Lifeguard Umbrellas
<b>SECTION H • COVERS, INFLATABLES AND TOYS</b>	
46	Solar Covers & Reels
47	Winter Covers
48	VGB Main Drain & Safety Vacuum Release System
49	VGB Frames & Grates
<b>SECTION I • COMMERCIAL EQUIPMENT</b>	
50	Energy Saving Systems Filters, Variable Frequency Drives, Level Controls & Total System Controllers
51	Flow Meters
52	Level Controllers, Flow Switch, Gauges & Accessories
53	Basket Strainers, Pump Connectors, Thermometers, Sight Glasses & Service Clamps
54	Pulsar Chlorine Feeder Systems & Stenner Peristaltic Pumps
55	Chemical Feeders (Diaphragm, Erosion & Peristaltic), Chemical Storage Tanks
56	Automatic Chemical Controllers ,Ozone Generators - Float Valves, Pipe Flanges & Flange Gaskets
57	Commercial Valves (Butterfly, Check, Float & Solenoid)
58	Chemical Feeder Parts
59	Chemical Feeder Parts, Tubing & Tubing Fittings
60	Chemical Controller Parts & Probes
61	Automation
<b>SECTION J • ABOVE GROUND</b>	
62	A/G Liners & Winterizing Products
<b>SECTION K • SPA ACCESSORIES &amp; SUPPLIES</b>	
63	Spa Accessories
<b>SECTION L • CHEMICALS</b>	
64	King Technology
65	Sea Klear/Nature 2
66	Chemical Water Balance Products
67	Leisure Time Spa Chemicals
68	GLB Pool Products
69	GLB Pool Products
70	Chemicals
71	Chemicals
72	Stabilized Chlorine & Bromine
73	Natural Chemistry

This catalog contains copyrighted materials which may not be reproduced without our consent. Any reproduction or duplication in any form is forbidden.

## SUPERMAX VS VARIABLE SPEED PUMP

The SuperFlo VS Variable Speed Pumps bring the remarkable energy cost savings of variable speed technology to standard pools at an affordable price. They reduce energy costs by up to 80%. SuperFlo VS Variable Speed Pumps have an easy-to-read graphical display and a built-in timer so the pumps are easy to install and easy to use.



### Features:

- Variable speed technology costs significantly less to operate
- Ideal for standard pools requiring up to 1.5 hp pump
- 110/230V and 50/60Hz capability
- Real-time clock with 24-hour memory retention
- Simple, intuitive user interface is easy to program and operate
- Easy to access electrical connections for simple installation
- Three operating speed settings plus override capability
- SuperFlo pump by Pentair Aquatic Systems is a direct replacement for the Hayward® Super Pump®
- WEF 5.9 THP 2.2

CAT.NO.	DESCRIPTION	VOLTS	AMPS	HP	SF	SHIP WT.	PRICE
34-3001	SUPERMAX VS	115/208-230	13.6/8.0-7.1	1.5	1.46	45	\$1,596.50

## VGREEN® VARIABLE SPEED MOTOR

The VGreen variable speed motor by Century is a durable TEFC replacement motor designed to deliver premium energy savings from 40 percent to 80 percent versus a standard single speed motor.



### REPLACE ANY MOTOR WITH A VGREEN MOTOR

The VGreen motor can replace any single speed motor without replacing the pump, turning any pool into a high-efficiency system that is better for the environment and lowers the cost of pool ownership.

### VGREEN EFFICIENCY

- Integrated user interface allows for easier and faster installation
- Durable TEFC construction with ECM technology delivers 40 to 80 percent energy savings versus a single speed motor

### Features:

- Freeze Protection
- Single Phase
- 50/60 Hz
- Full Variable Speed (600-3450 RPM)
- 303 Stainless Steel Shaft
- Class F Insulation
- 40°C Ambient
- UV and Rain-Proof Enclosure
- Digital Inputs for Third Party Automation
- VGreen User Interface\* Compatibility

ITEM ID	THP	FRAME	VOLTS	AMPS	PRICE
ELV08SQ	0.85 MAX	SQFL	115	0.4-10.0	\$890.33
ELV08C	0.85 MAX	C-FACE	115	0.4-10.0	\$890.33
ECM16SQU	1/2-1.65 MAX	SQFL	208-230	10.5-10.0	\$890.33
ECM16CU	1/2-1.65 MAX	C-FACE	208-230	10.5-10.0	\$890.33
ECM27SQU	3/4-2.7 MAX	SQFL	230	10.5	\$1,486.42
ECM27CU	3/4-2.7 MAX	C-FACE	230	10.5	\$1,486.42

## INTELLIPRO® VSF

### VARIABLE SPEED AND FLOW PUMP

IntelliPro VSF pump is the first variable speed and flow pump that adjusts to changes in flow conditions to maintain its preprogrammed flow rate to run optimally throughout the entire filtration cycle. It's like having cruise control for your pump.



### Features:

- Eight programmable speed or flow settings and built-in timer
- Rotatable keypad with optional wall mount kit (sold separately)
- Top-mounted field wiring compartment is easier to access and connect
- Totally enclosed fan-cooled design for increased performance and long life
- Menus are easier than ever to use
- Precisely maintains system flow requirements
- Compatible with Pentair Automation
- WEF 6.6 THP 3.95

CAT.NO.	DESCRIPTION	VOLTS	AMPS	HP	SF	SHIP WT.	PRICE
01-3004	INTELLIPRO VSF	230	16	3	1.32	57	\$2,354.92

## INTELLIFLO® VSF

### VARIABLE SPEED AND FLOW PUMP

IntelliFlo VSF pump is the first variable speed and flow pump that adjusts to changes in flow conditions to maintain its preprogrammed flow rate to run optimally throughout the entire filtration cycle. Filters get the right amount of flow to maintain water clarity. Laminars and other water features perform more consistently. Equipment efficiency and service life increase.



### Features:

- Eight programmable speed or flow settings and built-in timer
- Rotatable keypad with optional wall mount kit (sold separately)
- Top-mounted field wiring compartment is easier to access and connect
- Totally enclosed fan-cooled design for increased performance and long life
- Menus are easier than ever to use
- Consistently maintains system flow requirements
- Compatible with Pentair Automation
- WEF 6.1 THP 3.95

CAT.NO.	DESCRIPTION	VOLTS	AMPS	HP	SF	SHIP WT.	PRICE
01-1056	INTELLIFLO VSF	230	16	3	1.32	55	\$2,354.92

**833-SWIM-327**  
8 3 3 · 7 9 4 6 · 3 2 7  
[www.halogensupply.com](http://www.halogensupply.com)

NEW PRODUCTS



## WHISPERFLOXF® VS

### COMMERCIAL VARIABLE SPEED PUMP 5HP

The WhisperFloXF VS Commercial Pump is the first five-horsepower variable-speed pool pump that runs on single-phase or three-phase power. It's an economical, combined motor/drive solution for both H/MAC (hotel, motel, apartment, condominium) or large residential installations. The WhisperFloXF VS Commercial Pump provides sophisticated, energy-saving pump technology without the high costs typically associated with independent pump/external drive setups.



### STANDARD FEATURES

- Integrated 5HP motor/drive; no expensive external drive required.
- Versatile power input capability; runs off a wide range of single- or three-phase power.
- Speed or flow control for maximum efficiency and pool performance\*.
- External control capability through automation systems or relays.
- Intuitive programming operation.
- Meets commercial codes and agency requirements.

\* When connected to Pentair's inline 4-20mA flowmeter kit (sold separately), or similar 4-20mA flowmeters, this pump is capable of maintaining a constant flow based on the needs of your pool system.

CAT.NO.	DESCRIPTION	VOLTS	AMPS	HP	SF	SHIP WT.	PRICE
02-2035	WHISPERFLOXF VS	208-230(1PH)	20-21	5	1.0	95	\$4,099.58
		230/460(3PH)	13/6				

# POLES & LEAF SKIMMERS

## RESIDENTIAL POLES

- A. #467B 8'-16' telescoping pole . . . \$38.35
- B. #467C 6'-12' telescoping pole . . . \$31.25
- C. #R191128 1½" x 6' plastic pole . . . \$22.38

## SERVICE PRO POLES

- D. #212 2-6' heavy duty poles w/stainless steel clips . . . \$118.40
- E. #9018 6'-18' heavy duty 3 piece dual-locking pole . . . \$147.82
- F. #7016E 8'-16' heavy duty Promax telescoping pole . . . \$91.64
- G. #R191088 12'-24' telescoping pole \$85.26
- H. #5432 8'-29' heavy duty telescoping pole . . . \$348.31

## COMMERCIAL FIBERGLASS POLES

- I. #8016 8'-16' telescoping pole . . . \$105.71
- J. #8024 12'-24' telescoping pole . . . \$164.66



All poles over 8 feet must ship via truck

## HAND SKIMMERS & LEAF RAKES

For professional, commercial and residential use.



- K. #R16C 16" pocket with stainless steel construction and a protective vinyl coating. . . . . \$98.60



- L. #LN4135 24" Animal leaf rake w/24" opening . . . . . \$65.12



- M. #SP500 Spartan easy-flip leaf rake. . . . . \$47.69



- N. #R121230 Heavy duty leaf rake constructed of solid anodized aluminum. Squeegee attached to easily pick-up leaves, debris and toys . . . . . \$39.80



- O. #R121196 Heavy duty skimmer net w/ aluminum frame . . . . . \$27.41

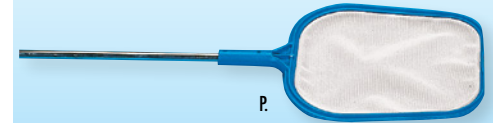

- P. #R121186 Flexible skimmer with 4' handle. . . . . \$27.42



- Q. #R121166 Flexible skimmer net with polyester screen and polypropylene frame. . . . \$15.75

## POLE HANGERS

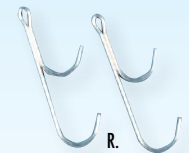

- R. #12P Metal pole hangers. Holds two poles. Packaged with screws. . . . . \$11.45



- S. #R221036 Plastic pole hangers. Holds two poles. Packaged with screws. . . . . \$8.61

## NYLON BRUSHES



- A. **#R111330** 36" Heavy Duty Curved Brush, Aluminum Back, Nylon Bristles (commercial usage) . . . . . **\$84.00**  
 B. **#R111342** 24" Heavy Duty Curved Brush, Aluminum Back, Nylon Bristles (commercial usage) . . . . . **\$40.24**  
 C. **#R111046** 18" Curved Brush, Aluminum Back, Nylon Bristles (residential usage). . . . . **\$23.02**



- D. **#4000** 18" Straight Brush, Aluminum Back, Nylon Bristles (residential or commercial use) . . . . . **\$32.87**  
 E. **#R111386** 18" Curved Brush, Plastic Back, Nylon Bristles w/end Caps for vinyl liners (residential use). . . . . **\$13.80**

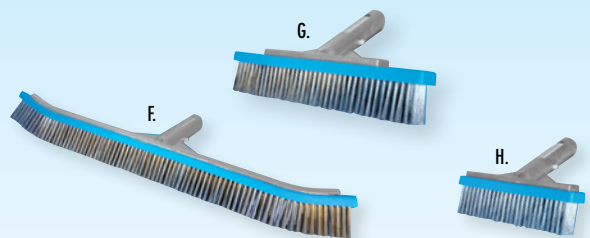

- F. **#R111646** 18" Curved Brush, Aluminum Back, Stainless Bristles . . . . . **\$41.37**  
 G. **#R111626** 9" Straight Brush, Aluminum Back, Stainless Bristles . . . . . **\$25.07**  
 H. **#R111616** 6" Straight Brush, Aluminum Back, Stainless Bristles . . . . . **\$20.14**

## ACID WASH/TILE/DECK BRUSHES



- I. **#6020** 10" Wood Acid Brush, Tapered . . . . . **\$18.48**  
 J. **#469** 5" Wood Acid Brush, Tapered . . . . . **\$15.23**  
 K. **#9600** 10" Plastic Acid Brush, Dual Sided, Threaded . . . . . **\$26.04**

## WYSIWASH SANITIZER



The Wysiwash Sanitizer is not only a hose-end sprayer. It is a precisely calibrated, scientifically designed and tested, patented sanitizing system.

The Wysiwash System will effectively clean, sanitize, and eliminate odors while blasting away dirt with a jet stream of water.

The hydro-injection venturi system produces a solution of hypochlorous acid that is up to 120 times more effective than liquid bleach!!!

Wysiwash is so easy to use that you will sanitize more often with increased effectiveness. Simply connect the Wysiwash Sanitizer to the hose and spray. There is no need to worry about proper dispensing-it's automatic!

- #WYS-101-ID** WYSIWASH Sanitizing Unit only. . . . . **\$180.25**  
**#20255** WYSIWASH Caplets 5.9 lbs . . . . . **\$47.33**

## HANDLES & SQUEEGEE

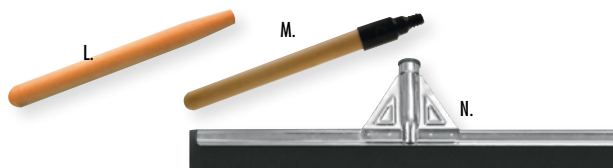

- L. **#471** 6ft Wood Tapered Handle. . . . . **\$11.93**  
 M. **#471A** 6ft Wood Plastic Threaded Handle . . . . . **\$14.13**  
 N. **#7090** Aluminum deck squeegee 22" must attach a tapered Handle . . . . . **\$19.55**

## BRUSHES WYSIWASH SCUBBERS

### PAINTING SUPPLIES & ACCESSORIES



- O. **#1525** 2 Qt. Plastic Paint Tray. . . . . **\$7.98**  
 P. **#1526** 9" Roller Frame . . . . . **\$9.15**  
 Q. **#1527** 9" Roller Cover . . . . . **\$4.05**  
 R. **#1528-02** 2" Wide Paint Brush . . . . . **\$3.84**  
 S. **#1528-04** 4" Wide Paint Brush . . . . . **\$11.04**  
 T. **#SCREEN** 5 Gallon Bucket Screen . . . . . **\$8.50**  
 U. **#LN28** 28 Mil Large Blue Gloves (reusable) . . . . . **\$7.60**

### HAND HELD SCRUBBERS



- V. **#8500** Hand Held Scrubber w/2 White Light Duty Pads. . . . . **\$14.07**  
**#8530** White light Duty Replacement Pad. . . . . **\$8.55/pair**  
 W. **#8510** Hand Held Scrubber w/2 Blue Medium Duty Pads. . . . . **\$14.28**  
**#8532** Blue Medium Duty Replacement Pad. . . . . **\$9.11/pair**  
 X. **#8520** Hand Held Scrubber w/2 Brown Heavy Duty Pads. . . . . **\$14.60**  
**#8534** Brown Heavy Duty Replacement Pad. . . . . **\$9.90/pair**

### SWIVEL SCRUBBERS, SPONGES & SCRUBBER PADS



- Y. **#8000** Swivel joint snap-in handle, Fits Most Pool Poles, includes White Light Duty Scrubber Pads. . . . . **\$34.86**  
**#8030** White Light Duty Scrubber Pads for 8000 Scrubber . . . . . **\$15.75/pair**  
 Z. **#8010** Swivel joint snap-in handle, Fits Most Pool Poles, includes Blue Medium Duty Scrubber Pads. . . . . **\$36.02**  
**#8032** Blue Medium Duty Scrubber Pads for 8010 Scrubber . . . . . **\$15.98/pair**  
 AA. **#6510** Corner Heavy Duty Scrubber Brush, Fits Most Pool Poles . . . . . **\$28.35**  
 BB. **#8600** Spa Pad 6" x 9", Will Not Scratch Spa Surface . . . . . **\$4.30**  
 CC. **#8700** Spa Sponge 3 1/2" x 6", Soft, Absorbent, Will Not Scratch Spa Surface. . . . . **\$6.41**  
 DD. **#8541** Scouring Pad 6" x 9 1/2", Heavy Duty . . . . . **\$3.38**

# VACUUM CLEANERS &

## Commercial Vacuums

### PRO-VAC®

These patented vac heads will clean a pool bottom in up to half the time. Unique suction chamber concentrates vacuum velocity equally. Has metal swivel handle and adjustable wheels that increase or decrease vacuum velocity. Special flex strips guide debris into exclusive suction chamber. Swivel connection for 1½" vac hose while 2" fits directly on body. Recommended by Service Pros throughout the world.

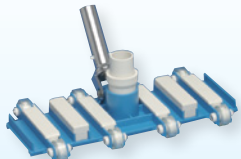

A. #R201276 14" Width . . . . . \$130.96

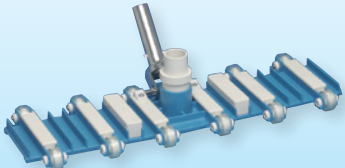

B #R201286 22" Width . . . . . \$166.40

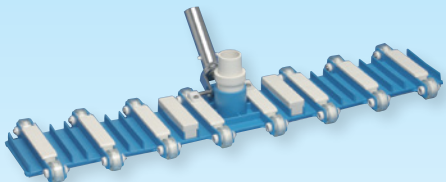

C. #R201296 29" Width. . . . . \$201.94

## RESIDENTIAL CONCRETE POOL VACUUM

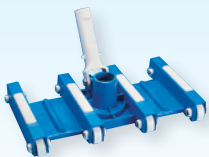

### E. FLEXIBLE VACUUM HEAD

A new improved vacuum made of rugged flexible plastic. Use with with 1½" vacuum hose.

#R201112 12" Width . . . . . \$68.38

## VINYL LINER VACUUM



### F. CLEAR VIEW VACUUM HEAD

Triangular shaped weighted see-thru design features newly improved two-piece ¼"-1½" vacuum hose swivel connection which allows hose to move freely without twisting. Replaceable brushes with vinyl bumpers (weight 4 lbs.)

#R201398 . . . . . \$81.44

#R201540 Brushes for 196 Vacuum Head . . . \$18.81



### G. ECONO TRIANGULAR VACUUM

Has replaceable nylon brushes, snap adapt handle and adapters for ¼"-1½" vacuum hose (weight 4 lbs.)

#R201392 . . . . . \$43.43

#R201536 Brushes for 194 & 195 Vacuum Head \$15.10



### H. VINYL LINER VACUUM-SPECIAL CONTOUR

Shape designed to keep vacuum on pool floor at all times. Replaceable brushes and vinyl bumpers. Fits ¼"-1½" vacuum hose

#R201350 . . . . . \$40.72

#R201526 Brushes for 193 New Style Vacuum Head . . . . . \$14.15

#R201302 Brushes for 198 Old Style Vacuum Head . . . . . \$8.51



### I. MINI-VAC

Designed for use with a garden hose, ¼", or 1½" vacuum hose. Unit is complete with silt bag, hose adapter, shut-off valve for garden hose use and snap-adapt handle. Includes brush attachment for use on vinyl pools.

#R201146 . . . . . \$34.97

### J. #R201696 Replacement bag

for #201146 Mini-Vac . . . . . \$8.57

### K. SPA WAND®

Simple, effective hand-held cleaning device for spas.

#5-300-00 Spa Wand Pro XL. . . \$166.05

#5-400-00 Residential Spa Wand. . . \$90.57

#5-500-00 Spa Wand Pro . . . \$147.23



## PARTS

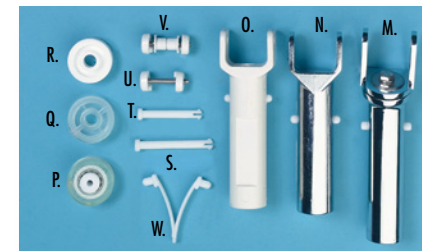

M. #R201408 Metal swivel handle— Fits most standard vac heads. Swivel feature allows freedom to steer in any direction with ease . . . \$33.35

N. #R201420 Metal handle fits most vac heads \$19.64

O.#R201476 Plastic handle fits most vac heads \$6.90

P. #R201557 Ball bearing wheel fits most vac heads . . . . . \$7.61

Q. #R03022 Polyurethane wheel 1¾" . . . \$4.89

R. #R03021 White wheel . . . . . \$2.46

S. #R03101 Pin for most vinyl vac heads. . . \$1.17

T. #R03086 Pin for small vac head . . . \$1.98

U. #R201458 Axle for ball bearing wheel . . \$1.95

V. #R201456 Axle for most wheels . . . \$4.20

W. #22001 Plastic spring clip — Used to clip handles into poles on all brushes and vac heads . . . \$2.58

**833-SWIM-327**  
8 3 3 · 7 9 4 6 · 3 2 7  
[www.halogensupply.com](http://www.halogensupply.com)

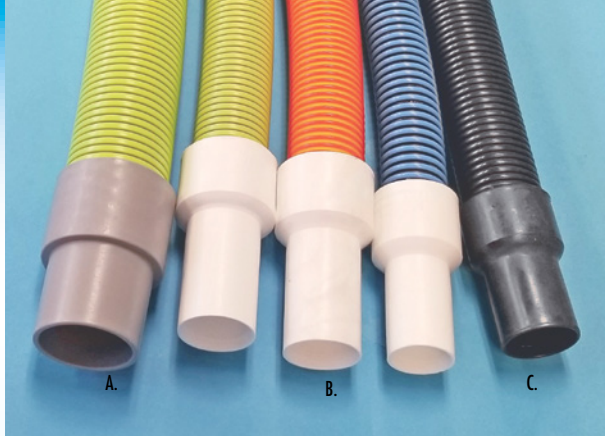

## SWIMMING POOL VACUUM HOSES

### A. COMMERCIAL VACUUM HOSE

Materflex vacuum hose is a high quality, heavy duty, professional grade, swivel cuffed, spiral formed hose with a inner and outer core giving it extreme flexibility and durability. A flat exterior profile keeps snags to a minimum while a smooth interior allows for a better flow.

#425-50 1½" x 50' . . . . .	\$134.55	#424-50 2" x 50' . . . . .	\$255.56
#425-75 1½" x 75' . . . . .	\$215.06	#424-100 2" x 100' . . . . .	\$509.74
#425-100 1½" x 100' . . . . .	\$286.47		

### B. VACUUM HOSE

Our 1½" Smoothflex vacuum hose is a high quality, medium duty, swivel cuffed hose with excellent flexibility. Durable enough for professionals, yet lightweight enough for the residential user. Round ribs make it easy to handle. Our 1¼" Valueflex vacuum hose is a high quality, light duty hose with excellent flexibility. Durable enough for everyday use but lightweight. Comes standard with swivel cuff.

#423-25 1½" x 25' . . . . .	\$60.93	#1990-18 1¼" x 18' . . . . .	\$36.29
#423-30 1½" x 30' . . . . .	\$71.06	#1990-21 1¼" x 21' . . . . .	\$40.59
#423-35 1½" x 35' . . . . .	\$83.66	#1990-27 1¼" x 27' . . . . .	\$49.95
#423-40 1½" x 40' . . . . .	\$94.75	#1990-30 1¼" x 30' . . . . .	\$55.49
#423-50 1½" x 50' . . . . .	\$118.44	#1990-36 1¼" x 36' . . . . .	\$66.58

### C. ABOVE GROUND FILTER HOSE

Our 1½" premium cuff filter hose provides the strength and flexibility necessary for your filter needs. This hose has Ultraviolet inhibitors and features retail packaging.

#1995-3 1½" x 3' . . . . .	\$15.43
#1995-4 1½" x 4' . . . . .	\$17.73
#1995-6 1½" x 6' . . . . .	\$22.35
#1995-8 1½" x 8' . . . . .	\$27.00

## DISCHARGE HOSE



### D. ECONOMY BLUE DISCHARGE HOSE

#452A-50 1½"x50' Prepacked hose . . . . .	\$40.92
---	---------

## VACUUM HOSE PARTS & ACCESSORIES

E. #9042100 Standard hose cuff, 1¼" for vacuum hoses . . . . .	\$14.00
#9012100 Swivel hose cuff, 1½" for vacuum hoses . . . . .	\$14.70
#9112100 2" hose cuff . . . . .	\$18.92
#90621 H.D. hose cuffs, 1½" for vacuum hoses . . . . .	\$10.50



### F. #FG-VHG VACUUM HOSE REEL

Easy snap together assembly for holding and storing bulky vacuum hoses. Made of high density polyethylene. Color is white . . . . .

### G. HOSE HUGGER – Vacuum Hose Carrier

#HH200 Hose Hugger 3" x 34" will accommodate 2" x 50" hose or 150' electrical cord . . . . .	\$9.00
#HH101 Hose Hugger 3" x 27" will accommodate 1½" x 25" hose or 100' garden hose . . . . .	\$7.85



## HEAVY DUTY DISCHARGE HOSES

### HEAVY DUTY BLUE DISCHARGE HOSE

#410 1½" Heavy duty discharge hose made of PVC reinforced with high strength PVA yarn . . . . .	\$1.84 Ft.
H. #411 2" Heavy duty discharge hose made of PVC reinforced with high strength PVA yarn . . . . .	\$2.28 Ft.
#415 3" Heavy duty discharge hose . . . . .	\$ 4.00 Ft.

## ALUMINUM HOSE FITTINGS

I. #ABF-200 2" Aluminum shank w/brass swivel nut . . . . .	\$25.84
#ABF-300 3" Aluminum shank w/brass swivel nut . . . . .	\$49.60
J. #ABM-200 2" Aluminum shank w/male threads . . . . .	\$11.40
#ABM-300 3" Aluminum shank w/male threads . . . . .	\$26.84

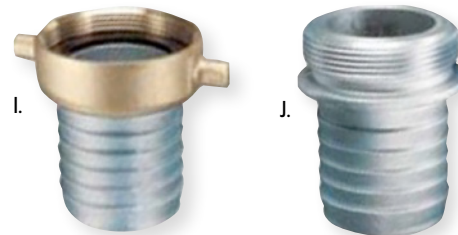

## VACUUM HOSES, ACCESSORIES, LEAF TRAPS

## LEAF TRAPS ETC

### K. CLEAR SEE-THRU SNAP-OPEN LEAF TRAP

Features snap open/close lid and large handle for ease of carrying. Clear housing lets you see debris collecting. For use with automatic suction type pool cleaners or conventional vacuum heads. Traps most debris in polyester bag. Also available with 25 sq. ft. cartridge (with special plug).

#R211084 1½" Leaf Trap w/mesh bag & 3 ft. hose . . . . .	\$98.68
#R211086 2" Leaf Trap w/mesh bag & 3 ft. hose . . . . .	\$129.11
#R211518 Fine silt bag only . . . . .	\$27.20
#R211516 Mesh bag only . . . . .	\$13.75
#R172653 25 sq. ft. cartridge only w/plug. . . . .	\$43.43



### L.#B5118X LEAF MASTER

Removes leaves and debris from pool faster than any other product on the market. The Leaf Master simply hooks up to a garden hose and standard pole or automatic pool cleaner hose. Filter bag slips on or off quickly with slide closure. Swivel wheels for easy turning . . . . .

#B9777 Fine mesh replacement bag . . . . .	\$21.12
--	---------



### M.#1148J STAIN MASTER BY JANDY

Removes algae spots, rust spots and leaf stains. Eliminates draining pool for acid washes. Hooks up to telescopic pole, and pumps acid or chlorine right on to spot or stain. . . . .

	\$103.61
--	----------

**833-SWIM-327**  
833-7946-327  
www.halogensupply.com

## COMMERCIAL POOL CLEANERS

### A. TIGERSHARK® 2

TigerShark® 2 commercial robotic cleaner is perfect for the class B pool market. It calculates pool size with an on-board computer for the most efficient cleaning pattern. The unit's ability to clean for 7 consecutive hours provides adequate time to clean a larger pool in a timely manner. Powerful on-board pump vacuums dirt and debris, while scouring pool bottom, walls, inclines and steps. It features a patented easy-clean removable cartridge that can simply be rinsed with a garden hose.



- On-board intelligent computer calculates pool size and most efficient cleaning pattern
- Preset 7-hour clean cycle automatically turns off when done
- Powerful on-board pump sucks up dirt and debris
- Scours pool bottom, walls, inclines and steps for a complete clean
- Patented easy-clean removable cartridge can be rinsed with a garden hose
- TigerShark 2 features a 100' cord

#RC9956GRCC TigerShark 2 . . . . . \$3341.38

Easy-to-clean filter cartridge



## TECHNICAL SPECIFICATIONS

Description	Specification
Rec. Pool Size	Up to 30' x 60'
Gallons Circulated	4500 GPH
Filter Micron Porosity/Area	5/1000 sq. in.
Motor System	Non-oil filled, microprocessor
Cleaning Speed	55 sq. ft/minute
Cleaning Cycle	7-hours bottom, wall and waterline
Recurring Cleaning Cycle	No
Cord Length	100'
Swivel	No
Out-of-Water Sensor	No
Voltage	115/50 24VDC
Height/Width/Length	11" x 16" x 16"
Caddy Cart	Included with CC Part Number Models
Warranty	1-year limited warranty on parts and labor

## RESIDENTIAL POOL CLEANERS

### B. AQUAVAC® 6 SERIES

AquaVac® 6 Series pool cleaners are reinventing the robotic cleaner market with first-of-their-kind capabilities. While other cleaners can lose suction, AquaVac 6 Series cleaners feature patented SpinTech™ filterless technology with 18 hydrocyclones, maintaining maximum suction power. The six variable-speed-driven rollers with adaptive traction offer wall-to-wall cleaning on any pool surface and the unique TouchFree™ debris canister, with a quick release button, is designed for effortless cleanup. AquaVac 6 Series cleaners are the perfect solution for pool owners who want the latest in innovation and smart technology.

#RCH601CUY AquaVac 600 . . . . . \$1,606.89

#RCH651CUY AquaVac 650 . . . . . \$1,801.68



- Spin Tech filterless technology maintains constant suction
- HexaDrive™ adaptive traction expertly navigates, climbs and scrubs all pool surfaces
- TouchFree debris canister empties and rinses itself with the press of a simple quick release button
- Wi-Fi\* offers control from an iPhone®, iPad®, or Android™ device, SpotClean remote steering and multiple programmable color themes (AquaCac 650 only)
- AquaVac 600 operates on a recurring 48-hour cleaning mode, while AquaVac 650 offers a programmable weekly cleaning schedule
- Caddy cart and power supply included with both models

## TIGERSHARK PARTS

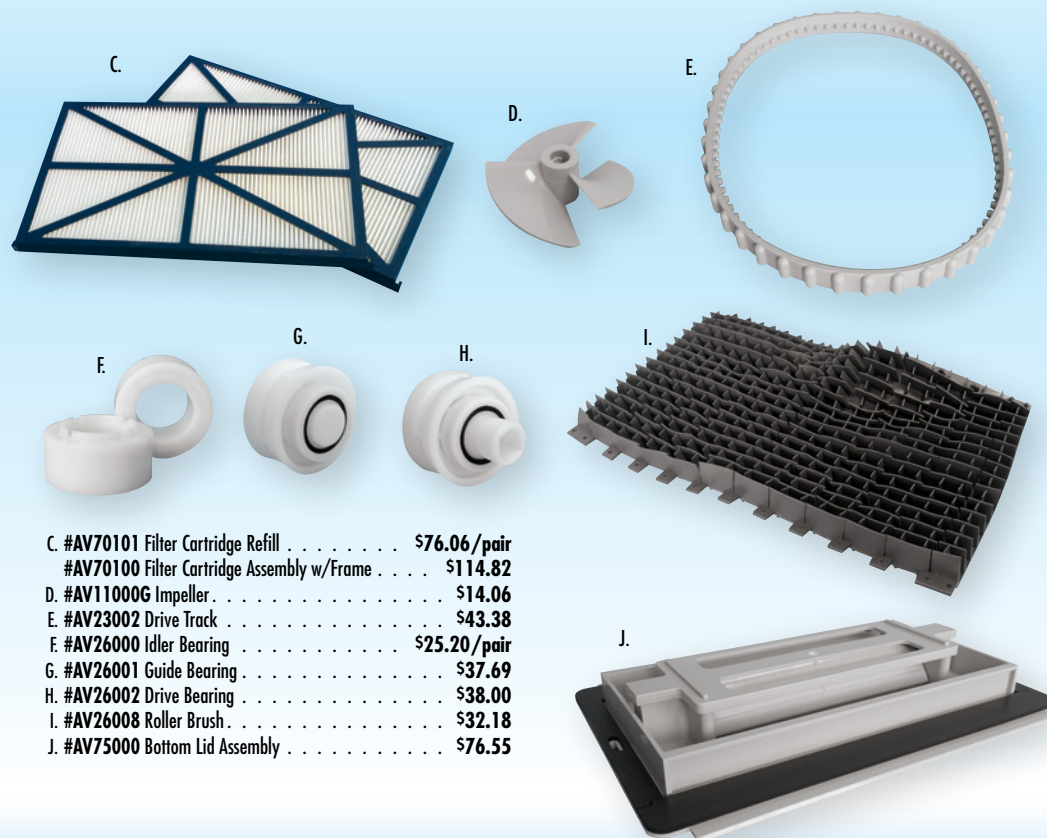

- C. #AV70101 Filter Cartridge Refill . . . . . \$76.06/pair
- #AV70100 Filter Cartridge Assembly w/Frame . . . . \$114.82
- D. #AV11000G Impeller . . . . . \$14.06
- E. #AV23002 Drive Track . . . . . \$43.38
- F. #AV26000 Idler Bearing . . . . . \$25.20/pair
- G. #AV26001 Guide Bearing . . . . . \$37.69
- H. #AV26002 Drive Bearing . . . . . \$38.00
- I. #AV26008 Roller Brush . . . . . \$32.18
- J. #AV75000 Bottom Lid Assembly . . . . . \$76.55



## RESIDENTIAL POOL CLEANERS



**A. POLARIS 380**  
 Powered by triple jets and a separate booster pump, the Polaris 380 is one of our most powerful, durable cleaners and is suitable for all in-ground pools. Sweeps, scrubs and vacuums the bottom, walls and steps of the pool prolonging the life of your filtration system.  
**#2005 Polaris Vac Sweep Cleaner**  
 Model 380 Only. . . . . **\$1,540.82**



**B. POLARIS 280**  
 Model 280 Only. . . . . **\$880.23**



The PB4-60 booster pump delivers the best combination of high performance power, quiet operation, and durability.  
**#PB-4 Polaris Booster Pump only \$612.16**



**C. POLARIS-65**  
**POLARIS-65 Cleaner** . . . . . **\$391.38**



## RESIDENTIAL AUTOMATIC POOL CLEANERS & PARTS

### POLARIS PARTS

- A. #9-100-1012 Polaris 380/360 Leaf Bag . . . . . **\$56.97**
- B. #9-100-1014 Polaris 380/360 All Purpose Bag . . . **\$52.09**
- C. #9-100-1015 Polaris 380/360 Sand/Silt Bag . . . **\$55.73**
- D. #9-100-1021 Polaris 380/360 All Purpose Zipper Bag **\$62.30**
- E. #9-100-1008 Polaris Wheel, Double-Side 380/360 . **\$18.59**
- F. #9-100-1108 Polaris Ball Bearing 380/360/ATV . . **\$11.61**
- G. #9-100-1017 Polaris Belt kit 380/360 . . . . . **\$43.92**
- H. #9-100-3105 Polaris Sweep Hose Scrubber . . . . . **\$3.65**
- I. #9-100-9001 Polaris UWF Connector Assembly . . . . **\$41.45**
- J. #6-500-00 Polaris Universal Wall Fitting . . . . . **\$5.78**
- K. #48-080 Polaris Inline Filter 480/380/280 . . . . **\$81.09**
- L. #A-20 Polaris 180 /280/360/380 Float . . . . . **\$9.47**
- M. #B-5 Polaris 180/380 Sweep Hose Complete. . . . **\$45.81**
- N. #B-10 Polaris Wear Rings 380/360/280/180 . . . . **\$3.29**
- O. #B-15 Polaris Sweep Hose Clamp . . . . . **\$3.33**
- P. #C-10 Polaris Tire, White 380/360/380/180. . . . . **\$13.68**
- Q. #D-15 Polaris Nut, Feed Hose 380/280/180 . . . . . **\$5.38**
- R. #D-20 Polaris Swivel, Ball Bearing 380/280/180 . **\$17.37**
- S. #D-45 Polaris Feed Hose, White Hard 380/280/180 **\$43.31**
- T. #G-52 Polaris Back-Up Valve Kit 380/280/180 . . **\$112.82**
- U. #C-6 Polaris Wheel, Large 280/180 . . . . . **\$17.10**
- V. #C-55 Polaris Wheel Screw (1) 280/180 . . . . . **\$2.43**
- W. #C-60 Polaris Ball Bearings, Wheels 280/180 . . . **\$12.17**
- X. #C-80 Polaris Ball Bearings, Turbine 280/180 . . **\$21.92**
- Y. #K-13 Polaris 280 All Purpose Bag, Zippered. . . . **\$60.28**
- Z. #K-14 Polaris 280 Sand/Silt bag, Velcro. . . . . **\$54.09**
- AA. #K-16 Polaris 280 All Purpose Bag, Velcro . . . . . **\$53.75**



### SUCTION SIDE CLEANERS

**Kreepy Krauly® E-Z Vac®**  
**Suction-Side Aboveground Pool Cleaner**  
 The redesigned Kreepy Krauly Lil Shark cleaner has a renewed and unmatched hunger for dirt and debris. Featuring high-performance two-way cleaning, this dynamic aboveground pool cleaner scrubs and vacuums even the toughest grime... leaving you with a beautiful, sparkling clean pool.  
**#36-0100 Lil Shark Cleaner \$284.74**

## The Wave of New Technology in Public Pool Cleaners Automatic Pool Cleaners A Dolphin for Every Pool

### COMMERCIAL POOL CLEANERS

#### wave 60

##### Automated robotic cleaner for shallow pools

A proven workhorse, the Maytronics Wave 60 robotic pool cleaner is the ideal solution for small hotel, condo, and apartment pools up to 50 feet. The Wave 60 saves you valuable time when it comes to maintaining your facility pool with its easy, plug-and-play operation.



#### WAVE 60 Product Specifications

Ideal pool length	Up to 50 ft.
Cleaning coverage	Floor, Walls, and Waterline

#DL1060-US WAVE 60 Cleaner . . . . . \$1,699.00

#### wave 80

##### The trusted name for commercial pool cleaners

Engineered for power, the Maytronics WAVE 80 robotic pool cleaner is the ideal solution for small to mid-sized condo, apartment, and neighborhood pools up to 68 feet.



#### WAVE 80 Product Specifications

Ideal pool length	Up to 68 ft.
Cleaning coverage	Floor, Walls, and Waterline
Brushing	Dual Scrubbing Brushes + Center Active Scrubber

#DL1080 WAVE 80 Cleaner . . . . . \$2,395.00

#### wave 120

##### Automated robotic cleaning for shallow pools

Designed for large pools up to 121 feet, put the power of two robots to work at once with the Maytronics Wave 120 commercial robotic pool cleaner. Ideal for universities, YMCAs, and water parks.



#### WAVE 120 Product Specifications

Ideal pool length	Up to 121 ft.
Cleaning coverage	Floor, Walls, and Waterline
Brushing	Quad Scrubbing Brushes

#DL9359 WAVE 120 Cleaner . . . . . \$5,675.00

#### wave 200 XL

##### Wave 200 XL key features and advantages

- Outstanding results:**
  - Line by-line cleaning process** - state-of-the-art programmable tracking systematically cleans the pool floor one path at a time.
  - AutoDirect** - intelligent, self-learning technology and multiple scanning modes delivers systematic, independent and fast cleaning of any large institutional pool of any shape or type.
  - Multi Pattern Scanning** - advanced navigation system and powerful technology ensure complete pool coverage.
  - Highly efficient dog-free filtration with spiral three layer system** - simultaneously separates and filters rough fine and ultra-fine dirt. Spiral flow system spins the water with large debris off the course filter net. The course filter mesh retains the large particles allowing the cartridge filter to run longer. The ultra-fine debris is caught in a large pleated cartridge filter. Top access, with snap-in/out separation of the layers, for easy and convenient maintenance and cleaning.
- Easy, everyday operation and maintenance** - with interactive MMI for intuitive programming and diagnosis of pool cleaner, including: Automatic pool entry and exit using "Drive to pool: and "Drive home" features. Choice of programs and multiple operation modes displayed on a user-friendly LCD screen. Remote control for manual manoeuvring to clean hard-to-reach pool corners. Full filter bag indicator. Operation delay feature.
- Multipurpose Caddy with Auto Cable Release** - transports the robot and automatically releases just enough cable to reach the far end of the pool, prevents kinks and tangles, simply crank the reel to neatly rewind the cable.
- Multi pool cleaning** - setup of up the four different scanning modes and remote control IDs provides optimizes cleaning of multiple different pools with a single robot



**Ideal for pools:** up to 108 ft in length **Cable length:** 115 ft  
**Weight :** 52 lbs **Warranty:** 36 months or 3000 hours on non-wearable

• #7200 Wave 200XL Cleaner **\$8,199.00**

#### wave 100

The best value for money in institutional cleaning Dolphin Wave 100 Highly efficient fully automated cleaning for park, high school, YMCA and other small institutional pools. The advanced gyroscopic system ensures accurate scanning for systematic coverage of floor, walls and water-line. High-capacity filtration space captures dirt, dust and all other types of debris, leaving a clean surface.



- Total pool cleaning** - Unique gyroscopic system delivers accurate and effective scanning along the entire pool.
- Advanced, high-capacity 2 levels filtration options** - 2 filtration options: ultra fine and fine for all pool conditions and seasons. 20% extra filtration capacity, leaves the pool water clean and free of hair, dust, insects and other debris.

**Ideal for pools:** up to 32' x 82' **Cable length:** 98 ft

**Caddy:** For handling & Storage

**Warranty:** 24 months or 3000 hours on non-wearable parts

**Filtration:** 2 filter bag options, 70 and 50 micron, for all types of dirt and debris

**Brushes:** Dual active combined brushes

**Weight:** 29 lbs

#9096X Wave 100S Cleaner **\$3,499.99**

#### wave 140

##### The trusted name for commercial pool cleaners

Extra-wide for maximum cleaning efficiency, the Wave 140 is the perfect solution for large university, fitness clubs, YMCA, and resort pools up to 127 feet, including those with beach entry. The Wave 140 helps minimize downtime due to cleaning with its plug-and-play, fully automated operation, and multiple cleaning options keeping your pool open for guests to enjoy. With a wide cleaning path of 22 inches, the Wave 140 excels at floor scrubbing and heavy-duty dirt collection, for an ultimate clean swimming pool.



#### WAVE 140 Product Specifications

Ideal pool length	Up to 127 ft.
Cleaning coverage	Floor only
Brushing	Dual Scrubbing Brushes

#DL7140 WAVE 140 Cleaner . . . . . \$5,889.00

### RESIDENTIAL POOL CLEANER

#### READY FOR YOUR POOL PARTY IN 2 HOURS!

The Dolphin T-Series robots are designed by Maytronics to do all the hard work - providing incredible cleaning performance and industry-leading technology.

T Series

S T35

#### Cleaning Features

**Pool Size:** Up to 50 ft  
**Cleaning cycle:** 2 Hours  
**Cleaning Mode(s):** Standard  
**Filtration:** Top load, Fine and Ultra-Fine Basket  
**Cable Length:** 60 ft  
**Warranty:** 2 Years- Limited  
#6240 T35 Cleaner . . . . . \$1,038.66



### DOLPHIN PARTS

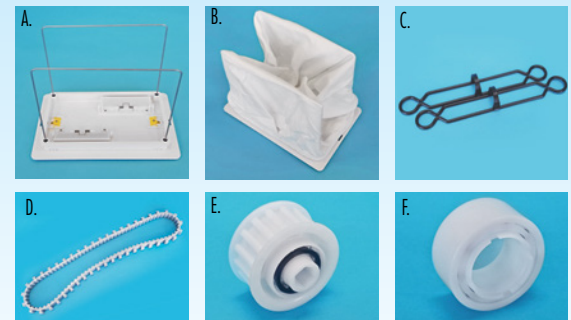

- A. #DL9995550 Bottom Lid Assembly Cart . . . . . \$30.22
- B. #DL9995430-ASSY 50 Micron Cloth Filter Bag . . . . . \$60.48
- C. #DL9981430-PAIR Filter Bag Clips . . . . . \$9.34
- D. #DL9985006 Track Grey Grooved . . . . . \$24.50
- E. #DL3883645 Drive Pulley . . . . . \$20.57
- F. #DL3884997 Guide Wheel . . . . . \$7.27
- G. #DL9996084-ASSY Caddy Cart New Style (Not Pictured) . . \$184.39

## WATER TECH

"The pool invention people"

### CLEAN THE ENTIRE POOL IN MINUTES OR SPOT CLEAN IN SECONDS

The Pool Blaster Volt FX-8, designed for cleaning medium to large swimming pools and spas, is a leap forward from the original Pool Blaster MAX. The VOLT FX-8 features over one liter of debris capacity and, with its thirteen inch wide vacuum head, offers a huge cleaning path. The FX-8 vacuums up to one hour between chargings.

#FX-8...\$316.05



The newly designed Pool Blaster VOLT FX-4 is the perfect choice for cleaning large spas and small to medium sized in-ground or above-ground residential pools. The rechargeable FX-4 features a "latch" style nose cap for ease of operation and, as with all VOLT pool vacuums, can be attached to a pool pole or can be used as a hand-held cleaner.

#FX-4...\$171.15



The new Pool Blaster VOLT FX-2 features vastly increased debris capacity and three times the cleaning power of the original Aqua Broom. Ideal for cleaning "quick set-up pools and residential spas, the VOLT FX-2 operates for over three hours powered by five "D" cell batteries.

#FX-2...\$88.20



### STA-RITE GASOLINE ENGINE PUMP

3 H.P. gasoline engine pump, 6" cast iron hair strainer and basket (not mounted), cart with handle, discharge hose 25', fittings and clamp. 2" suction and discharge. 104 g.p.m. with 5' lift, 95 g.p.m. with 10' lift; 83 g.p.m. with 15' lift. 150 lbs.

#437 ..... \$2,429.00

**833-SWIM-327**  
833-7946-327  
[www.halogensupply.com](http://www.halogensupply.com)



### HARMSCO PORTABLE VAC SYSTEM

A real money saver! Vacuum your pool through an Harmsco cartridge filter without water, chemical or heat loss. Comes complete with a single 105 sq. ft. filter, 3/4 H.P. Pentair Challenger, 25' discharge hose and PVC fittings. Electrical cord **now** included. We suggest a ground fault interrupter be used.

#1460 Specify 1 1/2" or 2" suction ..... \$2,620.00

**NOTE: GROUND FAULT INTERRUPTERS ARE RECOMMENDED FOR ALL ELECTRICAL PUMPS**



See pages  
2, 3, 4 & 5 for  
vacuum accessories

### VACUUM PUMP ASSEMBLY

All pumps are complete with fittings and clamps.

3/4 H.P. Pentair Challenger Pump, 115 volt, single phase, 60 cycle thermally protected motor designed for continuous duty operation. A heavy duty 50 foot cord and plug is supplied for maximum convenience and utility. A ground fault interrupter (GFI) protects the operator from electrical grounds in the cord and motor. A two-wheel chassis kit allows the unit to be easily wheeled about the pool. 1 1/2" suction and discharge.

#435 ..... \$1,533.00



### PORTABLE VAC SYSTEM

This all new portable vacuum system comes complete with 3/4 H.P. Pentair Challenger Pump, 50 feet of power supply cord and a 15 amp GFCI plug attached. Features a Pentair PXCPR100; 100 square foot posi-clear filter with easy access posi-ring mounted on a stainless steel cart. 1 1/2" suction and 1 1/2" x 25' H.D. discharge.

#495 ..... \$2,625.00

## PORTABLE AND HANDHELD VACUUMS

### BATTERY POWERED POOL CLEANING



#### RESORT UNITS - FOR FACILITY MANAGERS

Resort-21 and Resort-30 units are meant to be left on site and the caddy carts are not compatible with our vehicle mount assembly. The two standard configurations are the Resort-21, which has a 21" vacuum head and a 60ft cord, and the Resort-30 which has a 30" vacuum head and a 60ft power cord. All resort units ship fully assembled.

#### NOT INCLUDED

- 12 VOLT DEEP CYCLE MARINE BATTERY
- STANDARD POOL POLE
- NOT COMPATIBLE WITH THE HH1300 VEHICLE MOUNT

#### #RESORT-30

Hammerhead 30" resort unit complete with charger P.O.A.

#### #RESORT-21

Hammerhead 21" resort unit complete with charger P.O.A.  
FOB Factory

### WATER TECH PRECISION 2.0 Li Professional Pool Vacuum

Powerful, Cordless, Rechargeable Commercial Pool Vacuum  
Having the right tools to do the job will save you time, money and unnecessary headaches. The Precision 2.0Li works on any surface: concrete, tile, vinyl, or fiberglass. Simply attach the Precision 2.0Li to any standard telescopic pool pole, turn the unit on, and you are ready to vacuum! Its lightweight, no fuss design is free from hoses, external pumps and electrical cords. The durable design and powerful suction makes the Water Tech Precision 2.0Li the perfect companion for any Pool Service professional.

Perfect for overall pool vacuuming including: steps, swim outs, benches, spillover spas, negative edge troughs, tanning ledges and fountains.

#### Check Out What Comes Standard

Two powerful lithium batteries, wall charger, three high volume discharge valves, three high volume filter bags, 2 vacuum heads and a shoulder strap.

#PB-50000PL ..... \$1,270.50



**EPOXY PAINTS**

**ZERON**

A one-coat epoxy pool coating recommended for use by pool service professionals. This high solids epoxy covers all types of stains and even will seal hairline cracks. An excellent alternative to replastering rough and stained plaster pools and provides a long lasting finish. Coverage is 125 – 175 sq. ft. per gallon.

- #1517-W Zeron White 1 gallon . . . . . \$156.33
- #1517-BB Zeron Bikini Blue 1 gallon . . . . . \$156.33
- #1517-BM Zeron Blue Mist 1 gallon . . . . . \$156.33
- #1517-B Zeron Black 1 gallon . . . . . \$156.33
- #1517-VB Zeron Viking Blue 1 gallon . . . . . \$179.45

**POXOLON**

Poxolon is a high gloss pool coating that provides a tile like finish. This easy-to-apply epoxy is recommended when recoating existing epoxy pools but also is used to paint new unpainted pools or for refinishing rough and stained plaster. Use with primer on concrete, plaster, fiberglass and metal pools where two coats are usually required. Coverage is 225 – 250 sq. ft. per gallon.

- #1518-W Poxolon White 1 gallon . . . . . \$146.15
- #1518-BB Poxolon Bikini Blue 1 gallon . . . . . \$146.15
- #1518-BM Poxolon Blue Mist 1 gallon . . . . . \$146.15
- #1518-B Poxolon Black 1 gallon . . . . . \$146.15
- #1518-VB Poxolon Viking Blue 1 gallon . . . . . \$177.60
- #1518-BI Poxolon Blue Ice 1 gallon . . . . . \$146.15

**RUBBER BASED PAINT**

**PARALON 2**

Paralon 2 is a premium grade chlorinated rubber base pool enamel that is easy to apply, long lasting and provides a high gloss finish. Paralon 2 is recommended for existing chlorinated rubber base coatings. Two coats are recommended for repairing jobs and 3 coats over bare concrete. Coverage is 250 sq. ft. per gallon.

- #1519-W Paralon 2 White 1 gallon . . . . . \$112.85
- #1519-BB Paralon 2 Bikini Blue 1 gallon . . . . . \$112.85
- #1519-BM Paralon 2 Blue Mist 1 gallon . . . . . \$112.85
- #1519-B Paralon 2 Black 1 gallon . . . . . \$112.85
- #1519-BI Paralon 2 Blue Ice 1 gallon . . . . . \$112.85

**POOL COATINGS COLORS**

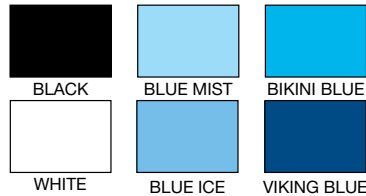

**FUSION PLUS**

Fusion Plus is the smart way to convert your worn rubber-base coated pool to an epoxy finish. Simply clean surface, roll on FUSION PLUS, then follow with one coat of ZERON or two coats of POXOLON. Your rubber-to-epoxy finish will be beautiful, and will last for years! Coverage is 225 - 250 sq. ft. per gallon.



- #1523 Fusion Plus \$105.45

**PRIMERS**

**POXOPRIME II**

Poxoprime II is an epoxy primer for application over unpainted concrete or plaster. Poxoprime II soaks in and seals the surface and can be applied over a damp surface to reduce down-time. Used as an undercoat for Poxolon or Zeron. Coverage 200 – 225 sq. ft. per gallon.



- #1520 Poxoprime II 1 gallon . . . . . \$98.05

**GUNZITE PRIMER**

Gunzite is a two-part primer used as an undercoat for Poxolon or Zeron usually used over rough plaster or concrete. The heavy viscosity of Gunzite acts as a fill coat that provides a smooth surface. Especially effective on sandblasted surfaces. Coverage 100 – 150 sq. ft. per gallon.

- #1521 Gunzite Primer 1 gallon . . . . . \$98.05

**SOLVENTS**

	GALLONS	QUARTS
#1109 Epoxy solvent 1 gallon . . . . .	\$46.25	\$16.65
#1108 Rubber base solvent 1 gallon . . . . .	\$48.10	\$17.58

**DURACOURT COURT PAINT**

Formulated from tough acrylic polymer specifically designed for asphalt or concrete outdoor surfaces. Colorfast coating retains fresh appearance for years and resists sun fading. One-coat product that requires no specialized labor. Simply sweep, mark boundary lines and you are ready to paint. Coverage approximately 100 – 125 sq. ft. per gallon.



**DIVING BOARD RESURFACING KIT**

The Olympic diving board resurfacing kit is used to resurface old worn diving board surfaces. Each unit contains one quart of Convoy epoxy non-slip coating, one textured roller cover, one pint of solvent and complete instructions. One unit resurfaces one – 8 ft. diving board. Not intended to repair cracks.

- #1518-U100 Diving Board Resurfacing Kit – White \$82.33
- #1518-U102 Diving Board Resurfacing Kit – Bikini Blue . . . . . \$82.33

**SURFACE PREP**

Olympic PREP MAGIC (245) is a one-step, clean and etch pool surface preparation solution that allows you to clean your surface without the extra steps of traditional surface cleaning. Simply mix PREP MAGIC with water, clean your surface, and then rinse



- #KEL-345 Prep Magic 1 gallon . . . \$37.93

**PATIO TONES DECK PAINT**

This water-based deck paint not only beautifies your pool and patio area but actually penetrates the concrete to provide a cooler surface that resists peeling and chipping for years. Can be applied over a wet surface with an approximate coverage of 120 square feet per gallon depending on surface porosity. Call for complete Patio Tones Color Charts and descriptive literature.

- #1520-CS Patio Tones – Creekstone 1 gallon . . \$72.15
- #1520-CH Patio Tones – Champagne 1 gallon . . \$72.15
- #1520-DS Patio Tones – Desert Sun 1 gallon . . \$72.15
- #1520-MG Patio Tones – Mystic Gray 1 gallon . . \$72.15
- #1520-SS Patio Tones – Silk Straw 1 gallon . . . \$72.15
- #1520-SV Patio Tones – Sand Valley 1 gallon . . \$72.15
- #1520-WB Patio Tones – Warm Biscuit 1 gallon \$72.15



**PATIO TONES COLORS**



**833-SWIM-327**  
833-7946-327  
www.halogensupply.com



## RAMUC "EP" EPOXY

Ramuc's finest epoxy swimming pool coating is a high solid, self-priming high gloss paint formulated to provide a tile-like, abrasion resistant surface. Ideal to use for the protection of concrete, plaster or fiberglass in swimming pools, spa's, reflecting pools, water parks and wave pools. Coverage is approximately 450 sq. ft. on recoats or 200 sq. ft. on bare surfaces.

- #1540-DB-1 Dawn Blue 1 gal. kit . . . . . \$146.52
- #1540-MW-1 White 1 gal. kit . . . . . \$146.52
- #1540-AG-1 Aqua Green 1 gal. kit . . . . . \$146.52
- #1540-B-1 Black 1 gal. kit . . . . . \$153.18
- #1540-DKB-1 Dark Blue 1 gal. kit/1 gal. kit. . . \$153.18

## RAMUC HI-BUILD EPOXY

Ramuc Epoxy Hi-Build is a premium satin finish self-priming epoxy that's an excellent choice to renovate plaster or concrete pools or spas. Long-lasting and durable it upgrades faded or scratched fiberglass. Coverage is 150-200 sq. ft. per 2 gallon kit on sandblasted or rough surfaces and 300-350 sq. ft. per 2 gallon kit on recoats.

- #1540-HBW Hi-Build White 2 gal. kit . . . . . \$293.04
- #1540-HBDB Hi-Build Dawn Blue 2 gal. kit. . . \$293.04

### POOL SURFACE



### ACCENTS



## RAMUC ULTRA PRO 2000 COMMERCIAL RUBBER

Ultra Pro 2000 is a low VOC rubber based pool paint formulated for commercial use on concrete or plaster pool surfaces. Self-priming - no primer needed. VOC Compliant in all 50 states. Two years' service life.

- #1545-DB Ultra Pro 2000 Dawn Blue 1 gallon \$109.89
- #1545-RB Ultra Pro 2000 Royal Blue 1 gallon \$109.89
- #1545-W Ultra Pro 2000 White 1 gallon . . . \$109.89

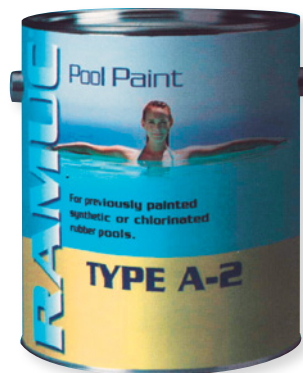

## INTRODUCING NEW TYPE A-2 PREMIUM RUBBER BASED POOL PAINT

- Versatile-topcoats and upgrades existing chlorinated and synthetic rubber systems.
- VOC Compliant-meets the strictest state and federal environmental regulation of 320 gpl VOC.
- Easy to clean, semi-gloss stain-resistant finish.
- Excellent hiding and coverage; spreads at 250 sq ft on bare surfaces, 350-400 sq ft on recoats.
- Self-priming

- #1544-DB-1 Dawn Blue 1 gal. can . . . . . \$126.54
- #1544-W-1 White 1 gal. can . . . . . \$126.54
- #1544-B-1 Black 1 gal. can . . . . . \$129.87



## RAMUC POOL PAINTS

### RAMUC DS WATER-BASED ACRYLIC

Type DS is formulated to provide a decorative but tough, durable film that protects concrete and plaster pools. Self-priming type DS can be applied over previously painted chlorinated and synthetic rubber base paint, as well as properly prepared epoxy painted surfaces. Type DS is ideal where down time is critical, can be applied over damp surface and put into service 3 days after final coat. Coverage is 250 sq. ft. on bare surfaces, 350-400 sq. ft. on recoats

- #9101-W-1 Type DS White 1 gallon . . . . . \$113.22
- #9101-DB-1 Type DS Dawn Blue 1 gallon . . . \$113.22
- #9101-B-1 Type DS Black 1 gallon . . . . . \$116.55

- #92242 Skid-Tex non-skid additive 1 lb. container \$8.62



### UNIVERSAL THINNER

Ramuc Universal thinner can be used for either epoxy or rubber base paints.

- #1539 Ramuc Thinner 1 gallon . . . . . \$43.29



### CLEAN AND PREP SOLUTION

**DESCRIPTION AND USE:** Clean & Prep Solution is used to clean and degrease while simultaneously dissolving mineral deposits, increasing porosity for good adhesion on surfaces prior to painting.

- #9306 CLEAN AND PREP SOLUTION 1 gallon . . . . . \$54.95

- VOC Compliant
- Perfect for painted surfaces
- Turns traditional 3-steps into a 1-step process
- Water-rinse neutralize
- Odor-free; No Fumes
- Biodegradable, safe to use near plants & grass
- Excellent for filter element cleaning



### RAMUC COPING SPRAY PAINT

Renew the vibrancy of pool coping with non-skid Coping Spray Paint by Ramuc Pool Specialty Coating Systems. Avoid expensive and time-consuming coping removal by using RAMUC COPING SPRAY to brighten, restore, and protect the existing coping material. Easy to use, environmentally safe and economical.

- #1541 Coping Spray Paint . . . . . \$25.81



# TILES, DEPTH MARKERS, GROUT, CAULK & SEALANT



## DEPTH MARKERS

Black print on white background  
Available in imperial and Metric units

**GLASS OVERLAY** – Tempered glass that can be installed over tile, fiberglass, or paint. Must use installation kit for permanent installations.

- #1596 6" x 6" Marker . . . . . \$11.14
- #1596-NDS 6" X 6" No Diving Sign . . . . . \$12.83
- #1598 Installation kit (up to 15 markers). . . . . \$18.00

**Vinyl Stick-Ons** – Self-adhesive skid resistant vinyl tiles for above waterline use only. Must use adhesive and edge sealer.

- #1595 6" x 6" Marker . . . . . \$11.14
- #1595-NDS 6" x 6" No Diving Sign . . . . . \$12.83
- #1595-8X8 8" x 8" Marker . . . . . \$19.35
- #1595-NDS-8X8 8" x 8" No Diving Sign. . . . . \$21.04
- #1597 Installation Kit (up to 40 6" and 22 8") . . . . . \$47.25
- #1597-ES Edge Sealer only . . . . . \$19.95

**PLASTIC STICK-ON** – For stainless steel gutters

- #1590 4" x 6" Marker . . . . . \$11.14
- #1590-NDS 4" X 6" No Diving Sign . . . . . \$12.83

**SKID RESISTANT CERAMIC TILE** – For permanent installation in decks

- #1594 6" x 6" Marker . . . . . \$8.33
- #1594-NDS 6" X 6" No Diving Sign . . . . . \$10.24
- #1594-8X8 8" x 8" Marker . . . . . \$17.55
- #1594-NDS-8X8 8" X 8" No Diving Sign. . . . . \$19.69

**SMOOTH CERAMIC TILE** – For permanent installation in walls

- #1592W 6" x 6" Marker . . . . . \$7.65
- #1592W-NDS 6" X 6" No Diving Sign . . . . . \$9.56

### 6" x 6" FROST-PROOF FLAT TILE

- #1592W White . . . . . \$4.50
- #1592B Blue . . . . . \$4.50
- #1592BL Black . . . . . \$4.50

### 6" x 6" BULLNOSE TILE

- #1593W White . . . . . \$11.40
- #1593B Blue . . . . . \$11.40
- #1593G Green . . . . . \$11.40

**SAFETY EDGE TILE** – Clearly mark the step edge for safe pool entry. Factory skid resistant surface. Frost resistant.

Colors: blue, black, brown and green

Specs: ¼" thickness 2 ¼" x 1" x 6"

- #1591 Safety Edge Tile (specify color) \$4.16

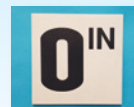
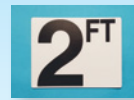
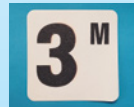
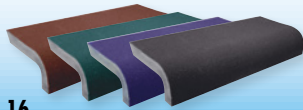

**TILE SET/GROUT** Thin set mortar for installation and grouting of all types of tiles. #1594 50 lbs. . . . . \$29.32



## GATOR GRIP TAPE

Our anti-slip safety grit tape help to provide extra traction where slippery surface conditions may occur on floors, steps and equipment. Constructed from a thick base layer with an aggressive 60-grit mineral abrasive compound. Tape is coated with an aggressive acrylic adhesive with a removable liner. Great for use in equipment rooms.

- #RE629BL Black Anti-Slip Strip 6" x 21" \$14.00



## SOFTEX TAPE

Softex coarse resilient slip-resistant tape works great in or around the home, pool, patio, workshop, locker room, boat, deck, or other areas where there is a bare foot or light shoe traffic. This tape has a deep embossed surface that will perform in heavier duty applications, while still being comfortable for bare foot traffic. Tape can be easily mopped for cleaning.

- #RE3891BL Vinyl Traction Tape 4" wide \$2.60/ft



## AQUABOND UNDERWATER REPAIR COMPOUND

### Swimming Pool Repair Epoxy Adhesive

- All purpose "Wet or Dry" adhesive provides an easy no-mess application
- Easily mix, apply, and cure underwater
- Repair coping, fiberglass, or a vinyl liner
- Secure handrails or rocks
- Kit contents: One DM-50 dispensing gun, One 50 ml cartridge of UW-5000 off white, Five SM-5416 static mixers

- #DMK-5000 AquaBond Repair Compound Kit \$124.95

- #UW-5000 50ml AquaBond Repair Compound . \$35.68



## AQUAFLEX UNDERWATER SEALANT

### Mixes, Applies & Cures Underwater

- Quickly and reliably repair leaks
- Can be mixed and applied underwater
- Kit contents: One DM-50 dispensing gun, One 50 ml cartridge of AFC-8100 clear, Five SM-5416 static mixers, One multi-radius spreader

- #DMK-C8100 AquaFlex Sealant Kit. . . \$146.60

- #AFC-8100 50ml AquaFlex Clear Sealant . \$57.33



**833-SWIM-327**  
833-7946-327  
www.halogensupply.com

## CAULK & SEALANT

### VULKEM SEALANT 116 & 45

A one-part, polyurethane sealant. For use in expansion joints for swimming pools, decks and sidewalks, and is suitable for continuous immersion. Vulkem 116 is for vertical or horizontal joints. Vulkem 45 is self leveling for horizontal joints only.

- #1570W Vulkem 116, White 10.5 oz. cartridge . \$10.40
- #1570G Vulkem 116, Gray 10.5 oz. cartridge . \$10.40
- #1572W Vulkem 45, White 30 oz. cartridge. . \$30.45
- #1572G Vulkem 45, Gray 30 oz. cartridge . \$30.45

### B. BOSS CAULK

801 Neutral silicone adhesive provides excellent adhesion to ceramic tile, spa jets, skimmers, lighting fixtures, and plumbing. 801 also adheres well to fiberglass, ABS, acrylic, PVC, wood and masonry.

- #80100B Silicone Adhesive, Clear 10.3 oz. cartridge \$14.36
- #80101B Silicone Adhesive, White 10.3 oz. cartridge \$14.36

### C. PERMANENT SEALER

Seals seams and cracks even under water. Leaking cracks have been successfully plugged when a pool is filled. Permanent Sealer will dry in about 30 minutes under water. Comes in 10 oz. cartridges.

- #1533W White . . . . . \$8.44
- #1533W-HV High Viscosity White . . . . . \$8.93
- #1533C-HV High Viscosity Clear . . . . . \$11.77

### D. POOL PUTTY

No need to drain concrete pools to repair leaks and cracks because pool putty hardens under water. Pool putty is packaged in convenient cartridges for an easy 1-to-1 mix. Approximate setting time at 70°F is 90 minutes.

- #1534 Pool Putty 14 oz. unit . . . . . \$21.38

### E. POOL PASTE

A high strength epoxy that creates a strong permanent bond to almost any material. Use pool paste to replace tiles or repairing cracked skimmers, fittings and accessories. Can be sanded and painted. Setting time is approximately 90 minutes at 70°F.

- #1535 Pool Paste 16 oz. unit. . . . . \$35.01

## CEMENT PATCHING

### MASTERSEAL 590 (FORMERLY WATERPLUG)

Thoro Waterplug stops running water instantly

- Fast setting (3 to 5 minutes)
- Expands as it sets
- Sets up under water
- Anchors bolts and fixtures firmly 1 lb. will fill 17 cu. in. or a crack  $\frac{3}{4}$ " x  $\frac{3}{4}$ " x 30"

#1560-10 Waterplug

10 lbs. \$49.43

#1560-50 Waterplug

50 lbs. \$101.98



### MASTEREMACO N424 (FORMERLY THORITE)

EmacoGP is a fast-setting cement base patching material that will not slump or shrink at patch edges. Excellent structural strength often stronger than original concrete.

#1561-60 Thorite 60 lb.-can

\$107.71

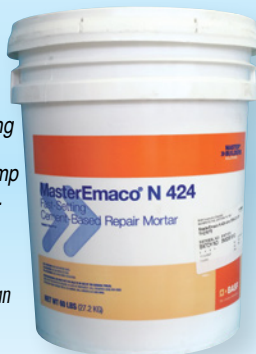

### MASTEREMACO N220 (FORMERLY ACRYL 60)

Acryl 60's acrylic polymers add extra strength and durability when mixed with cement base patches and coatings such as Emaco GP, All-Crete, Super Quickseal and Thoroseal. Use 1 part Acryl 60 to 3 parts water under normal conditions.

#1552-01 Acryl 60

1 gal. bottle \$61.13

#1552-05 Acryl 60

5 gal. can \$240.91



## SEALANTS

### MASTERSEAL 585 (FORMERLY SUPER QUICKSEAL)

Super Quickseal is a Portland based cement, dry-polymer-modified smooth coating. Super Quickseal is ideal for finishing concrete swimming pools.

Coverage: 750-1,000 sq. ft. per 50 lb.-bag.

#1566W Super Quickseal,

White 50 lb. bag

\$82.91



### MASTER 581 (FORMERLY THOROSEAL)

Thoroseal waterproofs anything of block, brick, concrete, or stone, including swimming pools and basement walls. A cement based sealer that works above or below grade. Keeps water out while allowing surface to breathe. Coverage: Approximately 225 sq. ft. per 50 lb. container, depending on surface conditions.

#1550 Thoroseal

50 lb. pail \$102.40



## BRUSHES FOR APPLICATION

#2714-LH 14" Patching Brush

less Handle ( see pg 3 for handle)

\$13.82



#1553

6" Beaver Brush

\$10.56



## PLASTER PATCHING



### SGM PEARL BRITE

#### Features:

- Pearl Brite high performance plaster mix is pre-blended and ready to use.
- Pure white color resists chemical attacks, etching, staining, discoloration and delamination
- 80-lb. bag covers approximately 25 to 35 sq. ft. depending upon surface roughness

#20-PBC300 Pearl Brite Plaster Mix. . . . . \$71.37



### SGM DYNAMITE POOL PATCH

• High strength • Sets under water • Brilliant white  
Dynamite pool patch is a mixture of portland cement and special additives that permits underwater patching and general concrete repair work to be done instantly. Pool patch can be used wherever a quick setting caulking or plugging material is needed. Extremely fast-setting. Working time 3-5 minutes

#1555 Dynamite Pool Patch 9 lbs. . . . . \$23.22

#1556 Dynamite Pool Patch 60 lbs. . . . . \$101.70

**833-SWIM-327**  
833-7946-327  
[www.halogensupply.com](http://www.halogensupply.com)

## SEALERS PATCHING & ACCESSORIES

## EPOXY PRODUCTS



### ABOWELD NO SLUMP EPOXY PATCH

For patching and building up vertical surfaces without forms or molds. Fills cracks. Bonds permanently. Will also bond to wet surfaces. Crack repairs and tile installation repairs. Available in white only

#5512QR Aboweld55-1 (2 Quart) . . . . . \$95.13

#5512GKR Aboweld55-1 (2 Gallon Kit) . . . . . \$251.79



### ABOCRETE SELF-LEVELING EPOXY COMPOUND

Permanently repairs, bonds, rebuilds and resurfaces concrete and most rigid surfaces. Self leveling. Fills cracks. Excellent substrate for decorative color grit and aggregate.

#ACK5R Abocrete (1 Gallon Kit) . . . . . \$93.45

#ACKR Abocrete (5 Gallon Kit) . . . . . \$264.39



### TREAD SPREAD SLIP RESISTANT EPOXY COATING

Bonds Tenaciously to concrete, wood, metal, fiberglass, and most rigid surfaces. Use on wet, dry, underwater surfaces where slip resistance is needed. Much more durable and longer lasting than tape. Exceeds OSHA and ADA recommendations for slip resistance in both wet and dry conditions. Coverage is 12 sq. ft. at 1/8 in thick per gallon. Color is Slate Gray.

#TS2PK Tread Spread 2 pint kit . . . . . \$56.491

#TS2GK Tread Spread 2 gallon kit . . . . . \$237.83

# PENTAIR/STA-RITE COMMERCIAL/ RESIDENTIAL SELF PRIMING POOL PUMPS

**STA-RITE®**

*Smarter.*

For largest inventory of Sta-Rite parts call 833-794-6372  
See pages 16 & 17 for replacement parts and motors.



## MAX-E-PRO

High efficiency, low maintenance and maximum performance - all the features demanded by today's pool professionals. The Max-E-Pro has our new Quick-Lock trap cover ring and the 2" ports incorporate internal and external threads. Available in single-two-speed models

### SINGLE-PHASE HIGH EFFICIENCY PUMP

Cat. No.	Voltage	Full Load Amps	THP	WEF	HHP	SF	Ship. Wt.	Price
34-8185	115/208-230	10.5/5.5	1.10	3.50	0.65	1.0	50	\$1,127.00

### THREE-PHASE TEFC SUPER DUTY

Cat. No.	Voltage	Full Load Amps	HP	SF	Ship. Wt.	Price
34-5076	208-230/460	4.9-4.5/2.3	1	1.65	45	\$1,228.02
34-5077	208-230/460	6.4-6.3/3.2	1½	1.47	47	\$1,324.26
34-5078	208-230/460	7.5-7.2/3.6	2	1.30	50	\$1,555.68
34-5079	208-230/460	9.8-9.4/4.7	3	1.15	53	\$1,899.28



## SELF-PRIMING CENTRIFUGAL PUMPS

Self-priming, centrifugal design available in 3 and 5 H.P. models. The pump body has a single suction port with four-bolt flange connection for mounting strainer.

Centerline discharge port – 3 H.P. –  
2"½ H.P. – 2"½" discharge. Bronze impeller.

**NOTE: Pumps do not include Hair & Lint Trap – Order separately.**

Cat. No.	Nominal HP	Phase	Motor Voltage	Approx. Ship. Wt. (lbs.)	Price
DMH-171	3	1	230	135	\$2,419.60
DMH3-171	3	3	230/460	135	\$1,227.34
DMJ-172	5	1	230	178	\$2,981.85
DMJ3-172	5	3	230/460	178	\$2,126.44

### HAIR & LINT STRAINER

Cat. No.	Description	Suction Port	Approx. Ship. Wt.	Price
PKG 98	8" Cast Iron	3" NPT	40 lbs.	\$833.87



## HIGH PERFORMANCE COMMERCIAL SELF-PRIMING PUMP

Especially designed for commercial/public swimming pools or spas where very high performance and self-priming characteristics are desired. Oversized hair and lint strainer for large debris capacity (1100 cu. in. capacity). Rugged cast iron construction with bronze impeller. Standard 4" x 6" flange connections (N.S.F.).

**NOTE: Pumps do not include Hair & Lint Trap – Order separately.**

Cat. No.	Nominal HP	Phase	Motor Voltage	Approx. Ship. Wt. (Pump only)
CSPHK-142	7½	1	230	270 lbs.
CSPHK3-142	7½	3	230/460	265 lbs.
CSPHL3-143	10	3	230/460	270 lbs.
CSPHM3-144	15	3	230/460	280 lbs.
CSPHN3-145	20	3	230/460	325 lbs.

### F.O.B. Sta-Rite

Cat. No.	Description	Approx. Ship. Wt.
PKG 184	1100 cu. in. capacity	180 lbs.

Price on Application

## C-SERIES PUMPS



Perfect for the toughest outdoor and indoor projects, the C-Series pump gets its durability from all-brass construction and a stainless steel basket. For decades, the C-Series has proven its dependability as one of the most effective commercial pumps available anywhere. It has set the standard for medium and high-head performance in the pool industry. The C-Series Pump is available with and without a hair and lint pot.

### Standard Features:

- Heavy-Gauge stainless steel strainer basket
- 6" suction and 4" discharge for maximum efficiency
- Open area of Strainer Basket is 5 times area of suction port
- Heat-resistant seal operates at up to 150° Fahrenheit
- One year limited warranty
- 200-208 and 575 volt models available on request

Available with or without strainer.  
Pumps are self-priming with strainer.  
Pricing upon request.

## EQ-SERIES PUMPS



- Designed in every detail for maximum efficiency
- The only non-corrosive, all plastic pump designed exclusively for the commercial pool and water applications market
- The EQ's impeller features an exclusive design that provides true breakthrough performance
- Lower load due to efficient impeller design means longer motor life
- Cam and Ramp™ lid design with clear lid for added convenience in servicing

### Additional Features:

- Lightweight
- 6" suction and 4" discharge with strainer pot
- Heat resistant seal operates at up to 150° Fahrenheit
- Cam and Ramp™ lid design with clear lid
- Self-priming pump(with strainer pot)
- NSF-Listed
- Available in single and three phase 60 hertz models
- Models available for water feature applications
- One-year limited warranty

Available with or without strainer. Pricing upon request.





## PENTAIR TEFC REPLACEMENT MOTORS

**TEFC Replacement Motors make happier customers. Case closed.**

Single-phase totally enclosed fan cooled (TEFC) replacement motors for Pentair provide longer service life and greater reliability than traditional open drip proof (ODP) motors.



### LONGER LASTING

TEFC motors last longer. That's because they're designed to help prevent the intrusion of water, dust and other contaminants that can lead to premature failure in ODP motors

PART NO.	HP	PH	SF	VOLTS	PRICE
35-4806S	1	3	1.65	208-230/460	\$418.37
35-4808S	1-1/2	3	1.47	208-230/460	\$548.15
35-4810S	2	3	1.3	208-230/460	\$610.18
35-4812S	3	3	1.15	208-230/460	\$740.25
35-4814S	5	3	1.0	208-230/460	\$899.80
35-4804S	3/4	1	1.65	115/208-230	\$380.30
35-4822S	1	1	1.65	115/208-230	\$412.99
35-4824S	1-1/2	1	1.47	208-230	\$486.45
35-4816S	2	1	1.3	208-230	\$579.58
35-4818S	3	1	1.15	208-230	\$757.35
35-4820S	5	1	1.0	208-230	\$445.20

## ABOVE GROUND POOL PUMPS

### PACFAB DYNAMO PUMPS

Fiberglass reinforced pump with closed impeller, large 5" strainer pot, see-thru lid for easier cleaning on strainer. One (1) year warranty on pump and motor. Comes with 3' cord.



Cat. No.	Pump Model	Full Load			Price
		Voltage	S.F.	Amp Wt.	
34-0194	¾ H.P.	115	1.00	9.2 33 lbs.	\$819.56
34-0219	2 H.P.	115	1.00	12.0 37 lbs.	\$478.17

LIMITED QUANTITIES



### STA-RITE® OPTIFLO PUMPS

Exceptionally quiet operation and high performance

#34-8196 115 Volts 1 HP pump . . . . . \$482.54

## WHISPERFLO® HIGH PERFORMANCE PUMPS

Energy efficient swimming pool pumps. 40% glass-filled thermo-plastic with the Cam& Ramp™ "see thru" lid design. Self priming, high flow with patented Funnel-Flo™ diffusers. 2 in. suction and discharge ports. Motor features threaded shaft and durable commercial duty 56 frame motor with NEMA square flange.



### SINGLE-PHASE HIGH EFFICIENCY PUMP

Cat. No.	Voltage	Full Load Amps	THP	WEF	HHP	SF	Ship. Wt. (lbs)	Price
01-5583	115/208-230	10.5/5.5-5.4	1.10	3.40	0.69	1.0	50	\$1,101.28

### 3-PHASE TEFC SUPER-DUTY

Product No.	Model No.	Voltage	Full Load Amps	HP	SF	Approx. Ship. Wt. (lbs.)	Price
01-1641	WFK-4	208-230/460V	4.9-4.5/2.3	1	1.65	46	\$1,261.34
01-1642	WFK-6	208-230/460V	6.4-6.3/3.2	1-1/2	1.47	48	\$1,385.45
01-1643	WFK-8	208-230/460V	7.5-7.2/3.6	2	1.30	51	\$1,629.16
01-1644	WFK-12	208-230/460V	9.8-9.4/4.7	3	1.15	58	\$1,992.82

**833-SWIM-327**  
833-7946-327  
[www.halogensupply.com](http://www.halogensupply.com)



## PENTAIR PUMPS & MOTORS

## WHISPERFLO XFT™ HIGH PERFORMANCE PUMPS

Drop-in replacement for all WhisperFlo® pump models. Simple replacement for Challenger® pumps.\* Hydraulic isolator separates priming water from pumping water. Union connectors included for connecting directly to 2.5" or 3" plumbing. Diamond seals. Easy-carry handle.



### SINGLE-PHASE HIGH EFFICIENCY PUMP

Cat. No.	Voltage	Full Load Amps	THP	WEF	HHP	SF	Ship. Wt. (lbs)	Price
02-2056	230	16	3.95	5.60	2.10	1.0	60	\$2,508.49

### 3-PHASE TEFC SUPER-DUTY

Product No.	Model No.	Voltage	Full Load Amps	HP	SF	Price
02-2017	XFK-8	208-230/460V	7.5-7.2/3.6	2	1.3	\$1,802.62
02-2018	XFK-12	208-230/460V	9.8-9.4/4.7	3	1.15	\$1,031.94
02-2019	XFK-20	208-230/460V	13.9-13.1/6.6	5	1.0	\$3,573.30

## SUPERFLO HIGH PERFORMANCE PUMP

- 1.5" internal slip (2" external slip) and quick-disconnect plumbing union for faster disassembly, making it a summer breeze to service.
- Cam and Ramp™ Lid permits easy inspection of the strainer basket and locks in place with a quarter turn for cleaning that is fast and easy.
- SuperFlo pumps are a high-performing drop-in replacement for the Hayward® Super Pump®.
- Meets DOE minimum efficiency requirements.



### SINGLE-PHASE HIGH EFFICIENCY PUMP

Cat. No.	Voltage	Full Load Amps	THP	WEF	HHP	SF	Ship. Wt. (lbs)	Price
34-8190	115/208-230	10.5/5.5-5.4	1.10	3.60	0.63	1.0	50	\$810.10

## C SERIES PUMP PARTS



C SERIES PUMP PARTS			
A.	07-5280	HAND KNOB	\$145.28
B.	07-5275	STRAINER LID	\$1053.81
C.	07-1433	STRAINER LID O-RING	\$17.72
D.	07-2795	STRAINER BASKET	\$495.71
E.	IMPELLER		
	07-0228	CMK-50 IMPELLER 5 HP	\$1,626.32
	07-0227	CMK-75 IMPELLER 7.5 HP	\$1,626.32
	07-0226	CMK-100 IMPELLER 10 HP	\$1,626.32
	07-0225	CMK-150 IMPELLER 15 HP	\$1,626.32
	07-3828	CHK-50 IMPELLER 5 HP	\$1,626.32
	07-3829	CHK-75 IMPELLER 7.5 HP	\$1,626.32
	07-3830	CHK-100 IMPELLER 10 HP	\$1,626.32
	07-3831	CHK-150 IMPELLER 15 HP	\$1,626.32
	07-3832	CHK-200 IMPELLER 20 HP	\$1,626.32
F.	07-1725	MECHANICAL SEAL	\$52.22
G.	07-0906	FLANGE	\$708.32
H.	07-1423	FLANGE O-RING	\$8.80
I.	07-1037	IMPELLER LOCKING SCREW	\$12.04
J.	07-1048	IMPELLER WASHER	\$17.03
K.	07-5713	IMPELLER GASKET	\$3.50
L.	07-1046	IMPELLER KEY	\$26.64

## D SERIES PUMP PARTS



D SERIES PUMP PARTS			
A.	C154-18D	HANDLE ASSEMBLY	\$35.66
*B.	C3-105	STRAINER COVER	\$199.42
*C.	U9-171	STRAINER O-RING	\$30.12
*D.	16401-0030	STRAINER BASKET	\$423.79
E.	C20-19	GASKET	\$6.70
F.	C21-2	DIFFUSER GASKET	\$5.94
G.	C101-126	DIFFUSER DMH 3 HP	\$185.36
	C101-126B	DIFFUSER DMJ 5 HP	\$193.41
H.	C5-246	IMPELLER DMH 3 HP	\$814.30
	C5-247	IMPELLER DMJ 5 HP	\$806.67
I.	U109-433SS	MECHANICAL SEAL	\$136.87
J.	C20-46	ADAPTER GASKET	\$15.24
K.	C23-58	SHAFT SLEEVE	\$129.51
L.	U65-42A	SLEEVE KEY	\$14.300

\* Pkg 98 Hair and Lint Strainer

## CSPH SERIES PUMP PARTS



CSPH SERIES PUMP PARTS			
A.	35505-0421	STRAINER COVER O-RING	\$94.10
B.	IMPELLER		
	16830-0209	IMPELLER 7.5 HP	\$1,505.48
	16830-0210	IMPELLER 10 HP	\$1,357.38
	16830-0211	IMPELLER 15 HP	\$1,551.13
	16830-0212	IMPELLER 20 HP	\$1,852.87
C.	S04757	GASKET(VOLUTE TO BRACKET)	\$17.23
D.	37447-0001L	SHAFT SLEEVE	\$229.39
	37447-0002L	SHAFT SLEEVE - 20 HP	\$284.40
E.	S11207	RETAINING RING	\$22.15
	S16767	RETAINING RING - 20 HP	\$44.28
F.	S32014	MECHANICAL SEAL	\$152.26
	S32015	MECHANICAL SEAL - 20 HP	\$328.28

## EQK SERIES PUMP PARTS



EQK SERIES PUMP PARTS			
A.	IMPELLER		
	35-0030	IMPELLER 5 HP	\$499.48
	35-0029	IMPELLER 7.5 HP	\$532.80
	35-0028	IMPELLER 10 HP	\$566.10
	35-0027	IMPELLER 15 HP	\$632.68
B.	DIFFUSER		
	35-0032	DIFFUSER 5 HP	\$820.60
	35-0033	DIFFUSER 7.5 HP	\$879.86
	35-0033	DIFFUSER 10 HP	\$879.86
	35-6735	DIFFUSER 15 HP	\$655.98
C.	07-1725	MECHANICAL SEAL	\$52.22
D.	35-0037	DIFFUSER O-RING	\$19.49
E.	35-6780	SEAL PLATE O-RING	\$57.94
F.	35-0171	CLAMP CAM & RAMP	\$730.40
G.	35-6750	STRAINER LID	\$528.59
H.	35-0166	STRAINER LID O-RING	\$26.13
I.	35-7184	BASKET	\$233.26

**833-SWIM-327**  
833-7946-327  
[www.halogensupply.com](http://www.halogensupply.com)

## WHISPER FLO PUMP PARTS

### A. Impellers

Part No.	Models	HP	Price
07-3126	WFE-2, WFK-2	1/2	\$102.35
07-3127	WFE-3, WFK-3	3/4	\$102.35
07-3128	WFE-4, WFK-4	1	\$102.35
07-3129	WFE-6, WFK-6	1 1/2	\$102.35
07-3130	WFE-8, WFK-8	2	\$102.35
07-3131	WFE-12, WFK-12	3	\$102.35

- B. #07-2927 Diffuser 1/2 - 2HP . . . . \$77.96  
 #07-2928 Diffuser 3HP only. . . . . \$93.17  
 C. #07-1734 Shaft Seal . . . . . \$31.07  
 D. #35-5227 Diffuser O' Ring (not shown) . . \$7.40  
 E. #35-7102 Housing Gasket. . . . . \$6.62  
 F. #35-7149 Volute Replacement Kit . . \$307.94  
 G. #35-0202 Seal Plate Kit . . . . . \$206.48  
 H. #07-0387 Basket . . . . . \$17.15  
 I. #35-0013 Lid O' Ring (not shown) . . . . \$8.60

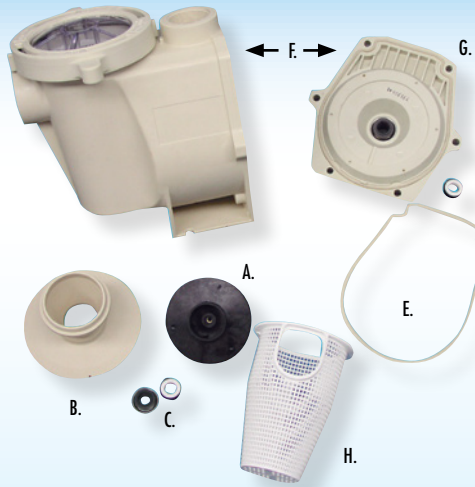

## CHALLENGER HIGH FLOW PUMP PARTS



Part No.	Description	Price
A. 35-5004	Seal Plate	\$104.18
B. 35-4545	Seal 5/8 Mech.	\$29.34
C. 35-5468	Front Housing	\$152.06
D. 35-5300	Strainer Pot	\$149.92
E. 35-5301	Strainer Lid	\$65.99
F. 35-5389*	Impeller Locking Screw	\$3.50

\*Parts not shown

Part No.	Description	Price
G. 35-5030*	Diffuser "O" Ring	\$9.61
H. 35-5331*	Diffuser "O" Ring (5 HP)	\$4.29
I. 35-5329*	Front Housing "O" Ring	\$17.21
J. 35-7161*	Drain Plug	\$5.75
K. 19-2115*	Drain Plug "O" Ring	\$2.88
L. 35-5013*	Lid "O" Ring	\$8.60
M. 35-5318	Basket	\$42.05
N. 35-5320	Clamp	\$88.83

### N. IMPELLER

Model No.	Cat. No.	Price
CF11-N1-3/4A	35-5043	\$55.80
CF11-N1-1A	35-5067	\$56.90
CF11-N1-1 1/4A	35-5074	\$57.58
CF11-N1-2A	35-5086	\$57.98
*CH11-N1-3FE	35-5544	\$75.74
C F11-N1-5FE	35-5068	\$56.90

### O. DIFFUSER

Model No.	Cat. No.	Price
CF11-N1-3/4A	35-5029	\$41.45
CF11-N1-1A	35-5029	\$41.45
CF11-N1-1 1/4A	35-5077	\$41.45
CF11-N1-2A	35-5077	\$41.45
*CH11-N1-3FE	35-5545	\$56.57
CF11-N1-5FE	35-5069	\$38.34

### P. MOUNTING PLATE

Model No.	Cat. No.	Price
CF11-N1-3/4A	35-5028	\$24.28
CF11-N1-1A	35-5028	\$24.28
CF11-N1-1 1/4A	35-5078	\$15.28
CF11-N1-2A	35-5078	\$15.28
*CH11-N1-3FE	35-5317	\$15.28
CF11-N1-5FE	35-5495	\$14.11

\*High Pressure 3HP

## STARITE PUMP PARTS

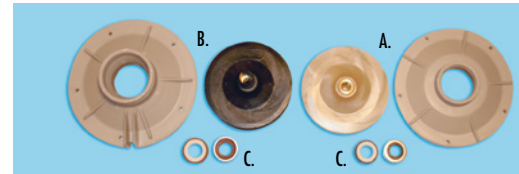

### A. Models P2RA & PEA

HP	Impeller	Price	Diffuser	Price
1/2	C105-92PR	\$71.21	C1-217P	\$29.75
3/4	C105-92PS	\$71.21	C1-216P	\$30.08
1	C105-138PEB	\$76.14	C1-200PA	\$31.97
1 1/2	C105-137PEB	\$93.60	C1-200PA	\$31.97
2	C105-137PDBA	\$93.60	C1-200PA	\$31.97

### B. Models P4RA, P4EA, P6RA & P6EA

HP	Impeller	Price	Diffuser	Price
1	C105-238P	\$80.12	C1-271PI	\$32.69
1 1/2	C105-238PB	\$80.12	C1-271PI	\$32.69
2	C105-238PDBA	\$82.55	C1-271P	\$31.57
2 1/2	C105-238PEBA	\$82.55	C1-271P	\$31.57
3	C105-238PLA	\$85.79	C1-271P	\$31.57

### C. SHAFT SEALS

Part No.	Pump Model No.	Price
U109-93SS <sup>1</sup>	PE, PEA, P2R, P2RA	\$23.87
17304-0100S <sup>2</sup>	PE, PEA, P2R, P2RA	\$13.32
U109-372SS <sup>1</sup>	P4E, P4EA, P4R, P4RA, P6R, P6RA, P6E, P6EA	\$35.10
17351-0101S <sup>2</sup>	P4E, P4EA, P4R, P4RA, P6R, P6RA, P6E, P6EA	\$26.73

<sup>1</sup> Models with copper inserts pre-1998

<sup>2</sup> Models without copper inserts beginning 1998

### D. SEAL/GASKETS KITS

Includes shaft seal, gaskets, and o-rings.

Part No.	Pump Model No.	Price
PP1000 <sup>1</sup>	PE, PEA, P2R, P2RA	\$50.65
PP4000 <sup>1</sup>	P4E, P4EA, P4R, P4RA	\$59.40
PP1200 <sup>2</sup>	PE, PEA, P2R, P2RA	\$50.65
PP4200 <sup>2</sup>	P4E, P4EA, P4R, P4RA	\$60.84

<sup>1</sup> Models with copper inserts pre-1998

<sup>2</sup> Models without copper inserts beginning 1998

### E. TRAP LID KITS

Includes trap lid and o-ring.

Part No.	Pump Model No.	Price
PP2075	PE, PEA, P2R, P2RA	\$58.22
PP4075	P4E, P4EA, P4R, P4RA	\$72.81

## PUMP PARTS



## STARITE PUMP PARTS



- F. #C176-59P Tank Body Assembly (P4 Series) . . \$288.45  
 #U9-375 P4 Lid O-Ring . . . . . \$29.48  
 G. #17307-0110S Tank Body Assembly (P6 Series) \$318.04  
 #35505-1440 P6 Lid O-Ring . . . . . \$19.01  
 H. #C108-33P Basket . . . . . \$13.07  
 I. #C8-58P Basket . . . . . \$14.11  
 J. #C19-37A Clamp Only . . . . . \$106.76  
 K. #PKG115 Trap Assembly (P2 Series) . . . . \$144.47  
 #U9-229 PKG115 Lid O-Ring . . . . . \$15.33

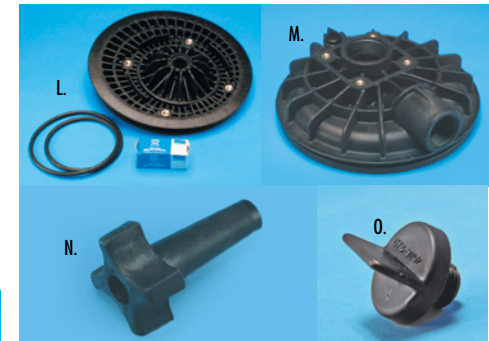

- L. #C203-193P Seal Plate Kit (P2 Series) \$171.38  
 #C203-194P Seal Plate Kit (P4 Series) \$171.38  
 M. #C176-47P1 Tank Body. . . . . \$136.46  
 N. #WC36-22 Hand Knob . . . . . \$13.12  
 O. #U178-920P Drain Plug with O-Ring . . \$5.18

# REPLACEMENT PUMPS MOTORS & TIMERS

## CENTURY AND A.O. SMITH MOTORS

### A. SQUARE FLANGE-56Y FRAME

#### LOW SERVICE FACTOR (UP-RATE)

CAT. NO	HP	SF	AMPS	VOLTS	PRICE
B852	3/4	1.25	10.8/5.4	115/230	\$288.45
B853	1	1.25	14.2/7.1	115/230	\$329.38
B854	1-1/2	1.10	16.0/8.0	115/230	\$382.55
B855	2	1.10	10	230	\$491.51
B840	2-1/2	1.04	11.5	230	\$598.66
B1000	5	1.00	21.0-19.4	208-230	\$1,148.09

#### ENERGY EFFICIENT HIGH SERVICE FACTOR (FULL-RATE)

CAT. NO	HP	SF	AMPS	VOLTS	PRICE
B845	1/2	1.90	8.8/4.5-4.4	115/208-230	\$355.57
B661	3/4	1.67	11.2/6.0-5.6	115/208-230	\$384.32
B841	1	1.65	14.8/7.8-7.4	115/208-230	\$414.86
B842	1-1/2	1.47	9.6-8.8	208-230	\$524.61
B843	2	1.30	11.0-10.2	208-230	\$630.07
B844	3	1.15	15.0-13.6	208-230	\$740.72

#### THREE PHASE HIGH SERVICE FACTOR (FULL RATE)

CAT. NO	HP	SF	AMPS	VOLTS	PRICE
H492	3/4	1.65	3.8-3.6/1.8	208-230/460	\$423.38
H635	1	1.65	5.0-4.6/2.3	208-230/460	\$475.13
H636	1-1/2	1.47	6.4-5.8/2.9	208-230/460	\$603.11
H637	2	1.30	7.1-6.8/3.4	208-230/460	\$731.07
H755	3	1.15	9.0-8.6/4.3	208-230/460	\$787.16
H995	5	1.00	13.4-13.4/6.7	208-230/460	\$1,023.26

#### ENERGY EFFICIENT TWO SPEED HIGH SERVICE FACTOR (FULL RATE)

CAT. NO	HP	SF	AMPS	VOLTS	PRICE
B980	3/4~.10	1.67	6.0/1.0	230	\$522.45
B981	3/4~.10	1.67	12.4/2.2	115	\$524.70
B982	1~.13	1.67	7.4/1.4	230	\$552.26
B983	1-1/4~.19	1.47	10.0/1.6	230	\$637.31
B984	2~.25	1.30	11.0/1.8	230	\$789.80

Applications: Pentair Challenger, Ultra-Flo and Whisper-Flo

### B. C-FACE-56J FRAME

#### HIGH SERVICE FACTOR (FULL RATE)

CAT. NO	HP	SF	AMPS	VOLTS	PRICE
B126	1/2	1.60	8.8/4.4	115/230	\$300.98
B127	3/4	1.50	12.0/6.0	115/230	\$314.62
B128	1	1.40	14.4/7.2	115/230	\$359.89
B129	1-1/2	1.30	18.4/9.2	115/230	\$487.15
B130	2	1.20	10.5	230	\$571.66
B131	3	1.15	14.1	230	\$800.87

Applications: Hayward Superpump, Jacuzzi Magnum

### C. SQUARE FLANGE-48Y FRAME

#### LOW SERVICE FACTOR (UP-RATE)

CAT. NO	HP	SF	AMPS	VOLTS	PRICE
USQ1052	1/2	1.30	9.9/5.0	115/230	\$280.62
USQ1072	3/4	1.27	13.4/6.7	115/230	\$288.45
USQ1102	1	1.25	15.3/7.6	115/230	\$324.20
USQ1152	1-1/2	1.10	19.2/9.6	115/230	\$375.59
USQ1202	2	1.10	10.4	230	\$483.64
USQ1252	2-1/2	1.00	11.2	230	\$598.66

#### ENERGY EFFICIENT HIGH SERVICE FACTOR (FULL-RATE)

CAT. NO	HP	SF	AMPS	VOLTS	PRICE
QC1052	1/2	1.90	9.6/4.8	115/230	\$346.25
QC1072	3/4	1.65	12.6/6.3	115/230	\$388.33
QC1102	1	1.65	16.0/8.0	115/230	\$419.02
SQ1152	1-1/2	1.47	10.4	230	\$483.64
SQ1202	2	1.30	11.2	230	\$598.66
SQ1302VI	3	1.15	15.4	230	\$740.72

#### THREE PHASE HIGH SERVICE FACTOR (FULL-RATE)

CAT. NO	HP	SF	AMPS	VOLTS	PRICE
Q3072	3/4	1.65	3.6/1.8	208-230/460	\$407.59
Q3102	1	1.65	4.7/2.35	208-230/460	\$454.95
Q3152	1-1/2	1.47	6.8/3.4	208-230/460	\$576.79
Q3202	2	1.30	8.5/4.25	208-230/460	\$699.53
Q3302	3	1.15	9.7/4.9	208-230/460	\$757.42

#### ENERGY EFFICIENT TWO SPEED HIGH SERVICE FACTOR (FULL-RATE)

CAT. NO	HP	SF	AMPS	VOLTS	PRICE
SQL1072R	3/4-1/8	1.65	13.0/4.2	115	\$583.81
SQS1102R	1-1/6	1.65	7.7/2.8	230	\$596.97
SQS1152R	1-1/2-1/4	1.47	10.0/3.0	230	\$717.95
SQS1202R	2-1/3	1.30	11.3/3.3	230	\$900.29

Applications: Sta-Rite Duraglas/Duraglas II, Sta-Rite Maxeglas/Maxeglas II, and Sta-Rite Max E Pro

### D. FLEX-48 THRU BOLT-48Y FRAME

#### SINGLE SPEED

CAT. NO	HP	SF	AMPS	VOLTS	PRICE
BN235S	1/2	1.00	7.2	115	\$213.53
BN245S	3/4	1.00	9.8	115	\$231.82
BN255S	1	1.00	12.0	115	\$254.45
BN355S	1-1/2	1.00	16.0/8.0	115/230	\$296.33
BN405S	2	1.00	20.0/10.0	115/230	\$356.40

#### TWO SPEED

CAT. NO	HP	SF	AMPS	VOLTS	PRICE
BN36	3/4~.10	1.00	8.8/2.6	115	\$296.33
BN37	1~.12	1.00	11.0/2.9	115	\$338.04
BN50	1-1/2~.25	1.00	16.4/4.4	115	\$431.37
BN34	1-1/2~.18	1.00	8.0/2.6	230	\$420.05
BN51	2~.25	1.00	10.5/2.6	230	\$476.71



### E. CLOSED-COUPLED

CAT. NO	HP	PHASE	FRAME	SF	AMPS	VOLTS	PRICE
P130	3	1	182JM	1.15	13.4	230	\$1,088.17
P231	5	1	184JM	1.15	26	230	\$1,739.99
CP026	3	3	145JM	1.15	8.2-7.4/3.7	208-230/460	\$1,179.14
CP038	5	3	182JM	1.15	13.2-11.8/5.9	208-230/460	\$1,362.15
CP045	7-1/2	3	184JM	1.15	19.0-17.0/8.5	208-230/460	\$1,634.76
E371ME	10	3	213JM	1.15	26.0-23.4/11.7	208-230/460	\$1,862.10
E377E	15	3	215JM	1.15	34.0/17.0	230/460	\$2,435.63

Applications: Sta-Rite DMH/DMJ Series, Sta-Rite CSP Series and ITT Marlow

### F. CMK/CHK THREE PHASE

CAT. NO	HP	FRAME	SF	AMPS	VOLTS	PRICE
R237	5	182TDZ	1.15	13.6-13/6.5	208-220/440	\$3,122.35
R232	7-1/2	184TDZ	1.15	19-18.4/9.2	208-220/440	\$3,418.99
R338	10	213TDZ	1.15	26.3-25.3/12.7	208-220/440	\$4,917.89
R339	15	215TDZ	1.15	40.5-38/19	208-220/440	\$5,761.22



### G. PENTAIR EQK SERIES THREE PHASE

CAT. NO	HP	FRAME	SF	AMPS	VOLTS	PRICE
CEQK500	5	182JMZ	1.15	11.8/5.9	230/460	\$1,019.00
CEQK750	7-1/2	184JMZ	1.15	17.8/8.9	230/460	\$1,173.26
CEQK1000	10	213JMZ	1.15	24.2/12.1	230/460	\$1,646.75
CEQK1500	15	215JMZ	1.15	36.5/18.2	230/460	\$1,729.01

## SEMI-COMMERCIAL D.E. FILTER SYSTEMS



### FNS PLUS D.E. Filter

Our FNS PLUS Series filters keep pool sparkling clean and free from impurities. For superior strength and reliability, these commercial-grade filter tanks are manufactured from fiberglass-reinforced polypropylene. Our unique top manifold design with curved vertical grids makes maintenance convenient.

- Rugged fiberglass-reinforced polypropylene tank combines fiberglass strength with the smooth finish of polypropylene.
- Top manifold design ensures better precoat and superior

Design Flow Rate*									
Catalog No.	Model No.	Sq. Ft.	GPM	GPH	6 Hours	8 Hours	Precoat Required	Tank Height	Price
18-0007	FNSP 36	36"	90	5,400	32,400	43,200	3.5 lbs.	43"	\$1,262.98
18-0008	FNSP 48	48"	120	7,200	43,200	57,600	5 lbs.	49"	\$1,420.97
18-0009	FNSP 60	60"	150	9,000	54,000	72,000	6 lbs.	55"	\$1,568.62

\* Flow rate is based on 2.5 GPM per sq. ft. of filter area. Actual system flow will depend on plumbing size and other system components.

\*See page 23 for valve options

## SEMI-COMMERCIAL HIGH-RATE SAND FILTERS

### TRITON® COMMERCIAL SAND FILTERS

C and Triton C-3  
High Capacity Fiberglass Side Mount  
Sand Filter without Valves



- Maximum Operating Pressure 50 psi
- Full 2 in. Drain
- 8 in. opening for easy access to sand bed
- The Triton C-3 features standard 3 in. flange connections
- TR 100C-3 & TR 140C-3 models are available in black only

TRITON C FILTER PERFORMANCE DATA									
Catalog No.	Model No.	Tank Dia.	Filter Area sq. ft.	Wt.	All Sand (lbs.)	Filter Media Pea Gravel	Sand	Price	
14-0264	TR-60	24 in.	3.14	39	325	75	250	\$1,084.02	
14-0315	TR-100C	30 in.	4.91	65	600	150	450	\$1,610.39	
14-0316	TR-140C	36 in.	7.06	82	925	275	650	\$2,384.55	
TRITON C-3 FILTER PERFORMANCE DATA									
14-0310	TR-100C-3	30 in.	4.91	65	600	150	450	\$2,027.42	
14-0342	TR-140C-3	36 in.	7.06	82	925	275	650	\$2,845.73	

F.O.B. Factory



This filter series features multiple diverters for increased filtration rates in commercial applications up to 20 GPM/sq. ft.

## QUAD D.E.™

### Cartridge Style Filter

The crystal clarity of D.E. with cartridge convenience

Diatomaceous earth (D.E.) filters have always been recognized for providing the cleanest pool water. And cartridge filters are popular for their convenience and easy cleaning features. Now Pentair has found a way to bring you the best of both. The new Quad D.E.® Filter features four easily accessible and removable D.E. cartridges. And cleaning couldn't be easier. In fact, you have three options...backwash and recharge like a traditional D.E. filter, remove and rinse off the cartridges, or simply remove the lid, leave the cartridges in place, open the drain plug, and rinse.



## DIATOMACEOUS EARTH SEMI- COMMERCIAL RESIDENTIAL FILTERS

Note: Must use a HiFlow™ Valve (Part # 261050) or Slide Valve (Part # 263034 or Part # 261165) when plumbing filter with a backwash valve. See page 23 for these values.

Catalog No.	Model No.	Filter Area Sq. Ft.	Vertical Clearance*	Filter Diameter	FlowRate Res.*** GPM	Com.	Turnover Capacity-Res.(Gallons) 8hrs.	10hrs.	12hrs.	Price
18-8592	QUAD 60**	60	62"	21.5"	120	90	57,600	72,000	86,400	\$1,468.59
18-8593	QUAD 80**	80	68"	21.5"	160	150	76,800	96,000	115,200	\$1,899.24
18-8594	QUAD 100**	100	74"	21.5"	160	150	76,800	96,000	115,200	\$2,068.46

\*Required clearance to remove filter elements \*\*NSF Listed \*\*\*Maximum flow rate

## ABOVE GROUND SAND SYSTEMS

We've combined the efficient Sand Dollar filter with the powerful and economical OptiFlo® Aboveground Pool Pump to create this high performance system for above ground pools. With its rugged construction highly efficient filter design and hydraulically matched components, this system provides all the clean, crystal clear water your pool requires. Plus, it's built with long-term reliability in mind, and incredibly simple to operate and maintain.

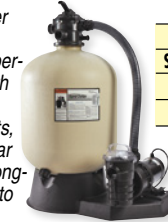

### Sand Dollar Systems Flow Rate †

Sq. Ft.	Diameter	Height	GPM	Flow			Lbs. Sand Required†
				8 Hour	10 Hour	12 Hour	
1.8	19 in.	34.0 in.	40.0	19,200	24,000	28,800	150
2.3	22 in.	35.5 in.	60.0	28,800	36,000	43,200	250

† Flow rates based on NSF 20 GPM per sq. ft. of filter area. Actual system flow will depend on plumbing size and other system components.  
† Sand must be 20 grade silica sand or equal.

- #PNSD0040DE1160 19" Sand Dollar System w/1 HP Pump . . . \$882.74
- #PNSD0060DO1160 22" Sand Dollar System w/1½ HP Pump . . . \$948.26

## RESIDENTIAL SAND FILTERS

### Features:

- Special lateral design provides superior flow characteristics, long filter cycles for economical operation.
- Maximum Operating Pressure 50 psi.
- Combination water and sand drain makes servicing and winterizing fast and easy.
- 40, 50 and 60D come with plastic clamp.



### TAGELUS™ TOP MOUNT FILTER Fiberglass Tank with Multiport Valve, Clamp Style

Our process creates a one-piece, fiberglass reinforced tank with superior strength and durability. Tagelus® Top Mount filters are equipped with a six-position, clamp style, top mounted multiport valve.

Model No.	Flow Rate GPM	Turnover Capacity (Gallons)		
		8 hrs.	10 hrs.	12 hrs.
TA 40D	40	19,200	24,000	28,800
TA 50D	50	24,000	30,000	36,000
TA 60D	60	28,800	36,000	43,200
TA 100D	100	48,000	60,000	72,200

Catalog No.	Model No.	Tank Dia.	Filter Area	All Sand (lbs.)	Price
14-4126	TA 40D	19 in.	1.8	175	\$712.82
14-4127	TA 50D	21 in.	2.3	225	\$700.71
14-5241	TA 60D	24 in.	3.1	325	\$848.32
14-5240	TA 100D	30 in.	4.9	600	\$1,315.55

### MEDIA

- #547 50 lb. bag Mystic white sand . . . . . \$17.55
- #548 50 lb. bag gravel . . . . . \$16.95
- #547-ZEO-25 25 lb. bag Zeo sand . . . . . \$25.00

See page 23 for all filter valves

# SEMI COMMERCIAL & RESIDENTIAL CARTRIDGE FILTERS

**STA-RITE®**

## SM Series



- Patented balanced-flow tank hydraulics direct water through each side of the filter module for uniform dirt loading, no clogging and long, unattended operation.
- Complete media coverage combined with shallow pleats for greater dirt holding capacities, longer filter cycles and less cleaning.
- Shallow pleat design also permits quick and thorough cleaning- just rinse the module with a hose.

Filter Sizing						
Cat. No.	Sq. Ft. of Area	Maximum Flow	Pool Size 8 Hr. Rate*	Pool Size 6 Hr. Rate*	Port Size	Price
S7M120	300	100 gpm	36,000-48,000	27,000-36,000	2	\$1,651.59
S8M150	450	125 gpm	45,120-60,000	33,840-45,000	2	\$2,166.65

## SYSTEM 3® MOD MEDIA

### One cleaning for an entire season?

Sta-Rite's System3® Mod Media™ filters handle 2-3 times more dirt than other filters to deliver maintenance-free performance for up to a full season. Featuring perfectly balanced flow and integral manifold design, these filters are engineered to deliver the ultimate in labor-savings. System3® Mod Media™ filters are ideal for inground pools, inground hot tubs and water features.

### Performing to a higher standard

Based on Sta-Rite's extensive research in filtration and media science, System3 Mod Media filters make Ultra-Capacity Filtration™ a reality. Unlike conventional "cartridges," these filters combine a patented balanced flow and integral manifold design, plus an easily-cleaned media element. Modular filter tanks permit quick change of filter media. The result is a filter system that not only requires less frequent cleaning, but is also easy to clean.

The System3 Mod Filter is constructed of Dura-Glas® high-density composite resin to weather the elements for long, dependable life. And its sleek, contemporary appearance and matte black finish looks attractive in any pool setting.

## ABOVE-GROUND FILTER SYSTEM

### CLEAN & CLEAR CC100 FILTER SYSTEM

- High quality filtration unit using a thermoplastic chemical-resistant tank. Equipped with easy spin-on unions for plumbing hookups
- High flow manual air relief valve
- 1 inch drain and washout
- Single piece base and body design 1 1/2 HP pump

#PNCC01000E1162

IHP SYSTEM . \$910.64



## CLEAN & CLEAR® PLUS FILTERS

### Fiberglass Reinforced Polypropylene Tank

Clean & Clear® Plus Filters have a corrosion resistant injection molded filter tank featuring superior strength and reliability. The cartridge assembly uses four easy to clean, non-woven, polyester cartridges. Each filter is supplied with a bulkhead union set for easy installation.

### Featured Highlights:

- NSF listed
- Superior strength
- Large filter area for increased dirt capacity
- 1-1/2 in., 100% drain clean-out port
- Continuous High Flow™ internal air relief
- Base and plumbing kits now available
- Injection molded tank
- Balanced hydraulic flow
- Tension Control™ clamp
- 100% factory tested
- Black bulkhead unions
- High Flow manual air relief valve

Cat. No.	Model No.	Sq. Ft.	Tank Height	Price
16-0310	CCP240	240	37"	\$1,227.58
16-0340	CCP320	320	43"	\$1,468.38
16-0301	CCP420	420	49"	\$1,666.71
16-0332	CCP520	520	56"	\$1,063.29



## CLEAN & CLEAR® CARTRIDGE FILTER

### Carefree...by design

Like all Pentair cartridge filters, the Clean & Clear® filter features an easily-cleaned cartridge for the ultimate in carefree pool filtration. The fiberglass-reinforced tank halves are secured with an innovative clamp ring—just loosen the ring and remove the top half for easy cartridge access and rinsing. Filter maintenance doesn't get any easier.

- 1 1/2" drain and washout for quick and convenient maintenance and winterization.
- Innovative lock-ring requires only half of a revolution for a safe, leak-proof seal.
- Single piece base and body designed for maximum durability.
- One-year limited warranty. See warranty for details.
- 2" plumbing for maximum flow.



Catalog No.	Model No.	Filter Area Sq. Ft.	Vertical Clearance*	Filter Diameter	FlowRate Res.** GPM	Com.	Turnover 8hrs.	Capacity-Res.(Gallons) 10hrs.	12hrs.	Price
16-0314	CC 50	50	30"	15.5"	50	19	24,000	30,000	36,000	\$436.13
16-0315	CC 75	75	39"	15.5"	75	28	36,000	45,000	54,000	\$565.05
16-0316	CC 100	100	61"	15.5"	100	38	48,000	60,000	72,000	\$715.24
16-0317	CC 150	150	76"	15.5"	150	56	72,000	90,000	108,000	\$947.71
16-0318	CC 200	200	76"	15.5"	150	75	72,000	90,000	108,000	\$1,109.83

\*Required clearance to remove filter elements \*\*Maximum flow rate

## STA-RITE

Tank Model	OEM P/N	HSC P/N	Price
PRC75	25200-0175S	H7483	\$87.40
PXC-75	25230-0075S	H8311	\$96.38
PXC-95	25230-0095S	H8311	\$96.38
PXC-125	25230-0125S	H8416	\$163.25
PXC-150	25230-0150S	H8416	\$163.25
PXCRP100	R173215	H9410	\$134.20
PXCRP150	R173216	H9415	\$176.83
PXCRP200	R173217	H9419	\$220.63
S7M120	25021-0200S		\$241.14
S7M120	25022-0201S		\$479.20
S7M400	25021-0223S		\$267.25
S7M400	25022-0224S		\$482.27
S8M150	25021-0202S		\$399.32
S8M150	25022-0203S		\$649.68
S8M500	25021-0224S		\$482.27
S8M500	25022-0225S		\$671.18
PLM100	27002-0100S		\$252.59
PLM125	27002-0125S		\$304.35
PLM150	27002-0150S		\$374.93
PLM175	27002-0175S		\$421.97
PLM200	27002-0200S		\$470.63
WC108-56S2X	UHD-SR50		\$85.35
WC108-57S2X	UHD-SR70		\$103.65
WC108-58S2X	UHD-SR100		\$136.20
WC108-59S2X	UHD-SR135		\$170.63
WC108-70S2X	UHD-SR137		\$170.63

## HARMSCO

Tank Model	OEM P/N	HSC P/N	Price
BF	ST6	H380	\$7.58
BF105	ST105	H7685	\$126.33
BF155	ST155	H7697	\$166.93
HUR 170	HC/170		\$204.26

## PENTAIR

Tank Model	OEM P/N	HSC P/N	Price
CC 50	R173213	H9405	\$89.38
CC 75	R173214	H9407	\$109.38
CC 100	R173215	H9410	\$134.20
CC 125	173200	H9410	\$134.20
CC 150	R173216	H9415	\$176.83
CC 175	173201	H9419	\$220.63
CC200	R173217	H9419	\$220.63
CCP 240	R173572	H7469	\$82.50
CCP 320	R173573	H7470	\$105.40
CCP 420	R173576	H7471	\$129.43
CCP 520	R173578	H7472	\$148.33
CCRP 100	R173215	H9410	\$134.20
CCRP 150	R173216	H9415	\$176.83
CCRP 200	R173217	H9419	\$220.63
Commander 75	R173205 R173204 57007400	H7698	\$120.05
Commander 100	R173208 57014400	H7698	\$120.05
Quantum 240	178569	H7469	\$82.5

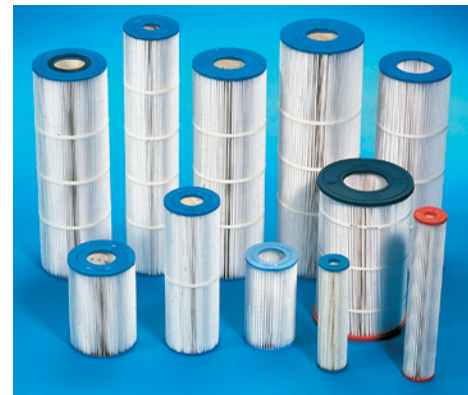

We carry cartridges for many different pool & spa cartridge filters. Please call with height, width, and endcap configurations.

## HAYWARD

Tank Model	OEM P/N	HSC P/N	Price
C400	CX410RE	H7442	\$65.48
C500	CX500RE	H7656	\$71.33
C550	CX550RE	H7656	\$71.33
C750	CX750RE	H7698	\$120.05
C800	CX800RE	H8600	\$103.18
C900	CX900RE	H8311	\$96.38
C1000	CX1000RE	H7698	\$120.05
C1100	CX1100RE	H8610	\$131.43
C1200	CX1200RE	H8410	\$126.45
C1250	CX1250RE	H9499	\$156.78
C1500	CX1500RE	H9499	\$156.78
C1750	CX1750RE	H8417	\$202.35
C2025	CX480XRE	H7469	\$82.50
C3000			
C3020	CX570XRE	H7483	\$87.40
C3000S			
C3025	CX580XRE	H7483	\$87.40
C3030			
C4000			
C4020	CX870XRE	H7488	\$73.58
C4000S			
C4025	CX880XRE	H7488	\$73.58
C4030			
C4500	CX875RE	H7488	\$73.58
C4520			
CC1000	CCX1000RE	H8311	\$96.38
CC1250	CCX1250RE	H8311	\$96.38
CC1500	CCX1500RE	H8316	\$138.70

## JANDY

Tank Model	OEM P/N	HSC P/N	Price
CL/CV 340	A0557900	H7459	\$102.03
CL/CV 460	A0558000	H7468	\$128.63
CL/CV 580	A0104000	H7482	\$154.18
CS100	R0462200	H8410	\$126.45
CS150	R0462300	H8316	\$138.70
CS200	R0462400	H8418	\$212.25

## REPLACEMENT FILTER CARTRIDGES

## WATERWAY

Tank Model	OEM P/N	HSC P/N	Price
Clearwater 75	817-0075	H9401	\$112.05
Clearwater 100	817-0100	H9402	\$137.58
Clearwater 150	817-0150	H9403	\$181.20
Clearwater II 75	817-0075P 817-0075PB	H8311	\$96.38
Clearwater II 100	817-0100P 817-0100PB		
Clearwater II 125	817-0125N 817-0125NB	H8410	\$126.45
Clearwater II 150	817-0150N 817-0150NB	H8316	\$138.70
Clearwater II 200	817-0200N 817-0200NB	H8419	\$216.68
Crystal Water 325	817-0081	H7470	\$105.40
Crystal Water 425	817-0106	H7471	\$129.43
Crystal Water 525	817-0131	H7472	\$148.33
ProClean 75	817-0075P		
ProClean Plus 75	817-0075PB	H8311	\$96.38
ProClean 100	817-0100P		
ProClean Plus 100	817-0100PB		
ProClean 125	817-0125P	H8416	\$163.25
ProClean Plus 125	817-0125N 817-0125NB 817-0125PB	H8410	\$126.45
ProClean 150	817-0150P	H8416	\$163.25
ProClean Plus 150	817-0150N 817-0150NB 817-0150PB	H8316	\$138.70
ProClean 175	817-0175P		
ProClean Plus 175	817-0175PB	H8417	\$202.35
ProClean 200	817-0200P		
ProClean Plus 200	817-0200PB		

## VACUUM D.E. FILTER ELEMENTS

Halogen Supply Company is a stocking distributor of Vacuum D.E. Filter Elements, Filter Discs, and accessories. We carry Mermade, Paddock, Keene-Bowser, Chester, B.I.F. and many more. We sell them as complete assemblies (elements with covers and gaskets), cover and gaskets only, or elements only. Standard Center Bottom Outlets and Custom Corner Outlets are available. Please call us at 1.800.777.SWIM or email us at info@halogensupply.com today for a quote.



## REPLACEMENT CARTRIDGE FILTER PARTS

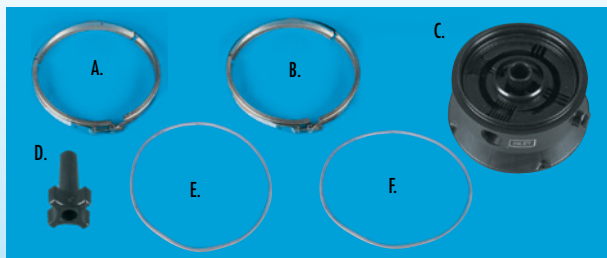

### PTM SERIES

- A. 25010-9101 Top clamp (Also-middle PTM 135 clamp) . . . . . \$174.08
- B. 25010-9100 Bottom clamp (all models) . . . . . \$160.13
- C. WC104-78P Base with plugs (all models) . . . . . \$207.70
- D. WC36-22 Clamp knob (all models) . . . . . \$13.12
- E. 25230-0010S Top O'ring (all models) . . . . . \$19.42
- F. WC9-3 Bottom O'ring all models . . . . . \$28.49



### CLEAN & CLEAR PARTS

- G. 98209800 High flow manual relief valve . . . \$35.17
- H. 19-0058 Pressure gauge . . . . . \$44.03
- I. 17-8553 Lid CC50 and CC100 . . . . . \$164.09
- J. 17-8561 Lid CC75, CC150 and CC200 . . . \$152.98
- K. 59052900 Locking ring assembly. . . . . \$100.69
- L. 87300400 Body O'ring. . . . . \$9.92

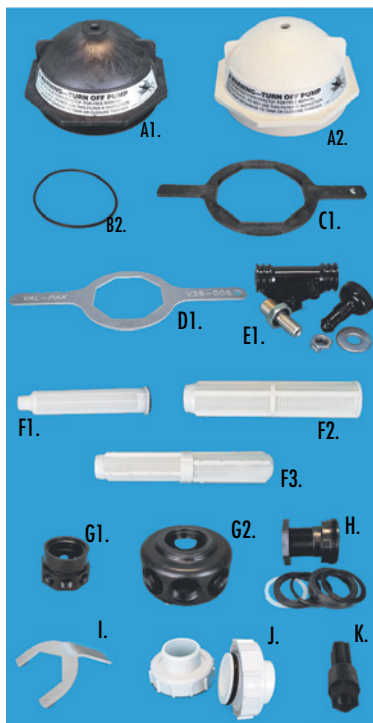

## PENTAIR(PAC-FAB) TRITON SAND FILTER PARTS

### TR60, TR100, TR140 FILTER PARTS

- A1. 15-2519Z Closure with Quad Ring . . . \$110.36
- A2. 15-4559 Closure (Before 1991) . . . . . \$56.50
- B2. 15-4493 Closure O'Ring . . . . . \$6.05
- B2. 15-2516 Quad Ring for 15-2519Z closure \$6.03
- C1. 15-4512 Plastic Closure Wrench . . . . . \$26.39
- D1. V38-006 Metal Closure Wrench . . . . . \$127.88
- E1. 15-4687 Air Bleed Assembly . . . . . \$49.55
- 15-4689 Air Bleed Tee Only. . . . . \$29.23
- F1. 15-2290 TR-60 Lateral. . . . . \$7.70
- 15-0085 ¼ Turn Lateral TR-60 after 6/07 \$14.56
- F2. 15-2202 TR-100 Lateral . . . . . \$11.63
- F3. 15-4540 TR-140 Lateral . . . . . \$21.08
- G1. 15-4763 TR60 HUB . . . . . \$32.24
- 15-5753 ¼ Turn Hub TR-60 after 6/07 . . . \$39.51
- G2. 15-4453 TR100 & 140 HUB. . . . . \$108.00
- H. 15-4714 Bulkhead. . . . . \$157.16
- I. V38-008 Bulkhead Wrench . . . . . \$53.91
- J. 27-1092 2" Threaded Adapter Kit . . . \$62.55
- 27-1094 1.5" Threaded Adapter Kit . . . \$62.55
- 27-1096 1.5" Soc x 2" Spig Adapter Kit . . \$62.55
- K. 15-4698 Drain Spigot . . . . . \$26.73
- 35-7161 ¼ Drain Plug Only. . . . . \$5.75
- 19-2115 O'ring for Drain Plug . . . . . \$2.88



### TR100C, TR140C FILTER PARTS

- A3. 15-4575 Closure. . . . . \$68.208
- B2. 15-2509 Closure O'Ring/Gasket. . . . . \$8.55
- C2. 15-4527 Plastic Closure Wrench . . . . . \$30.04
- D2. V38-007 Metal Closure Wrench . . . . . \$127.88
- E2. 27-3564 Air Relief Assembly . . . . . \$98.19
- F2. 15-2202 TR-100C Lateral. . . . . \$11.63
- F3. 15-4540 TR-140C Lateral. . . . . \$21.08
- G2. 15-4453 TR100C/140C LATERAL HUB \$108.00
- H. 15-4714 Bulkhead. . . . . \$157.16
- I. V38-008 Bulkhead Wrench . . . . . \$53.91
- J. 27-1092 2" Threaded Adapter Kit . . . \$62.55
- 27-1094 1.5" Threaded Adapter Kit . . . \$62.55
- 27-1096 1.5" Soc x 2" Spig Adapter Kit . . \$62.55
- K2. 15-2220Z Drain Assembly Complete . . \$45.27
- 15-4871 Cap Only For Drain . . . . . \$8.64



## D.E. FILTER GRIDS AND MANIFOLDS

### C. AMERICAN PRODUCTS - PENTAIR (PAC - FAB) & HAYWARD

- FG-1002 Large grid 12" long for 24 sq. ft. . . \$23.65
- FG-1003 Large grid 18" long for 36 sq. ft. . . \$31.05
- FG-1004 Large grid 24" long for 48 sq. ft. . . \$36.60
- FG-1005 Large grid 30" long for 60 sq. ft. . . \$45.70
- FG-1006 Large grid 36" long for 72 sq. ft. . . \$56.40
- PG-1902 Small grid 12" long for 24 sq. ft. . . \$24.35
- PG-1903 Small grid 18" long for 36 sq. ft. . . \$29.90
- PG-1904 Small grid 24" long for 48 sq. ft. . . \$37.60
- PG-1905 Small grid 30" long for 60 sq. ft. . . \$45.15
- PG-1906 Small grid 36" long for 72 sq. ft. . . \$58.53
- 59000400 Top Manifold for Amer Prod . . \$151.94
- 59000500 Bottom Spider for Amer Prod . . \$81.25
- 19-2193 Manifold grid for Pentair(Pac Fab) \$129.24
- 19-2194 Retainer grid for Pentair(Pac Fab) . \$56.84

### D. PUREX

- FG-1224 Purex element 24 sq. ft 12" long. . \$24.55
- FG-1236 Purex element 36 sq. ft 18" long. . \$34.73
- FG-1248 Purex element 48 sq. ft 24" long.. \$43.55
- FG-1260 Purex element 60 sq. ft 30" long.. \$52.30
- FG-1272 Purex element 72 sq. ft 36" long.. \$61.25
- 07-1019 Holding wheel 2000 Series. . . . . \$35.55
- 07-3270 Manifold 2000 Series—8 hole. . . . \$28.04

### E. COMPLETE GRID ASSEMBLY (Not Shown) AMERICAN PRODUCTS PENTAIR(PAC-FAB) & HAYWARD

- Includes Grids, Manifold, Retainer Grid, Rods and Nuts
- 19-2324 Grid assembly complete for 24 sq ft \$509.40
- 19-2325 Grid assembly complete for 36 sq ft \$615.62
- 19-2326 Grid assembly complete for 48 sq ft \$760.28
- 19-2327 Grid assembly complete for 60 sq ft \$904.59
- 19-5060 Grid assembly complete for 72 sq ft \$1,049.06

**833-SWIM-327**  
833-7946-327  
www.halogensupply.com



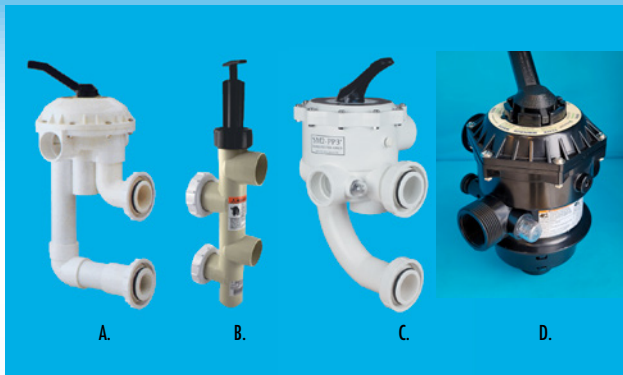

### PRE-PLUMBED PENTAIR VALVES

Pre-plumbed Push Pull and Multiport Valves are complete with bulkhead unions for simple installations with filters. All valves are designed for maximum performance and 100% factory tested.

- A. #26-1050 2" Slip HiFlow Sand Multiport Valve . . . . . \$266.30
- B. #26-3064 2" Slip Slip Slide Valve (old#26-1165) . . . . . \$149.37
- C. #26-1055 2" Threaded Sand Multiport Valve . . . . . \$305.97
- D. #26-2506 1-1/2" Top Mount Multiport Valve for Tagelus. . . \$198.91
- #26-1173 1-1/2" Threaded Sand Multiport Valve . . . . . \$203.95
- #26-1177 1-1/2" Threaded D.E. Multiport Valve . . . . . \$203.95
- #26-1152 2" Threaded D.E. Multiport Valve . . . . . \$305.97
- #26-1142 2" Slip HiFlow D.E. Multiport Valve . . . . . \$266.30

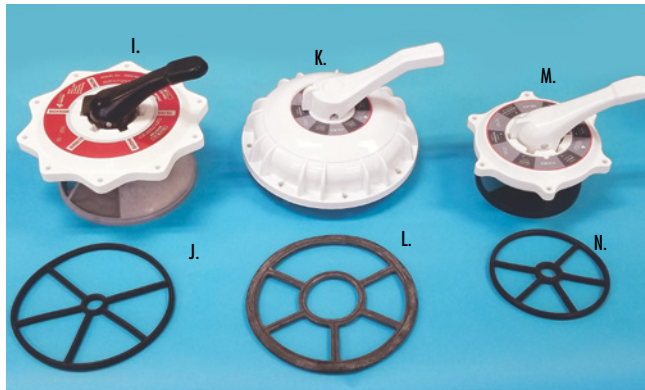

### REPLACEMENT MULTI-PORT VALVE PARTS

- I. 27-0067 Top Valve Assembly 2" . . . . . \$236.99
- J. 27-1148 Divertor Gasket . . . . . \$32.29
- K. 27-2422 Top Valve Assembly 2" High Flow . . . . . \$215.73
- L. 27-2409 Divertor Gasket 2" Hi-Flow . . . . . \$39.17
- M. 27-0068 Top Valve Assembly 1-1/2" . . . . . \$199.31
- N. 27-1104 Divertor Gasket . . . . . \$26.64
- 27-2550 Sight Glass . . . . . \$13.32
- 27-1106 Sight Glass Gasket. . . . . \$6.60
- 27-4407 Bulkhead Nut. . . . . \$17.35
- 27-4556 Threaded Valve Adapter . . . . . \$15.57
- 27-1103 Cover O' Ring 1-1/2" . . . . . \$15.77
- 27-1151 Cover O' Ring 2" . . . . . \$19.40
- 35-4053 Cover O' Ring for 262506 TA Valve . . . . . \$27.79

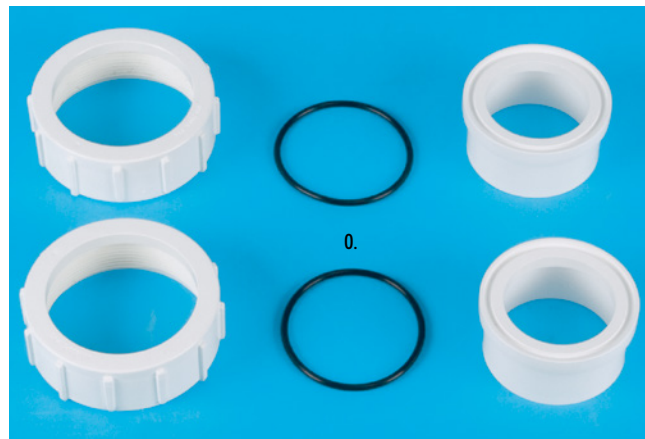

### REPLACEMENT UNION PACKAGE FOR SYSTEM 3 SERIES FILTER

- O. #PKG 188 Includes locknuts, adapters and o'rings . . . . . \$31.16

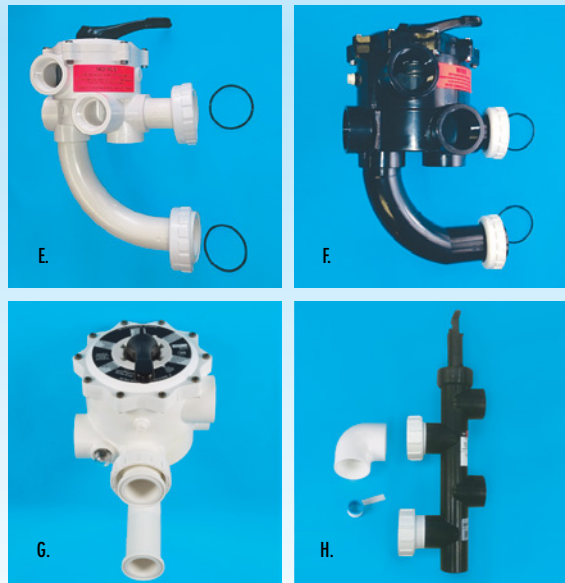

### PRE-PLUMBED STA-RITE VALVES

Valves for 2 inch System 3 filters. Connects directly to side ports. Positive seal prevents leakage between ports.

- E. 18202-0150 1 1/2" MPV SD/SS Series . . . . . \$206.22
- F. 18201-0200 2" MPV SD/SS Series. . . . . \$310.19
- G. 18201-0300 3" MPV SMD Series . . . . . \$310.19
- H. 26-3053 2" Sand/DE Slide Valve . . . . . \$161.22

## MULTI-PORT VALVES SLIDE VALVES VALVE PARTS & FITTINGS

### REPLACEMENT SLIDE VALVE PARTS

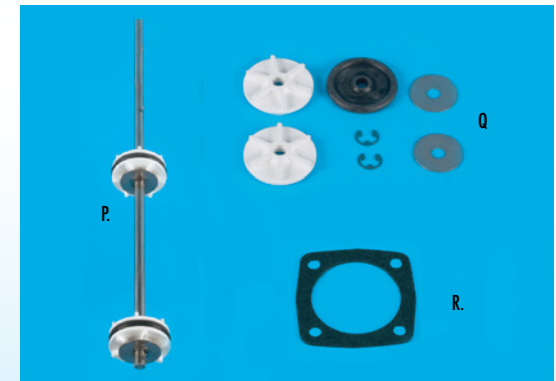

#### 2" BRASS PARTS (valve discontinued)

- P. V36-100 Piston rod assy. (stainless) . . . . . \$232.34
- Q. V36-178 Piston half assembly kit . . . . . \$44.06
- R. G-206 Gasket for top handle. . . . . \$4.80

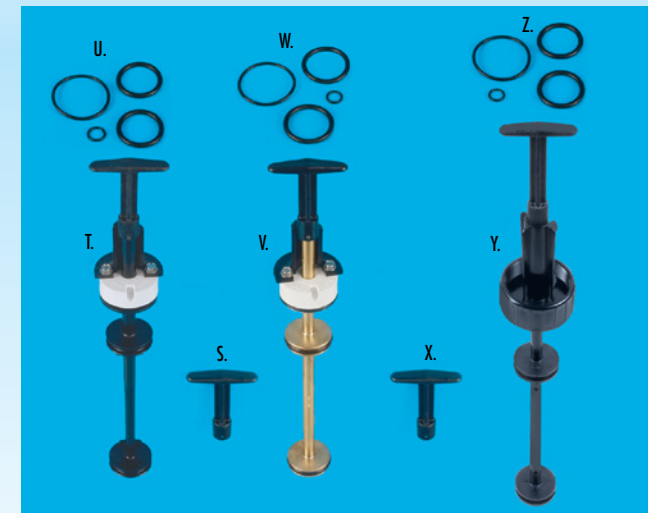

#### 2" PVC PARTS (26-1165 discontinued)

- S. 27-3089 Handle. . . . . \$17.35
- T. 27-3241 Plastic piston rod assembly . . . . . \$98.19
- U. 27-3109 O' ring kit . . . . . \$12.02
- V. V36-177 Brass piston rod assembly . . . . . \$205.04
- W. V36-185 O' ring kit for brass piston assembly . . . . . \$7.74
- X. V36-180 Handle for V36-177 piston . . . . . \$30.44
- 2" PVC NEW STYLE PARTS (26-3064, 26-3053)
- Y. 26-3055 Piston rod assembly . . . . . \$100.91
- Z. 26-3054 O' ring kit . . . . . \$19.93

**833-SWIM-327**  
833-7946-327  
[www.halogensupply.com](http://www.halogensupply.com)

# PENTAIR POOL & SPA HEATERS

## THE MAX-E-THERM™ LEAVES OTHER HEATERS COLD!

- **Easy-read digital display.** Pivoting UV-resistant plastic visor filters the sun's rays to give you a better view of the digital display.
- **Diagnostic lights.** Control panel indicator lights tell you whether to service the heater or the system if problems arise.
- **Weatherproof touch controls.**
- **Forever rust-proof.** Sleek, black matte enclosure made of Dura-Glas® – an exclusive Sta-Rite material that handles the heat and weathers the elements.
- **Cupro-Nickel heat exchanger.**

- #SR200HD Max-E-Therm Heavy Duty Heater \$3,687.18
- #SR333HD Max-E-Therm Heavy Duty Heater \$4,598.48
- #SR400HD Max-E-Therm Heavy Duty Heater \$4,916.96



Simply Smarter.



## ETI™ 400 HIGH EFFICIENCY GAS HEATER

**THE HIGHEST EFFICIENCY EVER.**  
**The longest-lasting heat exchanger ever built.**

The ETI™ 400 High-Efficiency Heater features the TitanTough™ Direct-Fire Pure Titanium Heat Exchanger, the longest-lasting heat exchanger ever built. And it delivers 96% thermal efficiency, the highest of any pool heater. The ETI™ 400 heater provides excellent flexibility for installation, with fully sealed Category IV direct air venting that does not require large room openings for combustion air.

### Features:

- Incredible 96% thermal efficiency gets more heat into pool water faster
  - TitanTough™ Direct-Fire Titanium Heat Exchanger stands up to the harshest water conditions
  - Rotatable front door and control keypad allow easy right-or left-hand plumbing
  - Ultra-quiet operation
- #46-1113 ETI™ 400 Heater . . . . . P.O.A.  
#47-5971 Direct Air Intake Kit. . . . . P.O.A.  
#47-5612 Condensate Neutralizer artridge Kit . . . . . P.O.A.

## High Performance Eco-Friendly Heaters



### MASTERTEMP® HEATER

MasterTemp heaters offer all the efficiency, convenience and reliability features you want in a pool heater, plus a lot more. As easy to use as your home heating system, plus, user-friendly indicator lights make system operation and monitoring a snap. The compact design and super quiet operation won't intrude on your pool side leisure time. Heavy-duty (HD) unit with cupro-nickel exchanger stands up to the harshest of applications, like low pH, high flow or heavy use.



### Features & Advantages

- Heats up fast so no long waits before enjoying your pool or spa
- Best-in-class energy efficiency\*
- Eco-friendly MasterTemp® is certified for low NOx emission and outperforms industry standards
- Rotating digital display allows for easy viewing
- Tough, rustproof exterior handles the heat and weathers the elements
- Certified for outdoor and indoor installations
- For Air Intake Kit order part number 46-1031

\* Standard Copper Heat Exchanger 84% Efficient.  
Heavy-duty (HD) Cupro-Nickel Heat Exchanger 82% Efficient.

### Ordering Information

- #46-1000 - MasterTemp 200 NA ASME Heater . . . \$4,606.50
- #46-0806 - MasterTemp 250 HD Heater . . . . . \$4,022.94
- #46-0805 - MasterTemp 400 HD Heater . . . . . \$4,916.94
- #46-1020 - MasterTemp 250 HD ASME Heater . . . \$4,958.78
- #46-1021 - MasterTemp 400 HD ASME Heater . . . \$5,416.74

- #Vertical Venting - Negative Pressure Kits
- #77707-0076 4" x 6" Metal Flue Collar . . . . . \$168.30
- #77707-0077 4" x 8" Metal Flue Collar . . . . . \$177.19
- #46-1031 Direct Air Intake Kit MasterTemp . . . . . \$265.00

## ABOVE GROUND HEATERS & LIGHTS

### A. MASTERTEMP® 125 HIGH PERFORMANCE HEATER



### Features:

- 82% energy efficiency is highest in its class.
- High-performance, affordable heating with premium features.
- 1-1/2" plumbing – ideal for smaller bodies of water up to 15,000 gallons.
- Pre-mixed combustion technology for ultra-fast heat-up.
- Easy-to-use, information-rich digital display/controller.
- Certified for low NOx emissions.

#46-1059 MasterTemp 125 . . . . . \$1,849.24

**833-SWIM-327**  
833-7946-327  
[www.halogensupply.com](http://www.halogensupply.com)

## DIGITAL POOL AND SPA HEATER



The sleek and stylish Raypak Digital Gas Pool and Spa Heater features innovative technology designed to keep your pool or spa at the perfect temperature for your enjoyment. Built to withstand various weather conditions, this modern pool and spa heater is the perfect solution for environments requiring efficiency, convenience and versatility.

Thanks to a brilliant low-profile design, corrosion resistant cabinet made of galvanized metal, copper or cupro fin tube heat exchanger, and a bevy of advanced-engineered materials, enjoying your heater year round is a breeze.



### A. POLYMER HEATERS

#### COPPER HEAT EXCHANGER

Cat. No.	Model No.	Price
009216	P-R206A-EN-C	\$3,274.00
009217	P-R266A-EN-C	\$3,596.00
009218	P-R336A-EN-C	\$4,092.00
009219	P-R406A-EN-C	\$4,646.00

#### CUPRO-NICKEL HEAT EXCHANGER

Cat. No.	Model No.	Price
014938	P-R206A-EN-X	\$3,510.00
014939	P-R266A-EN-X	\$3,832.00
014940	P-R336A-EN-X	\$4,330.00
014941	P-R406A-EN-X	\$4,886.00



### B. PREMIUM BRONZE HEADERS ASME

#### CUPRO-NICKEL HEAT EXCHANGER

Cat. No.	Model No.	Price
017399	B-206A-EN-X	\$4,256.00
017400	B-R266A-EN-X	\$4,596.00
017401	B-R336A-EN-X	\$5,106.00
017402	B-R406A-EN-X	\$5,686.00

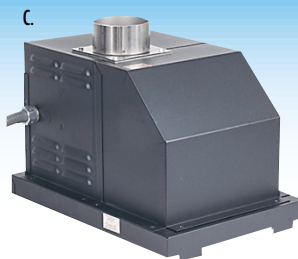

### C. D-2 POWER VENTS

Cat. No.	Model No.	Price
009832	206A-266A	\$930.00
009833	336A-406A	\$944.00



### D. INDOOR DRAFTHOODS

Cat. No.	Model No.	Flue Size	Price
009838	206A	6"	\$188.00
009839	266A	7"	\$192.00
009840	336A	8"	\$196.00
009841	406A	9"	\$200.00

## RAYPAK X94 PROFESSIONAL HEATER

### Highly Efficient.

Intelligent technology. Built with the same Raypak Professional Series high performance DNA.



Same digital control logic used on all Raypak pool products

#### Standard Features:

- Model 410 @399,000 BTU input
- Stainless Steel heat exchanger ASME certified.
- Pre-wired flow switch and T&P gauge, 50 state ASME compliant
- Industry leading diagnostic digital control-assembled in the U.S.A. Multi-unit functionality, pump and 3-way valve control.
- Flexible 4" venting options - PVC, CPVC, Polypropylene, Stainless Steel.
- Direct vent capable - ducted combustion air.
- 3 year parts and labor limited warranty (see warranty for details).



#014280 S-R410-EN ASME . . . P.O.A.

## RESIDENTIAL & COMMERCIAL POOL HEATERS



## COMMERCIAL POOL HEATERS

### By Raypak®

Clubs. Universities. Municipalities. Watersport Centers. Large residential pools.

23 model sizes- 511,500 to 4,000,000 BTUH inputs

Indoor and outdoor styles.

80-82% efficiency.

Natural or propane gas.

Fuel-saving electronic ignition.

Precision water temperature control + 1° F.

Low operating cost.

Low maintenance cost. Easy service.

Price on Application



## RAYPAK® A/G & I/G SPA HEATER

- Electronic ignition • Fire tile
- Dual voltage with 120 volt power cord and 3 - prong plug; or can be wired for 240 volt directly to transformer
- Polymer headers
- Wind resistant design
- 2" & 1½" water connection
- Powder coating

#014779 P-R106-AN-C . . . . \$2,002.00

#014784 P-R156A-EN-C . . . . \$2,444.00

#014357 Indoor Top 106 . . . . \$136.00

#014358 Indoor Top 156 . . . . \$140.00



# COMMERCIAL AND ELECTRIC POOL HEATERS



## Raypak's Next Generation Condensing Heater

Time-honored technologies unite with cutting-edge advancements in Raypak's new XTherm vertical heater. Never before has a vertical heater provided both the installer and pool builder such installation flexibility, ease-of-commissioning, reliability and long-term performance. Small space, not a problem. The XTherm has one of the smallest installed footprints of any vertical condensing heater. Our compact design makes it the perfect choice for those hard to reach retrofit projects. Raypak's XTherm is built with commercial-grade components and materials. From our steel channel base to our stainless steel flue wrapper, and condensing heat exchanger, you can tell the XTherm is built to last. It's easy to handle and install, but still user friendly to service. Now is the perfect time to take a closer look at Raypak. P.O.A. Call for pricing

Models 1005, 1505, 2005  
**97% Thermal Efficiency**



Can be vented with PVC pipe

### Key Features

- PVC vent capable - optional at time of order
- 3 models from 1,000,000 to 2,000,000 BTUH
- 97% thermal efficiency at full fire in pool applications
- Minimum continuous inlet water temperature (50°F)
- Small footprint, less than 11 square feet
- AB 1953 low lead certified
- On-board diagnostic center, real English, no codes
- All models indoor/outdoor certified
- Complete cabinet protects all controls and wiring
- Meets all current Low NOx regulations
- Suitable for altitudes up to 10,000 ft. (derate above 5,000 ft.)
- Equipped with all cupro-nickel, copper, bronze and stainless steel waterways



## COMMERCIAL MEGATHERM®

High Performance Electronic Ignition Heaters



Powerful, efficient, and reliable, MegTherm™ pool heater are for large commercial pools where economical performance and rapid heat-up are required. Available in indoor and outdoor models in both natural and propane. MegaTherm™ is design certified to the ANSI® Z21.56 Standard for Gas-Fired Pool Heaters. (Outdoor 500-1825 units are certified for use without the addition of a draft diverter or external vent. Indoor units incorporate a built-in draft diverter and require only vent piping.) Salt water models (500-1825) are available with cupronickel alloy heat exchanger tubes and bronze headers and header covers.

### LAARS COMMERCIAL: INDOOR (API) & OUTDOOR (APE) HEATERS

Cat. No.	Model No.	Price	Cat. No.	Model No.	Price	20° Rise	BTU Input	Weight
519	API500	P.O.A.	550	APE500	P.O.A.	2000	500,000	690
520	API600	P.O.A.	551	APE600	P.O.A.	2400	600,000	780
521	API715	P.O.A.	552	APE715	P.O.A.	2860	715,000	850
522	API850	P.O.A.	522A	APE850	P.O.A.	3315	850,000	780
523	API1010	P.O.A.	553	APE1010	P.O.A.	3400	1,010,000	900
524	API1200	P.O.A.	554	APE1200	P.O.A.	4040	1,200,000	1020
525	API1430	P.O.A.	555	APE1430	P.O.A.	4800	1,430,000	1145
526	API1670	P.O.A.	556	APE1670	P.O.A.	5720	1,670,000	1290
526B	API1825	P.O.A.	557	APE1825	P.O.A.	6680	1,825,000	1375

F.O.B. FACTORY \*CSD-1 Controls must be added in IL - P.O.A. Call for pricing

## ELECTRICAL POOL & SPA HEATERS



### ELECTRICAL HEATERS

#### For Pools & Spas By Coates

A built-in flow switch, to prevent operation of the heater when there is no water flow, is standard equipment.

**Standard features:** Stainless steel vessel. Incoloy heating element. Close differential thermostat. High temperature limit, manual reset. Flow switch. Element pilot light. Element sequencing of single phase heaters. Internal protective fusing. Easy electrical terminal blocks.



KW	1PH, 236V Cat.No.	Price	3PH, 240V Cat.No.	Price	3PH, 208V Cat.No.	Price	3PH, 480V Cat.No.	Price
12	12412CE	\$2,461.73	32412CE	\$2,168.78	32012CE	\$2,168.78	34812CE	\$2,206.58
15	12415CE	\$2,490.08	32415CE	\$2,211.30	32015CE	\$2,211.30	34815CE	\$2,324.70
18	12418CE	\$2,513.70	32418CE	\$2,499.53	32018CE	\$2,499.53	34818CE	\$2,338.88
24	12424CPH	\$3,080.70	32424CPH	\$2,953.13	32024CPH	\$2,953.13	34824CPH	\$2,655.45
30	12430CPH	\$3,142.13	32430CPH	\$3,024.00	32030CPH	\$3,024.00	34830CPH	\$2,707.43
36	12436PHS-3	\$4,143.83	32436PHS-3	\$3,746.93	32036PHS-3	\$3,746.93	34836PHS-3	\$3,151.58
45	12445PHS	\$4,257.23	32445PHS	\$3,808.35	32045PHS	\$3,808.35	34845PHS	\$3,524.85
54	12454PHS-4	\$4,734.45	32454PHS-4	\$3,370.63	32054PHS-4	\$4,370.63	34854PHS-4	\$3,813.08

F.O.B. FACTORY - WASHINGTON STATE



### ELECTRIC SPA HEATER

with Exclusive Built-in Flow Switch By Coates

**Standard features:** Incoloy heating element. Close differential thermostat. High temperature limit, manual reset. A seamless, red-cast vessel is one of the major features. Vessel design directs water flow over heating elements to optimize heat transfer. Flow switch. 1½" pipe connections.

Cat. No.	Coates Model No.	Price
527	12406ST, 5.5 KW, 240V	\$774.90
528	12411ST, 11 KW, 240V	\$822.15

### Hi-E2® THE MOST EFFICIENT HEATER

#### Hi-E2® Heater

The Hi-E2 sets the standard with a proven in-use record of over 20 years providing ultra-efficient heating with a 95% efficiency rating – cutting operating costs by 30% or more\*. Small, lightweight and easy to install indoors, it features a low-maintenance design using our hot surface ignition system – requiring no pilot light.

- Compact & Lightweight – 33% smaller footprint and is 42% smaller in volume and 34% lighter than comparable heaters
- Best Indoor Installation – Direct PVC pipe connection capability for flexible indoor installation with no additional parts
- Ultra-Efficient Heating – Features an impressive 95% heating efficiency rating and reduces operating cost by 30% or more\*
- Durable & Dependable – Over 20 years of proven performance in use

#EHE350NC- 350,000 BTU ASME Commercial Heater . . P.O.A.



## CAT CONTROLLERS

Introducing the CAT 6000, the industry's most advanced water chemistry controller. With an advanced, intuitive full-color touch screen, CAT 6000 guides you through programming. Innovative sensing technology utilizes a unique feature named "Dynamic Sanitizer Control", allowing for more precise sanitization control than ever before. The CAT 6000 uses innovative solid-state sensing technology\* for its low-maintenance true free chlorine, temperature, and conductivity sensors. The CAT 2000@ constantly monitors pH and sanitizer activity (chlorine, bromine, even salt systems) and automatically implements chemical feeding in proportion to demand for picture-perfect water quality at all times.



#CAT2000 Standard Controller . . . . . \$2,697.91  
 #CAT 6000 Free Cl, Wifi/Cellular Controller . . . . . \$6,123.25

## AQUARITE

As the global leader in salt chlorination, Hayward provides luxuriously soft water and the most convenient sanitization method on the market to millions of pool owners around the world. With the introduction of AquaRite 900, we're taking our industry-leading technology to the next level. AquaRite 900 is designed to provide the same superior salt chlorination you expect from Hayward, but with an Extended Life TurboCell, it produces 25% more chlorine over its lifetime than our leading AquaRite systems. The Extended Life TurboCell cuts your chlorine costs by 50% or more, to less than \$1 per pound. Plus, with an industry best 4-year warranty, you can relax in the comfort of your pool completely worry-free.

#AQR940 Aqua Rite 900 (w/40k cell) . . . . . \$2,660.13  
 #TCELL940 40K gal replacement cell only (4 yr warranty) \$1,546.07



## PRO SERIES FILTER

For both new and aftermarket installations Pro Series filter provide efficient flow, totally balanced backwashing and an advanced self-cleaning under-drain system for the best value in filtration. Durable corrosion-proof filter tank molded of color-fast material for long-lasting, all-weather performance. 7-position Vari-Flo valve provides maximum flow at lower pressure drop. Large pressure sand/water drain for rapid winterizing or servicing. Flange clamp design allows 360 rotation for easy installation. Integral top diffuser ensures even distribution of water over the entire sand bed for maximum use of the filtration area. Precision engineered umbrella-fold self-cleaning laterals for balanced flow and backwashing, plus easy serviceability.

#S166T 16" Sand Filter w/valve . . . \$480.29



## SWIMCLEAR CARTRIDGE FILTER



SwimClear single element filters are simply the most efficient single element cartridge filters ever produced. They capture more dirt for superior water clarity without the need of supplemental media while the industry's lowest head loss can increase energy savings. SwimClear is also the easiest to service: the Easy-Lok™ ring design, ergonomic grip handles, and lowest lift height provide fast cleaning and element replacement.

#C100S Swim Clear 100sq. ft. . . . . \$691.40  
 #C150S Swim Clear 150sq. ft. . . . . \$952.54

## PERFLEX EXTENDED-CYCLE DE

The Perflex Extended-Cycle DE filter series cleans pools fast-removing particles as small as one micron the first time through. That's because Perflex incorporates a patented Flex-Tube™ design that works in combination with DE (diatomaceous earth) filter powder to produce the clearest, most sparkling water possible.

#EC65A . . . . . \$1,210.99  
 #EC75A . . . . . \$1,303.62  
 #EC65BLP System III base pack for EC65/EC75 less pump . . . . . \$215.73



Model No.	Effective Filtration Area	Design Flow Rate*	Turnover Gals. 8 Hr.	10 Hr.	DE Required
EC65A	26.9 sq. ft. <sup>2</sup>	67 GPM	32,640	40,800	6 Lbs.
EC75A	40 sq. ft. <sup>2</sup>	80 GPM	38,400	48,000	7 Lbs.

## ABOVE GROUND D.E. SYSTEM

- New clamp style assembly
  - 6" Power cord
  - Pump to filter union connection
  - Hoses, clamps & hose adapters
  - 1HP & 1 1/2HP FloMatrix Pump
- #EC40C92S EC40 w/1 HP pump. . . \$1,194.50  
 #EC50C93S EC50 w/1-1/2 HP pump \$1,289.23



HAYWARD PRODUCTS

## VS OMNI PUMP W/SMART CONTROL



VS Omni variable-speed pumps offer the simplest, most affordable way to add smart control to an existing pool. Fast and easy to install, VS Omni can control up to 4 pieces of equipment. This pump enables pool owners to set schedules and control their pool and spa equipment with their smart phones from anywhere. Works with Amazon, Alexa, Nest and other popular smart phone home automation systems. Provides industry-leading energy cost savings and can pay for itself in less than 2 seasons  
 #HL2350020VSP MaxFlo Omni Pump w/Controller (1.65THP) \$2,477.11

## POWER-FLO MATRIX

The Power-Flo Matrix has been engineered as a uniquely superior above-ground pool pump. With a single push of a button, this truly versatile pump changes from a discharge and back again. It's large profile and integrated styling makes the Power-Flo Matrix a swimming pool pump like no other.



Model No.	HP	Voltage	Pipe Size	Ctn Weight	Price
SP1591	3/4	115	1-1/2"	25 Lbs.	\$529.39
SP1592	1	115	1-1/2"	25 Lbs.	\$545.90
SP1593	1-1/2	115	1-1/2"	26 Lbs.	\$571.62

## SUPER PUMP® – Medium Head Pump Series

Super Pump® is the world's best-selling medium head pool pump. Efficient, dependable and proven, it has set the standard for excellence and value. Also available in our exclusive Expert Line addition as the Super Pump 700 which includes additional features, such as an enhanced totally enclosed fan-cooled motor design and top-mount wiring compartment for easy installation.



Model No.	HP	Voltage	Pipe Size	Ctn Weight	Price
SP2605X7	3/4	115/230	1-1/2"	32 Lbs.	\$865.26
SP2670007X10*	1	115/230	1-1/2"	35 Lbs.	\$947.63
SP2670010X15*	1-1/2	115/230	1-1/2"	40 Lbs.	\$1,031.77
SP2615X20	2	115/230	2"	48 Lbs.	\$1,190.89

\*Denotes special expert line equipment (2 year warranty, viton shaft seal, and TEFC motor)

# HEATER PARTS

## MINI MAX NT STANDARD PARTS

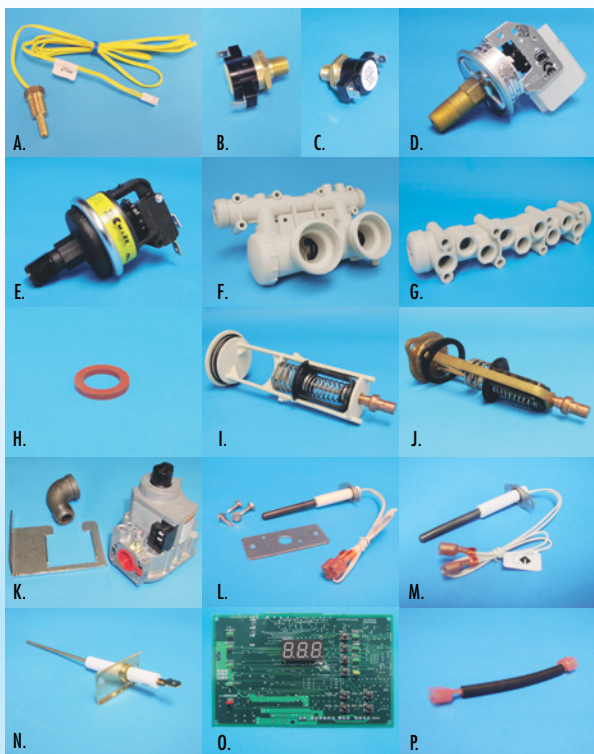

## MASTER TEMP/MAX-E-THERM PARTS

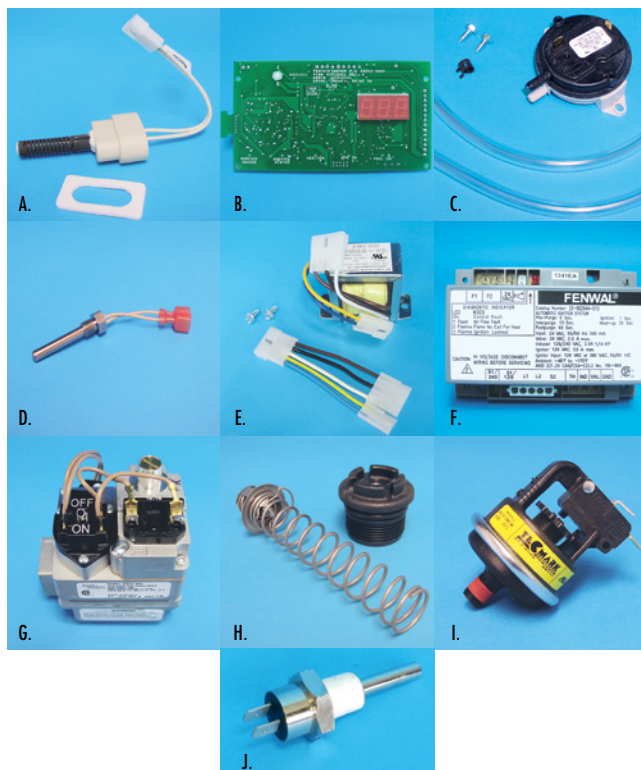

MASTER TEMP/MAX-E-THERM PARTS			
A.	77707-0054	IGNITOR W/GASKET	\$85.57
B.	42002-0007S	CONTROL BOARD	\$649.62
C.	42001-0061S	AIR FLOW SWITCH	\$141.50
D.	42002-0024S	STACK FLUE SENSOR	\$122.99
E.	42001-0107S	TRANSFORMER	\$69.80
F.	42001-0052S	IGNITION CONTROL	\$343.13
G.	42001-0051S	GAS VALVE N.G.	\$448.67
H.	77707-0010	THERMAL REGULATOR KIT	\$106.90
I.	42001-0060S	PRESSURE SWITCH	\$84.47
J.	42001-0053S	THERMISTOR	\$81.72



- A. #7828 Aquastat controller (SPDT switching / Range 40 to 180 F) \$225.75
- B. #7829 Aquastat well (1/2" male N.P.T.) . . . . . \$65.00
- C. #A0063300 Safety pressure relief Valve 3/4" (75 PSI) . . . . . \$39.98
- D. #0342692 Safety pressure relief Valve 3/4" (30 PSI) . . . . . \$137.35

## COATES HEATER PARTS

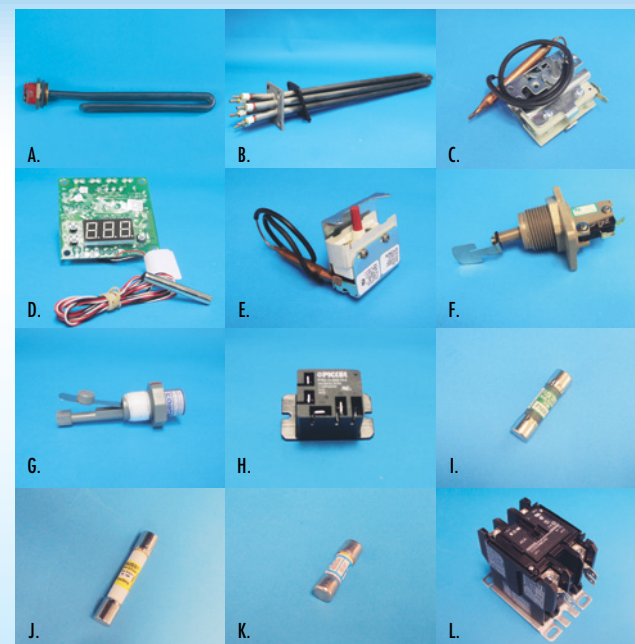

COATES HEATER PARTS			
A.	20005061	ELEMENTS 5.5KW, 240V	\$57.60

B. HEATING ELEMENTS				
KW	208V	240V	480V	Price
6 KW	20006036	20006046	20006056	\$281.70
9 KW	20006029	20006039	20006049	\$289.80
12 KW	20006003	20006009	20006015	\$324.00
15 KW	20006004	20006010	20006016	\$324.00
18 KW	20006005	20006011	20006017	\$324.00

C.	22002001	TEMPERATURE CONTROL	\$51.30
D.	22002150	DIGITAL TEMPERATURE CONTROL	\$125.10
E.	22003820	HI-TEMP SWITCH	\$52.50
F.	23000102	FLOW SWITCH 1"	\$126.00
G.	23000105	FLOW SWITCH 1/2"	\$80.10
H.	21006010	RELAY 240V FOR FLOW SWITCH	\$13.05
I.	29015052	FUSE 2 AMP, 250V, FNM-2	\$8.55
J.	29018910	FUSE 60 AMP, 480V, SC-60, SLC-60	\$11.70
K.	29019525	FUSE 2 AMP, 480V, SC-2, SLC-2	\$7.65
L.	21001000	CONTACTOR, 3 POLE, 50 AMP, 208/240V COIL	\$67.50
	21001300	CONTACTOR, 4 POLE, 50 AMP, 208/240V COIL	\$87.30

## JANDY HEATER PARTS



A. #R0317100	Gas Valve Natural LD, LJ	\$433.62
B. #R0096400	Gas Valve Natural LG	\$513.95
C. #R0011700	Temperature Control LD, HI-E2	\$563.38
D. #R0058200	Temperature Control LG	\$247.73
<b>E. IGNITORS</b>		
#R0367100	LJ	\$150.35
#R0317200	LD	\$156.38
#R0457500	Lxi	\$156.38
#R0457501	LRZE	\$227.72
#R0457502	Jxi	\$53.46
#R0016400	HI-E2	\$156.38
F. #W0036901	Pilot Generator LG	\$100.22
G. #R0096700	Pilot Generator Assembly LG	\$179.91
H. #R0318800	Mechanical Temperature Control LG	\$247.73
I. #R0013200	Pressure Switch	\$98.55
J. #R0023200	HI Limit Switch	\$112.14
K. #R0012200	Fusible Link	\$13.32
L. #R0099800	Rocker Switch	\$33.14
M. #R0408100	Ignition Control Assembly	\$666.63
N. #R0037000	Pilot Tubing	\$24.55
O. #R0334300	Flame Sensor	\$250.72

## RAYPAK RP2100 HEATER PARTS

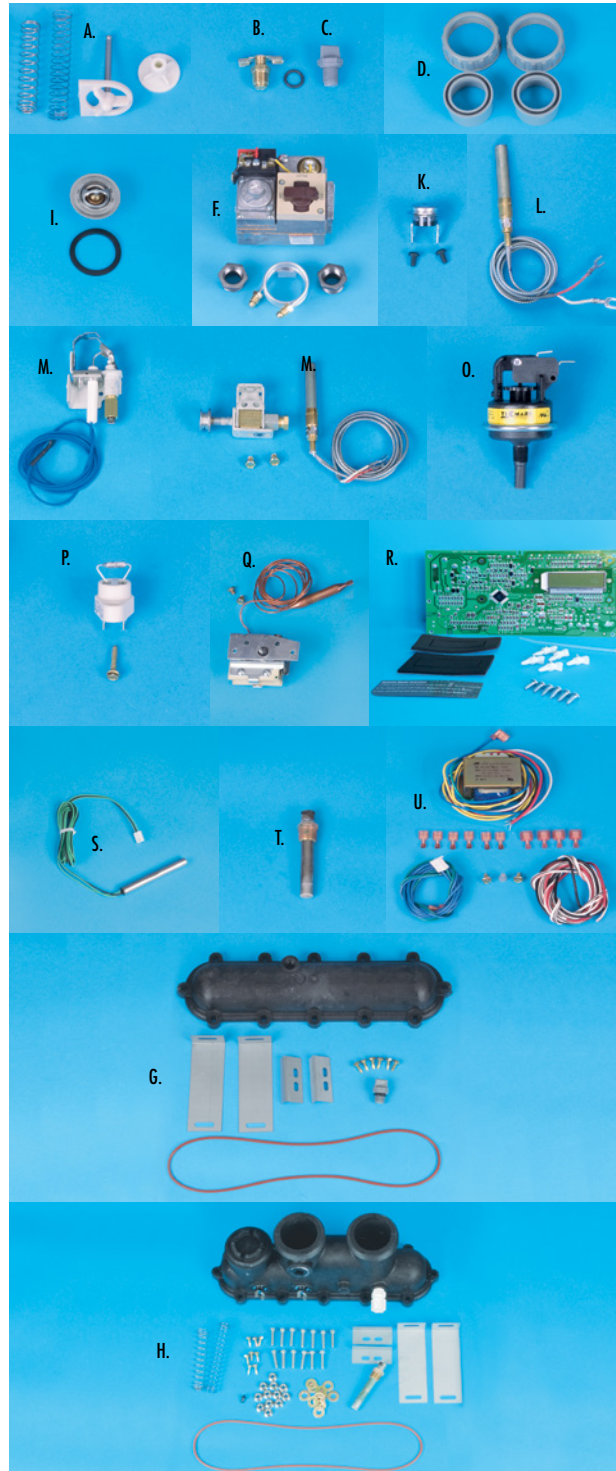

## RAYPAK RP2100 HEATER PARTS

PART DESCRIPTION	CAST IRON ASME MODELS				CAPRON MODELS			
	C-R206	C-R266	C-R336	C-R406	P-R206	P-R266	P-R336	P-R406
A. BY PASS VALVE		016194F	\$57.92			006715F	\$68.45	
B. DRAIN VALVE		013793F	\$25.45			006721F	\$19.31	
C. REAR DRAIN PLUG		005264F	\$35.98			006721F	\$19.31	
D. FLANGES/UNIONS		003766F	\$93.02			006723F	\$64.06	
E. FLANGES/UNIONS GASKET/O' RINGS		062236B	\$44.75			006724F	\$28.96	
F. GAS VALVE		003898F MILLIVOLT 003900F IID	\$382.59 \$322.04			003898F MILLIVOLT 003900F IID	\$382.59 \$322.04	
G. REAR HEADER		006731F	\$192.17			006707F	\$160.58	
H. IN/OUT HEADER		006730F	\$572.13			006827F	\$716.92	
I. UNITHERM GOVERNOR		062234B	\$71.08			006719F	\$77.22	
J. TUBE BUNDLES	<b>ASME (FOB FACTORY)</b>							
					P-R106A	P-R156A		
					014874F \$507.20	014875F \$675.55		
	C-R206	C-R266	C-R336	C-R406	P-R206	P-R266	P-R336	P-R406
	010055F \$1334.68	006733F \$1418.92	010057F \$1498.77	010058F \$1587.40	010059F \$1044.23	010060F \$129.34	010061F \$1206.56	010062F \$1297.82
K. HI-LIMITS		600892B 135* 600893B 140*	\$42.12 \$43.88			006725F	\$43.00	
L. PILOT GENERATOR		600019B MILLIVOLT	\$77.22			600019B MILLIVOLT	\$77.22	
M. PILOT ASSEMBLY		600525B MILLIVOLT 002003F IID	\$120.22 \$86.87			600525B MILLIVOLT 002003F IID	\$120.22 \$86.87	
N. ROCKER SWITCH		009493F	\$28.96			009493F	\$28.96	
O. PRESSURE SWITCH		006737F	\$60.55			006737F	\$60.55	
P. ROLL OUT SENSOR		005899F	\$34.22			005899F	\$34.22	
Q. MECHANICAL T-STAT		003346F	\$158.83			003346F	\$158.83	
R. PC BOARD DIGITAL		013464F	\$421.20			013464F	\$421.20	
S. TEMP SENSOR		009577F (3 WIRE)	\$68.45			009577F (3 WIRE)	\$68.45	
T. SENSOR WELL/ ADAPTER		003765F	\$86.00			006805F MILLIVOLT 006714F IID	\$47.39 \$35.98	
U. TRANSFORMER		006736F	\$89.51			006736F	\$89.51	

**NOTE:** ALL COMMERCIAL AND RESIDENTIAL RAYPAK, LAARS AND COATES HEATER PARTS AVAILABLE ON REQUEST.

# PLUMBING VALVES CHECK VALVES



## A. PVC UTILITY BALL VALVES BY SPEARS

#2622-005	1/2" Soc x Soc	\$13.94
#2622-007	3/4" Soc x Soc	\$16.53
#2622-010	1" Soc x Soc	\$22.47
#2622-015	1 1/2" Soc x Soc	\$45.40
#2622-020	2" Soc x Soc	\$57.37
#2621-005	1/2" Fpt x Fpt	\$13.94
#2621-007	3/4" Fpt x Fpt	\$16.53
#2621-010	1" Fpt x Fpt	\$22.47
#2621-015	1 1/2" Fpt x Fpt	\$45.40
#2621-020	2" Fpt x Fpt	\$57.37



## B. PVC COMPACT BALL VALVE BY SPEARS

#2122-015	1 1/2" Soc x Soc	\$109.37
#2122-020	2" Soc x Soc	\$117.89
#2122-030	3" Soc x Soc	\$478.95
#2122-040	4" Soc x Soc	\$736.85
#2122-060	6" Soc x Soc	\$956.93



## C. PVC TRUE UNION 2000 STANDARD BALL VALVE w/SOCxSOC w/TWO ADDITIONAL FPT UNION

#3629-005	1/2" Soc x Soc or Fpt	\$59.05
#3629-007	3/4" Soc x Soc or Fpt	\$69.85
#3629-010	1" Soc x Soc or Fpt	\$83.202
#3629-015	1 1/2" Soc x Soc or Fpt	\$138.52
#3629-020	2" Soc x Soc or Fpt	\$182.91



## D. TRUE SINGLE UNION BALL VALVES BY PRAHER

#150-010	1 1/2" Soc x Soc	\$223.56
#150-015	1 1/2" MIPT x FIPT	\$25.25
#200-010	2" Soc x Soc	\$32.70

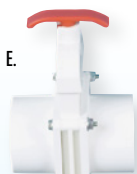

## E. KNIFE GATE VALVES BY PRAHER

#150-GATE	1 1/2" Soc x Soc	\$18.48
#150-GMFT	1 1/2" Fpt x Fpt	\$19.03
#200-GATE	2" Soc x Soc	\$24.65



## F. SINGLE UNION SPRING CHECK VALVES w/ LOAD & CLEAR BODY BY PRAHER

#150-CV-TRI	1 1/2" Soc x Soc	\$34.67
#200-CV-TRI	2" Soc x Soc	\$40.19



## G. DOUBLE UNION CLEAR SWING CHECK VALVE BY AMERICAN GRANBY

#AG1720C-07	3/4" Soc x Soc	\$31.37
#AG1720C-10	1" Soc x Soc	\$37.02
#AG1720C-15	1 1/2" Soc x Soc	\$47.02
#AG1720C-20	2" Soc x Soc	\$64.07
#AG1720C-30	3" Soc x Soc	\$127.09



## H. "SMART" SWING CHECK VALVE WITH 1/2 lb SPRING

#MCV823-15C	1 1/2" Soc x Soc	\$34.34
#MCV823-20C	2" Soc x Soc	\$43.37



## I. JANDY NEVER LUBE 180 DEGREE CHECK VALVE

#7305	2" - 2 1/2" Soc x 2" - 2 1/2" Soc	\$79.49
-------	-----------------------------------	---------

## J. FLEXIBLE PVC CREAM COLOR (ORDER BY THE FOOT OR IN 50FT OR 100FT ROLLS)

#2522	1/2" Flexible PVC Pipe	\$3.55
#2523	3/4" Flexible PVC Pipe	\$4.85
#2525	1" Flexible PVC Pipe	\$4.80
#2526	1 1/2" Flexible PVC Pipe	\$6.20
#2527	2" Flexible PVC Pipe	\$10.60



## K. PRIMER-68 CLEAR PRIMER

#PRIM68C-005	1/4 Pint	\$6.59
#PRIM68C-020	Pint	\$16.59
#PRIM68C-030	Quart	\$27.70



## L. PVC-95 BLUE PVC GLUE

#PVC95B-030	Quart	\$34.88
-------------	-------	---------



## M. PVC 95 CLEAR PVC GLUE

#PVC95C-005	1/4 Pint	\$8.15
#PVC95C-020	Pint	\$20.71
#PVC95C-030	Quart	\$34.94



## NEVER-LUBE JANDY VALVES AND ACTUATORS

N. #4715	1 1/2" - 2", 3 Port Positive Seal Jandy Never Lube Valve	\$91.58
O. #4724	1 1/2" - 2", 2 Port Positive Seal Jandy Never Lube Valve	\$85.13
P. #4716	2" - 2 1/2" - 2 Port Positive Seal Jandy Never Lube Valve (not shown)	\$88.62
Q. #4717	2" - 2 1/2" - 3 Port Positive Seal Jandy Never Lube Valve (not shown)	\$95.05
R. #4424	Jandy Valve Actuator 24 Volt, 180 Degree Rotation	\$279.70



The revolutionary IntelliValve™ Valve Actuator lets you set just the right flow for water features. Its intuitive controls and LED position indicator lights make operation fast and push-button easy. Thirteen (13) bright LEDs provide a clear visual indication of the valve position from fully open to fully closed and everywhere in between. Simply use the left/right and Save buttons to set the perfect flow rate in just seconds.

#52-1485 IntelliValve Actuator . . . \$316.24



## WINTERIZING PLUGS



	Part No.	Plug Size	Fits	Price
Rubber	A. SP201	1	1/2" pipe	\$2.10
	SP202	2	3/4" tubing	\$2.10
	SP203	3	3/4" pipe	\$2.20
	SP204	4	3/4"-1" pipe	\$2.20
	SP205	5	1" tubing	\$2.30
	SP206	6	1" fitting	\$2.35
	SP207	7	1 1/4" pipe	\$2.50
	SP208	8	1 1/2" pipe	\$2.80
	SP209	9	1 1/2" pipe, 1 1/4" fitting	\$2.90
	SP210	10	1 1/2" fitting	\$3.00
	SP211	11	2" pipe	\$4.25
	SP212	12	2" fitting	\$4.75
	SP213	13	2 1/2" pipe	\$6.75
	SP214	14	3" pipe	\$16.75
Plastic	B. SP1022B	1 1/2"	Flush style	\$4.90
	C. SP1022C	1 1/2"	Raised style	\$4.15
	D. SP210BT	10	Blow Through	\$14.00
	E. 004-302-1672-00	Paramount Blow Through Plug (pkg. of 6)		\$187.47
	F. BP15	1 1/2"	MPT Bungee Blow Through Plug	\$8.78

## SUBMERSIBLE PUMPS

### A. SIMER SUBMERSIBLE UTILITY DRAINER PUMP

- Strong thermoplastic construction
- Portable and light
- Simple plug in operation
- Includes garden hose adapter



Catalog No.	Description	Nominal HP	Motor Voltage	Price
2305-04	Simer Submersible	1/4	115	\$166.13

### B. LITTLE GIANT POOL COVER PUMP

- Activates in approximately 2" of water
- Convenient handle for portability
- Mechanical float for dependability
- 1" FNPT discharge
- 3/4" MNPT garden hose adapter



LG-577301 POOL COVER PUMP . . . . \$275.31

## WINTERIZING



### A. CYCLONE WINTERIZING BLOWER AND LINER VAC Model LV 275-1

The Cyclone is the most powerful portable blower on the market. The motor is a heavy duty bypass motor rated at 3 hp/120 volt. Sealed pressure is 160 inches of water & the open flow is 120 cfm. This blower is ideal for winterizing pools.

#4128100 . . . . . \$583.70



### B. CLEAR RTV SILICONE ADHESIVE SEALANT

#66B 3 oz Clear RTV Silicone . . . . . \$14.56

### C. AQUA LUBE ULTIMATE UNDERWATER LUBRICANT, SEALANT AND RUST PREVENTIVE

#AQUA LUBE 5.5 oz Aqua Lube. . . . . \$31.23



### D. MAGIC LUBE TEFLON BASED LUBRICANT

#630-1OZ 1 oz Magic Lube . . . . . \$4.23

#631-5OZ 5 oz Magic Lube . . . . . \$8.78



### E. TEFLON TAPE

#HTST520- 3/4" Teflon tape . . . . . \$2.64

### F. STAINLESS STEEL HOSE CLAMPS

#12 3/4" . . . . . \$2.68

#20 1" . . . . . \$2.72

#24 1"- 2" . . . . . \$2.72

#28 1 5/16"- 2 1/4" . . . . . \$2.75

#32 1 9/16"- 2 1/2" . . . . . \$2.75

## SPECIALTY TOOLS WINTERIZING PRODUCTS

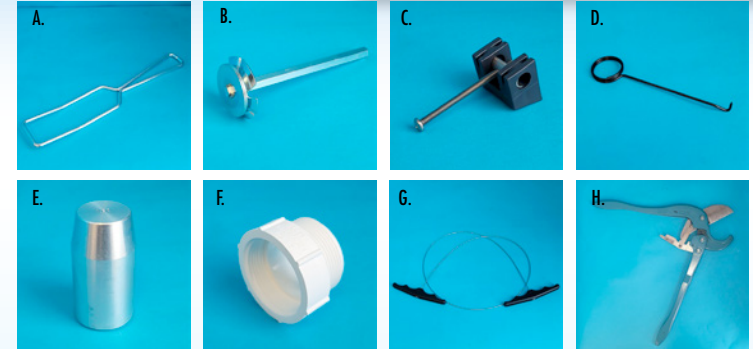

A. #PT110 Pump Lid Removal Tool-Lid Removal Wrench . . . \$22.50

B. #SKS-1.5 1 1/2" Socket Saver . . . . . \$43.81

#SKS-2.0 2" Socket Saver . . . . . \$46.22

#SKS-3.0 3" Socket Saver . . . . . \$73.96

C. #PT132 Light Wedge. . . . . \$14.29

D. #PT134 O Ring Pick . . . . . \$8.44

E. #PT144-A Hand Rail Stabilizer plug . . . . . \$38.25

F. #LASS-RPE-1.55 Plaster Eye Ball Extender. . . . . \$10.23

\*Eyeball not Included

G. #WST-1 Wire Saw for PVC . . . . . \$11.86

H. #HL50 PVC Pipe Cutters . . . . . \$141.16

I. #419-4110 1 1/2" Insider (Fits inside 1 1/2" pipe). . . . . \$5.35

#419-4120 2" Insider (Fits inside 2" pipe) . . . . . \$6.40

J. #418-5000 1 1/2" Pipe Extender . . . . . \$5.50

#418-6000 2" Pipe Extender . . . . . \$6.15

### K. RUBBER FLEXIBLE COUPLINGS

#AGMR5615 1 1/2" x 1 1/2" . . . . . \$10.15

#AGMRTC150 1 1/4" x 1 1/2" . . . . . \$6.44

#AGMRDTC150 1 1/4" or 1 1/2" x 1 1/4" or 1 1/2" . . . . . \$7.85

#AGMRDTC215 2" x 1 1/4" or 1 1/2" . . . . . \$5.09

### FULL FLOW UNIONS BY PRATHER

L. #150-903 1 1/2" Mpt x Soc w/O ring . . . . . \$9.05

#200-903 2" Mpt x Soc w/O ring . . . . . \$11.63

M. #150-906 1 1/2" Mpt x Soc w/O ring High Temp . . . . . \$12.60

#200-906 2" Mpt x Soc w/O ring High Temp. . . . . \$16.40

# POOL LIGHTS & ACCESSORIES



## INTELLIBRITE® 5G COLOR LED

The incredibly efficient IntelliBrite 5G color-changing pool lights are made up of combinations of individual, color LED lights that are automatically sequenced at varying speeds, producing a vibrant spectrum of hues. The superior design allows for uniform light intensity and color while avoiding hot spots and glare.

Choose from 5 predetermined fixed colors (blue, green, magenta, white and red) or 7 popular preprogrammed "color shows".

#601000 Pool 120V 30' cord . . . . .	\$1,293.60
#601001 Pool 120V 50' cord . . . . .	\$1,325.16
#601010 Pool 12V 30' cord. . . . .	\$1,197.69
#601011 Pool 12V 50' cord. . . . .	\$1,233.08
#640120 Spa 120V 30' cord . . . . .	\$1,035.38
#640121 Spa 120V 50' cord . . . . .	\$1,067.62
#640130 Spa 12V 30' cord . . . . .	\$979.92
#640131 Spa 12V 50' cord . . . . .	\$1,016.0

## INTELLIBRITE® 5G WHITE LED

The IntelliBrite 5G white lights combine unmatched energy efficiency with superior light intensity and distribution. The exclusive design can be adjusted to create a standard, wider beam or a narrower pattern, depending on your pool's needs.

#601100 Pool 120V 30' cord . . . . .	\$779.31
#601101 Pool 120V 50' cord . . . . .	\$811.15
#601105 Pool 12V 30' cord. . . . .	\$733.99
#601106 Pool 12V 50' cord. . . . .	\$769.69
#640140 Spa 120V 30' cord . . . . .	\$774.31
#640141 Spa 120V 50' cord . . . . .	\$808.12
#640150 Spa 12V 30' cord . . . . .	\$735.44
#640151 Spa 12V 50' cord . . . . .	\$765.89

## INTELLIBRITE® CONTROLLER

Provides Fast, Easy Access to 12 Color Modes

#600054 IntelliBrite Controller	\$463.85
---------------------------------	----------

- Waterproof Outdoor LED Color Light Controller
- Quick access to all colors and shows
- Convenient hold and recall function
- Fits in 22.5 cu.in. single gang box or larger
- Illuminated power button

## ABOVE GROUND

### THE AQUA-LUMINATOR



#98600000 . . . . .	\$251.90
---------------------	----------

### NIGHTLIGHTER

LED Underwater light for aboveground pools. This light fixture features an extra long cord and will not interfere with water return.



#NL50 . . . . .	\$95.04
-----------------	---------



## AMERLITE

The world standard of reliability for underwater lights. Features a stainless steel shell, 8" prismatic tempered glass lens, stainless steel face ring with uni-tension clamp. Amerlites are UL listed to install in all full-sized Pentair Pool Products, American, Pac Fab and Purex Niches.

#78431100 300W, 12V, 15' cord . . . . .	\$350.55
#78438100 300W, 12V, 50' cord . . . . .	\$476.93
#78435100 300W, 12V, 100' cord . . . . .	\$688.34
#78441100 400W, 120V, 15' cord . . . . .	\$354.40..
#78448100 400W, 120V, 50' cord . . . . .	\$420.00
#78949100 400W, 120V, 100' cord . . . . .	\$695.81

500W, 120V LIGHTS AVAILABLE ON REQUEST



## SPABRIGHT

This energy-efficient light is perfect for spas and areas where space is not available for a full-size light. SpaBrite lights install in small plastic or stainless-steel Pentair niches.

#78101200 100W, 12V, 15' cord . . . . .	\$326.17
#78108200 100W, 12V, 50' cord . . . . .	\$382.68
#78106000 *60W, 120V, 30' cord . . . . .	\$343.35
#78106100 *60W, 120V, 50' cord. . . . .	\$379.93



## STAINLESS STEEL NICHES

Large and small stainless-steel niches are formed with brass fittings. All niches have internal and external grounding lugs for use with either metal or PVC conduits.

### POOL

#78210400 Concrete . . . . .	\$122.39
#78232400 Vinyl liner and fiberglass (standard 10 hole) . . . . .	\$254.02

### SPA

#78243200 Concrete niche . . . . .	\$104.29
#78242200 Fiberglass niche . . . . .	\$158.40



## MICROBRITE COLOR AND WHITE LED LIGHT

- Installs in any standard 1.5 inch pool wall fitting.
- 10X the life of incandescent light.
- No Bonding required.
- Connects to any Pentair automation system and the Pentair IntelliBrite® Controller.

### COLOR

#62-0424 50 ft cord . . . . .	\$588.32
#62-0425 100 ft cord . . . . .	\$630.71
#62-0426 150 ft cord . . . . .	\$643.06

### WHITE

#62-0428 50 ft cord . . . . .	\$461.12
#62-0429 100 ft cord . . . . .	\$490.29
#62-0430 150 ft cord . . . . .	\$516.79

### AMERLITE PARTS (Not shown)

#79100100 Lens, clear 8" diameter . . . . .	\$35.53
#79104800 Retaining screw . . . . .	\$4.70
#79101600 Gasket for 8" lens . . . . .	\$34.94
#79110600 Face ring, stainless steel . . . . .	\$115.20
#79111000 Uni-Tention wire clamp . . . . .	\$68.75

## T100 SERIES

24-Hour Mechanical Time Switches in Type 3R Plastic Enclosure



### Timer with Enclosure

#T101P3 SPST Switch 120 VAC	\$141.56
#T104P3 DPST Switch 208-277	\$164.33
#T101P201 SPST Switch 120 VAC W/Fireman Switch	\$197.69
#T104P201 DPST Switch 208-277 W/Fireman Switch	\$197.69
#T10101R Dual Timer 30A Power Center	\$329.32
#T32404R Dual Timer 100A Load Center	\$491.65

### Mechanism Only

#T101M SPST Switch 120 VAC Input Voltage	\$102.56
#T104M DPST Switch 208-277 VAC Input Voltage	\$118.06

### Parts

#156T4042A Fireman Switch Only	\$44.21
#156T1978A Trippers Only (Set)	\$4.82

## UNDERWATER LIGHTS

### A. SWIMQUIP UNDERWATER LIGHTS & NICHS U.L. Listed

- #05082-0025 300 watt, 12 volt with 25' cord . . . . . \$492.53  
 #05086-0025 500 watt, 120 volt with 25' cord . . . . . \$424.70

#### PARTS

- #05057-0118 Lens gasket . . . . . \$54.36  
 #05055-0003 Clear lens . . . . . \$94.46  
 #WC203-52SS Stainless steel face ring . . \$263.09  
 #37337-0079 Retaining screw . . . . . \$7.85



### B. COLOR SPLASH XG POOL LIGHT FIXTURE

- 5 solid colors and 7 light shows
- Uses just 33w of power
- Fits in SwimQuip Niche

- #LPL-F2C-120-30-PSQ . . . . . \$1109.85  
 #LPL-F2C-12-30-PSQ . . . . . \$1018.48



### C. XG CONTROLLER

- Designed for use with XG fixtures and LXG Lamps
- Easy push button control
- Fits most gang junction boxes
- Bluetooth enabled operate light from Apple® or Android™ Device

- #LPL-XG-CTRL-1 . . . . . \$418.07



### D. HAYWARD UNDERWATER SEAL BEAM LIGHT UNIT

- #SPO50250 Hayward 300W, 12V with 50' cord \$605.16  
 \*For use as a replacement fixture only and not for new code installations

#### PARTS

- #SPX0502A Front rim, CPB . . . . . \$212.65  
 #SPX0501HJ Large and small "O" rings (set) . . . . . \$48.26  
 #SPX0502Z66 Securing rim screws (set of 6) . . . . . \$15.80



## REPLACEMENT BULBS

Model	Base Type	Item #	Description	Price
E. Incandescent		#873	R20 100W 12V	\$30.30
		#874	R20 100W 120V	\$15.40
		#876	BR30 100W 12V	\$12.38
		#877	R40 300W 12V	\$44.60
		#879	R40 300W 120V	\$35.80
		#880A	R40 400W 120V	\$37.65
F. Incandescent		#875	PAR56 300W 12V	\$81.10
		#875A	PAR56 300W 120V	\$77.65
G. Halogen		#889	T4 50W 12V	\$13.40
H. Halogen		#860	T4 100W 120V	\$31.60
		#862	T4 250W 120V	\$21.50
I. Halogen		#870	MR16 75W 12V	\$21.50
J. Halogen		#874A	PAR16 60W 120V	\$42.60
K. Halogen		#883	T3 150W 12V	\$23.60
		#884	T3 250W 120V	\$24.80
L. Compact Fluorescent		#885	T6 150W	\$125.95

### M. COLORSPLASH LXG LED REPLACEMENT LAMPS

ColorSplash LXG Replacement Multi-Color In-Ground Pool and Spa Lamps offer a variety of lighting modes that instantly transform any in-ground pool into a custom illuminated oasis. Whether the pool is used for playing, relaxing or entertaining, the advanced ColorSplash LXG Series with its multiple colors and light shows create the ideal pool and spa ambiance. This replacement for traditional light bulbs installs in minutes and provides immediate energy cost savings.



### COLORSPLASH LXG LED REPLACEMENT LAMPS

- POOL**  
 #LPL-P2-RGB-120 . . \$354.38  
 #LPL-P2-RGB-12 . . \$341.25
- SPA**  
 #LPL-S2-RGB-120 . \$249.39  
 #LPL-S2-RGB-12 . . \$236.25



## POOL LIGHTS BULBS & ACCESSORIES

### N. PUREWHITE® LED REPLACEMENT LAMPS

PureWhite® LED Replacement White In-Ground Pool & Spa Lamps are the brightest, most cost-effective alternative to inefficient incandescent lamps. They immediately and significantly reduce energy consumption and maintenance cost. Plus, PureWhite Pro fits most standard pool light housings and comes with a highly durable Guardian™ silicone lens gasket made for use with LED lamps



- \$2.93 a year to operate
- Energy efficient, 21 watts
- Fully dimmable

- POOL**  
 #LPL-PR-WHT-120  
 120V . . \$223.49  
 #LPL-PR-WHT-12  
 12V . . \$196.88

- SPA**  
 #LPL-M1-WHT-120  
 120V . . \$196.88  
 #LPL-M1-WHT-12  
 12V . . \$183.76

### O. BRASS DECK BOX—U.L. Listed

- #A41192-0 3/4" . . . \$282.53



### P. TRANSFORMERS

- #890 300 watt, 12 volt, 18 lbs.  
 . . . . . \$187.03  
 #892 100 watt, 12 volt  
 . . . . . \$163.57



### Q. ALADDIN ADAPTABLE LIGHT RING

The Adaptable Light Ring will fit any metal or hand-formed niche from 9 3/4" to 12". The unique feature of these light rings is that they can be installed in a few minutes and accept the Amerlite. #500C Aladdin Ring for Amerlite \$153.26



# CYCOLAC POOL FITTINGS SKIMMER BASKETS & ACCESSORIES

Hayward WG Series Suction Outlet Assemblies comply with provisions of ASME/ANSI A112.19.8 2007  
 Note: See "Guidelines for Addressing Entrapment Hazards with Pools and Spas" U.S. Consumer Product Safety Commission Publication #363-009081, (301)-504-0400 or www.cpsc.gov/cpsc/pub/pubs/363.pdf

## CYCOLAC POOL FITTINGS

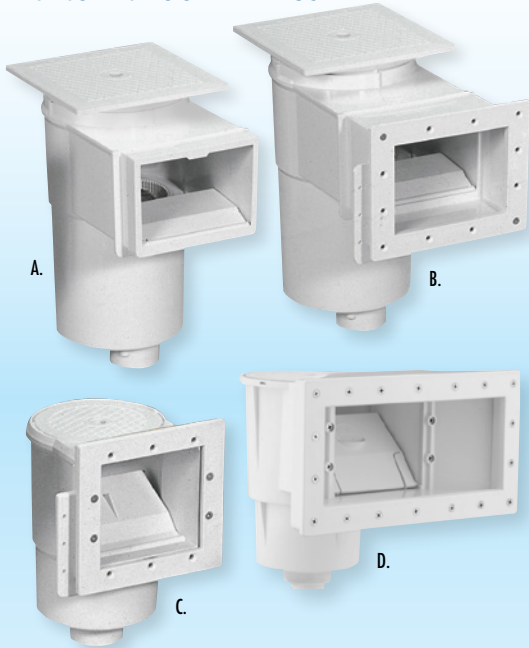

- SKIMMERS**
- A. **SP1082** Inground commercial and residential cycolac skimmer for concrete, comes with adjustable collar and tamperproof 10" x 10" square lid. 2" F.I.P. bottom connection . . . . . **\$182.23**
  - B. **SP1084** Inground commercial and residential skimmer for vinyl liner and fiberglass pools. Comes complete with 8 1/2" long throat, face plates, gaskets and screws. 2" F.I.P. bottom connection... . . . . **\$248.58**
  - C. **SP1091LX** Above ground cycolac skimmer with 1 1/2" female pipe connection. Includes SP1023, SP1419D, (2) 1 1/2" x 1 1/2" hose adapters, and SP11041 Skim Vac **\$74.21**
  - D. **SP1091WM** Same as above with wide mouth Dyna Skim (not shown) . . . . . **\$88.18**

## SKIMMERS, DRAINS, RELIEF VALVES, TUBE & SPOUTS

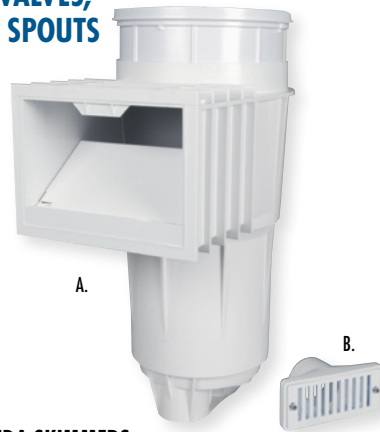

- A. BERMUDA SKIMMERS**
- #50-6300 Gunite 2" slip ports (PVC) . . . . . **\$201.12**
  - #50-6420 Vinyl/fiberglass 1 1/2" slip ports(ABS) . **\$239.09**
  - #51-6253 Gunite extension collar(not shown) . . **\$23.63**
- B. PVC GUTTER DRAINS**
- #54-0063 2" x 4" Gutter drain . . . . . **\$10.31**
  - #54-2039 2 1/2" x 6" Gutter drain . . . . . **\$16.56**



- INLET FITTINGS**
- C1. **SP1022** Concrete inlet/vacuum fitting 1 1/2" F.I.P. x 2" M.I.P. . . . . **\$6.80**
  - C2. **SP1022INS** Concrete 1 1/2" slip, 1 1/2" F.I.P. face x 1 1/2" slip stub end . . . . . **\$6.80**
  - C3. **SP1023** Vinyl liner, fiberglass 1 1/2" F.I.P. complete with lock nuts and gaskets . . . . . **\$11.50**
  - SP1023S2** Vinyl liner, fiberglass 2" F.I.P. complete with lock nuts and gaskets . . . . . **\$14.22**
  - C4. **SP1424** 1 1/2" F.I.P. x 2" M.I.P. adjustable inlet. . . **\$30.66**
  - SP1424S** 1 1/2" S.K.T. x 2" M.I.P. adjustable inlet. . **\$30.66**
  - C5. **SP1408** Inlet/Outlet Fitting with Face Plate 1 1/2" . **\$13.68**
  - SP1408S2** Inlet/Outlet Fitting with Face Plate 2" . **\$16.16**

- D. DIRECTIONAL CYCOLAC EYEBALLS**
- SP1419A** Slotted orifice . . . . . **\$5.67**
  - SP1419B** 3/8" orifice . . . . . **\$5.67**
  - SP1419C** 1/2" orifice. . . . . **\$5.67**
  - SP1419D** 3/4" orifice . . . . . **\$5.67**
  - SP1419E** 1" orifice . . . . . **\$5.67**

- E. SP1026** 1 1/2" MIP grate insert for all wall fittings . **\$3.39**

- F. MAIN DRAINS**
- Residential, Concrete**
  - WG1052AVPAK2** 2" side outlet, 1 1/2" bottom plug **\$100.60**
  - WG1054AVPAK2** 2" side outlet, 2" bottom plug **\$100.46**
  - Residential, Vinyl Liner and Fiberglass**
  - WG1048AVPAK2** 1 1/2" side outlet, 1 1/2" bottom plug **\$122.31**



- G. HYDROSTATIC RELIEF VALVES**
- #V50-125 1 1/2" . . . . . **\$167.18**
  - #V50-126 2" . . . . . **\$170.12**
  - #SP1056 1 1/2" & 2" PVC . . . . . **\$25.02**

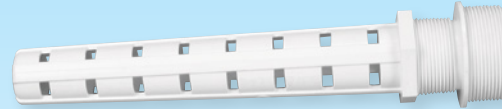

- H. CYCOLAC MAIN DRAIN (PEBBLE) COLLECTOR TUBE**
- #SP1055 12' long, slotted. Fits 2' and 1 1/2" M.P.T. **\$15.73**



- I. FILL SPOUTS**
- #A41227-0 3/4" Male, Fill Spout . . . . . **\$196.20**
  - #A41240-0 1" Male, Fill Spout. . . . . **\$176.93**
  - #A41242-0 1 1/2" Male, Fill Spout . . . . . **\$247.65**

**833-SWIM-327**  
 833-7946-327  
 www.halogensupply.com

## SKIMMER PARTS

- A. **SPX1082E**  
Hayward cover **\$24.73**
- B. **08650-0058**  
Swimquip cover **\$23.45**
- C. **85009500**  
American Products cover **\$28.26**
- 85007400**  
American Products lock-down cover (not shown) **\$36.18**
- D. **SPX1082K**  
Hayward weir **\$24.12**
- E. **08650-0022**  
Swimquip weir **\$26.12**

## UNIVERSAL WEIR DOORS

- F. **923**  
Aladdin 6" weir **\$17.13**
- 925**  
Aladdin 8" weir **\$16.71**
- 927**  
Aladdin 10" weir **\$21.21**

- G. **SPX1096K**  
Hayward weir **\$24.89**

- H. **SP11071**  
Hayward vacuum plate **\$19.35**

- I. **SP11041**  
Hayward vacuum plate **\$16.56**

- J. **SP1094D**  
Hayward vacuum plate **\$12.69**

ALL SKIMMER PARTS AVAILABLE

# HANDRAILS LADDERS & ACCESSORIES

## LADDERS



### RESIDENTIAL LADDERS (24" wide) by SR SMITH

Ladders with steps, stainless steel hardware & white rubber bumpers for private pool use. Stainless steel steps. Stainless steel (.049 thickness)

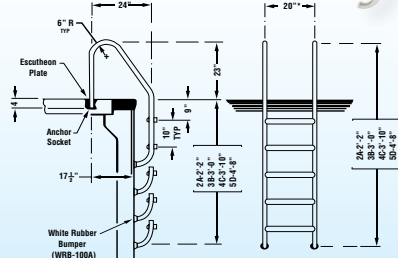

\*19" on ladders with LTDF-101 tread.

- RLF-24S-2A 2 Step (A.S.), 21 lbs. . . \$487.47
- RLF-24S-3B 3 Step (A.S.), 24 lbs. . . \$521.87
- RLF-24S-4C 4 Step (A.S.), 29 lbs. . . \$624.98
- RLF-24S-5D 5 Step (A.S.), 32 lbs. . . \$765.58

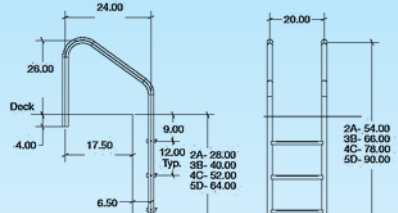

### COMMERCIAL - Stainless steel .065 thickness)

- LF-24-2A 2 Step (A.S.), 29 lbs. . . \$691.43
- LF-24-3B 3 Step (A.S.), 38 lbs. . . \$816.69
- LF-24-4C 4 Step (A.S.), 40 lbs. . . \$935.87
- LF-24-5D 5 Step (A.S.), 40 lbs. . . \$1,164.14

Order anchor sockets and escutcheons separately

## STAIR RAIL by SR SMITH

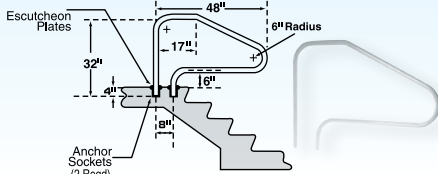

### DECK-MOUNTED STAIR RAIL DMS-101A 1.90" O.D. x .049 Stainless Steel . . . \$237.49

## HANDRAILS by SR SMITH

### 2-BEND STANDARD HANDRAIL by SR SMITH

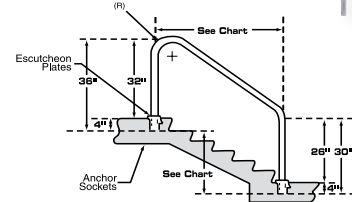

Model No.	Description	D	H	Price
2HR-4-049	4' 2-Bend (.049 Wall)	48"	26"	\$219.83
2HR-4-065	4' 2-Bend (.065 Wall)	48"	26"	\$363.91
2HR-5-049	5' 2-Bend (.049 Wall)	60"	36"	\$242.13
2HR-5-065	5' 2-Bend (.065 Wall)	60"	36"	\$393.39
2HR-6-049	6' 2-Bend (.049 Wall)	72"	46"	\$289.88
2HR-6-065	6' 2-Bend (.065 Wall)	72"	46"	\$439.32

Handrails are made of 1.90" O.D. x .049" or .065" wall, 304 stainless steel tube with mirror finish. All bends are 6" radius. Custom dimension handrails are available on a Special Order basis. Customer to specify "A" or "B" dimensions. Horizontal and vertical cross braces are also available upon request.

Also available in .109" & .145" wall  
Order anchor sockets and escutcheons separately.

### FIGURE 4 HANDRAIL

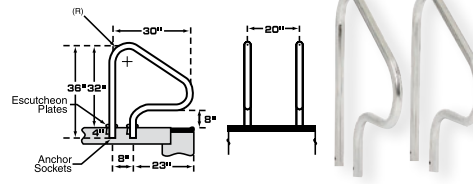

Model No.	Description	Price
F4H-101	1.90" O.D. x .049" Stainless Steel	\$415.59 pair
F4H-101-EA	1.90" O.D. x .049" Stainless Steel	\$207.80 each



- A. PH-82 Chrome plated bronze with removable eye \$73.35
- B. STBR-710 3/8" Thread eye bolt . . . \$38.33
- PI-82-EYE 1/2" Thread eye bolt . . . \$25.22
- STBR-4869 5/8" Thread eye bolt . . . \$45.15
- STBR-4863 3/4" Thread eye bolt . . . \$45.15

## DECK ANCHOR SOCKETS



- A. PS-4019-BC Brass socket anchor 4" . . . \$37.17
- B. PS-3019-B Brass socket anchor 3" . . . \$26.06
- C. AS-100D 6" Anchors for volleyball, basketball or slide. . . \$86.42

## PRE MOUNTED CHANNEL SETS

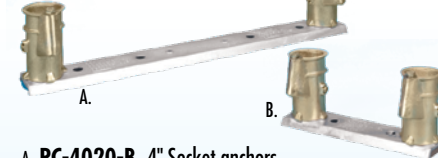

- A. PC-4020-B 4" Socket anchors w/20" centers . . . \$93.60
- B. PC-4008-BC 4" Socket anchors w/8" centers . . . \$90.43

## WEDGE ASSEMBLIES

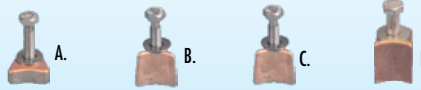

- A. PW-FROST Standard wedge dog . . . \$29.07
- B. PW-3C Hanover bronze wedge dog . . . \$9.03
- C. PW-4C Hanover bronze wedge dog . . . \$9.78
- D. SPX0392BA Hayward wedge dog . . . \$45.09

## ESCUTCHEONS

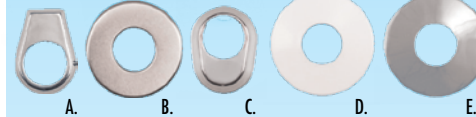

- A. PE-0019-CPB Chrome plated brass . . . \$25.131
- B. PE-0019-S Round stainless steel . . . \$6.82
- C. EP-100A Oval stainless steel . . . \$25.61
- D. PE-0019-W Round white Cylolac . . . \$2.30
- E. PE-0019-C Round chrome Cylolac. . . \$5.47

## LADDER DECK FLANGES

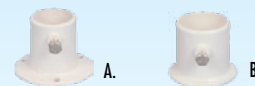

- A. PF-2116-L 1 1/2" flange above ground . . . \$12.13
- B. PF-2119-L 1.9 Flange . . . \$12.13

## SLIDE DECK FLANGES



- A. PF-3119 1.9 Flange no hardware . . . \$20.18
- B. PF-WEDGE set of 4 anchors. . . \$7.92
- C. 05-623 Slide or ladder flange. . . \$39.78

## IN WALL RECESSED STEPS

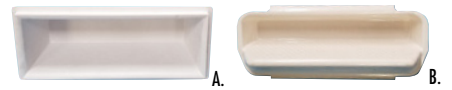

- A. 62-209-4001 in wall recessed step sold individually. . . \$77.00x
- B. 532-2010B in wall recessed step sold as set of 3 . . . \$8 1.84

## REPLACEMENT STEPS

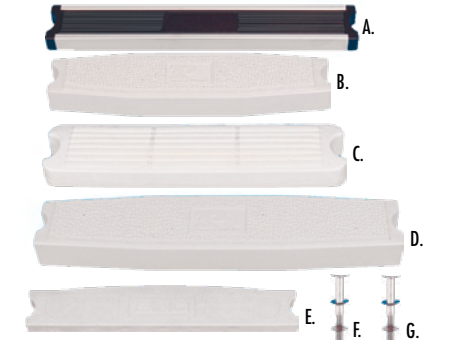

- All ladder steps include hardware.
- A. LTDF-103 Stainless steel 20" . . . \$73.08
  - B. 44104 Cylolac, 19" sloping . . . \$77.70
  - 44101 Cylolac, 19" vertical . . . \$77.70
  - C. A42077-0 Cylolac, 20" plastic . . . \$69.74
  - D. 44109 Cylolac, 26" sloping . . . \$162.23
  - 44107 Cylolac, 26" vertical . . . \$162.23
  - E. LTDF-101 Residential plastic step . . . \$38.93
  - F. 276 Stainless steel - 3/8" X 2 3/4" bolt, nut and washer sold as a pair. . . \$15.08
  - G. 60-703-pair 3/8" X 3/4 Bolt kit sold as a pair \$25.61

## END CAPS FOR STEPS

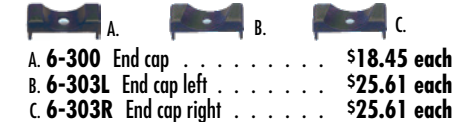

- A. 6-300 End cap . . . \$18.45 each
- B. 6-303L End cap left . . . \$25.61 each
- C. 6-303R End cap right . . . \$25.61 each

## LADDER BUMPERS



- A. 274 Male ladder bumper . . . \$5.64
- B. WRB-101A Female ladder bumper . . . \$7.16

## DIVING BOARD PARTS



- A. 67-209-911-SS Stainless steel diving board bolt kit . . . \$102.13
- B. 67-209-903-SS 18" Diving board mounting kit . . . \$174.11
- C. 69-209-041 Slide hose replacement kit . . . \$80.41

# DIVING BOARDS STANDS, POOL SLIDES



## GAMES AND FUN

### SWIM N' DUNK™ CHALLENGE RESIDENTIAL BASKETBALL Salt Friendly Challenge Game

- Durable, clear acrylic backboard
- Continuous upright dual post frame
- SealedSteel® frame and rim
- 1.90" OD, .065" wall thickness, 304 stainless steel frame
- Regulation rim, net, basketball and needle included

#### #S-BASK-CHA

Swim N' Dunk Salt Game. . . . . \$1408.61

**SPECIAL NOTE:** Two (2) In-Deck Bronze Anchors (AS-100D) for concrete decks are required to install each game. This item must be ordered separately.



### -SWIM N' SPIKE™ VOLLEYBALL GAME

Designed for in-ground pools with water depth of not more than 42". The standard game will fit pools with a width between 15 ft. and 20 ft. Special order games are available for other widths. Includes two 1.90" diameter stainless steel posts with removable stainless steel eyebolts which anchor a high-quality competitive net, adjustable for multiple width pools. Swim N' Spike™ Volleyball Game includes a competitive water volleyball and needle.

#VOLY1 Swim N' Volleyball . . . . . \$645.89

**SPECIAL NOTE:** Two (2) In-Deck Bronze Anchors (AS-100D) for concrete decks are required to install each game. This item must be ordered separately.



**833 SWIM 327**  
833-7946-327  
www.halogensupply.com

## RESIDENTIAL BOARDS & STANDS

### FIBERGLASS DIVING STANDS

The acrylic outside surface is very durable and will enhance the beauty of any pool. Snow white finish should not scratch, fade or rust. Our most popular stand. Jig mounted for easy installation. Available in 1/2 meter for 6', 8' and 10' boards. Order diving board separately.  
**#70-209-7362** Flyte Deck only for 6 ft. board \$656.23  
**#70-209-7382** Flyte Deck only for 8 ft. board \$703.12  
**#70-209-7402** Flyte Deck only for 10 ft. board \$904.72



### FRONTIER III DIVING BOARD

Our fastest-selling, new acrylic boards feature a solid core with flexible sides. White in color.

Cat. No.	Nominal Length	Wt./Lbs.	Price
#66-209-596S2	6 ft.	50 lbs.	\$734.37
#66-209-598S2	8 ft.	65 lbs.	\$971.88
#66-209-600S2	10 ft.	80 lbs.	\$1,196.83

F.O.B. CHICAGO, IL



## POOL SLIDES



**heliX2™** Add an all in one 360° adventure ride and a beautiful fountain feature to your backyard.

Height: 7' 4", 6' 5½" to seat Flume: 360 degrees, 12' 8" long, 22" wide  
**Water Delivery System:** Fountain feature and flume together or independent  
**Ladder:** Enclosed with molded handgrips **Required Deck Space:** 9' x 5'  
**Weight Limit:** 250 lbs

- Sandstone
- Gray Granite



**TurboTwister®** This thrill-ride pool slide is designed with curves and clips that guarantee hours of fun for the entire family!

Height: 8' 7", 7' 5½" to seat Flume: 14' 4" long, 23" wide, available in right or left curves  
**Water Delivery System:** Fountain feature and flume together or independent  
**Ladder:** Enclosed with molded handgrips **Required Deck Space:** 13' 6" x 6' 7"  
**Weight Limit:** 275 lbs

- Sandstone
- Gray Granite



**Typhoon®** Offers all the fun of its big brother, the TurboTwister, yet in a smaller package for more limited deck space. A perfect addition to any backyard.

Height: 7' 4", 6' 5½" to seat Flume: 9' 10" long, 22" wide, available in right or left curves  
**Water Delivery System:** Fountain feature and flume together or independent  
**Ladder:** Enclosed with molded handgrips **Required Deck Space:** 11' 8" x 4'  
**Weight Limit:** 275 lbs

- Sandstone
- Gray Granite



**Cyclone** Compact style ideal for limited deck space and hours of fun!

Height: 4' 1", 3' 2" to seat Flume: 6' 10" long, 17½" wide, available in right or left curves  
**Water Delivery System:** Fountain feature and flume together or independent  
**Ladder:** Enclosed with molded handgrips **Required Deck Space:** 6' 8" x 5' 6"  
**Weight Limit:** 175 lbs

- Sandstone
- Gray Granite
- Taupe



**Rogue2** A retro look with a thoroughly modern flume makes this the new standard for backyard fun.

Height: 8', 8' 6", 6' 6" to seat Flume: 9' 3" long, 22" wide, available in right or left curves  
**Water Delivery System:** Plumbed through pool's return or connected to a garden hose  
**Ladder:** Aluminum **Required Deck Space:** 5' 6" x 10' 7"  
**Weight Limit:** 250 lbs

- Blue
- Gray
- Taupe
- White

F.O.B. FACTORY PRICE ON APPLICATION

## REPLACEMENT BOARDS



### Eureka Diving Board

The Eureka is the ultimate board for heavy-duty use on commercial pools. It is available in both 14' and 16' lengths. The Eureka Boards feature a durable acrylic outer body (skin) and a non-slip tread. The entire core is reinforced with fiberglass.



### Swim Club Diving Board

The Swim Club Board is the ideal mid-range board for commercial pools. It is available in 10', 12', 14' and 16' lengths. It has a durable acrylic outer body and a non-slip tread.



### Olympian Aluminum Diving Board

The Olympian Aluminum Board is intended for heavy duty use on commercial and residential pools. It is available in 8', 10', 12', 14' and 16' lengths. The Olympian Aluminum Diving Board features an epoxy and welded beam extrusion construction with welded ends, providing exceptional durability, and a non-slip tread for maximum safety.



### Frontier III Diving Board

The Frontier III Commercial Board has a durable acrylic outer body and a non-slip tread. It is available in 10', 12', 14' and 16' lengths.

Priced on Application

## DIVING TOWERS

Heavy-duty towers designed for commercial aquatic facilities. Our diving towers pair with a variety of 8' to 16' boards, and are designed for a wide range of usage levels and pool envelopes.



### Deluxe

Deluxe towers come in 1 and 3 meter heights to accommodate 14' or 16' diving boards, allowing you to find the perfect size for your commercial diving pool. Choose from right, left, dual or heel mount models. The steel tower is primed only and ready for a paint topcoat.



**833 SWIM 327**  
833-7946-327  
[www.halogensupply.com](http://www.halogensupply.com)

### Steel Meter

The Steel Meter stand comes in three sizes ranging from 1/2 meter to 1 meter in height. Although ideal for commercial applications that require a strong and durable diving tower, the 1/2 meter size is also appropriate for residential pools where the diving board gets a lot of activity. The stainless steel, powder coated construction is built to last for years with minimal maintenance. Board length will be determined by size and type of pool. Handrails are required for 3/4 and 1 Meter models and are sold separately



Priced on Application

## LIFEGUARD CHAIRS

### O-Series: 360° Visibility

Scan more with the O-Series Lifeguard chair. Its circular design offers a full view of the protected area and unobstructed exit capability which enables quicker response to potential threats. Plus it's portable so you can have protection where you need it.



### Low Profile

This unit offers portability in a traditional form factor with the added benefit of 360° viewing



### Standard

This narrow profile unit offers portability and a 6'/1.8m high seat for elevated scanning



### Sentry™ Lifeguard Chair

Designed to complement any aquatic environment, Sentry lifeguard chairs provide an elegant look that will stand the test of time. Constructed from high-density polyethylene (HDPE) they are strong, durable and low maintenance.

Priced on Application

## DIVING BOARDS TOWERS, STARTING PLATFORMS & LIFE GUARD CHAIRS

**SR Smith™**

## STARTING PLATFORMS



### Universal

This platform's unique u-shape design provides a wide staging area that promotes safe platform access and doubles as a combination coaching step/rest area.



### Legacy™

These single-post models are ideal for competition aquatic facilities.



### Velocity

Designed for fast, solid starts, the Velocity Starting Platform is the next generation of starting blocks.

Priced on Application

# STARTING PLATFORMS DIVING TOWERS LIFEGUARD CHAIRS RACING LANES

## RACING LANES & PARTS

**COMPETITOR SWIM PRODUCTS**

Length	Standard (4" Disc)	Price	Gold Medal (6" Disc)	Price
60' lane	200329	\$617.37	200371	\$731.40
75' lane	200330	\$664.55	200372	\$831.67
25 meter lane	200331	\$707.81	200373	\$876.89
50 meter lane	200332	\$1,327.13	200374	\$1,659.40

Disconnect Lanes	Standard (4" Disc)	Price	Gold Medal (6" Disc)	Price
25 meter to 1-75' lane	200341	\$888.69	200383	\$1,067.61
50 meter to 2-75' lane	200342	\$1,592.57	200384	\$1,966.13
50 meter to 1-75' lane	200343	\$1,553.25	200387	\$1,909.11
50 meter to 1-75' and 1-25 meter lane	200344	\$1,592.57	200386	\$1,966.13
50 meter to 1-25 meter lane	200345	\$1,553.25	200385	\$1,909.11

Standard colors: red, white, blue, green, yellow.

All lanes F.O.B. Medina, OH

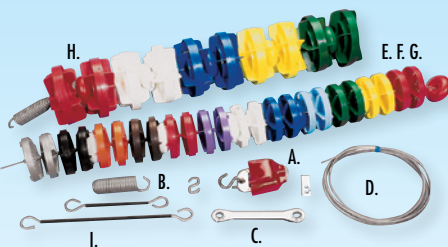

### COMPETITOR RACING LANE PARTS

A. 200200 Take-up reel . . . . .	\$119.93
B. 200201 Spring with clamp . . . . .	\$43.26
C. 200202 Ratchet wrench. . . . .	\$37.36
D. 200210 Cable (per ft.) . . . . .	\$1.58/ft
E. 200347 Body segment (approx. 4 per ft.) . . . . .	\$1.47
F. 200348 End segment (approx. 4 per ft.) . . . . .	\$1.47
G. 200349 Donut float (approx. 2 per ft.) . . . . .	\$1.47
H. 200371001 Gold medal lane segment (approx. 4 per ft.) . . . . .	\$3.34
I. 200000080 2" extension hook . . . . .	\$8.16
200240 8" extension hook . . . . .	\$28.40
200241 14" extension hook . . . . .	\$35.39
200206 S.S. cable lock . . . . .	\$4.13

## REEL & PARTS

200350 Stor-Lane Competitor Reels \$1,769.00

200351 Stor-Lane reel cover. Wt. 14 lbs \$143.00

F.O.B. Medina, OH

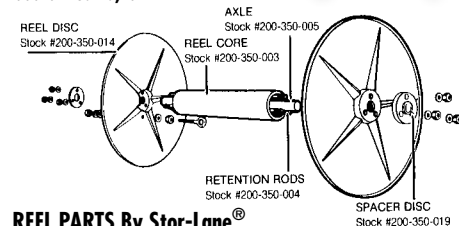

### REEL PARTS By Stor-Lane®

200350014 Reel disc . . . . .	\$262.90
200350005 Axle . . . . .	\$84.95
200350003 Reel core . . . . .	\$66.73
200350004 Retention rods . . . . .	\$66.73
200350019 Spacer disc . . . . .	\$15.37

## CLOCKS & PARTS



### PACE CLOCKS

200302 31" Electric model with white face (110V) . . . . .	\$521.03
200303 31" Electric model with black face (110V) . . . . .	\$521.03
200600 31" Battery model with white face. . . . .	\$521.03
200605 31" Battery model with black face. . . . .	\$521.03
200305 Roll away stand (for use with all 31" clocks) . . . . .	\$159.25
200400 15" Red battery clock with white face	\$289.01
200505 15" Red battery clock with black face	\$289.01
200405 15" White battery clock with white face. . . . .	\$289.01
200405 15" White battery clock with black face. . . . .	\$289.01

ALL PACE CLOCK PARTS AVAILABLE ON REQUEST



## PARAGON AQUATICS DIVING TOWER

3-meter, 1-meter, 3/4-meter, and 1/2-meter competitive/recreational diving towers in three grades of stainless steel. Choice of access ladders, fulcrums, pedestals, anchors and diving boards to meet every site requirement and budget. Towers meet FINA, NCAA, NFSA and U.S. Diving requirements. Priced on application

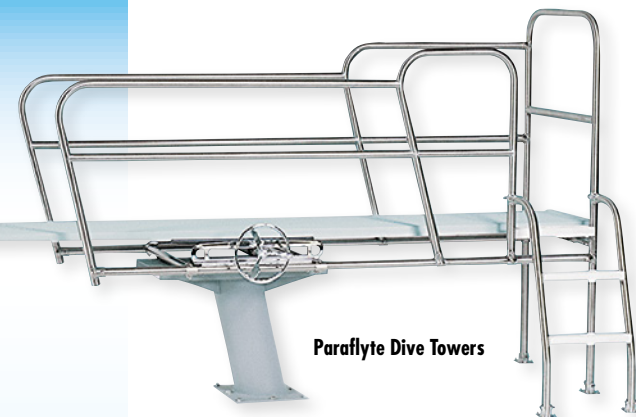

Paraflyte Dive Towers



Track Start Plus Starting Platform

## PARAGON AQUATICS STARTING PLATFORMS

Internationally acclaimed by coaches and competitive swimmers alike. Available in a wide variety of models and anchoring systems to meet your every need. Priced on application

## PARAGON AQUATICS LIFEGUARD CHAIRS

A wide selection of fixed, moveable, and portable chairs suitable for every need. The Paraflyte fixed-series chairs, designed to harmonize with the Paraflyte diving towers and starting platforms, feature both sloping pedestal and access ladder. We also have a variety of chairs that can easily be moved about as needed or to avoid the sun. Priced on application



All Terrain Griff Guard Station

833-SWIM-327  
833-7946-327  
www.halogensupply.com



## POOL LIFTS



### THE MIGHTY 400 & THE MIGHTY 600

The Mighty series is ADA compliant and UL certified to meet pool lift standards 60335-2-1000.

The Mighty lifts provide accessibility solutions with versatility, greater water drafts and a setback up to 44". Designed for in ground anchoring, the Mighty series will accommodate existing "standard" Scout 2 and Revolution concrete anchors. Created for its adaptability, the Mighty's can be purchased with a pedestal for additional wall clearance or unusual gutter profiles. Pedestals come in 8", 1', 2', 3' and 4' options.

The Mighty series is ideal for easy and affordable ADA compliance. US Patent Pending. \*If you have an existing Revolution anchor please let your sales rep know\*

#### Standard Features:

- UL Certification
- Setback up to 44"
- 360 degree rotation
- Direct drive rotation
- Flip-up armrests
- Stainless steel construction
- Durable powder coat finish
- Five year pro-rated electronics warranty
- Five year structural warranty

#### THE MIGHTY 400 LIFT

**F-MTY 400: Mighty 44, No Anchor**

- 400 pound ( 181 kg ) weight capacity
- Up to 12" deck to water

#### THE MIGHTY 600 LIFT

**F-MTY 600: Mighty 44, No Anchor**

- 600 pound ( 272 kg ) weight capacity
- Up to 14" deck to water

\*Plastic color options - standard blue, gray, tan or white

\*Powder coat options - white, gray or tan

#### Pedestal Options

Standard Pedestal, 8" anchor inserts

Shallow Pedestal, 4" anchor inserts

\*Pedestals come in 8", 1', 2', 3' and 4'

options (powder coat options, white, gray tan)

**#F-MTY400 MIGHTY 400, No Anchor . . . . . P.O.A.**

**#F-MTY600 MIGHTY 600, No Anchor . . . . . P.O.A.**

**#F-808SA STANDARD ANCHOR . . . . . P.O.A.**



### THE RANGER 2 LIFT

Welcome the newest lift in the Pro Pool Series, the Ranger 2 Pool Lift. The Ranger 2 is the newest version of our most popular lift, The Ranger. The new ADA compliant lift features a field reversible design, 350 pound weight capacity, UL Certification, and comes standard with a 14 inch deck to water draft.

The Ranger 2 upholds the same standards for durability and reliability as all Aqua Creek pool lifts. This lift is ideal for use on smaller hotel and motel pools. It is also a great choice for backyard pool enthusiasts who enjoy their independence. This lift is designed to be independently operated by the user, allowing full control of the lift with an easy to use 2 button handset.

The Ranger 2 is available with the same color options, solar charging station, anchoring system, and accessories as the Pro Pool Series lifts.

#### Features:

- UL Certification 350 lb (160 kg) weight capacity
- Setback range 14.5" to 19" (37 - 48 cm)
- 14" Water draft
- Field reversible
- Adjustable base plate
- All stainless steel construction
- Durable powder coat finish
- Flip-up armrest
- Adjustable footrest & lap belt
- Water resistant handset
- Rechargeable battery with wall mount charger
- Five year pro-rated electronics warranty
- Five year structural warranty

**#F-RNGR2 Ranger 2 Lift, No Anchor . . . . . P.O.A.**

**#F-04CAJP Anchor . . . . . P.O.A.**



## SRSMITH POOL LIFTS



### PAL® SERIES **SRSmith**

The fixed\* portable PAL® and PAL2 are ideal for commercial and hospitality pools • Easy to move by one person • 300 lb/ 136 kg lifting capacity • 240° rotation • Powder coated stainless steel and aluminum construction • Third party tested and verified ADA compliant • LiftOperator® Intelligent Control - includes 24 volt rechargeable battery

#### \*Secure-It Kit

Both Pal and Pal2 come with a Secure-It-Kit to meet the ADA "fixed" pool lift requirement.

**#200-0000 PAL Lift w/Arm Rests . . . . . P.O.A.**

**#202-0000 PAL2 Lift w/Arm Rests . . . . . P.O.A.**

**All Lifts FOB Factory**

## ADA COMPLIANT POOL ACCESS LIFTS



### SPLASH SERIES

This fixed lifting system is designed for facilities seeking to provide user-friendly access to their swimming pools.

- 400 lb/181.5 kg lifting capacity\* • Includes stainless steel anchor socket with cap • Powder coated stainless steel and aluminum construction
- Third party tested and verified ADA compliant • LiftOperator® Intelligent Control - includes 24 volt rechargeable battery
- \*Lifting capacity of the Extended Reach and round post models is 300 lb/136 kg

**#300-0000 Splash Pool Lift w/Arm Rests . . . . . P.O.A.**



### MULTILIFT

Flanged pool lifts, with right or left side mounting. • Easy flange mount installation with 4 anchor bolts • Multilift - 350 lb/159 kg lifting capacity • ML300 - 300 lb/136 kg lifting capacity • Comes with anchor jig to work on existing deck • Powder coated stainless steel and aluminum construction • Optional folding seat assembly (Multilift only) • LiftOperator® Intelligent Control - includes 24 volt rechargeable battery • Third party tested and verified ADA compliant

**#575-3000 ML300 Pool Lift w/Arm Rests . . . . . P.O.A.**

**#575-0000 Multilift Pool Lift w/Arm Rests . . . . . P.O.A.**

# TAYLOR TEST KITS AND REAGENTS

## SPECIALTY TEST KITS

### A. SALTWATER TEST KIT

1 drop = 10 or 200 ppm NaCl  
**K-1766** Saltwater Test Kit \$35.72



### B. PHOSPHATE TEST KIT by Taylor

Commercial Phosphate Test Kit helps you control algae by identifying the phosphate level in your pool.

**K-1106** Phosphate Test Kit \$42.44



### C. FAS-DPD CHLORINE TEST KIT

**K-1515-A** Chlorine Test  
 3/4 oz bottle \$37.88  
**K-1515-C** Chlorine Test  
 2oz bottle \$94.42



### D. FAS-DPD CHLORINE & MONOPERSULFATE COMBO TEST KIT

**FAS-DPD**  
**K-1518** Chlorine and Monopersulfate Combo Test Kit \$100.74



## TAYLOR TEST KITS AND TESTING ACCESSORIES

### E. TEST KIT FOR SODIUM HYPOCHLORITE by Taylor

Kit is used to verify strength of sodium hypochlorite by the drop method. **K-1579** \$119.18



### F. TEST KIT FOR TOTAL DISSOLVED SOLIDS (TDS) by Taylor

Kit quickly and easily tests for total dissolved solids (TDS) using the drop method. 1 drop = 50 p.p.m. TDS. A must test kit for commercial applications with heavy bather loads. **K-1764** \$93.07



## REPLACEMENT COMPONENTS FOR COMMERCIAL & RESIDENTIAL

<b>2004B</b> Pool and spa water chemistry booklet . . . . .	\$8.37
<b>3235</b> Cap for 5 ml. test cell . . . . .	\$1.53
<b>3243</b> Cap for 11.5 ml. test cell . . . . .	\$1.94
<b>T4024</b> 11.5 ml. test lucite cell . . . . .	\$7.56
<b>T4025</b> 5 ml. H.D. test lucite cell . . . . .	\$6.77
<b>T4030</b> 0.5 and 1.0 ml. pipet (eyedropper). . . . .	\$3.31
<b>6002</b> Sponge or brush cleaner . . . . .	\$2.27
<b>6026</b> Circular watergram . . . . .	\$5.87
<b>9056</b> High Test Block for K-2000 & K-2005 . . . . .	\$13.77
<b>9057</b> Low Test Block for K-2000 & K-2005 . . . . .	\$14.36
<b>9058</b> Test Block for K-2006 . . . . .	\$14.36
<b>9067</b> pH slide 6.8–8.4 p.p.m. . . . .	\$92.32
<b>9079</b> DPD bromine slide 0–3.0 p.p.m. . . . .	\$92.32
<b>9236</b> DPD bromine slide 2.0–10 p.p.m. . . . .	\$94.12
<b>9082</b> DPD chlorine slide 0.1–3.0 p.p.m. . . . .	\$92.32
<b>9083</b> DPD chlorine slide 1.0–10 p.p.m. . . . .	\$92.32
<b>9094</b> Copper slide 0–3.0 p.p.m. . . . .	\$92.32
<b>9106</b> Iron slide 0–2.0 p.p.m. . . . .	\$92.32
<b>9189</b> Enslow base . . . . .	\$80.60
<b>9193</b> Test tube (20-100 ppm) for cya test . . . . .	\$3.80
<b>9194</b> 15 ml. cya plastic bottle . . . . .	\$3.69
<b>9198</b> 25 ml. Sample tube . . . . .	\$6.59

## TAYLOR REPLACEMENT REAGENTS

### 2000 SERIES

KITS	R-0001	R-0002	R-0003	R-0004	R-0005	R-0006	R-0007	R-0008	R-0009	R-0010	R-0011L	R-0012	R-0013	R-0870	R-0871	R-0872
<b>K-2000</b>	1A	1A	1A	1A	1A	1A										
<b>K-2005</b>	1A	1A	1A	1A	1A	1A	1A	1A	1A	1A	1A	1A	2A			
<b>K-2005C</b>	1C	1C	1C	1C	1C	1C	1C	1C	1C	1C	1C	1C	3C			
<b>K-2006</b>			1A	1A	1A	1A	1A	1A	1A	1A	1A	1A	2A	1A		
<b>K-2106</b>				1A	1A	1A	1A	1A	1A	1A	1A	1A		1L		1A
<b>K-2006C</b>			1C	1C	1C	1C	1C	1C	1C	1C	1C	1C	2C	2L	1C	

### RESIDENTIAL SERIES

KITS	R-0001	R-0002	R-0003	R-0007	R-0008	R-0009	R-0010	R-0011L	R-0012	R-0013	R-0014	R-0015	R-0016	R-0600
<b>K-1001</b>	1A	1A									1A			
<b>K-1003</b>				1A	1A	1A					1A	1A	1A	1A
<b>K-1004</b>	1A	1A	1A	1A	A1	1A					1A	1A		

### REPRESENTATIVE OTHER

KITS	R-0001	R-0002	R-0003	R-0007	R-0008	R-0009	R-0010	R-0011L	R-0012	R-0013	R-0851	R-0852	R-0853	R-0854	R-0860	R-0861	R-0862	R-1003J
<b>K-1741</b>	1C	1C	1C	1C	1C	1C	1C	1C	1C	4C			1C				1C	1C
<b>K-1741C</b>	1C	1C	1C	1C	1C	1C	1C	1C	1C	4C	1C	2C	1C	1C	1C	1C	1C	1C

**Key:** A = .75 oz (22 ml) C = 2 oz (60 ml) E = 16 oz (500 ml) F = 32 oz (1000 ml); I = 10 g  
 The number equals the quantity of bottles in the kit; the letter indicates the size of the bottle: For instance 1A = one .75 oz (22 ml) bottle

<b>R-0001-A</b> DPD Reagent #1 3/4 oz. . . . .	\$5.06	<b>R-0013-A</b> Cyanuric Acid 3/4 oz. . . . .	\$4.21
<b>R-0001-C</b> DPD Reagent #1 2 oz. . . . .	\$10.42	<b>R-0013-C</b> Cyanuric Acid 2 oz. . . . .	\$6.41
<b>R-0002-A</b> DPD Reagent #2 3/4 oz. . . . .	\$5.13	<b>R-0013-E</b> Cyanuric Acid 16 oz. . . . .	\$14.58
<b>R-0002-C</b> DPD Reagent #2 2 oz. . . . .	\$10.73	<b>R-0014-A</b> Phenol Red 3/4 oz. . . . .	\$2.68
<b>R-0003-A</b> DPD Reagent #3 3/4 oz. . . . .	\$5.33	<b>R-0015-A</b> Acid Demand 3/4 oz. . . . .	\$2.68
<b>R-0003-C</b> DPD Reagent #3 2 oz. . . . .	\$11.41	<b>R-0600-A</b> OTO 3/4 oz. . . . .	\$2.43
<b>R-0004-A</b> PH Indicator SOL 3/4 oz. . . . .	\$4.52	<b>R-0600-E</b> OTO 16 oz. . . . .	\$17.12
<b>R-0004-C</b> PH Indicator SOL 2 oz. . . . .	\$7.65	<b>R-0718-A</b> Silver Nitrate 3/4 oz. . . . .	\$18.09
<b>R-0004-D</b> PH Indicator SOL 4 oz. . . . .	\$16.58	<b>R-0851-C</b> Iron RGT #1 2 oz. . . . .	\$12.71
<b>R-0004-E</b> PH Indicator SOL 16 oz. . . . .	\$26.17	<b>R-0852-C</b> Iron RGT #2 2 oz. . . . .	\$10.98
<b>R-0005-A</b> Acid Demand 3/4 oz. . . . .	\$4.52	<b>R-0853-C</b> Acid Demand 2 oz. . . . .	\$10.98
<b>R-0005-C</b> Acid Demand 2 oz. . . . .	\$7.31	<b>R-0854-C</b> Total Hardness 2 oz. . . . .	\$15.39
<b>R-0006-A</b> Base Demand 3/4 oz. . . . .	\$4.52	<b>R-0860-C</b> Copper #1 2 oz. . . . .	\$11.18
<b>R-0006-C</b> Base Demand 2 oz. . . . .	\$6.98	<b>R-0861-C</b> Copper #2 2 oz. . . . .	\$11.95
<b>R-0007-A</b> Thiosulfate 3/4 oz. . . . .	\$4.14	<b>R-0862-C</b> Base Demand RGT 2 oz. . . . .	\$10.31
<b>R-0007-C</b> Thiosulfate 2 oz. . . . .	\$6.71	<b>R-0870-I</b> DPD Powder (10 g). . . . .	\$11.52
<b>R-0007-E</b> Thiosulfate 16 oz. . . . .	\$19.98	<b>R-0870-J</b> DPD Powder (1/4 lb). . . . .	\$53.62
<b>R-0008-A</b> Total Alkalinity 3/4 oz. . . . .	\$4.01	<b>R-0871-A</b> FAS-DPD Titrating RGNT Chlorine 3/4 oz. . . . .	\$12.44
<b>R-0008-C</b> Total Alkalinity 2 oz. . . . .	\$7.04	<b>R-0871-C</b> FAS-DPD Titrating RGNT Chlorine 2 oz. . . . .	\$16.20
<b>R-0009-A</b> Sulfuric Acid 3/4 oz. . . . .	\$4.01	<b>R-0871-E</b> FAS-DPD Titrating RGNT Chlorine 16 oz. . . . .	\$40.37
<b>R-0009-C</b> Sulfuric Acid 2 oz. . . . .	\$6.41	<b>R-0872-A</b> FAS-DPD Titrating RGNT Bromine 3/4 oz. . . . .	\$12.58
<b>R-0010-A</b> Calcium Buffer 3/4 oz. . . . .	\$5.04	<b>R-0872-C</b> FAS-DPD Titrating RGNT Bromine 2 oz. . . . .	\$17.12
<b>R-0010-C</b> Calcium Buffer 2 oz. . . . .	\$8.39	<b>R-1003J-A</b> PH Indicator Solution 3/4 oz. . . . .	\$6.80
<b>R-0011L-A</b> Calcium Indicator 3/4 oz. . . . .	\$7.92	<b>R-1003J-C</b> PH Indicator Solution 2 oz. . . . .	\$8.44
<b>R-0011L-C</b> Calcium Indicator 2 oz. . . . .	\$12.47	<b>R-1003J-D</b> PH Indicator Solution 4 oz. . . . .	\$15.12
<b>R-0012-A</b> Hardness Reagent 3/4 oz. . . . .	\$5.06	<b>R-1003J-E</b> PH Indicator Solution 16 oz. . . . .	\$24.77
<b>R-0012-C</b> Hardness Reagent 2 oz. . . . .	\$7.52	<b>R-1003J-G</b> PH Indicator Solution 1 Gallon. . . . .	\$91.44

**833-SWIM-327**  
 833-7946-327  
[www.halogensupply.com](http://www.halogensupply.com)

## TAYLOR 2000 SERIES KITS



A.

### A. 2000 SERIES TEST KITS by Taylor

The K-2000 test kit will test for free available, total and combined chlorine and bromine, pH, acid and base demand. All reagents are ¼ oz.

**K-2000 . . . . . \$52.50**



B.

### B. COMPLETE™ - HIGH (K-2005)

- ¼ oz. Reagents
- Free & Total Chlorine 1-10 ppm
- Bromine 2-20 ppm • pH 7.0-8.0
- Acid & Base Demand
- Total Alkalinity
- Calcium Hardness • Cyanuric Acid

**K-2005 . . . . . \$82.49**



D.

### D. COMPLETE FAS-DPD CHLORINE

Same as K-2005 except uses 9058 comparator, sanitizer tests are titrations to improve accuracy and eliminate color-matching problems, and Free & Combined Chlorine is 1 drop = 0.2 or 0.5 ppm

**K-2006 Complete FAS-DPD Chlorine \$101.33**

### SERVICE COMPLETE FAS-DPD CHLORINE

Same as K-2006 except features 2 oz. reagents, more DPD powder, and large carrying case

**K-2006C Service Complete \$178.79**

### COMPLETE FAS-DPD BROMINE

Same as K-2006 except CYA test is not needed and Bromine 1 drop = 0.2 or 0.5 ppm

**K-2106 Complete FAS-DPD Bromine \$96.89**

## TAYLOR COMMERCIAL SERIES

Kits in the Commercial Series test for two closely related parameters using liquid-color standards. The Slide and Midget comparators in this series give the **most accurate colorimetric readings available** short of high - end electronic instrumentation. Cases are custom-molded plastic; reagents are .75 oz. in Midget kits and 2 oz. in Slide kits.

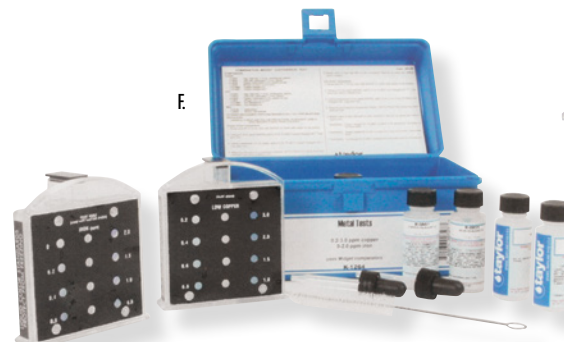

F.

### THE SLIDE COMPARATOR

Recognized by nine liquid-color standards and three test cells. Slide sits in Enslow base. Measures one parameter. Calibrated to work with specific reagents. Use to compensate for color and/or turbidity in the water sample.



G.

### G. DPD CHLORINE-HIGH & pH SLIDES

Free & Total Chlorine 1.0 - 10 ppm pH 6.8-8.4  
**K-1765-H Chlorine-High & pH Slides \$261.39**

### DPD CHLORINE-LOW & pH SLIDES

Free & Total Chlorine 0 - 3.0 ppm pH 6.8-8.4  
**K-1765 Chlorine-Low & pH Slides \$258.80**

### F. COPPER & IRON MIDGETS

Copper 0.2 - 3.0 ppm Iron 0-2.0 ppm  
**K-1264 Copper & Iron Midgets \$166.03**



### THE MIDGET COMPARATOR

Recognized by eight liquid-color standards and a single test cell. Measures one parameter. Calibrated to work with specific reagents. Use when color and turbidity in the water sample are not problems.

## TAYLOR PROFESSIONAL SERIES



H.

## TAKE A LAB POOLSIDE

### H. PROFESSIONAL COMPLETE CHLORINE

Provides the pool professional with accurate and reliable analysis of the major testing requirements for all pools, spas, and hot tubs. Each kit contains slide comparators which provide the most accurate colorimetric comparisons available. The professional complete test kit, tests for DPD chlorine 0.0-3.0 p.p.m. and 1.0-10 p.p.m., pH 6.8-8.4, acid and base demand, total alkalinity, calcium hardness, cyanuric acid, copper 0.0-3.0 p.p.m., iron 0.0-2.0 p.p.m. and total hardness. A must for every pool professional.  
**K-1741C Professional Complete . . . \$639.80**

**833-SWIM-327**  
833-7946-327  
[www.halogensupply.com](http://www.halogensupply.com)

# LAMOTTE TEST KITS & ACCESSORIES



**A. ColorQ PRO 7**  
 The ColorQ PRO7 photometer was designed for pool and spa professionals to measure seven primary pool and spa tests directly on a digital display. Test factors include **Free Chlorine, Total Chlorine, Bromine, pH, Alkalinity, and Calcium Hardness** using liquid or tablet reagents to measure tests, and **Cyanuric Acid** with 100 TesTabs®. The user friendly photometer, testing reagents and photo-diagrammatic multilingual instructions (English, Spanish, French) are packaged in a convenient carrying case.  
**MODEL LA-2056** (Reagent version) . . . . . \$208.95  
**MODEL LA-2057** (Tablet version) . . . . . \$208.95

## COLORQ REAGENTS & TEST TABS

<b>P-6740-G</b> DPD1A Reagent 30 ml . . . . .	\$9.45
<b>P-6741-G</b> DPD1B Reagent 30 ml . . . . .	\$9.45
<b>P-6743-G</b> DPD3 Reagent 30 ml . . . . .	\$11.70
<b>7037-G</b> pH Reagent 30 ml . . . . .	\$11.32
<b>7039-G</b> TA Reagent 30 ml . . . . .	\$13.73
<b>7041-G</b> CA2 Reagent 30 ml . . . . .	\$11.70
<b>7042-G</b> CA1 Reagent 30 ml . . . . .	\$11.77
<b>6996A-J</b> CY Tabs 100 pack (new version 2.0 or higher) . . . . .	\$34.14
<b>6903A-J</b> DPD1 Tabs 100 pack . . . . .	\$27.45
<b>6197A-J</b> DPD3 Tabs 100 pack . . . . .	\$27.45
<b>3880A-H</b> pH Tabs 50 pack . . . . .	\$15.90
<b>3882A-H</b> Alkaline Tabs 50 pack . . . . .	\$19.50
<b>3883A-H</b> CA Tabs 50 pack . . . . .	\$19.50

**B. INSTA-TEST 3 TEST STRIPS** Insta-test 3 strips provide the simplest and precise test for free chlorine or bromine (0–10 ppm) total alkalinity (0–240 ppm) and pH (6.8–9.0) in the market. Comes complete with 50 strips per bottle and complete instructions. **2976** . . . . . \$8.25

**INSTA-TEST 5** Tests for free and total chlorine/bromine, pH, total alkalinity and total hardness. Comes complete with 50 strips per bottle. **2977** . . . . . \$13.33

**INSTA-TEST PHOSPHATE** Measures the phosphate levels from 0, 100, 200, 300, 500, 1000, in 15 seconds. The phosphate strips are packaged 25 strips to a bottle. **3021** . . . . . \$13.00

**INSTA-TEST SALT** Measures from 1500, 2000, 2500, 3000, 3500, 4000 and 5000 ppm in 20 seconds. The Salt Strips are packaged 10 strips per bottle. **2998** . . . . . \$8.25



**C. WATERLINK® SPIN TOUCH™**  
 The innovative WaterLink® Spin photometer does all your pool and spa water testing for you. Each sealed reagent disk contains the precise amount of reagent needed to run a complete series of tests. Just fill one unique Spin reagent disk with less than 3 mL of water and all your vital tests are done automatically. In just 30 or 60 seconds all the test results are transferred into the DataMate® software (sold separately) and analyzed to display results and recommend precise treatment instructions.

- C. 3581** Mobile Waterlink Spin Touch Lab . . . . . \$1,305.94
- D. 4335-H** 3 Use Free CL/BR/ALK/PH (50 pkg) . . . . . \$148.75

## E. POCKET TESTERS

Lamotte Pocket Testers are a great way to accurately test your levels. They feature an easy to read LCD screen and push button calibration.

- 5-0103** Waterproof Ph Pocket Tester . . . . . \$189.58
- 1749** Salt/TDS/TEMP Pocket Tester . . . . . \$159.39



E.



**F. LAMOTTE DIP CELL SERIES TEST KIT**  
 This 7013L Test kit is designed for the pool operator and service pro. It tests for free and total chlorine in ranges of 0.5–10.0 ppm, pH 6.8–8.2, total alkalinity, calcium hardness, acid and base demand and cyanuric acid. Comes complete with color coded instructions and handbook.  
**7013L** . . . . . \$98.13

**G. LAMOTTE'S POOL MANAGER SERIES KIT**  
 This kit is an all table test kit designed for public pool operators. The precise Octa-Slide Comparator System tests for free and total chlorine 0.5–10.0 p.p.m., pH 6.8–8.2, total alkalinity, calcium hardness, acid demand and cyanuric acid. Also includes diagrammed instructions, saturation index calculator water quality handbook and enough tablets for 50 tests (Cl and pH).  
**3368-NJ** . . . . . \$115.77

**H. LAMOTTE PRO 250 SERIES TEST KIT**  
 This is a complete kit for the commercial public pool operator. It tests for free and total chlorine, pH, total alkalinity, calcium hardness, acid and base demand, cyanuric acid and copper and iron. A must test kit for the commercial pool operator.  
**7002-NJ** . . . . . \$244.76

**I. LAMOTTE EC-5 CYANURIC ACID KIT**  
 This kit provides an economical and simple way of determining cyanurics by turbidity methods in pools and spas in ranges of 20–100 p.p.m.  
**6838** . . . . . \$39.69

**J. LAMOTTE TEST TABLETS**

<b>6999A-J</b> DPD #1 tablets . . . . .	\$8.40 per 100
<b>6905A-J</b> DPD #3 tablets . . . . .	\$8.40 per 100
<b>6915A-J</b> pH tablets . . . . .	\$8.55 per 100
<b>3920A-J</b> Alkalinity tablets . . . . .	\$8.40 per 100
<b>6846A-J</b> Calcium hardness tablets . . . . .	\$8.40 per 100
<b>6994A-J</b> Cyanuric acid tablets . . . . .	\$11.10 per 100

## LAMOTTE TEST REAGENTS

<b>P-6111-H</b> Alkalinity Titrant 60 ml . . . . .	\$14.36	<b>P-6743-G</b> DPD3 30 ml . . . . .	\$11.70
<b>P-6740-G</b> DPD1A 30 ml . . . . .	\$9.45	<b>P-6743-H</b> DPD3 60 ml . . . . .	\$17.28
<b>P-6740-H</b> DPD1A 60 ml . . . . .	\$14.58	<b>P-7026-G</b> Phenol red indicator 30 ml . . . . .	\$11.36
<b>P-6741-G</b> DPD1B 30 ml . . . . .	\$9.45	<b>P-7026-H</b> Phenol red indicator 60 ml . . . . .	\$13.23
<b>P-6741-H</b> DPD1B 60 ml . . . . .	\$14.58	<b>P-7028-G</b> Alkalinity indicator 30 ml . . . . .	\$14.02

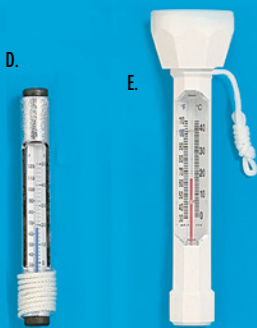

## THERMOMETERS

- A. 13" INDOOR/OUTDOOR BIG & BOLD CLOCK**  
 #90057 13" Big & Bold Clock . . . . . \$19.95
- B. 13" INDOOR/OUTDOOR BIG & BOLD THERMOMETER**  
 #90007 13" Big & Bold Thermometer . . . . . \$19.95
- C. THERMO DUCK POOL & SPA** Derby Duck® thermometer with tether.  
 #GAME-7000 . . . . . \$19.56
- D.. CHROME THERMOMETER by Rainbow**  
 The thermometer has an ABS cyclocac molded tube showing both fahrenheit and centigrade scales. Comes complete with 3' polyethylene cord. #R141076 . . . . . \$27.25
- E. E-Z READ COMBO SINK OR FLOAT THERMOMETER by Pentair**  
 Snap on/snap off floatation top with 3 foot tether.  
 #R141200 . . . . . \$17.90

**833-SWIM-327**  
 833-7946-327  
 www.halogensupply.com



- A. GUARDEX 4-IN-1 TEST KIT**  
 This kit tests for chlorine residual, pH, acid and base demand and total alkalinity quickly and economically. **26131GDX . . . . . \$49.23**
- B. GUARDEX DPD 4-IN-1 TEST KIT**  
 This kit tests for free available and total chlorine, pH, acid and base demand and total alkalinity. **26133GDX . . . . . \$60.28**
- GUARDEX REAGENTS**  
**26240GDX #1 Sol. . . . . \$5.82**    **26246GDX #4 Sol. . . . . \$4.74**  
**26242GDX #2 Sol. . . . . \$5.94**    **26252000 #5 Sol. . . . . \$6.09**  
**26244GDX #3 Sol. . . . . \$4.92**



- C. TAYLOR DPD TEST KIT**  
 This kit tests for free chlorine, .5–5 ppm or bromine 1–10 ppm, pH 6.8–8.2. Ideal for above-ground pool owners. **K-1001 . . . . . \$14.63**
- D TAYLOR TROUBLE-SHOOTER TEST KIT**  
 This kit tests for free and total chlorine, .5–5 ppm or bromine 1–10 ppm, pH 6.8–8.2 acid demand and total alkalinity. **K-1004 . . . . . \$25.88**



- E. RAINBOW CHALLENGER TEST KIT**  
 This kit is geared for the above-ground pool owner and tests for total chlorine (0.1–3ppm) and pH (6.8–8.2). **R151076 . . . . . \$17.48**
- F. RAINBOW CHALLENGER BROMINE TEST KIT**  
 This kit tests for bromine (0.4 to 3.0 ppm) and pH (6.8–8.2). Is ideal for residential pools and spas utilizing bromine. **R151196 . . . . . \$16.36**
- G. REAGENT REFILL FOR RAINBOW TEST KITS**  
 OTO & PH 1/2 oz. reagent pack refill. **R161150 . . . . . \$6.57**

## TEST KITS

# PALINTEST TEST KITS RESIDENTIAL TEST KITS THERMOMETERS



- A. POOL TEST 10 BLUETOOTH®**  
 The Pooltest 10 Bluetooth is ideal for large commercial pools, spas and pool engineers. The Pooltest 10 is quick and easy to use and is fully integrated with the Palintest tablet test reagents.
- Built in water balance calculations
  - Store 100 user ID's and 500 datasets
  - Includes all major pool parameters
  - Digital measurements for quick and accurate results
  - Simple and easy to use
  - Waterproof and portable
  - Suitable for poolside use
  - Bluetooth and USB connectivity
  - Compatible with Palintest's Aqua Pal app

### Test for

- Bromine
- Calcium Hardness
- Chlorine (free, combined & total)
- Copper
- Cyanuric Acid
- Iron
- Ozone
- pH Phenol Red
- Phosphate
- Total Alkalinity

### Calculations for

- Langelier Saturation Index
- Palintest Water Balance

**SPH7010US . . . . . \$967.00**

TEST	REAGENT RANGE	50 TEST PACK	250 TEST PACK
Alkalinity	10-500	PM188 \$51.30	AP188 \$114.60
Calcium Hardness	5-500	PM252 \$57.38	AP252 \$133.80
Free Chlorine(DPD 1)	.01-5	PM011 \$20.25	AP011 \$38.40
Total Chlorine (DPD1 & DPD3)	.01-5	PM031 \$37.80	AP031 \$72.60
Free Chlorine (DPD-XF)	.01-10	PM013 \$22.28	AP013 \$44.40
Total Chlorine (DPD1 & DPD3)XT	.01-10	PM033 \$44.55	AP033 \$84.60
Cyanuric Acid	2-200	PM087 \$47.25	AP087 \$93.00
PH (Phenol Red)	6.8-8.4	PM130 \$20.25	AP130 \$38.40
Replacement Photometer Test Tubes (pack of 5)	*PT595/5 \$60.00		

\*PT595/5 - Round 10ml test tube (5 pack) for SP709US

# SIGNS SAFETY LINES FITTINGS

## PUBLIC SIGNS

A.



### A. CPR CHART CARDIOPULMONARY RESUSCITATION

18" x 24" Sign that explains procedures for CPR Cardiopulmonary Resuscitation. An absolute necessity for your pool.

#R231100 ..... \$26.66



B.

### B. NO LIFEGUARD ON DUTY SIGN

A 18" x 24" sign that is a must for every public pool without a lifeguard.

#2024 ..... \$17.25

### C. NO PERSON MAY ENTER POOL AREA ALONE OR SWIM ALONE.

State sign.

#2029 ..... \$17.25

## Required by the State of Illinois



D.

### D. PUBLIC POOL REGULATIONS SIGN

Required by the State of Illinois

#2020-IL ..... \$17.25

#2030-IL (Public Spa Regulations) ..... \$17.25

### E. NO LIFEGUARD ON DUTY SIGN

Required by the State of Illinois

#2024-IL ..... \$17.25

### F. POOL BATHER LOAD

Required by the State of Illinois

#2026 ..... \$17.25

#2031-IL (Spa Bather Load) ..... \$17.25

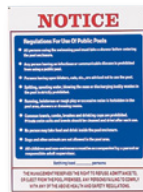

G.

### G. PUBLIC POOL REGULATION SIGN 18" x 24".

#2020 ..... \$17.25

### H. NO DIVING ALLOWED SIGN

A necessity for every pool commercial or residential.

#R231200 ..... \$15.50



H.

I.



### I. DIAL 911 EMERGENCY NUMBER SIGN

#R231700 ..... \$16.00

J. POOL CLOSED SIGN - #R231400 ..... \$17.95

K. SPA CLOSED SIGN - #R231500 ..... \$16.00



J.



K.

L.



L. SPA RULES SIGN - #R230300 ..... \$26.66

M.



M. POOL RULES SIGN - #R230400 ..... \$26.66



### N. CHEMICAL WARNING SIGNS

10" x 7" Chemical safety sign

#2602 Danger Acid Sign ..... \$23.60 ea.

#2606 Danger Chlorine Sign. .... \$23.60 ea.



## SAFETY LINES & FITTINGS



A.



B.

### A. STANDARD POLYETHYLENE FLOATS

5" x 9" Floats for 3/4" rope

#917BW Blue & White ..... \$5.42

3" x 5" Floats for 3/8" rope

#916BW Blue & White ..... \$3.04

### B. HANDILOCK FLOATS

Eliminates need for float clamps. Simply twist float on rope to lock float unto rope securely.

5" x 9" Handlelock for 3/4" rope

#915BWB Blue White Blue ..... \$10.30

#915RWR Red White Red. .... \$10.30

3" x 5" Handlelock for 3/8" rope

#914BWB Blue White Blue ..... \$5.33

#914RWR Red White Red. .... \$5.33



### C. POLYPROPYLENE LINE

Blue & white polypropylene line. Will not crack, fray or absorb water.

#932 3/8" diam.. \$0.60/ft. #933 3/4" diam.. \$1.10/ft.



### D. SAFETY LANE FLOAT KIT

Each kit contains Handlelock floats, 1 hook,

1 fid and blue and white rope.

#986 16 ft. kit, 5 floats ..... \$36.92

#987 18 ft. kit, 6 floats ..... \$45.41

#988 20 ft. kit, 7 floats ..... \$53.89

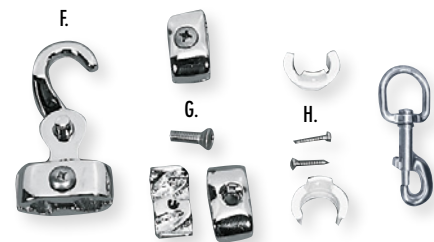

### F. CLAMP TYPE ROPE HOOKS

Chrome-plated brass.

#PH-51H For 3/4" rope ..... \$27.88

### G. ROPE CLAMPS

Chrome-plated brass clamps.

#PH-57 For 3/8" rope ..... \$8.06 ea.

#PH-59 For 3/4" rope ..... \$10.80 ea.

### H. FLOAT KEEPERS

Permanently secures the #916 and #917 floats to the line to prevent it from sliding. One set holds one float.

#943 For 3" x 5" float, 3/8" rope. . . \$2.00/set

#944 For 5" x 9" float, 3/4" rope. . . \$4.34/set

I. #920 Swivel Eye ..... \$8.33



## BUILD YOUR OWN CUSTOM LIFE LINES

### ROPE BY THE FOOT

#933 3/4" Rope

#932 3/8" Rope

### FLOATS (1 per every 5 ft)

#915BWB 5" x 9" HandiLock floats

#915RWR 5" x 9" HandiLock floats

#914BWB 3" x 5" HandiLock floats

#914RWR 3" x 5" HandiLock floats

### REQUIRED HARDWARE

#PH-59 3/4" Rope Hook (2 required)

#PH-57 3/8" Rope Hook (2 required)

**833 SWIM 327**  
833-7946-327  
www.halogensupply.com

## LIFE GUARD UMBRELLAS

### A. RED LIFEGUARD UMBRELLA

This Lifeguard umbrella is made of durable weather resistant nylon with a vinyl laminate covering to protect it against the elements. When opened this red lifeguard umbrella's diameter is 6 1/2'. This umbrella comes with a 7 1/2' aluminum pole that has push button device to allow the user to position the umbrella in a manner to protect the user from the sun.

#12-004 Red Umbrella  
6 1/2 ft. umbrella with  
7 1/2 x 1 1/2" pole . . . \$101.15

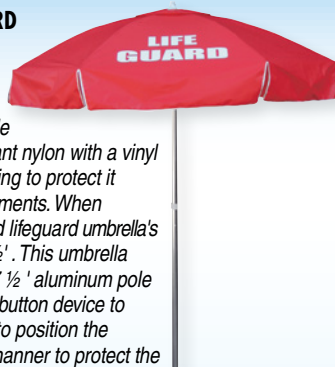

### B. THE WINDBRELLA

The Windbrella is ideal for windy areas due to superior venting at the top of the umbrella. This umbrella is extremely light and the pole diameter is 1 1/4" diameter. It also has a tilting mechanism and closure strap. Umbrella spans 6 1/2'. Comes with 7 1/2' pole.

#12-003-S-PB Silver outside with blue trim \$64.40  
#12-003-S-PG Silver outside with green trim \$64.40



### C. NYLON UMBRELLA

This umbrella is made of durable weather resistant nylon with a vinyl laminate covering to protect it against the elements. When opened, the diameter of the umbrella spans 6 1/2'. Comes with 7 1/2' pole.

#12-002-NAVY Navy & White Umbrella . . . \$90.13  
#12-002-RED Red & White Umbrella . . . \$90.13  
#12-002-ROYAL Royal & White Umbrella . . . \$90.13



All Umbrellas F.O.B. Charlotte, NC

**833-SWIM-327**  
833-7946-327  
www.halogensupply.com

## SAFETY EQUIPMENT

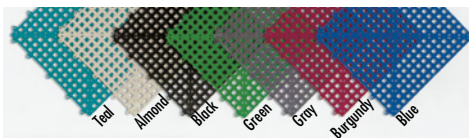

### D. DRI-DEK® – THE SELF-DRAINING FLOOR SYSTEM

No more puddles. No more wet floors. No more germs. Now there's Dri-Dek. The perfect solution for showers. Steam rooms. Dressing areas. Locker rooms – or any place that gets wet. Why? Because Dri-Dek's textured surface not only drains water. Its patented design lifts you above wet floors, too. And it comes in 9 designer colors. So you can match decor. Anywhere. Any time.

#978 1' x 1' Dri-Dek . . . . . \$7.40  
#978-3x4 3' x 4' Dri-Dek sheet . . \$104.18  
#978-3x12 3' x 12' Dri-Dek Roll . \$307.93  
#978-CORNER 2" x 2" Corner. . . . \$2.17  
#978-EDGE 2" x 12" Edge . . . . . \$3.45  
For color choices, add to code number  
(example: #978-1): -1 Red, -2 Yellow, -3 Blue,  
-4 Almond, -5 Green, -6 Gray, -7 Black, -8 Burgundy,  
-9 Teal. F.O.B. Naples, FL



### E. C.P.R. MICROSHIELD

A "First Response" protective device which provides a barrier between the victim and the rescuer, and one-way valve that prevents the victim's secretions from contacting the rescuer. Packaged in a convenient vinyl case with instructions, it is ready for use any time and is completely disposable.

**Note:** The microshield is for use by C.P.R. trained individuals only.

**DO NOT USE ON INFANT VICTIMS.**

Dispose of after initial use.

#975 . . . . . \$11.93



E. #18604 24 Unit First Aid Kit. . . . . \$76.50  
(ILLINOIS STATE APPROVED)

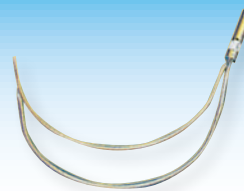

### G. LIFE HOOK and RESCUE POLE

Double loop life hook with 2-6 ft. poles.  
#909 Life Hook with Rescue Pole . . . \$144.44

H. #909A Life Hook only . . . . . \$34.10



### I. RING BUOY ASSEMBLY

U.S.C.G. Approved. Ideal for camps, pools and home use. Assembly consists of our JB-20 ring buoy. Equipped with stainless steel rack and 60 ft. throw line.

#962 . . . . . \$157.00

### J. RING BUOYS

U.S. Coast-Guard approved. Ring buoys are made of PVC foam. Covered with heavy nylon fabric.

#JB-20 20" dia. . . . . \$101.85

#JB-24 24" dia. . . . . \$109.20

### K. THROW LINES

Polypropylene throw lines with float can be attached to a ring buoy without taping or splicing.

#957 60' long . . . . . \$32.18



### L. WATER RESCUE TUBES

A wrap-around type life-saving aid for open water. Made of the highest quality Ensolite enclosed cell foam. Covered with an extra heavy duty vinyl skin. Comes complete with towline and shoulder strap. This device is not U.S.C.G. approved.

#980 40" Rescue Tube . . . . . \$67.41

#980A 50" Rescue Tube . . . . . \$73.50

## SAFETY EQUIPMENT

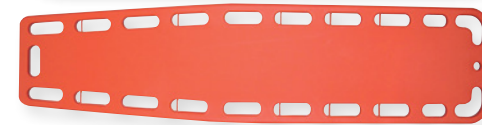

M.

### M. SPINE BOARD

AB Spineboard is an economical yet extremely strong board. The shell of the board is heavy duty and is x-ray translucent. The board comes with 21 hand holds and 8 pins for your strapping needs. The spineboard is waterproof and excellent for water rescue. The weight capacity of this board is 700 lbs. It's made of durable polyethylene. In large orders, we can do custom colors.

#10-993-ORG Spine board only 72" x 18" x 2.5" \$176.40



N.

N. #10-301-BLK One piece spine board strap 72" x 2" \$11.93

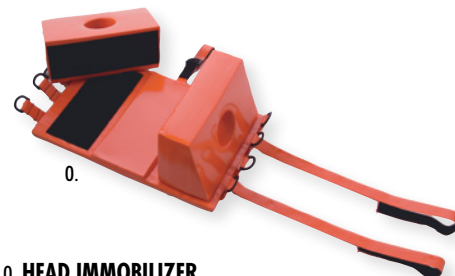

O.

### O. HEAD IMMOBILIZER

Head Immobilizer is easy to use and is compatible with the majority of spineboards on the market. Our immobilizer features side blocks with fast-stick closures for a snug fit and up to 50% more support surface. The Head Immobilizer comes with 2 head/chin straps and a base plate that adheres easily to the board. It's waterproof and buoyant, so it can be used for water rescues. Can easily be cleaned and disinfected for reuse.

#10-001-ORG Water rescue model 10" x 16" x 7" \$110.25



P.

### P. VELCRO SPINE BOARD STRAPS

Velcro straps are made of durable nylon webbing covered with velcro, enabling the user to accomplish fast and firm immobilization. This strap is for use with all spine boards. It's sold in a set of three.

#10-305-ORG Velcro spine board straps  
Set of 3 . . . . . \$4 2.00

# SOLAR BLANKETS SOLAR REELS



## COMMERCIAL REEL SYSTEM

### A. ELITE COMMERCIAL REELS

- Various sizes to fit any shape or size pool (may require multiple reels)
- Dual bearings per frame allow for smooth cover rollup
- 36" high white frames are made of structured aluminum
- Stainless steel hardware for maintenance free use
- Heavy duty aluminum tubes were designed to handle heavy loads



Cat No.	Pool Width	Max Reel Length	Max Cover Length	Price
HV-100C14	Up to 14'	16'	125'	\$1,347.50
HV-200C14	Up to 30'	16' (Dual Tube)	90'	\$2,012.50
HV-100C20	15' - 20'	22'	125'	\$1,592.50
HV-200C20	Up to 40'	22' (Dual Tube)	90'	\$2,502.50
HV-100C24	21' - 24'	26'	125'	\$1,751.75
HV-200C24	Up to 48'	26' (Dual Tube)	90'	\$2,821.00

F.O.B. FACTORY

## RESIDENTIAL SOLAR COVERS



### B. PROTECH RESIDENTIAL SOLAR COVERS

For residential pool applications. 6 year prorated warranty. Approximately 12 mil grade thickness. Reduces water evaporation. Conserves energy.

Cat. No.	Pool Size	Price	Cat. No.	Pool Size	Price
104012 x 24	12' x 24'	\$83.45	104020 x 40	20' x 40'	\$231.84
104016 x 32	16' x 32'	\$148.39	104020 x 44	20' x 44'	\$270.77
104018 x 36	18' x 36'	\$187.78	104024 x 40	24' x 40'	\$278.21
104018 x 40	18' x 40'	\$208.66	104024 x 44	24' x 44'	\$324.93
			104025 x 50	25' x 50'	\$393.75

## RESIDENTIAL REEL SYSTEM

### C. SIGNATURE INGROUND REEL SYSTEM

- 2 sizes (14' - 18') (19" - 20") For pools up to 20' x 40'
- Maximum strength.... All metal components
- Superior performance and quality. Low profile
- 1 person operation. Premium metal bearings
- Heavy duty tubing. Non sagging
- Fits under low profile diving boards (17" clearance)



Cat No.	Description	Pool Size	Price
HVSIGN-18	18' Reel	12' - 18'	\$360.50
HVSIGN-20	20' Reel	19' - 20' 6"	\$388.50
HV-7041	Optional Caster Set	Set of 4	\$49.50

## ABOVE GROUND SOLAR COVERS



### D. PROTECH ABOVEGROUND SOLAR COVERS

For aboveground pool applications. Cuts nighttime heat loss. Reduces water evaporation. Conserves energy.

Cat. No.	Pool Size	Price	Cat. No.	Pool Size	Price
103012	12' round	\$32.36	103012X24	12' x 24' oval	\$4.72
103015	15' round	\$50.57	103016X24	16' x 24' oval	\$86.29
103018	18' round	\$72.81	103016X32	16' x 32' oval	\$115.04
103021	21' round	\$99.10	103018X36	18' x 36' oval	\$145.61
103024	24' round	\$129.42	103018X38	18' x 38' oval	\$153.70
103028	28' round	\$176.17	103022X41	22' x 41' oval	\$203.83
103030	30' round	\$202.23			

## ABOVE GROUND REEL SYSTEM



### E. ELITE ABOVE GROUND SOLAR REEL SYSTEM

Designed for both Round and Oval aboveground pools. Three sizes to choose from. Sturdy 4" diameter extruded aluminium tubing prevents sagging. Portable and easy to remove. Swivel ends pivot or lift out.

Cat. No.	Description	Pool Width	Price
HV-18	Above-ground reel	12-18 ft.	\$245.50
HV-24	Above-ground reel	19-24 ft.	\$280.00
HV-28	Above-ground reel	25-28 ft.	\$341.25

**833-SWIM-327**  
8 3 3 · 7 9 4 6 · 3 2 7  
**www.halogensupply.com**



## ABOVE GROUND WINTER COVERS



### GLI WINTER COVERS FOR ABOVE-GROUND POOLS

GLI Pool Products attractive heavy-duty covers are available in, Estate Green solid, and Arctic Blue Solid complete with cable & winch. Backed by the strongest warranty in the business. Eliminate costly maintenance and clean up. Keep all dirt, debris and fine particles out of your pool.

Size	BLUE CLASSIC COVER		GREEN ESTATE COVER	
	Cat No.	Price	Cat No.	Price
10' x 15' Oval	4105010X15	\$46.77	4108010X15	\$62.94
12' Round	4105012	\$43.91	4108012	\$60.38
12' x 18' Oval	4105012X18	\$65.31	4108012X18	\$84.44
12' x 21' Oval	4105012X21	\$74.61	4108012X21	\$96.45
12' x 24' Oval	4105012X24	\$82.11	4108012X24	\$110.29
15' Round	4105015	\$64.55	4108015	\$85.22
15' x 27' Oval	4105015X27	\$113.55	4108015X27	\$148.64
15' x 30' Oval	4105015X30	\$114.68	4108015X30	\$151.68
16' x 25' Oval	4105016X25	\$102.75	4108016X25	\$138.58
16' x 32' Oval	4105016X32	\$124.89	4108016X32	\$163.70
18' Round	4105018	\$85.68	4108018	\$110.08
18' x 34' Oval	4105018X34	\$143.05	4108018X34	\$188.07
18' x 36' Oval	4105018X36	\$162.94	4108018X36	\$222.01
21' Round	4105021	\$106.60	4108021	\$137.03
21' x 41' Oval	4105021X41	\$210.69	4108021X41	\$286.19
24' Round	4105024	\$123.73	4108024	\$168.44
28' Round	4105028	\$163.95	4108028	\$216.78
30' Round	4105030	\$202.42	4108030	\$267.65

Winterizing Air Equalizer Pillows #1052 4' x 4' Equalizer \$20.67  
#1053 4' x 8' Equalizer \$37.20

### GLI POOL PRODUCTS LEAF NET Fits In-Ground or Above-Ground Pools!

• Stretches across solar blanket or winter pool cover  
• Catches leaves and other debris • Makes leaf-removal a snap • Helps prolong life of solar blankets and winter covers • Keeps pool clean



Cat. No.	Pool Size	Price	Cat. No.	Pool Size	Price
1145	18' round	\$146.52	1150	16' x 32' oval	\$213.59
1146	24' round	\$211.58	1151	16' x 32' rectangular	\$227.91
1147	27-28' round	\$280.39	1152	18' x 36' rectangular	\$280.18
1148	12' x 24' oval	\$140.43	1153	20' x 40' rectangular	\$329.28
Other sizes available. Call for prices.					

## IN GROUND WINTER COVERS



PVC coated polyester fabric is 30% lighter than standard solid covers. 50% more puncture resistant! 100% Sunlight Blockage - NO spring time algae growth. Comes with patented "Kleen-Screen" drain (drains water from surface filtering out dirt, leaves and debris) Secures pool from children, pets and stray animals. Also available with Sure-Flo™ full length drain! Pump is available in lieu of drain. Custom HyPerLite Covers come standard with Commercial Grade Springs - A \$125 value! Available in 3 attractive colors. 15 Year Limited Warranty.

#HYPERLITE POOL COVER ..... Price on Request



Blocks sun like a solid cover - No springtime algae growth. Made from a unique weave of polypropylene mesh that blocks out algae producing UV Rays. Keeping sunlight out ensures that you will open to cleaner water in the spring. Secures pool from children, pets and stray animals. Nearly 50% lighter than solid covers for easier installation, removal and storage. Nearly 75% more tensile strength than competitor's standard mesh! Custom ProMesh Covers comes standard with Commercial Grade Springs - A \$125 value! Available in 4 attractive colors. 15 Year Limited Warranty.

#PROMESH POOL COVER ..... Price on Request

**833-SWIM-327**  
833-7946-327  
[www.halogensupply.com](http://www.halogensupply.com)

## WINTER POOL COVERS

### Why use a winter cover?

- Keeps pool water clean and free from dirt, leaves and debris
- Stops chemical loss through evaporation • Prevents algae growth
- Protects pool from the wear and tear of winter
- Eliminates costly maintenance and spring cleanup



### #5200 SERIES "CLASSIC" BLUE WINTER COVER

**Features:** Lighter-Easy to put on or take off the pool. Lasts longer- will not crack, split or tear from the most severe winters. Will not stretch or distort out of shape in summer. Best Warranty! 8 years prorated 1 full year.

### #6200 SERIES "ESTATE" GREEN WINTER COVER

With a proper winterizing program, the Aquacover® Winter Cover: Protects pool from winter effects to eliminate costly maintenance and spring cleanup. Strongest Warranty! 12 years prorated, with 2 full years!

Pool Size	Cover Size	Cat. No.	Price	Cat. No.	Price
14' x 28'	19' x 33'	521428	\$109.54	621428	\$147.55
16' x 32'	21' x 37'	521632	\$133.27	621632	\$179.61
16' x 40'	21' x 45'	521640	\$164.56	621640	\$213.26
18' x 36'	23' x 41'	521836	\$163.84	621836	\$219.91
20' x 40'	25' x 45'	522040	\$192.55	622040	\$258.82
20' x 44'	25' x 49'	522044	\$208.80	622044	\$296.86
24' x 40'	29' x 45'	522440	\$205.74	622440	\$316.28
24' x 44'	29' x 49'	522444	\$270.54	622444	\$347.40
25' x 50'	30' x 55'	522550	\$280.41	622550	\$366.81
30' x 50'	35' x 55'	523050	\$327.18	623050	\$477.90

ORDER TUBES SEPARATELY. Water tubes retain pool covers where tie-downs fail.

Double Chamber: #1047-BL 8'-20 mil black . \$16.29

#1047-B 10'-20 mil black \$18.96

# SAFETY VACUUM RELEASE SYSTEMS GRATES & SUMPS



## SR-500 Stingl Switch (Safety Vacuum Release System)

The Model SR-500 is a Safety Vacuum Release System (SVRS) which works by monitoring the vacuum on the suction side of the pool or spa pump. When a blockage occurs in the main drain or skimmer a sudden rise in vacuum will cause the SR-500 to shut down pump operation and activate an audible alarm. The pump will remain off with the alarm sounding until manually reset.

#SR-500.....\$832.50

Note: High Voltage 240/480 triple phase 3.5 HP pumps (20 amps) or greater require a contactor. (not included)



## Vac-Alert™

“Save a child’s life....  
Vac-Alert™ saves lives”

### SAFETY VACUUM RELEASE SYSTEM

- Vac-Alert™ Model VA-2000 SVRS Unit reacts in less than a second to quickly release dangerous pump suction vacuum
  - A totally mechanical safety system easy to install, adjust, and test
  - Made of engineered plastics and 316 stainless steel
  - The vac-alert complies with ASME/ANSI standard A112.19.17 for vacuum release systems for residential and commercial pool and spas
  - 3-year limited warranty
- #VA-2000S Below Grade Unit \$725.00  
#VA-2000L Above Grade Unit \$725.00

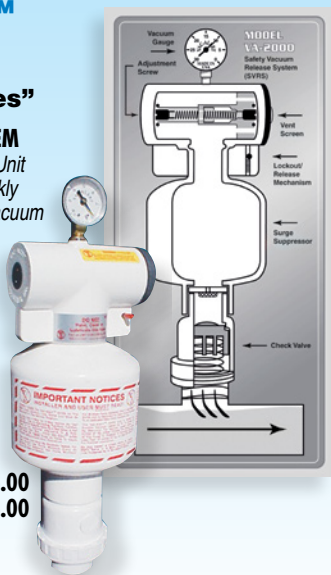

**833-SWIM-327**  
833-7946-327  
www.halogensupply.com

## SUPERFLOW™ SUMP AND GRATE (Up to 18 x 18 drains - VGB-2008) Only Lawson Aquatics, Inc. has SuperFlow™

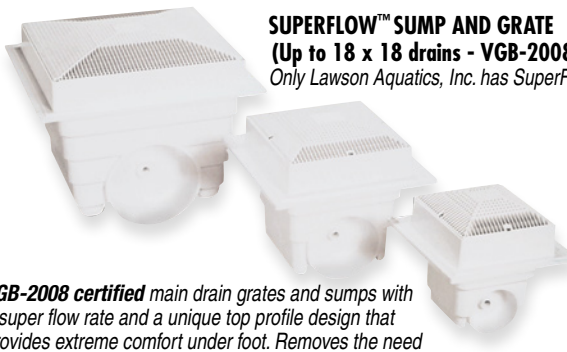

VGB-2008 certified main drain grates and sumps with a super flow rate and a unique top profile design that provides extreme comfort under foot. Removes the need for field-built sump certification.

- Open grate area of 54%-allowing for a maximum flow rate
- Internal plumbing fittings instead of external. Allows stacking and avoids breaking off or cracking during shipment, pressure testing or handling.
- Unique built-in water stop with two vertical extensions prevents water passing over the flange.
- A solid one-piece, injection-molded unit. Less expensive than fabricated PVC sheets, stainless steel and fiberglass.

MODEL NUMBER	DESCRIPTION	OPEN AREA SQ. IN.	PRICE
#MLD-SG-0909-WT	9" x 9" Sump & Grate - 4" Side Port	42.12	\$371.99
#MLD-SG-1212-WT	12" x 12" Sump & Grate - 6" Side Port	81.30	\$530.52
#MLD-SG-1818-WT	18" x 18" Sump & Grate - 8" Side Port	183.06	\$1,413.83



### FIBERGLASS SUMPS

(18 X 36 • 18 X 54 • 18 X 72 - VGB-2008)  
Lawson Aquatics offers standard-size fiberglass main drain sumps with unblockable PVC grating for area 18" x 36" and larger

- Plumbing connection are configured and customized to your piping schematics
- Connections can either be threaded, (for 8" and smaller) flanged or couplings

MODEL NUMBER	DESCRIPTION	OPEN AREA SQ. IN.	PRICE
#FI-SG-1836-WT	18" x 36" Sump & Grate	343.44	POA
#FI-SG-1854-WT	18" x 54" Sump & Grate	515.16	POA
#FI-SG-1872-WT	18" x 72" Sump & Grate	686.88	POA

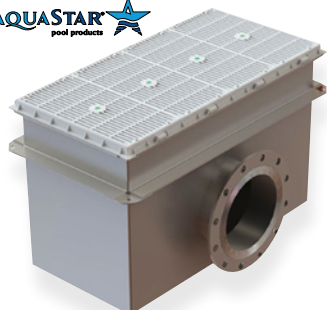

### MAHC-I SERIES

18" x 36" Stainless Steel Sump with Four 9" x 18" Anti-Entrapment Suction Outlet Covers

For ANSI/APSP-16 flow ratings and VGB Certification documentation.

Floor/Wall 1,674 GPM at 1.5 fps  
Floor/Wall 1,116 GPM at 1.0 fps

358 square inch opening

Configurable sumps simplify compliance with the Model Aquatic Health Code, the International Swimming Pool and Spa Code, and the latest revisions to ANSI/APSP-16.

Priced on application

# emotron®

**A simple, cost effective VGBA solution to prevent pool and spa entrapment**

### Key Features

The Emotron PSP20 uses the existing Pump Motor as a Sensor to protect swimmers from pool & spa entrapment. When a spa or swimming pool pump experiences a loss of suction caused by the drain being blocked, the PSP20 detects a significant drop in motor load and shuts the pump off in 1 second



MODEL	VOLTAGE	FULL LOAD AMPS	PHASES	HP RANGE	PRICE
#PSP20-10-25	120	0.4 - 25	1	0.5 - 1.5	\$1,236.64
#PSP20-20-25	208/230	0.4 - 25	1 3	0.5 - 3.0 0.3 - 7.5	\$1,236.64
#PSP20-20-50	208/230	26 - 50	1 3	5.0 - 7.5 10.0	\$1,398.34
#PSP20-40-10	480	0.4 - 10	3	0.5 - 7.5	\$1,236.64
#PSP20-40-25	480	11 - 25	3	10.0 - 15.0	\$1,236.64
#PSP20-40-50	480	26 - 50	3	20.0 - 30.0	\$1,236.64



### Anti-Entrapment Suction Outlet Covers

- All components meet or exceed ANSI/APSP 16-2011 and NSF/ANSI 50-2009a national standards and ASTM G154 UV testing exposure.
- Sump manufactured from strong PVC sump with 3" socket and 4" spigot side port, and 2" socket 2 1/2" spigot bottom port.
- Manufactured from superior UV-resistant engineered polymers.
- Comes with 3" and 2" NPT cap with o-ring for pressure testing and winterizing.
- #316 stainless steel screws
- Trademarked VGB compliance button easily identifies VGB 2008 compliant cover from on deck and underwater.
- Replace drain cover every five years from the date of installation.

MODEL NUMBER	DESCRIPTION	OPEN AREA SQ. IN.	PRICE
#WAV9WR101SSB	WAVE 9" Square Sump	48.4	\$520.93
#WAV12WR101SSB	WAVE 12" Square Sump	90.8	\$706.15

## FRAMES AND GRATES



### HAYWARD

MODEL NUMBER	DESCRIPTION	OPEN AREA SQ. IN.	PRICE
#WGX1048E	8" Round Grate Only (Each)	8.10	\$26.48
#WG1030AVPAK2	8" Round Frame and Grate (Pkg of 2)	8.10	\$51.64
#WG1031HF2PAK2	9" x 9" Inner/Outer Frame and Grate (Pkg of 2)	23.96	\$180.31
#WG1032HF2PAK2	12" x 12" Inner/Outer Frame and Grate (Pkg of 2)	41.07	\$286.71
#WG1033HF2PAK2	18" x 18" Inner/Outer Frame and Grate (Pkg of 2)	124.10	\$876.69
#WGX1031BHF2	9" x 9" Grate w/Inner Frame (Each)	23.96	\$74.70
#WGX1032BHF2	12" x 12" Grate w/Inner Frame (Each)	41.07	\$103.52

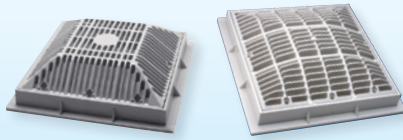

### WATERWAY

MODEL NUMBER	DESCRIPTION	OPEN AREA SQ. IN.	PRICE
#645-4790V	9" x 9" Grate Only	43.60	\$60.05
#640-4790V	9" x 9" Frame and Grate	43.60	\$79.83
#640-4740V	12" x 12" Grate Only	62.40	\$81.18
#640-4720V	12" x 12" Frame and Grate	62.40	\$121.08
#640-4770V	18" x 18" Frame and Grate	174.40	\$441.28

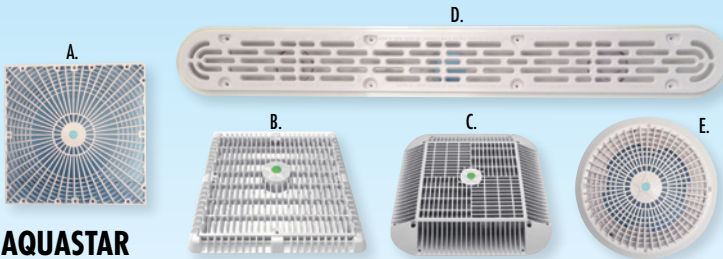

### AQUASTAR

MODEL NUMBER	DESCRIPTION	OPEN AREA SQ. IN.	PRICE
A. #R9MF101	9" x 9" Moflow Grate Only	35.80	\$81.08
#R12MF101	12" x 12" Moflow Grate Only	69.10	\$106.78
B. #WAV9WR101	Wave 9" x 9" Frame and Grate	48.40	\$183.88
#WAV12WR101	Wave 12" x 12" Frame and Grate	90.80	\$215.23
#WAV18WR101	Wave 18" x 18" Frame and Grate	176.80	\$523.03
C. #914101	14" x 14" Retrofit to 9" x 9"	84.00	\$223.45
#1216101	16" x 16" Retrofit to 12" x 12"	101.00	\$255.75
D. #32CDFL101	32" Channel Drain 3-Port	25.90	\$297.40
E. #A10RCFR101	10" Round Sumpless Cover	31.50	\$63.35

## ANTI-ENTRAPMENT

### AEGIS ANTI-ENTRAPMENT SHEID

- ASME A112.19.8.a-2008 VGB-2008 & NSF Certified
- Easily installed over existing main drains
- Prevents bather entrapment
- Fiberglass construction
- No bonding required
- Slip resistant surface
- Includes stainless steel hardware
- Wall flowrate: 1120 GPM
- Floor flowrate: 1432 GPM
- Life: 15 years - submerged outlet
- Covers up to 24" x 24" main drain

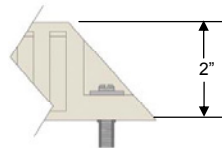
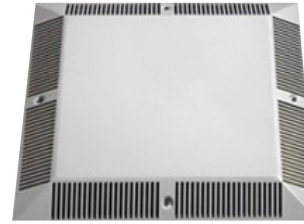

1/4" dia S.S. drop-in anchors with 1/4" S.S. fasteners & washers

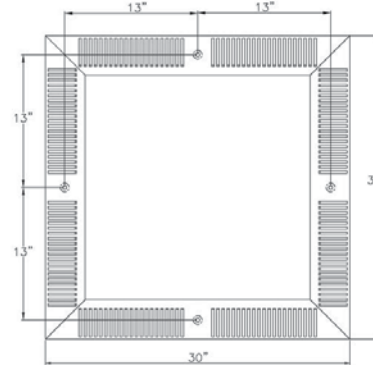

MODEL NUMBER	OVERALL SIZE L x W	OPEN AREA	MAX. FLOW RATE @ 1.5 F.P.S.
#3030AEC	30" X 30"	128.21 in <sup>2</sup>	600 GPM

#3030AEC ANTI-ENTRAPMENT SHIELD . . \$2,619.03

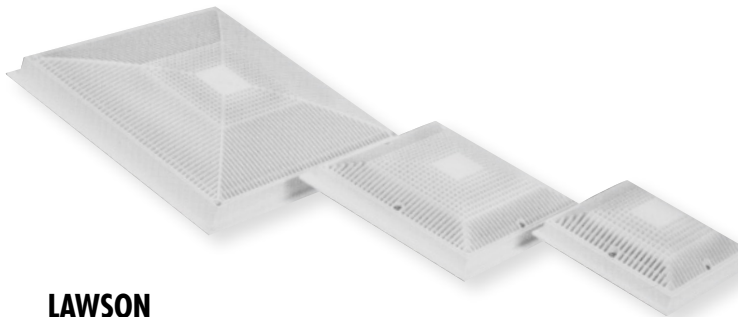

### LAWSON

MODEL NUMBER	DESCRIPTION	OPEN AREA SQ. IN.	PRICE
#MLD-FGD-0909-WT	9" x 9" Frame and Grate	42.12	\$216.55
#MLD-FGD-1212-WT	12" x 12" Frame and Grate	81.30	\$286.65
#MLD-FGD-1818-WT	18" x 18" Frame and Grate	183.06	\$528.28

## FRAMES AND GRATES

### VIRGINIA GRAEME-BAKER POOL & SPA SAFETY ACT

By December 19, 2008

**ALL public pool owners must**

- Install drain covers that meet ANSI/ASME A112.19.8-2007 standard on EVERY drain/grate.
- Install an automatic shut-off system, gravity drainage system, Safety Vacuum Release system (SVRS), suction-limiting vent system or disable the drain, if the pool operates off of a SINGLE main drain. Pools and spas with unblockable drains are exempt from this requirement.
- Ensure that dual or multiple main drains are at least 3 feet apart.

**WARNING:** Installing a VGB Act approved grate does not necessarily establish compliance. ONLY a professional design engineer or your local health department can help you to confirm that all criteria of the act have been met.



**Universal Drain Cover**  
Concrete, Vinyl & Equalizer Pools

### SDX2 RETRO HIGH-FLOW SAFETY DRAIN

SDX2 is a high flow suction outlet suitable for use as a wall fitting, or as a floor fitting when debris removal is not a concern. Available for concrete, vinyl and fiberglass pools, SDX2 performs at a very high flow rate while operating at one of the lowest velocity ratings in the industry. SDX2 boasts a flow rating of 188 gpm on the floor and 154 gpm on the wall.

# SDX-RETRO-WHT . . . . . \$79.60



**833-SWIM-327**  
833-7946-327  
www.halogensupply.com

# ENERGY SAVING SYSTEMS

## Filtrex INCORPORATED

Filtrex regenerative diatomaceous earth filters eliminate the need to backwash . . . saving makeup water, chemicals and heating energy. Filtrex provides unequalled water clarity – up to 99% effective in removing contaminants down to 1 micron.

Halogen has over 400 Filtrex installations. Call for references in your area.



## REGENERATIVE D. E. FILTERS

Diatomaceous Earth (D.E.) is the best pool filtration media. Filtrex makes the best D.E. Filter. Filtrex's advanced technology combines low carbon stainless steel construction with the exclusive Flex-Tube™ filter element and a proven system of precoat regeneration to eliminate the need for continuous slurry feed throughout the filter cycle. The New Vacuum Transfer System, now standard on all New Filtrex Systems, allows for quick and easy filter precoat and eliminates airborne diatomaceous earth previously associated with the old precoat tank. Existing Filtrex Systems can also be retrofitted with the New Vacuum Transfer System. Call us toll free for more information.

Price on Request

## EPD POLY LINED STEEL HIGH RATE SAND FILTERS

EPD has utilized the latest in plastics technology to bring you the new Poly lined steel filter vessels (50 and 100 psi models) which combine the corrosion durability of linear low-density polyethylene with the strength of steel. The monolithic liner means the need for cathodic protection is eliminated. These new poly lined steel tanks can be ordered with 13.5 or 16.5 sq. ft. of filter area per tank in single (1) through (8) tank configurations with the automatic filter controller, the EPD Hi-Rate sand filtration system does not require supervision of its day to day operation. Operating and maintenance costs, normally associated with commercial filtration systems, are non-existent. The automatic backwash control console is programmed to perform all of the filtration and backwash functions automatically 24 hours per day, 365 days per year. Systems can be also purchased with semi-automatic and pressure differential controllers. **Price on Request**



**833-SWIM-327**  
833-7946-327  
[www.halogensupply.com](http://www.halogensupply.com)

## DANFOSS ADJUSTABLE FREQUENCY DRIVES



Danfoss adjustable frequency drive offers a list of features and ease-of-use unmatched in the industry. On its own or when matched with our Halo Gen energy management system to provide state-of-the-art control of your pool and save you thousands of dollars in energy. Call and talk to one of our technical advisors on the advantages of this time-proven approach to energy savings.

#VLT 6000 Adjustable Frequency Drive  
Price on Request

## WATERMASTER II LEVEL CONTROL SYSTEM

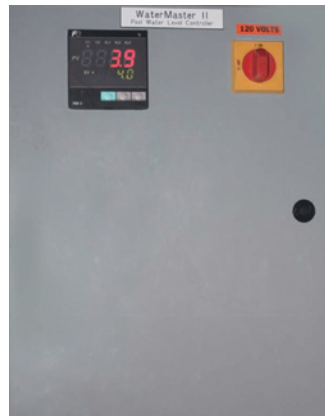

The WaterMaster II is an all-electronic level control system for commercial swimming pool applications. This system solves the level control needs of customers or designers who want to eliminate the need for pneumatic controls in their buildings systems.

The system controls surge tank water level to ± 0.05 feet of set point. The PLC controller also controls pool skimming action by measuring changes in gutter flow into the surge tank and turning on the fresh water make-up solenoid as needed

The control package includes a PLC based level controller, either an ultrasonic level sensor or an electronic pressure reducer, a 120 volt hydraulic main drain modulating valve and a 120 volt slow closing fresh water make-up solenoid valve

Price on Request

## HALOGEN CONTROLLERS



### All-Encompassing Control of Regenerative Systems:

It's More Than a Filter, It's a Science.  
**HALOGen.RTS (Regenerative Total System)**  
**HALOGen.CS (Custom System)**

Benefits include:

- Ease of Use
- Total System Control
- Mobile Connectivity
- Training Built In
- Alarm Logging and Trend Reports
- Maximize Resource Savings - Minimize Operating Costs



#### Ease of Use

- Large 15 1/2" color touch screen with sound, graphics and video
- Intuitive user interface and experience
- Graphically displayed system status shown on one screen
- Flexibility with auto or manual modes
- User-friendly set-point entry
- Accessible from tablets, mobile devices and PCs

#### Total System Control

- Filter cycle control
- Flow control with VFD
- Chemical control
- Temperature control
- Level control with automatic fresh water makeup
- Cleaning modes
- All safety interlocks
- Customized solutions tailored to your facility

**HALOGen.RTS**  
(Regenerative Filter System) and  
**HALOGen.CS** (Custom System)

#### Training Built In

- Training videos with audio for all procedures
- Imbedded manuals and data sheets specific to system design

#### Alarm Logging and Trend Reports

- Real-time trending reports for all control loops
- Trending histories stored
- Easy-to read graphical displays of real-time trends and histories
- Audible alarms to alert staff
- Alarm emails immediately sent to staff

#### Maximize Resource Savings - Minimize Operating Costs

- Complete integration of all system controls maximizes resources and ease of use
- System component synergy contributes to the longevity, performance and efficiency of a pool system.

Price on Request

## BLUE-WHITE FLOW METERS

### A. MODEL F300 BLUE WHITE FLOW METERS

**NEW!** Dual scale reads Sched 40 & Sched 80 PVC.  
**NEW!** Easy to read red float with no more float bounce. Unique pitot tube design increases accuracy & reduces straight pipe requirements by 50%. The **F-300 Series** is a low cost, accurate pitot tube type flow meter designed specifically for the swimming pool industry. Mounts on horizontal pipe only. Specify for pipe or copper tubing.

Cat. No.	Size	SCH40 / SCH 80	Price
F-30150	1½"	10-70/10-60 gpm	\$114.14
F-30200	2"	20-120/18-100 gpm	\$122.68
F-30250	2½"	29-150/25-130 gpm	\$139.99
F-30300	3"	45-240/40-215 gpm	\$157.79
F-30400	4"	79-400/70-375 gpm	\$172.12
F-30600	6"	170-1100/160-1000 gpm	\$278.33
F-30800	8"	300-2200/275-1950 gpm	\$309.41

Note: Add a "P" to Catalog No. for PVC or Iron pipe; "T" for copper pipe.

### B. VERTICAL MOUNT FLOW METERS D-300/U-300

For installations with a minimal amount of room, hence more vertical pipe than horizontal. Please specify if direction of flow is up or down.

Cat. No.	Flow Direction	Size	SCH 40 /SCH 80	Price
U-30150	Up	1½"	12-70/10-60 gpm	\$139.19
D-30150	Down	1½"	12-70/10-60 gpm	\$139.19
U-30200	Up	2"	20-120/18-100 gpm	\$149.98
D-30200	Down	2"	20-120/18-100 gpm	\$149.98

Note: Add a "P" to Catalog No. for PVC or Iron pipe; "T" for copper pipe.

### C. BLUE-WHITE F-2000 DIGITAL FLOWMETER

The **F-2000 Series** is battery or plug-in transformer (included) operated and can be quickly installed on an instrument panel or wall. This top quality meter is accurate to ± 1% full scale and can handle pressure up to 300 PSI and temperature to 200°F.

Cat. No.	Pipe Size/Type	Flow Range	Price
RTPB-15K8	1½" (sch. 80)	15-150 gpm	\$901.62
RTPB-20K8	2" (sch. 80)	30-300 gpm	\$901.62
RTPB-30K8	3" (sch. 80)	60-600 gpm	\$901.62
RTPB-40A8	4" (sch. 80)	100-1000 gpm	\$1,003.38
RTPB-60A8	6" (sch. 80)	250-2500 gpm	\$1,003.38
RTPB-80A8	8" (sch. 80)	400-4000 gpm	\$1,003.38
RTPB-100A8	10" (sch. 80)	600-6000 gpm	\$1,023.75
RTPB-120A8	12" (sch. 80)	800-8000 gpm	\$1,023.75

### D. BLUE & WHITE DIGI-FLO F-1000

This meter is ideal for those who require rate of flow only. The meter is shipped pre-programmed. The meter LCD display is powered with 2 (AAA) batteries. Please specify pipe type (sched. 40 or sched. 80 PVC).

#### Features:

- Display update time: every 2 seconds
- Enclosure ABS material
- Accuracy ± 2% full scale
- Saddle Mount design for easy installation.

Size	Cat. No.	Price
1½"	RB-150S8	\$427.42
2"	RB-200S8	\$427.42
3"	RB-300S8	\$427.42
4"	RB-400S8	\$478.29
6"	RB-600S8	\$478.29
8"	RB-800S8	\$478.29
10"	RB-1000S8	\$498.68
12"	RB-1200S8	\$498.68

F.O.B. Alsip, Illinois

## INTRODUCING

# FlowVis®

## FLOW METER



### E. FlowVis® Key Features

- The only flow meter to carry NSF 50 (required by CA Title 24)
  - NSF verified average accuracy 97.9%
  - Install right next to other fittings without the need for straight pipe before or after
  - Install horizontal, vertical, or even upside-down
  - Includes check valve function
  - Includes water velocity indication of 5', 7', and 9' per second
  - Establish correct flow rates for heaters, water features and chemical feeders
  - Quickly re-establish correct flow rates after customer tampering
  - Models for 1.5", 2", and 2.5" pipe
  - Retrofit kit easily, converts existing Jandy or Praher check valves into FlowVis flow meter or repairs existing FlowVis meters. No plumbing required.
  - Installing a flow meter with a variable speed pump allows you to use instrumentation to dial in the pump's optimum speed
- #FV-C Complete FlowVis for 2" & 2½" pipe . . . . \$189.00**  
**#FV-C-15 Complete FlowVis for 1½" pipe . . . . \$189.00**  
**#FVJ-R FlowVis retrofit for 2" & 2½" pipe . . . . \$131.25**  
**#FVJ-R-15 FlowVis retrofit for 1½" pipe . . . . \$131.25**  
**#FV-3 FlowVis for 3" Sched. 80 pipe . . . . \$495.25**  
**#FV-4 FlowVis for 4" Sched. 80 pipe . . . . \$547.75**

### F. SIGNET 8150 Battery Powered Flow Totalizer

The Signet 8150 Battery Powered Flow Totalizer is compatible with the Signet 515 and 529 flow sensors, and will provide years of dependable operation. The large digital display indicates flow rate and totalized flow volume simultaneously.

#### Features:

- Three totalizers: 2 resettable and 1 permanent, user-selectable
- Long-Lasting Lithium batteries
- Mounting versatility
- No-flow indicator
- Large digital display with averaging
- Simple push-button operation
- User-selectable access code prevents unwanted changes
- Auto-calibration

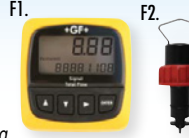

- F1. **#3-8150-1** (yellow body) FIELD MOUNT for Pipe, Tank and Wall Mounting . . . . . \$815.24  
**#3-8150-1P** (black body) PANEL MOUNT includes mounting bracket and gasket. Panel sold separately . . \$815.24  
**#3-8150-PO INTEGRAL MOUNT\*** ½" to 4" pipe . . \$1,271.46  
**#3-8150-P1 INTEGRAL MOUNT\*** 5" to 8" pipe . . \$1,303.23  
\* Mounted on Model 515 Paddlewheel Sensor For Installation Directly On Pipe to Be Monitored

### F2. SIGNET 515 ROTOR-X PADDLEWHEEL FLOW SENSORS

Cat. No.	Pipe Size	Price
P51530-P0	½" to 4"	\$449.54
P51530-P1	5" to 8"	\$517.83
P51530-P2	10" and up	\$560.18

See Installation Fittings For Mounting 515 Sensors and 3-8150 Integral Mount Units To Pipe

### G. SIGNET 2551 MAGMETER

The Signet 2551 Magmeter is an insertion style magnetic flow sensor without any moving parts. All versions are constructed of corrosion-resistant materials to provide long-term reliability with minimal maintenance costs. Utilizing the comprehensive line of Signet installation fittings, sensor alignment and insertion depth is automatic. These versatile, simple-to-install sensors deliver repeatable flow measurement over a wide dynamic range in pipe sizes ranging from 0.5 to 12 inches. The 4 to 20mA output can be used for a direct input to PLCs, chart recorders, etc. Price includes Magmeter sensor with local display.



#### Frequency or Digital (S²L) output No Display

with polypropylene and 316L SS Sensor Body. Programmable open collector for use with the 9900 instruments

Cat. No.	Pipe Size	Price
3-2551-P0-11	½" to 4"	\$1,321.51
3-2551-P1-11	5" to 8"	\$1,360.98
3-2551-P2-11	10" to 36"	\$1,889.39

#### 4 to 20mA output No Display-

for use with PLC, PC or similar equipment

Cat. No.	Pipe Size	Price
3-2551-P0-12	½" to 4"	\$1,321.51
3-2551-P1-12	5" to 8"	\$1,360.98
3-2551-P2-12	10" to 36"	\$2,032.80

#### 4 to 20mA output With Display-

for use with PLC, PC or similar equipment

Cat. No.	Pipe Size	Price
3-2551-P0-42	½" to 4"	\$2,079.76
3-2551-P1-42	5" to 8"	\$2,119.43
3-2551-P2-42	10" to 36"	\$2,648.80

## FLOW METERS

### H. 9900 SmartPro® Transmitter

#### Features:

- Large auto-sensing backlit display with at a glance visibility
- "Dial-type" digital bar graph
- Optional field upgradable labels
- Custom 13-character label capabilities for the channel type
- Intuitive and "user-friendly" interface consistent with legacy Signet ProPoint® and ProcessPro® devices



Panel Mount



Field Mount

Cat. No.	Description	Price
3-9900-1P	9900 Panel Mount	\$727.65
3-9900-1	9900 Field Mount	\$727.65

### I. 9950 Dual Channel® Transmitter

#### Features:

- One instrument for multiple sensor types
- Two different sensor types can be combined in one instrument
- Configurable display • Derived measurements
- Optional modules can be added for additional capabilities
- USB Port for Field Upgrades using standard USB Flash Drive



- Two Channel Multi-Parameter Inputs
- Two 4 to 20 mA Output
- Panel Mount

Cat. No.	Power	Price
3-9950-1	DC	\$1,189.65
3-9950-2	AC/DC	\$1,214.68

### INSTALLATION FITTINGS

#### PVC-U Clamp-on Saddles SCH 80

Cat. No.	Size-In.	Price
PV8S020	2	\$217.53
PV8S025	2.5	\$217.53
PV8S030	3	\$253.14
PV8S040	4	\$299.34
PV8S060	6	\$362.86
PV8S080	8	\$446.60

#### Iron Strap-on Saddle (Not shown)

Cat. No.	Size-In.	Price
IR8S100	10	\$772.89
IR8S120	12	\$772.89



PVC-U Clamp-on Saddle

### ACCESSORIES

- #3-8050 Universal Mount Kit for 9900 Transmitter . . . . . \$83.74**
- #7310-1024 24 VDC Power Supply, 0.42 A, 10W . . . . . \$139.56**
- #7310-1024-4X 24 Power Supply in NEMA 4X Enclosure . . . . . \$441.56**

# LEVEL CONTROLLERS SAFETY SWITCHES GAUGES & ACCESSORIES

## WATERMASTER II LEVEL CONTROL SYSTEM

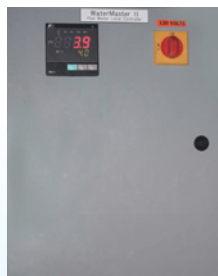

The WaterMaster II is an all-electronic level control system for commercial swimming pool applications. This system solves the level control needs of customers or designers who want to eliminate the need for pneumatic controls in their buildings systems.

The system controls surge tank water level to  $\pm 0.05$  feet of set point. The PLC controller also controls pool skimming action by measuring changes in gutter flow into the surge tank and turning on the fresh water make-up solenoid as needed.

The control package includes a PLC based level controller, either an ultrasonic level sensor or an electronic pressure reducer, a 120 volt hydraulic main drain modulating valve and a 120 volt slow closing fresh water make-up solenoid valve  
**Price on Request**



### B. LEVELOR ELECTRONIC WATER LEVELER

The alternative choice of contractors over mechanical floats. Trouble-free, easy to install and no moving parts. Levolor is a computer-controlled device that automatically detects and replaces a low water condition to a pre-set level. Works well on new and existing pools and spas and also where a consistent liquid level is desired like aquariums, ponds, reservoirs, storage tanks, water cooling towers, etc.

#K1100CKA Levolor Controller (110V) . . . \$750.17

### C. WARRICK AUTOMATIC WATER LEVEL CONTROL

To prevent vacuum filter overflow or to automate your city water make up to the swimming pool. This solid state control is more reliable as well as less expensive, compared to electromechanical units. Electrode fittings are available with either 2" pipe thread or 2" standard pipe flange. Electrodes are type 303 stainless steel.



- #16ML1A1 Warrick solid state level controller . . . . . \$616.83
  - #16ML1A0 Controller relay replacementless housing . . . . . \$463.37
  - #3E2B Electrode fitting threaded for two electrodes . . . . . \$592.88
  - #3E3B Electrode fitting threaded for three electrodes . . . . . \$674.77
  - #3F2E Electrode fitting flanged for two electrodes . . . . . \$755.39
  - #3F3E Electrode fitting flanged for three electrodes . . . . . \$858.79
  - #3R1C0 Electrode rod 1 ft. length . . . \$40.90/ft.
- NOTE: The third character in item no. indicates rod length. Please designate length when ordering and contact us for pricing.

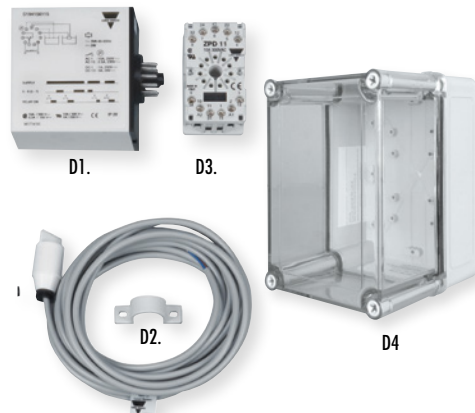

### D. CARLO GAVAZZI LEVEL SENSOR AMPLIFIER, CONDUCTIVE TYPE

Level control relay for conductive liquids for swimming pool applications. The relay operates approximately 10 seconds after the sensor is no longer immersed in the water. A complete system consists of all components listed below

- D1. #S194-156-115 Amplifier . . . . . \$357.32
- D2. #A94-10 Sensor . . . . . \$181.58
- D3. #ZPD11 11-Pole Socket . . . . . \$27.79
- D4. #VM755CT Enclosure for Gavazzi Controller \$113.99

## SWITCHES & VALVES

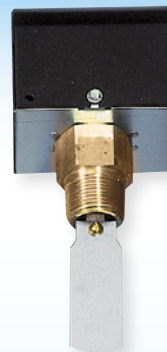

### E. MCDONNELL MILLER FLOW SWITCH

The FS250 Series flow switch with a 5 year warranty offers an economical and positive way to start or stop almost anything electrically operated. Actuate a signal light, sound an alarm, start or stop a motor, use wherever it is important to know when flow or no-flow occurs.

#FS251 . . . . . \$261.38

## POOL SENTRY



### AUTOMATIC POOL WATER LEVEL MONITOR

Pool Sentry takes the worry out of maintaining a constant water level. As any responsible pool owner knows pools lose water for a variety of reasons. Evaporation from the sun and wind, loss from playful splashing, the water gets carried out with emerging swimmers, and even minor leaks in the pool itself. The Pool Sentry works to keep water levels stable around the clock.

Works with above ground or in-ground pools!  
#M-3000 Pool Sentry. . . . . \$90.87

**833 SWIM 327**  
833-7946-327  
www.halogensupply.com

## GAUGES & ACCESSORIES

### G. EQUIPMENT GAUGES

Pressure • Vacuum • Compound 1/4" NPT, bottom mount.

- 2" Diameter, polypropylene case
- #1354 Vacuum 0-30 Hg . . . . . \$10.40
- #1354-30 Pressure 0-30 p.s.i. . . . . \$10.20
- #1354-60 Pressure 0-60 p.s.i. . . . . \$10.20
- #1354-60B Pressure 0-60 p.s.i. 1/4" Backmount Connection . . . . . \$10.20
- 2" Diameter, steel case
- #1355-30 Pressure 0-30 p.s.i. . . . . \$10.55
- #1355-60 Pressure 0-60 p.s.i. . . . . \$10.55
- #1355-60B Pressure 0-60 p.s.i. 1/4" Backmount Connection . . . . . \$10.55

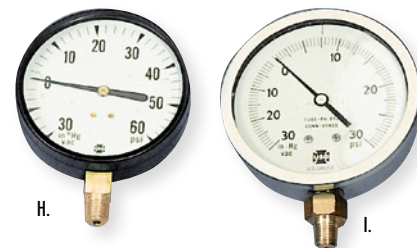

### H. 3/2" diameter - steel case

- #1356-30 Pressure 0-30 p.s.i. . . . . \$28.35
- #1356-60 Pressure 0-60 p.s.i. . . . . \$28.35
- #1356-100 Pressure 0-100 p.s.i. . . . . \$28.35
- #1357 Vacuum 0-30 Hg . . . . . \$28.35
- #1358 Compound 30 Hg-0-60 p.s.i. . . . . \$28.35

### I. Liquid filled gauges 4" diameter - stainless steel case

- #1364 Vacuum 0-30 Hg . . . . . \$82.74
- #1365 Compound 30 Hg-0-60 p.s.i. . . . . \$82.74
- #1366-30 Pressure 0-30 p.s.i. . . . . \$80.43
- #1366-60 Pressure 0-60 p.s.i. . . . . \$80.43
- #1366-100 Pressure 0-100 p.s.i. . . . . \$80.43

### Liquid filled gauges 2.5" diameter - stainless steel case 1/4" NPT

- #9767053 60 p.s.i. . . . . \$27.06
- #9767002 30" vacuum . . . . . \$30.84
- #9767029 Compound 30" 0-60 p.s.i. . . . . \$31.98



### Accessories

- J. Pressure snubber to protect gauges from pulsation and shock. 1/4" NPT x 1/4" FPT brass construction. #1367 . . . . . \$20.69
- K. Tee handle gauge cock. 1/4" NPT x 1/4" FPT brass construction. #1362 . . . . . \$18.14

## BASKET STRAINERS

### FLUIDTROL SW SERIES STAINLESS STEEL STRAINERS

Welded from schedule 10 type 304 stainless steel with perforated stainless steel baskets, stainless steel tee handles to secure the clear acrylic lid and loose flange rings to help ease installation.



Complete Strainer w/Basket			Replacement Baskets		
Cat. No.	Pipe Size	Price	Cat. No.	Pipe Size	Price
1440	3"	\$2,717.80	1448	3"	\$531.56
1441	4"	\$2,923.48	1449	4"	\$551.25
1442	6"	\$4,186.88	1450	6"	\$702.19
1443	8"	\$5,288.69	1451	8"	\$813.75
1444	10"	\$6,317.05	1452	10"	\$1,010.63
1445	12"	\$7,639.22	1453	12"	\$1,226.52

### TITAN CAST IRON IN-LINE BASKET STRAINERS

Heavy duty hair and lint strainers for use on commercial pool filtration systems. Heavy cast iron, quick opening cover, and stainless steel basket with 1/8" perforations designed for minimum pressure drop. 125 lb. flanged connections only. Prices are F.O.B. Chicago, IL.



Strainers				Replacement Baskets		
Cat. No.	Line Size	Shipping Weight	Price	Cat. No.	Line Size	Price
1301	2"	27 lbs.	\$338.47	1314	2"	\$113.40
1302	2 1/2"	51 lbs.	\$348.16	1315	2 1/2"	\$179.55
1303	3"	58 lbs.	\$386.91	1316	3"	\$228.90
1304	4"	88 lbs.	\$540.10	1317	4"	\$290.85
1305	5"	174 lbs.	\$726.60	1318	5"	\$387.45
1306	6"	195 lbs.	\$950.02	1319	6"	\$481.95
1307	8"	215 lbs.	\$1,536.15	1320	8"	\$801.15
1308	10"	425 lbs.	\$2,822.84	1321	10"	\$1,151.85
1309	12"	650 lbs.	\$4,758.02	1322	12"	\$1,508.85

## BASKET STRAINERS

### FRP "T" STYLE BASKET STRAINERS by Mermade Engineered For Commercial Systems

Strainer Housings are fiberglass reinforced plastic construction. FRP and stainless steel components assure that wetted parts will not rust. Features include: quick opening latches, see thru lid, and a stainless steel basket. Flanged connections are drilled to ANSI 150 lb. standard. Strainers are pressure tested to 50 PSI.



FRP Strainers				S.S. Replacement Baskets		
Cat. No.	Line Size	Shipping Weight	Price	Cat. No.	Line Size	Price
1340	3"	32	\$2,094.14	1346	3"	\$524.39
1341	4"	34	\$2,094.14	1347	4"	\$524.39
1342	6"	44	\$2,694.74	1348	6"	\$626.76
1343	8"	70	\$3,444.35	1349	8"	\$849.71
1344	10"	98	\$4,433.98	1350	10"	\$1,155.70
1345	12"	115	\$5,572.61	1351	12"	\$1,410.50

### Also Available As A Reducing Strainer

The outlet size can be sized smaller than the inlet to allow direct reduction to pump suction connection.

Call Toll Free For Pricing

## SERVICE CLAMPS

**SERVICE CLAMPS** Provide quick and easy installation of flow meters, sensors and chlorinator injection fittings. Please specify tap size required: 1/2", 3/4", 1", 1 1/4", 1 1/2" or 2".



PVC CLAMPS			
Cat. No.	Size	Material	Price
671	2"	PVC	\$52.26
673	2 1/2"	PVC	\$70.26
675	3"	PVC	\$70.26
677	4"	PVC	\$88.46
681	6"	PVC	\$127.89
683	8"	PVC	\$237.14
685	10"	PVC	\$364.09

All PVC clamps come with zinc plated hardware and EPDM seals

## THERMOMETERS & SIGHT GLASSES

### A. INDUSTRIAL THERMOMETER

9" adjustable angle industrial thermometer. 0°-160° range with 4" bottom stem for installation in 3/4" NPT separable brass well. #SX93575 Thermometer only. . . . \$122.64 #W35B Brass well only . . . . . \$31.08 Other scale ranges available upon request.



### B. POOL HEATER THERMOMETER

#1416 Pool heater thermometer, 1/2" N.P.T. Bottom connection. Range 40°F to 280°F . . . . . \$30.45 #1416-1 Same as 1416, but with lower back connection. (Not shown). . . . . \$24.36



### C. LETRO THERMOMETER

Reads 30°F to 130°F and 0°C to 55°C. Easy read 3" dial. 1/2" N.P.T. Nylon well. #SL-1 DW Thermometer with well . . \$74.55 #SWN Well only . . . . . \$20.46



### D. SIGHT GLASSES

Constructed of non-breakable clear plastic with brass bodies and deflecting vane to force water through sight chamber. #1398 1 1/2" M.I.P. . . . . \$255.12



### E. IN-LINE SIGHT GLASSES

With ABS plastic bodies. #SP1072S 1 1/2" SKT . . . . . \$41.35 #SP1074S 2" SKT . . . . . \$42.23



## BASKET STRAINERS PUMP CONNECTORS THERMOMETERS SIGHT GLASSES & SERVICE CLAMPS

## PUMP CONNECTORS

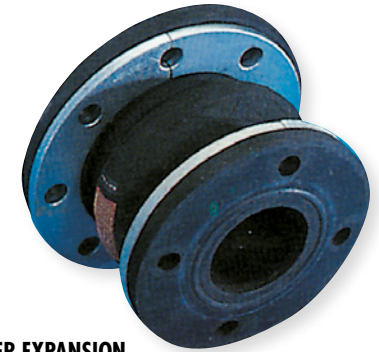

## RUBBER EXPANSION JOINTS/REDUCERS

Constructed of neoprene and a high strength synthetic fabric to reinforce the body. These connectors reduce the force exerted on pipe lines and equipment, as well as control pulsation shocks and noise transmission. These joints can be used to connect pipes of the same size, as a concentric reducer for pipes of varying size that share a common centerline or eccentric reducers for pipes of unequal sizes with offset axes.

Expansion Joints				Concentric Reducers			
Cat. No.	Size	Shipping Weight	Price	Cat. No.	Size	Shipping Weight	Price
1425	3"	14 lbs.	\$159.28	1431	4" x 3"	18 lbs.	P.O.A.
1426	4"	18 lbs.	\$208.14	1432	6" x 3"	19 lbs.	P.O.A.
1427	6"	28 lbs.	\$318.54	1433	6" x 4"	20 lbs.	P.O.A.
1428	8"	40 lbs.	\$459.66	1435	8" x 6"	33 lbs.	P.O.A.
1429	10"	68 lbs.	\$696.74				
1430	12"	94 lbs.	\$886.76				

Prices for eccentric reducers and sizes not listed available upon request. Prices are F.O.B. Chicago, IL

**833-SWIM-327**  
833-7946-327  
www.halogensupply.com

## \*PULSAR SYSTEMS

With the Pulsar® System chlorinator remarkable water clarity color and sparkle are as easy to achieve as they are to enjoy. The Pulsar System reduces the hazards of chlorine gas and liquid bleach, protects plaster and equipment and reduces chloramine odors dramatically. The Pulsar feeder chlorinates, removes organics and metals, boosts hardness and shock treats, all in one simple process. Pool water that's balanced using the Pulsar System is clean and clear with less hassle, leading to longer pool and equipment life.



### B. PULSAR I

For use on pools/spas from 500 to 50,000 gals. Capacity (weight of pellets): **27 lbs.** Feed-rate range (AvCl/day) (Minimum): **0.5 lbs.** (Maximum): **25 lbs.**

#79803 Pulsar I Chlorinator P.O.A.

## High-Tech Commercial Pool Disinfection with Powerful Performance

### A. PULSAR PRECISION

The Pulsar® Precision feeder is a high capacity erosion (HCE) feeder that is compact and lightweight with a modular design. This innovative feeder system is easy to maintain and service with a flexible design that allows for easy integration for small to large commercial pools.



- Won't overstabilize pool
- More concentrated than liquid bleach
- Dry, easy to handle formulation
- Will not cause reduction of ORP
- Highly concentrated to reduce shipping and handling costs
- Longer shelf life compared to liquid bleach

#73250 Pulsar Precision Feeder Complete P.O.A.

#73280 Pulsar Precision Feeder Only P.O.A.

#### Feeder Specifications

Width	25.3"	642.62mm
Depth	29.8"	756.92mm
Height	40.9"	1038.89mm
Water Inlet Size	1/2" MNPT	12mm MNPT
Solution Outlet Size	1/2" MNPT	12mm MNPT
Operating Weight	220lbs	99.7kg
Shipping Weight	60lbs	27.7kg
Dry Chemical Capacity	70lbs	31.75kg
Feed Rate Range	5-192lbs/day AvCl 0.2-8lbs/hour AvCl	2.3-87.3kg/day AvCl 0.09-3.6kg/hour AvCl
Electrical	115VAC	
Operating Temperature	40°- 120° F	4.4°- 48.9° C

### C. PULSAR INFINITY

The Pulsar® Infinity system is an innovative approach to commercial pool chlorination. The patent-pending, slow dissolving tablets work with our easy to use Pulsar® Infinity feeder, an automatic solution that meets the needs of the modern pool facility. The Pulsar® Infinity system is a 3-in-1 product that chlorinates, increases calcium and boosts alkalinity. With the simplicity of an erosion feeder, the Pulsar® Infinity feeder's streamlined design is easy to install, service and requires minimal operator attention. Capacity (weight of tablets): **6.4 lbs.** Feed-rate NSF Listed @7lbs/day for pool applications and **5.5 lbs/day** for spa applications



#74444 Pulsar Infinity Feeder P.O.A.

#30056 Pulsar Infinity Tablets 25 lb pail P.O.A.

#30480 Pulsar Cleaner Solution 1 qt. (not shown) \$14.36

SEE PAGE 70 FOR PULSAR BRIQUETTES AND PAGE 58 FOR PULSAR FEEDER PARTS

\*NOTE: ILLINOIS, NORTHERN INDIANA AND WESTERN MICHIGAN CUSTOMERS ONLY.

## STENNER CHEMICAL FEEDERS



D. Stenner Peristaltic Chemical Feeders are made of tough high strength polycarbonate plastic that is resistant to the most corrosive chemicals. Patented mechanical control allows precise controlled output and is self-priming. Comes complete with spare tube assembly, injection fitting and 20 feet of 3/8" tubing (1/4" tubing and fittings available upon request). Stenner maintains ETL (conforms to NSF STD-50), UL and CSA listing. Other models available upon request.

### SINGLE HEAD-ADJUSTABLE FEED RATE

Model 45MJL5A3S 50 gpd @ 25 psi . . . \$680.47

Model 85MJL5A3S 85 gpd @ 25 psi . . . \$680.47

### SINGLE HEAD-FIXED RATE

Model 45MFL5A3S 50 gpd @ 25 psi . . . \$499.68

Model 85MFL5A3S 85 gpd @ 25 . . . \$499.68

### HIGH PRESSURE PERISTALTIC PUMPS

Reliable operation against pressures up to 100 psi.

#### SINGLE HEAD-ADJUSTABLE FEED RATE

Model 45MJH7A3S 22 gpd @ 100 psi . \$705.24

Model 85MJH7A3S 40 gpd @ 100 psi . \$705.24

#### SINGLE HEAD-FIXED RATE

Model 45MFH7A3S 22 gpd @ 100 psi . \$524.70

Model 85MFH7A3S 40 gpd @ 100 psi . \$524.70



### E. DOUBLE HEAD-ADJUSTABLE FEED RATE

Model 100JL5A3S

100 gpd @ 25 psi dual head . . . . . \$965.27

Model 170JL5A3S

170 gpd @ 25 psi dual head . . . . . \$965.27

### DOUBLE HEAD-FIXED FEED RATE

Model 100FL5A3S

100 gpd @ 25 psi dual head . . . . . \$739.44

Model 170FL5A3S

170 gpd @ 25 psi dual head . . . . . \$739.44

See page 58 for Stenner parts

## STENNER TANK SYSTEMS



### F. PUMP AND TANK SYSTEM IN ONE!

- Increase savings and convenience pre-assembled for easy start-up.
- Rugged polyethylene construction for indoor or outdoor applications.
- Compact and light-weight design to minimize space requirements.
- Attractive styling for convenient access and placement.
- Includes rainroof.
- Available as tank only.
- Dimensions:

15 gallon: 25 1/4" H x 20 1/2" OD  
30 gallon: 37 1/2" H x 20 1/2" OD

Model S1N45MJL1A3S

3 gpd @ 25 psi w/15 gallon tank . . . . . \$922.75

Model S1N85MJL1A3S

5 gpd @ 25 psi w/15 gallon tank . . . . . \$922.75

Model S1N45MJL2A3S

10 gpd @ 25 psi w/15 gallon tank . . . . . \$922.75

Model S3N85MJL2A3S

17 gpd @ 25 psi w/30 gallon tank . . . . . \$1,071.54

Model S3N45MJL3A3S

22 gpd @ 25 psi w/30 gallon tank . . . . . \$1,071.54

Other models available upon request.

### TANKS ONLY

Model STS15NC 15 gallon. . . . . \$279.47

Model STS30NC 30 gallon. . . . . \$428.27

**833-SWIM-327**  
8 3 3 · 7 9 4 6 · 3 2 7  
[www.halogensupply.com](http://www.halogensupply.com)



## BLUE/WHITE FLEXFLO PERISTALTIC METERING PUMPS



### FEATURES:

- Peristaltic pump design does not have valves that can clog requiring maintenance.
- Self priming even against maximum line pressure. By pass valves not required. Cannot vapor lock or lose prime.
- Outputs pressures to 100 psi. • Base or rear panel mount.

### MODEL A-100NA FIXED SPEED - DIAL KNOB CONTROL

- Easy to use dial knob output control. • 20:1 turndown ratio.
- Adjustable 60 second repeating interval timer. 3-60 second adjustable on time per 60 second cycle. • Built-in Tube Failure Detection system (TFD). Senses chemical in the pump head, shuts off the pump and activates an NPN open collector output. • Compatible with Blue/White's output flow verification sensor system.

Model No.	Output GPD	PSI	RPM's	Pump Tube	Price
ATN00A-4T-1	2.3	100	14	1/4"	\$684.30
ATN10A-6T-1	16	100	30	3/8"	\$667.78
ATN30A-6T-1	30	75	60	3/8"	\$667.78
ATN10A-7T-1	52.5	50	30	7/16"	\$667.78
ATN30A-7T-1	95.1	50	60	7/16"	\$667.78

## NEW BLUE/WHITE PRO SERIES FLEXFLO A1A PERISTALTIC METERING PUMP



Specially designed for pools, Spas and Water Parks. Feed rates from .01 to 100 GPD Pressures to 40 PSI Tube Failure Detection (TFD) system Variable speed brushless DC motor 3-year warranty

- Peristaltic pump design does not have valves that can clog requiring maintenance.
- Self priming - even against maximum line pressure. Bypass valves are not required. Cannot vapor lock or lose prime.
- Outputs rates from .01 to 100 GPD (.01 to 15.8 LPH) and pressures up to 40 PSI (2.76 Bar).
- Energy efficient variable speed DC motor. to save money over VS. the competition
- Patented Tube Failure Detection (TFD) system. Senses tube failure by detecting chemical in the pump head, shuts off the pump and activates a 48VDC @80mA relay, No false triggering.
- Remote Start/Stop: Non-powered dry contact for remote start/stop.
- Three Nylon molded squeeze rollers for optimum squeeze, unparalleled accuracy, and long tube life.
- Heavy duty rotor - single piece plastic rotor means no flexing and increased accuracy with no metal springs or hinges to corrode.
- Chemically resistant tubing capable of pumping bleach (sodium hypochlorite), calcium hypochlorite 20%, and muriatic acid (hydrochloric acid).

Model.	Voltage*	Price
A1A4-7T	115 VAC	\$668.48

## CHLORINE & BROMINE EROSION FEEDERS

### HAYWARD SMALL RESIDENTIAL CHLORINATOR

**Easy-Lok Assembly** has thread assist mechanism to provide dependable sealing. **Chlorine Chamber** has extra large capacity CL-100 series holds 4.2 Lbs of Tri-Chlor tabs, CL-200 series holds 9 lbs. **Dual Regulating Valve** is easy to use and lets you control and adjust rate of feed.

- #CL100 In-Line 4.2 lb. capacity. \$111.59
- #CL200 In-Line 9 lb. capacity. \$143.33
- #CL110 Off-Line 4.2 lb. capacity \$125.87
- #CL220 Off-Line 9 lb. capacity. \$184.21



### RAINBOW IN-LINE FEEDER

Model 320 works the same way as Model 300 but is an in-line feeder. Comes complete for 2" standard PVC with pipe adapter for 1 1/2" pipe. Holds approximately 11-3" tablets or 98 small tablets. NSF listed. Treats 6,500 to 70,000 gallons

- #R171096 . . . . . \$145.61



### RAINBOW HIGH CAPACITY CHLORINE/BROMINE FEEDERS

These professional high capacity feeders are designed to sanitize large residential or commercial swimming pools using either Chlorine or Bromine tablets or sticks. For off-line 1" hard plumbing installations.



- #R171215-Model HC3315  
15 lb. capacity. Can treat up to 97,600 gals. with Chlorine (Tri-Chlor) and 20,200 gals with Bromine . . \$329.29
- #R171230-Model HC3330-30 lb. capacity.  
Can treat up to 160,000 gals. with Chlorine (Tri-Chlor) and 40,900 gals with Bromine . . . . . \$358.47
- #R171240-Model HC3340-40 lb. capacity can treat up to 332,000 gals. with Chlorine (Tri-Chlor) and 61,600 with Bromine . . . . . \$375.52

See page 58 for Erosion Feeder parts

### PENTAIR RAINBOW FEEDER

Model 300 works on pressure side of pump where chlorine is discharged in return line down-stream from equipment. For use with Bromine or Trichlor slow dissolving tablets. Comes complete with easy to adjust control valve and check valve. Holds approximately 11-3" tablets or 98 small tablets. NSF listed.

- #R171070 Treats 80,000 to 322,000 gallons . . . . . \$216.24
  - #R171016 Treats 12,000 to 48,000 gallons . . . . . \$131.54
- Holds approximately 237-1" tablets or 29-3" tablets. NSF listed. (Not shown).



## STORAGE TANKS

### POLYETHYLENE TANKS

Used for storage of liquid or granular chlorine, soda ash or sodium bisulfate solutions.

- #8613 30 gal. - tank only \$366.51
- #8614 55 gal. - tank only \$425.31
- #8625 Cover only for 55 or 30 gal. tank . . . . \$139.10
- #113 100 gallon polyethylene tank with cover . . . . \$1,000.16

### F.O.B Factory

Note: Other tank sizes available upon request.

**833 SWIM 327**  
8 3 3 - 7 9 4 6 - 3 2 7  
[www.halogensupply.com](http://www.halogensupply.com)

## CHEMICAL FEEDERS

## ELECTRONIC METERING PUMPS



### PUMPS By LMI

The safest and most versatile solid state electronic metering pump made. Feed corrosive acids or caustics with confidence. Comes complete with suction, discharge, foot, injection check 4-way anti-syphon/priming valves and tubing. Call for pricing on models not listed here.

- #AD251-930SI 24 gpd/110 psi. \$1,244.25
- #AD261-940SI 48 gpd/50 psi. \$1,285.20
- #B121-490SI 60 gpd/100 psi. \$1,499.40

See page 59 for LMI parts



### ELECTRONIC PUMPS By Pulsatron

The Pulsatron chemical feed pump comes complete with Teflon faced reinforced diaphragms, dual control versatility, safety circuit protection and water resistant cover. Comes complete with all necessary valves and tubing including Pulsatron's exclusive 5-function anti-syphon valve.

- #LPA3SAPTC1-500 12 gpd/100 psi. \$847.00
- #LPB4SAPTC1-500 24 gpd/100 psi. \$929.78
- #LPE4SAPTC3-500 44 gpd/100 psi. \$1,111.69
- #LPH6SAPTC3-500 120 gpd/100 psi \$1,487.06

See page 59 for Pulsatron parts

# AUTOMATIC CHEMICAL CONTROLLERS AND REPLACEMENT PROBES & OZONE GENERATORS

## AQUASOL CONTROLLERS



**A. THE AQUASOL LINE OF WATER CONTROLLERS** automatically maintains both the chlorine/bromine residual (using ORP technology) and pH in your pool or spa, continuously providing sanitary, clear water while eliminating tedious, manual water testing and treatment. Aquasol eliminates the problems associated with water chemistry control. By paying for themselves through chemical savings and reduced labor costs, the Aquasol controllers are an essential item to the operating budget of any commercial pool/spa operator.

### Advantages and Features:

- Saves on chemicals – up to 40%
- Saves on labor of testing and correcting
- Eliminates odor and eye burn complaints
- Functional lifetime warranty on the circuit board
- Indicator lights show feed and alert status
- Overfeed safety timer
- **Most importantly, Aquasols are serviceable by your staff saving you hundreds, even thousands of dollars in service fees charged by other controller companies.**

- Available in three models.
- A. #SPC Model SPC, basic controller . . . . . \$1,968.75
  - B. #WTC Model WTC – Features digital meters for both ORP and pH display . . . . . \$2,283.75
  - #M011-HP Safety Pressure Switch—Is recommended to interlock controller with system flow (not shown) . . . . . \$320.63

Controller Probes and Parts See Page 60

**833-SWIM-327**  
833-7946-327  
www.halogensupply.com

## HALOGEN CONTROLLERS



- Benefits include:
- Ease of Use
  - Total System Control
  - Mobile Connectivity
  - Training Built In
  - Alarm Logging and Trend Reports
  - Maximize Resource Savings - Minimize Operating Costs

**All-Encompassing Control of Regenerative Systems:**  
It's More Than a Filter, **It's a Science.**  
**HALO**Gen.RTS (Regenerative Total System)  
**HALO**Gen.CS (Custom System)



### Ease of Use

- Large 15 1/2" color touch screen with sound, graphics and video
- Intuitive user interface and experience
- Graphically displayed system status shown on one screen
- Flexibility with auto or manual modes
- User-friendly set-point entry
- Accessible from tablets, mobile devices and PCs

### Total System Control

- Filter cycle control
- Flow control with VFD
- Chemical control
- Temperature control
- Level control with automatic fresh water makeup
- Cleaning modes
- All safety interlocks
- Customized solutions tailored to your facility
- HALO** Gen.RTS (Regenerative Filter System) and **HALO** Gen.CS (Custom System)

### Training Built In

- Training videos with audio for all procedures
- Imbedded manuals and data sheets specific to system design

### Alarm Logging and Trend Reports

- Real-time trending reports for all control loops
- Trending histories stored
- Easy-to read graphical displays of real-time trends and histories
- Audible alarms to alert staff
- Alarm emails immediately sent to staff

### Maximize Resource Savings - Minimize Operating Costs

- Complete integration of all system controls maximizes resources and ease of use
- System component synergy contributes to the longevity, performance and efficiency of a pool system.

Price on Request

## CLEARWATER TECH OZONE GENERATORS

Ozone is a powerful oxidizer. It has been used in waste water treatment, aquariums and large volume water stores, as well as swimming pool and spa applications. Since 1986 ClearWater Tech (CWT) has designed, engineered, and manufactured ozone generation equipment for many applications such as bottled water, potable water, commercial laundry, and pool and spa systems. CWT's ozone systems provide not only oxidation, but also sanitation, reducing chloramine production and provide **The Ultimate Swimming Experience!** Allow Halogen to help with your ozone water treatment needs.



CELEBRATING  
**30**  
YEARS  
OF OZONE TECHNOLOGY

Call For A Quotation

## FLOAT VALVES FLUIDTROL MODULATING FLOAT VALVES

Designed to mount up to standard companion flanges. Valves have polypropylene disc, stainless steel shaft and float rods and polyethylene floats. Provides full flow when open and 80% shut-off when closed. Comes in five sizes and three styles for vertical or horizontal installation.



Size	Horizontal		Horizontal w/ Vertical Floats	
	Cat. No.	Price	Cat. No.	Price
4"	1252	\$1,323.00	1257	\$2,181.90
6"	1253	\$1,449.00	1258	\$2,337.30
8"	1254	\$1,776.60	1259	\$2,602.95
10"	1255	\$3,587.50	1260	\$2,730.00
12"	1256	\$4,036.25	1261	\$3,076.50

F.O.B. Huntsville, AL

## PVC VAN STONE PIPE FLANGES



Cat. No.	Pipe Size	Price
PF2	2"	\$9.25
PF2.5	2-1/2"	\$15.19
PF3	3"	\$15.28
PF4	4"	\$20.45
PF6	6"	\$32.99
PF8	8"	\$53.33
PF10	10"	\$71.28
PF12	12"	\$84.56

## VALVE BOLT KITS

Cat. No.	Size	Price	Cat. No.	Size	Price
BBK2WW	2"	\$19.31	BBK8WW	8"	\$58.39
BBK2½/3WW	2½" & 3"	\$19.44	BBK10WW	10"	\$166.10
BBK4WW	4"	\$36.14	BBK12WW	12"	\$179.93
BBK6WW	6"	\$55.06			

## FLANGE GASKETS

Cat. No.	Size	Price	Cat. No.	Size	Price
GSK2R	2"	\$9.99	GSK6R	6"	\$15.03
GSK2½R	2½"	\$19.44	GSK8R	8"	\$20.66
GSK3R	3"	\$13.97	GSK10R	10"	\$27.50
GSK4R	4"	\$14.24	GSK12R	12"	\$44.66

## CHECK VALVES



### A. SPEARS PVC CHECK VALVES

Unique resilient seal provides an airtight shut off and prolonged life compared to metal seated valves. Large free area resulting in low pressure loss. Flanged and wafer styles for 2" to 12" line sizes.

Flanged			Wafer		
Size	Cat. No.	Price	Size	Cat. No.	Price
2"	1280	\$584.69	2"	1272	\$627.04
2½"	1281	\$761.01	2½"	1273	\$864.13
3"	1290	\$1,093.05	3"	1274	\$1,105.34
4"	1291	\$1,419.18	4"	1275	\$1,503.23
6"	1292	\$2,300.66	6"	1276	\$2,278.99
8"	1293	\$3,296.70	8"	1277	\$3,866.61
10"	1299	\$6,070.44	10"	1278	\$7,109.66
12"	1300	\$8,600.24	12"	1279	\$10,024.53



### B. TITAN SILENT CHECK VALVES

Bronze to bronze seating with special stainless steel spring control to insure positive, noiseless opening and closing. These valves are applicable to all water systems, work in any position and are designed with larger-than-pipe-size flow area for low pressure loss and maximum efficiency.

Cat. No.	Size	Shipping Weight	Price
1285	3"	11 lbs.	\$246.07
1286	4"	18 lbs.	\$407.47
1287	6"	29 lbs.	\$887.04
1288	8"	86 lbs.	\$1,893.62
1289	10"	129 lbs.	\$3,275.58

Pricing for valve sizes not shown available upon request. Prices are F.O.B. Chicago, IL

## BUTTERFLY VALVES



### C. CAST IRON BUTTERFLY VALVES by Bray

Bray series 30-119 is a wafer style with polyester coated cast iron body, nylon II coated ductile iron disc, 416SS stem, EPDM seat and 10-position lever operator. Stainless steel disc available. Call for quotation.

Cat. No.	Size	Price	Cat. No.	Size	Price
1390	2"	\$158.76	1395	6"	\$363.83
1391	2½"	\$174.20	1396	8"	\$509.36
1392	3"	\$185.22	1397	10"	\$679.14
1393	4"	\$222.71			

F.O.B. Chicago



### D. PVC BUTTERFLY VALVES

Features PVC body and disc for better chemical and abrasion resistance, lever operator and EPDM seal for bubble tight shut-off.

Flange gaskets not required.

Cat. No.	Size	Price	Cat. No.	Size	Price
1226	2"	\$104.60	1230	6"	\$324.90
1227	3"	\$173.75	1231	8"	\$478.53
1228	4"	\$198.00			

F.O.B. Chicago

### E. MODULATING FLOAT CONTROL VALVE by Clayton

The Float Control acts to maintain a constant level in the filter or surge tank, automatically, by causing the main valve to open or close in proportion to the volume of water being withdrawn.

#1418 ½" SS and Bronze construction . . .	\$1,598.94
#BFVNL ¾" Brass float valve . . . . .	\$63.79
#BFVFP8 8" Float . . . . .	\$24.08
#BFVR12 12" Rod . . . . .	\$5.42



## SOLENOID VALVES

### F. GRANZOW SOLENOID VALVES

An economical solenoid valve alternative for air and water applications. 2-way, internally piloted, normally closed solenoid valve. Brass body, stainless steel armature, plunger spring and fixed core. Nema 4 electrical connection rating. Available in standard and slow close models. Slow closed models have manual flow control and bypass knob. All valves are 115 Vac normally closed, 230 and 24 volt models available upon request.



Size	Standard No.	Price	Slow Closing No.	Cat. Price
1/2"	W4B19-000	\$203.50		
3/4"	W5B19-000	\$306.25	W5B19-000-02	\$348.80
1"	W6B19-000	\$334.68	W6B19-000-02	\$377.18
1-1/4"	W7B19-000	\$644.63	W7B19-000-02	\$687.08
1-1/2"	W8B19-000	\$681.13	W8B19-000-02	\$723.73
2"	W9B19-000	\$925.10		

### G. PVC SOLENOID VALVES

TFV series solenoid valves are made from glass reinforced nylon with natural rubber diaphragm. Quarter turn bleed lever allows manual operation without spills. Exact water flow adjustment with flow control units. In-line maintenance - no need to remove from line. Available with 24 or 110 volt solenoid



Size	Voltage	Flow Control	Cat. No.	Price
1"	24	No	TFV100T	\$97.47
1"	110	No	TFV100T110V	\$106.36
1"	24	Yes	TFV100TF	\$105.57
1"	110	Yes	TFV100TF110V	\$114.48
1-1/2"	24	Yes	TFV150TF	\$191.93
1-1/2"	110	No	TFV150TF110V	\$200.52
2"	24	Yes	TFV200TF	\$248.09
2"	110	No	TFV2001TF10V	\$257.13

### H. ELECTRIC SOLENOID VALVES Normally closed, Nema-1 Enclosure by ASCO

Locate on chlorine booster pump discharge line for true safety. When main recirculation pump shuts down no water will be allowed to the chlorine ejector. Operate with chemical controller to automate erosion chemical feeders. Also used on fresh water make-up lines in conjunction with water level control.



Size	Standard No.	Price	Slow Closing No.	Cat. Price
1/2"	8210G002	\$187.30	8221G003	\$405.60
3/4"	8210G095	\$231.77	8221G005	\$433.90
1"	8210G004	\$321.91	8221G007	\$885.31
1-1/4"	8210G008	\$452.76	8221G009	\$1,056.44
1-1/2"	8210G022	\$688.57	8221G011	\$1,532.11
2"	8210G100	\$1,214.10	8221G013	\$1,852.81

All valves are 1 phase, 115 volt. 230 and 24 volt units available upon request.

## COMMERCIAL VALVES

## MODULATING VALVES



Modulating butterfly valves can be used on vacuum filters, gutter lines and surge tank applications.

### I. ROTARY ACTUATED BUTTERFLY VALVES by Bray

Bray Series 30 valve operated by their series 90 spring to close pneumatic rotary actuator complete with VRC pneumatic positioner, adjustable pressure regulating valve and pressure gauge. Please specify if valve is to be normally open or closed.

Cat. No.	Size	Price	Cat. No.	Size	Price
1483	3"	P.O.A.	1486	8"	P.O.A.
1484	4"	P.O.A.	1487	10"	P.O.A.
1485	6"	P.O.A.	1488	12"	P.O.A.

**NOTE:** If an electro-pneumatic positioner is required in lieu of pneumatic positioner add "-6A" to model numbers above.

Pricing Available Upon Request.

### J. DIAPHRAGM OPERATED BUTTERFLY VALVES by Dezurik

Model 632 with diaphragm actuator will utilize water or air pressure to actuate the diaphragm operator and will provide bubble tight shutoff. Comes complete with cast iron body, lugged end style stainless steel disc, and shaft. Please specify normally open or normally closed.

Pricing Available Upon Request.

**833-SWIM-327**  
833-7946-327  
www.halogensupply.com

# CHEMICAL FEEDER PARTS

## PULSAR FEEDER PARTS

- A. **OLIN-79217** Discharge valve assembly complete \$106.43
- B. **OLIN-79804** Discharge valve, arm & float only \$43.81
- C. **OLIN-79218** Check valve for discharge valve \$53.46
- C1 **OLIN-79805** Discharge valve arm \$29.70
- C2 **OLIN-79806** Discharge valve body \$27.23
- C3 **OLIN-79810** Discharge valve float \$25.49
- D. **OLIN-71583** Discharge valve locknut \$16.83
- E. **OLIN-71538** PVC nut, discharge valve arm \$5.45
- F. **OLIN-71576** Discharge valve gasket \$7.92
- G. **OLIN-71496** Emergency shut-off valve complete \$255.92
- H. **OLIN-71535** Emergency shut-off valve w arm only \$127.96
- I. **OLIN-71536** Emergency shut-off valve mounting plate \$13.61
- J. **OLIN-71537** Emergency shut-off mounting screws for PI & PIII \$19.06
- OLIN-71749** Emergency shut-off mounting screws for PIV \$66.03
- K. **OLIN-71539** Emergency shut-off float plate \$9.90
- L. **OLIN-71540** Emergency shut-off overflow float \$21.78
- M. **OLIN-71811** Venturi assembly for PIII & PIV \$347.99
- OLIN-71974** Venturi assembly for PI \$107.15
- N. **OLIN-71894** 24 volt solenoid valve for PIII & PIV \$397.98
- OLIN-79664** Solenoid valve for models 45, 140 and 500 (not shown) \$420.753
- O. **OLIN-71923** 24 volt transformer \$75.74
- P. **OLIN-72329** 24 volt cable 15 feet \$160.38
- Q. **OLIN-79214** 1 H.P. booster pump for PIII & PIV \$1,567.80
- R. **OLIN-79047** PIII spray manifold \$161.33
- S. **OLIN-71617** PIII spray nozzle \$76.97
- T. **OLIN-71605** In-line strainer for PIV \$126.47
- OLIN-79812** In-line strainer for models 45, 140 and 500 (not shown) \$14.85
- OLIN-71592** Strainer housing for PIV \$96.77
- OLIN-71593** Strainer gasket for PIV \$12.38
- OLIN-71594** Replacement strainer screen for PIV NLA
- U. **OLIN-71928** Flow indicator PIV \$272.25  
(Limited Quantities Available)
- V. **OLIN-72864** Enhancement kit for PIII units w/o washdown feature \$388.01
- W. **OLIN-71621** 1/2" MXM ball valve \$72.02
- X. **OLIN-71627** 1/2" MXF ball valve \$72.02
- Y. **OLIN-71609** Briquette screen for PIII \$207.41
- Z. **OLIN-71881** Briquette screen for PIV \$505.64
- AA. **OLIN-77332** PI Deep Well Grid \$6.19
- BB. **OLIN-79216** PI Cap Ring (not shown) \$2.97
- CC. **OLIN-71448** PI Flat Spike Grid \$7.43
- DD. **OLIN-77331** PI dissolving cup \$85.88
- EE. **OLIN-79664** Solenoid Valve 24 V DC \$420.75
- FF. **OLIN-79652** Briquette Screen Model 140 \$58.41
- GG. **OLIN-79651** Briquette Screen Model 45 (not shown) \$47.77
- HH. **OLIN-79643** Briquette Screen Model 500 (not shown) \$124.20
- II. **OLIN-79648** Washdown Manifold Model 45 \$100.73
- JJ. **OLIN-79649** Washdown Manifold Model 140 \$159.14
- KK. **OLIN-79650** Washdown Manifold Model 500 (not shown) \$159.14
- LL. **OLIN-79660** Agitation Nozzle \$3.47
- MM. **OLIN-71888** Spray Nozzle for Model PIV and Washdown Nozzel for Model 500 \$90.34

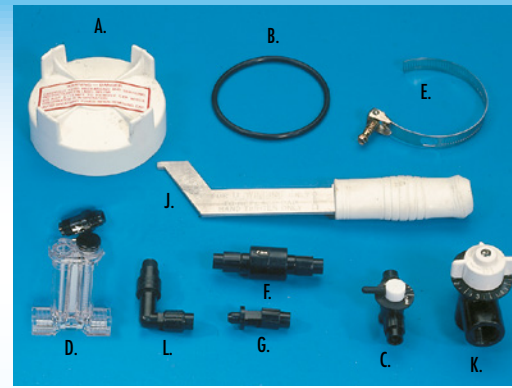
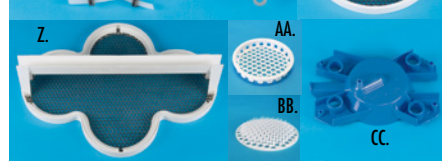
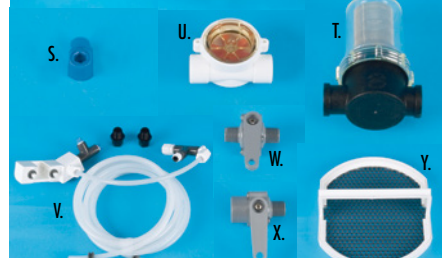
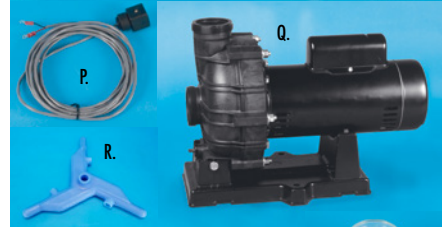
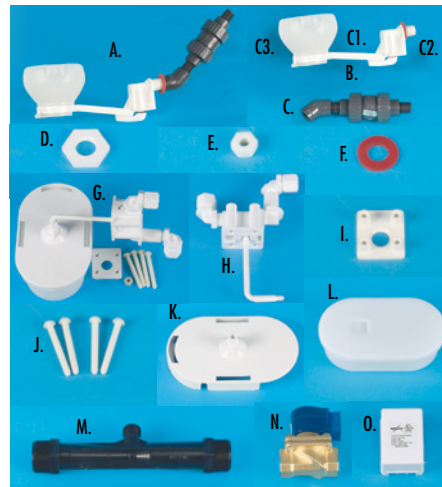

## RAINBOW FEEDERS

- A. **R172008W** 3" thread cap white \$18.29
- B. **R172009** Cap O-ring \$7.11
- C. **R172060** Control valve \$25.02
- D. **R172080** Flow indicator with check valve \$30.74
- E. **R172034** Saddle clamp \$6.01
- F. **R172323** 1/4" check valve \$17.87
- G. **R172032** Tube fitting with compression nut \$6.01
- R172274** Compression nut only \$2.77
- R172263** Saddle gasket only (not shown) \$2.21
- J. **R172052** Cap wrench \$29.07
- K. **R172086** 1/2" control valve \$52.79
- L. **R172061** Combination check valve w/elbow \$6.19
- R172272** 1/2" NPT x tube 90° elbow w/ nut. \$7.52



## PENTAIR HIGH CAPACITY FEEDERS HC SERIES

- A. **R172214** Lock ring \$17.96
- B. **R172385D** Lid assembly with o'ring \$31.70
- C. **R172240** Lid o'ring only \$18.74
- D. **R172224X** Vent valve \$5.85
- E. **R172221** Vent valve o'ring \$1.49
- F. **R175251** Screen \$5.92
- G. **R172435** Check ball \$1.53
- H. **R270531** 1" threaded union \$18.36
- I. **R172439** Control valve \$84.94
- J. **R175009** 1/2" drain valve \$18.07
- K. **R172134** 1/2" threaded plug \$5.76

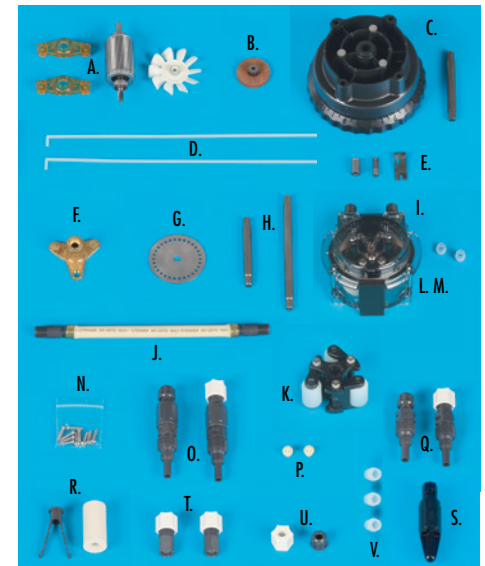

## STENNER CHEMICAL FEEDERS

- A. **PMBRPL2** Rotor Assembly with Bearings \$104.09
- B. **MP6N040** Phenolic Gear (45m) \$31.01
- MP6N080** Phenolic Gear (85m) \$31.01
- C. **FC5040D** Feed Rate Control w/Shaft (models 45 & 85) \$330.73
- DM5040D** Feed Rate Control w/Shaft (models 100 & 170) \$330.73
- D. **UCFCSHO** Variable Cam (2 pack) \$31.16
- E. **UCFCSAY** Index Pin Assembly with Lifter \$93.44
- F. **FC5K00D** Index Spider \$46.73
- G. **UCFCSID** Index Plate \$35.03
- H. **UCFCSAD** Main Shaft (single head adjustable) \$51.89
- DM5A00D** Main Shaft (double head adjustable) \$42.46
- I. **QP25 "X"-1** Quick Pro Pump Head Assembly \$163.46
- QP10 "X"-1** Quick Pro Pump Head Assembly Hi-Pressure Model \$176.51
- \*J. **UCCP20 "X"** Pump Tube Assembly (2 pack) \$49.32  
\*Add Numbers 1, 2, 3, 4, 5 or 7 for "X" to indicate pump, tube size required
- K. **QP500-1** QP Roller Assembly Quick Pro \$53.19
- UC3ASD** Roller Assembly Old Style (not shown) \$48.24
- L. **QP400-1** QP Tube Housing w/Latches \$48.67
- M. **QP100-1** Tube Housing Cover w/Bushing \$36.36
- N. **UCCPSOB** Cover Screw (10 pack) \$11.63
- O. **UCDBINJ** Injection Check Valve for 1/4" tubing \$24.68
- UCINJ38** Injection Check Valve for 3/8" tubing \$30.51
- P. **UCCVDBO** Check Valve Duckbill (2 pack) \$16.22
- Q. **UCAK300** Injection Valve w/ 1/4" nut (no check) \$14.29
- UCAK400** Injection Valve w/ 3/8" nut (no check) \$17.06
- R. **UCMAC38** Hose Weight w/adaptor (limited quantity) \$19.22
- UCMACW0** Weight w/clip 1/4" \$19.06
- S. **ST114** 1/4" Suction strainer \$30.22
- ST138** 3/8" Suction strainer \$30.22
- T. **UCADPTR** 3/8" Lead Tube Adapter w/nut (2 pack) \$20.05
- U. **UCAK100** 1/4" Connecting nut (10 pack) \$26.57
- MANUT00** 3/8" Connecting nut \$3.76
- V. **UCAK200** 1/4" Ferrules (10 pack) \$11.97
- AK600** 1/4" Flow indicator/bracket (not shown) \$28.35
- AK700** 3/8" Flow indicator/bracket (not shown) \$28.35

## BLUE/WHITE FEEDER PARTS

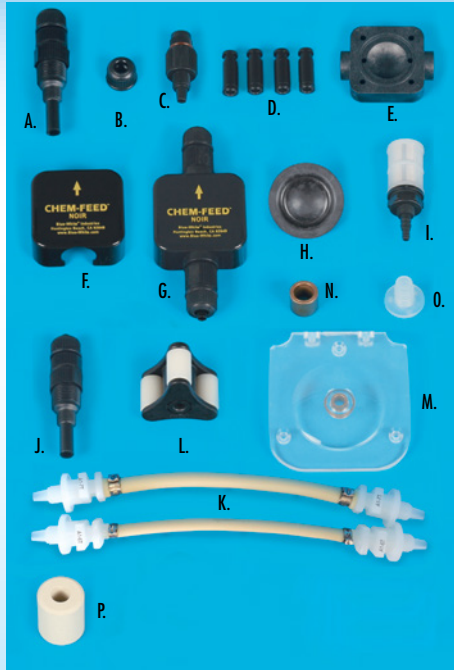

- MODEL C-600P**
- A. **C-395N-6A** Injection Check Valve . . . . . \$55.78
  - TI 40-4V** 1/4" Threadless Injection Fitting . . \$51.77  
For 1 1/2" & 2" Pipe
  - TI 40-6V** 3/8" Threadless Injection Fitting . . \$50.83  
For 1 1/2" & 2" Pipe
  - B. **C-330-6** Tubing Nut . . . . . \$3.51
  - C. **C-560-6V** Valve Housing . . . . . \$30.51
  - D. **K-568A-4** Bullet Cartridge Valve Insert(4/set) . . \$98.06
  - E. **C-535** Pump Head . . . . . \$46.95
  - F. **C-535FC** Head Cover . . . . . \$24.17
  - G. **C-535A6-6** Head Assembly . . . . . \$144.27
  - H. **C-406T** Diaphragm . . . . . \$47.70
  - I. **C-340A** Foot Valve . . . . . \$39.33
- MODEL A-100N**
- J. **A-014N-6A** Injection Check Valve. . . . . \$52.16
  - K. **A1-7T** Pump Tube Assembly 7/16" O.D. . . . \$44.84
  - A1-6T** New Pump Tube Assembly 3/8" O.D. . . \$39.53
- \*For Pumps Manufactured Prior to 9-1-15
- \***72000-550** Retro-Fit Kit to Adapt New Tube to Old Pump Head . . . . . \$15.03
  - L. **71000-159** Roller for 6T tube . . . . . \$91.87
  - 71000-350** Roller for 7T tube . . . . . \$91.87
  - M. **71000-156** Housing Cover . . . . . \$30.40
  - N. **90004-010** Roller Bushing(new Style) . . . . \$4.55
  - O. **C-342-6** Tube Strainer. . . . . \$4.75
- COMMON ITEMS**
- P. **C-346** Hose Weight . . . . . (while supply lasts) \$7.76

## PULSATRON CHEMICAL FEEDERS



- A. **KOP Kit** includes: head, diaphragm, complete suction & discharge valve assembly. All O-rings and head bolts. e.g. (For pump model LPB4SAPTC1 order K4PTC1) e.g. (For pump model LPH6SAPTC3 order K6PTC3)
- K2PTC1 . . . . . \$194.67
  - K4PTC1 . . . . . \$228.22
  - K5PTC3 . . . . . \$265.07
  - K3PTC1 . . . . . \$194.67
  - K4PTC3 . . . . . \$265.07
  - K6PTC3 . . . . . \$265.07
- B. **J40211** foot valve 3/8" O.D. tubing . . . . . \$74.79
  - J40212** foot valve 1/2" O.D. tubing . . . . . \$74.79
  - C. **J61098** injection check valve 3/8" O.D. tubing . . \$157.82
  - J41872** injection check valve 1/2" O.D. tubing . . \$143.78
  - D. **L3101TC1-FPP** suction valve 3/8" O.D. tubing . . . \$87.26
  - L3101TC3-FPP** suction valve 1/2" O.D. tubing. . . \$87.26
  - E. **L3201TC1-FPP** discharge valve 3/8" O.D. tubing. . . \$87.26
  - L3201TC3-FPP** discharge valve 1/2" O.D. tubing. . . \$87.26
  - F. **L0200300-FPP** pump head (A3 pumps). . . . . \$97.34
  - L0200400-FPP** pump head (B4&E4 pumps). . . . \$115.76
  - L0200600-FPP** pump head (H6 pumps). . . . . \$151.04
  - G. **L0301000-THY** diaphragm (A3 pumps). . . . . \$87.26
  - L0301100-THY** diaphragm (B4&E4 pumps). . . . \$87.26
  - L0301300-THY** diaphragm (H6 pumps) . . . . . \$129.31
  - I. **L380DT01-PVD** 5 function valve 3/8" O.D. tubing . . \$172.15
  - L380DT03-PVD** 5 function valve 1/2" O.D. tubing. . \$172.15

**833-SWIM-327**  
8 3 3 - 7 9 4 6 - 3 2 7  
www.halogensupply.com

## LMI CHEMICAL FEEDER PARTS

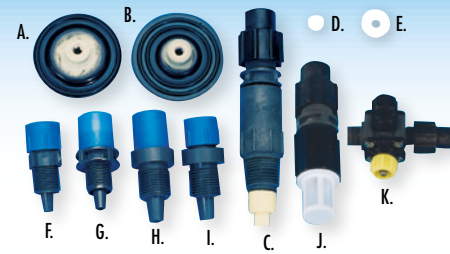

- \*A. **30917** 0.9 diaphragm. . . . . \$141.75
- \*B. **31420** 1.8 diaphragm. . . . . \$149.63
- C. **10501** Injection check valve 3/8" OD tubing . . \$119.07
- 25687** Injection check valve 1/2" OD tubing . . \$100.80
- \*D. **10338** Valve ceramic ball . . . . . \$7.88
- \*E. **10407** Seal ring . . . . . \$11.03
- F. **25232** 3/8" suction valve . . . . . \$61.04
- G. **25231** 3/8" discharge valve . . . . . \$67.73
- H. **25202** 1/2" suction valve . . . . . \$66.15
- I. **25201** 1/2" discharge valve . . . . . \$80.33
- J. **25234** 3/8" foot valve . . . . . \$98.75
- 25204** 1/2" foot valve . . . . . NLA
- K. **25690** 4 function 3/8" valve . . . . . \$157.50
- 25700** 4 function 1/2" valve (limited quantity available) \$157.50

- \* Items included in spare parts kit.
- #**SP-U1** Spare Parts Kit for models 81S, 81T, 82T, 85S, 85T, 91S, 92S, 92T, 94, 94S, 95S, 95T, 196, 196S, . . \$264.60
- #**SP-U2** Spare Parts Kit for models 65, 65S, 71S, 71T, 72S, 72T, 74, 74S, 75S, 75T \$264.60 (Spare Parts Kits not shown)

## PRESTOLOK FITTINGS

Specially designed for applications where fast assembly, disassembly and reassembly is important. Just insert the tubing until it bottoms and it's locked in place. Press the release button and remove the tubing brass connection.

- H. **W68PLP44** 1/4" MPT x 1/4" O.D. tubing \$8.91
- W68PLP64** 1/4" MPT x 3/8" O.D. tubing \$14.99
- W68PLP66** 3/8" MPT x 3/8" O.D. tubing \$16.11
- W68PLP84** 1/2" MPT x 1/2" O.D. tubing \$17.91
- W68PLP86** 3/8" MPT x 1/2" O.D. tubing \$21.47
- W68PLP88** 1/2" MPT x 1/2" O.D. tubing \$27.59
- I. **66PLP44** 1/4" FPT x 1/4" O.D. tubing \$17.60
- 66PLP64** 1/4" FPT x 3/8" O.D. tubing \$27.68
- 66PLPBH66** 3/8" FPT x 3/8" O.D. tubing \$24.35
- 66PLPBH86** 3/8" FPT x 1/2" O.D. tubing \$52.16
- J. **W169PLP44** 1/4" MPT x 1/4" O.D. tubing \$12.38
- W169PLP64** 1/4" MPT x 3/8" O.D. tubing \$17.33
- W169PLP66** 3/8" MPT x 3/8" O.D. tubing \$19.08
- W169PLP84** 1/2" MPT x 1/2" O.D. tubing \$22.23
- W169PLP88** 1/2" MPT x 1/2" O.D. tubing \$30.65
- K. **W172PLP44** 1/4" MPT x 1/4" O.D. tubing \$15.35
- W172PLP64** 1/4" MPT x 3/8" O.D. tubing \$24.62
- W172PLP66** 3/8" MPT x 3/8" O.D. tubing \$29.12
- W172PLP84** 1/2" MPT x 1/2" O.D. tubing \$32.94
- W172PLP88** 1/2" MPT x 1/2" O.D. tubing \$40.64

### Male Adaptors:



### Female Adaptors:



### Male 90° 's



### Male Branch Tees



# CHEMICAL FEEDER PARTS, TUBING & TUBING FITTINGS

## CHEMICAL PUMP TUBING

- Vinyl Suction:**
- A. **IV6062** 3/8" OD x 1/4" ID \$ .91/Ft
  - IV7062** 1/2" OD x 3/8" ID \$1.07/Ft

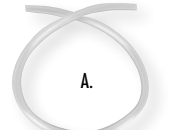

- Polyethylene Discharge:**
- B. **MV4062** 1/2" OD x 1/4" ID \$ .34/Ft
  - MV6062** 3/8" OD x 1/4" ID \$ .57/Ft
  - MV5062** 3/8" OD x 3/8" ID \$ .46/Ft
  - MV8062** 1/2" OD x 3/8" ID \$ .80/Ft
  - MV10062** 3/8" OD x 1/2" ID \$1.02/Ft

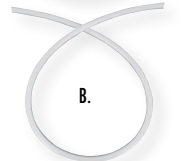

## FAST & TITE® THERMOPLASTIC FITTINGS

Fast & Tite fittings install in seconds without the use of tools and provide a tight leak proof seal without clamps or adjustments.

- C. **P4MC4** 1/4" MPT x 1/4" O.D. tubing \$4.02
- P6MC4** 1/4" MPT x 3/8" O.D. tubing \$4.98
- P6MC6** 3/8" MPT x 3/8" O.D. tubing \$5.16
- P6MC8** 1/2" MPT x 3/8" O.D. tubing \$5.58
- P8MC4** 1/4" MPT x 1/2" O.D. tubing \$5.88
- P8MC8** 1/2" MPT x 1/2" O.D. tubing \$7.44
- P10MC8** 1/2" MPT x 3/8" O.D. tubing \$8.88

### Male Adaptors



### Female Adaptors



### Male Elbow



### Female Elbows



### Male Branch Tee



- D. **P6FC4** 1/4" FPT x 3/8" O.D. tubing \$6.30
- P6FC8** 3/8" FPT x 3/8" O.D. tubing \$9.72
- P8FC8** 1/2" FPT x 1/2" O.D. tubing \$11.22
- P10FC8** 1/2" FPT x 3/8" O.D. tubing \$8.64
- E. **P4ME4** 1/4" MPT x 1/4" O.D. tubing \$5.22
- P6ME4** 1/4" MPT x 3/8" O.D. tubing \$6.96
- P6ME6** 3/8" MPT x 3/8" O.D. tubing \$7.14
- P8ME4** 1/4" MPT x 1/2" O.D. tubing \$9.48
- P8ME8** 1/2" MPT x 1/2" O.D. tubing \$8.88
- F. **P4FE4** 1/4" FPT x 1/4" O.D. tubing \$8.10
- P6FE4** 1/4" FPT x 3/8" O.D. tubing \$9.72
- G. **P4MT4** 1/4" MPT x 1/4" O.D. tubing \$9.00
- P6MT4** 1/4" MPT x 3/8" O.D. tubing \$9.84
- P6MT6** 3/8" MPT x 3/8" O.D. tubing \$13.80
- P8MT6** 3/8" MPT x 1/2" O.D. tubing \$16.68
- P8MT8** 1/2" MPT x 1/2" O.D. tubing \$17.70

# CHEMICAL CONTROLLER PROBES AND PARTS

## CHEMICAL CONTROLLER REPLACEMENT PROBES



	PRODUCT NO.	DESCRIPTION	CELL CONNECTION	CONTROLLER CONNECTION	USED WITH	PRICE
A.	S010	ORP PROBE	COMPRESSION	10' CABLE W/BNC END	AQUASOL	\$186.03
	S020	PH PROBE	COMPRESSION	10' CABLE W/BNC END	AQUASOL	\$115.02
B.	HSC-012	ORP PROBE	COMPRESSION	10' CABLE W/BNC END	CHEMTROL	\$136.32
	HSC-022	PH PROBE	COMPRESSION	10' CABLE W/BNC END	CHEMTROL	\$99.03
C.	HSC-013	ORP PROBE	1/2" MPT	10' CABLE W/BNC END	CAT/STRANTROL	\$204.48
	HSC-023	PH PROBE	1/2" MPT	10' CABLE W/BNC END	CAT/STRANTROL	\$175.26
D.	HSC-014	ORP PROBE	1/2" MPT	F/BNC	ACUTROL	\$204.51
	HSC-024	PH PROBE	1/2" MPT	F/BNC	ACUTROL	\$175.02
E.	HSC-019	ORP PROBE	TWIST LOCK	F/BNC	WATERMASTER	\$306.00
	HSC-029	PH PROBE	TWIST LOCK	F/BNC	WATERMASTER	\$260.37
F.	3-2725-60	ORP PROBE	3/4" MPT	MINI-DIN	HALO	\$446.25
	3-2726-00	PH PROBE	3/4" MPT	MINI-DIN	HALO	\$352.28

## CHEMICAL CONTROLLER ACCESSORIES

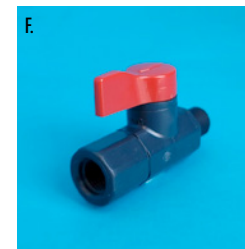
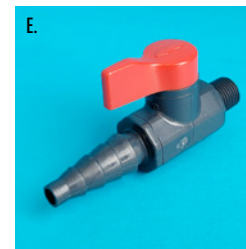
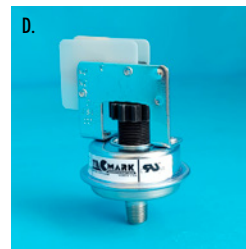
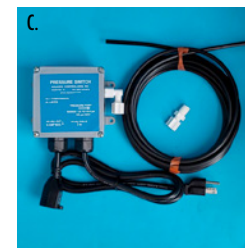

	PRODUCT NO.	DESCRIPTION	PRICE
A.	S030	FLOW CELL W/ FITTINGS	\$285.08
B.	F220	ELECTRODE FITTING 1/2" MPT	\$10.83
C.	M011-HP	SAFETY PRESSURE SWITCH	\$320.63
D.	3076	SAFETY PRESSURE SWITCH ONLY	\$56.68
E.	1078002	1/4" MPT X HOSE BALL VALVE	\$32.99
F.	1080002	1/4" MPT X FPT BALL VALVE	\$31.50
G.	155481	GEMS SENSOR 1/2" FPT RFO TYPE 4.5 TO 24 VDC PULSED OUTPUT	\$256.70
	155485	GEMS SENSOR 1/2" FPT RFS TYPE SET POINT CALIBRATION	\$439.52
H.	754000310	ACUTROL FLOW CELL W/FLOW SWITCH (NOT SHOWN)	\$827.93
I.	754000340	ACUTROL FLOW CELL JAR ONLY	\$303.24
J.	754000360	ACUTROL 1/4" IN-LINE STRAINER	\$76.59
K.	754000440	ACUTROL FLOW SWITCH W/10' CABLE	\$103.82

## INTELLICONNECT™ CONTROL MONITORING SYSTEM



IntelliCenter is Pentair's highest-capacity and most service-friendly control system ever. Communication with this system can be done on a wide range of devices and platforms. Many important service, programming and monitoring tasks can be done without an on-location service call. Order popular bundled systems and receive everything in one box or build systems a la carte.

### Features:

- Enables smart connections to any these Pentair devices: IntelliFlo® or IntelliPro® Pumps, IntelliChlor® or iChlor® Sanitizers.
- Allows for two relay connections to equipment like pool or landscape lights, pool cleaner booster pumps, or single-speed pumps including competitive models.
- Provides real-time information on the status of the filtration systems and other pool equipment.
- Easily sets up and schedules automatic operation of connected equipment.

PRODUCT NO.	MODEL	VOLTS	AMPS	SHIP WT.	PRICE
52-3317	INTELLICONNECT	115/208-230	13.2/12.0-11.5	53	\$469.31

**833.SWIM.327**  
8 3 3 · 7 9 4 6 · 3 2 7  
[www.halogenupply.com](http://www.halogenupply.com)

## INTELLICENTER® POOL CONTROL SYSTEM



IntelliConnect allows pool owners to monitor and control various devices, including pumps, lights sanitizers and more, all through an app on a smart device, for easy convenient control. IntelliConnect provides real-time information on the status of the filtration system and other pool equipment. Pool owners can command the system to work a little harder when extra filtration is needed.

### Features:

- Easy to program, with step-by-step, on screen instructions.
- Color touchscreen interface displays intuitive instructions in clear text and rich colors.
- Convenient control from inside and outside the home via outdoor and indoor control panels and wireless remotes.
- Remote control from anywhere: Android® and iOS® device, Web browsers on Mac® and PC computers and voice command with smart speaker devices like Amazon Echo®.
- Interfaces with iOS®, Android mobile devices, Apple Watch® and smart speakers, enabling owners to check their pools status remotely.

Priced on application

## AUTOMATION AND AUTOMATION PARTS

### AQUALINK ACCESSORIES

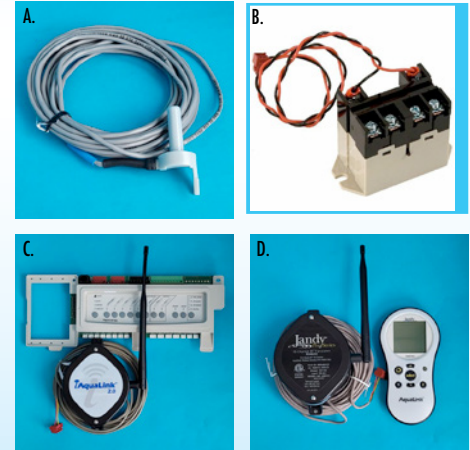

- A. JAN-7790 Temperature Sensor . . . . . \$105.44  
 B. R0658100 3HP Relay . . . . . \$129.331  
 C. IQ20-RS RS Upgrade Kit W/Web Connect . . \$1,387.58  
 D. AQWHR18 Wireless Handheld Remote . . \$1,171.91

### COMPOOL PARTS

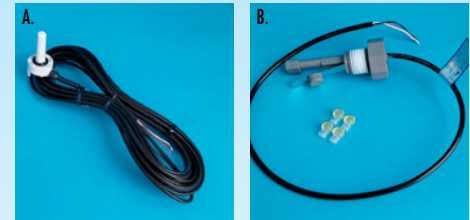

- A. 52-0272 Temperature Sensor . . . . . \$79 .49  
 B. 52-0736 Flow Switch . . . . . \$236.32

### INTELLICHLOR SALT CHLORINE GENERATOR

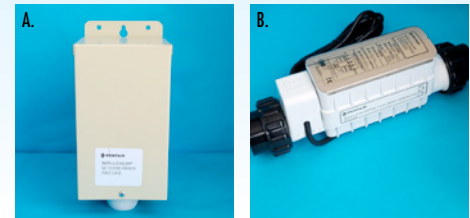

- A. 52-0556 Power Center . . . . . \$756.11  
 B. 52-0555 IC40 Cell . . . . . \$1,459.98

# POOL LINERS, LADDERS & ACCESSORIES

## OVERLAP PATTERNS

Made in the U.S.A. by GLI Pool Products with the highest quality workmanship using the best available virgin vinyl liner. Our colors are Solid Blue, Blue Wall with print floor. All liners are available in 20 gauge vinyl and are 48"/52" high walls.

A. Blue Wall Blue Floor		
ROUNDS	Cat. No.	48"/52"
12	1631212	\$166.05
15	1631515	\$219.79
18	1631818	\$261.70
21	1632121	\$354.33
24	1632424	\$386.99
<hr/>		
12 Round x 36"	1631236	\$99.46
<hr/>		
OVALS	Cat. No.	48"/52"
12x24	1630224	\$342.99
15x30	1630530	\$448.88
16x32	1630632	\$544.70

Expandable Liners only available on round size pools. Add 25% to list price. Beaded style liner pricing available upon request.

### B. Happy Bottom® Pool Pad

Ideal padding for underneath pool liner. 2 lb. density 1/4" thickness makes it soft and durable.

#PP300-FT 1/4" X 48" width x 1 Foot \$2.9 4 per foot

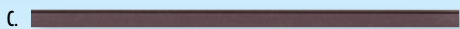

### C. MC-CP2 LINER COPING STRIPS 24"

for overlap liners . . . . . \$0.78 each

### D. COV-48" PEEL N' PLACE POOL COVE

48" long . . . . . \$12.20 per 4' strip

### E. QP-1562 LINER BEAD WEDGE LOCK 120'

\$50.56

### F. QP-521 SIDE MOUNT LINER

LOCK 8' PIECE . . . . . \$15.80

## REPAIR KITS FOR ALL ABOVEGROUND POOLS



- A. 2 oz. tube of #100 vinyl adhesive, 130 sq. in. of patching vinyl and dauber applicator. Works under water. #1060 #100 vinyl adhesive . . . . . \$9.16
- B. 4 oz. can of #100 vinyl adhesive, dauber applicator and 500 sq. in. of patching vinyl. Works under water. #1061 4 oz. can #100 vinyl adhesive . . . . . \$19.96
- C. Plastic pool patches, 100 sq. in. of patching vinyl. Works under water. #1062 Plastic pool patches . . . . . \$6.23
- D. #1068 Vinyl adhesive – 4 oz. can and dauber . . . . . \$11.66
- E. Vinyl repair kit. 1 oz. tube of #100 vinyl adhesive and 40 sq. in. of patching vinyl and dauber. #1069 Vinyl repair kit . . . . . \$5.04
- F. Vinyl repair patches for blue liners 2 H.D. gauge vinyl strips measuring 6" x 23" (must use vinyl adhesive) – Color blue vinyl. #1064 . . . . . \$8.80

## LADDERS & ACCESSORIES

### A. HEAVY DUTY A-FRAME FOR 48" TO 54" POOL

Unique one-piece handrail/leg design will hold 300 lbs. Outer steps swing up and lock into upright position. Just fill with water to prevent floating.

#7000 . . . . . \$395.12



### B. HEAVY-DUTY INPOOL LADDER FOR 48" TO 53"

18" wide, flat oversized (5") steps; 22" high handrails; 9 1/2" handrail span. Includes deck platform at top. Weight limit 300 lbs.

#6000 . . . . . \$245.94



## COMPLETE STEP-SYSTEM

### C. CONFER-STEP

For above ground pools with flat bottoms. Easy, snap together installation. Large, flat steps (each with 270 square inches) complete with two all-plastic handrails. Mounting brackets included; secures unit to pool or deck. Gray steps for high visibility in water. Economical, yet strong; holds 400 pounds.

- Fits Decks up to 60"
- Height to Top Step – 47 inches
- Height to Handrail – 38 inches
- Projection into Pool – 32 inches
- Width – 31 inches
- Riser Height – 11 inches
- Step Dimensions – 10" x 27"

#STEP-1 . . . . . \$391.88



**833-SWIM-327**  
833-7946-327  
[www.halogensupply.com](http://www.halogensupply.com)



## AIR BLOWERS

### A. FUJI COMMERCIAL AIR BLOWERS

Blower construction: cast aluminum housing, impeller and cover, 1 and 3 phase models.

Model No.	Type	HP	Phase	Volts	Use	Price
VFC400P-5T	Fuji	1	1	115/230	Spa Duty	\$1,149.31
VFZ401A-7W	Fuji	1.4	3	230/460	Spa Duty	\$1,038.62
VFC508P-2T	Fuji	2.5	1	230	Spa Duty	\$1,459.00
VFZ501A-7W	Fuji	2.7	3	230/460	Spa Duty	\$1,293.62

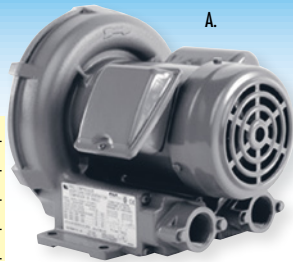

### B. SILENCER from AIR SUPPLY

Extremely quiet outdoor blower... nothing else compares. UL listed for indoor or outdoor use. A high quality spring check valve is included with each silencer. One year no-questions-asked warranty—including water damage.

- #6310101—  
1.0 H.P. 110 Volts . . . \$203.60
- #6310201—  
1.0 H.P. 220 Volts . . . \$216.20
- #6315101—  
1.5 H.P. 110 Volts . . . \$222.50
- #6315201—  
1.5 H.P. 220 Volts . . . \$235.10
- #6320101—  
2.0 H.P. 110 Volts . . . \$262.40
- #6320201—  
2.0 H.P. 220 Volts . . . \$268.70



### C. SPA FACTOR: Thermal Cover For Hot Tubs And Spas

Lightweight yet durable, the Spa Factor thermal cover helps prolong the life of spas and reduces daily maintenance. Floats on water surface, providing these advantages:

- Protects and extends the life of your hard cover
- Significantly reduces heat, water and chemical consumption by reducing evaporation
- Helps prevent moisture damage to sensitive electronic controls
- Trimable, easy to install
- Reversible colors, black/blue.

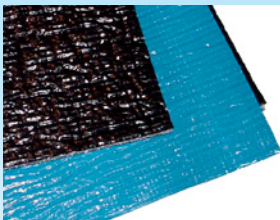

- #HV8x6 . . . . \$118.34    #HV9x9 . . . . \$193.20
- #HV8x7 . . . . \$137.66    #HV9x10 . . . \$214.94
- #HV8x8 . . . . \$156.98    #HV9x12 . . . \$265.65

### D. WATERWAY EXECUTIVE 56-FRAME PUMP

High performance, quiet operation, longer motor life.

2-Speed		Price
3720821-1D	EXECUTIVE 56 2 HP 2SPD	\$569.81
3721221-1D	EXECUTIVE 56 3 HP 2SPD	\$608.87
3721621-1D	EXECUTIVE 56 4 HP 2SPD	\$689.00
3722021-1D	EXECUTIVE 56 5 HP 2SPD	\$753.82

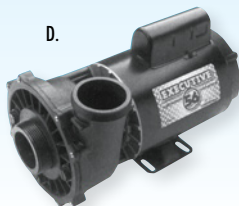

### E. SPRING WOUND COUNTDOWN TIMER

The FF Series Commercial Countdown timers are designed to replace any standard wall switch and do not require electricity to operate. These energy-efficient switches automatically limit the ON times for fans, lighting, motors, heaters and other energy consuming loads.

- #FF15M 15 Minute. . . . . \$46.98
- #FF30M 30 Minute. . . . . \$46.98



### F. LEN GORDON AIR SWITCHES Basic Air Switch

Turns on/off any piece of equipment, such as: pump, blower, lights, etc. Air button not included.

- F1. #910100-007 — FF-1094 Four function air switch 120/240V . . . . . \$419.81
- F2. #910106-007 — FF-1094TC System . . . . . \$497.72  
Four Function Switch w/Time Clock



- G. #921305-001 AS-Multi Combo 120/240V  
2 speed pump . . . . . \$227.86
- #921805-001 AS-TD-Multi Combo 120/240V on-off with  
10 min. delay . . . . . \$332.35

### H. AIR BUTTONS & AIR CONTROLS



- H1 #950401-000 Lite touch 1¼" mounting 75' max dis . . . \$33.50
- H2 #951590-601 Classic touch 1⅜" mounting 150' max dist \$17.10
- H3 #951001-000 Power touch 1¾" mounting 150' max dist \$38.86
- H4 #10-2100 1" Slip. . . . . \$31.59
- H5 #10-2200 ½" Slip . . . . . \$16.94

## SPA ACCESSORIES & SUPPLIES

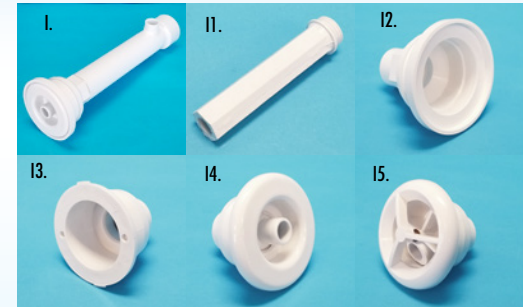

- I #10-4562 Converta'ssage Gunite Assy . . . . \$6 8.87
- J1 #30-4401 Nozzle . . . . . \$7.40
- J2 #30-4332 Niche . . . . . \$14.56
- J3 #56-5215 Wall fitting w/ bearing. . . . . \$17.08
- J4 #10-4564 Converta'ssage Fitting Assy. . . . \$34.67
- J5 #16-5274WHT Micro'ssage Fitting Assy. . . \$56.70

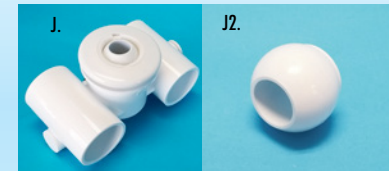

- J #10-5100 Hydro Jet Assembly . . . . . \$64.98
- J2 #30-3805 Eyeball. . . . . \$3.20
- J3 #30-3806 Eyeball retaining ring . . . . . \$4.97
- J4 #10-3500 Standard wall fitting assy. . . . \$17.33
- J5 #30-7825 Wrench tool (not pictured). . . . \$14.56

**833-SWIM-327**  
833-7946-327  
www.halogensupply.com



Frog® offers innovative mineral technology for pool & spa care that is EPA registered to destroy bacteria which SAVES 50% on chlorine or bromine use for softer water that leaves a crystal clear shine and is easier on equipment and surfaces. In addition Frog® offers repeat sales of multiple products every year for a strong after market business.

**A. FROG SERENE® FLOATING SYSTEM**  
 Complete spa care using mineral and bromine cartridges that snap into a reusable holder. With minerals in the spa, bromine use can be reduced by up to 50%.

#01-14-3883 Frog Serene System . . . \$44.90  
 #01-14-3824 Bromine Cartridge . . . \$13.48  
 #01-14-3812 Mineral Cartridge . . . \$29.30

**B. FLIPPIN FROG XL®**  
 Fresh mineral water for any pool up to 10,000 gallons. The patented floats and flips technology tells users to replace. Destroys bacteria with minerals and only 0.5 ppm chlorine.

#01-12-8606 Flippin Frog XL . . . \$67.54  
 #01-03-8550 Flippin Frog XL Cartridge Only . . . \$27.10

**C. POOL FROG® ABOVE GROUND PACKAGE**  
 Includes a POOL FROG® Cyclor 6100 and Mineral Reservoir Series 6100. Cyclor is in-line with 1½" threaded ports for pools up to 25,000 gallons. Includes 6" nipple installation kit, instruction manual, and video on CD-ROM. Do not install off-line. Mineral Reservoir lasts 6 months.

#01-01-6180 . . . \$296.66



**D. REPLACEMENT PRODUCTS FOR ABOVE GROUND AND IN GROUND POOL PRODUCTS**

- #01-12-5462 In ground mineral reservoir . . . \$123.40
- #01-12-6112 Above ground mineral reservoir . . . \$96.48
- #01-03-5880 Pool Frog Bac Pac. . . \$30.96
- #01-10-5060-1 Frog Bam Algaecide \$32.36

**833-SWIM-327**  
 833-7946-327  
[www.halogensupply.com](http://www.halogensupply.com)



**E. POOL FROG® IN GROUND PACKAGE**

- Includes a POOL FROG® Cyclor 5400 and Mineral Reservoir Series 5400. Cyclor is in-line with 2" male adapters installed for pools up to 40,000 gallons. Do not install off-line. Mineral Reservoir lasts 6 months.
- #01-01-5480 Inline unit. . . . . \$435.08
  - #01-01-5490 Offline unit . . . . . \$478.04



**F. POOL FROG XL PRO®**

- Includes a POOL FROG® Cyclor and Mineral Reservoir series 5400 and a second POOL FROG® Cyclor that fits the new FROG® 7lb. chlorine pac. Cyclors are inline with 2" slip ports for pools up to 40,000 gallons. Mineral Reservoir lasts 6 months.
- #01-01-5450 XL Pro. . . . . \$594.08
  - #01-03-5613 Pool Frog Chlorine Pac. . . \$78.02



- G. 1" and 3" tablets, 10lb. capacity. Do not install in-line. 2" threaded inlet/outlet ports. #01-05-0960 . . . . . \$178.18

**PERFORM-MAX™ IN GROUND IN-LINE 940**

- In-line chemical feeder for pools up to 50,000 gallons. Handles chlorine H. or bromine 1" and 3" tablets, 10lb. capacity. Do not install off-line. 2" threaded inlet/outlet ports.
- #01-05-0940 . . . . . \$145.46

I.  
J.  
K.  
L.  
M.

# SeaKlear®

Reliable. Safe. Effective.



## PHOSPHATE REMOVER

SeaKlear Phosphate Remover works better and does more than other phosphate removers.

- Commercial 1 oz per 5000 gallons  
Residential 3 oz per 5000 gallons
- Proven to eliminate phosphates from fertilizers, rainwater, soaps and decaying vegetation and other pollutants.
- Nontoxic - 100% safe for your family and the environment

#1040105 Phosphate Remover  
Commercial 1 Quart . . . . . \$58.99



## THICK TILE & VINYL CLEANER

SeaKlear Thick Tile & Vinyl Cleaner is designed to remove film, oil and scum lines from tile, vinyl and grout. Unlike other products of this type, SeaKlear Thick Tile & Vinyl Cleaner is non abrasive, yet it reaches down into the pores to remove soils.

- Removes oil and scum lines
- Cleans grout lines
- Removes dull films
- Safe for acrylic surfaces

#SKL-T-C Thick Tile & Vinyl Cleaner  
Quarts. . . . . \$18.19



## ALGAE PREVENTION & REMOVER

To control algae in pools, simply add SeaKlear Algae Prevention & Remover every 3 months.

- Use against blue-green, black and mustard algae
- A single treatment lasts 3 months
- Non staining formula
- Guaranteed superior performance
- Part of the proven family of SeaKlear water treatment solutions

#SKA-B-Q Algae Prevention & Remover  
Quarts. . . . . \$27.26



## CHITOSAN CLARIFIER

SeaKlear Chitosan Clarifier works better and does more than other clarifiers. Quite simply, it is the best clarifier money can buy. Our proprietary, patented chitosan polymer formula has been proven to be reliable at safely keeping pools clear, easily and effectively.

- Naturally clarifies cloudy water
- Eliminates oil and scum
- Safe to use with all sanitizers
- Removes excess metals
- Easy and simple to use
- Makes cleaning all filters quicker and easier

#SKP-C-Q Chitosan Clarifier for Pools  
Quarts. . . . . \$22.09



## FREE & KLEAR

Free & Klear blends our original SeaKlear Chitosan Clarifier, SeaKlear Phosphate Remover and enzyme formulations to keep pool water looking beautiful. Free & Klear is an ideal weekly maintenance product that tackles common issues faced by many pool owners. It reduces problems such as phosphate loading which can cause issues with pool surfaces and equipment. Free & Klear works great with salt systems as it helps maintain optimum performance of cells by reducing troublesome calcium phosphate scale. Free & Klear also treats the buildup of lotions and oils on both the filter and in pool water that can result in clarity problems. If phosphate levels exceed 1000 ppb, use SeaKlear Phosphate Remover to reduce the level down and use the Free & Klear to maintain low levels.

#1040400 Free & Klear  
Quart . . . . . \$26.00



## STAIN PREVENTION & REMOVER Professional Strength

Stain Removal: 1 qt. per 20,000 gallons  
Maintenance: 6-8oz. per 10,000 gallons

- Most effective metal prevention available
- Professional-strength, proprietary blend
- Superior product for iron and copper removal
- Removes and prevents metal stains from iron, copper and other metals
- Reduces scale buildup • Controls scale and metals

#1110012 Stain Prevention & Remover  
Quarts. . . . . \$27.26

**833 SWIM 327**  
8 3 3 - 7 9 4 6 - 3 2 7  
[www.halogensupply.com](http://www.halogensupply.com)

# SEAKLEAR & NATURE 2



Nature<sup>2</sup> is a sanitizing system that uses patented mineral-bed technology to provide crystal clear water and improved water quality. Working with the pool filtration system, Nature<sup>2</sup> uses elemental minerals that combine with a small amount of chlorine to inhibit bacteria growth and eliminate contaminants. Minerals make the water noticeably softer and less chlorine means a lower potential for red-eye, dry skin or foul odors. With Nature<sup>2</sup>, your swim experience is clean, fresh, and gently soothing.

## Nature<sup>2</sup> PROFESSIONAL "G"

Mineral sanitizer dispenser for all In-Ground pools.  
(order mineral cartridge separately)

- #W25904 Nature<sup>2</sup> Professional "G" Vessel 2" . . . . . \$754.28
- #W28125 G25 Cartridge 25,000 Gallons . . . \$212.06
- #W28135 G35 Cartridge 35,000 Gallons . . \$231.80
- #W28145 G45 Cartridge 45,000 Gallons . . \$250.61



## Nature<sup>2</sup> "A" SANITIZER

Nature<sup>2</sup> "A" brings all the sanitizing benefits of mineral technology to your above ground pool.

#W28165 A30 Mineral Cartridge . . . . . \$193.26



## Nature<sup>2</sup> EXPRESS

Nature<sup>2</sup> allows pool owners to bring all the benefits of mineral technology to their existing pool with a quick, do-it-yourself installation. The unit attaches to the plastic plumbing of most inground and above ground pool systems.(comes complete with mineral cartridge for pools up to 25,000 gallons)

- #W20086 Nature<sup>2</sup> Express 1/G . . . . . \$266.05
- #W20176 Nature<sup>2</sup> Express A/G. . . . . \$253.45
- #W28175 Nature<sup>2</sup> Express 1/G + A/G Mineral Cartridge. . . . . \$183.58



## Nature<sup>2</sup> SPA

Nature<sup>2</sup> Spa works with your existing filter to give you clean, clear water without high levels of chlorine. A difference you can see, feel and smell.

- #W20750 Spa Purifier. . . . . \$54.45
- #W29300 Spa Test Strips . . . . . \$17.03



# CHEMICAL WATER BALANCE PRODUCTS & FILTER AID

## CHEMICALS ETC.



**A. SODA ASH – (pH UP)**  
Dry granular product to increase pH of pool water. When pH drops below 7.2 soda ash will help restore your pool water to its proper pH level.

- #300-05 5-lb. container . . . . . \$13.50
  - #300-10 10-lb. container . . . . . \$21.32
  - #300-50 50-lb. bag . . . . . \$39.24
- Also, pH Up available in Great Lakes Biochemical brand.
- #3454 2-lb. jar . . . . . \$5.56
  - #3456 4-lb. jar . . . . . N/A
  - #3458 8-lb. container . . . . . \$15.14



**B. SODIUM BISULPHATE – (G.B.S. or pH DOWN)**  
Is a granular form of muriatic acid and is safer, easier and less corrosive. Whenever pH rises above 7.6 add pH reducer.

- #312-06 6-lb. container . . . . . \$21.20
  - #312-12 12-lb. container . . . . . \$37.92
  - #312-50 50-lb. drum . . . . . \$66.50
- Also, pH Down available in Great Lakes Biochemical brand.
- #3489 2-lb. jar . . . . . \$4.82
  - #3491 4-lb. jar . . . . . \$10.38
  - #3493 10-lb. container . . . . . \$17.46

**NOTE:** 50 lb. bags of Sodium Bisulphate (G. B. S.) available on request for BIDS.



**C. SODIUM BICARBONATE – (ALKALINITY INCREASER)**  
Is a granular product to increase the total alkalinity in your pool water when it drops below 80 p.p.m.

- #333-05 5-lb. container . . . . . \$13.14
  - #333-10 10-lb. container . . . . . \$22.44
  - #333-50 50-lb. bag . . . . . \$38.50
- Also, available in Great Lakes Biochemical brand.
- #3497 7½-lb. jar . . . . . \$14.46
- Dosage: 1½ lb. per 10,000 gallons of water will raise the alkalinity level 10 p.p.m.



**D. HAL-STA – (POOL CONDITIONER or STABILIZER)**  
Chlorine and its derivatives are susceptible to rapid decomposition by the sun's ultraviolet rays. To cut this loss and improve the chlorine's active life, stabilize with pool conditioner. Stabilizer is compatible with the chlorine releasing it at a slow rate to last longer and reduce chemical needs.

- #3393 2-lb. container . . . . . \$13.46
  - #3395 4-lb. container . . . . . \$26.68
  - #3396 25-lb. container . . . . . \$116.300
  - #3397 45-lb. container . . . . . \$196.20
  - #3398 100-lb. drum . . . . . \$365.620
- Also, available in Great Lakes Biochemical brand.
- #3481 2-lb. jar . . . . . \$8.64
  - #3483 4-lb. jar . . . . . \$16.64
  - #3486 10-lb. jar . . . . . \$40.14
- Dosage: 1 lb. per 4,000 gallons of water.



**E. SODIUM THIOSULPHATE**  
When chlorine concentration becomes too high in pool water, use this chemical to lower chlorine level safely.

- #335 5-lb. pail . . . . . \$24.30
  - #339 25-lb. pail . . . . . \$101.80
  - #340 50-lb. pail . . . . . \$190.64
- Dosage: 1 lb. per 100,000 gallons of water decreases chlorine 1 p.p.m.



**F. CellaPerl® PERLITE FILTER MEDIA FOR SWIMMING POOLS**  
CellaPerl® is a lightweight filter media suitable for use in all diatomaceous earth (DE) filters

- **EASY TO HANDLE**  
Lightweight Bags Makes it Easier for All to Use
- **ENVIRONMENTALLY FRIENDLY**  
All natural, Non-Toxic Product
- **GOOD CLARITY**  
Removes Particles Down to 4.0 Microns
- **IMPROVED OIL ABSORPTION**  
Provides a Cleaner Pool

- #313-25 lb CellaPerl® . . . . . \$37.38



**G. CALCIUM CHLORIDE**  
Dry granular chemical used in increasing hardness of the water.

- #3446 6-lb. jar (GLB brand) . . . . . \$10.44
  - #3442 15-lb. pail (GLB brand) . . . . . \$28.52
  - #318-50 50-lb. bag . . . . . \$32.10
- Dosage: 5 lb. per 10,000 gallons of water increase hardness 25 p.p.m.



**H. DIATOMACEOUS EARTH**  
Swimming pool grade precoat media produces brilliantly clear water for any diatomaceous filters.

- #310 50-lb. bag D.E. . . . . \$47.80 ea.
  - #310-P Pallet Price 50lb BAG-36 per bag . . . . . \$43.00 ea.
  - #316 25-lb. bag D.E. . . . . \$24.86 ea.
  - #FW60 50-lb. bags special D.E. . . . . \$130.00 ea.
- for regenerative filters . . . . .



**I. MURIATIC ACID**  
Is a liquid chemical used for lowering total alkalinity or pH.

- #325 1-gal. container . . . . . \$7.17

Note: Cases consist of 4 gallons.

**J. ANTI-FREEZE (non-toxic)**  
Protects your pool and spa water systems from freeze damage to 50°F (below zero) when used as directed (propylene glycol base).

- #399 1-gallon container . . . . . \$5.80

**K. WIPE OUT By King Technology**  
Quickly penetrates dirt, grease and grime and holds them in suspension for fast, easy removal.

- No scrubbing
- No toxic fumes
- Will not affect water balance
- Safely used on fiberglass, tile, concrete, marble, wood, covers and vinyl liners.

- #KING-6012 quarts . . . . . \$14.38
- #KING-6012-1 gallon . . . . . \$42.75

**L. WATERTITE LEAK SEALER**  
Fix cracks without draining. Dual action formula first stops and then seals leak with a waterproof glaze.

- #3643 quart . . . . . \$29.26

## BALANCERS



### A. Leisure Time Spa Up

A granular product that raises pH and total alkalinity levels in hot water. Increases the effectiveness of the sanitizer when levels are in range.

- Spa water should be maintained at a pH of 7.2-7.8 and a total alkalinity of 80-120 ppm.
- Compatible with all sanitizers.

#3998 Spa Up 2 lbs. . . . . \$10.65

### B. Leisure Time Spa Down

A granular product that lowers pH and total alkalinity levels in hot water. Increases the effectiveness of the sanitizer when levels are in range.

- Always maintain the pH of your spa water between 7.2-7.8.
- A high pH can cause scaling and or cloudy water.

#3997 Spa Down 2 lbs. . . . . \$11.07



### C. Leisure Time Calcium Booster

Raises the level of water hardness, which helps prevent foaming and corrosion of equipment to extend the life of the spa.

- Maintain a hardness level of 150-400 ppm.
- Compatible with chlorine, bromine, ozone and biguanide sanitizers.

#3999 Calcium Booster 2 lbs. \$11.94

## CLARIFIERS



### D. Leisure Time Bright & Clear

Specially designed for hot water application, Spa water becomes cloudy because millions of small, suspended particles accumulate in the water. The particles are too small to be filtered out. By using Bright & Clear, the small particles combine to form larger particles that can be trapped by the filter to improve water clarity.

- Clears cloudy spa water fast.
- Compatible with chlorine, bromine, ozone and biguanide sanitizers

#3995 Bright & Clear 2 lbs. \$18.278

### E. Foam Out

Foam Out rids spas of foam caused by a concentration of body oils and other materials. This fast acting liquid suppresses foam and suds in spas, hot tubs, therapeutic pools and fountains.

#3637 Foam Out 32 oz. . . . \$15.42

#3639 Foam Out 1 Gallon . . \$76.78



### F. Leisure Time Metal Gon

Sequesters iron, copper and other minerals and prevents staining of spa surfaces. It is highly concentrated and only needs to be added upon start-up.

- Last from refill to refill.
- Compatible with chlorine and bromine sanitizers

#3989 Metal Gon 2 lbs. . . . . \$15.78

## CLEANERS



### G. Leisure Time Jet Clean

Keeps spa and jetted tub plumbing clear of organics, oils, dirt and minerals to prevent buildup that can restrict water flow and damage equipment.

#3990 Jet Clean 2 lbs. . . . . \$12.84

## SANITIZER & SHOCKS

### H. Leisure Time Reserve

A bromide solution that remains in a stable bank in the spa water until Renew oxidizer added, releasing bromine to provide a non-chlorine sanitizing system.

- This product should be added when the spa/hot tub is filled and used weekly thereafter to maintain a bank of bromine water.
- Compatible with bromine sanitizing systems.

#3993 Reserve 2 lbs. . . . . \$22.20



### I. Leisure Time Renew

A non-chlorine shock oxidizer treatment with a buffering element that eliminates odors and clears cloudy water by reducing contaminants. Can be used with chlorine, bromine or other sanitizers.

#3994 Renew 2 lbs. . . . . \$27.68



### J. Leisure Time Brominating Tablets

Low-odor, low-dust tablets fit all floaters. When used as directed this product will sanitize spa and hot tub water, keeping it clean, clear and free of odor. This product gives the effectiveness of chlorine without the chlorine odor.

- Easy-to-dose tablets.
- Compatible with bromine sanitizing systems.

#3991 Brom Tabs 2 lbs. . . . . \$37.78

### K. Leisure Time 56 Granular

Specifically formulated for spas and hot tubs, this concentrated granular chlorine effectively sanitizes and shocks hot water to keep it clean and clear.

- Maintains clean, clear sanitized water
- Compatible with chlorine sanitizing systems.

#3992 56 Granular 2 lbs. . . . \$32.13



**833-SWIM-327**  
833-7946-327  
[www.halogenupply.com](http://www.halogenupply.com)

# POOL PRODUCTS



## NON-CHLORINE SHOCK

### A. OXY-BRITE® NON-CHLORINE SHOCK OXIDIZER

Oxy-Brite® non-chlorine shock oxidizer creates sparkling water and shock treats in one step. Containing DuPont™ Oxone®, a powerful oxygen-based oxidizer, its powerful formula rids pool water of contaminants that cause odor and irritation. It also brightens and clears the water with unique blue water brightening crystals.

#3400 1 lb. pouch . . . \$8.72 #3406 20 lb. pail . . . \$148.84  
 #3402 2.2 lb. bottle . \$18.78 #3408 50 lb. drum . \$328.86  
 #3404 5 lb. bottle . . . \$40.22

Swimming can resume in just 15 minutes! 1 lb. treats 10,000 gallons of water. Use weekly as part of your pool maintenance program. Compatible with chlorine, bromine, salt water chlorine, ozone and minerals



## CLARIFIERS

### B. CLEAR BLUE® CLARIFIER

This super-concentrated clarifier adds sparkle while removing particles that dull pool water. Clear Blue® clarifier improves filter efficiency and reduces sanitizer demand by removing organic particles that clog filters without affecting pH.

#3421 gallon bottle . . . \$57.20  
 #3423 quart bottle . . . \$18.76

Use just 2 fl. oz. per 10,000 gallons weekly to keep water sparkling clear. Will not affect water balance. Compatible with chlorine, bromine, ozone, salt water chlorine and biguanide sanitizing systems.



### C. NATURAL CLEAR® ENZYME CLARIFIER

Natural Clear® clarifier is an enzyme-based water cleaner that quickly rids pools of organics that cause odors, scum lines and cloudy water and helps keep filters clean.

#3405 quart bottle . . . \$14.20  
 #3407 gallon bottle . . . \$52.30

Compatible with chlorine, salt water chlorine, bromine, ozone and biguanide sanitizing systems. Prevents waterline buildup and clogged filters by rapidly digesting oils, lotions and organics. Improves filtration.



### D. DROP 'N' VAC® FLOCCULENT

With clarifying capabilities, this product drops unfilterable debris to the bottom of the pool for easy vacuum removal. This formula is effective over a wider range of pH levels than comparable products.

#3413 quart bottle . . . \$21.78

Compatible with chlorine, salt water chlorine, bromine, ozone and biguanide sanitizing systems. Prevents waterline buildup and clogged filters by rapidly digesting oils, lotions and organics. Improves filtration.



## ALGAEICIDES

### E. ALGIMYCIN® "2000" ALGAEICIDE

Algimycin® 2000 algaeicide kills, prevents and controls all algae types. A special wetting agent penetrates and kills algae cells. This nonmetallic, poly-complex formula gives fast and effective control with no foaming or staining. It also acts as a clarifier and filter aid by removing algae fast.

#3429 quart bottle . . . \$33.38  
 #3431 gallon bottle . . . \$117.46

Fast and effective treatment for green, black and yellow algae. Compatible with chlorine, bromine, ozone, salt water chlorine and biguanide sanitizing systems.



### F. ALGIMYCIN® "1000" ALGAEICIDE

This copper/quat formula eliminates black algae. Its patented triple-chelation process holds copper ingredients active in solution for longer algae control.

#3425 quart bottle . . . \$41.04

Swimming can resume immediately after treatment. Compatible with chlorine, bromine, mineral purification systems, salt water chlorine and ozone sanitizing systems



### I. ALGAE-X

Algae-X is a non-foaming multipurpose 30% polymer algaeicide that treats green and yellow algae. It is effective over a wide pH range.

#3445 quart bottle . . . \$28.30

Does not require pH adjustments to be effective. Compatible with chlorine, bromine, salt water chlorine, ozone, biguanide and mineral sanitizing systems



### H. VANQUISH® DEPOSIT CONTROL

Specially formulated to treat the pink deposits that accumulate on pool walls and in plumbing, Vanquish® deposit control treats pink, white and clear deposits in any swimming pool, including those sanitized with biguanide systems.

#3437 quart bottle . . . \$28.30

Compatible with all sanitizers including chlorine, bromine, salt water chlorine, ozone, minerals and biguanide.

### G. STRIKE OUT® ALGAEICIDE

Designed to control green and mustard algae, this chelated 7.4% copper algaeicide is effective and economical.

#3448 quart bottle . . . \$24.66

Swimming can resume immediately after treatment. Compatible with chlorine, bromine, ozone and salt water chlorine sanitizing systems.



### J. ALGIMYCIN® "600" ALGAEICIDE

This non-foaming, triple-action 60% polymer algaeicide destroys and prevents the regrowth of green algae and increases water clarity all in one step.

#3433 quart bottle . . . \$23.58

Does not require pH adjustment to be effective ideal for winterizing pools. Compatible with chlorine, bromine, salt water chlorine, ozone, biguanide and mineral sanitizing systems



**833-SWIM-327**  
 833-7946-327  
[www.halogensupply.com](http://www.halogensupply.com)



**SURFACE CLEANERS**

**A. TLC® SURFACE CLEANER**

TLC® surface cleaner removes oil, grime and mineral scale from common pool surfaces such as tile, vinyl and concrete. Its thick, concentrated formula clings to upright surfaces longer for more effective cleaning power. Do not use TLC® surface cleaner on marble, porcelain, terrazzo, enamel surfaces or bronze and metallic glazed tiles, or other surfaces not intended for cleaning.

#3434 quart bottle . . . . . \$15.48

Usage: Always wear rubber gloves with a sponge, cloth or soft brush for application. Allow 3 minutes while it bubbles then scrub briskly.



**STAIN PREVENTION/ MINERAL CONTROL Cont.**

**E. SUPER SEQUA-SOL® SEQUESTERING AGENT**

This concentrated granular is specially formulated to protect pool surfaces from minerals in the water and is ideal for use with hard water. It is also great for pool openings or when adding make-up water. Helps neutralize small quantities of stain-producing minerals such as iron, copper or manganese that occur when adding make-up water or initially filling a pool

#3414 2 lb. bottle . . . . . \$33.86  
#3416 20 lb. pail . . . . . \$250.46

Dosage: initial treatment 10 oz. per 10,000 gallons of water. Weekly treatment: 2 oz. per 10,000 gallons of water.



**B. COVER CARE**

Cover Care cleans, deodorizes and protects pool and solar covers from grime, grease, oils and dirt, leaving only a fresh lemon scent behind. Cover Care can also be used to clean plastic or canvas outdoor furniture, boat covers, umbrellas and other vinyl and canvas poolside accessories.

#3365 quart bottle . . . . . \$10.68

Dosage: Dilute 12 fl. oz. of Cover Care with 2½ gallons of water and spread over the entire cover. Clean with nylon brush and then rinse cover with fresh water.



**STAIN PREVENTION/ MINERAL CONTROL**

**C. STAIN MAGNET**

This granular formula quickly eliminates metallic stains from pool surfaces with no need to test the water or close the pool. It is compatible with most types of pool surfaces.

#3420 2½ lb. Granular . . . . \$27.24



**D. SEQUA-SOL® SEQUESTERING AGENT**

Sequa-Sol® sequestering agent holds iron, manganese, copper and calcium in solution so they do not react with other elements in the water. It prevents staining, scale and rust on pool equipment, pipes and fittings. Protects pool equipment and surfaces from stains, scale and ruse.

#3410 quart bottle . . . . . \$23.06

#3412 gallon bottle . . . . . \$87.40

Dosage: initial treatment 16 fl. oz. per 10,000 gallons of water. Weekly treatment: 4 fl. oz. per 10,000 gallons of water.

**FILTER CLEANERS**

**F. FILTER CLEANSE**

This multi-purpose granular formulation cleans and unclogs all types of swimming pool filters of grease, oils and scale with a combination of acids and detergents. Its unique chemistry will gradually change from red to yellow as it cleans. Use routinely once every month or two during season to maintain efficient operation

#3426 2 lb. bottle . . . . . \$23.04

#3430 20 lb. bottle . . . . . \$213.92

#3432 50 lb. drum . . . . . \$350.24

Dosage: Dissolve 1 lb. in 5 gallons of lukewarm water and let soak overnight (at least 12 hours).



**G. FILTER FRESH® FILTER CLEANER**

This specially developed acid-based liquid cartridge cleaner removes debris overnight. Regular treatment with this soak-and-rinse formula helps filters operate at maximum efficiency. Removes body oils, suntan lotions, grease and other organic materials as well as scale and mineral buildup from all swimming pool filters

#3629 quart bottle . . . . . \$16.15

#3631 gallon bottle . . . . . \$46.04

Dosage: 16 fl. oz. of Filter Fresh with every 2½ gallons of lukewarm water, then place elements in solution and allow to soak for 12 hours.



**H. FILTER RINSE**

This backwashing aid for sand filters couldn't be easier to use! Just pour it into the pool skimmer to clear sand particles of caked-on organic and inorganic materials. One-step formula cleans sand filters fast. Renews the sand particles and keeps the filter operating at maximum efficiency

#3499 quart bottle . . . . . \$20.54

Dosage: Adding filter rinse to the skimmer during the backwash cycle removes this caked-on material, and permits free and even water flow through the sand. 8 oz. per backwash.



**ULTIMA®**

**I. ULTIMA® ENZYME CLARIFIER**

- Enzyme & clarifier in 1
- Clears cloudy water
- Improves filter efficiency
- Compatible with sanitizers
- Non-toxic biodegradable

#3427 1/2 gallon container . . \$22.38



**J. ULTIMA® TOTAL CONTROL SHOCK & ALGAEICIDE**

Ultima® Total Control is a fast-acting shock and algaeicide in one formula. It combines the anti-algae power of chlorinating compounds and chelated copper for immediate and extended relief from black, green and yellow algae. It shock treats at the same time, leaving your pool crystal clear and contaminant-free.

- Shock treats and buffers pH
- Controls algae
- Improves water clarity
- For best results, use this product in the evening after pool use is finished for the day

#3424 3 lb. granular bottle . . \$27.80

Dosage: 3 lb. per 20,000 gallons.



**833-SWIM-327**

8 3 3 • 7 9 4 6 • 3 2 7

[www.halogensupply.com](http://www.halogensupply.com)

# CHEMICALS

## CHEMICAL PRODUCTS BY ALL CHEM

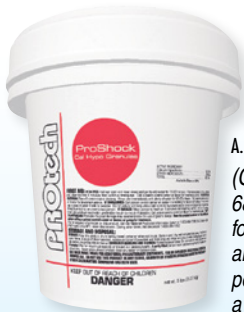

### A. PROSHOCK

(Calcium Hypochlorite)-68% available chlorine in powder form. Destroys bacteria, algae, and fungi. Can be manually poured into pool or fed through a chlorinator.  
(Formerly HTH)

- #PTHS-308 5-lb. pail . . . . . \$26.00
- #PTHS-304 25-lb. pail . . . . . \$104.18
- #PTHS-305 50-lb. pail . . . . . \$199.18

### POWER BLAST 70

68% available chlorine in powder form (commercial use).  
#308 100-lb. drum . . . . . \$339.28



### B. SUPER PROSHOCK

(Calcium Hypochlorite)-73% It is a more powerful shock treatment with more of the benefits pool owners look for. 73% available chlorine. No need to pre-dissolve because it quickly dissolves in less than a minute.  
(Formerly HTH)

- #PTHS-351 1-lb.(73% shock) . . . . . \$5.54
- #PTHS-358 5-lb.(73% shock) . . . . . \$28.68
- #PTHS-354 25-lb.(73% shock) . . . . . \$111.60
- #PTHS-355 50-lb.(73% shock) . . . . . \$211.54



### C. PULSAR TABLETS

A specially blended form of calcium hypochlorite (65% available chlorine). The pellets contain an additive that reduces the scale usually associated with calcium hypochlorite solutions. These patented pellets have a uniform dissolution rate, and provide steady, uniform chlorination of pool water.

- #165-50 50-lb. drums . . . . . \$198.00
- Call for Pallet Pricing

## CHEMICALS



### D. HAL-O-CHLOR (liquid chlorine)

12-15% sodium hypochlorite solution. Kills bacteria, algae and is used as disinfectant and deodorizer. Poured into pool directly or fed by chlorinator. Available in 1 gallon size throwaways.  
#302 1-gal. . . . . \$6.56

## NON CHLORINE SHOCK



### F. PROTECH – NO CHLOR

No Chlor is an auxiliary, non-chlorine shock treatment. It oxidizes organic materials in pool water and allows swimming immediately after use. Use on a regular weekly basis to improve the efficiency of your sanitizing chemicals.

- #3311 1-lb. bag . . . . . \$7.58
- #3313 6-lb. container . . . . . \$39.46
- #3309 25-lb. pail . . . . . \$143.10
- #3310 50-lb. pail . . . . . \$268.28



### G. PROCHEM POOL SHOCK (calcium hypochlorite)

65% available chlorine used for super chlorinating and winterizing pool water.  
#3305 1-lb. bag . . . \$5.18



### J. THE BUG

Devours scum, slime and grime from pools and spas  
• Absorbs 40 times its weight in body oils and lotions  
• 300% more surface area than the ball and cannot be closed in the water lines • When one side is scummy flip over, when saturated clean and reuse • Under normal conditions The Bug should last an average season.  
#SB-2 Double Pak \$13.68



### K. BUGMITT

• Abrasive pad is permanently bonded to the latex mitten  
• Ideal for fiberglass, acrylic, vinyl and tile  
• Scour powder designed specifically to remove scum lines from pools and spa.  
#SD-1 . . . . \$8.98



### L. BUG HOUSE

Traps debris, scum and bugs in most skimmer baskets. Place Bug House inside basket with stretch elastic binding for over the rim.  
#BH-3 . . . . \$6.01



### M. ALGAE BUGGER

Great for cleaning Sand and DE Filters plus cartridge filters. Ideal for hundreds of other uses. Algae Bugger features a shut off valve for easy control. Simply attach to garden hose.  
#AB-1 . . . . . \$17.03



### N. BUG-STRIP

Repairs fabric for solar and winter covers.  
• Easy to apply  
• Unsurpassed adhesion  
• Ultraviolet resistant  
• High strength reinforced.  
#BS-1 . . . \$12.65



### O. POLLEN BUG-A-BOO

Collects pollen, foam, minute insects & surface oils.  
#PB-2 . . . . \$8.98



## ALGAECIDES



**A. PROTECH – ALGAECIDE 30**  
Dual acting, concentrated algaecide, specially formulated with 30% polyquat. Non-foaming.  
#3320 quart . . . . . \$14.78



**B. PROTECH – ALGAECIDE 60 PLUS**  
Dual acting, concentrated algaecide which prevents and kills black and mustard algae. Specifically formulated with 60% polyquat. Non-foaming.  
#3324 quart . . . . . \$22.10



**C. PROTECH – COPPER ALGAECIDE**  
Economically priced. Copper algaecide is specially formulated for the smaller volume vinyl pool.  
#3352 quart . . . . . \$21.60



**D. PROTECT – YELLOW ELIMINATOR**  
This product is specially formulated to eliminate cloudy water due to accumulations of yellow or mustard colored debris from pool surfaces.  
#3353 2 lbs. . . . . \$20.66



**E. YELLOW OUT by Natural Chemistry**  
• Amazing algae cleanup results when used prior to shock treatment with a EPA-Registered compound that kills green and mustard algae.  
• 2lbs per 15,000 gallons of water.  
#3399 . . . . . \$19.68

## CLARIFIERS



**F. PROTECH – CLARIFIER**  
Highly concentrated water clarifier. Removes small, non-filterable particles by enlarging them to a filterable size. Does not affect pH.  
#3318 quart . . . . . \$8.90



**G. PROTECH – SUPER CLARIFIER**  
For the most healthful sparkling clean water possible use super clarifier once a week for desired water clarity.  
#3334 quart . . . . . \$11.75



**H. PROTECH – 4 IN 1 NATURAL CLARIFIER**  
• Clarifies cloudy water  
• removes excess metals  
• eliminates oil & scum lines  
• improves filter efficiency.  
#3327 1 quart (10 oz. per 5000 gal.)  
. . . . . \$19.50



**I. PROTECH – SUPER FLOC OUT**  
Thoroughly settles unfilterable suspended debris to the pool bottom so debris may be easily vacuumed to waste.  
#3351 quart . . . . . \$12.15



**J. PROTECH SPA DEFOAMER**  
Liquid that controls foaming and sudsing in spas.  
#3331 quart . . . . . \$13.78

## STAIN PREVENTION & METAL CONTROL



**K. PROTECH – METAL OUT PLUS**  
Super-sequestrant prevents stains caused by iron, copper and manganese in pool water and spa water.  
#3312 quart . . . . . \$17.38



**L. PROTECH A+ STAIN REMOVER**  
Helps remove the most stubborn stains caused by metals and scaling.  
#3321 2 lb . . . . . \$41.92

## SPECIALTY CLEANERS



**M. PROTECH TILE & VINYL CLEANER**  
Concentrated cleaner for use in and around all pools and spas. Removes oil, grime and scale deposits.  
#3325 quart . . . . . \$10.93



**N. PROTECH POOL COVER CLEANER**  
Cleans and deodorizes solar or winter cover. Removes stubborn stains. Easy to apply and rinse.  
#3326 quart . . . . . \$11.68



**O. PROTECH SPA FILTER CLEANER**  
Liquid concentrate excellent for cleaning sand, D.E. and cartridge filter.  
#3329 quart . . . . . \$13.78

## CHEMICALS



**P. DDDS-PINE (WAS HAL-PINE)**  
DDDS cleans, disinfects, deodorizes and sanitizes floors, walls, and bathrooms. 2 1/2 oz. of DDDS-Pine per gallon of water. Pine scented.  
#3116 1 gallon . . . . . \$31.10



**Q. HAL-TILE CLEANER AND BRIGHTENER**  
Use anywhere there is iron, rust, oxidation, hardwater stains, soap scum, magnesium and calcium stains, excellent on tiles and shower stalls.  
#3106 gallon \$24.45

## STAINLESS STEEL CLEANING PRODUCTS



**R. CITISURF 2310** is a high quality blend of chemicals formulated for cleaning, rust removal and passivation of stainless steel products. Citisurf 2310 is specifically designed to provide low cost and efficient removal of all rust and free iron from the surface of stainless steel and other metals, providing the highest chrome oxide levels possible.  
#CF1-2310 Citisurf 1 Gallon \$84.00



**S. RUST + RESCUE 200** is a high quality blend of chemicals formulated for the protection of stainless steel and other metal surfaces from moisture and harsh atmospheric chemicals that could lead to corrosion.  
#RR1-200 Rust + Rescue  
1 Gallon \$120.75

TRI-SODIUM PHOSPHATE

55 lbs.

**T T.S.P. (TRI-SODIUM PHOSPHATE)**  
• Removes dirt, grease and oils to prepare pool surfaces for painting.  
• Removes dirt, grease and oils from filter cartridges and filter elements.  
#331-50 55-lb. bag \$148.68

# STABILIZED CHLORINE & BROMINE

## CHLORINE



### A. PROTECH – DICHLORO 56% CONCENTRATED CHLORINE

Is the best stabilized granular chlorine on the market with a 56% available chlorine and 99% active ingredient. This chlorine leaves no residue and will be protected from the sun's damaging rays that affect chlorine. This quick dissolving granular stays effective against algae and bacteria longer than non-stabilized chlorine.

- #3375 2 lb. bottle . . . . . \$21.94
  - #3376 5 lb. pail . . . . . \$51.02
  - #3377 10 lb. pail . . . . . \$95.28
  - #3380 25 lb. bucket . . . . . \$209.66
  - #3381 50 lb. bucket . . . . . \$363.54
- All 25 lb. & 50 lb. buckets come with childproof easy-open lids.



### B. PROTECH 3" TABLETS – 8 Oz. each

Is an 8 oz. 3" doughnut shaped stabilized slow dissolving chlorine tablet. Each giant Trichlor tablet has the power of 90% available stabilized chlorine with 99% active ingredient. Works great in floaters, skimmers or almost any automatic chlorine feeders.

- #3300 5 lb. pail – 10 tablets . . . . . \$52.64
  - #3301 10 lb. pail – 20 tablets . . . . . \$92.60
  - #3303 25 lb. bucket – 50 tablets . . . . . \$192.36
  - #3304 50 lb. bucket – 100 tablets . . . . . \$363.54
- All 3" tablets come wrapped individually except 50 lb. & 25 lb. containers. All 25 lb. & 50 lb. buckets come with childproof easy-open lids.

### C. PROTECH 1" TABLETS –

#### 1/2 Oz. each

Is a 1/2 oz. stabilized slow dissolving chlorine tablet with 90% available stabilized chlorine and 99% active ingredient. This tablet will leave no residue when totally dissolved in water. Ideal for floaters, skimmers or almost any automatic chlorine feeders.



- #3333 5 lb. pail . . . . . \$54.02
  - #3335 10 lb. pail . . . . . \$99.22
  - #3337 25 lb. bucket . . . . . \$204.26
  - #3338 50 lb. bucket . . . . . \$375.00
- All 25 lb. & 50 lb. buckets come with childproof easy-open lids.

### D. PROTECH STICKS –

#### 8 Oz. each

A slow dissolving 8" stick with 90% available stabilized chlorine and 99% active ingredient. This stick will leave no residue when totally dissolved in water. Ideal for floaters, skimmers or almost any automatic chlorine feeders.



- #3389 10 lb. pail . . . . . \$98.98
  - #3387 25 lb. bucket . . . . . \$203.62
- All 25 lb. & 50 lb. buckets come with childproof easy-open lids.

## BROMINE

### E. PROTECH –

#### BROMINATING TABLET

Is a 63% available bromine and 31% available chlorine. Bactericide-algaecide disinfectant for pools and spas. Bromine is much more effective over a wider pH range and is less irritating to your eyes and skin. Recommended use in an automatic bromine feeder.



- #3339 4 lb. pail . . . . . \$64.12
  - #3340 1 1/2 lb. bottle . . . . . \$24.90
  - #3343 25 lb. bucket . . . . . \$335.66
  - #3345 50 lb. bucket . . . . . \$373.58
- All 25 lb. & 50 lb. buckets come with childproof easy-open lids.

**NOTE:** There is a Hazardous Fee on all Bromine, ProTech 1" & ProTech Sticks if shipped by UPS for \$30.00

## POOL CHLORINATORS

E.



G.



H.



### F. ELONGATED FLOATING CHLORINATOR

Elongated large floating chlorinator. Holds up to 4 lbs of tabs or sticks.

- #B8072 Large Floating Chlorinator . . . . . \$14.90

### G. RAINBOW FLOATING CHEMICAL DISPENSER

Adjustable floating chlorine feeder that has twist lock cap. Holds six 3" trichloro tablet or 3 lbs. of 1" tablets.

- #307 Rainbow floater . . . . . \$15.02
- #R18856 Strainer screen for floater . . . . . \$7.81H.

## POOL CHLORINATORS

- Adjustable flow rate. • Child resistant lock.
- Pools over 10,000 gallons.

- #GAME-11404 Clownfish . . . . . \$34.67

## ABOVE GROUND CHLORINATORS



I.

### I. ABOVE GROUND CHLORINATOR

- Adjustable flow rate. • Holds 3 tablets.
- Pools under 10,000 gallons.

- #GAME-4003 Derby Duck . . . . . \$18.56

## SPA CHLORINATORS

J.



K.



### J. RAINBOW CHLORINE/BROMINE FLOATING DISPENSER

For spas and small swimming pools. Chlorine, bromine tablets or sticks up to 1 1/8" diameter.

- #307A Chlorine/Bromine floater . . . . . \$15.98
- #R18855 Strainer screen for floater . . . . . \$3.93.

### K. SPA BROMINATORS

- #GAME-8000 Derby Duck . . . . . \$16.09



## L. ACID MAGIC

A full strength muriatic acid replacement that is safer to ship, store and handle.

- Up to 90% less fumes than traditional muriatic acid.
- Buffering agents prevent burns to intact skin.
- Equal in strength to 20° baume muriatic acid(31.45%).
- Direct one-to-one replacement for muriatic acid.

**Pools And Spas:** Excellent pH down, alkalinity reducer and filter cleaner. Apply ACID Magic as an acid wash to remove rust, scale, mineral deposits and stains from glass, tile, and porcelain surfaces in showers, locker rooms and restrooms.

- # USA/128-1 1 Gallon . . . . . \$17.22
- # USA/5G-1 5 Gallons . . . . . \$86.14
- # USA/15G-1 15 Gallons . . . . . \$258.40
- # USA/30G-1 30 Gallons . . . . . \$439.42



## M. POOL SALT

- High purity salt for use with salt water chlorinators.
- Quick Dissolving • Contains no YPS
- Meets recommendations of leading chlorinator manufacturers

- #SALT-40 40lb bag . . . . . \$11.09

Guide for 40lb. bags of salt required to increase salt

Pool Gallons	10,000	15,000	20,000	25,000	30,000
Salt 480 ppm	1 Bag	1.5 Bags	2 Bags	2.5 Bags	3 Bags
Salt 3,200 ppm	7 Bags	10 Bags	13 Bags	17 Bags	20 Bags
Salt 4,000 ppm	8 Bags	12.5 Bags	17 Bags	21 Bags	25 Bags

## POOL ENZYME PRODUCTS



**A. Pool Perfect – Just Capfuls Per Week for Clear Perfect Pool Water:** The industry standard for natural enzyme water treatment. Pool Perfect prevents scum and waterline ring. It eliminates chemical odors, keeps filters cleaner, extends filter life and reduces shocking.  
#03220 2 L/67.6 oz. \$34.36



**B. Pool First Aid – The Pool Problem Solver:** Combines powerful broad spectrum natural enzyme formula with our organic clarifier to fix pool problems fast.  
#03122 2 L/67.7 oz. \$27.70  
(2L/67.6oz treats 33,500 gallons)



**C. Pool Magic Spring & Fall – For Hassle Free Spring Startup:** Contains a concentrated natural enzyme based formula designed specifically to work in cold water. It quickly breaks down non-living organic contaminants, and cleans up cloudy, dirty pool water.  
#03722 1 L/33.9 oz. \$19.86  
(1L/33.9oz treats 25,000 gallons)

## PHOSPHATE REMOVAL PRODUCTS



**D. PHOSfree – Eliminates Phosphates from Pools:** Use Natural Chemistry's unique patented formula to reduce phosphate levels in a pool to near zero at initial fill or at season opening. The amount needed depends on pool size and phosphate level in the water.  
#05221 2 L/67.6 oz. \$30.08  
#05121 3 L/101.5 oz. \$40.10  
(1L/33.9oz treats 20,000 gal. pool with 300ppb phosphates)



**E. Pool Perfect+PHOSfree**  
A weekly maintenance product that reduces phosphates and non-living organic waste in pool water. Use it to make your water feel soft and silky while preventing problems such as; waterline rings, non-living organic staining, surface oils, and phosphate build up.  
#05235 2 L/67.6 oz. \$47.32  
#05131 3 L/101.5 oz. \$66.42  
(1 capful weekly treats 8,000 gallons)



**F. Pool Magic+PHOSfree**  
Ideal to treat your pool at the beginning and end of each season as well as reducing phosphates at any time as the first step of Natural Chemistry's Clear, Perfect Water Program. Pool Magic+PHOSfree contains all natural enzymes that break down non-living organics to make opening and closing fast and easy. A quick clean up to start off the season.  
#05141 1 L/33.9 oz. \$25.36  
(1L/33.9oz treats 25,000 gallons)

## METAL AND SCALE CONTROL



**G. Stain Free – Extra Strength:**  
An all natural citric acid product that eliminates metal staining to pool liners and finishes. Stainfree is ideal for treating staining on all pool surfaces. Use with Natural Chemistry's METALfree and you have the ultimate 1-2 combination for stain fighting!  
#07395 1.75lbs. \$39.10



**H. METALfree – Deactivates Metals:**  
A highly effective metal deactivation agent that prevents staining and discoloration from trace metals such as iron and copper. METALfree also prevents scale build-up due to calcium and other minerals. These trace metals and minerals may already be in the pool water or in the fill water. METALfree does not contain phosphonic acids and will NOT raise phosphate levels in pool water.  
#07001 1 L/33.9 oz. \$25.72 (1L/33.9oz treats 20,000 gallons)



**I. SCALEfree:**  
Protects your pool from the damaging effects of scale build-up and staining due to excessive calcium, iron, copper, and other minerals. SCALEfree protects generator cells from life shortening damage and performance issues caused by scale build-up. SCALEfree is compatible with all pool surfaces and can be used with most sanitizing systems.  
Do not use SCALEfree with biguanides.  
#07511 2 L/67.6 oz. \$40.56

## POOL SPECIALTY PRODUCTS



**J. Clear & Perfect Clarifier – The Ultimate 6 in 1 Clarifier:**  
A technologically advanced and highly concentrated pool water clarifier. Use to effectively and quickly clear problem water or to "polish" dull water by removing small suspended particles that filters cannot capture. Clear & Perfect is not pH sensitive, does not affect pool water pH. Does not contain any dyes.  
#03500 1 quart/32 oz. \$21.58



**K. Instant Pool Water Conditioners:**  
Used for stabilizing chlorine in swimming pools from sunlight loss. Works the instant it is added to pool water!  
• Concentrated liquid, one gallon will add 32 ppm of conditioner to 10,000 gallons.  
• Works efficiently in any water temperature  
#07401 1 gallon/3.78L \$35.42



**L. Filter Perfect – Sand and Cartridge Filter Cleaner:**  
A highly concentrated deep cleaning solution that removes build up caused by; oils, grease, non-living organics, and more on filters. It is very effective on cartridge elements, DE filter grids, and sand filters. Filter Perfect improves filter efficiency and lengthens cycles between filter cleanings.  
#03215 1 L/33.9 oz. \$19.34  
(1L/33.9oz treats average size filter.)



**M. COVERfree:**  
A patented technology that is a revolutionary liquid swimming pool cover. It is an advanced mono-layer product that helps save water and money by decreasing evaporation and heat loss. COVERfree creates an invisible barrier on the surface of the water that works even when swimmers are in the pool.  
#07100 1 quart/32 oz. \$27.52  
(4oz per 20,000 gallons weekly)

## NATURAL CHEMISTRY

## PRO SERIES Professional Strength - Professional Results



**N. PRO SERIES® ProZymes**  
PRO SERIES ProZymes Pool reduces the buildup of non-living organic contaminants. Sunscreens, body oils, lotions, cosmetics along with other contaminants make up the non-living organic load that contribute to problematic symptoms such as: waterline rings, short cycling filters, unpleasant odors, poor water clarity and peak load cloudiness. This concentrated naturally based enzyme formula works with all sanitizing systems.  
#20305 5 gallon \$290.20



**O. PRO SERIES® Stain & Scale Control:**  
PRO SERIES Stain & Scale Control protects pools from the damaging effects of scale buildup and staining due to excessive calcium, iron, copper and other minerals. It works without the use of phosphates or harsh acids. This product also works very well at preventing/reducing scale from forming on chlorine generator cells and UV crystal lens. It can be used with most sanitizing systems (do not use with biguanides) and is compatible with all pool surfaces #20705 5 gallon \$307.24



**P. PRO SERIES® PhosREMOVE:**  
Reducing phosphate levels in swimming pools is easy with Natural Chemistry's PRO SERIES phosREMOVE. This product is a lanthanum based formulation. PRO SERIES phosREMOVE effectively and efficiently removes phosphates and reduces pool problems! #20505 5 gallon \$461.36



**Q. PRO SERIES® Filter Cleaner:**  
PRO SERIES Filter Cleaner is a highly concentrated deep cleaning solution that removes buildup caused by: oils, grease, non-living organics and more on filters. It is very effective on cartridge elements, D.E. filter grids, sand filters and regenerative media filters. It improves filter efficiency and lengthens cycles between filter cleaning. PRO SERIES Filter Cleaner is compatible with chlorine, bromine and alternative sanitizing systems. Cleans without acid!  
#20325 5 gallon \$312.54

## SPA PRODUCTS



**R. Spa Perfect – One Capful Per Week\* for A Perfect Spa:**  
Specifically formulated for hot water temperatures and is a patented natural enzyme and botanical extract formula that powerfully, yet gently biodegrades body oils, cosmetics, suntan oils, and other non-living organics. No more waterline rings, clogged filters or cloudy smelly water. Spa Perfect is also a continuous cartridge filter cleaner. Since oils don't build up, cleaning with nasty chemicals and acids is rarely required.  
#04021 16 oz. \$9.48 #04131 1 L/33.9 oz. \$18.74  
#04034 2 L/67.7 oz. \$33.04 #04100 5 gallon/18.9L \$284.50  
\* 1 capful per week treats 400 gallons



**S. Spa Purge – Spa Plumbing Cleaner:**  
Restores spa plumbing to original condition. Removes built-up organic waste deposits from all spa plumbing. Easy and very safe to use. Cleans where you can't.  
#04137 1 L/33.9 oz. \$19.34  
(1L/33.9oz treats any size spa.)

**CURRENT RESIDENT or**

PRESORTED  
 STANDARD  
 U.S. POSTAGE  
 PAID  
 ALGONQUIN, IL  
 PERMIT NO. 13

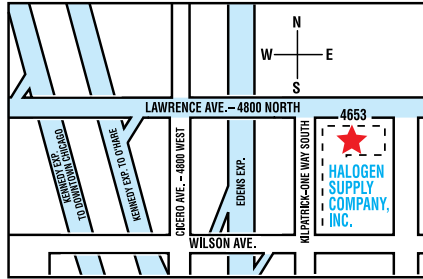

**EASY TO FIND... We're just minutes away!**

*For over 80 Years Halogen has been Integrating cost and resource-saving technologies without compromising performance and safety. The Halogen Total-System Approach recognizes the importance of integrating filtration, circulation and water chemistry control. The synergy of these components contributes to the longevity, performance and efficiency of a complete pool system.*

The  **HALOGEN**  
**TOTAL-SYSTEM Approach**

*Whether you're thinking about a new aquatic facility or a retrofit of your existing pool. Combine Halogen's Total-System Approach with our hands-on technical support, project management emphasis and customer advocacy, and the Solutions, Savings and Advantage you receive are clear! Call our Commercial Division at 1.833.SWIM.327.*

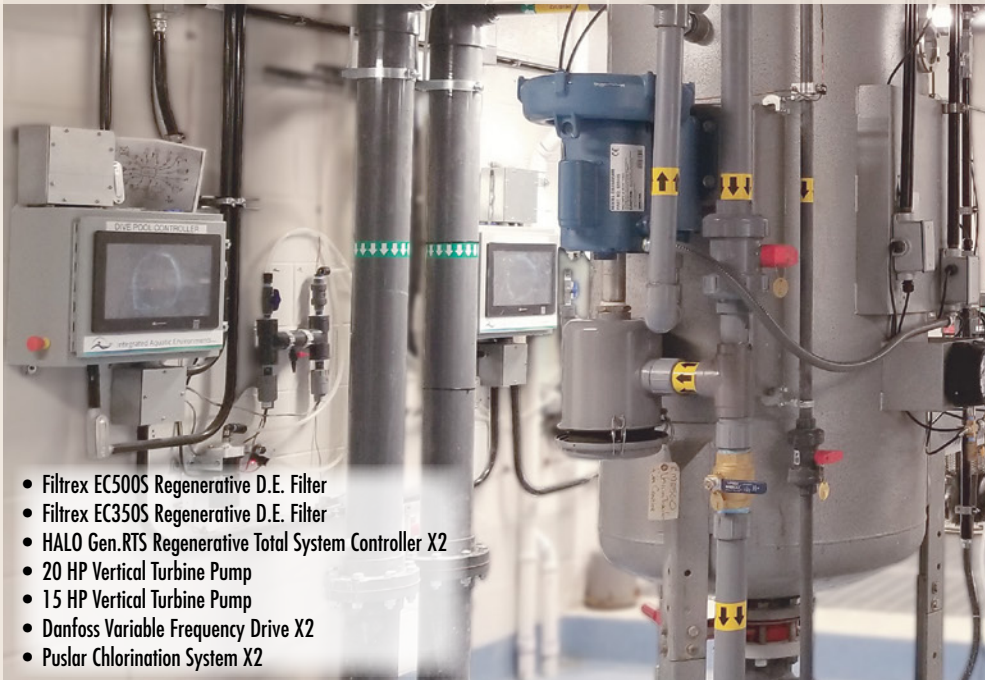

- Filtrix EC500S Regenerative D.E. Filter
- Filtrix EC350S Regenerative D.E. Filter
- HALO Gen.RTS Regenerative Total System Controller X2
- 20 HP Vertical Turbine Pump
- 15 HP Vertical Turbine Pump
- Danfoss Variable Frequency Drive X2
- Puslar Chlorination System X2

- East Leyden High School
- Franklin Park, IL
- Dive Pool 99,708 Gallons
- Lap Pool 218,790 Gallons