

Catalog #99
2024

SINCE 1939

ALMOST EVERYTHING FOR YOUR POOL

Residential • Commercial • Recreational



1.833.SWIM327 | halogensupply.com | Halogen Supply Co. 4653 W. Lawrence Ave Chicago IL 60630-2588





Since 1939 Halogen has been leading the way in the Swimming Pool Industry. With one of the oldest catalogs in the industry, Halogen has continuously provided high-quality pool and spa products throughout

the United States. Serving Residential, Commercial, and Institutional facilities for over 80 years, we've built our reputation on providing excellent customer service, product expertise, and a huge inventory of in-stock items.

It is our intention that this catalog is used as a valuable resource to provide "almost everything for your pool." More valuable than this catalog is our knowledgeable sales staff, which averages over 25 years' experience. It's these quality people that give your purchases from Halogen "VALUE" you won't receive anywhere else. Whatever your swimming pool supply needs may be, please call toll free at 1-833-SWIM-327. We look forward to serving you.

Halogen Supply Co.

CONDITIONS OF SALE

PRICE INFORMATION—All prices are F.O.B. Chicago unless otherwise stated. DUE TO MARKET CONDITIONS, PRICES ARE SUBJECT TO CHANGE WITHOUT NOTICE. Minimum billing \$10.00. All orders under \$10.00 are cash.

TAXES—All Illinois customers are subject to Illinois sales tax of 10.25% and all Michigan customers are subject to 6% sales tax. All tax exempt customers must provide us with proof of exemption in writing.

SHIPPING—All orders requiring shipping will be sent via Best Way at Halogen's discretion. All shipping charges plus a \$2.25 handling charge will be added to customers invoice.

TRANSPORTATION CLAIMS—All reasonable precautions are taken in packing goods for shipment, but we are unable to be responsible for goods damaged or lost in transit. Recovery claims must be filed with the common carrier by the purchaser within the time limit allowed by such a carrier, the loss or damage claim should be noted on the original copy of the freight bill by the receiver.

RETURNS—Merchandise returned for credit must be approved for return by a Halogen authorized representative and must be accompanied by proof of purchase and reason for return. All returns are subject to handling and restocking charges as determined by the product manufacturer and Halogen Supply Company, Inc.

ORDERING—Catalog numbers will expedite the shipment. Weights shown are approximate and a separate billing will be necessary where special packaging for export is required.

TERMS—Net 30 days where credit rating is satisfactory. A service charge of 1½% per month is charged on invoices over 30 days old.

INDEX

| Page | Description |
|--|--|
| 1 | New Products |
| SECTION A • MAINTENANCE | |
| 2 | Poles & Leaf Skimmers |
| 3 | Brushes, Scrubbers & Wysiwash Sanitizer |
| 4 | Vacuum Heads & Parts |
| 5 | Vacuum Hoses, Leaf Traps & Discharge Hose |
| 6 | Hayward Automatic Cleaners & Parts |
| 7 | Residential Automatic Cleaners & Parts |
| 8 | Dolphin Automatic Cleaners & Parts |
| 9 | Portable and Hand Held Vacuums |
| 10 | Olympic Pool Paint |
| 11 | Ramuc Pool Paint |
| 12 | Tiles, Grout, Caulk & Sealant |
| 13 | Sealers & Patching Material |
| SECTION B • PUMPS, FILTERS, HEATERS & PARTS | |
| 14 | Pentair & Starite Pumps |
| 15 | Pentair Pumps |
| 16 | Commercial Pump Parts |
| 17 | Pump Parts & Motors |
| 18 | Replacement Pump Motors |
| 19 | Diatomaceous Earth Filters & Sand Filters |
| 20 | Cartridge Filters |
| 21 | Replacement Filter Cartridges |
| 22 | Filter Parts |
| 23 | Filter Valves & Valve Parts |
| 24 | Pentair Heaters |
| 25 | Raypak Heaters |
| 26 | Pentair, Coates & Jandy Heaters |
| 27 | Hayward Products |
| 28 | Heater Parts |
| 29 | Heater Parts |
| SECTION C • PLUMBING SUPPLIES | |
| 30 | Plumbing Valves |
| 31 | Specialty Tools & Winterizing Products |
| SECTION D • LIGHTING AND WHITE GOODS | |
| 32 | Pool Lights |
| 33 | Pool Lights & Replacement Bulbs |
| 34 | Cycloc Pool Fittings & Skimmers |
| SECTION E • DECK EQUIPMENT | |
| 35 | Ladders, Rails & Accessories |
| 36 | SR Smith Residential |
| 37 | SR Smith Diving Boards, Towers, Starting Platforms & Life Guard Chairs |
| 38 | Paragon Dive Towers, Starting Platforms & Lifeguard Chairs |
| 39 | Competitor Racing Lanes, Reels & Pace Clocks |
| 39 | ADA Compliant Pool Access Lifts |

HOURS

MONDAY THROUGH FRIDAY: 8 A.M. to 5 P.M.

SATURDAY: 8 A.M. to NOON (Except December, January & February)

WINTER HOURS: 8 A.M. to 4 P.M. Monday through Friday

CLOSED SUNDAYS

| Page | Description |
|---|---|
| SECTION F • TEST KITS AND SUPPLIES | |
| 40 | Taylor Specialty Kits & Reagents |
| 41 | Taylor Test Kits |
| 42 | Lamotte Test Kits & Accessories |
| 43 | Test Kits, Thermometers & Patio Clocks |
| SECTION G • SAFETY EQUIPMENT | |
| 44 | Signs & Safety Lines |
| 45 | Safety Equipment & Lifeguard Umbrellas |
| SECTION H • COVERS, INFLATABLES AND TOYS | |
| 46 | Solar Covers & Reels |
| 47 | Winter Covers |
| 48 | VGB Main Drain & Safety Vacuum Release System |
| 49 | VGB Frames & Grates |
| SECTION I • COMMERCIAL EQUIPMENT | |
| 50 | Energy Saving Systems Filters, Variable Frequency Drives, Level Controls & Total System Controllers |
| 51 | Flow Meters & Accessories |
| 52 | Level Controllers, Flow Switch, Gauges & Accessories |
| 53 | Basket Strainers, Pump Connectors, Thermometers, Sight Glasses & Service Clamps |
| 54 | Pulsar Chlorine Feeder Systems & Stenner Peristaltic Pumps |
| 55 | Chemical Feeders (Diaphragm, Erosion & Peristaltic), Chemical Storage Tanks |
| 56 | Automatic Chemical Controllers, Ozone Generators - Float Valves, Pipe Flanges & Flange Gaskets |
| 57 | Commercial Valves (Butterfly, Check, Float & Solenoid Valves) |
| 58 | Chemical Feeder Parts |
| 59 | Chemical Feeder Parts, Tubing & Tubing Fittings |
| 60 | Chemical Controller Parts & Probes |
| 61 | Automation |
| SECTION J • ABOVE GROUND | |
| 62 | A/G Liners, Patch Kits, Ladders |
| SECTION K • SPA ACCESSORIES & SUPPLIES | |
| 63 | Spa Accessories |
| SECTION L • CHEMICALS | |
| 64 | King Technology |
| 65 | Sea Klear/Nature 2 |
| 66 | Chemical Water Balance Products |
| 67 | Leisure Time Spa Chemicals |
| 68 | GLB Pool Products |
| 69 | GLB Pool Products |
| 70 | Chemicals |
| 71 | Chemicals |
| 72 | Stabilized Chlorine & Bromine |
| 73 | Natural Chemistry |

This catalog contains copyrighted materials which may not be reproduced without our consent. Any reproduction or duplication in any form is forbidden.

JANDY VS FLOPRO - VARIABLE-SPEED PUMP



• Powerful Performance

The improved VS FloPro 2.7HP now generates higher head pressure and flow rates to accommodate large pool and spa designs with features such as waterfalls, jets, in-floor cleaning and solar heating systems.

• 115v/230v Dual Voltage Capability

The ability to operate with either 115v or 230v power sources provides installation flexibility and eliminates expensive main power rewiring, making the VS FloPro 2.7HP the ideal aftermarket replacement pump.

• Add iQPUMP01 for Instant Automation

Two auxiliary relays can be used to control other pool equipment, such as booster pumps and salt chlorinators, for easier installation and operation. No need for additional timeclocks!

Choose Your Own Controller (required)

Designed to work with the following Jandy control systems for complete programmability and customization (controller sold separately):

- Jandy AquaLink® Automation Systems
- iQPUMP01 with iAquaLink® App Control
- JEP-R Controller

• Additional Features

Adjustable base for seamless direct replacement of a variety of other pumps in the aftermarket

- Zero Clearance TEFC Motor for cool, quiet operation in tight spaces
- 2"x 2" unions included or utilize 2" internal threads
- Easy Controller Setup auto detects connection to an automation system or a traditional controller, eliminating the need to adjust settings manually
- RS485 Quick Connect Port for faster installation and maintenance
- Dry Contact Relay Control
- Tool-free lid for easy debris removal
- Ergonomic easy-transport handle

| Cat. No. | Voltage | Full Load Amps | THP | WEF | Ship Wt. | Price |
|-------------|---------|----------------|------|---------|----------|------------|
| VSFHP270DA2 | 115/230 | 16.0-10.5 | 2.70 | 8.7/7.3 | 53 lbs. | \$2,544.15 |

NEW PRODUCTS

ROLL-N-VAC

The Original Wheelbarrow Vacuum!

There are many advantages of having a commercial wet/dry vacuum that empties into a wheelbarrow.

- It holds a high capacity. A typical wheelbarrow approved for use with the Roll-n-Vac will hold around 20 gallons of material.
- It easily navigates rough terrain.
- It is easy to dispose of waste. Just lift the Roll-n Vac unit off of the wheelbarrow and wheel it away!



Concrete Slurry:

The Roll-n-Vac Hydrovac2 is ideal when used, for example, as a concrete slurry vacuum. It will suck up concrete slurry about 2x as fast as a regular wet/dry vac.

Pool Service Applications:

The Roll-n-Vac is also a favorite of pool service professionals and makes a great professional pool maintenance vacuum. There are many reasons why the Roll-n-Vac is the best wet/dry vac for pool service professionals. First, it is especially useful for sand filter changes. The Roll-n-Vac Hydrovac2 can accomplish in around 5 minutes which traditionally would take the better part of an hour.

Furthermore, the Roll-n-Vac can be used to clean up "green slime" out of empty pools. The Roll-n-Vac's strong suction allows the user to keep the unit and wheelbarrow up on the pool deck while workers use the long hose (also available in 30ft.) to clean out the pool from below. All waste is transported up top and is ready to dispose of.

*Wheelbarrow sold separately

| | |
|---------------------|------------|
| RNVHD-2 ROLL-N-VAC | \$2,597.40 |
| RNVHOSE-20 20' HOSE | \$167.63 |

JANDY IQPUMP01 FOR VARIABLE-SPEED PUMPS

INSTANT PUMP AUTOMATION

iQPUMP01 enables app control for Jandy variable-speed pumps. A mobile pump user interface that allows pool professionals to easily install, set up, and control the pump using a smartphone and the iAquaLink app, iQPUMP01's built-in hotspot technology makes set up and programming simple - even without Internet access.



iQPUMP01 is compatible with all Jandy Pro Series variable-speed pumps and doesn't require a JEP-R user interface or other automation system. No more bending, climbing, and leaning over hot equipment to access a tiny keypad and difficult-to-read display. Installers can program pump cycles, initiate one-touch quick-clean, and service variable-speed pumps remotely to reduce on-site service visits and increase energy efficiency for the pool owner.

| | |
|----------|----------|
| IQPUMP01 | \$183.65 |
|----------|----------|



LEVELSMART Wireless Autofill

Level-up your pool game, with the LevelSmart™ wireless autofill system. LevelSmart™ is an innovative device designed to help homeowners, property managers, builders and maintenance companies with the challenges of maintaining water levels in pools, spas, ponds, water features, and tanks.

SPECIFICATIONS

| | |
|-------------------------------|---|
| Environmental | Factory-sealed batteries and electronics |
| Valve | 24VAC valve |
| Maximum operating temperature | 130°F / 54°C |
| Minimum operating temperature | 40°F / 4°C |
| Monitoring Cycles | 7-minutes per 30-minutes. Up to 336 minutes of fill time per day |
| Communication | 1,000 feet max. of 433MHz interference free, radio communication |
| Dimensions | Valve Controller (HxW): 3" x 3" (7.6 x 7.6 cm); total width 4.07" (10.34 cm), screw holes 3.55" (9 cm) center-to-center Level Sensor (HxW): 2.85" x 2.9" (7.24 x 7.37 cm) Valve (HxWxL): 5" x 4.5" x 2.5" (13 x 11 x 6 cm) Valve Controller cables: 24VAC Power cable 55" (140 cm); 24VAC Control cable 55" (140 cm) |

| | |
|-----------------------------------|----------|
| LSWA LevelSmart wireless autofill | \$848.28 |
|-----------------------------------|----------|



LEVEL-UP YOUR POOL GAME
...WITH LEVELSMART™

POLES & LEAF SKIMMERS

RESIDENTIAL POLES

- A. #467B 8'-16' telescoping pole \$46.81
- B. #467C 6'-12' telescoping pole \$38.16
- C. #R191128 1 1/2" x 6' plastic pole \$27.33

SERVICE PRO POLES

- D. #212 2-6' heavy duty poles w/stainless steel clips \$130.18
- E. #9018 6'-18' heavy duty 3 piece dual-locking pole \$162.92
- F. #7016E 8'-16' heavy duty Promax telescoping pole \$100.99
- G. #R191088 12'-24' telescoping pole \$104.08
- H. #5432 8'-29' heavy duty telescoping pole \$376.34

COMMERCIAL FIBERGLASS POLES

- I. #8016 8'-16' telescoping pole \$116.51
- J. #8024 12'-24' telescoping pole \$181.48



All poles over 8 feet must ship via truck

HAND SKIMMERS & LEAF RAKES

For professional, commercial and residential use.



- K. #R16C 16" pocket with stainless steel construction and a protective vinyl coating. \$108.76



- L. #LN4135 24" Animal leaf rake w/24" opening \$68.04



- M. #SP500 Spartan easy-flip leaf rake. \$52.56



- N. #R121230 Heavy duty leaf rake constructed of solid anodized aluminum. Squeegee attached to easily pick-up leaves, debris and toys \$48.57



- O. #R121196 Heavy duty skimmer net w/ aluminum frame \$33.46



- P. #R121186 Flexible skimmer with 4' handle. \$33.45



- Q. #R121166 Flexible skimmer net with polyester screen and polypropylene frame. \$19.23

POLE HANGERS

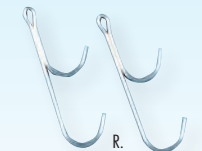

- R. #12P Metal pole hangers. Holds two poles. Packaged with screws. \$11.97

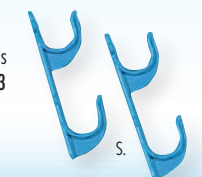

- S. #R221036 Plastic pole hangers. Holds two poles. Packaged with screws. \$10.53

833-SWIM-327
833-7946-327
www.halogenupply.com

NYLON BRUSHES



- A. #R11330 36" Heavy Duty Curved Brush, Aluminum Back, Nylon Bristles (commercial usage) \$101.43
 B. #R11342 24" Heavy Duty Curved Brush, Aluminum Back, Nylon Bristles (commercial usage) \$49.12
 C. #R11046 18" Curved Brush, Aluminum Back, Nylon Bristles (residential usage) \$28.10



- D. #4000 18" Straight Brush, Aluminum Back, Nylon Bristles (residential or commercial use) \$39.80
 E. #R11386 18" Curved Brush, Plastic Back, Nylon Bristles w/end Caps for vinyl liners (residential use) \$16.84

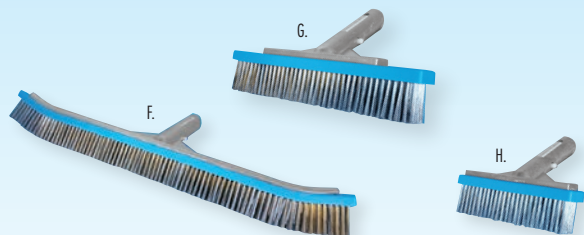

- F. #R11646 18" Curved Brush, Aluminum Back, Stainless Bristles \$50.51
 G. #R11626 9" Straight Brush, Aluminum Back, Stainless Bristles \$30.60
 H. #R11616 6" Straight Brush, Aluminum Back, Stainless Bristles \$24.59

ACID WASH/TILE/DECK BRUSHES



- I. #6020 10" Wood Acid Brush, Tapered \$22.47
 J. #469 5" Wood Acid Brush, Tapered \$18.48
 K. #9600 10" Plastic Acid Brush, Dual Sided, Threaded. \$31.50

WYSIWASH SANITIZER



The Wysiwash Sanitizer is not only a hose-end sprayer. It is a precisely calibrated, scientifically designed and tested, patented sanitizing system.

The Wysiwash System will effectively clean, sanitize, and eliminate odors while blasting away dirt with a jet stream of water.

The hydro-injection venturi system produces a solution of hypochlorous acid that is up to 120 times more effective than liquid bleach!!!

Wysiwash is so easy to use that you will sanitize more often with increased effectiveness. Simply connect the Wysiwash Sanitizer to the hose and spray. There is no need to worry about proper dispensing-it's automatic!

- #WYS-101-ID WYSIWASH Sanitizing Unit only \$157.50
 #20255 WYSIWASH Caplets 5.9 lbs. \$81.80

HANDLES & SQUEEGEE

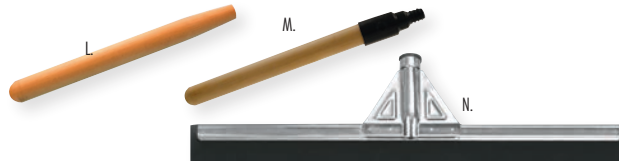

- L. #471 6ft Wood Tapered Handle. \$11.93
 M. #471A 6ft Wood Plastic Threaded Handle. \$14.76
 N. #7090 Aluminum deck squeegee 22" must attach a tapered Handle \$19.55

BRUSHES WYSIWASH SCUBBERS

PAINTING SUPPLIES & ACCESSORIES

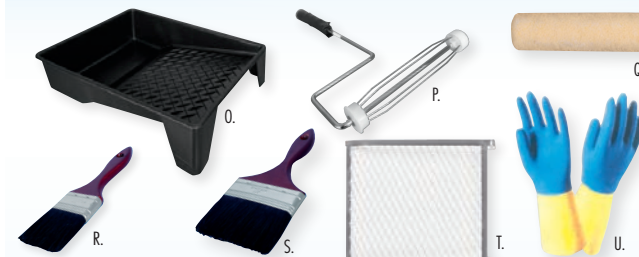

- O. #1525 2 Qt. Plastic Paint Tray \$7.83
 P. #1526 9" Roller Frame \$8.70
 Q. #1527 9" Roller Cover \$3.69
 R. #1528-02 2" Wide Paint Brush \$3.84
 S. #1528-04 4" Wide Paint Brush \$11.04
 T. #SCREEN 5 Gallon Bucket Screen \$10.55
 U. #LN28 28 Mil Large Blue Gloves (reusable) \$7.60

HAND HELD SCRUBBERS



- V. #8500 Hand Held Scrubber w/2 White Light Duty Pads. \$17.12
 #8530 White light Duty Replacement Pad. \$10.35/pair
 W. #8510 Hand Held Scrubber w/2 Blue Medium Duty Pads. \$17.33
 #8532 Blue Medium Duty Replacement Pad. \$11.25/pair
 X. #8520 Hand Held Scrubber w/2 Brown Heavy Duty Pads. \$17.64
 #8534 Brown Heavy Duty Replacement Pad. \$12.04/pair

SWIVEL SCRUBBERS, SPONGES & SCRUBBER PADS



- Y. #8000 Swivel joint snap-in handle, Fits Most Pool Poles, includes White Light Duty Scrubber Pads. \$46.12
 #8030 White Light Duty Scrubber Pads for 8000 Scrubber \$19.13/pair
 Z. #8010 Swivel joint snap-in handle, Fits Most Pool Poles, includes Blue Medium Duty Scrubber Pads. \$43.58
 #8032 Blue Medium Duty Scrubber Pads for 8010 Scrubber \$19.46/pair
 AA. #6510 Corner Heavy Duty Scrubber Brush, Fits Most Pool Poles \$34.23
 BB. #8600 Spa Pad 6" x 9", Will Not Scratch Spa Surface \$5.18
 CC. #8700 Spa Sponge 3 1/2" x 6", Soft, Absorbent, Will Not Scratch Spa Surface. \$7.81
 DD. #8541 Scouring Pad 6" x 9 1/2", Heavy Duty \$4.05

VACUUM CLEANERS & VACUUM PARTS

Commercial Vacuums

PRO-VAC®

These patented vac heads will clean a pool bottom in up to half the time, Unique suction chamber concentrates vacuum velocity equally. Has metal swivel handle and adjustable wheels that increase or decrease vacuum velocity.

Special flex strips guide debris into exclusive suction chamber. Swivel connection for 1½" vac hose while 2" fits directly on body. Recommended by Service Pros throughout the world.

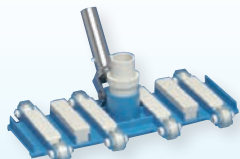

A. #R201276 14" Width. \$159.85

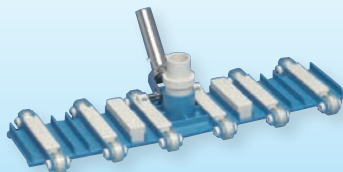

B. #R201286 22" Width. \$203.15

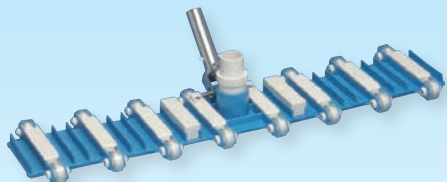

C. #R201296 29" Width. \$246.50

RESIDENTIAL CONCRETE POOL VACUUM

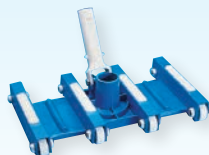

E. FLEXIBLE VACUUM HEAD

A new improved vacuum made of rugged flexible plastic. Use with with 1½" vacuum hose.

#R201112 12" Width \$83.48

VINYL LINER VACUUM



F. CLEAR VIEW VACUUM HEAD

Triangular shaped weighted see-thru design features newly improved two-piece 1¼"-1½" vacuum hose swivel connection which allows hose to move freely without twisting. Replaceable brushes with vinyl bumpers (weight 4 lbs.)

#R201398 \$99.41

#R201540 Brushes for 196 Vacuum Head \$20.52



G. ECONO TRIANGULAR VACUUM

Has replaceable nylon brushes, snap adapt handle and adapters for 1¼"-1½" vacuum hose (weight 4 lbs.)

#R201392 \$53.00

#R201536 Brushes for 194 & 195 Vacuum Head \$18.43



H. VINYL LINER VACUUM-SPECIAL CONTOUR

Shape designed to keep vacuum on pool floor at all times. Replaceable brushes and vinyl bumpers. Fits 1¼"-1½" vacuum hose

#R201350 \$49.73

#R201526 Brushes for 193 New Style Vacuum Head \$17.28

#R201302 Brushes for 198 Old Style Vacuum Head \$10.40



I. MINI-VAC

Designed for use with a garden hose, 1¼", or 1½" vacuum hose. Unit is complete with silt bag, hose adapter, shut-off valve for garden hose use and snap-adapt handle. Includes brush attachment for use on vinyl pools.

#R201146. \$42.69

J. #R201696 Replacement bag

for #201146 Mini-Vac. \$10.49

K. SPA WAND®

Simple, effective hand-held cleaning device for spas.

#5-300-00 Spa Wand Pro XL \$207.61

#5-400-00 Residential Spa Wand \$113.25

#5-500-00 Spa Wand Pro \$184.07



PARTS

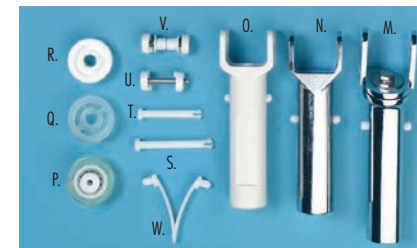

- M. #R201408 Metal swivel handle— Fits most standard vac heads. Swivel feature allows freedom to steer in any direction with ease \$40.70
- N. #R201420 Metal handle fits most vac heads \$23.99
- O. #R201476 Plastic handle fits most vac heads. \$8.43
- P. #R201557 Ball bearing wheel fits most vac heads \$9.27
- Q. #R03022 Polyurethane wheel 1¾" \$5.97
- R. #R03021 White wheel \$3.00
- S. #R03101 Pin for most vinyl vac heads \$3.33
- T. #R03086 Pin for small vac head \$2.43
- U. #R201458 Axle for ball bearing wheel \$2.37
- V. #R201456 Axle for most wheels. \$5.13
- W. #22001 Plastic spring clip — Used to clip handles into poles on all brushes and vac heads. \$3.15

833-SWIM-327
 8 3 3 • 7 9 4 6 • 3 2 7
www.halogensupply.com



SWIMMING POOL VACUUM HOSES

A. COMMERCIAL VACUUM HOSE

Materflex vacuum hose is a high quality, heavy duty, professional grade, swivel cuffed, spiral formed hose with a inner and outer core giving it extreme flexibility and durability. A flat exterior profile keeps snags to a minimum while a smooth interior allows for a better flow.

| | | | |
|------------------------|----------|--------------------|----------|
| #425-50 1 1/2" x 50' | \$134.55 | #424-50 2" x 50' | \$266.22 |
| #425-75 1 1/2" x 75' | \$215.06 | #424-100 2" x 100' | \$531.32 |
| #425-100 1 1/2" x 100' | \$286.47 | | |

B. VACUUM HOSE

Our 1 1/2" Smoothflex vacuum hose is a high quality, medium duty, swivel cuffed hose with excellent flexibility. Durable enough for professionals, yet lightweight enough for the residential user. Round ribs make it easy to handle. Our 1 1/4" Valueflex vacuum hose is a high quality, light duty hose with excellent flexibility. Durable enough for everyday use but lightweight. Comes standard with swivel cuff.

| | | | |
|----------------------|----------|-----------------------|---------|
| #423-25 1 1/2" x 25' | \$60.93 | #1990-18 1 1/4" x 18' | \$36.29 |
| #423-30 1 1/2" x 30' | \$71.06 | #1990-21 1 1/4" x 21' | \$40.59 |
| #423-35 1 1/2" x 35' | \$83.66 | #1990-27 1 1/4" x 27' | \$49.95 |
| #423-40 1 1/2" x 40' | \$94.75 | #1990-30 1 1/4" x 30' | \$55.49 |
| #423-50 1 1/2" x 50' | \$118.44 | #1990-36 1 1/4" x 36' | \$66.58 |

C. ABOVE GROUND FILTER HOSE

Our 1 1/2" premium cuff filter hose provides the strength and flexibility necessary for your filter needs. This hose has Ultraviolet inhibitors and features retail packaging.

| | |
|---------------------|---------|
| #1995-3 1 1/2" x 3' | \$15.43 |
| #1995-4 1 1/2" x 4' | \$17.73 |
| #1995-6 1 1/2" x 6' | \$22.35 |
| #1995-8 1 1/2" x 8' | \$27.00 |



DISCHARGE HOSE

D. ECONOMY BLUE DISCHARGE HOSE

| | | |
|-----------------------|--------------------------|---------|
| #452A-50 1 1/2" x 50' | Prepacked hose | \$42.78 |
|-----------------------|--------------------------|---------|

VACUUM HOSE PARTS & ACCESSORIES

| | |
|---|---------|
| E. #9042100 Standard hose cuff, 1 1/4" for vacuum hoses | \$14.65 |
| #9012100 Swivel hose cuff, 1 1/2" for vacuum hoses | \$18.10 |
| #9112100 2" hose cuff | \$20.84 |
| #90621 H.D. hose cuffs, 1 1/2" for vacuum hoses | \$12.90 |

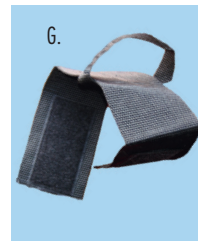

F. #FG-VHG VACUUM HOSE REEL

Easy snap together assembly for holding and storing bulky vacuum hoses. Made of high density polyethylene. Color is white

| |
|--------|
| #82.90 |
|--------|

G. HOSE HUGGER – Vacuum Hose Carrier

| | |
|--|---------|
| #HH200 Hose Hugger 3" x 34" will accommodate 2" x 50" hose or 150' electrical cord | \$12.31 |
| #HH101 Hose Hugger 3" x 27" will accommodate 1 1/2" x 25" hose or 100' garden hose | \$10.73 |



HEAVY DUTY DISCHARGE HOSES

H. HEAVY DUTY BLUE DISCHARGE HOSE

Heavy duty discharge hose made of PVC reinforced with high strength PVA yarn. Available in 1 1/2", 2", and 3" diameter.

| | |
|--|----------|
| #410-ROLL 1 1/2" x 300 ft Roll | \$382.50 |
| #410-100 1 1/2" x 100 ft Roll | \$153.00 |
| #411-ROLL 2" x 300 ft Roll | \$472.50 |
| #411-100 2" x 100 ft Roll | \$189.00 |
| #415-ROLL 3" x 300 ft Roll | \$825.00 |
| #415-100 3" x 100ft Roll | \$330.00 |

ALUMINUM HOSE FITTINGS

| | |
|--|---------|
| I. #ABF-200 2" Aluminum shank w/brass swivel nut | \$28.24 |
| #ABF-300 3" Aluminum shank w/brass swivel nut | \$54.20 |
| J. #ABM-200 2" Aluminum shank w/male threads | \$11.88 |
| #ABM-300 3" Aluminum shank w/male threads | \$27.92 |



VACUUM HOSES, ACCESSORIES, LEAF TRAPS

LEAF TRAPS ETC

K. CLEAR SEE-THRU SNAP-OPEN LEAF TRAP

Features snap open/close lid and large handle for ease of carrying. Clear housing lets you see debris collecting. For use with automatic suction type pool cleaners or conventional vacuum heads. Traps most debris in polyester bag. Also available with 25 sq. ft. cartridge (with special plug).

| | |
|---|----------|
| #R211084 1 1/2" Leaf Trap w/mesh bag & 3 ft. hose | \$147.08 |
| #R211086 2" Leaf Trap w/mesh bag & 3 ft. hose | \$157.63 |
| #R211518 Fine silt bag only | \$33.21 |
| #R211516 Mesh bag only | \$16.79 |
| #R172653 25 sq. ft. cartridge only w/plug | \$53.03 |



L. #B5118X LEAF MASTER

Removes leaves and debris from pool faster than any other product on the market. The Leaf Master simply hooks up to a garden hose and standard pole or automatic pool cleaner hose. Filter bag slips on or off quickly with slide closure. Swivel wheels for easy turning

| | |
|--|---------|
| #70.85 | |
| #89777 Fine mesh replacement bag | \$24.68 |



M. #1148J STAIN MASTER BY JANDY

Removes algae spots, rust spots and leaf stains. Eliminates draining pool for acid washes. Hooks up to telescopic pole, and pumps acid or chlorine right on to spot or stain

| |
|----------|
| \$129.55 |
|----------|

833-SWIM-327
833-7946-327
www.halogenupply.com

HAYWARD POOL CLEANERS & PARTS

COMMERCIAL POOL CLEANERS



A. TIGERSHARK® 2

TigerShark® 2 commercial robotic cleaner is perfect for the class B pool market. It calculates pool size with an on-board computer for the most efficient cleaning pattern. The unit's ability to clean for 7 consecutive hours provides adequate time to clean a larger pool in a timely manner. Powerful on-board pump vacuums dirt and debris, while scouring pool bottom, walls, inclines and steps. It features a patented easy-clean removable cartridge that can simply be rinsed with a garden hose.

- On-board intelligent computer calculates pool size and most efficient cleaning pattern
- Preset 7-hour clean cycle automatically turns off when done
- Powerful on-board pump sucks up dirt and debris
- Scours pool bottom, walls, inclines and steps for a complete clean
- Patented easy-clean removable cartridge can be rinsed with a garden hose
- TigerShark 2 features a 100' cord

#RC9956GRCC TigerShark 2 \$3,867.71



Easy-to-clean filter cartridge



TECHNICAL SPECIFICATIONS

| Description | Specification |
|-----------------------------|--|
| Rec. Pool Size | Up to 30' x 60' |
| Gallons Circulated | 4500 GPH |
| Filter Micron Porosity/Area | 5/1000 sq. in. |
| Motor System | Non-oil filled, microprocessor |
| Cleaning Speed | 55 sq. ft/minute |
| Cleaning Cycle | 7-hours bottom, wall and waterline |
| Recurring Cleaning Cycle | No |
| Cord Length | 100' |
| Swivel | No |
| Out-of-Water Sensor | No |
| Voltage | 115/50 24VDC |
| Height/Width/Length | 11" x 16" x 16" |
| Caddy Cart | Included with CC Part Number Models |
| Warranty | 1-year limited warranty on parts and labor |

RESIDENTIAL POOL CLEANERS

B. AQUAVAC® 6 SERIES

AquaVac® 6 Series pool cleaners are reinventing the robotic cleaner market with first-of-their-kind capabilities. While other cleaners can lose suction, AquaVac 6 Series cleaners feature patented SpinTech™ filterless technology with 18 hydrocyclones, maintaining maximum suction power. The six variable-speed-driven rollers with adaptive traction offer wall-to-wall cleaning on any pool surface and the unique TouchFree™ debris canister, with a quick release button, is designed for effortless cleanup. AquaVac 6 Series cleaners are the perfect solution for pool owners who want the latest in innovation and smart technology.

#RCH601CUY AquaVac 600. \$1,807.37



- Spin Tech filterless technology maintains constant suction
- HexaDrive™ adaptive traction expertly navigates, climbs and scrubs all pool surfaces
- TouchFree debris canister empties and rinses itself with the press of a simple quick release button
- Wi-Fi* offers control from an iPhone®, iPad®, or Android™ device, SpotClean remote steering and multiple programmable color themes (AquaVac 650 only)
- AquaVac 600 operates on a recurring 48-hour cleaning mode,
- Caddy cart and power supply included with both models

TIGERSHARK PARTS

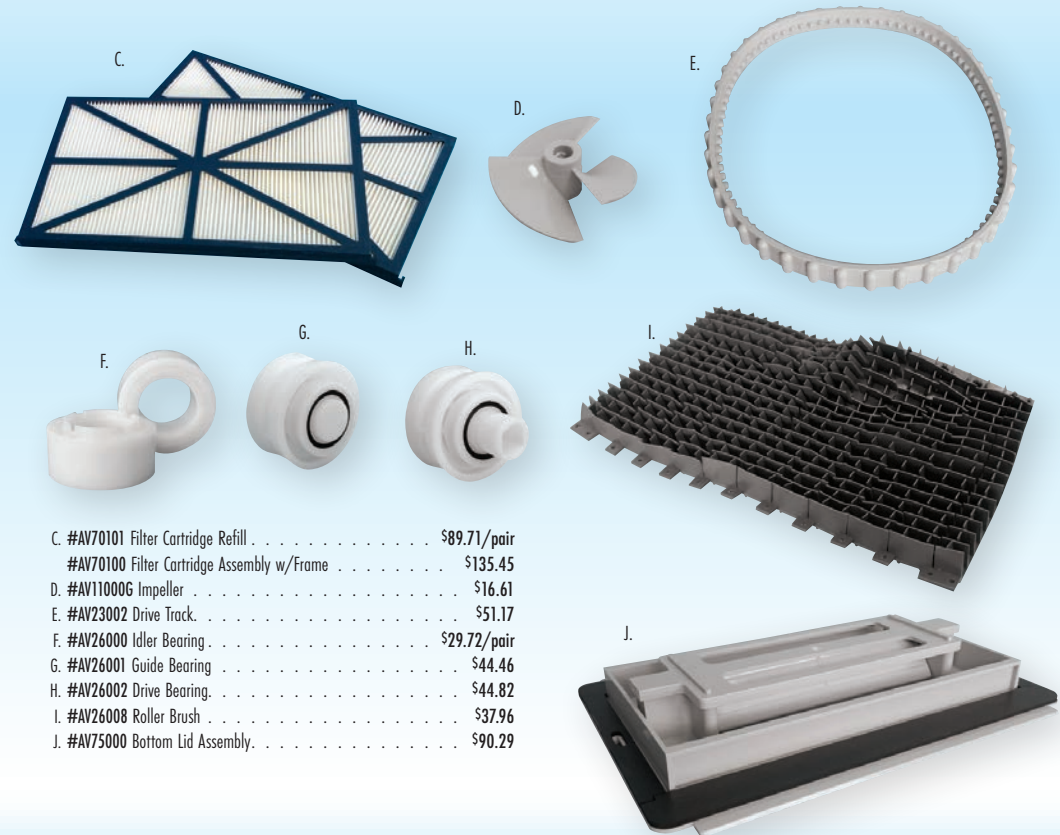

- C. #AV70101 Filter Cartridge Refill \$89.71/pair
- #AV70100 Filter Cartridge Assembly w/Frame \$135.45
- D. #AV11000G Impeller \$16.61
- E. #AV23002 Drive Track \$51.17
- F. #AV26000 Idler Bearing \$29.72/pair
- G. #AV26001 Guide Bearing \$44.46
- H. #AV26002 Drive Bearing. \$44.82
- I. #AV26008 Roller Brush \$37.96
- J. #AV75000 Bottom Lid Assembly. \$90.29

RESIDENTIAL AUTOMATIC POOL CLEANERS & PARTS



POLARIS TR28P

Powered by double jets, providing greater vacuum power and faster cleaning. The Polaris 280 easily connects to a dedicated pressure line and sweeps, scrubs, and vacuums all surfaces of the pool. The pressure cleaner is equipped with a single chamber filter bag where it captures large debris such as leaves, acorns, pebbles, and other small to large debris. Its unique filter bag removes debris before it reaches your pump basket or filter, prolonging the life of your filtration system.

Model 280 Only \$989.79

The PB4-60 booster pump delivers the best combination of high performance power, quiet operation, and durability.



#PB-4 Polaris Booster Pump only \$765.34

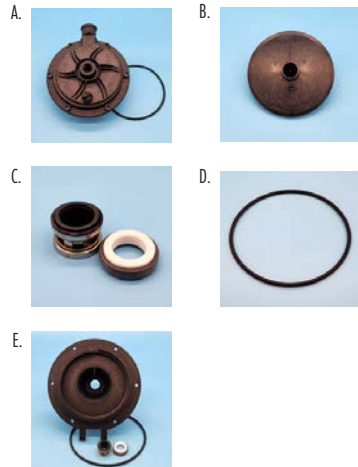

BOOSTER PUMP PARTS

- A. R0536300 Polaris Booster Pump Volute \$83.66
- B. R0536400 Polaris Booster Pump Impeller \$45.70
- C. R0445500 Polaris Booster Pump Mechanical Seal \$33.98
- D. R0536600 Polaris Booster Pump Backplate Oring \$20.18
- E. R0536700 Polaris Booster Pump Backplate \$83.66

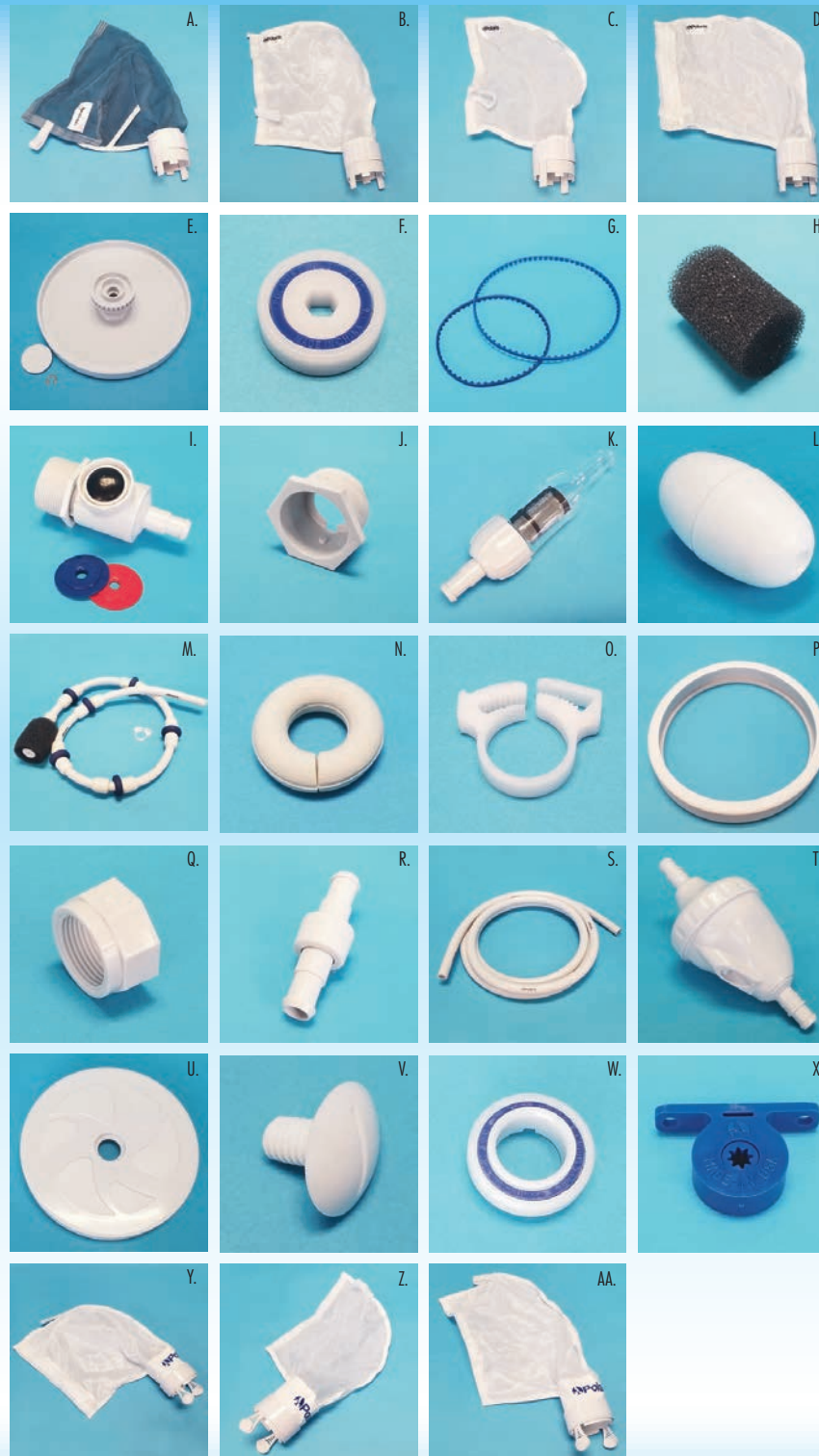

POLARIS PARTS

- A. #9-100-1012 Polaris 380/360 Leaf Bag \$68.15
- B. #9-100-1014 Polaris 380/360 All Purpose Bag \$63.56
- C. #9-100-1015 Polaris 380/360 Sand/Silt Bag \$68.00
- D. #9-100-1021 Polaris 380/360 All Purpose Zipper Bag \$76.03
- E. #9-100-1008 Polaris Wheel, Double-Side 380/360 \$22.68
- F. #9-100-1108 Polaris Ball Bearing 380/360/ATV \$14.15
- G. #9-100-1017 Polaris Belt kit 380/360 \$53.60
- H. #9-100-3105 Polaris Sweep Hose Scrubber \$4.46
- I. #9-100-9001 Polaris UWF Connector Assembly \$50.58
- J. #6-500-00 Polaris Universal Wall Fitting. \$7.07
- K. #48-080 Polaris Inline Filter 480/380/280 \$98.93
- L. #A-20 Polaris 180 /280/360/380 Float \$11.57
- M. #B-5 Polaris 180/380 Sweep Hose Complete \$55.91
- N. #B-10 Polaris Wear Rings 380/360/280/180. \$4.03
- O. #B-15 Polaris Sweep Hose Clamp \$4.07
- P. #C-10 Polaris Tire, White 380/360/380/180 \$16.72
- Q. #D-15 Polaris Nut, Feed Hose 380/280/180 \$6.57
- R. #D-20 Polaris Swivel, Ball Bearing 380/280/180 \$21.17
- S. #D-45 Polaris Feed Hose, White Hard 380/280/180 \$52.85
- T. #G-52 Polaris Back-Up Valve Kit 380/280/180 \$137.68
- U. #C-6 Polaris Wheel, Large 280/180 \$20.86
- V. #C-55 Polaris Wheel Screw (1) 280/180 \$2.97
- W. #C-60 Polaris Ball Bearings, Wheels 280/180 \$14.85
- X. #C-80 Polaris Ball Bearings, Turbine 280/180 \$26.75
- Y. #K-13 Polaris 280 All Purpose Bag, Zippered \$73.55
- Z. #K-14 Polaris 280 Sand/Silt bag, Velcro \$66.02
- AA. #K-16 Polaris 280 All Purpose Bag, Velcro \$65.59

833-SWIM-327
8 3 3 • 7 9 4 6 • 3 2 7
www.halogenupply.com

DOLPHIN POOL CLEANERS

maytronics
Exceptional Pool Experience

The Wave of New Technology in Public Pool Cleaners Automatic Pool Cleaners A Dolphin for Every Pool

COMMERCIAL POOL CLEANERS

wave 60

Automated robotic cleaner for shallow pools

A proven workhorse, the Maytronics Wave 60 robotic pool cleaner is the ideal solution for small hotel, condo, and apartment pools up to 50 feet. The Wave 60 saves you valuable time when it comes to maintaining your facility pool with its easy, plug-and-play operation.

WAVE 60 Product Specifications

| | |
|-------------------|-----------------------------|
| Ideal pool length | Up to 50 ft. |
| Cleaning coverage | Floor, Walls, and Waterline |

#DL1060-US WAVE 60 Cleaner \$1,929.00

wave 80

The trusted name for commercial pool cleaners

Engineered for power, the Maytronics WAVE 80 robotic pool cleaner is the ideal solution for small to mid-sized condo, apartment, and neighborhood pools up to 68 feet.

WAVE 80 Product Specifications

| | |
|-------------------|---|
| Ideal pool length | Up to 68 ft. |
| Cleaning coverage | Floor, Walls, and Waterline |
| Brushing | Dual Scrubbing Brushes + Center Active Scrubber |

#DL1080 WAVE 80 Cleaner \$2,699.00

wave 120

Automated robotic cleaning for shallow pools

Designed for large pools up to 121 feet, put the power of two robots to work at once with the Maytronics Wave 120 commercial robotic pool cleaner. Ideal for universities, YMCAs, and water parks.

WAVE 120 Product Specifications

| | |
|-------------------|-----------------------------|
| Ideal pool length | Up to 121 ft. |
| Cleaning coverage | Floor, Walls, and Waterline |
| Brushing | Quad Scrubbing Brushes |

#DL9359 WAVE 120 Cleaner \$7,399.00



wave 200 XL

Wave 200 XL key features and advantages

- Outstanding results:
 - Line by-line cleaning process - state-of-the-art programmable tracking systematically cleans the pool floor one path at a time.
 - AutoDirect - intelligent, self-learning technology and multiple scanning modes delivers systematic, independent and fast cleaning of any large institutional pool of any shape or type.
 - Multi Pattern Scanning - advanced navigation system and powerful technology ensure complete pool coverage.
 - Highly efficient clog-free filtration with spiral three layer system - simultaneously separates and filters rough fine and ultra-fine dirt. Spiral flow system spins the water with large debris off the course filter net. The course filter mesh retains the large particles allowing the cartridge filter to run longer. The ultra-fine debris is caught in a large pleated cartridge filter. Top access, with snap-in/out separation of the layers, for easy and convenient maintenance and cleaning.
- Easy, everyday operation and maintenance - with interactive MMI for intuitive programming and diagnosis of pool cleaner, including:
 - Automatic pool entry and exit using "Drive to pool: and "Drive home" features.
 - Choice of programs and multiple operation modes displayed on a user-friendly LCD screen.
 - Remote control for manual manoeuvring to clean hard-to-reach pool corners.
 - Full filter bag indicator.
 - Operation delay feature.
- Multipurpose Caddy with Auto Cable Release - transports the robot and automatically releases just enough cable to reach the far end of the pool, prevents kinks and tangles, simply crank the reel to neatly rewind the cable.
- Multi pool cleaning - setup of up the four different scanning modes and remote control IDs provides optimization of cleaning of multiple different pools with a single robot

Ideal for pools: up to 108 ft in length Cable length: 115 ft
Weight : 52 lbs Warranty: 36 months or 3000 hours on non-wearable

- #7200 Wave 200XL Cleaner \$10,399.00



wave 100

The best value for money in institutional cleaning Dolphin Wave 100 Highly efficient fully automated cleaning for park, high school, YMCA and other small institutional pools. The advanced gyroscopic system ensures accurate scanning for systematic coverage of floor, walls and water-line. High-capacity filtration space captures dirt, dust and all other types of debris, leaving a clean surface.

- Total pool cleaning - Unique gyroscopic system delivers accurate and effective scanning along the entire pool.
- Advanced, high-capacity 2 levels filtration options - 2 filtration options: ultra fine and fine for all pool conditions and seasons. 20% extra filtration capacity, leaves the pool water clean and free of hair, dust, insects and other debris.

Ideal for pools: up to 32' x 82' Cable length: 98 ft
Caddy: For handling & Storage
Warranty: 24 months or 3000 hours on non-wearable parts
Filtration: 2 filter bag options, 70 and 50 micron, for all types of dirt and debris
Brushes: Dual active combined brushes
Weight: 29 lbs
#9096X Wave 100S Cleaner \$4,499.00



wave 140

The trusted name for commercial pool cleaners

Extra-wide for maximum cleaning efficiency, the Wave 140 is the perfect solution for large university, fitness clubs, YMCA, and resort pools up to 127 feet, including those with beach entry. The Wave 140 helps minimize downtime due to cleaning with its plug-and-play, fully automated operation, and multiple cleaning options keeping your pool open for guests to enjoy.

With a wide cleaning path of 22 inches, the Wave 140 excels at floor scrubbing and heavy-duty dirt collection, for an ultimate clean swimming pool.

WAVE 140 Product Specifications

| | |
|-------------------|------------------------|
| Ideal pool length | Up to 127 ft. |
| Cleaning coverage | Floor only |
| Brushing | Dual Scrubbing Brushes |

#DL7140 WAVE 140 Cleaner \$7,699.00



RESIDENTIAL POOL CLEANER

READY FOR YOUR PARTY IN 2 HOURS!

The Dolphin T-Series robots are designed by Maytronics to do all the hard work - providing incredible cleaning performance and industry-leading technology.

Cleaning Features

Pool Size: Up to 50 ft
Cleaning cycle: 2 Hours
Cleaning Mode(s): Standard
Filtration: Top load, Fine and Ultra-Fine Basket
Cable Length: 60 ft
Warranty: 2 Years- Limited

#6240 T35 Cleaner \$1,171.08

T Series

S T35



DOLPHIN PARTS

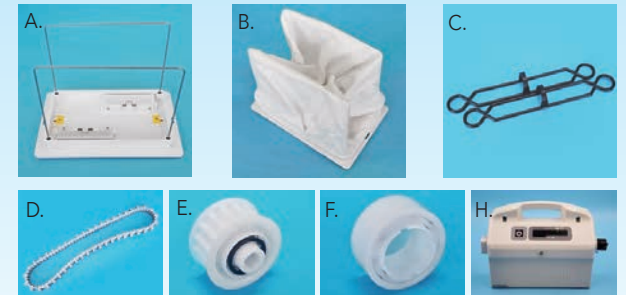

- A. #DL9995550 Bottom Lid Assembly Cart \$34.16
- B. #DL9995430-ASSY 50 Micron Cloth Filter Bag \$68.33
- C. #DL9981430-PAIR Filter Bag Clips \$10.55
- D. #DL9985006 Track Grey Grooved \$27.68
- E. #DL3883645 Drive Pulley \$23.22
- F. #DL3884997 Guide Wheel \$8.21
- G. #DL9996084-ASSY Caddy Cart New Style (Not Pictured) \$208.40
- H. #DL9995671-US-ASSY Power Supply \$410.15

WATER TECH

"The pool invention people"

CLEAN THE ENTIRE POOL
IN MINUTES OR
SPOT CLEAN IN SECONDS

The Pool Blaster Volt FX-8, designed for cleaning medium to large swimming pools and spas, is a leap forward from the original Pool Blaster MAX. The VOLT FX-8 features over one liter of debris capacity and, with its thirteen inch wide vacuum head, offers a huge cleaning path. The FX-8 vacuums up to one hour between chargings.

#FX-8 . . . \$316.05



**POOL BLASTER
VOLT
FX-8**

The newly designed Pool Blaster VOLT FX-4 is the perfect choice for cleaning large spas and small to medium sized in-ground or above-ground residential pools. The rechargeable FX-4 features a "latch" style nose cap for ease of operation and, as with all VOLT pool vacuums, can be attached to a pool pole or can be used as a hand-held cleaner.

#FX-4 . . . \$171.15



**POOL BLASTER
VOLT
FX-4**

The new Pool Blaster VOLT FX-2 features vastly increased debris capacity and three times the cleaning power of the original Aqua Broom. Ideal for cleaning "quick set-up pools and residential spas, the VOLT FX-2 operates for over three hours powered by five "D" cell batteries.

#FX-2 . . . \$88.20



**POOL BLASTER
VOLT
FX-2**



STA-RITE GASOLINE ENGINE PUMP

3 H.P. gasoline engine pump, 6" cast iron hair strainer and basket (not mounted), cart with handle, discharge hose 25', fittings and clamp. 2" suction and discharge. 104 g.p.m. with 5' lift, 95 g.p.m. with 10' lift; 83 g.p.m. with 15' lift. 150 lbs.

#437 \$2,852.00

833-SWIM-327
833-7946-327
www.halogensupply.com



HARMSCO PORTABLE VAC SYSTEM

A real money saver! Vacuum your pool through an Harmsco cartridge filter without water, chemical or heat loss. Comes complete with a single 105 sq. ft. filter, Pentair SuperFlo 1 HP Pump, 25' discharge hose and PVC fittings. Electrical cord now included. We suggest a ground fault interrupter be used.

#1460 Specify 1 1/2" or 2" suction \$3,818.00

NOTE: GROUND FAULT INTERRUPTERS ARE RECOMMENDED FOR ALL ELECTRICAL PUMPS



See pages
2, 3, 4 & 5 for
vacuum accessories

VACUUM PUMP ASSEMBLY

All pumps are complete with fittings and clamps. Pentair SuperFlo 1 HP Pump A heavy duty 50 foot cord and plug is supplied for maximum convenience and utility. A ground fault interrupter (GFI) protects the operator from electrical grounds in the cord and motor. A two-wheel chassis kit allows the unit to be easily wheeled about the pool. 1 1/2" suction and discharge.

#435 \$1,777.00



PORTABLE VAC SYSTEM

This all new portable vacuum system comes complete with a Pentair SuperFlo 1 HP Pump, 50 feet of power supply cord and a 15 amp GFCI plug attached. Features a Pentair PXCPR100; 100 square foot posi-clear filter with easy access posi-ring mounted on a stainless steel cart. 1 1/2" suction and 1 1/2" x 25" H.D. discharge.

#495 \$3008.00

PORTABLE AND HANDHELD VACUUMS

BATTERY POWERED
POOL CLEANING



RESORT UNITS - FOR FACILITY MANAGERS

Resort-21 and Resort-30 units are meant to be left on site and the caddy carts are not compatible with our vehicle mount assembly. The two standard configurations are the Resort-21, which has a 21" vacuum head and a 60ft cord, and the Resort-30 which has a 30" vacuum head and a 60ft power cord. All resort units ship fully assembled.

NOT INCLUDED

- 12 VOLT DEEP CYCLE MARINE BATTERY
- STANDARD POOL POLE
- NOT COMPATIBLE WITH THE HH1300 VEHICLE MOUNT

#RESORT-30

Hammerhead 30" resort unit complete with charger . . . P.O.A.

#RESORT-21

Hammerhead 21" resort unit complete with charger . . . P.O.A.

FOB Factory

WATER TECH PRECISION 2.0 Li Professional Pool Vacuum

Powerful, Cordless, Rechargeable Commercial Pool Vacuum Having the right tools to do the job will save you time, money and unnecessary headaches. The Precision 2.0Li works on any surface: concrete, tile, vinyl, or fiberglass. Simply attach the Precision 2.0Li to any standard telescopic pool pole, turn the unit on, and you are ready to vacuum. Its lightweight, no fuss design is free from hoses, external pumps and electrical cords. The durable design and powerful suction makes the Water Tech Precision 2.0Li the perfect companion for any Pool Service professional. Perfect for overall pool vacuuming including: steps, swim outs, benches, spillover spas, negative edge troughs, tanning ledges and fountains.



Check Out What Comes Standard

Two powerful lithium batteries, wall charger, three high volume discharge valves, three high volume filter bags, 2 vacuum heads and a shoulder strap.

#PB-5000OPL \$1,270.50

Replacement Cartridge Filter available on page 21

OLYMPIC POOL COATINGS



EPOXY PAINTS

ZERON

A one-coat epoxy pool coating recommended for use by pool service professionals. This high solids epoxy covers all types of stains and even will seal hairline cracks. Coverage is 125 - 175 sq. ft. per gallon.

- #1517-W Zeron White 1 gallon \$168.35
- #1517-BB Zeron Bikini Blue 1 gallon \$168.35
- #1517-BM Zeron Blue Mist 1 gallon \$168.35
- #1517-B Zeron Black 1 gallon \$168.35
- #1517-VB Zeron Viking Blue 1 gallon \$192.40

POXOLON

Poxolon is a high gloss pool coating that provides a tile like finish. Use with primer on concrete, plaster, fiberglass and metal pools where two coats are usually required. Coverage is 225 - 250 sq. ft. per gallon.

- #1518-W Poxolon White 1 gallon \$158.18
- #1518-BB Poxolon Bikini Blue 1 gallon \$158.18
- #1518-BM Poxolon Blue Mist 1 gallon \$158.18
- #1518-B Poxolon Black 1 gallon \$158.18
- #1518-VB Poxolon Viking Blue 1 gallon \$192.40
- #1518-BI Poxolon Blue Ice 1 gallon \$158.18

SUPER CONVOY

Super Convoy is unexcelled for shower room floors, locker room floors, pool coping, wading pool, pool steps, and on pool decks. The steam and hot water in shower rooms will have no effect on this epoxy product. Coverage is 90-110 sq. ft. per gallon.

- #KEL-368 SuperConvoy White 1 gallon \$130.43

To request Olympic Color Cards call 800-458-2842 or visit olympicpoolpaint.com

RUBBER BASED PAINT

PARALON 2

Paralon 2 is a premium grade chlorinated rubber base pool enamel that is easy to apply, long lasting and provides a high gloss finish. Paralon 2 is recommended for existing chlorinated rubber base coatings. Two coats are recommended for repairing jobs and 3 coats over bare concrete. Coverage is 250 sq. ft. per gallon.

- #1519-W Paralon 2 White 1 gallon \$125.80
- #1519-BB Paralon 2 Bikini Blue 1 gallon \$125.80
- #1519-BM Paralon 2 Blue Mist 1 gallon \$125.80
- #1519-B Paralon 2 Black 1 gallon \$125.80
- #1519-BI Paralon 2 Blue Ice 1 gallon \$125.80

POOL COATINGS COLORS

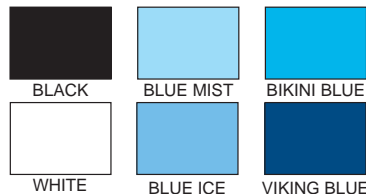

FUSION PLUS

Fusion Plus is the smart way to convert your worn rubber-base coated pool to an epoxy finish. Simply clean surface, roll on FUSION PLUS, then follow with one coat of ZERON or two coats of POXOLON. Your rubber-to-epoxy finish will be beautiful, and will last for years! Coverage is 225 - 250 sq. ft. per gallon.

- #1523 Fusion Plus \$117.48



PRIMERS

POXOPRIME II

Poxoprime II is an epoxy primer for application over unpainted concrete or plaster. Poxoprime II soaks in and seals the surface and can be applied over a damp surface to reduce down-time. Used as an undercoat for Poxolon or Zeron. Coverage 200 - 225 sq. ft. per gallon.

- #1520 Poxoprime II 1 gallon \$108.23

GUNZITE PRIMER

Gunzite is a two-part primer used as an undercoat for Poxolon or Zeron usually used over rough plaster or concrete. The heavy viscosity of Gunzite acts as a fill coat that provides a smooth surface. Especially effective on sandblasted surfaces. Coverage 100 - 150 sq. ft. per gallon.

- #1521 Gunzite Primer 1 gallon \$108.23

SOLVENTS

| | GALLONS | QUARTS |
|--|---------|---------|
| #1109 Epoxy solvent 1 gallon | \$58.28 | \$24.05 |
| #1108 Rubber base solvent 1 gallon | \$61.05 | \$24.98 |

DURACOURT COURT PAINT

Formulated from tough acrylic polymer specifically designed for asphalt or concrete outdoor surfaces. Colorfast coating retains fresh appearance for years and resists sun fading. One-coat product that requires no special labor. Simply sweep, mark boundary lines and you are ready to paint. Coverage approximately 100 - 125 sq. ft. per gallon.

- #1522 DC Duracourt 5 gallon . . . P.O.A.

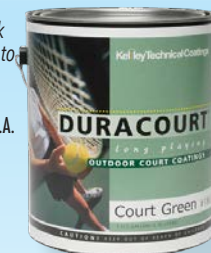

DIVING BOARD RESURFACING KIT

The Olympic diving board resurfacing kit is used to resurface old worn diving board surfaces. Each unit contains one quart of Convoy epoxy non-slip coating, one textured roller cover, one pint of solvent and complete instructions. One unit resurfaces one - 8 ft. diving board. Not intended to repair cracks.

- #1518-U100 Diving Board Resurfacing Kit - White \$95.28
- #1518-U102 Diving Board Resurfacing Kit - Bikini Blue \$95.28

SURFACE PREP

Olympic PREP MAGIC (245) is a one-step, clean and etch pool surface preparation solution that allows you to clean your surface without the extra steps of traditional surface cleaning. Simply mix PREP MAGIC with water, clean your surface, and then rinse

- #KEL-345 Prep Magic 1 gallon \$40.70



PATIO TONES DECK PAINT

This water-based deck paint not only beautifies your pool and patio area but actually penetrates the concrete to provide a cooler surface that resists peeling and chipping for years. Can be applied over a wet surface with an approximate coverage of 120 square feet per gallon depending on surface porosity. Call for complete Patio Tones Color Charts and descriptive literature.

- #1520-CS Patio Tones - Creekstone 1 gallon \$77.70
- #1520-CH Patio Tones - Champagne 1 gallon \$77.70
- #1520-DS Patio Tones - Desert Sun 1 gallon \$77.70
- #1520-MG Patio Tones - Mystic Gray 1 gallon \$77.70
- #1520-SS Patio Tones - Silk Straw 1 gallon \$77.70
- #1520-SV Patio Tones - Sand Valley 1 gallon \$77.70
- #1520-WB Patio Tones - Warm Biscuit 1 gallon \$77.70



PATIO TONES COLORS





RAMUC "EP" EPOXY

Ramuc's finest epoxy swimming pool coating is a high solid, self-priming high gloss paint formulated to provide a tile-like, abrasion resistant surface. Ideal to use for the protection of concrete, plaster or fiber-glass in swimming pools, spas, reflecting pools, water parks and wave pools. Coverage is approximately 450 sq. ft. on recoats or 200 sq. ft. on bare surfaces.

- #1540-DB-1 Down Blue 1 gal. kit \$166.43
- #1540-MW-1 White 1 gal. kit \$166.43
- #1540-AG-1 Aquo Green 1 gal. kit \$166.43
- #1540-B-1 Black 1 gal. kit \$183.08
- #1540-DKB-1 Dork Blue 1 gal. kit 1 gal. kit \$183.08

RAMUC HI-BUILD EPOXY

Ramuc Epoxy Hi-Build is a premium satin finish self-priming epoxy that's an excellent choice to renovate plaster or concrete pools or spas. Long-lasting and durable it upgrades faded or scratched fiberglass. Coverage is 150-200 sq. ft. per 2 gallon kit on sandblasted or rough surfaces and 300-350 sq. ft. per 2 gallon kit on recoats.

- #1540-HBW Hi-Build White 2 gal. kit \$311.28
- #1540-HBDB Hi-Build Down Blue 2 gal. kit \$311.28

POOL SURFACE



ACCENTS



RAMUC ULTRA PRO 2000 COMMERCIAL RUBBER

Ultra Pro 2000 is a low VOC rubber based pool paint formulated for commercial use on concrete or plaster pool surfaces. Self-priming - no primer needed. VOC Compliant in all 50 states. Two years' service life.

- #1545-DB Ultra Pro 2000 Dawn Blue 1 gallon \$129.80
- #1545-RB Ultra Pro 2000 Royal Blue 1 gallon \$138.12
- #1545-W Ultra Pro 2000 White 1 gallon \$129.80



INTRODUCING NEW TYPE A-2 PREMIUM RUBBER BASED POOL PAINT

- Versatile-topcoats and upgrades existing chlorinated and synthetic rubber systems.
- VOC Compliant-meets the strictest state and federal environmental regulation of 320 gpl VOC.
- Easy to clean, semi-gloss stain-resistant finish.
- Excellent hiding and coverage; spreads at
- 250 sq ft on bare surfaces, 350-400 sq ft on recoats.
- Self-priming

- #1544-DB-1 Dawn Blue 1 gal. can \$138.12
- #1544-W-1 White 1 gal. can \$138.12
- #1544-B-1 Black 1 gal. can \$146.45



RAMUC POOL PAINTS

RAMUC DS WATER-BASED ACRYLIC

Type DS is formulated to provide a decorative but tough, durable film that protects concrete and plaster pools. Self-priming type DS can be applied over previously painted chlorinated and synthetic rubber base paint, as well as properly prepared epoxy painted surfaces. Type DS is ideal where down time is critical, can be applied over damp surface and put into service 3 days after final coat. Coverage is 250 sq. ft. on bare surfaces, 350-400 sq. ft. on recoats

- #9101-W-1 Type DS White 1 gallon \$124.80
- #9101-DB-1 Type DS Down Blue 1 gallon \$124.80
- #9101-B-1 Type DS Black 1 gallon \$133.13

- #92242 Skid-Tex non-skid additive 1 quart Container \$13.50



UNIVERSAL THINNER

Ramuc Universal thinner can be used for either epoxy or rubber base paints.

- #1539 Ramuc Thinner 1 gallon \$48.21



CLEAN AND PREP SOLUTION

DESCRIPTION AND USE: Clean & Prep Solution is used to clean and degrease while simultaneously dissolving mineral deposits, increasing porosity for good adhesion on surfaces prior to painting.

- #9306 CLEAN AND PREP SOLUTION 1 gallon \$59.87

- VOC Compliant
- Perfect for painted surfaces
- Turns traditional 3-steps into a 1-step process
- Water-rinse neutralize
- Odor-free; No Fumes
- Biodegradable, safe to use near plants & grass
- Excellent for filter element cleaning



RAMUC COPING SPRAY PAINT

Renew the vibrancy of pool coping with non-skid Coping Spray Paint by Ramuc Pool Specialty Coating Systems. Avoid expensive and time-consuming coping removal by using RAMUC COPING SPRAY to brighten, restore, and protect the existing coping material. Easy to use, environmentally safe and economical.

- #1541 Coping Spray Paint \$29.56



TILES, DEPTH MARKERS, GROUT, CAULK & SEALANT



DEPTH MARKERS

Black print on white background
Available in imperial and Metric units

- **GLASS OVERLAY** – Tempered glass that can be installed over tile, fiberglass, or paint. Must use installation kit for permanent installations.

| | |
|---|---------|
| #1596 6" x 6" Marker | \$11.70 |
| #1596-NDS 6" X 6" No Diving Sign | \$13.50 |
| #1598 Installation kit (up to 15 markers) | \$22.10 |

- **Vinyl Stick-Ons** – Self-adhesive skid resistant vinyl tiles for above waterline use only. Must use adhesive and edge sealer.

| | |
|--|---------|
| #1595 6" x 6" Marker | \$11.70 |
| #1595-NDS 6" x 6" No Diving Sign | \$13.50 |
| #1595-8X8 8" x 8" Marker | \$20.25 |
| #1595-NDS-8X8 8" x 8" No Diving Sign | \$22.05 |
| #1597 Installation Kit (up to 40 6" and 22 8") | \$49.40 |
| #1597-ES Edge Sealer only | \$21.00 |

- **PLASTIC STICK-ON** – For stainless steel gutters

| | |
|----------------------------------|---------|
| #1590 4" x 6" Marker | \$11.70 |
| #1590-NDS 4" X 6" No Diving Sign | \$13.50 |

- **SKID RESISTANT CERAMIC TILE** – For permanent installation in decks

| | |
|--------------------------------------|---------|
| #1594 6" x 6" Marker | \$8.66 |
| #1594-NDS 6" X 6" No Diving Sign | \$10.69 |
| #1594-8X8 8" x 8" Marker | \$18.45 |
| #1594-NDS-8X8 8" X 8" No Diving Sign | \$20.70 |

- **SMOOTH CERAMIC TILE** – For permanent installation in walls

| | |
|-----------------------------------|---------|
| #1592W 6" x 6" Marker | \$8.00 |
| #1592W-NDS 6" X 6" No Diving Sign | \$10.01 |

6" x 6" FROST-PROOF FLAT TILE

| | | | |
|---------------|--------|-------------|--------|
| #1592W White | \$5.22 | #1592B Blue | \$5.22 |
| #1592BL Black | \$5.22 | | |

6" x 6" BULLNOSE TILE

| | | | |
|--------------|---------|-------------|---------|
| #1593W White | \$11.40 | #1593B Blue | \$11.40 |
| #1593G Green | \$11.40 | | |

SAFETY EDGE TILE – Clearly mark the step edge for safe pool entry. Factory skid resistant surface. Frost resistant.

Colors: blue, black, brown and green

Specs: 1/4" thickness 2 1/4" x 1" x 6"

#1591 Safety Edge Tile (specify color) \$4.28

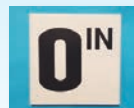
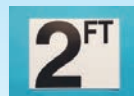
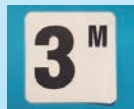
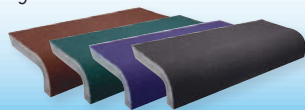

TILE SET/GROUT Thin set mortar for installation and grouting of all types of tiles.
#1594 50 lbs. \$30.44



GATOR GRIP TAPE

Our anti-slip safety grit tape help to provide extra traction where slippery surface conditions may occur on floors, steps and equipment. Constructed from a thick base layer with an aggressive 60-grit mineral abrasive compound. Tape is coated with an aggressive acrylic adhesive with a removable liner. Great for use in equipment rooms.

#RE629BL Black Anti-Slip Strip
6" x 21" \$19.16



SOFTEX TAPE

Softex coarse resilient slip-resistant tape works great in or around the home, pool, patio, workshop, locker room, boat, deck, or other areas where there is a bare foot or light shoe traffic. This tape has a deep embossed surface that will perform in heavier duty applications, while still being comfortable for bare foot traffic. Tape can be easily mopped for cleaning.

#RE3891BL Vinyl Traction Tape 4" wide \$3.04/ft

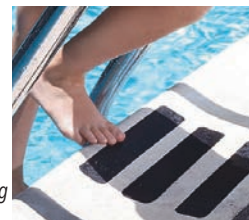

AQUABOND UNDERWATER REPAIR COMPOUND

Swimming Pool Repair Epoxy Adhesive

- All purpose "Wet or Dry" adhesive provides an easy no-mess application
- Easily mix, apply, and cure underwater
- Repair coping, fiberglass, or a vinyl liner
- Secure handrails or racks

• Kit contents: One DM-50 dispensing gun, One 50 ml cartridge of UW-5000 off white, Five SM-5416 static mixers

#DMK-5000 AquaBond Repair Compound Kit \$124.95

#UW-5000 50ml AquaBond Repair Compound \$35.68



AQUAFLEX UNDERWATER SEALANT

Mixes, Applies & Cures Underwater

- Quickly and reliably repair leaks
- Can be mixed and applied underwater
- Kit contents: One DM-50 dispensing gun, One 50 ml cartridge of AFC-8100 clear, Five SM-5416 static mixers, One multi-radius spreader

#DMK-W8000 AquaFlex Sealant Kit \$146.60

#AFW-8000 50ml AquaFlex White Sealant \$57.33



833-SWIM-327
833 • 7946 • 327
www.halogenupply.com



CAULK & SEALANT

VULKEM SEALANT 116 & 45

A. A one-part, polyurethane sealant. For use in expansion joints for swimming pools, decks and sidewalks, and is suitable for continuous immersion. Vulkem 116 is for vertical or horizontal joints. Vulkem 45 is self leveling for horizontal joints only.

| | |
|---|---------|
| #1570W Vulkem 116, White 10.5 oz. cartridge | \$10.40 |
| #1570G Vulkem 116, Gray 10.5 oz. cartridge | \$10.40 |
| #1572W Vulkem 45, White 30 oz. cartridge | \$34.02 |
| #1572G Vulkem 45, Gray 30 oz. cartridge | \$34.02 |

B. BOSS CAULK

801 Neutral silicone adhesive provides excellent adhesion to ceramic tile, spa jets, skimmers, lighting fixtures, and plumbing. 801 also adheres well to fiberglass, ABS, acrylic, PVC, wood and masonry.

| | |
|---|---------|
| #80100B Silicone Adhesive, Clear 10.3 oz. cartridge | \$19.94 |
| #80101B Silicone Adhesive, White 10.3 oz. cartridge | \$19.94 |

C. PERMANENT SEALER

Seals seams and cracks even under water. Leaking cracks have been successfully plugged when a pool is filled. Permanent Sealer will dry in about 30 minutes under water. Comes in 10 oz. cartridges.

| | |
|--------------------------------|---------|
| #1533W White | \$10.44 |
| #1533W-HV High Viscosity White | \$10.96 |
| #1533C-HV High Viscosity Clear | \$13.01 |

D. POOL PUTTY

No need to drain concrete pools to repair leaks and cracks because pool putty hardens under water. Pool putty is packaged in convenient cartridges for an easy 1-to-1 mix. Approximate setting time at 70°F. is 90 minutes.

| | |
|------------------------------|---------|
| #1534 Pool Putty 14 oz. unit | \$23.06 |
|------------------------------|---------|

E. POOL PASTE

A high strength epoxy that creates a strong permanent bond to almost any material. Use pool paste to replace tiles or repairing cracked skimmers, fittings and accessories. Can be sanded and painted. Setting time is approximately 90 minutes at 70°F.

| | |
|------------------------------|---------|
| #1535 Pool Paste 16 oz. unit | \$41.24 |
|------------------------------|---------|

CEMENT PATCHING

MASTERSEAL 590 (FORMERLY WATERPLUG)

Thoro Waterplug stops running water instantly

- Fast setting (3 to 5 minutes)
- Expands as it sets
- Sets up under water
- Anchors bolts and fixtures firmly 1 lb. will fill 17 cu. in. or a crack 3/8" x 3/8" x 30"

#1560-10 Waterplug 10 lbs. \$47.80
 #1560-50 Waterplug 50 lbs. . . . \$105.67



SEALANTS

MASTER 581 (FORMERLY THOROSEAL)

Thorseal waterproofs anything of block, brick, concrete, or stone, including swimming pools and basement walls. A cement based sealer that works above or below grade. Keeps water out while allowing surface to breathe. Coverage: Approximately 225 sq. ft. per 50 lb. container, depending on surface conditions.

#1550 Thorseal 50 lb. pail . . . \$105.27

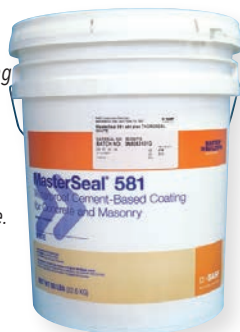

BRUSHES FOR APPLICATION

#2714-LH 14" Patching Brush less Handle (see pg 3 for handle) \$15.95



#1553 6" Beaver Brush \$11.52



MASTEREMACO N424 (FORMERLY THORITE)

EmacoGP is a fast-setting cement base patching material that will not slump or shrink at patch edges. Excellent structural strength often stronger than original concrete.

#1561-60 Thorite 60 lb.-can \$100.82

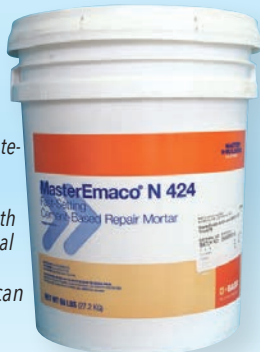

MASTEREMACO N220 (FORMERLY ACRYL 60)

Acryl 60's acrylic polymers add extra strength and durability when mixed with cement base patches and coatings such as Emaco GP, All-Crete, Super Quickseal and Thorseal. Use 1 part Acryl 60 to 3 parts water under normal conditions.

#1552-01 Acryl 60 1 gal. bottle \$65.79
 #1552-05 Acryl 60 5 gal. can \$273.00



PLASTER PATCHING

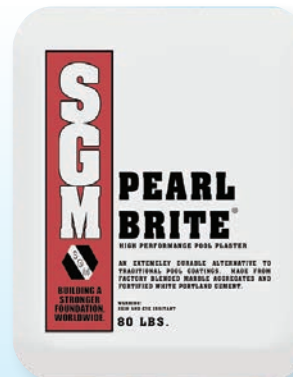

SGM PEARL BRITE

Features:

- Pearl Brite high performance plaster mix is pre-blended and ready to use.
- Pure white color resists chemical attacks, etching, staining, discoloration and delamination
- 80-lb. bag covers approximately 25 to 35 sq. ft. depending upon surface roughness

#20-PBC300 Pearl Brite Plaster Mix \$68.13



SGM DYNAMITE POOL PATCH

• High strength • Sets under water • Brilliant white Dynamite pool patch is a mixture of portland cement and special additives that permits underwater patching and general concrete repair work to be done instantly. Pool patch can be used wherever a quick setting caulking or plugging material is needed. Extremely fast-setting. Working time 3-5 minutes

#1555 Dynamite Pool Patch 9 lbs \$79.67
 #1556 Dynamite Pool Patch 60 lbs \$101.54

833-SWIM-327
 833 • 7946 • 327
www.halogensupply.com

SEALERS PATCHING & ACCESSORIES

EPOXY PRODUCTS



ABOWELD NO SLUMP EPOXY PATCH

For patching and building up vertical surfaces without forms or molds. Fills cracks. Bonds permanently. Will also bond to wet surfaces. Crack repairs and tile installation repairs. Available in white only

#5512QR Aboweld55-1 (2 Quart) \$119.91
 #5512GKR Aboweld55-1 (2 Gallon Kit) \$335.79



ABOCRETE SELF-LEVELING EPOXY COMPOUND

Permanently repairs, bonds, rebuilds and resurfaces concrete and most rigid surfaces. Self leveling. Fills cracks. Excellent substrate for decorative color grit and aggregate.

#ACK5R Abocrete (1 Gallon Kit) \$104.90
 #ACKR Abocrete (5 Gallon Kit) \$283.29



TREAD SPREAD SLIP RESISTANT EPOXY COATING

Bonds Tenaciously to concrete, wood, metal, fiberglass, and most rigid surfaces. Use on wet, dry, underwater surfaces where slip resistance is needed. Much more durable and longer lasting than tape. Exceeds OSHA and ADA recommendations for slip resistance in both wet and dry conditions. Coverage is 12 sq. ft. at 1/8 in thick per gallon. Color is Slate Gray.

#TS2PK Tread Spread 2 pint kit \$70.25
 #TS2GK Tread Spread 2 gallon kit \$278.78

PENTAIR/STA-RITE COMMERCIAL/ RESIDENTIAL SELF PRIMING POOL PUMPS

STA-RITE®

For largest inventory of
Sta-Rite parts call 833-794-6372
See pages 16 & 17 for
replacement parts and motors.

Smarter.



MAX-E-PRO

High efficiency, low maintenance and maximum performance - all the features demanded by today's pool professionals. The Max-E-Pro has our new Quick-Lock top cover ring and the 2" ports incorporate internal and external threads. Meets DOE minimum efficiency requirements.

SINGLE-PHASE HIGH EFFICIENCY PUMP

| Cat. No. | Voltage | Full Load Amps | THP | WEF | HHP | SF | Ship. Wt. | Price |
|----------|-------------|----------------|------|------|------|-----|-----------|------------|
| 34-8185 | 115/208-230 | 10.5/5.5 | 1.10 | 3.50 | 0.65 | 1.0 | 50 | \$1,375.94 |

THREE-PHASE TEFC SUPER DUTY

| Cat. No. | Voltage | Full Load Amps | HP | SF | Ship. Wt. | Price |
|----------|-------------|----------------|----|------|-----------|------------|
| 34-5076 | 208-230/460 | 4.9-4.5/2.3 | 1 | 1.65 | 45 | \$1,499.15 |
| 34-5077 | 208-230/460 | 6.4-6.3/3.2 | 1½ | 1.47 | 47 | \$1,616.64 |
| 34-5078 | 208-230/460 | 7.5-7.2/3.6 | 2 | 1.30 | 50 | \$1,899.18 |
| 34-5079 | 208-230/460 | 9.8-9.4/4.7 | 3 | 1.15 | 53 | \$2,318.65 |

INTELLIPRO® VSF

VARIABLE SPEED AND FLOW PUMP

IntelliPro VSF pump is the first variable speed and flow pump that adjusts to changes in flow conditions to maintain its preprogrammed flow rate to run optimally throughout the entire filtration cycle. It's like having cruise control for your pump.



Features:

- Eight programmable speed or flow settings and built-in timer
- Rotatable keypad with optional wall mount kit (sold separately)
- Top-mounted field wiring compartment is easier to access and connect
- Totally enclosed fan-cooled design for increased performance and long life
- Menus are easier than ever to use
- Precisely maintains system flow requirements
- Compatible with Pentair Automation
- WEF 6.6 THP 3.95
- Variable Speed

| CAT.NO. | DESCRIPTION | VOLTS | AMPS | HP | SF | SHIP WT. | PRICE |
|---------|----------------|-------|------|----|------|----------|------------|
| 01-3004 | INTELLIPRO VSF | 230 | 16 | 3 | 1.32 | 57 | \$2,791.15 |

Limited Quantities

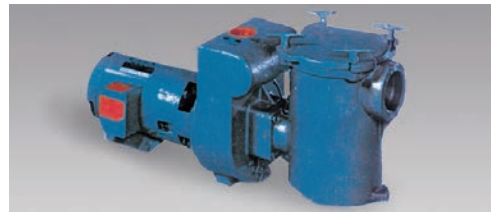

SELF-PRIMING CENTRIFUGAL PUMPS

Self-priming, centrifugal design available in 3 and 5 H.P. models. The pump body has a single suction port with four-bolt flange connection for mounting strainer. Centerline discharge port - 3 H.P. - 2" ½ H.P. - 2" discharge. Bronze impeller.

NOTE: Pumps do not include Hair & Lint Trap - Order separately.

| Cat. No. | Nominal HP | Phase | Motor Voltage | Approx. Ship. Wt. (lbs.) | Price |
|----------|------------|-------|---------------|--------------------------|------------|
| DMH3-171 | 3 | 3 | 230/460 | 135 | \$2,719.12 |
| DMJ3-172 | 5 | 3 | 230/460 | 178 | \$2,902.64 |

| HAIR & LINT STRAINER | | | | |
|----------------------|--------------|--------------|-------------------|------------|
| Cat. No. | Description | Suction Port | Approx. Ship. Wt. | Price |
| PKG 98 | 8" Cast Iron | 3" NPT | 40 lbs. | \$1,018.00 |



HIGH PERFORMANCE COMMERCIAL SELF-PRIMING PUMP

Especially designed for commercial/public swimming pools or spas where very high performance and self-priming characteristics are desired. Oversized hair and lint strainer for large debris capacity (1100 cu. in. capacity). Rugged cast iron construction with bronze impeller. Standard 4" x 6" flange connections (N.S.F.).

NOTE: Pumps do not include Hair & Lint Trap - Order separately.

| Cat. No. | Nominal HP | Phase | Motor Voltage | Approx. Ship. Wt. (Pump only) |
|------------|------------|-------|---------------|-------------------------------|
| CSPHK-142 | 7½ | 1 | 230 | 270 lbs. |
| CSPHK3-142 | 7½ | 3 | 230/460 | 265 lbs. |
| CSPHL3-143 | 10 | 3 | 230/460 | 270 lbs. |
| CSPHM3-144 | 15 | 3 | 230/460 | 280 lbs. |
| CSPHN3-145 | 20 | 3 | 230/460 | 325 lbs. |

| F.O.B. Sta-Rite | | |
|-----------------|-----------------------|-------------------|
| Cat. No. | Description | Approx. Ship. Wt. |
| PKG 184 | 1100 cu. in. capacity | 180 lbs. |

Price on Application

C-SERIES PUMPS



Perfect for the toughest outdoor and indoor projects, the C-Series pump gets its durability from all-brass construction and a stainless steel basket. For decades, the C-Series has proven its dependability as one of the most effective commercial pumps available anywhere. It has set the standard for medium and high-head performance in the pool industry. The C-Series Pump is available with and without a hair and lint pot.

Standard Features:

- Heavy-Gauge stainless steel strainer basket
 - 6" suction and 4" discharge for maximum efficiency
 - Open area of Strainer Basket is 5 times area of suction port
 - Heat-resistant seal operates at up to 150° Fahrenheit
 - One year limited warranty
 - 200-208 and 575 volt models available on request
- Available with or without strainer.
Pumps are self-priming with strainer.
Pricing upon request.

EQ-SERIES PUMPS



- Designed in every detail for maximum efficiency
- The only non-corrosive, all plastic pump designed exclusively for the commercial pool and water applications market
- The EQ's impeller features an exclusive design that provides true breakthrough performance
- Lower load due to efficient impeller design means longer motor life
- Cam and Ramp™ lid design with clear lid for added convenience in servicing

Additional Features:

- Lightweight
- 6" suction and 4" discharge with strainer pot
- Heat resistant seal operates at up to 150° Fahrenheit
- Cam and Ramp™ lid design with clear lid
- Self-priming pump (with strainer pot)
- NSF-Listed
- Available in single and three phase 60 hertz models
- Models available for water feature applications
- One-year limited warranty

Available with or without strainer. Pricing upon request.

SUPERFLO HIGH PERFORMANCE PUMP

- 1.5" internal slip (2" external slip) and quick-disconnect plumbing union for faster disassembly, making it a summer breeze to service.
- Cam and Ramp™ Lid permits easy inspection of the strainer basket and locks in place with a quarter turn for cleaning that is fast and easy.
- SuperFlo pumps are a high-performing drop-in replacement for the Hayward® Super Pump®.
- Meets DOE minimum efficiency requirements.



SINGLE-PHASE HIGH EFFICIENCY PUMP

| Cat. No. | Voltage | Full Load Amps | THP | WEF | HHP | Ship. Wt. (lbs) | Price |
|----------|-------------|----------------|-------|-----|------|-----------------|----------|
| 34-8190 | 115/208-230 | 10.5/5.5-5.4 | 1.103 | .60 | 0.63 | 50 | \$988.95 |

SUPERMAX VS VARIABLE SPEED PUMP

The SuperMax VS Variable Speed Pumps bring the remarkable energy cost savings of variable speed technology to standard pools at an affordable price. They reduce energy costs by up to 80%. SuperMax VS Variable Speed Pumps have an easy-to-read graphical display and a built-in timer so the pumps are easy to install and easy to use.

- **Variable Speed**



| CAT.NO. | VOLTAGE | FULL LOAD AMPS | THP | WEF | HHP | SHIP WT. | PRICE |
|---------|-------------|----------------|-----|-----|------|----------|------------|
| 34-3001 | 115/208-230 | 13.6/8.0-7.1 | 2.2 | 9.0 | 1.08 | 53 | \$2,055.88 |

ABOVE GROUND POOL PUMPS



STA-RITE® OPTIFLO PUMPS

Exceptionally quiet operation and high performance

#34-8196 115 Volts 1 HP pump \$589.09

833-SWIM-327
833 • 7946 • 327
www.halogensupply.com

WHISPERFLO® HIGH PERFORMANCE PUMPS

Energy efficient swimming pool pumps. 40% glass-filled thermoplastic with the Cam & Ramp™ "see thru" lid design. Self priming, high flow with patented Funnel-Flo™ diffusers. 2 in. suction and discharge ports. Motor features threaded shaft and durable commercial duty 56 frame motor with NEMA square flange. Meets DOE minimum efficiency requirements.



SINGLE-PHASE HIGH EFFICIENCY PUMP

| Cat. No. | Voltage | Full Load Amps | THP | WEF | HHP | Ship. Wt. (lbs) | Price |
|----------|-------------|----------------|------|------|------|-----------------|------------|
| 01-5583 | 115/208-230 | 10.5/5.5-5.4 | 1.10 | 3.40 | 0.69 | 50 | \$1,344.44 |

3-PHASE TEFC SUPER-DUTY

| Product No. | Model No. | Voltage | Full Load Amps | HP | SF | Approx. Ship. Wt. (lbs.) | Price |
|-------------|-----------|----------------|----------------|-------|------|--------------------------|------------|
| 01-1641 | WFK-4 | 208 - 230/460V | 4.9 - 4.5/2.3 | 1 | 1.65 | 46 | \$1,539.87 |
| 01-1642 | WFK-6 | 208 - 230/460V | 6.4 - 6.3/3.2 | 1-1/2 | 1.47 | 48 | \$1,691.36 |
| 01-1643 | WFK-8 | 208 - 230/460V | 7.5 - 7.2/3.6 | 2 | 1.30 | 51 | \$1,988.87 |
| 01-1644 | WFK-12 | 208 - 230/460V | 9.8 - 9.4/4.7 | 3 | 1.15 | 58 | \$2,432.83 |

WHISPERFLO VST

VARIABLE SPEED POOL PUMP

Our growing portfolio of variable speed pumps has a solution for every pool.



- WhisperFlo VST brings features and benefits that are just right for pool owners' needs.
- **Energy Savings:** Variable speed technology reduces energy costs by up to 90%.*
- **Long, Dependable Performance:** Improved mechanical seal and totally enclosed fan-cooled (TEFC) motor help withstand harsh temperatures and chemicals.
- **Improved Connectivity for Higher Flexibility:** RS-485 connectivity for improved interface with automation systems and IoT devices for more flexibility.
- **Simple to Program:** Advanced onboard digital display and real-time, 24-hour clock. Select from three programmable speeds plus an override to meet your specific needs.
- **The Smarter Upgrade:** Ideal for new and standard pool pump replacement for pools requiring up to a 2.0 HP pump for filtration, water features, and higher head applications.
- **Installation Friendly:** Adapts to 115V to 230V and 50hz or 60hz power with no special wiring or switching.
- **Variable Speed**

| CAT.NO. | VOLTAGE | FULL LOAD AMPS | THP | WEF | HHP | SHIP WT. | PRICE |
|---------|-------------|----------------|-----|-----|------|----------|------------|
| 01-1533 | 115/208-230 | 13.9/12.4-11.2 | 2.6 | 8.4 | 1.64 | 45 | \$2,519.98 |



PENTAIR PUMPS & MOTORS

INTELLIFLO3™ VSF VARIABLE SPEED AND FLOW POOL PUMP



VARIABLE SPEED TECHNOLOGY REDUCES ENERGY COSTS UP TO 90%

Proprietary sensorless flow control maintains optimal flow for pool and spa combos with water features.

- WiFi or Bluetooth wireless technology:
 - Easy control and installation.
 - Remote monitoring option via the Pentair Pro App.
 - Seamless software updates for feature enhancements.
- Optional built-in automation can control up to two relay devices right from the pump via the Pentair Home App.
- Lay in bonding-lug tray for easy wire attachment on retrofits.
- 2.5" Union Kit
- **Variable Speed**

| CAT.NO. | VOLTAGE | FULL LOAD AMPS | THP | WEF | SHIP WT. | PRICE |
|---------|---------|----------------|-----|-----|----------|------------|
| 01-1075 | 208-230 | 12.4-11.2 | 3.0 | 7.1 | 55 | \$2,855.98 |

WHISPERFLO XFT™ HIGH PERFORMANCE PUMPS

Drop-in replacement for all WhisperFlo® pump models. Simple replacement for Challenger® pumps.* Hydraulic isolator separates priming water from pumping water. Union connectors included for connecting directly to 2.5" or 3" plumbing. Diamond seals. Easy-carry handle.



VARIABLE SPEED AND FLOW PUMP

| Cat. No. | Voltage | Full Load Amps | THP | WEF | HHP | SF | Ship. Wt. (lbs) | Price |
|----------|---------|----------------|------|------|------|-----|-----------------|------------|
| 02-2056 | 230 | 16 | 3.95 | 5.60 | 2.10 | 1.0 | 60 | \$2,973.16 |

| CAT.NO. | VOLTAGE | FULL LOAD AMPS | THP | WEF | HHP | SHIP WT. | PRICE |
|---------|------------------|----------------|-----|-----|------|----------|------------|
| 02-2035 | 115/208-230(1PH) | 13.6/8.0-7.1 | 5.0 | 5.0 | 2.09 | 95 | \$5,004.74 |
| | 230/460(3PH) | 13.0/6.0 | | | | | |

3-PHASE TEFC SUPER-DUTY

| Product No. | Model No. | Voltage | Full Load Amps | HP | SF | Price |
|-------------|-----------|----------------|-----------------|----|------|------------|
| 02-2017 | XFK-8 | 208 - 230/460V | 7.5 - 7.2/3.6 | 2 | 1.3 | \$2,200.63 |
| 02-2018 | XFK-12 | 208 - 230/460V | 9.8 - 9.4/4.7 | 3 | 1.15 | \$2,480.56 |
| 02-2019 | XFK-20 | 208 - 230/460V | 13.9 - 13.1/6.6 | 5 | 1.0 | \$4,362.25 |

COMMERCIAL PUMP PARTS

C SERIES PUMP PARTS



| C SERIES PUMP PARTS | | | |
|---------------------|----------|------------------------|------------|
| A. | 07-5280 | HAND KNOB | \$177.37 |
| B. | 07-5275 | STRAINER LID | \$1,286.48 |
| C. | 07-1433 | STRAINER LID O'RING | \$21.64 |
| D. | 07-2795 | STRAINER BASKET | \$605.27 |
| E. | IMPELLER | | |
| | 07-0228 | CMK-50 IMPELLER 5 HP | \$1,985.40 |
| | 07-0227 | CMK-75 IMPELLER 7.5 HP | \$1,985.40 |
| | 07-0226 | CMK-100 IMPELLER 10 HP | \$1,985.40 |
| | 07-0225 | CMK-150 IMPELLER 15 HP | \$1,985.40 |
| | 07-3828 | CHK-50 IMPELLER 5 HP | \$1,985.40 |
| | 07-3829 | CHK-75 IMPELLER 7.5 HP | \$1,985.40 |
| | 07-3830 | CHK-100 IMPELLER 10 HP | \$1,985.40 |
| | 07-3831 | CHK-150 IMPELLER 15 HP | \$1,985.40 |
| | 07-3832 | CHK-200 IMPELLER 20 HP | \$1,985.40 |
| F. | 07-1725 | MECHANICAL SEAL | \$63.74 |
| G. | 07-0906 | FLANGE | \$864.70 |
| H. | 07-1423 | FLANGE O'RING | \$10.70 |
| I. | 07-1037 | IMPELLER LOCKING SCREW | \$14.72 |
| J. | 07-1048 | IMPELLER WASHER | \$20.78 |
| K. | 07-5713 | IMPELLER GASKET | \$4.30 |
| L. | 07-1046 | IMPELLER KEY | \$32.51 |

D SERIES PUMP PARTS



| D SERIES PUMP PARTS | | | |
|---------------------|------------|-------------------|----------|
| A. | C154-18D | HANDLE ASSEMBLY | \$43.56 |
| *B. | C3-105 | STRAINER COVER | \$243.45 |
| *C. | U9-171 | STRAINER O'RING | \$36.80 |
| *D. | 16401-0030 | STRAINER BASKET | \$517.37 |
| E. | C20-19 | GASKET | \$8.15 |
| F. | C21-2 | DIFFUSER GASKET | \$7.22 |
| | C101-126B | DIFFUSER DMJ 5 HP | \$236.12 |
| G. | C5-246 | IMPELLER DMH 3 HP | \$994.10 |
| | C5-247 | IMPELLER DMJ 5 HP | \$984.78 |
| H. | U109-433SS | MECHANICAL SEAL | \$167.09 |
| I. | C20-46 | ADAPTER GASKET | \$18.56 |
| J. | C23-58 | SHAFT SLEEVE | \$158.11 |
| K. | U65-42A | SLEEVE KEY | \$17.45 |

* Pkg 98 Hair and Lint Strainer

833-SWIM-327
833-7946-327
www.halogensupply.com

CSPH SERIES PUMP PARTS



| CSPH SERIES PUMP PARTS | | | |
|------------------------|-------------|---------------------------|------------|
| A. | 35505-0421 | STRAINER COVER O'RING | \$115.13 |
| B. | IMPELLER | | |
| | 16830-0209 | IMPELLER 7.5 HP | \$1,837.89 |
| | 16830-0210 | IMPELLER 10 HP | \$1,657.08 |
| | 16830-0211 | IMPELLER 15 HP | \$1,893.62 |
| | 16830-0212 | IMPELLER 20 HP | \$2,274.18 |
| C. | S04757 | GASKET(VOLUTE TO BRACKET) | \$21.23 |
| D. | 37447-0001L | SHAFT SLEEVE | \$280.06 |
| | 37447-0002L | SHAFT SLEEVE - 20 HP | \$332.24 |
| E. | S11207 | RETAINING RING | \$27.28 |
| | S16767 | RETAINING RING - 20 HP | \$54.59 |
| F. | S32014 | MECHANICAL SEAL | \$185.87 |
| | S32015 | MECHANICAL SEAL - 20 HP | \$400.77 |

EQK SERIES PUMP PARTS



| EQK SERIES PUMP PARTS | | | |
|-----------------------|----------|---------------------|------------|
| A. | IMPELLER | | |
| | 35-0030 | IMPELLER 5 HP | \$609.77 |
| | 35-0029 | IMPELLER 7.5 HP | \$650.43 |
| | 35-0028 | IMPELLER 10 HP | \$691.09 |
| | 35-0027 | IMPELLER 15 HP | \$772.36 |
| B. | DIFFUSER | | |
| | 35-0032 | DIFFUSER 5 HP | \$1001.77 |
| | 35-0033 | DIFFUSER 7.5 HP | \$1,074.13 |
| | 35-0033 | DIFFUSER 10 HP | \$1,074.13 |
| | 35-6735 | DIFFUSER 15 HP | \$813.04 |
| C. | 07-1725 | MECHANICAL SEAL | \$63.74 |
| D. | 35-0037 | DIFFUSER O'RING | \$23.78 |
| E. | 35-6780 | SEAL PLATE O'RING | \$70.74 |
| F. | 35-0171 | CLAMP CAM & RAMP | \$891.65 |
| G. | 35-6750 | STRAINER LID | \$645.30 |
| H. | 35-0166 | STRAINER LID O'RING | \$31.88 |
| I. | 35-7184 | BASKET | \$284.76 |

WHISPER FLO PUMP PARTS

A. Impellers

| Part No. | Models | HP | Price |
|----------|----------------|-------|----------|
| 07-3126 | WFE-2, WFK-2 | 1/2 | \$124.94 |
| 07-3127 | WFE-3, WFK-3 | 3/4 | \$124.94 |
| 07-3128 | WFE-4, WFK-4 | 1 | \$124.94 |
| 07-3129 | WFE-6, WFK-6 | 1 1/2 | \$124.94 |
| 07-3130 | WFE-8, WFK-8 | 2 | \$124.94 |
| 07-3131 | WFE-12, WFK-12 | 3 | \$124.94 |

- B. #07-2927 Diffuser 1/2 - 2HP \$95.15
 #07-2928 Diffuser 3HP only \$113.74
 C. #07-1734 Shaft Seal \$37.94
 D. #35-5227 Diffuser O' Ring (not shown) \$9.05
 E. #35-7100 Housing Gasket \$14.36
 F. #35-7149 Volute Replacement Kit \$375.93
 G. #35-0202 Seal Plate Kit \$252.09
 H. #07-0387 Basket \$20.95
 I. #35-0013 Lid O' Ring (not shown) \$10.50



CHALLENGER HIGH FLOW PUMP PARTS



| Part No. | Description | Price |
|-------------|------------------------|----------|
| A. 35-5004 | Seal Plate | \$127.17 |
| B. 35-4545 | Seal 3/8 Mech. | \$35.82 |
| C. 35-5468 | Front Housing | \$185.60 |
| D. 35-5300 | Strainer Pot | \$183.00 |
| E. 35-5301 | Strainer Lid | \$80.57 |
| F. 35-5389* | Impeller Locking Screw | \$4.30 |

*Parts not shown

N. IMPELLER

| Model No. | Cat. No. | Price |
|----------------|----------|---------|
| CF11-N1-3/4A | 35-5043 | \$68.13 |
| CF11-N1-1A | 35-5067 | \$69.48 |
| CF11-N1-1 1/2A | 35-5074 | \$70.29 |
| CF11-N1-2A | 35-5086 | \$70.76 |
| *CH11-N1-3FE | 35-5544 | \$92.45 |
| C F11-N1-5FE | 35-5068 | \$69.48 |

*High Pressure 3HP

O. DIFFUSER

| Model No. | Cat. No. | Price |
|----------------|----------|---------|
| CF11-N1-3/4A | 35-5029 | \$50.60 |
| CF11-N1-1A | 35-5029 | \$50.60 |
| CF11-N1-1 1/2A | 35-5077 | \$50.60 |
| CF11-N1-2A | 35-5077 | \$50.60 |
| *CH11-N1-3FE | 35-5545 | \$69.05 |
| CF11-N1-5FE | 35-5069 | \$46.80 |

P. MOUNTING PLATE

| Model No. | Cat. No. | Price |
|----------------|----------|---------|
| CF11-N1-3/4A | 35-5028 | \$29.63 |
| CF11-N1-1A | 35-5028 | \$29.63 |
| CF11-N1-1 1/2A | 35-5078 | \$18.65 |
| CF11-N1-2A | 35-5078 | \$18.65 |
| *CH11-N1-3FE | 35-5317 | \$18.65 |
| CF11-N1-5FE | 35-5495 | \$17.24 |

STARITE PUMP PARTS

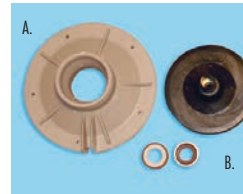

A. Models P4RA, P4EA, P6RA & P6EA

| HP | Impeller | Price | Diffuser | Price |
|-------|--------------|----------|----------|---------|
| 1 | C105-238P | \$97.81 | C1-271P1 | \$39.89 |
| 1 1/2 | C105-238PB | \$97.81 | C1-271P1 | \$39.89 |
| 2 | C105-238PDBA | \$100.78 | C1-271P | \$38.54 |
| 2 1/2 | C105-238PEBA | \$100.78 | C1-271P | \$38.54 |
| 3 | C105-238PLA | \$104.76 | C1-271P | \$38.54 |

B. SHAFT SEALS

| Part No. | Pump Model No. | Price |
|---------------|--|---------|
| 17304-0100S 2 | PE, PEA, P2R, P2RA | \$16.27 |
| 17351-0101S 2 | P4E, P4EA, P4R, P4RA, P6R, P6RA, P6E, P6EA | \$32.63 |



PENTAIR TEFC REPLACEMENT MOTORS

TEFC Replacement Motors make happier customers. Case closed.

TEFC motors last longer. That's because they're designed to help prevent the intrusion of water, dust and other contaminants that can lead to premature failure in ODP motors



| PART NO. | HP | PH | SF | VOLTS | PRICE |
|----------|-------|----|------|-------------|------------|
| 35-4806S | 1 | 3 | 1.65 | 208-230/460 | \$538.20 |
| 35-4808S | 1-1/2 | 3 | 1.47 | 208-230/460 | \$669.17 |
| 35-4810S | 2 | 3 | 1.3 | 208-230/460 | \$746.53 |
| 35-4812S | 3 | 3 | 1.15 | 208-230/460 | \$903.67 |
| 35-4814S | 5 | 3 | 1.0 | 208-230/460 | \$1,098.47 |
| 35-4804S | 3/4 | 1 | 1.65 | 115/208-230 | \$464.27 |
| 35-4822S | 1 | 1 | 1.65 | 115/208-230 | \$504.16 |
| 35-4824S | 1-1/2 | 1 | 1.47 | 208-230 | \$593.84 |
| 35-4816S | 2 | 1 | 1.3 | 208-230 | \$707.54 |
| 35-4818S | 3 | 1 | 1.15 | 208-230 | \$924.57 |
| 35-4820S | 5 | 1 | 1.0 | 208-230 | \$1,153.91 |

PUMP PARTS AND MOTORS



STARITE PUMP PARTS



- C. #C176-59P Tank Body Assembly (P4 Series) \$352.15
 #U9-375 P4 Lid O-Ring \$35.96
 D. #17307-0110S Tank Body Assembly (P6 Series) \$388.26
 #35505-1440 P6 Lid O-Ring \$23.20
 E. #C108-33P Basket \$15.98
 F. #C8-58P Basket \$17.24
 G. #C19-37A Clamp Only \$130.34
 H. #PKG115 Trap Assembly (P2 Series) \$180.02
 #U9-229 PKG115 Lid O-Ring \$18.70



- I. #C203-193P Seal Plate Kit (P2 Series) \$209.21
 #C203-194P Seal Plate Kit (P4 Series) \$209.21
 J. #C176-47P1 Tank Body \$166.59
 K. #WC36-22 Hand Knob \$15.86
 L. #U178-920P Drain Plug with O-Ring \$6.32

REPLACEMENT PUMPS & MOTORS

CENTURY AND A.O. SMITH MOTORS

A. SQUARE FLANGE-56Y FRAME

LOW SERVICE FACTOR (UP-RATE)

| CAT. NO | HP | SF | AMPS | VOLTS | PRICE |
|---------|-------|------|-----------|---------|------------|
| B852 | 3/4 | 1.25 | 10.8/5.4 | 115/230 | \$331.20 |
| B853 | 1 | 1.25 | 14.2/7.1 | 115/230 | \$378.18 |
| B854 | 1-1/2 | 1.10 | 16.0/8.0 | 115/230 | \$439.22 |
| B855 | 2 | 1.10 | 10 | 230 | \$564.32 |
| B840 | 2-1/2 | 1.04 | 11.5 | 230 | \$687.38 |
| B1000 | 5 | 1.00 | 21.0-19.4 | 208-230 | \$1,318.16 |

ENERGY EFFICIENT HIGH SERVICE FACTOR (FULL-RATE)

| CAT. NO | HP | SF | AMPS | VOLTS | PRICE |
|---------|-------|------|--------------|-------------|----------|
| B845 | 1/2 | 1.90 | 8.8/4.5-4.4 | 115/208-230 | \$408.24 |
| B661 | 3/4 | 1.67 | 11.2/6.0-5.6 | 115/208-230 | \$441.25 |
| B841 | 1 | 1.65 | 14.8/7.8-7.4 | 115/208-230 | \$476.30 |
| B842 | 1-1/2 | 1.47 | 9.6-8.8 | 208-230 | \$602.35 |
| B843 | 2 | 1.30 | 11.0-10.2 | 208-230 | \$723.40 |
| B844 | 3 | 1.15 | 15.0-13.6 | 208-230 | \$850.48 |

THREE PHASE HIGH SERVICE FACTOR (FULL RATE)

| CAT. NO | HP | SF | AMPS | VOLTS | PRICE |
|---------|-------|------|---------------|-------------|------------|
| H492 | 3/4 | 1.65 | 3.8-3.6/1.8 | 208-230/460 | \$486.61 |
| H635 | 1 | 1.65 | 5.0-4.6/2.3 | 208-230/460 | \$545.52 |
| H636 | 1-1/2 | 1.47 | 6.4-5.8/2.9 | 208-230/460 | \$692.46 |
| H637 | 2 | 1.30 | 7.1-6.8/3.4 | 208-230/460 | \$839.43 |
| H755 | 3 | 1.15 | 9.0-8.6/4.3 | 208-230/460 | \$903.72 |
| H995 | 5 | 1.00 | 13.4-13.4/6.7 | 208-230/460 | \$1,174.86 |

ENERGY EFFICIENT TWO SPEED HIGH SERVICE FACTOR (FULL RATE)

| CAT. NO | HP | SF | AMPS | VOLTS | PRICE |
|---------|------------|------|----------|-------|----------|
| B980 | 3/4 ~.10 | 1.67 | 6.0/1.0 | 230 | \$522.45 |
| B981 | 3/4 ~.10 | 1.67 | 12.4/2.2 | 115 | \$524.70 |
| B982 | 1 ~.13 | 1.67 | 7.4/1.4 | 230 | \$634.07 |
| B983 | 1-1/4 ~.19 | 1.47 | 10.0/1.6 | 230 | \$731.75 |
| B984 | 2 ~.25 | 1.30 | 11.0/1.8 | 230 | \$906.82 |

Applications: Pentair Challenger, Ultra-Flo and Whisper-Flo

B.C-FACE-56J FRAME

HIGH SERVICE FACTOR (FULL RATE)

| CAT. NO | HP | SF | AMPS | VOLTS | PRICE |
|---------|-------|------|----------|---------|----------|
| B126 | 1/2 | 1.60 | 8.8/4.4 | 115/230 | \$345.58 |
| B127 | 3/4 | 1.50 | 12.0/6.0 | 115/230 | \$361.22 |
| B128 | 1 | 1.40 | 14.4/7.2 | 115/230 | \$413.21 |
| B129 | 1-1/2 | 1.30 | 18.4/9.2 | 115/230 | \$559.31 |
| B130 | 2 | 1.20 | 10.5 | 230 | \$656.39 |
| B131 | 3 | 1.15 | 14.1 | 230 | \$919.51 |

Applications: Hayward Superpump, Jacuzzi Magnum

C. SQUARE FLANGE-48Y FRAME

LOW SERVICE FACTOR (UP-RATE)

| CAT. NO | HP | SF | AMPS | VOLTS | PRICE |
|---------|-------|------|----------|---------|----------|
| USQ1052 | 1/2 | 1.30 | 9.9/5.0 | 115/230 | \$322.18 |
| USQ1072 | 3/4 | 1.27 | 13.4/6.7 | 115/230 | \$331.20 |
| USQ1102 | 1 | 1.25 | 15.3/7.6 | 115/230 | \$372.24 |
| USQ1152 | 1-1/2 | 1.10 | 19.2/9.6 | 115/230 | \$431.24 |
| USQ1202 | 2 | 1.10 | 10.4 | 230 | \$555.30 |
| USQ1252 | 2-1/2 | 1.00 | 11.2 | 230 | \$687.38 |

ENERGY EFFICIENT HIGH SERVICE FACTOR (FULL-RATE)

| CAT. NO | HP | SF | AMPS | VOLTS | PRICE |
|---------|-------|------|----------|---------|----------|
| QC1052 | 1/2 | 1.90 | 9.6/4.8 | 115/230 | \$397.55 |
| QC1072 | 3/4 | 1.65 | 12.6/6.3 | 115/230 | \$445.84 |
| QC1102 | 1 | 1.65 | 16.0/8.0 | 115/230 | \$481.10 |
| SQ1152 | 1-1/2 | 1.47 | 10.4 | 230 | \$555.30 |
| SQ1202 | 2 | 1.30 | 11.2 | 230 | \$687.38 |
| SQ1302M | 3 | 1.15 | 15.4 | 230 | \$850.48 |

THREE PHASE HIGH SERVICE FACTOR (FULL-RATE)

| CAT. NO | HP | SF | AMPS | VOLTS | PRICE |
|---------|-------|------|----------|-------------|----------|
| Q3072 | 3/4 | 1.65 | 3.6/1.8 | 208-230/460 | \$467.98 |
| Q3102 | 1 | 1.65 | 4.7/2.35 | 208-230/460 | \$522.36 |
| Q3152 | 1-1/2 | 1.47 | 6.8/3.4 | 208-230/460 | \$662.27 |
| Q3202 | 2 | 1.30 | 8.5/4.25 | 208-230/460 | \$803.18 |
| Q3302 | 3 | 1.15 | 9.7/4.9 | 208-230/460 | \$869.65 |

ENERGY EFFICIENT TWO SPEED HIGH SERVICE FACTOR (FULL-RATE)

| CAT. NO | HP | SF | AMPS | VOLTS | PRICE |
|----------|-------------|------|----------|-------|------------|
| SQS1102R | 1 ~ 1/6 | 1.65 | 7.7/2.8 | 230 | \$596.97 |
| SQS1152R | 1-1/2 ~ 1/4 | 1.47 | 10.0/3.0 | 230 | \$824.31 |
| SQS1202R | 2 ~ 1/3 | 1.30 | 11.3/3.3 | 230 | \$1,033.67 |

Applications: Sta-Rite Duraglas/Duraglas II, Sta-Rite Maxeglas/Maxeglas II, and

Sta-Rite Max E Pro

D. FLEX-48 THRU BOLT-48Y FRAME

SINGLE SPEED

| CAT. NO | HP | SF | AMPS | VOLTS | PRICE |
|---------|-------|------|-----------|---------|----------|
| BN23SS | 1/2 | 1.00 | 7.2 | 115 | \$245.18 |
| BN24SS | 3/4 | 1.00 | 9.8 | 115 | \$266.18 |
| BN25SS | 1 | 1.00 | 12.0 | 115 | \$292.16 |
| BN35SS | 1-1/2 | 1.00 | 16.0/8.0 | 115/230 | \$340.20 |
| BN40SS | 2 | 1.00 | 20.0/10.0 | 115/230 | \$409.23 |

TWO SPEED

| CAT. NO | HP | SF | AMPS | VOLTS | PRICE |
|---------|-------------|------|----------|-------|----------|
| BN36 | 3/4 ~ .10 | 1.00 | 8.8/2.6 | 115 | \$340.20 |
| BN37 | 1 ~ .12 | 1.00 | 11.0/2.9 | 115 | \$388.13 |
| BN50 | 1-1/2 ~ .25 | 1.00 | 16.4/4.4 | 115 | \$495.27 |
| BN34 | 1-1/2 ~ .18 | 1.00 | 8.0/2.6 | 230 | \$420.05 |
| BN51 | 2 ~ .25 | 1.00 | 10.5/2.6 | 230 | \$547.34 |



E. CLOSED-COUPLED

| CAT. NO | HP | PHASE | FRAME | SF | AMPS | VOLTS | PRICE |
|---------|-------|-------|-------|------|----------------|-------------|------------|
| P130 | 3 | 1 | 182JM | 1.15 | 13.4 | 230 | \$1,328.45 |
| P231 | 5 | 1 | 184JM | 1.15 | 26 | 230 | \$1,673.01 |
| CP026 | 3 | 3 | 145JM | 1.15 | 8.2-7.4/3.7 | 208-230/460 | \$1,682.48 |
| CP038 | 5 | 3 | 182JM | 1.15 | 13.2-11.8/5.9 | 208-230/460 | \$1,867.55 |
| CP045 | 7-1/2 | 3 | 184JM | 1.15 | 19.0-17.0/8.5 | 208-230/460 | \$2,241.90 |
| E371ME | 10 | 3 | 213JM | 1.15 | 26.0-23.4/11.7 | 208-230/460 | \$2,890.15 |
| E377E | 15 | 3 | 215JM | 1.15 | 34.0/17.0 | 230/460 | \$3,569.06 |

Applications: Sta-Rite DMH/DMJ Series, Sta-Rite CSP Series and ITT Marlow

F. CMK/CHK THREE PHASE

| CAT. NO | HP | FRAME | SF | AMPS | VOLTS | PRICE |
|---------|-------|--------|------|----------------|-------------|------------|
| R237 | 5 | 182TDZ | 1.15 | 13.6-13/6.5 | 208-220/440 | \$3,811.75 |
| R232 | 7-1/2 | 184TDZ | 1.15 | 19-18.4/9.2 | 208-220/440 | \$4,173.89 |
| R338 | 10 | 213TDZ | 1.15 | 26.3-25.3/12.7 | 208-220/440 | \$6,003.72 |
| R339 | 15 | 215TDZ | 1.15 | 40.5-38/19 | 208-220/440 | \$7,033.18 |



G. PENTAIR EQK SERIES THREE PHASE

| CAT. NO | HP | FRAME | SF | AMPS | VOLTS | PRICE |
|----------|-------|--------|------|-----------|---------|------------|
| CEQK500 | 5 | 182JMZ | 1.15 | 11.8/5.9 | 230/460 | \$1,218.76 |
| CEQK750 | 7-1/2 | 184JMZ | 1.15 | 17.8/8.9 | 230/460 | \$1,403.24 |
| CEQK1000 | 10 | 213JMZ | 1.15 | 24.2/12.1 | 230/460 | \$1,890.77 |
| CEQK1500 | 15 | 215JMZ | 1.15 | 36.5/18.2 | 230/460 | \$2,067.91 |



SEMI-COMMERCIAL D.E. FILTER SYSTEMS



FNS PLUS D.E. Filter

Our FNS PLUS Series filters keep pool sparkling clean and free from impurities. For superior strength and reliability, these commercial-grade filter tanks are manufactured from fiberglass-reinforced polypropylene. Our unique top manifold design with curved vertical grids makes maintenance convenient.

- Rugged fiberglass-reinforced polypropylene tank combines fiberglass strength with the smooth finish of polypropylene.
- Top manifold design ensures better precoat and superior top-to-bottom back washing for longer times between cleanings.

Features the new Service-Ease™ grid pack with grid-locating spider for convenient, one-at-a-time grid servicing.

- High Flow™ manual air relief valve and continuous internal air relief work together to eliminate air accumulation.
- 1-1/2" bottom clean-out port for easy maintenance.

| Design Flow Rate* | | | | | | | | | |
|-------------------|-----------|---------|-----|-------|---------|---------|------------------|-------------|------------|
| Catalog No. | Model No. | Sq. Ft. | GPM | GPH | 6 Hours | 8 Hours | Precoat Required | Tank Height | Price |
| 18-0007 | FNSP 36 | 36" | 90 | 5,400 | 32,400 | 43,200 | 3.5 lbs. | 43" | \$1,541.84 |
| 18-0008 | FNSP 48 | 48" | 120 | 7,200 | 43,200 | 57,600 | 5 lbs. | 49" | \$1,734.73 |
| 18-0009 | FNSP 60 | 60" | 150 | 9,000 | 54,000 | 72,000 | 6 lbs. | 55" | \$1,914.97 |

*Flow rate is based on 2.5 GPM per sq. ft. of filter area. Actual system flow will depend on plumbing size and other system components.

*See page 23 for valve options

SEMI-COMMERCIAL HIGH-RATE SAND FILTERS

TRITON® COMMERCIAL SAND FILTERS
C and Triton C-3
High Capacity Fiberglass Side Mount
Sand Filter without Valves



- Maximum Operating Pressure 50 psi
- Full 2 in. Drain
- 8 in. opening for easy access to sand bed
- The Triton C-3 features standard 3 in. flange connections
- TR 100C-3 & TR 140C-3 models are available in black only



This filter series features multiple diverters for increased filtration rates in commercial applications up to 20 GPM/sq. ft.

| TRITON C FILTER PERFORMANCE DATA | | | | | | | | |
|------------------------------------|-----------|-----------|---------------------|-----|-----------------|------------|------|------------|
| Catalog No. | Model No. | Tank Dia. | Filter Area sq. ft. | Wt. | All Sand (lbs.) | Pea Gravel | Sand | Price |
| 14-0264 | TR-60 | 24 in. | 3.14 | 39 | 325 | 75 | 250 | \$1,498.29 |
| 14-0315 | TR-100C | 30 in. | 4.91 | 65 | 600 | 150 | 450 | \$2,030.85 |
| 14-0316 | TR-140C | 36 in. | 7.06 | 82 | 925 | 275 | 650 | \$2,932.25 |
| TRITON C-3 FILTER PERFORMANCE DATA | | | | | | | | |
| 14-0310 | TR-100C-3 | 30 in. | 4.91 | 65 | 600 | 150 | 450 | \$2,474.47 |
| 14-0342 | TR-140C-3 | 36 in. | 7.06 | 82 | 925 | 275 | 650 | \$3,519.39 |

F.O.B. Factory

QUAD D.E.™

Cartridge Style Filter

The crystal clarity of D.E. with cartridge convenience

Diatomaceous earth (D.E.) filters have always been recognized for providing the cleanest pool water. And cartridge filters are popular for their convenience and easy cleaning features. Now Pentair has found a way to bring you the best of both. The new Quad D.E.® Filter features four easily accessible and removable D.E. cartridges. And cleaning couldn't be easier. In fact, you have three options...backwash and recharge like a traditional D.E. filter, remove and rinse off the cartridges, or simply remove the lid, leave the cartridges in place, open the drain plug, and rinse.



| Catalog No. | Model No. | Filter Area Sq. Ft. | Vertical Clearance* | Filter Diameter | FlowRate GPM | | Turnover Capacity-Res.(Gallons) | | | Price |
|-------------|------------|---------------------|---------------------|-----------------|--------------|------|---------------------------------|--------|---------|------------|
| | | | | | Res.*** | Com. | 8hrs. | 10hrs. | 12hrs. | |
| 18-8592 | QUAD 60** | 60 | 62" | 21.5" | 120 | 90 | 57,600 | 72,000 | 86,400 | \$1,792.85 |
| 18-8593 | QUAD 80** | 80 | 68" | 21.5" | 160 | 150 | 76,800 | 96,000 | 115,200 | \$2,318.57 |
| 18-8594 | QUAD 100** | 100 | 74" | 21.5" | 160 | 150 | 76,800 | 96,000 | 115,200 | \$2,525.15 |

*Required clearance to remove filter elements

**NSF Listed

***Maximum flow rate

ABOVE GROUND SAND SYSTEMS

We've combined the efficient Sand Dollar filter with the powerful and economical OptiFlo® Aboveground Pool Pump to create this high performance system for above ground pools. With its rugged construction highly efficient filter design and hydraulically matched components, this system provides all the clean, crystal clear water your pool requires. Plus, it's built with long-term reliability in mind, and incredibly simple to operate and maintain.



| Sand Dollar Systems Flow Rate † | | | | | | | |
|---------------------------------|----------|----------|------|--------|---------|---------|----------------------|
| Sq. Ft. | Diameter | Height | GPM | Flow | | | Lbs. Sand Required ‡ |
| | | | | 8 Hour | 10 Hour | 12 Hour | |
| 2.3 | 22 in. | 35.5 in. | 60.0 | 28,800 | 36,000 | 43,200 | 250 |

† Flow rates based on NSF 20 GPM per sq. ft. of filter area. Actual system flow will depend on plumbing size and other system components.

‡ Sand must be 20 grade silica sand or equal.

#PNSD00600E1160 22" Sand Dollar System w/1½ HP Pump \$1,092.11

RESIDENTIAL SAND FILTERS

Features:

- Special lateral design provides superior flow characteristics, long filter cycles for economical operation.
- Maximum Operating Pressure 50 psi.
- Combination water and sand drain makes servicing and winterizing fast and easy.
- 40, 50 and 60D come with plastic clamp.



TAGELUS™ TOP MOUNT FILTER
Fiberglass Tank with
Multiport Valve, Clamp Style

Our process creates a one-piece, fiberglass reinforced tank with superior strength and durability. Tagelus® Top Mount filters are equipped with a six-position, clamp style, top mounted multiport valve.

| Model No. | Flow Rate GPM | Turnover Capacity (Gallons) | | |
|-----------|---------------|-----------------------------|---------|---------|
| | | 8 hrs. | 10 hrs. | 12 hrs. |
| TA 40D | 40 | 19,200 | 24,000 | 28,800 |
| TA 60D | 60 | 28,800 | 36,000 | 43,200 |
| TA 100D | 100 | 48,000 | 60,000 | 72,200 |

| Catalog No. | Model No. | Tank Dia. | Filter Area | All Sand (lbs.) | Price |
|-------------|-----------|-----------|-------------|-----------------|------------|
| 14-4126 | TA 40D | 19 in. | 1.8 | 175 | \$870.22 |
| 14-5241 | TA 60D | 24 in. | 3.1 | 325 | \$1,035.62 |
| 14-5240 | TA 100D | 30 in. | 4.9 | 600 | \$1,763.87 |

MEDIA

#547 50 lb. bag Mystic white sand \$19.28
#548 50 lb. bag gravel \$24.35
#547-ZEO-25 25 lb. bag Zeo sand \$28.15

See page 23 for all filter valves

SEMI COMMERCIAL & RESIDENTIAL CARTRIDGE FILTERS

ABOVE-GROUND FILTER SYSTEM

CLEAN & CLEAR CCI00 FILTER SYSTEM

- High quality filtration unit using a thermoplastic chemical-resistant tank. Equipped with easy spin-on unions for plumbing hookups
 - High flow manual air relief valve
 - 1 inch drain and washout
 - Single piece base and body design 1 1/2 HP pump
- #PNCC01000E1162 IHP SYSTEM.
 \$1,101.22



CLEAN & CLEAR® CARTRIDGE FILTER

Carefree...by design

Like all Pentair cartridge filters, the Clean & Clear® filter features an easily-cleaned cartridge for the ultimate in carefree pool filtration. The fiberglass-reinforced tank halves are secured with an innovative clamp ring—just loosen the ring and remove the top half for easy cartridge access and rinsing. Filter maintenance doesn't get any easier.

- 1 1/2" drain and washout for quick and convenient maintenance and winterization.
- Innovative lock-ring requires only half of a revolution for a safe, leak-proof seal.
- Single piece base and body designed for maximum durability.
- One-year limited warranty. See warranty for details.
- 2" plumbing for maximum flow.



| Catalog No. | Model No. | Filter Area Sq. Ft. | Vertical Clearance* | Filter Diameter | FlowRate GPM | | Turnover Capacity-Res.(Gallons) | | | Price |
|-------------|-----------|---------------------|---------------------|-----------------|--------------|------|---------------------------------|--------|---------|------------|
| | | | | | Res.** | Com. | 8hrs. | 10hrs. | 12hrs. | |
| 16-0314 | CC 50 | 50 | 30" | 15.5" | 50 | 19 | 24,000 | 30,000 | 36,000 | \$554.95 |
| 16-0315 | CC 75 | 75 | 39" | 15.5" | 75 | 28 | 36,000 | 45,000 | 54,000 | \$689.81 |
| 16-0316 | CC 100 | 100 | 61" | 15.5" | 100 | 38 | 48,000 | 60,000 | 72,000 | \$928.77 |
| 16-0317 | CC 150 | 150 | 76" | 15.5" | 150 | 56 | 72,000 | 90,000 | 108,000 | \$1,156.97 |
| 16-0318 | CC 200 | 200 | 76" | 15.5" | 150 | 75 | 72,000 | 90,000 | 108,000 | \$1,354.88 |

*Required clearance to remove filter elements **Maximum flow rate

SYSTEM 3® MOD MEDIA

One cleaning for an entire season! Sta-Rite's System3® Mod Media™ filters handle 2-3 times more dirt than other filters to deliver maintenance-free performance for up to a full season. Featuring perfectly balanced flow and integral manifold design, these filters are engineered to deliver the ultimate in labor-savings. System3® Mod Media™ filters are ideal for inground pools, inground hot tubs and water features.



| Filter Sizing | | | | | | |
|---------------|-----------------|--------------|-----------------------|-----------------------|-----------|------------|
| Cat. No. | Sq. Ft. of Area | Maximum Flow | Pool Size 8 Hr. Rate* | Pool Size 6 Hr. Rate* | Port Size | Price |
| S7M120 | 300 | 100 gpm | 36,000–48,000 | 27,000–36,000 | 2 | \$2,016.25 |
| S8M150 | 450 | 125 gpm | 45,120–60,000 | 33,840–45,000 | 2 | \$2,645.03 |



CLEAN & CLEAR® PLUS FILTERS

Fiberglass Reinforced Polypropylene Tank

Clean & Clear® Plus Filters have a corrosion resistant injection molded filter tank featuring superior strength and reliability. The cartridge assembly uses four easy to clean, non-woven, polyester cartridges. Each filter is supplied with a bulkhead union set for easy installation.

| Cat. No. | Model No. | Sq. Ft. | Tank Height | Price |
|----------|-----------|---------|-------------|------------|
| 16-0310 | CCP240 | 240 | 37" | \$1,498.64 |
| 16-0340 | CCP320 | 320 | 43" | \$1,844.83 |
| 16-0301 | CCP420 | 420 | 49" | \$2,054.49 |
| 16-0332 | CCP520 | 520 | 56" | \$2,543.31 |



JANDY PRO SERIES CL CARTRIDGE FILTERS

CL Cartridge Filters set the benchmark in cartridge filtration. Loaded with user friendly features, Jandy Pro Series Cartridge Filters optimize surface area and help provide clean, sparkling water. They are constructed of durable and corrosion resistant materials for maximum durability.

| Cat. No. | Sq. Ft. | Tank Height | Price |
|----------|---------|-------------|------------|
| CL460 | 460 | 41" | \$2,046.24 |
| CL580 | 580 | 47" | \$2,527.79 |



STA-RITE

| Tank Model | OEM P/N | HSC P/N | Price |
|-------------|-------------|---------|----------|
| PRC75 | 25200-0175S | H7483 | \$93.08 |
| PXC-75 | 25230-0075S | H8311 | \$102.65 |
| PXC-95 | 25230-0095S | H8311 | \$102.65 |
| PXC-125 | 25230-0125S | H8416 | \$173.85 |
| PXC-150 | 25230-0150S | H8416 | \$173.85 |
| PXCRP100 | R173215 | H9410 | \$142.93 |
| PXCRP150 | R173216 | H9415 | \$188.33 |
| PXCRP200 | R173217 | H9419 | \$234.98 |
| S7M120 | 25021-0200S | | \$294.38 |
| S7M120 | 25022-0201S | | \$585.00 |
| S7M400 | 25021-0223S | | \$326.26 |
| S7M400 | 25022-0224S | | \$800.63 |
| S8M150 | 25021-0202S | | \$487.47 |
| S8M150 | 25022-0203S | | \$783.11 |
| S8M500 | 25021-0224S | | \$588.74 |
| S8M500 | 25022-0225S | | \$819.38 |
| PLM100 | 27002-0100S | | \$308.34 |
| PLM125 | 27002-0125S | | \$304.35 |
| PLM150 | 27002-0150S | | \$457.72 |
| PLM175 | 27002-0175S | | \$421.97 |
| PLM200 | 27002-0200S | | \$574.56 |
| WC108-56S2X | UHD-SR50 | | \$90.90 |
| WC108-57S2X | UHD-SR70 | | \$110.38 |
| WC108-58S2X | UHD-SR100 | | \$145.05 |
| WC108-59S2X | UHD-SR135 | | \$181.73 |
| WC108-70S2X | UHD-SR137 | | \$181.73 |

HARMSCO

| Tank Model | OEM P/N | HSC P/N | Price |
|------------|---------|---------|----------|
| BF | ST6 | H380 | \$8.08 |
| BF105 | ST105 | H7685 | \$134.53 |
| BF155 | ST155 | H7697 | \$177.78 |
| HUR 170 | HC/170 | | \$330.23 |

PENTAIR

| Tank Model | OEM P/N | HSC P/N | Price |
|---------------|--------------------------------|---------|----------|
| CC 50 | R173213 | H9405 | \$95.18 |
| CC 75 | R173214 | H9407 | \$116.48 |
| CC 100 | R173215 | H9410 | \$142.93 |
| CC 125 | 173200 | H9410 | \$142.93 |
| CC 150 | R173216 | H9415 | \$188.33 |
| CC 175 | 173201 | H9419 | \$234.98 |
| CC200 | R173217 | H9419 | \$234.98 |
| CCP 240 | R173572 | H7469 | \$87.88 |
| CCP 320 | R173573 | H7470 | \$112.25 |
| CCP 420 | R173576 | H7471 | \$137.85 |
| CCP 520 | R173578 | H7472 | \$157.98 |
| CCRP 100 | R173215 | H9410 | \$142.93 |
| CCRP 150 | R173216 | H9415 | \$188.33 |
| CCRP 200 | R173217 | H9419 | \$234.98 |
| Commander 75 | R173205 R173204 57007400 | H7698 | \$127.85 |
| Commander 100 | R173208 57014400 | H7698 | \$127.85 |
| Quantum 240 | 178569 | H7469 | \$87.88 |

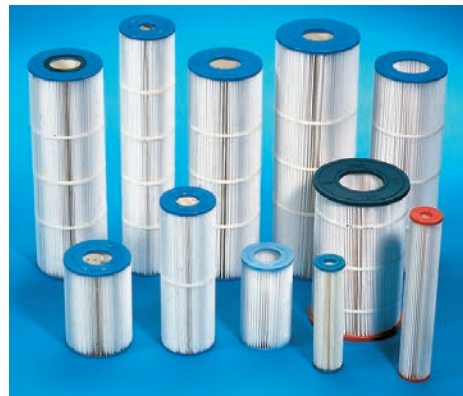

We carry cartridges for many different pool & spa cartridge filters. Please call with height, width, and endcap configurations.

HAYWARD

| Tank Model | OEM P/N | HSC P/N | Price |
|------------|-----------|---------|----------|
| C400 | CX410RE | H7442 | \$69.73 |
| C500 | CX500RE | H7656 | \$75.95 |
| C550 | CX550RE | H7656 | \$75.95 |
| C750 | CX750RE | H7698 | \$127.85 |
| C800 | CX800RE | H8600 | \$109.88 |
| C900 | CX900RE | H8311 | \$102.65 |
| C1000 | CX1000RE | H7698 | \$127.85 |
| C1100 | CX1100RE | H8610 | \$139.98 |
| C1200 | CX1200RE | H8410 | \$134.68 |
| C1250 | CX1250RE | H9499 | \$166.98 |
| C1500 | CX1500RE | H9499 | \$166.98 |
| C1750 | CX1750RE | H8417 | \$215.50 |
| C2025 | CX480XRE | H7469 | \$87.88 |
| C3000 | | | |
| C3020 | CX570XRE | H7483 | \$93.08 |
| C3000S | | | |
| C3025 | CX580XRE | H7483 | \$93.08 |
| C3030 | | | |
| C4000 | | | |
| C4020 | CX870XRE | H7488 | \$124.30 |
| C4000S | | | |
| C4025 | CX880XRE | H7488 | \$124.30 |
| C4030 | | | |
| C4500 | CX875RE | H7488 | \$124.30 |
| C4520 | | | |
| CC1000 | CCX1000RE | H8311 | \$102.65 |
| CC1250 | CCX1250RE | H8311 | \$102.65 |
| CC1500 | CCX1500RE | H8316 | \$147.73 |

JANDY

| Tank Model | OEM P/N | HSC P/N | Price |
|------------|----------|---------|----------|
| CL/CV 340 | A0557900 | H7459 | \$108.65 |
| CL/CV 460 | A0558000 | H7468 | \$136.98 |
| CL/CV 580 | A0104000 | H7482 | \$164.20 |
| CS100 | R0462200 | H8410 | \$134.68 |
| CS150 | R0462300 | H8316 | \$147.73 |
| CS200 | R0462400 | H8418 | \$226.05 |

REPLACEMENT FILTER CARTRIDGES

WATERWAY

| Tank Model | OEM P/N | HSC P/N | Price |
|-------------------|---------------------------------------|---------|----------|
| Clearwater 75 | 817-0075 | H9401 | \$119.33 |
| Clearwater 100 | 817-0100 | H9402 | \$146.53 |
| Clearwater 150 | 817-0150 | H9403 | \$192.98 |
| Clearwater II 75 | 817-0075P 817-0075PB | H8311 | \$102.65 |
| Clearwater II 100 | 817-0100P 817-0100PB | | |
| Clearwater II 125 | 817-0125N 817-0125NB | H8410 | \$134.68 |
| Clearwater II 150 | 817-0150N 817-0150NB | H8316 | \$147.73 |
| Clearwater II 200 | 817-0200N 817-0200NB | H8419 | \$230.75 |
| Crystal Water 325 | 817-0081 | H7470 | \$112.25 |
| Crystal Water 425 | 817-0106 | H7471 | \$137.85 |
| Crystal Water 525 | 817-0131 | H7472 | \$157.98 |
| ProClean 75 | 817-0075P | | |
| ProClean Plus 75 | 817-0075PB | H8311 | \$102.65 |
| ProClean 100 | 817-0100P | | |
| ProClean Plus 100 | 817-0100PB | | |
| ProClean 125 | 817-0125P | H8416 | \$173.85 |
| ProClean Plus 125 | 817-0125N 817-0125NB 817-0125PB | H8410 | \$134.68 |
| ProClean 150 | 817-0150P | H8416 | \$173.85 |
| ProClean Plus 150 | 817-0150N 817-0150NB 817-0150PB | H8316 | \$147.73 |
| ProClean 175 | 817-0175P | | |
| ProClean Plus 175 | 817-0175PB | H8417 | \$215.50 |
| ProClean 200 | 817-0200P | | |
| ProClean Plus 200 | 817-0200PB | | |

FILTER PARTS & FILTER GRIDS

VACUUM D.E. FILTER ELEMENTS

Halogen Supply Company is a stocking distributor of Vacuum D.E. Filter Elements, Filter Discs, and accessories. We carry Mermade, Paddock, Keene-Bowser, Chester, B.I.F. and many more. We sell them as complete assemblies (elements with covers and gaskets), cover and gaskets only, or elements only. Standard Center Bottom Outlets and Custom Corner Outlets are available. Please call us at 1.800.777.SWIM or email us at info@halogensupply.com today for a quote.



REPLACEMENT CARTRIDGE FILTER PARTS

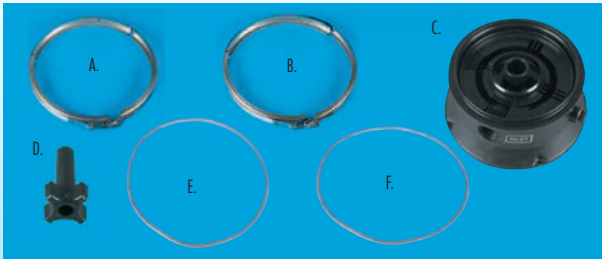

PTM SERIES

- A. 25010-9101 Top clamp (Also-middle PTM 135 clamp) \$212.33
- B. 25010-9100 Bottom clamp (all models) \$195.50
- C. WC104-78P Base with plugs (all models) \$246.20
- D. WC36-22 Clamp knob (all models) \$15.86
- E. 25230-0010S Top O'ring (all models) \$23.69
- F. WC9-3 Bottom O'ring all models \$34.79



CLEAN & CLEAR PARTS

- G. 98209800 High flow manual relief valve \$42.93
- H. 19-0058 Pressure gauge \$52.18
- I. 17-8553 Lid CC50 and CC100 \$200.30
- J. 17-8561 Lid CC75, CC150 and CC200 \$186.77
- K. 59052900 Locking ring assembly \$122.92
- L. 87300400 Body O'ring \$12.13

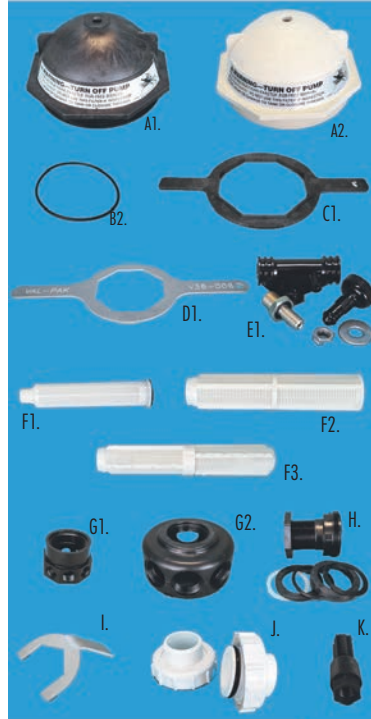

PENTAIR(PAC-FAB) TRITON SAND FILTER PARTS

TR60, TR100, TR140 FILTER PARTS

- A1. 15-2519Z Closure with Quad Ring \$134.73
- A2. 15-4559 Closure (Before 1991) \$68.96
- B2. 15-4493 Closure O'Ring \$7.38
- B2. 15-2516 Quad Ring for 15-2519Z closure \$7.35
- C1. 15-4512 Plastic Closure Wrench \$32.20
- D1. V38-006 Metal Closure Wrench \$156.58
- E1. 15-4687 Air Bleed Assembly \$60.50
- 15-4689 Air Bleed Tee Only \$35.66
- F1. 15-2290 TR-60 Lateral \$9.38
- 15-0085 1/4 Turn Lateral TR-60 after 6/07 \$18.88
- F2. 15-2202 TR-100 Lateral \$14.20
- F3. 15-4540 TR-140 Lateral \$25.74
- G1. 15-4763 TR60 HUB \$39.38
- 15-5753 1/4 Turn Hub TR-60 after 6/07 \$39.51
- G2. 15-4453 TR100 & 140 HUB \$131.83
- H. 15-4714 Bulkhead \$191.86
- I. V38-008 Bulkhead Wrench \$66.00
- J. 27-1092 2" Threaded Adapter Kit \$76.37
- 27-1094 1.5" Threaded Adapter Kit \$76.37
- 27-1096 1.5" Soc x 2" Spig Adapter Kit \$76.37
- K. 15-4698 Drain Spigot \$32.63
- 35-7161 1/4 Drain Plug Only \$7.03
- 19-2115 O'ring for Drain Plug \$3.50



TR100C, TR140C FILTER PARTS

- A3. 15-4575 Closure \$83.25
- B2. 15-2509 Closure O'Ring/Gasket \$10.23
- C2. 15-4527 Plastic Closure Wrench \$36.68
- D2. V38-007 Metal Closure Wrench \$156.58
- E2. 27-3564 Air Relief Assembly \$119.86
- F2. 15-2202 TR-100C Lateral \$14.20
- F3. 15-4540 TR-140C Lateral \$25.74
- G2. 15-4453 TR100C/140C LATERAL HUB \$131.83
- H. 15-4714 Bulkhead \$191.86
- I. V38-008 Bulkhead Wrench \$66.00
- J. 27-1092 2" Threaded Adapter Kit \$76.37
- 27-1094 1.5" Threaded Adapter Kit \$76.37
- 27-1096 1.5" Soc x 2" Spig Adapter Kit \$76.37
- K2. 15-2220Z Drain Assembly Complete \$55.26
- 15-4871 Cap Only For Drain \$10.53

833-SWIM-327
833-7946-327
www.halogensupply.com



D.E. FILTER GRIDS AND MANIFOLDS

C. AMERICAN PRODUCTS - PENTAIR (PAC - FAB) & HAYWARD

- FG-1002 Large grid 12" long for 24 sq. ft. \$17.80
- FG-1003 Large grid 18" long for 36 sq. ft. \$24.03
- FG-1004 Large grid 24" long for 48 sq. ft. \$30.28
- FG-1005 Large grid 30" long for 60 sq. ft. \$37.85
- FG-1006 Large grid 36" long for 72 sq. ft. \$43.83
- PG-1902 Small grid 12" long for 24 sq. ft. \$20.10
- PG-1903 Small grid 18" long for 36 sq. ft. \$26.65
- PG-1904 Small grid 24" long for 48 sq. ft. \$33.73
- PG-1905 Small grid 30" long for 60 sq. ft. \$40.65
- PG-1906 Small grid 36" long for 72 sq. ft. \$47.55
- 59000400 Top Manifold for Amer Prod. \$185.49
- 59000500 Bottom Spider for Amer Prod \$99.18
- 19-2193 Manifold grid for Pentair(Pac Fab) \$157.77
- 19-2194 Retainer grid for Pentair(Pac Fab) \$69.39

D. PUREX

- FG-1224 Purex element 24 sq. ft 12" long \$43.83
- FG-1236 Purex element 36 sq. ft 18" long \$34.73
- FG-1248 Purex element 48 sq. ft 24" long \$31.28
- FG-1260 Purex element 60 sq. ft 30" long \$39.18
- FG-1272 Purex element 72 sq. ft 36" long \$45.48
- 07-1019 Holding wheel 2000 Series \$43.40
- 07-3270 Manifold 2000 Series—8 hole \$34.22

E. COMPLETE GRID ASSEMBLY (Not Shown)

AMERICAN PRODUCTS PENTAIR(PAC-FAB) & HAYWARD

Includes Grids, Manifold, Retainer Grid, Rods and Nuts

- 19-2324 Grid assembly complete for 24 sq ft \$603.77
- 19-2325 Grid assembly complete for 36 sq ft \$751.55
- 19-2326 Grid assembly complete for 48 sq ft \$928.13
- 19-2327 Grid assembly complete for 60 sq ft \$1,104.35
- 19-5060 Grid assembly complete for 72 sq ft \$1,280.70

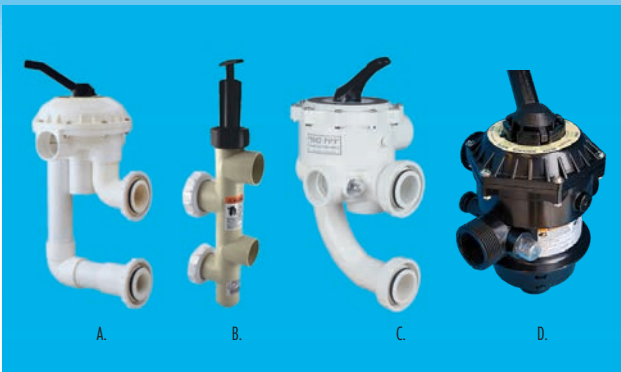

PRE-PLUMBED PENTAIR VALVES

Pre-plumbed Push Pull and Multiport Valves are complete with bulkhead unions for simple installations with filters. All valves are designed for maximum performance and 100% factory tested.

- A. #26-1050 2" Slip HiFlow Sand Multiport Valve \$325.08
- B. #26-3064 2" Slip Slip Slide Valve (old#26-1165) \$182.34
- C. #26-1055 2" Threaded Sand Multiport Valve \$373.53
- D. #26-2506 1-1/2" Top Mount Multiport Valve for Tagelus \$242.82
- #26-1173 1-1/2" Threaded Sand Multiport Valve \$248.98
- #26-1177 1-1/2" Threaded D.E. Multiport Valve \$248.98
- #26-1152 2" Threaded D.E. Multiport Valve \$373.53
- #26-1142 2" Slip HiFlow D.E. Multiport Valve \$315.63
- #26-3080 Full Flow XF Valve \$327.14

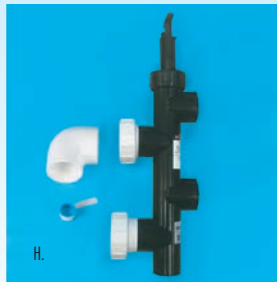
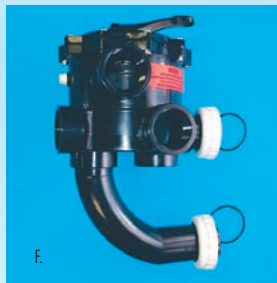
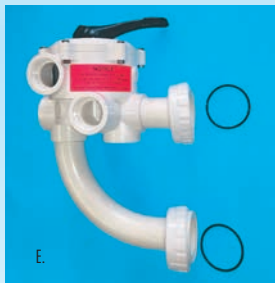

PRE-PLUMBED STA-RITE VALVES

Valves for 2 inch System 3 filters. Connects directly to side ports. Positive seal prevents leakage between ports.

- E. 18202-0150 1 1/2" MPV SD/SS Series \$251.75
- F. 18201-0200 2" MPV SD/SS Series \$378.67
- G. 18201-0300 3" MPV SMD Series \$378.67
- H. 26-3053 2" Sand/DE Slide Valve \$196.81

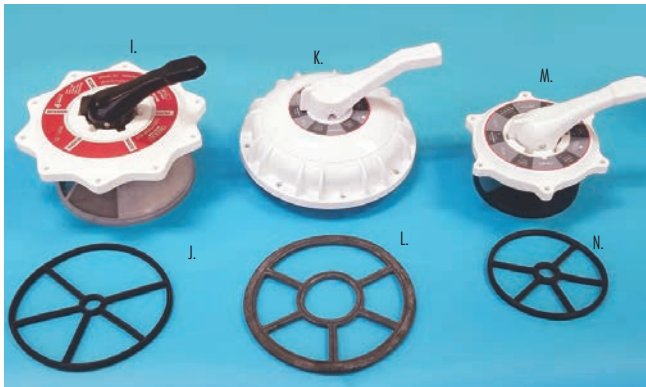

REPLACEMENT MULTIPORT VALVE PARTS

- I. 27-0067 Top Valve Assembly 2" \$289.31
- J. 27-1148 Divertor Gasket \$39.42
- K. 27-2422 Top Valve Assembly 2" High Flow \$263.34
- L. 27-2409 Divertor Gasket 2" Hi-Flow \$47.81
- M. 27-0068 Top Valve Assembly 1-1/2" \$243.32
- N. 27-1104 Divertor Gasket \$32.51
- 27-2550 Sight Glass \$16.27
- 27-1106 Sight Glass Gasket \$8.10
- 27-4407 Bulkhead Nut \$21.17
- 27-4556 Threaded Valve Adapter \$18.99
- 27-1103 Cover O' Ring 1-1/2" \$19.24
- 27-1151 Cover O' Ring 2" \$23.67
- 35-4053 Cover O' Ring for 262506 TA Valve \$33.93



REPLACEMENT UNION PACKAGE FOR SYSTEM 3 SERIES FILTER

- O. #PKG 188 Includes locknuts, adapters and o'rings \$38.05

833-SWIM-327
 833 • 7946 • 327
www.halogensupply.com

**MULTI-PORT VALVES
 SLIDE VALVES
 VALVE PARTS &
 FITTINGS PACKAGE**

REPLACEMENT SLIDE VALVE PARTS

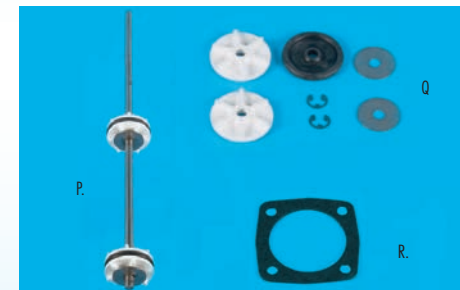

- 2" BRASS PARTS (valve discontinued)
- P. V36-100 Piston rod assy. (stainless) \$284.45
- Q. V36-178 Piston half assembly kit \$53.93
- R. G-206 Gasket for top handle \$4.95

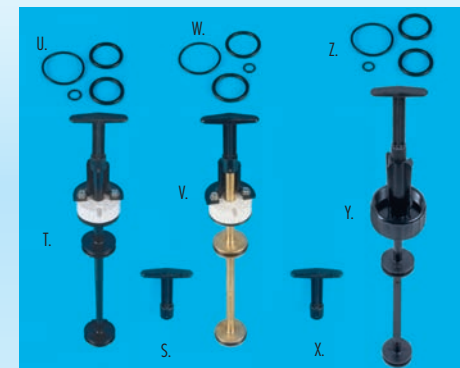

- 2" PVC PARTS (26-1165 discontinued)
- S. 27-3089 Handle \$21.17
- T. 27-3241 Plastic piston rod assembly \$119.86
- U. 27-3109 O' ring kit \$14.67
- V. V36-177 Brass piston rod assembly \$251.06
- W. V36-185 O' ring kit for brass piston assembly \$9.47
- X. V36-180 Handle for V36-177 piston \$37.28
- 2" PVC NEW STYLE PARTS (26-3064, 26-3053)
- Y. 26-3055 Piston rod assembly \$131.99
- Z. 26-3054 O' ring kit \$26.06

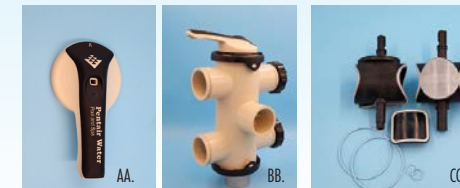

- FULL FLOW XF PARTS (26-3080)
- AA. 27-0187Z Full Flow XF Handle \$60.95
- BB. 27-0190Z Full Flow XF End Cap \$52.88
- CC. 27-0514Z Full Flow XF Rebuild Kit \$203.24

PENTAIR POOL & SPA HEATERS

THE MAX-E-THERM™ LEAVES OTHER HEATERS GOLD!

- **Easy-read digital display.** Pivoting UV-resistant plastic visor filters the sun's rays to give you a better view of the digital display.
- **Diagnostic lights.** Control panel indicator lights tell you whether to service the heater or the system if problems arise.
- **Weatherproof touch controls.**
- **Forever rust-proof.** Sleek, black matte enclosure made of Dura-Glas® - an exclusive Sta-Rite material that handles the heat and weathers the elements.
- **Cupro-Nickel heat exchanger.**

| | |
|--|------------|
| #SR200HD Max-E-Therm Heavy Duty Heater | \$4,587.88 |
| #SR333HD Max-E-Therm Heavy Duty Heater | \$5,501.72 |
| #SR400HD Max-E-Therm Heavy Duty Heater | \$6,061.06 |



MEGATHERM

HIGH PERFORMANCE GAS FIRED COMMERCIAL POOL HEATER

Powerful, efficient, and reliable, MegaTherm pool heaters are designed for commercial, institutional and large residential pools where economical performance and rapid heat-up are required. Available in indoor and outdoor models, with twenty-two sizes from 500,000 to 5,000,000 BTU/h to precisely match any heating requirement. MegaTherm heaters are designed to deliver efficiencies as high as 82%. Integral finned copper tubes are rolled directly into the headers, and conformal heat exchanger baffles and an eight-fins-per-inch tubing configuration maximize combustion heat extraction. We've also designed the MegaTherm heater to be simple to service. Heat exchanger header covers are field-removable for complete inspection of tubing and header passages, and the heat exchanger is replaceable without disassembly of the burners or combustion chamber.

MegaTherm heaters are design certified to the ANSI® Z21.56 Standard for Gas-Fired Pool Heaters. (Outdoor 500-1825 units are certified for use without the addition of a draft diverter or external vent. Indoor units incorporate a built-in draft diverter and require only vent piping.) Salt water models (500-1825) are available with cupro-nickel alloy heat exchanger tubes and header covers.

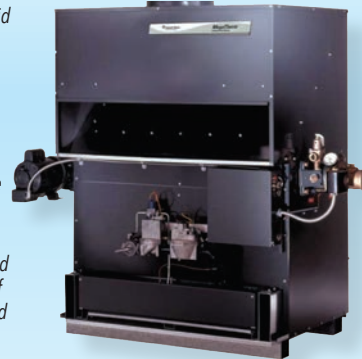

ETI™ 400 HIGH EFFICIENCY GAS HEATER



THE HIGHEST EFFICIENCY EVER.

The longest-lasting heat exchanger ever built.

The ETi™ 400 High-Efficiency Heater features the TitanTough™ Direct-Fire Pure Titanium Heat Exchanger, the longest-lasting heat exchanger ever built. And it delivers 96% thermal efficiency, the highest of any pool heater. The ETi™ 400 heater provides excellent flexibility for installation, with fully sealed Category IV direct air venting that does not require large room openings for combustion air.

| | |
|--|--------|
| #46-1113 ETi™ 400 Heater | P.O.A. |
| #47-5971 Direct Air Intake Kit | P.O.A. |
| #47-5612 Condensate Neutralizer artridge Kit | P.O.A. |



High Performance Eco-Friendly Heaters



MASTERTEMP® HEATER

MasterTemp heaters offer all the efficiency, convenience and reliability features you want in a pool heater, plus a lot more. As easy to use as your home heating system, plus, user-friendly indicator lights make system operation and monitoring a snap. The compact design and super quiet operation won't intrude on your pool side leisure time. Heavy-duty (HD) unit with cupro-nickel exchanger stands up to the harshest of applications, like low pH, high flow or heavy use.



Ordering Information

| | |
|--|------------|
| #46-0806 - MasterTemp 250 HD Heater | \$4,813.14 |
| #46-0805 - MasterTemp 400 HD Heater | \$5,882.74 |
| #46-1000 - MasterTemp 200 NA ASME Heater | \$5,676.64 |
| #46-1020 - MasterTemp 250 HD ASME Heater | \$6,110.76 |
| #46-1021 - MasterTemp 400 HD ASME Heater | \$6,675.12 |

#Vertical Venting - Negative Pressure Kits

| | |
|---|----------|
| #77707-0076 4" x 6" Metal Flue Collar | \$207.43 |
| #77707-0077 4" x 8" Metal Flue Collar | \$218.34 |
| #46-1031 Direct Air Intake Kit MasterTemp | \$326.55 |



ABOVE GROUND HEATERS & LIGHTS

A. MASTERTEMP® 125 HIGH PERFORMANCE HEATER



Features:

- 82% energy efficiency is highest in its class.
- High-performance, affordable heating with premium features.
- 1-1/2" plumbing - ideal for smaller bodies of water up to 15,000 gallons.
- Pre-mixed combustion technology for ultra-fast heat-up.
- Easy-to-use, information-rich digital display/controller.
- Certified for low NOx emissions.

| | |
|-------------------------|------------|
| #46-1059 MasterTemp 125 | \$2,323.10 |
|-------------------------|------------|

833-SWIM-327
833-7946-327
www.halogensupply.com

DIGITAL POOL AND SPA HEATER



The sleek and stylish Raypak Digital Gas Pool and Spa Heater features innovative technology designed to keep your pool or spa at the perfect temperature for your enjoyment. Built to withstand various weather conditions, this modern pool and spa heater is the perfect solution for environments requiring efficiency, convenience and versatility.

Thanks to a brilliant low-profile design, corrosion resistant cabinet made of galvanized metal, copper or cupro fin tube heat exchanger, and a bevy of advanced-engineered materials, enjoying your heater year round is a breeze.



A. POLYMER HEATERS

COPPER HEAT EXCHANGER

| Cat. No. | Model No. | Price |
|----------|--------------|------------|
| 009216 | P-R206A-EN-C | \$3,808.00 |
| 009217 | P-R266A-EN-C | \$4,144.00 |
| 009218 | P-R336A-EN-C | \$4,670.00 |

CUPRO-NICKEL HEAT EXCHANGER

| Cat. No. | Model No. | Price |
|----------|--------------|------------|
| 014938 | P-R206A-EN-X | \$4,082.00 |
| 014939 | P-R266A-EN-X | \$4,458.00 |
| 014940 | P-R336A-EN-X | \$4,940.00 |
| 014941 | P-R406A-EN-X | \$5,576.00 |



B. PREMIUM BRONZE HEADERS ASME

CUPRO-NICKEL HEAT EXCHANGER

| Cat. No. | Model No. | Price |
|----------|--------------|------------|
| 017399 | B-206A-EN-X | \$4,948.00 |
| 017400 | B-R266A-EN-X | \$5,344.00 |
| 017401 | B-R336A-EN-X | \$5,826.00 |
| 017402 | B-R406A-EN-X | \$6,490.00 |

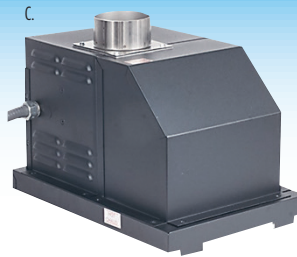

C. D-2 POWER VENTS

| Cat. No. | Model No. | Price |
|----------|-----------|------------|
| 009832 | 206A-266A | \$1,026.00 |
| 009833 | 336A-406A | \$1,066.00 |



D. INDOOR DRAFTHOODS

| Cat. No. | Model No. | Flue Size | Price |
|----------|-----------|-----------|----------|
| 009838 | 206A | 6" | \$210.00 |
| 009839 | 266A | 7" | \$214.00 |
| 009840 | 336A | 8" | \$218.00 |
| 009841 | 406A | 9" | \$222.00 |

RAYPAK X94 PROFESSIONAL HEATER

Highly Efficient.

Intelligent technology. Built with the same Raypak Professional Series high performance DNA.



Same digital control logic used on all Raypak pool products

Standard Features:

- Model 410 @399,000 BTU input
- Stainless Steel heat exchanger ASME certified.
- Pre-wired flow switch and T&P gauge, 50 state ASME compliant
- Industry leading diagnostic digital control-assembled in the U.S.A. Multi-unit functionality, pump and 3-way valve control.



- Flexible 4" venting options - PVC, CPVC, Polypropylene, Stainless Steel.
- Direct vent capable - ducted combustion air.
- 3 year parts and labor limited warranty (see warranty for details).

#014280 S-R410-EN ASME . . . P.O.A.

RESIDENTIAL & COMMERCIAL POOL HEATERS



RAYPAK® AVIA

Managing your pool heater has never been easier or smarter. AVIA is built with an innovative Wi-Fi enabled control system that allows you to manage your pool heater and onenaccessory through the Raymote app. No need for a separate control panel to manage your pool heater.



| Cat. No. | Model No. | Price |
|----------|--------------|------------|
| 018044 | P-R264A-EN-N | \$4,412.00 |
| 018045 | P-R404A-EN-N | \$5,404.00 |

RAYPAK® A/G & I/G SPA HEATER

- Electronic ignition • Fire tile
- Dual voltage with 120 volt power cord and 3 - prong plug; or can be wired for 240 volt directly to transformer
- Polymer headers
- Wind resistant design
- 2" & 1½" water connection
- Powder coating

- #014779 P-R106-AN-C \$2,168.00
- #014784 P-R156A-EN-C. \$2,646.00
- #014357 Indoor Top 106 \$152.00
- #014358 Indoor Top 156 \$156.00



COMMERCIAL AND ELECTRIC POOL HEATERS



Commercial Pool Heaters

Raypak's Next Generation Condensing Heater

Time-honored technologies unite with cutting-edge advancements in Raypak's new XTherm vertical heater. Never before has a vertical heater provided both the installer and pool builder such installation flexibility, ease-of-commissioning, reliability and long-term performance. Small space, not a problem. The XTherm has one of the smallest installed footprints of any vertical condensing heater. Our compact design makes it the perfect choice for those hard to reach retrofit projects. Raypak's XTherm is built with commercial-grade components and materials. From our steel channel base to our stainless steel flue wrapper, and condensing heat exchanger, you can tell the XTherm is built to last. It's easy to handle and install, but still user friendly to service. Now is the perfect time to take a closer look at Raypak.

P.O.A. Call for pricing

Models 1005, 1505, 2005
97% Thermal Efficiency



Key Features

- PVC vent capable - optional at time of order
- 3 models from 1,000,000 to 2,000,000 BTUH
- 97% thermal efficiency at full fire in pool applications
- Minimum continuous inlet water temperature (50°F)
- Small footprint, less than 11 square feet
- AB 1953 low lead certified
- On-board diagnostic center, real English, no codes
- All models indoor/outdoor certified
- Complete cabinet protects all controls and wiring
- Meets all current Low NOx regulations
- Suitable for altitudes up to 10,000 ft. (derate above 5,000 ft.)
- Equipped with all cupro-nickel, copper, bronze and stainless steel waterways

Can be vented with PVC pipe



RAYPAK HIGH DELTA®

Commercial pool Heater is Durable Under the Most Challenging of Conditions

Raypak's Next Generation Condensing Heater

Raypak's Hi Delta is easy to install, operate and service. The Hi Delta has a patented burner with an innovative design that provides an optimized air-gas pathway for complete combustion. This makes the Hi Delta the most adaptable sealed-combustion boiler on the market today.

The touch panel display on the Hi-Delta includes onboard diagnostics. In the event of any system problems, technicians can quickly review the fault history of the unit.

The Hi Delta product family covers the full spectrum of both indoor and outdoor applications including space heating, process heating, pool heating and domestic hot water heating.

When installed indoors, the Hi Delta's versatility is revealed via smaller vent diameters, direct-venting capability, and the convenience of stacking to decrease the footprint for multiple appliances.

P.O.A. Call for pricing



ELECTRICAL POOL & SPA HEATERS



ELECTRICAL HEATERS

For Pools & Spas By Coates

A built-in flow switch, to prevent operation of the heater when there is no water flow, is standard equipment.

Standard features: Stainless steel vessel. Incoloy heating element. Close differential thermostat. High temperature limit, manual reset. Flow switch. Element pilot light. Element sequencing of single phase heaters. Internal protective fusing. Easy electrical terminal blocks.



| KW | 1PH, 236V | | 3PH, 240V/3PH, 208V | | 3PH, 480V | | Price | Cat.No. | Price |
|----|------------|--------|---------------------|--------|------------|--------|------------|---------|--------|
| | Cat.No. | Price | Cat.No. | Price | Cat.No. | Price | | | |
| 12 | 12412CE | P.O.A. | 32412CE | P.O.A. | 32012CE | P.O.A. | 34812CE | P.O.A. | P.O.A. |
| 15 | 12415CE | P.O.A. | 32415CE | P.O.A. | 32015CE | P.O.A. | 34815CE | P.O.A. | P.O.A. |
| 18 | 12418CE | P.O.A. | 32418CE | P.O.A. | 32018CE | P.O.A. | 34818CE | P.O.A. | P.O.A. |
| 24 | 12424CPH | P.O.A. | 32424CPH | P.O.A. | 32024CPH | P.O.A. | 34824CPH | P.O.A. | P.O.A. |
| 30 | 12430CPH | P.O.A. | 32430CPH | P.O.A. | 32030CPH | P.O.A. | 34830CPH | P.O.A. | P.O.A. |
| 36 | 12436PHS-3 | P.O.A. | 32436PHS-3 | P.O.A. | 32036PHS-3 | P.O.A. | 34836PHS-3 | P.O.A. | P.O.A. |
| 45 | 12445PHS | P.O.A. | 32445PHS | P.O.A. | 32045PHS | P.O.A. | 34845PHS | P.O.A. | P.O.A. |
| 54 | 12454PHS-4 | P.O.A. | 32454PHS-4 | P.O.A. | 32054PHS-4 | P.O.A. | 34854PHS-4 | P.O.A. | P.O.A. |

F.O.B. FACTORY - WASHINGTON STATE P.O.A. Call for Pricing

ELECTRIC SPA HEATER

with Exclusive Built-in Flow Switch By Coates

Standard features: Incoloy heating element. Close differential thermostat. High temperature limit, manual reset. A seamless, red-cast vessel is one of the major features. Vessel design directs water flow over heating elements to optimize heat transfer. Flow switch. 1½" pipe connections.



| Cat. No. | Coates Model No. | Price |
|----------|-----------------------|------------|
| 527 | 12406ST, 5.5 KW, 240V | \$940.28 |
| 528 | 12411ST, 11 KW, 240V | \$1,006.43 |

Hi-E2® THE MOST EFFICIENT HEATER

Hi-E2® Heater

The Hi-E2 sets the standard with a proven in-use record of over 20 years providing ultra-efficient heating with a 95% efficiency rating - cutting operating costs by 30% or more*. Small, lightweight and easy to install indoors, it features a low-maintenance design using our hot surface ignition system - requiring no pilot light.

- Compact & Lightweight - 33% smaller footprint and is 42% smaller in volume and 34% lighter than comparable heaters
 - Best Indoor Installation - Direct PVC pipe connection capability for flexible indoor installation with no additional parts
 - Ultra-Efficient Heating - Features an impressive 95% heating efficiency rating and reduces operating cost by 30% or more*
 - Durable & Dependable - Over 20 years of proven performance in use
- #EHE350NC- 350,000 BTU ASME Commercial Heater . . P.O.A.



THE #1 SELLER FOR OVER 60 YEARS



CAT CONTROLLERS

The CAT 2000® constantly monitors pH and sanitizer activity (chlorine, bromine, even salt systems) and automatically implements chemical feeding in proportion to demand for picture-perfect water quality at all times.



The CAT 4000® is a wireless commercial remote water quality controller. The controller provides picture-perfect water quality on-site and remote monitoring via the Internet or web-enabled mobile device from anywhere in the world.



#CAT 2000 Standard Controller \$3,005.01
 #CAT 4000 WiFi Controller with WiFi \$5,032.62

833-SWIM-327
 833-7946-327
www.halogensupply.com

AQUARITE S3 SALT SYSTEM

AquaRite S3 automatically converts dissolved salt into a virtually endless supply of chlorine. Experience softer, silkier pool water that won't irritate eyes, dry out skin or fade fabrics—all while reducing chlorine costs by up to 50%. Superior salt chlorination plus control of salt level, a heater and a variable-speed pump via the on-unit display.



#AQRS340 S3 SALT SYSTEM (WITH 40K CELL) \$2877.21
 #TCELLS340 40K GAL SALT CELL S3 \$1560.76

SUPER PUMP®

Hayward Super Pump sets the industry standard for excellence and value—and new Super Pump XE is no exception. Offering energy efficiency that outperforms Dept. of Energy standards while cutting pump equipment costs by almost a third, Super Pump XE is the just-right pump for just about any pool. With its easy installation, dual-voltage capability and durable design that's up to 30% lighter weight than competitive VS models, it's the most versatile option for unmatched value.



| Model No. | THP | Voltage | Pipe Size | Ctn Weight | Price |
|--------------|------|---------|-----------|------------|------------|
| SP2605X7 | 0.85 | 115/230 | 2" | 32 Lbs. | \$1030.60 |
| SP2670007X10 | 1.1 | 115/230 | 2" | 35 Lbs. | \$1,081.20 |
| SP2615X20XE* | 2.25 | 115/230 | 2" | 37 Lbs. | \$1,790.38 |

*Denotes variable speed pump

TRISTAR® XL VS PUMP

The TriStar® XL is a game changer for large residential pools, feature-rich pools or complex pool pad configurations. Engineered for performance and versatility, the TriStar® XL delivers increased flow from extra-large 2.5" x 3" unions, the removable strainer housing allows for more adaptable pump configurations, and the oversized strainer basket reduces cleaning and maintenance.



#HCP3020VSP 2.7HP 1PH VS PUMP \$2,964.00



HAYWARD PRODUCTS

PERFLEX EXTENDED-CYCLE DE

The Perflex Extended-Cycle DE filter series cleans pools fast-removing particles as small as one micron the first time through. That's because Perflex incorporates a patented Flex-Tube™ design that works in combination with DE (diatomaceous earth) filter powder to produce the clearest, most sparkling water possible.



#EC65A \$1,408.34
 #EC75A \$1,516.10
 #EC65BLP System III base pack for EC65/EC75
 less pump \$254.46

| Model No. | Effective Filtration Area | Design Flow Rate* | Turnover Gals. 8 Hr. | Turnover Gals. 10 Hr. | DE Required |
|-----------|---------------------------|-------------------|----------------------|-----------------------|-------------|
| EC65A | 26.9 sq. ft. ² | 67 GPM | 32,640 | 40,800 | 6 Lbs. |
| EC75A | 40 sq. ft. ² | 80 GPM | 38,400 | 48,000 | 7 Lbs. |

POWER-FLO MATRIX

The Power-Flo Matrix has been engineered as a uniquely superior above-ground pool pump. With a single push of a button, this truly versatile pump changes from a discharge and back again. It's large profile and integrated styling makes the Power-Flo Matrix a swimming pool pump like no other.



| Model No. | HP | Voltage | Pipe Size | Ctn Weight | Price |
|-----------|-------|---------|-----------|------------|----------|
| SP1592 | 1 | 115 | 1-1/2" | 25 Lbs. | \$637.92 |
| SP1593 | 1-1/2 | 115 | 1-1/2" | 26 Lbs. | \$667.95 |

ABOVE GROUND D.E. SYSTEM

- New clamp style assembly
 - 6' Power cord
 - Pump to filter union connection
 - Hoses, clamps & hose adapters
 - 1HP Pump
- #EC40C92S EC40
 w/1 HP pump \$1,389.17



HEATER PARTS

MASTER TEMP/MAX-E-THERM PARTS



| MASTER TEMP/MAX-E-THERM PARTS | | | |
|-------------------------------|-------------|-------------------------|----------|
| A. | 77707-0054 | IGNITOR W/GASKET | \$105.44 |
| B. | 46-1105 | CONTROL BOARD | \$800.55 |
| C. | 42001-0061S | AIR FLOW SWITCH | \$174.38 |
| D. | 42002-0024S | STACK FLUE SENSOR | \$151.54 |
| E. | 42001-0107S | TRANSFORMER | \$86.00 |
| F. | 47-6223 | IGNITION CONTROL | \$422.82 |
| G. | 42001-0051S | GAS VALVE N.G. | \$552.92 |
| H. | 77707-0010 | THERMAL REGULATOR KIT | \$131.72 |
| I. | 42001-0060S | PRESSURE SWITCH | \$104.09 |
| J. | 42001-0053S | THERMISTOR | \$100.71 |
| K. | 77707-0001 | BY PASS KIT | \$72.11 |
| L. | 42001-0063S | HI LIMIT SWITCH | \$78.86 |
| M. | 42002-0025S | AUTO GAS SHUTOFF SWITCH | \$64.85 |



- A. #7828 Aquastat controller (SPDT switching / Range 40 to 180 F) . . . \$247.21
- B. #7829 Aquastat well (1/2" male N.P.T.) \$65.32
- C. #A0063300 Safety pressure relief Valve 3/4" (75 PSI) \$55.26
- D. #0342692 Safety pressure relief Valve 3/4" (30 PSI). \$117.84

COATES HEATER PARTS

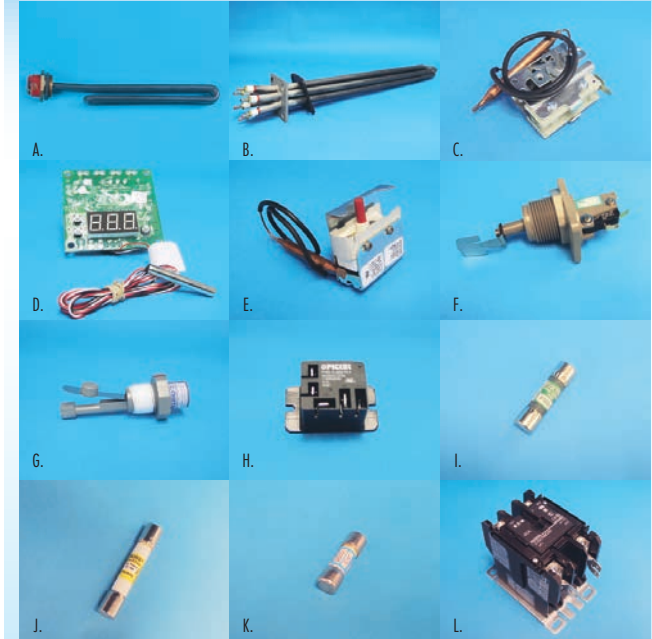

| COATES HEATER PARTS | | | |
|---------------------|----------|----------------------|---------|
| A. | 20005061 | ELEMENTS 5.5KW, 240V | \$70.20 |

| B. HEATING ELEMENTS | | | | |
|---------------------|----------|----------|----------|----------|
| KW | 208V | 240V | 480V | Price |
| 6 KW | 20006036 | 20006046 | 20006056 | \$316.80 |
| 9 KW | 20006029 | 20006039 | 20006049 | \$316.80 |
| 12 KW | 20006003 | 20006009 | 20006015 | \$396.00 |
| 15 KW | 20006004 | 20006010 | 20006016 | \$396.00 |
| 18 KW | 20006005 | 20006011 | 20006017 | \$396.00 |

| | | | |
|----|----------|--|----------|
| C. | 22002001 | TEMPERATURE CONTROL | \$67.50 |
| D. | 22002150 | DIGITAL TEMPERATURE CONTROL | \$148.50 |
| E. | 22003820 | HI-TEMP SWITCH | \$63.00 |
| F. | 23000102 | FLOW SWITCH 1" | \$140.40 |
| G. | 23000105 | FLOW SWITCH 1/2" | \$88.20 |
| H. | 21006010 | RELAY 240V FOR FLOW SWITCH | \$15.30 |
| I. | 29015052 | FUSE 2 AMP, 250V, FNM-2 | \$17.55 |
| J. | 29018910 | FUSE 60 AMP, 480V, SC-60, SLC-60 | \$26.10 |
| K. | 29019525 | FUSE 2 AMP, 480V, SC-2, SLC-2 | \$15.30 |
| L. | 21001000 | CONTACTOR, 3 POLE, 50 AMP, 208/240V COIL | \$120.60 |
| | 21001300 | CONTACTOR, 4 POLE, 50 AMP, 208/240V COIL | \$166.50 |

JANDY HEATER PARTS



| | | |
|--------------|-----------------------------------|----------|
| A. #R0317100 | Gas Valve Natural LD, LJ | \$518.76 |
| B. #R0011700 | Temperature Control LD, HI-E2 | \$704.32 |
| C. #R0058200 | Temperature Control LG | \$309.71 |
| D. IGNITORS | | |
| #R0367100 | LJ | \$187.99 |
| #R0317200 | LD | \$195.50 |
| #R0457500 | Lxi | \$195.50 |
| #R0457501 | LRZE | \$284.69 |
| #R0457502 | Jxi | \$66.83 |
| #R0016400 | HI-E2 | \$195.50 |
| E. #W0036901 | Pilot Generator LG | \$125.30 |
| F. #R0096700 | Pilot Generator Assembly LG | \$224.91 |
| G. #R0318800 | Mechanical Temperature Control LG | \$247.73 |
| H. #R0013200 | Pressure Switch | \$123.19 |
| I. #R0023200 | HI Limit Switch | \$140.20 |
| J. #R0012200 | Fusible Link | \$16.65 |
| K. #R0099800 | Rocker Switch | \$41.42 |
| L. #R0408100 | Ignition Control Assembly | \$833.42 |
| M. #R0037000 | Pilot Tubing | \$30.70 |
| N. #R0334300 | Flame Sensor | \$313.45 |

RAYPAK RP2100 HEATER PARTS



HEATER PARTS



RAYPAK RP2100 HEATER PARTS

| PART DESCRIPTION | CAST IRON ASME MODELS | | | | CAPRON MODELS | | | |
|----------------------------------|--|-------------------|-------------------|-------------------|--|-------------------|-------------------|-------------------|
| | C-R206 | C-R266 | C-R336 | C-R406 | P-R206 | P-R266 | P-R336 | P-R406 |
| A. BY PASS VALVE | 016194F \$64.94 | | | | 006715F \$77.22 | | | |
| B. DRAIN VALVE | 013793F \$29.84 | | | | 006721F \$21.94 | | | |
| C. REAR DRAIN PLUG | 005264F \$40.37 | | | | 006721F \$21.94 | | | |
| D. FLANGES/UNIONS | 013812F BRONZE \$244.82 EACH | | | | 006723F \$72.83 | | | |
| E. FLANGES/UNIONS GASKET/O'RINGS | 062236B \$50.90 | | | | 006724F \$12.29 | | | |
| F. GAS VALVE | 003898F MILLIVOLT \$426.47 003900F IID \$358.90 | | | | 003898F MILLIVOLT \$426.47 003900F IID \$358.90 | | | |
| G. REAR HEADER | 006731F \$214.99 | | | | 006707F \$179.01 | | | |
| H. IN/OUT HEADER | 006730F \$637.07 | | | | 006827F \$798.53 | | | |
| I. UNITHERM GOVERNOR | 062234B \$79.85 | | | | 006719F \$86.87 | | | |
| J. TUBE BUNDLES | ASME (FOB FACTORY) | | | | | | | |
| | | | | | P-R106A | P-R156A | | |
| | | | | | 014874F \$565.11 | 014875F \$752.90 | | |
| | C-R206A | C-R266A | C-R336A | C-R406A | P-R206A | P-R266A | P-R336A | P-R406A |
| | 010055F \$1486.49 | 006733F \$1580.38 | 010057F \$1669.01 | 010058F \$1767.29 | 010059F \$1162.69 | 010060F \$1258.34 | 010061F \$1343.45 | 010062F \$1445.24 |
| K. HI-LIMITS | 600892B 135" \$48.26 600893B 140" \$50.02 | | | | 006725F \$49.14 | | | |
| L. PILOT GENERATOR | 600019B MILLIVOLT \$86.87 | | | | 600019B MILLIVOLT \$86.87 | | | |
| M. PILOT ASSEMBLY | 600525B MILLIVOLT \$134.26 002003F IID \$97.40 | | | | 600525B MILLIVOLT \$134.26 002003F IID \$97.40 | | | |
| N. ROCKER SWITCH | 009493F \$33.35 | | | | 009493F \$33.35 | | | |
| O. PRESSURE SWITCH | 006737F \$67.57 | | | | 006737F \$67.57 | | | |
| P. ROLL OUT SENSOR | 005899F \$38.61 | | | | 005899F \$38.61 | | | |
| Q. MECHANICAL T-STAT | 003346F \$177.26 | | | | 003346F \$177.26 | | | |
| R. PC BOARD DIGITAL | 013464F \$469.46 | | | | 013464F \$469.46 | | | |
| S. TEMP SENSOR | 009577F (3 WIRE) \$77.22 | | | | 009577F (3 WIRE) \$77.22 | | | |
| T. SENSOR WELL/ADAPTER | 003765F \$96.53 | | | | 006805F MILLIVOLT \$53.53 006714F IID \$40.37 | | | |
| U. TRANSFORMER | 006736F \$100.91 | | | | 006736F \$100.91 | | | |

NOTE: ALL COMMERCIAL AND RESIDENTIAL RAYPAK, LAARS AND COATES HEATER PARTS AVAILABLE ON REQUEST.

PLUMBING VALVES CHECK VALVES



A. PVC UTILITY BALL VALVES BY SPEARS

| | | |
|-----------|------------------|---------|
| #2622-005 | 1/2" Soc x Soc | \$17.28 |
| #2622-007 | 3/4" Soc x Soc | \$20.52 |
| #2622-010 | 1" Soc x Soc | \$27.89 |
| #2622-015 | 1 1/2" Soc x Soc | \$56.34 |
| #2622-020 | 2" Soc x Soc | \$71.23 |
| #2621-005 | 1/2" Fpt x Fpt | \$17.28 |
| #2621-007 | 3/4" Fpt x Fpt | \$20.52 |
| #2621-010 | 1" Fpt x Fpt | \$27.89 |
| #2621-015 | 1 1/2" Fpt x Fpt | \$56.34 |
| #2621-020 | 2" Fpt x Fpt | \$71.23 |



B. PVC COMPACT BALL VALVE BY SPEARS

| | | |
|-----------|------------------|------------|
| #2122-015 | 1 1/2" Soc x Soc | \$135.74 |
| #2122-020 | 2" Soc x Soc | \$146.33 |
| #2122-030 | 3" Soc x Soc | \$594.43 |
| #2122-040 | 4" Soc x Soc | \$914.53 |
| #2122-060 | 6" Soc x Soc | \$1,187.66 |



C. PVC TRUE UNION 2000 STANDARD BALL VALVE
w/SOCxSOC w/TWO ADDITIONAL FPT UNION

| | | |
|-----------|-------------------------|----------|
| #3629-005 | 1/2" Soc x Soc or Fpt | \$73.29 |
| #3629-007 | 3/4" Soc x Soc or Fpt | \$86.71 |
| #3629-010 | 1" Soc x Soc or Fpt | \$103.26 |
| #3629-015 | 1 1/2" Soc x Soc or Fpt | \$172.03 |
| #3629-020 | 2" Soc x Soc or Fpt | \$222.62 |



D. TRUE SINGLE UNION BALL VALVES BY PRAHER

| | | |
|----------|--------------------|---------|
| #150-010 | 1 1/2" Soc x Soc | \$24.63 |
| #150-015 | 1 1/2" MIPT x FIPT | \$24.63 |
| #200-010 | 2" Soc x Soc | \$34.19 |

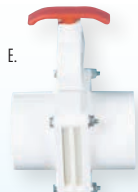

E. KNIFE GATE VALVES BY PRAHER

| | | |
|-----------|------------------|---------|
| #150-GATE | 1 1/2" Soc x Soc | \$19.32 |
| #150-GMFT | 1 1/2" Fpt x Fpt | \$19.91 |
| #200-GATE | 2" Soc x Soc | \$25.77 |



F. SINGLE UNION SPRING CHECK VALVES w/ LOAD & CLEAR
BODY BY PRAHER

| | | |
|-------------|------------------|---------|
| #150-CV-TRI | 1 1/2" Soc x Soc | \$31.65 |
| #200-CV-TRI | 2" Soc x Soc | \$37.40 |



G. DOUBLE UNION CLEAR SWING CHECK VALVE
BY AMERICAN GRANBY

| | | |
|-------------|------------------|----------|
| #AG1720C-07 | 3/4" Soc x Soc | \$37.68 |
| #AG1720C-10 | 1" Soc x Soc | \$44.50 |
| #AG1720C-15 | 1 1/2" Soc x Soc | \$56.51 |
| #AG1720C-20 | 2" Soc x Soc | \$77.01 |
| #AG1720C-30 | 3" Soc x Soc | \$152.71 |



H. "SMART" SWING CHECK VALVE WITH 1/2 lb SPRING

| | | |
|-------------|------------------|---------|
| #MCV823-15C | 1 1/2" Soc x Soc | \$38.16 |
| #MCV823-20C | 2" Soc x Soc | \$48.20 |



I. JANDY NEVER LUBE 180 DEGREE CHECK VALVE

| | | |
|-------|-----------------------------------|---------|
| #7305 | 2" - 2 1/2" Soc x 2" - 2 1/2" Soc | \$99.37 |
|-------|-----------------------------------|---------|



J. FLEXIBLE PVC CREAM COLOR

| | | |
|-----------|------------------------------|----------|
| #2522-50 | TIGER FLEX PVC 1/2" X 50' | \$88.30 |
| #2523-10 | TIGER FLEX PVC 1/2" X 10' | \$21.18 |
| #2525-50 | TIGER FLEX PVC 3/4" X 50' | \$120.98 |
| #2526-10 | TIGER FLEX PVC 3/4" X 10' | \$29.04 |
| #2527-100 | TIGER FLEX PVC 1" X 100' | \$239.40 |
| #2525-50 | TIGER FLEX PVC 1" X 50' | \$127.18 |
| #2525-10 | TIGER FLEX PVC 1" X 10' | \$30.51 |
| #2526-100 | TIGER FLEX PVC 1 1/2" X 100' | \$309.70 |
| #2526-50 | TIGER FLEX PVC 1 1/2" X 50' | \$165.33 |
| #2526-10 | TIGER FLEX PVC 1 1/2" X 10' | \$39.69 |
| #2527-100 | TIGER FLEX PVC 2" X 100' | \$529.20 |
| #2527-50 | TIGER FLEX PVC 2" X 50' | \$283.50 |
| #2527-10 | TIGER FLEX PVC 2" X 10' | \$68.04 |



K. PRIMER-68 CLEAR PRIMER

| | | |
|--------------|----------|---------|
| #PRIM68C-005 | 1/4 Pint | \$8.38 |
| #PRIM68C-020 | Pint | \$21.06 |
| #PRIM68C-030 | Quart | \$35.15 |



L. PVC-95 BLUE PVC GLUE

| | | |
|-------------|--------|---------|
| #PVC95B-030 | Quart. | \$44.27 |
|-------------|--------|---------|



M. PVC 95 CLEAR PVC GLUE

| | | |
|-------------|----------|---------|
| #PVC95C-005 | 1/4 Pint | \$10.33 |
| #PVC95C-020 | Pint | \$26.31 |
| #PVC95C-030 | Quart. | \$44.37 |



NEVER-LUBE JANDY VALVES AND ACTUATORS

| | | |
|----------|--|----------|
| N. #4715 | 1 1/2" - 2", 3 Port Positive Seal Jandy Never Lube Valve | \$114.49 |
| O. #4724 | 1 1/2" - 2", 2 Port Positive Seal Jandy Never Lube Valve | \$106.43 |
| P. #4716 | 2" - 2 1/2" - 2 Port Positive Seal Jandy Never Lube Valve (not shown) | \$110.78 |
| Q. #4717 | 2" - 2 1/2" - 3 Port Positive Seal Jandy Never Lube Valve (not shown) | \$118.84 |
| R. #4424 | Jandy Valve Actuator 24 Volt, 180 Degree Rotation | \$334.64 |



The revolutionary IntelliValve™ Valve Actuator lets you set just the right flow for water features. Its intuitive controls and LED position indicator lights make operation fast and push-button easy. Thirteen (13) bright LEDs provide a clear visual indication of the valve position from fully open to fully closed and everywhere in between. Simply use the left/right and Save buttons to set the perfect flow rate in just seconds.

| | | |
|----------|-----------------------|----------|
| #52-1485 | IntelliValve Actuator | \$386.06 |
|----------|-----------------------|----------|

WINTERIZING PLUGS



| | Part No. | Plug Size | Fits | Price |
|---------|--------------------|---|------------------------------|----------|
| Rubber | A. SP201 | 1 | 1/2" pipe | \$2.75 |
| | SP202 | 2 | 3/4" tubing | \$2.95 |
| | SP203 | 3 | 3/4" pipe | \$2.95 |
| | SP204 | 4 | 3/4"-1" pipe | \$3.15 |
| | SP205 | 5 | 1" tubing | \$3.15 |
| | SP206 | 6 | 1" fitting | \$3.35 |
| | SP207 | 7 | 1 1/4" pipe | \$3.65 |
| | SP208 | 8 | 1 1/2" pipe | \$3.95 |
| | SP209 | 9 | 1 1/2" pipe, 1 1/4" fitting | \$4.15 |
| | SP210 | 10 | 1 1/2" fitting | \$4.55 |
| | SP211 | 11 | 2" pipe | \$5.95 |
| | SP212 | 12 | 2" fitting | \$6.95 |
| | SP213 | 13 | 2 1/2" pipe | \$9.00 |
| | SP214 | 14 | 3" pipe | \$25.50 |
| Plastic | B. SP1022B | 1 1/2" | Flush style | \$4.85 |
| | C. SP1022C | 1 1/2" | Raised style | \$4.85 |
| | D. SP210BT | 10 | Blow Through | \$19.00 |
| | E. 004-302-1672-00 | Paramount Blow Through Plug (pkg. of 6) | | \$170.31 |
| | F. BP15 | 1 1/2" | MPT Bungee Blow Through Plug | \$9.56 |

SUBMERSIBLE PUMPS

A. SIMER SUBMERSIBLE UTILITY DRAINER PUMP

- Strong thermoplastic construction
- Portable and light
- Simple plug in operation
- Includes garden hose adapter



| Catalog No. | Description | Nominal HP | Motor Voltage | Price |
|-------------|-------------------|------------|---------------|----------|
| 2305-04 | Simer Submersible | 1/4 | 115 | \$205.00 |

B. LITTLE GIANT POOL COVER PUMP

- Activates in approximately 2" of water
- Convenient handle for portability
- Mechanical float for dependability
- 1" FNPT discharge
- 3/4" MNPT garden hose adapter

LG-577301 POOL COVER PUMP \$296.31



WINTERIZING



A. CYCLONE WINTERIZING BLOWER AND LINER VAC Model LV 275-1

The Cyclone is the most powerful portable blower on the market. The motor is a heavy duty bypass motor rated at 3 hp/120 volt. Sealed pressure is 160 inches of water & the open flow is 120 cfm. This blower is ideal for winterizing pools.

#4128100 \$583.70



B. CLEAR RTV SILICONE ADHESIVE SEALANT

#66B 3 oz Clear RTV Silicone \$25.43

C. AQUA LUBE ULTIMATE UNDERWATER LUBRICANT, SEALANT AND RUST PREVENTIVE

#AQUA LUBE 14.1 oz Aqua Lube. \$53.82



D. MAGIC LUBE TEFLON BASED LUBRICANT

#630-1OZ 1 oz Magic Lube. \$4.44

#631-5OZ 5 oz Magic Lube. \$12.27



E. TEFLON TAPE

#HTST520- 3/4" Teflon tape. \$2.64

F. STAINLESS STEEL HOSE CLAMPS

#12 3/4" \$3.15

#20 1" \$3.22

#24 1" - 2" \$3.22

#28 1 5/16" - 2 1/4" \$3.24

#32 1 9/16" - 2 1/2" \$3.24

SPECIALTY TOOLS WINTERIZING PRODUCTS

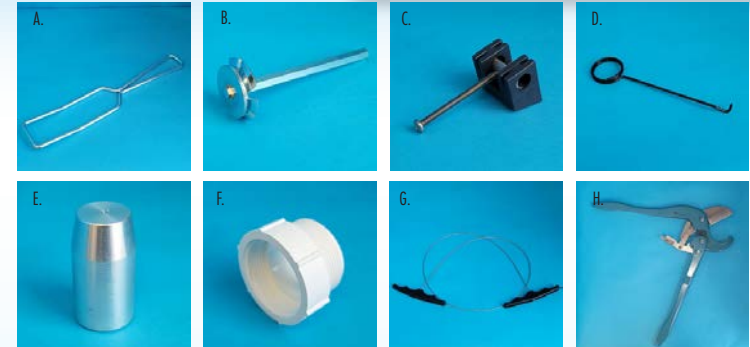

A. #PT110 Pump Lid Removal Tool-Lid Removal Wrench \$27.00

B. #SKS-1.5 1 1/2" Socket Saver \$47.84

#SKS-2.0 2" Socket Saver \$50.47

#SKS-3.0 3" Socket Saver \$80.75

C. #PT132 Light Wedge. \$15.19

D. #PT134 O Ring Pick \$8.44

E. #PT144-A Hand Rail Stabilizer plug \$43.88

F. #LASS-RPE-1.55 Plaster Eye Ball Extender \$11.16

*Eyeball not Included

G. #WST-1 Wire Saw for PVC \$12.94

H. #HL50 PVC Pipe Cutters \$164.96

I. #419-4110 1 1/2" Insider (Fits inside 1 1/2" pipe) \$6.15

#419-4120 2" Insider (Fits inside 2" pipe) \$7.15

J. #418-5000 1 1/2" Pipe Extender. \$6.15

#418-6000 2" Pipe Extender \$6.85

K. RUBBER FLEXIBLE COUPLINGS

#AGMR5615 1 1/2" x 1 1/2" \$11.16

#AGMRTC150 1 1/4" x 1 1/2" \$7.07

#AGMRDTC150 1 1/4" or 1 1/2" x 1 1/4" or 1 1/2" \$8.64

#AGMRDTC215 2" x 1 1/4" or 1 1/2" \$11.72

FULL FLOW UNIONS BY PRATHER

L. #150-903 1 1/2" Mpt x Soc w/O ring \$18.90

#200-903 2" Mpt x Soc w/O ring \$24.35

M. #150-906 1 1/2" Mpt x Soc w/O ring High Temp \$26.35

#200-906 2" Mpt x Soc w/O ring High Temp \$34.25

POOL LIGHTS & ACCESSORIES



PENTAIR INTELLIBRITE ARCHITECTURAL SERIES

Elevate customers' nighttime pool experiences with the next generation of LED underwater pool lighting. The IntelliBrite Architectural Series Lights deliver a more dazzling and dynamic LED pool lighting experience with a brighter light and greater energy efficiency. With refined optics and simple automation, it's like having a brand new pool to explore.

- More light, more energy efficient.
 - Spreads light widely and evenly in all directions to minimize hot spots, dark areas, glare and stripes.
 - Color for any mood with five brilliant colors and seven dynamic color-changing light shows with IntelliBrite Architectural Series Color Pool Light.
 - IntelliBrite Architectural Series White Pool Light illuminates the pool with revealing white light.
 - Easy pool control through a Pentair automation system for instant ambiance.
 - Ideal upgrade from incandescent or first generation LED lighting.
 - Improved proprietary LED product design from a trusted pool lighting leader.
- limited quantities of 5G, Amerlite, and Spabright in stock. Call for availability.

| | Item No. | Description | Voltage | Cord Length | Price |
|--------------|----------|-------------------|---------|-------------|------------|
| Pool Lights. | 602141 | WHITE 500W EQUIV. | 12 | 100' | \$1,195.99 |
| | 602143 | WHITE 300W EQUIV. | 12 | 30' | \$902.79 |
| | 602144 | WHITE 300W EQUIV. | 12 | 50' | \$946.68 |
| | 602145 | WHITE 300W EQUIV. | 12 | 100' | \$1,063.10 |
| | 602416 | WHITE 300W EQUIV. | 12 | 150' | \$1,157.84 |
| | 602178 | WHITE 500W EQUIV. | 120 | 50' | \$1,101.26 |
| | 602179 | WHITE 500W EQUIV. | 120 | 100' | \$1,184.15 |
| | 602180 | WHITE 500W EQUIV. | 120 | 150' | \$1,243.35 |
| | 602181 | WHITE 300W EQUIV. | 120 | 30' | \$947.31 |
| | 602182 | WHITE 300W EQUIV. | 120 | 50' | \$978.89 |
| | 602183 | WHITE 300W EQUIV. | 120 | 100' | \$1,052.56 |
| | 602184 | WHITE 300W EQUIV. | 120 | 150' | \$1,105.21 |
| | 602152 | COLOR | 12 | 50' | \$1,516.60 |
| | 602153 | COLOR | 12 | 100' | \$1,660.18 |
| Spa Lights. | 602186 | COLOR | 120 | 50' | \$1,529.51 |
| | 602187 | COLOR | 120 | 100' | \$1,644.64 |
| | 618016 | WHITE 100W EQUIV. | 12 | 50' | \$942.04 |
| | 618017 | WHITE 100W EQUIV. | 12 | 100' | \$1,007.96 |
| | 602194 | WHITE 100W EQUIV. | 120 | 50' | \$928.12 |
| | 602195 | WHITE 100W EQUIV. | 120 | 100' | \$997.96 |
| | 602196 | WHITE 100W EQUIV. | 120 | 50' | \$1,047.86 |
| | 602198 | COLOR | 12 | 50' | \$1,249.69 |
| | 602199 | COLOR | 12 | 100' | \$1,362.10 |
| | 602202 | COLOR | 120 | 50' | \$1,254.20 |
| 602203 | COLOR | 120 | 100' | \$1,348.60 | |

INTELLIBRITE® CONTROLLER Provides Fast, Easy Access to 12 Color Modes

- Select dazzling light shows from 7 predefined themes or 5 fixed colors to suit your mood
- Set automated schedules for your backyard oasis through the easy-to-use Pentair Home App
- Suitable for indoor and outdoor environments for flexible installation
- Featuring twilight mode with automatic seasonal adjustments
- Weekday and weekend scheduling options right from your SmartPhone
- Control up to 300 Watts of Pentair Color LED Lights on a single circuit
- Intuitive user control via the Color Sync direct control panel
- Upgrade from a standard light switch for easy control of your pool lighting



#618031 IntelliBrite Controller \$518.64

ABOVE GROUND LIGHTS

NIGHTLIGHTER

LED Underwater light for aboveground pools. This light fixture features an extra long cord and will not interfere with water return.



#NL50 \$95.04



STAINLESS STEEL NICHES

Large and small stainless-steel niches are formed with brass fittings. All niches have internal and external grounding lugs for use with either metal or PVC conduits.

POOL

#78210500 Concrete \$144.65
 #78232400 Vinyl liner and fiberglass (standard 10 hole). \$292.53

SPA

#78243200 Concrete niche \$120.08
 #78242200 Fiberglass niche \$182.45



MICROBRITE COLOR AND WHITE LED LIGHT

- Installs in any standard 1.5 inch pool wall fitting.
- 10X the life of incandescent light.
- No Bonding required.
- Connects to any Pentair automation system and the Pentair IntelliBrite® Controller.

COLOR

#62-0424 50 ft cord. \$657.83
 #62-0425 100 ft cord \$723.91
 #62-0426 150 ft cord \$806.48

WHITE

#62-0428 50 ft cord. \$587.91
 #62-0429 100 ft cord \$624.96
 #62-0430 150 ft cord \$658.73

AMERLITE PARTS (Not shown)

#79100100 Lens, clear 8 3/8" diameter. \$39.74
 #79104800 Retaining screw \$5.63
 #79101600 Gasket for 8 3/8" lens \$40.23
 #79110600 Face ring, stainless steel \$132.66
 #79111000 Uni-Tention wire clamp \$79.18

T100 SERIES

24-Hour Mechanical Time Switches in Type 3R Plastic Enclosure



Timer with Enclosure

#T101P3 SPST Switch 120 VAC \$159.05
 #T104P3 DPST Switch 208-277 \$184.65
 #T101P201 SPST Switch 120 VAC W/Fireman Switch \$224.14
 #T104P201 DPST Switch 208-277 W/Fireman Switch \$224.14
 #T10101R Dual Timer 30A Power Center \$370.02
 #T32404R Dual Timer 100A Load Center \$552.43

Mechanism Only

#T101M SPST Switch 120 VAC Input Voltage \$114.16
 #T104M DPST Switch 208-277 VAC Input Voltage \$132.66

Parts

#156T4042A Fireman Switch Only \$46.87
 #156T1978A Trippers Only (Set) \$5.56

POOL LIGHTS BULBS & ACCESSORIES

PARTS FOR SWIMQUIP

| | |
|---|----------|
| #05057-0118 Lens gasket | \$63.18 |
| #05055-0003 Clear lens | \$109.80 |
| #WC203-525S Stainless steel face ring | \$305.87 |
| #37337-0079 Retaining screw | \$9.11 |

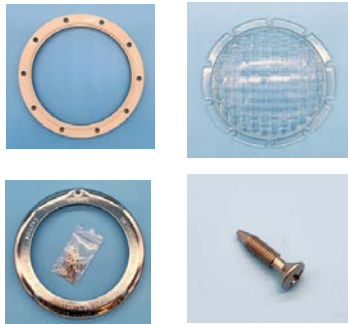

FIXTURES FOR SWIMQUIP NICHES

| | |
|---------------------------------|-----------|
| #21064 White 120V 50' | \$861.71 |
| #21136 White 12V 50' | \$864.59 |
| #23052 Color 120V 50' | \$1223.64 |
| #23058 Color 12V 50' | \$1181.25 |



C. XG CONTROLLER

- Designed for use with XG fixtures and LXG Lamps
- Easy push button control
- Fits most gang junction boxes
- Bluetooth enabled operate light from Apple® or Android™ Device



| | |
|------------------|----------|
| #26043 | \$439.65 |
|------------------|----------|

HAYWARD SEALED BEAM LIGHT

PARTS

| | |
|--|----------|
| #SPX0502A Front rim, CPB. | \$260.48 |
| #SPX0501HJ Large and small "O" rings (set). | \$59.13 |
| #SPX0502Z66 Securing rim screws (set of 6) | \$19.35 |

CRYSTALOGIC LED WHITE

CrystaLogic® is available to virtually anyone; its all-plastic construction is truly universal. It's UL listed to retrofit virtually any installed niches, allowing most lights to be upgraded. These 12V, 2-wire, all-plastic lights can be installed as close as 4 inches from the water-line, and even upward facing without a rock guard, opening a wide range of new applications. The optimized LED and optic design delivers both extraordinary lumen per watt energy efficiency and associated long lifetime cost.

| | |
|---|----------|
| #LPLUS11050 CrystaLogic LED White 12V 50' | \$873.52 |
|---|----------|

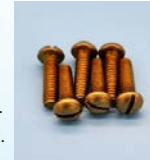

COLORSPASH LXG LED REPLACEMENT LAMPS

ColorSplash LXG Replacement Multi-Color In-Ground Pool and Spa Lamps offer a variety of lighting modes that instantly transform any in-ground pool into a custom illuminated oasis. Whether the pool is used for playing, relaxing or entertaining, the advanced ColorSplash LXG Series with its multiple colors and light shows create the ideal pool and spa ambiance. This replacement for traditional light bulbs installs in minutes and provides immediate energy cost savings.



N. PUREWHITE™ LED REPLACEMENT LAMPS

PureWhite™ LED Replacement White In-Ground Pool & Spa Lamps are the brightest, most cost-effective alternative to inefficient incandescent lamps. They immediately and significantly reduce energy consumption and maintenance cost. Plus, PureWhite Pro fits most standard pool light housings and comes with a highly durable Guardian™ silicone lens gasket made for use with LED lamps



| | |
|----------------|-----------|
| POOL | |
| #26610 | |
| 120V | \$120.06 |
| #26612 | |
| 12V | \$ 120.06 |



| | |
|----------------|---------|
| SPA | |
| #26710 | |
| 120V | \$82.51 |
| #26712 | |
| 12V | \$82.51 |

- \$2.93 a year to operate
- Energy efficient, 21 watts
- Fully dimmable

O. BRASS DECK BOX—U.L. Listed

| | |
|--------------------------|----------|
| #A41192-0 3/4" | \$337.93 |
|--------------------------|----------|



P. TRANSFORMERS

| | |
|---|----------|
| #890 300 watt, 12 volt, 18 lbs. | \$214.10 |
| #892 100 watt, 12 volt | \$187.24 |



Q. ALADDIN ADAPTABLE LIGHT RING

The Adaptable Light Ring will fit any metal or hand-formed niche from 9 3/4" to 12". The unique feature of these light rings is that they can be installed in a few minutes and accept the Amerlite. #500C Aladdin Ring for Amerlite \$160.92



COLORSPASH LXG LED REPLACEMENT LAMPS

| | |
|-----------------------|----------|
| POOL | |
| #26910 120V | \$237.76 |
| #26911 12V | \$237.76 |

| | |
|-----------------------|----------|
| SPA | |
| #26912 120V | \$188.91 |
| #26913 12V | \$188.91 |



CYCOLAC POOL FITTINGS SKIMMER BASKETS & ACCESSORIES

Hayward WG Series Suction Outlet Assemblies comply with provisions of ASME/ANSI A112.19.8 2007
 Note: See "Guidelines for Addressing Entrapment Hazards with Pools and Spas" U.S. Consumer Product Safety Commission Publication #363-009081, (301)-504-0400 or www.cpsc.gov/cpscpub/pubs/363.pdf

CYCOLAC POOL FITTINGS



SKIMMERS

- A. **SP1082** Inground commercial and residential cyclac skimmer for concrete, comes with adjustable collar and tamperproof 10" x 10" square lid.
 2" F.I.P. bottom connection \$193.66
- B. **SP1084** Inground commercial and residential skimmer for vinyl liner and fiberglass pools. Comes complete with 8 1/2" long throat, face plates, gaskets and screws.
 2" F.I.P. bottom connection.. . . . \$264.24
- C. **SP1091LX** Above ground cyclac skimmer with 1 1/2" female pipe connection. Includes SP1023, SP1419D, (2) 1 1/2" x 1 1/2" hose adapters, and SP11041 Skim Vac. \$80.39
- D. **SP1091WM** Same as above with wide mouth Dyna Skim (not shown) \$93.69

SKIMMERS, DRAINS, RELIEF VALVES, TUBE & SPOUTS



- A. **BERMUDA SKIMMERS**
 #50-6300 Gunite 2" slip ports (PVC) \$245.51
 #50-6420 Vinyl/fiberglass 1 1/2" slip ports(ABS) \$291.86
 #51-6253 Gunite extension collar(not shown) \$28.87
- B. **PVC GUTTER DRAINS**
 #54-0063 2" x 4" Gutter drain \$11.72
 #54-2039 2 1/2" x 6" Gutter drain \$18.88



INLET FITTINGS

- C1. **SP1022** Concrete inlet/vacuum fitting 1 1/2" F.I.P. x 2" M.I.P. \$8.20
- C2. **SP1022INS** Concrete 1 1/2" slip, 1 1/2" F.I.P. face x 1 1/2" slip stub end. \$8.20
- C3. **SP1023** Vinyl liner, fiberglass 1 1/2" F.I.P. complete with lock nuts and gaskets \$13.83
SP1023S2 Vinyl liner, fiberglass 2" F.I.P. complete with lock nuts and gaskets \$17.15
- C4. **SP1424** 1 1/2" F.I.P. x 2" M.I.P. adjustable inlet \$44.46
SP1424S 1 1/2" S.K.T. x 2" M.I.P. adjustable inlet \$44.46
- C5. **SP1408** Inlet/Outlet Fitting with Face Plate 1 1/2" \$20.58
SP1408S2 Inlet/Outlet Fitting with Face Plate 2" \$24.30

D. DIRECTIONAL CYCOLAC EYEBALLS

- SP1419A** Slotted orifice \$6.27
- SP1419B** 3/8" orifice \$6.27
- SP1419C** 1/2" orifice.. . . . \$6.27
- SP1419D** 3/4" orifice \$6.24
- SP1419E** 1" orifice \$6.24



- E. **SP1026** 1 1/2" MIP grate insert for all wall fittings \$3.69

F. MAIN DRAINS

- Residential, Concrete**
WG1052AVPAK2 2" side outlet, 1 1/2" bottom plug \$108.97
WG1054AVPAK2 2" side outlet, 2" bottom plug \$108.86
Residential, Vinyl Liner and Fiberglass
WG1048AVPAK2 1 1/2" side outlet, 1 1/2" bottom plug \$132.53



G. HYDROSTATIC RELIEF VALVES

- #V50-125 1 1/2" \$196.40
- #V50-126 2" \$208.28
- #SP1056 1 1/2" & 2" PVC \$27.09

- #V50-127 Hydrostat removal tool for 1.5" and 2" Brass valves \$122.24

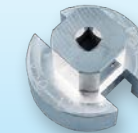

H. CYCOLAC MAIN DRAIN (PEBBLE) COLLECTOR TUBE

- #SP1055 12' long, slotted. Fits 2' and 1 1/2" M.P.T. \$18.95



I. FILL SPOUTS

- #A41227-0 3/4" Male, Fill Spout \$234.65
- #A41240-0 1" Male, Fill Spout \$211.60
- #A41242-0 1 1/2" Male, Fill Spout \$296.18

833-SWIM-327
 8 3 3 • 7 9 4 6 • 3 2 7
www.halogensupply.com

SKIMMER PARTS

- A. **SPX1082E**
 Hayward cover \$27.83
- B. **08650-0058**
 Swimquip cover \$28.64
- C. **85009500**
 American Products cover **85007400** \$34.52
 American Products lock-down cover (not shown) \$44.17
- D. **SPX1082K**
 Hayward weir \$27.11
- E. **08650-0022**
 Swimquip weir \$31.88



UNIVERSAL WEIR DOORS

- F. **923**
 Aladdin 6" weir \$15.00
- 925**
 Aladdin 8" weir \$14.63
- 927**
 Aladdin 10" weir \$18.55



- G. **SPX1096K**
 Hayward weir \$27.99



- H. **SP11071**
 Hayward vacuum plate \$29.13



- I. **SP11041**
 Hayward vacuum plate \$24.93



- J. **SP1094D**
 Hayward vacuum plate \$13.77



ALL SKIMMER PARTS AVAILABLE

HANDRAILS LADDERS & ACCESSORIES

LADDERS

RESIDENTIAL LADDERS

(24" wide) by SR SMITH

Ladders with steps, stainless steel hardware & white rubber bumpers for private pool use. Stainless steel steps. Stainless steel (.049 thickness)

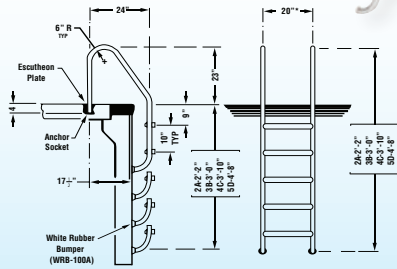

*19" on ladders with LTDF-101 tread.

- RLF-24S-2A 2 Step (A.S.), 21 lbs. \$571.87
- RLF-24S-3B 3 Step (A.S.), 24 lbs. \$612.21
- RLF-24S-4C 4 Step (A.S.), 29 lbs. \$733.17
- RLF-24S-5D 5 Step (A.S.), 32 lbs. \$898.09

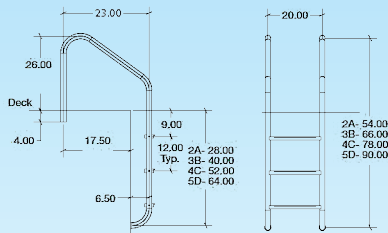

COMMERCIAL - Stainless steel .065 thickness

- 10037 2 Step .065. \$811.13
- 10040 3 Step .065. \$958.25
- 10043 4 Step .065. \$1,097.88
- 10046 5 Step .065. \$1,365.67

Order anchor sockets and escutcheons separately

STAIR RAIL by SR SMITH

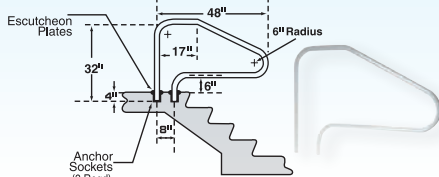

DECK-MOUNTED STAIR RAIL DMS-101A

1.90" O.D. x .049 Stainless Steel . . . \$278.61

HANDRAILS by SR SMITH

2-BEND STANDARD HANDRAIL by SR SMITH

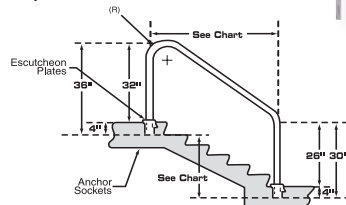

| Model No. | Description | D | H | Price |
|-----------|-----------------------|-----|-----|----------|
| 2HR-4-049 | 4' 2-Bend (.049 Wall) | 48" | 26" | \$257.88 |
| 2HR-4-065 | 4' 2-Bend (.065 Wall) | 48" | 26" | \$426.91 |
| 2HR-5-049 | 5' 2-Bend (.049 Wall) | 60" | 36" | \$284.03 |
| 2HR-5-065 | 5' 2-Bend (.065 Wall) | 60" | 36" | \$461.50 |
| 2HR-6-049 | 6' 2-Bend (.049 Wall) | 72" | 46" | \$340.07 |
| 2HR-6-065 | 6' 2-Bend (.065 Wall) | 72" | 46" | \$515.38 |

Handrails are made of 1.90" O.D. x .049" or .065" wall, 304 stainless steel tube with mirror finish. All bends are 6" radius. Custom dimension handrails are available on a Special Order basis. Customer to specify "A" or "B" dimensions. Horizontal and vertical cross braces are also available upon request.

Also available in .109" & .145" wall

Order anchor sockets and escutcheons separately.

FIGURE 4 HANDRAIL

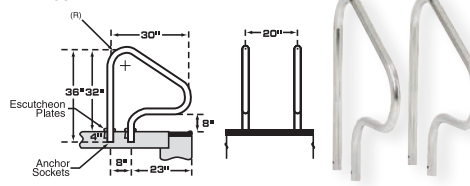

| Model No. | Description | Price |
|------------|------------------------------------|---------------|
| F4H-101 | 1.90" O.D. x .049" Stainless Steel | \$487.56 pair |
| F4H-101-EA | 1.90" O.D. x .049" Stainless Steel | \$281.25 each |



- A. PH-82 Chrome plated bronze with removable eye . . . \$79.95
- B. STBR-710 3/8" Thread eye bolt \$38.33
- PI-82-EYE 1/2" Thread eye bolt \$27.50
- STBR-4869 5/8" Thread eye bolt \$45.15
- STBR-4863 3/4" Thread eye bolt \$46.20

DECK ANCHOR SOCKETS



- A. PS-4019-BC Brass socket anchor 4" \$40.52
- B. PS-3019-B Brass socket anchor 3" \$28.40
- C. AS-100D 6" Anchors for volleyball, basketball or slide \$103.36

PRE MOUNTED CHANNEL SETS

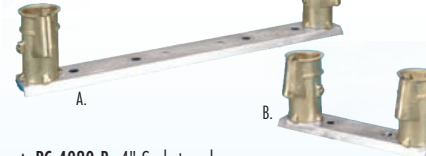

- A. PC-4020-B 4" Socket anchors w/20" centers \$102.02
- B. PC-4008-BC 4" Socket anchors w/8" centers \$98.57

WEDGE ASSEMBLIES



- A. PW-FR05T Standard wedge dog \$31.68
- B. PW-3C Hanover bronze wedge dog \$9.84
- C. PW-4C Hanover bronze wedge dog \$10.65
- D. SPX0392BA Hayward wedge dog \$50.74

ESCUTCHEONS

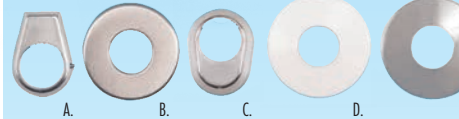

- A. PE-0019-CPB Chrome plated brass \$27.41
- B. PE-0019-S Round stainless steel \$7.56
- C. EP-100A Oval stainless steel \$30.62
- D. PE-0019-W Round white Cylolac \$2.54
- E. PE-0019-C Round chrome Cylolac \$6.19

LADDER DECK FLANGES

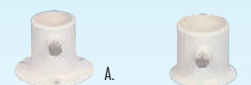

- A. PF-2116-L 1 1/2" flange above ground \$13.23
- B. PF-2119-L 1.9 Flange \$13.23

SLIDE DECK FLANGES



- A. PF-3119 1.9 Flange no hardware \$22.05
- B. PF-WEDGE set of 4 anchors \$8.64
- C. 05-623 Slide or ladder flange \$47.59

IN WALL RECESSED STEPS

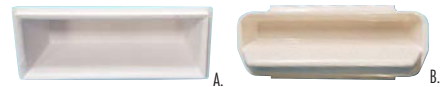

- A. 62-209-4001 in wall recessed step sold individually \$92.09
- B. 532-2010B in wall recessed step sold as set of 3 \$88.50

REPLACEMENT STEPS

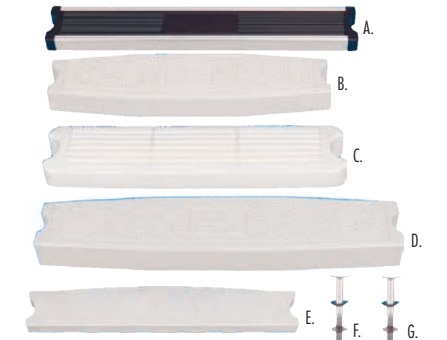

- All ladder steps include hardware.
- A. LTDF-103 Stainless steel 20" \$88.31
- B. 44104 Cylolac, 19" sloping \$98.53
- 44101 Cylolac, 19" vertical \$98.53
- C. A42077-0 Cylolac, 20" plastic \$84.32
- D. 44109 Cylolac, 26" sloping \$205.74
- 44107 Cylolac, 26" vertical \$205.74
- E. LTDF-101 Residential plastic step \$47.70
- F. 276 Stainless steel - 1/8" X 2 3/4" bolt, nut and washer sold as a pair \$19.11
- G. 60-703-pair 3/8" X 3/4" Bolt kit sold as a pair \$30.62

END CAPS FOR STEPS

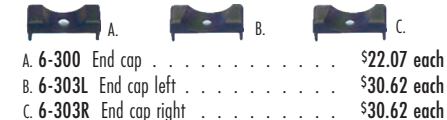

- A. 6-300 End cap \$22.07 each
- B. 6-303L End cap left \$30.62 each
- C. 6-303R End cap right \$30.62 each

LADDER BUMPERS



- A. 274 Male ladder bumper \$10.35
- B. WRB-101A Female ladder bumper \$8.55

DIVING BOARD PARTS



- A. 67-209-911-SS Stainless steel diving board bolt kit \$122.15
- B. 67-209-903-SS 18" Diving board mounting kit \$208.24
- C. 69-209-041 Slide hose replacement kit \$96.18

DIVING BOARDS STANDS, POOL SLIDES, GAMES



GAMES AND FUN

SWIM N' DUNK™ CHALLENGE RESIDENTIAL BASKETBALL

Salt Friendly Challenge Game

- Durable, clear acrylic backboard
- Continuous upright dual post frame
- SealedSteel® frame and rim
- 1.90" OD, .065" wall thickness, 304 stainless steel frame
- Regulation rim, net, basketball and needle included

#S-BASK-CHA

Swim N' Dunk Salt Game \$2,021.63

SPECIAL NOTE: Two (2) In-Deck Bronze Anchors (AS-100D) for concrete decks are required to install each game. This item must be ordered separately.



-SWIM N' SPIKE™ VOLLEYBALL GAME

Designed for in-ground pools with water depth of not more than 42". The standard game will fit pools with a width between 15 ft. and 20 ft. Special order games are available for other widths. Includes two 1.90" diameter stainless steel posts with removable stainless steel eyebolts which anchor a high-quality competitive net, adjustable for multiple width pools. Swim N' Spike™ Volleyball Game includes a competitive water volleyball and needle.

#VOLY1 Swim N' Volleyball \$812.50

SPECIAL NOTE: Two (2) In-Deck Bronze Anchors (AS-100D) for concrete decks are required to install each game. This item must be ordered separately.



833-SWIM-327
833-7946-327
www.halogensupply.com

RESIDENTIAL BOARDS & STANDS

FIBERGLASS DIVING STANDS

The acrylic outside surface is very durable and will enhance the beauty of any pool. Snow white finish should not scratch, fade or rust. Our most popular stand. Jig mounted for easy installation. Available in 1/2 meter for 6', 8' and 10' boards. Order diving board separately.

#70-209-7362 Flyte Deck only for 6 ft. board \$784.83

#70-209-7382 Flyte Deck only for 8 ft. board \$840.92

#70-209-7402 Flyte Deck only for 10 ft. board \$1,082.05



FRONTIER III DIVING BOARD

Our fastest-selling, new acrylic boards feature a solid core with flexible sides. White in color.

| Cat. No. | Nominal Length | Wt./Lbs. | Price |
|---------------|----------------|----------|------------|
| #66-209-596S2 | 6 ft. | 50 lbs. | \$878.30 |
| #66-209-598S2 | 8 ft. | 65 lbs. | \$1,043.60 |
| #66-209-600S2 | 10 ft. | 80 lbs. | \$1,431.42 |

F.O.B. CHICAGO, IL



POOL SLIDES



helix2™ Add an all in one 360° adventure ride and a beautiful fountain feature to your backyard.

Height: 7' 4", 6' 5½" to seat Flume: 360 degrees, 12' 8" long, 22" wide
Water Delivery System: Fountain feature and flume together or independent
Ladder: Enclosed with molded handgrips Required Deck Space: 9' x 5'
Weight Limit: 250 lbs



TurboTwister® This thrill-ride pool slide is designed with curves and clips that guarantee hours of fun for the entire family!

Height: 8' 7", 7' 5½" to seat Flume: 14' 4" long, 23" wide, available in right or left curves
Water Delivery System: Fountain feature and flume together or independent
Ladder: Enclosed with molded handgrips Required Deck Space: 13' 6" x 6' 7"
Weight Limit: 275 lbs



Typhoon® Offers all the fun of its big brother, the TurboTwister, yet in a smaller package for more limited deck space. A perfect addition to any backyard.

Height: 7' 4", 6' 5½" to seat Flume: 9' 10" long, 22" wide, available in right or left curves
Water Delivery System: Fountain feature and flume together or independent
Ladder: Enclosed with molded handgrips Required Deck Space: 11' 8" x 4'
Weight Limit: 275 lbs



Cyclone Compact style ideal for limited deck space and hours of fun!

Height: 4' 1", 3' 2" to seat Flume: 6' 10" long, 17½" wide, available in right or left curves
Water Delivery System: Fountain feature and flume together or independent
Ladder: Enclosed with molded handgrips Required Deck Space: 6' 8" x 5' 6"
Weight Limit: 175 lbs



Rogue2 A retro look with a thoroughly modern flume makes this the new standard for backyard fun.

Height: 8', 8' 6", 6' 6" to seat Flume: 9' 3" long, 22" wide, available in right or left curves
Water Delivery System: Plumbed through pool's return or connected to a garden hose
Ladder: Aluminum Required Deck Space: 5' 6" x 10' 7"
Weight Limit: 250 lbs



F.O.B. FACTORY PRICE ON APPLICATION

REPLACEMENT BOARDS



Eureka Diving Board

The Eureka is the ultimate board for heavy-duty use on commercial pools. It is available in both 14' and 16' lengths. The Eureka Boards feature a durable acrylic outer body (skin) and a non-slip tread. The entire core is reinforced with fiberglass.



Swim Club Diving Board

The Swim Club Board is the ideal mid-range board for commercial pools. It is available in 10', 12', 14' and 16' lengths. It has a durable acrylic outer body and a non-slip tread.



Olympian Aluminum Diving Board

The Olympian Aluminum Board is intended for heavy duty use on commercial and residential pools. It is available in 8', 10', 12', 14' and 16' lengths. The Olympian Aluminum Diving Board features an epoxy and welded beam extrusion construction with welded ends, providing exceptional durability, and a non-slip tread for maximum safety.



Frontier III Diving Board

The Frontier III Commercial Board has a durable acrylic outer body and a non-slip tread. It is available in 10', 12', 14' and 16' lengths.

Priced on Application

DIVING TOWERS

Heavy-duty towers designed for commercial aquatic facilities. Our diving towers pair with a variety of 8' to 16' boards, and are designed for a wide range of usage levels and pool envelopes.



Deluxe

Deluxe towers come in 1 and 3 meter heights to accommodate 14' or 16' diving boards, allowing you to find the perfect size for your commercial diving pool. Choose from right, left, dual or heel mount models. The steel tower is primed only and ready for a paint topcoat.



833-SWIM-327
833-7946-327
www.halogenupply.com

Steel Meter

The Steel Meter stand comes in three sizes ranging from 1/2 meter to 1 meter in height. Although ideal for commercial applications that require a strong and durable diving tower, the 1/2 meter size is also appropriate for residential pools where the diving board gets a lot of activity. The stainless steel, powder coated construction is built to last for years with minimal maintenance. Board length will be determined by size and type of pool. Handrails are required for 3/4 and 1 Meter models and are sold separately



Priced on Application

LIFEGUARD CHAIRS

O-Series: 360° Visibility

Scan more with the O-Series Lifeguard chair. Its circular design offers a full view of the protected area and unobstructed exit capability which enables quicker response to potential threats. Plus it's portable so you can have protection where you need it.



Low Profile

This unit offers portability in a traditional form factor with the added benefit of 360° viewing



Standard

This narrow profile unit offers portability and a 6'1.8m high seat for elevated scanning



Sentry™ Lifeguard Chair

Designed to complement any aquatic environment, Sentry lifeguard chairs provide an elegant look that will stand the test of time. Constructed from high-density polyethylene (HDPE) they are strong, durable and low maintenance.

Priced on Application

DIVING BOARDS TOWERS, STARTING PLATFORMS & LIFE GUARD CHAIRS

SR Smith™

STARTING PLATFORMS



Universal

This platform's unique u-shape design provides a wide staging area that promotes safe platform access and doubles as a combination coaching step/rest area.



Legacy™

These single-post models are ideal for competition aquatic facilities.



Velocity

Designed for fast, solid starts, the Velocity Starting Platform is the next generation of starting blocks.

Priced on Application

STARTING PLATFORMS DIVING TOWERS LIFEGUARD CHAIRS RACING LANES CLOCKS

RACING LANES & PARTS



| Length | Standard (4" Disc) | Price | Gold Medal (6" Disc) | Price |
|---------------|--------------------|------------|----------------------|------------|
| 60' lane | 200329 | \$642.06 | 200371 | \$760.66 |
| 75' lane | 200330 | \$691.13 | 200372 | \$864.94 |
| 25 meter lane | 200331 | \$736.12 | 200373 | \$911.96 |
| 50 meter lane | 200332 | \$1,380.23 | 200374 | \$1,725.78 |

| Disconnect Lanes | Standard (4" Disc) | Price | Gold Medal (6" Disc) | Price |
|---------------------------------------|--------------------|------------|----------------------|------------|
| 25 meter to 1-75' lane | 200341 | \$924.23 | 200383 | \$1,110.31 |
| 50 meter to 2-75' lane | 200342 | \$1,656.27 | 200384 | \$2,044.77 |
| 50 meter to 1-75' lane | 200343 | \$1,615.37 | 200387 | \$1,985.48 |
| 50 meter to 1-75' and 1-25 meter lane | 200344 | \$1,656.27 | 200386 | \$2,044.77 |
| 50 meter to 1-25 meter lane | 200345 | \$1,615.37 | 200385 | \$1,985.48 |

Standard colors: red, white, blue, green, yellow.

All lanes F.O.B. Medina, OH

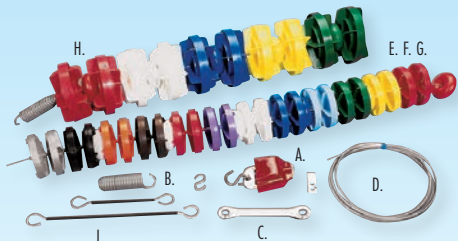

COMPETITOR RACING LANE PARTS

- A. 200200 Take-up reel \$133.07
- B. 200201 Spring with clamp \$46.29
- C. 200202 Ratchet wrench \$39.53
- D. 200210 Cable (per ft.) \$1.63/ft
- E. 200347 Body segment (approx. 4 per ft.) \$1.52
- F. 200348 End segment (approx. 4 per ft.) \$1.52
- G. 200349 Donut float (approx. 2 per ft.) \$1.52
- H. 200371001 Gold medal lane segment (approx. 4 per ft.) \$3.45
- I. 200000080 2" extension hook \$8.42
- 200240 8" extension hook \$34.23
- 200241 14" extension hook \$38.57
- 200206 S.S. cable lock \$5.69

REEL & PARTS

200350 Stor-Lane Competitor Reels \$2,494.99

200351 Stor-Lane reel cover. Wt. 14 lbs \$212.15

F.O.B. Medina, OH

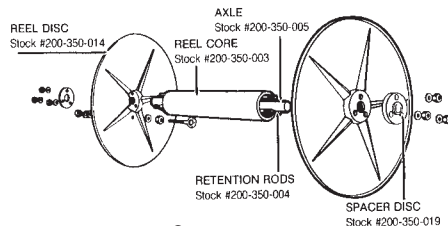

REEL PARTS By Stor-Lane®

- 200350014 Reel disc \$370.76
- 200350005 Axle \$98.32
- 200350003 Reel core \$88.48
- 200350004 Retention rods \$74.71
- 200350019 Spacer disc \$18.32

F.O.B. Medina, OH

CLOCKS & PARTS



PACE CLOCKS

- 200600 31" Battery model with white face \$564.74
- 200605 31" Battery model with black face \$564.74
- 200305 Roll away stand (for use with all 31" clocks) \$194.74
- 200400 15" Red battery clock with white face \$321.32
- 200505 15" Red battery clock with black face \$321.32
- 200405 15" White battery clock with white face \$321.32
- 200500 15" White battery clock with black face \$321.32

F.O.B. Medina, OH

ALL PACE CLOCK PARTS AVAILABLE ON REQUEST



PARAGON AQUATICS DIVING TOWER

3-meter, 1-meter, 3/4-meter, and 1/2-meter competitive/recreational diving towers in three grades of stainless steel. Choice of access ladders, fulcrums, pedestals, anchors and diving boards to meet every site requirement and budget. Towers meet FINA, NCAA, NFSHCA and U.S. Diving requirements.

Priced on application

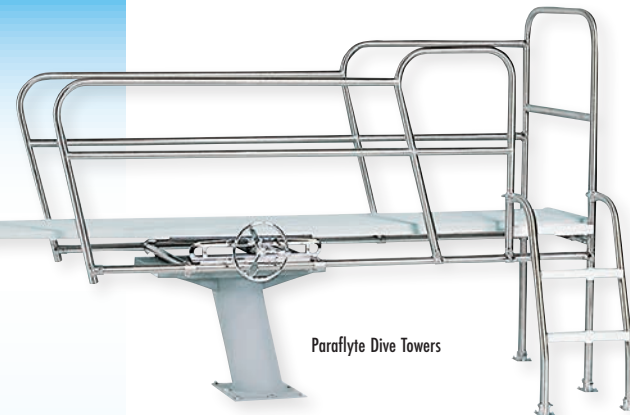

Paraflyte Dive Towers

PARAGON AQUATICS STARTING PLATFORMS

Internationally acclaimed by coaches and competitive swimmers alike. Available in a wide variety of models and anchoring systems to meet your every need.

Priced on application



Track Start Plus Starting Platform

PARAGON AQUATICS LIFEGUARD CHAIRS

A wide selection of fixed, moveable, and portable chairs suitable for every need. The Paraflyte fixed-series chairs, designed to harmonize with the Paraflyte diving towers and starting platforms, feature both sloping pedestal and access ladder. We also have a variety of chairs that can easily be moved about as needed or to avoid the sun.

Priced on application



All Terrain Griff Guard Station

833-SWIM-327
833-7946-327
www.halogensupply.com

POOL LIFTS



THE MIGHTY 400 & THE MIGHTY 600

The Mighty series is ADA compliant and UL certified to meet pool lift standards 60335-2-1000.

The Mighty lifts provide accessibility solutions with versatility, greater water drafts and a setback up to 44". Designed for in ground anchoring, the Mighty series will accommodate existing "standard" Scout 2 and Revolution concrete anchors. Created for its adaptability, the Mighty's can be purchased with a pedestal for additional wall clearance or unusual gutter profiles. Pedestals come in 8", 1', 2', 3' and 4' options.

The Mighty series is ideal for easy and affordable ADA compliance. US Patent Pending. *If you have an existing Revolution anchor please let your sales rep know*

THE MIGHTY 400 LIFT

F-MTY 400: Mighty 44, No Anchor

- 400 pound (181 kg) weight capacity
- Up to 12" deck to water

THE MIGHTY 600 LIFT

F-MTY 600: Mighty 44, No Anchor

- 600 pound (272 kg) weight capacity
- Up to 14" deck to water

*Plastic color options - standard blue, gray, tan or white

*Powder coat options - white, gray or tan

| | |
|---|--------|
| #F-MTY400 MIGHTY 400, No Anchor | P.O.A. |
| #F-MTY600 MIGHTY 600, No Anchor | P.O.A. |
| #F-80BSA STANDARD ANCHOR | P.O.A. |



AQUACREEK PARTS

| | |
|--|----------|
| A. #F-004AB LINAK BATTERY | \$422.10 |
| B. #F-004ABV VITO BATTERY | \$422.10 |
| #HB00-U017 2 BUTTON HAND CONTROL | \$300.30 |
| C. #HB00-U10 4 BUTTON HAND CONTROL | \$300.30 |



THE RANGER 2 LIFT

Welcome the newest lift in the Pro Pool Series, the Ranger 2 Pool Lift. The Ranger 2 is the newest version of our most popular lift, The Ranger. The new ADA compliant lift features a field reversible design, 350 pound weight capacity, UL Certification, and comes standard with a 14 inch deck to water draft.

The Ranger 2 upholds the same standards for durability and reliability as all Aqua Creek pool lifts. This lift is ideal for use on smaller hotel and motel pools. It is also a great choice for backyard pool enthusiasts who enjoy their independence. This lift is designed to be independently operated by the user, allowing full control of the lift with an easy to use 2 button handset.

The Ranger 2 is available with the same color options, solar charging station, anchoring system, and accessories as the Pro Pool Series lifts.

| | |
|---|--------|
| #F-RNGR2 Ranger 2 Lift, No Anchor | P.O.A. |
| #F-04CAJP Anchor | P.O.A. |

SRSMITH POOL LIFTS



PAL2® SERIES



The fixed portable PAL2 pool lift features a sleek, modern design and attractive matte finish. It comes standard with our Secure-It Kit which allows the lift to be fixed to the deck.

- Third-party tested and verified ADA compliant.
- Integrated armrests • State of California compliant.
- 300 lb/136kg lifting capacity. • Easy to move by one person.
- LiftOperator® Intelligent Controller.
- 240° rotation helps ensure safe transfer.
- Powder-coated stainless steel and aluminum construction

#202-0000 PAL2 Portable Lift P.O.A.

All Lifts FOB Factory

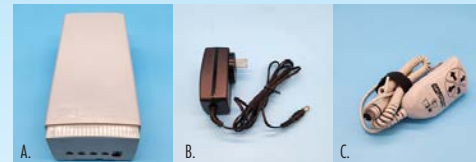

SR SMITH PARTS

| | |
|---|----------|
| A. #100-1495 24V BATTERY | \$488.71 |
| B. #100-1530 BATTERY CHARGER | \$184.86 |
| C. #1001600 4 BUTTON HAND CONTROL | \$301.12 |



ADA COMPLIANT POOL ACCESS LIFTS



SPLASH!™ SERIES



This fixed lifting system is designed for swimming facilities seeking to provide user-friendly access to their swimming pools.

- Third-party tested & verified ADA compliant.
- Integrated arm rests. • State of California compliant.
- 400 lb/181.5 kg lifting capacity*
- LiftOperator® Intelligent Controller
- 344° rotation helps ensure a safe transfer area
- Powder-coated stainless steel and aluminum construction

*Lifting capacity of Extended Reach models are 300 lb/136 kg

#300-0000 Splash Pool Lift w/Arm Rests P.O.A.

TAYLOR TEST KITS AND REAGENTS

SPECIALTY TEST KITS

A. SALTWATER TEST KIT
1 drop = 10 or 200 ppm NaCl
K-1766 Saltwater Test Kit \$39.35



B. PHOSPHATE TEST KIT by Taylor
Commercial Phosphate Test Kit helps you control algae by identifying the phosphate level in your pool.
K-1106 Phosphate Test Kit \$46.77



C. FAS-DPD CHLORINE TEST KIT
K-1515-A Chlorine Test
3/4 oz bottle \$41.73
K-1515-C Chlorine Test
2oz bottle \$104.01



D. FAS-DPD CHLORINE & MONOPERSULFATE COMBO TEST KIT
FAS-DPD
K-1518 Chlorine and Monopersulfate Combo Test Kit \$111.01



833-SWIM-327
833-7946-327
www.halogensupply.com

TAYLOR TEST KITS AND TESTING ACCESSORIES

E. TEST KIT FOR SODIUM HYPOCHLORITE by Taylor
Kit is used to verify strength of sodium hypochlorite by the drop method. K-1579 \$131.29



F. TEST KIT FOR TOTAL DISSOLVED SOLIDS (TDS) by Taylor
Kit quickly and easily tests for total dissolved solids (TDS) using the drop method. 1 drop = 50 p.p.m. TDS. A must test kit for commercial applications with heavy bather loads. K-1764 \$102.54



REPLACEMENT COMPONENTS FOR COMMERCIAL & RESIDENTIAL

| | |
|---|----------|
| 2004B Pool and spa water chemistry booklet. | \$9.23 |
| 3235 Cap for 5 ml. test cell | \$1.69 |
| 3243 Cap for 11.5 ml. test cell | \$2.14 |
| T4024 11.5 ml. test lucite cell | \$8.33 |
| T4025 5 ml. H.D. test lucite cell | \$7.47 |
| T4030 0.5 and 1.0 ml. pipet (eyedropper). | \$3.62 |
| 6002 Sponge or brush cleaner | \$2.50 |
| 6026 Circular watergram. | \$6.48 |
| 9056 High Test Block for K-2000 & K-2005 | \$15.19 |
| 9057 Low Test Block for K-2000 & K-2005 | \$15.80 |
| 9058 Test Block for K-2006 | \$15.80 |
| 9067 pH slide 6.8-8.4 p.p.m. | \$103.68 |
| 9079 DPD bromine slide 0-3.0 p.p.m. | \$103.50 |
| 9236 DPD bromine slide 2.0-10 p.p.m. | \$103.68 |
| 9082 DPD chlorine slide 0.1-3.0 p.p.m. | \$103.50 |
| 9083 DPD chlorine slide 1.0-10 p.p.m. | \$103.50 |
| 9094 Copper slide 0-2.0 p.p.m. | \$100.67 |
| 9106 Iron slide 0-2.0 p.p.m. | \$100.67 |
| 9189 Enslow base | \$88.79 |
| 9193 Test tube (20-100 ppm) for cya test. | \$4.19 |
| 9194 15 ml. cya plastic bottle | \$4.07 |
| 9198 25 ml. Sample tube | \$7.29 |

TAYLOR REPLACEMENT REAGENTS

2000 SERIES

| KITS | R-0001 | R-0002 | R-0003 | R-0004 | R-0005 | R-0006 | R-0007 | R-0008 | R-0009 | R-0010 | R-0011L | R-0012 | R-0013 | R-0870 | R-0871 | R-0872 |
|---------|--------|--------|--------|--------|--------|--------|--------|--------|--------|--------|---------|--------|--------|--------|--------|--------|
| K-2000 | 1A | 1A | 1A | 1A | 1A | 1A | | | | | | | | | | |
| K-2005 | 1A | 1A | 1A | 1A | 1A | 1A | 1A | 1A | 1A | 1A | 1A | 1A | 2A | | | |
| K-2005C | 1C | 1C | 1C | 1C | 1C | 1C | 1C | 1C | 1C | 1C | 1C | 1C | 3C | | | |
| K-2006 | | | 1A | 1A | 1A | 1A | 1A | 1A | 1A | 1A | 1A | 1A | 2A | 1A | 1A | |
| K-2106 | | | | 1A | 1A | 1A | 1A | 1A | 1A | 1A | 1A | 1A | | 1A | | 1A |
| K-2006C | | | 1C | 1C | 1C | 1C | 1C | 1C | 1C | 1C | 1C | 1C | 2C | 2A | 1C | |

RESIDENTIAL SERIES

| KITS | R-0001 | R-0002 | R-0003 | R-0007 | R-0008 | R-0009 | R-00010 | R-0011L | R-0012 | R-0013 | R-0014 | R-0015 | R-0016 | R-0800 |
|--------|--------|--------|--------|--------|--------|--------|---------|---------|--------|--------|--------|--------|--------|--------|
| K-1001 | 1A | 1A | | | | | | | | | 1A | | | |
| K-1003 | | | | 1A | 1A | 1A | | | | | 1A | 1A | 1A | 1A |
| K-1004 | 1A | 1A | 1A | 1A | 1A | 1A | | | | | 1A | 1A | | |

REPRESENTATIVE OTHER

| KITS | R-0001 | R-0002 | R-0003 | R-0007 | R-0008 | R-0009 | R-0010 | R-0011L | R-0012 | R-0013 | R-0851 | R-0852 | R-0853 | R-0854 | R-0860 | R-0861 | R-0862 | R-1003J |
|---------|--------|--------|--------|--------|--------|--------|--------|---------|--------|--------|--------|--------|--------|--------|--------|--------|--------|---------|
| K-1741 | 1C | 1C | 1C | 1C | 1C | 1C | 1C | 1C | 1C | 4C | | | 1C | | | | 1C | 1C |
| K-1741C | 1C | 1C | 1C | 1C | 1C | 1C | 1C | 1C | 1C | 4C | 1C | 2C | 1C | 1C | 1C | 1C | 1C | 1C |

Key: A = .75 oz (22 ml) C = 2 oz (60 ml) E = 16 oz (500 ml) F = 32 oz (1000 ml); 1 = 10 g
The number equals the quantity of bottles in the kit; the letter indicates the size of the bottle. For instance 1A = one .75 oz (22 ml) bottle

| | | | | | |
|-----------|-----------------------------------|---------|-----------|---|----------|
| R-0001-A | DPD Reagent #1 3/4 oz. | \$5.56 | R-0013-A | Cyanuric Acid 3/4 oz. | \$4.64 |
| R-0001-C | DPD Reagent #1 2 oz. | \$11.48 | R-0013-C | Cyanuric Acid 2 oz. | \$7.07 |
| R-0002-A | DPD Reagent #2 3/4 oz. | \$5.65 | R-0013-E | Cyanuric Acid 16 oz. | \$16.07 |
| R-0002-C | DPD Reagent #2 2 oz. | \$11.84 | R-0014-A | Phenol Red 3/4 oz. | \$2.95 |
| R-0003-A | DPD Reagent #3 3/4 oz. | \$5.90 | R-0015-A | Acid Demand 3/4 oz. | \$2.95 |
| R-0003-C | DPD Reagent #3 2 oz. | \$12.65 | R-0600-A | OTO 3/4 oz. | \$2.43 |
| R-0004-A | PH Indicator SOL 3/4 oz. | \$4.97 | R-0600-E | OTO 16 oz. | \$18.86 |
| R-0004-C | PH Indicator SOL 2 oz. | \$8.44 | R-0718-A | Silver Nitrate 3/4 oz. | \$19.91 |
| R-0004-D | PH Indicator SOL 4 oz. | \$17.73 | R-0851-C | Iron RGT #1 2 oz. | \$14.00 |
| R-0004-E | PH Indicator SOL 16 oz. | \$28.85 | R-0852-C | Iron RGT #2 2 oz. | \$12.11 |
| R-0005-A | Acid Demand 3/4 oz. | \$4.97 | R-0853-C | Acid Demand 2 oz. | \$12.11 |
| R-0005-C | Acid Demand 2 oz. | \$8.06 | R-0854-C | Total Hardness 2 oz. | \$16.94 |
| R-0006-A | Base Demand 3/4 oz. | \$4.97 | R-0860-C | Copper #1 2 oz. | \$12.31 |
| R-0006-C | Base Demand 2 oz. | \$7.70 | R-0861-C | Copper #2 2 oz. | \$13.16 |
| R-0007-A | Thiosulfate 3/4 oz. | \$4.57 | R-0862-C | Base Demand RGT 2 oz. | \$11.34 |
| R-0007-C | Thiosulfate 2 oz. | \$7.38 | R-0870-I | DPD Powder (10 g). | \$12.69 |
| R-0007-E | Thiosulfate 16 oz. | \$22.01 | R-0870-J | DPD Powder (1/4 lb). | \$59.06 |
| R-0008-A | Total Alkalinity 3/4 oz. | \$4.43 | R-0871-A | FAS-DPD Titrating RGNT Chlorine 3/4 oz. | \$13.70 |
| R-0008-C | Total Alkalinity 2 oz. | \$7.76 | R-0871-C | FAS-DPD Titrating RGNT Chlorine 2 oz. | \$17.84 |
| R-0009-A | Sulfuric Acid 3/4 oz. | \$4.43 | R-0871-E | FAS-DPD Titrating RGNT Chlorine 16 oz. | \$44.48 |
| R-0009-C | Sulfuric Acid 2 oz. | \$7.09 | R-0872-A | FAS-DPD Titrating RGNT Bromine 3/4 oz. | \$15.86 |
| R-0010-A | Calcium Buffer 3/4 oz. | \$5.54 | R-0872-C | FAS-DPD Titrating RGNT Bromine 2 oz. | \$18.86 |
| R-0010-C | Calcium Buffer 2 oz. | \$9.25 | R-1003J-A | PH Indicator Solution 3/4 oz. | \$7.49 |
| R-0011L-A | Calcium Indicator 3/4 oz. | \$8.73 | R-1003J-C | PH Indicator Solution 2 oz. | \$9.32 |
| R-0011L-C | Calcium Indicator 2 oz. | \$13.75 | R-1003J-D | PH Indicator Solution 4 oz. | \$16.65 |
| R-0012-A | Hardness Reagent 3/4 oz. | \$5.51 | R-1003J-E | PH Indicator Solution 16 oz. | \$27.32 |
| R-0012-C | Hardness Reagent 2 oz. | \$8.28 | R-1003J-G | PH Indicator Solution 1 Gallon. | \$100.73 |

TAYLOR 2000 SERIES KITS



A. 2000 SERIES TEST KITS
by Taylor
The K-2000 test kit will test for free available, total and combined chlorine and bromine, pH, acid and base demand. All reagents are ¾ oz.
K-2000 \$57.83



B. COMPLETE™ - HIGH (K-2005)
• ¾ oz. Reagents
• Free & Total Chlorine 1-10 ppm
• Bromine 2-20 ppm • pH 7.0-8.0
• Acid & Base Demand
• Total Alkalinity
• Calcium Hardness • Cyanuric Acid
K-2005 \$90.89



D. COMPLETE FAS-DPD CHLORINE
Same as K-2005 except uses 9058 comparator, sanitizer tests are titrations to improve accuracy and eliminate color-matching problems, and Free & Combined Chlorine is 1 drop = 0.2 or 0.5 ppm
K-2006 Complete FAS-DPD Chlorine \$111.64

SERVICE COMPLETE FAS-DPD CHLORINE
Same as K-2006 except features 2 oz. reagents, more DPD powder, and large carrying case
K-2006C Service Complete \$196.98

COMPLETE FAS-DPD BROMINE
Same as K-2006 except CYA test is not needed and Bromine 1 drop = 0.2 or 0.5 ppm
K-2106 Complete FAS-DPD Bromine \$118.61

833-SWIM-327
833-7946-327
www.halogensupply.com

TAYLOR COMMERCIAL SERIES

Kits in the Commercial Series test for two closely related parameters using liquid-color standards. The Slide and Midget comparators in this series give the **most accurate colorimetric readings available** short of high-end electronic instrumentation. Cases are custom-molded plastic; reagents are .75 oz. in Midget kits and 2 oz. in Slide kits.



THE MIDGET COMPARATOR
Recognized by eight liquid-color standards and a single test cell. Measures one parameter. Calibrated to work with specific reagents. Use when color and turbidity in the water sample are not problems.

F. COPPER & IRON MIDGETS
Copper 0.2 - 3.0 ppm Iron 0-2.0 ppm
K-1264 Copper & Iron Midgets \$182.91

THE SLIDE COMPARATOR
Recognized by nine liquid-color standards and three test cells. Slide sits in Enslow base. Measures one parameter. Calibrated to work with specific reagents. Use to compensate for color and/or turbidity in the water sample.



G. DPD CHLORINE-HIGH & pH SLIDES
Free & Total Chlorine 1.0 - 10 ppm pH 6.8-8.4
K-1765-H Chlorine-High & pH Slides \$287.97
DPD CHLORINE-LOW & pH SLIDES
Free & Total Chlorine 0 - 3.0 ppm pH 6.8-8.4
K-1765 Chlorine-Low & pH Slides \$285.14

TAYLOR PROFESSIONAL SERIES



TAKE A LAB POOLSIDE

H. PROFESSIONAL COMPLETE CHLORINE
Provides the pool professional with accurate and reliable analysis of the major testing requirements for all pools, spas, and hot tubs. Each kit contains slide comparators which provide the most accurate colorimetric comparisons available. The professional complete test kit, tests for DPD chlorine 0.0-3.0 p.p.m. and 1.0-10 p.p.m., pH 6.8-8.4, acid and base demand, total alkalinity, calcium hardness, cyanuric acid, copper 0.0-3.0 p.p.m., iron 0.0-2.0 p.p.m. and total hardness. A must for every pool professional.
K-1741C Professional Complete . . . \$704.84

LAMOTTE TEST KITS & ACCESSORIES



A. ColorQ PRO 7

The ColorQ PRO7 photometer was designed for pool and spa professionals to measure seven primary pool and spa tests directly on a digital display. Test factors include **Free Chlorine, Total Chlorine, Bromine, pH, Alkalinity, and Calcium Hardness** using liquid or tablet reagents to measure tests, and **Cyanuric Acid** with 100 TestTabs®. The user friendly photometer, testing reagents and photo-diagrammatic multilingual instructions (English, Spanish, French) are packaged in a convenient carrying case.

MODEL LA-2056 (Reagent version) \$262.50
 MODEL LA-2057 (Tablet version) \$262.50

COLORQ REAGENTS & TEST TABS

| | |
|--|---------|
| P-6740-G DPD1A Reagent 30 ml | \$10.58 |
| P-6741-G DPD1B Reagent 30 ml | \$10.58 |
| P-6743-G DPD3 Reagent 30 ml | \$13.05 |
| 7037-G pH Reagent 30 ml | \$12.94 |
| 7039-G TA Reagent 30 ml | \$15.26 |
| 7041-G CA2 Reagent 30 ml | \$13.05 |
| 7042-G CA1 Reagent 30 ml | \$13.12 |
| 6996A-J CY Tabs 100 pack (new version 2.0 or higher) | \$40.50 |
| 6903A-J DPD1 Tabs 100 pack | \$31.50 |
| 6197A-J DPD3 Tabs 100 pack | \$31.50 |
| 3880A-H pH Tabs 50 pack | \$17.70 |
| 3882A-H Alkaline Tabs 50 pack | \$21.75 |
| 3883A-H CA Tabs 50 pack | \$21.69 |

B. INSTA-TEST 3 TEST STRIPS Insta-test 3 strips provide the simplest and precise test for free chlorine or bromine (0-10 ppm) total alkalinity (0-240 ppm) and pH (6.8-9.0) in the market. Comes complete with 50 strips per bottle and complete instructions. 2976 . . . \$8.88

INSTA-TEST 5 Tests for free and total chlorine/bromine, pH, total alkalinity and total hardness. Comes complete with 50 strips per bottle. 2977 . . . \$13.88

INSTA-TEST PHOSPHATE Measures the phosphate levels from 0, 100, 200, 300, 500, 1000, in 15 seconds. The phosphate strips are packaged 25 strips to a bottle. 3021 . . . \$13.75

INSTA-TEST SALT Measures from 1500, 2000, 2500, 3000, 3500, 4000 and 5000 ppm in 20 seconds. The Salt Strips are packaged 10 strips per bottle 2998 . . . \$8.75



B.



F.



G.



C.



D.

C. WATERLINK® SPIN TOUCH™

The innovative WaterLink® Spin photometer does all your pool and spa water testing for you. Each sealed reagent disk contains the precise amount of reagent needed to run a complete series of tests. Just fill one unique Spin reagent disk with less than 3 mL of water and all your vital tests are done automatically. In just 30 or 60 seconds all the test results are transferred into the DataMate® software (sold separately) and analyzed to display results and recommend precise treatment instructions.

| | | |
|-----------|--|------------|
| C. 3581 | Mobile Waterlink Spin Touch Lab. | \$1,483.13 |
| D. 4335-H | 3 Use Free CL/BR/ALK/PH (50 pkg) | \$157.50 |

E. POCKET TESTERS

Lamotte Pocket Testers are a great way to accurately test your levels. They feature an easy to read LCD screen and push button calibration.

| | | |
|------|---------------------------------------|----------|
| 1749 | Salt/TDS/TEMP Pocket Tester | \$178.45 |
|------|---------------------------------------|----------|



E.



H.



I.



J.

F. LAMOTTE DIP CELL SERIES TEST KIT

This 7013L Test kit is designed for the pool operator and service pro. It tests for free and total chlorine in ranges of 0.5-10.0 ppm, pH 6.8-8.2, total alkalinity, calcium hardness, acid and base demand and cyanuric acid. Comes complete with color coded instructions and handbook.

| | |
|-----------------|----------|
| 7013L | \$108.63 |
|-----------------|----------|

G. LAMOTTE'S POOL MANAGER SERIES KIT

This kit is an all table test kit designed for public pool operators. The precise Octa-Slide Comparator System tests for free and total chlorine 0.5-10.0 p.p.m., pH 6.8-8.2, total alkalinity, calcium hardness, acid demand and cyanuric acid. Also includes diagrammed instructions, saturation index calculator water quality handbook and enough tablets for 50 tests (Cl and pH).

| | |
|-------------------|----------|
| 3368-NJ | \$128.79 |
|-------------------|----------|

H. LAMOTTE PRO 250 SERIES TEST KIT

This is a complete kit for the commercial public pool operator. It tests for free and total chlorine, pH, total alkalinity, calcium hardness, acid and base demand, cyanuric acid and copper and iron. A must test kit for the commercial pool operator.

| | |
|-------------------|----------|
| 7002-NJ | \$271.95 |
|-------------------|----------|

I. LAMOTTE EC-5 CYANURIC ACID KIT

This kit provides an economical and simple way of determining cyanurics by turbidity methods in pools and spas in ranges of 20-100 p.p.m.

| | |
|----------------|---------|
| 6838 | \$44.16 |
|----------------|---------|

J. LAMOTTE TEST TABLETS

| | |
|--|-----------------|
| 6999A-J DPD #1 tablets | \$10.80 per 100 |
| 6905A-J DPD #3 tablets | \$10.80 per 100 |
| 6915A-J pH tablets | \$10.80 per 100 |
| 3920A-J Alkalinity tablets | \$10.80 per 100 |
| 6846A-J Calcium hardness tablets | \$10.80 per 100 |
| 6994A-J Cyanuric acid tablets | \$14.10 per 100 |

LAMOTTE TEST REAGENTS

| | | | |
|---|---------|---|---------|
| P-6111-H Alkalinity Titrant 60 ml | \$15.98 | P-6743-G DPD3 30 ml | \$13.05 |
| P-6740-G DPD1A 30 ml | \$10.58 | P-6743-H DPD3 60 ml | \$19.24 |
| P-6740-H DPD1A 60 ml | \$16.20 | P-7026-G Phenol red indicator 30 ml | \$12.94 |
| P-6741-G DPD1B 30 ml | \$10.58 | P-7026-H Phenol red indicator 60 ml | \$15.19 |
| P-6741-H DPD1B 60 ml | \$16.20 | P-7028-G Alkalinity indicator 30 ml | \$15.59 |

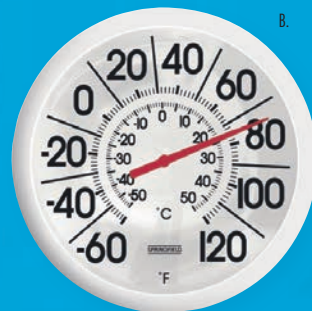

C



D



THERMOMETERS

- A. 13" INDOOR/OUTDOOR BIG & BOLD CLOCK
 #90057 13" Big & Bold Clock. \$19.95
- B. 13" INDOOR/OUTDOOR BIG & BOLD THERMOMETER
 #90007 13" Big & Bold Thermometer. \$19.95
- C. CHROME THERMOMETER by Rainbow
The thermometer has an ABS cyclac molded tube showing both fahrenheit and centigrade scales. Comes complete with 3' polyethylene cord. #R141076 \$33.28
- D. E-Z READ COMBO SINK OR FLOAT THERMOMETER by Pentair
Snap on/snap off floatation top with 3 foot tether. #R141200 \$21.88

833-SWIM-327
 833-7946-327
www.halogensupply.com



- A. GUARDEX 4-IN-1 TEST KIT
This kit tests for chlorine residual, pH, acid and base demand and total alkalinity quickly and economically. 26131GDX No Longer Available
- B. GUARDEX DPD 4-IN-1 TEST KIT
This kit tests for free available and total chlorine, pH, acid and base demand and total alkalinity. 26133GDX No Longer Available
- GUARDEX REAGENTS
- | | | | |
|--------------------------|--------|--------------------------|--------|
| 26240GDX #1 Sol. | \$5.82 | 26246GDX #4 Sol. | \$4.74 |
| 26242GDX #2 Sol. | \$5.94 | 26252000 #5 Sol. | \$6.09 |
| 26244GDX #3 Sol. | \$4.92 | | |



- C. TAYLOR DPD TEST KIT
This kit tests for free chlorine, .5-5 ppm or bromine 1-10 ppm, pH 6.8-8.2. Ideal for above-ground pool owners. K-1001 \$16.11
- D. TAYLOR TROUBLE-SHOOTER TEST KIT
This kit tests for free and total chlorine, .5-5 ppm or bromine 1-10 ppm, pH 6.8-8.2 acid demand and total alkalinity. K-1004 \$31.12



- E. RAINBOW CHALLENGER TEST KIT
This kit is geared for the above-ground pool owner and tests for total chlorine (0.1-3ppm) and pH (6.8-8.2). R151076 \$21.33
- F. RAINBOW CHALLENGER BROMINE TEST KIT
This kit tests for bromine (0.4 to 3.0 ppm) and pH (6.8-8.2). Is ideal for residential pools and spas utilizing bromine. R151196 \$21.35
- G. REAGENT REFILL FOR RAINBOW TEST KITS
OTO & PH 1/2 oz. reagent pack refill. R161150 \$8.03

PALINTEST TEST KITS RESIDENTIAL TEST KITS THERMOMETERS

TEST KITS



- A. LUMISO POOL TEST EXPERT
The Pooltest 10 Bluetooth is ideal for large commercial pools, spas and pool engineers. The Pooltest 10 is quick and easy to use and is fully integrated with the Palintest tablet test reagents.

- Built in water balance calculations
- Store 100 user ID's and 500 datasets
- Includes all major pool parameters
- Digital measurements for quick and accurate results
- Simple and easy to use
- Waterproof and portable
- Suitable for poolside use
- Bluetooth and USB connectivity
- Compatible with Palintest's Aqua Pal app

Test for

- Bromine
- Calcium Hardness
- Chlorine (free, combined & total)
- Copper
- Cyanuric Acid
- Iron
- Ozone
- pH Phenol Red
- Phosphate
- Total Alkalinity

Calculations for

- Langelier Saturation Index
- Palintest Water Balance

LMPXUS \$1,977.75

| TEST | REAGENT RANGE | 250 TEST PACK | |
|---|---------------|---------------|----------|
| Alkalinity | 10-500 | AP188 | \$152.60 |
| Calcium Hardness | 5-500 | AP252 | \$179.20 |
| Free Chlorine(DPD 1) | .01-5 | AP011 | \$51.10 |
| Total Chlorine (DPD1 & DPD3) | .01-5 | AP031 | \$101.50 |
| Free Chlorine (DPD-XF) | .01-10 | AP013 | \$59.50 |
| Total Chlorine (DPD1 & DPD3)XT | .01-10 | AP033 | \$118.30 |
| Cyanuric Acid | 2-200 | AP087 | \$126.00 |
| PH (Phenol Red) | 6.8-8.4 | AP130 | \$51.10 |
| Replacement Photometer Test Tubes (pack of 5) | | *PT595/5 | \$70.20 |

*PT595/5 - Round 10ml test tube (5 pack) for SP709US

SIGNS SAFETY LINES FITTINGS

PUBLIC SIGNS



- A. CPR CHART CARDIOPULMONARY RESUSCITATION
18" x 24" Sign that explains procedures for CPR Cardiopulmonary Resuscitation.
An absolute necessity for your pool.
#R231100 \$31.23



- B. NO LIFEGUARD ON DUTY SIGN
A 18" x 24" sign that is a must for every public pool without a lifeguard.
#2024 \$17.25



- C. NO PERSON MAY ENTER POOL AREA ALONE OR SWIM ALONE.
State sign.
#2029 \$17.25

Required by the State of Illinois



- D. PUBLIC POOL REGULATIONS SIGN
Required by the State of Illinois
#2020-IL \$17.25
#2030-IL (Public Spa Regulations) \$17.25
- E. NO LIFEGUARD ON DUTY SIGN
Required by the State of Illinois
#2024-IL \$17.25
- F. POOL BATHER LOAD
Required by the State of Illinois
#2026 \$17.25
#2031-IL (Spa Bather Load) \$17.25

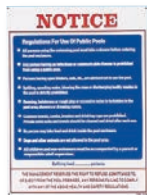

- G. PUBLIC POOL REGULATION SIGN 18" x 24".
#2020 \$17.25
- H. NO DIVING ALLOWED SIGN
A necessity for every pool commercial or residential.
#R231200 \$18.92



- I. DIAL 911 EMERGENCY NUMBER SIGN
#R231700 \$19.55
- J. POOL CLOSED SIGN — #R231400 \$21.00
- K. SPA CLOSED SIGN — #R231500 \$16.00



- L. SPA RULES SIGN — #R230300 \$32.56
- M. POOL RULES SIGN — #R230400 \$32.56



- N. CHEMICAL WARNING SIGNS
10" x 7" Chemical safety sign
#2602 Danger Acid Sign \$23.60 ea.
#2606 Danger Chlorine Sign \$23.60 ea.



SAFETY LINES & FITTINGS



- A. STANDARD POLYETHYLENE FLOATS
5" x 9" Floats for 3/4" rope \$9.83
#917BW Blue & White \$9.83
3" x 5" Floats for 3/8" rope \$4.13
#916BW Blue & White \$4.13



- B. HANDILOCK FLOATS
Eliminates need for float clamps. Simply twist float on rope to lock float unto rope securely.
5" x 9" Handlelock for 3/4" rope \$11.23
#915BWB Blue White Blue \$11.23
#915RWR Red White Red \$11.23
3" x 5" Handlelock for 3/8" rope \$5.87
#914BWB Blue White Blue \$5.87
#914RWR Red White Red \$5.87



- C. POLYPROPYLENE LINE
Blue & white polypropylene line. Will not crack, fray or absorb water.
#932 3/8" diam. . . . \$0.60/ft. #933 3/4" diam. . . \$1.10/ft.



- D. SAFETY LANE FLOAT KIT
Each kit contains Handlelock floats, 1 hook, 1 fid and blue and white rope.
#986 16 ft. kit, 5 floats \$45.07
#987 18 ft. kit, 6 floats \$55.42
#988 20 ft. kit, 7 floats \$65.81

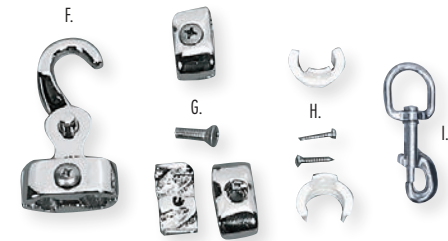

- F. CLAMP TYPE ROPE HOOKS
Chrome-plated brass.
#PH-51H For 3/4" rope \$30.40
- G. ROPE CLAMPS
Chrome-plated brass clamps.
#PH-57 For 3/8" rope \$8.78 ea.
#PH-59 For 3/4" rope \$11.77 ea.
- H. FLOAT KEEPERS
Permanently secures the #916 and #917 floats to the line to prevent it from sliding. One set holds one float.
#943 For 3" x 5" float, 3/8" rope \$2.45/set
#944 For 5" x 9" float, 3/4" rope \$5.31/set
- I. #920 Swivel Eye. \$9.16

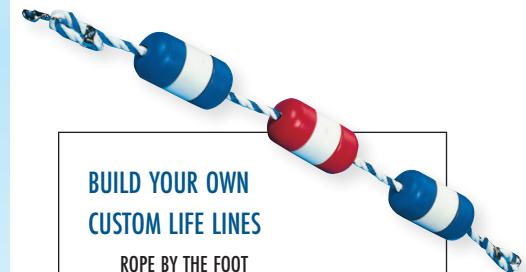

BUILD YOUR OWN CUSTOM LIFE LINES

- ROPE BY THE FOOT
#933 3/4" Rope
#932 3/8" Rope
- FLOATS (1 per every 5 ft)
#915BWB 5" x 9" HandiLock floats
#915RWR 5" x 9" HandiLock floats
#914BWB 3" x 5" HandiLock floats
#914RWR 3" x 5" HandiLock floats
- REQUIRED HARDWARE
#PH-59 3/4" Rope Hook (2 required)
#PH-57 3/8" Rope Hook (2 required)

833-SWIM-327
833-7946-327
www.halogenupply.com

LIFE GUARD UMBRELLAS

A. RED LIFE GUARD UMBRELLA

This Lifeguard umbrella is made of durable weather resistant nylon with a vinyl laminate covering to protect it against the elements. When opened this red lifeguard umbrella's diameter is 6 1/2'. This umbrella comes with a 7 1/2' aluminum pole that has push button device to allow the user to position the umbrella in a manner to protect the user from the sun.

#12-004 Red Umbrella
6 1/2 ft. umbrella with
7 1/2' x 1 1/2" pole \$110.25



B. THE WINDBRELLA

The Windbrella is ideal for windy areas due to superior venting at the top of the umbrella. This umbrella is extremely light and the pole diameter is 1 1/4" diameter. It also has tilting mechanism and closure strap.

Umbrella spans 6 1/2'. Comes with 7 1/2' pole.

#12-003-S-PB Silver outside with blue trim \$66.50
#12-003-S-PG Silver outside with green trim \$66.50



C. NYLON UMBRELLA

This umbrella is made of durable weather resistant nylon with a vinyl laminate covering to protect it against the elements. When opened, the diameter of the umbrella spans 6 1/2'. Comes with 7 1/2' pole.

#12-002-NAVY Navy & White Umbrella \$98.00
#12-002-RED Red & White Umbrella. \$90.13
#12-002-ROYAL Royal & White Umbrella \$98.00



All Umbrellas F.O.B. Charlotte, NC

833-SWIM-327
833-7946-327
www.halogensupply.com

SAFETY EQUIPMENT

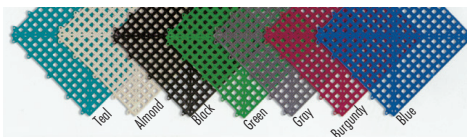

D. DRI-DEK® – THE SELF-DRAINING FLOOR SYSTEM

No more puddles. No more wet floors. No more germs. Now there's Dri-Dek. The perfect solution for showers. Steam rooms. Dressing areas. Locker rooms – or any place that gets wet. Why? Because Dri-Dek's textured surface not only drains water. Its patented design lifts you above wet floors, too. And it comes in 9 designer colors. So you can match decor. Anywhere. Any time.

#978 1' x 1' Dri-Dek P.O.A.
#978-3x4 3' x 4' Dri-Dek sheet P.O.A.
#978-3x12 3' x 12' Dri-Dek Roll P.O.A.
#978-CORNER 2" x 2" Corner P.O.A.
#978-EDGE 2" x 12" Edge P.O.A.
For color choices, add to code number
(example: #978-1): -1 Red, -2 Yellow, -3 Blue,
-4 Almond, -5 Green, -6 Gray, -7 Black, -8 Burgundy,
-9 Teal. F.O.B. Naples, FL

E. C.P.R. MICROSHIELD

A "First Response" protective device which provides a barrier between the victim and the rescuer, and one-way valve that prevents the victim's secretions from contacting the rescuer. Packaged in a convenient vinyl case with instructions, it is ready for use any time and is completely disposable.

Note: The microshield is for use by C.P.R. trained individuals only.
DO NOT USE ON INFANT VICTIMS.
Dispose of after initial use.

#975 \$10.13



F. #18604 24 Unit First Aid Kit \$78.75
(ILLINOIS STATE APPROVED)

G. LIFE HOOK and RESCUE POLE

Double loop life hook with 2-6 ft. poles..
#909 Life Hook with Rescue Pole \$157.37

H. #909A Life Hook only \$60.52



I. RING BUOY ASSEMBLY

U.S.C.G. Approved. Ideal for camps, pools and home use. Assembly consists of our JB-20 ring buoy. Equipped with stainless steel rack and 60 ft. throw line.
#962 \$182.00

J. RING BUOYS

U.S. Coast-Guard approved. Ring buoys are made of PVC foam. Covered with heavy nylon fabric.
#JB-20 20" dia. \$118.65
#JB-24 24" dia. \$126.00

K. THROW LINES

Polypropylene throw lines with float can be attached to a ring buoy without taping or splicing.
#957 60' long \$36.68



L. WATER RESCUE TUBES

A wrap-around type life-saving aid for open water. Made of the highest quality Ensolite enclosed cell foam. Covered with an extra heavy duty vinyl skin. Comes complete with towline and shoulder strap. This device is not U.S.C.G. approved.
#980 40" Rescue Tube \$73.19
#980A 50" Rescue Tube \$79.28

SAFETY EQUIPMENT



M. SPINE BOARD

AB Spineboard is an economical yet extremely strong board. The shell of the board is heavy duty and is x-ray translucent. The board comes with 21 hand holds and 8 pins for your strapping needs. The spineboard is waterproof and excellent for water rescue. The weight capacity of this board is 700 lbs. It's made of durable polyethylene. In large orders, we can do custom colors.
#10-993-ORG Spine board only 72" x 18" x 2.5" \$220.50



N. #10-301-BLK One piece spine board strap 72" x 2" \$12.38

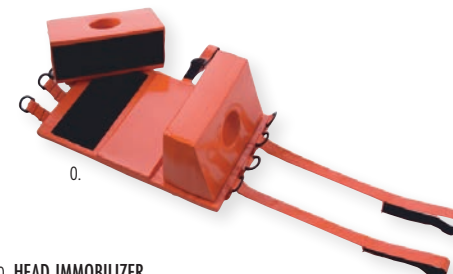

O. HEAD IMMOBILIZER

Head Immobilizer is easy to use and is compatible with the majority of spineboards on the market. Our immobilizer features side blocks with fast-stick closures for a snug fit and up to 50% more support surface. The Head Immobilizer comes with 2 head/chin straps and a base plate that adheres easily to the board. It's waterproof and buoyant, so it can be used for water rescues. Can easily be cleaned and disinfected for reuse.
#10-001-ORG Water rescue model 10" x 16" x 7" \$115.50



P. VELCRO SPINE BOARD STRAPS

Velcro straps are made of durable nylon webbing covered with velcro, enabling the user to accomplish fast and firm immobilization. This strap is for use with all spine boards. It's sold in a set of three.
#10-305-ORG Velcro spine board straps
Set of 3 \$42.00

SOLAR BLANKETS SOLAR REELS



- Why use a solar blanket?**
- **Warms pool water 10° or more in season.**
 - **Extends swimming season!**
 - **Cuts heating bills by 70% or more!**
 - **Reduces evaporation! Saves water and chemicals!**
 - **Keeps pool cleaner, too!**

COMMERCIAL REEL SYSTEM

A. ELITE COMMERCIAL REELS

- Various sizes to fit any shape or size pool (may require multiple reels)
- Dual bearings per frame allow for smooth cover rollup
- 36" high white frames are made of structured aluminum
- Stainless steel hardware for maintenance free use
- Heavy duty aluminum tubes were designed to handle heavy loads



| Cat No. | Pool Width | Max Reel Length | Max Cover Length | Price |
|-----------|------------|-----------------|------------------|------------|
| HV-100C14 | Up to 14' | 16' | 125' | \$1,386.00 |
| HV-200C14 | Up to 30' | 16' (Dual Tube) | 90' | \$2,054.50 |
| HV-100C20 | 15' - 20' | 22' | 125' | \$1,631.00 |
| HV-200C20 | Up to 40' | 22' (Dual Tube) | 90' | \$2,544.50 |
| HV-100C24 | 21' - 24' | 26' | 125' | \$1,790.25 |
| HV-200C24 | Up to 48' | 26' (Dual Tube) | 90' | \$2,863.00 |

F.O.B. FACTORY

RESIDENTIAL SOLAR COVERS



B. PROTECH RESIDENTIAL SOLAR COVERS

For residential pool applications. 6 year prorated warranty. Approximately 12 mil grade thickness. Reduces water evaporation. Conserves energy.

| Cat. No. | Pool Size | Price | Cat. No. | Pool Size | Price |
|-------------|-----------|----------|-------------|-----------|----------|
| 104012 x 24 | 12' x 24' | \$99.79 | 104020 x 40 | 20' x 40' | \$277.20 |
| 104016 x 32 | 16' x 32' | \$177.41 | 104020 x 44 | 20' x 44' | \$270.77 |
| 104018 x 36 | 18' x 36' | \$224.53 | 104024 x 40 | 24' x 40' | \$332.64 |
| 104018 x 40 | 18' x 40' | \$249.48 | 104024 x 44 | 24' x 44' | \$324.93 |
| | | | 104025 x 50 | 25' x 50' | \$393.75 |

RESIDENTIAL REEL SYSTEM

C. SIGNATURE INGROUND REEL SYSTEM

- 2 sizes (14' - 18') (19" - 20')
- For pools up to 20' x 40'
- Maximum strength.... All metal components
- Superior performance and quality. Low profile
- 1 person operation. Premium metal bearings
- Heavy duty tubing. Non sagging
- Fits under low profile diving boards (17' clearance)



| Cat No. | Description | Pool Size | Price |
|-----------|---------------------|--------------|----------|
| HVSIGN-18 | 18' Reel | 12' - 18' | \$390.25 |
| HVSIGN-20 | 20' Reel | 19' - 20' 6" | \$420.00 |
| HV-7041 | Optional Caster Set | Set of 4 | \$49.50 |

ABOVE GROUND SOLAR COVERS



D. PROTECH ABOVEGROUND SOLAR COVERS

For aboveground pool applications. Cuts nighttime heat loss. Reduces water evaporation. Conserves energy.

| Cat. No. | Pool Size | Price | Cat. No. | Pool Size | Price |
|----------|-----------|----------|-----------|----------------|----------|
| 103012 | 12' round | \$33.26 | 103012X24 | 12' x 24' oval | \$66.53 |
| 103015 | 15' round | \$51.98 | 103016X24 | 16' x 24' oval | \$88.70 |
| 103018 | 18' round | \$74.84 | 103016X32 | 16' x 32' oval | \$118.27 |
| 103021 | 21' round | \$101.87 | 103018X36 | 18' x 36' oval | \$149.69 |
| 103024 | 24' round | \$133.06 | 103018X38 | 18' x 38' oval | \$158.00 |
| 103028 | 28' round | \$181.10 | 103022X41 | 22' x 41' oval | \$203.83 |
| 103030 | 30' round | \$207.90 | | | |

ABOVE GROUND REEL SYSTEM



HV-18 / HV-24 / HV-28

E. ELITE ABOVE GROUND SOLAR REEL SYSTEM

Designed for both Round and Oval aboveground pools. Three sizes to choose from. Sturdy 4" diameter extruded aluminium tubing prevents sagging. Portable and easy to remove. Swivel ends pivot or lift out.

| Cat. No. | Description | Pool Width | Price |
|----------|-------------------|------------|----------|
| HV-18 | Above-ground reel | 12-18 ft. | \$259.00 |
| HV-24 | Above-ground reel | 19-24 ft. | \$302.75 |
| HV-28 | Above-ground reel | 25-28 ft. | \$360.50 |

833-SWIM-327
8 3 3 • 7 9 4 6 • 3 2 7
www.halogenupply.com

ABOVE GROUND WINTER COVERS



GLI WINTER COVERS FOR ABOVE-GROUND POOLS

GLI Pool Products attractive heavy-duty covers are available in, Estate Green solid, and Arctic Blue Solid complete with cable & winch. Backed by the strongest warranty in the business. Eliminate costly maintenance and clean up. Keep all dirt, debris and fine particles out of your pool.

| Size | BLUE CLASSIC COVER | | GREEN ESTATE COVER | |
|----------------|--------------------|----------|--------------------|----------|
| | Cat No. | Price | Cat No. | Price |
| 10' x 15' Oval | 4105010X15 | \$53.17 | 4108010X15 | \$71.53 |
| 12' Round | 4105012 | \$49.98 | 4108012 | \$68.69 |
| 12' x 18' Oval | 4105012X18 | \$72.98 | 4108012X18 | \$91.10 |
| 12' x 21' Oval | 4105012X21 | \$82.93 | 4108012X21 | \$103.51 |
| 12' x 24' Oval | 4105012X24 | \$90.80 | 4108012X24 | \$122.01 |
| 15' Round | 4105015 | \$71.93 | 4108015 | \$94.96 |
| 15' x 27' Oval | 4105015X27 | \$123.88 | 4108015X27 | \$165.12 |
| 15' x 30' Oval | 4105015X30 | \$124.74 | 4108015X30 | \$164.96 |
| 16' x 25' Oval | 4105016X25 | \$112.04 | 4108016X25 | \$151.10 |
| 16' x 32' Oval | 4105016X32 | \$135.22 | 4108016X32 | \$177.22 |
| 18' Round | 4105018 | \$94.06 | 4108018 | \$120.81 |
| 18' x 34' Oval | 4105018X34 | \$153.89 | 4108018X34 | \$202.34 |
| 18' x 36' Oval | 4105018X36 | \$175.10 | 4108018X36 | \$238.56 |
| 21' Round | 4105021 | \$115.69 | 4108021 | \$148.68 |
| 21' x 41' Oval | 4105021X41 | \$224.45 | 4108021X41 | \$304.88 |
| 24' Round | 4105024 | \$133.06 | 4108024 | \$181.15 |
| 28' Round | 4105028 | \$174.70 | 4108028 | \$231.00 |
| 30' Round | 4105030 | \$214.89 | 4108030 | \$284.11 |

Winterizing Air Equalizer Pillows
 #1052 4' x 4' Equalizer \$20.67
 #1053 4' x 8' Equalizer \$37.20

GLI POOL PRODUCTS LEAF NET Fits In-Ground or Above-Ground Pools!

- Stretches across solar blanket or winter pool cover
- Catches leaves and other debris • Makes leaf-removal a snap • Helps prolong life of solar blankets and winter covers • Keeps pool clean



| Cat. No. | Pool Size | Price | Cat. No. | Pool Size | Price |
|----------|----------------|----------|----------|-----------------------|----------|
| 1145 | 18' round | \$146.52 | 1150 | 16' x 32' oval | \$213.59 |
| 1146 | 24' round | \$211.58 | 1151 | 16' x 32' rectangular | \$227.91 |
| 1147 | 27-28' round | \$280.39 | 1152 | 18' x 36' rectangular | \$280.18 |
| 1148 | 12' x 24' oval | \$140.43 | 1153 | 20' x 40' rectangular | \$329.28 |

Other sizes available. Call for prices.

IN GROUND WINTER COVERS



PVC coated polyester fabric is 30% lighter than standard solid covers. 50% more puncture resistant! 100% Sunlight Blockage - NO spring time algae growth. Comes with patented "Kleen-Screen" drain (drains water from surface filtering out dirt, leaves and debris) Secures pool from children, pets and stray animals. Also available with Sure-Flo™ full length drain! Pump is available in lieu of drain. Custom HyPerLite Covers come standard with Commercial Grade Springs - A \$125 value! Available in 3 attractive colors. 15 Year Limited Warranty.

#HYPERLITE POOL COVER Price on Request



Blocks sun like a solid cover - No springtime algae growth. Made from a unique weave of polypropylene mesh that blocks out algae producing UV Rays. Keeping sunlight out ensures that you will open to cleaner water in the spring. Secures pool from children, pets and stray animals. Nearly 50% lighter than solid covers for easier installation, removal and storage. Nearly 75% more tensile strength than competitor's standard mesh! Custom ProMesh Covers comes standard with Commercial Grade Springs - A \$125 value! Available in 4 attractive colors. 15 Year Limited Warranty.

#PROMESH POOL COVER Price on Request

833-SWIM-327
 833-7946-327
www.halogensupply.com

WINTER POOL COVERS

Why use a winter cover?

- Keeps pool water clean and free from dirt, leaves and debris
- Stops chemical loss through evaporation • Prevents algae growth
- Protects pool from the wear and tear of winter
- Eliminates costly maintenance and spring cleanup



#5200 SERIES "CLASSIC" BLUE WINTER COVER

Features: Lighter-Easy to put on or take off the pool. Lasts longer- will not crack, split or tear from the most severe winters. Will not stretch or distort out of shape in summer. Best Warranty! 8 years prorated 1 full year.

#6200 SERIES "ESTATE" GREEN WINTER COVER

With a proper winterizing program, the Aquacover® Winter Cover: Protects pool from winter effects to eliminate costly maintenance and spring cleanup. Strongest Warranty! 12 years prorated, with 2 full years!

| Pool Size | Cover Size | Cat. No. | Price | Cat. No. | Price |
|-----------|------------|----------|----------|----------|----------|
| 14' x 28' | 19' x 33' | 521428 | \$109.54 | 621428 | \$147.55 |
| 16' x 32' | 21' x 37' | 521632 | \$133.27 | 621632 | \$179.61 |
| 16' x 40' | 21' x 45' | 521640 | \$164.56 | 621640 | \$213.26 |
| 18' x 36' | 23' x 41' | 521836 | \$163.84 | 621836 | \$219.91 |
| 20' x 40' | 25' x 45' | 522040 | \$192.55 | 622040 | \$258.82 |
| 20' x 44' | 25' x 49' | 522044 | \$208.80 | 622044 | \$296.86 |
| 24' x 40' | 29' x 45' | 522440 | \$205.74 | 622440 | \$316.28 |
| 24' x 44' | 29' x 49' | 522444 | \$270.54 | 622444 | \$347.40 |
| 25' x 50' | 30' x 55' | 522550 | \$280.41 | 622550 | \$366.81 |
| 30' x 50' | 35' x 55' | 523050 | \$327.18 | 623050 | \$477.90 |

ORDER TUBES SEPARATELY. Water tubes retain pool covers where tie-downs fail.

Double Chamber: #1047-BL 8'-20 mil black . . . \$16.29
 #1047-B 10'-20 mil black . . . \$18.96

SAFETY VACUUM RELEASE SYSTEMS GRATES & SUMPS



SR-500 Stingl Switch (Safety Vacuum Release System)

The Model SR-500 is a Safety Vacuum Release System (SVRS) which works by monitoring the vacuum on the suction side of the pool or spa pump. When a blockage occurs in the main drain or skimmer a sudden rise in vacuum will cause the SR-500 to shut down pump operation and activate an audible alarm. The pump will remain off with the alarm sounding until manually reset.

#SR-500 \$832.50
Note: High Voltage 240/480 triple phase 3.5 HP pumps (20 amps) or greater require a contactor. (not included)



Vac-Alert™

“Save a child’s life...
Vac-Alert™ saves lives”

SAFETY VACUUM RELEASE SYSTEM

- Vac-Alert™ Model VA-2000 SVRS Unit reacts in less than a second to quickly release dangerous pump suction vacuum
 - A totally mechanical safety system easy to install, adjust, and test
 - Made of engineered plastics and 3 16 stainless steel
 - The vac-alert complies with ASME/ANSI standard A112.19.17 for vacuum release systems for residential and commercial pool and spas
 - 3-year limited warranty
- #VA-2000S Below Grade Unit . . . \$725.00
#VA-2000L Above Grade Unit . . . \$725.00



833-SWIM-327
833-7946-327
www.halogensupply.com

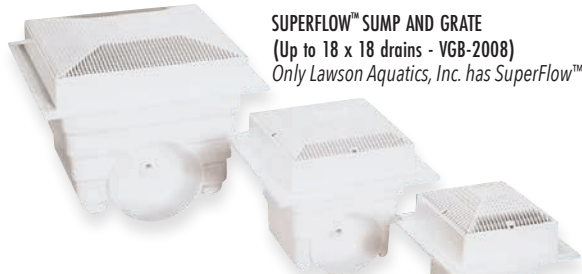

SUPERFLOW™ SUMP AND GRATE
(Up to 18 x 18 drains - VGB-2008)
Only Lawson Aquatics, Inc. has SuperFlow™

VGB-2008 certified main drain grates and sumps with a super flow rate and a unique top profile design that provides extreme comfort under foot. Removes the need for field-built sump certification.

- Open grate area of 54%-allowing for a maximum flow rate
- Internal plumbing fittings instead of external. Allows stacking and avoids breaking off or cracking during shipment, pressure testing or handling.
- Unique built-in water stop with two vertical extensions prevents water passing over the flange.
- A solid one-piece, injection-molded unit. Less expensive than fabricated PVC sheets, stainless steel and fiberglass.

| MODEL NUMBER | DESCRIPTION | OPEN AREA SQ. IN. | PRICE |
|-----------------|---------------------------------------|-------------------|------------|
| #MLD-SG-0909-WT | 9" x 9" Sump & Grate - 4" Side Port | 42.12 | \$494.28 |
| #MLD-SG-1212-WT | 12" x 12" Sump & Grate - 6" Side Port | 81.30 | \$776.24 |
| #MLD-SG-1818-WT | 18" x 18" Sump & Grate - 8" Side Port | 183.06 | \$1,905.62 |



FIBERGLASS SUMPS

(18 X 36 • 18 X 54 • 18 X 72 - VGB-2008)
Lawson Aquatics offers standard-size fiberglass main drain sumps with unblockable PVC grating for area 18" x 36" and larger

- Plumbing connection are configured and customized to your piping schematics
- Connections can either be threaded, (for 8" and smaller) flanged or couplings

| MODEL NUMBER | DESCRIPTION | OPEN AREA SQ. IN. | PRICE |
|----------------|------------------------|-------------------|-------|
| #FI-SG-1836-WT | 18" x 36" Sump & Grate | 343.44 | POA |
| #FI-SG-1854-WT | 18" x 54" Sump & Grate | 515.16 | POA |
| #FI-SG-1872-WT | 18" x 72" Sump & Grate | 686.88 | POA |

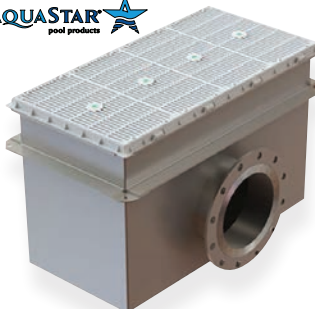

MAHC-I SERIES

18" x 36" Stainless Steel Sump with Four 9" x 18" Anti-Entrapment Suction Outlet Covers
For ANSI/APSP-16 flow ratings and VGB Certification documentation.

Floor/Wall 1,674 GPM at 1.5 fps
Floor/Wall 1,116 GPM at 1.0 fps

358 square inch opening

Configurable sumps simplify compliance with the Model Aquatic Health Code, the International Swimming Pool and Spa Code, and the latest revisions to ANSI/APSP-16.
Priced on application

emotron®

A simple, cost effective VGBA solution to prevent pool and spa entrapment

Key Features

The Emotron PSP20 uses the existing Pump Motor as a Sensor to protect swimmers from pool & spa entrapment. When a spa or swimming pool pump experiences a loss of suction caused by the drain being blocked, the PSP20 detects a significant drop in motor load and shuts the pump off in 1 second



| MODEL | VOLTAGE | FULL LOAD AMPS | PHASES | HP RANGE | PRICE |
|--------------|---------|----------------|--------|------------------------|------------|
| #PSP20-10-25 | 120 | 0.4 - 25 | 1 | 0.5 - 1.5 | \$1,564.50 |
| #PSP20-20-25 | 208/230 | 0.4 - 25 | 1 3 | 0.5 - 3.0 0.3 - 7.5 | \$1,564.50 |
| #PSP20-20-50 | 208/230 | 26 - 50 | 1 3 | 5.0 - 7.5 10.0 | \$1,729.00 |
| #PSP20-40-10 | 480 | 0.4 - 10 | 3 | 0.5 - 7.5 | \$1,564.50 |
| #PSP20-40-25 | 480 | 11 - 25 | 3 | 10.0 - 15.0 | \$1,564.50 |



Anti-Entrapment Suction Outlet Covers

- All components meet or exceed ANSI/APSP 16-2011 and NSF/ANSI 50-2009a national standards and ASTM G154 UV testing exposure.
- Sump manufactured from strong PVC sump with 3" socket and 4" spigot side port, and 2" socket 2 1/2" spigot bottom port.
- Manufactured from superior UV-resistant engineered polymers.
- Comes with 3" and 2" NPT cap with o-ring for pressure testing and winterizing.
- #316 stainless steel screws
- Trademarked VGB compliance button easily identifies VGB 2008 compliant cover from on deck and underwater.
- Replace drain cover every five years from the date of installation.

| MODEL NUMBER | DESCRIPTION | OPEN AREA SQ. IN. | PRICE |
|----------------|----------------------|-------------------|----------|
| #WAV9WR101SSB | WAVE 9" Square Sump | 48.4 | \$620.45 |
| #WAV12WR101SSB | WAVE 12" Square Sump | 90.8 | \$841.03 |

FRAMES AND GRATES



HAYWARD

| MODEL NUMBER | DESCRIPTION | OPEN AREA SQ. IN. | PRICE |
|----------------|--|-------------------|----------|
| #WGX1048E | 8" Round Grate Only (Each) | 8.10 | \$29.79 |
| #WG1030AVPAK2 | 8" Round Frame and Grate (Pkg of 2) | 8.10 | \$69.91 |
| #WG1031HF2PAK2 | 9" x 9" Inner/Outer Frame and Grate (Pkg of 2) | 23.96 | \$195.32 |
| #WG1032HF2PAK2 | 12" x 12" Inner/Outer Frame and Grate (Pkg of 2) | 41.07 | \$310.59 |
| #WG1033HF2PAK2 | 18" x 18" Inner/Outer Frame and Grate (Pkg of 2) | 124.10 | \$949.70 |
| #WGX1031BHF2 | 9" x 9" Grate w/Inner Frame (Each) | 23.96 | \$84.04 |
| #WGX1032BHF2 | 12" x 12" Grate w/Inner Frame (Each) | 41.07 | \$116.44 |

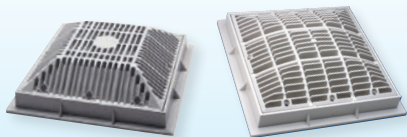

WATERWAY

| MODEL NUMBER | DESCRIPTION | OPEN AREA SQ. IN. | PRICE |
|--------------|---------------------------|-------------------|----------|
| #645-4790V | 9" x 9" Grate Only | 43.60 | \$66.90 |
| #640-4790V | 9" x 9" Frame and Grate | 43.60 | \$95.15 |
| #640-4740V | 12" x 12" Grate Only | 62.40 | \$90.43 |
| #640-4720V | 12" x 12" Frame and Grate | 62.40 | \$134.88 |
| #640-4770V | 18" x 18" Frame and Grate | 174.40 | \$524.93 |

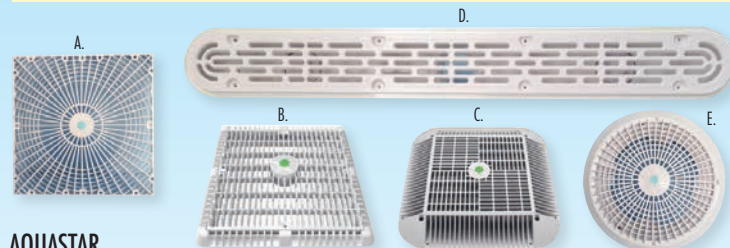

AQUASTAR

| | MODEL NUMBER | DESCRIPTION | OPEN AREA SQ. IN. | PRICE |
|----|---------------|---------------------------------|-------------------|----------|
| A. | #R9MF101 | 9" x 9" MoFlow Grate Only | 35.80 | \$96.55 |
| | #R12MF101 | 12" x 12" MoFlow Grate Only | 69.10 | \$127.18 |
| B. | #WAV9WR101 | Wave 9" x 9" Frame and Grate | 48.40 | \$219.00 |
| | #WAV12WR101 | Wave 12" x 12" Frame and Grate | 90.80 | \$256.33 |
| | #WAV18WR101 | Wave 18" x 18" Frame and Grate | 176.80 | \$622.93 |
| | #WAV18WRNF101 | Retro Fit Grate Kit w/ Riser | 176.80 | \$514.03 |
| C. | #914101 | 14" x 14" Retrofit to 9" x 9" | 84.00 | \$266.13 |
| | #1216101 | 16" x 16" Retrofit to 12" x 12" | 101.00 | \$304.60 |
| D. | #32CDFL101 | 32" Channel Drain 3-Port | 25.90 | \$354.20 |
| E. | #A10RCFR101 | 10" Round Sumpless Cover | 31.50 | \$75.45 |
| | #R8MF101 | 8" Round MoFlow Grate | 16.1 | \$39.30 |

ANTI-ENTRAPMENT

AEGIS ANTI-ENTRAPMENT SHIELD

- ASME A112.19.8.a-2008 VGB-2008 & NSF Certified
- Easily installed over existing main drains
- Prevents bather entrapment
- Fiberglass construction
- No bonding required
- Slip resistant surface
- Includes stainless steel hardware
- Wall flowrate: 1120 GPM
- Floor flowrate: 1432 GPM
- Life: 15 years - submerged outlet
- Covers up to 24" x 24" main drain

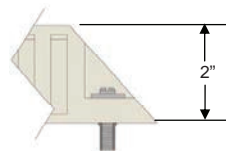
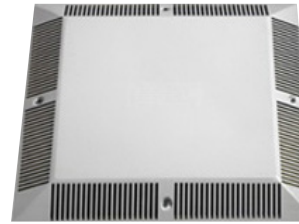

1/4" dia S.S. drop-in anchors with 1/4" S.S. fasteners & washers

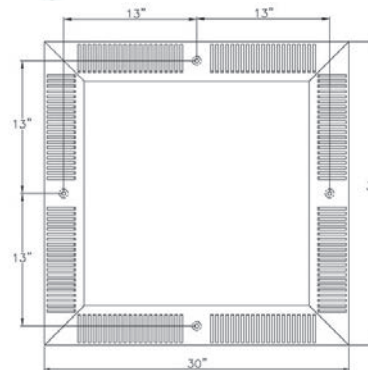

| MODEL NUMBER | OVERALL SIZE L x W | OPEN AREA | MAX. FLOW RATE @ 1.5 F.P.S. |
|--------------|--------------------|------------------------|-----------------------------|
| #3030AEC | 30" X 30" | 128.21 in ² | 600 GPM |

#3030AEC ANTI-ENTRAPMENT SHIELD \$2,619.03

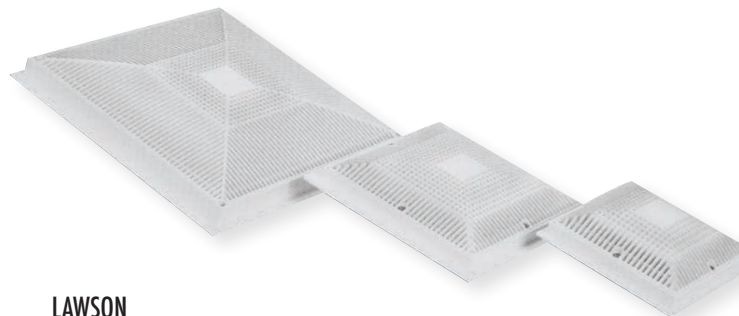

LAWSON

| MODEL NUMBER | DESCRIPTION | OPEN AREA SQ. IN. | PRICE |
|------------------|---------------------------|-------------------|----------|
| #MLD-FGD-0909-WT | 9" x 9" Frame and Grate | 42.12 | \$216.55 |
| #MLD-FGD-1212-WT | 12" x 12" Frame and Grate | 81.30 | \$286.65 |
| #MLD-FGD-1818-WT | 18" x 18" Frame and Grate | 183.06 | \$639.09 |

FRAMES AND GRATES

VIRGINIA GRAEME-BAKER POOL & SPA SAFETY ACT

By December 19, 2008

ALL public pool owners must

- Install drain covers that meet ANSI/ASME A112.19.8-2007 standard on EVERY drain/grate.
- Install an automatic shut-off system, gravity drainage system, Safety Vacuum Release system (SRVS), suction-limiting vent system or disable the drain, if the pool operates off of a SINGLE main drain. Pools and spas with unblockable drains are exempt from this requirement.
- Ensure that dual or multiple main drains are at least 3 feet apart.

WARNING: Installing a VGB Act approved grate does not necessarily establish compliance. ONLY a professional design engineer or your local health department can help you to confirm that all criteria of the act have been met.



Universal Drain Cover
Concrete, Vinyl & Equalizer Pools

SDX2 RETRO HIGH-FLOW SAFETY DRAIN

SDX2 is a high flow suction outlet suitable for use as a wall fitting, or as a floor fitting when debris removal is not a concern. Available for concrete, vinyl and fiberglass pools, SDX2 performs at a very high flow rate while operating at one of the lowest velocity ratings in the industry. SDX2 boasts a flow rating of 188 gpm on the floor and 154 gpm on the wall. 43.2 SQ. IN.

SDX-RETRO-WHT \$72.33



833-SWIM-327
8 3 3 • 7 9 4 6 • 3 2 7
www.halogensupply.com

ENERGY SAVING SYSTEMS

Filtrex INCORPORATED

Filtrex regenerative diatomaceous earth filters eliminate the need to backwash . . . saving makeup water, chemicals and heating energy. Filtrex provides unequalled water clarity – up to 99% effective in removing contaminants down to 1 micron.

Halogen has over 400 Filtrex installations. Call for references in your area.



REGENERATIVE D. E. FILTERS

Diatomaceous Earth (D.E.) is the best pool filtration media. Filtrex makes the best D.E. Filter. Filtrex's advanced technology combines low carbon stainless steel construction with the exclusive Flex-Tube™ filter element and a proven system of precoat regeneration to eliminate the need for continuous slurry feed throughout the filter cycle. The New Vacuum Transfer System, now standard on all New Filtrex Systems, allows for quick and easy filter precoat and eliminates airborne diatomaceous earth previously associated with the old precoat tank. Existing Filtrex Systems can also be retrofit with the New Vacuum Transfer System. Call us toll free for more information.

Price on Request

EPD POLY LINED STEEL HIGH RATE SAND FILTERS

EPD has utilized the latest in plastics technology to bring you the new Poly lined steel filter vessels (50 and 100 psi models) which combine the corrosion durability of linear low-density polyethylene with the strength of steel. The monolithic liner means the need for cathodic protection is eliminated. These new poly lined steel tanks can be ordered with 13.5 or 16.5 sq. ft. of filter area per tank in single (1) through (8) tank configurations with the automatic filter controller, the EPD Hi-Rate sand filtration system does not require supervision of its day to day operation. Operating and maintenance costs, normally associated with commercial filtration systems, are non-existent. The automatic backwash control console is programmed to perform all of the filtration and backwash functions automatically

24 hours per day, 365 days per year. Systems can be also purchased with semi-automatic and pressure differential controllers. Price on Request



833-SWIM-327
833-7946-327
www.halogensupply.com



DANFOSS ADJUSTABLE FREQUENCY DRIVES



Danfoss adjustable frequency drive offers a list of features and ease-of-use unmatched in the industry. On its own or when matched with our Halo Gen energy management system to provide state-of-the-art control of your pool and save you thousands of dollars in energy. Call and talk to one of our technical advisors on the advantages of this time-proven approach to energy savings.

#FC 102 Adjustable Frequency Drive
#VLT 6000 Adjustable Frequency Drive
Price on Request

WATERMASTER II LEVEL CONTROL SYSTEM



The WaterMaster II is an all-electronic level control system for commercial swimming pool applications. This system solves the level control needs of customers or designers who want to eliminate the need for pneumatic controls in their buildings systems.

The system controls surge tank water level to ± 0.05 feet of set point. The PLC controller also controls pool skimming action by measuring changes in gutter flow into the surge tank and turning on the fresh water make-up solenoid as needed

The control package includes a PLC based level controller, either an ultrasonic level sensor or an electronic pressure reducer, a 120 volt hydraulic main drain modulating valve and a 120 volt slow closing fresh water make-up solenoid valve

Price on Request

HALOGEN CONTROLLERS



All-Encompassing Control of Regenerative Systems: It's More Than a Filter, It's a Science. HALOGen.RTS (Regenerative Total System) HALOGen.CS (Custom System)

Benefits include:

- Ease of Use • Total System Control
- Mobile Connectivity • Training Built In
- Alarm Logging and Trend Reports
- Maximize Resource Savings - Minimize Operating Costs



Ease of Use

- Large 15 1/2" color touch screen with sound, graphics and video
- Intuitive user interface and experience
- Graphically displayed system status shown on one screen
- Flexibility with auto or manual modes
- User-friendly set-point entry
- Accessible from tablets, mobile devices and PCs

Total System Control

- Filter cycle control
 - Flow control with VFD
 - Chemical control
 - Temperature control
 - Level control with automatic fresh water makeup
 - Cleaning modes
 - All safety interlocks
 - Customized solutions tailored to your facility
- HALOGen.RTS**
(Regenerative Filter System) and
HALOGen.CS (Custom System)

Training Built In

- Training videos with audio for all procedures
- Imbedded manuals and data sheets specific to system design

Alarm Logging and Trend Reports

- Real-time trending reports for all control loops
- Trending histories stored
- Easy-to read graphical displays of real-time trends and histories
- Audible alarms to alert staff
- Alarm emails immediately sent to staff

Maximize Resource Savings - Minimize Operating Costs

- Complete integration of all system controls maximizes resources and ease of use
 - System component synergy contributes to the longevity, performance and efficiency of a pool system.
- Price on Request

BLUE-WHITE FLOW METERS

A. MODEL F300 BLUE WHITE FLOW METERS

NEW! Dual scale reads Sched 40 & Sched 80 PVC.
NEW! Easy to read red float with no more float bounce. Unique pitot tube design increases accuracy & reduces straight pipe requirements by 50%. The **F-300 Series** is a low cost, accurate pitot tube type flow meter designed specifically for the swimming pool industry. Mounts on horizontal pipe only. Available for pipe only.

| Cat. No. | Size | SCH40 / SCH 80 | Price |
|----------|------|-----------------------|----------|
| F-30150 | 1½" | 10-70/10-60 gpm | \$153.26 |
| F-30200 | 2" | 20-120/18-100 gpm | \$153.26 |
| F-30250 | 2½" | 29-150/25-130 gpm | \$153.26 |
| F-30300 | 3" | 45-240/40-215 gpm | \$153.26 |
| F-30400 | 4" | 79-400/70-375 gpm | \$153.26 |
| F-30600 | 6" | 170-1100/160-1000 gpm | \$219.41 |
| F-30800 | 8" | 300-2200/275-1950 gpm | \$219.41 |

Note: Add a "P" to Catalog No. for PVC or Iron pipe.
No longer available for copper pipe.

B. VERTICAL MOUNT FLOW METERS D-300/U-300

For installations with a minimal amount of room, hence more vertical pipe than horizontal. Please specify if direction of flow is up or down.

| Cat. No. | Flow Direction | Size | SCH 40 / SCH 80 | Price |
|----------|----------------|------|-------------------|----------|
| U-30150 | Up | 1½" | 12-70/10-60 gpm | \$153.26 |
| D-30150 | Down | 1½" | 12-70/10-60 gpm | \$153.26 |
| U-30200 | Up | 2" | 20-120/18-100 gpm | \$153.26 |
| D-30200 | Down | 2" | 20-120/18-100 gpm | \$153.26 |

Note: Add a "P" to Catalog No. for PVC or Iron pipe.
No longer available for copper pipe.

C. BLUE-WHITE F-2000 DIGITAL FLOWMETER

The **F-2000 Series** is battery or plug-in transformer (included) operated and can be quickly installed on an instrument panel or wall. This top quality meter is accurate to ± 1% full scale and can handle pressure up to 300 PSI and temperature to 200°F.

| Cat. No. | Pipe Size/Type | Flow Range | Price |
|------------|----------------|--------------|------------|
| RTPB-15K8 | 1½" (sch. 80) | 15-150 gpm | \$1,024.22 |
| RTPB-20K8 | 2" (sch. 80) | 30-300 gpm | \$1,024.22 |
| RTPB-30K8 | 3" (sch. 80) | 60-600 gpm | \$1,024.22 |
| RTPB-40A8 | 4" (sch. 80) | 100-1000 gpm | \$1,024.22 |
| RTPB-60A8 | 6" (sch. 80) | 250-2500 gpm | \$1,024.22 |
| RTPB-80A8 | 8" (sch. 80) | 400-4000 gpm | \$1,024.22 |
| RTPB-100A8 | 10" (sch. 80) | 600-6000 gpm | \$1,024.22 |
| RTPB-120A8 | 12" (sch. 80) | 800-8000 gpm | \$1,024.22 |

D. BLUE & WHITE DIGI-FLO F-1000

This meter is ideal for those who require rate of flow only. The meter is shipped pre-programmed. The meter LCD display is powered with 2 (AAA) batteries. Please specify pipe type (sched. 40 or sched. 80 PVC).



Features:

- Display update time: every 2 seconds
- Enclosure ABS material
- Accuracy ± 2% full scale
- Saddle Mount design for easy installation.

| Size | Cat. No. | Price |
|------|-----------|----------|
| 1½" | RB-150S8 | \$495.02 |
| 2" | RB-200S8 | \$495.02 |
| 3" | RB-300S8 | \$495.02 |
| 4" | RB-400S8 | \$495.02 |
| 6" | RB-600S8 | \$495.02 |
| 8" | RB-800S8 | \$495.02 |
| 10" | RB-1000S8 | \$495.02 |
| 12" | RB-1200S8 | \$495.02 |

F.O.B. Alsip, Illinois

INTRODUCING

FlowVis®

FLOW METER



E. FlowVis® Key Features

- The only flow meter to carry NSF 50 (required by CA Title 24)
 - NSF verified average accuracy 97.9%
 - Install right next to other fittings without the need for straight pipe before or after
 - Install horizontal, vertical, or even upside-down
 - Includes check valve function
 - Includes water velocity indication of 5', 7', and 9' per second
 - Establish correct flow rates for heaters, water features and chemical feeders
 - Quickly re-establish correct flow rates after customer tampering
 - Models for 1.5", 2", and 2.5" pipe
 - Retrofit kit easily, converts existing Jandy or Praher check valves into FlowVis flow meter or repairs existing FlowVis meters. No plumbing required.
 - Installing a flow meter with a variable speed pump allows you to use instrumentation to dial in the pump's optimum speed
- #FV-C Complete FlowVis for 2" & 2½" pipe \$212.80**
#FV-C-15 Complete FlowVis for 1½" pipe \$212.80
#FVJ-R FlowVis retrofit for 2" & 2½" pipe \$150.15
#FVJ-R-15 FlowVis retrofit for 1½" pipe \$150.15
#FV-3 FlowVis for 3" Sched. 80 pipe \$559.65
#FV-4 FlowVis for 4" Sched. 80 pipe \$620.03

F. SIGNET 8150 Battery Powered Flow Totalizer

The Signet 8150 Battery Powered Flow Totalizer is compatible with the Signet 515 and 529 flow sensors, and will provide years of dependable operation. The large digital display indicates flow rate and totalized flow volume simultaneously.

Features:

- Three totalizers: 2 resettable and 1 permanent, user-selectable
- Long-Lasting Lithium batteries
- Mounting versatility
- No-flow indicator
- Large digital display with averaging
- Simple push-button operation
- User-selectable access code prevents unwanted changes
- Auto-calibration



- F1. **#3-8150-1** (yellow body) FIELD MOUNT for Pipe, Tank and Wall Mounting \$928.81
#3-8150-1P (black body) PANEL MOUNT includes mounting bracket and gasket. Panel sold separately. \$928.81
#3-8150-PO INTEGRAL MOUNT* ½" to 4" pipe \$1,447.60
#3-8150-P1 INTEGRAL MOUNT* 5" to 8" pipe \$1,483.21
* Mounted on Model 515 Paddlewheel Sensor For Installation Directly On Pipe to Be Monitored

F2. SIGNET 515 ROTOR-X PADDLEWHEEL FLOW SENSORS

| Cat. No. | Pipe Size | Price |
|-----------|------------|----------|
| P51530-P0 | ½" to 4" | \$568.84 |
| P51530-P1 | 5" to 8" | \$590.01 |
| P51530-P2 | 10" and up | \$637.18 |

See Installation Fittings For Mounting 515 Sensors and 3-8150 Integral Mount Units To Pipe

G. SIGNET 2551 MAGMETER

The Signet 2551 Magmeter is an insertion style magnetic flow sensor without any moving parts. All versions are constructed of corrosion-resistant materials to provide long-term reliability with minimal maintenance costs. Utilizing the comprehensive line of Signet installation fittings, sensor alignment and insertion depth is automatic. These versatile, simple-to-install sensors deliver repeatable flow measurement over a wide dynamic range in pipe sizes ranging from 0.5 to 12 inches. The 4 to 20mA output can be used for a direct input to PLCs, chart recorders, etc. Price includes Magmeter sensor with local display.



Frequency or Digital (5³L) output

| Cat. No. | Pipe Size | Price |
|--------------|------------|------------|
| 3-2551-P0-11 | ½" to 4" | \$1,504.39 |
| 3-2551-P1-11 | 5" to 8" | \$1,548.66 |
| 3-2551-P2-11 | 10" to 36" | \$2,151.19 |

4 to 20mA output

| Cat. No. | Pipe Size | Price |
|--------------|------------|------------|
| 3-2551-P0-12 | ½" to 4" | \$1,504.39 |
| 3-2551-P1-12 | 5" to 8" | \$1,548.66 |
| 3-2551-P2-12 | 10" to 36" | \$2,313.85 |

4 to 20mA output

| Cat. No. | Pipe Size | Price |
|--------------|------------|------------|
| 3-2551-P0-42 | ½" to 4" | \$2,367.75 |
| 3-2551-P1-42 | 5" to 8" | \$2,412.99 |
| 3-2551-P2-42 | 10" to 36" | \$3,015.51 |

FLOW METERS

H. 9900 SmartPro® Transmitter

Features:

- Large auto-sensing backlit display with at a glance visibility
- "Dial-type" digital bar graph
- Custom 13-character label capabilities for the channel type
- Intuitive and "user-friendly" interface consistent with legacy Signet ProPoint® and ProcessPro® devices
- Optional field upgradable relays

+GF+



Panel Mount



Field Mount

| Cat. No. | Description | Price |
|-----------|------------------|----------|
| 3-9900-1P | 9900 Panel Mount | \$828.71 |
| 3-9900-1 | 9900 Field Mount | \$828.71 |

I. 9950 Dual Channel® Transmitter

Features:

- One instrument for multiple sensor types
- Two different sensor types can be combined in one instrument
- Configurable display
- Derived measurements
- Optional modules can be added for additional capabilities
- USB Port for Field Upgrades using standard USB Flash Drive



- Two Channel Multi-Parameter Inputs
- Two 4 to 20 mA Output
- Panel Mount

| Cat. No. | Power | Price |
|----------|-------|------------|
| 3-9950-1 | DC | \$1,417.76 |
| 3-9950-2 | AC/DC | \$1,438.94 |

INSTALLATION FITTINGS

| Cat. No. | Size-In. | Price |
|----------|----------|----------|
| PV8S020 | 2 | \$239.66 |
| PV8S025 | 2.5 | \$239.66 |
| PV8S030 | 3 | \$278.16 |
| PV8S040 | 4 | \$329.18 |
| PV8S060 | 6 | \$399.44 |
| PV8S080 | 8 | \$490.88 |

Iron Strap-on Saddle (Not shown)

| Cat. No. | Size-In. | Price |
|----------|----------|----------|
| IR8S100 | 10 | \$879.73 |
| IR8S120 | 12 | \$879.73 |



PVC-U Clamp-on Saddle

ACCESSORIES

- #3-8050** Universal Mount Kit for 9900 Transmitter \$95.29
- #7310-1024** 24 VDC Power Supply, 0.42 A, 10W \$159.78
- #7310-1024-4X** 24 Power Supply in NEMA 4X Enclosure. \$508.88

LEVEL CONTROLLERS SAFETY SWITCHES GAUGES & ACCESSORIES

WATERMASTER II LEVEL CONTROL SYSTEM



The WaterMaster II is an all-electronic level control system for commercial swimming pool applications. This system solves the level control needs of customers or designers who want to eliminate the need for pneumatic controls in their buildings systems.

The system controls surge tank water level to ± 0.05 feet of set point. The PLC controller also controls pool skimming action by measuring changes in gutter flow into the surge tank and turning on the fresh water make-up solenoid as needed

The control package includes a PLC based level controller, either an ultrasonic level sensor or an electronic pressure reducer, a 120 volt hydraulic main drain modulating valve and a 120 volt slow closing fresh water make-up solenoid valve

Price on Request



B. LEVELOR ELECTRONIC WATER LEVELER

The alternative choice of contractors over mechanical floats. Trouble-free, easy to install and no moving parts. Levelor is a computer-controlled device that automatically detects and replaces a low water condition to a pre-set level. Works well on new and existing pools and spas and also where a consistent liquid level is desired like aquariums, ponds, reservoirs, storage tanks, water cooling towers, etc.

#K1100CKA Levelor Controller (110V) \$937.87

C. WARRICK AUTOMATIC

WATER LEVEL CONTROL

To prevent vacuum filter overflow or to automate your city water make up to the swimming pool. This solid state control is more reliable as well as less expensive, compared to electromechanical units. Electrode fittings are available with either 2" pipe thread or 2" standard pipe flange. Electrodes are type 303 stainless steel.



- #16ML1A1 Warrick solid state level controller \$665.88
- #16ML1A0 Controller relay replacementless housing \$516.95
- #3E2B Electrode fitting threaded for two electrodes \$564.87
- #3E3B Electrode fitting threaded for three electrodes \$727.49
- #3F2E Electrode fitting flanged for two electrodes \$772.00
- #3F3E Electrode fitting flanged for three electrodes \$926.05
- #3R1C0 Electrode rod 1 ft. length. \$46.04/ft.

NOTE: The third character in item no. indicates rod length.

Please designate length when ordering and contact us for pricing.

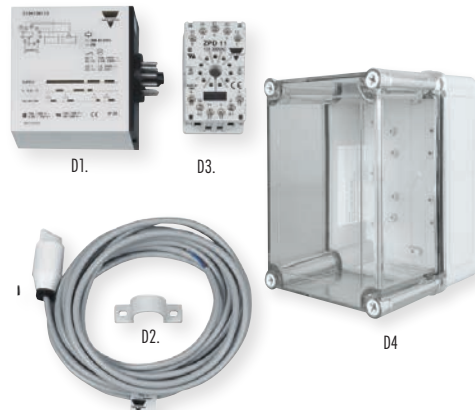

D. CARLO GAVAZZI LEVEL SENSOR AMPLIFIER, CONDUCTIVE TYPE

Level control relay for conductive liquids for swimming pool applications. The relay operates approximately 10 seconds after the sensor is no longer immersed in the water. A complete system consists of all components listed below

- D1. #5194-156-115 Amplifier \$357.32
- D2. #A94-10 Sensor \$190.64
- D3. #ZPD11 11-Pole Socket \$21.44
- D4. #VM755CT Enclosure for Gavazzi Controller \$140.76
- D5. #CLD1EA1CM24 Amplifier (New style, not pictured) \$346.03

SWITCHES & VALVES



E. MCDONNELL MILLER FLOW SWITCH

The FS250 Series flow switch with a 5 year warranty offers an economical and positive way to start or stop almost anything electrically operated. Actuate a signal light, sound an alarm, start or stop a motor, use wherever it is important to know when flow or no-flow occurs.

#FS251 \$306.24

POOL SENTRY



AUTOMATIC POOL WATER LEVEL MONITOR

Pool Sentry takes the worry out of maintaining a constant water level. As any responsible pool owner knows pools lose water for a variety of reasons. Evaporation from the sun and wind, loss from playful splashing, the water gets carried out with emerging swimmers, and even minor leaks in the pool itself. The Pool Sentry works to keep water levels stable around the clock.

Works with above ground or in-ground pools!

#M-3000 Pool Sentry. \$104.94

GAUGES & ACCESSORIES

G. EQUIPMENT GAUGES

Pressure • Vacuum • Compound 1/4" NPT, bottom mount.

2" Diameter, polypropylene case

- #1354 Vacuum 0-30 Hg \$11.40
- #1354-30 Pressure 0-30 p.s.i. \$10.20
- #1354-60 Pressure 0-60 p.s.i. \$10.20
- #1354-60B Pressure 0-60 p.s.i. \$10.20
- 1/4" Backmount Connection \$10.20

2" Diameter, steel case

- #1355-30 Pressure 0-30 p.s.i. \$10.55
- #1355-60 Pressure 0-60 p.s.i. \$10.55
- #1355-60B Pressure 0-60 p.s.i. \$10.55
- 1/4" Backmount Connection \$10.55

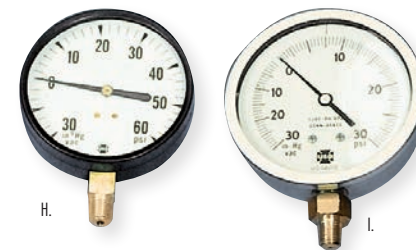

H. 3 1/2" diameter - steel case

- #1356-30 Pressure 0-30 p.s.i. \$29.82
- #1356-60 Pressure 0-60 p.s.i. \$29.82
- #1356-100 Pressure 0-100 p.s.i. \$29.82
- #1357 Vacuum 0-30 Hg \$29.82
- #1358 Compound 30 Hg-0-60 p.s.i. \$29.82

I. Liquid filled gauges 4" diameter - stainless steel case

- #1364 Vacuum 0-30 Hg \$86.94
- #1365 Compound 30 Hg-0-60 p.s.i. \$86.94
- #1366-30 Pressure 0-30 p.s.i. \$84.53
- #1366-60 Pressure 0-60 p.s.i. \$84.53
- #1366-100 Pressure 0-100 p.s.i. \$84.53

Liquid filled gauges 2.5" diameter - stainless steel case 1/4" NPT

- #9767053 60 p.s.i. \$27.06
- #9767002 30" vacuum \$30.84
- #9767029 Compound 30" 0-60 p.s.i. \$31.98



Accessories

- J. Pressure snubber to protect gauges from pulsation and shock. 1/4" NPT x 1/4" FPT brass construction. #1367 \$21.84
- K. Tee handle gauge cock. 1/4" NPT x 1/4" FPT brass construction. #1362 \$19.07

833-SWIM-327
833-7946-327
www.halogensupply.com

BASKET STRAINERS

FLUIDROL SW SERIES STAINLESS STEEL STRAINERS
Welded from schedule 10 type 304 stainless steel with perforated stainless steel baskets, stainless steel tee handles to secure the clear acrylic lid and loose flange rings to help ease installation.



| Complete Strainer w/Basket | | | Replacement Baskets | | |
|----------------------------|-----------|------------|---------------------|-----------|------------|
| Cat. No. | Pipe Size | Price | Cat. No. | Pipe Size | Price |
| 1440 | 3" | \$3,174.94 | 1448 | 3" | \$613.62 |
| 1441 | 4" | \$3,415.13 | 1449 | 4" | \$637.00 |
| 1442 | 6" | \$4,891.69 | 1450 | 6" | \$812.07 |
| 1443 | 8" | \$6,177.94 | 1451 | 8" | \$940.36 |
| 1444 | 10" | \$7,380.19 | 1452 | 10" | \$1,167.88 |
| 1445 | 12" | \$8,926.31 | 1453 | 12" | \$1,416.08 |

TITAN CAST IRON IN-LINE BASKET STRAINERS

Heavy duty hair and lint strainers for use on commercial pool filtration systems. Heavy cast iron, quick opening cover, and stainless steel basket with 1/8" perforations designed for minimum pressure drop. 125 lb. flanged connections only. Prices are F.O.B. Chicago, IL.



| Strainers | | | | Replacement Baskets | | | |
|-----------|-----------|-----------------|------------|---------------------|-----------|-----------------|------------|
| Cat. No. | Line Size | Shipping Weight | Price | Cat. No. | Line Size | Shipping Weight | Price |
| 1301 | 2" | 27 lbs. | \$403.87 | 1314 | 2" | 18 lbs. | \$130.20 |
| 1302 | 2 1/2" | 51 lbs. | \$415.37 | 1315 | 2 1/2" | 20 lbs. | \$206.85 |
| 1303 | 3" | 58 lbs. | \$460.79 | 1316 | 3" | 22 lbs. | \$264.60 |
| 1304 | 4" | 88 lbs. | \$643.65 | 1317 | 4" | 24 lbs. | \$336.00 |
| 1305 | 5" | 174 lbs. | \$865.87 | 1318 | 5" | 26 lbs. | \$447.30 |
| 1306 | 6" | 195 lbs. | \$1,197.68 | 1319 | 6" | 28 lbs. | \$556.50 |
| 1307 | 8" | 215 lbs. | \$1,831.03 | 1320 | 8" | 30 lbs. | \$926.10 |
| 1308 | 10" | 425 lbs. | \$3,363.55 | 1321 | 10" | 32 lbs. | \$1,330.35 |
| 1309 | 12" | 650 lbs. | \$5,669.30 | 1322 | 12" | 34 lbs. | \$1,743.00 |

BASKET STRAINERS

FRP "T" STYLE BASKET STRAINERS

by Mermade
Engineered For Commercial Systems
Strainer Housings are fiberglass reinforced plastic construction. FRP and stainless steel components assure that wetted parts will not rust. Features include: quick opening latches, see thru lid, and a stainless steel basket. Flanged connections are drilled to ANSI 150 lb. standard. Strainers are pressure tested to 50 PSI.



| FRP Strainers | | | | S.S. Replacement Baskets | | |
|---------------|-----------|-----------------|------------|--------------------------|-----------|------------|
| Cat. No. | Line Size | Shipping Weight | Price | Cat. No. | Line Size | Price |
| 1340 | 3" | 32 | \$2,474.50 | 1346 | 3" | \$574.00 |
| 1341 | 4" | 34 | \$2,474.50 | 1347 | 4" | \$574.00 |
| 1342 | 6" | 44 | \$3,223.50 | 1348 | 6" | \$722.75 |
| 1343 | 8" | 70 | \$4,070.50 | 1349 | 8" | \$901.25 |
| 1344 | 10" | 98 | \$5,181.75 | 1350 | 10" | \$1,221.50 |
| 1345 | 12" | 115 | \$6,552.00 | 1351 | 12" | \$1,487.50 |

Also Available As A Reducing Strainer

The outlet size can be sized smaller than the inlet to allow direct reduction to pump suction connection.

Call Toll Free For Pricing

SERVICE CLAMPS

SERVICE CLAMPS Provide quick and easy installation of flow meters, sensors and chlorinator injection fittings. Please specify tap size required: 1/2", 3/4", 1", 1 1/4", 1 1/2" or 2".



| PVC CLAMPS | | | |
|------------|-----------|----------|----------|
| Cat. No. | Line Size | Material | Price |
| 671 | 2" | PVC | \$49.46 |
| 673 | 2 1/2" | PVC | \$67.57 |
| 675 | 3" | PVC | \$67.57 |
| 677 | 4" | PVC | \$85.12 |
| 681 | 6" | PVC | \$141.87 |
| 683 | 8" | PVC | \$300.28 |
| 685 | 10" | PVC | \$437.34 |

All PVC clamps come with zinc plated hardware and EPDM seals

THERMOMETERS & SIGHT GLASSES

A. INDUSTRIAL THERMOMETER

9" adjustable angle industrial thermometer. 0°-160° range with 4" bottom stem for installation in 3/4" NPT separable brass well.

#SX93575 Thermometer only \$129.05

#W35B Brass well only \$32.76

Other scale ranges available upon request.



B. POOL HEATER THERMOMETER

#1416 Pool heater thermometer, 1/2" N.P.T. Bottom connection.

Range 40°F to 280°F \$32.03

#1416-1 Same as 1416, but with lower back connection. (Not shown) \$38.75



C. LETRO THERMOMETER

Reads 30°F to 130°F and 0°C to 55°C.

Easy read 3" dial. 1/2" N.P.T. Nylon well.

#SL-1DW Thermometer with well \$85.43

#SWN Well only \$27.93



D. SIGHT GLASSES

Constructed of non-breakable clear plastic with brass bodies and deflecting vane to force water through sight chamber.

#A41198-0 1 1/2" M.I.P. \$269.24



E. IN-LINE SIGHT GLASSES

With ABS plastic bodies.

#SP1072S 1 1/2" SKT \$44.79

#SP1074S 2" SKT \$45.76



BASKET STRAINERS PUMP CONNECTORS THERMOMETERS SIGHT GLASSES & SERVICE CLAMPS

PUMP CONNECTORS



RUBBER EXPANSION JOINTS/REDUCERS

Constructed of neoprene and a high strength synthetic fabric to reinforce the body. These connectors reduce the force exerted on pipe lines and equipment, as well as control pulsation shocks and noise transmission. These joints can be used to connect pipes of the same size, as a concentric reducer for pipes of varying size that share a common centerline or eccentric reducers for pipes of unequal sizes with offset axes.

| Expansion Joints | | | | Concentric Reducers | | | |
|------------------|-----------|-----------------|--------|---------------------|-----------|-----------------|--------|
| Cat. No. | Line Size | Shipping Weight | Price | Cat. No. | Line Size | Shipping Weight | Price |
| 1425 | 3" | 14 lbs. | P.O.A. | 1431 | 4" x 3" | 18 lbs. | P.O.A. |
| 1426 | 4" | 18 lbs. | P.O.A. | 1432 | 6" x 3" | 19 lbs. | P.O.A. |
| 1427 | 6" | 28 lbs. | P.O.A. | 1433 | 6" x 4" | 20 lbs. | P.O.A. |
| 1428 | 8" | 40 lbs. | P.O.A. | 1435 | 8" x 6" | 33 lbs. | P.O.A. |
| 1429 | 10" | 68 lbs. | P.O.A. | | | | |
| 1430 | 12" | 94 lbs. | P.O.A. | | | | |

Prices for eccentric reducers and sizes not listed available upon request. Prices are F.O.B. Chicago, IL

833-SWIM-327
833-7946-327
www.halogensupply.com

CHEMICAL FEEDERS

* PULSAR SYSTEMS

With the Pulsar® System chlorinator remarkable water clarity color and sparkle are as easy to achieve as they are to enjoy. The Pulsar System reduces the hazards of chlorine gas and liquid bleach, protects plaster and equipment and reduces chloramine odors dramatically. The Pulsar feeder chlorinates, removes organics and metals, boosts hardness and shock treats, all in one simple process. Pool water that's balanced using the Pulsar System is clean and clear with less hassle, leading to longer pool and equipment life.



High-Tech Commercial Pool Disinfection with Powerful Performance

A. PULSAR PRECISION

The Pulsar® Precision feeder is a high capacity erosion (HCE) feeder that is compact and lightweight with a modular design. This innovative feeder system is easy to maintain and service with a flexible design that allows for easy integration for small to large commercial pools.



- Won't overstabilize pool
- More concentrated than liquid bleach
- Dry, easy to handle formulation
- Will not cause reduction of ORP
- Highly concentrated to reduce shipping & handling costs
- Longer shelf life compared to liquid bleach

#73250 Pulsar Precision Feeder Complete P.O.A.

#73280 Pulsar Precision Feeder Only P.O.A.

Feeder Specifications

| | | |
|-----------------------|---|---|
| Width | 25.3" | 642.62mm |
| Depth | 29.8" | 756.92mm |
| Height | 40.9" | 1038.89mm |
| Water Inlet Size | 1/2" MNPT | 12mm MNPT |
| Solution Outlet Size | 1/2" MNPT | 12mm MNPT |
| Operating Weight | 220lbs | 99.7kg |
| Shipping Weight | 60lbs | 27.7kg |
| Dry Chemical Capacity | 70lbs | 31.75kg |
| Feed Rate Range | 5-192lbs/day AvCl 0.2-8lbs/hour AvCl | 2.3-87.3kg/day AvCl 0.09-3.6kg/hour AvCl |
| Electrical | 115VAC | |
| Operating Temperature | 40°- 120° F | 4.4°- 48.9° C |



High-Tech Commercial Pool Disinfection with Powerful Performance

B. PULSAR PRECISION 30

The Pulsar® Precision 30 feeder is a high capacity erosion (HCE) feeder that is compact and lightweight with a modular design. The feeder uses Pulsar® Plus Briquettes that produces a fresh concentrated liquid chlorine solution for clean & sanitized water. This innovative feeder system is easy to maintain and service with a flexible design that allows for easy integration for small to medium size commercial pools.



- Won't overstabilize pool
- More concentrated than liquid bleach
- Dry, easy to handle formulation
- Will not cause reduction of ORP
- Highly concentrated to reduce shipping and handling costs
- Longer shelf life compared to liquid bleach

#73371 Pulsar Precision 30 Feeder Complete P.O.A.

#73379 Pulsar Precision 30 Feeder Only P.O.A.

Feeder Specifications

| | | |
|-----------------------|-------------|-------------|
| Width | 15.5" | 393.7 mm |
| Depth | 19.5" | 495.3 mm |
| Height | 34.0" | 863.6 mm |
| Water Inlet Size | 1/2" MNPT | 12 mm MNPT |
| Solution Outlet Size | 1/2" MNPT | 12 mm MNPT |
| Operating Weight | 52 lbs | 23.6 kg |
| Shipping Weight | 20 lb s | 9.1 kg |
| Dry Chemical Capacity | 30 lbs | 13.6 kg |
| Electrical | | None |
| Operating Temperature | 40°- 120° F | 4.4°- 49° C |

SEE PAGE 70 FOR PULSAR BRIQUETTES AND PAGE 58 FOR PULSAR FEEDER PARTS

* NOTE: ILLINOIS, NORTHERN INDIANA AND WESTERN MICHIGAN CUSTOMERS ONLY.

STENNER CHEMICAL FEEDERS



D. Stenner Peristaltic Chemical Feeders are made of tough high strength polycarbonate plastic that is resistant to the most corrosive chemicals. Patented mechanical control allows precise controlled output and is self-priming. Comes complete with spare tube assembly, injection fitting and 20 feet of 3/8" tubing (1/4" tubing and fittings available upon request). Stenner maintains ETL (conforms to NSF STD-50), UL and CSA listing. Other models available upon request.

SINGLE HEAD-ADJUSTABLE FEED RATE

Model 45MJL5A3S50 gpd @ 25 psi \$732.08

Model 85MJL5A3S 85 gpd @ 25 psi \$732.08

SINGLE HEAD-FIXED RATE

Model 45MFL5A3S 50 gpd @ 25 psi \$537.58

Model 85MFL5A3S 85 gpd @ 25 \$537.58

HIGH PRESSURE PERISTALTIC PUMPS

Reliable operation against pressures up to 100 psi.

SINGLE HEAD-ADJUSTABLE FEED RATE

Model 45MJH7A3S 22 gpd @ 100 psi \$758.73

Model 85MJH7A3S 40 gpd @ 100 psi \$758.73

SINGLE HEAD-FIXED RATE

Model 45MFH7A3S 22 gpd @ 100 psi \$564.48

Model 85MFH7A3S 40 gpd @ 100 psi \$564.48

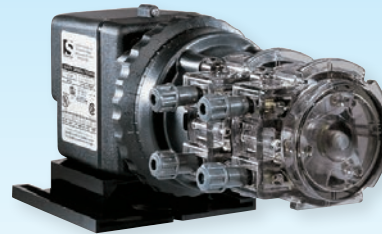

E. DOUBLE HEAD-ADJUSTABLE FEED RATE

Model 100JL5A3S

100 gpd @ 25 psi dual head \$1,038.47

Model 170JL5A3S

170 gpd @ 25 psi dual head \$1,038.47

DOUBLE HEAD-FIXED FEED RATE

Model 100FL5A3S

100 gpd @ 25 psi dual head \$752.64

Model 170FL5A3S

170 gpd @ 25 psi dual head \$752.64

See page 58 for Stenner parts

STENNER TANK SYSTEMS



F. PUMP AND TANK SYSTEM IN ONE!

- Increase savings and convenience pre-assembled for easy start-up.
- Rugged polyethylene construction for indoor or outdoor applications.
- Compact and light-weight design to minimize space requirements.
- Attractive styling for convenient access and placement.
- Includes rainroof.
- Available as tank only.
- Dimensions:
15 gallon: 25 1/4" H x 20 1/2" OD
30 gallon: 37 1/2" H x 20 1/2" OD

Model S1N45MJL1A3S

3 gpd @ 25 psi w/15 gallon tank \$1,024.65

Model S1N85MJL1A3S

5 gpd @ 25 psi w/15 gallon tank \$1,024.65

Model S1N45MJL2A3S

10 gpd @ 25 psi w/15 gallon tank \$1,072.66

Model S3N85MJL2A3S

17 gpd @ 25 psi w/30 gallon tank \$1,072.66

Model S3N45MJL3A3S

22 gpd @ 25 psi w/30 gallon tank \$1,072.66

Other models available upon request.

TANKS ONLY

Model STS15NC 15 gallon. \$299.25

Model STS30NC 30 gallon \$458.56

833-SWIM-327
8 3 3 • 7 9 4 6 • 3 2 7
www.halogenupply.com

BLUE/WHITE FLEXFLO PERISTALTIC METERING PUMPS



FEATURES:

- Peristaltic pump design does not have valves that can clog requiring maintenance.
- Self priming even against maximum line pressure. Bypass valves not required. Cannot vapor lock or lose prime.
- Outputs pressures to 100 psi. • Base or rear panel mount.

MODEL A-100NA FIXED SPEED - DIAL KNOB CONTROL

- Easy to use dial knob output control. • 20:1 turndown ratio.
- Adjustable 60 second repeating interval timer. 3-60 second adjustable on time per 60 second cycle. • Built-in Tube Failure Detection system (TFD). Senses chemical in the pump head, shuts off the pump and activates an NPN open collector output.
- Compatible with Blue/White's output flow verification sensor system.

| Model No. | Output GPD | PSI | RPM's | Pump Tube | Price |
|-------------|------------|-----|-------|-----------|----------|
| ATN00A-4T-1 | 2.3 | 100 | 14 | 1/4" | \$775.96 |
| ATN10A-6T-1 | 16 | 100 | 30 | 3/8" | \$775.96 |
| ATN30A-6T-1 | 30 | 75 | 60 | 3/8" | \$775.96 |
| ATN10A-7T-1 | 52.5 | 50 | 30 | 7/16" | \$775.96 |
| ATN30A-7T-1 | 95.1 | 50 | 60 | 7/16" | \$775.96 |

NEW

BLUE/WHITE PRO SERIES FLEXFLO ATA PERISTALTIC METERING PUMP



Specially designed for pools, Spas and Water Parks.

Feed rates from .01 to 100 GPD
Pressures to 40 PSI
Tube Failure Detection (TFD) system
Variable speed brushless DC motor
3-year warranty

- Peristaltic pump design does not have valves that can clog requiring maintenance.
- Self priming - even against maximum line pressure. Bypass valves are not required. Cannot vapor lock or lose prime.
- Outputs rates from .01 to 100 GPD (.01 to 15.8 LPH) and pressures up to 40 PSI (2.76 Bar).
- Energy efficient variable speed DC motor. to save money over VS. the competition
- Patented Tube Failure Detection (TFD) system. Senses tube failure by detecting chemical in the pump head, shuts off the pump and activates a 48VDC @80mA relay, No false triggering.
- Remote Start/Stop: Non-powered dry contact for remote start/stop.
- Three Nylon molded squeeze rollers for optimum squeeze, unparallel accuracy, and long tube life.
- Heavy duty rotor - single piece plastic rotor means no flexing and increased accuracy with no metal springs or hinges to corrode.
- Chemically resistant tubing capable of pumping . . . bleach (sodium hypochlorite), calcium hypochlorite 20%, and muriatic acid (hydrochloric acid).

| Model. | Voltage* | Price |
|---------|----------|----------|
| ATA4-7T | 115 VAC | \$900.90 |

CHLORINE & BROMINE EROSION FEEDERS

HAYWARD SMALL RESIDENTIAL CHLORINATOR

Easy-Lok Assembly has thread assist mechanism to provide dependable sealing. Chlorine Chamber has extra large capacity CL-100 series holds 4.2 Lbs of Tri-Chlor tabs, CL-200 series holds 9 lbs. Dual Regulating Valve is easy to use and lets you control and adjust rate of feed.

- #CL100 In-Line 4.2 lb. capacity \$120.88
- #CL200 In-Line 9 lb. capacity \$155.23
- #CL110 Off-Line 4.2 lb. capacity \$136.37
- #CL220 Off-Line 9 lb. capacity \$199.56



RAINBOW IN-LINE FEEDER

Model 320 works the same way as Model 300 but is an in-line feeder. Comes complete for 2" standard PVC with pipe adapter for 1 1/2" pipe. Holds approximately 11-3" tablets or 98 small tablets. NSF listed. Treats 6,500 to 70,000 gallons

- #R171096 \$176.36



RAINBOW HIGH CAPACITY CHLORINE/BROMINE FEEDERS

These professional high capacity feeders are designed to sanitize large residential or commercial swimming pools using either Chlorine or Bromine tablets or sticks. For off-line 1" hard plumbing installations.



- #R171215—Model HC3315
15 lb. capacity. Can treat up to 97,600 gals. with Chlorine (Tri-Chlor) and 20,200 gals with Bromine \$396.40
- #R171230—Model HC3330—30 lb. capacity.
Can treat up to 160,000 gals. with Chlorine (Tri-Chlor) and 40,900 gals with Bromine \$434.15
- #R171240—Model HC3340—40 lb. capacity can
treat up to 332,000 gals. with Chlorine (Tri-Chlor)
and 61,600 with Bromine \$454.84

See page 58 for Erosion Feeder parts

PENTAIR RAINBOW FEEDER

Model 300 works on pressure side of pump where chlorine is discharged in return line down-stream from equipment. For use with Bromine or Trichlor slow dissolving tablets. Comes complete with easy to adjust control valve and check valve. Holds approximately 11-3" tablets or 98 small tablets. NSF listed.



- #R171070 Treats 80,000 to 322,000 gallons \$261.89
 - #R171016 Treats 12,000 to 48,000 gallons \$159.35
- Holds approximately 237-1" tablets or 29-3" tabs lets. NSF listed. (Not shown).*



STORAGE TANKS

POLYETHYLENE TANKS

Used for storage of liquid or granular chlorine, soda ash or sodium bisulfate solutions.

- #8613 30 gal. - tank only \$390.03
 - #8614 55 gal. - tank only \$453.51
 - #8625 Cover only for 55 or 30 gal. tank \$151.63
 - #113 100 gallon polyethylene tank with cover. \$1,055.16
- F.O.B Factory

Note: Other tank sizes available upon request.

CHEMICAL FEEDERS

ELECTRONIC METERING PUMPS



ELECTRONIC PUMPS By Pulsatron

The Pulsatron chemical feed pump comes complete with Teflon faced reinforced diaphragms, dual control versatility, safety circuit protection and water resistant cover. Comes complete with all necessary valves and tubing including Pulsatron's exclusive 5-function anti-syphon valve.

- #LPA3SAPTC1-500 12 gpd/100 psi \$1,106.70
- #LPB4SAPTC1-500 24 gpd/100 psi \$1,214.85
- #LPE4SAPTC3-500 44 gpd/100 psi \$1,451.10
- #LPH6SAPTC3-500 120 gpd/100 psi \$1,942.50

See page 59 for Pulsatron parts

833-SWIM-327
8 3 3 • 7 9 4 6 • 3 2 7
www.halogenupply.com

AUTOMATIC CHEMICAL CONTROLLERS AND REPLACEMENT PROBES & OZONE GENERATORS

AQUASOL CONTROLLERS

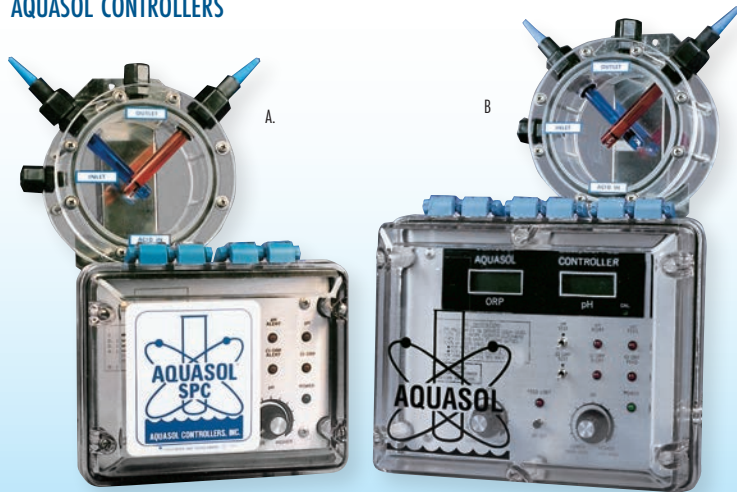

A. THE AQUASOL LINE OF WATER CONTROLLERS automatically maintains both the chlorine/bromine residual (using ORP technology) and pH in your pool or spa, continuously providing sanitary, clear water while eliminating tedious, manual water testing and treatment. Aquasol eliminates the problems associated with water chemistry control. By paying for themselves through chemical savings and reduced labor costs, the Aquasol controllers are an essential item to the operating budget of any commercial pool/spa operator.

Advantages and Features:

- Saves on chemicals – up to 40%
- Saves on labor of testing and correcting
- Eliminates odor and eye burn complaints
- Functional lifetime warranty on the circuit board
- Indicator lights show feed and alert status
- Overfeed safety timer
- **Most importantly, Aquasols are serviceable by your staff saving you hundreds, even thousands of dollars in service fees charged by other controller companies. Available in three models.**

- B. #WTC Model WTC – Features digital meters for both ORP and pH display \$2,768.89
 #M011-HP Safety Pressure Switch—Is recommended to interlock controller with system flow (not shown) \$220.14

Controller Probes and Parts See Page 60

833-SWIM-327
 833 • 7946 • 327
www.halogensupply.com

HALOGEN CONTROLLERS



Benefits include:

- Ease of Use
- Total System Control
- Mobile Connectivity
- Training Built In
- Alarm Logging and Trend Reports
- Maximize Resource Savings - Minimize Operating Costs



All-Encompassing Control of Regenerative Systems: It's More Than a Filter, It's a Science.
HALO Gen.RTS (Regenerative Total System)
HALO Gen.CS (Custom System)

Ease of Use

- Large 15 1/2" color touch screen with sound, graphics and video
- Intuitive user interface and experience
- Graphically displayed system status shown on one screen
- Flexibility with auto or manual modes
- User-friendly set-point entry
- Accessible from tablets, mobile devices and PCs

Total System Control

- Filter cycle control
- Flow control with VFD
- Chemical control
- Temperature control
- Level control with automatic fresh water makeup
- Cleaning modes
- All safety interlocks
- Customized solutions tailored to your facility
- HALO Gen.RTS (Regenerative Filter System) and HALO Gen.CS (Custom System)**

Training Built In

- Training videos with audio for all procedures
- Imbedded manuals and data sheets specific to system design

Alarm Logging and Trend Reports

- Real-time trending reports for all control loops
- Trending histories stored
- Easy-to read graphical displays of real-time trends and histories
- Audible alarms to alert staff
- Alarm emails immediately sent to staff

Maximize Resource Savings - Minimize Operating Costs

- Complete integration of all system controls maximizes resources and ease of use
- System component synergy contributes to the longevity, performance and efficiency of a pool system.

Price on Request

CLEARWATER TECH OZONE GENERATORS

Ozone is a powerful oxidizer. It has been used in waste water treatment, aquariums and large volume water stores, as well as swimming pool and spa applications. Since 1986 ClearWater Tech (CWT) has designed, engineered, and manufactured ozone generation equipment for many applications such as bottled water, potable water, commercial laundry, and pool and spa systems. CWT's ozone systems provide not only oxidation, but also sanitation, reducing chloramine production and provide **The Ultimate Swimming Experience!** Allow Halogen to help with your ozone water treatment needs.



Call For A Quotation

FLOAT VALVES

FLUIDROL MODULATING FLOAT VALVES

Designed to mount up to standard companion flanges. Valves have polypropylene disc, stainless steel shaft and float rods and polyethylene floats. Provides full flow when open and 80% shut-off when closed. Comes in five sizes and three styles for vertical or horizontal installation.



| Size | Horizontal | | Horizontal w/ Vertical Floats | |
|------|------------|------------|----------------------------------|------------|
| | Cat. No. | Price | Cat. No. | Price |
| 4" | 1252 | \$1,603.86 | 1257 | \$2,798.48 |
| 6" | 1253 | \$1,758.52 | 1258 | \$2,998.07 |
| 8" | 1254 | \$2,154.36 | 1259 | \$3,338.49 |
| 10" | 1255 | \$2,609.65 | 1260 | \$3,502.70 |
| 12" | 1256 | \$2,970.89 | 1261 | \$3,947.23 |

F.O.B. Huntsville,AL

PVC VAN STONE PIPE FLANGES



| Cat. No. | Pipe Size | Price |
|----------|-----------|----------|
| PF2 | 2" | \$12.06 |
| PF2.5 | 2-1/2" | \$18.63 |
| PF3 | 3" | \$20.58 |
| PF4 | 4" | \$26.03 |
| PF6 | 6" | \$40.96 |
| PF8 | 8" | \$66.70 |
| PF10 | 10" | \$124.27 |
| PF12 | 12" | \$133.98 |

VALVE BOLT KITS

| Cat. No. | Size | Price | Cat. No. | Size | Price |
|-----------|----------|---------|----------|------|----------|
| BBK2WW | 2" | \$22.23 | BBK8WW | 8" | \$79.71 |
| BBK2½/3WW | 2½" & 3" | \$22.17 | BBK10WW | 10" | \$174.35 |
| BBK4WW | 4" | \$41.40 | BBK12WW | 12" | \$205.18 |
| BBK6WW | 6" | \$61.24 | | | |

FLANGE GASKETS

| Cat. No. | Size | Price | Cat. No. | Size | Price |
|----------|------|---------|----------|------|---------|
| GSK2R | 2" | \$11.76 | GSK6R | 6" | \$18.31 |
| GSK2½R | 2½" | \$14.46 | GSK8R | 8" | \$26.57 |
| GSK3R | 3" | \$17.99 | GSK10R | 10" | \$33.50 |
| GSK4R | 4" | \$17.53 | GSK12R | 12" | \$56.45 |

CHECK VALVES

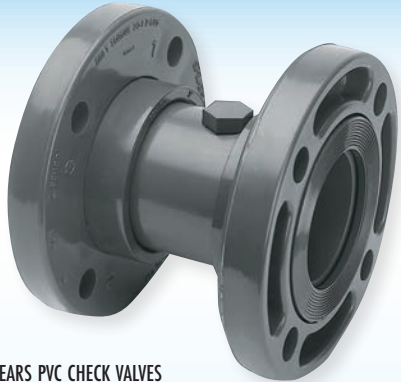

A. SPEARS PVC CHECK VALVES

Unique resilient seal provides an airtight shut off and prolonged life compared to metal seated valves. Large free area resulting in low pressure loss. Flanged and wafer styles for 2" to 12" line sizes.

| Flanged | | | Wafer | | |
|---------|----------|-------------|--------|----------|-------------|
| Size | Cat. No. | Price | Size | Cat. No. | Price |
| 2" | 1280 | \$992.67 | 2" | 1272 | \$778.24 |
| 2 1/2" | 1281 | \$1,292.03 | 2 1/2" | 1273 | \$1,072.51 |
| 3" | 1290 | \$1,855.76 | 3" | 1274 | \$1,371.87 |
| 4" | 1291 | \$2,409.49 | 4" | 1275 | \$1,865.71 |
| 6" | 1292 | \$3,906.06 | 6" | 1276 | \$2,828.53 |
| 8" | 1293 | \$5,597.13 | 8" | 1277 | \$4,798.97 |
| 10" | 1299 | \$10,306.37 | 10" | 1278 | \$8,824.03 |
| 12" | 1300 | \$14,601.48 | 12" | 1279 | \$12,441.79 |



B. TITAN SILENT CHECK VALVES

Bronze to bronze seating with special stainless steel spring control to insure positive, noiseless opening and closing. These valves are applicable to all water systems, work in any position and are designed with larger-than-pipe-size flow area for low pressure loss and maximum efficiency.

| Cat. No. | Size | Shipping Weight | Price |
|----------|------|-----------------|------------|
| 1285 | 3" | 11 lbs. | \$348.77 |
| 1286 | 4" | 18 lbs. | \$550.40 |
| 1287 | 6" | 29 lbs. | \$1,196.47 |
| 1288 | 8" | 86 lbs. | \$2,554.00 |
| 1289 | 10" | 129 lbs. | \$4,417.73 |

Pricing for valve sizes not shown available upon request.
Prices are F.O.B. Chicago, IL

BUTTERFLY VALVES



C. CAST IRON BUTTERFLY VALVES by Bray

Bray series 30-119 is a wafer style with polyester coated cast iron body, nylon II coated ductile iron disc, 416SS stem, EPDM seat and 10-position lever handle operator. Stainless steel disc available. Call for quotation.

| Cat. No. | Size | Price | Cat. No. | Size | Price |
|----------|--------|----------|----------|------|----------|
| 1390 | 2" | \$186.48 | 1395 | 6" | \$439.32 |
| 1391 | 2 1/2" | \$199.08 | 1396 | 8" | \$623.28 |
| 1392 | 3" | \$219.24 | 1397 | 10" | \$833.28 |
| 1393 | 4" | \$266.28 | | | |

F.O.B. Chicago



D. PVC BUTTERFLY VALVES

Features PVC body and disc for better chemical and abrasion resistance, lever operator and EPDM seal for bubble tight shut-off.

Flange gaskets not required.

| Cat. No. | Size | Price | Cat. No. | Size | Price |
|----------|------|----------|----------|------|----------|
| 1226 | 2" | \$175.54 | 1230 | 6" | \$337.90 |
| 1227 | 3" | \$177.23 | 1231 | 8" | \$492.89 |
| 1228 | 4" | \$201.97 | | | |

F.O.B. Chicago

E. MODULATING FLOAT CONTROL VALVE by Clayton

The Float Control acts to maintain a constant level in the filter or surge tank, automatically, by causing the main valve to open or close in proportion to the volume of water being withdrawn.

| | |
|---------------------------------------|------------|
| #1418 1/2" SS and Bronze construction | \$1,866.85 |
| #BFVNL 3/4" Brass float valve | \$38.06 |
| #BFVFP8 8" Float | \$38.06 |
| #BFVR12 12" Rod | \$5.41 |



SOLENOID VALVES

F. GRANZOW SOLENOID VALVES

An economical solenoid valve alternative for air and water applications. 2-way, internally piloted, normally closed solenoid valve. Brass body, stainless steel armature, plunger spring and fixed core. Nema 4 electrical connection rating. Available in standard and slow close models. Slow closed models have manual flow control and bypass knob. All valves are 115 Vac normally closed, 230 and 24 volt models available upon request.



| Size | Standard No. | Price | Slow Closing No. | Cat. Price |
|--------|--------------|------------|------------------|------------|
| 1/2" | W4B19-000 | \$278.63 | W5B19-000-02 | \$471.73 |
| 3/4" | W5B19-000 | \$415.45 | W6B19-000-02 | \$509.63 |
| 1" | W6B19-000 | \$452.95 | W7B19-000-02 | \$921.38 |
| 1-1/4" | W7B19-000 | \$865.13 | W8B19-000-02 | \$970.13 |
| 1-1/2" | W8B19-000 | \$913.45 | W9B19-000-02 | \$1,294.13 |
| 2" | W9B19-000 | \$1,237.88 | | |

G. PVC SOLENOID VALVES

TFV series solenoid valves are made from glass reinforced nylon with natural rubber diaphragm. Quarter turn bleed lever allows manual operation without spills. Exact water flow adjustment with flow control units. In-line maintenance - no need to remove from line. Available with 24 or 110 volt solenoid



| Size | Voltage | Flow Control | Cat. No. | Price |
|--------|---------|--------------|--------------|----------|
| 1" | 24 | No | TFV100T | \$107.01 |
| 1" | 110 | No | TFV100T110V | \$115.21 |
| 1" | 24 | Yes | TFV100TF | \$117.87 |
| 1" | 110 | Yes | TFV100TF110 | \$126.06 |
| 1-1/2" | 24 | Yes | TFV150TF | \$211.14 |
| 1-1/2" | 110 | No | TFV150TF110V | \$219.10 |
| 2" | 24 | Yes | TFV200TF | \$274.16 |
| 2" | 110 | No | TFV200TF110V | \$282.04 |

H. ELECTRIC SOLENOID VALVES

Normally closed, Nema-1 Enclosure by ASCO

Locate on chlorine booster pump discharge line for true safety. When main recirculation pump shuts down no water will be allowed to the chlorine ejector. Operate with chemical controller to automate erosion chemical feeders. Also used on fresh water make-up lines in conjunction with water level control.



| Size | Standard No. | Price | Slow Closing No. | Cat. Price |
|--------|--------------|------------|------------------|------------|
| 1/2" | 8210G002 | \$215.60 | 8221G003 | \$493.19 |
| 3/4" | 8210G095 | \$265.46 | 8221G005 | \$526.87 |
| 1" | 8210G004 | \$425.64 | 8221G007 | \$1,073.96 |
| 1-1/4" | 8210G008 | \$518.79 | 8221G009 | \$1,282.82 |
| 1-1/2" | 8210G022 | \$788.29 | 8221G011 | \$1,859.55 |
| 2" | 8210G100 | \$1,389.27 | 8221G013 | \$2,248.98 |

All valves are 1 phase, 115 volt. 230 and 24 volt units available upon request.

COMMERCIAL VALVES

MODULATING VALVES



Modulating butterfly valves can be used on vacuum filters, gutter lines and surge tank applications.

I. ROTARY ACTUATED BUTTERFLY VALVES by Bray

Bray Series 30 valve operated by their series 90 spring to close pneumatic rotary actuator complete with VRC pneumatic positioner, adjustable pressure regulating valve and pressure gauge. Please specify if valve is to be normally open or closed.

| Cat. No. | Size | Price | Cat. No. | Size | Price |
|----------|------|--------|----------|------|--------|
| 1483 | 3" | P.O.A. | 1486 | 8" | P.O.A. |
| 1484 | 4" | P.O.A. | 1487 | 10" | P.O.A. |
| 1485 | 6" | P.O.A. | 1488 | 12" | P.O.A. |

NOTE: If an electro-pneumatic positioner is required in lieu of pneumatic positioner add "-6A" to model numbers above.

Pricing Available Upon Request.

J. DIAPHRAGM OPERATED BUTTERFLY VALVES by Dezurik

Model 632 with diaphragm actuator will utilize water or air pressure to actuate the diaphragm operator and will provide bubble tight shutoff. Comes complete with cast iron body, lugged end style stainless steel disc, and shaft. Please specify normally open or normally closed.

Pricing Available Upon Request.

833-SWIM-327
833-7946-327
www.halogensupply.com

CHEMICAL FEEDER PARTS

PULSAR FEEDER PARTS

| | |
|---|------------|
| A. OLIN-79217 Discharge valve assembly complete | \$130.93 |
| B. OLIN-79804 Discharge valve, arm & float only | \$45.99 |
| C. OLIN-79218 Check valve for discharge valve | \$92.54 |
| C1. OLIN-79805 Discharge valve arm | \$31.19 |
| C2. OLIN-79806 Discharge valve body | \$28.60 |
| C3. OLIN-79810 Discharge valve float | \$25.49 |
| D. OLIN-71583 Discharge valve locknut | \$17.66 |
| E. OLIN-71538 PVC nut, discharge valve arm | \$5.72 |
| F. OLIN-71576 Discharge valve gasket | \$8.33 |
| G. OLIN-71496 Emergency shut-off valve complete | \$268.72 |
| H. OLIN-71535 Emergency shut-off valve w arm only | \$134.35 |
| I. OLIN-71536 Emergency shut-off valve mounting plate | \$14.29 |
| J. OLIN-71537 Emergency shut-off mounting screws for PI & PIII | \$20.00 |
| OLIN-71749 Emergency shut-off mounting screws for PIV | \$69.64 |
| K. OLIN-71539 Emergency shut-off float plate | \$10.40 |
| L. OLIN-71540 Emergency shut-off overflow float | \$22.86 |
| M. OLIN-71811 Venturi assembly for PIII & PIV | \$447.75 |
| OLIN-71974 Venturi assembly for PI | \$112.50 |
| N. OLIN-71894 24 volt solenoid valve for PIII & PIV | \$417.87 |
| OLIN-79664 Solenoid valve for models 45, 140 and 500 (not shown) | \$441.79 |
| O. OLIN-71923 24 volt transformer | \$79.52 |
| P. OLIN-72329 24 volt cable 15 feet | \$168.39 |
| Q. OLIN-79214 1 1/2 H.P. booster pump for PIII & PIV | \$1,810.80 |
| R. OLIN-79047 PIII spray manifold | \$169.38 |
| S. OLIN-71617 PIII spray nozzle | \$80.82 |
| T. OLIN-71605 In-line strainer for PIV | \$132.80 |
| OLIN-79812 In-line strainer for models 45, 140 and 500 (not shown) | \$15.17 |
| OLIN-71592 Strainer housing for PIV | \$101.61 |
| OLIN-71593 Strainer gasket for PIV | \$13.01 |
| U. OLIN-71928 Flow indicator PIV (Limited Quantities Available) | \$212.45 |
| V. OLIN-72864 Enhancement kit for PIII units w/o washdown feature | \$407.43 |
| W. OLIN-71621 1/2" MXM ball valve | \$75.62 |
| X. OLIN-71627 1/2" MXF ball valve | \$76.57 |
| Y. OLIN-71609 Briquette screen for PIII | \$363.06 |
| Z. OLIN-71881 Briquette screen for PIV | \$530.93 |
| AA. OLIN-77332 PI Deep Well Grid | \$6.50 |
| OLIN-79216 PI Cap Ring (not shown) | \$3.13 |
| BB. OLIN-71448 PI Flat Spike Grid | \$7.81 |
| CC. OLIN-77331 PI dissolving cup | \$90.18 |
| DD. OLIN-79652 Briquette Screen Model 140 (not shown) | \$92.09 |
| OLIN-79651 Briquette Screen Model 45 (not shown) | \$51.48 |
| OLIN-79643 Briquette Screen Model 500 (not shown) | \$219.31 |
| EE. OLIN-73062 Washdown Kit w/Nozzel P45/140/500 (not shown) | \$156.20 |
| FF. OLIN-79649 Washdown Manifold Model 140 (not shown) | \$121.52 |
| GG. OLIN-73057 Well Agitator Assembly (not shown) | \$19.76 |
| HH. OLIN-71888 Spray Nozzle for Model PIV and Washdown Nozzel for Model 500 (not shown) | \$94.86 |

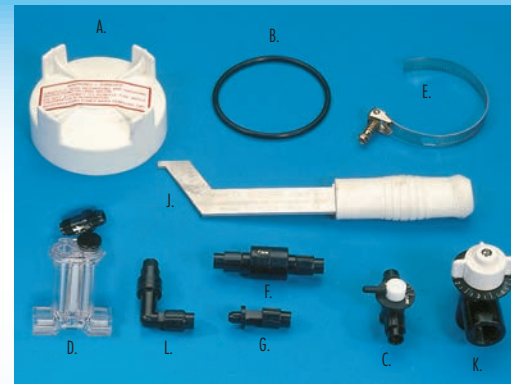

RAINBOW FEEDERS

| | |
|--|---------|
| A. R172008W 3" thread cap white | \$22.34 |
| B. R172009 Cap O-ring\$8.69 | |
| C. R172060 Control valve | \$30.53 |
| D. R172080 Flow indicator with check valve | \$39.67 |
| E. R172034 Saddle clamp | \$7.36 |
| F. R172323 1/4" check valve | \$23.06 |
| G. R172032 Tube fitting with compression nut | \$7.36 |
| R172274 Compression nut only | \$3.35 |
| R172263 Saddle gasket only (not shown) | \$2.68 |
| J. R172052 Cap wrench | \$37.51 |
| K. R172086 1/2" control valve | \$64.44 |
| L. R172061 Combination check valve w/elbow | \$7.56 |
| R172272 1/2" NPT x tube90° elbow w/ nut | \$9.18 |



PENTAIR HIGH CAPACITY FEEDERS HC SERIES

| | |
|--------------------------------------|----------|
| A. R172214 Lock ring | \$21.94 |
| B. R172385D Lid assembly with o'ring | \$38.72 |
| C. R172240 Lid o'ring only | \$14.69 |
| D. R172224X Vent valve | \$7.16 |
| E. R172221 Vent valve o'ring | \$1.82 |
| F. R175251 Screen | \$7.22 |
| G. R172435 Check ball | \$1.87 |
| H. R270531 1" threaded union | \$22.41 |
| I. R172439 Control valve | \$103.70 |
| J. R175009 1/2" drain valve | \$22.07 |
| K. R172134 1/2" threaded plug | \$7.88 |



STENNER CHEMICAL FEEDERS

| | |
|--|----------|
| A. PMBRPL2 Rotor Assembly with Bearings | \$107.06 |
| B. MP6N040 Phenolic Gear (45m) | \$31.88 |
| MP6N080 Phenolic Gear (85m) | \$31.88 |
| C. FC5040D Feed Rate Control w/Shaft (models 45 & 85) | \$340.18 |
| DM5040D Feed Rate Control w/Shaft (models 100 & 170) | \$340.18 |
| D. UCFC5HO Variable Cam (2 pack) | \$32.04 |
| E. UCFC5AY Index Pin Assembly with Lifter | \$96.10 |
| F. FC5K00D Index Spider | \$48.06 |
| G. UCFC5ID Index Plate | \$36.50 |
| H. UCFC5AD Main Shaft (single head adjustable) | \$51.14 |
| DM5A00D Main Shaft (double head adjustable) | \$43.65 |
| I. QP25 "X"-1 Quick Pro Pump Head Assembly | \$168.12 |
| QP10 "X"-1 Quick Pro Pump Head Assembly Hi-Pressure Model | \$188.55 |
| *J. UCCP20 "X" Pump Tube Assembly (2 pack) | \$50.69 |
| *Add Numbers 1, 2, 3, 4, 5 or 7 for "X" to indicate pump, tube size required | |
| K. QP500-1 QP Roller Assembly Quick Pro | \$54.70 |
| UC3ASYD Roller Assembly Old Style (not shown) | \$54.70 |
| L. QP400-1 QP Tube Housing w/Latches | \$50.06 |
| M. QP100-1 Tube Housing Cover w/Bushing | \$37.40 |
| N. UCCPSOB Cover Screw (10 pack) | \$10.73 |
| O. UCDBINJ Injection Check Valve for 1/4" tubing | \$25.38 |
| UCINJ38 Injection Check Valve for 3/8" tubing | \$31.39 |
| P. UCCVDBO Check Valve Duckbill (2 pack) | \$16.70 |
| Q. UCAK300 Injection Valve w/ 1/4" nut (no check) | \$14.69 |
| UCAK400 Injection Valve w/ 3/8" nut (no check) | \$17.55 |
| R. UCMAC38 Hose Weight w/adaptor (limited quantity) | \$21.42 |
| UCMACW0 Weight w/dip 1/4" | \$20.93 |
| S. ST114 1/4" Suction strainer | \$31.10 |
| ST138 3/8" Suction strainer | \$31.10 |
| T. UCADPTR 3/8" Lead Tube Adapter w/nut (2 pack) | \$19.98 |
| U. UCAK100 1/4" Connecting nut (10 pack) | \$27.34 |
| MANUT00 3/8" Connecting nut | \$3.87 |
| V. UCAK200 1/4" Ferrules (10 pack) | \$12.31 |
| AK600 1/4" Flow indicatorw/bracket (not shown) | \$29.16 |
| AK700 3/8" Flow indicatorw/bracket (not shown) | \$29.16 |

BLUE/WHITE FEEDER PARTS



MODEL C-600P

- A. C-395N-6A Injection Check Valve \$57.89
- TI 40-4V 1/4" Threadless Injection Fitting \$60.26
For 1 1/2" & 2" Pipe
- TI 40-6V 3/8" Threadless Injection Fitting \$60.26
For 1 1/2" & 2" Pipe

- B. C-330-6 Tubing Nut \$3.56
- C. C-560-6V Valve Housing \$35.44
- D. K-568A-4 Bullet Cartridge Valve Insert(4/set) \$113.40
- E. C-535 Pump Head \$54.34
- F. C-535FC Head Cover \$28.35
- G. C-535A6-6 Head Assembly \$166.57
- H. C-406T Diaphragm \$55.53
- I. C-340A Foot Valve \$46.08

MODEL A-100N

- J. A-014N-6A Injection Check Valve \$57.89
- K. A1-7T Pump Tube Assembly 7/16" O.D. \$57.89
- A1-6T New Pump Tube Assembly 3/8" O.D. \$57.89
- *For Pumps Manufactured Prior to 9-1-15
- *72000-550 Retro-Fit Kit to Adapt New Tube
to Old Pump Head \$42.53
- L. 71000-159 Roller for 6T tube \$106.31
- 71000-350 Roller for 7T tube \$106.31
- M. 71000-156 Housing Cover \$35.44
- N. 90004-010 Roller Bushing(new Style) \$4.73
- O. C-342-6 Tube Strainer \$5.92
- COMMON ITEMS
- P. C-346 Hose Weight (while supply lasts) \$9.45

PULSATRON CHEMICAL FEEDERS



- A. **KOP Kit: includes:** head, diaphragm, complete suction & discharge valve assembly. All O-rings and head bolts. e.g. (For pump model LPB4SAPTC1 order K4PTC1) e.g.(For pump model LPH6SAPTC3 order K6PTC3)
- K2PTC1 \$231.53
 - K4PTC1 \$231.53
 - K5PTC3 \$272.93
 - K3PTC1 \$315.95
 - K4PTC3 \$315.95
 - K6PTC3 \$315.95



- B. J40211 foot valve 3/8" O.D. tubing \$103.95
- J40212 foot valve 1/2" O.D. tubing \$103.95
- C. J61098 injection check valve 3/8" O.D tubing \$189.32
- J41872 injection check valve 1/2" O.D tubing \$200.18
- D. L3101TC1-FPP suction valve 3/8" O.D tubing \$103.95
- L3101TC3-FPP suction valve 1/2" O.D tubing. \$103.95
- E. L3201TC1-FPP discharge valve 3/8" O.D tubing. \$103.95
- L3201TC3-FPP discharge valve 1/2" O.D tubing. \$103.95
- F. L0200300-FPP pump head (A3 pumps) \$115.92
- L0200400-FPP pump head (B4&E4 pumps) \$137.97
- L0200600-FPP pump head (H6 pumps) \$180.50
- G. L0301000-THY diaphragm (A3 pumps) \$103.95
- L0301100-THY diaphragm (B4&E4 pumps) \$103.95
- H. L0301300-THY diaphragm (H6 pumps) \$154.35
- I. L380DT01-PVD 5 function valve 3/8" O.D tubing \$207.43
- L380DT03-PVD 5 function valve 1/2" O.D tubing. \$207.43

833-SWIM-327
8 3 3 • 7 9 4 6 • 3 2 7
www.halogensupply.com

LMI CHEMICAL FEEDER PARTS

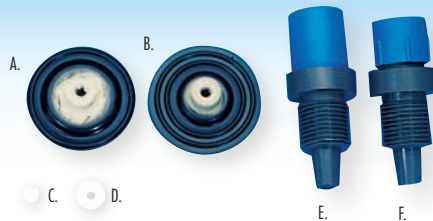

- *A. 30917 0.9 diaphragm \$288.00
- *B. 31420 1.8 diaphragm \$288.00
- *C. 10338 Valve ceramic ball. \$24.75
- *D. 10407 Seal ring \$27.00
- E. 25202 1/2" suction valve \$123.75
- F. 25201 1/2" discharge valve \$146.25

- * Items included in spare parts kit.
- #SP-U1 Spare Parts Kit for models 81S, 81T, 82T, 85S, 85T, \$474.75
- 91S, 92S, 92T, 94, 94S, 95S, 95T, 196, 196S, \$474.75
- #SP-U2 Spare Parts Kit for models 65, 65S, 71S, 71T, 72S, \$474.75
- 72T, 74, 74S, 75S, 75T (Spare Parts Kits not shown)

PRESTOLOK FITTINGS

Specially designed for applications where fast assembly, disassembly and reassembly is important. Just insert the tubing until it bottoms and it's locked in place. Press the release button and remove the tubing brass connection.

- H. W68PLP44 1/4" MPT x 1/4" O.D. tubing \$9.63
- W68PLP64 1/4" MPT x 3/8" O.D. tubing \$16.20
- W68PLP66 3/8" MPT x 3/8" O.D. tubing \$17.39
- W68PLP84 1/2" MPT x 1/2" O.D. tubing \$19.35
- W68PLP86 3/4" MPT x 1/2" O.D. tubing \$23.20
- W68PLP88 1" MPT x 1/2" O.D. tubing \$29.79
- I. 66PLP44 1/4" FPT x 1/4" O.D. tubing \$19.01
- 66PLP64 1/4" FPT x 3/8" O.D. tubing \$34.13
- 66PLPBH66 3/8" FPT x 3/8" O.D. tubing \$26.30
- 66PLPBH86 1/2" FPT x 1/2" O.D. tubing \$56.32
- J. W169PLP44 1/4" MPT x 1/4" O.D. tubing \$13.39
- W169PLP64 1/4" MPT x 3/8" O.D. tubing \$18.72
- W169PLP66 3/8" MPT x 3/8" O.D. tubing \$20.61
- K. W172PLP44 1/4" MPT x 1/4" O.D. tubing \$16.58
- W172PLP64 1/4" MPT x 3/8" O.D. tubing \$26.57
- W172PLP86 3/8" MPT x 3/8" O.D. tubing \$31.43
- W172PLP84 1/2" MPT x 1/2" O.D. tubing \$35.57
- W172PLP88 1/2" MPT x 1/2" O.D. tubing \$43.85

Male Adaptors:



Female Adaptors:



Male 90°s



Male Branch Tees



CHEMICAL FEEDER PARTS, TUBING & TUBING FITTINGS

CHEMICAL PUMP TUBING

Vinyl Suction:

- A. 1V6062-ROLL 3/8" OD x 1/4" ID \$88.25/100' per roll
- 1V7062-ROLL 1/2" OD x 3/8" ID \$105.78/100' per roll

Polyethylene Discharge:

- B. MV4062 1/2" OD x 1/4" ID \$39.41/100' per roll
- MV6062 3/8" OD x 1/4" ID \$66.01/100' per roll
- MV5062 3/8" OD x 3/8" ID \$52.57/100' per roll
- MV8062 1/2" OD x 3/8" ID \$92.54/100' per roll
- MV10062 3/4" OD x 1/2" ID \$116.62/100' per roll

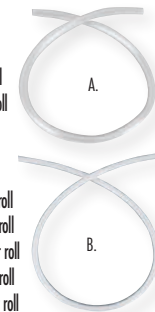

FAST & TITE® THERMOPLASTIC FITTINGS

Fast & Tite fittings install in seconds without the use of tools and provide a tight leak proof seal without clamps or adjustments.

- C. P4MC4 1/4" MPT x 1/4" O.D. tubing \$4.11
- P6MC4 1/4" MPT x 3/8" O.D. tubing \$5.07
- P6MC6 3/8" MPT x 3/8" O.D. tubing \$5.25
- P6MC8 1/2" MPT x 1/2" O.D. tubing \$5.67
- P8MC4 1/4" MPT x 1/2" O.D. tubing \$5.97
- P8MC8 1/2" MPT x 1/2" O.D. tubing \$7.56
- P10MC8 1/2" MPT x 3/8" O.D. tubing \$9.00
- D. P6FC4 1/4" FPT x 3/8" O.D. tubing \$6.39
- P6FC8 1/2" FPT x 3/8" O.D. tubing \$9.87
- P8FC8 1/2" FPT x 1/2" O.D. tubing \$11.40
- P10FC8 1/2" FPT x 3/8" O.D. tubing \$8.79
- E. P4ME4 1/4" MPT x 1/4" O.D. tubing \$5.31
- P6ME4 1/4" MPT x 3/8" O.D. tubing \$7.08
- P6ME6 3/8" MPT x 3/8" O.D. tubing \$7.29
- P8ME4 1/4" MPT x 1/2" O.D. tubing \$9.63
- P8ME8 1/2" MPT x 1/2" O.D. tubing \$9.00
- F. P4FE4 1/4" FPT x 1/4" O.D. tubing \$8.25
- P6FE4 1/4" FPT x 3/8" O.D. tubing \$9.87
- G. P4MT4 1/4" MPT x 1/4" O.D. tubing \$9.12
- P6MT4 1/4" MPT x 3/8" O.D. tubing \$9.99
- P6MT6 3/8" MPT x 3/8" O.D. tubing \$14.01
- P8MT6 3/8" MPT x 1/2" O.D. tubing \$17.97
- P8MT8 1/2" MPT x 1/2" O.D. tubing \$21.75

Male Adaptors



Female Adaptors



Male Elbow



Female Elbows



Male Branch Tee



CHEMICAL CONTROLLER PROBES AND PARTS

CHEMICAL CONTROLLER REPLACEMENT PROBES



| | PRODUCT NO. | DESCRIPTION | CELL CONNECTION | CONTROLLER CONNECTION | USED WITH | PRICE |
|----|-------------|-------------|-----------------|-----------------------|---------------|----------|
| A. | S010 | ORP PROBE | COMPRESSION | 10' CABLE W/BNC END | AQUASOL | \$243.81 |
| | S020 | PH PROBE | COMPRESSION | 10' CABLE W/BNC END | AQUASOL | \$156.48 |
| B. | HSC-012 | ORP PROBE | COMPRESSION | 10' CABLE W/BNC END | CHEMTROL | \$151.71 |
| | HSC-022 | PH PROBE | COMPRESSION | 10' CABLE W/BNC END | CHEMTROL | \$110.19 |
| C. | HSC-013 | ORP PROBE | 1/2" MPT | 10' CABLE W/BNC END | CAT/STRANTROL | \$227.58 |
| | HSC-023 | PH PROBE | 1/2" MPT | 10' CABLE W/BNC END | CAT/STRANTROL | \$195.03 |
| D. | HSC-014 | ORP PROBE | 1/2" MPT | F/BNC | ACUTROL | \$227.58 |
| | HSC-024 | PH PROBE | 1/2" MPT | F/BNC | ACUTROL | \$194.76 |
| E. | HSC-019 | ORP PROBE | TWIST LOCK | F/BNC | WATERMASTER | \$342.84 |
| | HSC-029 | PH PROBE | TWIST LOCK | F/BNC | WATERMASTER | \$289.74 |
| F. | 3-2725-60 | ORP PROBE | 3/4" MPT | MINI-DIN | HALO | \$508.20 |
| | 3-2726-00 | PH PROBE | 3/4" MPT | MINI-DIN | HALO | \$401.36 |

CHEMICAL CONTROLLER ACCESSORIES



| | PRODUCT NO. | DESCRIPTION | PRICE |
|----|-------------|---|-----------|
| A. | S030 | FLOW CELL W/ FITTINGS | \$272.19 |
| B. | F220 | ELECTRODE FITTING 1/2" MPT | \$10.29 |
| C. | M011-HP | SAFETY PRESSURE SWITCH | \$356.48 |
| D. | 3076 | SAFETY PRESSURE SWITCH ONLY | \$56.68 |
| E. | 1078002 | 1/4" MPT X HOSE BALL VALVE | \$45.25 |
| F. | 1080002 | 1/4" MPT X FPT BALL VALVE | \$45.25 |
| G. | 155481 | GEMS SENSOR 1/2" FPT RFO TYPE 4.5 TO 24 VDC PULSED OUTPUT | \$377.96 |
| | 155485 | GEMS SENSOR 1/2" FPT RFS TYPE SET POINT CALIBRATION | \$564.81 |
| H. | 754000310 | ACUTROL FLOW CELL W/FLOW SWITCH | \$1001.28 |
| I. | 754000340 | ACUTROL FLOW CELL JAR ONLY | \$366.72 |
| J. | 754000360 | ACUTROL 1/4" IN-LINE STRAINER | \$92.61 |
| K. | 754000440 | ACUTROL FLOW SWITCH W/10' CABLE | \$125.58 |

AQUALINK® RS POOL & SPA AUTOMATION SYSTEM



Make Smart Pool Control Simple

Premium Automation at its Finest Jandy AquaLink RS systems enable total control of your backyard experience. AquaLink RS systems are fully integratable with home automation systems and feature our patented seasonal adjust technology, which can modify schedules throughout the year for additional energy savings. AquaLink RS delivers the ultimate pool/spa automation experience.

Features:

- Control individual pool and spa functions, lighting, and water features from the convenience of your home.
- Automate daily pool equipment functions, such as filtration, sanitation and cleaning, and create one-touch macros.
- Integrates seamlessly with home automation systems.
- Control equipment anytime, anywhere from a smartphone or tablet with the iAquaLink® app.
- Program and enable preferred operational settings with one-touch control.

Priced on application

833-SWIM-327
8 3 3 • 7 9 4 6 • 3 2 7
www.halogenupply.com

INTELLICENTER® POOL CONTROL SYSTEM



IntelliConnect allows pool owners to monitor and control various devices, including pumps, lights sanitizers and more, all through an app on a smart device, for easy convenient control. IntelliConnect provides real-time information on the status of the filtration system and other pool equipment. Pool owners can command the system to work a little harder when extra filtration is needed.

Features:

- Easy to program, with step-by-step, on screen instructions.
- Color touchscreen interface displays intuitive instructions in clear text and rich colors.
- Convenient control from inside and outside the home via outdoor and indoor control panels and wireless remotes.
- Remote control from anywhere: Android® and iOS® device, Web browsers on Mac® and PC computers and voice command with smart speaker devices like Amazon Echo®.
- Interfaces with iOS®, Android mobile devices, Apple Watch® and smart speakers, enabling owners to check their pools status remotely.

Priced on application

AUTOMATION AND AUTOMATION PARTS

AQUALINK ACCESSORIES



- A. JAN-7790 Temperature Sensor \$131.81
- B. R0658100 3HP Relay \$126.75
- C. IQ30-RS RS Upgrade Kit W/Web Connect \$1,734.75
- D. AQWHR18 Wireless Handheld Remote \$1,465.11

COMPOOL PARTS

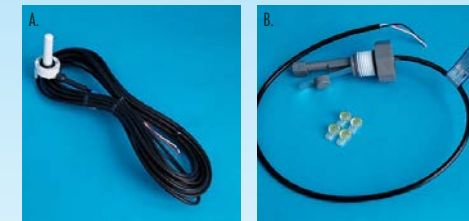

- A. 52-0272 Temperature Sensor \$100.73
- B. 52-0736 Flow Switch \$304.83

INTELLICHLOR SALT CHLORINE GENERATOR

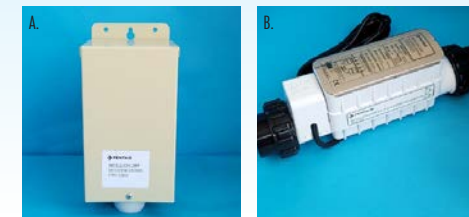

- A. 52-0556 Power Center. \$975.32
- B. 52-0555 IC40 Cell \$1,883.22

POOL LINERS, LADDERS & ACCESSORIES

OVERLAP PATTERNS

Made in the U.S.A. by GLI Pool Products with the highest quality workmanship using the best available virgin vinyl liner. Our colors are Solid Blue, Blue Wall with print floor. All liners are available in 20 gauge vinyl and are 48"/52" high walls.

| A. Blue Wall Blue Floor | | |
|-------------------------|----------|----------|
| ROUNDS | Cat. No. | 48"/52" |
| 12 | 1631212 | \$166.05 |
| 15 | 1631515 | \$219.79 |
| 18 | 1631818 | \$261.70 |
| 21 | 1632121 | \$354.33 |
| 24 | 1632424 | \$386.99 |
| <hr/> | | |
| 12 Round x 36" | 1631236 | \$106.56 |
| OVALS | | |
| | Cat. No. | 48"/52" |
| 12x24 | 1630224 | \$342.99 |
| 15x30 | 1630530 | \$448.88 |
| 16x32 | 1630632 | \$544.70 |

Expandable Liners only available on round size pools. Add 25% to list price. Beaded style liner pricing available upon request.

B. Happy Bottom® Pool Pad

Ideal padding for underneath pool liner. Made with 2 lb. high density foam, 1/4" thickness makes it soft and durable. Sold in a 300 ft Roll or 100 ft Sheets

#PP300-ROLL 1/4" X 48" x 300' Roll . . . \$825.00

#PP300-SHEET 1/4" X 48" x 100' Sheet . . . \$330.00

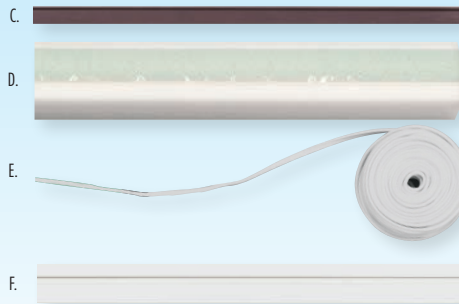

C. MC-CP2 LINER COPING STRIPS 24" for overlap liners . . . \$1.60 each

D. COV-48" PEEL N' PLACE POOL COVE 48" long . . . \$12.20 per 4' strip

E. QP-1562 LINER BEAD WEDGE LOCK 120' . . . \$52.07

F. QP-521 SIDE MOUNT LINER LOCK 8' PIECE. . . \$16.29

REPAIR KITS FOR ALL ABOVEGROUND POOLS



A. 2 oz. tube of #100 vinyl adhesive, 130 sq. in. of patching vinyl and dauber applicator. Works under water.

#1060 #100 vinyl adhesive . . . \$9.90

B. 4 oz. can of #100 vinyl adhesive, dauber applicator and 500 sq. in. of patching vinyl. Works under water.

#1061 4 oz. can #100 vinyl adhesive . . . \$22.10

C. Plastic pool patches, 100 sq. in. of patching vinyl. Works under water.

#1062 Plastic pool patches . . . \$6.77

D. #1068 Vinyl adhesive — 4 oz. can and dauber . . . \$12.89

E. Vinyl repair kit. 1 oz. tube of #100 vinyl adhesive and 40 sq. in. of patching vinyl and dauber.

#1069 Vinyl repair kit . . . \$5.45

F. Vinyl repair patches for blue liners 2 H.D. gauge vinyl strips measuring 6" x 23" (must use vinyl adhesive) — Color blue vinyl.

#1064 . . . \$9.52

LADDERS & ACCESSORIES

A. HEAVY DUTY A-FRAME FOR 48" TO 54" POOL

Unique one-piece handrail/leg design will hold 300 lbs. Outer steps swing up and lock into upright position. Just fill with water to prevent floating.

#7000 . . . \$395.12



B. HEAVY-DUTY INPOOL LADDER FOR 48" TO 53"

18" wide, flat oversized (5") steps; 22" high handrails; 9 1/2" handrail span. Includes deck platform at top. Weight limit 300 lbs.

#6000 . . . \$245.94



COMPLETE STEP-SYSTEM

C. CONFER-STEP

For above ground pools with flat bottoms. Easy, snap together installation. Large, flat steps (each with 270 square inches) complete with two all-plastic handrails. Mounting brackets included; secures unit to pool or deck. Gray steps for high visibility in water. Economical, yet strong; holds 400 pounds.

- Fits Decks up to 60"
- Height to Top Step — 47 inches
- Height to Handrail — 38 inches
- Projection into Pool — 32 inches
- Width — 31 inches
- Riser Height — 11 inches
- Step Dimensions — 10" x 27"

#STEP-1 . . . \$391.88



833-SWIM-327
833-7946-327
www.halogensupply.com

AIR BLOWERS

A. FUJI COMMERCIAL AIR BLOWERS

Blower construction: cast aluminum housing, impeller and cover, 1 and 3 phase models.

| Model No. | Type | HP | Phase | Volts | Use | Price |
|------------|------|-----|-------|---------|----------|------------|
| VFC400P-ST | Fuji | 1 | 1 | 115/230 | Spa Duty | \$1,361.20 |
| VFZ401A-7W | Fuji | 1.4 | 3 | 230/460 | Spa Duty | \$1,230.08 |
| VFC508P-2T | Fuji | 2.5 | 1 | 230 | Spa Duty | \$1,727.96 |
| VFZ501A-7W | Fuji | 2.7 | 3 | 230/460 | Spa Duty | \$1,532.10 |



B. SILENCER from AIR SUPPLY

Extremely quiet outdoor blower... nothing else compares. UL listed for indoor or outdoor use. A high quality spring check valve is included with each silencer. One year no-questions-asked warranty-including water damage.

| | | |
|------------|----------------------------|----------|
| #6310101 - | 1.0 H.P. 110 Volts | \$203.60 |
| #6310201 - | 1.0 H.P. 220 Volts | \$216.20 |
| #6315101 - | 1.5 H.P. 110 Volts | \$222.50 |
| #6315201 - | 1.5 H.P. 220 Volts | \$235.10 |
| #6320101 - | 2.0 H.P. 110 Volts | \$262.40 |
| #6320201 - | 2.0 H.P. 220 Volts | \$268.70 |



C. SPA FACTOR: Thermal Cover For Hot Tubs And Spas

Lightweight yet durable, the Spa Factor thermal cover helps prolong the life of spas and reduces daily maintenance. Floats on water surface, providing these advantages:

- Protects and extends the life of your hard cover
- Significantly reduces heat, water and chemical consumption by reducing evaporation
- Helps prevent moisture damage to sensitive electronic controls
- Trimmable, easy to install
- Reversible colors, black/blue.

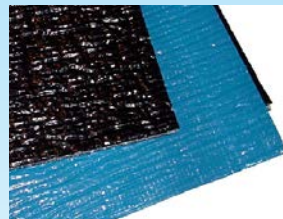

| | | | |
|------------------|----------|-------------------|----------|
| #HV8x6 | \$125.90 | #HV9x9 | \$206.01 |
| #HV8x7 | \$146.77 | #HV9x10 | \$229.15 |
| #HV8x8 | \$167.41 | #HV9x12 | \$340.20 |

D. WATERWAY EXECUTIVE 56-FRAME PUMP

High performance, quiet operation, longer motor life.

| 2-Speed | | Price |
|------------|------------------------|----------|
| 3720821-1D | EXECUTIVE 56 2 HP 2SPD | \$634.75 |
| 3721221-1D | EXECUTIVE 56 3 HP 2SPD | \$678.24 |
| 3721621-1D | EXECUTIVE 56 4 HP 2SPD | \$739.46 |
| 3722021-1D | EXECUTIVE 56 5 HP 2SPD | \$839.70 |

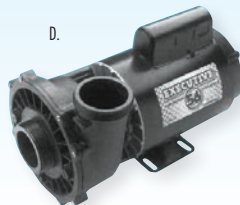

E. SPRING WOUND COUNTDOWN TIMER

The FF Series Commercial Countdown timers are designed to replace any standard wall switch and do not require electricity to operate. These energy-efficient switches automatically limit the ON times for fans, lighting, motors, heaters and other energy consuming loads.



| | |
|----------------------------|---------|
| #FF15M 15 Minute | \$52.29 |
| #FF30M 30 Minute | \$52.29 |



F. LEN GORDON AIR SWITCHES Basic Air Switch

Turns on/off any piece of equipment, such as: pump, blower, lights, etc. Air button not included.

| | |
|--|----------|
| F1. #910100-007 - FF-1094 Four function air switch 120/240V | \$431.17 |
| F2. #910106-007 - FF-1094TC System Four Function Switch w/Time Clock | \$490.30 |



| | |
|--|----------|
| G. #921305-001 AS-Multi Combo 120/240V 2 speed pump | \$247.77 |
| #921805-001 AS-TD-Multi Combo 120/240V on-off with 10 min. delay | \$365.27 |

H. AIR BUTTONS & AIR CONTROLS



| | |
|--|---------|
| H1 #950401-000 Lite touch 1 1/4" mounting 75' max dist | \$47.32 |
| H2 #951590-601 Classic touch 1 3/8" mounting 150' max dist | \$40.55 |
| H3 #951001-000 Power touch 1 3/4" mounting 150' max dist | \$42.48 |
| H4 #10-2100 1" Slip* | \$32.81 |
| H5 #10-2200 1/2" Slip | \$21.76 |

*Limited Stock Available

SPA ACCESSORIES & SUPPLIES

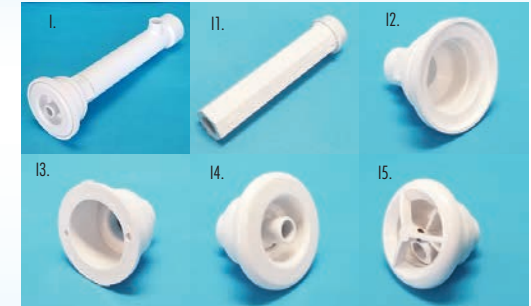

| | |
|--|---------|
| I #10-4562 Converta'ssage Gunite Assy | \$71.55 |
| I1 #30-4401 Nozzle | \$8.80 |
| I2 #30-4332 Niche | \$12.98 |
| I3 #56-5215 Wall fitting w / bearing | \$18.20 |
| I4 #10-4564 Converta'ssage Fitting Assy. | \$36.79 |
| I5 #16-5274WHT Micro'ssage Fitting Assy. | \$70.90 |

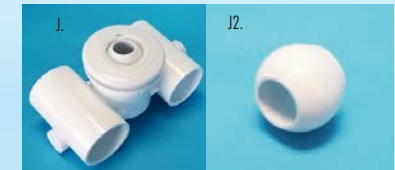

| | |
|---|---------|
| J #10-5100 Hydro Jet Assembly | \$67.91 |
| J2 #30-3805 Eyeball | \$2.90 |
| J3 #30-3806 Eyeball retaining ring. | \$4.19 |
| J4 #10-3500 Standard wall fitting assy. | \$18.32 |
| J5 #30-7825 Wrench tool. | \$16.99 |

833-SWIM-327
833-7946-327
www.halogenupply.com

FROG PRODUCTS



Frog® offers innovative mineral technology for pool & spa care that is EPA registered to destroy bacteria which SAVES 50% on chlorine or bromine use for softer water that leaves a crystal clear shine and is easier on equipment and surfaces. In addition Frog® offers repeat sales of multiple products every year for a strong after market business.

A. FROG SERENE® FLOATING SYSTEM
 Complete spa care using mineral and bromine cartridges that snap into a reusable holder. With minerals in the spa, bromine use can be reduced by up to 50%.

| | |
|--|---------|
| #01-14-3883 Frog Serene System | \$51.39 |
| #01-14-3824 Bromine Cartridge | \$15.86 |
| #01-14-3812 Mineral Cartridge. | \$32.61 |

B. FLIPPIN FROG XL®
 Fresh mineral water for any pool up to 10,000 gallons. The patented floats and flips technology tells users to replace. Destroys bacteria with minerals and only 0.5 ppm chlorine.

flippin' 30j XL

| | |
|---|---------|
| #01-12-8606 Flippin Frog XL | \$73.04 |
| #01-03-8550 Flippin Frog XL Cartridge Only. | \$28.46 |

C. POOL FROG® ABOVE GROUND PACKAGE
 Includes a POOL FROG® Cyclor 6100 and Mineral Reservoir Series 6100. Cyclor is in-line with 1½" threaded ports for pools up to 25,000 gallons. Includes 6" nipple installation kit, instruction manual, and video on CD-ROM. Do not install off-line. Mineral Reservoir lasts 6 months.

| | |
|-------------------|----------|
| #01-01-6180 . . . | \$311.50 |
|-------------------|----------|



D. REPLACEMENT PRODUCTS FOR ABOVE GROUND AND IN GROUND POOL PRODUCTS

| | |
|--|----------|
| #01-12-5462 In ground mineral reservoir. | \$137.34 |
| #01-12-6112 Above ground mineral reservoir | \$107.37 |
| #01-03-5880 Pool Frog Bac Pac | \$32.51 |
| #01-10-5060-1 Frog Bam Algaecide. | \$37.04 |

833-SWIM-327
 8 3 3 • 7 9 4 6 • 3 2 7
www.halogensupply.com



E. POOL FROG® IN GROUND PACKAGE
 Includes a POOL FROG® Cyclor 5400 and Mineral Reservoir Series 5400. Cyclor is in-line with 2" male adapters installed for pools up to 40,000 gallons. Do not install off-line. Mineral Reservoir lasts 6 months.

| | |
|-----------------------------------|----------|
| #01-01-5480 Inline unit | \$479.68 |
| #01-01-5490 Offline unit. | \$527.04 |



F. POOL FROG XL PRO®
 Includes a POOL FROG® Cyclor and Mineral Reservoir series 5400 and a second POOL FROG® Cyclor that fits the new FROG® 7lb. chlorine pac. Cyclors are in-line with 2" slip ports for pools up to 40,000 gallons. Mineral Reservoir lasts 6 months.

| | |
|---|----------|
| #01-01-5450 XL Pro | \$654.97 |
| #01-03-5613 Pool Frog Chlorine Pac. | \$81.92 |



G. NEW WATER® ABOVE GROUND CYCLER 120
 In-line with 1½" threaded inlet/outlet ports for use on pools up to 25,000 gallons. Do not install off-line. Uses Cyclor Pac #01-03-1413

| | |
|--|----------|
| #01-01-0120 Unit | \$189.76 |
| #01-03-1413 4.1 lb container | \$58.01 |

H. NEW WATER® IN GROUND CYCLER 400
 In-line with 2" threaded inlet/outlet ports for use on pools up to 40,000 gallons. Do not install off-line. Uses Cyclor Pac #407C

| | |
|----------------------------|----------|
| #01-01-0400 Unit | \$201.79 |
|----------------------------|----------|

I. NEW WATER® IN GROUND CYCLER 430
 Off-line with off-line accessory kit for use on pools up to 25,000 gallons. Do not install in-line. Uses Cyclor Pac #407C

| | |
|----------------------------|----------|
| #01-01-0430 Unit | \$248.87 |
|----------------------------|----------|

J. NEW WATER® IN GROUND CYCLER PAK 407C
 6.1 lb trichlor pak used in all new water feeders. #01-03-4613 unit

| | |
|----------------------------|---------|
| #01-03-4613 unit | \$83.22 |
|----------------------------|---------|

K. PERFORM-MAX™ ABOVE GROUND 920
 Inline chemical feeder for pools up to 25,000 gallons. For use with chlorine or bromine, 1" and 3" tablets. 7lb capacity. Do not install off-line. 1½" threaded inlet/outlet ports and 1½" union threaded.

| | |
|-----------------------|----------|
| #01-05-0920 | \$145.11 |
|-----------------------|----------|

L. PERFORM-MAX™ IN GROUND OFF-LINE 960
 Off-line chemical feeder for pools up to 50,000 gallons. Handles chlorine or bromine 1" and 3" tablets, 10lb. capacity. Do not install in-line. 2" threaded inlet/outlet ports.

| | |
|-----------------------|----------|
| #01-05-0960 | \$205.80 |
|-----------------------|----------|

M. PERFORM-MAX™ IN GROUND IN-LINE 940
 In-line chemical feeder for pools up to 50,000 gallons. Handles chlorine or bromine 1" and 3" tablets, 10lb. capacity. Do not install of f-line. 2" threaded inlet/outlet ports.

| | |
|-----------------------|----------|
| #01-05-0940 | \$163.42 |
|-----------------------|----------|

SeaKlear®

Reliable. Safe. Effective.



PHOSPHATE REMOVER

SeaKlear Phosphate Remover works better and does more than other phosphate removers.

- Commercial 1 oz per 5000 gallons
- Residential 3 oz per 5000 gallons
- Proven to eliminate phosphates from fertilizers, rainwater, soaps and decaying vegetation and other pollutants.
- Nontoxic - 100% safe for your family and the environment

#1040105 Phosphate Remover
Commercial 1 Quart \$58.99



ALGAE PREVENTION & REMOVER

To control algae in pools, simply add SeaKlear Algae Prevention & Remover every 3 months.

- Use against blue-green, black and mustard algae
- A single treatment lasts 3 months
- Non staining formula
- Guaranteed superior performance
- Part of the proven family of SeaKlear water treatment solutions

#SKA-B-Q Algae Prevention & Remover
Quarts \$27.26



FREE & KLEAR

Free & Klear blends our original SeaKlear Chitosan Clarifier, SeaKlear Phosphate Remover and enzyme formulations to keep pool water looking beautiful. Free & Klear is an ideal weekly maintenance product that tackles common issues faced by many pool owners. It reduces problems such as phosphate loading which can cause issues with pool surfaces and equipment. Free & Klear works great with salt systems as it helps maintain optimum performance of cells by reducing troublesome calcium phosphate scale. Free & Klear also treats the buildup of lotions and oils on both the filter and in pool water that can result in clarity problems. If phosphate levels exceed 1000 ppb, use SeaKlear Phosphate Remover to reduce the level down and use the Free & Klear to maintain low levels.

#1040400 Free & Klear
Quart \$26.00



THICK TILE & VINYL CLEANER

SeaKlear Thick Tile & Vinyl Cleaner is designed to remove film, oil and scum lines from tile, vinyl and grout. Unlike other products of this type, SeaKlear Thick Tile & Vinyl Cleaner is non abrasive, yet it reaches down into the pores to remove soils.

- Removes oil and scum lines
- Cleans grout lines
- Removes dull films
- Safe for acrylic surfaces

#SKL-T-C Thick Tile & Vinyl Cleaner
Quarts \$18.19



CHITOSAN CLARIFIER

SeaKlear Chitosan Clarifier works better and does more than other clarifiers. Quite simply, it is the best clarifier money can buy. Our proprietary, patented chitosan polymer formula has been proven to be reliable at safely keeping pools clear, easily and effectively.

- Naturally clarifies cloudy water
- Eliminates oil and scum
- Safe to use with all sanitizers
- Removes excess metals
- Easy and simple to use
- Makes cleaning all filters quicker and easier

#SKP-C-Q Chitosan Clarifier for Pools
Quarts \$22.09



RESCUE KLEAR

Rescue Klear blends powerful enzymes and a clarifier to quickly and effectively clean up oils from bathers and vandalism, as well as dead algae. When your pool needs to be rescued, there is no better solution than Rescue Klear.

Suntan oils and lotions can cause buildup on the waterline or in the filter media. Rescue Klear tackles the problem using enzymes to degrade oils, lotions and more. It also uses our highly effective clarifying technology to clear cloudy water and allow the filter to remove pollutants.

#90180SKR Rescue Klear
Quarts \$14.41

833-SWIM-327
833 • 7946 • 327
www.halogenupply.com

SEAKLEAR & NATURE 2



Nature² is a sanitizing system that uses patented mineral-bed technology to provide crystal clear water and improved water quality. Working with the pool filtration system, Nature² uses elemental minerals that combine with a small amount of chlorine to inhibit bacteria growth and eliminate contaminants. Minerals make the water noticeably softer and less chlorine means a lower potential for red-eye, dry skin or foul odors. With Nature², your swim experience is clean, fresh, and gently soothing.

Nature² PROFESSIONAL "G"

Mineral sanitizer dispenser for all In-Ground pools. (order mineral cartridge separately)

#W25904 Nature² Professional "G" Vessel 2" \$943.01

#W28125 G25 Cartridge 25,000 Gallons \$265.10

#W28135 G35 Cartridge 35,000 Gallons \$289.78

#W28145 G45 Cartridge 45,000 Gallons \$313.32



Nature² "A" SANITIZER

Nature² "A" brings all the sanitizing benefits of mineral technology to your above ground pool.

#W28165 A30 Mineral Cartridge \$241.61



Nature² EXPRESS

Nature² allows pool owners to bring all the benefits of mineral technology to their existing pool with a quick, do-it-yourself installation. The unit attaches to the plastic plumbing of most inground and above ground pool systems. (comes complete with mineral cartridge for pools up to 25,000 gallons)

#W20086 Nature² Express 1/G \$332.62

#W20176 Nature² Express A/G \$316.87

#W28175 Nature² Express 1/G + A/G Mineral Cartridge \$227.39



Nature² SPA

Nature² Spa works with your existing filter to give you clean, clear water without high levels of chlorine. A difference you can see, feel and smell.

#W20750 Spa Purifier \$68.10

#W29300 Spa Test Strips \$20.37



CHEMICAL WATER BALANCE PRODUCTS & FILTER AID

CHEMICALS ETC.



A. SODA ASH – (pH UP)
 Dry granular product to increase pH of pool water. When pH drops below 7.2 soda ash will help restore your pool water to its proper pH level.

- #300-05 5-lb. container \$15.64
 - #300-10 10-lb. container \$25.90
 - #300-50 50-lb. bag \$55.00
- Also, pH Up available in Great Lakes Biochemical brand.
- #3454 2-lb. jar \$5.51
 - #3458 8-lb. container \$18.36



B. SODIUM BISULPHATE – (G.B.S. or pH DOWN)
 Is a granular form of muriatic acid and is safer, easier and less corrosive. Whenever pH rises above 7.6 add pH reducer.

- #312-06 6-lb. container \$19.89
 - #312-12 12-lb. container \$35.79
 - #312-50 50-lb. drum \$70.50
- Also, pH Down available in Great Lakes Biochemical brand.
- #3490 2.5-lb. jar \$5.96
 - #3493 10-lb. container \$22.10

NOTE: 50 lb. bags of Sodium Bisulphate (G. B. S.) available on request for BIDS.



C. SODIUM BICARBONATE – (ALKALINITY INCREASER)
 Is a granular product to increase the total alkalinity in your pool water when it drops below 80 p.p.m.

- #333-05 5-lb. container \$14.28
 - #333-10 10-lb. container \$24.74
 - #333 50-lb. bag \$46.26
- Also, available in Great Lakes Biochemical brand.
- #3497 10-lb. pail \$22.36
- Dosage: 1½ lb. per 10,000 gallons of water will raise the alkalinity level 10 p.p.m.



D. HAL-STA – (POOL CONDITIONER or STABILIZER)
 Chlorine and its derivatives are susceptible to rapid decomposition by the sun's ultraviolet rays. To cut this loss and improve the chlorine's active life, stabilize with pool conditioner. Stabilizer is compatible with the chlorine releasing it at a slow rate to last longer and reduce chemical needs.

- #3393 2-lb. container \$14.52
 - #3395 4-lb. container \$25.72
 - #3396 25-lb. container \$98.32
 - #3397 45-lb. container \$166.92
 - #3398 100-lb. drum \$284.70
- Also, available in Great Lakes Biochemical brand.
- #3483 4-lb. jar \$20.24
- Dosage: 1 lb. per 4,000 gallons of water.



E. SODIUM THIOSULPHATE
 When chlorine concentration becomes too high in pool water, use this chemical to lower chlorine level safely.

- #335 5-lb. pail \$33.06
 - #339 25-lb. pail \$152.02
 - #340 50-lb. pail \$295.76
- Dosage: 1 lb. per 100,000 gallons of water decreases chlorine 1 p.p.m.



F. CetaPerl®
PERLITE FILTER MEDIA FOR SWIMMING POOLS
 CetaPerl® is a lightweight filter media suitable for use in all diatomaceous earth (DE) filters

- EASY TO HANDLE
- Lightweight Bags Makes it Easier for All to Use
- ENVIRONMENTALLY FRIENDLY
- All natural, Non-Toxic Product
- GOOD CLARITY
- Removes Particles Down to 4.0 Microns
- IMPROVED OIL ABSORPTION
- Provides a Cleaner Pool

- #313 25 lb CetaPerl® \$42.10



G. CALCIUM CHLORIDE
 Dry granular chemical used in increasing hardness of the water.

- #3447 8-lb. pail (GLB brand) \$18.46
 - #318-50 50-lb. bag \$32.70
- Dosage: 5 lb. per 10,000 gallons of water increase hardness 25 p.p.m.



H. DIATOMACEOUS EARTH
 Swimming pool grade precoat media produces brilliantly clear water for any diatomaceous filters.

- #310 50-lb. bag D.E. \$53.30 ea.
 - #316 25-lb. bag D.E. \$27.90 ea.
 - #FW60 50-lb. bags special D.E. \$152.00 ea.
- for regenerative filters.



I.



J.



K.

I. MURIATIC ACID
 Is a liquid chemical used for lowering total alkalinity or pH.

- #325 1-gal. container \$9.02

Note: Cases consist of 4 gallons.

J. ANTI-FREEZE (non-toxic)
 Protects your pool and spa water systems from freeze damage to 50°F (below zero) when used as directed (propylene glycol base).

- #399 1-gallon container \$6.38

K. WIPE OUT By King Technology
 Quickly penetrates dirt, grease and grime and holds them in suspension for fast, easy removal.

- No scrubbing
- No toxic fumes
- Will not affect water balance
- Safely used on fiberglass, tile, concrete, marble, wood, covers and vinyl liners.

- #KING-6012 quarts \$15.88
- #KING-6012-1 gallon \$43.00

833-SWIM-327
 833 • 7946 • 327
www.halogensupply.com

BALANCERS



A. Leisure Time Spa Up

A granular product that raises pH and total alkalinity levels in hot water. Increases the effectiveness of the sanitizer when levels are in range.

- Spa water should be maintained at a pH of 7.2-7.8 and a total alkalinity of 80-120 ppm.
- Compatible with all sanitizers.

#3998 Spa Up 2 lbs. \$16.23

B. Leisure Time Spa Down

A granular product that lowers pH and total alkalinity levels in hot water. Increases the effectiveness of the sanitizer when levels are in range.

- Always maintain the pH of your spa water between 7.2-7.8.
- A high pH can cause scaling and or cloudy water.

#3997 Spa Down 2.5 lbs. \$13.35



C. Leisure Time Calcium Booster

Raises the level of water hardness, which helps prevent foaming and corrosion of equipment to extend the life of the spa.

- Maintain a hardness level of 150-400 ppm.
- Compatible with chlorine, bromine, ozone and biguanide sanitizers.

#3999 Calcium Booster 32 oz. \$16.71



CLARIFIERS



D. Leisure Time Bright & Clear

Specially designed for hot water application, Spa water becomes cloudy because millions of small, suspended particles accumulate in the water. The particles are too small to be filtered out. By using Bright & Clear, the small particles combine to form larger particles that can be trapped by the filter to improve water clarity.

- Clears cloudy spa water fast.
- Compatible with chlorine, bromine, ozone and biguanide sanitizers

#3995 Bright & Clear 2 qt. \$18.27

E. Foam Down

Foam Down rids spas of foam caused by a concentration of body oils and other materials. This fast acting liquid suppresses foam and suds in spas, hot tubs, therapeutic pools and fountains.

#3996 Foam Down 32 oz. \$24.91



F. Leisure Time Metal Gon

Sequesters iron, copper and other minerals and prevents staining of spa surfaces. It is highly concentrated and only needs to be added upon start-up.

- Last from refill to refill.
- Compatible with chlorine and bromine sanitizers

#3989 Metal Gon 16 oz. \$15.78



CLEANERS



G. Leisure Time Jet Clean

Keeps spa and jetted tub plumbing clear of organics, oils, dirt and minerals to prevent buildup that can restrict water flow and damage equipment.

#3990 Jet Clean 16 oz. \$16.23

SANITIZER & SHOCKS

H. Leisure Time Reserve

A bromide solution that remains in a stable bank in the spa water until Renew oxidizer added, releasing bromine to provide a non-chlorine sanitizing system.

- This product should be added when the spa/hot tub is filled and used weekly thereafter to maintain a bank of bromine water.
- Compatible with bromine sanitizing systems.

#3993 Reserve 32 oz. \$22.85



I. Leisure Time Renew

A non-chlorine shock oxidizer treatment with a buffering element that eliminates odors and clears cloudy water by reducing contaminants. Can be used with chlorine, bromine or other sanitizers.

#3994 Renew 2.2 lbs. \$27.68



SPA CARE PRODUCTS



J. Leisure Time Brominating Tablets

Low-odor, low-dust tablets fit all floaters. When used as directed this product will sanitize spa and hot tub water, keeping it clean, clear and free of odor. This product gives the effectiveness of chlorine without the chlorine odor.

- Easy-to-dose tablets.
- Compatible with bromine sanitizing systems.

#3991 Brom Tabs 2.21 lbs. \$42.34

K. Leisure Time 56 Granular

Specifically formulated for spas and hot tubs, this concentrated granular chlorine effectively sanitizes and shocks hot water to keep it clean and clear.

- Maintains clean, clear sanitized water
- Compatible with chlorine sanitizing systems.

#3992 56 Granular 2 lbs. \$26.02



L. Leisure Time Sodium Bromide

Creates an immediate bromide reserve before using Brom Tabs to ensure a full bromine based sanitizing system.

#3987 Sodium Bromide 6 x 2 oz Package \$23.52



POOL PRODUCTS



NON-CHLORINE SHOCK

A. OXY-BRITE® NON-CHLORINE SHOCK OXIDIZER
Oxy-Brite® non-chlorine shock oxidizer creates sparkling water and shock treats in one step. Containing DuPont™ Oxone®, a powerful oxygen-based oxidizer, its powerful formula rids pool water of contaminants that cause odor and irritation. It also brightens and clears the water with unique blue water brightening crystals.
#3400 1 lb. pouch \$9.06 **#3406** 20 lb. pail \$151.82
 Swimming can resume in just 15 minutes! 1 lb. treats 10,000 gallons of water. Use weekly as part of your pool maintenance program.
 Compatible with chlorine, bromine, salt water chlorine, ozone and minerals



CLARIFIERS

B. CLEAR BLUE® CLARIFIER
This super-concentrated clarifier adds sparkle while removing particles that dull pool water. Clear Blue® clarifier improves filter efficiency and reduces sanitizer demand by removing organic particles that clog filters without affecting pH.
#3423 quart bottle \$18.76
 Use just 2 fl. oz. per 10,000 gallons weekly to keep water sparkling clear. Will not affect water balance.
 Compatible with chlorine, bromine, ozone, salt water chlorine and biguanide sanitizing systems.



C. NATURAL CLEAR® ENZYME CLARIFIER
Natural Clear® clarifier is an enzyme-based water cleaner that quickly rids pools of organics that cause odors, scum lines and cloudy water and helps keep filters clean.
#3405 quart bottle \$14.20
 Compatible with chlorine, salt water chlorine, bromine, ozone and biguanide sanitizing systems. Prevents waterline buildup and clogged filters by rapidly digesting oils, lotions and organics. Improves filtration.



D. DROP 'N' VAC® FLOCCULENT
With clarifying capabilities, this product drops unfilterable debris to the bottom of the pool for easy vacuum removal. This formula is effective over a wider range of pH levels than comparable products.
#3413 quart bottle \$21.78
 Compatible with chlorine, salt water chlorine, bromine, ozone and biguanide sanitizing systems. Prevents waterline buildup and clogged filters by rapidly digesting oils, lotions and organics. Improves filtration.



ALGAEICIDES

E. ALGIMYCIN® "2000" ALGAEICIDE
Algimycin® 2000 algaeicide kills, prevents and controls all algae types. A special wetting agent penetrates and kills algae cells. This nonmetallic, poly-complex formula gives fast and effective control with no foaming or staining. It also acts as a clarifier and filter aid by removing algae fast.
#3429 quart bottle \$33.38
 Fast and effective treatment for green, black and yellow algae. Compatible with chlorine, bromine, ozone, salt water chlorine and biguanide sanitizing systems.



F. ALGIMYCIN® "1000" ALGAEICIDE
This copper/quat formula eliminates black algae. Its patented triple-chelation process holds copper ingredients active in solution for longer algae control.
#3425 quart bottle \$41.04
 Swimming can resume immediately after treatment. Compatible with chlorine, bromine, mineral purification systems, salt water chlorine and ozone sanitizing systems

G. STRIKE OUT® ALGAEICIDE
Designed to control green and mustard algae, this chelated 7.4% copper algaeicide is effective and economical.
#3448 quart bottle \$24.66
 Swimming can resume immediately after treatment. Compatible with chlorine, bromine, ozone and salt water chlorine sanitizing systems.



H. VANQUISH® DEPOSIT CONTROL
Specially formulated to treat the pink deposits that accumulate on pool walls and in plumbing, Vanquish® deposit control treats pink, white and clear deposits in any swimming pool, including those sanitized with biguanide systems..
#3437 quart bottle \$28.30
 Compatible with all sanitizers including chlorine, bromine, salt water chlorine, ozone, minerals and biguanide.



I. ALGAE-X
Algae-X is a non-foaming multipurpose 30% polymer algaeicide that treats green and yellow algae. It is effective over a wide pH range.
#3445 quart bottle \$28.30
 Does not require pH adjustments to be effective. Compatible with chlorine, bromine, salt water chlorine, ozone, biguanide and mineral sanitizing systems

J. ALGIMYCIN® "600" ALGAEICIDE
This non-foaming, triple-action 60% polymer algaeicide destroys and prevents the regrowth of green algae and increases water clarity all in one step.
#3433 quart bottle \$27.12
 Does not require pH adjustment to be effective ideal for winterizing pools. Compatible with chlorine, bromine, salt water chlorine, ozone, biguanide and mineral sanitizing systems



833-SWIM-327
 8 3 3 • 7 9 4 6 • 3 2 7
www.halogensupply.com

SURFACE CLEANERS

A. TLC® SURFACE CLEANER

TLC® surface cleaner removes oil, grime and mineral scale from common pool surfaces such as tile, vinyl and concrete. Its thick, concentrated formula clings to upright surfaces longer for more effective cleaning power. Do not use TLC® surface cleaner on marble, porcelain, terrazzo, enamel surfaces or bronze and metallic glazed tiles, or other surfaces not intended for cleaning.

#3434 quart bottle \$15.94

Usage: Always wear rubber gloves with a sponge, cloth or soft brush for application. Allow 3 minutes while it bubbles then scrub briskly.



STAIN PREVENTION/ MINERAL CONTROL

B. STAIN MAGNET

This granular formula quickly eliminates metallic stains from pool surfaces with no need to test the water or close the pool. It is compatible with most types of pool surfaces.

#3420 2½ lb. Granular \$28.60

C. SEQUA-SOL® SEQUESTERING AGENT

Sequa-Sol® sequestering agent holds iron, manganese, copper and calcium in solution so they do not react with other elements in the water. It prevents staining, scale and rust on pool equipment, pipes and fittings. Protects pool equipment and surfaces from stains, scale and ruse.

#3410 quart bottle \$24.20

Dosage: initial treatment 16 fl. oz. per 10,000 gallons of water. Weekly treatment: 4 fl. oz. per 10,000 gallons of water.



STAIN PREVENTION/ MINERAL CONTROL Cont.

D. SUPER SEQUA-SOL® SEQUESTERING AGENT

This concentrated granular is specially formulated to protect pool surfaces from minerals in the water and is ideal for use with hard water. It is also great for pool openings or when adding make-up water. Helps neutralize small quantities of stain-producing minerals such as iron, copper or manganese that occur when adding make-up water or initially filling a pool.

#3414 2 lb. bottle \$35.86

Dosage: initial treatment 10 oz. per 10,000 gallons of water. Weekly treatment: 2 oz. per 10,000 gallons of water.



FILTER CLEANERS

E. FILTER CLEANSE

This multi-purpose granular formulation cleans and unclogs all types of swimming pool filters of grease, oils and scale with a combination of acids and detergents. Its unique chemistry will gradually change from red to yellow as it cleans. Use routinely once every month or two during season to maintain efficient operation.

#3426 2 lb. bottle \$23.04

Dosage: Dissolve 1 lb. in 5 gallons of lukewarm water and let soak overnight (at least 12 hours).



Advantis®

TECHNOLOGIES
An Arch Chemicals Business

POOL PRODUCTS

F. FILTER FRESH® FILTER CLEANER

This specially developed acid-based liquid cartridge cleaner removes debris overnight. Regular treatment with this soak-and-rinse formula helps filters operate at maximum efficiency. Removes body oils, suntan lotions, grease and other organic materials as well as scale and mineral buildup from all swimming pool filters

#3629 quart bottle \$16.15

Dosage: 16 fl. oz. of Filter Fresh with every 2½ gallons of lukewarm water, then place elements in solution and allow to soak for 12 hours.



G. FILTER RINSE

This backwashing aid for sand filters couldn't be easier to use! Just pour it into the pool skimmer to clear sand particles of caked-on organic and inorganic materials. One-step formula cleans sand filters fast. Renews the sand particles and keeps the filter operating at maximum efficiency.

#3499 quart bottle \$20.54

Dosage: Adding filter rinse to the skimmer during the backwash cycle removes this caked-on material, and permits free and even water flow through the sand. 8 oz. per backwash.



833-SWIM-327
8 3 3 • 7 9 4 6 • 3 2 7
www.halogenupply.com

CHEMICALS

CHEMICAL PRODUCTS BY ALL CHEM



A. PROSHOCK
(Calcium Hypochlorite)-68% available chlorine in powder form. Destroys bacteria, algae, and fungi. Can be manually poured into pool or fed through a chlorinator.
(Formerly HTH)

- A. #3305 1-lb. bag \$6.38
- #PTH5-305 50-lb. pail \$267.92
- #308 100-lb. pail \$404.00



B. SUPER PROSHOCK
(Calcium Hypochlorite)-73% It is a more powerful shock treatment with more of the benefits pool owners look for. 73% available chlorine. No need to pre-dissolve because it quickly dissolves in less than a minute.
(Formerly HTH)



- B. #PTH5-351 1-lb.(73% shock) \$8.00
- #PTH5-358 5-lb.(73% shock) \$39.80
- #PTH5-355 50-lb.(73% shock) \$315.92



D. PULSAR TABLETS
A specially blended form of calcium hypochlorite (65% available chlorine). The pellets contain an additive that reduces the scale usually associated with calcium hypochlorite solutions. These patented pellets have a uniform dissolution rate, and provide steady, uniform chlorination of pool water.

- #165-50 50-lb. drums P.O.A.
- Call for Pallet Pricing

CHEMICALS



E. HAL-O-CHLOR (liquid chlorine)
12-15% sodium hypochlorite solution. Kills bacteria, algae and is used as disinfectant and deodorizer. Poured into pool directly or fed by chlorinator. Available in 1 gallon size throwaways.
#302 1-gal. \$8.85

833-SWIM-327
833-7946-327
www.halogensupply.com

NON CHLORINE SHOCK



F. PROTECH – NO CHLOR
No Chlor is an auxiliary, non-chlorine shock treatment. It oxidizes organic materials in pool water and allows swimming immediately after use. Use on a regular weekly basis to improve the efficiency of your sanitizing chemicals.

- #3311 1-lb. bag \$7.90
- #3313 6-lb. container \$43.52
- #3309 25-lb. pail \$159.36
- #3310 50-lb. pail \$301.00



G. THE BUG
Devours scum, slime and grime from pools and spas
• Absorbs 40 times its weight in body oils and lotions
• 300% more surface area than the ball and cannot be closed in the water lines • When one side is scummy flip over, when saturated clean and reuse • Under normal conditions The Bug should last an average season.
#SB-2 Double Pak \$16.40



H. BUGMITT
• Abrasive pad is permanently bonded to the latex mitten
• Ideal for fiberglass, acrylic, vinyl and tile
• Scour powder designed specifically to remove scum lines from pools and spa.
#SD-1 \$10.37



I. BUG HOUSE
Traps debris, scum and bugs in most skimmer baskets. Place Bug House inside basket with stretch elastic binding for over the rim.
#BH-3 . . . \$6.93



J. ALGAE BUGGER
Great for cleaning Sand and DE Filters plus cartridge filters. Ideal for hundreds of other uses. Algae Bugger features a shut off valve for easy control. Simply attach to garden hose.
#AB-1 \$19.69



K. BUG-STRIP
Repairs fabric for solar and winter covers.
• Easy to apply
• Unsurpassed adhesion
• Ultraviolet resistant
• High strength reinforced.
#BS-1 . . . \$12.65



L. POLLEN BUG-A-BOO
Collects pollen, foam, minute insects & surface oils.
#PB-2 . . . \$10.32

ALGAEICIDES



- A. PROTECH – ALGAEICIDE 30**
Dual acting, concentrated algaecide, specially formulated with 30% polyquat. Non-foaming.
- | | |
|------------------------|---------|
| #3320 quart | \$26.75 |
| #3431 gallon | \$95.53 |



- B. PROTECH – ALGAEICIDE 60 PLUS**
Dual acting, concentrated algaecide which prevents and kills black and mustard algae. Specifically formulated with 60% polyquat. Non-foaming.
- | | |
|-----------------------|---------|
| #3324 quart | \$32.90 |
|-----------------------|---------|



- C. PROTECH – COPPER ALGAEICIDE**
Economically priced. Copper algaecide is specially formulated for the smaller volume vinyl pool.
- | | |
|-----------------------|---------|
| #3352 quart | \$21.53 |
|-----------------------|---------|



- D. YELLOW OUT by Natural Chemistry**
- Amazing algae cleanup results when used prior to shock treatment with a EPA-Registered compound that kills green and mustard algae.
 - 2lbs per 15,000 gallons of water.
- | | |
|-----------------|---------|
| #3399 | \$17.77 |
|-----------------|---------|

CLARIFIERS



- E. PROTECH – CLARIFIER**
Highly concentrated water clarifier. Removes small, non-filterable particles by enlarging them to a filterable size. Does not affect pH.
- | | |
|-----------------------|--------|
| #3318 quart | \$8.95 |
|-----------------------|--------|



- F. PROTECH – SUPER CLARIFIER**
For the most healthful sparkling clean water possible use super clarifier once a week for desired water clarity.
- | | |
|------------------------|---------|
| #3334 quart | \$11.80 |
| #3421 gallon | \$38.65 |



- G. PROTECH – 4 IN 1 NATURAL CLARIFIER**
- Clarifies cloudy water
 - removes excess metals
 - eliminates oil & scum lines
 - improves filter efficiency.
- | | |
|--|---------|
| #3327 1 quart (10 oz. per 5000 gal.) | \$19.55 |
| #3407 gallon | \$65.38 |



- H. PROTECH – SUPER FLOC OUT**
Thoroughly settles unfilterable suspended debris to the pool bottom so debris may be easily vacuumed to waste.
- | | |
|-----------------------|---------|
| #3351 quart | \$13.03 |
|-----------------------|---------|

STAIN PREVENTION & METAL CONTROL



- J. PROTECH – METAL OUT PLUS**
Super-sequestrant prevents stains caused by iron, copper and manganese in pool water and spa water.
- | | |
|------------------------|---------|
| #3312 quart | \$24.10 |
| #3412 gallon | \$88.38 |

SPECIALTY CLEANERS



- K. PROTECH TILE & VINYL CLEANER**
Concentrated cleaner for use in and around all pools and spas. Removes oil, grime and scale deposits.
- | | |
|-----------------------|---------|
| #3325 quart | \$10.93 |
|-----------------------|---------|



- L. PROTECH POOL COVER CLEANER**
Cleans and deodorizes solar or winter cover. Removes stubborn stains. Easy to apply and rinse.
- | | |
|-----------------------|---------|
| #3326 quart | \$16.75 |
|-----------------------|---------|



- I. PROTECH SPA DEFOAMER**
Liquid that controls foaming and sudsing in spas.
- | | |
|------------------------|---------|
| #3331 quart | \$18.73 |
| #3639 gallon | \$61.78 |

CHEMICALS



- N. DDDS-PINE (WAS HAL-PINE)**
DDDS cleans, disinfects, deodorizes and sanitizes floors, walls, and bathrooms. 2 1/2 oz. of DDDS-Pine per gallon of water. Pine scented.
- | | |
|--------------------------|---------|
| #3116 1 gallon | \$30.22 |
|--------------------------|---------|



- O. HAL-TILE CLEANER AND BRIGHTENER**
Use anywhere there is iron, rust, oxidation, hardwater stains, soap scum, magnesium and calcium stains, excellent on tiles and shower stalls.
- | | |
|------------------------|---------|
| #3106 gallon | \$32.40 |
|------------------------|---------|

STAINLESS STEEL CLEANING PRODUCTS



- P. CITISURF 2310** is a high quality blend of chemicals formulated for cleaning, rust removal and passivation of stainless steel products. CitriSurf 2310 is specifically designed to provide low cost and efficient removal of all rust and free iron from the surface of stainless steel and other metals, providing the highest chrome oxide levels possible.
- | | |
|--|---------|
| #CF1-2310 Citrisurf 1 Gallon | \$92.75 |
|--|---------|



- Q. RUST + RESCUE 200** is a high quality blend of chemicals formulated for the protection of stainless steel and other metal surfaces from moisture and harsh atmospheric chemicals that could lead to corrosion.
- | | |
|---|----------|
| #RR1-200 Rust + Rescue 1 Gallon | \$133.00 |
|---|----------|

TSP
TRI-SODIUM
PHOSPHATE
55 lbs.

- R T.S.P. (TRI-SODIUM PHOSPHATE)**
- Removes dirt, grease and oils to prepare pool surfaces for painting.
 - Removes dirt, grease and oils from filter cartridges and filter elements.
- | | |
|------------------------------|----------|
| #331-50 55-lb. bag | \$148.68 |
|------------------------------|----------|

STABILIZED CHLORINE & BROMINE

CHLORINE



A. PROTECH – DICHLORO 56% CONCENTRATED CHLORINE

Is the best stabilized granular chlorine on the market with a 56% available chlorine and 99% active ingredient. This chlorine leaves no residue and will be protected from the sun's damaging rays that affect chlorine. This quick dissolving granular stays effective against algae and bacteria longer than non-stabilized chlorine.

- #3375 2 lb. bottle \$21.94
 - #3376 5 lb. pail \$46.58
 - #3380 25 lb. bucket \$177.12
 - #3381 50 lb. bucket \$341.42
- All 25 lb. & 50 lb. buckets come with childproof easy-open lids.



B. PROTECH 3" TABLETS – 8 Oz. each

Is an 8 oz. 3" doughnut shaped stabilized **slow** dissolving chlorine tablet. Each giant Trichlor tablet has the power of **90%** available stabilized chlorine with 99% active ingredient. Works great in floaters, skimmers or almost any automatic chlorine feeders.

- #3300 5 lb. pail – 10 tablets \$40.50
- #3301 10 lb. pail – 20 tablets \$74.20
- #3303 25 lb. bucket – 50 tablets \$159.25
- #3304 50 lb. bucket – 100 tablets \$305.00

All 3" tablets come wrapped individually except 50 lb. & 25 lb. containers. All 25 lb. & 50 lb. buckets come with childproof easy-open lids.



C. PROTECH 1" TABLETS –

1/2 Oz. each
Is a 1/2 oz. stabilized **slow** dissolving chlorine tablet with **90%** available stabilized chlorine and 99% active ingredient. This tablet will leave no residue when totally dissolved in water. Ideal for floaters, skimmers or almost any automatic chlorine feeders.

- #3333 5 lb. pail \$54.02
 - #3337 25 lb. bucket \$204.26
- All 25 lb. & 50 lb. buckets come with childproof easy-open lids.

BROMINE



D. PROTECH –

BROMINATING TABLET

Is a 63% available bromine and 31% available chlorine. Bactericide-algaecide disinfectant for pools and spas. Bromine is much more effective over a wider pH range and is less irritating to your eyes and skin. Recommended use in an automatic bromine feeder.

- #3339 4 lb. pail \$64.94
- #3340 1 1/2 lb. bottle \$25.20
- #3343 25 lb. bucket \$325.24
- #3345 50 lb. bucket \$541.20

All 25 lb. & 50 lb. buckets come with childproof easy-open lids.

NOTE: There is a Hazardous Fee on all Bromine, ProTech 1" & ProTech Sticks if shipped by UPS for **\$30.00**

POOL CHLORINATORS



E. ELONGATED FLOATING CHLORINATOR

Elongated large floating chlorinator. Holds up to 4 lbs of tabs or sticks.

- #B8072 Large Floating Chlorinator \$17.39

F. RAINBOW FLOATING CHEMICAL DISPENSER

Adjustable floating chlorine feeder that has twist lock cap. Holds six 3" trichloro tablet or 3 lbs. of 1" tablets.

- #307 Rainbow floater \$19.68

SPA CHLORINATORS



G. RAINBOW CHLORINE/BROMINE FLOATING DISPENSER

For spas and small swimming pools. Chlorine, bromine tablets or sticks up to 1 1/8" diameter.

- #307A Chlorine/Bromine floater \$20.62



H. ACID MAGIC

A full strength muriatic acid replacement that is safer to ship, store and handle.

- Up to 90% less fumes than traditional muriatic acid.
- Buffering agents prevent burns to intact skin.
- Equal in strength to 20° baume muriatic acid(31.45%).
- Direct one-to-one replacement for muriatic acid.

Pools And Spas: Excellent pH down, alkalinity reducer and filter cleaner. Apply ACID Magic as an acid wash to remove rust, scale, mineral deposits and stains from glass, tile, and porcelain surfaces in showers, locker rooms and restrooms.

- # USA/128-1 1 Gallon \$16.16
- # USA/5G-1 5 Gallons \$90.52
- # USA/15G-1 15 Gallons \$241.58



I. POOL SALT

- High purity salt for use with salt water chlorinators.
- Quick Dissolving • Contains no YPS
- Meets recommendations of leading chlorinator manufacturers

- #SALT-40 40lb bag \$12.10

Guide for 40lb. bags of salt required to increase salt level

| Pool Gallons | 10,000 | 15,000 | 20,000 | 25,000 | 30,000 |
|----------------|--------|-----------|---------|----------|---------|
| Salt 480 ppm | 1 Bag | 1.5 Bags | 2 Bags | 2.5 Bags | 3 Bags |
| Salt 3,200 ppm | 7 Bags | 10 Bags | 13 Bags | 17 Bags | 20 Bags |
| Salt 4,000 ppm | 8 Bags | 12.5 Bags | 17 Bags | 21 Bags | 25 Bags |

POOL ENZYME PRODUCTS



A. Pool Perfect - Just Capfuls Per Week for Clear Perfect Pool Water: The industry standard for natural enzyme water treatment. Pool Perfect prevents scum and waterline ring. It eliminates chemical odors, keeps filters cleaner, extends filter life and reduces shocking.

#03220 2 L/67.6 \$34.36



B. Pool First Aid - The Pool Problem Solver: Combines powerful broad spectrum natural enzyme formula with our organic clarifier to fix pool problems fast.

#03122 2 L/67.7 oz. \$27.70

(2L/67.6oz treats 33,500 gallons)



C. Pool Magic Spring & Fall - For Hassle Free Spring Startup:

Contains a concentrated natural enzyme based formula designed specifically to work in cold water. It quickly breaks down non-living organic contaminants, and cleans up cloudy, dirty pool water.

#03722 1 L/33.9 oz. \$19.86

(1L/33.9oz treats 25,000 gallons)

PHOSPHATE REMOVAL PRODUCTS



D. PHOSfree - Eliminates Phosphates from Pools: Use Natural Chemistry's unique patented formula to reduce phosphate levels in a pool to near zero at initial fill or at season opening. The amount needed depends on pool size and phosphate level in the water.

#05221 2 L/67.6 oz. \$30.08

#05121 3 L/101.5 oz. \$40.10

(1L/33.9oz treats 20,000 gal. pool with 300ppb phosphates)



E. Pool Perfect+PHOSfree

A weekly maintenance product that reduces phosphates and non-living organic waste in pool water. Use it to make your water feel soft and silky while preventing problems such as; waterline rings, non-living organic staining, surface oils, and phosphate build up.

#05235 2 L/67.6 oz. \$47.32

#05131 3 L/101.5 oz. \$66.42

(1 capful weekly treats 8,000 gallons)



F. Pool Magic+PHOSfree

Ideal to treat your pool at the beginning and end of each season as well as reducing phosphates at any time as the first step of Natural Chemistry's Clear, Perfect Water Program. Pool Magic+PHOSfree contains all natural enzymes that break down non-living organics to make opening and closing fast and easy. A quick clean up to start off the season.

#05141 1 L/33.9 oz. \$25.36

(1L/33.9oz treats 25,000 gallons)

METAL AND SCALE CONTROL



G. Stain Free - Extra Strength:

An all natural citric acid product that eliminates metal staining to pool liners and finishes. Stainfree is ideal for treating staining on all pool surfaces. Use with Natural Chemistry's METALfree and you have the ultimate 1-2 combination for stain fighting!

#07395 1.75lbs. \$39.10



H. METALfree - Deactivates Metals:

A highly effective metal deactivation agent that prevents staining and discoloration from trace metals such as iron and copper. METALfree also prevents scale build-up due to calcium and other minerals. These trace metals and minerals may already be in the pool water or in the fill water. METALfree does not contain phosphonic acids and will NOT raise phosphate levels in pool water.

#07001 1 L/33.9 oz. \$25.72

(1L/33.9oz treats 20,000 gallons)



I. SCALEfree:

Protects your pool from the damaging effects of scale build-up and staining due to excessive calcium, iron, copper, and other minerals. SCALEfree protects generator cells from life shortening damage and performance issues caused by scale build-up. SCALEfree is compatible with all pool surfaces and can be used with most sanitizing systems.

Do not use SCALEfree with biguanides.

#07511 2 L/67.6 oz. \$40.56

POOL SPECIALITY PRODUCTS



J. Clear & Perfect Clarifier - The Ultimate 6 in 1 Clarifier:

A technologically advanced and highly concentrated pool water clarifier. Use to effectively and quickly clear problem water or to "polish" dull water by removing small suspended particles that filters cannot capture. Clear & Perfect is not pH sensitive, does not affect pool water pH. Does not contain any dyes.

#03500 1 quart/32 oz. \$21.58



K. Instant Pool Water Conditioner:

Used for stabilizing chlorine in swimming pools from sunlight loss. Works the instant it is added to pool water!

- Concentrated liquid, one gallon will add 32 ppm of conditioner to 10,000 gallons.
- Works efficiently in any water temperature

#07401 1 gallon/3.78L \$35.42



L. Filter Perfect - Sand and Cartridge Filter Cleaner:

A highly concentrated deep cleaning solution that removes build up caused by; oils, grease, non-living organics, and more on filters. It is very effective on cartridge elements, DE filter grids, and sand filters. Filter Perfect improves filter efficiency and lengthens cycles between filter cleanings.

#03215 1 L/33.9 oz. \$19.34

(1L/33.9oz treats average size filter.)



M. COVERfree:

A patented technology that is a revolutionary liquid swimming pool cover. It is an advanced mono-layer product that helps save water and money by decreasing evaporation and heat loss. COVERfree creates an invisible barrier on the surface of the water that works even when swimmers are in the pool.

#07100 1 quart/32 oz. \$27.52

(4oz per 20,000 gallons weekly)

NATURAL CHEMISTRY

PRO SERIES

Professional Strength - Professional Results



N. PRO SERIES® ProZymes

PRO SERIES ProZymes Pool reduces the buildup of non-living organic contaminants. Sunscreens, body oils, lotions, cosmetics along with other contaminants make up the non-living organic load that contribute to problematic symptoms such as: waterline rings, short cycling filters, unpleasant odors, poor water clarity and peak load cloudiness. This concentrated naturally based enzyme formula works with all sanitizing systems.

#20305 5 gallon \$290.20



O. PRO SERIES® Stain & Scale Control:

PRO SERIES Stain & Scale Control protects pools from the damaging effects of scale buildup and staining due to excessive calcium, iron, copper and other minerals. It works without the use of phosphates or harsh acids. This product also works very well at preventing/reducing scale from forming on chlorine generator cells and UV crystal lens. It can be used with most sanitizing systems (do not use with biguanides) and is compatible with all pool surfaces

#20705 5 gallon \$307.24



P. PRO SERIES® PhosREMOVE:

Reducing phosphate levels in swimming pools is easy with Natural Chemistry's PRO SERIES phosREMOVE. This product is a lanthanum based formulation. PRO SERIES phosREMOVE effectively and efficiently removes phosphates and reduces pool problems!

#20505 5 gallon \$461.36



Q. PRO SERIES DUAL-ACTION ALGAEICIDE:

PRO SERIES® Dual-Action Algaecide™ is a highly effective fast acting swimming pool algae destroyer. This product kills all types of pool algae: black algae, green algae, and mustard algae. This product is formulated to complement most swimming pool sanitizers. This product is effective and non-staining when used as directed. When used as directed you will see results in 24 hours. PRO SERIES® Dual-Action Algaecide™ is non-foaming and can be used in pools with attached spas or jetted returns.

#20605-PRO 1 gallon \$96.90

SPA PRODUCTS



R. Spa Perfect - One Capful Per Week* for A Perfect Spa:

Specifically formulated for hot water temperatures and is a patented natural enzyme and botanical extract formula that powerfully, yet gently biodegrades body oils, cosmetics, suntan oils, and other non-living organics. No more waterline rings, clogged filters or cloudy smelly water. Spa Perfect is also a continuous cartridge filter cleaner. Since oils don't build up, cleaning with nasty chemicals and acids is rarely required.

#04021 16 oz. \$9.48

#04131 1 L/33.9 oz. \$18.74

#04034 2 L/67.7 oz. \$33.04

* 1 capful per week treats 400 gallons



S. Spa Purge - Spa Plumbing Cleaner:

Restores spa plumbing to original condition. Removes built-up organic waste deposits from all spa plumbing. Easy and very safe to use. Cleans where you can't.

#04137 1 L/33.9 oz. \$19.34

(1L/33.9oz treats any size spa.)



CURRENT RESIDENT or

PRESORTED
STANDARD
U.S. POSTAGE
PAID
ALGONQUIN, IL
PERMIT NO. 13

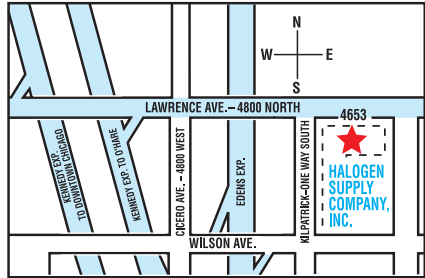

We're Easy to Find.
Just minutes away!

Halogen brings innovative solutions that offer savings on natural resources and in turn, extend your dollars.

Whether you're thinking about a new aquatic facility or a retrofit of your existing pool. Combine **Halogen's Total-System Approach** with our hands-on technical support, project management emphasis, and customer advocacy. The solutions, savings and advantage you receive are clear! **Call our Commercial Division at 1.833.SWIM.327**

Morton Grove Park District – Morton Grove, IL

- Five bodies of water
- Lap Pool ~ 250,000 gallons
- Deep Pool ~ 213,000 gallons
- Plunge Pool ~ 18,000 gallons
- Tot Pool and Splash Pad
- EC500S Regenerative D.E. Filter
- EC350S Regenerative D.E. Filter
- EC145 Regenerative D.E. Filter
- HALO Gen.RTS Regenerative Total System Controller X 3
- HALO Gen.CS Custom System Controller
- Close Coupled Pumps, (1) 25HP, (1) 20HP, (1) 15HP, (4) 7.5HP, (1) 5HP (X 8)
- Danfoss Variable Frequency Drives X 10
- Raypak XTherm Hi-Efficiency Heater
- Raypak X94 Hi-Efficiency Heater
- Raypak Professional Series NG Heater X 3



Photos courtesy of © 2022 Kmiecik Imagery