



INSTALLATION GUIDE | PUBLIC

SAP Marketing

Document Version: 1.03 – 2019-01-11

Installation and Configuration Guide 1809

Content

- 1 Introduction. 7**
- 1.1 About this Document. 7
- 1.2 Feedback. 7
- 1.3 Licenses of SAP Marketing. 8
- 1.4 Integration. 8
- 1.5 SAP Notes for Installation. 9
- 2 Technical System Landscape. 11**
- 3 Deployment Scenarios. 14**
- 3.1 Scenario A: Standalone Deployment. 15
- 3.2 Scenario B: Hub-Deployment with Separate SAP HANA System. 15
- 3.3 Scenario C: Hub-Deployment with Shared SAP HANA System of SAP Business Suite. 16
- 3.4 Scenario D: Hub-Deployment with Shared SAP HANA System of Other Application. 18
- 4 Development and Production Systems. 20**
- 5 Installation. 21**
- 5.1 Installation of the SAP HANA Platform. 22
 - Correct Sizing of the SAP HANA Database. 22
 - Installing the SAP HANA Database. 22
 - Updating to Higher Revisions of the SAP HANA Database. 22
 - Installing the SAP HANA Application Function Library (AFL). 23
- 5.2 Installation of Foundation on ABAP Platform and SAP Marketing. 23
 - Up-to-Date Installation Using Maintenance Planner. 24
- 5.3 Installing SAPUI5 Tools and ABAP Development Tools. 25
- 5.4 Implementation of SAP Notes Listed in Release Information Note. 26
- 6 Data Replication. 27**
- 6.1 Installation of SAP Landscape Transformation Replication Server. 27
 - Connection Setup between SAP Marketing and SAP LT Replication Server. 27
 - Connection Setup between SAP Marketing and SAP Source System. 28
 - Basic Configuration of Data Replication. 29
- 7 Post-Installation. 30**
- 7.1 Application Configuration and Customizing. 31
 - Initial Customizing Adjustment. 31
 - Customizing via SAP Solution Manager. 32
- 7.2 Configuring the SAP HANA Database. 32

	SAP HANA User for Technical Configuration.	32
	Enabling the Script Server for the Tenant Database.	34
	Authorization Settings for Deployment Scenario C: Hub-Deployment with Shared SAP HANA System of SAP Business Suite.	34
7.3	Profile Parameter Settings.	35
	Configuring HTTPS.	36
	Configuring the Secure Sockets Layer Protocol.	36
7.4	Configuring the SAP Web Dispatcher.	37
7.5	Prerequisites in AS ABAP System.	41
	User for Application Setup.	41
	Maintaining the Client.	44
	Creating Development Packages.	45
7.6	Using the Technical Configuration Cockpit.	46
	Section "Overview".	46
	Section "Scenarios".	48
7.7	Applying Technical Configuration Artifacts to Production System.	61
	Releasing Transport Requests in Development System.	61
	Importing Transport Requests and Executing Technical Configuration in Production System	62
7.8	Initial Setup of SAP Fiori.	62
7.9	Displaying the SAP Online Documentation.	63
7.10	Defining a Virus Scan Profile.	64
7.11	Generating Authorization Profiles for the User Interface.	65
7.12	Generating the URL for Displaying the User Interface.	67
8	General Configuration Settings in SAP Marketing.	69
8.1	Setting up Integration with SAP Jam.	69
9	Configuring Data Management.	71
9.1	Sentiment Engagement (Optional).	71
	Setting up Data Harvesting.	71
	Setting up SMTP for Post Groups (Send Email to Me).	72
9.2	Scoring.	73
	Scoring Including SAP Predictive Analytics.	73
	Scoring Based on SAP HANA Rules Framework (HRF).	73
	Predictive Model Training Based on [nu]-Support Vector Machine (R).	73
9.3	Web Shop Personalization Based on Customer Segments.	74
9.4	Customer Journey Insight.	74
	Setting up Customer Journey Insight.	75
	Setting up Customer Journey Events.	76
9.5	Setting up Applications for Data Import.	76
9.6	Setting up Application "Business User".	77

9.7	Setting up Application "Digital Accounts".	77
9.8	Marketing Locations.	78
	Setting up Marketing Locations.	79
9.9	Google Analytics Integration (Optional).	79
9.10	Marketing Agencies.	80
	Setting up Marketing Agencies.	80
9.11	Setting Up the Use of Agreements.	80
10	Configuring Insight.	83
10.1	Configuring SAP Analytics Cloud.	83
	Setup for SAP Marketing Business Users.	84
	Creation of SAP Marketing Business Users.	84
10.2	SAP CRM Business Transactions and SAP Marketing Interactions.	84
10.3	Importing Data from External Source to "Margin Decomposition".	85
10.4	Enabling Customer Value Intelligence Applications.	86
11	Configuring Segmentation.	87
11.1	Dialog Work Processes.	87
11.2	Geospatial Segmentation (Optional).	87
11.3	Geospatial Segmentation with Baidu Maps.	89
12	Configuring Recommendation.	90
12.1	Post-Installation Steps.	90
	Adapting Customer Channels for New Integration Scenarios.	90
	Configuring Offer Management and Coupons.	90
13	Configuring Planning.	94
13.1	Setting up "Budget Plans".	100
13.2	Setting up "Marketing Plans".	102
13.3	Setting up "Programs".	103
13.4	Setting up Spend Management.	104
13.5	Setting up "Marketing Calendar".	106
14	Configuring Acquisition.	109
14.1	Configuring Campaigns.	109
	Prerequisites.	109
	Setting Up Service Provider for Emails and Text Messages.	111
	Setting Up Suppression Rules.	148
14.2	Setup for Content Studio.	148
	Customizing Settings.	149
	Setting up Display of Campaign Emails in a Browser.	150
14.3	Integrations.	150
	Setting up Integration with AdWords Campaigns (Optional).	151

	Setting up Integration with SAP CRM (Optional)	154
	Setting Up Call Center Integration (Optional)	154
14.4	Configuring the Marketing Calendar.	157
14.5	Configuring the Journey Tab in Campaigns.	157
15	Configuring Manager-Related Tasks.	158
15.1	Configuring Workflow.	158
16	Configuring WeChat Integration.	160
17	Configuring LINE Integration.	161
18	Frequently Asked Questions.	162
19	SAP Notes for Installation and Upgrade.	163
20	Appendix.	164
20.1	Technical Configuration - Expert Mode.	164
20.2	Replicated Tables in SAP Marketing.	165

Document History

Before you start, make sure you have the latest version of this document. You can find the latest version at the following location:

<https://help.sap.com/mkt-op> ► *Installation and Upgrade* ►

i Note

Make sure that the required version is selected in the upper right corner of the Help Portal page.

The following table provides an overview of the most important document changes.

Document History

Version	Date	Description
1.0	2018-09-24	Initial version for SAP Marketing 1809
1.01	2018-11-14	Chapters added: <ul style="list-style-type: none">• Setting Up Suppression Rules [page 148] Chapters adapted: <ul style="list-style-type: none">• Scenario "HANA Rules Framework" [page 53]• Configuring Workflow [page 158]
1.02	2018-12-04	Chapters adapted: <ul style="list-style-type: none">• Scenario B: Hub-Deployment with Separate SAP HANA System [page 15]• Scenario C: Hub-Deployment with Shared SAP HANA System of SAP Business Suite [page 16]• Scenario "ERP Integration" [page 51]• Generating Authorization Profiles for the User Interface [page 65]• Replicated Tables in SAP Marketing [page 165]
1.03	2019-01-11	Chapter adapted: <ul style="list-style-type: none">• Configuring Workflow [page 158]

1 Introduction

This installation guide describes how to install the high-performance application SAP Marketing on premise. The application can also be operated in the SAP HANA Enterprise Cloud, under the name SAP Marketing Cloud with a separate license.

1.1 About this Document

This guide applies to consultants and system administrators who intend to install one or more of the components of SAP Marketing. It covers both the technical side (how installation is done) and the functional side (for example, customizing activities).

- **Constraints:**

This guide provides you with the main application-specific installation and configuration steps. The installation and configuration of the underlying SAP HANA platform and the required foundation on ABAP platform are not described in this installation guide in particular, but in separate documentation, referenced where necessary.

- **Considerations:**

- The sections and instructions in this guide are relevant for all above mentioned components unless otherwise expressly indicated.
- Access to the separate solutions is managed via the corresponding authorization roles. For more information about activating roles, see [Generating Authorization Profiles for the User Interface \[page 65\]](#).
- Before starting the installation make sure that you are aware of all required installation steps that have to be executed before the actual installation of the application. The prerequisites are mentioned in this document.

i Note

In the PDF version of this guide, some links to certain topics may be missing. All links are available in the HTML version of the guide.

1.2 Feedback

We'd really like to know what you think of the quality, structure or content of this guide. Please send your feedback to us at <mailto:feedback4sapmarketing@sap.com>.

1.3 Licenses of SAP Marketing

SAP Marketing contains the following licenses that can be purchased separately:

- SAP Marketing Data Management (mandatory)
- SAP Marketing Insight
- SAP Marketing Segmentation
- SAP Marketing Recommendation
- SAP Marketing Planning
- SAP Marketing Acquisition

Any licensing of SAP Marketing includes the marketing platform SAP Marketing Data Management. In addition, the common objects such as Target Group, Campaign, Interaction, Export Definition, Predictive Model, or User Lists are always available regardless of the purchased license.

For a brief description of the SAP Marketing licenses and the corresponding applications, see [Applications and Price List Components](#) on the SAP Help Portal at:

<https://help.sap.com/mkt-op> ► [Application Help](#) ► [SAP Marketing](#) ►

1.4 Integration

SAP Marketing is based on the SAP HANA appliance software, in particular the SAP HANA database, and the foundation on ABAP Platform 1809, version for SAP HANA.

The SAP HANA database must be available and configured with the latest revision of the current support package before starting the actual installation of SAP Marketing. You can check the exact support package and required revision levels in the [Preconditions](#) section of Release Information Note [1885803](#).

For more information about how to receive the latest revision of the SAP HANA database, see section [Updating an SAP HANA System Landscape](#) in the *SAP HANA Master Guide* on the SAP Help Portal at:

http://help.sap.com/hana_platform ► **Select the required version in the "Version" field** ► [Installation and Upgrade](#) ► [SAP HANA Master Guide](#) ► [SAP HANA Implementation and Operation](#) ► [Updating an SAP HANA System Landscape](#) ►

In addition, if you plan to use SAP ERP and/or SAP CRM as source system to operate your marketing, sales, and/or service business, the following releases are proposed for the different solutions:

SAP Marketing License	SAP ERP	SAP CRM
SAP Marketing Insight	6.0 or higher (mandatory)	7.01 (SP04 plus SAP Note 1995798) or higher (optional)
SAP Marketing Segmentation on SAP ERP Accounts	6.0 or higher (mandatory)	7.01 (SP04 plus SAP Note 1995798) or higher (optional)

SAP Marketing License	SAP ERP	SAP CRM
SAP Marketing Segmentation on SAP CRM Business Partners	6.0 or higher (optional)	7.01 (SP04 plus SAP Note 1995798) or higher (mandatory)
SAP Marketing Data Management	6.0 or higher (optional)	7.01 (SP04 plus SAP Note 1995798) or higher (optional)
SAP Marketing Recommendation	6.0 or higher (mandatory)	

The solutions SAP Marketing Acquisition and SAP Marketing Planning do not use SAP ERP or SAP CRM data.

Browser Recommendations

For a recommendation concerning the appropriate browser platform to run the application, refer to the Product Availability Matrix (PAM) at <http://support.sap.com/pam>. In the PAM, enter **SAP MARKETING 1809** in the "Find Product Versions" field in the upper right corner and select the corresponding entry in the search results. In the *Details for Product Version SAP MARKETING 1809*, select tab *Technical Release Information* and then *Web Browser Platforms*.

1.5 SAP Notes for Installation

The Release Information Note (RIN) contains general installation information concerning SAP Marketing.

You find the RIN under <https://launchpad.support.sap.com/#/mynotes>. Enter the RIN number **1885803** in the corresponding field in the upper right corner of the screen.

i Note

Ensure that you have carefully read the RIN before you implement the included SAP Notes. The RIN contains information about the exact point in time for the implementation of every included SAP Note:

- Before the import of the support package
- Before executing the technical configuration
- After executing the technical configuration
- SAP Note only relevant for a certain solution scope

If there is additional information or updates to the installation process described in this installation and configuration guide, you find the corresponding information in the SAP Notes mentioned below in the table.

Make sure that you have the up-to-date version of each SAP Note, which you can find on the SAP Support Portal at: <https://launchpad.support.sap.com/#/mynotes>.

SAP Note Number	Title	Description
Release Information Note 1885803	RIN SAP Marketing (formerly SAP Customer Engagement Intelligence)	Contains information and references in the context of applying SAP Marketing
Note 2076331	Follow Up Tasks after System Copy	Contains information about the actions to be carried out after system copy

2 Technical System Landscape

SAP Marketing is based on the following components:

- SAP HANA 2.0, SPS03 or higher
- Foundation on ABAP Platform 1809, version for SAP HANA, including the following components:
 - ABAP Platform 1809, version for SAP HANA (ABAP FND 1809 ON HANA)
 - SAP Business Suite Foundation (S4FND 103 DEV)
 - SAP MDG Foundation (MDG_FND 803 SP00 or higher)

Full Set of Included Components

Product	SAP Marketing
Release	1809
Based On	<ul style="list-style-type: none">• HANA RULES FRAMEWORK 1.0 SP11 PL3+• SAP HANA 2.0, SPS03 - APL 3.3• XI Content SAP Marketing 140 SP00• UICUAN 140 SP00• SAP_CUAN 140 SP00• UIBAS001 400 SP00• ABAP FND 1809 ON HANA - ABAPFND 100• MDG_FND 803 SP00• S4FND 103 DEV• NW 753• SAP_UI 753• HANA 2.0 SPS03 - AFL• HANA 2.0 SPS03 – Revision 3X
Documentation Published	September 24, 2018

i Note

Most applications within SAP Marketing such as *Customer Journey Insight*, are SAP Fiori apps. All SAP Fiori apps are directly deployed on the SAP Marketing server.

All these components are embedded in the SAP Fiori launchpad that is based on HTML5 (SAPUI5). Some administrative tasks, such as Customizing tasks, are also based on the traditional SAP GUI technology, which is not explicitly shown in Figure 1. Figure 1 gives an example of a possible technical system landscape for SAP Marketing, which includes the use of SAP ERP and SAP CRM data.

The communication of the front-end components with the back end, which is the ABAP Platform 1809 (7.53 SP00), is based on HTTPS. The Web applications are embedded in a shell that ensures secure session management. All servers run behind the firewall.

The requests of the stateless Web applications to the back end are based on OData (read and write) using HTTPS.

The main reused components of the application server are those of the ABAP Platform 1809, for example, user management, authentication, and authorization. SAP Gateway handles the requests from the front end through OData channel services.

The underlying database for SAP Marketing is SAP HANA 2.0. To leverage the capabilities of the SAP HANA database, parts of the segmentation, search capabilities, and analysis are performed directly on the database using stored procedures and SAP HANA information models, such as calculation views, attribute views, and analytical views. All access to the database is done through the ABAP Platform 1809 using OpenSQL or the ABAP Database Connectivity (ADBC) interface of ABAP to the SAP HANA database. Only the user management of the ABAP Platform 1809 is required and only a technical user within the SAP HANA database is required for the access.



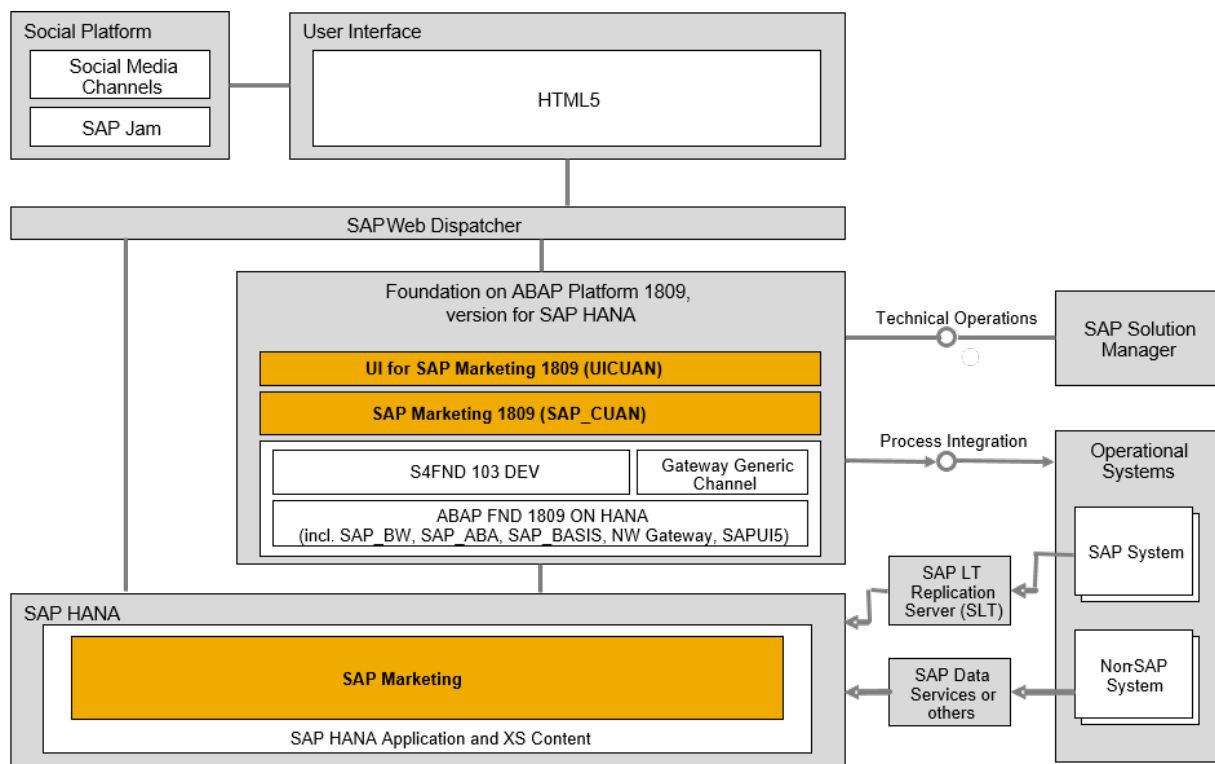

Data from SAP ERP, for example, and other SAP components can be replicated to SAP Marketing with the SAP LT replication framework. For more information about the tables that are required for the usage of SAP Marketing in connection with SAP ERP or SAP CRM, and need to be configured in SAP LT, see the [Appendix](#) section of this document. Results for SAP Marketing can be sent to SAP CRM. For other deployment options of SAP Marketing with SAP ERP and SAP CRM, see [Deployment Scenarios \[page 14\]](#).

The ABAP platform role and authorization framework is used with SAP Marketing.





More Information

For more information about the SAP HANA database system landscape, see the [SAP HANA Security Guide](#) on the SAP Help Portal at:

http://help.sap.com/hana_platform  **Select the required version in the "Version" field**  *Security*  *SAP HANA Security Guide* 

For more information, see the resources listed in the following table.

Topic	Guide/Tool	Quick Link on SAP Service Marketplace or SCN
Security	See applicable documents	http://scn.sap.com/community/security  https://help.sap.com/mkt-op  <i>Security</i> 

3 Deployment Scenarios

SAP Marketing can use SAP ERP data from SAP ERP 6.0 or higher and SAP CRM data from enhancement package (EHP) 1 for SAP CRM 7.0 SP04 (plus SAP Note [1995798](#)) or higher. Several deployment options are available. Your decision for a certain deployment option depends on the release of your source system and the SAP Marketing applications that you want to run. The table below shows which data is mandatory for each solution.

The following options are described in more detail:

- [Scenario A: Standalone Deployment \[page 15\]](#)
- [Scenario B: Hub-Deployment with Separate SAP HANA System \[page 15\]](#)
- [Scenario C: Hub-Deployment with Shared SAP HANA System of SAP Business Suite \[page 16\]](#)
- [Scenario D: Hub-Deployment with Shared SAP HANA System of Other Application \[page 18\]](#)

For recommendations concerning the appropriate system landscape to run the application, refer to the Product Availability Matrix (PAM) at <http://support.sap.com/pam>. In the PAM, enter **SAP MARKETING 1809** in the "Find Product Versions" field in the upper right corner and select the corresponding entry in the search results. In the *Details for Product Version SAP MARKETING 1809*, see the *Landscape Recommendations* document in the *Related Links* section.

SAP Marketing Licenses or Applications	SAP ERP	SAP CRM
Data Management	optional	optional
Insight - Marketing Executive Dashboard	optional	optional
Insight - Relationship Analysis Sales, Stratification, Margin Decomposition	mandatory	optional
Insight - Relationship Analysis Presales	optional	mandatory
Segmentation on SAP ERP Accounts	mandatory	optional
Segmentation on SAP CRM Accounts	optional	mandatory
Segmentation on contact of third party data	optional	optional
Recommendation	optional	optional
Planning	optional	optional
Acquisition	optional	optional

3.1 Scenario A: Standalone Deployment

SAP Marketing Segmentation and *SAP Marketing Data Management* can be used without SAP ERP or SAP CRM data. Third-party data to be used in these applications can be replicated to the SAP HANA database or imported to the SAP Marketing system with different tools:

- For the replication of your third-party data, you can use one of the SAP HANA data provisioning tools described in the [SAP HANA Master Guide](#) on the SAP Help Portal at:
http://help.sap.com/hana_platform ▶ Select the required version in the "Version" field ▶ [Installation and Upgrade](#) ▶
- For the import of your third-party data to your SAP Marketing system, you can use one of the integration services for data upload, described in section [Integration APIs](#) of the Integration Guide on the SAP Help Portal at:
<https://help.sap.com/mkt-op> ▶ [Integration](#) ▶

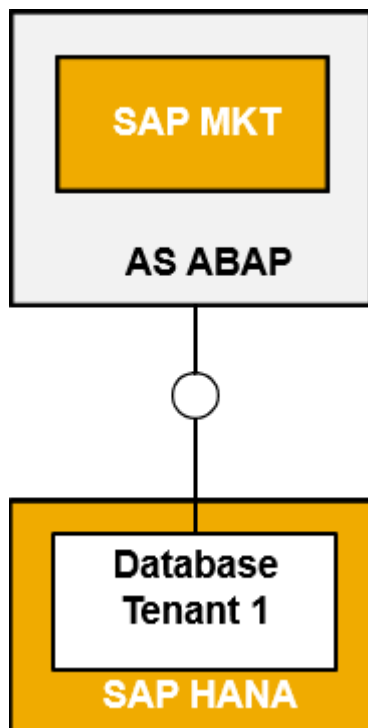

Standalone Deployment

3.2 Scenario B: Hub-Deployment with Separate SAP HANA System

You can deploy SAP Marketing in a side-by-side approach. This means that the application runs on a separate application server with a separate SAP HANA database. In this case the data is replicated from your source system into the SAP HANA database with the SAP Landscape Transformation Replication Server (SAP LT).

Using separate deployment and data replication ensures that there is no incident or disruption in your production source systems, since the application does not directly access your production data. Replication

also allows your SAP HANA-based application to work with data even if your production systems do not use SAP HANA.

For more information about the data replication, see [Data Replication \[page 27\]](#).

In this scenario, you can, in addition, upload third-party data to your SAP Marketing system by using one of the integration services for data upload, described in section [Integration APIs](#) of the Integration Guide on the SAP Help Portal at:

<https://help.sap.com/mkt-op> ► [Integration](#) ►

Deployment Examples

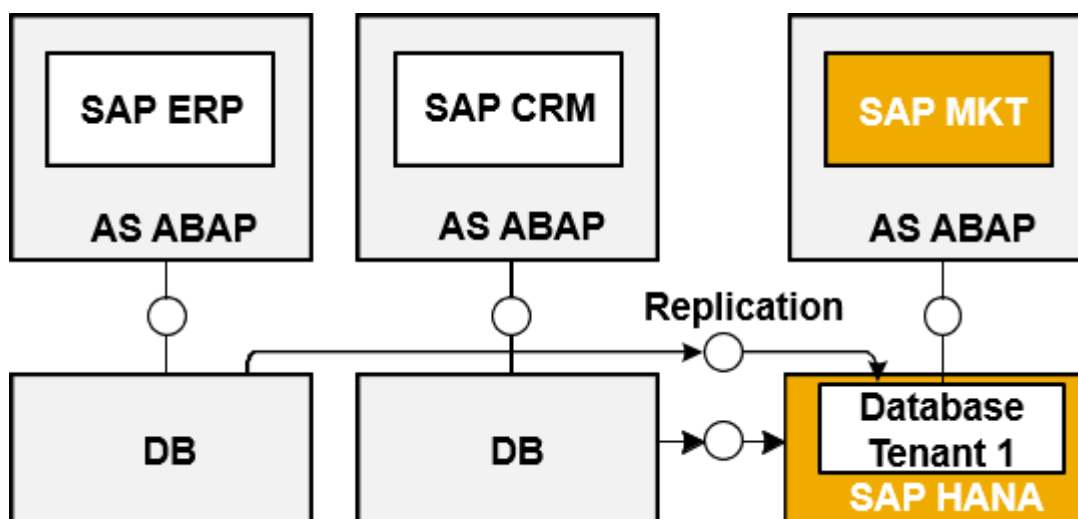

Hub-Deployment with SAP ERP and SAP CRM and Separate SAP HANA System

The following table shows the minimum required releases:

SAP ERP	SAP CRM
SAP ERP 6.0	EHP1 for SAP CRM 7.0 SP04 plus SAP Note 1995798

3.3 Scenario C: Hub-Deployment with Shared SAP HANA System of SAP Business Suite

SAP Marketing can be deployed in parallel with SAP Business Suite applications on the same SAP HANA database. In this case SAP Marketing shares the SAP HANA database with one SAP ERP or one SAP CRM, reading SAP ERP or SAP CRM data directly without replication.

i Note

In this scenario, ensure that you have carefully read and considered SAP Note [1826100](#) as it contains more information about this deployment.

In this scenario, you can, in addition, upload third-party data to your SAP Marketing system by using one of the integration services for data upload, described in section [Integration APIs](#) of the Integration Guide on the SAP Help Portal at:

<https://help.sap.com/mkt-op> ► [Integration](#) ►

Deployment Examples

If you decide to deploy SAP Marketing in such a deployment scenario, you have the following options:

- You can deploy SAP Marketing on the same SAP HANA database as your SAP ERP system if your SAP ERP system is minimum an EHP6 for SAP ERP 6.0 on SAP HANA. In addition, if you require to use SAP CRM business data as well, you can replicate this data from your SAP CRM system into the same SAP HANA database. This means that the SAP Marketing system is deployed with a shared SAP HANA database of SAP ERP, whereas SAP CRM runs on a separate database, as shown in scenario B.

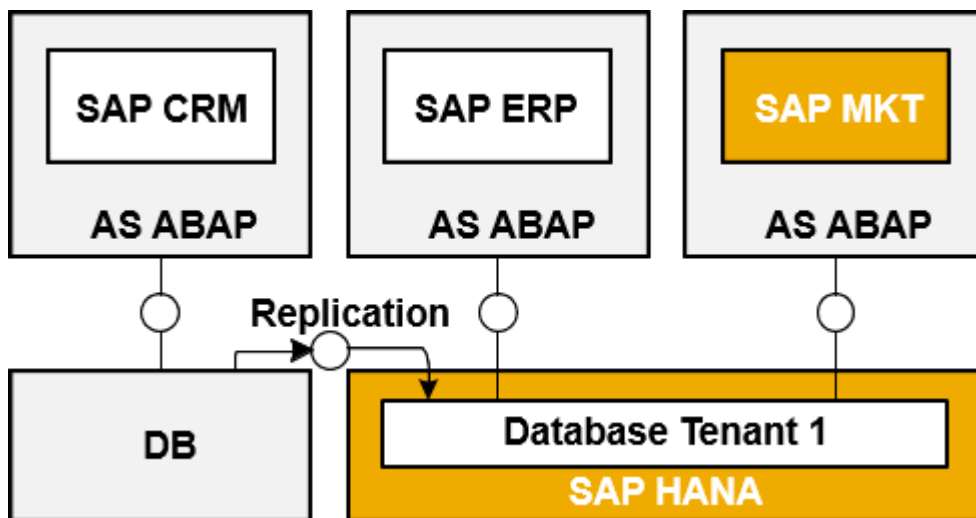

Hub-Deployment with Shared SAP HANA System of SAP ERP

The following table shows the minimum required releases:

SAP ERP	SAP CRM
EHP6 for SAP ERP 6.0 on SAP HANA	EHP1 for SAP CRM 7.0 SP04 plus SAP Note 1995798
EHP7 for SAP ERP 6.0	EHP1 for SAP CRM 7.0 SP04 plus SAP Note 1995798

- You can deploy SAP Marketing on the same SAP HANA database as your SAP CRM system if your SAP CRM system is minimum an EHP2 for SAP CRM 7.0 on SAP HANA. In addition, if you require to use SAP ERP business data as well, you can replicate this data from your SAP ERP system into the same SAP HANA

database. This means that the SAP Marketing system is deployed with a shared SAP HANA database of SAP CRM, whereas SAP ERP runs on a separate database, as shown in scenario B.

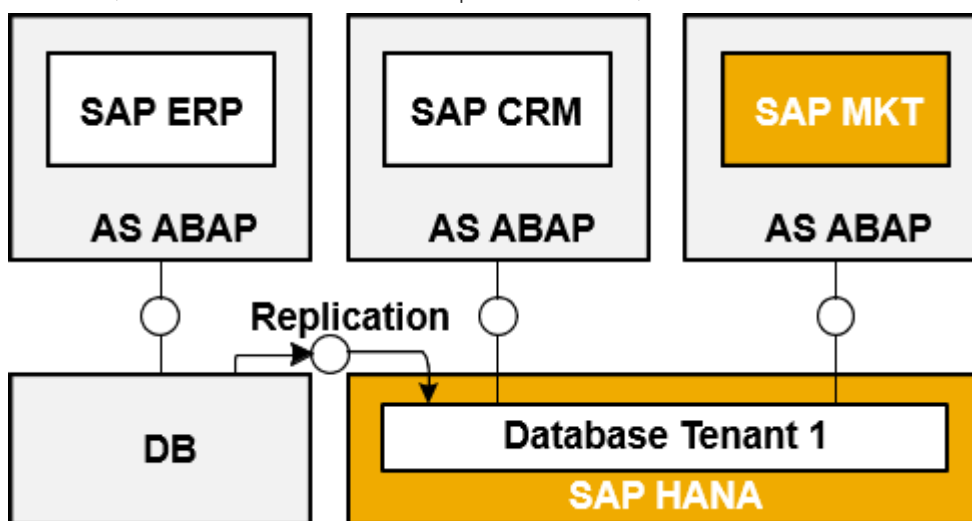

Hub-Deployment with Shared SAP HANA System of SAP CRM

The following table shows the minimum required releases:

SAP ERP	SAP CRM
SAP ERP 6.0	EHP2 for SAP CRM 7.0 on SAP HANA SPO1 plus SAP Note 1996523
SAP ERP 6.0	EHP3 for SAP CRM 7.0

3.4 Scenario D: Hub-Deployment with Shared SAP HANA System of Other Application

SAP Marketing can be deployed on an SAP HANA database that is already used for applications which are listed in SAP Note [1661202](#) – *Support for Multiple Applications on SAP HANA*. If you require to use SAP ERP or SAP CRM business data as well, you can replicate this data into the same SAP HANA database.

This deployment scenario is not separately pointed out in this installation guide. If you require to replicate data refer to the deployment process for scenario B; if you do **not** require to replicate data refer to the deployment process for scenario A.

In this scenario, you can, in addition, upload third-party data to your SAP Marketing system by using one of the integration services for data upload, described in section [Integration APIs](#) of the Integration Guide on the SAP Help Portal at:

<https://help.sap.com/mkt-op> ► [Integration](#) ►

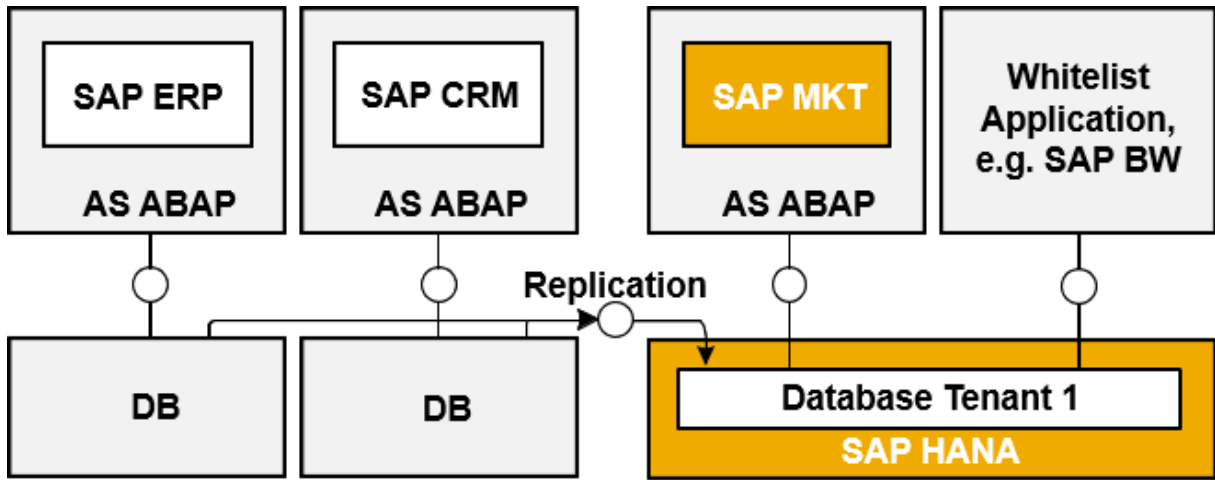

Hub-Deployment with Shared SAP HANA System of Other Application

4 Development and Production Systems

We recommend that you install or update first in a development system. After testing, you may begin installation in your production system.

i Note

Certain tasks are only carried out in the development system (see [Creating Development Package \[page 45\]](#)). These tasks generate repository objects and Customizing objects that are imported into the production system at a later point in time (see [Applying Technical Configuration Artifacts to Production System \[page 61\]](#)).

5 Installation

This section explains how the base installation of SAP Marketing on premise is to be executed. Since SAP Marketing runs on the foundation on ABAP platform with SAP HANA as the primary and only database, you must set up the database first. The foundation on ABAP platform as well as the SAP Marketing system will be installed on this SAP HANA database in a second step.

The following flow chart illustrates the sequence of the installation process.

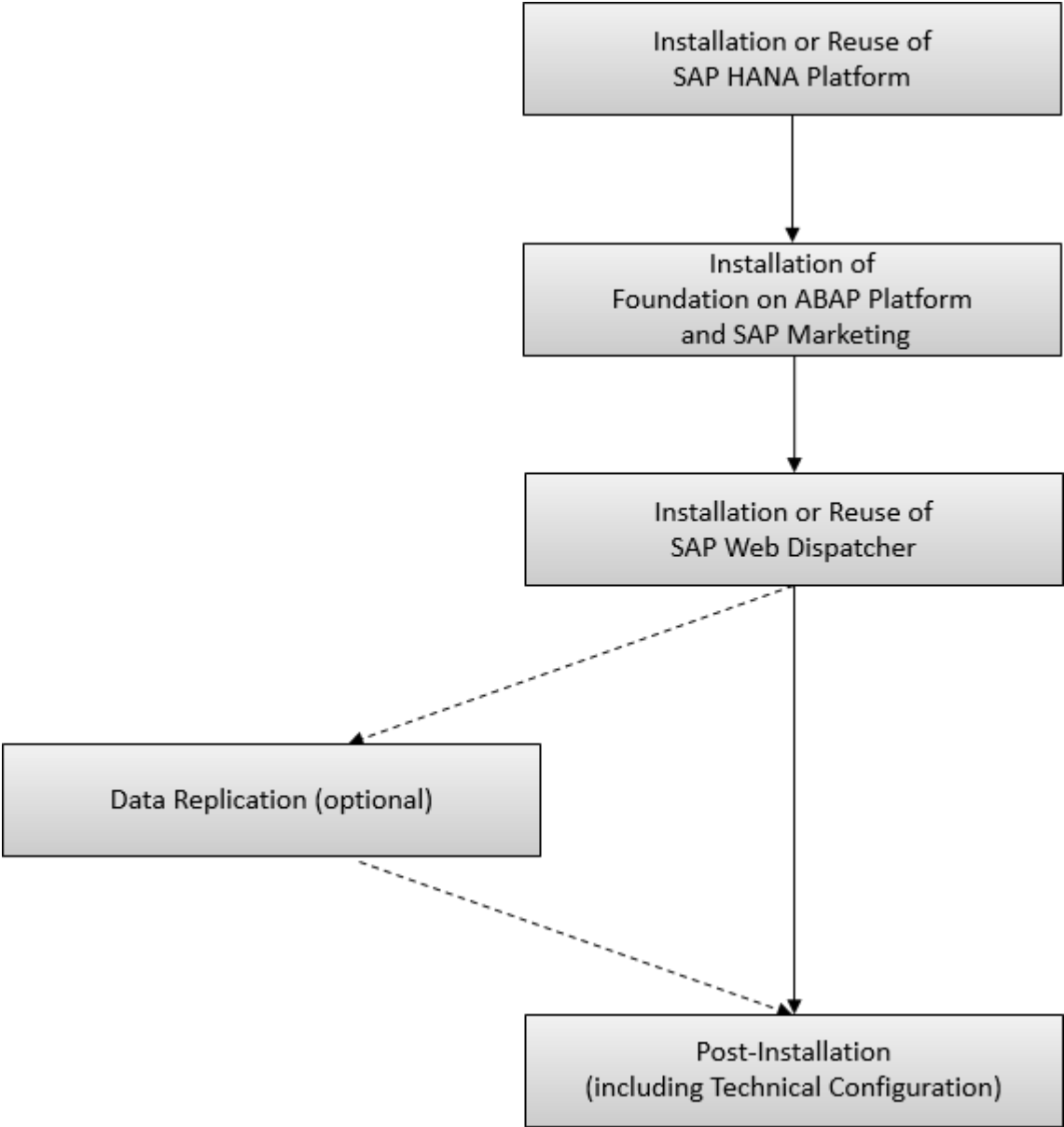

5.1 Installation of the SAP HANA Platform

As an appliance, SAP HANA uses software components from SAP optimized for proven hardware provided by SAP's hardware partners. Therefore, the components of SAP HANA can only be installed by certified hardware partners on validated hardware running a specific operating system.

To ensure that your SAP HANA appliance is optimally prepared for use with your application, you should consider the following topics.

5.1.1 Correct Sizing of the SAP HANA Database

For help in determining SAP HANA sizing for SAP Marketing, see the [Sizing Guide](#) for SAP Marketing on the SAP Help Portal at:

<https://help.sap.com/mkt-op> ► *Installation and Upgrade* ► *View All* 📄.

Another option is to use the web-based Quick Sizer at <https://www.sap.com/about/benchmark/sizing.quick-sizer.html#quick-sizer> 🖱️.

5.1.2 Installing the SAP HANA Database

The installation of the SAP HANA database is a multi-tenancy-enabled installation. This means that you receive two databases during the installation procedure:

- A system database, which contains information about the system as a whole, as well as all its tenant databases. It is used for central system administration. For more information, see [The System Database](#).
- One tenant database, in which business applications and business data is stored. For more information, see [Overview of SAP HANA Tenant Databases](#).

For information about the installation and configuration procedure of the SAP HANA databases, follow the instructions in the corresponding master and installation guides. You find all documents on the SAP Help Portal at http://help.sap.com/hana_platform Select the required version in the "Version" field ► *Installation and Upgrade* 📄:

- [SAP HANA Master Guide](#)
- [SAP HANA Server Installation and Update Guide](#)
- [SAP HANA Tenant Databases Operations Guide](#)

5.1.3 Updating to Higher Revisions of the SAP HANA Database

SAP ships SAP HANA Support Package revisions, which contain latest capabilities in SAP HANA. As your current installation might not contain the latest revision, you must update your SAP HANA database

accordingly. Check the Release Information Note (RIN) for SAP Marketing [1885803](#) to find information about the minimum SAP HANA revision required for SAP Marketing.

You can find the RIN under <http://support.sap.com/notes>.

For information about the SAP HANA update, see [Updating an SAP HANA System Landscape](#) in the SAP HANA Master Guide on the SAP Help Portal at:

http://help.sap.com/hana_platform Select the required version in the "Version" field ► [Installation and Upgrade](#) ► [SAP HANA Master Guide](#) ►

5.1.4 Installing the SAP HANA Application Function Library (AFL)

An SAP HANA system consists of the SAP HANA server and additional components like the *Application Function Library (AFL)*. SAP Marketing requires this library. Therefore install the library as described in section [Managing SAP HANA System Components](#) of the SAP HANA Administration Guide on the SAP Help Portal at:

http://help.sap.com/hana_platform Select the required version in the "Version" field ► [Administration](#) ► [SAP HANA Administration Guide](#) ► [SAP HANA Lifecycle Management](#) ► [SAP HANA Platform Lifecycle Management](#) ► [About the SAP HANA Database Lifecycle Manager \(HDBLCM\)](#) ► [Using the SAP HANA Platform LCM Tools](#) ► [Additional Information About Using the SAP HANA Platform LCM Tools](#) ► [Managing SAP HANA System Components](#) ►

5.2 Installation of Foundation on ABAP Platform and SAP Marketing

i Note

Your application runs only on the foundation on ABAP Platform that is installed with SAP HANA as the primary and only database system. Other types of database systems are not supported.

The SAP Marketing applications are based on the foundation on ABAP Platform 1809, version for SAP HANA that is built on the ABAP Platform 1809 (ABAP FND 1809 ON HANA). The installation of the foundation and the SAP Marketing system is executed using tools of the software logistics toolset (SL Toolset). The SL Toolset is a product-independent delivery channel that delivers up-to-date software logistics tools.

You have several options supported by the ABAP Platform to install SAP Marketing. In the following, you are provided with a description of an up-to-date installation based on Maintenance Planner, a tool that is based on SAP Solution Manager's processes and data. Maintenance Planner is part of the SL Toolset.

For other installation options, see the required information in the corresponding standard guides on the SAP Support Portal (<https://support.sap.com/sltoolset>).

The simplified up-to-date installation supports planning of new installations on a chosen stack level. You can generate a consolidated stack configuration file, which allows you to install and directly update your system at

the chosen SPS level. The up-to-date installation allows you to select target software level and push archives to the download basket in a single step.

For a first impression about Maintenance Planner, see <https://blogs.sap.com/2015/07/09/maintenance-planner-2/>.

To start the up-to-date installation procedure, follow the description in the following section, [Up-to-Date Installation Using Maintenance Planner \[page 24\]](#).

5.2.1 Up-to-Date Installation Using Maintenance Planner

To initially use Maintenance Planner, follow the instructions in the corresponding [Maintenance Planner - User Guide](#) on the SAP Help Portal at:

<http://help.sap.com/maintenanceplanner> ► *Application Help* ▾

Once you have logged on to Maintenance Planner following the description in the appropriate chapters of the user guide, you start the up-to-date installation of the ABAP-based software components required to run SAP Marketing:

- Foundation on ABAP 1809, version for SAP HANA and all required subcomponents
- SAP Marketing add-on including all depending subcomponents

For a general step-by-step description of the up-to-date installation process, see <https://blogs.sap.com/2016/10/21/up-to-date-installation-2/>.

During the installation process, you select the following components:

- [ABAP FND 1809 ON HANA](#)
- [SAP MARKETING 1809](#)

Be sure to consider the following during the installation process:

- In the [Select Files](#) step, ensure that you selected the latest version of the Software Update Manager for your operating system as this tool is used in the background during the installation process. Maintenance Planner, in addition, recommends to select the latest versions of Software Provisioning Manager, SAP Kernel, SAP IGS, and SAP Host Agent for your operating system.
- In the [Download Files](#) step, you choose the [Download Stack XML](#) pushbutton to download the corresponding XML file as this file is required during the installation process.
- In the [Download Files](#) step, you choose the [Download PDF](#) pushbutton to receive the overview of your maintenance plan.
 1. Once downloaded, open the PDF document.
 2. Click the [Download Installation/Upgrade Media from SAP Service Marketplace](#) link.
 3. The [Software Downloads](#) application in the SAP Support Portal opens.
 4. Under [Installation and Upgrade](#), verify your operating system and database and select the following entry in addition: [ABAP FND 1809 ON HANA](#). You can add other entries according to your requirements, for example, the language files. The selected entries are added to your already existing download basket created in Maintenance Planner.
 5. At the end of the process, check your download basket for all required components.

Installation

To install the foundation on ABAP and SAP Marketing, follow the instructions in the corresponding installation guide for your operating system. You can find the appropriate guide at [Installation Guides - Application Server Systems - Software Provisioning Manager 2.0](#) on the SAP Help Portal.

In the table provided in the document linked above, search for **ABAP** in the *Technical Stack* column, and for **SAP HANA Database** in the *Database* column. In addition, filter for your operating system.

You can also navigate to the required guide on the SAP Support Portal using the following path:

<http://support.sap.com/slttoolset> ► [System Provisioning](#) ► [System Provisioning Scenarios](#) ► [Install a System Using Software Provisioning Manager](#) ► [Installation Option of Software Provisioning Manager 2.0 SP 01](#) ► [Installation Guides - Application Server Systems](#) ►

i Note

During the installation procedure, make use of the option to add the parameter
`SAPINST_STACK_XML=<Absolute_Path_To_Stack_XML_File>`.

Integrated SAP Web Dispatcher

The use of an SAP Web Dispatcher is mandatory for running SAP Marketing. To simplify the installation, SAP recommends to use the integrated SAP Web Dispatcher.

For information on how to install the integrated SAP Web Dispatcher, see section [ASCS Instance with Integrated SAP Web Dispatcher](#) in the installation guide that you have accessed above.

i Note

If you already use an SAP Web Dispatcher in your system landscape, you can reuse it for SAP Marketing purposes. For the required configuration, see [Configuring the SAP Web Dispatcher \[page 37\]](#).

If you do not want to use the integrated SAP Web Dispatcher or reuse your SAP Web Dispatcher that is already in use, you can install the SAP Web Dispatcher from scratch. To do so, follow the instructions in the corresponding installation guide for your operating system. You can find the appropriate guide at [Installation Guides - SAP Web Dispatcher](#) on the SAP Help Portal.

In the table provided in the document linked above, search for your operating system to access the required guide.

You can also navigate to the guide on the SAP Support Portal using the following path:

<http://support.sap.com/slttoolset> ► [System Provisioning](#) ► [System Provisioning Scenarios](#) ► [Install a System Using Software Provisioning Manager](#) ► [Installation Option of Software Provisioning Manager 2.0 SP 01](#) ► [Installation Guides – Web Dispatcher](#) ►

5.3 Installing SAPUI5 Tools and ABAP Development Tools

If you want to enhance or change the the SAPUI5-based user interface of SAP Marketing, then you must install the required development tools, which are the SAPUI5 Tools integrated development environment (IDE) and

the SAPUI5 Team Provider, on each client. With the installation of these tools, you also install the ABAP Development Tools.

For detailed information about the installation process, see the [Master Guide for User Interface Add-On 2.0 for SAP NetWeaver](#) on the SAP Help Portal at:

https://help.sap.com/viewer/p/UI_ADD-ON_FOR_SAP_NETWEAVER_20 ► *Installation and Upgrade* ►

5.4 Implementation of SAP Notes Listed in Release Information Note

To complete the installation process, you must implement all SAP Notes listed in the Release Information Note (RIN) for SAP Marketing, number [1885803](#) that have not been implemented before.

You can find the RIN under <http://support.sap.com/notes>, entering the RIN number in the corresponding field on the screen.

i Note

Ensure that you have carefully read the RIN before you implement the included SAP Notes. The RIN contains information about the exact point in time for the implementation of every included SAP Note:

- Before the import of the support package
- Before executing the technical configuration
- After executing the technical configuration
- SAP Note only relevant for a certain solution scope

To install the SAP Notes in the RIN, do the following:

1. Log on to the back-end SAP NetWeaver system as an administrator. You can log on to the production client of the application; installing SAP Notes is a client-independent procedure.
2. Use transaction `SNOTE` to install the SAP Notes in the RIN.

6 Data Replication

i Note

This section is relevant only if you have decided to deploy SAP Marketing separately from your source system using one of the hub-deployment approaches.

For more information about the various deployment scenarios, see [Deployment Scenarios \[page 14\]](#).

6.1 Installation of SAP Landscape Transformation Replication Server

To install and set up trigger-based data replication, follow the instructions in the [Installation Guide - Trigger-Based Data Replication Using SAP Landscape Transformation Replication Server](#) on the SAP Help Portal at:

<https://help.sap.com/sapslt> ► [Installation and Upgrade](#) ► [Installation Guide - Replicating Data to SAP HANA](#) ►

→ Recommendation

SAP recommends to use the latest version of SAP Landscape Transformation Replication Server, minimum version 2.0 SP13.

6.1.1 Connection Setup between SAP Marketing and SAP LT Replication Server

1. Log on to your SAP LT Replication Server system.
2. Enter transaction `PFCG`, and copy the role `SAP_IUUC_REPL_REMOTE`. You must enhance the role by the following authorizations:
 - **Authorization Object:** `S_RFC`
 - **Activity:** `16 (Execute)`
 - **Name of RFC to be protected:** `SDTB, SDIFRUNTIME`
 - **Type of RFC to be protected:** `FUGR`
 - **Authorization Object:** `S_RFC`
 - **Activity:** `16 (Execute)`
 - **Name of RFC to be protected:** `SCSI_GET_SYSTEM_INFO`
 - **Type of RFC to be protected:** `FUNC`
 - **Authorization Object:** `S_DMIS`
 - **Activity:** `02 (Change)`

- *MBT PCL Scenario*: SLOP
- *MBT PCL Processing Role Level*: **PACKAGE**

For more information about the maintenance of authorization profiles, see [Maintaining Authorizations and Their Values](#) on the SAP Help Portal at:

<https://help.sap.com/mkt-op> ► *Foundation on ABAP Platform 1809, version for SAP HANA* ► *ABAP Platform* ► *Securing the ABAP Platform* ► *Security and User Administration* ► *User Administration and Identity Management in ABAP Systems* ► [Scroll down to section "Related Information"] ► *User and Role Administration of Application Server ABAP* ► *Reference Documentation for User and Role Administration* ► *Organization Without the Profile Generator* ► *Creating and Maintaining Authorizations and Profiles Manually* ► *Maintaining Authorizations and Their Values* ►

3. Generate the profile of your role and leave transaction PFCG.
4. Enter transaction SU01 and create a user with your new role. You use this user in the RFC destination between your SAP Marketing system and the SAP LT Replication Server.
5. Log on to your SAP Marketing system.
6. Enter transaction SM59, and choose the *Create* menu option in the *Edit* menu to create a new ABAP connection between your SAP Marketing system and your SAP LT Replication Server.
7. Enter your name for the RFC destination. Enter all required information and use the user you created in step 4.
8. Confirm your entries and save the RFC destination. Test the RFC destination using the connection test.

6.1.2 Connection Setup between SAP Marketing and SAP Source System

During the installation of SAP Landscape Transformation Replication Server you have installed the SAP Landscape Transformation add-on on your SAP source system. To enable the replication between your SAP Marketing system and your SAP source system, you must create an RFC destination. To do so, execute the following steps:

1. Log on to your SAP source system.
2. Enter transaction PFCG, and copy the role SAP_IUUC_REPL_REMOTE. You must enhance the copied role by the following authorizations:
 - **Authorization Object**: S_RFC
 - *Activity*: 16 (Execute)
 - *Name of RFC to be protected*: SDTB, SDIFRUNTIME
 - *Type of RFC to be protected*: FUGR

For more information about the maintenance of authorization profiles, see [Maintaining Authorizations and Their Values](#) on the SAP Help Portal at:

<https://help.sap.com/mkt-op> ► *Foundation on ABAP Platform 1809, version for SAP HANA* ► *ABAP Platform* ► *Securing the ABAP Platform* ► *Security and User Administration* ► *User Administration and Identity Management in ABAP Systems* ► [Scroll down to section "Related Information"] ► *User and Role Administration of Application Server ABAP* ► *Reference Documentation for User and Role Administration* ► *Organization Without the Profile Generator* ► *Creating and Maintaining Authorizations and Profiles Manually* ► *Maintaining Authorizations and Their Values* ►

3. Generate the profile of your role and leave transaction `PF00`.
4. Enter transaction `SU01` and create a user with your new role. You use this user in the RFC destination between your SAP Marketing system and your SAP source system.
5. Log on to your SAP Marketing system.
6. Enter transaction `SM59`, and choose the *Create* menu option in the *Edit* menu to create a new ABAP connection between your SAP Marketing system and your SAP source system.
7. Enter your name for the RFC destination. Enter all required information and use the user you created in step 4.
8. Confirm your entries and save the RFC destination. Test the RFC destination using the connection test.

6.1.3 Basic Configuration of Data Replication

You must create a basic configuration for all source systems from which you want to replicate data to your SAP Marketing system. To do so, follow the instructions in section *Creating a Configuration* of the Application Operations Guide for SAP Landscape Transformation Replication Server. You find this Application Operations Guide on the SAP Help Portal at:

[https://help.sap.com/saps/it/Operations/Operations > Application Operations Guide SP13 - Replicating Data to SAP HANA](https://help.sap.com/saps/it/Operations/Operations%20Guide%20SP13%20-%20Replicating%20Data%20to%20SAP%20HANA)

(<https://help.sap.com/doc/e1b3799f5d524d44b2dc781d9bb6eef4/2.0.13/en-US/Application%20Operations%20Guide.pdf>)

The technical configuration (see [Using the Technical Configuration Cockpit \[page 46\]](#)) automatically adjusts this configuration and adds the required tables (see also the *Replicated Tables* sections in the [Appendix \[page 164\]](#)).

7 Post-Installation

After you have installed all the components that you need to run the SAP Marketing application and have implemented all relevant SAP Notes from the RIN [1885803](#), carry out the following technical configuration steps. You find these steps listed in the following sections.

⚠ Caution

- Make sure that you carry out the following post-installation steps in the same client in which you want to run the SAP Marketing application.
- The sequence of the post-installation steps reflected by the following sections depends on the role of system, in which you execute the installation: The sequence in the development system differs from the sequence in the production system.
For more information, see the graphic below.

i Note

During the following post-installation process executed in your **development system**, transport requests are created, which contain generated objects and Customizing entries. While some of the requests are created automatically by the technical configuration cockpit, you need to create other requests manually.

After testing, the transport requests are imported into the **production system** in a specific sequence (see [Applying Technical Configuration Artifacts to Production System \[page 61\]](#)).

When you carry out the installation in the production system, the technical configuration cockpit automatically skips the tasks that no longer need to be carried out, due to the import of transport requests from the development system.

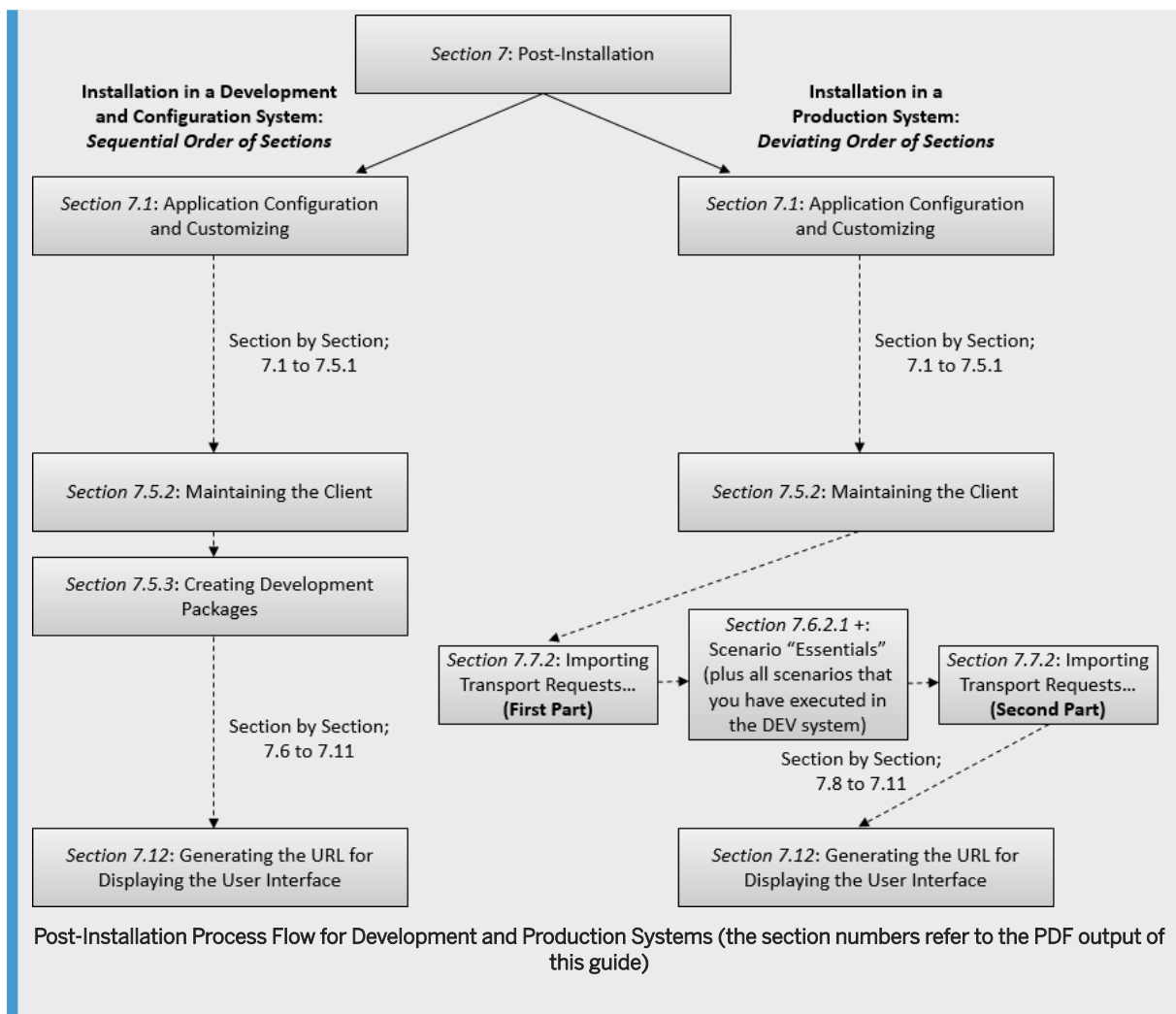

7.1 Application Configuration and Customizing

7.1.1 Initial Customizing Adjustment

With the installation of SAP Marketing (see [Installation of Foundation on ABAP Platform and SAP Marketing \[page 23\]](#)), Customizing is installed only in client 000 of your AS ABAP system. To ensure the availability of all relevant Customizing in your productive client, we recommend to create this client via client copy from client 000. During the client copy process, select a copy role, which ensures that Customizing is copied. Note that all application data is erased during the copy procedure.

i Note

Ensure that the SAP Marketing add-on is installed before executing the client copy. If the SAP Marketing add-on is not installed the Customizing to be copied is not available.

For more information, see [Client Copier](#) on the SAP Help Portal at:

<https://help.sap.com/mkt-op> ► *Foundation on ABAP Platform 1809, version for SAP HANA* ► *ABAP Platform* ► *Application Server ABAP Infrastructure* ► *Administration of Application Server ABAP* ► *Change and Transport System* ► *BC - Client Copy and Transport (BC-CTS-CCO)* ► *Client Copier* ►

7.1.2 Customizing via SAP Solution Manager

You execute the configuration for SAP Marketing with the help of SAP Solution Manager 7.1, SP05 or higher. In your Solution Management system, you can find the corresponding business scenario group, named SAP Marketing under *Applications Powered by SAP HANA* in transaction SOLAR01.

i Note

Make sure that you implemented ST_ICO_150_700_SP046 to access the required content.

More Information

- For an introduction to the use of the SAP Solution Manager content, see the SAP Help Portal at:
<http://help.sap.com/fms> ► *Configuration* ► *SAP Solution Manager Content* ►
(<https://help.sap.com/doc/eb312ed39796467989b954cb49ba12d2/1.0.10/en-US/SolmanContentSP10.pdf>)
- For detailed information on executing application configuration via SAP Solution Manager, see the SAP Help Portal at:
<http://help.sap.com/solutionmanager> ► *Select "Version: 7.1 SPS 14" in the upper right corner* ►
Application Help ► *Application Help <your_language>* ► *Solution Implementation* ► *Implementation/Upgrade Work Center* ► *Business Blueprint* ►
(https://help.sap.com/saphelp_sm71_sp14/helpdata/en/45/f6da633a292312e10000000a11466f/frameset.htm)

7.2 Configuring the SAP HANA Database

7.2.1 SAP HANA User for Technical Configuration

During the technical configuration of SAP Marketing, several actions must be executed on the SAP HANA database which require different authorizations. To ensure that all of these authorizations are available, run the script below in the tenant database. The executed script creates a user with sufficient authorization for carrying out the SAP Marketing technical configuration on the SAP HANA database.

In addition, you must enable the script server for the tenant database.

i Note

The SAP HANA authorizations required during business usage are granted to the AS ABAP user (SAP<SID>).

You can deactivate the user after successful completion of the technical configuration for the installation of SAP Marketing. You must reactivate the user again when performing technical configuration such as upgrade activities.

Creating the SAP HANA User

Ensure that you run the script in the **tenant database** of your SAP HANA appliance. Proceed as follows:

1. Log on to the SAP HANA studio with the `SYSTEM` user.
2. Open the [SQL console](#).
3. Copy the script below into the [SQL console](#). If there are more than one, choose the correct database connection, which is the tenant database connection.
4. Choose [Execute \(F8\)](#).
5. Check the log to see if all steps were carried out successfully.

i Note

- If you want to copy and paste the SQL statements below, ensure that all blank characters are copied accurately.
- After running the script, you must ensure the following:
 - Check if every single statement is successfully executed.
 - Log off and log back on again in order to change the initial password.

```
CREATE USER TC_USER PASSWORD <Your chosen password>;
ALTER USER TC_USER DISABLE PASSWORD LIFETIME;

-- object privileges
GRANT EXECUTE ON "GRANT_ACTIVATED_ROLE" TO TC_USER WITH GRANT OPTION;
GRANT EXECUTE ON "REVOKE_ACTIVATED_ROLE" TO TC_USER WITH GRANT OPTION;
GRANT EXECUTE ON "GRANT_PRIVILEGE_ON_ACTIVATED_CONTENT" TO TC_USER WITH GRANT
OPTION;
GRANT EXECUTE ON "REVOKE_PRIVILEGE_ON_ACTIVATED_CONTENT" TO TC_USER WITH GRANT
OPTION;
GRANT EXECUTE ON "GRANT_APPLICATION_PRIVILEGE" TO TC_USER WITH GRANT OPTION;
GRANT EXECUTE ON "REVOKE_APPLICATION_PRIVILEGE" TO TC_USER WITH GRANT OPTION;
GRANT EXECUTE ON "GRANT_SCHEMA_PRIVILEGE_ON_ACTIVATED_CONTENT" TO TC_USER WITH
GRANT OPTION;
GRANT EXECUTE ON "REVOKE_SCHEMA_PRIVILEGE_ON_ACTIVATED_CONTENT" TO TC_USER WITH
GRANT OPTION;
GRANT SELECT ON SCHEMA "_SYS_REPO" TO TC_USER WITH GRANT OPTION;
GRANT UPDATE, SELECT ON "_SYS_XS"."SQL_CONNECTIONS" TO TC_USER;

-- system privileges
GRANT "CREATE R SCRIPT" TO TC_USER WITH ADMIN OPTION;
GRANT "CREATE STRUCTURED PRIVILEGE" TO TC_USER WITH ADMIN OPTION;
GRANT "CREATE SCHEMA" TO TC_USER WITH ADMIN OPTION;
GRANT "ROLE ADMIN" TO TC_USER WITH ADMIN OPTION;
GRANT "DATA ADMIN" TO TC_USER WITH ADMIN OPTION;
GRANT "USER ADMIN" TO TC_USER WITH ADMIN OPTION;
GRANT "WORKLOAD ADMIN" TO TC_USER;
```

```
-- XS appl privileges
CALL
SYS_REPO.GRANT_ACTIVATED_ROLE('sap.hana.xs.admin.roles::RuntimeConfAdministrator', 'TC_USER');
CALL
SYS_REPO.GRANT_ACTIVATED_ROLE('sap.hana.xs.admin.roles::SQLCCAdministrator', 'TC_USER');
```

7.2.2 Enabling the Script Server for the Tenant Database

As administrator of the **system** database (SYSTEMDB), execute the following SQL statement:

```
ALTER DATABASE <SID of your SAP Marketing Tenant Database>
ADD 'scriptserver'
```

For more information about adding a service to the tenant database via SQL statement, see section [Add or Remove Services in a Tenant Database](#) of the SAP HANA Administration Guide on the SAP Help Portal at:

http://help.sap.com/hana_platform Select the required version in the "Version" field ► [Administration](#) ► [SAP HANA Administration Guide](#) ► [System Administration](#) ► [Managing Tenant Databases](#) ► [Monitoring and Managing Tenant Databases](#) ► [Add or Remove Services in a Tenant Database](#) ►

7.2.3 Authorization Settings for Deployment Scenario C: Hub-Deployment with Shared SAP HANA System of SAP Business Suite

Note

You follow the instructions in this section if you have decided to run deployment scenario C, [Scenario C: Hub-Deployment with Shared SAP HANA System of SAP Business Suite \[page 16\]](#). If you have chosen deployment scenario C, carry out the following steps.

7.2.3.1 Authorization Enhancement for _SYS_REPO User

Check if user `_SYS_REPO` has `SELECT` authorization on your embedded SAP ERP or SAP CRM system:

1. Log on to the SAP HANA studio with a user that is allowed to view the authorizations of user `_SYS_REPO`, for example, the `SAP<SID>` user of your embedded SAP ERP or SAP CRM system.

If you are familiar with the SQL Console you can run the following command:

```
SELECT DISTINCT PRIVILEGE, IS_GRANTABLE, IS_VALID FROM
SYS.EFFECTIVE_PRIVILEGES WHERE USER_NAME = '_SYS_REPO' AND SCHEMA_NAME =
'<schema name of your embedded SAP ERP or SAP CRM>' AND PRIVILEGE = 'SELECT'
AND IS_GRANTABLE = 'TRUE' AND IS_VALID = 'TRUE'
```

If you get a result, the user `_SYS_REPO` is allowed to select data from the schema of your embedded SAP ERP or SAP CRM system.

2. If you are not familiar with the SQL Console choose the *Modeler* perspective in the upper right corner.
3. In the *Navigator* section on the left, expand the folder of your SAP HANA database.
4. Expand the corresponding *Security* folder and the *Users* folder.
5. Double-click the `_SYS_REPO` user.
6. On the *Granted Roles* tab check if role `ABAP_SYS_REPO` is assigned. If the role is assigned, double click the role. The role will be opened in a new tab.
7. Navigate to *Object Privileges* tab. Check that the schema of your embedded deployed SAP ERP or SAP CRM system is displayed and marked as *Grantable to others*.

If you cannot find the `SELECT` authorization for your embedded deployed SAP ERP or SAP CRM system add the following authorizations to the `_SYS_REPO` user of your SAP Marketing system:

1. Log on to the SAP HANA studio with the `SAP<SID>` user of your embedded deployed SAP ERP or SAP CRM system.
2. Choose the *Modeler* perspective in the upper right corner.
3. In the *Navigator* section on the left, expand the folder of your SAP HANA database.
4. Expand the corresponding *Security* folder and the *Users* folder.
5. Double-click the `_SYS_REPO` user.
6. In the center section, choose the *Object Privileges* tab, and choose the **+** pushbutton.
7. In the following *Select Catalog Object* dialog box, search for the schema of your embedded deployed SAP ERP or SAP CRM system.
8. Select the privilege `SELECT` and the corresponding *Grantable to Others* option.
9. Save the `_SYS_REPO` user.

The `SELECT` authorization is required for SAP HANA content activation. The `_SYS_REPO` user is a system user that actually activates the SAP HANA content regardless of which user started the activation. The user takes all models and creates the corresponding runtime objects. After having activated all models the `_SYS_REPO` user grants read access to the activated models to the user that started the activation. For this reason, the *Grantable to Others* option is required.

More Information

For more information about changing a user's authentication information, see section [Change a User](#) of the SAP HANA Administration Guide on the SAP Help Portal at:

http://help.sap.com/hana_platform **Select the required version in the "Version" field** ► [Administration](#) ► [SAP HANA Administration Guide](#) ► [Security Administration and User Management](#) ► [Managing SAP HANA Users](#) ► [Provisioning Users](#) ► [Provisioning Users in SAP HANA Studio](#) ► [Change a User](#) ►

7.3 Profile Parameter Settings

SAP Marketing requires several profile parameter settings, for example, to set up HTTPS connections.

After you have set the required profile parameters, restart your system to make the parameter changes effective.

7.3.1 Configuring HTTPS

We recommend to realize the communication of the SAP Web Dispatcher (see subsection *Integrated SAP Web Dispatcher* in section [Up-to-Date Installation Using Maintenance Planner \[page 24\]](#)) with the SAP NetWeaver system via HTTPS.

To prepare the system for HTTPS communication, log on with the [User for Application Setup \[page 41\]](#), go to transaction `RZ10`, and configure an HTTPS port in the instance profile of the system.

The following example shows how these parameters may be set:

❁ Example

```
icm/server_port_1 = PROT=HTTPS, PORT=443$$
```

For more information, see section [ICM Parameter Reference](#) of the ABAP platform documentation on the SAP Help Portal at:

<https://help.sap.com/mkt-op> ► [Foundation on ABAP Platform 1809, version for SAP HANA](#) ► [ABAP Platform](#) ► [Application Server ABAP - Infrastructure](#) ► [Components of Application Server ABAP](#) ► [Internet Communication Manager \(ICM\)](#) ► [Administration of the ICM](#) ►

7.3.2 Configuring the Secure Sockets Layer Protocol

To secure HTTP connections to and from the AS ABAP system you use the Secure Sockets Layer (SSL) protocol.

To configure SSL, follow the instructions of section [Configuring AS ABAP to Support SSL](#) of the ABAP platform documentation on the SAP Help Portal at:

<https://help.sap.com/mkt-op> ► [Foundation on ABAP Platform 1809, version for SAP HANA](#) ► [ABAP Platform](#) ► [Securing the ABAP Platform](#) ► [Security Concepts and Tools](#) ► [Network and Transport Layer Security](#) ► [Transport Layer Security on the AS ABAP](#) ►

i Note

After following the procedures in [Configuring AS ABAP to Support SSL](#), add the SSL server certificate that you have created to the trusted certificate list for the Standard SSL and Anonymous SSL Client PSE in transaction `STRUST`. This allows the AS ABAP to communicate with itself via HTTPS.

→ Tip

You can check whether the SAP Cryptographic Library software is already installed in your system by doing the following:

1. Go to transaction `STRUST`.
2. Choose **Environment** > **Display SSF_Version**. If the system response shows that the `SAPCRYPTOLIB` is installed, then you can skip the installation step for the Cryptographic Library in the documentation cited above.

7.4 Configuring the SAP Web Dispatcher

SAP Marketing comprises both ABAP-based applications and applications based on SAP HANA extended application services, classic model (SAP HANA XS Classic). For this reason, SAP Marketing requires an SAP Web Dispatcher due to the same origin policy of browsers. In addition, the SAP Web Dispatcher is required to display and use the Web Assistant, an integrated help system that provides context sensitive user assistance.

To configure the SAP Web Dispatcher you must set up a few communication channels. To do so, proceed as follows.

Communication Between SAP Web Dispatcher and Clients

To configure the communication between clients (for example, your browser) and the SAP Web Dispatcher, follow the instructions under http://help.sap.com/fiori_implementation ► *Installation and Upgrade* ► *SAP Fiori: Setup and Configuration* ► *Configuration of SAP Fiori Infrastructure* ► *Communication Channels* ► *SAP Web Dispatcher: Setup of Communication* ► *Configuring Communication Channel between Clients and SAP Web Dispatcher*.

([Configuring Communication Channel between Clients and SAP Web Dispatcher](#))

As a result, your SAP Web Dispatcher will support HTTPS connections. Keep your HTTPS port in mind.

Communication Between SAP Web Dispatcher and AS ABAP

To configure the communication between the SAP Web Dispatcher and the SAP Marketing AS ABAP server, follow the instructions in the following documentation sections:

- [Defining Routing Rules for SAP Web Dispatcher and ABAP Front End](#)
- [Defining Routing Rules for SAP Web Dispatcher and ABAP Back End](#)
- [Configuring Trust Between SAP Web Dispatcher and ABAP Servers](#)

You find these sections on the SAP Help Portal under:

http://help.sap.com/fiori_implementation ► *Installation and Upgrade* ► *SAP Fiori: Setup and Configuration* ► *Configuration of SAP Fiori Infrastructure* ► *Communication Channels* ► *SAP Web Dispatcher: Setup of Communication* ►

([SAP Web Dispatcher: Setup of Communication](#))

Your SAP Marketing server is the AS ABAP front-end and back-end server.

Communication Between SAP Web Dispatcher and SAP HANA XS Classic

To set up communication between the SAP Web Dispatcher and SAP HANA extended application services, classic model, follow the instructions under http://help.sap.com/fiori_implementation ► *Installation and Upgrade* ► *Setup of SAP Fiori System Landscape* ► *Setup of SAP Fiori System Landscape with SAP HANA XS* ►

([Setup of SAP Fiori System Landscape with SAP HANA XS](#))

i Note

The communication paths for communication between the SAP Web Dispatcher and the SAP HANA Extended Application Services must be disjunct to the paths for communication between the SAP Web Dispatcher and the SAP Marketing AS ABAP server.

When you define the routing rules between SAP Web Dispatcher and SAP HANA Extended Application Services, add `/sap/hana-app` and `/sap/ui5` as a routing rule.

During configuration a number of changes are made to the SAP Web Dispatcher profile. The following list shows a sample profile after configuration.

Example

i Note

The example does not ensure the proper run of the SAP Web Dispatcher in your system. Adapt your settings according to your specific system requirements.

Sample Code

```
SAPSYSTEMNAME = WEB
SAPSYSTEM = 02
INSTANCE_NAME = W02
DIR_CT_RUN = $(DIR_EXE_ROOT)$(DIR_SEP)$(OS_UNICODE)$(DIR_SEP)linuxx86_64
DIR_EXECUTABLE = $(DIR_CT_RUN)
DIR_PROFILE = $(DIR_INSTALL)/profile
PF = $(DIR_PROFILE)/WEB W02 mo-29b02f1eb
SETENV_00 = DIR_LIBRARY=$(DIR_LIBRARY)
SETENV_01 = LD_LIBRARY_PATH=$(DIR_LIBRARY):%(LD_LIBRARY_PATH)
SETENV_02 = SHLIB_PATH=$(DIR_LIBRARY):%(SHLIB_PATH)
SETENV_03 = LIBPATH=$(DIR_LIBRARY):%(LIBPATH)
SETENV_04 = PATH=$(DIR_EXECUTABLE):%(PATH)
#-----
# Accessibility of Message Server
#-----
```

```

rdisp/mshost = mo-29b02f1eb
ms/http_port = 8100
#-----
# Configuration for medium scenario
#-----
icm/max_conn = 500
icm/max_sockets = 1024
icm/req_queue_len = 500
icm/min_threads = 10
icm/max_threads = 50
mpi/total_size_MB = 80
#-----
# SAP Web Dispatcher Ports
#-----
icm/server_port_0 = PROT=HTTP,HOST=mo-29b02f1eb,PORT=81$$
icm/server_port_1 = PROT=HTTPS,HOST=mo-29b02f1eb,PORT=82$$
icm/HTTP/admin_0 = PREFIX=/sap/admin,DOCROOT=$(DIR_DATA)$(DIR_SEP)
icmandir,AUTHFILE=$(icm/authfile),PORT=81$$;82$$
#-----
# Start Web Dispatcher
#-----
_WD = wd.sap$(SAPSYSTEMNAME)_$(INSTANCE_NAME)
Execute_00 = local rm -f $_WD
Execute_01 = local ln -s -f $(DIR_EXECUTABLE)/sapwebdisp$(FT_EXE) $_WD
Start_Program_00 = local $_WD pf=$(PF)
SETENV_05 = SECUDIR=$(DIR_INSTANCE)/sec
wdisp/ping_protocol = https
wdisp/group_info_protocol = https
wdisp/url_map_protocol = https
ssl/ssl_lib = /usr/sap/WEB/SYS/exe/nuc/linuxx86_64/libsapcrypto.so
ssl/server_pse = /usr/sap/WEB/W02/sec/sapssls.pse
icm/HTTPS/verify_client = 0
ssl/client_pse = /usr/sap/WEB/W02/sec/sapssls.pse
wdisp/ssl_encrypt = 2
wdisp/ssl_auth = 2
wdisp/ssl_cred = /usr/sap/WEB/W02/sec/sapssls.pse
icm/HTTPS/forward_ccert_as_header = true
wdisp/system_conflict_resolution = 1
wdisp/add_client_protocol_header = 1
wdisp/handle_webdisp_ap_header = 1
wdisp/add_xforwarded_for_header = true
#-----
#Forwarding Rule to AS ABAP
#-----
wdisp/system_0 = SID=NW1, NR=01, MSHOST=mo-29b02f1eb.mo.sap.corp,
MSPORT=8100, SRCURL=/sap/opu;/sap/bc;/sap/public;/sap/es;/sap/cuan;/sap/
ushell_config
#-----
#Forwarding Rule to SAP HANA XS
#-----
wdisp/system_2 = SID=HNA, EXTSRV=https://mo-02d2d957f.mo.sap.corp:4300,
SRCURL=/sap/hba;/sap/hana;/sap/hana-app;/sap/ui5;/sap/ead;/sap/bi
#-----
#Forwarding Rule to Content Server
#-----
wdisp/system_<number> = SID=<SID1>, EXTSRV=https://cp.hana.ondemand.com,
SRCURL=/sap/dfa/help/, SRCSRV=*:*, STANDARD_COOKIE_FILTER=OFF
#-----
#Forwarding Rule to Script Server
#-----
wdisp/system_<number> = SID=<SID2>, EXTSRV=https://xray.hana.ondemand.com,
SRCURL=/resources/sap/dfa/help/, SRCSRV=*:*, STANDARD_COOKIE_FILTER=OFF

```

Considering Documentation-Relevant Parameters

If you want to make context-sensitive user assistance available in the SAP Fiori launchpad, you must configure the SAP Web Dispatcher.

1. Adjust the SAP Web Dispatcher profile file.

In the `sapwebdisp_pf.txt` file, add the following parameters:

- For the User Assistance Content Platform:
`wdisp/system_<number> = SID=<SID1>, EXTSRV=https://cp.hana.ondemand.com, SRCURL=/sap/dfa/help/, SRCSRV=*,*, PROXY=<your proxy>:<your proxy port>, STANDARD_COOKIE_FILTER=OFF`
- For the User Assistant script server:
`wdisp/system_<number> = SID=<SID2>, EXTSRV=https://xray.hana.ondemand.com, SRCURL=/resources/sap/dfa/help/, SRCSRV=*,*, PROXY=<your proxy>:<your proxy port>, STANDARD_COOKIE_FILTER=OFF`

i Note

- Make sure that the numbers following `wdisp/system_` are smaller than the numbers that you use for all your application server. The rules for the context-sensitive user assistance need to come before the rules for the application servers.
- Make sure that the SIDs are not the same as your system IDs.

2. Activate the usage of the modification handler:

```
icm/HTTP/mod_0 = PREFIX=/, FILE=$(DIR_PROFILE)/redirect.txt
```

For more information about the profile parameter, see section [icm/HTTP/mod_<xx>](#) of the ABAP platform documentation on the SAP Help Portal at:

<https://help.sap.com/mkt-op> ► *Foundation on ABAP Platform 1809, version for SAP HANA* ► *ABAP Platform* ► *Application Server ABAP - Infrastructure* ► *Components of Application Server ABAP* ► *SAP Web Dispatcher* ► *Administration of the SAP Web Dispatcher* ► *SAP Web Dispatcher Parameters - Reference* ►

3. Adjust the SAP Web Dispatcher redirect file:

In the `redirect.txt` file, add the following parameters:

Code Syntax

```
# User Assistance ContentPlatform - rewrite rule
if %{SID} = <SID1>
begin
SetHeader HOST cp.hana.ondemand.com
RegRewriteRawUrl ^/sap/dfa/help/(.*) /dps/$1
end
# Script Server - rewrite rule
if %{SID} = <SID2>
begin
SetHeader HOST xray.hana.ondemand.com
RegRewriteRawUrl ^/resources/sap/dfa/help/(.*) /xRayControls/
resources/sap/dfa/help/$1
end
```

i Note

Make sure that the SIDs in the `redirect.txt` file are the same as in the `sapwebdisp_cf.txt` file.

Restart of SAP Web Dispatcher

After you have made these changes, restart your SAP Web Dispatcher.

7.5 Prerequisites in AS ABAP System

Before you carry out the technical configuration, you need to do the following:

- Allow system changes to the relevant clients
- Create development packages (development and configuration system only)

7.5.1 User for Application Setup

For the technical configuration of SAP Marketing, system settings must be changed and application setup steps must be performed. You therefore need an application user that can carry out the following tasks:

- Change **client settings**.
- Create a **development package**.
- Start the **technical configuration** in the *Technical Configuration Cockpit*, which sets up the application environment that is, for example, relevant for the activation of ICF services.
- Set profile **parameters**.

To ensure an error-free configuration procedure, the user in the production client of your AS ABAP system needs the following set of roles.

Role	You need to
Z_RT_GW_USER	Create the role, then assign it to the application setup user.
SAP_MARKETING_TECHNICAL_CONF	Assign it to the application setup user
SAP_CUSTOMER_ANALYTICS_ADMIN	Assign it to the application setup user.
SAP_BC_CTS_ADMIN	Assign it to the application setup user.
SAP_BC_SIW_DEV	Assign it to the application setup user.
SAP_BC_SEC_AUTH_ADMIN	Assign it to the application setup user.
SAP_BC_WEBSERVICE_ADMIN_TEC	Change the role, then assign it to the application setup user.
SAP_BC_DB_ADMIN	Change the role, then assign it to the application setup user.
SAP_BC_BASIS_ADMIN	Change the role, then assign it to the application setup user.

In the following, you find information about how to create a specific user with the required roles.

Proceed as follows:

Create Role Z_RT_GW_USER

In order to start external services, you first need to create a new single role and clear your cache:

1. Go to transaction PFCG and create a new role.
2. Choose the *Change Authorization Data* pushbutton in the *Maintain Authorization Data and Generate Profiles* section on the *Authorizations* tab.
3. When entering the *Change Role: Authorizations* screen you are provided with a list of templates. Select the following template: /IWFND/RT_GW_USER. Choose *Adopt References*.
4. You see a yellow light for the *Cross-application Authorization Objects* node. Drill down to ► *Check at Start of External Services* ► *Check at Start of External Services* ► by expanding the corresponding nodes.
5. Open *Program, transaction or function* in edit mode. In the dialog box that appears, select TADIR Service and then choose the *Full Authorization* pushbutton. Save your entries.
6. Choose the + *Manually* pushbutton, add the S_USER_GRP authorization object, and choose *Continue*.
7. Under the *Basis: Administration* node, expand the *User Master Maintenance: User Groups (S_USER_GRP)* node.
8. Set the following values for the *User Master Maintenance: User Groups (S_USER_GRP)* authorization object:
 1. Open *Activity (ACTVT)* in edit mode and choose the *Full authorization* pushbutton. Save your entries.
 2. Open *User group in user master maintenance (CLASS)* in edit mode and choose the *Full authorization* pushbutton. Save your entries.
9. Choose the + *Manually* pushbutton, add the /UI2/CHIP authorization object, and choose *Continue*.
10. Under the *Basis: Administration* node, expand the *Page Building Service: CHIP* node.
11. Set the following values for the *Page Building Service: CHIP (/UI2/CHIP)* authorization object:
 1. Open *Web Dynpro ABAP: CHIP ID (/UI2/CHIP)* in edit mode and set the value to X-SAP-UI2*. Save your entries.
 2. Open *Activity (ACTVT)* in edit mode and check the value 06 (*Delete*). Save your entries.
12. Generate a profile for the authorizations.

Change Standard Roles

Make changes to the following roles:

- Role SAP_BC_WEBSERVICE_ADMIN_TEC:
 1. Call up role SAP_BC_WEBSERVICE_ADMIN_TEC in transaction PFCG in change mode.
 2. Switch to the *Authorizations* tab and choose the *Change Authorization Data* pushbutton under *Maintain Authorization Data and Generate Profiles*.
 3. Expand node *Basis: Administration*, then node *SOAP Runtime: Web Service Provider Configuration* (authorization object S_SRT_CF_P). In field *Activity*, add the value 01 (*Create*).
 4. Save the changes and generate the profile.

- Role `SAP_BC_DB_ADMIN` must be enhanced by the authorization for table access:
 1. Call up role `SAP_BC_DB_ADMIN` in transaction `PF03` in change mode.
 2. Switch to the *Authorizations* tab and select the *Change Authorization Data* pushbutton under *Maintain Authorization Data and Generate Profiles*.
 3. Expand the *Basis: Administration* node, then expand the *Table Access via Generic Standard Tools* node (authorization object `S_TABU_NAM`). In field *Activity*, add the values **02** (*Change*) and **03** (*Display*).
 4. Regenerate the profile. Check if a user comparison is required.
- Role `SAP_BC_BASIS_ADMIN` must be enhanced by the authorization to access the *Trust Manager* for SSL setup purposes:
 1. Call up role `SAP_BC_BASIS_ADMIN` in transaction `PF03` in change mode.
 2. Switch to the *Authorizations* tab and choose the *Change Authorization Data* pushbutton under *Maintain Authorization Data and Generate Profiles*.
 3. Expand the *Cross-application Authorization Objects* node, then expand the *Transaction Code Check at Transaction Start* node.
 4. Choose the **+ Manually** pushbutton. Enter the authorization object `S_TCODE` and choose *Execute*.
 5. Now choose the *Edit* pushbutton next to the transaction code you just created.
 6. In field *'From'*, enter **STRUST**, then save.
 7. Regenerate the profile. Check if a user comparison is required.

Note

The role changes mentioned above need to be available in all relevant systems such as development, quality, and production systems. You can add the changed roles to a transport request and transport them through your system landscape.

Create a User for Application Setup and Assign the Relevant Roles

Before you assign a single role to a user you have to ensure that its role profile is generated.

To do this, call up the role in transaction `PF03` in change mode, switch to the *Authorizations* tab and choose the *Change Authorization Data* pushbutton under *Maintain Authorization Data and Generate Profiles*. Then choose the pushbutton *Generate*.

For more information about profile generation, see section [Generating Authorization Profiles](#) of the ABAP platform documentation on the SAP Help Portal at:

<https://help.sap.com/mkt-op> ► *Foundation on ABAP Platform 1809, version for SAP HANA* ► *ABAP Platform* ► *Securing the ABAP Platform* ► *Security Concepts and Tools* ► *Identity Management* ► *User and Role Administration of Application Server ABAP* ► *Configuration of User and Role Administration* ► *Role Administration* ► *Role Administration Functions* ►

Note

Remember to also generate profiles for the single roles included in composite role `SAP_MARKETING_TECHNICAL_CONF` as well as for all other roles listed below under step 2.

Now, create a user for application setup and assign the following roles.

1. Go to transaction SU01 to create a new user of type *Dialog* (see tab *Logon Data* on the *Maintain User* screen).
2. Assign the following roles
 - Z_RT_GW_USER
 - SAP_MARKETING_TECHNICAL_CONF (composite role)
 - SAP_CUSTOMER_ANALYTICS_ADMIN
 - SAP_BC_CTS_ADMIN
 - SAP_BC_SIW_DEV
 - SAP_BC_WEBSERVICE_ADMIN_TEC
 - SAP_BC_DB_ADMIN
 - SAP_BC_BASIS_ADMIN
 - SAP_BC_SEC_AUTH_ADMIN

You can lock the users after successful configuration of SAP Marketing. The user is needed again when you carry out an upgrade of SAP Marketing.

7.5.2 Maintaining the Client

SAP Marketing uses Operational Data Provisioning (ODP) for the access of SAP HANA content. For the configuration of ODP within your development and configuration system, you must allow system changes on the relevant clients. To do so, proceed as follows:

1. Log on to the system with the user that you have created in section [User for Application Setup \[page 41\]](#).
2. Execute transaction `SCC4` for client maintenance. Ensure that a logical system is assigned to the client that will be used for SAP Marketing.
For more information on logical system assignment, see section [Setting Up Logical Systems](#) of the ABAP platform documentation on the SAP Help Portal at:
<https://help.sap.com/mkt-op> ► [Foundation on ABAP Platform 1809, version for SAP HANA](#) ► [ABAP Platform](#) ► [Securing the ABAP Platform](#) ► [Security Concepts and Tools](#) ► [Identity Management](#) ► [User and Role Administration of Application Server ABAP](#) ► [Configuration of User and Role Administration](#) ► [Central User Administration](#) ► [Setting Up Central User Administration](#) ►
3. Set the field *Cross-Client Object Changes* to *No changes to cross-client Customizing objects*.

Then, ensure that the system changes become effective in the BW namespaces:

1. Go to transaction `SE03`.
2. Choose ► [Administration](#) ► [Set System Change Option](#) ►. Set the *Global* setting to modifiable.
3. Set the attribute *Modifiable* for the namespaces `/BIC/` and `/BI0/`.
4. Set your own namespaces to *Modifiable* by setting component `LOCAL` and customer name spaces to *Modifiable*.

For more information, see section [Setting the System Change Option](#) of the ABAP platform documentation on the SAP Help Portal at:

<https://help.sap.com/mkt-op> ► [Foundation on ABAP Platform 1809, version for SAP HANA](#) ► [ABAP Platform](#) ► [Adminstrating the ABAP Platform](#) ► [Administration Concepts and Tools](#) ► [Administration of Application Server](#)

[ABAP](#) > [Change and Transport System](#) > [Transport Organizer \(BC-CTS-ORG\)](#) > [Requirements for Working with the Transport Organizer](#) >

For general information, see section [Namespaces and Naming Conventions \(BC-CTS-NAM\)](#) of the ABAP platform documentation on the SAP Help Portal at:

<https://help.sap.com/mkt-op> > [Foundation on ABAP Platform 1809, version for SAP HANA](#) > [ABAP Platform](#) > [Adminstrating the ABAP Platform](#) > [Administration Concepts and Tools](#) > [Administration of Application Server ABAP](#) > [Change and Transport System](#) >

In your productive system, you must also ensure that system changes to software component `LOCAL` are allowed:

1. Execute transaction `SE03`.
2. Choose > [Administration](#) > [Set System Change Option](#) >. Set the *Global Setting* to *Modifiable* in order to be able to set component `LOCAL` to modifiable.
3. Set the component `LOCAL` to *Modifiable*. All other components and name spaces can be set to *Not modifiable*.

7.5.3 Creating Development Packages

You can skip this step if your system is a production system that is supplied with transports from a development and configuration system.

If your system is a development and configuration system, you need to create two separate development packages for the following content:

- Generated OData services
- BI content (required only if you plan to use applications available in the *Customer Value Intelligence* business group, see section [Enabling Customer Value Intelligence Applications \[page 86\]](#))

The development requests need to be transported through your system landscape.

To create the development packages, proceed as follows:

1. Log on to the system with the user for application setup that you have created in section [User for Application Setup \[page 41\]](#).
2. Create a workbench request for transports to the productive system (see [Releasing Transport Requests in Development System \[page 61\]](#)).
3. Execute transaction `SE80` and choose the entry *Package* in the dropdown box to the left. Enter a name for the new package for generated OData services, then press the enter key. In the following dialog box, confirm that you want to create a new package. Enter a short description and a transport layer. Confirm your entries.
4. Repeat step 3, this time creating a package for activated BI content.

7.6 Using the Technical Configuration Cockpit

SAP Marketing requires several technical configuration steps that need to be carried out after installation.

i Note

We recommend that you first complete the technical configuration in your development and configuration system, then in the productive system.

The technical configuration cockpit is an application that helps you to carry out the bulk of technical steps.

i Note

Before you start the technical configuration cockpit for the very first time **in a closed system such as a productive system**, the required runtime objects are stored locally, ensure the following settings in your system:

- In transaction SE03, under node *Administration* of the *Transport Organizer Tools* tree, double-click *Set System Change Option*. Ensure that the *Global Setting* field as well as the software component *Local Developments (No Automatic Transport)* (LOCAL) are set to *Modifiable*.
- In transaction SCC4, double-click the client, in which you want to execute the technical configuration cockpit. Ensure that the *Changes and Transports for Client-Specific Objects* are **not** set to *No changes allowed*. In addition, ensure that *Cross-Client Object Changes* are set to *Changes to repository and cross-client customizing allowed*.

You can change these settings according to your requirements after the very first start of the technical configuration cockpit.

To start the technical configuration cockpit, run transaction CUAN_TECHNICAL_CONF with the user for application setup (see section [User for Application Setup \[page 41\]](#)) in your AS ABAP system. First, you have to provide the fully qualified domain main and the port of your SAP Web Dispatcher (see section [Configuring the SAP Web Dispatcher \[page 37\]](#)).

The technical configuration cockpit consists of clickable tiles that are divided into separate sections, which are described in the chapters below.

i Note

To speed up the post-installation process and to avoid errors, we strongly recommend that you use the technical configuration cockpit.

If you are not able to use the technical configuration cockpit due to, for example, authorization restrictions, you can fall back on the expert mode (see section [Technical Configuration - Expert Mode \[page 164\]](#)). In this case, you will need to carry out all steps in the back end, with much less tool assistance.

7.6.1 Section "Overview"

In this section, you are provided with information about your AS ABAP back-end system.

- *SAP Marketing Product Version* provides information about the installed software components and their versions. In addition, you can check whether the installed component versions are compatible with the current release of SAP Marketing, and whether an upgrade is required.
- *Users Online* provides information about the number of logged on users. Based on this information, you can decide whether to start your configuration activities while other activities may be still ongoing in the system.
- *Systems Connected* includes a graphical representation of the most relevant components currently connected in your system landscape, such as SAP Web Dispatcher, or an SAP ERP system. It also indicates the status of the connections and includes other connection information such as server name and port. Erroneous system connections are indicated with red numbers on the tile (3/7 in red with the status *Action Required*, for example, means that only three of seven connections work properly). Note that some components and connections are added during the scenario configuration, depending on your functional scope and integration options.

- **Tiles with SAP Note Information**

You are provided with the following tiles offering information about SAP Notes to be implemented:

- *Mandatory Notes for Essentials Scenario* provides information about the SAP Notes to be implemented **before** executing the *Essentials* scenario, and about their current implementation status. Open SAP Notes that are still to be implemented are indicated with red numbers on the tile (3/7 in red with the status *Action Required*, for example, means that only three of seven mandatory SAP Notes are implemented).
- *SAP Marketing Application Notes* provides information about optional SAP Notes related to the various SAP Marketing applications or integrations. If you have an application or integration, to which a note refers, in scope, you must implement the note after you have completed the installation procedure (see section [SAP Notes for Installation and Upgrade \[page 163\]](#)). The number on the tile indicates the number of available SAP Notes.

The SAP Note information of both tiles is derived from the Release Information Note (RIN), which you can access directly from within the tiles. You can download the relevant SAP Notes into your system. Implement the SAP Notes using transaction `SNOTE` in your AS ABAP back-end system.

- *Scenario Check* provides information about the current technical configuration status of your SAP Marketing system and corresponding solutions in case the check detects errors. Is the system ready for use or does it require additional adaptations or corrections to be carried out? The check starts automatically when the technical configuration cockpit is launched. It refers to and displays scenarios that have been executed minimum one time and covers the following scenarios: *Essentials*, *ERP Integration*, and *CRM Integration*. The following check statuses are possible:

- *Check Successful*
If the scenario check is successful the system is ready for use with no additional adaptations.
- *Solutions Available*
If solutions are available the check detected errors in at least one of the already executed scenarios and offers more information on the check's detail screen.

On the details screen of the check, you are provided with the *Check* and the *Solve* views:

- On the *Check* view, you are provided with information about the check result and the latest check date for each scenario. In addition, you can drill down into the check results for different configuration tasks using the *Show Details* pushbutton.
- The *Solve* view offers detailed solutions with step by step descriptions for configuration tasks with errors.

The *Run Check* pushbutton allows you to re-execute the scenario check, for example, to update the check result after you fixed an error or executed an additional scenario.

i Note

Be prepared that re-executing the check can take up to a few minutes.

7.6.2 Section "Scenarios"

In this section, you are provided with the available technical configuration scenarios. With the scenarios, the cockpit follows an additive approach dividing the technical configuration into smaller executable parts: the basic configuration (scenario *Essentials*), which is mandatory, and additional configuration that is optional and depends on your scope.

You can execute any optional scenario at any time, either directly after the execution of *Essentials*, or at a later point in time.

Every scenario consists of a description, the *Progress* section, and the *Parameters* section.

The *Progress* section is visible only once the configuration check or the configuration run has been started. It includes clickable icons representing a task of the task list behind the scenario. Clicking the icon provides you with more information about task and its configuration status.

In the *Parameters* section you have to provide the required input. The parameter fields are explained below in the dedicated scenario descriptions for each scenario.

Once you provided the parameter values for a scenario, you choose the *Check Configuration* pushbutton first, to let the system check your input. If the check is completed successfully, you choose the *Run Configuration* pushbutton to execute the technical configuration scenario.

i Note

You can run every configuration multiple times by choosing the *Run Configuration* pushbutton.

The following scenarios are available:

- *Essentials*
- *ERP Integration*
- *CRM Integration*
- *HANA Rules Framework*
- *Campaign Management*
- *Lead Management with Cloud for Customer Integration*
- *Recommendation*

7.6.2.1 Scenario "Essentials"

i Note

This scenario is mandatory for the setup of SAP Marketing and must be executed before any other scenario. The scenario enables a basic configuration that allows the display of the SAP Marketing user

interface without any integration to other systems once all following steps (of section [Post-Installation](#)) are carried out.

The following is an extract of the steps that are automatically carried out by *Essentials*:

- The execution of **task list** `CUAN_BASE_CONFIG` is automatically triggered.
- **Users** needed for post-installation steps are created automatically (where possible)
- **Workbench and Customizing requests** are created (for development systems):

Customizing Requests

- [Common Customizing Activities](#)

Workbench Requests

- [Common Workbench Objects](#)
-

Note

The transport requests must be released manually and imported in the production system in a predefined sequence. For details, see [Releasing Transport Requests in Development System \[page 61\]](#).

- **OData services** are activated (for development systems).
- **Background jobs** are scheduled and executed.
In transaction `SJOBREPO`, you can check, which jobs are delivered with SAP Marketing. The name of the relevant job definitions is `SAP_CUAN_<*>`, while job definitions and job names are identical. In column *JD Status* (Job Definition Status), you can check whether a job definition is scheduled in a task list. By double-clicking a job definition, you can see the meta data of a job such as frequency or name of the corresponding program.
In transaction `SM37`, you can check which jobs are scheduled or executed. In addition, you can change the default frequency of regular background jobs.
- **Full text indexes** are generated.

You must provide values for the following parameters in *Essentials*:

- **Role of System:**
For this field, you have the following options:
 - **Dev. System:** If you run the technical configuration in a development or configuration system (such as an integration system), the system creates objects according to your settings in the wizard and writes them to a transport request.
 - **Prod. System:** If you run the technical configuration in a production system (such as a consolidation system), the system does not create any objects according to your settings in the wizard, but the system is capable to import objects via a transport request from a development or configuration system.
 - **Local System:** If you run the technical configuration in another system (such as a demo system), the system creates objects according to your configuration settings, but does **not** write them to a transport request.

Caution

Note that changing the *Role of System* entry is not possible anymore once you have started the technical configuration.

For example, if you configured the system as a demo system you cannot convert it into a development or production system. These system types would need to be created from scratch.

Note

Ensure that the selected system type matches with the corresponding entries in transaction SCC4 (field *Client role* and related entries):

- If you select *Dev. System* in field *Role of System*, the entry in the *Client role* field (transaction SCC4) must be other than *Production*.
- If you select *Prod. System* in field *Role of System*, the entry in the *Client role* field (transaction SCC4) must be other than *Customizing*.

- **User for SAP HANA Database Connection:**
In this field, you enter the SAP HANA user that you created in section [SAP HANA User for Technical Configuration \[page 32\]](#). The user enables executing changes, for example, granting privileges to other users, in the SAP HANA database during the configuration of the system. By default, the user is TC_USER. As you need the user also for an upgrade of SAP Marketing, we recommend to deactivate the user after technical configuration rather than deleting it.
- **Password:**
In this field, you enter the password of the SAP HANA user that you created in section [SAP HANA User for Technical Configuration \[page 32\]](#). The password is stored in the secure store. As you need the user and password also for an upgrade of SAP Marketing, we recommend to document the password outside the system.
- **Fully Qualified Domain Name:**
In this field, you indicate the domain name of the installed and configured SAP Web Dispatcher (see section [Configuring the SAP Web Dispatcher \[page 37\]](#)) for your system in the following format: <3rd-level-label>.<2nd-level-label>.<Top-Level-Domain>.<root-label>, for example, mywebdispatcher.wdf.sap.corp.
If you already specified the domain name in transaction CUAN_TECHNICAL_CONF before initially opening the technical configuration cockpit, the field is already prefilled, and you can skip this step.
- **Port:**
In this field, you indicate the port of the installed and configured SAP Web Dispatcher (see section [Configuring the SAP Web Dispatcher \[page 37\]](#)), for example, 10100.
If you already specified the port in transaction CUAN_TECHNICAL_CONF before initially opening the technical configuration cockpit, the field is already prefilled, and you can skip this step.
- **OData Service Package:**
This field is only available if you selected *Dev. System* in the *Role of System* field (see above). Enter the package that you created for OData service generation in section [Creating Development Packages \[page 45\]](#).
- **User for Background Processing:**
In this field, you can specify a user for the processing of background jobs. SAP Marketing processes jobs for several parts of the functionality in the background, for example, the data load from connected systems. By default, the system provides you with BATCH_USER.
If you want to use another user for background job processing, indicate the required user name. If the indicated user exists, the system uses it for background job processing. If this user does not exist, the system creates this user.

i Note

If you indicate a user for background job processing that is still to be created, ensure that the central user administration is deactivated.

7.6.2.2 Scenario "ERP Integration"

You have the option to integrate SAP Marketing with your existing SAP ERP system to use your SAP ERP data such as accounts and contacts within SAP Marketing. In this case, the SAP ERP data is either reused (in case of co-deployment of SAP ERP with SAP Marketing on the same SAP HANA database), or replicated to your SAP Marketing system using the SAP Landscape Transformation Replication Server (SAP LT). For more information, see [Data Replication \[page 27\]](#).

For the optional integration with SAP ERP, you must specify the following parameters:

- **SAP ERP Deployment:**
By default, the parameter is set to *No Integration*. Choose one of the following alternatives for the business data integration with SAP ERP:
 - *Reuse of Original Suite Schema:* You can co-deploy SAP ERP and SAP Marketing on the same SAP HANA database.
 - *Use of Replicated Suite Schema:* You can replicate the required business data from the SAP ERP system into the SAP HANA database of SAP Marketing.Before you run the scenario, create the RFC destinations to the SAP ERP client.
- **SAP ERP Source Data Client**
Enter the source client number of the SAP ERP system.
- **RFC Destination to SAP ERP System**
Enter the name of the RFC destination to your SAP ERP source client.

If you use the option to co-deploy SAP Marketing on the same database SAP HANA database as your SAP ERP system, specify the following parameter:

- **SAP ERP Schema**
Enter the name of your original ERP schema.

If you use the option of replicating the SAP ERP business data, specify the following parameters:

- **RFC Destination to LT System** for your SLT instance
- **SAP LT Configuration Name** as specified within your SLT configuration
- **SAP LT HANA Target Host**
Enter the host ID as specified within your SLT configuration.
- **SAP LT HANA Target Host Inst.**
Enter the instance number as specified within your SLT configuration.
- Select the option *One Time Initial Data Load Only* if you want to replicate the business data once for an initial load. As a result, any changes in the source system are not reflected in your replicated business data.

7.6.2.3 Scenario "CRM Integration"

You have the option to integrate SAP Marketing with your existing SAP CRM system to use your SAP CRM data such as accounts and contacts within SAP Marketing. In this case, the SAP CRM data is either reused (in case of co-deployment of SAP CRM with SAP Marketing on the same SAP HANA database), or replicated to your SAP Marketing system using the SAP Landscape Transformation Replication Server (SAP LT). For more information, see [Data Replication \[page 27\]](#).

For the optional integration with SAP CRM, you must specify the following parameters:

- **SAP CRM Deployment**
By default, the parameter is set to *No Integration*. Choose one of the following alternatives for the business data integration with SAP CRM:
 - *Reuse of Original Suite Schema*: You can co-deploy SAP CRM and SAP Marketing on the same SAP HANA database.
 - *Use of Replicated Suite Schema*: You can replicate the required business data from the SAP CRM system into the SAP HANA database of SAP Marketing.Before you run the scenario, create the RFC destination to the SAP CRM client, and specify the HTTPS connection to the SAP CRM source system:
- **SAP CRM Source Data Client**
Enter the source client number of the SAP CRM system
- **RFC Destination to SAP CRM System**
Enter the name of the RFC destination to your SAP CRM source client.
- Specify the following for the *HTTPS Connection to SAP CRM Source System*:
 - *Fully Qualified Host Name*
 - *HTTPS Port*

If you use the option to co-deploy SAP Marketing on the same database SAP HANA database as your SAP CRM system, specify the following parameter:

- **SAP CRM Schema**
Enter the name of your original CRM schema.

If you use the option of replicating the SAP CRM business data, specify the following parameters:

- **RFC Destination to LT System** for your SLT instance
- **SAP LT Configuration Name** as specified within your SLT configuration
- **SAP LT HANA Target Host**
Enter the host ID as specified within your SLT configuration.
- **SAP LT HANA Target Host Inst.**
Enter the instance number as specified within your SLT configuration.
- Select the option *One-Time Initial Data Load Only* if you want to replicate the business data once for an initial load. As a result, any changes in the source system are not reflected in your replicated business data.

For more information about the integration with SAP CRM, see [SAP CRM Business Transactions and SAP Marketing Interactions \[page 84\]](#).

7.6.2.4 Scenario "HANA Rules Framework"

The SAP HANA rules framework (HRF) allows you to manage and automate business decisions based on rules and rule services. HRF is available as a SAP HANA deployment unit, which uses SAP HANA extended application services, classic model (SAP HANA XS Classic).

Within SAP Marketing, HRF is used for the following options:

- **Scoring Based on SAP HANA Rules Framework in SAP Marketing:**
HRF helps you to manage your heuristic scoring models in the *Score Builder Data Management* app. For more information, see [Scoring Based on SAP HANA Rules Framework \(HRF\) \[page 73\]](#).
- **Suppression Rules:**
HRF helps you to manage the rules by which you can control whether and how often a campaign interacts with contacts in the *Suppression Rules* app. For more information, see [Setting Up Suppression Rules \[page 148\]](#).

If you want to use one of the options above, proceed as follows:

Prerequisites

Prior to execute the scenario *HANA Rules Framework* in the technical configuration cockpit, you must carry out the following steps:

- **Installing the SAP HANA Rules Framework**
You must install the SAP HANA rules framework separately on the specific tenant database of the SAP HANA appliance. For the required version of HRF, see the release information note (RIN) for SAP Marketing, [1885803](#). For the installation procedure, see the [SAP HANA Rules Framework on XS Classic - Installation and Upgrade Guide](#) on the SAP Help Portal at:

<https://help.sap.com/hrf10> Select the required version in the "Version" field ► [Installation and Upgrade](#) ►.

i Note

Since you have already installed SAP HANA, you can skip section [Installing/Updating the SAP HANA Appliance Software](#) in this guide. The relevant sections are the following:

- [Downloading the Software](#)
- [Deploying the SAP HANA Rules Framework Software Component](#)

The additional sections about the HRF configuration can be skipped as they are automatically covered by the execution of the technical configuration scenario (see below, subsection *Executing the Scenario "HANA Rules Framework"*).

- **Ensuring Activation of the SAP HANA XS Classic Engine**
DataActivate the XS Classic engine on the tenant database because the access to the HRF components on the database (for example, from the user interface) is realized via the SAP HANA XS Classic server. To do so, follow the instructions in section [Add or Remove Services in a Tenant Database](#) of the SAP HANA Administration Guide on the SAP Help Portal at:
http://help.sap.com/hana_platform Select the required version in the "Version" field ► [Administration](#) ► [SAP HANA Administration Guide](#) ► [System Administration](#) ► [Managing Tenant Databases](#) ► [Creating and](#)

[Configuring Tenant Databases](#) > [Monitoring and Managing Tenant Databases](#) > [Add or Remove Services in a Tenant Database](#) >

- **Configuring Access to Tenant Database**

Set up the internal SAP Web Dispatcher, included in SAP HANA, to enable the correct routing of HTTP(S) requests from the user interface to the HRF components on the tenant database via the SAP HANA XS Classic server. To do so, follow the instructions in section [Configure HTTP\(S\) Access to Tenant Databases via SAP HANA XS Classic](#) of the SAP HANA Tenant Databases Operations Guide on the SAP Help Portal at: http://help.sap.com/hana_platform **Select the required version in the "Version" field** > [Administration](#) > [SAP HANA Administration Guide](#) > [Application Run-Time Services](#) > [Maintaining the SAP HANA XS Classic Model Run Time](#) > [Maintaining HTTP Access to SAP HANA](#) > [Configure HTTP\(S\) Access to Tenant Databases via SAP HANA XS Classic](#) >

- **Configuring SSL for SAP HANA XS Classic Engine**

Set up secure communication between Web-based clients and SAP HANA extended application services, classic model.

For information how to establish the secure communication, see the following instructions in the SAP HANA documentation:

- Section [Secure Communication Between SAP HANA XS Classic and HTTP Clients](#) of the SAP HANA Security Guide at:
http://help.sap.com/hana_platform **Select the required version in the "Version" field** > [Security](#) > [SAP HANA Security Guide](#) > [SAP HANA Network and Communication Security](#) > [Securing Data Communication](#) > [Secure Communication Between SAP HANA XS Classic and HTTP Clients](#) >
- Section [Configure HTTPS \(SSL\) for Client Application Access](#) of the SAP HANA Administration Guide under:
http://help.sap.com/hana_platform **Select the required version in the "Version" field** > [Administration](#) > [SAP HANA Administration Guide](#) > [Application Run-Time Services](#) > [Maintaining the SAP HANA XS Classic Model Run Time](#) > [Maintaining HTTP Access to SAP HANA](#) > [Configure HTTPS \(SSL\) for Client Application Access](#) >

You must establish a trust relationship between your AS ABAP server and your SAP HANA database later on. For this reason, you either export the certificate of your SAP HANA server or the Certificate Authority (CA) root certificate, which has been used to sign the SAP HANA server certificate. Provide the certificate to the AS ABAP administrator who performs the SSL setup of the AS ABAP system.

i Note

If you use the tenant database, which has been prepared with the installation of the SAP HANA database, the SAP HANA XS Classic engine should be active, the access to the HRF components on the tenant database should be enabled, and the SSL for the XS Classic engine should be configured.

In this case, you do not have to **execute** but only to **verify** the steps mentioned under the last three bullet points above.

→ Recommendation

You can display and copy the certificates of the SAP HANA server to the file by connecting your internet browser to the address <https://<host name of SAP HANA server>:43<instance number>>, and choosing the lock symbol in the address bar.

For more information, see SAP Note [1094342](#).

Executing the Scenario "HANA Rules Framework"

For the use of HRF, you must specify the following parameters:

- *HANA Fully Qual. Hostname*: Enter the name including domain details of your SAP HANA extended application services, classic model (SAP HANA XS Classic).
- *HANA XS HTTPS Port Number*: Enter the SSL port number of your SAP HANA XS Classic.

7.6.2.5 Scenario "Campaign Management"

The applications belonging to *Campaign Management* allow the efficient planning and execution of marketing campaigns, which aim to increase the merchandise sales of individual products or the company as a whole, and to increase the customer retention to the company.

The main features include the creation of marketing campaigns and their execution using various communication channels such as emails or text message.

i Note

The *Campaign Management* applications are available only if *SAP Marketing Acquisition* is active.

If you want to use the *Campaign Management*, proceed as follows:

Executing the Scenario "Campaign Management"

For the use of the *Campaign Management* applications, you must specify the following parameters:

- *SAP Web Dispatcher Settings for Tracking and Bouncing*
Enter the *Fully Qualified Domain Name*, and the corresponding *Port* of the SAP Web Dispatcher you use to enable the tracking for messages.
- *SAP Mobile Services for Sending Text Messages*
If you want to use the option *Enable Text Messaging Integration*, make sure you have an SAP SMS 365 account available. In addition, specify the following:
 - *User* for your account
 - *Password* for your account
 - *Path Prefix*: Part of the URL made available by your provider that identifies the web service for your account. For example, in the URL `https://sms-pp.sapmobileservices.com/cmn/<accountid>/<accountid>.sms`, the path prefix is `/cmn/<accountid>/<accountid>.sms`.
- *SAP Mobile Services for Sending Email Messages*
Choose the option *Enable Mobile Service Integration* to enable sending emails using SAP Mobile Service. Make sure you have an SAP Mobile Service account available. Specify the *User*, and the *Password* for the SAP Mobile Service account. In addition, specify the path prefix (part of the URL that identifies the web service for your account).
- *Amazon Services for Sending Email Messages*

If you want to use the option [Enable Amazon Email Integration](#), make sure you have created an Amazon web services (AWS) account for using the Amazon Simple Email Service (Amazon SES). You can create access keys using the AWS Management Console. To use the option specify the following parameters:

- [Amazon Access Key ID](#), and [Amazon Secret Access Key](#) for your account
- Define a name for the [Amazon Feedback Queue](#). Configure the Amazon email service to collect all bounces and complaints in a queue on the Amazon Queue Service. Make sure the feedback queue name matches the queue name that is set up on Amazon's side. The feedback queue path is the last individual part of the queue URL at Amazon. For example, in the queue URL `https://sqs.eu-west-1.amazonaws.com/NNN/ABC`, the feedback queue path is `/NNN/ABC`.

- [Firebase for Sending Mobile Push Notifications](#)

Choose the option [Firebase Integration](#) to enable the creation of mobile campaigns to send marketing offers and messages to mobile devices as push notifications using Firebase Cloud Messaging. As a prerequisite, you have a valid Firebase account, created a corresponding project, and received the Firebase API key.

Specify this key in the [Firebase Key](#) fields. If the Firebase key is longer than 255 characters, split the key in two parts and enter it accordingly in the two key fields.

- [Configuration for Data Buffer](#)

The option [Enable Data Buffer Settings](#) sets up a data buffer servlet application, which you can deploy in any Web application server. The servlet application prevents you from any loss of your contacts' interaction data in case of a downtime of your AS ABAP system (for example, during system upgrades). In particular, the advantages of the data buffer are the following:

- In case of a system downtime, all inbound interaction requests are buffered in the data buffer servlet application. Once the system is back, a pull report, which is scheduled every minute, pulls the buffered interactions and creates the interactions in the AS ABAP system.
- In case of a system downtime, the redirection of trackable links do not fail for you contacts, as these redirections are served by the data buffer servlet application.
- The data buffer prevents you from denial of service attacks as anonymous requests are not served by the public ICF node, but by the servlet application.
- The data buffer can prevent your URLs of being tampered if the HMAC validation is active (see below) as tampered URLs will not pass the validation, thus will not be processed.

Settings

- **RFC Destination**

You create an RFC destination establishing a connection between your AS ABAP system and the system hosting the servlet application. You can either create a new RFC destination or use an already existing RFC destination by indicating the corresponding [RFC Destination Name](#), [User](#), [Password](#), and [Host](#).

- **Change Link Tracking Settings**

If you use a data buffer, the interactions created when a customer clicks a trackable redirect link in an email, are not sent to your AS ABAP system but to your data buffer servlet application. As the servlet application is installed on your Web application server, you must indicate the host and port information of this server for your trackable links in fields [Host for Link Tracking](#) and [Port](#).

- **Change Mobile Ch. Tracking**

This option is not enabled in SAP Marketing.

For more information about the data buffer configuration, see the [SAP Marketing Data Buffer Configuration Guide](#).

- [HMAC Validation Settings](#)

The *Activate HMAC Validation* option (HMAC = hash-based message authentication code) sets up a validation check for your interactions. The check verifies that the interactions came from the stated sender and have not been changed.

By default, the *Mandatory Validation Start* date is set to the current date. If you want to adapt this date, for example, to also validate interactions from earlier mails from your customers, you can enter the required date in format `YYMMDD`. Note that URLs, which do not comply with HMAC validation, are rejected after the specified date.

- **Digital Asset Management**

The integration with Digital Asset Management allows you to search for, and to insert images into messages. Choose an option depending on the external system you use. For the option *Open Text*, specify the *User*, and the *Password*.

When you choose one of the options an empty RFC destination (HTTP connection to external server) is created:

- RFC for *Product Content Management*: `CEI_ME_DAM_HYBRIS`
- RFC for *Open Text*: `CEI_ME_DAM_OPENTEXT`

Maintain the RFC destination according to requirements of the external system you use, for example, specifying target host, service number, logon. Use backend transaction *RFC Destinations* (SM59) to maintain the RFC destination.

7.6.2.6 Scenario "Lead Management with Cloud for Customer Integration"

This scenario covers the technical configuration for the usage of the following applications or features:

- **Lead Management**

Lead Management integrates the business process between marketing and direct or indirect sales channels, to drive higher-value opportunities through improved demand creation, execution, and opportunity management. It comprises all measures a company takes to convert potential buyers and interested persons to real buyers.

For more information, see section *Lead Management* in the application help for SAP Marketing on the SAP Help Portal at:

<https://help.sap.com/mkt-op> ► *Application Help* ► *SAP Marketing* ► *SAP Marketing Applications* ► *Lead Management* ▾

The *Lead Management* business group in SAP Marketing includes the following applications:

- *Lead Dashboard*
- *Score Builder*
- *Lead Stages*
- *Transfer Leads*

- **Call Center Integration with SAP Cloud for Customer**

In *SAP Marketing Acquisition*, you are provided with the option to trigger SAP Cloud for Customer call qualifications to the SAP Cloud for Customer system directly from a campaign in your SAP Marketing system. For more information, see [Setting Up Call Center Integration with SAP Cloud for Customer \[page 154\]](#).

The following prerequisites and dependencies apply for the *Lead Management* applications and for the Call Center Integration with SAP Cloud for Customer:

Application/Integration	Prerequisite
Lead Dashboard	<ul style="list-style-type: none"> <i>SAP Analytics Cloud</i> must be installed and configured (see section Integration with SAP Analytics Cloud (ISO) in the Integration Guide for SAP Marketing on the SAP Help Portal at: https://help.sap.com/mkt-op ► Integration ► Integration Guide ► SSL for SAP HANA XS Classic Engine must be configured (see section Configuring SSL for SAP HANA XS Classic Engine under Prerequisites in section Scenario "HANA Rules Framework" [page 53])
Score Builder	<ul style="list-style-type: none"> Technical configuration scenario <i>HANA Rules Framework</i> must be executed (see section Scenario "HANA Rules Framework" [page 53])
Lead Stages	<ul style="list-style-type: none"> <i>Lead Management</i> indicator in technical configuration scenario <i>Lead Management with Cloud for Customer Integration</i> must be selected
Transfer Leads	<ul style="list-style-type: none"> SAP Cloud for Customer must be installed and configured (see section Setting Up Integration with SAP Cloud for Customer below) <i>Lead Management</i> and <i>C4C Integration</i> indicators in technical configuration scenario <i>Lead Management with Cloud for Customer Integration</i> must be selected
Call Center Integration with SAP Cloud for Customer	<ul style="list-style-type: none"> SAP Cloud for Customer must be installed and configured (see section Setting Up Integration with SAP Cloud for Customer below) <i>C4C Integration</i> indicator in technical configuration scenario <i>Lead Management with Cloud for Customer Integration</i> must be selected

Setting Up Integration with SAP Cloud for Customer

If you want to use the *Transfer Leads* application or the Call Center Integration with SAP Cloud for Customer, you must set up the integration with SAP Cloud for Customer before you execute the *Lead Management with Cloud for Customer Integration* scenario.

To do so, proceed as follows:

The integration of SAP Cloud for Customer is based on an integration system. You have two options concerning your integration system:

- SAP Process Integration* (PI), an on premise solution
The minimum required release is SAP PI 7.3 with OData adapter `PIADAPTERS02_7-20012293.SCA`.
- SAP Cloud Platform Integration*, a cloud solution

For more information, see the corresponding integration guide on SAP Help Portal at:

[Integration with SAP Marketing](#)

(https://help.sap.com/c4c_re ► [Integration](#) ► [View All](#) ► [Prepackaged Integration with SAP Marketing](#) ►)

For information about how to set up the *SAP Process Integration* system, see [Integrating SAP Cloud for Customer with SAP Marketing using SAP Process Integration](#).

For information about how to set up the *SAP Cloud Platform Integration* system, see [Integrating SAP Cloud for Customer with SAP Marketing using SAP Cloud Platform Integration](#).

Web Services Reliable Messaging

Web Services Reliable Messaging (WS-ReliableMessaging) describes a protocol that allows messages to be delivered reliably between distributed applications in the presence of software component, system, or network failures.

To be able to use Web services with WS-ReliableMessaging, you must configure the Web service runtime. In each productive client and in client 000, execute the technical setup in transaction `SRT_ADMIN` of your SAP Marketing back-end system.

For information about how to configure the Web service runtime, see section [Configuring the Web Service Runtime](#) of the ABAP platform documentation on the SAP Help Portal at:

<https://help.sap.com/mkt-op> ► [Foundation on ABAP Platform 1809, version for SAP HANA](#) ► [ABAP Platform](#) ► [Developing on the ABAP Platform](#) ► [Development Concepts and Tools ABAP](#) ► [Application Development on AS ABAP](#) ► [ABAP Workbench - Classic](#) ► [ABAP Workbench Tools](#) ► [ABAP Web Services](#) ► [Operating Web Services](#) ►

Executing the Scenario "Lead Management with Cloud for Customer Integration"

For the use of the *Lead Management with Cloud for Customer Integration*, you must specify the following parameters:

- **Lead Management**
Select this indicator to activate *Lead Management* applications along with the corresponding SAP HANA content and BC sets in your system.
- **C4C Integration Configuration**
This parameter controls the configuration of the SAP Cloud for Customer in your system. Select this indicator to set up the RFC destination to SAP Cloud for Customer and logical ports to *SAP Process Integration* (PI) and *SAP Cloud Platform Integration* (CPI).
Set the following parameters:
 - **Host Name of C4C:**
Fully qualified domain name of your SAP Cloud for Customer system (UI front end) for UI navigation.
Example: `myUiServer.ondemand.com`.
 - **Port for C4C:**
Enter the port number of your SAP Cloud for Customer system (UI front end). Example: `443` (This is the default https port).
 - **Proxy Server (optional):**
Fully qualified domain name of your proxy server for the PI/CPI communication. Use these parameters if you require a proxy server to allow network connections to servers outside of your network.
 - **Proxy Port (optional):**
Port number of your proxy server for the PI/CPI communication.

- *Proxy User (optional):*
If required, replace the default by the service port number of your target host.
- *Proxy User Password (optional):*
Password for the proxy server user for the PI/CPI communication.
- If you want to replicate campaign information from SAP Marketing to SAP Cloud for Customer, select the *Activate Campaign Transfer* checkbox.
Once selected, you have to provide the following additional parameter:
 - *URL Access Path for Campaign:*
Service path of the PI/CPI server for communicating campaigns.
 - *Example for PI systems:* /XISOAPAdapter/MessageServlet?channel=:<yMKT system name>_<client>:<yMKT system name>_SOAP_CampaignReplicationNotification_Out
 - *Example for CPI systems:* /cx/yMKT/C4C/CampaignReplicationNotification_<yMKT system name><client>
 - *URL Access Path for Lead:*
Service path of the PI/CPI server for communicating leads.
 - *Example for PI systems:* /XISOAPAdapter/MessageServlet?channel=:<yMKT system name>_<client>:<yMKT system name>_SOAP_LeadReplRequest_Out
 - *Example for CPI systems:* /cx/yMKT/C4C/LeadReplicationRequest_Out_<yMKT system name><client>
 - *URL Access Path for Activity:*
Service path of the PI/CPI server for communicating activities.
 - *Example for PI systems:* /XISOAPAdapter/MessageServlet?channel=:<yMKT system name>_<client>:<yMKT system name>_SOAP_ActivityReplication_Out
 - *Example for CPI systems:* /cx/yMKT/C4C/ActivityReplicationOut_<yMKT system name><client>
 - *Host Name of PI/CPI:*
Fully qualified domain name of your PI/CPI server.
 - *Port of PI/CPI:*
Port number of your PI/CPI server.
 - *PI/CPI User:*
User of the PI/CPI server.
 - *PI/CPI Password:*
Password of the PI/CPI user.

7.6.2.7 Scenario "Recommendation"

The applications belonging to *Recommendation* allow business analysts and marketing experts to create recommendation models that provide consumers with relevant recommendations in real time, simultaneously across multiple sales channels. Recommendation models leverage algorithms and SAP HANA to query and retrieve recommendations from sales or business event data.

i Note

The *Recommendation* applications are available only if *SAP Marketing Recommendation* is active.

If you want to use *Recommendation*, proceed as follows:

Executing the Scenario "Recommendation"

For the use of the *Recommendation* applications, you must execute the scenario **without** specifying any of the available parameters. Note that the parameters are obsolete.

7.7 Applying Technical Configuration Artifacts to Production System

In your development and configuration system, the *Essentials* scenario in the technical configuration cockpit automatically creates transport requests with repository and Customizing objects (see [Scenario "Essentials" \[page 48\]](#)).

To make the artifacts - created during technical configuration in the development system - available in the production system, you must carry out the following two steps:

- In the development and configuration system, release the transport requests.
- In the production system, import the transport requests in a specific sequence and execute the technical configuration

7.7.1 Releasing Transport Requests in Development System

To release the transport requests in your **development system**, proceed as follows:

1. Log on to the **development** system with the [User for Application Setup \[page 41\]](#).
2. Go to transaction `SE09` and release and transport the following requests in the following sequence:
 1. Workbench Request created manually for the development packages (see [Creating Development Packages \[page 45\]](#)).
 2. Customizing Request: *Common Customizing Activities*
 3. Workbench Request: *Common Workbench Objects*
 4. Workbench Request: *Activated BI Queries* (available only if you have created this request in section [Creating Development Packages \[page 45\]](#), because you plan to use applications available in the *Customer Value Intelligence* business group, see section [Enabling Customer Value Intelligence Applications \[page 86\]](#))

7.7.2 Importing Transport Requests and Executing Technical Configuration in Production System

After you have carried out the technical configuration and released the relevant transport requests in your development system, you need to import the requests and execute the technical configuration of the *Essentials* scenario in the **production system**.

Proceed as follows in the **production system**:

1. Log on to the **production** system with the [User for Application Setup \[page 41\]](#).
2. Go to transaction `STMS_IMPORT` and import the requests listed above in the specified sequence:
 1. Workbench Request created manually for the development packages (see [Creating Development Packages \[page 45\]](#)).
 2. Customizing Request: *Common Customizing Activities*
 3. Workbench Request: *Common Workbench Objects*
3. Execute the *Essentials* scenario in the technical configuration cockpit in the **production system** (see section [Scenario "Essentials" \[page 48\]](#)).
4. Import the following request:
 - Workbench Request: *Activated BI Queries* (available only if you have created this request in section [Creating Development Packages \[page 45\]](#), because you plan to use applications available in the *Customer Value Intelligence* business group, see section [Enabling Customer Value Intelligence Applications \[page 86\]](#))

Note

When importing the transports into the production system, ensure that the client-specific Customizing is transported to the client, in which you execute the technical configuration.

7.8 Initial Setup of SAP Fiori

Set up the administrator role as well as the end user role for SAP Fiori by following the instructions described in the following two sections of the ABAP platform documentation on the SAP Help Portal at:

- [Protecting Access to Launchpad Designer](#) at:
<https://help.sap.com/mkt-op> ► [Foundation on ABAP Platform 1809, version for SAP HANA](#) ► [ABAP Platform](#) ► [UI Technologies](#) ► [SAP Fiori Launchpad](#) ► [Administration Guide](#) ► [Initial Setup of the Launchpad](#) ► [Initial Setup of the Launchpad Designer](#) ►
- [Configuring Roles with Launchpad Start Authorizations](#) at:
<https://help.sap.com/mkt-op> ► [Foundation on ABAP Platform 1809, version for SAP HANA](#) ► [ABAP Platform](#) ► [UI Technologies](#) ► [SAP Fiori Launchpad](#) ► [Administration Guide](#) ► [Initial Setup of the Launchpad](#) ► [Configuring Authorization Roles](#) ► [Configuring Roles with Launchpad Start Authorizations](#) ►

Now go to transaction `PF03`, create a new role (for example `ZCHIP_FOUNDATION`) and add the following authorizations

Authorization Object	Web Dynpro ABAP	Activity
/UI2/CHIP	X-SAP-UI2-CHIP*	03
/UI2/CHIP	X-SAP-UI2-PAGE*	03,16
S_PB_CHIP	X-SAP-UI2-CHIP*	03

Authorization Object	Activity	Package	Object Name	Object Type	Authorization Group ABAP / 4 Program
S_DEVELOP	03	*	X-SAP-UI2-CHIP*	*	*
S_DEVELOP	03, 16	*	X-SAP-UI2-PAGE*	*	*
S_DEVELOP	03	/UI2/ SERVICES_P B_UTIL_700	/UI2/*	WDCC	*

Authorization Object	Activity	Request Type
S_TRANSPRT	03	*

Generate the profile. Now assign the new role to all your business and administration users.

7.9 Displaying the SAP Online Documentation

SAP currently provides an HTML-based solution for the online documentation, including the Application Help, the Web Assistant, Glossary, Implementation Guide (IMG), and Release Notes. You can display the documentation with a JavaScript-compatible Web browser on all front-end platforms supported by SAP.

To ensure the display of the online documentation in SAP Marketing, you must do the following:

- Considering documentation-relevant parameters in your SAP Web Dispatcher configuration
- Enabling context-sensitive user assistance in your AS ABAP system
- Setting up the User Assistance Plugin

Considering Documentation-Relevant Parameters in the SAP Web Dispatcher Configuration

If you want to make context-sensitive user assistance available in the SAP Fiori launchpad, you must configure the SAP Web Dispatcher. You have already executed the relevant steps, which are included in the previous

chapter about SAP Web Dispatcher configuration, see section *Considering Documentation-Relevant Parameters* in *Configuring the SAP Web Dispatcher* [page 37].

Enabling Context-Sensitive User Assistance in Your AS ABAP System

You need to do these settings in the AS ABAP system which you use to create your system configuration setting. After you have done the settings, you save them, create a transport for them, and transport them to your productive system(s).

Proceed as follows:

1. Open transaction SR13.
2. Select the tab *PlainHtmlHttp*.
3. Choose *New Entry*. Enter the following values:

Name	Value to Be Entered
<i>Variant</i>	Enter a name for the variant (any name).
<i>Platform</i>	Select the platform relevant for your implementation, for example, NONE .
<i>Area</i>	Select <i>XML Documentation</i> . This will display as <i>XML_DOCU</i> in the table.
<i>Server Name</i>	Enter https://help.sap.com/http.svc/ahp2/
<i>Path</i>	Enter SAP_HYBRIS_MARKETING/1809.YMKT
<i>Language</i>	Select the language you need.
<i>Default</i>	Select one entry as default per platform.

4. Repeat step 3 for each relevant platform and language.
5. Save your changes and create a transport.

7.10 Defining a Virus Scan Profile

In order to adhere to security standards, we recommend that you use a virus scanner. The scanner performs checks in various SAP Marketing applications. For example, the scanner checks the HTML code of emails in *SAP Marketing Acquisition*.

By default, the virus scanning is switched on in the SAP NetWeaver Gateway, and as a result, you need to maintain the corresponding profile in Customizing of the virus scanning. For information about how to define a profile, see section *Virus Scan Profile (ABAP)* in the Security Guide for SAP Marketing at:

<https://help.sap.com/mkt-op> ► Security ►

You can switch on, or switch off the virus scanner in the SAP NetWeaver Gateway using transaction / IWFND/ VIRUS_SCAN, or using the corresponding activity in the *SAP Customizing Implementation Guide* (transaction SPRO) under **SAP NetWeaver > Gateway > OData Channel > Administration > General Settings > Define Virus Scan Profiles**.

i Note

SAP strongly recommends to keep the virus scan switched on.

i Note

Make sure that you complete this customizing step as part of the installation process.

7.11 Generating Authorization Profiles for the User Interface

In SAP Marketing several composite roles are provided that give you access to the SAP Marketing applications. These composite roles include all single roles that are necessary to run the corresponding solution.

The following table lists the available composite roles by business roles:

Business Role	Composite Role Name	Description
Marketing Experts	SAP_MARKETING_EXPERT	General access to SAP Marketing
	SAP_MARKETING_SEGMENTATION	Access to applications belonging to <i>Segmentation</i>
	SAP_MARKETING_CAMPAIGNS	Access to applications belonging to <i>Acquisition</i>
	SAP_MARKETING_SPEND_MGMT_PROG	Access to applications belonging to <i>Planning</i>
	SAP_MARKETING_RECOMMEND_EXPERT	Access to applications belonging to <i>Recommendations</i>
	SAP_MARKETING_INSIGHT	Access to applications belonging to <i>Insight</i>
	SAP_MARKETING_DATA_MANAGEMENT	Access to applications belonging to <i>Data Management</i>
	SAP_MARKETING_IN_S4H_EXPERT	General access to SAP Marketing excluding <i>Customer Value Intelligence</i> roles (for the use of SAP Marketing in combination with SAP S/4HANA, on premise)
Marketing Managers	SAP_MARKETING_MANAGER	General access to SAP Marketing

	SAP_MARKETING_PLANNING	Access to <i>Planning</i>
Marketing Executives	SAP_MARKETING_EXECUT_DASHBOARD	General Access to SAP Marketing
Business Analysts	SAP_MARKETING_RECOMMENDATION	Access to applications belonging to <i>Recommendations</i>
Administrator - Marketing	SAP_MARKETING_BUS_ADMIN_USER	Access to applications for key user and administrative tasks
Installation / Upgrade Team Members	SAP_MARKETING_TECHNICAL_CONF	Contains all roles needed to run the technical configuration tasks of the installation and upgrade process
User Administrator - Marketing	SAP_MARKETING_USER_ADMIN	Access for user administrators
Sales Representative	SAP_SALES_REP_MKT_INFO	Access to applications for sales representatives
Analytics Specialist	SAP_MARKETING_ANA_SPECIALIST	Access to applications for analytics specialists

To initially generate an authorization profile in your AS ABAP system and assign it to a user, you have to copy the required composite role including the single roles (depending on your purchased SAP Marketing solutions) and configure the copies of all roles according to your requirements.

1. Log on to your AS ABAP system and go to transaction PFCG.
2. For example, if you purchased the *Segmentation* price list component, enter SAP_MARKETING_SEGMENTATION in the *Role* field and choose the *Copy* pushbutton. A dialog box appears.
3. Enter a self-defined name for your role and choose the *Copy all* pushbutton.
4. In the following dialog box, choose the *Yes* pushbutton to copy the related single roles and assign them to the composite role.
5. In the following dialog box, select all single roles. Enter suitable names for each role in the *New Role* column.
6. Back on the *Role Maintenance* screen, choose the *Change* pushbutton.
7. Choose the *Roles* tab, and access the first new role by double-clicking it.
8. Choose the *Authorizations* tab, switch to *Edit* mode, and choose the *Propose Profile Name* pushbutton in the *Information About Authorization Profile* section. The system enters a profile name and a profile text.
9. Choose the *Change Authorization Data* pushbutton in the *Maintain Authorization Data and Generate Profiles* section.
10. On the *Change Role: Authorizations* screen, maintain authorizations to suit your requirements.
11. To generate the authorization profile, choose the *Generate* menu option from the *Authorizations* menu or choose the *Generate* pushbutton.
12. Repeat step 7 to 11 for all new roles in your composite role.

i Note

If you create a copy of another composite role (as you purchased more than one SAP Marketing solution), be aware that some of the included single roles may already have been copied.

i Note

These steps do not apply to roles for which a profile cannot be generated because they do not contain any authorization data, for example, business catalog roles such as `SAP_CEI_KUA_FLP`.

13. All required authorizations roles are described in section [Roles and Authorizations](#) of the Security Guide for SAP Marketing on the SAP Help Portal at:
<https://help.sap.com/mkt-op> ► [Security](#) ►
14. Assign your copied composite role to the users in transaction `SU01`.

i Note

If you purchase additional licenses, you need to adapt your roles accordingly.

7.12 Generating the URL for Displaying the User Interface

⚠ Caution

All previous steps have to be completed successfully before you can start with this step.

You create a start URL and distribute it to all potential end users as follows: `https://<fully qualified domain name of your SAP Web Dispatcher>:<HTTPS Port of SAP Web Dispatcher>/sap/bc/ui5_ui5/ui2/ushell/shells/abap/FioriLaunchpad.html?sap-client=<Client>#Shell-home`

From the AS ABAP system, you can launch the user interface using transaction `START_CEI`.

Logout Screen for the SAP Fiori Launchpad

By default, the SAP Marketing front-end system redirects you to a standard page, when you log out of the system.

If you want your users who log out of the system to be redirected to another page such as the SAP Fiori default log in page, follow the instructions described in section [Configure a Sign-Out Screen for the SAP Fiori Launchpad \(Optional\)](#) of the ABAP platform documentation on the SAP Help Portal at:

<https://help.sap.com/mkt-op> ► [Foundation on ABAP Platform 1809, version for SAP HANA](#) ► [ABAP Platform](#) ► [UI Technologies](#) ► [SAP Fiori Launchpad](#) ► [Administration Guide](#) ► [Configuring the Launchpad](#) ► [Configuring Sign-Out \(Logout\)](#) ►

Configuring the Launchpad in Customizing

If you want to adapt the launchpad configuration, for example, to prevent business users from changing the application by creating an own personalization or from showing or hiding business groups, you can do so by setting parameters in Customizing on the front-end server. For more information, see section [Setting Parameters in SAP Fiori Customizing](#) of the ABAP platform documentation on the SAP Help Portal at:

<https://help.sap.com/mkt-op> ► *Foundation on ABAP Platform 1809, version for SAP HANA* ► *ABAP Platform* ► *UI Technologies* ► *SAP Fiori Launchpad* ► *Administration Guide* ► *Configuring the Launchpad* ►

For general information about about the levels of the launchpad, see section [Configuring the Launchpad](#) of the ABAP platform documentation on the SAP Help Portal at:

<https://help.sap.com/mkt-op> ► *Foundation on ABAP Platform 1809, version for SAP HANA* ► *ABAP Platform* ► *UI Technologies* ► *SAP Fiori Launchpad* ► *Administration Guide* ►

8 General Configuration Settings in SAP Marketing

8.1 Setting up Integration with SAP Jam

You have the option to integrate various parts of SAP Marketing with the collaboration platform SAP Jam. The integration with SAP Jam is available for the following licenses and applications:

- **Data Management** (*Sentiment Engagement*):
You can use SAP Jam as a data source for *Sentiment Engagement*, which allows you to filter, analyze, and process posts from SAP Jam. In addition, you can create SAP Jam groups directly from the *Sentiment Engagement* user interface.
- **Acquisition:**
 - *Campaign Management*:
You can store campaign-related information in corresponding SAP Jam groups to support online communication such as discussions with other sales people about your campaign.
 - *Campaign Management (Paid Search)*:
You can share paid search campaign data with an existing group on SAP Jam to collaborate with other marketing experts. The post on SAP Jam will include a link to the specific paid search campaign you are sharing and the external marketing campaign associated with it.
- **Planning** (*Budget Plans*):
You can share planning data with an existing group on SAP Jam to collaborate with other marketing managers. The post on SAP Jam will include a link to the *Budget Plans* application.
- In addition, you must set up the integration with SAP Jam if you want to use the share function which is available in some SAP Fiori applications. This function allows the user to send posts to the feed of any SAP Jam group.

To set up the integration with SAP Jam, you need to carry out the following steps:

- Set up the connection with SAP Jam:
 - For a description of how to connect SAP Jam with AS ABAP systems, see section [Configuration](#) of the ABAP platform documentation on the SAP Help Portal at:
<https://help.sap.com/mkt-op> ► [Foundation on ABAP Platform 1809, version for SAP HANA](#) ► [ABAP Platform](#) ► [UI Technologies](#) ► [Social Media Integration](#) ► [Information for Administrators](#) ►
 - You find the relevant steps in the SAP NetWeaver implementation guide (IMG) (transaction SPRO) under ► [SAP NetWeaver](#) ► [UI Technologies](#) ► [SAP Jam Integration](#) ►.
- Carry out the customizing steps specified under SAP Marketing: ► [General Settings](#) ► [Integration](#) ► [Define Settings for Integration of SAP Jam](#) ►.
- In addition, for the use in *Sentiment Engagement*, you have to carry out the Customizing steps specified under SAP Marketing: ► [Contacts and Profiles](#) ► [Sentiment Engagement](#) ►.

i Note

You can only access the *Collaboration* menu path if you have activated the business function BC_SRV_STW_03 (*Enable Social Media ABAP Integration 3*) in customizing under ► *Activate Business Functions* ► *ENTERPRISE_BUSINESS_FUNCTIONS* ►.

9 Configuring Data Management

This section is relevant for all SAP Marketing applications.

With *SAP Marketing Data Management*, you can analyze contact data from various sources (such as SAP ERP, SAP CRM as well as external data sources such as social media) in order to gain a deeper insight into your contacts' sentiments and interests. Based on this information, you can create contact target groups and identify follow-up actions.

9.1 Sentiment Engagement (Optional)

Sentiment Engagement allows you to filter, analyze, and process data that has been harvested from external data sources such as social networks.

i Note

The use of information originating from social networks and other data sources must be checked in the individual case against the background of all applicable laws and regulations (e.g. on data protection) and individual rules (e.g. for the relevant data source). SAP does not accept any liability for the use of the application by its customers.

Since the setup requirements for collecting external data will always vary greatly depending between individual customers and countries, data harvesting is not part of the *SAP Marketing Data Management* application.

9.1.1 Setting up Data Harvesting

Prerequisites

In order to set up Sentiment Engagement, you need to carry out the steps below.

Ensure that the following Customizing entries have been made under *Contacts and Profiles* in SAP Marketing:

- ▶ *Interaction Contacts* ▶ *Define Settings for Social Media Integration* ▶
Enter the social media channel codes that you want to use in the *Sentiment Engagement* application (for example, **FB**).
- ▶ *Interactions* ▶ *Define Communication Media* ▶
Enter the communication media that you need (for example, **FB**).

i Note

Every communication medium that you want to use in the *Sentiment Engagement* application must correspond to a social media channel code.

- [Interactions](#) > [Define Interaction Types](#) > Select the *Text Anlys* checkbox for all interaction types that you want to use in the *Sentiment Engagement* application.
- [Interactions](#) > [Assign Interaction Types and Communication Media to Channels](#) > Assign the communication media that you have created to the interaction types that are selected for the text analysis.

Importing Social Posts

You first have to import the data that you want to analyze to your SAP Marketing system. Social posts are imported as interactions of interaction type `SOCIAL_POSTING`. In addition, social posts of any other interaction type are displayed in Sentiment Engagement if the text analysis is selected in Customizing for these interaction types (see the corresponding Customizing setting above).

The import is realized using one of the following data upload interfaces:

- OData service `CUAN_IMPORT_SRV`
- RFC function module `CUAN_CE_INTERACTIONS_POST` or `CUAN_CE_INTERACTIONS_POST_FLAT`
- Web service `CUANPOSTINTERACTIONS`

The regular background job `CUAN_IA_TA_EXTR_DELTA` that is scheduled during technical configuration ensures that the imported interactions are updated by sentiments and tags according to the results of *SAP HANA Text Analysis*.

For more information about the import of interactions, search for *Interactions* in the table of integration services in section [Integration APIs](#) of the Integration Guide on the SAP Help Portal at:

<https://help.sap.com/mkt-op> > [Integration](#) >

9.1.2 Setting up SMTP for Post Groups (Send Email to Me)

As a prerequisite for the usage of the post group action *Send Email to Me* (see the corresponding Customizing path below), you must set up the SMTP configuration for SAPconnect. To do so, proceed as follows:

1. Make the configuration settings for email exchange between your AS ABAP system and any SMTP (Simple Mail Transfer Protocol) mail server. For more information, see section [Quick Guide to SMTP Configuration](#) of the ABAP platform documentation on the SAP Help Portal at:
<https://help.sap.com/mkt-op> > [Foundation on ABAP Platform 1809, version for SAP HANA](#) > [ABAP Platform](#) > [Application Server ABAP - Infrastructure](#) > [Other Services](#) > [Services for Business Users](#) > [SAPconnect \(BC-SRV-COM\)](#) >
2. Make the required settings in Customizing for SAP Marketing under [Contacts and Profiles](#) > [Sentiment Engagement](#) > [Create Action ID for Post Groups](#) >. The `EMAIL2ME` (*Send Email to Me*) action must be active.

9.2 Scoring

Scores are calculated KPIs that help your end users to make assumptions about the future actions and decisions of an account, a contact, consumer, or prospect. Scores are displayed in a separate facet of the fact sheets on the user interface and can be used within [Segmentation](#).

9.2.1 Scoring Including SAP Predictive Analytics

[SAP Predictive Analytics](#) allows for an automated training of predictive models, which reduces the effort of the business analyst, and provides best results.

To enable the usage of [SAP Predictive Analytics](#) as an implementation method, an installation of [SAP Automated Predictive Library \(APL\)](#) on SAP HANA is required. The integration setup of [SAP Predictive Analytics](#) with SAP Marketing is not part of the SAP Marketing delivery.

If you have installed SAP HANA SPS09 or higher, you can use the [APL](#) for an easier and more convenient setup installation.

For details on how to install the APL, see the [SAP HANA Automated Predictive Library Reference Guide](#) on the SAP Help Portal at:

<https://help.sap.com/viewer/p/apl> ► [Development](#) ►

9.2.2 Scoring Based on SAP HANA Rules Framework (HRF)

You have the option of integrating the SAP HANA rules framework (HRF) to help manage your heuristic scoring models. With this feature, your business analysts can create heuristic scoring models by defining the score calculation directly on the user interface in the [Score Builder](#) app using an intuitive rules expression language.

A prerequisite for using this option is an installed and configured HRF. If you did not install and configure HRF before, follow the instructions in section [Scenario "HANA Rules Framework" \[page 53\]](#).

9.2.3 Predictive Model Training Based on [nu]-Support Vector Machine (R)

If you want to use [nu]-Support Vector Machine (R) for the training of a predictive model, you need to integrate R with the SAP HANA database. For more information about how to enable the embedding of R code in the SAP HANA database, see the [SAP HANA R Integration Guide](#) on the SAP Help Portal at:

https://help.sap.com/hana_platform Select the required version in the "Version" field ► [Reference](#) ► [View All](#) ► [SAP HANA R Integration Guide](#) ►

9.3 Web Shop Personalization Based on Customer Segments

You can integrate SAP Marketing with release 5.3 or higher of SAP Commerce, to personalize your Web shop based on customer segments. You do this by defining tactical customer segments in *Segmentation*, which leads to a personalized shopping experience in SAP Commerce.

The Web shop designer who works in the SAP Commerce design environment calls up a list of campaigns resulting from the customer segments defined in *Segmentation*. The designer implements the personalization for the Web shop, which can range from layout and featured products to promotional pricing, for example.

This feature is enabled via the OData service `CUAN_COMMON_SRV`: The SAP Commerce content management system (*WCMS Cockpit*) calls the SAP Marketing system during design time via this service to search for customer segments and, therefore, campaigns that are available for assignment to customer segment rules.

During runtime, that is when a user logs on to the SAP Commerce platform, the SAP Commerce system calls the SAP Marketing system via the OData service to establish which campaign and, therefore, to which customer segment the login user is assigned. With this information the corresponding customer segment rules as defined in *WCMS Cockpit* are derived and the web shop is personalized accordingly.

In order to use the appropriate level of authorization when accessing information in SAP Marketing from the SAP Commerce system, we recommend that you carry out the following steps:

1. Copy the single role `SAP_CEI_ECOMMERCE_INTEGRATION` using transaction `PFCG`.
2. Assign the new copied role to the technical user specified for accessing SAP Marketing from the SAP Commerce system.

The integration setup of the SAP Commerce system with SAP Marketing is not part of the SAP Marketing delivery. You can implement the setup on a project basis.

For more information, see the SAP Commerce documentation at:

<https://wiki.hybris.com/display/release5/SAP+hybris+Marketing+Integration> (for integration with release 5.x of SAP Commerce)

<https://help.hybris.com/6.7.0/hcd/8c48fea886691014a66bb78985584870.html> (for integration with release 6.7 of SAP Commerce)

9.4 Customer Journey Insight

Customer Journey Insight allows you to view customer journeys. A journey is a sequence of events performed by a customer over time through various media, such as social, Web and phone, for example, clicked ads, opened emails, and confirmed Web searches. Marketing managers can explore journeys that lead to a certain event performed by a customer, such as a buy, an abandoned shopping cart, or a conversion.

You can view customer journey data, such as all customers taking the same journey, the number of times a specific journey is taken, and the top journeys by percentage. You can filter customer journeys based on date range, touchpoints, top journey percentage, events, interaction types, target group, and granularity.

In addition, you are provided with the option to create target groups of identified contacts for further processing in campaigns or promotion activities.

9.4.1 Setting up Customer Journey Insight

Before you start with the configuration for *Customer Journey Insight*, ensure that you have carried out the steps described in the following section:

- [Initial Setup of SAP Fiori \[page 62\]](#)

To set up *Customer Journey Insight*, carry out the following steps:

1. Carry out the Customizing steps specified under SAP Marketing under [▶ Contacts and Profiles ▶](#). Ensure that you make all the required settings for interaction contacts, origins of contact ID, communication media, interaction types, interaction channels, and that you assign the interaction types and communication media to channels. Specifically, these need to be done in the following customizing steps:
 - [▶ Contacts and Profiles ▶ Interaction Contacts ▶ Define Origins of Contact ID ▶](#)
 - [▶ Contacts and Profiles ▶ Interactions ▶ Define Communication Media ▶](#)
 - [▶ Contacts and Profiles ▶ Interactions ▶ Define Interaction Types ▶](#)
 - [▶ Contacts and Profiles ▶ Interactions ▶ Define Interaction Channels ▶](#)
 - [▶ Contacts and Profiles ▶ Interactions ▶ Assign Interaction Types and Communication Media to Channels ▶](#)
2. Define interaction interests on the user interface, in the *Interaction Interests* application within the *Business Administration* business group.
3. Upload the necessary data including interactions and interaction contacts. Ensure that there are some interaction contacts and interactions available in your system, otherwise the chart will be empty.
4. Define events on the user interface, in the *Customer Journey Events* application within the *Business Administration* business group (see [Setting up Customer Journey Events \[page 76\]](#)). Enter the events and assign the interactions you want to use to these events. Save your entries.
5. To enable users to use *Customer Journey Insight*, assign your copies of the following PFCG roles to AS ABAP users:
 - SAP_CEI_SCI_FLP (business catalog role)
 - SAP_CEI_TG_INI (for creating, filtering and viewing target groups; included in composite role SAP_MARKETING_DATA_MANAGEMENT)
 - SAP_CEI_CJI (for accessing *Customer Journey Insight*; included in composite role SAP_MARKETING_DATA_MANAGEMENT)
 - SAP_CEI_CJI_EVENTS (for accessing *Customer Journey Events*; included in composite role SAP_MARKETING_BUS_ADMIN_USER)
 - SAP_CEI_HOME (for personalization purposes)

9.4.2 Setting up Customer Journey Events

Customer Journey Events, located in the *Business Administration* business group, allows business administrators to define events for customer journeys. An event can be any outcome of a customer journey, such as a buy, an abandoned shopping cart, or a conversion.

To enable business administrators to use *Customer Journey Events*, assign your copies of the following PFCG roles to the corresponding AS ABAP users:

- SAP_CEI_KUA_FLP (business catalog role)
- SAP_MARKETING_BUS_ADMIN_USER (for accessing all applications for key user and administrative activities)
- SAP_CEI_CJI_EVENTS (for accessing *Customer Journey Events*; included in composite role SAP_MARKETING_BUS_ADMIN_USER)

i Note

Ensure that the OData service CUAN_ODATA_CJI_SRV is added to your copy of role SAP_CEI_CJI_EVENTS. For a description of how to add an OData service manually, see section [Adding an OData Service to a Role](#) in chapter [New OData Services in Single Roles](#) of the Upgrade Guide for SAP Marketing on the SAP Help Portal at:

<https://help.sap.com/mkt-op> ► [Installation and Upgrade](#) ► [Upgrade Guide](#) ► [General Adaptations in SAP Marketing](#) ► [Adaptations of Roles and Authorizations](#) ►

- SAP_CEI_HOME (for personalization purposes)

9.5 Setting up Applications for Data Import

The following applications are available in the *Import Data* business group and allow you to import data for analytic purposes in the *Marketing Executive Dashboard*:

- *Import Data for Analytics* allows you to upload KPI data records.
- *Brands* allows you to add and edit brands, as well as to import brand data from a comma-separated value (CSV) file.
- *Competitors* allows you to import competitor data such as the competitor's market share via CSV upload.
- *Audiences* allows you to import audience data such as a group or a segment of customers via CSV upload.

Assign Users to Roles

To enable administrators in marketing to upload analytic data, you have to assign their AS ABAP users to your copy of the following roles:

For *Import Data for Analytics*:

- SAP_CEI_KUA_FLP (business catalog role; no copy required - you can assign the delivered standard role)

- SAP_CEI_IMPORT_ANALYTICS (back-end role; included in composite role SAP_MARKETING_BUS_ADMIN_USER)
- SAP_CEI_HOME (for personalization purposes)

For *Brands*:

- SAP_CEI_KUA_FLP (business catalog role; no copy required - you can assign the delivered standard role)
- SAP_CEI_BRANDS (back-end role; included in composite role SAP_MARKETING_BUS_ADMIN_USER)
- SAP_CEI_HOME (for personalization purposes)

For *Competitors*:

- SAP_CEI_KUA_FLP (business catalog role; no copy required - you can assign the delivered standard role)
- SAP_CEI_COMPETITORS (back-end role; included in composite role SAP_MARKETING_BUS_ADMIN_USER)
- SAP_CEI_HOME (for personalization purposes)

For *Audiences*:

- SAP_CEI_KUA_FLP (business catalog role; no copy required - you can assign the delivered standard role)
- SAP_CEI_AUDIENCES (back-end role; included in composite role SAP_MARKETING_BUS_ADMIN_USER)
- SAP_CEI_HOME (for personalization purposes)

9.6 Setting up Application "Business User"

The application *Business User* in the *Business Administration* business group allows marketing user administrators to create business users in the SAP Marketing system, for example, business users in the context of the *Marketing Executive Dashboard* (see [Setup for SAP Marketing Business Users \[page 84\]](#)). The user administrator can only use this app, if his or her user is assigned to your copy of the following roles:

- SAP_CEI_USER_HANDLING (back-end role; included in composite role SAP_MARKETING_USER_ADMIN)
- SAP_CEI_HOME (for personalization purposes)

9.7 Setting up Application "Digital Accounts"

With the *Digital Accounts* application in the *Marketing Data* business group, marketing experts can view and analyze the followers of social media accounts of their companies.

i Note

Currently, the only social network supported by *Digital Accounts* is WeChat, a social network mainly used in China. For the use of *Digital Accounts*, you must also apply the settings described in section [Configuring WeChat Integration \[page 160\]](#).

Customizing Activities and Business Add-Ins

The Customizing activities and BAdIs for the *Digital Accounts* app are located in Customizing for SAP Marketing under [▶ Contacts and Profiles > Digital Accounts >](#).

- **Customizing Activity "Define Digital Account Types"**
You decide what types of digital accounts can be configured in *Digital Accounts*.
- **Business Add-In "Acquiring Access Token"**
Due to business requirements, you may have multiple servers that receive various types of messages from the same digital account. If you allow each server to request the access token that is required for calling APIs for the digital account, trouble will arise due to conflicting access tokens. Instead, you should use one of them as a primary server, which is responsible for getting and storing the access token. If the server that you have configured for the integration of the digital account and SAP Marketing is not the primary server, then you need to implement this BAdI to get the access token from the primary server.

Assign PFCG Role to Users

To set up the *Digital Accounts* application, assign your copy of the following role to the AS ABAP users of your marketing experts in transaction PFCG of your SAP Marketing back-end system:

- SAP_CEI_DIGITAL_ACCOUNTS (back-end role; included in composite role SAP_MARKETING_EXPERT)

9.8 Marketing Locations

Marketing Locations allows you to maintain information about marketing locations. You can store information such as location name, location address, coordinates, phone number, web address, email and location picture. You can also upload location data using the *Import Data* application in the *Import Data* business group.

Access to Map Provider

You can also view marketing locations on a map. As a prerequisite, the user's browser needs access to the internet domain here.com, which provides the map data. Note that only locations with a valid latitude and longitude are shown on the map.

Consider the implications of communicating with servers outside your firewall.

For more information, see the [Security Guide](#) for SAP Marketing on the SAP Help Portal at:

<https://help.sap.com/mkt-op> [▶ Security >](#)

9.8.1 Setting up Marketing Locations

To set up *Marketing Locations*, make the settings in the following activities in Customizing for SAP Marketing under [▶ Contacts and Profiles > Marketing Locations >](#):

- [Define Origins of Marketing Location ID](#)
- [Define Marketing Location Types](#)

To enable users for *Marketing Locations*, assign your copies of the following PFCG roles to the corresponding AS ABAP users:

- SAP_CEI_SCI_FLP (business catalog role)
- SAP_CEI_MARKETING_LOCATION (for accessing *Marketing Locations*; included in composite role SAP_MARKETING_DATA_MANAGEMENT)

Uploading Marketing Location Data

To add marketing locations to SAP Marketing, you must import marketing location data from a comma-separated value (CSV) file using the *Import Data* application in the *Import Data* business group.

For more information about importing marketing locations, see section [Import Data \(CSV\)](#) in the application help for SAP Marketing on SAP Help Portal at:

<https://help.sap.com/mkt-op> [▶ Application Help > SAP Marketing > SAP Marketing Applications >](#)

To access the *Import Data* application, the user must be assigned a copy of the SAP_MARKETING_BUS_ADMIN_USER role.

For more information, see the [Security Guide](#) for SAP Marketing on the SAP Help Portal at:

<https://help.sap.com/mkt-op> [▶ Security >](#)

9.9 Google Analytics Integration (Optional)

You can enrich a sales order interaction of type SALES_ORDER with its source campaign and device category information. This information is retrieved from your Google Analytics view. After the information is added to the sales order interaction, you can do the following:

- View the *Number of Orders* and the *Order Amount* on the *Performance* tab of a campaign.
- View the source campaign of the sales order from the *Interactions* tab of a contact.
- Build a target group that only includes contacts who made purchases resulting from a specific campaign.

Sales orders are enriched with Google Analytics data using the report CUAN_GA_ENRICH_IA. You can schedule this job to run on a regular basis to always have the most up to date Google Analytics data for your sales orders.

For more information, see the report documentation provided within the report itself using the [Help](#) menu as well as the corresponding section [Integration with Google Analytics](#) in the Integration Guide of SAP Marketing on the SAP Help Portal at:

<https://help.sap.com/mkt-op> ► [Integration](#) ► [Integration Guide](#) ► [Integration Scenarios](#) ► [Inbound](#) ► [Commerce, Social Media, Web, and IoT](#) ►

9.10 Marketing Agencies

[Marketing Agencies](#) allows you to maintain information about agencies, that are dedicated to creating, planning, and handling advertising and other forms of marketing activities for its clients. You can store information such as agency name, agency address, phone number, Web address, email address, and agency picture.

Additionally, you can do the following:

- **Assign marketing areas**
You can assign marketing areas to a marketing agency to identify which marketing areas are relevant for the marketing agency.
- **View campaigns**
You can view and navigate to campaigns from a marketing area, when the agency has been added to the campaign in the [Collaboration](#) tab.

9.10.1 Setting up Marketing Agencies

To authorize users for [Marketing Agencies](#), assign your copies of the following PFCG role to the corresponding AS ABAP users:

- SAP_CEI_BCR_AGC_OP (for accessing [Marketing Agencies](#); included in composite role SAP_MARKETING_SPEND_MGMT_PROG)

9.11 Setting Up the Use of Agreements

The API OData Service [Agreements](#) (API_MKT_AGREEMENT_SRV) allows you to load customer agreements (including terms) into SAP Marketing. An agreement can be any kind of customer contract that comprises specific services. This API includes the option to update agreements from different source systems.

For more information about how to use the API, see section [Agreements](#) in the Integration Guide for SAP Marketing on the SAP Help Portal at:

<https://help.sap.com/mkt-op> ► [Integration](#) ► [Integration Guide](#) ►

Prerequisites

As a prerequisite to use the API OData Service [Agreements](#), you must execute the following activities in Customizing for SAP Marketing (transaction `SPRO`) under [SAP Marketing > Contacts and Profiles > Agreements](#):

- In **Define Agreement Origin**, you can define various originating systems for an agreement. The origin of an agreement is the operative system where an agreement is originally maintained.
- In **Define Agreement Type**, you can define different types of agreements, which can be used to segment customers holding agreements.
- In **Define Agreement Payment Frequency**, you can define names and IDs for various payment frequencies, in order to see how often the customer makes a payment.
- In **Define Agreement Cancellation Reason**, you can define reasons for the cancellation of an agreement.
- In **Define Agreement Cancellation Condition**, you can define and name the cancellation condition of an agreement.

Additional Options

- You can use the attributes of agreements as filter elements in the [Segmentation Modelling](#) app in [Segmentation](#) business group. As a prerequisite, these agreement attributes must be made visible in the [Segmentation Configuration](#) app in the [Segmentation and Campaign Configuration](#) business group. To do so, proceed as follows:
 1. In the [Segmentation Configuration](#) app, choose the [Segmentation Objects and Attributes](#) tile.
 2. To use the agreement attributes as filters for **contacts** in [Segmentation Modelling](#), select segmentation object [Contacts \(SCI 11SP8\)](#) (`SAP_CONTACT_ENGAGEMENT_11SP8`).
 3. In the [Assigned Data Sources](#) section, select `SAP_CONTACT_INTERACTIONS` in the [Data Source Alias](#) column, and choose [Edit](#).
 4. In the next view on the [Attributes](#) tab, choose [Edit](#).
 5. Select the [Visible as Attribute](#) checkbox for all those attributes that have the entries [Agreement](#) or [Agreement Terms](#) in the [Group](#) column.

i Note

To ensure that you cover all available agreement attributes, you can enter **Agreement** in the [Search](#) field.

6. Save your entries.
 7. To use the agreement attributes as filters for **consumers** in [Segmentation Modelling](#), repeat steps 3 to 6 for segmentation object [Consumers \(SCI 11SP8\)](#) (`SAP_CONTACT_EGM_CONSUMER_11SP8`). The data source alias `SAP_CONTACT_INTERACTIONS` remains the same.
 8. If you use own customer segmentation objects with the assigned data source `SAP_CONTACT_INTERACTIONS`, repeat steps 3 to 6 for these segmentation objects if you want to use the agreement attributes as filters in [Segmentation Modelling](#).
- In the SAP Marketing back-end system, you are provided with a status report (`CUAN_AGR_UPDATE_CURRENT_STATUS`) that allows you to update the current status of an agreement (see transaction `SA38`). The current status is dependent on the agreement status that comes from the originating system and on the agreement term that is valid at the current time. The report should be

running on a regular basis. SAP recommends to schedule the report to run it as a periodic background job. For more information, see the documentation attached to the report.

10 Configuring Insight

The settings described in this section are only relevant if you want to run *SAP Marketing Insight*.

10.1 Configuring SAP Analytics Cloud

The following applications within SAP Marketing are based on *SAP Analytics Cloud*:

Marketing Executive Dashboard

This application is available for marketing executives in the *Marketing Executive* business group.

The *Marketing Executive Dashboard* contains key performance indicators (KPI), which allow marketing executives to review the success of marketing investments, and gain an overview of KPI attainment and marketing performance benchmarks.

You are provided with a range of KPIs for the *Marketing Executive Dashboard*. For an overview of the available KPIs, see *Marketing Executive Dashboard* and subsequent chapters.

i Note

- The KPIs are delivered as templates. You might need to adjust them to better meet your business requirements.
- The KPIs, and the descriptions of the measures and dimensions are only available in English.

Lead Dashboard

This application is available for marketing experts in the *Lead Management* business group.

The *Lead Dashboard* app allows marketing experts to review the success of the lead management process, and provides them with a comprehensive overview of Key Performance Indicator (KPI) attainment and lead management performance benchmarks.

i Note

As a prerequisite for the use of the *Marketing Executive Dashboard* as well as the *Lead Dashboard*, you must integrate *SAP Analytics Cloud*. For a description of the integration, see section [Integration with SAP Analytics Cloud \(ISO\)](#) in the Integration Guide for SAP Marketing on the SAP Help Portal at:

<https://help.sap.com/mkt-op> ► [Integration](#) ► [Integration Guide](#) ►

10.1.1 Setup for SAP Marketing Business Users

To create marketing users for SAP Marketing, you are provided with the application *Business User* (see [Setting up Application "Business User" \[page 77\]](#)). To create marketing users that are allowed to access the *Marketing Executive Dashboard* or the *Lead Dashboard*, proceed as follows:

1. For the *Marketing Executive Dashboard*, copy the composite role `SAP_MARKETING_EXECUT_DASHBOARD` and its single roles to customer roles.
2. For the *Lead Dashboard*, copy one of the following composite roles and the included single roles to customer roles:
 - `SAP_MARKETING_INSIGHT`
 - `SAP_MARKETING_EXPERT`
3. Create a user for SAP Marketing *Business User*, and assign your copy of role `SAP_CEI_USER_HANDLING`.

i Note

You can also create marketing users for SAP Marketing using transaction `SU01` in the SAP Marketing AS ABAP system.

10.1.2 Creation of SAP Marketing Business Users

To create a business user within SAP Marketing, follow these steps:

1. Open SAP Marketing through the following URL: `https://<webdispatcher_host>:<webdispatcher_port>/sap/bc/ui5_ui5/ui2/ushell/shells/abap/FioriLaunchpad.html?sap-client=<Client>#Shell-home`.
2. Log on with the user for SAP Marketing *Business User Administration* from section [Setup for SAP Marketing Business Users \[page 84\]](#).
3. Open the *Business User Administration* application and create SAP Marketing business users. Assign your copy of composite role `SAP_MARKETING_EXECUT_DASHBOARD` or `SAP_MARKETING_INSIGHT`, respectively (see section [Setup for SAP Marketing Business Users \[page 84\]](#)).
4. When the SAP Marketing business users open SAP Marketing, they find the dashboard as follows:
 - The *Marketing Executive Dashboard* within business group *Marketing - Executive Dashboard*
 - The *Lead Dashboard* within business group *Lead Management*

10.2 SAP CRM Business Transactions and SAP Marketing Interactions

If you use SAP CRM as a source system, you can create activities directly in the SAP CRM source system from your SAP Marketing system. In addition, you can create interactions in SAP Marketing from replicated CRM business transactions that you already have in SAP Marketing.

To create CRM business transactions from SAP Marketing, you use the enhancement spot `CUAN_CRM_CREATE_10` (*Trigger Creation of CRM Activity*) to implement the BAdl

CUAN_CRM_CREATE_ONEORDER_ACT (*Create Business Transactions*). This BAdI includes a standard implementation.

If you want to enhance the standard implementation, create your own implementation on the basis of the standard. In addition, consider SAP Note [1784897](#).

To create interactions in SAP Marketing from existing CRM business transactions, you use the report CUAN_IA_EXTR_FROM_CRM and the transaction *Full Extraction of CRM Data as Interactions* (CUAN_CRM_IA_UPD).

For more information, see the document [Integrating SAP Marketing with SAP CRM](#).

10.3 Importing Data from External Source to "Margin Decomposition"

With the Web service CUAN_ANALYTIC_FND (to be accessed in your AS ABAP system under transaction SEGW), you can import analytical data from any external source into the *Margin Decomposition* application of *SAP Marketing Insight*.

In particular, you can import the amount and the document currency of the invoicing account for each of the following decomposition groups in *Margin Decomposition*:

- Gross Revenue
- Invoice Discounts
- Accrued Discounts
- CoGS
- Direct Costs
- Invoice Surcharges

The data can also be provided on the granularity of decomposition subgroups, for example, to show reporting results for different types of invoice discounts.

i Note

You can also use the Web service to integrate Controlling data from SAP ERP (CO-PA).

In addition, the data records are to be provided together with values (for IDs and codes) for characteristics/dimensions such as the following:

- Customer Group
- Industry Code
- Sales Organization
- Country
- Region of Country
- Distribution Channel
- Division
- Sales Group
- Sales Office

- Sales District
- Product
- Product Group
- Product Category

i Note

The needed master data or Customizing information for the dimensions values must be already part of SAP Marketing by means of a connected SAP ERP system.

For information about all required steps to set up the data import by Web service, see the section [Import Analytical Data Using a Web Service](#) on the SAP Help Portal at:

<https://help.sap.com/mkt-op> ► [Integration](#) ►

10.4 Enabling Customer Value Intelligence Applications

In the *Customer Value Intelligence* business group on the SAP Marketing user interface, your end users are provided with several tiles including marketing KPIs.

If you want your end users to be able to use these KPI tiles, proceed as follows:

1. In your AS ABAP **development** system, execute task list CUAN_SETUP_INSIGHT in transaction STC01.

i Note

Ensure that a corresponding BI and OData package is created beforehand. The task list automatically activates the corresponding BI content as well as BI-related OData services.

2. In the development system, release the transport requests created by task list CUAN_SETUP_INSIGHT.
3. In your **quality** and **production** systems, import the very same transport requests.
For general information about releasing and importing transports requests in development, quality, and production systems, see [Applying Technical Configuration Artifacts to Production System \[page 61\]](#).
4. Once you have imported the transport requests, execute task list CUAN_SETUP_INSIGHT in transaction STC01 of your **quality** and **production** systems **as well**.

If you **do not** want your end users to be able to use these KPI tiles, proceed as follows:

1. In transaction PFCG of your development system, remove the following roles from your copy of composite role SAP_MARKETING_EXPERT:
 - SAP_CEI_CVI
 - SAP_CEI_CVI_FLP

For more information, see the application help for SAP Marketing on the SAP Help Portal at:

- [Stratification](#)
- [Relationship Analysis](#)
- [Margin Decomposition](#)

11 Configuring Segmentation

The settings described in this section are only relevant if you want to run *SAP Marketing Segmentation*.

11.1 Dialog Work Processes

To achieve optimal performance, *SAP Marketing Segmentation* parallelizes requests in the ABAP application server as well as in the SAP HANA database. Therefore you must configure a suitable number of dialog work processes. The number of dialog work processes depends on the number of frequent *SAP Marketing Segmentation* users. A frequent user works, for example, every day for several hours in the system. The minimum number of processes that the application requires is 25.

To configure the number of dialog work processes, follow the description in SAP Note [39412](#).

→ Recommendation

SAP recommends the following number of dialog work processes per number of frequent users:

Frequent Users	≤ 10	25	50	75
Dialog Work Processes	25	30	65	90

11.2 Geospatial Segmentation (Optional)

This function allows viewing the distribution of geolocations on a map (for example, the distribution of customers in a region) and creating new segments based on areas defined on a map (radius or polygon).

If you want to use this function with any segmentation profile, you need to ensure that your attribute universe provides the necessary geolocation information. For details, see section [Setting up the Geospatial Segmentation and Map Preview](#) of the Extensibility Guide for SAP Marketing on the SAP Help Portal at:

<https://help.sap.com/mkt-op>  [Development](#) 

Access to Map Provider

To use geospatial segmentation, you need both map visualization and geocoding services.

Access to Map Provider with Default Configuration

SAP ships a default configuration, which uses here.com for map visualization and geocoding. You can use this default configuration if it fits your legal and functional requirements.

Note

SAP only provides the interfaces and configuration options which allow you to connect the map visualization and geocoding services. The usage of here.com is not part of your end-user license agreement with SAP. It is your responsibility to check and/or adapt the default configuration.

If you keep the default configuration, you need to check the following:

Map Visualization

The user's browser will need access to the internet domain here.com. The domain provides the map data that is used in the geospatial segmentation option. Check, whether the users in question have access to this domain and consider the implications of communicating with servers outside your firewall.

For more information, see section [Communication Destinations](#) of the Security Guide for SAP Marketing on the SAP Help Portal at:

<https://help.sap.com/mkt-op> ► Security ► Security Guide ► Network and Communication Security ►

Access to Map Provider with Custom Configuration

You can change the configuration using *SAP Visual Business*. For more information, see the corresponding documentation on the SAP Help Portal at:

https://help.sap.com/viewer/p/SAP_VISUAL_BUSINESS_2.1

To change the default configuration, go to *Customizing Mode* by selecting ► [Personalization](#) ► [Start Customizing Mode](#) ► on the segmentation UI.

In the *Console* view, enter the following:

- `sap.hpa.gseg.gen.Config(function (c) {c.setGeoService("sap.hpa.gseg.gen.VbService");c.saveAllBagAttrValues();})` to change the configuration for the geocoding service
- `sap.hpa.gseg.gen.Config(function (c) {c.setGeoMap("sap.hpa.gseg.controls.VbMap");c.saveAllBagAttrValues();})` to change the configuration for the map visualization

You can now change the configuration for the geocoding service under Customizing: ► [SAP NetWeaver](#) ► [UI Technologies](#) ► [SAP Visual Business](#) ► [Maintain Application Definition](#) ►. The relevant application name is GSEG_GEOSPATIAL.

In case you want to go back to the default configuration, enter the following in the *Console* view:

- `sap.hpa.gseg.gen.Config(function (c) {c.setGeoService("sap.hpa.gseg.gen.NokiaService");c.saveAllBagAttrValues();})` for geocoding services
- `sap.hpa.gseg.gen.Config(function (c) {c.setGeoMap("sap.hpa.gseg.controls.NokiaMap");c.saveAllBagAttrValues();})` for map visualization.

11.3 Geospatial Segmentation with Baidu Maps

You are provided with the option to integrate Baidu Maps into Segmentation to segment contacts in China by geographic location in a visualized way.

For a detailed description of this integration, see section [Integration with Baidu Maps for Geospatial Segmentation](#) of the Integration Guide for SAP Marketing on the SAP Help Portal at:

<https://help.sap.com/mkt-op> ► *Integration* ►

12 Configuring Recommendation

The settings described in this section are only relevant if you want to run *SAP Marketing Recommendation*.

With *SAP Marketing Recommendation* you can build different product recommendation model types from various sources (such as *SAP ERP*, *SAP Marketing Data Management*, as well as external data sources such as social media) in order to provide a recommendation. This recommendation can be consumed by various applications such as a web shop or an interaction contact.

In addition, *Recommendation* includes the Offer Management applications *Manage Offers*, and *Manage Coupons*.

For more information about performance and load balance, see SAP Note [2264072](#).

i Note

As a prerequisite for the use of the *Recommendation* applications, you must have executed the technical configuration scenario *Recommendation* (see section [Scenario "Recommendation" \[page 60\]](#)).

12.1 Post-Installation Steps

12.1.1 Adapting Customer Channels for New Integration Scenarios

Customer channels for which SAP does not provide an integration scenario must be adapted to consume recommendations models using one of the following:

- Remote Function Call (RFC)
- OData service

For more information, see section [Recommendation](#) of the Extensibility Guide for SAP Marketing on the SAP Help Portal at:

<https://help.sap.com/mkt-op> ► [Development](#) ► [Extensibility Guide](#) ► [SAP Marketing Recommendation](#) ►

12.1.2 Configuring Offer Management and Coupons

Offer Management provides you with the following applications:

- The app *Manage Offers* allows you to create, release, and put offers on hold. During creation, you define a validity period and define the offer content.
In addition, you can use an interface to generate offers from external systems.

While the actual offer content is prepared in *Manage Offers*, marketing experts can create and manage models, and maintain offer recommendation scenarios in the *Manage Recommendations* app. For more information, see the [Manage Recommendations](#) in the application help for SAP Marketing on the SAP Help Portal.

- The app *Manage Coupons* allows you to create and release coupons. The coupon itself can be used within the app *Manage Offers*.

i Note

Before you start configuring Offer Management, ensure that you have carried out the steps described in section [Initial Setup of SAP Fiori \[page 62\]](#).

12.1.2.1 Setting up Application "Manage Offers"

To set up the *Manage Offers* application, assign your copy of the following role to the AS ABAP users of your marketing managers or experts:

- `SAP_CEI_OFFER_APP` (back-end role; included in composite role `SAP_MARKETING_RECOMMEND_EXPERT`)

i Note

The standard role `SAP_CEI_OFFER_APP` includes an authorization check at instance level for marketing areas. The marketing areas are defined in Customizing for SAP Marketing under [►► Planning ► General Settings ► Define Marketing Areas ►](#). If a user assigned to a copy of `SAP_CEI_OFFER_APP` tries to access an object instance for a particular marketing area, the system checks whether they are allowed to access that area.

In addition, you have to assign your copies of the following roles to the AS ABAP users of your marketing experts:

- `SAP_CEI_ROF_FLP` (business catalog role; no copy required - you can assign the delivered standard role)
- `SAP_CEI_HOME` (for personalization purposes)

Enabling the OData API for E-Commerce Integration

To display suitable offers to customers, the public OData API `CUAN_OFFER_DISCOVERY_SRV` can be used to make offers available in an e-commerce scenario, for example in the SAP Commerce Web shop.

For more information about the OData API, see section [Discover Offers](#) of the Integration Guide for SAP Marketing on the SAP Help Portal at:

<https://help.sap.com/mkt-op> [►► Integration ► Integration Guide ► Integration Services ►](#)

To enable the OData API for e-commerce integration, you need to assign the technical AS ABAP user that is used to communicate between the e-commerce suite, such as SAP Commerce, and the SAP Marketing back-end system to the following role:

- SAP_CEI_OFFER_PUBLIC_API

Enabling the OData API for Offer Import

You are provided with the public OData API CUAN_OFFER_IMPORT_SRV to import offers from any third-party system to your SAP Marketing system. To enable the OData API for offer import, you need to assign the technical AS ABAP user that is used to communicate between the legacy system and the SAP Marketing back-end system to the following role:

- SAP_CEI_OFFER_IMPORT_API

For more information about the public OData API CUAN_OFFER_IMPORT_SRV, see section [Import Offers](#) of the Integration Guide for SAP Marketing on the SAP Help Portal at:

<https://help.sap.com/mkt-op>  [Integration](#)  [Integration Guide](#)  [Integration Services](#) 

12.1.2.2 Setting up Application "Manage Coupons"

The *Manage Coupons* app controls a single code and manages relations between the coupon code and contacts during business processes.

To set up the *Manage Coupons* app, assign your copies of the following roles to the AS ABAP users of your marketing experts:

- SAP_CEI_COUPONS (back-end role; included in composite role SAP_MARKETING_RECOMMEND_EXPERT)
- SAP_CEI_ROF_FLP (business catalog role; no copy required - you can assign the delivered standard role)

Enabling the OData API for Interactions of Type OFFER_REDEMPTION

You are provided with the public OData API CUAN_IMPORT_SRV to import interactions from any third-party system to your SAP Marketing system. To enable the OData API for interaction import, you need to assign the technical AS ABAP user that is used to communicate between the legacy system and the SAP Marketing back-end system to the following role:

- SAP_CEI_ECOMMERCE_INTEGRATION (back-end role including all required authorizations to call external services. You can copy and adapt this role according to your requirements.)

For more information about role SAP_CEI_ECOMMERCE_INTEGRATION, see section [Roles and Authorizations](#) in the Security Guide for SAP Marketing on the SAP Help Portal at:

<https://help.sap.com/mkt-op>  [Security](#) 

For more information about the OData API `CUAN_IMPORT_SRV`, see section [Compound Import Service](#) in the Integration Guide for SAP Marketing on the SAP Help Portal at:

<https://help.sap.com/mkt-op> ► *Integration* ►

13 Configuring Planning

The settings described in this section are only relevant if you want to run *SAP Marketing Planning*.

The following apps belong to *SAP Marketing Planning*:

- With the *Budget Plans* app, marketing managers can plan budgets, programs, and spends.
- With applications belonging to spend management (*Quick Campaign Spend* and the *Spend* tab of a campaign in the *Campaigns* application also known as *Detailed Campaign Spend*), marketing experts can plan campaigns and spends in a simple and intuitive way.
- With the *Programs* app, marketing managers can view programs and the corresponding campaigns that are assigned to the programs, and assign and remove campaigns to programs.
- With the *Marketing Plans* app, marketing managers and marketing experts can group marketing objects, such as programs and campaigns, into marketing plans for a marketing area and calendar year.
- With the *Marketing Calendar* app, marketing managers and marketing experts can have a complete overview of ongoing and planned marketing activities.

Required Customizing Settings

In the following, you find the required Customizing settings that for you have to carry out for the use of the planning applications. The settings are listed per app.

Application for Which Settings Apply	Settings
<i>Budget Plans</i>	If custom dimensions are going to be used for budget planning, define them in Customizing for SAP Marketing under ► Planning > Budget Planning > Define Custom Dimensions  .
<i>Budget Plans</i>	If you defined custom dimensions, upload data for them in the system from a comma-separated value (CSV) file in the <i>Import Data</i> application. For more information, see Import Data (CSV) .
<i>Budget Plans</i>	If brand is going to be used as a dimension for budget planning, add brands or upload brand data in the system from a CSV file in the <i>Brands</i> application. For more information, see Brands .

Application for Which Settings Apply Settings

Budget Plans

If country is going to be used as a dimension for budget planning, define countries in Customizing for [SAP NetWeaver](#) under ► [General settings](#) ► [Set Countries](#) ►.

Budget Plans

If region is going to be used as a dimension for budget planning, assign regions to countries in Customizing for [SAP NetWeaver](#) under ► [General settings](#) ► [Set Countries](#) ► [Insert Regions](#) ►.

Budget Plans

If market is going to be used as a dimension for budget planning, make the required settings in Customizing for SAP Marketing under ► [Planning](#) ► [General Settings](#) ► [Define Markets](#) ►.

Budget Plans

If audience is going to be used as a dimension for budget planning, you have defined audiences in the [Audiences](#) application. For more information, see [Audiences](#).



Application for Which Settings Apply Settings

Budget Plans



Programs

Campaigns

If planning is going to be done for different media types, make the required settings in Customizing for SAP

Marketing under  [General Settings](#) 
[Define Media Types](#) .

In the Customizing activity, you can also define icons for media types. If you want to use images for media types, you can define them in the [Manage Images](#) application. For more information, see the extensibility guide on SAP Help Portal at <http://help.sap.com/mkt-op>

 [Development](#) . If a budget plan uses a planning model for which media type is enabled, and no images or icons are defined for the media types, the media type descriptions are shown in the axis of the chart. If only an image is defined for a media type, the image is shown in the axis of the chart. If only an icon is defined for a media type, the icon is shown in the axis of the chart. If both an image and an icon are defined for a media type, only the image is shown in the axis of the chart.

i Note

It is not mandatory to use media type for campaigns. However, if budget is planned for different media types, it is mandatory that all campaigns that are assigned to programs and are funded by that budget have media type assigned. Otherwise, if such campaigns have actual spend data, the actual spend cannot be shown in budget planning. We recommend that you create a media type, such as other or miscellaneous, and assign it to campaigns so that actual spend data for this media type can be shown in budget planning.

Application for Which Settings Apply Settings

Budget Plans
Programs
Marketing Plans

Make the required settings in Customizing for SAP Marketing under
[▶ Planning ▶ General Settings ▶ Define Marketing Areas ▶](#).

Budget Plans

To define planning models that are going to be used for budget planning, make the required settings in Customizing for SAP Marketing under
[▶ Planning ▶ Budget Planning ▶ Define Planning Models ▶](#).

Budget Plans

If you want to restrict the values that can be used for budget plans in budget planning, create dimension relationships and select the values of the dimensions that can be used in the *Dimension Relationships* application. For more information, see [Dimension Relationships](#).

Budget Plans

To set up user authorization for budget planning, do the following:

1. Make the required settings in Customizing for SAP Marketing under
[▶ Planning ▶ Budget Planning ▶ Define Areas of Responsibility ▶](#).
2. Assign marketing areas and areas of responsibility to roles and then assign users to the roles using the *Role Maintenance* (PFCG) transaction.

Budget Plans
Programs
Marketing Plans
Quick Campaign Spend
Detailed Campaign Spend

To define the default currency that is going to be used for planning, make the required settings in Customizing for SAP Marketing under [▶ Planning ▶ General Settings ▶ Set Currency ▶](#).

Application for Which Settings Apply Settings

Budget Plans
Programs
Marketing Plans
Quick Campaign Spend
Detailed Campaign Spend

To set up all the currencies that you are going to use for planning and their exchange rates, make the required settings in Customizing for SAP NetWeaver [▶▶ General Settings ▶ Currencies ▶](#).

Budget Plans
Programs
Marketing Plans
Quick Campaign Spend
Detailed Campaign Spend

If you defined custom dimensions or if you want to change the labels for the standard dimensions or measures, make the required settings in Customizing for SAP Marketing under [▶▶ Planning ▶ General Settings ▶ Define Labels for Dimensions and Measures ▶](#).

Budget Plans
Programs
Marketing Plans
Detailed Campaign Spend

To define the actual spend data you want to display in planning, make the required settings in Customizing for SAP Marketing under [▶▶ Planning ▶ General Settings ▶ Define Settings for Actual Spend and Ad Serving Cost ▶](#).

Quick Campaign Spend
Detailed Campaign Spend

Define spend types in Customizing for SAP Marketing under [▶▶ Planning ▶ Spend Management ▶ Define Spend Types ▶](#).

Marketing Plans
Programs
Campaigns

To activate workflow for marketing plans, programs, and campaigns, make the required settings in Customizing for SAP Marketing under [▶▶ General Settings ▶ Activate Workflow for Business Objects ▶](#).

Marketing Plans

If you want to change the labels for the statuses for marketing plans, make the required settings in Customizing for SAP Marketing under [▶▶ Planning ▶ General Settings ▶ Define Labels for Statuses in Marketing Plans ▶](#).

Application for Which Settings Apply Settings

Marketing Plans

If you want to change the labels for the status buttons for marketing plans, make the required settings in Customizing for SAP Marketing under [▶ Planning ▶ General Settings ▶ Define Labels for Status Buttons in Marketing Plans ▶](#).

Programs

If you want to change the labels for the statuses for programs, make the required settings in Customizing for SAP Marketing under [▶ Planning ▶ General Settings ▶ Define Labels for Statuses in Programs ▶](#).

Programs

If you want to change the labels for the status buttons for programs, make the required settings in Customizing for SAP Marketing under [▶ Planning ▶ General Settings ▶ Define Labels for Status Buttons in Programs ▶](#).

Programs

Marketing Plans

If you want to have a log with the changes made by users to business objects, make the required settings in Customizing for SAP Marketing under [▶ General Settings ▶ Activate Change Log for Business Objects ▶](#).

i Note

Marketing Calendar does not yet support multiple currencies.

When configuring currencies, note that *Budget Plans*, *Programs*, and the applications belonging to spend management only support rates of type M.

13.1 Setting up "Budget Plans"

i Note

Before you start with the configuration for *Budget Plans*, ensure that you have performed the steps described in the following section:

- [Initial Setup of SAP Fiori \[page 62\]](#)

To allow marketing managers to plan a budget according to their organization's requirements, you configure how budget planning is performed by defining a planning model and setting up the authorization for budget planning in Customizing for SAP Marketing (see below). A planning model has a hierarchical structure that can have both standard and custom dimensions for which budget can be planned. Dimensions can be as follows:

- Standard dimensions:
 - Brand
 - Market
 - Country
 - Region
 - Audience
- Custom dimensions:

Other dimensions for which marketing managers can plan budget. Custom dimensions are defined in Customizing for SAP Marketing (see subsection *Required Customizing Settings* of section [Configuring Planning \[page 94\]](#) (in the table, search for **Budget Plans**).

When you define a planning model, you assign a dimension to a level in the hierarchy. You must have at least two levels in your planning model. A budget is allocated to the dimension at the first level of the hierarchy. The marketing manager plans a budget for the dimensions at the other levels of the hierarchy.

For more information, see section [Budget Planning](#) in the application help for SAP Marketing on SAP Help Portal at:

<https://help.sap.com/mkt-op> ► [Application Help](#) ► [SAP Marketing](#) ► [SAP Marketing Applications](#) ► [Planning](#) ►

Customizing Settings

For the Customizing settings to be carried out for running *Budget Plans*, see subsection *Required Customizing Settings* of section [Configuring Planning \[page 94\]](#) (in the table, search for **Budget Plans**).

Uploading Data for "Budget Plans"

If the planning model you have defined includes brand information, you need to upload brands in the system. You upload brand data from a comma-separated value (CSV) file using the *Import Data* application in the *Import Data* business group.

For more information, see section [Import Data \(CSV\)](#) in the application help for SAP Marketing on the SAP Help Portal.

To access the *Import Data* application, the user must be assigned a copy of the following role:

- SAP_MARKETING_BUS_ADMIN_USER

For more information, see the [Security Guide](#) for SAP Marketing on the SAP Help Portal at:

<https://help.sap.com/mkt-op> ► [Security](#) ►

If you want to use custom dimensions, you proceed as follows:

1. Define the custom dimensions in Customizing for SAP Marketing under ► [Planning](#) ► [Budget Planning](#) ► [Define Custom Dimensions](#) ►. You can define a maximum of 10 custom dimensions. The technical object name for each dimension is CUAN_CUSTOM_DIMENSION_(SAP technical ID of custom dimension from 01 to 10). The mapping from the dimension ID and the technical ID is done automatically. For example, you have defined a custom dimension with the ID *MyDimension*. It will be mapped to the technical ID CUAN_CUSTOM_DIMENSION_01.
2. Assign the custom dimensions to the planning model dimensions in Customizing for SAP Marketing under ► [Planning](#) ► [Budget Planning](#) ► [Define Planning Model](#) ►.
3. Upload the custom dimension values in the system from a CSV file using the *Import Data* application in the *Import Data* business group.

To access the *Import Data* application, the user must be assigned a copy of the following composite role:

- SAP_MARKETING_BUS_ADMIN_USER

For more information, see the [Security Guide](#) for SAP Marketing on the SAP Help Portal.

Setting up the Authorization for "Budget Plans"

Budget planning, programs, and marketing spend management use marketing areas for authorization. In addition, budget planning and programs use areas of responsibility. It is mandatory to set the marketing area and area of responsibility for each user. For more information, see [Authorization Examples for Budget Planning, Programs, and Marketing Spend Management](#) in the application help for SAP Marketing in the application help.

1. Define the marketing areas in Customizing for SAP Marketing under ► [General Settings](#) ► [Define Marketing Areas](#) ►.
2. Define the areas of responsibility in Customizing for SAP Marketing under ► [Planning](#) ► [Budget Planning](#) ► [Define Areas of Responsibility](#) ►.
For more information, see section [Areas of Responsibility Areas of Responsibility](#) in the application help.
3. Assign areas of responsibility to users in transaction PFCG.

4. The users must be assigned a copy of the `SAP_CEI_AMP` role with the following start authorization settings:

Authorization Object	Object Name (HPA_OBJ)	Activity (ACTVT)
HPA_OBJECT	CUAN_BUDGET_PLANNING	<ul style="list-style-type: none"> ○ 02 (Change) ○ 03 (Display)

5. Assign instance authorization to users as follows:

Authorization Object	Object Name (HPA_OBJ)	Area of Responsibility ID (RSPAREA_ID)	Activity (ACTVT)
HPA_RSP_AR	CUAN_BUDGET_PLANNING	Area of responsibility ID as defined in Customizing for SAP Marketing under ► <i>Planning</i> ► <i>Budget</i> <i>Planning</i> ► <i>Define Areas of Responsibility</i> ►	02 (Change)

For more information about the authorization object, see the [Security Guide](#) for SAP Marketing on the SAP Help Portal.

Setting Up the Map Visualization

The *Budget Plans* application does not come with a pre-configured map. To set up your map, follow the steps in the SCN blog on SAP Visual Business:

<http://scn.sap.com/docs/DOC-59547>

For more information, see the SAP Visual Business documentation on the SAP Help Portal at:

<http://help.sap.com/visualbusiness21>

13.2 Setting up "Marketing Plans"

The *Marketing Plans* application allows you as a marketing manager or marketing expert to group marketing objects, such as programs and campaigns, into marketing plans for a marketing area and calendar year. The application provides visibility on budget and spend for marketing activities.

To set up *Marketing Plans*, you must ensure that the corresponding delivered Customizing is copied from client 000 to the productive client of your SAP Marketing AS ABAP system. This copy should usually be executed during the post-installation, see section [Initial Customizing Adjustment \[page 31\]](#).

For the concrete Customizing settings to be carried out for *Marketing Plans*, see subsection *Required Customizing Settings* of section *Configuring Planning* [page 94] (in the table, search for **Marketing Plans**).

For general information, see section *Marketing Plans* in the application help for SAP Marketing on SAP Help Portal at:

<https://help.sap.com/mkt-op> ► *Application Help* ► *SAP Marketing* ► *SAP Marketing Applications* ► *Planning* ►

13.3 Setting up "Programs"

Programs are containers for marketing activities. Marketing managers propose how much to be spent on marketing activities.

To set up *Programs*, you must ensure that the corresponding delivered Customizing is copied from client 000 to the productive client of your SAP Marketing AS ABAP system. This copy should usually be executed during the post-installation, see section *Initial Customizing Adjustment* [page 31].

For the concrete Customizing settings to be carried out for *Programs*, see subsection *Required Customizing Settings* of section *Configuring Planning* [page 94] (in the table, search for **Programs**).

For general information, see section *Programs* in the application help for SAP Marketing on SAP Help Portal at:

<https://help.sap.com/mkt-op> ► *Application Help* ► *SAP Marketing* ► *SAP Marketing Applications* ► *Planning* ►

Setting Up the Authorization for Programs

A user can assign a funding source to a program from any plan based on the area of responsibility and marketing area to which the user is assigned.

1. The users must be assigned a copy of the `SAP_CEI_PROGRAM` role.
2. Assign the authorization for funding assignment as follows:

Authorization Object	Object Name (HPA_OBJ)	Area of Responsibility ID (RSPAREA_ID)	Activity (ACTVT)
HPA_RSP_AR	CUAN_BUDGET_PLANNING	Area of responsibility ID as defined in Customizing for <i>SAP Marketing</i> under ► <i>Planning</i> ► <i>Budget Planning</i> ► <i>Define Areas of Responsibility</i> ►	○ 03 (Display)

For more information about the authorization object, see the *Security Guide* for SAP Marketing on the SAP Help Portal at:

<https://help.sap.com/mkt-op> ► *Security* ►

13.4 Setting up Spend Management

Before you start with the configuration for the applications belonging to spend management (*Quick Campaign Spend*, *Spend* tab of a campaign in the *Campaigns* application), ensure that you have carried out steps described in section [Initial Setup of SAP Fiori \[page 62\]](#).

To set up spend management applications, you need to carry out the following steps:

Set up Spend Types

1. In Customizing, under SAP Marketing, go to ► [Planning](#) ► [Spend Management](#) ► [Define Spend Types](#) ►.
2. Enter the spend types you want to use.
3. Save and close the transaction.

Assign Users to Roles for Spend Management

To enable marketing managers/experts to use the spend management application *Quick Campaign Spend* and the *Spend* tab of a campaign in the *Campaigns* application, you need to assign your copies of the following PFCG roles to their AS ABAP users:

- One of the following business catalog roles (no copy required - you can assign the delivered standard role):
 - For managers: `SAP_CEI_PLG_FLP`
 - For experts: `SAP_CEI_SMP_FLP`
- For managers: `SAP_CEI_MSM_SM_APP` (back-end role; included in composite role `SAP_MARKETING_PLANNING`)
- For experts: `SAP_CEI_MSM_QE_APP` and `SAP_CEI_MSM_SM_APP` (backend roles; included in composite role `SAP_MARKETING_SPEND_MGMT_PROG`)
- `SAP_CEI_HOME` (for personalization purposes)

Add Authorization for Approval of Spends

1. Log on to your SAP Marketing system and call up transaction `PFCG`.
2. In order to authorize users to approve spends, you need to assign the following activities to the following authorization objects in your copies of the SAP standard roles `SAP_CEI_MSM_QE_APP` and `SAP_CEI_MSM_SM_APP`.

To assign the activities to the authorization objects in your copies of the SAP standard roles, proceed as follows:

1. Go to transaction `PFCG` and call up your copy of SAP standard role `SAP_CEI_MSM_QE_APP` in change mode.
2. Switch to the *Authorizations* tab.

3. Choose the [Change Authorization Data](#) pushbutton.
4. Expand the node [Cross-application Authorization Objects](#).
5. Add the missing activities based on the table above.
6. Save your changes and generate the profile.
7. Repeat steps 1 to 6 for your copy of SAP standard role `SAP_CEI_MSM_SM_APP`.

Activate SAP ERP PS Integration for Cost Collection

- To enable cost tracking for marketing spends in SAP ERP, activate one of the BAdI implementations of the [BAdI: Outbound System Integration for Cost References](#) in Customizing under SAP Marketing: [► Planning ► Spend Management ►](#).
- If you have activated multiple BAdI implementations, we recommend that you use filter options to distinguish between different campaign categories so that for one campaign category one implementation is processed. With this option, you can create project WBS elements in different systems and avoid to generate multiple projects and WBS elements for the same campaign. If you activated the BAdI implementation [Marketing Spends Actuals - Create Projects and WBS Elements \(ES\)](#), which is based on Enterprise Services, you have also to establish a logical port. For more information, see also the documentation of the Customizing activity [BAdI: Outbound System Integration for Cost References](#).

As a prerequisite you have maintained a logical port in the target SAP ERP system using the [SOA Manager](#).

In the transaction `SOAMANAGER` under [► Service Administration ► Web Service Configuration ►](#) you have configured the following services as SSL (https) connection and with the same service and binding name `CUAN_MSM_PROJECT`:

- `ProjectERPCreateRequestConfirmation_In_V1` (internal name `ECC_PROJECTERPCTR1`)
- `ProjectERPByIDQueryResponse_In_V1` (internal Name `ECC_PROJECTERPIDQR1`)
- `ProjectERPUpdateRequestConfirmation_In` (internal name `ECC_PROJECTUPDR1`)

As a next step run task list `CUAN_MSM_SETUP_PS_INTEGRATION` as follows:

1. Log on to your SAP Marketing AS ABAP system with the application setup user. For more information, see [User for Application Setup \[page 41\]](#).
2. Go to transaction `STC01`.
3. Execute task list `CUAN_MSM_SETUP_PS_INTEGRATION`.

Assign Marketing Area to Project Profile

1. In Customizing, under SAP Marketing, go to [► Planning ► Spend Management ► Assign Marketing Area to Project Profile ►](#). (Defined in SAP ERP Customizing under [► Project System ► Structures ► Operative Structures ► Work Breakdown Structure \(WBS\) ► Create Project Profile ►](#))
2. Enter a [Project Profile ID](#) from SAP ERP PS to which you would like to assign a [Marketing Area](#).
3. Select the [Project Profile ID](#) and select the [Folder](#) Assign Marketing Area
4. Choose [New Entries](#) to assign a new [Marketing Area](#).

Maintain Project and WBS Element Prefix for SAP ERP

1. In Customizing, under SAP Marketing, go to [► Planning](#) [► Spend Management](#) [► Maintain Project and WBS Element Prefix for ERP](#) [►](#).
2. Create a first entry and enter **Prefix for ERP Project** as well as **WBS Prefix**. (Defined in SAP ERP Customizing under [► Project System](#) [► Structures](#) [► Operative Structures](#) [► Work Breakdown Structure \(WBS\)](#) [► Project Coding Mask](#) [► Define Project Coding Mask](#) [►](#)). These prefixes must not have any masks assigned in SAP ERP.

Upload Actual and Committed Spend from External System

You can use one of the following ways to upload actual and committed spend:

- Using a report.
Go to transaction SE38 (*Program Execution*) and run program CUAN_MSM_UPLOAD_ACTUAL. You upload actual and committed spend from a file. For more information about the required file format, see the report documentation.
- Using the CUAN_ACTUAL_IMPORT_SRV OData service.
For detailed information about how to use the OData service for the upload of actual spend, see section [Actual and Committed Spend](#) of the Integration Guide for SAP Marketing on the SAP Help Portal at: <https://help.sap.com/mkt-op> [► Integration](#) [► Integration Guide](#) [► Integration Services](#) [►](#)
- Using a CSV file in the *Import Data* application within the *Import Data* business group.
To access the *Import Data* application, the user must be assigned a copy of the role SAP_MARKETING_BUS_ADMIN_USER.

The report, as well as the OData service, and the import using the CSV file, log either a success or an error message. The log is displayed once the report is executed. You can also find all log messages using the transaction *Analyze Application Log* (SLG1) transaction, entering the parameters CUAN_IMPORT as an object and CUAN_ACTUAL_IMPORT as a subobject.

13.5 Setting up "Marketing Calendar"

Marketing Calendar is an application that marketing managers and experts can use to see an overview of all marketing-related activities for which they are responsible during selected time ranges. The focus here is on aggregated KPIs and how they are influenced by marketing activities in the corresponding time context.

Marketing Calendar aggregates and displays data from different SAP Marketing applications. To use the full functionality (all charts in the *Marketing Calendar* app show data), the following solutions should be enabled:

- Segmentation
- Planning

In addition, you are provided with the *Subscribe to Campaign Calendar* function. This calendar service for subscription can be used with native calendar applications on devices that support the ICS format. The calendar events contain detailed information about the corresponding campaigns.

Before you start with the configuration *Marketing Calendar*, ensure that you have carried out steps described in section [Initial Setup of SAP Fiori \[page 62\]](#).

To set up the *Marketing Calendar* app, carry out the following steps:

1. To enable marketing managers/experts to use the *Marketing Calendar* app, you need to assign your copies of the following PFCG roles to their AS ABAP users:
 - One of the following business catalog roles (no copy required - you can assign the delivered standard role):
 - For managers: `SAP_CEI_PLG_FLP`
 - For experts: `SAP_CEI_SMP_FLP`
 - `SAP_CEI_MKT_CAL_APP` (back-end role; included in composite role `SAP_MARKETING_MANAGER` for managers and in composite role `SAP_MARKETING_SPEND_MGMT_PROG` for experts)
 - `SAP_CEI_HOME` (for personalization purposes)

i Note

The standard role `SAP_CEI_MKT_CAL_APP` includes an authorization check at instance level for marketing areas. The marketing areas are defined in customizing under SAP Marketing under [► Planning ► General Settings ► Define Marketing Areas ►](#). If a user assigned to a copy of `SAP_CEI_MKT_CAL_APP` tries to access an object instance for a particular marketing area, the system checks whether they are allowed to access that area.

2. Configure your ABAP system to access the SAP Web Dispatcher as follows:
 1. Log on to your SAP Marketing system with the user for application setup.
 2. Call up transaction `SE16` and enter table `HTTPURLLOC`.
 3. Press *Create Entries*.
 4. Create an entry with the following parameters:
 - *SORT KEY*: `MCAL`
 - *PROTOCOL*: `HTTPS`
 - *APPLICATN*: `/SAP/CUAN/CUAN_MKTCAL_IC`
 - *HOST*: Enter the fully qualified domain name of your SAP Web Dispatcher that matches the *Common Name* in your SSL certificate.
 - *PORT*: Enter the HTTPS port.
 - Save your entry.
 5. Create an entry with the following parameters:
 - *SORT KEY*: `NAVT`
 - *PROTOCOL*: `HTTPS`
 - *APPLICATN*: `/SAP/BC/UI5_UI5/SAP/CUAN_NAV_TO`
 - *HOST*: Enter the fully qualified domain name of your SAP Web Dispatcher that matches the *Common Name* in your SSL certificate.
 - *PORT*: Enter the HTTPS port.
 - Save your entry.
 6. Integrate the marketing calendar as an internet calendar into your calendar application (supporting the ICS format). For more information about this step, see the documentation of your calendar application.

You can use the *Subscribe to Campaign Calendar* function to transfer campaigns to your calendar application. This works with all calendar applications (such as Microsoft Outlook) that support ICS

format. If you select this function, a mail opens in your email program containing a link which you can copy and use once in your calendar application. The campaigns that are matching the filter criteria applied in the marketing calendar (before running the *Subscribe* function) are then transferred to your calendar application.

3. Configure SAP Visual Business by following the steps in the SAP Visual Business installation guide on the SAP Help Portal at:

<http://help.sap.com/visualbusiness21> ► *Installation and Upgrade* ► *Installation and Configuration Guide* ►

i Note

There is also an SCN blog on the subject:

<http://scn.sap.com/docs/DOC-59547> ►

14 Configuring Acquisition

The settings described in this section are only relevant if you want to run *SAP Marketing Acquisition*.

i Note

To install *Acquisition*, you must first install *Segmentation* (see [Configuring Segmentation \[page 87\]](#)).

A prerequisite for configuring *Acquisition* is the corresponding technical configuration. If you have not executed the technical configuration for *Acquisition* yet, follow the instructions in section [Scenario "Campaign Management" \[page 55\]](#).

14.1 Configuring Campaigns

The configuration of campaigns requires a few manual steps that are described in this section.

14.1.1 Prerequisites

Define Interaction Interests

If required, you have defined the necessary interests on the user interface in the *Manage Interests* application in the *Business Administration* business group.

Configuring the SAP Web Dispatcher

Mandatory Prerequisite for Open and Link Tracking in Email Campaigns

⚠ Caution

To be able to run email campaigns, you mandatorily must configure a Web dispatcher. This Web dispatcher must run on a host that is accessible anonymously from the Internet. The Web dispatcher is responsible for routing HTTP requests corresponding to email opened and link click through events to the SAP Marketing backend.

The following section describes details about the configuration of the SAP Web Dispatcher.

For the tracking services to run as required, define a routing rule for the tracking and bounce ICF services `/sap/public/cuan/link` and `/sap/public/cuan/bounce`. They need to be routed to the ABAP backend servers where the corresponding ICF services run.

For the tracking services to run as required, extend the SAP Web Dispatcher profile of your publicly accessible web dispatcher as follows:

1. Enter the port number to be used to access the SAP Web Dispatcher for the tracking services: `icm/server_port_<port_enum> = PROT=HTTPS,PORT=43<xx>, VCLIENT=0`
 - `<port_enum>` is used to enumerate the port number entries in the profile. It determines the order in which these entries are searched for. As soon as the first valid entry is found, the web dispatcher stops searching and uses that entry.
 - `<xx>` defines the last digits of the port number used.
2. Enter the system and URL of the backend system running the tracking services: `wdisp/system_<sys_enum> = SID=<SID>, EXTSRV=https://<hostname>:<port>, SRCSRV=*<port_number>`
 - `<sys_enum>` is used to enumerate the system entries in the profile. It determines the order in which these entries are searched for. As soon as the first valid entry is found, the web dispatcher stops searching and uses that entry.
 - `<SID>` defines the ID of the SAP system that the services are running on.
 - `<host_name>` and `<port>` define the host name and port that must be used to access the tracking services.
 - `<port_number>` defines the complete port number defined above in the entry `icm/server_port_<port_enum>`

⚠ Caution

For the tracking services it is essential that you disable the client verification at the SAP Web Dispatcher.

- **Disabling client verification for all ports**

The following code line in the sample profile disables client verification for all ports: `icm/HTTPS/verify_client = 0`

- **Disabling client verification for a specific port**

If certain application parts require client authentication, you can disable the client verification at port level. This is done by adding `VCLIENT=0` to the code line that specifies the SAP Web Dispatcher port in question.

In the sample profile, for example, you would have to make the following changes:

- Take out the following code line from section 'Start Web Dispatcher': `icm/HTTPS/verify_client = 0`
- Change the following code line in section 'SAP Web Dispatcher Ports' from: `icm/server_port_1 = PROT=HTTPS,HOST=mo-29b02f1eb,PORT=82$$` to: `icm/server_port_1 = PROT=HTTPS,HOST=mo-29b02f1eb,PORT=82$$, VCLIENT=0`

14.1.2 Setting Up Service Provider for Emails and Text Messages

In the following you will find information about how to conduct your system for SAP Marketing with the required service providers, such as SAP Digital Interconnect (formerly known as SAP Mobile Services), for sending out emails and text messages directly out of the system.

Available Service Providers

Read the following chapters to set up the connection with an email or text message provider.

[Setting Up SAP Digital Interconnect \[page 112\]](#)

With SAP Digital Interconnect as service provider, you send mass emails and text messages to your customers and inform them, for example, about your new developments.

[Setting up a Generic Email Service Provider \[page 113\]](#)

Learn how to conduct generic email service provider (ESP) with your system.

[Setting up a Generic Text Message Service Provider \[page 121\]](#)

Learn how to conduct a generic text message service provider (SP) with your system.

[Setting up Amazon \[page 127\]](#)

To establish the connection to Amazon's Simple Email Service (SES) for email and bounce handling, you must do several steps at Amazon and at SAP.

[Setting Up Alibaba Cloud DirectMail Service \[page 132\]](#)

Set up Alibaba Cloud DirectMail Service so that you can use it to send emails to your customers. Configurations, including RFC destinations, provider credentials, and sender profiles, are required.

[Setting Up Alibaba Cloud Short Message Service \[page 135\]](#)

Set up Alibaba Cloud Short Message Service (Alibaba Cloud SMS) so that you can use it to send text messages to your customers. Configurations, including RFC destinations, provider credentials, export definitions, and sender profiles, are required.

[Sender Profiles \[page 140\]](#)

A sender profile allows you to carry out campaigns for different channels in different markets. You can maintain sender profiles for channels, such as email, text message, and mobile push notifications.

[Provider Credentials \[page 140\]](#)

Provider credentials are provided by a service provider such as Amazon SES for sending out emails and text messages out of your system. You can maintain the provider credentials and update them in case of changes after the setup.

[Campaign Execution Whitelist \[page 142\]](#)

With this app, you define the only allowed recipients for your campaigns in the test system.

[Handling Bounces \[page 143\]](#)

Invalid contact data can result in soft and hard bounces. The system tracks the bounces and helps you with this information to optimize the reachability of your customers.

[Enabling Unsubscribe for Emails \[page 146\]](#)

When you want to use the unsubscribe offered by Amazon, you need to do settings at Amazon and at SAP.

14.1.2.1 Setting Up SAP Digital Interconnect

With SAP Digital Interconnect as service provider, you send mass emails and text messages to your customers and inform them, for example, about your new developments.

As a preparation we recommend to read the following documents and recommendations to don't get listed as a spammer [Deliverability Best Practices](#) .

To be prepared for the onboarding for SAP Digital Interconnect as email provider, see [SAP Intelligent Notification 365, Email Service, On-Boarding Guide](#) and fill out the following form [Details To Be Collected During Email Provisioning \[page 112\]](#).

Follow the steps below to get your service provider up and running:

1. Set up *SAP Digital Interconnect*:
 - You have an account with *SAP Digital Interconnect* for sending emails using http service call. If you need more details or have questions on this solution, send an email to *SAP Digital Interconnect* <mailto:sapdigitalinterconnect@sap.com>.
 - To access the http service from *SAP Digital Interconnect*, you must populate the externally visible IP address of your server to *SAP Digital Interconnect* and you must know the ID, so that it can be added to the whitelist of allowed callers for your account. If you are using a proxy for sending, you must populate the external IP address of the proxy.
 - If you want to receive delivery feedback (text messages delivered to handset or delivery failed), you have to open a port in your firewall for inbound calls from the server of *SAP Digital Interconnect*. You have to provide an externally visible host name and port for this connection. This should already be set up during the system installation. For more information, see [Prerequisites \[page 109\]](#).
 - Check that you got a *User* and a *Password* as well as a *Host* and a *Path Prefix* from *SAP Digital Interconnect*.
2. Import SSL certificates for email and text messages from SAP Digital Interconnect in the Trust Store.
 1. Download SSL certificates from [NEW SSL Certificate - For SAP Digital Interconnect Customers](#) (already existing customers: [SSL Certificate - For SAP Marketing Customers](#)). Save the linked *.txt-file on your local machine.
 2. Import the certificates into the PSE as described in section **Configuring Client Certificates** of the ABAP platform documentation on the SAP Help Portal at: <https://help.sap.com/mkt-op> ► [Foundation on ABAP Platform 1809, version for SAP HANA](#) ► [ABAP Platform](#) and search for **Configuring Client Certificates**.
 3. Set SSL to *Active* for RFC destinations `MSMAIL` and `SMSSAP`.
 4. Select the certificate list to which you uploaded the certificates.
 5. Test the `MSMAIL` and `SMSSAP` RFC destination. If you receive an HTTP response code 500 with a response body containing a JSON string, then the setup is correct.
3. Finally maintain your sender profiles. For more information, see [Sender Profiles \[page 140\]](#).

14.1.2.1.1 Details To Be Collected During Email Provisioning

Use the form to collect the required data.

Customer Service(s) Details

Please enter for each email the required sub-domains with the addresses for <i>From</i> (Sender) and <i>Reply To</i> addresses.	Domain or Sub-Domain	Sender Name	From Address	Reply-To Address
	Example: newsletter.example.com	<Your Company Name>	<Your main email address such as info@example.com>	
Deliverability?	SPF or DKIM			
	DKIM key size			
	<ul style="list-style-type: none">• 2048• 1024			
Notifications From?	Single Source (Application)			
	Multiple Sources (Applications)			
Source Public IP Addresses for On-Prem Only (Please list.)				
Contact Name and Phone Number (Customer)				

14.1.2.2 Setting up a Generic Email Service Provider

Learn how to conduct generic email service provider (ESP) with your system.

You have prepared the following data from your integration engine or ESP:

- URL from your provider as *Host Name*.
- User and password from your provider for the outbound communication. Note that from the point of view of your service provider it's the inbound side.
- The path of your host (service provider) to reach the HTTP API.
- A valid email address as *Sender Address*. Keep in mind that this email address must be a verified email address.

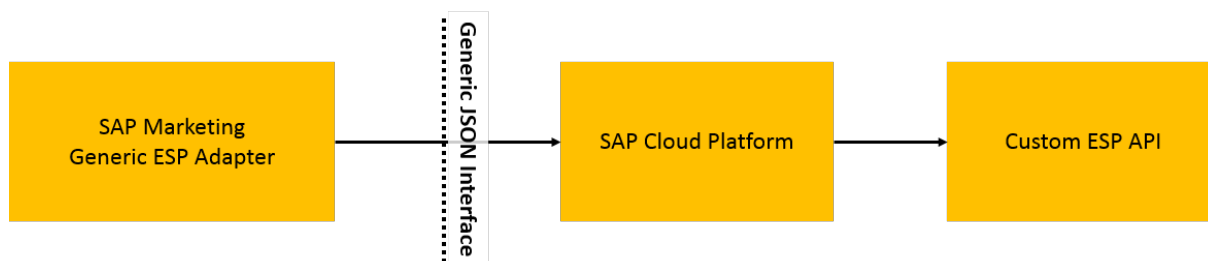

Set Up

1. Open the *Configuration of RFC Connections* (transaction **SM59**) in your system and create your RFC destinations as follows:
 - For your destination, use *Type G*.
 - Enter the host URL and the path under *Technical Settings*.
 The generic adapter automatically adds the following parts:
 - To send email: `/send`
 - To get bounce: `/bounces`
 - To get complaints: `/complaints`
 - To get verified sender email addresses: `/verifiedSenders`
2. Create a provider configuration in Customizing under **SAP Marketing > Campaigns > Campaign > Define Provider Configuration**.

Create a provider using the following details:

 - Assign a previously created RFC connection.
 - Use *Communication Medium EMAIL* and *Adapter CL_CUAN_MKT_EXEC_EMAIL_ADAPTER*.
3. Create a sender profile in Customizing under **SAP Marketing > Campaigns > Campaign > Define Sender Profile** and assign the created provider, as well as a valid marketing area.

In addition, enter *Sender Address*, *Sender Name*, *Reply-To Address*, and *Reply-To Name*.

14.1.2.2.1 Generic Email Integration

With this REST service and methods you can integrate any email service provider (ESP) with SAP Marketing. The *Scenario ID* is **SAP_COM_0234**.

Using the campaign automation, you can send emails to your customers. The email bodies contain personalized content and trackable links. Countable interactions are, for example, email opened, link clicked, and email hard bounce. Emails are sent using a REST service to an ESP.

The integration is a pure outbound scenario. The customer requires an account and license on the ESPs side.

If the system supports the defined interface, it calls the ESP directly. Otherwise the integration calls an integration engine such as SAP Cloud Platform to transform the message from our format into any kind of legacy formats. This means that an integration engine is optional in this scenario even though it is the most likely use case.

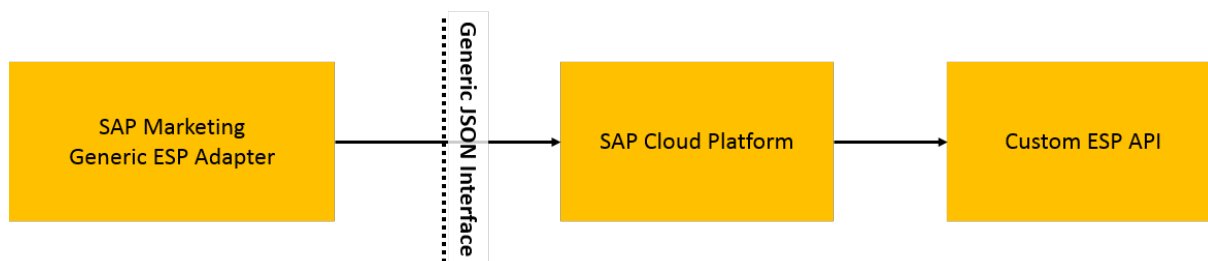

Base URI: The base URI depends on your integration platform or ESP.

Methods

HTTP Method	Action	URI
Send Emails <i>POST</i>	Send Emails [page 115]	/send
Get Bounces <i>GET</i>	Get Bounces [page 118]	/bounces
Get Complaints <i>GET</i>	Get Complaints [page 120]	/complaints
Get Verified Senders <i>GET</i>	Get Verified Senders [page 121]	/verifiedSenders

14.1.2.2.1.1 Send Emails

With this method you send the emails to your email service provider (ESP).

Request

URI: /send

HTTP Method: *POST*

Request Parameters

Parameter	Required	Data Type	Description
bodyContentHTML	Yes	String	Body Content. Format: HTML, JSON encoded
bodyContentPlainText	Yes	String	Body Content (for multipart or alternative email MIME). Format: Plain Text, JSON encoded
campaignId	No	String	<i>Campaign ID</i> of the campaign that generates this email. Can be empty for send tests in campaign content and sender profile. Helpful for support.
listUnsubscribe	No	String	Header for list unsubscribe in raw format. Possible entries: <code>mailto:<email address></code> , <code>https://<URL></code>
outboundId	No	String	Unique identifier of outbound message generated by SAP Marketing
recipient	Yes	String	Recipient (<i>To</i> field)
recipientName	No	String	Recipient name. Not yet supported. Format: Plain Text, JSON encoded
replyTo	Yes	String	Reply-To Address (<i>Reply-To</i> field)
replyToName	Yes	String	Reply-To Name. Format: Plain Text, JSON encoded
sender	Yes	String	Sender Address (<i>From</i> field)
senderName	Yes	String	Sender Name. Format: Plain Text, JSON encoded
sourceSystem	No	String	Logical System (Netweaver). Required to get corresponding bounces and complaints related to outbound messages.
subjectContentPlainText	Yes	String	Subject; Format: Plain Text, JSON encoded
type	No	String	Indicates for the middleware which integration flow for which type of ESP should be processed

Request Example

Sample Code

```
/send
HTTP method POST

Content-Type:
application/json
Encoding: UTF-8

Body:
{
  "type" : "email",
  "outboundId" : "33fds34534r4",
  "campaignId" : "123456789",
  "sourceSystem" : "XYZCLNT100",
  "sender" : "john.miller@example.com",
  "senderName" : "John Miller",
  "replyTo" : "news@example.com",
  "replyToName" : "SAP News",
  "recipient" : "recipient@example.com",
  "recipientName" : "Recipient",
  "listUnsubscribe" : "<mailto:yyyy>, <http::zzz>",
  "subjectContentPlainText" : "Hello Recipient",
  "bodyContentHtml" : "<b>Hello, this email body is HTML<b>",
  "bodyContentPlainText" : "Hello, this email body is plain text"
}
```

Response

Response Parameters

Parameter	Required	Data Type	Description
errorCategory	No	String	Permanently appearing errors lead to a stop of the campaign execution. Retriable errors result in multiple retries to resolve the issue before the campaign stops. Throttling reduces the throughput that is generated by the backend. Possible values are <code>Retriable</code> , <code>Permanent</code> , <code>Throttling</code>
errorText	No	String	Error text is written to the log and shown to the end user. Format: Plain Text
messageId	Yes	String	Unique identifier for outbound message provided by ESP. Could be 'outboundId' if supported by ESP, but not necessarily.

i Note

Note that the success code must start with 2 followed by two digits, for example, 202.

Response Example

Sample Code

```
Success Code 202

Content-Type:
application/json
{
  "messageId": "33fds34534r4"
}
```

Error Example

Sample Code

```
Error Codes 4xx, 5xx:
{
  "errorCategory" : "Retriable/Permanent/Throttling"
  "errorText"     : "Internal Server Error"
}
```

14.1.2.2.1.2 Get Bounces

With this method you request the bounces from your connected ESP.

Request

URI: /bounces

HTTP Method: *GET*

Request Parameters

Parameter	Required	Data Type	Description
sourceSystem	No	String	Logical system that is required to get bounces and complaints related to outbound messages.
startTimeUTC	No	String	Timestamp to begin with query collected bounces on ESP side. Not required for bounce queue. Format: YYYYMMDDHHMMSS

Parameter	Required	Data Type	Description
endTimeUTC	No	String	Timestamp to end with query collected bounces on ESP side. Not required for bounce queue. Format: YYYYMMDDHHMMSS
page	No	Integer	Indicates the result page in case of multiple pages. Possible values are 0 to n

Request Example

```
/bounces
GET
sourceSystem=XYZCLNT100
startTimeUTC=xxxxxxxxxxxxx
endTimeUTC=yyyyyyyyyyy
Page=2
```

Response

Response Parameters

Parameter	Required	Data Type	Description
page	No	Integer	Indicates the result page in case of multiple pages. Possible values are 0 to n
lastPage	Yes	Boolean	Indicates the last page of the result.
bounces	Yes	JSON Array	Contains the bounce details.
messageId	No	String	Reference to outbound message, see sending interface.
recipient	Yes	String	The email address that bounced or created a complaint. Value: <email address>
type	Yes	String	Type of feedback, depending on bounce or complaint use case. Possible values are: Hard, Soft, abuse, fraud, virus, other, not-spam
timestamp	No	String	Timestamp when bounce occurred. Format: YYYYMMDDHHMMSS
errorCode	No	String	Error code for bounces. Possible entries are: DSN error code (X.Y.Z), SMTP error code (XYZ)
errorText	No	String	Error text for bounce message.

Response Example

```
{
  "page": "2",
  "lastPage": "false",
  "bounces": [
    {
```

```

        "messageId" : "12343243243413",
        "recipient" : "bounce@example.com",
        "errorCode" : "5.1.1.",
        "errorText" : "Address does not exist",
        "Type"      : "Hard",
        "Timestamp" : "zzzzzzzzzzzzzz"
      }
    ]
  }

```

14.1.2.2.1.3 Get Complaints

With this method you request the complaints from the connected ESP.

For the parameter values please refer to [Get Bounces \[page 118\]](#).

Request

URI: /complaints

HTTP Method: *GET*

Request Example

```

/complaints
GET
sourceSystem=XYZCLNT100
startTimeUTC=xxxxxxxxxxxxx
endTimeUTC=yyyyyyyyyy
Page=2

```

Response

Response Example

```

{
  "page": "2",
  "lastPage": "false",
  "complaints": [
    {
      "messageId" : "12343243243413",
      "recipient"  : "spam@example.com",

      "Type"      : "abuse",
      "Timestamp" : "zzzzzzzzzzzzzz"
    }
  ]
}

```

14.1.2.2.1.4 Get Verified Senders

With this method you get the verified senders from your connected ESP.

Request

URI: /verifiedSenders

HTTP Method: *GET*

Request Example

```
/verifiedSenders
GET
```

Response

Response Example

```
Response
{
  "senders"      : [ "sender1@example.com", "sender2@example.com" ],
  "senderDomains" : [ "news.sap.com", "sap.com", "example.com" ]
}
```

14.1.2.3 Setting up a Generic Text Message Service Provider

Learn how to conduct a generic text message service provider (SP) with your system.

You have prepared the following data from your integration engine or text message SP:

- URL from your provider as *Host Name*.
- User and password from your provider for the outbound communication.
Note that from the point of view of your service provider it's the inbound side.
- The path of your host (service provider) to reach the HTTP API.

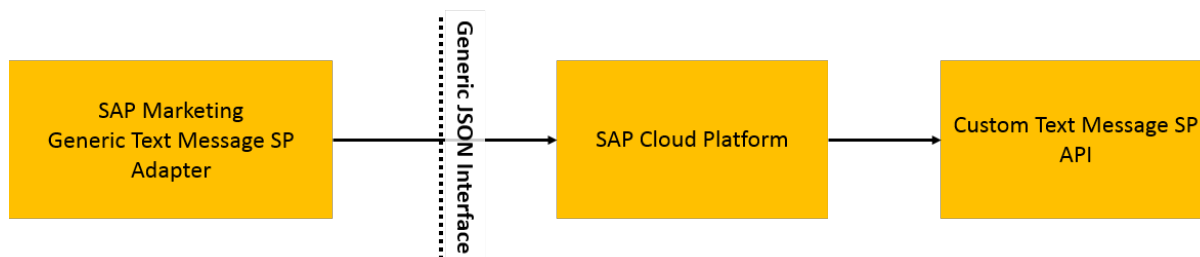

Set Up

1. Open the *Configuration of RFC Connections* (transaction **SM59**) in your system and create your RFC destinations as follows:
 - For your destination, use *Type G*.
 - Enter the host URL and the path under *Technical Settings*.The generic adapter automatically adds the following parts:
 - To send text message: `/send`
 - To get status: `/status`
2. Create a provider configuration in Customizing under **SAP Marketing > Campaigns > Campaign > Define Provider Configuration**. Create a provider using the following details:
 - Assign a previously created RFC connection.
 - Use *Communication Medium SMS* and *Adapter CL_CUAN_MKT_EXEC_SMS_ADAPTER*. The adapter must include the HTTP reference you previously created.
3. Create a sender profile in Customizing under **SAP Marketing > Campaigns > Campaign > Define Sender Profile** and assign the created provider, as well as a valid marketing area. In addition, enter *Sender Address*, *Sender Name*, *Reply-To Address*, and *Reply-To Name*.

14.1.2.3.1 Generic Text Message Integration

With this REST service and methods you can integrate any text message service provider (SP) with SAP Marketing. The *Scenario ID* is **SAP_COM_0258**.

Using the campaign automation, you can send text messages to your customers. The text messages contain personalized content. Text messages are sent using a REST service API to an SP for text messages.

This integration scenario enables you to integrate to any text message SP.

The integration is a pure outbound scenario. You require an account and license on the text message SPs side.

The SAP Marketing can either call the text message SP directly, if they support our defined interface, or the integration would call an integration engine like SAP Cloud Platform to transform the message from our format into any kind of legacy formats. This means that an integration engine is optional in this scenario even though it is the most likely use case.

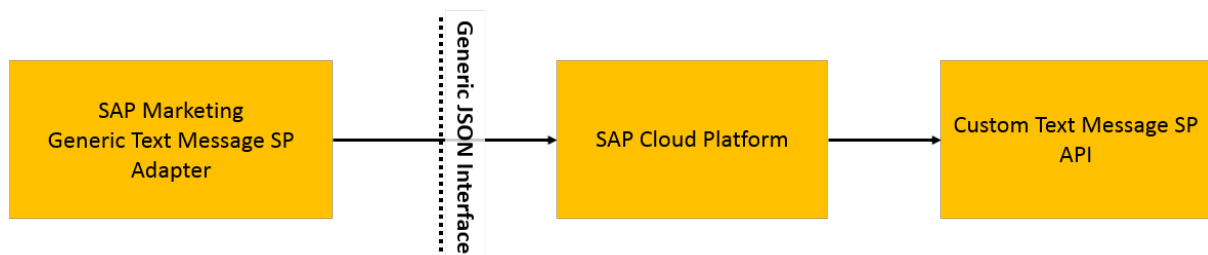

Base URI: The base URI depends on your integration platform or text message SP.

Methods

HTTP Method	Action	URI
Send	Send [page 123]	/send
<i>POST</i>		
Collect Delivery Status	Collect Delivery Status [page 126]	/status
<i>GET</i>		

14.1.2.3.1.1 Send

With this method you send text messages to your text messaging service provider.

Request

URI: /send

HTTP Method: *POST*

Request Parameters

Parameter	Required	Data Type	Description
type	No	String	Indicates for the middleware which integration flow for which type of service provider should be processed; entry 'sms'
outboundId	No	String	Unique identifier of outbound message generated by SAP Marketing
campaignId	No	String	Campaign ID of SAP Marketing that generates this email. Can be empty for send tests in campaign content and sender profile. Helpful for support.
sourceSystem	No	String	Logical System (SAP Net-Weaver). Required to get corresponding bounces or complaints related to outbound messages.

Parameter	Required	Data Type	Description
sender	Yes	String	Sender address; name or phone number
recipient	Yes	String	Recipient; phone number
bodyContentPlainText	Yes	String	Body content as plain text and JSON encoded.

Request Example

Sample Code

```

Path /send
HTTP method POST

Content-Type: application/json
Encoding: UTF-8

Body:
{
  "type" : "sms",
  "outboundId" : "33fds34534r4",
  "campaignId" : "123456789",
  "sourceSystem" : "ANACLNT100",
  "sender" : "SAP News",
  "recipient" : "+49123456789",
  "bodyContentPlainText" : "Hello, this is plain text"
}

```

Response

Response Parameters

Parameter	Required	Data Type	Description
messageId	Yes	String	Unique identifier for outbound message provided by service provider. Could be outboundId if supported by service provider.

Parameter	Required	Data Type	Description
errorCategory	No	String	Permanent errors lead to a stop of the campaign execution. Errors that can be fixed by a retry result in multiple retries to resolve the issue before the campaign stops. Throttling reduces the throughput that is generated by the backend. Possible values are <code>Retryable</code> , <code>Permanent</code> , <code>Throttling</code>
errorText	No	String	Error text is written to the log and shown to the end user in plain text.

Note

Note that the success code must start with 2 followed by two digits, for example, 202.

Response Example

Sample Code

```
Response:
Success Code 202
Content-Type: application/json

{
  "messageId": "33fds34534r4"
}
```

Error Example

Sample Code

```
Error Codes 4xx, 5xx:

{
  "errorCategory" : "Retriable/Permanent/Throttling"
  "errorText"    : "Internal Server Error"
}
```

14.1.2.3.1.2 Collect Delivery Status

With this method you get back the status of your text messages sent.

Request

URI: `/status`

HTTP Method: *GET*

Request Parameters

Parameter	Required	Data Type	Description
<code>sourceSystem</code>	No	String	Logical System (SAP NetWeaver). Required to get corresponding bounces or complaints related to outbound messages.
<code>startTimeUTC</code>	No	String	Timestamp to begin with query collected bounces on service provider side. Not needed in case of a bounce queue; format: <code>YYYYMMDDHHMMSS</code>
<code>endTimeUTC</code>	No	String	Timestamp to end with query collected bounces on service provider side. Not needed in case of a bounce queue; format: <code>YYYYMMDDHHMMSS</code>
<code>page</code>	No	Integer	Indicates the result page in case of multiple pages; possible values: 0..n

Request Example

```
/status

GET
sourceSystem=ANACLNT100
startTimeUTC=20170912144813
endTimeUTC=20170913144813
Page=2
```

Response

Response Parameters

Parameter	Required	Data Type	Description
<code>page</code>	No	Integer	Indicates the result page in case of multiple pages. Possible values are 0 to n
<code>lastPage</code>	Yes	Boolean	Indicates the last page of the result.
<code>status</code>	Yes	JSON Array	Contains the bounce details.

Parameter	Required	Data Type	Description
messageId	No	String	Reference to outbound message, see sending interface.
recipient	Yes	String	The phone number that bounced or created a complaint. Value: <code>phone number</code>
type	Yes	String	Type of feedback, depending on bounce or complaint use case . Possible values are: <code>Permanent</code> or <code>Temporary</code> .
timestamp	No	String	Timestamp when bounce occurred. Format: <code>YYYYMMDDHHMMSS</code>
statusCode	No	String	Status code
errorText	No	String	Error text for bounce message.

Response Example

Sample Code

```

Response
{
  "page": 2,
  "lastPage": false,
  "status": [
    {
      "messageId" : "12343243243413",
      "recipient" : "+49123456789",
      "statusCode" : "10",
      "statusText" : "Number does not exist",
      "type" : "Permanent",
      "timestamp" : "20170913144813"
    }
  ]
}

```

14.1.2.4 Setting up Amazon

To establish the connection to Amazon's Simple Email Service (SES) for email and bounce handling, you must do several steps at Amazon and at SAP.

Prerequisites

The following prerequisites exist for setting up Amazon as an email service provider:

- You are familiar with the basics of the *Amazon Service for Emails, Notifications and Queues*:
 - aws.amazon.com/de/documentation/ses/
 - aws.amazon.com/de/documentation/sns/

- aws.amazon.com/de/documentation/sqs/
- You have access granted on Amazon for the following API methods:
 - `SendRawEmail` (SES)
 - `ListIdentities` (SES)
 - `GetIdentityVerificationAttributes` (SES)
 - `GetSendQuota` (SES)
 - `ReceiveMessage` (SQS)
 - `DeleteMessageBatch` (SQS)

For more information, see [Controlling Access to Amazon SES](#) .

Set up

After you did the [Settings at Amazon \[page 129\]](#) and the [Settings at SAP \[page 130\]](#), you can execute email campaigns and send emails.

i Note

During the system setup and test phase, we recommend to use the *Campaign Execution Whitelist* app. The settings in the app prevent that target group members (contacts) receive emails when you execute an email campaign for test purposes.

For more information, see [Campaign Execution Whitelist \[page 142\]](#).

[Settings at Amazon \[page 129\]](#)

Here you create an Amazon Web Services (AWS) account and verified email addresses. Then you configure your SNS topics and bounce queues, create Identity and Access Management (IAM) users, generate your credentials for the Simple Email Service (SES), and set up group administration for your users to assign policies.

[Settings at SAP \[page 130\]](#)

After you did the configuration at Amazon, you go further with the configuration at SAP. Here you download the certificates, import them to the system, and establish the connection between Amazon and SAP.

[How the System Reacts on Amazon's Throttling \[page 132\]](#)

When Amazon runs into throttling, Amazon returns an error message. The SAP system reacts on it by reducing the send rate and processing the failed messages.

Related Information

[SAP Marketing integration with AWS-SES Email provider](#) 

<http://docs.aws.amazon.com/ses/latest/DeveloperGuide/before-you-begin.html> 

<http://docs.aws.amazon.com/ses/latest/DeveloperGuide/configure-sns-notifications.html> 

<http://docs.aws.amazon.com/AWSSimpleQueueService/latest/SQSDeveloperGuide/sqssubscribe.html> 

14.1.2.4.1 Settings at Amazon

Here you create an Amazon Web Services (AWS) account and verified email addresses. Then you configure your SNS topics and bounce queues, create Identity and Access Management (IAM) users, generate your credentials for the Simple Email Service (SES), and set up group administration for your users to assign policies.

1. Create an Amazon Web Services (AWS) account to get an account ID and password.
2. Log in to <https://console.aws.amazon.com> with your credentials.
3. Ensure, to select the correct region you intend to use. You see the region beside your account ID in the AWS Console itself and in the URL of your browser, for example, `https://eu-west-1.console.aws.amazon.com/ses/home?region=eu-west-1#`
4. In the AWS Console under *Identity Management*, create the required verified sender email addresses under *Email Addresses*.
You need the verified sender address, when you define a sender profile later on.

i Note

Keep in mind that the *MAIL FROM Domain* of your verified email addresses must in the same region as the *Target Host* entered in the system connection later on.

For more information, see [Regions and Amazon SES](#).

5. Now edit the notification configuration for the verified sender email address by choosing **Notifications** **Edit Configuration** **Click here to create a ne Amazon SNS topic**.
An *Edit Notification Configuration* popup opens.
Create a new Amazon SNS topic, for example, for bounces and complaints. Give the new topic the same name as the feedback queue, such as **AMAZON_BOUNCE**.
6. Then under *SNS Topic Configuration* select the previously created topics for bounces and complaints.

i Note

Do not maintain a topic for deliveries. The system is not able to handle the delivery notification.

7. Also in the *Edit Notification Configuration* popup under *Email Feedback Forwarding*, disable the email feedback forwarding.
8. Save your configuration.
After the saving you can find your Amazon Resource Names (ARN) under *Notifications*.
For more information, see also [Amazon Resource Names \(ARNs\) and AWS Service Namespaces](#).
9. In the *SQS* console, create a new queue with the same name you gave the feedback queue in technical configuration.
To do so, choose **SQS** **Create New Queue** and enter a topic name from the previous steps. Keep all other values as default and save your entries.
10. Subscribe to new queue to the SNS topic you created earlier.
Go to your AWS-SES account and choose *Security Credentials*.
Under *Your Security Credentials*, you create an IAM user required to send or used in *Sender Profiles*. We recommend to use IAM users to send emails as you can control with them the permissions and authorizations.
11. To start, choose *Get Started with IAM Users*:
 1. Choose *Create New Users*.

2. Enter the user names.
3. Select *Generate an access key for each user*.
4. Choose *Create*.

A confirmation message should appear that the users have been created.

12. Now you have set up an account at Amazon for and you receive the following parameters during account set-up:

- *Amazon Access Key ID* (hash string)
- *Secret Access Key* (hash string)
- *Feedback Queue Path*

The *Feedback Queue Path* is the last individual portion of the queue URL at Amazon. For example, the path from `https://sqs.eu-west-1.amazonaws.com/NNNNNNNNNNNN/ABC` is `/NNNNNNNNNNNN/ABC`.

i Note

You need these parameters again during the *Technical Configuration* and in the *Provider Credentials [page 140]* app.

13. In the AWS Dashboard under *Groups*, create a new group to assign policies to users. For example, create a group named **Administrator** and assign all the admin policies in the *Attach Policies* step.
14. To assign users to the created group, choose **Group Actions** > *Add Users to Group*.

Now follow-up with the *Settings at SAP [page 130]*.

14.1.2.4.2 Settings at SAP

After you did the configuration at Amazon, you go further with the configuration at SAP. Here you download the certificates, import them to the system, and establish the connection between Amazon and SAP.

[Import the Certificates \[page 130\]](#)

Download the certificates and import them to the system of SAP Marketing.

[Establish the System Connection \[page 131\]](#)

Establish the connection between Amazon and the system of SAP Marketing.

14.1.2.4.2.1 Import the Certificates

Download the certificates and import them to the system of SAP Marketing.

Procedure

1. To download the certificates, open the URL <https://email.eu-west-1.amazonaws.com/> in Chrome and open developer tools (**CTRL** + **SHIFT** + **I** or simply press **F12**).

2. Choose **► Security ► View certificate ►** and save all available certificates locally from the *Details* tab.
 - Store it as Base-64 file.
 - The links do not work in all browsers. Use an appropriate browser to open the link.
 - You have the following options regarding installing the SSL certificates:
 - You can either install the intermediate and root certificates in your trust store (certificate chain)
 - or install the leaf certificate in your trust store.
3. Open the *Trust Manager* (transaction code: **STRUST**) and import all available certificates.

14.1.2.4.2.2 Establish the System Connection

Establish the connection between Amazon and the system of SAP Marketing.

Procedure

1. Open the *Configuration of RFC Connections* (transaction code: **SM59**) and create RFC destinations for Amazon Mail and Amazon Bounce.

We recommend to:

- name them **AMAZONMAIL** and **AMAZONBOUNCE**.
 - use *Connection Type G*
 - use *Target Host*, for example, for email **email.eu-west-1.amazonaws.com** and for bounces **sqs.eu-west-1.amazonaws.com**
 - use *Port 443*
 - leave the *Path Prefix* empty and fill it later on using the *Provider Credentials* app.
2. Check the security options on the *Logon & Security* tab:
 - a. Set *SSL* to *Active*.
 - b. Select the certificate list *ANONYM SSL Client (Anonymous)* as *SSL Certificate*. Note that the selected certificate list similar to the list you uploaded the certificates.
 3. On the *Special Options* set the *HTTP Version* to *HTTP 1.1* and the *Compression* to *Active (full document)*
 4. Finally perform a connection test.

You should get *Status HTTP Response* 404, which confirms that the connection to the Amazon server has been established.

5. Now open the *Provider Credentials* app and maintain the credentials you got from Amazon including the path prefix. For more information, see [Provider Credentials \[page 140\]](#).

14.1.2.4.3 How the System Reacts on Amazon's Throttling

When Amazon runs into throttling, Amazon returns an error message. The SAP system reacts on it by reducing the send rate and processing the failed messages.

When campaign execution exceeds the send rate per customer, Amazon returns the following error: API error: Code "400", Reason: "Bad Request", Message: "Throttling Maximum sending rate exceeded."

In addition the system of SAP Marketing reduces the send rate and process the failed mails again.

→ Recommendation

If the issue still persists, we recommend to exceed the quota at Amazon.

For more information, see also information given by Amazon: [What Happens When You Reach Your Sending Limits?](#)

14.1.2.5 Setting Up Alibaba Cloud DirectMail Service

Set up Alibaba Cloud DirectMail Service so that you can use it to send emails to your customers. Configurations, including RFC destinations, provider credentials, and sender profiles, are required.

Prerequisites

You should be familiar with the basics of Alibaba Cloud DirectMail Service. For product details and documentation, see [Alibaba Cloud DirectMail Service](#) at the Alibaba Cloud site.

If you want to get bounces from the Alibaba Cloud platform, you need a basic knowledge of Alibaba Cloud Message Service. For product details and documentation, see [Alibaba Cloud Message Service](#) at the Alibaba Cloud site.

The following are concrete prerequisites that you must meet:

- You have an account on the Alibaba Cloud platform (<https://www.aliyun.com/>).
- You have created a pair of access key and secret key for your Alibaba Cloud account in the Alibaba Cloud Console, under [accesskeys](#).
A pair of access key and secret key is required to call Alibaba Cloud APIs. Later you need to configure them in SAP Marketing.
- You have activated Alibaba Cloud DirectMail Service and completed the following configurations in the Alibaba Cloud DirectMail Service Console:
 - Email domain
See [Setting Up Domain Names](#) at the Alibaba Cloud site for instructions.
 - Sender address
When creating a sender profile in SAP Marketing, you must provide a sender address that has been configured in the DirectMail Service Console.

For instructions on how to create a sender address, see [Setting Up Sender Addresses](#)  at the Alibaba Cloud site.

- You have activated Alibaba Cloud Message Service and created message queues in the Alibaba Cloud Message Service Console.
Use this service only if you want to get bounce data for e-mail campaigns from the Alibaba Cloud platform.
For instructions on how to create a message queue, see [Queue Operations](#)  at the Alibaba Cloud site.

Procedure

1. Add the SSL certificates of Alibaba Cloud SMS and Alibaba Cloud Message Service to the trust list of SAP Marketing.
For more information, see [Importing SSL Certificates \[page 133\]](#).
2. Create the technical configurations required to establish communication between Alibaba Cloud and SAP Marketing by running a task list.
For more information, see [Creating Technical Configurations \[page 134\]](#).
3. Create a sender profile.
For more information, see [Customizing a Sender Profile \[page 134\]](#).



Related Information

[Function Documentation: Email Campaigns Using Alibaba Cloud DirectMail Service](#)

14.1.2.5.1 Importing SSL Certificates

Import the SSL certificate for Alibaba Cloud DirectMail Service into SAP Marketing. If you want to get bounces from the Alibaba Cloud platform, import the SSL certificate for Alibaba Cloud Message Service as well.

Proceed as follows:

1. Download the SSL certificates from the following sites:
 - Certificate for Alibaba Cloud DirectMail Service: <https://dm.aliyuncs.com/> 
 - Certificate for Alibaba Cloud Message Service (region: East China 1): <https://mns.cn-hangzhou.aliyuncs.com/> 
2. In the back-end system, call up transaction `STRUST` and switch to change mode.
3. Choose the SSL client *SSL Client (Standard)*.
4. From the *Certificate* area, choose *Import Certificate* and import a certificate.
5. Choose *Add to Certificate List* and save the PSE file.

14.1.2.5.2 Creating Technical Configurations

Create the technical configurations required for the integration with Alibaba Cloud DirectMail Service, for example, RFC destinations and service providers, by running a task list.

Proceed as follows:

1. In the back-end system, call up transaction `STC01`.
2. Display task list `CUAN_LOCALIZATION_CN`.
3. Choose [Generate Task List Run](#).
4. Choose the [Change Parameters](#) button for the first task [Define Parameters for Setting Up Asia Localization](#).
5. Select the [AliCloud DirectMail and Bounce](#) checkbox.
The parameters for Alibaba Cloud DirectMail Service and bounces display.
6. Enter the access key and secret key for your Alibaba Cloud account.
These parameters are required to call Alibaba Cloud APIs. Later you can also change them using the [Provider Credentials](#) app if required.
7. In the [Regions and Queues](#) section, select the [Option 1](#) checkbox. In the first input field after the checkbox, enter a service region code defined by Alibaba Cloud, for example, `cn-hangzhou`.
8. Configure the following parameters, which are required only if you want to get bounces from the Alibaba Cloud platform:
 - Alibaba Cloud account ID
You can find the Alibaba Cloud account ID from the Alibaba Cloud Console, under [Account Management](#) [Security Settings](#).
 - Message queue for getting bounces
The message queue for getting bounces is the one that you have created in the Alibaba Cloud Message Service Console under [Message Queue](#).

14.1.2.5.3 Customizing a Sender Profile

Create a sender profile that contains settings about a text message sender (for example, service provider and sender name) using the [Sender Profiles](#) app. Use standard sender profiles as a basis to create your own sender profiles.

When you complete running task list `CUAN_LOCALIZATION_CN`, the system creates standard sender profiles for you depending on the service region you have configured. The following are examples of standard sender profiles:

Service Region	Standard Sender Profile
<code>cn-hangzhou</code>	AMCN
<code>ap-southeast-1</code>	AMSG
<code>ap-southeast-2</code>	AMAU

To create your own sender profile for Alibaba Cloud DirectMail Service, proceed as follows:

1. Log into SAP Fiori launchpad.
2. Open the *Sender Profiles* app.
3. Select a standard sender profile from the left pane.
4. Choose *Copy*.
5. Enter the required information, such as profile ID and sender address.
The sender address that you enter must have been configured in the Alibaba Cloud DirectMail Service Console.

14.1.2.6 Setting Up Alibaba Cloud Short Message Service

Set up Alibaba Cloud Short Message Service (Alibaba Cloud SMS) so that you can use it to send text messages to your customers. Configurations, including RFC destinations, provider credentials, export definitions, and sender profiles, are required.

Prerequisites

You should be familiar with the basics of Alibaba Cloud SMS. For product details and documentation, see [Alibaba Cloud SMS](#) at the Alibaba Cloud site.

If you want to get bounces from the Alibaba Cloud platform, you need a basic knowledge of Alibaba Cloud Message Service. For product details and documentation, see [Alibaba Cloud Message Service](#) at the Alibaba Cloud site.

The following are concrete prerequisites that you must meet:

- You have an account on the Alibaba Cloud platform (<https://www.aliyun.com/>).
- You have created a pair of access key and secret key for your Alibaba Cloud account in the Alibaba Cloud Console, under *accesskeys*.
A pair of access key and secret key is required to call Alibaba Cloud APIs. Later you need to configure them in SAP Marketing.
For instructions on how to create access keys and secret keys, see [Creating an Access Key](#) at the Alibaba Cloud site.
- You have activated Alibaba Cloud SMS and completed the following configurations in the Alibaba Cloud SMS Console:
 - Text message signatures
Text message signatures in the Alibaba Cloud SMS Console refer to **sender names** in SAP Marketing. When creating a sender profile in SAP Marketing, you must provide a sender name (text message signature) that has been approved by Alibaba Cloud.
For instructions, see [Applying For a Text Message Signature](#) at the Alibaba Cloud site.
 - Text message templates
When creating a text message campaign in SAP Marketing, you must provide a text message template that have been approved by Alibaba Cloud.
If you want to use customer attribute variables in a text message template, you must have an export definition that contains customer attribute variables in SAP Marketing and enter their technical names in your template in the Alibaba Cloud SMS Console. For more information, see [Creating an Export Definition \[page 138\]](#).

For instructions on how to create a text message template, see [Applying For a Text Message Template](#)  at the Alibaba Cloud site.

- You have activated Alibaba Cloud Message Service and created message queues in the Alibaba Cloud Message Service Console.
Use this service only if you want to get bounce data for text message campaigns from the Alibaba Cloud platform.
For instructions on how to create a message queue, see [Queue Operations](#)  at the Alibaba Cloud site.

Procedure

1. Add the SSL certificates of Alibaba Cloud SMS and Alibaba Cloud Message Service to the trust list of SAP Marketing.
For more information, see [Importing SSL Certificates \[page 136\]](#).
2. Create the technical configurations required to establish communication between Alibaba Cloud and SAP Marketing by running a task list.
For more information, see [Creating Technical Configurations \[page 137\]](#).
3. Create a sender profile.
For more information, see [Customizing a Sender Profile \[page 137\]](#).
4. Create an export definition that contains personalization variables (customer attributes) to be used in campaign text messages.
For more information, see [Creating an Export Definition \[page 138\]](#).



Related Information

[Function Documentation: Text Message Campaigns Using Alibaba Cloud Short Message Service](#)

14.1.2.6.1 Importing SSL Certificates

Import the SSL certificate for Alibaba Cloud SMS into SAP Marketing. If you want to get bounces from the Alibaba Cloud platform, import the SSL certificate for Alibaba Cloud Message Service as well.

Proceed as follows:

1. Download the SSL certificates from the following sites:
 - Certificate for Alibaba Cloud SMS: <https://dysmsapi.aliyuncs.com/> 
 - Certificate for Alibaba Cloud Message Service (region cn-hangzhou): <https://mns.cn-hangzhou.aliyuncs.com/> 
2. In the back-end system, call up transaction `STRUST` and switch to change mode.
3. Choose the SSL client *SSL Client (Standard)*.
4. From the *Certificate* area, choose *Import Certificate* and import a certificate.
5. Choose *Add to Certificate List* and save the PSE file.

14.1.2.6.2 Creating Technical Configurations

Create the technical configurations required for the integration with Alibaba Cloud SMS, for example, RFC destinations and service providers, by running a task list.

Proceed as follows:

1. In the back-end system, call up transaction `STC01`.
2. Display task list `CUAN_LOCALIZATION_CN`.
3. Choose [Generate Task List Run](#).
4. Choose the [Change Parameters](#) button for the first task [Define Parameters for Setting Up Asia Localization](#).
5. Select the [AliCloud SMS and Bounce](#) checkbox.
The parameters for Alibaba Cloud SMS and bounces display.
6. Enter the access key and secret key for your Alibaba Cloud account.
These parameters are required to call Alibaba Cloud APIs. Later you can also change them using the [Provider Credentials](#) app if required.
7. In the [Regions and Queues](#) section, select the [Option 1](#) checkbox. In the first input field after the checkbox, enter a service region code defined by Alibaba Cloud, for example, `cn-hangzhou`.
8. Configure the following parameters, which are required only if you want to get bounces from the Alibaba Cloud platform:
 - Alibaba Cloud account ID
This ID has a fixed value **1943695596114318**. It is not your Alibaba Cloud account ID that you can find from the Alibaba Cloud Console.
 - Message queue for getting SMS sending reports
In the [Regions and Queues](#) section, enter your message queue for getting SMS sending reports in the input field after the region code. You can find the message queue name from the Alibaba Cloud SMS Console, under [Application Development](#) > [API](#) > [SMS Sending Report](#) . The message queue name looks like **Alicom-Queue-`<a specific ID>`-SmsReport**.

14.1.2.6.3 Customizing a Sender Profile

Create a sender profile that contains settings about a text message sender (for example, service provider and sender name) using the [Sender Profiles](#) app. Use standard sender profiles as a basis to create your own sender profiles.

When you complete running task list `CUAN_LOCALIZATION_CN`, the system creates standard sender profiles for you, for example, `ASCN` for region `cn-hangzhou`.

To create your own sender profile for Alibaba Cloud SMS, proceed as follows:

1. Log into SAP Fiori launchpad.
2. Open the [Sender Profiles](#) app.
3. Select a standard sender profile from the left pane.
4. Choose [Copy](#).
5. Enter the required information, such as profile ID and sender name.

i Note

Sender names in SAP Marketing refer to text message signatures in the Alibaba Cloud SMS Console. Here you must provide a sender name (text message signature) that has been approved by Alibaba Cloud.

14.1.2.6.4 Creating an Export Definition

If you want to use customer attribute variables, such as first name and last name, to personalize your campaign text messages, create an export definition and add the customer attributes that you want to use into it.

To send text messages using Alibaba Cloud SMS, one of the prerequisites is that you create text message templates in the Alibaba Cloud SMS Console. You can include customer attribute variables in text message templates. When setting the parameters for the *Send Alibaba Text Message* campaign action, you specify a text message template ID and an export definition that contains the customer attributes used in the template. You can use an export definition predefined by SAP or create your own export definition.

i Note

If the text message to be sent contains customer attribute variables, then the segmentation profiles of the export definition and target group assigned to the *Send Alibaba Text Message* campaign action must be the same.

Using the Predefined Export Definition

SAP provides you with a predefined export definition `Template_Alibaba_SMS`, which contains the customer attribute variables most commonly used in campaign content. This export definition is available after you have created the required technical configurations by running task list `CUAN_LOCALIZATION_CN`. The predefined export definition contains the following customer attributes:

Export Definition	Attribute	Technical Name of Attribute
Template_Alibaba_SMS	Region	REGION
	Postal Code	POSTCODE1
	Full Name	NAME_TEXT
	Last Name	NAME_LAST
	First Name	NAME_FIRST

You can use these customer attributes as personalization variables when creating text message templates in the Alibaba Cloud SMS Console.

i Note

Segmentation profile `SAP_CE_CONTACT_1508` is assigned to the predefined export definition `Template_Alibaba_SMS`. If you specify `Template_Alibaba_SMS` for the *Send Alibaba Text Message* campaign action, then you must specify a target group that is assigned the same segmentation profile `SAP_CE_CONTACT_1508`.

Creating Your Own Export Definition

You create your own export definitions using the *Export Definitions* app. Select the *Alibaba SMS* usage. When deciding on a segmentation profile, keep in mind that the segmentation profiles of the export definition and target group assigned to the *Send Alibaba Text Message* campaign action must be the same.

Using Customer Attribute Variables in a Text Message Template

To personalize your campaign text message with customer attribute variables, you include the technical names of customer attributes where needed in a text message template in the Alibaba Cloud SMS Console. You get technical names of customer attributes from SAP Marketing. To find the technical name of an attribute, do the following:

1. Log into SAP Fiori launchpad.
2. Open the *Segmentation Configuration* app.
3. Select *Segmentation Profiles*.
4. Select the segmentation profile that is assigned to your export definition.
5. In the *Attribute Visibility* section, click the attribute you are looking for, for example, **Full Name**.
An information box appears. The technical name `NAME_TEXT` is displayed right under the attribute name.

i Note

The technical name of an attribute that you enter in a template must be the same as that in SAP Marketing. If there is an underscore (`_`) in a technical name, remove it and do not leave a space.

❖ Example

If you want to use the Full Name (`NAME_TEXT`) attribute in your template, enter **`NAMETEXT`**.

14.1.2.7 Sender Profiles

A sender profile allows you to carry out campaigns for different channels in different markets. You can maintain sender profiles for channels, such as email, text message, and mobile push notifications.

Prerequisites

- You have set up the service provider for emails and text messages.
For more information, see [Setting Up Service Provider for Emails and Text Messages \[page 111\]](#).
- You have done the steps in Customizing for SAP Marketing, by choosing ► [Campaigns](#) ► [Campaign](#) ► [Define Sender Profile](#) ►.
- You have registered the *Sender Address* and the *Reply-To Address* at SAP Digital Interconnect and/or Amazon.

i Note

Note that the registered email address in your Amazon account for the bounce queue is case-sensitive.

Recommendation: Test Sender Profiles

To test the maintained sender profiles, we recommend to use [Send Test Email](#) or [Send Test Text Message](#) to ensure that the settings are working. Otherwise the issues can appear during campaign execution.

Related Information

[Mobile Campaigns](#)
[Opting-Out and Unsubscribing by Email](#)

14.1.2.8 Provider Credentials

Provider credentials are provided by a service provider such as Amazon SES for sending out emails and text messages out of your system. You can maintain the provider credentials and update them in case of changes after the setup.

i Note

The settings here are pre-filled with data that has been already entered during the technical configuration.

Prerequisites

- Your user has been assigned to the single role `SAP_CEI_PROVIDER_CREDENTIALS`.
- Your user has been assigned to the business catalog role `SAP_CEI_KUA_FLP`.

Maintaining Provider Credentials

1. Choose the *Provider Credential* app.
2. Depending on the services you use you have to maintain some of the following credentials you got from your service providers:
 - *SAP Intelligent Notification 365, e-mail API*
 - *User ID*
 - *Password*
 - *Path Prefix:* `/email/<accountID>/notifications`
 - *SAP Intelligent Notification 365, SMS API*
 - *User ID*
 - *Password*
 - *Path Prefix:* `/cmn/<accountID>/<accountID>.sms`
 - *Amazon SES*
 - *Access Key*
 - *Secret Key*
 - *Bounce Queue Path:* The *Bounce Queue Path* (also known as *Feedback Queue Path*) is the last individual portion of the queue URL at Amazon. For example, the path from `https://sqs.eu-west-1.amazonaws.com/NNNNNNNNNNNN/ABC` is `/NNNNNNNNNNNN/ABC`.
 - *Unsubscribe Queue Path:* The *Unsubscribe Queue Path* is the last individual portion of the queue URL at Amazon for unsubscribe.
For more information, see [Enabling Unsubscribe for Emails \[page 146\]](#).
3. Save your entries.

Test Provider Credentials

To test the saved credentials choose *Test*.

The system then checks the saved data and shows the results in a popup. Choosing the corresponding line you get more information in case there are any issues.

With the check report `CUAN_MKT_EXEC_CHECK_CONFIG` you can check your configuration settings for sending emails and text messages.

Related Information

[Setting Up Service Provider for Emails and Text Messages \[page 111\]](#)

14.1.2.9 Campaign Execution Whitelist

With this app, you define the only allowed recipients for your campaigns in the test system.

You use the *Campaign Execution Whitelist* app to maintain the allowed email addresses and telephone numbers that you want to use, when you create marketing campaigns for test purposes.

With the entries you avoid to send test emails and test text messages to your customers.

i Note

- You use this app only in your test system.
- As soon as you have maintained email addresses or telephone numbers in the *Campaign Execution Whitelist* app, only those recipients from this list can be contacted.

Create an Entry

1. Choose *Create Object (+)* to create a new whitelist entry.
2. Select a *Communication Medium*, such as EMAIL or SMS.
3. Depending of your selected *Communication Medium* enter either an email address or a telephone number.

i Note

- Note that you can use wild card entries for email addresses by just entering the domain name, for example, `@example.net`.

❖ Example

For example, your whitelist has the entries `john.doe@example.com`, `jane.smith@example.com`, and `@example.net`. So only John Doe, Jane Smith, and recipients from `example.net` can receive emails from an executed campaign.

- Enter the telephone numbers using the schema `+<country code>nnn`, because otherwise the telephone numbers cannot be cross-checked with the master data entries.

❖ Example

`+1nnnnnn` for a telephone number located in the United States or `+49nnnnnn` for a telephone number located in Germany.

4. Save your entry.

14.1.2.10 Handling Bounces

Invalid contact data can result in soft and hard bounces. The system tracks the bounces and helps you with this information to optimize the reachability of your customers.

SAP Marketing collects the bounce information from the email service provider using a background job. The job is executed every minute. If there are bounce records returned, the bounce handler takes the information received from the email service provider and creates the interactions.

- **Soft Bounce**

A soft bounce is returned when the email address of the recipient is valid but the mail server bounced back. Typical examples for soft bounces are when the mailbox of the recipient is full or when the mail server is currently down. The soft bounce updates the interaction from `EMAIL_OUTBOUND` to `EMAIL_BOUNCE_SOFT` for the contact. The system does not perform any follow-up processing for soft bounces.

- **Hard Bounces**

A hard bounce is returned when the email address of the recipient is permanently rejected. For example, if the email address is not valid or does not exist. The hard bounce updates the interaction from `EMAIL_OUTBOUND` to `EMAIL_BOUNCE_HARD` for the contact. With a hard bounce the system removes the contact's email address in the contact master.

i Note

When the system gets bounces, the counter for the outbound interactions goes down.

Later on, if the system receives other inbound interactions for an email address that has been invalidated, it resets the email address to valid for all contacts who have the address.

Additionally, if a contact is subsequently updated from a new data source that provides an email address that has been invalidated by a hard bounce, or if a new contact is created with this email address, then the email address will be considered as valid again, but only for the contact involved.

Recommended Quality Checks

There are checks that can be performed on all email addresses stored in source systems to ensure that the basic formatting and details are correct. We recommend the following:

- Ensure that all email addresses are correct and incorrect ones are removed from the list.
- Obtain a breakdown of email addresses by internet service provider (ISP) such as GMAIL. A breakdown helps to monitor which emails are going into junk folders or are being considered as spam.

Related Information

[Email Validation Checks](#)

14.1.2.10.1 Monitor Email Bounces Using Success Data

Get an overview of how email bounces are handled by the system and reflected in the performance details of a campaign.

❁ Example

The following example shows the interactions and key performance indicators (KPIs) for a campaign after it has been executed. The campaign has a target group with 5 members, and an email has been sent to all target group members. The initial results are the following:

- 4 emails have been delivered to the email service provider (ESP).
- 1 email delivery failed due to missing marketing permissions.
- 2 email addresses are erroneous.
- ESP is unavailable for 1 email address.

The system creates the following interactions:

- 1 `EMAIL_OUTBOUND` interaction. Only as long as the system hasn't got back the bounces, the count is 4.
- 1 `OUTBOUND_CHK_FAILED` interaction
- 2 `EMAIL_BOUNCE_HARD` interactions
- 1 `EMAIL_BOUNCE_SOFT` interaction

You can also find the interactions in the *Contacts* app under *Interactions*.

The following key performance indicators (KPIs) are displayed in the campaign under *Performance*:

- *Marketing Permission Check Failed*: 1
- *Number of Sent Messages*: 4
Formula: Sent Messages = (Number of Delivered Messages + Sum of Soft and Hard Bounced Messages)
Which means: 4 Sent Messages = 1 delivered + 2 hard bounce + 1 soft bounce
- *Number of Hard Bounces*: 2
- *Number of Soft Bounces*: 1
- *Number of Delivered Messages*: 1
Formula: Delivered Messages = Number of `EMAIL_OUTBOUND` Interactions

KPIs

The KPIs are calculated based on the interactions created in the system. They are part of the CDS view *Campaign Success for Messages* (`C_MKT_CampaignSuccessQ` and `C_MKT_CAMPAIGNSUCCESS2Q`).

The KPIs *Sent Messages* and *Delivered Messages* do not yet give any information that the email was delivered to the email address of the contact. The KPIs give the information that the email is sent to the connected ESP, such as SAP Digital Interconnect.

To get the **bounce codes** and **descriptions**, add the attributes *Business Document Status* and *Business Document Status Description* to your analyses.

For more information, see [Campaign Success for Messages](#).

Email Open and Click Through

When a contact receives the email and opens the email or clicks a trackable link from the email, an `EMAIL_OPENED` and `CLICK_THROUGH` interaction is created. When the contact opens the email, the system creates an `EMAIL_OPENED` interaction. However, the system creates a `CLICK_THROUGH` interaction each time a link within the email is opened. The interaction is created with a reference to the `EMAIL_OUTBOUND` interaction.

The `EMAIL_OPENED` and `CLICK_THROUGH` interaction information is also available in the campaign performance area.

When the contact clicks on a link inside an email several times, the number of `CLICK_THROUGH` interactions increases.

Delivered Email and Soft Bounce

In some cases, the ESP first sends a soft bounce response to your system, then later delivers the email successfully. In that case, the system first creates a soft bounce interaction. When the contact opens the email, or opens a trackable link from the email, the soft bounce changes to an `EMAIL_OUTBOUND` interaction.

The system can't update the `EMAIL_BOUNCE_SOFT` interaction when the email is delivered after a soft bounce and remains unopened.

14.1.2.10.2 Monitor Bounces Using Segmentation

Fetch bounce data from segmentation.

Configuration

Before you create a new segmentation model, you must add some key attributes to the segmentation object using the segmentation configuration. Please refer to the segmentation configuration documentation for general details.

Most segmentation objects have the *Interaction Type, Campaign* (ID), and *Interaction Date* attributes available in the *Interactions* group. However, you must add the *ID* of the contact using the segmentation configuration.

For example, you can use the *All Contacts* segmentation profile to add the *ID* attribute for the underlying segmentation object *All Contacts* (`SAP_CONTACT_ENGAGEMENT_SIN`). The *ID* field is available in the data source *Contacts, ERP Customers, and Related Interactions* (`SAP_CE_CONTACT_IA_ERP_CUSTOMER`) where *ID* (ID) is a required attribute.

You set the *Visible as Attribute* flag and add the *ID* field to the *Interactions* attribute group.

Segmentation

For many scenarios, the figures in the performance screen and the information in the contact details are sufficient. However, in some cases, you might need more detailed information. The following steps show you how to get bounce information using the segmentation:

1. Campaign Interactions in Segmentation

To get more information about the email opened interaction, create a segmentation model in the [Segmentation](#) app and use the campaign ID as a filter.

Use the preview for the interaction type attribute to see which interactions are created for the campaign:

The numbers in the [Count](#) field must match the figures from the campaign success screen.

You can use the following attributes to get additional information:

- [Name](#) to get the full name of the contact.
- [ID](#) to get the email address.
- [Interaction Date](#) to understand when the email was opened.

2. Find Hard Bounces

When a campaign throws hard bounces in the campaign success screen, you must fetch the email addresses that caused the hard bounce.

Due to the hard bounce, the email ID of the interaction contact is not valid and no longer available in the contact details.

To get the bounced email addresses, use the segmentation model to filter for the campaign ID and the hard bounce interactions. Use the preview for the [ID](#) attribute to see the bounced email addresses, then use this information for follow-up processing.

3. Export Data

Now you can export the data using the [Export to CSV](#) feature of the preview in segmentation.

Related Information

[Segmentation Configuration](#)

14.1.2.11 Enabling Unsubscribe for Emails

When you want to use the unsubscribe offered by Amazon, you need to do settings at Amazon and at SAP.

After you did all the settings, the header of the recipient's email contains the possibility to unsubscribe.

If the contact does not want to get further emails, she or he sends an unsubscribe request to the unsubscribe email address entered in the sender profile. The unsubscribe requests are collected on Amazon side in a queue. A background job then pulls the unsubscribe requests from Amazon and creates corresponding interactions in the system. The system evaluates the interactions and updates marketing permissions or list subscriptions for the marketing contact.

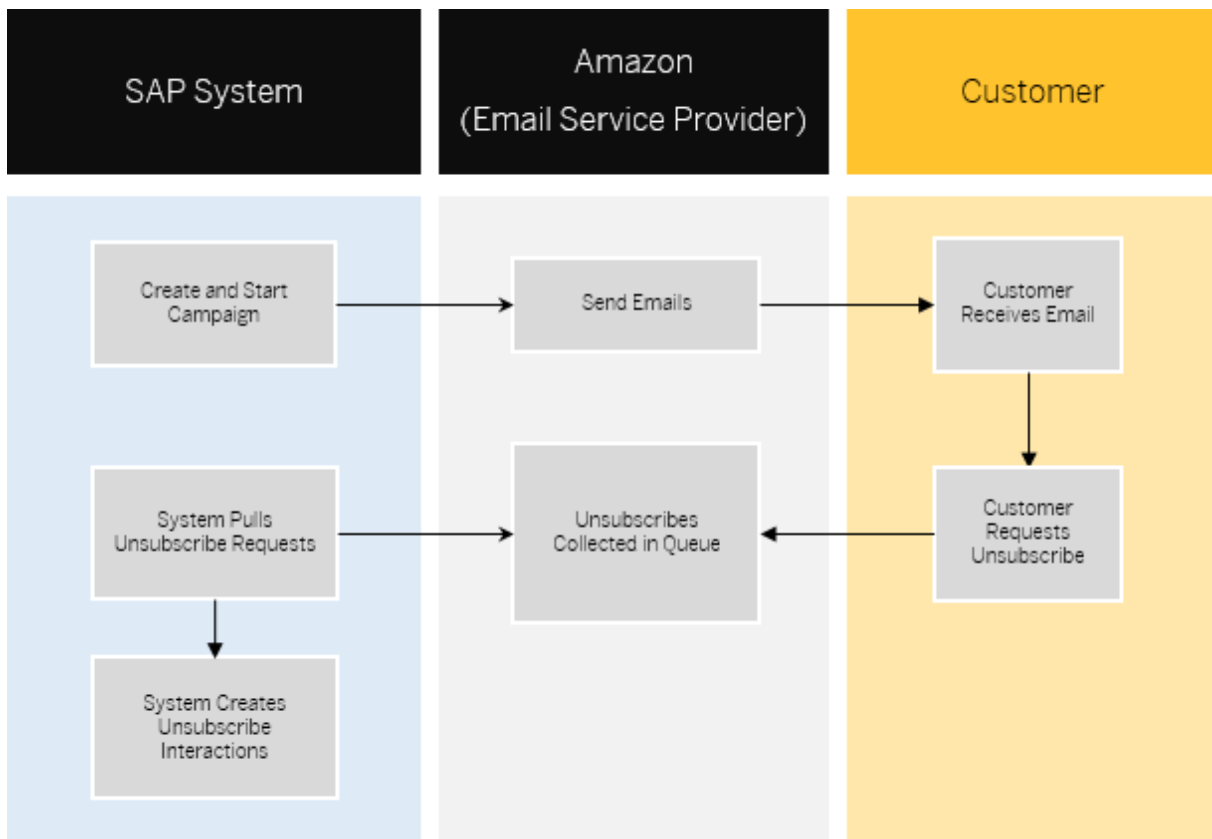

In detail the following steps will happen:

1. The marketing expert executes an email campaign.
2. The system sends out the marketing emails.
3. A recipient is getting an email in the inbox.
4. The recipient unsubscribes by clicking on the option in the email header.
5. Email client sends an unsubscribe request to unsubscribe email address of Amazon.
6. Amazon collects unsubscribe requests in a queue.
7. SAP pulls the unsubscribe requests and creates interactions.
8. Based on the interactions the system updates marketing permissions and list subscriptions.

Setup

At Amazon

1. Create and configure an AWS account. For more information, see [Before You Begin](#) .
2. [Registering a New Domain](#) .
3. Check and verify your domain. For more information, see [Verify your Domain](#) , [Amazon SES Domain Verification TXT Records](#) , and [Publishing an MX Record for Amazon SES Email Receiving](#) .
4. Now you can create your rule set. For more information, see [Set up a Receipt Rule](#) .
Note that when you create a rule, choose action type **SNS** (instead of **S3** mentioned in the documentation) and give the SNS topic a meaningful name such as **unsubscribe**.

5. Then create a queue with Amazon Simple Queue Service (SQS) by choosing [Subscribe Queue to SNS Topic](#) from the dropdown menu. Important here to know is that you must connect this queue with the previously created SNS topic. For more information, see [Create a Queue in Amazon Simple Queue Service](#) .

At SAP

1. In the technical configuration (report CUAN_TECH_CONF_CA) enter the [Unsubscribe Queue Path](#) in the section [Credentials for Amazon SES](#). This path represents the Amazon queue as created in the previous steps on Amazon side.
Then run the technical configuration (report CUAN_TECH_CONF_CA) for the initial setup.
Note that you can change the settings later in the [Provider Credentials](#) app or you use transaction SM59 in the backend.
2. Alternatively to the technical configuration, open transaction SM59 and create an HTTP connection to an external server.
Choose connection type **G** and enter the technical details from the previously created queue under [Technical Settings](#), such as [Host](#) and [Path Prefix](#).
3. In the Customizing under SAP Marketing choose [Campaigns](#) > [Campaign](#) > [Define Provider Configuration](#) 
Enter there the [HTTP Destination for Unsubscribing](#) created in the technical configuration or in transaction SM59.
4. Open the [Sender Profiles](#) app and add the [Email Address for Unsubscribing](#). For more information, see [Opting-Out and Unsubscribing by Email](#).
Create either a new domain or register an existing one using Amazon Route 53 for the Amazon Email sender profiles you use in the messages for your campaign execution.

14.1.3 Setting Up Suppression Rules

With the [Suppression Rules](#) application in the [Segmentation and Campaign Configuration](#) business group, you have the option of integrating the SAP HANA rules framework (HRF) to control whether and how often a campaign interacts with contacts. With this feature, your marketing administrators can set up rules that are checked every time a campaign is executed.

A prerequisite for using this option is an installed and configured HRF. If you did not install and configure HRF before, follow the instructions in section [Scenario "HANA Rules Framework" \[page 53\]](#).

For more information, see section [Suppression Rules](#) in the application help for SAP Marketing on the SAP Help Portal at:

<https://help.sap.com/mkt-op>  [Application Help](#) > [SAP Marketing](#) > [SAP Marketing Applications](#) 

14.2 Setup for Content Studio

For the use of messages created in the [Content Studio](#) app, you are provided with several mandatory or optional settings. You find the corresponding setting descriptions in the following sections.

14.2.1 Customizing Settings

General Customizing Settings

i Note

SAP delivers Customizing settings in Business Configuration (BC) sets. You can use these settings, or you can create your own by copying the SAP settings, and changing them according to your requirements.

Prerequisites

Contacts are available in SAP Marketing.

i Note

To ensure emails and text messages are sent to a controllable predefined list of contacts in a test or development environment, you can use the whitelist (transaction `ME_WHITELIST`). For more information, see [Campaign Execution Whitelist \[page 142\]](#).

Customizing

Ensure that the following Customizing settings are available, both for trigger-based sending of campaigns by email or text message, and for target group-based sending using a preselected target group:

- ▶ [General Settings](#) ▶ [Define Marketing Areas](#) ▶
 - To provide users with authorizations for specific marketing areas, you have created different copies of the roles, provided by SAP, with different marketing areas assigned.
 - To manage the authorizations for marketing areas for each user, you assign the suitable role copy to each user.
 - To ensure that the authorizations for your email templates are correct, select a marketing area for each new template.
 - To ensure that the authorizations for your emails or text messages are correct, select a marketing area when you create them.
- ▶ [Segmentation](#) ▶ [Define Segmentation Objects](#) ▶
Ensure that segmentation objects for trigger-based sending, and for target group-based sending are available.
- ▶ [Segmentation](#) ▶ [Define Segmentation Profiles](#) ▶
Ensure that the segmentation objects you use are assigned to a segmentation profile.
Check that the indicator *Obsolete* has not been selected for the segmentation profile `SAP_CE_INTERACTION` provided.
- ▶ [Campaigns](#) ▶ [Content Studio](#) ▶ [Manage Content Types](#) ▶
Deactivate predefined content types that are not relevant. Once you have done so, they are no longer displayed during creation and in the search results list in the Content Studio. You can also change the order of the quick filter tiles and the value help when creating new content.

i Note

By default, the predefined content type *LINE Message* (LIN) is disabled. If you need this content type, remove the corresponding flag from the checkbox.

14.2.2 Setting up Display of Campaign Emails in a Browser

If you want the recipients of your email campaigns to be able to display their received emails in their mail clients and also in a browser, proceed as follows:

- In Customizing for SAP Marketing (transaction SPRO) under ► *Campaigns* ► *Content Studio* ► *Set Up View Email in Browser Link* ►, provide the URL to your deployed servlet to get the *Insert View in Browser* link on the user interface.
- Create your own servlet. For a detailed description of how to create such a servlet, see [API based "View in Browser" with SAP Marketing](#).

14.3 Integrations

The Campaign Management in SAP Marketing can be integrated with various internal or external systems or services. You can find a description of available integrations in the [Integration Guide](#) for SAP Marketing on the SAP Help Portal at:

<https://help.sap.com/mkt-op> ► *Integration* ►

The setup of the following integrations are included in the integration guide:

Setting up Integration with Facebook and Instagram

You can plan and create campaigns that are handed over to Facebook and Instagram for execution. Optionally, you can define and transfer a target group to be addressed at Facebook. From Facebook, actual spend and campaign success data is retrieved and made available for analysis in SAP Marketing.

For more information, see [Social Campaigns Using Facebook and Instagram](#).

Setting up External Campaign Integration

You can create campaigns on generic external systems, which are implementing the interfaces for external campaigns. Alternatively, you can use a middleware such as SAP Cloud Platform Integration service to map the SAP Marketing interfaces to the interfaces of the external system (such as Twitter).

For more information, see [Setting Up External Campaign Execution](#).

Creating and Executing WeChat Campaigns

You can integrate WeChat with your system to create and carry out WeChat campaigns.

For more information, see [WeChat Integration](#).

Setting up Landing Pages

You are provided with the [Landing Pages](#) application. This app allows you to design landing pages to collect interaction contact and marketing permission data. The content of the app is also included in the [Content Studio](#) application.

For more information, see [Custom Integration](#).

Setting up the Integration of Digital Asset Management Systems

Digital asset management (DAM) systems provide catalogs of digital images, videos, documents, music etc. Digital assets can be searched easily by keywords. With the integration of DAM systems you can directly access images for use in static image links in an email. SAP delivers standard settings for the following DAM systems:

- SAP Product Content Management
- SAP Digital Asset Management by OpenText

For more information, see [Integration with Digital Asset Management Systems](#).

14.3.1 Setting up Integration with AdWords Campaigns (Optional)

The integration of SAP Marketing with Google AdWords provides you with the following options:

- You can create marketing campaigns that correspond to a campaign in Google AdWords using the [Google AdWords Campaign](#) pushbutton in the [Select Campaign Type](#) dialog. This dialog opens once you clicked the [Create](#) pushbutton on the [Campaign](#) overview screen in the [Campaigns](#) app.
- From the [Campaign](#) overview screen, you can open an AdWords campaign by selecting it in the overview list, and display key performance indicators (KPIs) either retrieved from Google AdWords or manually uploaded.
- When you open a target group in the [Target Groups](#) app, on the [Campaigns](#) tab of the target group details screen, you can open an AdWords campaign by selecting it from the list.
- From the [Marketing Calendar](#) app (in the [Campaign Management](#) or the [Spend Management](#) business groups), you can open an AdWords campaign by selecting it in the campaign calendar view.

- From the *Import Data* app (in the *Import Data* business group), you can upload campaign KPIs using the *Campaign Success* option.

Before you start with the configuration for the Google AdWords integration, carry out the following steps in Customizing for SAP Marketing (transaction SPRO):

- Under **►► General Settings ► Define Media Types** :

Media Type	Media Type Description	SAPUI5 Icon Name
PAID_SEARCH	Paid Search	search

Upload an image for the entry above to be shown on the *Campaign Listing* and the *Campaign Overview* screens using the *Manage Images* app.

- Under **►► Contacts and Profiles ► Interactions ► Define Communication Media** :

Communication Medium	Communication Medium Description	Media Type ID
GOOGLE_ADS	Google Ads	PAID_SEARCH

- Under **►► Campaigns ► Campaign ► Define Categories and Actions**  in the *Define Campaign Categories* view:

Category ID	Category Name	Category Tooltip	Is Active	Perm. Hldng	Process Type
PGS	AdWords Campaigns	AdWords campaigns for advertising on Google advertising networks (Search and Display)	Yes	Check Marketing Permission	AdWords

- Under **►► Campaigns ► Campaign ► Define Categories and Actions**  in the *Define Campaign Actions* view:

Action ID	Action Name	Class/Interface
PS_CUSTOM_AUDIENCE	Create AdWords Custom Audience	CL_CUAN_MO_TG_TRANSFER_PS

- Keep the PGS category ID selected in the *Define Campaign Categories* view. Under **►► Campaigns ► Campaign ► Define Categories and Actions**  in the *Assign Actions to Categories* view for the PGS category ID:

Action ID	Action Name
PS_CUSTOM_AUDIENCE	Create AdWords Custom Audience

To access the *Campaign Management* business group and the *Paid Search* application, the user must be assigned a copy of the following roles:

- SAP_CEI_CPM_FLP (business catalog role; no copy required - you can assign the delivered standard role)
- SAP_CEI_TG_INI (back-end role; included in composite role SAP_MARKETING_DATA_MANAGEMENT)
- SAP_CEI_HOME (for personalization purposes)

For more information, see the document [Integrating SAP Marketing 1809 with Google AdWords via SAP Cloud Platform Integration](#).

Uploading Data for AdWords Campaign KPIs

KPIs for Google AdWords campaigns are retrieved automatically from Google via the scheduled background job SAP_CUAN_PAID_SEARCH_KPI . This job is scheduled to run on a regular basis to always have the most up to date KPIs for your Google AdWords campaigns.

You can also manually upload campaign success KPIs. You upload campaign success data from a comma-separated value (CSV) file using the *Import Data* application in the *Import Data* business group.

For more information, see the expandable subsection *Campaign Success* in section *Object Types You Can Upload* in chapter *Import Data (CSV)* of the application help for SAP Marketing on SAP Help Portal at:

<https://help.sap.com/mkt-op> ► *Application Help* ► *SAP Marketing* ► *SAP Marketing Applications* ► *Import Data* ► *Import Data (CSV)* ►

To access the *Import Data* application, the user must be assigned a copy of the following role:

- SAP_MARKETING_BUS_ADMIN_USER

To upload AdWords campaign KPIs, the user must have the following authorization object assignments:

Authorization Object	Object Name (HPA_OBJ)	Activity (ACTVT)
HPA_OBJECT	CUAN_INITIATIVE	02 (Change)

Authorization Object	Object Name (HPA_OBJ)	Action Name (HPA_ACTION)	Activity (ACTVT)
HPA_ACTION	CUAN_INITIATIVE	UPDATE_EXTERNAL_REPORT ING_DATA	16 (Execute)

For more information, see the [Security Guide](#) for SAP Marketing on the SAP Help Portal at:

<https://help.sap.com/mkt-op> ► *Security* ►

14.3.2 Setting up Integration with SAP CRM (Optional)

Enhanced integration of SAP Marketing with SAP CRM offers the following options:

- In the *Campaigns* app in business group *Campaign Management*, you can use an action to create leads, opportunities, tasks, activities, or call lists in *SAP CRM*.
- For a campaign, you can display success measures that are based on the leads, opportunities, tasks, activities, or call lists created in *SAP CRM*.
- In the *Marketing Executive Dashboard*, the leads created in *SAP CRM* are displayed as key figures.

For more information, see document [Integrating SAP Marketing with SAP CRM](#).

14.3.3 Setting Up Call Center Integration (Optional)

SAP Marketing provides you with the option to integrate call centers in your campaign execution.

You have the following integration options:

- Integration with SAP Cloud for Customer (see [Setting Up Call Center Integration with SAP Cloud for Customer \[page 154\]](#))
- Integration with *SAP CRM Interaction Center* (see [Setting Up the SAP CRM Interaction Center Integration \[page 155\]](#))

14.3.3.1 Setting Up Call Center Integration with SAP Cloud for Customer

i Note

- As a prerequisite for the call center integration with SAP Cloud for Customer, you must have carried out the steps related to C4C integration described in section [Scenario "Lead Management with Cloud for Customer Integration" \[page 57\]](#).
- If SAP Marketing is integrated with SAP CRM or SAP ERP, these systems must also be connected to the SAP Cloud for Customer systems. This ensures that the replication of customers and business transactions, such as leads or opportunities is consistent.

You are provided with the option to trigger SAP Cloud for Customer call qualifications to the SAP Cloud for Customer system directly from a campaign in your SAP Marketing system. A standard action for campaigns is available to do so. These call qualifications are handled as marketing leads in SAP Cloud for Customer.

Assigning Standard Action to Campaign Category

To activate this function, you must assign the standard action `CALL_QUALIFICATION` ([Trigger C4C Call Qualification](#)) to a campaign category in Customizing for SAP Marketing (transaction `SPRO`) under

► [Campaigns](#) ► [Campaign](#) ► [Define Campaign Categories and Actions](#) ►. This is already assigned to the campaign category *CIC - Call Center* in the standard SAP system or you assign the action `CALL_QUALIFICATION` to the required category as follows:

1. Select the required category to which you want to assign the action `CALL_QUALIFICATION` in the [Define Campaign Categories](#) view.
2. Choose the [Assign Actions to Categories](#) view.
3. Choose [New Entries](#).
4. Choose the action `CALL_QUALIFICATION` from the value help for the [Action ID](#) field and confirm your entry
5. Enter any required text in the [Action Button Tooltip](#) and [Button Tooltip](#) fields if you want to override the action button text and button tooltip that is specified directly in the action. This override is valid in the context of this category/action relationship only.

As a result, the new action is available for new campaigns with this category.

Check Permission to Contact in SAP Marketing

According to the Customizing settings you have made, when the action to create the call list is executed in SAP Marketing, the system checks whether permission to make contact by telephone is available. Check this setting in Customizing for SAP Marketing under ► [Campaigns](#) ► [Campaign](#) ► [Define Campaign Categories and Actions](#) ►. Choose [Define Campaign Categories](#) followed by the category `CIC`. If the value [Ignore Marketing Permission](#) has not been selected for the [Category Type](#), the system checks whether permission to make contact is available when the action to create the leads (`CALL_QUALIFICATION`) is executed.

14.3.3.2 Setting Up the SAP CRM Interaction Center Integration

Use

To set up the integration, perform the configuration settings that are described in section [Setting up Integration with SAP CRM \(Optional\)](#) [page 154].

Customizing

The most important Customizing settings are delivered with the standard system Customizing for SAP Marketing and SAP CRM.

Using Your Own Transaction Type in SAP CRM

If you do not want to use the default transaction type in SAP CRM, which is found in the standard system (`PCHC`), in Customizing for SAP Marketing under ► [General Settings](#) ► [Integration](#) ► [Specify the SAP CRM](#)

[Business Transaction Type](#) you must assign your own transaction type to the transaction category BUS126_CL.

Set up the Inbox Search for the New Main Category for the Agent in SAP CRM

Set up the inbox search for the new main category for the agent as follows:

1. In Customizing for *Customer Relationship Management* under [Interaction Center WebClient](#) [Agent Inbox](#) [Inbox Search Definitions](#) [Define Item Types for Searches](#), create a new entry with the item type *Inbox One Order Item* and the transaction type PCHC as the main category or use your own transaction type.
2. Determine the profile value for the role IC_AGENT and the function profile IC_INBOX in Customizing for *Customer Relationship Management* under [UI Framework](#) [Business Roles](#). An example of a possible value is DEFAULT - 1.
3. Assign the transaction type PCHC or your own transaction type to the inbox profile determined previously (such as DEFAULT - 1) in Customizing for *Customer Relationship Management* under [Interaction Center WebClient](#) [Agent-Inbox](#) [Define Inbox Profiles](#). You do this in the dialog structure *Assign Main Categories*.

Displaying Information from SAP Marketing in SAP CRM

The Transaction Launcher is used to make information from SAP Marketing available to the agent in SAP CRM. Navigation can take place directly to the SAP Marketing system or by using the SAP Web Dispatcher. For more information about setting up the SAP Web Dispatcher to do this, see SAP Note [2140478](#).

The following data is provided:

- Customer and contact information
To ensure that the Interaction Center agent can view information from SAP Marketing about the customer and the contact in the WebClient UI using the navigation bar in SAP CRM before making a planned call, note the following:
 - Customer and contact data was replicated from SAP Marketing to SAP CRM.
 - Set up provision of information in the SAP CRM navigation bar. For more information about the provision of information for the role IC_AGENT, see SAP Note [2135184](#). For more information about the provision of information for roles other than the role IC_AGENT, see SAP Note [2146974](#).
 - If you are using SAP CRM EHP3, you must import SPO9 as a minimum.
- Information about the campaign from SAP Marketing
The Interaction Center agent (user role IC_AGENT) can use a link in the header data for the planned call activity to view the referenced campaign from SAP Marketing.
Note that you must import SPO9 as a minimum if you are using SAP CRM EHP3.
For more information about the provision of this information for the other user roles, see SAP Note [2146978](#).

Provision of Product Recommendations in SAP CRM

If in SAP CRM, you want to display alerts with product recommendations that are based on recommendation scenarios from SAP Marketing, note the following:

- Since no preconfigured alerts are supplied, define these in the role for the Interaction Center manager in the Alert Editor and assign them using rule policies. A new rule policy must be available, which is used to call automatic actions as soon as a defined condition is met. For more information about creating the rule policy for the product recommendation, see SAP Note [2140606](#).

- Data replication for products from SAP Marketing to SAP CRM has been configured. Note that the system only displays products that also exist in SAP CRM.
- If you are using SAP CRM EHP3, you must import SPO9 as a minimum.

Check Permission to Contact in SAP Marketing

According to your Customizing settings, when the action to create the call list is executed in SAP Marketing, the system checks whether permission to make contact by telephone is available. Check this setting in Customizing for SAP Marketing under [▶ Campaigns > Campaign > Define Campaign Categories and Actions](#). Choose [Define Campaign Categories](#) followed by the category `CIC`. If the value [Ignore Marketing Permission](#) has not been selected for the [Category Type](#), the system checks whether permission to make contact is available when the action to create the call list (`CRM_CALL_LIST`) is executed.

View Planned Call to a Contact in SAP Marketing

You can see whether a planned call exists in SAP CRM in the factsheet for the contact in SAP Marketing for every business partner in a target group.

If you want to display outbound calls on a different tile, configure this in Customizing for SAP Marketing under [▶ Contacts and Profiles > Interactions > Assign Interaction Types and Communication Media to Channels](#).

View Success of Campaign in SAP Marketing

If you want to measure the success of the campaign, create a new interaction profile in Customizing for SAP Marketing under [▶ Campaigns > Campaign > Define Interaction Profiles](#).

Now assign the interaction profile to the campaign. You do this in Customizing for SAP Marketing under [▶ Campaigns > Campaign > Define Campaign Categories and Actions](#) in the dialog structure [Define Campaign Categories](#) in the field [Interaction Profile](#).

14.4 Configuring the Marketing Calendar

If you have not already carried out this step as a part of [Configuring Planning](#), configure the marketing calendar as described in [Setting up "Marketing Calendar" \[page 106\]](#).

14.5 Configuring the Journey Tab in Campaigns

Marketing experts can analyze the customer journeys for a campaign to gain valuable insights into which interactions either lead customers to or deter customers from a purchase, for example, or any other key event you choose to analyze.

To enable the [Journey](#) tab on the [Campaign](#) factsheet, you must set up events in the [Customer Journey Events](#) application within the [Business Administration](#) business group (see [Setting up Customer Journey Events \[page 76\]](#)).

15 Configuring Manager-Related Tasks

The following functions and apps are available to managers:

- Workflow for the marketing approval process with the the apps *Marketing Approvals* and *Manage Workflows*

15.1 Configuring Workflow

The following manager-related applications improve the approval process for marketing campaigns by a workflow-based approach:

- *Marketing Approvals*
- *Manage Workflows*

Both applications are located in the *Marketing Manager - Quick Launch* business group.

Marketing Approvals

To set up the *Marketing Approvals* application, you need to carry out the following steps:

Enable Workflow

To ensure the workflow is enabled, go to transaction `SWU3` in your SAP Marketing system and execute the automatic workflow Customizing. To do so, follow the instructions in section [Automatic Workflow Customizing](#) of the ABAP platform documentation on the SAP Help Portal at:

<https://help.sap.com/mkt-op> ► *Foundation on ABAP Platform 1809, version for SAP HANA* ► *ABAP Platform* ► *Application Server ABAP - Infrastructure* ► *Other Services* ► *Services for Application Developers* ► *SAP Business Workflow* ► *SAP Business Workflow: Reference Documentation* ► *Workflow System Administration* ►

Activate Workflows in Customizing

In Customizing for SAP Marketing under ► *General Settings* ► *Activate Workflow for Business Objects* ►, choose the business object for which you want to activate workflows, and select the *Active* checkbox.

Assign Users to Roles

To enable marketing managers to use the *Marketing Approvals* application, you need to assign your copies of the following PFCG roles to the corresponding AS ABAP users:

- `SAP_CEI_PLG_FLP` (business catalog role, no copy is required, you can assign the delivered standard role)
- `SAP_CEI_MKT_APPROVAL` (back-end role; included in composite role `SAP_MARKETING_MANAGER`)
- `SAP_CEI_HOME` (for personalization purposes)

In addition, you must assign a copy of the back-end role `SAP_CEI_MKT_BATCH_APPROVAL` to the workflow batch user `WF-BATCH` to execute the user decision in the *Marketing Approvals* app.

Deactivate Task Filter

To be able to see approval requests in the *Marketing Approvals* app, in the *Enable Task Filter* activity in Customizing for *SAP NetWeaver* under [SAP Gateway Service Enablement > Content > Workflow Settings](#), the task filter must always be deactivated.

Email Configuration

SAPconnect is required for sending notifications for workflow. For more information about configuring SAPconnect, see sections [SAPconnect \(BC-SRV-COM\)](#) and [Quick Guide to SMTP Configuration](#) of the ABAP platform documentation on the SAP Help Portal at:

<https://help.sap.com/mkt-op> [▶ Foundation on ABAP Platform 1809, version for SAP HANA](#) [▶ ABAP Platform](#) [▶ Application Server ABAP - Infrastructure](#) [▶ Other Services](#) [▶ Services for Business Users](#) [▶ SAPconnect \(BC-SRV-COM\)](#)

Notification Configuration

Notification channel configuration is required for receiving notifications in the SAP Fiori launchpad. For more information, see section [Notification Channel Configuration](#) of the ABAP platform documentation on the SAP Help Portal at

<https://help.sap.com/mkt-op> [▶ Foundation on ABAP Platform 1809, version for SAP HANA](#) [▶ ABAP Platform](#) [▶ Developing on the ABAP Platform](#) [▶ Development Concepts and Tools](#) [▶ SAP Gateway Foundation \(SAP_GWFND\)](#) [▶ Notification Channel](#)

Language Handling

To display marketing approval requests in a language other than English, you must carry out the corresponding Customizing settings described in SAP Note [2732277](#).

Manage Workflows

To enable marketing managers to use *Manage Workflows*, assign your copies of the following PFCG roles to the corresponding AS ABAP users.

- `SAP_CEI_PLG_FLP` (business catalog role; no copy required - you can assign the delivered standard role)
- `SAP_CEI_WORKFLOW_EDITOR` (back-end role; included in composite role `SAP_MARKETING_MANAGER`)
- `SAP_CEI_HOME` (for personalization purposes)

16 Configuring WeChat Integration

The WeChat integration of SAP Marketing contains the following functions:

- Synchronization of WeChat followers and interactions to SAP Marketing
- Segmentation of WeChat followers
- Creation and execution of WeChat campaigns through SAP Marketing
- Analytical report about the acquisition of WeChat followers
- Analytical report about WeChat interactions
- Analytical report for WeChat campaigns carried out through Shake Nearby

For detailed information, see section [WeChat Integration](#) in the Integration Guide for SAP Marketing on the SAP Help Portal at:

<https://help.sap.com/mkt-op> ► *Integration* ►

17 Configuring LINE Integration

With the integration of the instant communications service LINE, you can synchronize followers of your LINE accounts as well as follower interactions to SAP Marketing. In addition, you can create and carry out LINE campaigns through SAP Marketing. Analytical reports about LINE followers and interactions are available as well.

i Note

The LINE integration supports LINE@ accounts only.

For detailed information about the LINE integration, see section [LINE Integration](#) in the Integration Guide for SAP Marketing on the SAP Help Portal at:

<https://help.sap.com/mkt-op> ► *Integration* ►

18 Frequently Asked Questions

- **Can I install SAP Marketing on any database and access SAP HANA using a secondary database connection?**

SAP Marketing runs on an SAP NetWeaver AS ABAP system with SAP HANA database as primary and only database. During the installation of under SAP Marketing SAP HANA content is unpacked to the SAP HANA database. This content is used for accessing SAP ERP, SAP CRM as well as SAP Marketing data.

- **How is the SAP ERP and SAP CRM data accessed?**

SAP ERP and SAP CRM data is stored in separate database schemas in the SAP HANA database. SAP Marketing delivers SAP HANA information models that join together data from these separate database schemas. The application accesses the data through these SAP HANA models. As the database schema name is unique in your system, a schema mapping from SAP's authoring schema to your schema name is defined during the technical configuration of SAP Marketing.

For more information about SAP HANA schema mapping, see the [SAP HANA Modeling Guide](#) (SAP HANA Studio) on the SAP Help Portal at:

http://help.sap.com/hana_platform ► [Development](#) ► [View All](#) ►

- **What is the name of the database schema of my SAP ERP and SAP CRM data?**

If you replicate data (see [Scenario B: Hub-Deployment with Separate SAP HANA System \[page 15\]](#)) through SAP LT replication server the name of the SAP HANA database schema is your SAP LT configuration name. If you run deployment scenario C, [Hub-Deployment with Shared SAP HANA System of SAP Business Suite](#), your database schema name is SAP<SID> while <SID> is the system ID of your SAP ERP or SAP CRM system.

- **Do I have to set up HTTPS?**

You have to set up HTTPS as SAP Marketing does not allow HTTP calls.

- **Do I have to set up a Web Dispatcher?**

You have to set up a Web Dispatcher as SAP Marketing integrates ABAP and SAP HANA

- **Do I need to set up a BW Client? Do I have to set up the BW Client for all solutions? Can I use a BW client in another system?**

You have to set up a BW client in your SAP Marketing system regardless of the SAP Marketing solution you have licensed. The application uses the operational data provisioning (ODP) to directly access SAP HANA information models. For ODP, you only need to perform minimal configuration of the BW in your application system. You do not need to set up a Data Warehouse. Replication of the data to a BW system is not necessary.

19 SAP Notes for Installation and Upgrade

If there is additional information to the installation process as described in this guide, you find the new information in the following SAP Note or SAP Notes.

Make sure that you have the current version of each SAP Note, which you can find on the SAP Service Marketplace at <http://support.sap.com/notes>.

SAP Note Number	Title	Description
Release Information Note 1885803	RIN SAP Marketing	Contains information and references in the context of applying SAP Marketing
Note 2076331	Follow Up Tasks after System Copy	Contains information about the actions to be carried out after system copy
Note 2072589	Installing and Configuring SAP Fiori Apps for SAP CEI on a central Fiori Frontend Server	Contains information about the installation and configuration of SAP Fiori apps for SAP Marketing on a central SAP Fiori front-end server

Final Implementation of SAP Notes

The Release Information Note (RIN) is the central note containing general installation/upgrade information on SAP Marketing.

Make sure that you have implemented all notes that are listed in the RIN. For more information about the sequence of the note implementation, see [SAP Notes for Installation \[page 9\]](#).

20 Appendix

20.1 Technical Configuration - Expert Mode

If you are not able to use the technical configuration cockpit ([Using the Technical Configuration Cockpit \[page 46\]](#)), you can use the *Technical Configuration Expert Mode* to carry out the steps in the back end.

To use the expert mode, call up transaction STC01 and execute task list CUAN_BASE_CONFIG (which corresponds to the *Essentials* scenario in the technical configuration wizard). To call the parameter screen, select the last task in the list and then click on the *Change Parameters* icon (column *Parameter*).

Afterwards, execute the following task lists if required:

- CUAN_SETUP_ERPCONTENT corresponding to the *ERP Integration* scenario in the technical configuration wizard
- CUAN_SETUP_CRMCONTENT corresponding to the *CRM Integration* scenario in the technical configuration wizard
- CUAN_SETUP_HRF corresponding to the *HANA Rules Framework* scenario in the technical configuration wizard
- CUAN_SETUP_CMO_DASHBOARD corresponding to the *Marketing Executive Dashboard* scenario in the technical configuration wizard
- CUAN_SETUP_CA corresponding to the *Campaign Management* scenario in the technical configuration wizard

For more information about the parameters to be provided within the different task lists, see the descriptions for every scenario in section [Section "Scenarios" \[page 48\]](#).

20.2 Replicated Tables in SAP Marketing

If you replicate data from SAP ERP and/or SAP CRM into SAP Marketing, the following tables are replicated via SAP Landscape Transformation Replication Server:

SAP ERP Tables

(A - M)	(N - TCURV)	(TCURX - TVKO)	(TVKOT - W)
ADCP	NDBSMATG16	TCURX	TVKOT
ADR2	PA0105	TKA01	TVLS
ADR3	PRPS	TKEB	TVLST
ADR6	T000	TKEBB	TVM1
ADRC	T001	TKEBC	TVM1T
ADRP	T001W	TKEBT	TVM2
ADRU	T005	TKEF	TVM2T
BKPF	T005N	TKEFE	TVM3
BSEG	T005S	TKUKL	TVM3T
BUT000	T005T	TKUKT	TVM4
BUT021_FS	T005U	TPFK	TVM4T
BUT050	T006	TPFKT	TVM5
BUT051	T006A	TPTMT	TVM5T
BUT100	T009	TSAB	TVMS
COBK	T016	TSABT	TVTW
COEP	T016T	TSAD12	TVTWT
COOI	T023	TSAD12T	TVV1
CRMKUNNR	T023T	TSAD2	TVV1T
CRMPARNR	T077D	TSAD2T	TVV2
CVI_CUST_LINK	T077X	TSAD3	TVV2T
DD02L	T134M	TSAD3T	TVV3
DD02T	T151	TSAD4	TVV3T
DD04T	T151T	TSADV	TVV4
DD07L	T171	TSADVT	TVV4T
DD07T	T171T	TSPA	TVV5
FPLA	T179	TSPAT	TVV5T
HRP1001	T179T	TTZZ	VAKGU

(A - M)	(N - TCURV)	(TCURX - TVKO)	(TVKOT - W)
HRP1222	T685	TTZZT	VBAK
HRT1222	T685T	TVAG	VBAP
KNA1	TB003	TVAGT	VBEP
KNB1	TB910	TVAK	VBFA
KNVK	TB911	TVAKT	VBKA
KNVP	TB912	TVBUR	VBKD
KNVV	TB913	TVBVK	VBKPA
KONV	TBRC	TVFKT	VBRK
LIKP	TBRCT	TVFS	VBRP
LIPS	TCURC	TVFST	VBUK
MAKT	TCURF	TVGRT	VBUP
MARA	TCURN	TVKBT	VEDA
MARC	TCURR	TVKBZ	WRF_BRANDS
MARD	TCURT	TVKGR	
MBEW	TCURV	TVKO	

SAP CRM Tables

(A - CRMC_CANCREASON)	(CRMC_CANCREASONT - CRMC_PH)	(CRMC_PR - CRMM)	(D - T)
ADCP	CRMC_CANCREASONT	CRMC_PROC_TYPE	DD02L
ADR2	CRMC_CHM_PROG_T	CRMC_PROC_TYPE_T	DD02T
ADR3	CRMC_CHM_STATU_T	CRMC_SOURCE	DD07L
ADR6	CRMC_CHM_TYPE_T	CRMC_SOURCE_T	DD07T
ADRC	CRMC_CON_PHASE_T	CRMD_BRELVONAE	HRP1000
ADRP	CRMC_CUSTGRP1	CRMD_CHM_CLASS	HRP1001
AUSP	CRMC_CUSTGRP2	CRMD_DHR_ACTIV	HRP1222
BUT000	CRMC_CUSTGRP3	CRMD_DHR_HEADOPP	HRT1222
BUT020	CRMC_CUSTGRP4	CRMD_DHR_HSLSCON	QPCT
BUT021_FS	CRMC_CUSTGRP5	CRMD_DHR_HSLSORD	QPGT
BUT050	CRMC_CYCLE_T	CRMD_DHR_HSLSQUO	SCPRI0
BUT051	CRMC_DISTCHAN	CRMD_DHR_ISLSCON	SCPRI0T
BUT052	CRMC_DISTCHAN_T	CRMD_DHR_ISLSORD	T000
BUT100	CRMC_DIVISION	CRMD_DHR_ISLSQUO	T001
CABN	CRMC_DIVISION_T	CRMD_DHR_ITEMOPP	T002
CABNT	CRMC_ERMS_CAT_CA	CRMD_DHR_LEAD	T002T
CAWN	CRMC_ERMS_CAT_CD	CRMD_IM_ML_HEAD	T005
CAWNT	CRMC_INDUSTRY	CRMD_IM_ML_ITEM	T005T
CGPL_HIERARCHY	CRMC_INDUSTRY_T	CRMD_MKTCA_CT_IN	T005U
CGPL_PRI0	CRMC_LEAD_QL	CRMD_MKTHV_MC	T006
CGPL_PRI0TX	CRMC_LEAD_QL_T	CRMD_MKTHV_MC_TC	T006A
CGPL_PROJECT	CRMC_LEAD_TYPE	CRMD_MKTPL_TGGRP	T009
CGPL_TASK	CRMC_LEAD_TYPE_T	CRMD_MKTPL_TODO	TB002
CGPL_TEXT	CRMC_MKP_CHAN	CRMD_MKTTG_TG_EA	TB003
COMC_PR_TYPE_T	CRMC_MKTPL_AUTHG	CRMD_MKTTG_TG_H	TB003T
COMM_CATEGORY	CRMC_MKTPL_AUTHT	CRMD_MKTTG_TG_I	TB004
COMM_CATEGORYT	CRMC_MKTPL_CHAN	CRMD_MKTTG_TG_I0	TB004T
COMM_HIERARCHY	CRMC_MKTPL_CHANT	CRMD_MKTTG_TG_I1	TB024
COMM_HIERARCHYT	CRMC_MKTPL_CTYPE	CRMD_MKTTG_TG_I2	TB027T
COMM_IL_PRDBP	CRMC_MKTPL_CTYPT	CRMD_MKTTG_TG_I3	TB028T
COMM_PR_FRG_ROD	CRMC_MKTPL_OBJTT	CRMD_MKTTG_TG_I4	TB038A



(A - CRMC_CANCREASON)	(CRMC_CANCREASONT - CRMC_PH)	(CRMC_PR - CRMM)	(D - T)
COMM_PRODUCT	CRMC_MKTPL_OBJTV	CRMD_MKTTG_TG_I5	TB910
COMM_PRRDCATR	CRMC_MKTPL_TACTS	CRMD_ORDER_INDEX	TB911
COMM_PRSHTEXT	CRMC_MKTPL_TACTT	CRMD_ORDERADM_H	TB912
CRM_JEST	CRMC_MKTPL_TDCAT	CRMD_ORDERADM_I	TB913
CRM_MKTPL_ATTR	CRMC_MKTPL_TODO	CRMD_PRICING_I	TCURC
CRM_MKTPL_OBJTXT	CRMC_MKTPL_TODOT	CRMM_BUT_CONTNO	TCURF
CRM_MKTPL_OBJTYP	CRMC_MKTTG_OT_H	CRMM_BUT_CUSTNO	TCURN
CRM_STACOM_ATTR	CRMC_OPPIMPOR	CRMM_BUT_FRG0041	TCURR
CRM_STACOM_TEXT	CRMC_OPPIMPOR_T	CRMM_BUT_FRG0080	TCURT
CRMC_ACT_CAT_ASS	CRMC_OPPT_TYPE	CRMM_BUT_FRG0100	TCURV
CRMC_ACT_CAT_T	CRMC_OPPT_TYPE_T	CRMM_BUT_LNK0011	TCURX
CRMC_ACT_CATEGOR	CRMC_PARTNER_FCT	CRMM_BUT_MKTPERM	TJ02T
CRMC_BUPA_CBBL	CRMC_PARTNER_FT	CRMM_BUT_SET0010	TJ30
CRMC_BUPA_CDBL	CRMC_PARTY	CRMM_TERRITORY	TJ30T
CRMC_BUPA_COBL	CRMC_PARTY_T	CRMM_TERRITORY_T	TSAD3
CRMC_CANCREASON	CRMC_PHASE_T	CRMM_TERRITORY_V	TSAD3T

Important Disclaimers and Legal Information

Hyperlinks

Some links are classified by an icon and/or a mouseover text. These links provide additional information.

About the icons:

- Links with the icon : You are entering a Web site that is not hosted by SAP. By using such links, you agree (unless expressly stated otherwise in your agreements with SAP) to this:
 - The content of the linked-to site is not SAP documentation. You may not infer any product claims against SAP based on this information.
 - SAP does not agree or disagree with the content on the linked-to site, nor does SAP warrant the availability and correctness. SAP shall not be liable for any damages caused by the use of such content unless damages have been caused by SAP's gross negligence or willful misconduct.
- Links with the icon : You are leaving the documentation for that particular SAP product or service and are entering a SAP-hosted Web site. By using such links, you agree that (unless expressly stated otherwise in your agreements with SAP) you may not infer any product claims against SAP based on this information.

Beta and Other Experimental Features

Experimental features are not part of the officially delivered scope that SAP guarantees for future releases. This means that experimental features may be changed by SAP at any time for any reason without notice. Experimental features are not for productive use. You may not demonstrate, test, examine, evaluate or otherwise use the experimental features in a live operating environment or with data that has not been sufficiently backed up.

The purpose of experimental features is to get feedback early on, allowing customers and partners to influence the future product accordingly. By providing your feedback (e.g. in the SAP Community), you accept that intellectual property rights of the contributions or derivative works shall remain the exclusive property of SAP.

Example Code

Any software coding and/or code snippets are examples. They are not for productive use. The example code is only intended to better explain and visualize the syntax and phrasing rules. SAP does not warrant the correctness and completeness of the example code. SAP shall not be liable for errors or damages caused by the use of example code unless damages have been caused by SAP's gross negligence or willful misconduct.

Gender-Related Language

We try not to use gender-specific word forms and formulations. As appropriate for context and readability, SAP may use masculine word forms to refer to all genders.

© 2019 SAP SE or an SAP affiliate company. All rights reserved.

No part of this publication may be reproduced or transmitted in any form or for any purpose without the express permission of SAP SE or an SAP affiliate company. The information contained herein may be changed without prior notice.

Some software products marketed by SAP SE and its distributors contain proprietary software components of other software vendors. National product specifications may vary.

These materials are provided by SAP SE or an SAP affiliate company for informational purposes only, without representation or warranty of any kind, and SAP or its affiliated companies shall not be liable for errors or omissions with respect to the materials. The only warranties for SAP or SAP affiliate company products and services are those that are set forth in the express warranty statements accompanying such products and services, if any. Nothing herein should be construed as constituting an additional warranty.

SAP and other SAP products and services mentioned herein as well as their respective logos are trademarks or registered trademarks of SAP SE (or an SAP affiliate company) in Germany and other countries. All other product and service names mentioned are the trademarks of their respective companies.

Please see <https://www.sap.com/about/legal/trademark.html> for additional trademark information and notices.