

## Installation Guide

CUSTOMER

SAP Hybris Marketing  
Document Version: 1.01 – 2016-12-02

# Installation and Configuration Guide 1611

# Content

<b>1</b>	<b>Introduction.</b>	<b>7</b>
1.1	About this Document.	7
1.2	Feedback.	7
1.3	Licenses of SAP Hybris Marketing.	7
1.4	Integration.	8
1.5	SAP Notes for Installation.	9
<b>2</b>	<b>Technical System Landscape.</b>	<b>11</b>
<b>3</b>	<b>Deployment Scenarios.</b>	<b>14</b>
3.1	Scenario A: Standalone Deployment.	15
3.2	Scenario B: Hub-Deployment with Separate SAP HANA System.	15
3.3	Scenario C: Hub-Deployment with Shared SAP HANA System of SAP Business Suite.	17
3.4	Scenario D: Hub-Deployment with Shared SAP HANA System of Other Application.	20
<b>4</b>	<b>Development and Production Systems.</b>	<b>22</b>
<b>5</b>	<b>Installation.</b>	<b>23</b>
5.1	Installation of the SAP HANA Platform.	24
	Correct Sizing of the SAP HANA Database.	24
	Installing the SAP HANA Database.	24
	Updating to Higher Revisions of the SAP HANA Database.	24
	Installing the SAP HANA Application Function Library (AFL).	25
5.2	Installation of Application Server ABAP (AS ABAP).	25
	Standard Installation of SAP NetWeaver 7.5.	25
5.3	Installing SAP Hybris Marketing as an Add-On.	26
	Running the Maintenance Optimizer.	26
	Running the Software Update Manager.	27
5.4	Installing the SAP Web Dispatcher.	27
5.5	Installing SAPUI5 Tools and ABAP Development Tools.	28
5.6	Installing SAP Smart Business, executive edition.	28
5.7	Implementation of SAP Notes Listed in Release Information Note.	29
<b>6</b>	<b>Data Replication.</b>	<b>31</b>
6.1	Installation of SAP Landscape Transformation Replication Server.	31
	Connection Setup between SAP Hybris Marketing and SAP LT Replication Server.	31
	Connection Setup between SAP Hybris Marketing and SAP Source System.	32
	Basic Configuration of Data Replication.	33

<b>7</b>	<b>Post-Installation</b>	<b>34</b>
7.1	Application Configuration and Customizing	35
	Initial Customizing Adjustment	35
	Customizing via SAP Solution Manager	36
7.2	Configuring the SAP HANA Database	36
	Configuring SSL for SAP HANA XS Engine	36
	SAP HANA User for Technical Configuration	37
	Authorization Settings for Deployment Scenario C: Hub-Deployment with Shared SAP HANA System of SAP Business Suite	39
7.3	Profile Parameter Settings	40
	Configuring HTTPS	40
	Configuring the Secure Sockets Layer Protocol	41
7.4	Displaying the SAP Online Documentation	41
7.5	Configuring the SAP Web Dispatcher	43
7.6	Prerequisites in AS ABAP System	47
	User for Application Setup	47
	Maintaining the Client	50
	Creating Development Packages	51
7.7	Using the Technical Configuration Cockpit	52
	Section "Overview"	53
	Section "Scenarios"	53
7.8	Applying Technical Configuration Artifacts to Production System	66
	Releasing Transport Requests in Development System	66
	Importing Transport Requests and Executing Technical Configuration in Production System	66
7.9	Initial Setup of SAP Fiori	67
7.10	Defining a Virus Scan Profile	68
7.11	Generating Authorization Profiles for the User Interface	68
7.12	Generating the URL for Displaying the User Interface	70
<b>8</b>	<b>General Configuration Settings in SAP Hybris Marketing</b>	<b>73</b>
8.1	Setting up Integration with SAP Jam	73
<b>9</b>	<b>Configuring Data Management</b>	<b>75</b>
9.1	Sentiment Engagement (Optional)	75
	Setting up Data Harvesting	75
	Setting up SMTP for Post Groups (Send Email to Me)	76
9.2	Scoring	77
	Scoring Including SAP Predictive Analytics	77
	Scoring Based on SAP HANA Rules Framework (HRF)	77
	Predictive Model Training Based on [nu]-Support Vector Machine (R)	78
9.3	Web Shop Personalization Based on Customer Segments	78

9.4	Customer Journey Insight. . . . .	78
	Setting up Customer Journey Insight. . . . .	79
	Setting up Customer Journey Events. . . . .	80
9.5	Configuring Commerce Integration. . . . .	80
	Generating Interactions from the Tracking of Unknown Web Site Visitors. . . . .	80
9.6	Setting up Applications for Data Import for Analytics. . . . .	81
9.7	Setting up Application "Business User". . . . .	81
9.8	Setting up Application "Digital Accounts". . . . .	82
9.9	Marketing Locations. . . . .	83
	Setting up Marketing Locations. . . . .	84
<b>10</b>	<b>Configuring Insight. . . . .</b>	<b>86</b>
10.1	Configuring SAP Smart Business, executive edition. . . . .	86
	User Configuration for SAP Smart Business, executive edition. . . . .	87
	Exchange of Certificates Between SAP HANA and AS ABAP. . . . .	89
	Setup for SAP Hybris Marketing Business Users. . . . .	89
	Creation of SAP Hybris Marketing Business Users. . . . .	90
	Optional: Modeling Instance Authorizations for Restricted User Access. . . . .	90
10.2	Creating SAP CRM Business Transactions. . . . .	93
10.3	Importing Data from External Source to "Margin Decomposition". . . . .	94
<b>11</b>	<b>Configuring Segmentation. . . . .</b>	<b>96</b>
11.1	Dialog Work Processes. . . . .	96
11.2	Geospatial Segmentation (Optional). . . . .	96
11.3	SAP Hybris Marketing Integration with SAP Consumer Insight 365. . . . .	97
11.4	Enabling China-Specific Segmentation Profile. . . . .	98
<b>12</b>	<b>Configuring Recommendation. . . . .</b>	<b>99</b>
12.1	Post-Installation Steps. . . . .	99
	Adapting Customer Channels for New Integration Scenarios. . . . .	99
	Configuring Offer Management. . . . .	99
12.2	Using Rule-Based Tasks. . . . .	103
<b>13</b>	<b>Configuring Planning. . . . .</b>	<b>105</b>
13.1	Setting up "Budget Plans". . . . .	105
13.2	Setting up "Programs". . . . .	109
13.3	Setting up Spend Management. . . . .	110
13.4	Setting up "Marketing Calendar". . . . .	113
13.5	Setting up Manager-Related Applications. . . . .	115
<b>14</b>	<b>Configuring Acquisition. . . . .</b>	<b>117</b>
14.1	General Settings. . . . .	117
	Setting up Integration with Facebook (Optional). . . . .	117

	Setting up Integration with Paid Search (Optional) . . . . .	119
	Setting up Integration with SAP CRM (Optional) . . . . .	122
	Setting Up Call Center Integration (Optional) . . . . .	122
	Setting up Integration with SAP Exchange Media (Optional) . . . . .	125
	Setting up External Campaign Integration (Optional) . . . . .	126
	Enabling WeChat-Specific Campaign Categories and Actions . . . . .	128
	Setting up Landing Pages . . . . .	129
14.2	Configuring Campaigns . . . . .	136
	Prerequisites . . . . .	136
	Setting Up Service Provider for Emails and Text Messages . . . . .	138
	Setting up the Integration of Digital Asset Management Systems . . . . .	144
14.3	Configuring the Marketing Calendar . . . . .	145
<b>15</b>	<b>Configuring Manager-Related Tasks . . . . .</b>	<b>146</b>
15.1	Setting up "Release Target Groups" . . . . .	146
<b>16</b>	<b>Configuring China Localization . . . . .</b>	<b>147</b>
<b>17</b>	<b>Integration with Extended Marketing Applications (YaaS Extensions) . . . . .</b>	<b>149</b>
17.1	Setting up YaaS Application "Customer Journey Manager" . . . . .	149
17.2	Setting up YaaS Application "Profile Graph" . . . . .	150
17.3	Setting Up YaaS Application "Loyalty" . . . . .	150
<b>18</b>	<b>SAP Hybris Marketing Integration with SAP Fraud Management . . . . .</b>	<b>152</b>
<b>19</b>	<b>Frequently Asked Questions . . . . .</b>	<b>153</b>
<b>20</b>	<b>SAP Notes for Installation and Upgrade . . . . .</b>	<b>154</b>
<b>21</b>	<b>Appendix . . . . .</b>	<b>155</b>
21.1	Technical Configuration - Expert Mode . . . . .	155
21.2	Replicated Tables in SAP Hybris Marketing . . . . .	156

---

# Document History

Before you start, make sure you have the latest version of this document. You can find the latest version at the following location:

<http://service.sap.com/mkt>

The following table provides an overview of the most important document changes. If the information you are looking for is not described in this guide or if you find something described incorrectly, please send an email to <mailto:saphybrismarketingfeedback@sap.com> and we'll update this guide.

Table 1: Document History

Version	Date	Description
1.0	2016-11-21	Initial version for SAP Hybris Marketing 1611 (1.2 SP04)
1.01	2016-12-02	Chapter adapted: <ul style="list-style-type: none"><li>• <a href="#">7.7, Using the Technical Configuration Cockpit</a></li></ul>

---

# 1 Introduction

This installation guide describes how to install the high-performance application SAP Hybris Marketing on premise. The application can also be operated in the SAP HANA Enterprise Cloud, under the name SAP S/4HANA Marketing Cloud with a separate license.

## 1.1 About this Document

This guide applies to consultants and system administrators who intend to install one or more of the components of SAP Hybris Marketing. It covers both the technical side (how installation is done) and the functional side (for example, customizing activities).

- **Constraints:**

This guide provides you with the main application-specific installation and configuration steps. The installation and configuration of the underlying SAP HANA platform and the required SAP NetWeaver ABAP AS system are not described in this installation guide in particular, but in separate documentation, referenced where necessary.

- **Considerations:**

- The sections and instructions in this guide are relevant for all above mentioned components unless otherwise expressly indicated.
- Access to the separate solutions is managed via the corresponding authorization roles. For more information about activating roles, see [Generating Authorization Profiles for the User Interface \[page 68\]](#).
- Before starting the installation make sure that you are aware of all required installation steps that have to be executed before the actual installation of the application. The prerequisites are mentioned in this document.

## 1.2 Feedback

We'd really like to know what you think of the quality, structure or content of this guide. Please send your feedback to us at <mailto:saphybrismarketingfeedback@sap.com>.

## 1.3 Licenses of SAP Hybris Marketing

SAP Hybris Marketing contains the following licenses that can be purchased separately:

- SAP Hybris Marketing Data Management (mandatory)

- SAP Hybris Marketing Insight
- SAP Hybris Marketing Segmentation
- SAP Hybris Marketing Recommendation
- SAP Hybris Marketing Planning
- SAP Hybris Marketing Acquisition

Any licensing of SAP Hybris Marketing includes the marketing platform SAP Hybris Marketing Data Management. In addition, the common objects such as Target Group, Campaign, Interaction, Export Definition, Predictive Model, or User Lists are always available regardless of the purchased license.

For a brief description of the SAP Hybris Marketing licenses and the corresponding applications, see the SAP Help Portal at:

<http://help.sap.com/mkt> ► *SAP Hybris Marketing Application Help* ► *SAP Hybris Marketing* ►

([http://help.sap.com/saphelp\\_mkt124/helpdata/en/38/4cec689d514199bff6b2837a5482c8/frameset.htm](http://help.sap.com/saphelp_mkt124/helpdata/en/38/4cec689d514199bff6b2837a5482c8/frameset.htm))

## 1.4 Integration

SAP Hybris Marketing is based on the SAP HANA appliance software, in particular the SAP HANA database, and SAP NetWeaver 7.5.

The SAP HANA database must be available and configured with the latest revision of the current support package before starting the actual installation of SAP Hybris Marketing. You can check the exact support package and required revision levels in the *Preconditions* section of Release Information Note [1885803](#).

For more information about how to receive the latest revision of the SAP HANA database, see the *SAP HANA Master Update Guide* at:

[http://help.sap.com/hana\\_appliance](http://help.sap.com/hana_appliance) ► *Installation and Upgrade Information* ► *SAP HANA Update Guides* ►

([http://help.sap.com/hana/SAP\\_HANA\\_Master\\_Update\\_Guide\\_en.pdf](http://help.sap.com/hana/SAP_HANA_Master_Update_Guide_en.pdf))

In addition, if you plan to use SAP ERP and/or SAP CRM as source system to operate your marketing, sales, and/or service business, the following releases are proposed for the different solutions:

Table 2:

SAP Hybris Marketing License	SAP ERP	SAP CRM
<b>SAP Hybris Marketing Insight</b>	6.0 or higher (mandatory)	7.01 (SP04 plus SAP Note <a href="#">1995798</a> ) or higher (optional)
<b>SAP Hybris Marketing Segmentation</b> on SAP ERP Accounts	6.0 or higher (mandatory)	7.01 (SP04 plus SAP Note <a href="#">1995798</a> ) or higher (optional)
<b>SAP Hybris Marketing Segmentation</b> on SAP CRM Business Partners	6.0 or higher (optional)	7.01 (SP04 plus SAP Note <a href="#">1995798</a> ) or higher (mandatory)



SAP Hybris Marketing License	SAP ERP	SAP CRM
<b>SAP Hybris Marketing Data Management</b>	6.0 or higher (optional)	7.01 (SP04 plus SAP Note <a href="#">1995798</a> ) or higher (optional)
<b>SAP Hybris Marketing Recommendation</b>	6.0 or higher (mandatory)	

The solutions SAP Hybris Marketing Acquisition and SAP Hybris Marketing Planning do not use SAP ERP or SAP CRM data.

## Browser Recommendations

For a recommendation concerning the appropriate browser platform to run the application, refer to the Product Availability Matrix (PAM) at <http://support.sap.com/pam> under SAP Hybris Marketing 1.2.

## 1.5 SAP Notes for Installation

The Release Information Note (RIN) contains general installation information concerning SAP Hybris Marketing.

### **i** Note

Ensure that you have carefully read the RIN before you implement the included SAP Notes. The RIN contains information about the exact point in time for the implementation of every included SAP Note:

- Before the import of the support package
- Before executing the technical configuration
- After executing the technical configuration
- SAP Note only relevant for a certain solution scope

If there is additional information or updates to the installation process described in this installation and configuration guide, you find the corresponding information in the SAP Notes mentioned below in the table.

Make sure that you have the up-to-date version of each SAP Note, which you can find on the SAP Service Marketplace at: <http://support.sap.com/notes>.

Table 3:

SAP Note Number	Title	Description
Release Information Note <a href="#">1885803</a>	RIN SAP Hybris Marketing (formerly SAP Customer Engagement Intelligence)	Contains information and references in the context of applying SAP Hybris Marketing

---

SAP Note Number	Title	Description
Note <a href="#">2076331</a> 	Follow Up Tasks after System Copy	Contains information about the actions to be carried out after system copy

## 2 Technical System Landscape

SAP Hybris Marketing is based on the following components:

- SAP HANA 1.0, SPS12
- SAP NetWeaver 7.50, SP05 (including SAP NetWeaver Gateway and SAP NetWeaver UI Extension)
- SAP Business Suite Foundation (SAP\_BS\_FND) 7.48, SP01
- SAP MDG Foundation (MDG\_FND) 7.49, SP01 or higher
- SAP Web UIF (WEBCUIF) 7.48, SP01

### **i** Note

Most applications within SAP Hybris Marketing such as *Customer Journey Insight*, are SAP Fiori apps. All SAP Fiori apps are directly deployed on the SAP Hybris Marketing server.

All these components are embedded in the SAP Fiori launchpad that is based on HTML5 (SAPUI5). Some administrative tasks, such as Customizing tasks, are also based on the traditional SAP GUI technology, which is not explicitly shown in Figure 1. Figure 1 gives an example of a possible technical system landscape for SAP Hybris Marketing, which includes the use of SAP ERP and SAP CRM data.

The communication of the front-end components with the back end, which is an SAP NetWeaver 7.5 application server, is based on HTTPS. The Web applications are embedded in a shell that ensures secure session management. All servers run behind the firewall.

The requests of the stateless Web applications to the back end are based on OData (read and write) using HTTPS.

The main reused components of the application server are those of SAP NetWeaver 7.5, for example, user management, authentication, and authorization. SAP Gateway handles the requests from the front end through OData channel services.

The underlying database for SAP Hybris Marketing is SAP HANA 1.0. To leverage the capabilities of the SAP HANA database, parts of the segmentation, search capabilities, and analysis are performed directly on the database using stored procedures and SAP HANA information models, such as calculation views, attribute views, and analytical views. All access to the database is done through the SAP NetWeaver 7.5 application server using OpenSQL or the ABAP Database Connectivity (ADBC) interface of ABAP to the SAP HANA database. Only the user management of SAP NetWeaver is required and only a technical user within the SAP HANA database is required for the access.

Data from SAP ERP, for example, and other SAP components can be replicated to SAP Hybris Marketing with the SAP LT replication framework. For more information about the tables that are required for the usage of SAP Hybris Marketing in connection with SAP ERP or SAP CRM, and need to be configured in SAP LT, see the [Appendix](#) section of this document. Results for SAP Hybris Marketing can be sent to SAP CRM. For other deployment options of SAP Hybris Marketing with SAP ERP and SAP CRM, see [Deployment Scenarios \[page 14\]](#).

The SAP NetWeaver role and authorization framework is used with SAP Hybris Marketing.

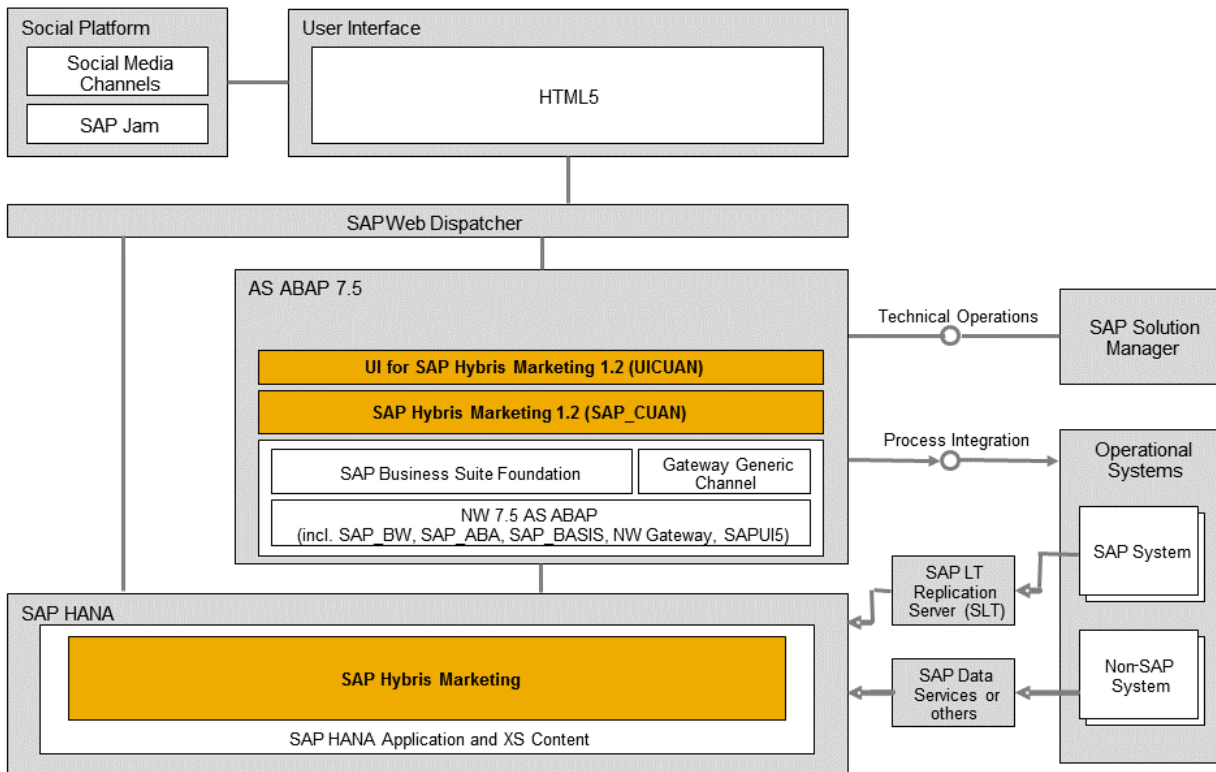

## More Information

For more information about the SAP HANA database system landscape, see the SAP Help Portal at:

[http://help.sap.com/hana\\_platform](http://help.sap.com/hana_platform) » Security » English » SAP HANA Security Guide »

([http://help.sap.com/hana/SAP\\_HANA\\_Security\\_Guide\\_en.pdf](http://help.sap.com/hana/SAP_HANA_Security_Guide_en.pdf))

For more information about the technical system landscape, see the resources listed in the following table.

Table 4:

Topic	Guide/Tool	Quick Link on SAP Service Marketplace or SDN
Technical landscape design	See applicable documents	<a href="http://sdn.sap.com/irj/sdn/landscape-design">http://sdn.sap.com/irj/sdn/landscape-design</a>

Topic	Guide/Tool	Quick Link on SAP Service Marketplace or SDN
Security	See applicable documents	<a href="http://scn.sap.com/community/security">http://scn.sap.com/community/security</a> <a href="http://help.sap.com/mkt">http://help.sap.com/mkt</a> Security Information

### 3 Deployment Scenarios

SAP Hybris Marketing can use SAP ERP data from SAP ERP 6.0 or higher and SAP CRM data from enhancement package (EHP) 1 for SAP CRM 7.0 SP04 (plus SAP Note [1995798](#)) or higher. Several deployment options are available. Your decision for a certain deployment option depends on the release of your source system and the SAP Hybris Marketing applications that you want to run. The table below shows which data is mandatory for each solution.

For recommendations concerning the appropriate system landscape to run the application, refer to the Product Availability Matrix (PAM) at <http://support.sap.com/pam> under **SAP HYBRIS MARKETING 1.2** [Related Links](#).

Table 5:

SAP Hybris Marketing Licenses or Applications	SAP ERP	SAP CRM
<b>Data Management</b>	optional	optional
<b>Insight</b> - Marketing Executive Dashboard	optional	optional
<b>Insight</b> - Relationship Analysis Sales, Stratification, Margin Decomposition	<b>mandatory</b>	optional
<b>Insight</b> - Relationship Analysis Presales	optional	<b>mandatory</b>
<b>Segmentation</b> on SAP ERP Accounts	<b>mandatory</b>	optional
<b>Segmentation</b> on SAP CRM Accounts	optional	<b>mandatory</b>
<b>Segmentation</b> on contact of third party data	optional	optional
<b>Recommendation</b>	optional	optional
<b>Planning</b>	optional	optional
<b>Acquisition</b>	optional	optional

## 3.1 Scenario A: Standalone Deployment

SAP Hybris Marketing Segmentation and SAP Hybris Marketing Data Management can be used without SAP ERP or SAP CRM data. Third-party data to be used in these applications can be replicated to the SAP HANA database or imported to the SAP Hybris Marketing system with different tools:

- For the replication of your third-party data, you can use one of the SAP HANA data provisioning tools described in the SAP HANA Master Guide under:  
[http://help.sap.com/hana\\_appliance](http://help.sap.com/hana_appliance) ► *Installation and Update* ► *SAP HANA Master Guide* ►  
([http://help.sap.com/hana/SAP\\_HANA\\_Master\\_Guide\\_en.pdf](http://help.sap.com/hana/SAP_HANA_Master_Guide_en.pdf))
- For the import of your third-party data to your SAP Hybris Marketing system, you can use one of the inbound interfaces for data upload, described in the Data Management Upload Interfaces guide under:  
<http://help.sap.com/mkt> ► *Configuration and Deployment Information* ► *Data Management Upload Interfaces* ►  
(<http://service.sap.com/%7Esapidb/012002523100017104782016E/>)

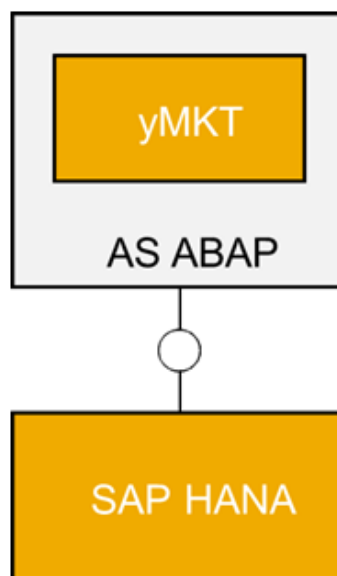

Figure 1: Standalone Deployment

## 3.2 Scenario B: Hub-Deployment with Separate SAP HANA System

You can deploy SAP Hybris Marketing in a side-by-side approach. This means that the application runs on a separate application server with a separate SAP HANA database. In this case the data is replicated from your

source system into the SAP HANA database with the SAP Landscape Transformation Replication Server (SAP LT).

Using separate deployment and data replication ensures that there is no incident or disruption in your production source systems, since the application does not directly access your production data. Replication also allows your SAP HANA-based application to work with data even if your production systems do not use SAP HANA.

For more information about the data replication, see section 6 of the installation guide at <http://help.sap.com/mkt> ► *Installation and Upgrade Information* ► *Installation Guide* ►.

In this scenario, you can, in addition, upload third-party data to your SAP Hybris Marketing system by using one of the inbound interfaces for data upload, described in the Data Management Upload Interfaces guide under:

<http://help.sap.com/mkt> ► *Configuration and Deployment Information* ► *Data Management Upload Interfaces* ►

(<http://service.sap.com/%7Esapidb/012002523100017104782016E/>)

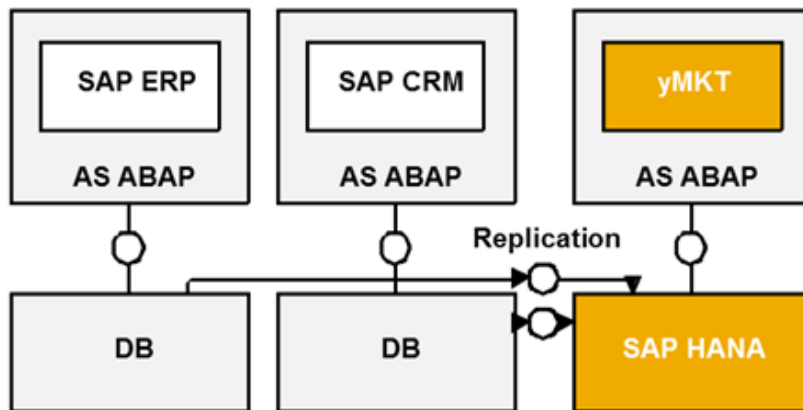

Figure 2: Hub-Deployment with Separate SAP HANA System

The following table shows the minimum required releases:

Table 6:

SAP ERP	SAP CRM
SAP ERP 6.0	EHP1 for SAP CRM 7.0 SP04 plus SAP Note 1995798



### 3.3 Scenario C: Hub-Deployment with Shared SAP HANA System of SAP Business Suite

SAP Hybris Marketing can be deployed in parallel with SAP Business Suite applications on the same SAP HANA database. In this case SAP Hybris Marketing shares the SAP HANA database with one SAP ERP, one SAP CRM, or one SAP S/4HANA system, reading SAP ERP, SAP CRM, or SAP S/4HANA data directly without replication.

#### **i** Note

In this scenario, ensure that you have carefully read and considered SAP Note [1826100](#) as it contains more information about this deployment.

In this scenario, you can, in addition, upload third-party data to your SAP Hybris Marketing system by using one of the inbound interfaces for data upload, described in the Data Management Upload Interfaces guide under:

<http://help.sap.com/mkt> ► *Configuration and Deployment Information* ► *Data Management Upload Interfaces* ►

(<http://service.sap.com/%7Esapidb/012002523100017104782016E/>)

If you decide to deploy SAP Hybris Marketing in such a deployment scenario, you have the following options:

- You can deploy SAP Hybris Marketing on the same SAP HANA database as your SAP ERP system if your SAP ERP system is minimum an EHP6 for SAP ERP 6.0 on SAP HANA. In addition, if you require to use SAP CRM business data as well, you can replicate this data from your SAP CRM system into the same SAP HANA database. This means that the SAP Hybris Marketing system is deployed with a shared SAP HANA database of SAP ERP, whereas SAP CRM runs on a separate database, as shown in scenario B.

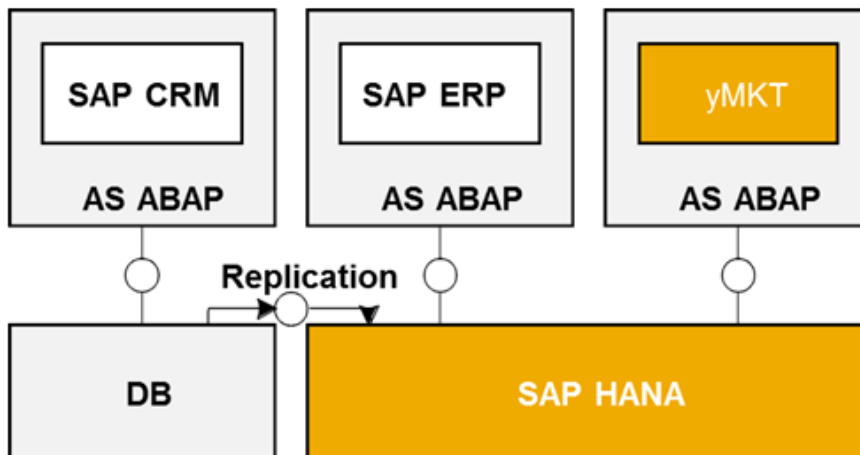

Figure 3: Hub-Deployment with Shared SAP HANA System of SAP ERP

The following table shows the minimum required releases:

Table 7:

SAP ERP	SAP CRM
EHP6 for SAP ERP 6.0 on SAP HANA	EHP1 for SAP CRM 7.0 SP04 plus SAP Note <a href="#">1995798</a>
EHP7 for SAP ERP 6.0	EHP1 for SAP CRM 7.0 SP04 plus SAP Note <a href="#">1995798</a>

- You can deploy SAP Hybris Marketing on the same SAP HANA database as your SAP CRM system if your SAP CRM system is minimum an EHP2 for SAP CRM 7.0 on SAP HANA. In addition, if you require to use SAP ERP business data as well, you can replicate this data from your SAP ERP system into the same SAP HANA database. This means that the SAP Hybris Marketing system is deployed with a shared SAP HANA database of SAP CRM, whereas SAP ERP runs on a separate database, as shown in scenario B.

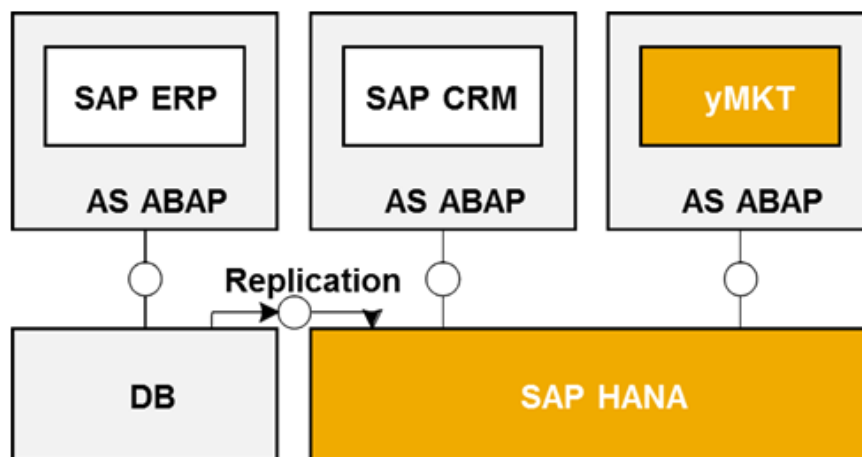

Figure 4: Hub-Deployment with Shared SAP HANA System of SAP CRM

The following table shows the minimum required releases:

Table 8:

SAP ERP	SAP CRM
SAP ERP 6.0	EHP2 for SAP CRM 7.0 on SAP HANA SP01 plus SAP Note <a href="#">1996523</a>
SAP ERP 6.0	EHP3 for SAP CRM 7.0

- You can deploy SAP Hybris Marketing on the same SAP HANA database as your SAP S/4HANA system. In addition, if you require to use SAP CRM or SAP ERP business data as well, you can replicate this data from your SAP CRM or SAP ERP system into the same SAP HANA database. This means that the SAP Hybris Marketing system is deployed with a shared SAP HANA database of SAP S/4HANA, whereas SAP CRM or SAP ERP runs on a separate database, as shown in scenario B.

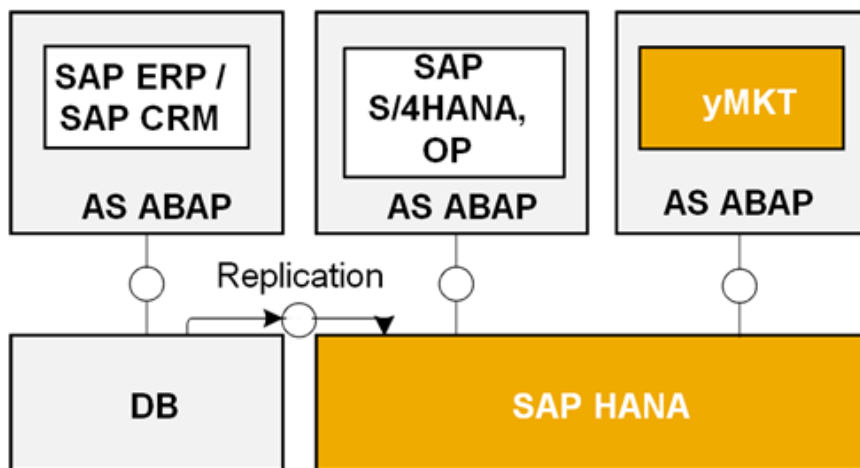

Figure 5: Hub-Deployment with Shared SAP HANA System of SAP S/4HANA

### 3.4 Scenario D: Hub-Deployment with Shared SAP HANA System of Other Application

SAP Hybris Marketing can be deployed on an SAP HANA database that is already used for applications which are listed in SAP Note [1661202](#) – *Support for Multiple Applications on SAP HANA*. If you require to use SAP ERP or SAP CRM business data as well, you can replicate this data into the same SAP HANA database.

This deployment scenario is not separately pointed out in this installation guide. If you require to replicate data refer to the deployment process for scenario B; if you do **not** require to replicate data refer to the deployment process for scenario A.

In this scenario, you can, in addition, upload third-party data to your SAP Hybris Marketing system by using one of the inbound interfaces for data upload, described in the Data Management Upload Interfaces guide under:

<http://help.sap.com/mkt> ► *Configuration and Deployment Information* ► *Data Management Upload Interfaces* ►

(<http://service.sap.com/%7Esapidb/012002523100017104782016E/>)

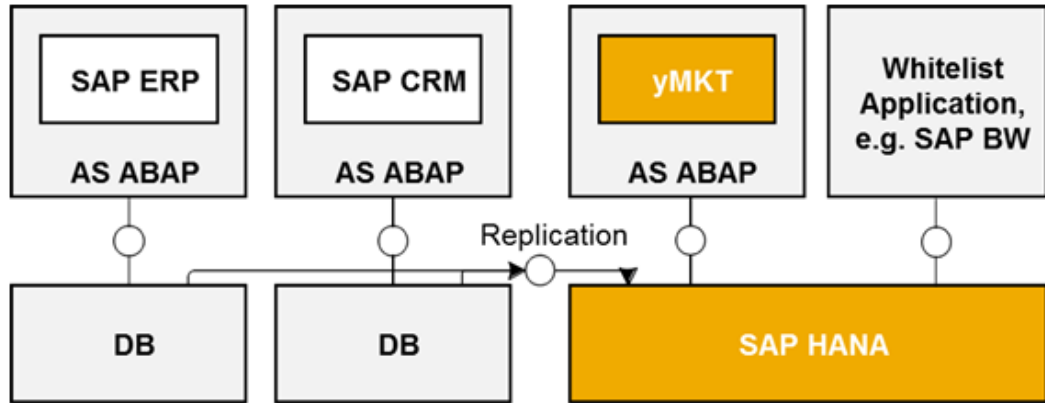

Figure 6: Hub-Deployment with Shared SAP HANA System of Other Application

---

## 4 Development and Production Systems

We recommend that you install or update first in a development system. After testing, you may begin installation in your production system.

### **i** Note

Certain tasks are only carried out in the development system (see [Creating Development Package \[page 51\]](#)). These tasks generate repository objects and Customizing objects that are imported into the production system at a later point in time (see [Applying Technical Configuration Artifacts to Production System \[page 66\]](#)).

## 5 Installation

This section explains how the base installation of SAP Hybris Marketing on premise is to be executed. Since SAP Hybris Marketing runs on an SAP NetWeaver AS ABAP system with SAP HANA as the primary and only database, you must set up the database first. The SAP NetWeaver AS ABAP system will be installed on this SAP HANA database in a second step.

The following flow chart illustrates the sequence of the installation process according to the various sections of this installation guide.

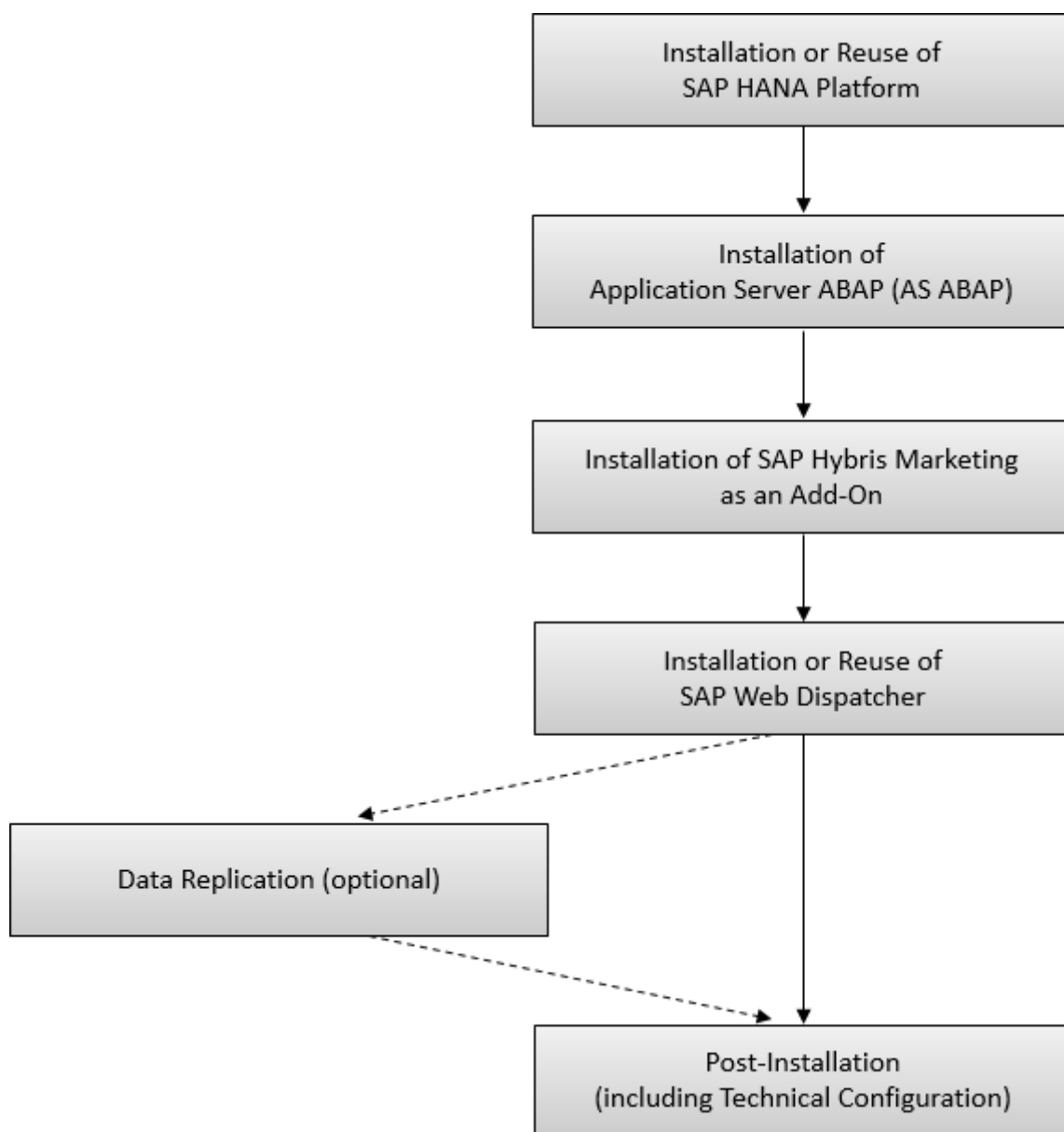

## 5.1 Installation of the SAP HANA Platform

As an appliance, SAP HANA uses software components from SAP optimized for proven hardware provided by SAP's hardware partners. Therefore, the components of SAP HANA can only be installed by certified hardware partners on validated hardware running a specific operating system.

To ensure that your SAP HANA appliance is optimally prepared for use with your application, you should consider the following topics.

### 5.1.1 Correct Sizing of the SAP HANA Database

For help in determining SAP HANA sizing for SAP S/4HANA Marketing Cloud, see the *Sizing Guide* for SAP S/4HANA Marketing Cloud on the SAP Service Marketplace at:

<http://service.sap.com/sizing> ► *Sizing Guidelines* ► *Database and Technology* ► *SAP In-Memory Computing*.

(<http://service.sap.com/%7Esapidb/011000358700000373142013E>)

Another option is to use the web-based Quick Sizer at <http://service.sap.com/quicksizing>.

### 5.1.2 Installing the SAP HANA Database

For information about the installation and configuration of the SAP HANA database follow the instructions in the corresponding master and installation guides. You find both documents under [http://help.sap.com/hana\\_platform](http://help.sap.com/hana_platform)

► *Installation and Upgrade Information* :

- *SAP HANA Master Guide*: [http://help.sap.com/hana/SAP\\_HANA\\_Master\\_Guide\\_en.pdf](http://help.sap.com/hana/SAP_HANA_Master_Guide_en.pdf)
- *SAP HANA Server Installation Guide*: [http://help.sap.com/hana/SAP\\_HANA\\_Server\\_Installation\\_Guide\\_en.pdf](http://help.sap.com/hana/SAP_HANA_Server_Installation_Guide_en.pdf)

### 5.1.3 Updating to Higher Revisions of the SAP HANA Database

SAP ships SAP HANA Support Package revisions, which contain latest capabilities in SAP HANA. As your current installation might not contain the latest revision, you must update your SAP HANA database accordingly. Check the Release Information Note (RIN) for SAP Hybris Marketing [1885803](#) to find information about the minimum SAP HANA revision required for SAP Hybris Marketing.

You can find the RIN under <http://support.sap.com/notes>. Enter the number of the RIN in the corresponding field in the upper right corner of the screen.



For information about the SAP HANA update, see the SAP HANA Master Update Guide at:

[http://help.sap.com/hana\\_platform](http://help.sap.com/hana_platform) ► [Installation and Upgrade Information](#) ► [SAP HANA Update Guides](#) ► [SAP HANA Master Update Guide](#) ►

([http://help.sap.com/hana/SAP\\_HANA\\_Master\\_Update\\_Guide\\_en.pdf](http://help.sap.com/hana/SAP_HANA_Master_Update_Guide_en.pdf))

## 5.1.4 Installing the SAP HANA Application Function Library (AFL)

An SAP HANA system consists of the SAP HANA server and additional components like the *Application Function Library (AFL)*. SAP Hybris Marketing requires this library. Therefore install the library as described in section *Managing SAP HANA System Components* of the *SAP HANA Administration Guide* under:

[http://help.sap.com/hana\\_platform](http://help.sap.com/hana_platform) ► [System Administration](#) ► [SAP HANA Administration Guide](#) ►

([http://help.sap.com/saphelp\\_hanaplatform/helpdata/en/10/c5148560354ac98f1b098cb2bbf03a/content.htm](http://help.sap.com/saphelp_hanaplatform/helpdata/en/10/c5148560354ac98f1b098cb2bbf03a/content.htm))

## 5.2 Installation of Application Server ABAP (AS ABAP)

### **i** Note

Your application runs only on a SAP NetWeaver system that is installed with SAP HANA as the primary and only database system. Other types of database systems are not supported.

The SAP Hybris Marketing application is based on an SAP NetWeaver 7.5 application server (AS). The AS ABAP installation is executed using the software provisioning manager, a tool that is part of the software logistics toolset (SL Toolset). The SL Toolset is a product-independent delivery channel that delivers up-to-date software logistics tools. The software provisioning manager performs software provisioning processes such as installation, deinstallation, or system copy.

To install this AS ABAP, follow the procedure described in the sections below.

### 5.2.1 Standard Installation of SAP NetWeaver 7.5

To install SAP NetWeaver AS ABAP Release 7.5, follow the instructions in the installation guide for your operating system (*SAP Systems Based on the Application Server ABAP of SAP NetWeaver on <Your Operating System>*):

SAP HANA Database Using Software Provisioning Manager 1.0). You can find the appropriate guide on the SAP Help Portal at:

<http://help.sap.com/nw75> ► [Installation and Upgrade Information](#) ► [Installation Guide](#) ► [Installation](#) ► [Plan and Install](#) ► [Installation - SAP NetWeaver 7.5-based Systems](#) ► [Download Page](#) ► [SAP HANA Database](#) ► [<Your Operating System>](#) ► [ABAP](#) ►

(<https://service.sap.com/~sapidb/011000358700000828172012E>) ► [SAP HANA Database](#) ► [<Your Operating System>](#) ► [ABAP](#) ►

#### **i** Note

Ensure that the time zone of the ABAP server and the server of the SAP HANA database match.

## 5.3 Installing SAP Hybris Marketing as an Add-On

The deployment of the SAP Hybris Marketing application is executed with the Software Update Manager (SUM), a tool of the Software Logistics Toolset (SL Toolset). The SUM is a multi-purpose tool that supports various processes, such as performing a release upgrade, installing enhancement packages, applying support package stacks, or updating single components. The SUM requires a stack configuration file as well as all software files for the installation. All files are provided by the maintenance optimizer, a tool being part of the *SAP Solution Manager* that plays a central role for a successful upgrade and update of SAP product systems. To ensure a successful installation, follow the steps below.

#### **i** Note

- Make sure you use *SAP Solution Manager 7.1*, Support Package 05 or higher, as lower versions do not support SAP HANA scenarios.
- Make sure that you use no other tools than the SL Toolset with the latest SUM version, and the maintenance optimizer to deploy SAP Hybris Marketing.

### 5.3.1 Running the Maintenance Optimizer

The maintenance optimizer in *SAP Solution Manager* calculates and downloads the required software files and creates the stack configuration file.

SAP Hybris Marketing requires the latest support package of SAP NetWeaver 7.5. You have already completed the standard installation of SAP NetWeaver in section [Installation of Application Server ABAP \(AS ABAP\) \[page 25\]](#).

The maintenance optimizer ensures that the update of the standard installation to the required support package level and the installation of SAP Hybris Marketing is done in one single stack configuration. As SAP Hybris Marketing requires some additional components such as SAP Business Suite Foundation, the maintenance optimizer also ensures that all required components are automatically identified and provided for installation with the add-on.

When using the maintenance optimizer transaction, select *SAP Hybris Marketing 1.2* as add-on.

### Caution

On the *Select OS/DB-Dependent Files* tab, the maintenance optimizer provides you with the *Alternative Selection* component *USER INTERFACE TECHNOLOGY*.

Although the component *USER INTERFACE TECHNOLOGY 7.50* with description *Version: SAP\_UI 750 (recommended)* is preselected, you must deselect this option and select *USER INTERFACE TECHNOLOGY 7.51* with description *Version: SAP\_UI 751*.

At the end of the maintenance optimizer transaction, check your download basket for all required components.

For general information on how to run a maintenance optimizer transaction, see chapter 5, *Executing a Maintenance Optimizer Transaction*, in the following guide in the SAP Community Network at:

<http://wiki.scn.sap.com/wiki/x/VlwqCw> ▶ Section "Guides" ▶ Maintenance Planning Guide for SAP Solution Manager 7.1 SP05 ▶

([https://wiki.scn.sap.com/wiki/display/SM/Maintenance+Tools%3A+Maintenance+Planner+and+Maintenance+Optimizer?preview=/187337812/441456111/SolMan\\_71\\_MaintPlanGuide\\_en.pdf](https://wiki.scn.sap.com/wiki/display/SM/Maintenance+Tools%3A+Maintenance+Planner+and+Maintenance+Optimizer?preview=/187337812/441456111/SolMan_71_MaintPlanGuide_en.pdf))

## 5.3.2 Running the Software Update Manager

The Software Update Manager takes the result of the maintenance optimizer, the stack configuration file and the software files, and installs SAP Hybris Marketing.

For the concrete steps to be executed, see the SAP Service Marketplace at:

<http://support.sap.com/sltoolset> ▶ System Maintenance ▶ Software Update Manager (SUM) 1.0 SP17 ▶ Guides ▶ Update of SAP Systems Using Software Update Manager (ABAP Systems) ▶ <your operating system> ▶ SAP HANA DB ▶

Microsoft Windows: <https://service.sap.com/%7Esapibd/011000358700000890302012E>

Unix: <https://service.sap.com/%7Esapibd/011000358700000890292012E>

IBM i: <https://service.sap.com/%7Esapibd/011000358700000756342013E>

### Note

If you install the SAP Hybris Marketing add-on on SAP NetWeaver, use the resource-minimized update strategy (see section 3.9, *Update Strategy Parameter*, of the above mentioned documents).

## 5.4 Installing the SAP Web Dispatcher

SAP Hybris Marketing comprises both ABAP-based applications and SAP HANA Extended Application Services (SAP HANA XS) applications. For this reason, SAP Hybris Marketing requires an SAP Web Dispatcher due to the

same origin policy of browsers. In addition, the SAP Web Dispatcher is required to display and use the Web Assistant, an integrated help system that provides context sensitive user assistance.

### **i** Note

If you already use an SAP Web Dispatcher in your system landscape, you can reuse it for SAP Hybris Marketing purposes. For the required configuration, see [Configuring the SAP Web Dispatcher \[page 43\]](#).

To install the SAP Web Dispatcher, follow the instructions under:

<http://help.sap.com/nw75> ► [Installation and Upgrade Information](#) ► [Additional Installation Information](#) ► [Installation - Standalone Engines](#) ► [Installation: Web Dispatcher for SAP NetWeaver 7.1 or Higher](#) ► [<Your Operating System>](#) ►

Microsoft Windows: <https://service.sap.com/~sapidb/011000358700000877232012E>

Unix: <https://service.sap.com/~sapidb/011000358700000851902012E>

IBM i: <https://service.sap.com/~sapidb/011000358700000877242012E>

## 5.5 Installing SAPUI5 Tools and ABAP Development Tools

If you want to enhance or change the the SAPUI5-based user interface of SAP Hybris Marketing, then you must install the required development tools, which are the SAPUI5 Tools integrated development environment (IDE) and the SAPUI5 Team Provider, on each client. With the installation of these tools, you also install the ABAP Development Tools.

For detailed information about the installation process, see the master guide for user interface add-ons for SAP NetWeaver on the SAP Service Marketplace at:

<http://service.sap.com/instguides> ► [SAP NetWeaver](#) ► [User Interface Add-On 1.0 for SAP NetWeaver](#) ► [Master Guide for UI Add-On 1.0 SPS 16 for SAP NetWeaver](#) ►

(<https://service.sap.com/~sapidb/011000358700000436252013E>)

## 5.6 Installing SAP Smart Business, executive edition

Within SAP Hybris Marketing, the following applications are based on the native SAP HANA application *SAP Smart Business, executive edition*:

- [Marketing Executive Dashboard](#)  
The [Marketing Executive Dashboard](#) application contains key performance indicators (KPI), which allow marketing executives to review the success of marketing investments, and gain an overview of KPI attainment and marketing performance benchmarks.
- [Lead Dashboard](#)

The *Lead Dashboard* application allows marketing experts to review the success of the lead management process, and provides them with a comprehensive overview of KPI attainment and lead management performance benchmarks.

If you want to use one of the applications above, you must install *SAP Smart Business, executive edition* by downloading and installing the following component before executing the technical configuration scenarios *Marketing Executive Dashboard* (see section [Scenario "Marketing Executive Dashboard" \[page 59\]](#)) or *Lead Management with Cloud for Customer Integration* (see section [Scenario "Lead Management with Cloud for Customer Integration" \[page 61\]](#)).

To do so, proceed as follows:

1. Go to the *SAP Software Download Center* at <https://support.sap.com/swdc>.
2. Choose **Installation and Upgrades** > **Software Downloads** > **By Alphabetical Index (A-Z)** > **S** and search for the following component:
  - **SAP SBEE FOR HYBRIS MARKETING** > **SAP SBEE FOR HYBRIS MARKETING 1.0**

#### Caution

*SAP Smart Business, executive edition* is available in a special version for SAP Hybris Marketing. Make sure that you download the component mentioned above. The component contains two delivery units that you must install in the following sequence:

- First you install *ENTERPRISE COCKPIT CON 100* (HCOEADCON)
- Then you install *ENTERPRISE COCKPIT FND 100* (HCOEADFND)

#### Note

After the installation of *SAP Smart Business, executive edition* and the execution of the corresponding technical configuration scenario (see above), you must ensure the **configuration** of *SAP Smart Business, executive edition*.

For more information, see section [Configuring SAP Smart Business, executive edition \[page 86\]](#).

## 5.7 Implementation of SAP Notes Listed in Release Information Note

To complete the installation process, you must implement all SAP Notes listed in the Release Information Note (RIN) for SAP Hybris Marketing, number [1885803](#) that have not been implemented before.

You can find the RIN under <http://support.sap.com/notes>, entering the RIN number in the corresponding field on the screen.

#### Note

Ensure that you have carefully read the RIN before you implement the included SAP Notes. The RIN contains information about the exact point in time for the implementation of every included SAP Note:

- Before the import of the support package

- 
- Before executing the technical configuration
  - After executing the technical configuration
  - SAP Note only relevant for a certain solution scope

To install the SAP Notes in the RIN, do the following:

1. Log on to the back-end SAP NetWeaver system as an administrator. You can log on to the production client of the application; installing SAP Notes is a client-independent procedure.
2. Use transaction `SNOTE` to install the SAP Notes in the RIN.

## 6 Data Replication

### **i** Note

This section is relevant only if you have decided to deploy SAP Hybris Marketing separately from your source system using one of the hub-deployment approaches.

For more information about the various deployment scenarios, see [Deployment Scenarios \[page 14\]](#).

### 6.1 Installation of SAP Landscape Transformation Replication Server

To install and set up trigger-based data replication, follow the instructions in the following installation guide in the SAP Help Portal at:

[http://help.sap.com/hana\\_options\\_replication](http://help.sap.com/hana_options_replication)  *SAP HANA Trigger-Based Data Replication Using SAP LT Replication Server*  *Installation and Upgrade Information* 

([http://help.sap.com/hana/SAP\\_HANA\\_Installation\\_Guide\\_Trigger-Based\\_Replication\\_SLT\\_en.pdf](http://help.sap.com/hana/SAP_HANA_Installation_Guide_Trigger-Based_Replication_SLT_en.pdf) )

### Recommendation

SAP recommends to use at minimum the SAP Landscape Transformation Replication Server version 2.0 SP05 for SAP Hybris Marketing.

#### 6.1.1 Connection Setup between SAP Hybris Marketing and SAP LT Replication Server

1. Log on to your SAP LT Replication Server system.
2. Enter transaction `PFCG`, and copy the role `SAP_IUUC_REPL_REMOTE`. You must enhance the role by the following authorizations:
  - **Authorization Object:** `S RFC`
    - *Activity:* **16 (Execute)**
    - *Name of RFC to be protected:* `SDTB, SDIFRUNTIME`
    - *Type of RFC to be protected:* `FUGR`
  - **Authorization Object:** `S RFC`
    - *Activity:* **16 (Execute)**
    - *Name of RFC to be protected:* `SCSI_GET_SYSTEM_INFO`

- *Type of RFC to be protected*: FUNC
- **Authorization Object**: S\_DMIS
  - *Activity*: O2 (Change)
  - *MBT PCL Scenario*: SLOP
  - *MBT PCL Processing Role Level*: **PACKAGE**

For more information about the maintenance of authorization profiles, see the SAP Help Portal at:

<http://help.sap.com/nw75> ► *Application Help* ► *Function-Oriented View* ► *Security* ► *Identity Management* ► *User and Role Administration of Application Server ABAP* ► *Reference Documentation for User and Role Administration* ► *Organization Without the Profile Generator* ► *Creating and Maintaining Authorizations/Profiles Manually* ► *Maintaining Authorizations and Their Values* ►  
 ([http://help.sap.com/saphelp\\_nw75/helpdata/en/4c/a289f2d4233b9ee10000000a42189b/content.htm](http://help.sap.com/saphelp_nw75/helpdata/en/4c/a289f2d4233b9ee10000000a42189b/content.htm))

3. Generate the profile of your role and leave transaction PFCG.
4. Enter transaction SU01 and create a user with your new role. You use this user in the RFC destination between your SAP Hybris Marketing system and the SAP LT Replication Server.
5. Log on to your SAP Hybris Marketing system.
6. Enter transaction SM59, and choose the *Create* menu option in the *Edit* menu to create a new ABAP connection between your SAP Hybris Marketing system and your SAP LT Replication Server.
7. Enter your name for the RFC destination. Enter all required information and use the user you created in step 4.
8. Confirm your entries and save the RFC destination. Test the RFC destination using the connection test.

## 6.1.2 Connection Setup between SAP Hybris Marketing and SAP Source System

During the installation of SAP Landscape Transformation Replication Server you have installed the SAP Landscape Transformation add-on on your SAP source system. To enable the replication between your SAP Hybris Marketing system and your SAP source system, you must create an RFC destination. To do so, execute the following steps:

1. Log on to your SAP source system.
2. Enter transaction PFCG, and copy the role SAP\_IUUC\_REPL\_REMOTE. You must enhance the copied role by the following authorizations:
  - **Authorization Object**: S\_RFC
    - *Activity*: 16 (Execute)
    - *Name of RFC to be protected*: SDTB, SDIFRUNTIME
    - *Type of RFC to be protected*: FUGR

For more information about the maintenance of authorization profiles, see the SAP Help Portal at:

<http://help.sap.com/nw75> ► *Application Help* ► *Function-Oriented View* ► *Security* ► *Identity Management* ► *User and Role Administration of Application Server ABAP* ► *Reference Documentation for User and Role Administration* ► *Organization Without the Profile Generator* ► *Creating and Maintaining Authorizations/Profiles Manually* ► *Maintaining Authorizations and Their Values* ►  
 ([http://help.sap.com/saphelp\\_nw75/helpdata/en/4c/a289f2d4233b9ee10000000a42189b/content.htm](http://help.sap.com/saphelp_nw75/helpdata/en/4c/a289f2d4233b9ee10000000a42189b/content.htm))

3. Generate the profile of your role and leave transaction PFCG.



4. Enter transaction `SU01` and create a user with your new role. You use this user in the RFC destination between your SAP Hybris Marketing system and your SAP source system.
5. Log on to your SAP Hybris Marketing system.
6. Enter transaction `SM59`, and choose the *Create* menu option in the *Edit* menu to create a new ABAP connection between your SAP Hybris Marketing system and your SAP source system.
7. Enter your name for the RFC destination. Enter all required information and use the user you created in step 4.
8. Confirm your entries and save the RFC destination. Test the RFC destination using the connection test.

### 6.1.3 Basic Configuration of Data Replication

You must create a basic configuration for all source systems from which you want to replicate data to your SAP Hybris Marketing system. To do so, follow the instructions in section *Creating a Configuration* of the Application Operations Guide for SAP Landscape Transformation Replication Server. You find this Application Operations Guide on the SAP Help Portal at:

[http://help.sap.com/hana\\_options\\_replication](http://help.sap.com/hana_options_replication) ► *System Administration and Maintenance Information* ► *Application Operations Guide – Trigger-Based Data Replication Using SAP LT Replication Server for SAP HANA* ►  
([http://help.sap.com/hana/SAP\\_Landscape\\_Transformation\\_for\\_SAP\\_HANA\\_Operations\\_Guide\\_en.pdf](http://help.sap.com/hana/SAP_Landscape_Transformation_for_SAP_HANA_Operations_Guide_en.pdf))

The technical configuration (see [Using the Technical Configuration Cockpit \[page 52\]](#)) automatically adjusts this configuration and adds the required tables (see also the *Replicated Tables* sections in the [Appendix \[page 155\]](#)).

## 7 Post-Installation

After you have installed all the components that you need to run the SAP Hybris Marketing application and have implemented all relevant SAP Notes from the RIN [1885803](#), carry out the following technical configuration steps. You find these steps listed in the following sections.

### Caution

- Make sure that you carry out the following post-installation steps in the same client in which you want to run the SAP Hybris Marketing application.
- The sequence of the post-installation steps reflected by the following sections depends on the role of system, in which you execute the installation: The sequence in the development system differs from the sequence in the production system.  
For more information, see the graphic below.

### Note

During the following post-installation process executed in your **development system**, transport requests are created, which contain generated objects and Customizing entries. While some of the requests are created automatically by the technical configuration cockpit, you need to create other requests manually.

After testing, the transport requests are imported into the **production system** in a specific sequence (see [Applying Technical Configuration Artifacts to Production System \[page 66\]](#)).

When you carry out the installation in the production system, the technical configuration cockpit automatically skips the tasks that no longer need to be carried out, due to the import of transport requests from the development system.

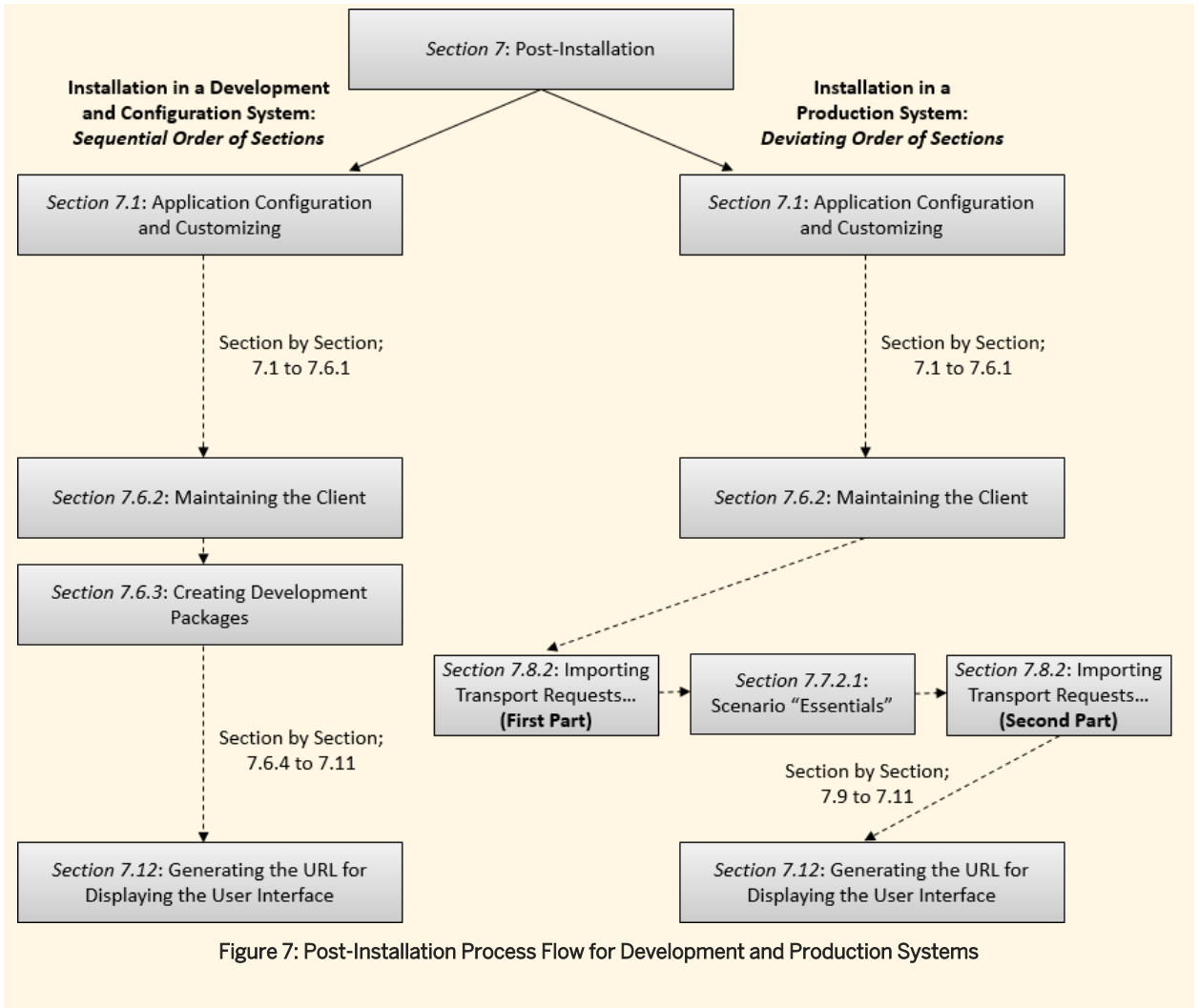

## 7.1 Application Configuration and Customizing

### 7.1.1 Initial Customizing Adjustment

With the installation of SAP Hybris Marketing (see [Installing SAP Hybris Marketing as an Add-On \[page 26\]](#)), Customizing is installed only in client 000 of your SAP NetWeaver system. To ensure the availability of all relevant Customizing in your productive client, we recommend to create this client via client copy from client 000. During the client copy process, select a copy role, which ensures that Customizing is copied.

#### **i** Note

Ensure that the SAP Hybris Marketing add-on is installed before executing the client copy. If the SAP Hybris Marketing add-on is not installed the Customizing to be copied is not available.

For more information, see the SAP Help Portal under:

<http://help.sap.com/nw75> ► *System Administration and Maintenance Information* ► *Technical Operations for SAP NetWeaver* ► *Administration of Application Server ABAP* ► *Change and Transport System* ► *BC - Client Copy and Transport (BC-CTS-CCO)* ► *Client Copier* ►

([http://help.sap.com/saphelp\\_nw75/helpdata/en/4d/7ce15219a00f88e10000000a42189b/content.htm](http://help.sap.com/saphelp_nw75/helpdata/en/4d/7ce15219a00f88e10000000a42189b/content.htm))

## 7.1.2 Customizing via SAP Solution Manager

You execute the configuration for SAP Hybris Marketing with the help of SAP Solution Manager 7.1, SP05 or higher. In your Solution Management system, you can find the corresponding business scenario group, named SAP Hybris Marketing under *Applications Powered by SAP HANA* in transaction SOLAR01.

### **i** Note

Make sure that you implemented ST\_ICO\_150\_700\_SP046 to access the required content.

## More Information

- For an introduction to the use of the SAP Solution Manager content, see the SAP Help Portal at:  
<http://help.sap.com/crm702> ► *SAP Enhancement Package 2 for SAP CRM 7.0* ► *Configuration and Deployment Information* ► *SAP Solution Manager Content* ►  
(<http://help.sap.com/content/documentation/solutionmanager/DISPLAYSOLMANCONTENT.pdf>)
- For detailed information on executing application configuration via SAP Solution Manager, see the SAP Help Portal at:  
<http://help.sap.com/solutionmanager71> ► *Application Help* ► *SAP Solution Manager 7.1 SPS14* ► *SAP Solution Manager* ► *Solution Implementation* ► *Implementation/Upgrade Work Center* ► *Business Blueprint* ►  
([http://help.sap.com/saphelp\\_sm71\\_sp14/helpdata/en/45/f6da633a292312e10000000a11466f/content.htm](http://help.sap.com/saphelp_sm71_sp14/helpdata/en/45/f6da633a292312e10000000a11466f/content.htm))

## 7.2 Configuring the SAP HANA Database

### 7.2.1 Configuring SSL for SAP HANA XS Engine

Set up secure communication between Web-based clients and *SAP HANA Extended Application Services*.

This secure communication is required for the following SAP Hybris Marketing applications and features:

- Applications and features in the context of the SAP HANA rules framework (see section [Scenario "HANA Rules Framework"](#) [page 58])

- Applications and features in the context of *SAP Smart Business, executive edition* (see sections [Scenario "Marketing Executive Dashboard" \[page 59\]](#) and [Configuring SAP Smart Business, executive edition \[page 86\]](#))

For information and how to establish the secure communication, see the following instructions in the SAP HANA documentation:

- Chapter *Secure Communication Between SAP HANA XS Classic and HTTP Clients* in the SAP HANA security guide under:  
[http://help.sap.com/hana\\_platform](http://help.sap.com/hana_platform) ► [Security](#) ► [Security Guide](#) ► [SAP HANA Network and Communication Security](#) ► [Securing Data Communication](#) ► [Secure Communication Between SAP HANA XS Classic and HTTP Clients](#) ▾  
[http://help.sap.com/saphelp\\_hanaplatform/helpdata/en/dd/cc0645464a4a2b8b3eead269ea09d7/content.htm](http://help.sap.com/saphelp_hanaplatform/helpdata/en/dd/cc0645464a4a2b8b3eead269ea09d7/content.htm))
- Chapter *Configure HTTPS (SSL) for Client Application Access* in the SAP HANA administration guide under:  
[http://help.sap.com/hana\\_platform](http://help.sap.com/hana_platform) ► [System Administration](#) ► [SAP HANA Administration Guide](#) ► [Maintaining the Application Services Run-Time Environment](#) ► [Maintaining the SAP HANA XS Classic Model Run Time](#) ► [Maintaining HTTP Access to SAP HANA](#) ► [Configure HTTPS \(SSL\) for Client Application Access](#) ▾  
[http://help.sap.com/saphelp\\_hanaplatform/helpdata/en/d3/3b259c567441aa97e99228dc0f2088/content.htm](http://help.sap.com/saphelp_hanaplatform/helpdata/en/d3/3b259c567441aa97e99228dc0f2088/content.htm))

You must establish a trust relationship between your AS ABAP server and your SAP HANA database later on. For this reason, you either export the certificate of your SAP HANA server or the Certificate Authority (CA) root certificate, which has been used to sign the SAP HANA server certificate. Provide the certificate to the AS ABAP administrator who performs the SSL setup of the AS ABAP system.

### ➔ Recommendation

You can display and copy the certificates of the SAP HANA server to the file by connecting your internet browser to the address <https://<host name of SAP HANA server>:43<instance number>>, and choosing the lock symbol in the address bar.

For more information, see SAP Note [1094342](#) 📄.

## 7.2.2 SAP HANA User for Technical Configuration

During the technical configuration of SAP Hybris Marketing, several actions must be executed on the SAP HANA database which require different authorizations. To ensure that all of these authorizations are available, run the following script to create a user with sufficient authorization for carrying out the SAP Hybris Marketing technical configuration on the SAP HANA database.

### i Note

The SAP HANA authorizations required during business usage are granted to the AS ABAP user (`SAP<SID>`).

You can deactivate the user after successful completion of the technical configuration for the installation of SAP Hybris Marketing. You must reactivate the user again when performing technical configuration such as upgrade activities.

Proceed as follows:

1. Log on to the SAP HANA studio with the `SYSTEM` user.
2. Open the *SQL console*.
3. Copy the script below into the *SQL console*. If there are more than one, choose the correct database connection.
4. Choose *Execute (F8)*.
5. Check the log to see if all steps were carried out successfully.

### **i** Note

- If you want to copy and paste the SQL statements below, ensure that all blank characters are copied accurately.
- After running the script, you must ensure the following:
  - Check if every single statement is successfully executed.
  - Log off and log back on again in order to change the initial password.

```
CREATE USER TC_USER PASSWORD Initial1234;
-- object privileges
GRANT EXECUTE ON "GRANT_ACTIVATED_ROLE" TO TC_USER WITH GRANT OPTION;
GRANT EXECUTE ON "REVOKE_ACTIVATED_ROLE" TO TC_USER WITH GRANT OPTION;
GRANT EXECUTE ON "GRANT_PRIVILEGE_ON_ACTIVATED_CONTENT" TO TC_USER WITH GRANT
OPTION;
GRANT EXECUTE ON "REVOKE_PRIVILEGE_ON_ACTIVATED_CONTENT" TO TC_USER WITH GRANT
OPTION;
GRANT EXECUTE ON "GRANT_APPLICATION_PRIVILEGE" TO TC_USER WITH GRANT OPTION;
GRANT EXECUTE ON "REVOKE_APPLICATION_PRIVILEGE" TO TC_USER WITH GRANT OPTION;
GRANT EXECUTE ON "GRANT_SCHEMA_PRIVILEGE_ON_ACTIVATED_CONTENT" TO TC_USER WITH
GRANT OPTION;
GRANT EXECUTE ON "REVOKE_SCHEMA_PRIVILEGE_ON_ACTIVATED_CONTENT" TO TC_USER WITH
GRANT OPTION;
GRANT EXECUTE ON "AFL_WRAPPER_GENERATOR" TO TC_USER WITH GRANT OPTION;
GRANT EXECUTE ON "AFL_WRAPPER_ERASER" TO TC_USER WITH GRANT OPTION;
GRANT SELECT ON SCHEMA "_SYS_REPO" TO TC_USER WITH GRANT OPTION;
GRANT UPDATE, SELECT ON "_SYS_XS"."SQL_CONNECTIONS" TO TC_USER;
-- system privileges
GRANT "CREATE R SCRIPT" TO TC_USER WITH ADMIN OPTION;
GRANT "CREATE STRUCTURED PRIVILEGE" TO TC_USER WITH ADMIN OPTION;
GRANT "CREATE SCHEMA" TO TC_USER WITH ADMIN OPTION;
GRANT "ROLE ADMIN" TO TC_USER WITH ADMIN OPTION;
GRANT "DATA ADMIN" TO TC_USER WITH ADMIN OPTION;
GRANT "USER ADMIN" TO TC_USER WITH ADMIN OPTION;
CALL
SYS_REPO.GRANT_ACTIVATED_ROLE('sap.hana.xs.admin.roles::RuntimeConfAdministrator',
'TC_USER');
CALL
SYS_REPO.GRANT_ACTIVATED_ROLE('sap.hana.xs.admin.roles::SQLCCAdministrator',
'TC_USER');
```

## 7.2.3 Authorization Settings for Deployment Scenario C: Hub-Deployment with Shared SAP HANA System of SAP Business Suite

### **i** Note

You follow the instructions in this section if you have decided to run deployment scenario C, *Hub-Deployment with Shared SAP HANA System of SAP Business Suite*. If you have chosen deployment scenario C, carry out the following steps. If not, proceed with section 7.4.

### 7.2.3.1 Authorization Enhancement for `_SYS_REPO` User

Check if user `_SYS_REPO` has `SELECT` authorization on your embedded SAP ERP or SAP CRM system:

1. Log on to the SAP HANA studio with a user that is allowed to view the authorizations of user `_SYS_REPO`, for example, the `SAP<SID>` user of your embedded SAP ERP or SAP CRM system.

If you are familiar with the SQL Console you can run the following command:

```
SELECT DISTINCT PRIVILEGE, IS_GRANTABLE, IS_VALID FROM SYS.EFFECTIVE_PRIVILEGES
WHERE USER_NAME = '_SYS_REPO' AND SCHEMA_NAME = '<schema name of your embedded
SAP ERP or SAP CRM>' AND PRIVILEGE = 'SELECT' AND IS_GRANTABLE = 'TRUE' AND
IS_VALID = 'TRUE'
```

If you get a result, the user `_SYS_REPO` is allowed to select data from the schema of your embedded SAP ERP or SAP CRM system.

2. If you are not familiar with the SQL Console choose the *Modeler* perspective in the upper right corner.
3. In the *Navigator* section on the left, expand the folder of your SAP HANA database.
4. Expand the corresponding *Security* folder and the *Users* folder.
5. Double-click the `_SYS_REPO` user.
6. On the *Granted Roles* tab check if role `ABAP_SYS_REPO` is assigned. If the role is assigned, double click the role. The role will be opened in a new tab.
7. Navigate to *Object Privileges* tab. Check that the schema of your embedded deployed SAP ERP or SAP CRM system is displayed and marked as *Grantable to others*.

If you cannot find the `SELECT` authorization for your embedded deployed SAP ERP or SAP CRM system add the following authorizations to the `_SYS_REPO` user of your SAP Hybris Marketing system:

1. Log on to the SAP HANA studio with the `SAP<SID>` user of your embedded deployed SAP ERP or SAP CRM system.
2. Choose the *Modeler* perspective in the upper right corner.
3. In the *Navigator* section on the left, expand the folder of your SAP HANA database.
4. Expand the corresponding *Security* folder and the *Users* folder.
5. Double-click the `_SYS_REPO` user.
6. In the center section, choose the *Object Privileges* tab, and choose the `+` pushbutton.
7. In the following *Select Catalog Object* dialog box, search for the schema of your embedded deployed SAP ERP or SAP CRM system.

8. Select the privilege *SELECT* and the corresponding *Grantable to Others* option.
9. Save the `_SYS_REPO` user.

The *SELECT* authorization is required for SAP HANA content activation. The `_SYS_REPO` user is a system user that actually activates the SAP HANA content regardless of which user started the activation. The user takes all models and creates the corresponding runtime objects. After having activated all models the `_SYS_REPO` user grants read access to the activated models to the user that started the activation. For this reason, the *Grantable to Others* option is required.

## More Information

For more information about granting privileges to users, see the SAP HANA Developer Guide under *Setting Up Roles and Authorizations* → *Privileges* → *Granting Privileges to Users*. See the SAP Help Portal at:

[http://help.sap.com/hana\\_appliance](http://help.sap.com/hana_appliance) ▶ *Development and Modeling* ▶ *SAP HANA Developer Guide* ▶

([http://help.sap.com/hana/SAP\\_HANA\\_Developer\\_Guide\\_en.pdf](http://help.sap.com/hana/SAP_HANA_Developer_Guide_en.pdf))

## 7.3 Profile Parameter Settings

SAP Hybris Marketing requires several profile parameter settings, for example, to set up HTTPS connections.

After you have set the required profile parameters, restart your system to make the parameter changes effective.

### 7.3.1 Configuring HTTPS

We recommend to realize the communication of the SAP Web Dispatcher (see section *Installing the SAP Web Dispatcher [page 27]*) with the SAP NetWeaver system via HTTPS.

To prepare the system for HTTPS communication, log on with the *User for Application Setup [page 47]*, go to transaction `RZ10`, and configure an HTTPS port in the instance profile of the system.

The following example shows how these parameters may be set:

#### Example

```
icm/server_port_1 = PROT=HTTPS, PORT=443$$
```

For more information, see the SAP Help Portal at:

<http://help.sap.com/nw75> ▶ *Application Help* ▶ *Function-Oriented View* ▶ *Application Server* ▶ *Application Server Infrastructure* ▶ *Components of SAP NetWeaver Application Structure* ▶ *Internet Communication Manager (ICM) - SAP NetWeaver* ▶ *Administration of the ICM-SAPNetWeaver* ▶ *ICM Parameters -Reference for ABAP and Java* ▶



([http://help.sap.com/saphelp\\_nw75/helpdata/en/26/4e0677f391432fb0af513731bbf58d/content.htm](http://help.sap.com/saphelp_nw75/helpdata/en/26/4e0677f391432fb0af513731bbf58d/content.htm)).

## 7.3.2 Configuring the Secure Sockets Layer Protocol

To secure HTTP connections to and from the SAP NetWeaver system you use the Secure Sockets Layer (SSL) protocol.

To configure SSL, follow the instructions of the documentation in the SAP Help Portal at:

<http://help.sap.com/nw75> ► [Application Help](#) ► [Function-Oriented View](#) ► [Security](#) ► [Network and Transport Layer Security](#) ► [Transport Layer Security on the AS ABAP](#) ► [Configuring the AS ABAP to Support SSL](#) ►

([http://help.sap.com/saphelp\\_nw75/helpdata/en/49/23501ebf5a1902e10000000a42189c/content.htm](http://help.sap.com/saphelp_nw75/helpdata/en/49/23501ebf5a1902e10000000a42189c/content.htm))

### **i** Note

You can check whether the SAP Cryptographic Library software is already installed in your system by doing the following:

1. Go to transaction `STRUST`.
2. Choose ► [Environment](#) ► [Display SSF\\_Version](#) ►. If the system response shows that the `SAPCRYPTOLIB` is installed, then you can skip the installation step for the Cryptographic Library in the documentation cited above.

## 7.4 Displaying the SAP Online Documentation

SAP currently provides an HTML-based solution for the online documentation, including the Application Help, the Web Assistant, Glossary, Implementation Guide (IMG), and Release Notes. You can display the documentation with a JavaScript-compatible Web browser on all front-end platforms supported by SAP.

To ensure the display of the online documentation in SAP Hybris Marketing, you must do the following:

- Considering documentation-relevant parameters in your SAP Web Dispatcher configuration
- Enabling context-sensitive user assistance in your AS ABAP system
- Setting up the User Assistance Plugin

### Considering Documentation-Relevant Parameters in the SAP Web Dispatcher Configuration

If you want to make context-sensitive user assistance available in the SAP Fiori launchpad, you must configure the SAP Web Dispatcher. The steps to be executed are included in the section about the SAP Web Dispatcher configuration, see section [Considering Documentation-Relevant Parameters](#) in [Configuring the SAP Web Dispatcher \[page 43\]](#).

## Enabling Context-Sensitive User Assistance in Your AS ABAP System

You need to do these settings in the AS ABAP system which you use to create your system configuration setting. After you have done the settings, you save them, create a transport for them, and transport them to your productive system(s).

Proceed as follows:

1. Open transaction `SR13`.
2. Select the tab *PlainHtmlHttp*.
3. Choose *New Entry*. Enter the following values:

Table 9:

Name	Value to Be Entered
<i>Variant</i>	Enter a name for the variant (any name).
<i>Platform</i>	Select the platform relevant for your implementation, for example, <b>WN32</b> .
<i>Area</i>	Select <i>XML Documentation</i> . This will display as <i>XML_DOCU</i> in the table.
<i>Server Name</i>	Enter <b>https://cp.hana.ondemand.com</b>
<i>Path</i>	Enter <b>dps/d/ahp/1611%20YMKT</b>
<i>Language</i>	Select the language you need.
<i>Default</i>	Select <b>one</b> entry as default per platform.

4. Repeat step 3 for each relevant platform and language.
5. Save your changes and create a transport.

## Setting up the User Assistance Plugin

To make context-sensitive user assistance available in the SAP Fiori launchpad, you set up the user assistance plugin as follows:

1. You create a catalog.  
For information about creating catalogs, see the documentation about the *SAP Fiori Launchpad* on SAP Help Portal at:  
<https://help.sap.com/nw75> ➤ *Application Help* ➤ *UI Technologies in SAP NetWeaver with SAP\_UI 750* ➤ *SAP Fiori Launchpad* ➤ *Setting Up Launchpad Content* ➤ *Best Practices for Setting Up Content* ➤ *Configure Custom Catalogs and Groups* ➤  
([http://help.sap.com/saphelp\\_nw75/helpdata/en/af/35d42e7d4f49d7b8e46080cd01c299/content.htm](http://help.sap.com/saphelp_nw75/helpdata/en/af/35d42e7d4f49d7b8e46080cd01c299/content.htm))
2. You create a role that references the catalog.

For more information about creating roles for tile catalogs, see the documentation about the *SAP Fiori Launchpad* on SAP Help Portal at:

<https://help.sap.com/nw75> **»** *Application Help* **»** *UI Technologies in SAP NetWeaver with SAP\_UI 750* **»** *SAP Fiori Launchpad* **»** *Setting Up Launchpad Content* **»** *Configuring Authorization Roles* **»** *Configuring Roles for Tile Catalogs and Groups* **»** *Configure Roles for Tile Catalogs* **»**  
 ([http://help.sap.com/saphelp\\_nw75/helpdata/en/90/d6b4e61091405e99bad598ee654eff/content.htm](http://help.sap.com/saphelp_nw75/helpdata/en/90/d6b4e61091405e99bad598ee654eff/content.htm))

3. You assign the role to every user that needs to access the context-sensitive user assistance.
4. In the catalog, you create a target mapping with the following values:

Table 10:

Field Label	Value
<i>Semantic Object</i>	<b>Shell</b>
<i>Action</i>	<b>plugin</b>
<i>Application Type</i>	<b>SAPUI5 Fiori App</b>
<i>Title</i>	<b>User Assistance Plugin</b>
<i>URL</i>	<b>/resources/sap/dfa/help/utils/adapters/fiori</b>  This requires that the SAP Web Dispatcher is set up accordingly so that this URL is routed to the script server.
<i>Component</i>	<b>sap.dfa.help.utils.adapters.fiori</b>
<i>Information</i>	<b>User Assistance Plugin, relevant for all app users</b>
<i>Device Types</i>	Select your devices: <ul style="list-style-type: none"> <li>○ <i>Desktop</i></li> <li>○ <i>Tablet</i></li> <li>○ <i>Phone</i></li> </ul>
<i>Parameters</i>	Enter the following parameters in the table: <ul style="list-style-type: none"> <li>○ <i>Name: <b>product</b>; Default Value: <b>SAP_HYBRIS_MARKTING</b></i></li> <li>○ <i>Name: <b>version</b>; Default Value: <b>1611 YMKT</b></i></li> <li>○ <i>Name: <b>editor</b>; Default Value: <b>false</b></i></li> </ul>

After you have made these setting, the user assistance icon is available for the SAP Fiori launchpad.

## 7.5 Configuring the SAP Web Dispatcher

To configure the SAP Web Dispatcher you must set up a few communication channels. To do so, proceed as follows.

## Communication Between SAP Web Dispatcher and Clients

To configure the communication between clients (for example, your browser) and the SAP Web Dispatcher, follow the instructions under [http://help.sap.com/fiori\\_bs2013](http://help.sap.com/fiori_bs2013) ► *System Landscape Required for SAP Fiori* ► *Setup of SAP Fiori System Landscape with SAP HANA Database* ► *Communication Channels* ► *Communication Between Client and SAP Web Dispatcher* ► *Configuring Communication Channel between Clients and SAP Web Dispatcher*.

([http://help.sap.com/fiori\\_bs2013/helpdata/en/f8/0f4453d2e57425e10000000a44176d/content.htm](http://help.sap.com/fiori_bs2013/helpdata/en/f8/0f4453d2e57425e10000000a44176d/content.htm))

As a result, your SAP Web Dispatcher will support HTTPS connections. Keep your HTTPS port in mind.

## Communication Between SAP Web Dispatcher and AS ABAP

To configure the communication between the SAP Web Dispatcher and the SAP Hybris Marketing AS ABAP server, follow the instructions in sections *Defining Routing Rules for SAP Web Dispatcher and ABAP Front-End*, *Defining Routing Rules for SAP Web Dispatcher and ABAP Backend*, and *Configuring Trust Between SAP Web Dispatcher and ABAP Servers* under [http://help.sap.com/fiori\\_bs2013](http://help.sap.com/fiori_bs2013) ► *System Landscape Required for SAP Fiori* ► *System Landscape* ► *Setup of Fiori System Landscape with SAP HANA Database* ► *Communication Channels* ► *Communication Between SAP Web Dispatcher and ABAP Servers*.

([http://help.sap.com/fiori\\_bs2013/helpdata/en/49/e243539b47e344e10000000a423f68/content.htm](http://help.sap.com/fiori_bs2013/helpdata/en/49/e243539b47e344e10000000a423f68/content.htm))

Your SAP Hybris Marketing server is the AS ABAP front-end and back-end server.

## Communication Between SAP Web Dispatcher and SAP HANA XS

To set up communication between the SAP Web Dispatcher and SAP HANA Extended Application Services, follow the instructions under [http://help.sap.com/fiori\\_bs2013](http://help.sap.com/fiori_bs2013) ► *System Landscape Required for SAP Fiori* ► *System Landscape* ► *Setup of Fiori System Landscape with SAP HANA XS* ► *Communication Channels* ► *Communication Between SAP Web Dispatcher and SAP HANA XS*.

([http://help.sap.com/fiori\\_bs2013/helpdata/en/49/e243539b47e344e10000000a423f68/content.htm](http://help.sap.com/fiori_bs2013/helpdata/en/49/e243539b47e344e10000000a423f68/content.htm))

### **i** Note

The communication paths for communication between the SAP Web Dispatcher and the SAP HANA Extended Application Services must be disjunct to be paths for communication between the SAP Web Dispatcher and the SAP Hybris Marketing AS ABAP server.

When you define the routing rules between SAP Web Dispatcher and SAP HANA Extended Application Services, add `/sap/hana-app` and `/sap/ui5` as a routing rule.

During configuration a number of changes are made to the SAP Web Dispatcher profile. The following list shows a sample profile after configuration.

## Example

### **i** Note

The example does not ensure the proper run of the SAP Web Dispatcher in your system. Adapt your settings according to your specific system requirements.

### Sample Code

```
SAPSYSTEMNAME = WEB
SAPSYSTEM = 02
INSTANCE_NAME = W02
DIR_CT_RUN = $(DIR_EXE_ROOT)$ (DIR_SEP) $(OS_UNICODE) $(DIR_SEP) linuxx86_64
DIR_EXECUTABLE = $(DIR_CT_RUN)
DIR_PROFILE = $(DIR_INSTALL)/profile
_PF = $(DIR_PROFILE)/WEB_W02_mo-29b02f1eb
SETENV_00 = DIR_LIBRARY=$(DIR_LIBRARY)
SETENV_01 = LD_LIBRARY_PATH=$(DIR_LIBRARY):%(LD_LIBRARY_PATH)
SETENV_02 = SHLIB_PATH=$(DIR_LIBRARY):%(SHLIB_PATH)
SETENV_03 = LIBPATH=$(DIR_LIBRARY):%(LIBPATH)
SETENV_04 = PATH=$(DIR_EXECUTABLE):%(PATH)
#-----
# Accessibility of Message Server
#-----
rdisp/mshost = mo-29b02f1eb
ms/http_port = 8100
#-----
# Configuration for medium scenario
#-----
icm/max_conn = 500
icm/max_sockets = 1024
icm/req_queue_len = 500
icm/min_threads = 10
icm/max_threads = 50
mpi/total_size_MB = 80
#-----
# SAP Web Dispatcher Ports
#-----
icm/server_port_0 = PROT=HTTP,HOST=mo-29b02f1eb,PORT=81$$
icm/server_port_1 = PROT=HTTPS,HOST=mo-29b02f1eb,PORT=82$$
icm/HTTP/admin_0 = PREFIX=/sap/admin,DOCROOT=$(DIR_DATA) $(DIR_SEP)
icmandir,AUTHFILE=$(icm/authfile),PORT=81$$;82$$
#-----
# Start Web Dispatcher
#-----
_WD = wd.sap$(SAPSYSTEMNAME)_$(INSTANCE_NAME)
Execute_00 = local rm -f $_WD
Execute_01 = local ln -s -f $(DIR_EXECUTABLE)/sapwebdisp$(FT_EXE) $_WD
Start_Program_00 = local $_WD pf=$_PF
SETENV_05 = SECUDIR=$(DIR_INSTANCE)/sec
wdisp/ping_protocol = https
wdisp/group_info_protocol = https
wdisp/url_map_protocol = https
ssl/ssl_lib = /usr/sap/WEB/SYS/exe/nuc/linuxx86_64/libsapcrypto.so
ssl/server_pse = /usr/sap/WEB/W02/sec/sapssls.pse
icm/HTTPS/verify_client = 0
ssl/client_pse = /usr/sap/WEB/W02/sec/sapssls.pse
wdisp/ssl_encrypt = 1
wdisp/ssl_auth = 2
wdisp/ssl_cred = /usr/sap/WEB/W02/sec/sapssls.pse
icm/HTTPS/forward_ccert_as_header = true
wdisp/system_conflict_resolution = 1
wdisp/add_client_protocol_header = 1
wdisp/handle_webdisp_ap_header = 1
wdisp/add_xforwardedfor_header = true
```

```

#-----
#Forwarding Rule to AS ABAP
#-----
wdisp/system_0 = SID=NW1, NR=01, MSHOST=mo-29b02f1eb.mo.sap.corp, MSPORT=8100,
SRCURL=/sap/opu;/sap/bc;/sap/public;/sap/es;/sap/cuan;/sap/ushell_config
#-----
#Forwarding Rule to SAP HANA XS
#-----
wdisp/system_2 = SID=HNA, EXTSRV=https://mo-02d2d957f.mo.sap.corp:4300,
SRCURL=/sap/hba;/sap/hana;/sap/hana-app;/sap/ui5;/sap/ead;/sap/bi
#-----
#Forwarding Rule to Content Server
#-----
wdisp/system_<number> = SID=<SID1>, EXTSRV=https://cp.hana.ondemand.com,
SRCURL=/sap/dfa/help/, SRCSRV=*,*, STANDARD_COOKIE_FILTER=OFF
#-----
#Forwarding Rule to Script Server
#-----
wdisp/system_<number> = SID=<SID2>, EXTSRV=https://xray.hana.ondemand.com,
SRCURL=/resources/sap/dfa/help/, SRCSRV=*,*, STANDARD_COOKIE_FILTER=OFF

```

## Considering Documentation-Relevant Parameters

If you want to make context-sensitive user assistance available in the SAP Fiori launchpad, you must configure the SAP Web Dispatcher.

### 1. Adjust the SAP Web Dispatcher profile file.

In the `sapwebdisp_pf.txt` file, add the following parameters:

- For the User Assistance Content Platform:
 

```
wdisp/system_<number> = SID=<SID1>, EXTSRV=https://cp.hana.ondemand.com,
SRCURL=/sap/dfa/help/, SRCSRV=*,*, PROXY=<your proxy>:<your proxy port>,
STANDARD_COOKIE_FILTER=OFF
```
- For the script server in your production system:
 

```
wdisp/system_<number> = SID=<SID2>, EXTSRV=https://xray.hana.ondemand.com,
SRCURL=/resources/sap/dfa/help/, SRCSRV=*,*, PROXY=<your proxy>:<your proxy
port>, STANDARD_COOKIE_FILTER=OFF
```

### **i** Note

- Make sure that the numbers following `wdisp/system_` are smaller than the numbers that you use for all your application server. The rules for the context-sensitive user assistance need to come before the rules for the application servers.
- Make sure that the SIDs are not the same as your system IDs.

### 2. Activate the usage of the modification handler:

```
icm/HTTP/mod_0 = PREFIX=/, FILE=$(DIR_PROFILE)/redirect.txt
```

For more information about the profile parameter, see SAP Help Portal at:

<http://help.sap.com/nw75> ▶ *Application Help* ▶ *Function-Oriented View* ▶ *Application Server* ▶ *Application Server Infrastructure* ▶ *Components of SAP NetWeaver Application Server* ▶ *SAP Web Dispatcher* ▶ *Administration of the SAP Web Dispatcher* ▶ *SAP Web Dispatcher Parameters - Reference* ▶ *icm/HTTP/mod\_<xx>* ▶ [http://help.sap.com/saphelp\\_nw75/helpdata/en/6a/d519e582334d94a3372e9992680e33/content.htm](http://help.sap.com/saphelp_nw75/helpdata/en/6a/d519e582334d94a3372e9992680e33/content.htm)

3. Adjust the SAP Web Dispatcher redirect file:  
In the `redirect.txt` file, add the following parameters:

#### Code Syntax

```
# User Assistance Content Platform - rewrite rule
if %{SID} = <SID1>
begin
SetHeader HOST cp.hana.ondemand.com
RegRewriteRawUrl ^/sap/dfa/help/(.*) /dps/$1
end
# Script Server - rewrite rule
if %{SID} = <SID2>
begin
SetHeader HOST xray.hana.ondemand.com
RegRewriteRawUrl ^/resources/sap/dfa/help/(.*) /xRayControls/resources/sap/dfa/
help/$1
end
```

#### Note

Make sure that the SIDs in the `redirect.txt` file are the same as in the `sapwebdisp_cf.txt` file.

## Restart of SAP Web Dispatcher

After you have made these changes, restart your SAP Web Dispatcher.

## 7.6 Prerequisites in AS ABAP System

Before you carry out the technical configuration, you need to do the following:

- Allow system changes to the relevant clients
- Create development packages (development and configuration system only)

### 7.6.1 User for Application Setup

For the technical configuration of SAP Hybris Marketing, system settings must be changed and application setup steps must be performed. You therefore need an application user that can carry out the following tasks:

- Change **client settings**.
- Create a **development package**.
- Start the **technical configuration** in the *Technical Configuration Cockpit*, which sets up the application environment that is, for example, relevant for the activation of ICF services.
- Set profile **parameters**.

To ensure an error-free configuration procedure, the user in the production client of your AS ABAP system needs the following set of roles.

Table 11:

Role	You need to
Z_RT_GW_USER	Create the role, then assign it to the application setup user.
SAP_MARKETING_TECHNICAL_CONF	Assign it to the application setup user
SAP_CUSTOMER_ANALYTICS_ADMIN	Assign it to the application setup user.
SAP_BC_CTS_ADMIN	Assign it to the application setup user.
SAP_BC_SIW_DEV	Assign it to the application setup user.
SAP_BC_WEBSERVICE_ADMIN_TEC	Change the role, then assign it to the application setup user.
SAP_BC_DB_ADMIN	Change the role, then assign it to the application setup user.
SAP_BC_BASIS_ADMIN	Change the role, then assign it to the application setup user.
SAP_CEI_KUA	If you want to use <i>SAP Smart Business, executive edition</i> for running the Marketing Executive Dashboard or the Lead Dashboard (see <a href="#">Configuring SAP Smart Business, executive edition [page 86]</a> ), copy this role, then assign it to the application setup user.

In the following, you find information about how to create a specific user with the required roles.

Proceed as follows:

## Create Role Z\_RT\_GW\_USER

In order to start external services, you first need to create a new single role and clear your cache:

1. Go to transaction PFCG and create a new role.
2. Choose the *Change Authorization Data* pushbutton in the *Maintain Authorization Data and Generate Profiles* section on the *Authorizations* tab.
3. When entering the *Change Role: Authorizations* screen you are provided with a list of templates. Select the following template: /IWFND/RT\_GW\_USER. Choose *Adopt References*.
4. You see a yellow light for the *Cross-application Authorization Objects* node. Drill down to **►** *Check at Start of External Services* **►** *Check at Start of External Services* **►** by expanding the corresponding nodes.
5. Open *Program, transaction or function* in edit mode. In the dialog box that appears, select TADIR Service and then choose the *Full Authorization* pushbutton. Save your entries.
6. Choose the **+** *Manually* pushbutton, add the S\_USER\_GRP authorization object, and choose *Continue*.
7. Under the *Basis: Administration* node, expand the *User Master Maintenance: User Groups (S\_USER\_GRP)* node.



8. Set the following values for the *User Master Maintenance: User Groups* (S\_USER\_GRP) authorization object:
  1. Open *Activity* (ACTVT) in edit mode and choose the *Full authorization* pushbutton. Save your entries.
  2. Open *User group in user master maintenance* (CLASS) in edit mode and choose the *Full authorization* pushbutton. Save your entries.
9. Choose the + *Manually* pushbutton, add the /UI2/CHIP authorization object, and choose *Continue*.
10. Under the *Basis: Administration* node, expand the *Page Building Service: CHIP* node.
11. Set the following values for the *Page Building Service: CHIP* (/UI2/CHIP) authorization object:
  1. Open *Web Dynpro ABAP: CHIP ID* (/UI2/CHIP) in edit mode and set the value to X-SAP-UI2\*. Save your entries.
  2. Open *Activity* (ACTVT) in edit mode and check the value 06 (*Delete*). Save your entries.
12. Generate a profile for the authorizations.

## Change Standard Roles

Make changes to the following roles:

- Role SAP\_BC\_WEBSERVICE\_ADMIN\_TEC:
  1. Call up role SAP\_BC\_WEBSERVICE\_ADMIN\_TEC in transaction PFCG in change mode.
  2. Switch to the *Authorizations* tab and choose the *Change Authorization Data* pushbutton under *Maintain Authorization Data and Generate Profiles*.
  3. Expand node *Basis: Administration*, then node *SOAP Runtime: Web Service Provider Configuration* (authorization object S\_SRT\_CF\_P). In field *Activity*, add the value 01 (*Create*).
  4. Save the changes and generate the profile.
- Role SAP\_BC\_DB\_ADMIN must be enhanced by the authorization for table access:
  1. Call up role SAP\_BC\_DB\_ADMIN in transaction PFCG in change mode.
  2. Switch to the *Authorizations* tab and select the *Change Authorization Data* pushbutton under *Maintain Authorization Data and Generate Profiles*.
  3. Expand the *Basis: Administration* node, then expand the *Table Access via Generic Standard Tools* node (authorization object S\_TABU\_NAM). In field *Activity*, add the values 02 (*Change*) and 03 (*Display*).
  4. Regenerate the profile. Check if a user comparison is required.
- Role SAP\_BC\_BASIS\_ADMIN must be enhanced by the authorization to access the *Trust Manager* for SSL setup purposes:
  1. Call up role SAP\_BC\_BASIS\_ADMIN in transaction PFCG in change mode.
  2. Switch to the *Authorizations* tab and choose the *Change Authorization Data* pushbutton under *Maintain Authorization Data and Generate Profiles*.
  3. Expand the *Cross-application Authorization Objects* node, then expand the *Transaction Code Check at Transaction Start* node.
  4. Choose the + *Manually* pushbutton. Enter the authorization object S\_TCODE and choose *Execute*.
  5. Now choose the *Edit* pushbutton next to the transaction code you just created.
  6. In field '*From*', enter **STRUST**, then save.
  7. Regenerate the profile. Check if a user comparison is required.

## Create a User for Application Setup and Assign the Relevant Roles

Before you assign a single role to a user you have to ensure that its role profile is generated.

To do this, call up the role in transaction `PFCG` in change mode, switch to the *Authorizations* tab and choose the *Change Authorization Data* pushbutton under *Maintain Authorization Data and Generate Profiles*. Then choose the pushbutton *Generate*.

For more information about profile generation, see the SAP Help Portal at:

<http://help.sap.com/nw75> ► *Application Help* ► *Function-Oriented View* ► *Security* ► *Identity Management* ► *User and Role Administration of Application Server ABAP* ► *Configuration of User and Role Administration* ► *Role Administration* ► *Role Administration Functions* ► *Generating Authorization Profiles* ►  
([http://help.sap.com/saphelp\\_nw75/helpdata/en/73/9317502c729d38e10000000a44176d/content.htm](http://help.sap.com/saphelp_nw75/helpdata/en/73/9317502c729d38e10000000a44176d/content.htm))

### **i** Note

Remember to also generate profiles for the single roles included in composite role `SAP_MARKETING_TECHNICAL_CONF`.

Now, create a user for application setup and assign the following roles.

1. Go to transaction `SU01` to create a new user.
2. Assign the following roles
  - `Z_RT_GW_USER`
  - `SAP_MARKETING_TECHNICAL_CONF` (composite role)
  - `SAP_BC_CTS_ADMIN`
  - `SAP_BC_WEBSERVICE_ADMIN_TEC`
  - `SAP_BC_DB_ADMIN`
  - `SAP_BC_BASIS_ADMIN`

You can lock the users after successful configuration of SAP Hybris Marketing. The user is needed again when you carry out an upgrade of SAP Hybris Marketing.

## 7.6.2 Maintaining the Client

SAP Hybris Marketing uses Operational Data Provisioning (ODP) for the access of SAP HANA content. For the configuration of ODP within your development and configuration system, you must allow system changes on the relevant clients. To do so, proceed as follows:

1. Log on to the system with the user that you have created in section [User for Application Setup \[page 47\]](#).
2. Execute transaction `SCC4` for client maintenance. Ensure that a logical system is assigned to the client that will be used for SAP Hybris Marketing.

For more information on logical system assignment, see the SAP Help Portal at:

<http://help.sap.com/nw75> ► *Application Help* ► *Function-Oriented View* ► *Security* ► *Identity Management* ► *User and Role Administration of Application Server ABAP* ► *Configuration of User and Role Administration* ► *Central User Administration* ► *Setting Up Central User Administration* ► *Setting Up Logical Systems* ►

([http://help.sap.com/saphelp\\_nw75/helpdata/en/b4/b0b13bb3acef3ce10000000a11402f/content.htm](http://help.sap.com/saphelp_nw75/helpdata/en/b4/b0b13bb3acef3ce10000000a11402f/content.htm))

3. Set the field *Cross-Client Object Changes* to *No changes to cross-client Customizing objects*.

Then, ensure that the system changes become effective in the BW namespaces:

1. Go to transaction SE03.
2. Choose **Administration** > **Set System Change Option**. Set the *Global* setting to modifiable.
3. Set the attribute *Modifiable* for the namespaces /BIC/ and /BI0/.
4. Set your own namespaces to *Modifiable* by setting component LOCAL and customer name spaces to *Modifiable*.

For more information, see the SAP Help Portal at:

<http://help.sap.com/nw75> > **Application Help** > **Function-Oriented View** > **Application Server** > **Application Server ABAP** > **Administration of Application Server ABAP** > **Change and Transport System** > **Transport Organizer (BC-CTS-ORG)** > **Requirements for Working with the Transport Organizer** > **Setting the System Change Option**

([http://help.sap.com/saphelp\\_nw75/helpdata/en/57/38de9b4eb711d182bf0000e829fbfe/content.htm](http://help.sap.com/saphelp_nw75/helpdata/en/57/38de9b4eb711d182bf0000e829fbfe/content.htm))

For general information about *Namespaces and Naming Conventions*, see the SAP Help Portal at:

<http://help.sap.com/nw75> > **Application Help** > **Function-Oriented View** > **Application Server** > **Application Server ABAP** > **Administration of Application Server ABAP** > **Change and Transport System** > **Namespaces and Naming Conventions (BC-CTS-NAM)**

([http://help.sap.com/saphelp\\_nw75/helpdata/en/2a/6b0afe547a11d189600000e829fbbd/content.htm](http://help.sap.com/saphelp_nw75/helpdata/en/2a/6b0afe547a11d189600000e829fbbd/content.htm))

In your productive system, you must also ensure that system changes to software component LOCAL are allowed:

1. Execute transaction SE03.
2. Choose **Administration** > **Set System Change Option**. Set the *Global Setting* to *Modifiable* in order to be able to set component LOCAL to modifiable.
3. Set the component LOCAL to *Modifiable*. All other components and name spaces can be set to *Not modifiable*.

## 7.6.3 Creating Development Packages

You can skip this step if your system is a production system that is supplied with transports from a development and configuration system.

If your system is a development and configuration system, you need to create two separate development packages for the following content:

- Generated OData services
- BI content.

The development requests need to be transported through your system landscape.

To create the development packages, proceed as follows:

1. Log on to the system with the user for application setup that you have created in section [User for Application Setup \[page 47\]](#).
2. Create a workbench request for transports to the productive system (see [Releasing Transport Requests in Development System \[page 66\]](#)).

- Execute transaction SE80 and choose the entry *Package* in the dropdown box to the left. Enter a name for the new package for generated OData services, then press the enter key. In the following dialog box, confirm that you want to create a new package. Enter a short description and a transport layer. Confirm your entries.
- Repeat step 3, this time creating a package for activated BI content.

## 7.7 Using the Technical Configuration Cockpit

SAP Hybris Marketing requires several technical configuration steps that need to be carried out after installation.

### **i** Note

We recommend that you first complete the technical configuration in your development and configuration system, then in the productive system.

The technical configuration cockpit is an application that helps you to carry out the bulk of technical steps.

### **i** Note

Before you start the technical configuration cockpit for the very first time **in a closed system such as a productive system**, the required runtime objects are stored locally, ensure the following settings in your system:

- In transaction SE03, under node *Administration* of the *Transport Organizer Tools* tree, double-click *Set System Change Option*. Ensure that the *Global Setting* field as well as the software component *Local Developments (No Automatic Transport) (LOCAL)* are set to *Modifiable*.
- In transaction SCC4, double-click the client, in which you want to execute the technical configuration cockpit. Ensure that the *Changes and Transports for Client-Specific Objects* are **not** set to *No changes allowed*. In addition, ensure that *Cross-Client Object Changes* are set to *Changes to repository and cross-client customizing allowed*.

You can change these settings according to your requirements after the very first start of the technical configuration cockpit.

To start the technical configuration cockpit, run transaction CUAN\_INITIAL\_SETUP with the user for application setup (see section [User for Application Setup \[page 47\]](#)) in your AS ABAP system. First, you have to provide the fully qualified domain main and the port of your SAP Web Dispatcher (see section [Configuring the SAP Web Dispatcher \[page 43\]](#)).

The technical configuration cockpit consists of clickable tiles that are divided into separate sections, which are described in the chapters below.

### **i** Note

To speed up the post-installation process and to avoid errors, we strongly recommend that you use the technical configuration cockpit.

If you are not able to use the technical configuration cockpit due to, for example, authorization restrictions, you can fall back on the expert mode (see section [Technical Configuration - Expert Mode \[page 155\]](#)). In this case, you will need to carry out all steps in the back end, with much less tool assistance.

## 7.7.1 Section "Overview"

In this section, you are provided with information about your AS ABAP back-end system.

- [SAP Hybris Marketing Product Version](#) provides information about the installed software components and their versions. In addition, you can check whether the installed component versions are compatible with the current release of SAP Hybris Marketing, and whether an upgrade is required.
- [Users Online](#) provides information about the number of logged on users. Based on this information, you can decide whether to start your configuration activities while other activities may be still ongoing in the system.
- [Systems Connected](#) includes a graphical representation of the most relevant components currently connected in your system landscape, such as SAP Web Dispatcher, or an SAP ERP system. It also indicates the status of the connections and includes other connection information such as server name and port. Note that some components and connections are added during the scenario configuration, depending on your functional scope, and integration options.
- [Notes of RIN Implemented](#) provides information about the SAP Notes to be implemented, and about the current implementation status. The information is derived from the Release Information Note (RIN), which you can access from the cockpit. You can download the relevant SAP Notes into your system. Implement the SAP Notes using transaction `SNOTE` in your AS ABAP back-end system. Note that you must implement specific notes before you configure any scenario, and others after the scenario configuration.

## 7.7.2 Section "Scenarios"

In this section, you are provided with the available technical configuration scenarios. With the scenarios, the cockpit follows an additive approach dividing the technical configuration into smaller executable parts: the basic configuration (scenario [Essentials](#)), which is mandatory, and additional configuration that is optional and depends on your scope.

You can execute any optional scenario at any time, either directly after the execution of [Essentials](#), or at a later point in time.

Every scenario consists of a description, the [Progress](#) section, and the [Parameters](#) section.

The [Progress](#) section is visible only once the configuration check or the configuration run has been started. It includes clickable icons representing a task of the task list behind the scenario. Clicking the icon provides you with more information about task and its configuration status.

In the [Parameters](#) section you have to provide the required input. The parameter fields are explained below in the dedicated scenario descriptions for each scenario.

Once you provided the parameter values for a scenario, you choose the [Check Configuration](#) pushbutton first, to let the system check your input. If the check is completed successfully, you choose the [Run Configuration](#) pushbutton to execute the technical configuration scenario.

### **i** Note

You can run every configuration multiple times by choosing the [Run Configuration](#) pushbutton.

The following scenarios are available:

- [Essentials](#)
- [ERP Integration](#)
- [CRM Integration](#)
- [HANA Rules Framework](#)
- [Marketing Executive Dashboard](#)
- [Campaign Management](#)
- [Lead Management with Cloud for Customer Integration](#)
- [Recommendation](#)

### 7.7.2.1 Scenario "Essentials"

#### **i** Note

This scenario is mandatory for the setup of SAP Hybris Marketing and must be executed before any other scenario. The scenario enables a basic configuration that allows the display of the SAP Hybris Marketing user interface without any integration to other systems once all following steps (of section [Post-Installation](#)) are carried out.

The following is an extract of the steps that are automatically carried out by [Essentials](#):

- The execution of **task list** CUAN\_BASE\_CONFIG is automatically triggered.
- **Users** needed for post-installation steps are created automatically (where possible)
- **Workbench and Customizing requests** are created (for development systems):

Table 12:

<b>Customizing Requests</b>	<ul style="list-style-type: none"><li>◦ <a href="#">Common Customizing Activities</a></li></ul>
<b>Workbench Requests</b>	<ul style="list-style-type: none"><li>◦ <a href="#">Activated BI Queries</a></li><li>◦ <a href="#">Common Workbench Objects</a></li></ul>

#### **i** Note

The transport requests must be released manually and imported in the production system in a predefined sequence. For details, see [Releasing Transport Requests in Development System \[page 66\]](#).

- **BI content** and **OData services** are activated (for development systems).
- **Background jobs** are scheduled and executed.  
In transaction `SJOBREPO`, you can check, which jobs are delivered with SAP Hybris Marketing. The name of the relevant job definitions is `SAP_CUAN_<*>`, while job definitions and job names are identical. In column *JD Status* (Job Definition Status), you can check whether a job definition is scheduled in a task list. By double-clicking a job definition, you can see the meta data of a job such as frequency or name of the corresponding program.  
In transaction `SM37`, you can check which jobs are scheduled or executed. In addition, you can change the default frequency of regular background jobs.

- **Full text indexes** are generated.

You must provide values for the following parameters in *Essentials*:

- **Role of System:**

For this field, you have the following options:

- **Dev. System:** If you run the technical configuration in a development or configuration system (such as an integration system), the system creates objects according to your settings in the wizard and writes them to a transport request.
- **Prod. System:** If you run the technical configuration in a production system (such as a consolidation system), the system does not create any objects according to your settings in the wizard, but the system is capable to import objects via a transport request from a development or configuration system.
- **Local System:** If you run the technical configuration in another system (such as a demo system), the system creates objects according to your configuration settings, but does **not** write them to a transport request.

### Caution

Note that changing the *Role of System* entry is not possible anymore once you have started the technical configuration.

For example, if you configured the system as a demo system you cannot convert it into a development or production system. These system types would need to be created from scratch.

### Note

Ensure that the selected system type matches with the corresponding entries in transaction *SCC4* (field *Client role* and related entries):

- If you select *Dev. System* in field *Role of System*, the entry in the *Client role* field (transaction *SCC4*) must be other than *Production*.
- If you select *Prod. System* in field *Role of System*, the entry in the *Client role* field (transaction *SCC4*) must be other than *Customizing*.

- **User for SAP HANA Database Connection:**

In this field, you enter the SAP HANA user that you created in section [SAP HANA User for Technical Configuration \[page 37\]](#). The user enables executing changes, for example, granting privileges to other users, in the SAP HANA database during the configuration of the system. By default, the user is `TC_USER`. As you need the user also for an upgrade of SAP Hybris Marketing, we recommend to deactivate the user after technical configuration rather than deleting it.

- **Password:**

In this field, you enter the password of the SAP HANA user that you created in section [SAP HANA User for Technical Configuration \[page 37\]](#). The password is stored in the secure store. As you need the user and password also for an upgrade of SAP Hybris Marketing, we recommend to document the password outside the system.

- **Fully Qualified Domain Name:**

In this field, you indicate the domain name of the installed and configured SAP Web Dispatcher (see section [Configuring the SAP Web Dispatcher \[page 43\]](#)) for your system in the following format: `<3rd-level-label>.<2nd-level-label>.<Top-Level-Domain>.<root-label>`, for example, `mywebdispatcher.wdf.sap.corp`.

If you already specified the domain name in transaction `CUAN_INITIAL_SETUP` before initially opening the technical configuration cockpit, the field is already prefilled, and you can skip this step.

- **Port:**  
In this field, you indicate the port of the installed and configured SAP Web Dispatcher (see section [Configuring the SAP Web Dispatcher \[page 43\]](#)), for example, 10100.  
If you already specified the port in transaction CUAN\_INITIAL\_SETUP before initially opening the technical configuration cockpit, the field is already prefilled, and you can skip this step.
- **OData Service Package:**  
This field is only available if you selected *Dev. System* in the *Role of System* field (see above).  
Enter the package that you created for OData service generation in section [Creating Development Packages \[page 51\]](#).
- **BI Artifacts Package:**  
This field is only available if you selected *Dev. System* in the *Role of System* field (see above).  
Enter the package that you created for BI content activation in section [Creating Development Packages \[page 51\]](#).
- **User for Background Processing:**  
In this field, you can specify a user for the processing of background jobs. SAP Hybris Marketing processes jobs for several parts of the functionality in the background, for example, the data load from connected systems. By default, the system provides you with BATCH\_USER.  
If you want to use another user for background job processing, indicate the required user name. If the indicated user exists, the system uses it for background job processing. If this user does not exist, the system creates this user.

### **i** Note

If you indicate a user for background job processing that is still to be created, ensure that the central user administration is deactivated.

## 7.7.2.2 Scenario "ERP Integration"

You have the option to integrate SAP Hybris Marketing with your existing SAP ERP system to use your SAP ERP data such as accounts and contacts within SAP Hybris Marketing. In this case, the SAP ERP data is either reused (in case of co-deployment of SAP ERP with SAP Hybris Marketing on the same SAP HANA database), or replicated to your SAP Hybris Marketing system using the SAP Landscape Transformation Replication Server (SAP LT). For more information, see [Data Replication \[page 31\]](#).

For the optional integration with SAP ERP, you must specify the following parameters:

- **SAP ERP Deployment:**  
By default, the parameter is set to *No Integration*. Choose one of the following alternatives for the business data integration with SAP ERP:
  - **Reuse of Original Suite Schema:** You can co-deploy SAP ERP and SAP Hybris Marketing on the same SAP HANA database.
  - **Use of Replicated Suite Schema:** You can replicate the required business data from the SAP ERP system into the SAP HANA database of SAP Hybris Marketing.

Before you run the scenario, create the RFC destinations to the SAP ERP client, and to the SAP Landscape Transformation (SLT).
- **SAP ERP Source Data Client**  
Enter the source client number of the SAP ERP system.



- [RFC Destination to SAP ERP System](#)  
Enter the name of the RFC destination to your SAP ERP source client.

Specify the following parameters if you use the option of replicating the SAP ERP business data:

- [SAP LT Configuration Name](#) as specified within your SLT configuration
- [RFC Destination to SAP LT System](#) for your SLT instance
- [SAP HANA Host ID](#) as specified within your SLT configuration
- [SAP HANA Instance Number](#) as specified within your SLT configuration
- Select the option [One Time Initial Data Load Only](#) if you want to replicate the business data once for an initial load. As a result, any changes in the source system are not reflected in your replicated business data.

### 7.7.2.3 Scenario "CRM Integration"

You have the option to integrate SAP Hybris Marketing with your existing SAP CRM system to use your SAP CRM data such as accounts and contacts within SAP Hybris Marketing. In this case, the SAP CRM data is either reused (in case of co-deployment of SAP CRM with SAP Hybris Marketing on the same SAP HANA database), or replicated to your SAP Hybris Marketing system using the SAP Landscape Transformation Replication Server (SAP LT). For more information, see [Data Replication \[page 31\]](#).

For the optional integration with SAP CRM, you must specify the following parameters:

- [SAP CRM Deployment](#)  
By default, the parameter is set to [No Integration](#). Choose one of the following alternatives for the business data integration with SAP CRM:
  - [Reuse of Original Suite Schema](#): You can co-deploy SAP CRM and SAP Hybris Marketing on the same SAP HANA database.
  - [Use of Replicated Suite Schema](#): You can replicate the required business data from the SAP CRM system into the SAP HANA database of SAP Hybris Marketing.

Before you run the scenario, create the RFC destinations to the SAP CRM client, and to the SAP Landscape Transformation (SLT).

- [SAP CRM Source Data Client](#)  
Enter the source client number of the SAP CRM system
- [RFC Destination to SAP CRM System](#)  
Enter the name of the RFC destination to your SAP CRM source client.

Specify the following parameters if you use the option of replicating the SAP CRM business data:

- [SAP LT Configuration Name](#) as specified within your SLT configuration
- [RFC Destination to SAP LT System](#) for your SLT instance
- [SAP HANA Host ID](#) as specified within your SLT configuration
- [SAP HANA Instance Number](#) as specified within your SLT configuration
- Select the option [One Time Initial Data Load Only](#) if you want to replicate the business data once for an initial load. As a result, any changes in the source system are not reflected in your replicated business data.

Specify the following for the [HTTPS Connection to SAP CRM Source System](#):

- [Fully Qualified Host Name](#)
- [HTTPS Port](#)

## 7.7.2.4 Scenario "HANA Rules Framework"

The SAP HANA rules framework (HRF) allows you to manage and automate business decisions based on rules and rule services.

Within SAP Hybris Marketing, HRF is used for the following options:

- **Scoring Based on SAP HANA Rules Framework in SAP Hybris Marketing Data Management:**  
HRF helps you to manage your heuristic scoring models.  
For more information, see [Scoring Based on SAP HANA Rules Framework \(HRF\) \[page 77\]](#).
- **Rule-based Tasks in SAP Hybris Marketing Recommendation:**
  - HRF is used in the *Manage Recommendations* app, for example, to re-rank and filter rules.
  - HRF is used in the *Manage Offer Recommendations* app.  
For more information, see [Configuring Recommendation \[page 99\]](#).

If you want to use one of the options above, proceed as follows:

### Prerequisites

Prior to execute the scenario *SAP HANA Rules Framework* in the technical configuration cockpit, you must carry out the following steps:

- **Configuring SSL for SAP HANA XS Engine**  
You have configured the SSL already in section [Configuring SSL for SAP HANA XS Engine \[page 36\]](#).
- **Installing the SAP HANA Rules Framework**  
You must install the SAP HANA rules framework separately on the SAP HANA database of your application. For the required version of HRF, see the release information note (RIN) for SAP Hybris Marketing, [1885803](#). For the installation procedure, see the *SAP HANA Rules Framework Installation Guide*. Since you have already installed SAP HANA, you can omit *Installing the SAP HANA Appliance Software* in this guide.  
You can find this guide under: <http://service.sap.com/instguides> ► *SAP In-Memory Computing* ► *SAP HANA Rules Framework* ► *SAP HANA Rules Framework 1.0 Inst. & Upgrade Guide*.  
(<https://service.sap.com/~sapidb/012002523100001842442016>)

### Executing the Scenario "HANA Rules Framework"

For the use of HRF, you must specify the following parameters:

- **HANA Fully Qual. Hostname:** Enter the name including domain details of your SAP HANA Extended Application Services (SAP HANA XS).
- **HANA XS HTTPS Port Number:** Enter the SSL port number of your SAP HANA XS.

## 7.7.2.5 Scenario "Marketing Executive Dashboard"

The *Marketing Executive Dashboard* is an application available for marketing executives in the *Marketing Executive* business group. The app contains key performance indicators (KPI), which allow marketing executives to review the success of marketing investments, and gain an overview of KPI attainment and marketing performance benchmarks.

### **i** Note

The *Marketing Executive Dashboard* application is available only if *SAP Hybris Marketing Insight* is active.

If you want to use the option above, proceed as follows:

## Prerequisites

Prior to execute the scenario *Marketing Executive Dashboard* in the technical configuration cockpit, you must carry out the following steps:

- **Configuring SSL for SAP HANA XS Engine**  
You have already configured the SSL in section [Configuring SSL for SAP HANA XS Engine \[page 36\]](#).
- **Installing SAP Smart Business, executive edition**  
You have already installed *SAP Smart Business, executive edition* in section [Installing SAP Smart Business, executive edition \[page 28\]](#).

### **i** Note

You must ensure the following:

- You have installed the latest version of *SAP Smart Business, executive edition*.
- You have applied the latest configuration file for the *Marketing Executive Dashboard* for *SAP Smart Business, executive edition*.

## Executing the Scenario "Marketing Executive Dashboard"

For the use of the *Marketing Executive Dashboard*, you must specify the following parameters:

- **Target Host**  
If required, replace the default by the target host you use to run the SAP HANA Extended Application Services (SAP HANA XS).
- **Service Port Number**  
If required, replace the default by the service port number of your target host.

## 7.7.2.6 Scenario "Campaign Management"

The applications belonging to *Campaign Management* allow the efficient planning and execution of marketing campaigns, which aim to increase the merchandise sales of individual products or the company as a whole, and to increase the customer retention to the company.

The main features include the creation of marketing campaigns and their execution using various communication channels such as emails or text message.

### **i** Note

The *Campaign Management* applications are available only if *SAP Hybris Marketing Acquisition* is active.

If you want to use the *Campaign Management*, proceed as follows:

## Executing the Scenario "Campaign Management"

For the use of the *Campaign Management* applications, you must specify the following parameters:

- *SAP Web Dispatcher Settings for Tracking and Bouncing*  
Enter the *Fully Qualified Domain Name*, and the corresponding *Port* of the SAP Web Dispatcher you use to enable the tracking for messages.
- *SAP Mobile Services for Sending Text Messages*  
If you want to use the option *Enable Text Messaging Integration*, make sure you have an SAP SMS 365 account available. In addition, specify the following:
  - *User* for your account
  - *Password* for your account
  - *Path Prefix*: Part of the URL made available by your provider that identifies the web service for your account. For example, in the URL `https://sms-pp.sapmobileservices.com/cm/⟨accountid⟩/⟨accountid⟩.sms`, the path prefix is `/cm/⟨accountid⟩/⟨accountid⟩.sms`.
- *SAP Mobile Services for Sending Email Messages*  
Choose the option *Enable Mobile Service Integration* to enable sending emails using SAP Mobile Service. Make sure you have an SAP Mobile Service account available. Specify the *User*, and the *Password* for the SAP Mobile Service account. In addition, specify the path prefix (part of the URL that identifies the web service for your account).
- *Amazon Services for Sending Email Messages*  
If you want to use the option *Enable Amazon Email Integration*, make sure you have created an Amazon web services (AWS) account for using the Amazon Simple Email Service (Amazon SES). You can create access keys using the AWS Management Console. To use the option specify the following parameters:
  - *Amazon Access Key ID*, and *Amazon Secret Access Key* for your account
  - Define a name for the *Amazon Feedback Queue*. Configure the Amazon email service to collect all bounces and complaints in a queue on the Amazon Queue Service. Make sure the feedback queue name matches the queue name that is set up on Amazon's side. The feedback queue path is the last individual part of the queue URL at Amazon. For example, in the queue URL `https://sqs.eu-west-1.amazonaws.com/NNN/ABC`, the feedback queue path is `/NNN/ABC`.
- *Digital Asset Management*

The integration with Digital Asset Management allows you to search for, and to insert images into messages. Choose an option depending on the external system you use. For the option *Open Text*, specify the *User*, and the *Password*.

When you choose one of the options an empty RFC destination (HTTP connection to external server) is created:

- RFC for *Hybris Product Content Management*: CEI\_ME\_DAM\_HYBRIS
- RFC for *Open Text*: CEI\_ME\_DAM\_OPENTEXT

Maintain the RFC destination according to requirements of the external system you use, for example, specifying target host, service number, logon. Use backend transaction *RFC Destinations* (SM59) to maintain the RFC destination.

## 7.7.2.7 Scenario "Lead Management with Cloud for Customer Integration"

This scenario covers the technical configuration for the usage of the following applications or features:

- **Lead Management**

*Lead Management* integrates the business process between marketing and direct or indirect sales channels, to drive higher-value opportunities through improved demand creation, execution, and opportunity management. It comprises all measures a company takes to convert potential buyers and interested persons to real buyers.

For more information about lead management, see the application help for SAP Hybris Marketing at:

<http://help.sap.com/mkt> ► *Application Help* ► *SAP Hybris Marketing Applications* ► *Lead Management* ► [http://help.sap.com/saphelp\\_mkt124/helpdata/en/27/ffe755856f7b43e10000000a4450e5/frameset.htm](http://help.sap.com/saphelp_mkt124/helpdata/en/27/ffe755856f7b43e10000000a4450e5/frameset.htm)

The *Lead Management* business group in SAP Hybris Marketing includes the following applications:

- *Lead Dashboard*
- *Score Builder*
- *Lead Stages*
- *Transfer Leads*

- **Call Center Integration with SAP Hybris Cloud for Customer**

In *SAP Hybris Marketing Acquisition*, you are provided with the option to trigger SAP Hybris Cloud for Customer call qualifications to the SAP Hybris Cloud for Customer system directly from a campaign in your SAP Hybris Marketing system. For more information, see [Setting Up Call Center Integration with SAP Hybris Cloud for Customer \[page 123\]](#).

The following prerequisites and dependencies apply for the *Lead Management* applications and for the Call Center Integration with SAP Hybris Cloud for Customer:

Table 13:

Application/Integration	Prerequisite
Lead Dashboard	<ul style="list-style-type: none"> <li>• <i>SAP Smart Business, executive edition</i> must be installed (see section <a href="#">Installing SAP Smart Business, executive edition [page 28]</a>)</li> <li>• SSL for SAP HANA XS Engine must be configured (see <a href="#">Configuring SSL for SAP HANA XS Engine [page 36]</a>)</li> <li>• <i>Lead Management</i> and <i>Lead Dashboard</i> indicators in technical configuration scenario <i>Lead Management with Cloud for Customer Integration</i> must be selected</li> </ul>
Score Builder	<ul style="list-style-type: none"> <li>• Technical configuration scenario <i>HANA Rules Framework</i> must be executed (see section <a href="#">Scenario "HANA Rules Framework" [page 58]</a>)</li> <li>• <i>Lead Management</i> indicator in technical configuration scenario <i>Lead Management with Cloud for Customer Integration</i> must be selected</li> </ul>
Lead Stages	<i>Lead Management</i> indicator in technical configuration scenario <i>Lead Management with Cloud for Customer Integration</i> must be selected
Transfer Leads	<ul style="list-style-type: none"> <li>• SAP Hybris Cloud for Customer must be installed and configured (see section <a href="#">Setting Up Integration with SAP Hybris Cloud for Customer</a> below)</li> <li>• <i>Lead Management</i> and <i>C4C Integration</i> indicators in technical configuration scenario <i>Lead Management with Cloud for Customer Integration</i> must be selected</li> </ul>
Call Center Integration with SAP Hybris Cloud for Customer	<ul style="list-style-type: none"> <li>• SAP Hybris Cloud for Customer must be installed and configured (see section <a href="#">Setting Up Integration with SAP Hybris Cloud for Customer</a> below)</li> <li>• <i>C4C Integration</i> indicator in technical configuration scenario <i>Lead Management with Cloud for Customer Integration</i> must be selected</li> </ul>

## Setting Up Integration with SAP Hybris Cloud for Customer

If you want to use the *Transfer Leads* application or the Call Center Integration with SAP Hybris Cloud for Customer, you must set up the integration with SAP Hybris Cloud for Customer before you execute the *Lead Management with Cloud for Customer Integration* scenario.

To do so, proceed as follows:

The integration of SAP Hybris Cloud for Customer is based on an integration system. You have two options concerning your integration system:

- *SAP Process Integration* (PI), an on premise solution  
The minimum required release is SAP PI 7.3 with OData adapter `PIADAPTERS02_7-20012293.SCA`.
- *SAP HANA Cloud Integration* (HCI), a cloud solution

For information about how to set up the *SAP Process Integration* system, see the corresponding integration guide on SAP Service Marketplace at:

<http://service.sap.com/cloud4customer> ► **INTEGRATION: SAP Hybris Marketing and C4C via PI** ►

(<http://service.sap.com/%7Esapidb/012002523100017104542016E/>)

For information about how to set up the *SAP HANA Cloud Integration* system, see the corresponding integration guide on SAP Service Marketplace at:

<http://service.sap.com/cloud4customer> ► **INTEGRATION: SAP Hybris Marketing and SAP C4C via HCI** ►

(<http://service.sap.com/%7Esapidb/012002523100017104762016E/>)

## Executing the Scenario "Lead Management with Cloud for Customer Integration"

For the use of the *Lead Management with Cloud for Customer Integration*, you must specify the following parameters:

- **Lead Management**  
Select this indicator to activate *Lead Management* applications along with the corresponding SAP HANA content and BC sets in your system.
- **Lead Dashboard**  
Select this indicator to activate the *Lead Dashboard* application. The dashboard can only be activated when you selected the *Lead Management* indicator as well.

### **i** Note

To display the *Lead Dashboard* application on the user interface, ensure that a copy of standard role `SAP_CEI_LEAD_DASHBOARD` is assigned to the corresponding users.

Set the following parameters:

- **Target Host:**  
If required, replace the default by the target host you use to run the SAP HANA Extended Application Services (SAP HANA XS).
- **Service Port Number:**  
If required, replace the default by the service port number of your target host.
- **C4C Integration Configuration**  
This parameter controls the configuration of the SAP Hybris Cloud for Customer in your system. Select this indicator to set up the RFC destination to SAP Hybris Cloud for Customer and logical ports to *SAP NetWeaver Process Integration* (PI) and *SAP HANA Cloud Integration* (HCI).

Set the following parameters:

- **Host Name of C4C:**  
Fully qualified domain name of your SAP Hybris Cloud for Customer system (UI front end) for UI navigation. Example: `myUIServer.ondemand.com`.
- **Port for C4C:**  
Enter the port number of your SAP Hybris Cloud for Customer system (UI front end). Example: `443` (This is the default https port).

- *Proxy Server (optional):*  
Fully qualified domain name of your proxy server for the PI/HCI communication. Use these parameters if you require a proxy server to allow network connections to servers outside of your network.
- *Proxy Port (optional):*  
Port number of your proxy server for the PI/HCI communication.
- *Proxy User (optional):*  
If required, replace the default by the service port number of your target host.
- *Proxy User Password (optional):*  
Password for the proxy server user for the PI/HCI communication.
- *URL Access Path for Lead:*  
Service path of the PI/HCI server for communicating leads.
  - *Example for PI systems:* /XISOAPAdapter/MessageServlet?channel=:<yMKT system name>\_<client>:<yMKT system name>\_SOAP\_LeadReplRequest\_Out
  - *Example for HCI systems:* /cx/yMKT/C4C/LeadReplicationRequest\_Out\_<yMKT system name><client>
- *URL Access Path for Activity:*  
Service path of the PI/HCI server for communicating activities.
  - *Example for PI systems:* /XISOAPAdapter/MessageServlet?channel=:<yMKT system name>\_<client>:<yMKT system name>\_SOAP\_ActivityReplication\_Out
  - *Example for HCI systems:* /cx/yMKT/C4C/ActivityReplicationOut\_<yMKT system name><client>
- *Host Name of PI/HCI:*  
Fully qualified domain name of your PI/HCI server.
- *Port of PI/HCI:*  
Port number of your PI/HCI server.
- *PI/HCI User:*  
User of the PI/HCI server.
- *PI/HCI Password:*  
Password of the PI/HCI user.

## 7.7.2.8 Scenario "Recommendation"

The applications belonging to *Recommendation* allow business analysts and marketing experts to create recommendation models that provide consumers with relevant recommendations in real time, simultaneously across multiple sales channels. Recommendation models leverage algorithms and SAP HANA to query and retrieve recommendations from sales or business event data.

### **i** Note

The *Recommendation* applications are available only if *SAP Hybris Marketing Recommendation* is active.



If you want to use *Recommendation*, proceed as follows:

## Executing the Scenario "Recommendation"

For the use of the *Recommendation* applications, you must specify the following parameters:

- **Section "SAP ERP Retail":**
  - *Rule-Based Product Recommendations:*  
Select this option if you want to use rule-based tasks in the *Manage Recommendations* application, for example, to re-rank and filter rules.
- **Section "Rule-Based Offer Recommendation Scenarios":**
  - *SAP Customer Activity Repository:*  
Select this option, together with one of the following options:
    - *SAP Promotion Management for Retail (SAP PMR):*  
Select this option, if you want to include offers from *SAP Promotion Management for Retail* (PMR) in the *Manage Offer Recommendations* app.
    - *SAP Hybris Marketing Offer Integrated with SAP PMR:*  
You have the option to combine offers from *SAP Promotion Management for Retail* (PMR) with offers created in SAP Hybris Marketing. While the SAP Hybris Marketing offers contain the visual content such as pictures and texts, the PMR offers contain the process-relevant part such as products, prices, and discounts. You can build recommendation rules on the combined set of attributes of both of the objects.  
Select this option, if you want to use this feature.
  - *SAP Hybris Marketing Offer Recommendations:*  
Select this option, if you want to use rules that have been created in the *Manage Offer Recommendations* app, in the OData service `CUAN_OFFER_DISCOVERY_SRV` to display the best offers to customers in the *Offers* app.

### **i** Note

We recommend to select only one of the options for offer recommendation at a time, as the options are self-contained and do not build on each other.

### **i** Note

Keep in mind that all rule-based options above require an installed SAP HANA rules framework as a prerequisite. If not yet done, execute the technical configuration scenario *HANA Rules Framework* (see [Scenario "HANA Rules Framework" \[page 58\]](#)).

---

## 7.8 Applying Technical Configuration Artifacts to Production System

In your development and configuration system, the *Essentials* scenario in the technical configuration cockpit automatically creates transport requests with repository and Customizing objects (see [Scenario "Essentials" \[page 54\]](#)).

To make the artifacts - created during technical configuration in the development system - available in the production system, you must carry out the following two steps:

- In the development and configuration system, release the transport requests.
- In the production system, import the transport requests in a specific sequence and execute the technical configuration

### 7.8.1 Releasing Transport Requests in Development System

To release the transport requests in your **development system**, proceed as follows:

1. Log on to the **development** system with the [User for Application Setup \[page 47\]](#).
2. Go to transaction `SE09` and release and transport the following requests in the following sequence:
  1. Workbench Request created manually for the development packages (see [Creating Development Packages \[page 51\]](#)).
  2. Customizing Request: *Common Customizing Activities*
  3. Workbench Request: *Common Workbench Objects*
  4. Workbench Request: *Activated BI Queries*

### 7.8.2 Importing Transport Requests and Executing Technical Configuration in Production System

After you have carried out the technical configuration and released the relevant transport requests in your development system, you need to import the requests and execute the technical configuration of the *Essentials* scenario in the **production system**.

Proceed as follows in the **production system**:

1. Log on to the **production** system with the [User for Application Setup \[page 47\]](#).
2. Go to transaction `STMS_IMPORT` and import the requests listed above in the specified sequence:
  1. Workbench Request created manually for the development packages (see [Creating Development Packages \[page 51\]](#)).
  2. Customizing Request: *Common Customizing Activities*
  3. Workbench Request: *Common Workbench Objects*
3. Execute the *Essentials* scenario in the technical configuration cockpit in the **production system** (see section [Scenario "Essentials" \[page 54\]](#)).

4. Import the following request:
  - Workbench Request: *Activated BI Queries*

**i Note**

When importing the transports into the production system, ensure that the client-specific Customizing is transported to the client, in which you execute the technical configuration.

## 7.9 Initial Setup of SAP Fiori

Set up the administrator role as well as the end user role for SAP Fiori by following the instructions described on the SAP Help Portal in the following two sections:

[http://help.sap.com/fiori\\_bs2013](http://help.sap.com/fiori_bs2013) ► *Configuration of SAP Fiori Infrastructure* ► *Configuration Information* ► *Setup of SAP Fiori Launchpad* ► *Assign Administrator Role for SAP Fiori Launchpad to Administrator User*   
 ([http://help.sap.com/fiori\\_bs2013/helpdata/en/38/ca4353c7b9f663e10000000a4450e5/content.htm?frameset.htm](http://help.sap.com/fiori_bs2013/helpdata/en/38/ca4353c7b9f663e10000000a4450e5/content.htm?frameset.htm))

[http://help.sap.com/fiori\\_bs2013](http://help.sap.com/fiori_bs2013) ► *Configuration of SAP Fiori Infrastructure* ► *Configuration Information* ► *Setup of SAP Fiori Launchpad* ► *Assign Role with Launchpad Start Authorization to End Users*   
 ([http://help.sap.com/fiori\\_bs2013/helpdata/en/26/cf4353c7b9f663e10000000a4450e5/content.htm?frameset.htm](http://help.sap.com/fiori_bs2013/helpdata/en/26/cf4353c7b9f663e10000000a4450e5/content.htm?frameset.htm))

Now go to transaction PFCG, create a new role (for example **ZCHIP\_FOUNDATION**) and add the following authorizations

Table 14:

Authorization Object	Web Dynpro ABAP	Activity
/UI2/CHIP	X-SAP-UI2-CHIP*	03
/UI2/CHIP	X-SAP-UI2-PAGE*	03,16
S_PB_CHIP	X-SAP-UI2-CHIP*	03

Table 15:

Authorization Object	Activity	Package	Object Name	Object Type	Authorization Group ABAP / 4 Program
S_DEVELOP	03	*	X-SAP-UI2-CHIP*	*	*
S_DEVELOP	03,16	*	X-SAP-UI2-PAGE*	*	*

S_DEVELOP	03	/UI2/ SERVICES_P B_UTIL_700	/UI2/*	WDCC	*
-----------	----	-----------------------------------	--------	------	---

Table 16:

Authorization Object	Activity	Request Type
S_TRANSPRT	03	*

Generate the profile. Now assign the new role to all your business and administration users.

## 7.10 Defining a Virus Scan Profile

In order to adhere to security standards, we recommend that you use a virus scanner. The scanner performs checks in various SAP Hybris Marketing applications. For example, the scanner checks the HTML code of emails in *SAP Hybris Marketing Acquisition*.

By default, the virus scanning is switched on in the SAP NetWeaver Gateway, and as a result, you need to maintain the corresponding profile in the customizing of the virus scanning. For information about how to define a profile, see the Security Guide at:

<http://help.sap.com/mkt> ► [Security Information](#) ► under *Virus Scan Profile (ABAP)*.

You can switch on, or switch off the virus scanner in the SAP NetWeaver Gateway using transaction / IWFND/ VIRUS\_SCAN, or using the ► [SAP Customizing Implementation Guide](#) ► [SAP NetWeaver](#) ► [Gateway](#) ► [OData Channel](#) ► [Administration](#) ► [General Settings](#) ► [Define Virus Scan Profiles](#) ►.

### **i** Note

SAP strongly recommends to keep the virus scan switched on.

### **i** Note

Make sure that you complete this customizing step as part of the installation process.

## 7.11 Generating Authorization Profiles for the User Interface

In SAP Hybris Marketing, several composite roles give you access to the SAP Hybris Marketing applications. These composite roles include all single roles that are necessary to run the corresponding solution.

The following table lists the available composite roles by business roles:

Table 17:

Business Role	Composite Role Name	Description
Marketing Experts	SAP_MARKETING_EXPERT	General access to SAP Hybris Marketing
	SAP_MARKETING_SEGMENTATION	Access to applications belonging to <i>Segmentation</i>
	SAP_MARKETING_CAMPAGNS	Access to applications belonging to <i>Acquisition</i>
	SAP_MARKETING_SPEND_MGMT_PROG	Access to applications belonging to <i>Planning</i>
	SAP_MARKETING_RECOMMEND_EXPERT	Access to applications belonging to <i>Recommendations</i>
	SAP_MARKETING_INSIGHT	Access to applications belonging to <i>Insight</i>
	SAP_MARKETING_DATA_MANAGEMENT	Access to applications belonging to <i>Data Management</i>
	SAP_MARKETING_EAC	Access to extended application components (applications based on SAP Hybris as as Service (YaaS) - separate license required)
Marketing Managers	SAP_MARKETING_MANAGER	General Access to SAP Hybris Marketing
	SAP_MARKETING_PLANNING	Access to <i>Planning</i>
Marketing Executives	SAP_MARKETING_EXECUT_DASHBOARD	General Access to SAP Hybris Marketing
Business Analysts	SAP_MARKETING_RECOMMENDATION	Access to applications belonging to <i>Recommendations</i>
Administrator - Marketing	SAP_MARKETING_BUS_ADMIN_USER	Access to applications for key user and administrative tasks
Installation / Upgrade Team Members	SAP_MARKETING_TECHNICAL_CONF	Contains all roles needed to run the technical configuration tasks of the installation and upgrade process
User Administrator - Marketing	SAP_MARKETING_USER_ADMIN	Access for user administrators
Sales Representative	SAP_SALES_REP_MKT_INFO	Access to applications for sales representatives

To initially generate an authorization profile in your AS ABAP system and assign it to a user, you have to copy the required composite role including the single roles (depending on your purchased SAP Hybris Marketing solutions) and configure the copies of all roles according to your requirements.

1. Log on to your AS ABAP system and go to transaction PFCG.



2. For example, if you purchased the *Segmentation* price list component, enter `SAP_MARKETING_SEGMENTATION` in the *Role* field and choose the *Copy* pushbutton. A dialog box appears.
3. Enter a self-defined name for your role and choose the *Copy all* pushbutton.
4. In the following dialog box, choose the *Yes* pushbutton to copy the related single roles and assign them to the composite role.
5. In the following dialog box, select all single roles. Enter suitable names for each role in the *New Role* column.
6. Back on the *Role Maintenance* screen, choose the *Change* pushbutton.
7. Choose the *Roles* tab, and access the first new role by double-clicking it.
8. Choose the *Authorizations* tab, switch to *Edit* mode, and choose the *Propose Profile Name* pushbutton in the *Information About Authorization Profile* section. The system enters a profile name and a profile text.
9. Choose the *Change Authorization Data* pushbutton in the *Maintain Authorization Data and Generate Profiles* section.
10. On the *Change Role: Authorizations* screen, maintain authorizations to suit your requirements.
11. To generate the authorization profile, choose the *Generate* menu option from the *Authorizations* menu or choose the *Generate* pushbutton.
12. Repeat step 7 to 11 for all new roles in your composite role.

#### Note

If you create a copy of another composite role (as you purchased more than one SAP Hybris Marketing solution), be aware that some of the included single roles may already have been copied.

#### Note

These steps do not apply to roles for which a profile cannot be generated because they do not contain any authorization data, for example, business catalog roles such as `SAP_CEI_KUA_FLP`.

13. All required authorization roles are described in the SAP Hybris Marketing Security Guide at <http://help.sap.com/mkt>  *Security Information*  under *Authorizations*.  
<http://service.sap.com/%7Esapidb/012002523100017103972016E/> 
14. Assign your copied composite role to the users in transaction `SU01`.

#### Note

If you purchase additional licenses, you need to adapt your roles accordingly.

## 7.12 Generating the URL for Displaying the User Interface

#### Caution

All previous steps have to be completed successfully before you can start with this step.

You create a start URL and distribute it to all potential end users as follows: `https://<fully qualified domain name of your SAP Web Dispatcher>:<HTTPS Port of SAP Web Dispatcher>/sap/bc/ui5_ui5/ui2/ushell/shells/abap/FioriLaunchpad.html?sap-client=<Client>#Shell-home`

From the AS ABAP system, you can launch the user interface using transaction `START_CEI`.

### **i** Note

If you face issues opening the user interface, you can run transaction `CUAN_TC_CHECK` to check all system configuration steps for correctness.

## Logout Screen for the SAP Fiori Launchpad

By default, the SAP Hybris Marketing front-end system redirects you to a standard page, when you log out of the system.

If you want your users who log out of the system to be redirected to another page such as the SAP Fiori default log in page, follow the instructions described in the following documentation on the SAP Help Portal:

<http://help.sap.com/nw75> ► *Application Help* ► *UI Technologies in SAP NetWeaver with SAP\_UI 750* ► *SAP Fiori Launchpad* ► *Setting Up the Launchpad* ► *Configuring Logout* ► *Configure a Logout Screen for the SAP Fiori Launchpad (Optional)* ►

([http://help.sap.com/saphelp\\_nw75/helpdata/en/8e/b10085b029478c8498fba3bc35ef60/content.htm](http://help.sap.com/saphelp_nw75/helpdata/en/8e/b10085b029478c8498fba3bc35ef60/content.htm))

## Creating a Custom Configuration File

If you want to adapt the launchpad configuration, for example, to prevent business users from changing the application by creating an own personalization or from showing or hiding business groups, you can create your own configuration file without adapting the file delivered by SAP. For more information, see the SAP Library at:

<http://help.sap.com/nw75> ► *Application Help* ► *UI Technologies in SAP NetWeaver with SAP\_UI 750* ► *SAP Fiori Launchpad* ► *Setting Up the Launchpad* ► *Configuring the Launchpad* ► *Setting Parameters in a Launchpad Configuration File* ►

([http://help.sap.com/saphelp\\_nw75/helpdata/en/2c/616173d5354fd69a904cbc296792e2/content.htm](http://help.sap.com/saphelp_nw75/helpdata/en/2c/616173d5354fd69a904cbc296792e2/content.htm))

### **⚠** Caution

If you create your own configuration file, you must ensure that your start URL includes the path `&sap-ushell-config-url=/sap/ushell_config/CEC_MKT.json` when generating this URL (see above).

For general information about about the levels of the launchpad, see the SAP Library at:

<http://help.sap.com/nw75> ► *Application Help* ► *UI Technologies in SAP NetWeaver with SAP\_UI 750* ► *SAP Fiori Launchpad* ► *Setting Up the Launchpad* ► *Configuring the Launchpad* ►

---

([http://help.sap.com/saphelp\\_nw75/helpdata/en/98/cb0b6355094b2e91a0e6de030cd4ea/content.htm](http://help.sap.com/saphelp_nw75/helpdata/en/98/cb0b6355094b2e91a0e6de030cd4ea/content.htm))



# 8 General Configuration Settings in SAP Hybris Marketing

## 8.1 Setting up Integration with SAP Jam

You have the option to integrate various parts of SAP Hybris Marketing with the collaboration platform SAP Jam. The integration with SAP Jam is available for the following licenses and applications:

- **Data Management** (*Sentiment Engagement*):  
You can use SAP Jam as a data source for *Sentiment Engagement*, which allows you to filter, analyze, and process posts from SAP Jam. In addition, you can create SAP Jam groups directly from the *Sentiment Engagement* user interface.
- **Acquisition:**
  - *Campaign Management*:  
You can store campaign-related information in corresponding SAP Jam groups to support online communication such as discussions with other sales people about your campaign.
  - *Campaign Management (Paid Search)*:  
You can share paid search campaign data with an existing group on SAP Jam to collaborate with other marketing experts. The post on SAP Jam will include a link to the specific paid search campaign you are sharing and the external marketing campaign associated with it.
- **Planning** (*Budget Plans*):  
You can share planning data with an existing group on SAP Jam to collaborate with other marketing managers. The post on SAP Jam will include a link to the *Budget Plans* application.
- In addition, you must set up the integration with SAP Jam if you want to use the share function which is available in some SAP Fiori applications. This function allows the user to send posts to the feed of any SAP Jam group.

To set up the integration with SAP Jam, you need to carry out the following steps:

- Set up the connection with SAP Jam:
  - For a description of how to connect SAP Jam with AS ABAP systems, see the SAP Library at: <http://help.sap.com/netweaver> ► *UI add-on for SAP NetWeaver* ► *UI add-on 2.0 for SAP NetWeaver* ► *Application Help* ► *Social Media Integration* ► *Information for Administrators* ► *Configuration* ( [http://help.sap.com/saphelp\\_uiaddon10/helpdata/en/1c/8f86d5fe634a28b1da186a5fd87f81/content.htm](http://help.sap.com/saphelp_uiaddon10/helpdata/en/1c/8f86d5fe634a28b1da186a5fd87f81/content.htm) )
  - You find the relevant steps in the SAP NetWeaver implementation guide (IMG) (transaction `SPRO`) under ► *SAP NetWeaver* ► *Application Server* ► *Basis Services* ► *Collaboration* ► *SAP Jam Integration* .
- Carry out the customizing steps specified under SAP Hybris Marketing: ► *General Settings* ► *Integration* ► *Define Settings for Integration of SAP Jam* .
- In addition, for the use in *Sentiment Engagement*, you have to carry out the Customizing steps specified under SAP Hybris Marketing: ► *Contacts and Profiles* ► *Sentiment Engagement* .

---

**i** Note

You can only access the *Collaboration* menu path if you have activated the business function BC\_SRV\_STW\_03 (*Enable Social Media ABAP Integration 3*) in customizing under ► *Activate Business Functions* ► *ENTERPRISE\_BUSINESS\_FUNCTIONS* ►.

# 9 Configuring Data Management

This section is relevant for all SAP Hybris Marketing applications.

With *SAP Hybris Marketing Data Management*, you can analyze contact data from various sources (such as SAP ERP, SAP CRM as well as external data sources such as social media) in order to gain a deeper insight into your contacts' sentiments and interests. Based on this information, you can create contact target groups and identify follow-up actions.

## 9.1 Sentiment Engagement (Optional)

Sentiment Engagement allows you to filter, analyze, and process data that has been harvested from external data sources such as social networks.

### **i** Note

The use of information originating from social networks and other data sources must be checked in the individual case against the background of all applicable laws and regulations (e.g. on data protection) and individual rules (e.g. for the relevant data source). SAP does not accept any liability for the use of the application by its customers.

Since the setup requirements for collecting external data will always vary greatly depending between individual customers and countries, data harvesting is not part of the *SAP Hybris Marketing Data Management* application.

### 9.1.1 Setting up Data Harvesting

#### Prerequisites



In order to set up Sentiment Engagement, you need to carry out the steps below.

Ensure that the following Customizing entries have been made under *Contacts and Profiles* in SAP Hybris Marketing:

- ▶ *Interaction Contacts* ▶ *Define Settings for Social Media Integration* ▶  
Enter the social media channel codes that you want to use in the *Sentiment Engagement* application (for example, **FB**).
- ▶ *Interactions* ▶ *Define Communication Media* ▶  
Enter the communication media that you need (for example, **FB**).

### **i** Note

Every communication medium that you want to use in the *Sentiment Engagement* application must correspond to a social media channel code.

- [Interactions > Define Interaction Types](#)  Select the *Text Anlys* checkbox for all interaction types that you want to use in the *Sentiment Engagement* application.
- [Interactions > Assign Interaction Types and Communication Media to Channels](#)  Assign the communication media that you have created to the interaction types that are selected for the text analysis.

## Importing Social Posts

You first have to import the data that you want to analyze to your SAP Hybris Marketing system. Social posts are imported as interactions of interaction type `SOCIAL_POSTING`. In addition, social posts of any other interaction type are displayed in Sentiment Engagement if the text analysis is selected in Customizing for these interaction types (see the corresponding Customizing setting above).

The import is realized using one of the following data upload interfaces:

- OData service `CUAN_IMPORT_SRV`
- RFC function module `CUAN_CE_INTERACTIONS_POST` or `CUAN_CE_INTERACTIONS_POST_FLAT`
- Web service `CUANPOSTINTERACTIONS`

The regular background job `CUAN_IA_TA_EXTR_DELTA` that is scheduled during technical configuration ensures that the imported interactions are updated by sentiments and tags according to the results of *SAP HANA Text Analysis*.

For more information about the import of interactions, see the corresponding sections for interactions in the Data Management Upload Interfaces guide for SAP Hybris Marketing under:









<http://help.sap.com/mkt>  [Configuration and Deployment Information](#)  [Data Management Upload Interfaces](#) 

<http://service.sap.com/%7Esapidb/012002523100017104782016E/> 

## 9.1.2 Setting up SMTP for Post Groups (Send Email to Me)

As a prerequisite for the usage of the post group action *Send Email to Me* (see the corresponding Customizing path below), you must set up the SMTP configuration for SAPconnect. To do so, proceed as follows:

1. Make the configuration settings for email exchange between your AS ABAP system and any SMTP (Simple Mail Transfer Protocol) mail server. For more information, see the *Quick Guide for SMTP Configuration* on SAP Help Portal at:

<http://help.sap.com/nw75>  [Application Help](#)  [Function-Oriented View](#)  [Application Server](#)  [Application Server ABAP](#)  [Other Services](#)  [Services for Business Users](#)  [SAPconnect \(BC-SRV-COM\)](#)  [Quick Guide to SMTP Configuration](#) 

[http://help.sap.com/saphelp\\_nw75/helpdata/en/49/e5e6a986420896e10000000a421937/content.htm](http://help.sap.com/saphelp_nw75/helpdata/en/49/e5e6a986420896e10000000a421937/content.htm)



2. Make the required settings in Customizing for SAP Hybris Marketing under **▶ Contacts and Profiles ▶ Sentiment Engagement ▶ Create Action ID for Post Groups ▶**. The `EMAIL2ME` (*Send Email to Me*) action must be active.

## 9.2 Scoring

Scores are calculated KPIs that help your end users to make assumptions about the future actions and decisions of an account, a contact, consumer, or prospect. Scores are displayed in a separate facet of the fact sheets on the user interface and can be used within *Segmentation*.

### 9.2.1 Scoring Including SAP Predictive Analytics

*SAP Predictive Analytics* allows for an automated training of predictive models, which reduces the effort of the business analyst, and provides best results.

To enable the usage of *SAP Predictive Analytics* as an implementation method, an installation of *SAP Automated Predictive Library (APL)* on SAP HANA is required. The integration setup of *SAP Predictive Analytics* with SAP Hybris Marketing is not part of the SAP Hybris Marketing delivery.

If you have installed SAP HANA SPS09, you can use the *APL* for an easier and more convenient setup installation.

For details on how to install the *APL*, go to <http://help.sap.com/pa> **▶▶ Development Information ▶ APL Reference Guide ▶**.

(<https://service.sap.com/~sapidb/012002523100013455472015E/> )

### 9.2.2 Scoring Based on SAP HANA Rules Framework (HRF)

You have the option of integrating the SAP HANA rules framework (HRF) to help manage your heuristic scoring models. With this feature, your business analysts can create heuristic scoring models by defining the score calculation directly on the user interface using an intuitive rules expression language.

A prerequisite for using this option is an installed and configured HRF. If you did not install and configure HRF before, follow the instructions in section [Scenario "HANA Rules Framework" \[page 58\]](#).

## 9.2.3 Predictive Model Training Based on [nu]-Support Vector Machine (R)

If you want to use [nu]-Support Vector Machine (R) for the training of a predictive model, you need to integrate R with the SAP HANA database. For more information about how to enable the embedding of R code in the SAP HANA database, see the SAP HANA R Integration Guide at:

[http://help.sap.com/hana\\_platform/](http://help.sap.com/hana_platform/)  [References](#)  [R Integration Guide](#) 

[http://help.sap.com/hana/SAP\\_HANA\\_R\\_Integration\\_Guide\\_en.pdf](http://help.sap.com/hana/SAP_HANA_R_Integration_Guide_en.pdf) 

## 9.3 Web Shop Personalization Based on Customer Segments

You can integrate SAP Hybris Marketing with release 5.3 of the *Hybris Commerce Suite*, to personalize your Web shop based on customer segments. You do this by defining tactical customer segments in *Segmentation*, which leads to a personalized shopping experience in *Hybris commerce*.

The Web shop designer who works in the Hybris design environment calls up a list of campaigns resulting from the customer segments defined in *Segmentation*. The designer implements the personalization for the Web shop, which can range from layout and featured products to promotional pricing, for example.

This feature is enabled via the OData service CUAN\_COMMON\_SRV: The Hybris content management system (*Hybris CMS Cockpit*) calls the SAP Hybris Marketing system during design time via this service to search for customer segments and, therefore, campaigns that are available for assignment to customer segment rules.

During runtime, that is when a user logs on to the *Hybris commerce* platform, the *Hybris commerce* system calls the SAP Hybris Marketing system via the OData service to establish which campaign and, therefore, to which customer segment the login user is assigned. With this information the corresponding customer segment rules as defined in *Hybris CMS Cockpit* are derived and the web shop is personalized accordingly.

In order to use the appropriate level of authorization when accessing information in SAP Hybris Marketing from the *Hybris Commerce Suite*, we recommend that you carry out the following steps:

1. Copy the single role SAP\_CEI\_ECOMMERCE\_INTEGRATION using transaction PFCG.
2. Assign the new copied role to the technical user specified for accessing SAP Hybris Marketing from the *Hybris Commerce Suite*.

The integration setup of the *Hybris Commerce Suite* with SAP Hybris Marketing is not part of the SAP Hybris Marketing delivery. You can implement the setup on a project basis.

For more information, see the SAP Hybris Marketing documentation at: <https://wiki.hybris.com/display/release5/SAP+hybris+Marketing+Integration> 

## 9.4 Customer Journey Insight

*Customer Journey Insight* allows you to view customer journeys. A journey is a sequence of events performed by a customer over time through various media, such as social, Web and phone, for example, clicked ads, opened

emails, and confirmed Web searches. Marketing managers can explore journeys that lead to a certain event performed by a customer, such as a buy, an abandoned shopping cart, or a conversion.

You can view customer journey data, such as all customers taking the same journey, the number of times a specific journey is taken, and the top journeys by percentage. You can filter customer journeys based on date range, touchpoints, top journey percentage, events, interaction types, target group, and granularity.

In addition, you are provided with the option to create target groups of identified contacts for further processing in campaigns or promotion activities.

## 9.4.1 Setting up Customer Journey Insight

Before you start with the configuration for *Customer Journey Insight*, ensure that you have carried out the steps described in the following section:

- [Initial Setup of SAP Fiori \[page 49\] \[page 67\]](#)

To set up *Customer Journey Insight*, carry out the following steps:

1. Carry out the Customizing steps specified under SAP Hybris Marketing under [▶ Contacts and Profiles ▶](#). Ensure that you make all the required settings for interaction contacts, origins of contact ID, communication media, interaction types, interaction channels, and that you assign the interaction types and communication media to channels. Specifically, these need to be done in the following customizing steps:
  - [▶ Contacts and Profiles ▶ Interaction Contacts ▶ Define Origins of Contact ID ▶](#)
  - [▶ Contacts and Profiles ▶ Interactions ▶ Define Communication Media ▶](#)
  - [▶ Contacts and Profiles ▶ Interactions ▶ Define Interaction Types ▶](#)
  - [▶ Contacts and Profiles ▶ Interactions ▶ Define Interaction Channels ▶](#)
  - [▶ Contacts and Profiles ▶ Interactions ▶ Assign Interaction Types and Communication Media to Channels ▶](#)
2. Define interaction interests on the user interface, in the *Interaction Interests* application within the *Business Administration* business group.
3. Upload the necessary data including interactions and interaction contacts. Ensure that there are some interaction contacts and interactions available in your system, otherwise the chart will be empty.
4. Define events on the user interface, in the *Customer Journey Events* application within the *Business Administration* business group (see [Setting up Customer Journey Events \[page 80\]](#)). Enter the events and assign the interactions you want to use to these events. Save your entries.
5. To enable users to use *Customer Journey Insight*, assign your copies of the following PFCG roles to AS ABAP users:
  - SAP\_CEI\_SCI\_FLP (business catalog role)
  - SAP\_CEI\_TG\_INI (for creating, filtering and viewing target groups; included in composite role SAP\_MARKETING\_DATA\_MANAGEMENT)
  - SAP\_CEI\_CJI (for accessing *Customer Journey Insight*; included in composite role SAP\_MARKETING\_DATA\_MANAGEMENT)
  - SAP\_CEI\_CJI\_EVENTS (for accessing *Customer Journey Events*; included in composite role SAP\_MARKETING\_BUS\_ADMIN\_USER)
  - SAP\_CEI\_HOME (for personalization purposes)



## 9.4.2 Setting up Customer Journey Events

*Customer Journey Events*, located in the *Business Administration* business group, allows business administrators to define events for customer journeys. An event can be any outcome of a customer journey, such as a buy, an abandoned shopping cart, or a conversion.

To enable business administrators to use *Customer Journey Events*, assign your copies of the following PFCG roles to the corresponding AS ABAP users:

- SAP\_CEI\_KUA\_FLP (business catalog role)
- SAP\_MARKETING\_BUS\_ADMIN\_USER (for accessing all applications for key user and administrative activities)
- SAP\_CEI\_CJI\_EVENTS (for accessing *Customer Journey Events*; included in composite role SAP\_MARKETING\_BUS\_ADMIN\_USER)

### Note

Ensure that the OData service CUAN\_ODATA\_CJI\_SRV is added to your copy of role SAP\_CEI\_CJI\_EVENTS. For a description of how to add an OData service manually, see the upgrade guide for SAP Hybris Marketing, section *Adding an OData Service to a Role* under  *General Adaptations in SAP Hybris Marketing*  *New OData Services in Single Roles*  at:

[!\[\]\(fa6f3af6bfa46c5d4a2d362681095beb\_img.jpg\) !\[\]\(a9bc825d1a15412853cf9ebcbd72219d\_img.jpg\) \*Installation and Upgrade Information\* !\[\]\(855eb27d3d242e620031eb19ab2e732f\_img.jpg\) \*Upgrade Guide\* !\[\]\(528d698dbdf3a7863b8ddb9bfdc0181d\_img.jpg\)](http://help.sap.com/mkt)

<http://service.sap.com/%7Esapidb/012002523100017106602016E/> 

- SAP\_CEI\_HOME (for personalization purposes)

## 9.5 Configuring Commerce Integration

### 9.5.1 Generating Interactions from the Tracking of Unknown Web Site Visitors

You can use the results of the visitors tracking in Hybris Commerce Suite Web shops as interactions in SAP Hybris Marketing. Based on the clicks of visitors, the *Business Event Extension* of the Web shop generates a set of events, and sends it to the *SAP Event Stream Processor* (ESP). From the ESP, the events are converted to SAP Hybris Marketing interactions.

To find out how to set up the required components, see *Integrating SAP Hybris Marketing with Web Tracking* on the Help Portal at:

[!\[\]\(e9474ce1d70442456f8fe9c393ea149c\_img.jpg\) !\[\]\(ffe2f3b8164b215a6319685156ac6550\_img.jpg\) \*Configuration and Deployment Information\* !\[\]\(b96ae9ffae94351d4c9f95c4ad403e54\_img.jpg\) \*More Information\* !\[\]\(2ed4f83e9ec391a2b574855fcf02660a\_img.jpg\)](http://help.sap.com/mkt)

<http://service.sap.com/~sapidb/012002523100017106012016E/> 



## 9.6 Setting up Applications for Data Import for Analytics

The following applications are available in the *Import Data* business group and allow you to import data for analytic purposes in the *Marketing Executive Dashboard*:

- *Import Data for Analytics* allows you to upload KPI data records.

### Note

You can find example data for the available KPIs (see [Configuring SAP Smart Business, executive edition \[page 86\]](#)) on the SAP Community Network (SCN) at: <http://scn.sap.com/docs/DOC-65033>.

- *Competitors* allows you to import competitor data such as the competitor's market share via CSV upload.
- *Audiences* allows you to import audience data such as a group or a segment of customers via CSV upload.

## Assign Users to Roles

To enable administrators in marketing to upload analytic data, you have to assign their AS ABAP users to your copy of the following roles:

For *Import Data for Analytics*:

- SAP\_CEI\_KUA\_FLP (business catalog role; no copy required - you can assign the delivered standard role)
- SAP\_CEI\_IMPORT\_ANALYTICS (back-end role; included in composite role SAP\_MARKETING\_BUS\_ADMIN\_USER)
- SAP\_CEI\_HOME (for personalization purposes)

For *Competitors*:

- SAP\_CEI\_KUA\_FLP (business catalog role; no copy required - you can assign the delivered standard role)
- SAP\_CEI\_COMPETITORS (back-end role; included in composite role SAP\_MARKETING\_BUS\_ADMIN\_USER)
- SAP\_CEI\_HOME (for personalization purposes)

For *Audiences*:

- SAP\_CEI\_KUA\_FLP (business catalog role; no copy required - you can assign the delivered standard role)
- SAP\_CEI\_AUDIENCES (back-end role; included in composite role SAP\_MARKETING\_BUS\_ADMIN\_USER)
- SAP\_CEI\_HOME (for personalization purposes)

## 9.7 Setting up Application "Business User"

The application *Business User* in the *Business Administration* business group allows marketing user administrators to create business users in the SAP Hybris Marketing system, for example, business users in the context of *SAP Smart Business, executive edition* (see [Setup for SAP Hybris Marketing Business Users \[page](#)

89]). The user administrator can only use this app, if his or her user is assigned to your copy of the following roles:

- SAP\_CEI\_USER\_HANDLING (back-end role; included in composite role SAP\_MARKETING\_USER\_ADMIN)
- SAP\_CEI\_HOME (for personalization purposes)

## 9.8 Setting up Application "Digital Accounts"

With the *Digital Accounts* application, marketing experts can view and analyze the followers of social media accounts of their companies.

### **i** Note

Currently, the only social network supported by *Digital Accounts* is WeChat. As WeChat is mainly used in China, you must also apply the settings described in section [Configuring China Localization \[page 147\]](#).

## Customizing Activities and Business Add-Ins

The Customizing activities and BADIs for the *Digital Accounts* app are located in Customizing for SAP Hybris Marketing under ► *Contacts and Profiles* ► *Digital Accounts* ►.

- **Customizing Activity "Define Digital Account Types"**  
You decide what types of digital accounts can be configured in *Digital Accounts*.
- **Business Add-In "Acquiring Access Token"**  
Due to business requirements, you may have multiple servers that receive various types of messages from the same digital account. If you allow each server to request the access token that is required for calling APIs for the digital account, trouble will arise due to conflicting access tokens.  
Instead, you should use one of them as a primary server, which is responsible for getting and storing the access token. If the server that you have configured for the integration of the digital account and SAP Hybris Marketing is not the primary server, then you need to implement this BAdI to get the access token from the primary server.

## Display Digital Accounts on SAP Fiori Launchpad

To display *Digital Accounts* in the *Contacts and Profiles* business group on the SAP Fiori launchpad, you do the following:

1. Launch the SAP Fiori launchpad designer.  
For information about how to call up the SAP Fiori launchpad designer, see the SAP Library under:  
<https://help.sap.com/nw75> ► *Application Help* ► *UI Technologies in SAP NetWeaver with SAP\_UI 750* ► *SAP Fiori Launchpad* ► *Using the Launchpad Designer* ► *Launching the Launchpad Designer* ►  
([http://help.sap.com/saphelp\\_nw75/helpdata/en/2d/98610a5bcf43dfad588e755459dc42/content.htm](http://help.sap.com/saphelp_nw75/helpdata/en/2d/98610a5bcf43dfad588e755459dc42/content.htm))

2. Create a new business catalog ZSAP\_CEI\_DA.
3. Open the technical catalog SAP\_CEI\_TC\_T.
4. On the *Target Mappings* tab, select the semantic object `DigitalAccounts` and then click the *Create Reference* button. The *Select Catalog* dialog box appears.
5. Select the business catalog ZSAP\_CEI\_DA.
6. Repeat steps 3 – 5 to assign the semantic objects `TargetGroup` and `InteractionContact` to the business catalog ZSAP\_CEI\_DA.
7. On the *Tiles* tab for the technical catalog SAP\_CEI\_TC\_T, drag and drop the *Digital Accounts* tile into the *Create Reference* zone. The *Select Catalog* dialog box appears.
8. Select the business catalog ZSAP\_CEI\_DA.
9. Open the SAP\_CEC\_BCG\_MKT\_DM\_OP business group.
10. Add the *Digital Accounts* tile that the business catalog ZSAP\_CEI\_DA references to the business group.
11. On the SAP Fiori launchpad, click *Personalize Home Page* to add *Digital Accounts* to the business group *Contacts and Profiles*.

## Assign PFCG Role to Users

1. Call up transaction PFCG.
2. In the *Role* field, enter Z\_CEI\_BCR\_DIGITAL\_ACCOUNT. Click the *Single Role* button to create a new PFCG role for *Digital Accounts*.
3. On the *Menu* tab, insert the *SAP Fiori Tile Catalog* node. The *Assign Tile Catalog* dialog box appears.
4. Enter ZSAP\_CEI\_DA as the catalog ID.
5. On the *Authorizations* tab, assign the following authorization to the PFCG role:

Table 18:

Authorization Object	Object Name	Activity
HPA_OBJECT	CUAN_DIGITAL_ACCOUNT	Display, Change

6. On the *User* tab, assign the new PFCG role to users.

## 9.9 Marketing Locations

*Marketing Locations* allows you to maintain information about marketing locations. You can store information such as location name, location address, coordinates, phone number, web address, email and location picture. You can also upload location data using the *Import Data* application in the *Import Data* business group.

## Access to Map Provider

You can also view marketing locations on a map. As a prerequisite, the user's browser needs access to the internet domain [here.com](http://here.com), which provides the map data. Note that only locations with a valid latitude and longitude are shown on the map.

Consider the implications of communicating with servers outside your firewall.

For more information, see the security guide for SAP Hybris Marketing at:

<http://help.sap.com/mkt> ► [Security Information](#) ►

<http://service.sap.com/%7Esapldb/012002523100017103972016E/>

## 9.9.1 Setting up Marketing Locations

To set up *Marketing Locations*, make the settings in the following activities in Customizing for SAP Hybris Marketing under ► [Contacts and Profiles](#) ► [Marketing Locations](#) ►:

- [Define Origins of Marketing Location ID](#)
- [Define Marketing Location Types](#)

To enable users for *Marketing Locations*, assign your copies of the following PFCG roles to the corresponding AS ABAP users:

- SAP\_CEI\_SCI\_FLP (business catalog role)
- SAP\_CEI\_MARKETING\_LOCATION (for accessing *Marketing Locations*; included in composite role SAP\_MARKETING\_DATA\_MANAGEMENT)

## Uploading Marketing Location Data

To add marketing locations to SAP Hybris Marketing, you must import marketing location data from a comma-separated value (CSV) file using the *Import Data* application in the *Import Data* business group.

For more information about importing marketing locations, see SAP Library for SAP Hybris Marketing on SAP Help Portal at:

<http://help.sap.com/mkt> ► [Application Help](#) ► [SAP Hybris Marketing Applications](#) ► [Contacts and Profiles](#) ► [Import of Data Using CSV Upload](#) ►

([http://help.sap.com/saphelp\\_mkt124/helpdata/en/7d/d16e5458548c4ce10000000a4450e5/content.htm](http://help.sap.com/saphelp_mkt124/helpdata/en/7d/d16e5458548c4ce10000000a4450e5/content.htm))

To access the *Import Data* application, the user must be assigned a copy of the SAP\_MARKETING\_BUS\_ADMIN\_USER role.

For more information, see the security guide for SAP Hybris Marketing on SAP Help Portal at:

<http://help.sap.com/mkt> ► [Security Information](#) ►

---

<http://service.sap.com/%7Esapidb/012002523100017103972016E/>

# 10 Configuring Insight

The settings described in this section are only relevant if you want to run *SAP Hybris Marketing Insight*.

## 10.1 Configuring SAP Smart Business, executive edition

The following applications within SAP Hybris Marketing are based on *SAP Smart Business, executive edition*:

### Marketing Executive Dashboard

This application is available for marketing executives in the *Marketing Executive* business group.

The *Marketing Executive Dashboard* contains key performance indicators (KPI), which allow marketing executives to review the success of marketing investments, and gain an overview of KPI attainment and marketing performance benchmarks.

You are provided with a range of KPIs for the *Marketing Executive Dashboard*.

The following KPIs are available:

- Contact Conversion
- Sentiment Media Mix
- Leads
- Opportunities
- Sales Forecast
- Revenue
- Return on Marketing Investment (ROMI)
- Sales Pipeline
- Converted Pipeline
- Pipeline Acceleration
- Market Share
- Net Promoter Score
- Web Visits
- Web Downloads
- Brand Awareness
- Planned Budget, Planned and Actual Spend for Current and Last Year

#### **i** Note

- The KPIs are delivered as templates. You might need to adjust them to better meet your business requirements.

- The KPIs, and the descriptions of the measures and dimensions are only available in English.

#### **i** Note

As a prerequisite for the use of the *Marketing Executive Dashboard* application, you must install *SAP Smart Business, executive edition* and execute the technical configuration scenario *Marketing Executive Dashboard* (see section [Scenario "Marketing Executive Dashboard" \[page 59\]](#)).

## Lead Dashboard

This application is available for marketing experts in the *Lead Management* business group.

The *Lead Dashboard* app allows marketing experts to review the success of the lead management process, and provides them with a comprehensive overview of Key Performance Indicator (KPI) attainment and lead management performance benchmarks.

#### **i** Note

As a prerequisite for the use of the *Lead Dashboard* application, you must install *SAP Smart Business, executive edition* and execute the technical configuration scenario *Lead Management with Cloud for Customer Integration* (see section [Scenario "Lead Management with Cloud for Customer Integration" \[page 61\]](#)).

## 10.1.1 User Configuration for SAP Smart Business, executive edition

For the use of *SAP Smart Business, executive edition*, you must set up a user environment that creates a corresponding SAP HANA user for every AS ABAP user.

### Creating SAP HANA User for Configuration of SAP Smart Business, executive edition

1. Log on to the SAP HANA studio with the `SYSTEM` user and choose the *SAP HANA Administration Console* perspective under menu **Window** > *Open Perspective*.
2. In the *Navigator* section on the left, expand the folder of your SAP HANA database.
3. Expand the corresponding `Security` folder, select the *Users* folder, and choose the menu item *New User* from the context menu. The *User* view appears.
4. Enter a name for the user (`ABAP_HANA_USER_ADMIN`, for example) and a password.
5. On the *Granted Roles* tab, choose the **+** pushbutton. In the following *Select Catalog Object* dialog box, search for `sap.hana-app.cuan.common.roles::XSUserAdmin`. Select it in the *Matching Items* field, and confirm your entry.

6. Save the user. Role `PUBLIC` is automatically assigned to your new user.
7. Open the SQL Console and run the following command:

```
ALTER USER ABAP_HANA_USER_ADMIN DISABLE PASSWORD LIFETIME
```

## Creating Database Connection for User Creation

To set up a database connection to the SAP HANA database, proceed as follows:

1. Log on to the system with the user that you have created in section [User for Application Setup \[page 47\]](#).
2. Go to transaction `DBCO` and choose the *New Entry* pushbutton.
3. Enter a user-defined name in field *DB Connection*.
4. Enter `HDB` in field *DBMS (Database Management System)* to indicate that you are establishing a database connection to a SAP HANA database.
5. Enter the name of the user that you have just created in the preceding section (*Creating SAP HANA User for Configuration of SAP Smart Business, executive edition*) in field *User Name* and the corresponding password in field *DB Password*.
6. Enter `<Servername>:<SQLport>` (for example, `ld9719:30215`) in field *Connection Info*. In a SAP HANA single-container system, this entry is usually `<Servername>:3<InstanceNumber>15`.  
Take a note of this info for further processing in technical configuration.
7. Save your entries.

## Maintaining System Settings for User Management in DBMS (Client-Specific)

1. Log on to the system with the user that you have created in section [User for Application Setup \[page 47\]](#).
2. Go to transaction `SM30`.
3. Enter `USR_DBMS_SYSTEM` in field *View/Table* and choose the *Maintain* pushbutton.
4. On the next screen, create a new entry and enter the following parameters:
  - The database connection that you have created in section [Creating Database Connection for User Creation](#) (see above).
  - The current client.
5. Save the entry.

As a result, for each ABAP user you create, a corresponding SAP HANA user is created automatically. If you have already created your business users for SAP Hybris Marketing, do the following:

1. Go to transaction `SA38` and run report `RSUSR_DBMS_USERS`. Enter all AS ABAP business users and select *Create and Map DBMS Users* in the *Function Selection* section. Execute the report.
2. To check if your creation was successful you can open one of your users in transaction `SU01`. On the tab *DBMS*, you see a DBMS user and the information that a DBMS user exists.



## 10.1.2 Exchange of Certificates Between SAP HANA and AS ABAP

To be able to use SAP Single Sign-On in connection with logon tickets to log on to *SAP Smart Business, executive edition*, you must exchange the corresponding certificates between the SAP HANA database and your SAP Hybris Marketing AS ABAP system.

To do so, proceed as follows:

1. Log on to the SAP HANA XS Administration console under `https://<your server>:<your HTTPS port>/sap/hana/xs/admin` with a SAP HANA user that is assigned the role `sap.hana.xs.admin.roles::TrustStoreAdministrator`.
2. From the menu in the upper left corner, select *Trust Manager*.
3. In the *Trust Store* list, select *SAPLOGON*.
4. In the *Trust Store* details to the right, select the *Certificate List* tab.
5. Choose the *Import Certificate* pushbutton to import the HTTPS certificate presented by AS ABAP.
6. To complete the process, you must restart the SAP HANA Extended Application Services (SAP HANA XS). To do so, proceed as follows:
  1. Log on to the SAP HANA studio with the `SYSTEM` user and choose the *SAP HANA Administration Console* perspective under menu **▶ Window ▶ Open Perspective ▾**.
  2. In the navigation section to the right, choose the context menu of your system.
  3. In the appearing section with system details to the left, select the *Landscape* tab.
  4. In the context menu of the table entry with value `xsengine` in column *Service*, choose *Stop*.
  5. To restart, choose *Start* from the context menu of the same table entry.

## 10.1.3 Setup for SAP Hybris Marketing Business Users

To create marketing users for SAP Hybris Marketing, you are provided with the application *Business User Administration* (see [Setting up Application "Business User" \[page 81\]](#)). To create marketing users that are allowed to access the *Marketing Executive Dashboard* or the *Lead Dashboard*, proceed as follows:

1. For the *Marketing Executive Dashboard*, copy the composite role `SAP_MARKETING_EXECUT_DASHBOARD` and its single roles to customer roles.
2. For the *Lead Dashboard*, copy the composite role `SAP_MARKETING_INSIGHT` and its single roles to customer roles.
3. By default, the application creates all SAP HANA users with SAP Logon Ticket authentication. If you want to restrict the role selection in this application to marketing roles only, open transaction `SM30` and maintain view `CUANV_UM_ROLES`. Enter the marketing roles, to which the role selection of the application is to be restricted.
4. Create a user for SAP Hybris Marketing *Business User Administration*, and assign your copy of composite role `SAP_MARKETING_USER_ADMIN`.

## 10.1.4 Creation of SAP Hybris Marketing Business Users

To create a business user within SAP Hybris Marketing, follow these steps:

1. Open SAP Hybris Marketing through the following URL: `https://<webdispatcher_host>:<webdispatcher_port>/sap/bc/ui5_ui5/ui2/ushell/shells/abap/FioriLaunchpad.html?sap-client=<Client>#Shell-home`.
2. Log on with the user for SAP Hybris Marketing *Business User Administration* from [Setup for SAP Hybris Marketing Business Users \[page 89\]](#).
3. Open the *Business User Administration* application and create SAP Hybris Marketing business users. Assign your copy of composite role `SAP_MARKETING_EXECUT_DASHBOARD` or `SAP_MARKETING_INSIGHT`, respectively (see section [Setup for SAP Hybris Marketing Business Users \[page 89\]](#)).
4. When the SAP Hybris Marketing business users open SAP Hybris Marketing, they find the dashboard as follows:
  - The *Marketing Executive Dashboard* within business group *Marketing - Executive Dashboard*
  - The *Lead Dashboard* within business group *Lead Management*

## 10.1.5 Optional: Modeling Instance Authorizations for Restricted User Access

If you want to prevent your business users from seeing all data in the *Marketing Executive Dashboard* or in the *Lead Dashboard*, you can model instance authorizations (for example, to restrict data by country) with the help of analytic privileges. Analytic privileges in the SAP HANA database are used to grant different users access to different portions of data in the same view depending on their business role.

As a prerequisite to model instance authorization using analytic privileges, you must grant your users start authorization for the corresponding SAP HANA information models relevant for the *Marketing Executive Dashboard* or the *Lead Dashboard*.

For some of the steps below, you will need the SAP HANA developer guide, which you can find at:

[http://help.sap.com/hana\\_platform](http://help.sap.com/hana_platform)  [Development Information](#)  [SAP HANA Developer Guide](#) 

([http://help.sap.com/saphelp\\_hanaplatform/helpdata/en/34/29fc63a1de4cd6876ea211dc86ee54/frameset.htm](http://help.sap.com/saphelp_hanaplatform/helpdata/en/34/29fc63a1de4cd6876ea211dc86ee54/frameset.htm) )

## Creating a SAP HANA Role for Authorization Purposes

To model authorizations, we recommend that you create a corresponding role first, which you can assign to the relevant users. To do so, proceed as follows:

Create a new role as described in the SAP HANA developer guide under  [Setting Up Roles and Privileges](#)   
[Create a Design-Time Role](#) 

## Granting Start Authorization for Relevant SAP HANA Information Models

1. Log on to the SAP HANA studio with the SAP HANA user for technical configuration (see section [SAP HANA User for Technical Configuration \[page 37\]](#)).
2. In the *Navigator* section on the left, expand the folder of your SAP HANA database.
3. Expand the corresponding *Security* folder and the *Roles* folder.
4. Double-click the SAP HANA role that you have created in the previous step.
5. In the center section, choose the *Object Privileges* tab, and choose the + pushbutton.
6. In the following *Select Catalog Object* dialog box, search for one of the following SAP HANA information models, confirm your selection, and select the privilege *SELECT*. Repeat this step for every information model in the list below:
  - For *Marketing Executive Dashboard*:
    - `sap.hana-app.cuan.mkteff.XSAPP.v/CA_CE_IC_CONTACT_ANALYSIS (_SYS_BIC)`
    - `sap.hana-app.csan.common.internal/CA_SE_INTERACTION_ANALYSIS (_SYS_BIC)`
    - `sap.hana-app.cuan.mkteff.XSAPP.v/CA_D_CMO_KPI_VALUES (_SYS_BIC)`
    - `sap.hana-app.cuan.mkteff.XSAPP.v/CA_D_CMO_KPI_VALUES_OVER_TIME (_SYS_BIC)`
    - `sap.hana-app.cuan.mkteff.ext/AN_CMO_WEB_DOWNLOADS (_SYS_BIC)`
    - `sap.hana-app.cuan.mkteff.ext/AN_CMO_WEB_VISITS (_SYS_BIC)`
  - For *Lead Dashboard*:
    - `sap.hana-app.cuan.lm.internal/CA_LM_IA_KPI (_SYS_BIC)`
    - `sap.hana-app.cuan.lm.internal/ CA_LM_LEAD_PER_IOI (_SYS_BIC)`
    - `sap.hana-app.cuan.lm.internal/CA_LM_LEAD_STAGE (_SYS_BIC)`
    - `sap.hana-app.cuan.lm.internal/CA_LM_LEAD_STAGE_DAYS (_SYS_BIC)`
    - `sap.hana-app.cuan.lm.internal/CA_LM_LEAD_STAGE_CURRENT (_SYS_BIC)`
7. Save the role.

## Creating Analytic Privileges

SAP has delivered an example analytic privilege, which you find in the SAP HANA database under [Content](#) > [sap](#) > [hana-app](#) > [cuan](#) > [mkteff](#) > [Analytic Privileges](#) > [AP\\_CMO\\_COUNTRY\\_TMP](#).

To create your own analytic privilege, proceed as follows:

1. Log on to the SAP HANA system with the SAP HANA user for technical configuration (see section [SAP HANA User for Technical Configuration \[page 37\]](#)).
2. Create a new repository package as described in the *SAP HANA Developer Guide* under [Setting Up Your Application](#) > [Maintaining Repository Packages](#) > [Create a Repository Package](#).
3. Create a new analytic privilege as described in the *SAP HANA Developer Guide* under [Setting Up Roles and Privileges](#) > [Create Analytic Privileges](#). You can use the following pre-delivered analytic privileges as templates:
  - For *Marketing Executive Dashboard*: `sap.hana-app.cuan.mkteff.internal::AP_CMO_KPI_S4H`
  - For *Lead Dashboard*: `sap.hana-app.cuan.lm.internal::AP_LM_KPI_S4H`

In the section [Reference Models](#), add the SAP HANA information model to which you want to apply access restrictions. The following information models are available:

For the [Marketing Executive Dashboard](#):

Table 19:

SAP Smart Business, executive edition Data Source	SAP HANA Information Models	Package
Contact Conversion	CA_CE_IC_CONTACT_ANALYSIS	sap.hana-app.cuan.mkteff.XSAPP.v
Sentiment Media Mix	CA_SE_INTERACTION_ANALYSIS	sap.hana-app.csan.common
Marketing Executive Dashboard – KPI Values	CA_D_CMO_KPI_VALUES	sap.hana-app.cuan.mkteff.XSAPP.v
Marketing Executive Dashboard - KPI Values Over Time	CA_D_CMO_KPI_VALUES_OVER_TIME	sap.hana-app.cuan.mkteff.XSAPP.v
Web Downloads	AN_CMO_WEB_DOWNLOADS	sap.hana-app.cuan.mkteff.ext
Web Visits	AN_CMO_WEB_VISITS	sap.hana-app.cuan.mkteff

For the [Lead Dashboard](#):

Table 20:

SAP Smart Business, executive edition Data Source	SAP HANA Information Models	Package
Lead Dashboard – KPI Values	CA_LM_IA_KPI	sap.hana-app.cuan.lm.internal
Lead Dashboard – Item of Interests	CA_LM_LEAD_PER_IOI	sap.hana-app.cuan.lm.internal
Lead Dashboard – Stages per Month/Year	CA_LM_LEAD_STAGE	sap.hana-app.cuan.lm.internal
Lead Dashboard – Stages per Day	CA_LM_LEAD_STAGE_DAYS	sap.hana-app.cuan.lm.internal
Lead Dashboard – Current Stages	CA_LM_LEAD_STAGE_CURRENT	sap.hana-app.cuan.lm.internal

In the section [Associated Attributes Restrictions](#) the column is defined on which the instance check should be executed. In the example delivered with SAP Hybris Marketing, column LAND1, which represents a country, is taken into account.

In the section [Assign Restrictions](#), you define the values that need to be checked when the instance authorization is carried out. You can define either fixed filter values or determine the values using a filter procedure. A procedure has the advantage that you have to create less analytic privileges and roles. Performance depends on the logic of the procedure. You can find detailed information on filter procedures in the SAP HANA developer guide at:

► [Setting up Roles and Privileges](#) ► [Create Analytic Privileges](#) ► [Example: Create an Analytic Privilege with Dynamic Value Filter](#) ►

([http://help.sap.com/saphelp\\_hanaplatform/helpdata/en/b5/08f2d6a35a4059b7505afb7a3682df/content.htm](http://help.sap.com/saphelp_hanaplatform/helpdata/en/b5/08f2d6a35a4059b7505afb7a3682df/content.htm))

The example delivered with SAP Hybris Marketing uses the procedure `sap.hana-app.cuan.mkteff/PR_XMLBASED_FILTER_FOR_COUNTRY` to determine the values for the field `Country` from the authorization object `CRA_CUNTR` from the AS ABAP user assigned to the SAP HANA user.

### Caution

Do not assign the analytic privilege directly to the users. It will be assigned to a role in the next step.

4. Now add your analytic privilege to the role that you have created in section *Creating a SAP HANA Role for Authorization Purposes* above.
5. Log on to the SAP Hybris Marketing system with the user that you have created in section *User for Application Setup [page 47]*.
6. Go to transaction `SA38` and run report `RSUSR_DBMS_USERS`. Enter all relevant AS ABAP business users. Choose the *Select DBMS Roles* pushbutton in the *DBMS Role Selection* section and choose your new role. Select *Assign DBMS Roles* in the *Function Selection* section. Execute the report. As an alternative to the assignment in the back end, you can also assign the new role to the relevant users in the SAP HANA studio. To do so, proceed as follows:
  - Expand the *Security* folder of your SAP HANA database, then expand the *Users* folder.
  - Double-click the user to which you want to assign the new role.
  - In the center section, choose the *Granted Roles* tab, and choose the *+* pushbutton.
  - In the following *Select Catalog Object* dialog box, search for the new role, double-click it, and save the user.
  - Repeat these steps for every user to which you want to assign the role.

## 10.2 Creating SAP CRM Business Transactions

If you use SAP CRM as a source system, you can create activities directly in the SAP CRM source system from your SAP Hybris Marketing system.

This function is based on the enhancement spot `CUAN_CRM_CREATE_10` (*Trigger Creation of CRM Activity*) to implement the BAdI `CUAN_CRM_CREATE_ONEORDER_ACT` (*Create Business Transactions*). This BAdI includes a standard implementation.

If you want to enhance the standard implementation, create your own implementation on the basis of the standard. In addition, consider SAP Note [1784897](#).

For more information, see the document *Create SAP CRM Business Transactions on the SAP Service Marketplace* at <http://service.sap.com/mkt>:

<http://service.sap.com/%7Esapidb/012002523100017104722016/>

## 10.3 Importing Data from External Source to "Margin Decomposition"

With the Web service `CUAN_ANALYTIC_FND` (to be accessed in your AS ABAP system under transaction `SEGW`), you can import analytical data from any external source into the *Margin Decomposition* application of *SAP Hybris Marketing Insight*.

In particular, you can import the amount and the document currency of the invoicing account for each of the following decomposition groups in *Margin Decomposition*:

- Gross Revenue
- Invoice Discounts
- Accrued Discounts
- CoGS
- Direct Costs
- Invoice Surcharges

The data can also be provided on the granularity of decomposition subgroups, for example, to show reporting results for different types of invoice discounts.

### **i** Note

You can also use the Web service to integrate Controlling data from SAP ERP (`CO-PA`).

In addition, the data records are to be provided together with values (for IDs and codes) for characteristics/dimensions such as the following:

- Customer Group
- Industry Code
- Sales Organization
- Country
- Region of Country
- Distribution Channel
- Division
- Sales Group
- Sales Office
- Sales District
- Product
- Product Group
- Product Category

### **i** Note

The needed master data or Customizing information for the dimensions values must be already part of SAP Hybris Marketing by means of a connected SAP ERP system.

For information about all required steps to set up the data import by Web service, see the corresponding guide on the SAP Service Marketplace under:

<http://service.sap.com/mkt>  *Importing Analytical Data by Web Service* 

---

(<https://service.sap.com/%7Esapidb/012002523100017105922016E/>)

# 11 Configuring Segmentation

The settings described in this section are only relevant if you want to run *SAP Hybris Marketing Segmentation*.

## 11.1 Dialog Work Processes

To achieve optimal performance, *SAP Hybris Marketing Segmentation* parallelizes requests in the ABAP application server as well as in the SAP HANA database. Therefore you must configure a suitable number of dialog work processes. The number of dialog work processes depends on the number of frequent *SAP Hybris Marketing Segmentation* users. A frequent user works, for example, every day for several hours in the system. The minimum number of processes that the application requires is 25.

To configure the number of dialog work processes, follow the description in SAP Note [39412](#).

### ➔ Recommendation

SAP recommends the following number of dialog work processes per number of frequent users:

Table 21:

<b>Frequent Users</b>	≤ 10	25	50	75
<b>Dialog Work Processes</b>	25	30	65	90

## 11.2 Geospatial Segmentation (Optional)

This function allows viewing the distribution of geolocations on a map (for example, the distribution of customers in a region) and creating new segments based on areas defined on a map (radius or polygon).

- If you use the standard segmentation profile *All Consumers (SCI)*, this function is automatically available for the *Geolocation* attribute.
- If you want to use this function with one of your own custom segmentation profiles, you need to ensure that your attribute universe provides the necessary geolocation information (for details, see chapter *Setting up the Geospatial Segmentation and Map Preview* of the extensibility guide under: <https://help.sap.com/mkt> **Configuration and Deployment Information** **Extensibility Guide**).  
(<https://service.sap.com/%7Esapidb/012002523100017105512016E/>)



## Access to Map Provider

To use geospatial segmentation, you need both map visualization and geocoding services.

SAP ships a default configuration, which uses [here.com](https://here.com) for map visualization and OpenStreetMap for geocoding. You can use this default configuration if it fits your legal and functional requirements.

### **i** Note

SAP only provides the interfaces and configuration options which allow you to connect the map visualization and geocoding services. The content of the configuration is in your responsibility, both from a licensing perspective and from a functional perspective.

You can change the configuration for the geo-coding service under Customizing: ► [SAP NetWeaver](#) ► [UI Technologies](#) ► [SAP Visual Business](#) ► [Maintain Application Definition](#) ►. The relevant application name is GSEG\_GEOSPATIAL.

If you keep the default configuration, you need to check the following points:

- **Map Visualization**

The user's browser will need access to the internet domain [here.com](https://here.com). The domain provides the map data that is used in the geospatial segmentation option. Check, whether the users in question have access to this domain and consider the implications of communicating with servers outside your firewall.

For more information, see the SAP Hybris Marketing Security Guide at <https://help.sap.com/mkt>

► [Security Information](#) ► [Security Guide](#) ► [Network and Communication Security](#) ► [Communication Destinations](#) ►.

<http://service.sap.com/%7Esapidb/012002523100017103972016E/>

- **Geocoding Services**

The application server will need access to the internet domain [nominatim.openstreetmap.org](https://nominatim.openstreetmap.org). For more information on how to do that, go to <http://help.sap.com/netweaver> ► [User interface add-on 2.0 for SAP NetWeaver](#) ► [Application Help](#) ► [Choose your language](#) ► [SAP Visual Business](#) ► [Setting up SAP Visual Business](#) ► -> [Configuring SAP Visual Business](#) ► [Allowing External Geo-Coding Service Calls](#) ► ([http://help.sap.com/saphelp\\_uiaddon20/helpdata/en/5d/ef8651437dfc53e10000000a44538d/content.htm](http://help.sap.com/saphelp_uiaddon20/helpdata/en/5d/ef8651437dfc53e10000000a44538d/content.htm)).

For more information, such as changing the default configuration of geocoding, see the installation and configuration guide for Visual Business under <http://help.sap.com/visualbusiness21> ► [Installation and Upgrade Information](#) ►.

(<https://service.sap.com/~sapidb/011000358700000544602013E/>)

## 11.3 SAP Hybris Marketing Integration with SAP Consumer Insight 365

### **i** Note

To use this integration, you must have licensed and set up [SAP Hybris Marketing Segmentation](#) (see [Configuring Segmentation \[page 96\]](#)).

---

If you productively use SAP Hybris Marketing as well as *SAP Consumer Insight 365* you have the option to take advantage of the integration of these products. By using the location planning or catchment features of *SAP Consumer Insight 365*, the integration provides you with the automatic creation of a segmentation model in *SAP Hybris Marketing Segmentation*.

For more information about the implementation of the integration, see the corresponding guide on SAP Service Marketplace at:

<http://service.sap.com/mkt> ► *Installation Guide SAP Consumer Insight 365* ► ►

<http://service.sap.com/%7Esapidb/012002523100017106572016E/> ►

## 11.4 Enabling China-Specific Segmentation Profile

To enable the use of the China-specific segmentation profile *All China Consumers (B2C)* (SAP\_CE\_LOC\_CN), configure the china localization as described in section [Configuring China Localization \[page 147\]](#).

The *All China Consumers (B2C)* segmentation profile is used to segment WeChat followers by geographical location on Baidu Maps. For more information, see the application help for SAP Hybris Marketing at:

<http://help.sap.com/mkt> ► *SAP Hybris Marketing Application Help* ► *SAP Hybris Marketing Applications* ► *Segmentation* ► *Segmentation of WeChat Followers via Baidu Maps* ►

([http://help.sap.com/saphelp\\_mkt124/helpdata/en/39/ac65044ca841a89f3898d927e12c9e/content.htm](http://help.sap.com/saphelp_mkt124/helpdata/en/39/ac65044ca841a89f3898d927e12c9e/content.htm))

# 12 Configuring Recommendation

The settings described in this section are only relevant if you want to run *SAP Hybris Marketing Recommendation*.

With *SAP Hybris Marketing Recommendation* you can build different product recommendation model types from various sources (such as *SAP ERP*, *SAP Hybris Marketing Data Management*, as well as external data sources such as social media) in order to provide a recommendation. This recommendation can be consumed by various applications such as a web shop or an interaction contact.

In addition, *Recommendation* includes the Offer Management applications *Offers* and *Manage Offer Recommendations*.

For more information about performance and load balance, see SAP Note [2264072](#).

## **i** Note

As a prerequisite for the use of the *Recommendation* applications, you must have executed the technical configuration scenario *Recommendation* (see section [Scenario "Recommendation" \[page 64\]](#)).

## 12.1 Post-Installation Steps

### 12.1.1 Adapting Customer Channels for New Integration Scenarios

Customer channels for which SAP does not provide an integration scenario must be adapted to consume recommendations models using one of the following:

- Remote Function Call (RFC)
- OData service

For more information, go to <http://help.sap.com/mkt>. Choose a release and then ► [Configuration and Deployment Information](#) ► [Extensibility Guide](#) ► [Recommendation](#) ►.

### 12.1.2 Configuring Offer Management

Offer Management provides you with the following applications:

- The app *Offers* allows you to create, release, and put offers on hold. During creation, you define a validity period and define the offer content. This can be both a picture and a text.  
If you want to manage rule-based tasks in SAP Hybris Marketing, the SAP HANA rules framework must be installed (see [Scenario "HANA Rules Framework" \[page 58\]](#)).

In addition, you can use an interface to generate offers from external systems.

- With the app *Manage Offer Recommendations*, you are provided with a rule-based offer finding option. The app is based on the SAP HANA rules framework (see [Scenario "HANA Rules Framework" \[page 58\]](#)). The app can include offers created in the *Offers* app or offers from *SAP Promotion Management for Retail*.

**i Note**

Before you start configuring Offer Management, ensure that you have carried out the steps described in section [Initial Setup of SAP Fiori \[page 67\]](#).

## 12.1.2.1 Setting up Application "Offers"

To set up the *Offers* application, assign your copy of the following role to the AS ABAP users of your marketing managers or experts:

- SAP\_CEI\_OFFER\_APP (back-end role; included in composite role SAP\_MARKETING\_RECOMMEND\_EXPERT)

By assigning the role, the users are given the following authorizations:

Table 22:

Authorization Object	HPA_OBJECT
Object Name (HPA_OBJ)	CUAN_OFFER, CUAN_TARGET_GROUP
Activity	<i>Display</i>

Table 23:

Authorization Object	HPA_MKT_AR
Object Name (HPA_OBJ)	CUAN_INITIATIVE, CUAN_INTERACTION, CUAN_OFFER
Activity	<i>Display</i>

**i Note**

The standard role SAP\_CEI\_OFFER\_APP includes an authorization check at instance level for marketing areas. The marketing areas are defined in Customizing for SAP Hybris Marketing under [► Planning ► General Settings ► Define Marketing Areas ►](#). If a user assigned to a copy of SAP\_CEI\_OFFER\_APP tries to access an object instance for a particular marketing area, the system checks whether they are allowed to access that area.

In addition, you have to assign your copies of the following roles to the AS ABAP users of your marketing experts:

- SAP\_CEI\_ROF\_FLP (business catalog role; no copy required - you can assign the delivered standard role)
- SAP\_CEI\_HOME (for personalization purposes)

## Enabling the OData API for E-Commerce Integration

To display suitable offers to customers, the public OData service API `CUAN_OFFER_DISCOVERY_SRV` can be used to make offers available in an e-commerce scenario, for example in the *SAP Hybris Commerce* Web shop.

For more information about the OData API, see the *Extensibility Guide* on the SAP Help Portal at:

<http://help.sap.com/mkt> ► *Configuration and Deployment Information* ► *Extensibility Guide* ► *Displaying Offers in a Web Shop Using a Public OData Service* ►

<http://service.sap.com/%7Esapidb/012002523100017105512016E/>

To enable the OData API for e-commerce integration, you need to assign the technical AS ABAP user that is used to communicate between the e-commerce suite, such as *SAP Hybris Commerce*, and the SAP Hybris Marketing back-end system to the following role:

- `SAP_CEI_OFFER_PUBLIC_API`

After you have assigned the role, the user should have the following authorizations:

Table 24:

Authorization Object	HPA_OBJECT
Object Name (HPA_OBJ)	CUAN_OFFER
Activity	<i>Display</i>

Table 25:

Authorization Object	S_SERVICE
<i>Program, transaction or function module name</i>	<ul style="list-style-type: none"> <li>• 0AC639FB8EBFB4F9FBEA65AF56B546 R3TR IWSV CUAN_OFFER_DISCOVERY_SRV_0001</li> <li>• F06EB29134F3DA0EE136BA140613FB R3TR IWSG ZCUAN_OFFER_DISCOVERY_SRV_0001</li> </ul>
<i>Type of Check Flag and Authorization Default Values</i>	Hash Value for TADIR Object

## Enabling the OData API for Offer Import

You are provided with the public OData API `CUAN_OFFER_IMPORT_SRV` to import offers from any third-party system to your SAP Hybris Marketing system. To enable the OData API for offer import, you need to assign the technical AS ABAP user that is used to communicate between the legacy system and the SAP Hybris Marketing back-end system to the following role:

- `SAP_CEI_OFFER_IMPORT_API`

For more information about the public OData API `CUAN_OFFER_IMPORT_SRV`, see <http://help.sap.com/mkt> ► *Installation and Upgrade Information* ► *Master Guide* ► *Appendix* ► *API Reference* ► *Import of Offers Using an OData Service* ►.

<http://service.sap.com/%7Esapidb/012002523100017106582016E/>

After you have assigned the role, the user should have the following authorizations:

Table 26:

Authorization Object	HPA_OBJECT
Object Name (HPA_OBJ)	CUAN_OFFER
<i>Activity</i>	<ul style="list-style-type: none"> <li>• <i>Display</i></li> <li>• <i>Change</i></li> </ul>

Table 27:

Authorization Object	HPA_OBJECT
Object Name (HPA_OBJ)	HPA_USER
<i>Activity</i>	<ul style="list-style-type: none"> <li>• <i>Display</i></li> </ul>

Table 28:

Authorization Object	S_SERVICE
<i>Program, transaction or function module name</i>	<ul style="list-style-type: none"> <li>• 649DCCE8465AA4448AC9617AECEE27 R3TR IWSV CUAN_OFFER_IMPORT_SRV_0001</li> <li>• 9B46720527408B9E1F11D1A881D0FA R3TR IWGS ZCUAN_OFFER_IMPORT_SRV_0001</li> </ul>
<i>Type of Check Flag and Authorization Default Values</i>	Hash Value for TADIR Object

## 12.1.2.2 Setting up Application "Manage Offer Recommendations"

The *Manage Offer Recommendations* app is based on the SAP HANA rules framework. For this reason, as a prerequisite for using the app, you need to follow the steps described in section [Using Rule-Based Tasks \[page 103\]](#).

In addition, you have to assign the following role to the AS ABAP users of your marketing experts:

- SAP\_CEI\_RECO\_MKT\_OFFER (back-end role; included in composite role SAP\_MARKETING\_RECOMMEND\_EXPERT)

After you have assigned the role, the user should have the following authorizations:

Table 29:

Authorization Object	HPA_OBJECT
Object Name (HPA_OBJ)	PROD_RECO_RUNTIME

<i>Activity</i>	<ul style="list-style-type: none"> <li>• <i>Display</i></li> <li>• <i>Change</i></li> </ul>
-----------------	---

Table 30:

Authorization Object	S_SERVICE
<i>Program, transaction or function module name</i>	<ul style="list-style-type: none"> <li>• BFEC7A2EF5E9DC425B0A52F413DAD7</li> <li>• CB8C95D3F8063D9DF121A571A16BBB</li> </ul>
<i>Type of Check Flag and Authorization Default Values</i>	Hash Value for TADIR Object

Table 31:

Authorization Object	S_RFC
<i>Activity</i>	<i>Execute</i>
<i>Name (Whitelist) of RFC object</i>	<ul style="list-style-type: none"> <li>• PROD_RECO_GET_RECOMMENDATIONS</li> <li>• PROD_RECO_GET_RECO_BY_SCENARIO</li> <li>• PROD_RECO_POST_IA_FOR_SCENARIO</li> <li>• PROD_RECO_POST_INTERACTION</li> </ul>
Type of RFC object to which access	<i>Function Module</i>

Table 32:

Authorization Object	CRA_COUNTR
<i>Activity</i>	<ul style="list-style-type: none"> <li>• <i>Display</i></li> <li>• <i>Change</i></li> </ul>

Table 33:

Authorization Object	RECO_RTGET
<i>Activity</i>	<i>Read</i>

In addition, you have to assign your copies of the following roles to the AS ABAP users of your marketing experts:

- SAP\_CEI\_ROF\_FLP (business catalog role; no copy required - you can assign the delivered standard role)
- SAP\_CEI\_HOME (for personalization purposes)

## 12.2 Using Rule-Based Tasks

Rule-based tasks are used in the *Manage Recommendations* app (for example, to do a re-rank of a result from a previous step) as well as in the *Manage Offer Recommendations* app. Rules can also be used to find the best offer using an OData service. For more information, see [Setting up Application "Offers" \[page 100\]](#), section *Enabling the OData API for E-Commerce Integration*.

---

To use rule-based tasks, it is required to have the SAP HANA rules framework installed. To do so, follow the steps described in section [Scenario "HANA Rules Framework" \[page 58\]](#).

In addition, make sure that:

- SAP HANA rules framework activation plug-in is activated
- SAP HANA user `SAP_COM_2002_<SAP_SID>_<Client>` has the following privileges:
  - All package privileges on the package system `system-local.prodreco.hrf`
  - Object privilege `SELECT` and `EXECUTE` on data base schemas `SAP_CUAN_APPL` and on physical data base schema of authoring schema `SAP_CUAN_ERP`
  - Object privilege `SELECT` and `EXECUTE` on data base schemas `SAP_CUAN_APPL`, on physical data base schema of authoring schema `SAP_CUAN_ERP`, and on physical data base schema of authoring schema `SAP_CUAN_CAR`.



# 13 Configuring Planning

The settings described in this section are only relevant if you want to run *SAP Hybris Marketing Planning*.

With *SAP Hybris Marketing Planning*, marketing managers can plan budgets, programs, and spends in *Budget Plans*; marketing experts can plan campaigns and spends in a simple and intuitive way in applications belonging to the *Spend Management* business group. Marketing managers can view programs and the corresponding campaigns that are assigned to the programs, and assign and remove campaigns to programs in the *Programs* application. Marketing managers and marketing experts can have a complete overview of ongoing and planned marketing activities in the *Marketing Calendar* application.

## **i** Note

*Marketing Calendar* does not yet support multiple currencies.

When configuring currencies, note that *Budget Plans*, *Spend Management*, and *Programs* only support rates of type M.

## 13.1 Setting up "Budget Plans"

### **i** Note

Before you start with the configuration for *Budget Plans*, ensure that you have performed the steps described in the following section:

- [Initial Setup of SAP Fiori \[page 67\]](#)

To allow marketing managers to plan a budget according to their organization's requirements, you configure how budget planning is performed by defining a planning model and setting up the authorization for budget planning in Customizing for SAP Hybris Marketing (see below). A planning model has a hierarchical structure that can have both standard and custom dimensions for which budget can be planned. Dimensions can be as follows:

- Standard dimensions:
  - Brand
  - Market
  - Country
  - Region
  - Audience
- Custom dimensions:

Other dimensions for which marketing managers can plan budget. Custom dimensions are defined in Customizing for SAP Hybris Marketing (see below).

When you define a planning model, you assign a dimension to a level in the hierarchy. You must have at least two levels in your planning model. A budget is allocated to the dimension at the first level of the hierarchy. The marketing manager plans a budget for the dimensions at the other levels of the hierarchy.

For more information, see SAP Library for SAP Hybris Marketing on SAP Help Portal at:

<http://help.sap.com/mkt> ► [Application Help](#) ► [SAP Hybris Marketing Applications](#) ► [Planning](#) ► [Budget Planning](#) ►

([http://help.sap.com/saphelp\\_mkt124/helpdata/en/e0/3a20562d06c34ee10000000a44147b/content.htm](http://help.sap.com/saphelp_mkt124/helpdata/en/e0/3a20562d06c34ee10000000a44147b/content.htm))

To set up budget planning, ensure that you make the following settings:

1. If custom dimensions are going to be used for budget planning, define them in Customizing for SAP Hybris Marketing under ► [Planning](#) ► [Budget Planning](#) ► [Define Custom Dimensions](#) ►.
2. If you defined custom dimensions, upload data for them in the system from a comma-separated value (CSV) file using the [Import Data](#) application in the [Import Data](#) business group.
3. If brand is going to be used as a dimension for budget planning, upload brand data in the system from a CSV file using the [Import Data](#) application in the [Import Data](#) business group.
4. If country is going to be used as a dimension for budget planning, define countries in Customizing for [SAP NetWeaver](#) under ► [General Settings](#) ► [Set Countries](#) ►.
5. If region is going to be used as a dimension for budget planning, assign regions to countries in Customizing for [SAP NetWeaver](#) under ► [General Settings](#) ► [Set Countries](#) ► [Insert Regions](#) ►.
6. If market is going to be used as a dimension for budget planning, make the required settings in Customizing for SAP Hybris Marketing under ► [Planning](#) ► [General Settings](#) ► [Define Markets](#) ►.
7. If audience is going to be used as a dimension for budget planning, maintain the audience data using the [Import Data](#) application in the [Import Data](#) business group.
8. If budget planning is going to be done for different media types, make the required settings in Customizing for SAP Hybris Marketing under ► [General Settings](#) ► [Define Media Types](#) ►.

If a plan uses a planning model for which media type is enabled, and no images or icons are defined for the media types, the media type descriptions are shown in the axis of the chart. If only an image is defined for a media type, the image is shown in the axis of the chart. If only an icon is defined for a media type, the icon is shown in the axis of the chart. If both an image and an icon are defined for a media type, only the image is shown in the axis of the chart.

#### **i** Note

It is not mandatory to use media type for campaigns. However, if budget is planned for different media types, it is mandatory that all campaigns that are assigned to programs and are funded by that budget have media type assigned. Otherwise, if such campaigns have actual spend data, the actual spend cannot be shown in [Budget Plans](#). We recommend that you create a media type, such as other or miscellaneous, and assign it to campaigns so that actual spend data for this media type can be shown in [Budget Plans](#).

9. Make the required settings in Customizing for SAP Hybris Marketing under ► [Planning](#) ► [General Settings](#) ► [Define Marketing Areas](#) ►.
10. To define planning models that are going to be used for budget planning, make the required settings in Customizing for SAP Hybris Marketing under ► [Planning](#) ► [Budget Planning](#) ► [Define Planning Models](#) ►.
11. If you want to restrict the values that can be used for plans in budget planning, create dimension relationships and select the values of the dimensions that can be used in the [Dimension Relationships](#) application.
12. To set up user authorization for budget planning, do the following:
  1. Make the required settings in Customizing for SAP Hybris Marketing under ► [Planning](#) ► [Budget Planning](#) ► [Define Areas of Responsibility](#) ►.

For more information, see *Areas of Responsibility* in the application help for SAP Hybris Marketing at:

<http://help.sap.com/mkt> ► *SAP Hybris Marketing Application Help* ► *SAP Hybris Marketing Applications* ► *Planning* ► *Authorization in Planning* ►  
([http://help.sap.com/saphelp\\_mkt124/helpdata/en/65/5ae7917e85443380b7b9f4ee17c3d8/content.htm](http://help.sap.com/saphelp_mkt124/helpdata/en/65/5ae7917e85443380b7b9f4ee17c3d8/content.htm))

2. Assign marketing areas and areas of responsibility to roles and then assign users to the roles using the *Role Maintenance* (PF03) transaction.
13. To define the currency that is going to be used for budget planning and spend management, make the required settings in Customizing for SAP Hybris Marketing under ► *Planning* ► *General Settings* ► *Set Currency* ►.
14. If you defined custom dimensions or if you want to change the labels for the standard dimensions and measures, make the required settings in Customizing for SAP Hybris Marketing under ► *Planning* ► *Budget Planning* ► *Define Labels for Dimensions and Labels* ►.

For more information, see:

- SAP Library for SAP Hybris Marketing on SAP Help Portal at:  
<http://help.sap.com/mkt> ► *Application Help* ► *SAP Hybris Marketing Applications* ► *Contacts and Profiles* ► *Import of Data Using CSV Upload* ►  
([http://help.sap.com/saphelp\\_mkt124/helpdata/en/7d/d16e5458548c4ce10000000a4450e5/content.htm](http://help.sap.com/saphelp_mkt124/helpdata/en/7d/d16e5458548c4ce10000000a4450e5/content.htm))
- SAP Library for SAP Hybris Marketing on SAP Help Portal at:  
<http://help.sap.com/mkt> ► *Application Help* ► *SAP Hybris Marketing Applications* ► *Planning* ► *Authorization Examples for Budget Planning, Programs, and Marketing Spend Management* ►  
([http://help.sap.com/saphelp\\_mkt124/helpdata/en/a5/d4845400082357e10000000a44176d/content.htm](http://help.sap.com/saphelp_mkt124/helpdata/en/a5/d4845400082357e10000000a44176d/content.htm))

## Uploading Data for "Budget Plans"

If the planning model you have defined includes brand information, you need to upload brands in the system. You upload brand data from a comma-separated value (CSV) file using the *Import Data* application in the *Import Data* business group.

For more information, see SAP Library for SAP Hybris Marketing on SAP Help Portal at:

<http://help.sap.com/mkt> ► *SAP Hybris Marketing Applications* ► *Contacts and Profiles* ► *Import of Data Using CSV Upload* ►

([http://help.sap.com/saphelp\\_mkt124/helpdata/en/7d/d16e5458548c4ce10000000a4450e5/content.htm](http://help.sap.com/saphelp_mkt124/helpdata/en/7d/d16e5458548c4ce10000000a4450e5/content.htm))

To access the *Import Data* application, the user must be assigned a copy of the following role:

- SAP\_MARKETING\_BUS\_ADMIN\_USER

For more information, see the security guide for SAP Hybris Marketing on SAP Help Portal at:

<http://help.sap.com/mkt> ► *Security Information* ►

<http://service.sap.com/%7Esapidb/012002523100017103972016E/>

If you want to use custom dimensions, you proceed as follows:

1. Define the custom dimensions in Customizing for SAP Hybris Marketing under ► *Planning* ► *Budget Planning* ► *Define Custom Dimensions* ►. You can define a maximum of 10 custom dimensions. The technical object name for each dimension is CUAN\_CUSTOM\_DIMENSION\_(SAP technical ID of custom dimension from 01 to 10). The mapping from the dimension ID and the technical ID is done automatically. For example, you have defined a custom dimension with the ID *MyDimension*. It will be mapped to the technical ID CUAN\_CUSTOM\_DIMENSION\_01.
2. Assign the custom dimensions to the planning model dimensions in Customizing for SAP Hybris Marketing under ► *Planning* ► *Budget Planning* ► *Define Planning Model* ►.
3. Upload the custom dimension values in the system from a CSV file using the *Import Data* application in the *Import Data* business group.

To access the *Import Data* application, the user must be assigned a copy of the following composite role:

- SAP\_MARKETING\_BUS\_ADMIN\_USER

For more information, see the security guide for SAP Hybris Marketing on SAP Help Portal at:

<http://help.sap.com/mkt> ► *Security Information* ►.

<http://service.sap.com/%7Esapidb/012002523100017103972016E/>

## Setting up the Authorization for "Budget Plans"

Budget planning, programs, and marketing spend management use marketing areas for authorization. In addition, budget planning and programs use areas of responsibility. It is mandatory to set the marketing area and area of responsibility for each user. For more information, see *Authorization Examples for Budget Planning, Programs, and Marketing Spend Management* on SAP Help Portal at:

<http://help.sap.com/mkt> ► *Application Help* ► *SAP Hybris Marketing Applications* ► *Planning* ► *Authorization in Planning* ► *Authorization Examples for Budget Planning, Programs, and Marketing Spend Management* ►

[http://help.sap.com/saphelp\\_mkt124/helpdata/en/a5/d4845400082357e10000000a44176d/content.htm](http://help.sap.com/saphelp_mkt124/helpdata/en/a5/d4845400082357e10000000a44176d/content.htm)

1. Define the marketing areas in Customizing for SAP Hybris Marketing under ► *General Settings* ► *Define Marketing Areas* ►.
2. Define the areas of responsibility in Customizing for SAP Hybris Marketing under ► *Planning* ► *Budget Planning* ► *Define Areas of Responsibility* ►.

For more information, see *Areas of Responsibility* in the application help for SAP Hybris Marketing at: <http://help.sap.com/mkt> ► *SAP Hybris Marketing Application Help* ► *SAP Hybris Marketing Applications* ► *Planning* ► *Authorization in Planning* ►.

[http://help.sap.com/saphelp\\_mkt124/helpdata/en/d0/355ce14ea640378676aa809c6f2652/content.htm](http://help.sap.com/saphelp_mkt124/helpdata/en/d0/355ce14ea640378676aa809c6f2652/content.htm)

3. Assign areas of responsibility to users in transaction PFCG.

4. The users must be assigned a copy of the SAP\_CEI\_AMP role with the following start authorization settings:

Table 34:

Authorization Object	Object Name (HPA_OBJ)	Activity (ACTVT)
HPA_OBJECT	CUAN_BUDGET_PLANNING	<ul style="list-style-type: none"> <li>○ 02 (Change)</li> <li>○ 03 (Display)</li> </ul>

5. Assign instance authorization to users as follows:

Table 35:

Authorization Object	Object Name (HPA_OBJ)	Area of Responsibility ID (RSPAREA_ID)	Activity (ACTVT)
HPA_RSP_AR	CUAN_BUDGET_PLANNING	Area of responsibility ID as defined in Customizing for SAP Hybris Marketing under ► Planning ► Budget Planning ► Define Areas of Responsibility ►	02 (Change)

For more information about the authorization object, see the security guide for SAP Hybris Marketing on SAP Help Portal at:

<http://help.sap.com/mkt> ► Security Information ►  
 (<http://service.sap.com/%7Esapidb/012002523100017103972016E/>)

## Setting Up the Map Visualization

The *Budget Plans* application does not come with a pre-configured map. To set up your map, follow the steps in the SCN blog on SAP Visual Business:

<http://scn.sap.com/docs/DOC-59547>

For more information, see the SAP Visual Business documentation on the SAP Help Portal at:

<http://help.sap.com/visualbusiness21>

## 13.2 Setting up "Programs"

Programs are containers for marketing activities. Marketing managers propose how much to be spent on marketing activities.

## Setting Up the Authorization for Programs

A user can assign a funding source to a program from any plan based on the area of responsibility and marketing area to which the user is assigned.

1. The users must be assigned a copy of the `SAP_CEI_PROGRAM` role.
2. Assign the authorization for funding assignment as follows:

Table 36:

Authorization Object	Object Name (HPA_OBJ)	Area of Responsibility ID (RSPAREA_ID)	Activity (ACTVT)
HPA_RSP_AR	CUAN_BUDGET_PLANNING	Area of responsibility ID as defined in Customizing for SAP Hybris Marketing under ▶ Planning ▶ Budget ▶ Planning ▶ Define Areas of Responsibility ▶	◦ 03 (Display)

For more information about the authorization objects, see the security guide for SAP Hybris Marketing on SAP Help Portal at:

<http://help.sap.com/mkt> ▶ Security Information ▶

<http://service.sap.com/%7Esapidb/012002523100017103972016E/>

## 13.3 Setting up Spend Management

Before you start with the configuration for the applications belonging to spend management (*Quick Campaign Spend*, *Detailed Campaign Spend*), ensure that you have carried out steps described in section [Initial Setup of SAP Fiori \[page 67\]](#).

To set up spend management apps, you need to carry out the following steps:

### Set up Spend Types

1. In Customizing, under SAP Hybris Marketing, go to ▶ Planning ▶ Spend Management ▶ Define Spend Types ▶.
2. Enter the spend types you want to use.
3. Save and close the transaction.

## Assign Users to Roles for Spend Management

To enable marketing managers/experts to use the spend management apps *Quick Campaign Spend* and *Detailed Campaign Spend*, you need to assign your copies of the following PFCG roles to their AS ABAP users:

- One of the following business catalog roles (no copy required - you can assign the delivered standard role):
  - For managers: SAP\_CEI\_PLG\_FLP
  - For experts: SAP\_CEI\_SMP\_FLP
- For managers: SAP\_CEI\_MSM\_SM\_APP (back-end role; included in composite role SAP\_MARKETING\_PLANNING)
- For experts: SAP\_CEI\_MSM\_QE\_APP and SAP\_CEI\_MSM\_SM\_APP (backend roles; included in composite role SAP\_MARKETING\_SPEND\_MGMT\_PROG)
- SAP\_CEI\_HOME (for personalization purposes)

## Add Authorization for Approval of Spends

1. Log on to your SAP Hybris Marketing system and call up transaction PFCG.
2. In order to authorize users to approve spends, you need to assign the following activities to the following authorization objects in your copies of the SAP standard roles SAP\_CEI\_MSM\_QE\_APP and SAP\_CEI\_MSM\_SM\_APP.

To assign the activities to the authorization objects in your copies of the SAP standard roles, proceed as follows:

1. Go to transaction PFCG and call up your copy of SAP standard role SAP\_CEI\_MSM\_QE\_APP in change mode.
2. Switch to the *Authorizations* tab.
3. Choose the *Change Authorization Data* pushbutton.
4. Expand the node *Cross-application Authorization Objects*.
5. Add the missing activities based on the table above.
6. Save your changes and generate the profile.
7. Repeat steps 1 to 6 for your copy of SAP standard role SAP\_CEI\_MSM\_SM\_APP.

## Activate SAP ERP PS Integration for Cost Collection

- To enable cost tracking for marketing spends in SAP ERP, activate one of the BAdI implementations of the *BAdI: Outbound System Integration for Cost References* in Customizing under SAP Hybris Marketing: **► Planning ► Spend Management ►**.
- If you have activated multiple BAdI implementations, we recommend that you use filter options to distinguish between different campaign categories so that for one campaign category one implementation is processed. With this option, you can create project WBS elements in different systems and avoid to generate multiple projects and WBS elements for the same campaign.  
If you activated the BAdI implementation *Marketing Spends Actuals - Create Projects and WBS Elements (ES)*, which is based on Enterprise Services, you have also to establish a logical port. For more information, see also the documentation of the Customizing activity *BAdI: Outbound System Integration for Cost References*.

---

As a prerequisite you have maintained a logical port in the target SAP ERP system using the *SOA Manager*. In the transaction SOAMANAGER under **► Service Administration ► Web Service Configuration ►** you have configured the following services as SSL (https) connection and with the same service and binding name CUAN\_MSM\_PROJECT:

- ProjectERPCreateRequestConfirmation\_In\_V1 (internal name ECC\_PROJECTERPCTR1)
- ProjectERPByIDQueryResponse\_In\_V1 (internal Name ECC\_PROJECTERPIDQR1)
- ProjectERPUpdateRequestConfirmation\_In (internal name ECC\_PROJECTUPDRC)

As a next step run task list CUAN\_MSM\_SETUP\_PS\_INTEGRATION as follows:

1. Log on to your SAP Hybris Marketing AS ABAP system with the application setup user. For more information, see [User for Application Setup \[page 47\]](#).
2. Go to transaction STC01.
3. Execute task list CUAN\_MSM\_SETUP\_PS\_INTEGRATION.

## Assign Marketing Area to Project Profile

1. In Customizing, under SAP Hybris Marketing, go to **► Planning ► Spend Management ► Assign Marketing Area to Project Profile ►**. (Defined in SAP ERP Customizing under **► Project System ► Structures ► Operative Structures ► Work Breakdown Structure (WBS) ► Create Project Profile ►**)
2. Enter a *Project Profile ID* from SAP ERP PS to which you would like to assign a *Marketing Area*.
3. Select the *Project Profile ID* and select the *Folder* Assign Marketing Area
4. Choose *New Entries* to assign a new *Marketing Area*.

## Maintain Project and WBS Element Prefix for SAP ERP

1. In Customizing, under SAP Hybris Marketing, go to **► Planning ► Spend Management ► Maintain Project and WBS Element Prefix for ERP ►**.
2. Create a first entry and enter **Prefix for ERP Project** as well as **WBS Prefix**. (Defined in SAP ERP Customizing under **► Project System ► Structures ► Operative Structures ► Work Breakdown Structure (WBS) ► Project Coding Mask ► Define Project Coding Mask ►**). These prefixes must not have any masks assigned in SAP ERP.

## Upload Actual and Committed Spend from External System

You can use one of the following ways to upload actual and committed spend:

- Using a report.  
Go to transaction SE38 (*Program Execution*) and run program CUAN\_MSM\_UPLOAD\_ACTUAL. You upload actual and committed spend from a file. For more information about the required file format, see the report documentation.



- Using the CUAN\_ACTUAL\_IMPORT\_SRV OData service.  
For detailed information about how to use the OData service for the upload of actual spend, see section *Import of Actual Spend Using an OData Service* in the SAP Hybris Marketing Master Guide under:  
<http://help.sap.com/mkt> ► *Installation and Upgrade Information* ► *Master Guide* ►  
(<http://service.sap.com/%7Esapidb/012002523100017106582016E/>)
- Using a CSV file in the *Import Data* application within the *Import Data* business group.  
To access the *Import Data* application, the user must be assigned a copy of the role SAP\_MARKETING\_BUS\_ADMIN\_USER.

The report, as well as the OData service, and the import using the CSV file, log either a success or an error message. The log is displayed once the report is executed. You can also find all log messages using the transaction *Analyze Application Log* (SLG1) transaction, entering the parameters CUAN\_IMPORT as an object and CUAN\_ACTUAL\_IMPORT as a subobject.

## 13.4 Setting up "Marketing Calendar"

*Marketing Calendar* is an application that marketing managers and experts can use to see an overview of all marketing-related activities for which they are responsible during selected time ranges. The focus here is on aggregated KPIs and how they are influenced by marketing activities in the corresponding time context.

*Marketing Calendar* aggregates and displays data from different SAP Hybris Marketing applications. To use the full functionality (all charts in the *Marketing Calendar* app show data), the following solutions should be enabled:

- Segmentation
- Planning

In addition, you are provided with the *Subscribe to Campaign Calendar* function. This calendar service for subscription can be used with native calendar applications on devices that support the ICS format. The calendar events contain detailed information about the corresponding campaigns.

Before you start with the configuration *Marketing Calendar*, ensure that you have carried out steps described in section *Initial Setup of SAP Fiori* [page 67].





To set up the *Marketing Calendar* app, carry out the following steps:

1. To enable marketing managers/experts to use the *Marketing Calendar* app, you need to assign your copies of the following PFCG roles to their AS ABAP users:
  - One of the following business catalog roles (no copy required - you can assign the delivered standard role):
    - For managers: SAP\_CEI\_PLG\_FLP
    - For experts: SAP\_CEI\_SMP\_FLP
  - SAP\_CEI\_MKT\_CAL\_APP (back-end role; included in composite role SAP\_MARKETING\_MANAGER for managers and in composite role SAP\_MARKETING\_SPEND\_MGMT\_PROG for experts)
  - SAP\_CEI\_HOME (for personalization purposes)

### **i** Note

The standard role SAP\_CEI\_MKT\_CAL\_APP includes an authorization check at instance level for marketing areas. The marketing areas are defined in customizing under SAP Hybris Marketing under ► *Planning* ►

**General Settings** > **Define Marketing Areas**  If a user assigned to a copy of SAP\_CEI\_MKT\_CAL\_APP tries to access an object instance for a particular marketing area, the system checks whether they are allowed to access that area.

2. Configure your ABAP system to access the SAP Web Dispatcher as follows:
  1. Log on to your SAP Hybris Marketing system with the user for application setup.
  2. Call up transaction SE16 and enter table HTTPURLLOC.
  3. Press *Create Entries*.
  4. Create an entry with the following parameters:
    - *SORT KEY*: MCAL
    - *PROTOCOL*: HTTPS
    - *APPLICATN*: /SAP/CUAN/CUAN\_MKTCAL\_ICS
    - *HOST*: Enter the fully qualified domain name of your SAP Web Dispatcher that matches the *Common Name* in your SSL certificate.
    - *PORT*: Enter the HTTPS port.
    - Save your entry.
  5. Create an entry with the following parameters:
    - *SORT KEY*: NAVT
    - *PROTOCOL*: HTTPS
    - *APPLICATN*: /SAP/BC/UI5\_UI5/SAP/CUAN\_NAV\_TO
    - *HOST*: Enter the fully qualified domain name of your SAP Web Dispatcher that matches the *Common Name* in your SSL certificate.
    - *PORT*: Enter the HTTPS port.
    - Save your entry.
  6. Integrate the marketing calendar as an internet calendar into your calendar application (supporting the ICS format). For more information about this step, see the documentation of your calendar application. You can use the *Subscribe to Campaign Calendar* function to transfer campaigns to your calendar application. This works with all calendar applications (such as Microsoft Outlook) that support ICS format. If you select this function, a mail opens in your email program containing a link which you can copy and use once in your calendar application. The campaigns that are matching the filter criteria applied in the marketing calendar (before running the *Subscribe* function) are then transferred to your calendar application.
3. Configure the SAP Visual Business by following the steps in the SAP Visual Business documentation:  
<http://help.sap.com/visualbusiness21>   *Installation and Upgrade Information* > *Installation and Configuration Guide*   
(<https://service.sap.com/~sapidb/011000358700000544602013E> )

### Note

There is also an SCN blog on the subject:

<http://scn.sap.com/docs/DOC-59547> 

## 13.5 Setting up Manager-Related Applications

The following manager-related applications improve the approval process for marketing campaigns by a workflow-based approach:

- [Marketing Approvals](#)
- [Manage Workflows](#)

Both applications are located in the [Marketing Manager - Quick Launch](#) business group.

### Marketing Approvals

To set up the [Marketing Approvals](#) application, you need to carry out the following steps:

#### 1. Enable Workflow

To ensure the workflow is enabled, go to transaction `SWU3` in your SAP Hybris Marketing system and execute the automatic workflow Customizing. To do so, follow the instructions documented in the SAP Library under: <http://help.sap.com/nwpi71> ► [Configuration of the IT Scenarios](#) ► [Business Process Management](#) ► [Variant-Specific Configuration](#) ► [Automatic Workflow Customizing](#) ► [http://help.sap.com/SAPHELP\\_NWPI71/helpdata/en/a0/28e937a5caba6ee10000009b38f842/frameset.htm](http://help.sap.com/SAPHELP_NWPI71/helpdata/en/a0/28e937a5caba6ee10000009b38f842/frameset.htm)

#### 2. Agents

Go to the [Task Customizing Overview](#) (`OOCU`) transaction.

Choose ► [CEC](#) ► [CEC-MKT](#) ► [CEC-MKT-CPG](#) ► [Assign Agents](#) ►. For each item, choose [Attributes](#) and select the [General Task](#) radio button.

If the path [CEC-MKT-CPG](#) or the [Assign Agents](#) button is not displayed, execute report `RS_APPL_REFRESH` in transaction `SA38` and repeat the step above.

#### 3. Activate Advanced Status Management

In Customizing for SAP Hybris Marketing under ► [General Settings](#) ► [Activate Workflow for Business Objects](#) ►, choose the business object for which you want to activate workflows, and select the [Active](#) checkbox.

#### 4. Assign Users to Roles

To enable marketing managers to use the [Marketing Approvals](#) application, you need to assign your copies of the following PFCG roles to the corresponding AS ABAP users:

- `SAP_CEI_PLG_FLP` (business catalog role, no copy is required, you can assign the delivered standard role)
- `SAP_CEI_MKT_APPROVAL` (back-end role; included in composite role `SAP_MARKETING_MANAGER`)
- `SAP_CEI_HOME` (for personalization purposes)

In addition, you must assign a copy of the back-end role `SAP_CEI_MKT_BATCH_APPROVAL` to the workflow batch user `WF-BATCH` to execute the user decision in the [Marketing Approvals](#) app.

---

## Manage Workflows

To enable marketing managers to use [Manage Workflows](#), assign your copies of the following PFCG roles to the corresponding AS ABAP users.

- SAP\_CEI\_PLG\_FLP (business catalog role; no copy required - you can assign the delivered standard role)
- SAP\_CEI\_WORKFLOW\_EDITOR (back-end role; included in composite role SAP\_MARKETING\_MANAGER)
- SAP\_CEI\_HOME (for personalization purposes)

---

# 14 Configuring Acquisition

The settings described in this section are only relevant if you want to run *SAP Hybris Marketing Acquisition*.

## **i** Note

To install *Acquisition*, you must first install *Segmentation* (see [Configuring Segmentation \[page 96\]](#)).

A prerequisite for configuring *Acquisition* is the corresponding technical configuration. If you have not executed the technical configuration for *Acquisition* yet, follow the instructions in section [Scenario "Campaign Management" \[page 60\]](#).

## 14.1 General Settings

### 14.1.1 Setting up Integration with Facebook (Optional)

In SAP Hybris Marketing, you can plan and create campaigns that are handed over to Facebook for execution. Optionally, you can define and transfer a target group to be addressed at Facebook. From Facebook, actual spend and campaign success data is retrieved and made available for analysis in SAP Hybris Marketing.

## Prerequisites

Before you begin, a few things need to be done:

Table 37:

In Facebook	In the SAP Hybris Marketing Back-End
<ul style="list-style-type: none"> <li>You need your own Facebook app that must be reviewed and released for productive usage by Facebook. When starting the review process, mention that you are using SAP Hybris Marketing.</li> </ul> <div data-bbox="165 696 732 922" style="background-color: #fff9c4; padding: 10px; margin: 10px 0;"> <p><b>i Note</b></p> <p>Note that a prerequisite for the approval is a link to a data privacy policy that is visible to every user of the app. Ensure that your company has such a policy in place.</p> </div> <ul style="list-style-type: none"> <li>Look up the application ID (<i>App ID</i>) and client secret (<i>App Secret</i>) in Facebook for later use when configuring the OAuth 2.0 Client.</li> <li>To actually do advertising on Facebook you need a Facebook ad account. It is recommended to use <i>Facebook Business Manager</i>. For details refer to the Facebook documentation. If you work together with a marketing agency, you have to clarify who owns and manages the ad account. In any case your users need marketer permissions on the ad account. You can also work with multiple ad accounts (such as one account per marketing area).</li> </ul>	<ul style="list-style-type: none"> <li>Ensure the required role: SAP_CUSTOMER_ANALYTICS_ADMIN (single) is included in composite role SAP_CEI_TECHNICAL_CONF</li> </ul>

## Back-End Configuration for Integration with Facebook

- Configure an OAuth 2.0 client:
  - From the *SAP Easy Access* menu, start the transaction OA2C\_CONFIG. This will open the *OAuth 2.0 Client Configuration* in a Web browser. Alternatively, you can open the URL with:  
`https://<host>:<port>/sap/bc/webdynpro/sap/oa2c_config?sap-language=EN&sapclient=<client>`.
  - From the *OAuth 2.0 Clients* window, choose *Create*, select FACEBOOK from the client profile drop-down menu and enter the client identification (*App ID*) number you received during registration of the application with Facebook.
  - Enter the following scenario-specific *Target Endpoint*:  
`/sap/bc/ui5_ui5/sap/CUAN_NAV_TO/index.html#CUAN_TI_F_INI_MKT_AUTOMATION_ENDPOINT`.

- The target endpoint entered on your ABAP application server is used to redirect the browser of the end user after completing the authorization process.
- Under *General Settings*, enter the *Client Secret (App Secret)* information you received during registration of the application with Facebook and press **Enter** to confirm the entry.
  - From the *Scopes* tab page, verify that `FACEBOOK` is displayed in the profile table, and `Ads Management` and `Public Profile` are listed in the *Scopes* table.
  - Save the OAuth 2.0 Client configuration.
2. Maintain Facebook application settings:
    - As in step 1 from the *OAuth 2.0 Client* (transaction `OA2C_CONFIG`) window, copy the *Redirection URI* into the clipboard.
    - Add it to Facebook under **▶ App settings ▶ Advanced ▶ Valid OAuth redirect URIs ▶**. This will make your OAuth 2.0 client known to the OAuth 2.0 authorization server on Facebook.
  3. Configure proxy settings:
 

Access to the internet from the AS ABAP system is made possible through a proxy server. If not yet configured, please configure your proxy server settings.

Although proxy settings may be active, the HTTPS protocol might not have a proxy listed. If so, add your proxy.
  4. Configure Secure Socket Layer (SSL) settings:

#### **i** Note

You will need a user assigned the role `SAP_BC_BASIS_ADMIN`. For more information, see section [User for Application Setup \[page 47\]](#).

- Go to <https://www.facebook.com> and click on the lock symbol next to the URL to get the site information.
  - Locate the `DigiCert High Assurance EV Root CA` and save it as a file.
  - Start transaction `STRUST` in *SAP Easy Access* menu and switch to change mode.
  - Choose *PSE SSL Client Anonymous*.
  - From the *Certificate* area, choose *Import Certificate* and import the saved Facebook certificate file.
  - Choose *Add to Certificate List* and save the PSE file.
- The AS ABAP will now trust SSL servers whose identity is confirmed by this certificate.
5. Activate the *FB* campaign category in Customizing from **▶ Define Campaign Categories ▶ Assign Actions to Categories ▶**.

## 14.1.2 Setting up Integration with Paid Search (Optional)

The integration of SAP Hybris Marketing with Paid Search provides you with the following options:

- From the *Campaign* overview screen on the user interface, you can create marketing campaigns that correspond to a paid search campaign in Google AdWords, Yahoo Gemini, or Bing Ads using the *Create Paid Search Campaign* pushbutton.
- From the *Campaign* overview screen, you can open a paid search campaign by selecting it in the overview list, and display key performance indicators (KPIs) either retrieved from Google AdWords or manually uploaded (for Google, Yahoo, and Bing campaigns).

- When you open a target group in the *Target Groups* app, on the *Campaigns* tab of the target group details screen, you can open a paid search campaign by selecting it from the list.
- From the *Marketing Calendar* app (in the *Campaign Management* or the *Spend Management* business groups), you can open a paid search campaign by selecting it in the campaign calendar view.
- From the *Import Data* app (in the *Import Data* business group), you can upload campaign KPIs using the *Campaign Success* option.
- When *SAP Hybris Marketing Planning* is active, you can plan spends for paid search campaigns and open these campaigns by selecting the corresponding campaign ID in the *Marketing Spend - Details* app (*Spend Management* business group). You can also see the cost of the campaign in the *Spend* view.

Before you start with the configuration for the Paid Search integration, carry out the following steps Customizing for SAP Hybris Marketing (transaction `SPRO`):

- Under **General Settings > Define Media Types**:

Table 38:

Media Type	Media Type Description	SAPUI5 Icon Name
PAID_SEARCH	Paid Search	search

- Under **Contacts and Profiles > Interactions > Define Communication Media**:

Table 39:

Communication Medium	Communication Medium Description	Media Type ID
BING_ADS	Bing Ads	PAID_SEARCH
GOOGLE_ADS	Google Ads	PAID_SEARCH
_YAHOO_ADS	Yahoo! Ads	PAID_SEARCH

- Upload an image for each of the entries above, with the logo of the specific communication medium (shown on the *Paid Search* and the *Campaigns* screens) using the *Manage Images* Fiori app.
- Under **Campaigns > Campaign > Define Categories and Actions** in the *Define Campaign Categories* view:

Table 40:

Category ID	Category Name	Category Tooltip	Is Active	Perm. Hldng	Process Type
PS	Paid Search	Campaigns for creating and linking to paid search campaigns executed on search platforms such as Google, Bing, Yahoo	Yes	Ignore Marketing Permission	Paid Search



- Under **Campaigns > Campaign > Define Categories and Actions** in the *Define Campaign Actions* view:

Table 41:

Action ID	Action Name	Action Button Text	Button Tooltip	Class/Interface
PS_CUSTOM_AUDIENCE	Create Paid Search Custom Audience	Create Paid Search Custom Audience	Create Paid Search Custom Audience	CL_CUAN_MO_TG_TRANSFER_PS

- Under **Campaigns > Campaign > Define Categories and Actions** in the *Assign Actions to Categories* view for the PS category ID:

Table 42:

Action ID	Action Name
PS_CUSTOM_AUDIENCE	Create Paid Search Custom Audience

To access the *Campaign Management* business group and the *Paid Search* application, the user must be assigned a copy of the following roles:

- SAP\_CEI\_CPM\_FLP (business catalog role; no copy required - you can assign the delivered standard role)
- SAP\_CEI\_TG\_INI (back-end role; included in composite role SAP\_MARKETING\_DATA\_MANAGEMENT)
- SAP\_CEI\_HOME (for personalization purposes)

For more information, see *Paid Search and SAP HANA Cloud Integration* at:

<http://service.sap.com/mkt> **Paid Search and SAP HANA Cloud Integration**

<http://service.sap.com/%7Esapidb/012002523100017106002016/>

## Uploading Data for Paid Search KPIs

KPIs for Google AdWords campaigns are retrieved automatically from Google via the scheduled background job SAP\_CUAN\_PAID\_SEARCH\_KPI. This job is scheduled to run on a regular basis to always have the most up to date KPIs for your Google AdWords campaigns.

You can also manually upload campaign success KPIs. You upload campaign success data from a comma-separated value (CSV) file using the *Import Data* application in the *Import Data* business group.

For more information, see SAP Library for SAP Hybris Marketing on SAP Help Portal at:

<http://help.sap.com/mkt> **Application Help > SAP Hybris Marketing Applications > Contacts and Profiles > Import of Data Using CSV Upload**

([http://help.sap.com/saphelp\\_mkt124/helpdata/en/7d/d16e5458548c4ce10000000a4450e5/content.htm](http://help.sap.com/saphelp_mkt124/helpdata/en/7d/d16e5458548c4ce10000000a4450e5/content.htm))

To access the *Import Data* application, the user must be assigned a copy of the following role:

- SAP\_MARKETING\_BUS\_ADMIN\_USER

To upload paid search KPIs, the user must have the following authorization object assignments:

Table 43:

Authorization Object	Object Name (HPA_OBJ)	Activity (ACTVT)
HPA_OBJECT	CUAN_INITIATIVE	02 (Change)

Table 44:

Authorization Object	Object Name (HPA_OBJ)	Action Name (HPA_ACTION)	Activity (ACTVT)
HPA_ACTION	CUAN_INITIATIVE	UPDATE_EXTERNAL_REPORTING_DATA	16 (Execute)

For more information, see the security guide for SAP Hybris Marketing on SAP Help Portal at:

<http://help.sap.com/mkt> ► Security Information ►

<http://service.sap.com/%7Esapibd/012002523100017103972016E/>

### 14.1.3 Setting up Integration with SAP CRM (Optional)

Enhanced integration of SAP Hybris Marketing with SAP CRM offers the following options:

- In the *Campaigns* app in business group *Campaign Management*, you can use an action to create leads, opportunities, tasks, activities, or call lists in *SAP CRM*.
- For a campaign, you can display success measures that are based on the leads, opportunities, tasks, activities, or call lists created in *SAP CRM*.
- In the *Marketing Executive Dashboard*, the leads created in *SAP CRM* are displayed as key figures.

For more information, see the *SAP CRM Integration checklist* under <http://service.sap.com/mkt> ► Checklist for the Integration Setup with *SAP CRM* ►

<http://service.sap.com/%7Esapibd/012002523100017106232016E/>

### 14.1.4 Setting Up Call Center Integration (Optional)

*SAP Hybris Marketing* provides you with the option to integrate call centers in your campaign execution.

You have the following integration options:

- Integration with *SAP Hybris Cloud for Customer* (see [Setting Up Call Center Integration with SAP Hybris Cloud for Customer \[page 123\]](#))
- Integration with *SAP Contact Center* or an external call center (see [Setting up Call Center Integration with SAP Contact Center or External Call Centers \[page 124\]](#))
- Integration with *SAP CRM Interaction Center* (see [Setting up Integration with SAP CRM \(Optional\) \[page 122\]](#) and [Installation of SAP Landscape Transformation Replication Server \[page 31\]](#))

## 14.1.4.1 Setting Up Call Center Integration with SAP Hybris Cloud for Customer

### **i** Note

- As a prerequisite for the call center integration with SAP Hybris Cloud for Customer, you must have carried out the steps related to C4C integration described in section [Scenario "Lead Management with Cloud for Customer Integration" \[page 61\]](#).
- If SAP Hybris Marketing is integrated with SAP CRM or SAP ERP, these systems must also be connected to the SAP Hybris Cloud for Customer systems. This ensures that the replication of customers and business transactions, such as leads or opportunities is consistent.

You are provided with the option to trigger SAP Hybris Cloud for Customer call qualifications to the SAP Hybris Cloud for Customer system directly from a campaign in your SAP Hybris Marketing system. A standard action for campaigns is available to do so. These call qualifications are handled as marketing leads in SAP Hybris Cloud for Customer.

### Assigning Standard Action to Campaign Category

To activate this function, you must assign the standard action `CALL_QUALIFICATION` ([Trigger C4C Call Qualification](#)) to a campaign category in Customizing for SAP Hybris Marketing (transaction `SPRO`) under [Campaigns > Campaign > Define Campaign Categories and Actions](#). This is already assigned to the campaign category `CIC - Call Center` in the standard SAP system or you assign the action `CALL_QUALIFICATION` to the required category as follows:

1. Select the required category to which you want to assign the action `CALL_QUALIFICATION` in the [Define Campaign Categories](#) view.
2. Choose the [Assign Actions to Categories](#) view.
3. Choose [New Entries](#).
4. Choose the action `CALL_QUALIFICATION` from the value help for the [Action ID](#) field and confirm your entry
5. Enter any required text in the [Action Button Tooltip](#) and [Button Tooltip](#) fields if you want to override the action button text and button tooltip that is specified directly in the action. This override is valid in the context of this category/action relationship only.

As a result, the new action is available for new campaigns with this category.

### Check Permission to Contact in SAP Hybris Marketing

According to the Customizing settings you have made, when the action to create the call list is executed in SAP Hybris Marketing, the system checks whether permission to make contact by telephone is available. Check this setting in Customizing for SAP Hybris Marketing under [Campaigns > Campaign > Define Campaign Categories and Actions](#). Choose [Define Campaign Categories](#) followed by the category `CIC`. If the value [Ignore Marketing Permission](#) has not been selected for the [Category Type](#), the system checks whether permission to make contact is available when the action to create the leads (`CALL_QUALIFICATION`) is executed.

## 14.1.4.2 Setting up Call Center Integration with SAP Contact Center or External Call Centers

### Integration with SAP Contact Center

#### File Export for SAP Contact Center

You can export call center requests to *SAP Contact Center* directly from a campaign in your SAP Hybris Marketing system. A new standard action for campaigns has been provided for this.

This will create a CSV file that can be imported to *SAP Contact Center*. To activate this function, you must assign the new standard action `EXPORT_TO_CC` (Create Exp. File for *SAP Contact Center*) to a campaign category in Customizing for SAP Hybris Marketing (transaction `CEI_IMG`) under ► *Campaign* ► *Campaigns* ► *Define Campaign Categories and Actions* ►. This is already assigned to the campaign category *CIC - Call Center* in the standard SAP system, or you can assign the action `EXPORT_TO_CC` to the required category as follows:

1. Select the required category to which you want to assign the action `EXPORT_TO_CC` in the *Define Campaign Categories* view.
2. Choose the *Assign Actions to Categories* view.
3. Choose *New Entries*.
4. Choose the action `EXPORT_TO_CC` from the value help for the *Action ID* field and confirm your entry
5. Enter any required text in the *Action Button Tooltip* and *Button Tooltip* fields if you want to override the action button text and button tooltip that is specified directly in the action. This override is only valid in the context of this category/action relationship.

This results in the new action being available for new campaigns of this category.

As a default, the CSV file is created in the application server directory defined by the `DIR_HOME` directory parameter. You can see the value of this parameter in the transaction `AL11`. If you want the CSV file to be written to a different application server directory, you can do this as follows:

1. Call the transaction `FILE`.
2. Create a logical file path definition, such as `Z_SAP_CONTACT_CENTER`, and assign the directory to which you want the file to be written as a physical path to it, using a syntax group appropriate for your application server file system.
3. Open the logical file name definition `CALL_CENTER_CSV` and enter the name of your logical path definition in field *Logical Path*.
4. Save and exit.

So that it can be imported to *SAP Contact Center*, the CSV file created by the action has to be transferred from the file system for the SAP Hybris Marketing application server to the file system for *SAP Contact Center*. You should schedule an appropriate job (such as FTP) to do this periodically. This file can be imported to *SAP Contact Center* using the System Configurator (SC). For more information about SAP Contact Center, see <http://help.sap.com/contact-center>.

#### Check Permission to Contact in SAP Hybris Marketing

According to the Customizing settings you have made, when the action to create the call list is executed in SAP Hybris Marketing, the system checks whether permission to make contact by telephone is available. Check this setting in Customizing for SAP Hybris Marketing under ► *Campaigns* ► *Campaign* ► *Define Campaign Categories and Actions* ►. Choose *Define Campaign Categories* followed by the category `CIC`. If the value *Ignore Marketing*

*Permission* has not been selected for the *Category Type*, the system checks whether permission to make contact is available when the action (such as *Create Export File for SAP Contact Center* - EXPORT\_TO\_CC) is executed to create the CSV file.

### Import of Call Results from SAP Contact Center

You can import call results from *SAP Contact Center* to your SAP Hybris Marketing system.

You can export CSV files with call results from *SAP Contact Center* to the System Configurator (SC). Following this, the CSV file that contains the call results has to be transferred from the file system for the *SAP Contact Center* to the file system for the SAP Hybris Marketing application server. You should schedule an appropriate job (such as FTP) to do this periodically.

Once the file is available on the application server, it can be imported to SAP Hybris Marketing. You can do this using a new report CUAN\_CC\_UPLOAD\_CSV that can be scheduled periodically.

To do so, you have to create a variant of the selection screen for the report.

1. Call transaction SE38 and execute the report CUAN\_CC\_UPLOAD\_CSV.
2. Leave the default value SAP\_CC in the parameter *Call Center*.
3. Enter the directory from where the call result files are read in the parameter *Upload Files from Directory*.
4. Leave the default value \*.csv in the parameter *Upload Files with Name Pattern*.
5. Optionally enter the directory to which the process call result files are to be archived in the parameter *Archive Files to Directory*.
6. Save the variant by choosing **Go to > Variants > Save as Variant...**

## Integration with External Call Centers

If you want to connect a call center other than *SAP Contact Center* to SAP Hybris Marketing using CSV files, see SAP Note 2182902 - *How-To Configuration Guide - Execute SAP Hybris Marketing Campaigns using an external Call Center*.

### 14.1.5 Setting up Integration with SAP Exchange Media (Optional)

You can create campaigns on *SAP Exchange Media* (SAP XM), for example, to display ads shown on web pages. You can also track the success of the SAP XM campaign in SAP Hybris Marketing once it has been activated.

To set up the integration with SAP Exchange Media, follow the instructions in the corresponding integration guide. You find this guide on the SAP Service Marketplace at:

<http://service.sap.com/mkt> **Integration of SAP Exchange Media with SAP Hybris Marketing**

<http://service.sap.com/%7Esapidb/012002523100017106562016E/>

## 14.1.6 Setting up External Campaign Integration (Optional)

You can create campaigns on generic external systems, which are implementing the interfaces for external campaigns. Alternatively, you can use a middleware such as SAP HANA Cloud Integration (HCI) to map the SAP Hybris Marketing interfaces to the interfaces of the external system (such as Twitter).

The interfaces in SAP Hybris Marketing create campaigns on external systems, track the success of that campaign from the external system, and transfer target groups to the external system.

### **i** Note

The following explanations describe the necessary settings for the setup of external campaign in SAP Hybris Marketing. For more information on the necessary settings in the **external system** that you want to connect, see the corresponding integration guide on the SAP Service Marketplace under:

<http://service.sap.com/mkt>  **External Campaign Execution** 

<http://service.sap.com/%7Esapidb/012002523100017106222016E/> 

## Prerequisites

Ensure that you have the required role in the SAP Hybris Marketing back end:

SAP\_CUSTOMER\_ANALYTICS\_ADMIN (single) is included in composite role SAP\_CEI\_TECHNICAL\_CONF.

## Technical Configuration for Integration

1. Configure proxy settings:  
Access to the internet from the AS ABAP system is made possible through a proxy server. If not yet configured, please configure your proxy server settings.  
Although proxy settings may be active, the HTTPS protocol might not have a proxy listed. If so, maintain your proxy for HTTPS.
2. Configure Secure Socket Layer (SSL) settings. This is only required if the connection to the external system has already been configured.

### **i** Note

You will need a user assigned the role SAP\_BC\_BASIS\_ADMIN. For more information, see section [User for Application Setup \[page 47\]](#)

To configure SSL do the following:

1. Go to the URL of your external system and choose the lock symbol next to the URL to get the site information.
2. Locate the certificate and export it to a file. [Hint: In Chrome, right click on lock, go to [Details](#), click on [View Certificate](#) and export the root certificate into a file.]

3. Start transaction `STRUST` in *SAP Easy Access* menu and switch to change mode.
4. Choose *PSE SSL Client Anonymous*.
5. From the *Certificate* area, choose *Import Certificate* and import the saved SAP XM certificate file.
6. Choose *Add to Certificate List* and save the PSE file.

The AS ABAP will now trust SSL servers whose identity is confirmed by this certificate.

3. Create a suitable campaign category in Customizing for SAP Hybris Marketing (transaction `SPRO`) under **► Define Campaign Categories ► Assign Actions to Categories ▾**. Remember to set the category to active. The process type must be set to externally executed. For integrating over HCI, you may use a name such as **ZHC** as category code.

## Configure an OAuth Client (optional)

You have the option to choose between using basic authentication or OAuth 2.0. If you elect to use basic authentication, you are not required to configure an OAuth client. If you elect to use an OAuth client, the server must be implemented according to the `SAP_CUAN_ECPG_HCI` OAuth 2.0 client profile.

To set up an OAuth Client in your system do the following:

1. From the *SAP Easy Access* menu, start the transaction `OA2C_CONFIG`.  
This will open the *OAuth 2.0 Client Configuration* in a web browser. Alternatively, you can open the URL with:  
`https://<host>:<port>/sap/bc/webdynpro/sap/oa2c_config?sap-language=EN&sapclient=<client>`
2. From the *OAuth 2.0 Clients* window, choose *Create*, select `SAP_CUAN_ECPG_HCI` from the client profile drop-down menu and enter the client identification number of the OAuth client.
3. Enter the following scenario-specific *Target Endpoint*:  
`/sap/bc/ui5_ui5/sap/CUAN_NAV_TO/index.html#CUAN_TI_F_INI_MKT_AUTOMATION_ENDPOINT`.  
The target endpoint entered on your ABAP application server is used to redirect the browser of the end user after completing the authorization process.
4. Under *General Settings*, enter the *Client Secret* information you received during registration of the OAuth client and choose *Enter* to confirm the entry.
5. Fill in the Authorization Endpoint and Token Endpoint under Authorization Server Settings.

## Define HTTP Destination

Before you can connect to SAP Hybris Marketing, you must define a connection in your system.

1. In SAP Hybris Marketing go to transaction `SM59` to access *RFC Destinations (Display/Maintain)*.
2. Create a new *HTTP Connection to External System (Type G)*.
3. You can enter a RFC destination name of your choice and create your own description.
4. Enter the `hostname` of the external system in the *Target Host* field..
5. Under *Logon & Security*, make sure that SSL is active in *Security Options*.
6. For the authentication, choose *Logon Procedure* and either of the following:
  - *Do not use a user*  
Connects to the external system via OAuth.

- *Basic authentication*  
Requires *User* and *Password*.

## Define Connections for Externally Executed Campaigns

To set up a connection between SAP Hybris Marketing and external system:

1. Go to Customizing for SAP Hybris Marketing. The Customizing activity is located under ► *Campaigns* ► *Campaign* ► *Define Connections for Externally Executed Campaign* ▾.
2. Create a new entry for the campaign category you have created before.
3. *Marketing Area* can be left blank unless you have decided to use marketing areas.
4. Choose the *Authentication Method* that your external system uses.  
For OAuth, enter the name of the profile in *OAuth 2.0 Profile* that you created the OAuth client for in transaction OA2C\_CONFIG.

### **i** Note

Leave the field empty for *Basic* authentication.

5. Enter the *Service Path* of the external system's URL.  
For example, to use the campaign endpoint enter `http://yoursystem.com/some/Path/CampaignSet`.

### **i** Note

The endpoint names, for example, `CampaignSet`, are fixed and cannot be altered.

6. The *Destination* is the RFC destination you defined earlier. Enter the corresponding name here.
7. Under *Activate OData Entity*, mark all six endpoints as active.  
If you do not want to use all features, you can set endpoints to inactive. Refer to the Application Help for more information about the possible combinations.
8. Save your entries.

## 14.1.7 Enabling WeChat-Specific Campaign Categories and Actions

To enable the use of WeChat-specific campaign categories and actions, configure the china localization as described in section [Configuring China Localization \[page 147\]](#).



The following WeChat-specific campaign categories are available after you have configured the china localization:

Table 45:

Campaign Categories	Actions
<i>WeChat - Automated Campaign (Once)</i> (WCA)	<i>WeChat Broadcast Message</i> (WC_BROADCAST_MESSAG) <i>WeChat Direct Message</i> (WC_DIRECT_MESSAGE)
<i>WeChat - Automated Campaign (Periodic)</i> (WCP)	<i>WeChat Broadcast Message</i> (WC_BROADCAST_MESSAG) <i>WeChat Direct Message</i> (WC_DIRECT_MESSAGE)
<i>WeChat - Trigger-Based Campaign</i> (WCT)	<i>WeChat Direct Message</i> (WC_DIRECT_MESSAGE)

For more information about WeChat campaigns, see the application help for SAP Hybris Marketing at:

<http://help.sap.com/mkt> ► [SAP Hybris Marketing Application Help](#) ► [SAP Hybris Marketing Applications](#) ► [Campaigns](#) ► [WeChat Campaigns](#) ►

([http://help.sap.com/saphelp\\_mkt124/helpdata/en/e5/62cd6e7ca9488e8a5ca78287c1cf7c/content.htm](http://help.sap.com/saphelp_mkt124/helpdata/en/e5/62cd6e7ca9488e8a5ca78287c1cf7c/content.htm))

## 14.1.8 Setting up Landing Pages

In *Acquisition*, you are provided with the *Landing Pages* application. This app allows you to design landing pages to collect interaction contact and marketing permission data. The content of the app is also included in the *Content Studio* application.

For security and performance reasons, you must deploy the landing pages that you have created using this app, on your Web server available to make them available to the internet. The Web server must send the collected data to the SAP Hybris Marketing server using the OData service CUAN\_CONTENT\_PAGE\_RESULT\_SRV. The service saves the data and triggers follow-on actions.

Implementation of the landing pages includes the following parts:

- Deploying the files on your Web server
- Implementing the Web server in order to forward the results to the SAP Hybris Marketing system.

## Assign Users to Roles

A marketing expert can only use *Landing Pages*, if his or her user is assigned to your copy of the following roles:

- SAP\_CEI\_CPM\_FLP (business catalog role; no copy required - you can assign the delivered standard role)
- SAP\_CEI\_CONTENT\_PAGES (back-end role; included in composite role SAP\_MARKETING\_CAMPAIGNS)
- SAP\_CEI\_HOME (for personalization purposes)

Configuration steps related to the SAP Hybris Marketing server require a user which has your copy of the following role assigned:

- `SAP_CEI_CONTENT_PAGE_RSLT` (back-end role; included in composite role `SAP_MARKETING_CAMPAIGNS`)

### **i** Note

Your copy of the latter role is also required for testing newly created landing pages.

## 14.1.8.1 Deploying the Landing Page

The source code (HTML) for every landing page you design must be downloaded via the user interface and deployed on your Web server.

In addition, you can download a style sheet (CSS) and a JavaScript file. You must adapt the JavaScript file according to your requirements and your system setup. This step is required for your initial system setup and allows you to deploy the CSS and JavaScript files. You do not need to adapt these files again until you perform an upgrade to a new release. Adapting the files when you upgrade ensures that you can avail of new features.

By default, the HTML file tries to load both files with the names `sapContentPage.css` and `sapContentPage.js` from the same folder in which the HTML file is located. If you want to adjust those names or the file paths you must change the HTML file content.

## 14.1.8.2 Adjusting the JavaScript File

After downloading the JavaScript file you must adjust the Web service path written in the file.

The base is the path for the OData service on the SAP Hybris Marketing server:

- `/sap/opu/odata/sap/CUAN_CONTENT_PAGE_RESULT_SRV`

You must adjust this path according to the Web server implementation (see section [Implementing the Result OData Service \[page 131\]](#)).

When a user opens a landing page, the path is loaded via a `HTTP HEAD` request in order to fetch a CSRF token. Further data requests are sent to the result path which is added to the base path. The result path can be adjusted or left empty in the JavaScript file. The default path `ResultHeaders` describes the OData service entity used for the results.

You are not required to perform any implementation for the front end. The JavaScript that is delivered is capable of collecting the user input independently. It is possible to adapt and enhance the landing page HTML file that is generated, but you must ensure you preserve the integrity of the standard structure.

## 14.1.8.3 Implementing the Result OData Service

You must implement your Web server in a way that makes it capable of receiving the requests of the landing page JavaScript files and forwarding them to the SAP Hybris Marketing server. By default, the requests are ready for the result OData service `CUAN_CONTENT_PAGE_RESULT_SRV` and do not need to be adjusted.

### Note

In some usage scenarios, the request data must be enhanced to enable all features. To do this, you must decode the JSON payload string and add the appropriate attributes before encoding the JSON string again for the OData service.

The actual implementation depends on the technology and development language that you use in your company. See an example implementation in PHP below.

### Caution

**The following code is an example implementation. SAP does not take responsibility if you use it in your productive system.**

## Example

### Sample Code

```
<?php
/**
 * This class is an example implementation of a PHP based landing page
 integration.
 * Note: This is a template, which is used at your own risk.
 */
class LandingPageIntegration
{
    /**
     * The BasePath is the URL for the system including the landing page result
 OData service.
     *
     * @var string
     */
    const BASE_PATH = "https://<server>:<port>/sap/opu/odata/sap/
CUAN_CONTENT_PAGE_RESULT_SRV/";
    /**
     * The ResultHeadersPath is the name of the ResultHeaders entity which is
 used for processing the landing page results.
     *
     * @var string
     */
    const RESULT_HEADERS_PATH = "ResultHeaders";
    /**
     * The credentials are used for authenticating on the system.
     * This is usually a dedicated system or communication user with the
 integration role assigned.
     *
     * @var string
     */
    const CREDENTIALS = "USERNAME:PASSWORD";
```

```

/**
 * The cookies are remembered between consecutive OData requests to implement
the session handling and security measures of the SAP Gateway.
 *
 * @var string
 */
private $cookies = "";
/**
 * The X-CSRF-Token is required for the OData service communication and must
be fetched before it is possible to perform any changing requests such as 'POST'.
 *
 * @var string
 */
private $xCsrfToken = null;
/**
 * This method is the main entry point for processing the requests received
landing page.
 */
public function execute()
{
    session_start();

    switch ($_SERVER["REQUEST_METHOD"]) {
        case "POST":
            $this->handlePostRequest();
            break;
    }
}
/**
 * POST requests must be forwarded to the system and the responses must be
passed to the client to ensure correct landing page integration.
 */
private function handlePostRequest()
{
    // first fetch the x-csrf-token
    $this->fetchxCsrfToken();

    // read the POST data sent by the landing page
    $requestBody = @file_get_contents("php://input");
    $requestData = json_decode($requestBody);

    // enhance the request data with session id, IP address and campaign id
    $requestData->SessionId = session_id();
    $requestData->IpAddress = $_SERVER["REMOTE_ADDR"];
    $requestData->CampaignId = "";

    // add the concat information for identification
    $requestData->ContactFacets = $this->getContactFacets();

    // send the prepared request data to the system
    $requestString = json_encode($requestData);
    $response = $this->sendHttpRequest("POST", $this::BASE_PATH .
$this::RESULT_HEADERS_PATH, $requestString);

    // print the response
    echo $response;
}
/**
 * The landing page OData service supports contact identification using
ContactIdOrigin and ContactId value pairs.
 * This example reads the corresponding values of the session data.
 *
 * @return stdClass[]
 */
private function getContactFacets()
{
    $contactIdOrigin = null;
    $contactId = null;

```

```

    if (isset($_SESSION["CONTACT_ID_ORIGIN"])) {
        $contactIdOrigin = $_SESSION["CONTACT_ID_ORIGIN"];
    }
    if (isset($_SESSION["CONTACT_ID"])) {
        $contactId = $_SESSION["CONTACT_ID"];
    }

    $contactFacets = array();

    if ($contactIdOrigin && $contactId) {
        // build contact facet with IdOrigin and Id
        $contactFacet = new stdClass();
        $contactFacet->IdOrigin = $contactIdOrigin;
        $contactFacet->Id = $contactId;
        array_push($contactFacets, $contactFacet);
    }

    return $contactFacets;
}
/**
 * Send a 'HEAD' request to fetch the required X-CSRF-Token from the OData
service.
 * If the HEAD request fails, a 'GET' request is performed.
 */
private function fetchXcsrfToken()
{
    $this->sendHttpRequest("HEAD", $this::BASE_PATH, null);
    if (!$this->xcsrfToken) {
        // HEAD request failed -> fallback using GET
        $this->sendHttpRequest("GET", $this::BASE_PATH, null);
    }
}
/**
 * This method performs a synchronous HTTP request and returns its response.
 *
 * @param string $method
 *             The HTTP method (e.g. 'HEAD', 'POST')
 * @param string $path
 *             The URL for the request
 * @param string $body
 *             The request payload (POST data)
 * @return string The response
 */
private function sendHttpRequest($method, $path, $body)
{
    // first create stream context
    $context = $this->createStreamContext($method, $body);

    // perform http request
    $response = file_get_contents($path, false, $context);

    if ($response === false) {
        // request failed - print error for analysis
        echo error_get_last();
    }

    // process response headers
    $this->readResponseHeaders($http_response_header);

    // return response
    return $response;
}
/**
 * This method creates a stream context, which is used for the HTTP request.
 * It configures the context for the authorization, content-type, cookies,
and x-csrf-token.
 *
 * @param string $method

```

```

*           The HTTP method
* @param string $body
*           The request payload (POST data)
* @return resource The stream context
*/
private function createStreamContext($method, $body)
{
    // basic authorization uses base64 encoded credentials
    $credentials = base64_encode($this::CREDENTIALS);

    // build http request headers
    $headers = array(
        "Authorization: Basic " . $credentials,
        "Accept: application/json",
        "Content-Type: application/json"
    );

    if ($this->cookies) {
        // add remembered cookies
        array_push($headers, "Cookie: " . $this->cookies);
    }

    // add x-csrf-token header for fetching or using the already fetched token
    $xCsrfToken = ($this->xCsrfToken ? "Fetch");
    array_push($headers, "x-csrf-token: " . $xCsrfToken);

    // build complete options array
    $options = array(
        "http" => array(
            "header" => $headers,
            "method" => $method,
            "content" => $body,
            "ignore_errors" => true,
            "max_redirects" => 0
        )
    );

    // return stream context using the built options
    return stream_context_create($options);
}
/**
 * This method processes the HTTP response headers in order to read the
 * fetched X-CSRF-Token and cookies
 */
private function readResponseHeaders($responseHeaders)
{
    // loop response headers
    foreach ($responseHeaders as $responseHeader) {
        // split header name from value
        $parts = explode(" ", $responseHeader);

        // handle response header based on name
        switch ($parts[0]) {
            case "x-csrf-token:":
                // save fetched x-csrf-token
                $this->xCsrfToken = $parts[1];
                break;
            case "set-cookie:":
                // set received cookies
                $this->cookies .= $parts[1];
                break;
        }
    }
}
// initialize the integration class and start the processing

```

```
$landingPageIntegration = new LandingPageIntegration();
$landingPageIntegration->execute();
```

## System User Authentication

The result OData service `CUAN_CONTENT_PAGE_RESULT_SRV` can only be called by users with the corresponding authorization. For this reason, your Web server implementation must include a user authentication containing a technical user with role `SAP_CEI_CONTENT_PAGE_RSLT` assigned.

The example PHP script above shows the authentication via an HTTP header named *Authorization* using *Basic* authentication (user/password).

## Contact Identification

The landing pages integration offers different ways to identify the Web user who visits the landing page. The following usage scenarios are supported:

- **Scenario A:** The Web user is anonymous (unknown)  
For this scenario, you must implement a session handling (see below, section *Session Handling*) in order to fully track the user on the landing page.
- **Scenario B:** The Web user has accessed the landing page using a tracking link in an SAP Hybris Marketing email.  
Scenario B does not require any additional implementation effort. The landing page script performs the required actions autonomously. If the landing page is accessed using a SAP Hybris Marketing email, the link contains a tracking ID that is sent along with the data requests. This ID is used to identify the user that received the email.
- **Scenario C:** The Web user is logged in on your Web site and can be identified via his or her user account data. For scenario C, you must provide the necessary information to identify the user on the SAP Hybris Marketing system. For this purpose, you must enhance the request that is built by the landing page with contact facets. The property `ContactFacets` of the request entity `ResultHeader` can contain an array of contact facet objects that comprise an `IdOrigin` and an `Id`. You must fill these fields with the information used to identify the contact in SAP Hybris Marketing.  
An example for the `IdOrigin` is `EMAIL`. An example for the `Id` is a contact email address such as `mail@domain.com`.  
The example PHP script above tried to set a contact facet by reading the data in the current session.

## Prefill Contact Data

When a Web user who accesses a landing page is identified, it is possible to prefill data for the *Input* and *Permission* elements on the landing page. Selecting the *Prefill Contact Data* checkbox allows the landing page elements to be filled with data for the identified contact, which is maintained in the SAP Hybris Marketing system.

To support the prefill of contact data, the Web server implementation needs to pass the response data from the SAP Hybris Marketing system to the landing page (web client) that initiated the request. The SAP Hybris

---

Marketing system provides all necessary data for landing pages with the *Prefill Contact Data* setting. There is no additional effort for the implementation, apart from the forwarding of response data.

## Session Handling

You must implement a session handling on your Web server to track an unknown Web user visiting a landing page.

To do so, you must add a `sessionId` to the object `ResultHeader` of the landing page request:

Once the Web user has entered his or her data and clicked the *Submit* pushbutton, the OData service of the SAP Hybris Marketing system uses this ID to create a contact record for this user and, in addition, to create and store the corresponding user interactions for the landing page visit. Using the `sessionId`, the OData service is able to map both interactions, the submission of data and the access of the landing page, as both requests include the same `sessionId`.

The example PHP script above includes the starting of a session and the setting of the `sessionId` for requests.

## Optional Attributes

In order to complete the landing page integration, you can enhance the OData requests with the following optional attributes:

- *IPAddress*  
The IP address of the web client visiting a landing page can be saved in order to have additional evidence that the user submitted the landing page, and gave marketing permissions and contact data.
- *CampaignId*  
The campaign ID can be supplied to connect the interactions created out of the landing page to a specific SAP Hybris Marketing campaign. If the landing page is opened with a URL parameter `sap-campaign-id` with its value set to the ID, it is automatically added to all landing page requests. This connection will also be created if the landing page is opened out of a SAP Hybris Marketing email sent as part of a campaign.

## 14.2 Configuring Campaigns

The configuration of campaigns requires a few manual steps that are described in this section.

### 14.2.1 Prerequisites

#### Define Interaction Interests

If required, you have defined the necessary interests on the user interface in the *Manage Interests* application in the *Business Administration* business group.



## Configuring the SAP Web Dispatcher

For the tracking services to run as required, define a routing rule for the tracking and bounce ICF services `/sap/public/cuan/link` and `/sap/public/cuan/bounce`. They need to be routed to the ABAP backend servers where the corresponding ICF services run.

For the tracking services to run as required, extend the SAP Web Dispatcher profile of your publicly accessible web dispatcher as follows:

1. Enter the port number to be used to access the SAP Web Dispatcher for the tracking services: `icm/server_port_<port_enum> = PROT=HTTPS,PORT=43<xx>, VCLIENT=0`
  - `<port_enum>` is used to enumerate the port number entries in the profile. It determines the order in which these entries are searched for. As soon as the first valid entry is found, the web dispatcher stops searching and uses that entry.
  - `<xx>` defines the last digits of the port number used.
2. Enter the system and URL of the backend system running the tracking services: `wdisp/system_<sys_enum> = SID=<SID>, EXTSRV=https://<hostname>:<port>, SRCSRV=*<port_number>`
  - `<sys_enum>` is used to enumerate the system entries in the profile. It determines the order in which these entries are searched for. As soon as the first valid entry is found, the web dispatcher stops searching and uses that entry.
  - `<SID>` defines the ID of the SAP system that the services are running on.
  - `<host_name>` and `<port>` define the host name and port that must be used to access the tracking services.
  - `<port_number>` defines the complete port number defined above in the entry `icm/server_port_<port_enum>`

### Caution

For the tracking services it is essential that you disable the client verification at the SAP Web Dispatcher.

- **Disabling client verification for all ports**

The following code line in the sample profile disables client verification for all ports: `icm/HTTPS/verify_client = 0`

- **Disabling client verification for a specific port**

If certain application parts require client authentication, you can disable the client verification at port level. This is done by adding `VCLIENT=0` to the code line that specifies the SAP Web Dispatcher port in question. In the sample profile, for example, you would have to make the following changes:

- Take out the following code line from section 'Start Web Dispatcher': `icm/HTTPS/verify_client = 0`
- Change the following code line in section 'SAP Web Dispatcher Ports' from: `icm/server_port_1 = PROT=HTTPS,HOST=mo-29b02f1eb,PORT=82$$` to: `icm/server_port_1 = PROT=HTTPS,HOST=mo-29b02f1eb,PORT=82$$, VCLIENT=0`

---

## 14.2.2 Setting Up Service Provider for Emails and Text Messages

In the following you will find information about how to conduct your system for SAP Hybris Marketing with the required service providers for sending out emails and text messages directly out of the system.

Please follow the steps below to get your service provider up and running:

1. First of all set up your service providers according to your needs using the following information:
  - [Setting up SAP Mobile Services for Email \[page 138\]](#)
  - [Setting up Amazon Email Service Provider \[page 139\]](#)
  - [Setting up SAP Mobile Services for Text Messages \[page 141\]](#)
2. Then maintain the provider credentials for the ones you are using. For more information, see [Provider Credentials \[page 142\]](#).
3. Finally maintain your sender profiles. For more information, see [Sender Profiles \[page 143\]](#).

### 14.2.2.1 Setting up SAP Mobile Services for Email

SAP Mobile Services (also known as e-mail API for SAP Intelligent Notification 365) is an additional or alternative option to the Amazon service for sending out emails in a campaign.

To set up SAP Mobile Services for sending emails, proceed as follows.

#### Prerequisites



- If you need more details or have questions on this solution, send an email to SAP Mobile Services <mailto:sapmobileservices@sap.com>.  
You need an account with *SAP Mobiles Services* for sending emails using http service call.  
To access the http service from *SAP Mobile Services*, you must populate the externally visible IP address of your server to *SAP Mobiles Services* and you must know the ID, so that it can be added to the whitelist of allowed callers for your account. If you are using a proxy for sending, you must populate the external IP address of the proxy.
- You have a *User* and a *Password* as well as a *URL* and a *Path Prefix* from *SAP Mobile Services*.

#### Import Email SSL Certificates from SAP Mobile Services in the Trust Store

1. Download SSL certificates for your e-mail API target host by using the following URL (you can also download the SSL certificate by opening the target host URL in your internet browser and downloading the SSL certificate):  
<https://multichannel-pp.sapmobileservices.com/email/>  
<https://multichannel-pp.sapmobileservices.com/email/> ➔

### **i** Note

The link above do not work in all browsers. Use an appropriate browser to open the link.

2. Import the certificate into the PSE as described in *Creating the Anonymous SSL Client PSE*. You find this topic under <http://help.sap.com/nw75>  **Application Help** > **Function-Oriented View** > **Security** > **Network and Transport Layer Security** > **Transport Layer Security on the AS ABAP** > **Configuring the SAP NetWeaver AS for ABAP to Support SSL** > **Creating the Anonymous SSL Client PSE**   
[http://help.sap.com/saphelp\\_nw75/helpdata/en/49/26af8639242583e10000000a421937/content.htm](http://help.sap.com/saphelp_nw75/helpdata/en/49/26af8639242583e10000000a421937/content.htm) 
3. Set SSL to *Active* for RFC destinations `MSMAIL`.
4. Select the certificate list to which you uploaded the certificates.
5. Test the `MSMAIL` RFC destination. If you receive an HTTP response code 500 with a response body containing a JSON string, then the setup is correct.

## 14.2.2.2 Setting up Amazon Email Service Provider

In order to set up the Amazon email service provider, several parameters have to be adjusted in *Amazon Service for Emails, Notifications and Queues* and SAP Customizing.

### Prerequisites

The following prerequisites exist for setting up Amazon as an email service provider:

- You are familiar with the basics of the *Amazon Service for Emails, Notifications and Queues*:
  - [aws.amazon.com/de/documentation/ses/](http://aws.amazon.com/de/documentation/ses/)
  - [aws.amazon.com/de/documentation/sns/](http://aws.amazon.com/de/documentation/sns/)
  - [aws.amazon.com/de/documentation/sqs/](http://aws.amazon.com/de/documentation/sqs/)
- You have an Amazon Web Service Account for the Simple Email Service (SES) using `http` (not `smtp`)
- The *Amazon Service for Emails, Notifications and Queues* have been configured correctly. To do this, go into the *Amazon Management Console* and prepare the following:
  1. Configure a verified sender email address. You will need this when you define a sender profile later on.
  2. For the verified sender email address, edit the *Notification Configuration* and create a new Amazon SNS topic, so that bounces and complaints create notifications. Give the new topic the same name as the feedback queue.
  3. In the *Sender Notification Configuration*, assign the SNS topic and disable *Email Feedback Forwarding*.
  4. In the SQS console, create a new queue with the same name you gave the feedback queue in technical configuration.
  5. Subscribe the new queue to the SNS topic you created earlier.

### **i** Note

Please create for each system and client a separate bounce queue on the Amazon side, because otherwise the bounces aren't processed correctly and might be missing in the corresponding system.

- You have set an account up at Amazon and got the following parameters during the set-up:
  - *Amazon Access Key ID* (hash string)
  - *Secret Access Key* (hash string)
  - *Feedback Queue Path*  
The *Feedback Queue Path* is the last individual portion of the queue URL at Amazon. For example, the path from `https://sqs.eu-west-1.amazonaws.com/NNNNNNNNNNNN/ABC` is `/NNNNNNNNNNNN/ABC`.



### Note

You will need these parameters again during the *Technical Configuration*.

For more details on setting up the Amazon side, see the following links:



- Sending: <http://docs.aws.amazon.com/ses/latest/DeveloperGuide/before-you-begin.html> 
- Notifications: <http://docs.aws.amazon.com/ses/latest/DeveloperGuide/configure-sns-notifications.html> 
- Queue: <http://docs.aws.amazon.com/AWSSimpleQueueService/latest/SQSDeveloperGuide/sqssubscribe.html> 

## Import Amazon SES SSL Certificates in the Trust Store

1. Download SSL Certificates for your AMAZON SES target host by using the following URLs (you can also download the SSL certificate by opening the target host URLs in your internet browser and downloading the SSL certificate):
  - Certificate for sending: <https://email.eu-west-1.amazonaws.com>  
<https://email.eu-west-1.amazonaws.com> 
  - Certificate for the bouncing queue: <https://sqs.eu-west-1.amazonaws.com>  
<https://sqs.eu-west-1.amazonaws.com> 

### Note

The links above do not work in all browsers. Use an appropriate browser to open the links.

2. Import the certificate into the PSE as described in *Creating the Anonymous SSL Client PSE*. You find this topic under <http://help.sap.com/nw75>  **Application Help** **>** *Function-Oriented View* **>** *Security* **>** *Network and Transport Layer Security* **>** *Transport Layer Security on the AS ABAP* **>** *Configuring the SAP NetWeaver AS for ABAP to Support SSL* **>** *Creating the Anonymous SSL Client PSE*   
[http://help.sap.com/saphelp\\_nw75/helpdata/en/49/26af8639242583e10000000a421937/content.htm](http://help.sap.com/saphelp_nw75/helpdata/en/49/26af8639242583e10000000a421937/content.htm) 
3. Set SSL to *Active* for RFC destinations `AMAZONMAIL` and `AMAZONBOUNCE`.
4. Select the certificate list to which you uploaded the certificates.
5. Test the `AMAZONMAIL` RFC destination. If you receive an HTTP response code 404, then the set up is correct.

## 14.2.2.3 Setting up SAP Mobile Services for Text Messages

With the following steps you can send out text messages to your customers directly out of your campaign using the services from **SAP Mobile Services**.

To set up text messaging, proceed as follows.

### Prerequisites

- Before you start, make yourself familiar with the SAP SMS 365 service under <http://go.sap.com/product/technology-platform/enterprise-sms.html> or send an email to <mailto:sapmobileservices@sap.com>. You need an account with SAP Mobile Services for sending text messages using http service call. To access the http service from *SAP Mobile Services*, you must populate the externally visible IP address of your server to *SAP Mobile Services* know what is, so that it can be added to the whitelist of allowed callers for your account. If you are using a proxy for sending, you must populate the external IP address of the proxy.
- If you want to receive delivery feedback (text messages delivered to handset or delivery failed), you have to open a port in your firewall for inbound calls from the server of *SAP Mobile Services*. You have to provide an externally visible host name and port for this connection. This should already be set up in section [Prerequisites \[page 136\], Configuring the SAP Web Dispatcher](#), above for tracking and also applies here.
- You have a *User* and a *Password* as well as a *URL* resp. a *Path Prefix* (such as `https://sms-pp.sapmobileservices.com/cmn/<accountid>/<accountid>.sms` whereas `/<accountid>/<accountid>.sms` is the path prefix) from *SAP Mobile Services*.

### Import SAP SMS 365 SSL Certificates in the Trust Store

1. Download SSL Certificates for your target host for *SAP Mobile Services* by using the following URL (you can also download the SSL certificate by opening the target host URL in your internet browser and downloading the SSL certificate):

<https://sms-pp.sapmobileservices.com/cmn/>  
<https://sms-pp.sapmobileservices.com/cmn/>

#### **i** Note

The link above do not work in all browsers. Use an appropriate browser to open the link.

2. Import the certificate into the PSE as described in *Creating the Anonymous SSL Client PSE*. You find this topic under <http://help.sap.com/nw75> **Application Help** > **Function-Oriented View** > **Security** > **Network and Transport Layer Security** > **Transport Layer Security on the AS ABAP** > **Configuring the SAP NetWeaver AS for ABAP to Support SSL** > **Creating the Anonymous SSL Client PSE**.  
[http://help.sap.com/saphelp\\_nw75/helpdata/en/49/26af8639242583e1000000a421937/content.htm](http://help.sap.com/saphelp_nw75/helpdata/en/49/26af8639242583e1000000a421937/content.htm)
3. Set SSL to *Active* for RFC destination `SMSSAP`.
4. Select the certificate list to which you uploaded the certificates.
5. Test the `SMSSAP` RFC destination. If you receive an HTTP response code 400, then the set up is correct.

## 14.2.2.4 Provider Credentials

With the *Provider Credentials* app you maintain the provider credentials that you got from the service providers such as SAP Mobile Services or Amazon SES for sending out emails and text messages out of your system.

### **i** Note

The settings here are pre-filled with data that has been already entered during the technical configuration.

## Prerequisites

- You have created the communication arrangements for the required service providers.
- Your user has been assigned to the single role `SAP_CEI_PROVIDER_CREDENTIALS`.
- Your user has been assigned to the business catalog role `SAP_CEI_KUA_FLP`.

## Maintaining Provider Credentials

1. Choose the *Provider Credential* app.
2. Depending on the services you use you have to maintain some of the following credentials you got from your service providers:
  - *SAP Mobile Services (Email)* and *SAP Mobile Services (Text Message)*
    - *User ID*
    - *Password*
    - *Path Prefix* such as `/email/<accountID customer-specific>/notifications`
  - *Amazon SES*
    - *Access Key*
    - *Secret Key*
    - *Bounce Queue Path*: The *Bounce Queue Path* (also known as *Feedback Queue Path*) is the last individual portion of the queue URL at Amazon. For example, the path from `https://sqs.eu-west-1.amazonaws.com/NNNNNNNNNNNN/ABC` is `/NNNNNNNNNNNN/ABC`.
3. Save your entries.

## Test Provider Credentials

To test the saved credentials choose *Test*.

The system then checks the saved data and shows the results in a popup. Choosing the corresponding line you get more information in case there are any issues.

With the check report `CUAN_MKT_EXEC_CHECK_CONFIG` you can check your configuration settings for sending emails and text messages.

## 14.2.2.5 Sender Profiles

Marketing administrators can use this app to maintain sender profiles on the user interface for the channels *email* and *text message*. It allows them to ensure, their marketers can carry out campaigns for different channels in different markets.

### Prerequisites

- You have setup the service provider for emails and text messages.  
For more information, see chapter **Setting Up Service Provider for Emails and Text Messages** in the Installation Guide on the SAP Help Portal under <http://help.sap.com/mkt> ► *Installation and Upgrade Information* ► *Installation Guide* and carry out the steps in Customizing for SAP Hybris Marketing, by choosing ► *Campaigns* ► *Campaign* ► *Define Sender Profile* .
- You have registered the *Sender Address* and the *Reply-To Address* at SAP Mobile Services and/or Amazon.

### Maintain Sender Profiles

You use this app to:

1. Choose the *Sender Profiles* app and edit either an existing sender profile for a specific marketing area or create a new sender profile by copying an existing entry.
  - For email messages: Adapt a sender profile name and enter the name and email addresses for the sender and recipient.
  - For text messages: Adapt a sender profile name and enter the name for the sender of the text message.
2. Save your entries.

### Test Sender Profiles

To test the maintained sender profiles, we recommend to use *Send Test Email* or *Send Test Text Message* to ensure that the settings are working. Otherwise the issues can appear during campaign execution.

The test sends a message to one or more email addresses.

#### ➔ Recommendation

We strongly recommend to test the sender profile to ensure that the settings are working.

## 14.2.3 Setting up the Integration of Digital Asset Management Systems

Digital asset management (DAM) systems provide catalogs of digital images, videos, documents, music etc. Digital assets can be searched easily by keywords. With the integration of DAM systems you can directly access images for use in static image links in an email. SAP delivers standard settings for the following DAM systems:

- Hybris Product Content Management
- SAP Hybris Digital Asset Management by OpenText

Typically, the systems are activated and the credentials are set during the execution of the technical configuration. You can call up transaction `ME_DAM` to change the activation status and set the credentials afterwards.

If a system was activated with transaction `ME_DAM`, its RFC destination has to be set up manually.

If a system was activated during technical configuration, its empty RFC destination is created either with name `CEI_ME_DAM_HYBRIS` or with name `CEI_ME_DAM_OPENTEXT`, depending on the DAM system activated. Afterwards, the RFC destination has to be configured manually.

To perform this manual step, start transaction *Configuration of RFC Connections* (SM59) and choose *HTTP Connections to External Server*.

### RFC Destination CEI\_ME\_DAM\_HYBRIS for Hybris Product Content Management

Go to *Technical Settings* and maintain the following:

- *Target Host*: host name of the Hybris PCM system
- *Service No.*: port number for the API calls (i.e. 9001 for http and 9002 for https)
- *Path Prefix*: `/rest/v1/<site>/products/` with `<site>` being the BaseSite.uid property of the Web site (see documentation for Hybris Product Content Management).

Go to *Logon & Security* and maintain the following:

- *Logon Procedure*: Choose *Do Not Use a User* or *Basic Authentication with User and Password* depending on the configuration of the DAM system
- *Security Options*: Choose *SSL Inactive* or *SSL Active with SSL Certificate* depending on the configuration of the DAM system

Go to *Special Options*.

- *HTTP Cookies*: Set *Accept Cookies* to *Yes (All)*



---

## RFC Destination CEI\_ME\_DAM\_OPENTEXT for SAP Hybris Digital Asset Management by OpenText

Go to *Technical Settings* and maintain the following:

- *Target Host*: Host name of the OpenText system
- *Service No.*: Port number for the API calls (i.e. 80 for http and 443 for https)
- *Path Prefix*: none

Go to *Logon & Security* and maintain the following:

- *Logon Procedure*: Choose *Do Not Use a User*
- *Security Options*: Choose *SSL Inactive* or *SSL Active with SSL Certificate* depending on the configuration of the DAM system

Go to *Special Options*.

- *HTTP Cookies*: Set *Accept Cookies* to *Yes (All)*.

### 14.3 Configuring the Marketing Calendar

If you have not already carried out this step as a part of *Configuring Planning*, configure the marketing calendar as described in [Setting up "Marketing Calendar" \[page 113\]](#).

# 15 Configuring Manager-Related Tasks

The following apps are available to managers:

- Release target groups
- Release campaigns

## 15.1 Setting up "Release Target Groups"

To set up the *Release Campaigns* application, you need to carry out the following steps:

- **Activate Advanced Status Management**

1. In Customizing, under SAP Hybris Marketing, go to ► *Segmentation* ► *Target Group* ► *Activate Advanced Status Management* ►
2. Select *Activate Advanced Status Management* and, if desired, *Enable Editing of Target Group*. Save your entries.
3. In Customizing, under SAP Hybris Marketing, go to ► *General Settings* ► *Set Up Quick Filter Tiles* ► and enable a quick filter *To Be Released* for the target group list. Save your entries.

- **Assign Users to Roles**

To enable managers to use the *Release Target Group* app, you need to assign your copies of the following PFCG roles to their AS ABAP users:

- SAP\_CEI\_REL\_FLP (business catalog role; no copy required - you can assign the delivered standard role)
- SAP\_CEI\_CUAN\_MK\_TG\_REL\_APP (back-end role; included in composite role SAP\_MARKETING\_MANAGER)
- SAP\_CEI\_HOME (for personalization purposes)

# 16 Configuring China Localization

The China localization of under SAP Hybris Marketing contains the following functions:

- Viewing of followers of WeChat official accounts via the *Digital Accounts* application
- Analysis of followers of WeChat official accounts via the *Digital Accounts* application
- Integration of Baidu Maps into *Segmentation*
- China-specific segmentation profile
- Launch of WeChat campaigns via *Campaign Management*

## **i** Note

To integrate Baidu Maps into *Segmentation*, you need to apply for a Baidu account key.

## Required Technical Configuration

Technical configuration are required before you can use the China-specific functions. To make the required technical configuration, you do the following:

- Call up transaction `STC01` and run task list `CUAN_LOCALIZATION_CN`.  
Note that you need to do the following in the parameters of the first task:
  - Select the *Tech. Customizing System* checkbox and enter your Customizing request number.
  - Enter your Baidu account key.

## Business Add-Ins (BAdIs)

There are BAdIs available, which you can use to customize the way you use the China-specific functions.

In Customizing for under SAP Hybris Marketing under **► General Settings ► Integration ► Integration Settings for WeChat** **►**, you can implement the following BAdIs:

- *Selection of Inbound WeChat Messages for Processing*  
You use this BAdI to determine which types of WeChat messages are processed by the system.
- *Processing of Inbound WeChat Messages*  
You use this BAdI to determine how the system processes inbound WeChat messages.

## Proxy Settings

Access to the internet from the AS ABAP system is made possible through a proxy server. If it is not yet configured, configure your proxy server settings.

---

Although the proxy settings may be active, the HTTPS protocol might not have a proxy listed. If this is the case, add the SAP proxy **8080**.

## Secure Socket Layer (SSL) Settings for WeChat

### **i** Note

You will need a user assigned the role `SAP_BC_BASIS_ADMIN`. For more information, see [User for Application Setup \[page 47\]](#).

1. Go to `https://api.weixin.qq.com` and click on the lock symbol next to the URL to get the site information.
2. Locate the WeChat certificate and export it to a file.
3. Start transaction `STRUST` in the *SAP Easy Access* menu and switch to change mode.
4. Choose SSL client *SSL Client (Standard)*.
5. From the *Certificate* area, choose *Import Certificate* and import the saved WeChat certificate file.
6. Choose *Add to Certificate List* and save the PSE file.
7. The AS ABAP will now trust SSL servers whose identity is confirmed by this certificate.

# 17 Integration with Extended Marketing Applications (YaaS Extensions)





## 17.1 Setting up YaaS Application "Customer Journey Manager"

The application *Customer Journey Manager* in the *Campaign Management* business group allows marketing experts to build, monitor, and optimize activities based on various stages in a customer's lifecycle.

### Note

The application requires a separate license as it is based on SAP Hybris as a Service (YaaS).

To integrate the application with SAP Hybris Marketing, you must set up a corresponding RFC destination in your SAP Hybris Marketing system. To do so, proceed as follows:

1. Go to transaction SM59 (*Configuration of RFC Connections*) and choose *HTTP Connections to External Server*.
2. Choose  *Edit*  *Create* .
3. On the appearing screen, enter the following **SAP\_COM\_0058** in the *RFC Destination* field.
4. On the *Technical Settings* tab, enter the following values:
  - *Target Host*: `customerjourney.yaas.io`
  - *Service No.* : **001**
  - *Path Prefix*: `/<Client ID>`  
For information on how to obtain the client ID, refer to the section *Obtain the client credentials* in the document *Create a Client* of the *YaaS Getting Started* guide under:  
<https://devportal.yaas.io/gettingstarted/createclient/index.html> 
  - Save your entry.

To enable marketing experts to use *Customer Journey Manager*, assign your copies of the following roles to the corresponding AS ABAP users:

- **SAP\_CEI\_EAC\_FLP** (business catalog role to access YaaS applications from the SAP Fiori launchpad, included in composite role **SAP\_MARKETING\_EAC**; no copy required - you can assign the delivered standard role)
- **SAP\_CEI\_HOME** (for personalization purposes)

For more information about the integration of *Customer Journey Manager*, see the corresponding integration guide on the SAP Service Marketplace under:

<http://service.sap.com/mkt>  *Integration with SAP Hybris Customer Journey Manager* 

(<http://service.sap.com/%7Esapidb/012002523100017106242016E/> )

## 17.2 Setting up YaaS Application "Profile Graph"

The application *Profile Graph* in the *Contacts and Profiles* business group allows marketing experts to launch the *Graph Explorer* to view the customer profile information within their Hybris profiles.

### **i** Note

The application requires a separate license as it is based on SAP Hybris as a Service (YaaS).

To integrate the application with SAP Hybris Marketing you must set up a corresponding RFC destination in your SAP Hybris Marketing system. To do so, proceed as follows:

1. Go to transaction SM59 (*Configuration of RFC Connections*) and choose *HTTP Connections to External Server*.
2. Choose **Edit** **Create**.
3. On the appearing screen, enter the following **SAP\_COM\_0059** in the *RFC Destination* field.
4. On the *Technical Settings* tab, enter the following values:
  - *Target Host*: `builder.yaas.io`
  - *Service No. :* **001**
  - *Path Prefix*: `/<tenant ID>`
  - Save your entry.

To enable marketing experts to use *Profile Graph*, assign your copies of the following roles to the corresponding AS ABAP users:

- **SAP\_CEI\_EAC\_FLP** (business catalog role to access YaaS applications from the SAP Fiori launchpad, included in composite role **SAP\_MARKETING\_EAC**; no copy required - you can assign the delivered standard role)
- **SAP\_CEI\_HOME** (for personalization purposes)

For more information about the integration of *Profile Graph*, see the corresponding integration guide on the SAP Service Marketplace under:

<http://service.sap.com/mkt> **Integrating with SAP Profile Services for Marketing**

(<http://service.sap.com/%7Esapidb/012002523100017104772016E/>)

## 17.3 Setting Up YaaS Application "Loyalty"

The application *Loyalty* in the *Loyalty Management* business group allows marketing experts to create their own cloud-based loyalty program in minutes and gain valuable consumer insights.

### **i** Note

The application requires a separate license as it is based on SAP Hybris as a Service (YaaS).

---

To integrate the application with under SAP Hybris Marketing you must set up a corresponding RFC destination in your under SAP Hybris Marketing system. To do so, proceed as follows:

1. Go to transaction SM59 (*Configuration of RFC Connections*) and choose *HTTP Connections to External Server*.
2. Choose **Edit** **Create**.
3. On the appearing screen, enter the following **SAP\_COM\_0043** in the *RFC Destination* field.
4. On the *Technical Settings* tab, enter the following values:
  - *Target Host*: builder.yaas.io
  - *Service No.* : **007**
  - *Path Prefix*: /
  - Save your entry.

To enable marketing experts to use *Loyalty*, assign your copies of the following roles to the corresponding AS ABAP users:

- SAP\_CEI\_EAC\_FLP (business catalog role to access YaaS applications from the SAP Fiori launchpad, included in composite role SAP\_MARKETING\_EAC; no copy required - you can assign the delivered standard role)
- SAP\_CEI\_HOME (for personalization purposes)

For more information about the integration of *Loyalty*, see the corresponding integration guide on the SAP Service Marketplace under:

<http://service.sap.com/mkt> **Integrating SAP Hybris Marketing with SAP Hybris Loyalty**

(<http://service.sap.com/%7Esapidb/012002523100017106542016E/>)

---

## 18 SAP Hybris Marketing Integration with SAP Fraud Management

If you productively use under SAP Hybris Marketing as well as *SAP Fraud Management* you have the option to take advantage of the integration of these products. By using the detection methods of *SAP Fraud Management*, the integration offers the automatic creation of an alert in *SAP Fraud Management* in case of a deviation in number or evaluation of interactions such as a post in Sentiment Engagement.

For more information about the implementation of the integration, see the corresponding guide on the SAP Service Marketplace at:

<http://service.sap.com/mkt> ► *SAP Fraud Mgmt. Integration with SAP Hybris Marketing* ►

<http://service.sap.com/%7E%7Bsapidb/012002523100017106252016E/>



# 19 Frequently Asked Questions

- **Can I install SAP Hybris Marketing on any database and access SAP HANA using a secondary database connection?**

SAP Hybris Marketing runs on an SAP NetWeaver AS ABAP system with SAP HANA database as primary and only database. During the installation of under SAP Hybris Marketing SAP HANA content is unpacked to the SAP HANA database. This content is used for accessing SAP ERP, SAP CRM as well as SAP Hybris Marketing data.

- **How is the SAP ERP and SAP CRM data accessed?**

SAP ERP and SAP CRM data is stored in separate database schemas in the SAP HANA database. SAP Hybris Marketing delivers SAP HANA information models that join together data from these separate database schemas. The application accesses the data through these SAP HANA models. As the database schema name is unique in your system, a schema mapping from SAP's authoring schema to your schema name is defined during the technical configuration of SAP Hybris Marketing.

For more information about SAP HANA schema mapping, see the SAP HANA Modeling Guide at:

[http://help.sap.com/hana\\_appliance](http://help.sap.com/hana_appliance)  **Modeling Information** 

([http://help.sap.com/hana/SAP\\_HANA\\_Modeling\\_Guide\\_for\\_SAP\\_HANA\\_Studio\\_en.pdf](http://help.sap.com/hana/SAP_HANA_Modeling_Guide_for_SAP_HANA_Studio_en.pdf) )

- **What is the name of the database schema of my SAP ERP and SAP CRM data?**

If you replicate data (see [Scenario B: Hub-Deployment with Separate SAP HANA System \[page 15\]](#)) through SAP LT replication server the name of the SAP HANA database schema is your SAP LT configuration name. If you run deployment scenario C, *Hub-Deployment with Shared SAP HANA System of SAP Business Suite*, your database schema name is SAP<SID> while <SID> is the system ID of your SAP ERP or SAP CRM system.

- **Do I have to set up HTTPS?**

You have to set up HTTPS as SAP Hybris Marketing does not allow HTTP calls.

- **Do I have to set up a Web Dispatcher?**

You have to set up a Web Dispatcher as SAP Hybris Marketing integrates ABAP and SAP HANA

- **Do I need to set up a BW Client? Do I have to set up the BW Client for all solutions? Can I use a BW client in another system?**

You have to set up a BW client in your SAP Hybris Marketing system regardless of the SAP Hybris Marketing solution you have licensed. The application uses the operational data provisioning (ODP) to directly access SAP HANA information models. For ODP, you only need to perform minimal configuration of the BW in your application system. You do not need to set up a Data Warehouse. Replication of the data to a BW system is not necessary.

## 20 SAP Notes for Installation and Upgrade

If there is additional information to the installation process as described in this guide, you find the new information in the following SAP Note or SAP Notes.

Make sure that you have the current version of each SAP Note, which you can find on the SAP Service Marketplace at <http://support.sap.com/notes>.

Table 46:

SAP Note Number	Title	Description
Release Information Note <a href="#">1885803</a>	RIN SAP Hybris Marketing	Contains information and references in the context of applying <i>SAP Hybris Marketing</i>
Note <a href="#">2076331</a>	Follow Up Tasks after System Copy	Contains information about the actions to be carried out after system copy
Note <a href="#">2072589</a>	Installing and Configuring SAP Fiori Apps for SAP CEI on a central Fiori Front-end Server	Contains information about the installation and configuration of SAP Fiori apps for <i>SAP Hybris Marketing</i> on a central SAP Fiori front-end server

### Final Implementation of SAP Notes

The Release Information Note (RIN) is the central note containing general installation/upgrade information on *SAP Hybris Marketing*.

Make sure that you have implemented all notes that are listed in the RIN. For more information about the sequence of the note implementation, see [SAP Notes for Installation \[page 9\]](#).

---

# 21 Appendix

## 21.1 Technical Configuration - Expert Mode

If you are not able to use the technical configuration cockpit ([Using the Technical Configuration Cockpit \[page 52\]](#)), you can use the *Technical Configuration Expert Mode* to carry out the steps in the back end.

To use the expert mode, call up transaction `STC01` and execute task list `CUAN_BASE_CONFIG` (which corresponds to the *Essentials* scenario in the technical configuration wizard). To call the parameter screen, select the last task in the list and then click on the *Change Parameters* icon (column *Parameter*).

Afterwards, execute the following task lists if required:

- `CUAN_SETUP_ERPCONTENT` corresponding to the *ERP Integration* scenario in the technical configuration wizard
- `CUAN_SETUP_CRMCONTENT` corresponding to the *CRM Integration* scenario in the technical configuration wizard
- `CUAN_SETUP_HRF` corresponding to the *HANA Rules Framework* scenario in the technical configuration wizard
- `CUAN_SETUP_CMO_DASHBOARD` corresponding to the *Marketing Executive Dashboard* scenario in the technical configuration wizard
- `CUAN_SETUP_CA` corresponding to the *Campaign Management* scenario in the technical configuration wizard

For more information about the parameters to be provided within the different task lists, see the descriptions for every scenario in section [Section "Scenarios" \[page 53\]](#).

## 21.2 Replicated Tables in SAP Hybris Marketing

If you replicate data from SAP ERP and/or SAP CRM into SAP Hybris Marketing, the following tables are replicated via SAP Landscape Transformation Replication Server:

Table 47: SAP ERP Tables

(A - M)	(N - TCURV)	(TCURX - TVKO)	(TVKOT - W)
ADCP	NDBSMATG16	TCURX	TVKOT
ADR2	PA0105	TKA01	TVLS
ADR3	PRPS	TKEB	TVLST
ADR6	T000	TKEBB	TVM1
ADRC	T001	TKEBC	TVM1T
ADRP	T001W	TKEBT	TVM2
ADRU	T005	TKEF	TVM2T
BKPF	T005N	TKEFE	TVM3
BSEG	T005S	TKUKL	TVM3T
BUT000	T005T	TKUKT	TVM4
BUT021_FS	T005U	TPFK	TVM4T
BUT050	T006	TPFKT	TVM5
BUT051	T006A	TPTMT	TVM5T
BUT100	T009	TSAB	TVMS
COBK	T016	TSABT	TVTW
COEP	T016T	TSAD12	TVTWT
COOI	T023	TSAD12T	TVV1
CRMKUNNR	T023T	TSAD2	TVV1T
CRMPARNR	T077D	TSAD2T	TVV2
CVI_CUST_LINK	T077X	TSAD3	TVV2T
DD02L	T134M	TSAD3T	TVV3
DD02T	T151	TSAD4	TVV3T
DD04T	T151T	TSADV	TVV4
DD07L	T171	TSADVT	TVV4T
DD07T	T171T	TSPA	TVV5
FPLA	T179	TSPAT	TVV5T
HRP1001	T179T	TTZZ	VAKGU

(A - M)	(N - TCURV)	(TCURX - TVKO)	(TVKOT - W)
HRP1222	T685	TTZZT	VBAK
HRT1222	T685T	TVAG	VBAP
KNA1	TB003	TVAGT	VBEP
KNB1	TB910	TVAK	VBFA
KNVK	TB911	TVAKT	VBKA
KNVP	TB912	TVBUR	VBKD
KNVV	TB913	TVBVK	VBKPA
KONV	TBRC	TVFKT	VBRK
LIKP	TBRCT	TVFS	VBRP
LIPS	TCURC	TVFST	VBUK
MAKT	TCURF	TVGRT	VBUP
MARA	TCURN	TVKBT	VEDA
MARC	TCURR	TVKBZ	WRF_BRANDS
MARD	TCURT	TVKGR	
MBEW	TCURV	TVKO	

Table 48: SAP CRM Tables

(A - CRMC_CANCREASON)	(CRMC_CANCREASONT - CRMC_PH)	(CRMC_PR - CRMM)	(D - T)
ADCP	CRMC_CANCREASONT	CRMC_PROC_TYPE	DD02L
ADR2	CRMC_CHM_PROG_T	CRMC_PROC_TYPE_T	DD02T
ADR3	CRMC_CHM_STATU_T	CRMC_SOURCE	DD07L
ADR6	CRMC_CHM_TYPE_T	CRMC_SOURCE_T	DD07T
ADRC	CRMC_CON_PHASE_T	CRMD_BRELVONAE	HRP1000
ADRP	CRMC_CUSTGRP1	CRMD_CHM_CLASS	HRP1001
AUSP	CRMC_CUSTGRP2	CRMD_DHR_ACTIV	HRP1222
BUT000	CRMC_CUSTGRP3	CRMD_DHR_HEADOPP	HRT1222
BUT020	CRMC_CUSTGRP4	CRMD_DHR_HSLSCON	QPCT
BUT021_FS	CRMC_CUSTGRP5	CRMD_DHR_HSLSORD	QPGT
BUT050	CRMC_CYCLE_T	CRMD_DHR_HSLSQUO	SCPRI0
BUT051	CRMC_DISTCHAN	CRMD_DHR_ISLSCON	SCPRI0T
BUT052	CRMC_DISTCHAN_T	CRMD_DHR_ISLSORD	T000
BUT100	CRMC_DIVISION	CRMD_DHR_ISLSQUO	T001
CABN	CRMC_DIVISION_T	CRMD_DHR_ITEMOPP	T002
CABNT	CRMC_ERMS_CAT_CA	CRMD_DHR_LEAD	T002T
CAWN	CRMC_ERMS_CAT_CD	CRMD_IM_ML_HEAD	T005
CAWNT	CRMC_INDUSTRY	CRMD_IM_ML_ITEM	T005T
CGPL_HIERARCHY	CRMC_INDUSTRY_T	CRMD_MKTCA_CT_IN	T005U
CGPL_PRIO	CRMC_LEAD_QL	CRMD_MKTHV_MC	T006
CGPL_PRIOTX	CRMC_LEAD_QL_T	CRMD_MKTHV_MC_TC	T006A
CGPL_PROJECT	CRMC_LEAD_TYPE	CRMD_MKTPL_TGGRP	T009
CGPL_TASK	CRMC_LEAD_TYPE_T	CRMD_MKTPL_TODO	TB002
CGPL_TEXT	CRMC_MKP_CHAN	CRMD_MKTTG_TG_EA	TB003
COMC_PR_TYPE_T	CRMC_MKTPL_AUTHG	CRMD_MKTTG_TG_H	TB003T
COMM_CATEGORY	CRMC_MKTPL_AUTHT	CRMD_MKTTG_TG_I	TB004
COMM_CATEGORYT	CRMC_MKTPL_CHAN	CRMD_MKTTG_TG_I0	TB004T
COMM_HIERARCHY	CRMC_MKTPL_CHANT	CRMD_MKTTG_TG_I1	TB024
COMM_HIERARCHYT	CRMC_MKTPL_CTYPE	CRMD_MKTTG_TG_I2	TB027T
COMM_IL_PRDBP	CRMC_MKTPL_CTYPT	CRMD_MKTTG_TG_I3	TB028T
COMM_PR_FRG_ROD	CRMC_MKTPL_OBJTT	CRMD_MKTTG_TG_I4	TB038A

(A - CRMC_CANCREASON)	(CRMC_CANCREASONT - CRMC_PH)	(CRMC_PR - CRMM)	(D - T)
COMM_PRODUCT	CRMC_MKTPL_OBJTV	CRMD_MKTTG_TG_I5	TB910
COMM_PRRDCATR	CRMC_MKTPL_TACTS	CRMD_ORDER_INDEX	TB911
COMM_PRSHTEXT	CRMC_MKTPL_TACTT	CRMD_ORDERADM_H	TB912
CRM_JEST	CRMC_MKTPL_TDCAT	CRMD_ORDERADM_I	TB913
CRM_MKTPL_ATTR	CRMC_MKTPL_TODO	CRMD_PRICING_I	TCURC
CRM_MKTPL_OBJTXT	CRMC_MKTPL_TODOT	CRMM_BUT_CONTNO	TCURF
CRM_MKTPL_OBJTYP	CRMC_MKTTG_OT_H	CRMM_BUT_CUSTNO	TCURN
CRM_STACOM_ATTR	CRMC_OPPIMPOR	CRMM_BUT_FRG0041	TCURR
CRM_STACOM_TEXT	CRMC_OPPIMPOR_T	CRMM_BUT_FRG0080	TCURT
CRMC_ACT_CAT_ASS	CRMC_OPPT_TYPE	CRMM_BUT_FRG0100	TCURV
CRMC_ACT_CAT_T	CRMC_OPPT_TYPE_T	CRMM_BUT_LNK0011	TCURX
CRMC_ACT_CATEGOR	CRMC_PARTNER_FCT	CRMM_BUT_MKTPERM	TJ02T
CRMC_BUPA_CBBL	CRMC_PARTNER_FT	CRMM_BUT_SET0010	TJ30
CRMC_BUPA_CDBL	CRMC_PARTY	CRMM_TERRITORY	TJ30T
CRMC_BUPA_COBL	CRMC_PARTY_T	CRMM_TERRITORY_T	TSAD3
CRMC_CANCREASON	CRMC_PHASE_T	CRMM_TERRITORY_V	TSAD3T

---

# Important Disclaimers and Legal Information

## Coding Samples

Any software coding and/or code lines / strings ("Code") included in this documentation are only examples and are not intended to be used in a productive system environment. The Code is only intended to better explain and visualize the syntax and phrasing rules of certain coding. SAP does not warrant the correctness and completeness of the Code given herein, and SAP shall not be liable for errors or damages caused by the usage of the Code, unless damages were caused by SAP intentionally or by SAP's gross negligence.

## Accessibility

The information contained in the SAP documentation represents SAP's current view of accessibility criteria as of the date of publication; it is in no way intended to be a binding guideline on how to ensure accessibility of software products. SAP in particular disclaims any liability in relation to this document. This disclaimer, however, does not apply in cases of willful misconduct or gross negligence of SAP. Furthermore, this document does not result in any direct or indirect contractual obligations of SAP.

## Gender-Neutral Language

As far as possible, SAP documentation is gender neutral. Depending on the context, the reader is addressed directly with "you", or a gender-neutral noun (such as "sales person" or "working days") is used. If when referring to members of both sexes, however, the third-person singular cannot be avoided or a gender-neutral noun does not exist, SAP reserves the right to use the masculine form of the noun and pronoun. This is to ensure that the documentation remains comprehensible.

## Internet Hyperlinks

The SAP documentation may contain hyperlinks to the Internet. These hyperlinks are intended to serve as a hint about where to find related information. SAP does not warrant the availability and correctness of this related information or the ability of this information to serve a particular purpose. SAP shall not be liable for any damages caused by the use of related information unless damages have been caused by SAP's gross negligence or willful misconduct. All links are categorized for transparency (see: <http://help.sap.com/disclaimer>).



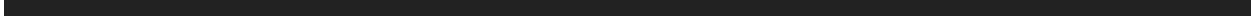



**go.sap.com/registration/  
contact.html**

© 2017 SAP SE or an SAP affiliate company. All rights reserved.  
No part of this publication may be reproduced or transmitted in any form or for any purpose without the express permission of SAP SE or an SAP affiliate company. The information contained herein may be changed without prior notice.  
Some software products marketed by SAP SE and its distributors contain proprietary software components of other software vendors. National product specifications may vary.  
These materials are provided by SAP SE or an SAP affiliate company for informational purposes only, without representation or warranty of any kind, and SAP or its affiliated companies shall not be liable for errors or omissions with respect to the materials. The only warranties for SAP or SAP affiliate company products and services are those that are set forth in the express warranty statements accompanying such products and services, if any. Nothing herein should be construed as constituting an additional warranty.  
SAP and other SAP products and services mentioned herein as well as their respective logos are trademarks or registered trademarks of SAP SE (or an SAP affiliate company) in Germany and other countries. All other product and service names mentioned are the trademarks of their respective companies.  
Please see <http://www.sap.com/corporate-en/legal/copyright/index.epx> for additional trademark information and notices.