



# MC65

## User Guide





## ***MC65 User Guide***

*72E-133769-01*

*Rev. A*

*September 2010*

© 2010 Motorola, Inc. All rights reserved.

No part of this publication may be reproduced or used in any form, or by any electrical or mechanical means, without permission in writing from Motorola. This includes electronic or mechanical means, such as photocopying, recording, or information storage and retrieval systems. The material in this manual is subject to change without notice.

The software is provided strictly on an “as is” basis. All software, including firmware, furnished to the user is on a licensed basis. Motorola grants to the user a non-transferable and non-exclusive license to use each software or firmware program delivered hereunder (licensed program). Except as noted below, such license may not be assigned, sublicensed, or otherwise transferred by the user without prior written consent of Motorola. No right to copy a licensed program in whole or in part is granted, except as permitted under copyright law. The user shall not modify, merge, or incorporate any form or portion of a licensed program with other program material, create a derivative work from a licensed program, or use a licensed program in a network without written permission from Motorola. The user agrees to maintain Motorola’s copyright notice on the licensed programs delivered hereunder, and to include the same on any authorized copies it makes, in whole or in part. The user agrees not to decompile, disassemble, decode, or reverse engineer any licensed program delivered to the user or any portion thereof.

Motorola reserves the right to make changes to any software or product to improve reliability, function, or design.

Motorola does not assume any product liability arising out of, or in connection with, the application or use of any product, circuit, or application described herein.

No license is granted, either expressly or by implication, estoppel, or otherwise under any Motorola, Inc., intellectual property rights. An implied license only exists for equipment, circuits, and subsystems contained in Motorola products.

MOTOROLA, MOTO, MOTOROLA SOLUTIONS and the Stylized M Logo are trademarks or registered trademarks of Motorola Trademark Holdings, LLC and are used under license. All other trademarks are the property of their respective owners.

Motorola, Inc.  
One Motorola Plaza  
Holtsville, New York 11742-1300  
<http://www.motorola.com/enterprisemobility>

---

## Revision History

Changes to the original manual are listed below:

Change	Date	Description
-01 Rev. A	9/2010	Initial release.



# Table of Contents

## About This Guide

Introduction .....	xiii
Documentation Set .....	xiii
Configurations.....	xiii
Software Versions.....	xiv
Chapter Descriptions .....	xiv
Notational Conventions.....	xv
Related Documents .....	xv
Service Information.....	xvi

## Chapter 1: Getting Started

Introduction .....	1-1
Unpacking .....	1-1
Getting Started .....	1-2
Installing a microSD Card .....	1-2
Installing the SIM Card .....	1-3
Installing the Battery .....	1-4
Charging the Battery .....	1-5
Charging the Main Battery .....	1-5
Charging Spare Batteries .....	1-6
Charging Temperature .....	1-6
Powering On the MC65 .....	1-6
Calibrating the Screen .....	1-6
First-time Network Activation .....	1-7
GSM/UMTS Activation .....	1-7
Network Activation .....	1-7
Checking Battery Status .....	1-7
Replacing the Battery .....	1-8
Replacing the microSD Card .....	1-8
Replacing the SIM Card .....	1-9
Battery Management .....	1-10
Changing the Power Settings .....	1-10
Changing the Backlight Settings .....	1-10
Changing the Keypad Backlight Settings .....	1-10

Turning Off the Radios .....	1-11
Handstrap Replacement .....	1-11
Removal .....	1-11
Installation .....	1-12

## Chapter 2: Using the MC65

Introduction .....	2-1
Features .....	2-1
Function Buttons .....	2-3
Keypads .....	2-4
Keypad Remapping .....	2-4
Finger Scrolling .....	2-4
Motorola Home Screen .....	2-5
Cards .....	2-7
Simple Home Card .....	2-7
Full Home Card .....	2-7
Weather Card .....	2-9
Time Tracker Card .....	2-9
Card Configuration .....	2-9
Program Shortcuts .....	2-9
My Apps Window .....	2-10
Tile Bar .....	2-10
Device Management .....	2-12
Programs .....	2-13
Memory Manager .....	2-13
Sound Profiles .....	2-14
Power & Radio .....	2-15
Alarms .....	2-16
Fusion .....	2-16
Status .....	2-17
Settings .....	2-17
Adjusting Volume .....	2-18
Battery Status Indications .....	2-18
LED Indicators .....	2-18
Resetting the MC65 .....	2-19
Locking the MC65 .....	2-19
Stylus .....	2-20
Entering Data .....	2-21
Data Capture .....	2-22
Imaging .....	2-22
Operational Modes .....	2-22
Digital Camera .....	2-22
Scanning Considerations .....	2-23
Imager Scanning .....	2-23
Digital Camera Scanning .....	2-25
Using Voice-Over-IP .....	2-26



**Chapter 3: Making Calls**

Introduction .....	3-1
Making a Call .....	3-1
Using the Phone Keypad .....	3-1
Smart Dialing .....	3-2
Using Contacts .....	3-3
Using Call Log .....	3-4
Answering a Call .....	3-4
Incoming Call Features .....	3-4
Missed Call Notification .....	3-4
Emergency Calling .....	3-5
Audio Modes .....	3-5
Using a Bluetooth Headset .....	3-5
Adjusting Audio Volume .....	3-5
Muting a Call .....	3-5
Using Call Log .....	3-6
Managing Call Log .....	3-6
Using the Call Log Menu .....	3-6
Conference Calling .....	3-7
Making a 3-Way Call .....	3-10
Voice Commander .....	3-10
Call .....	3-11
Find .....	3-11
Redial .....	3-12
Callback .....	3-12
Start .....	3-12
Appointments .....	3-12
Read .....	3-12
What time is it .....	3-13
Call History .....	3-13
Voice Play Music .....	3-13
What can I say .....	3-14
Goodbye .....	3-14

**Chapter 4: Using WLAN**

Introduction .....	4-1
Fusion Overview .....	4-1
Wireless Zero Config Overview .....	4-2
Switching Between Fusion and WZC .....	4-2
Supported Applications .....	4-3
Fusion Setup .....	4-3
Wireless Zero Config Setup .....	4-6
More Information on WZC .....	4-8

**Chapter 5: Messaging**

Introduction .....	5-1
Email .....	5-1
Creating an Email Message .....	5-1

Viewing an Email Message .....	5-1
Replying to or Forwarding a Message .....	5-2
SMS Messaging .....	5-2
Sending a Text Message .....	5-2
Viewing Text Messages .....	5-3
Replying to an SMS Message .....	5-4
MMS Messaging .....	5-4
Creating and Sending MMS Messages .....	5-4
Viewing an MMS Message .....	5-5
Replying to an MMS Message .....	5-6
Blocking Incoming SMS Messages .....	5-6

## Chapter 6: Using the Camera

Introduction .....	6-1
Taking Pictures .....	6-1
Burst Mode .....	6-2
Timer Mode .....	6-2
Editing Pictures .....	6-2
Setting a Picture as Wallpaper .....	6-2
Camera Configuration .....	6-3
Recording a Video .....	6-3
Video Configuration .....	6-4
Viewing Pictures and Videos .....	6-4
Customizing Pictures & Videos .....	6-5
.....	6-5

## Chapter 7: Using Bluetooth

Introduction .....	7-1
Adaptive Frequency Hopping .....	7-1
Security .....	7-2
Bluetooth Configuration .....	7-3
Bluetooth Power States .....	7-3
Suspend .....	7-3
Resume .....	7-3
Turning Bluetooth On and Off .....	7-4
Enabling Bluetooth .....	7-4
Disabling Bluetooth .....	7-4
Discovering Bluetooth Device(s) .....	7-4
Available Services .....	7-7
Object Push Services via Beam .....	7-7
Internet Sharing .....	7-8
Hands-free Services .....	7-9
Serial Port Services .....	7-9
ActiveSync Using Bluetooth .....	7-10
Phone Book Access Profile Services .....	7-11
Dial-Up Networking Services .....	7-12
Connect to a HID Device .....	7-12
A2DP/AVRCP Services .....	7-12

**Chapter 8: Using GPS Navigation**

Introduction .....	8-1
Software Installation .....	8-1
MC65 GPS Setup .....	8-1
Operation .....	8-2
GPS Maps on microSD Cards .....	8-2
Answering a Phone Call While Using GPS .....	8-2
Losing the GPS Signal While in a Vehicle .....	8-2
Assisted GPS .....	8-2

**Chapter 9: Settings**

Introduction .....	9-1
Settings Folder .....	9-1
Locking the MC65 .....	9-4
Switching the Dialer .....	9-4
Device Management .....	9-5
Sound Profiles .....	9-5
Power Profiles .....	9-6
Alarms .....	9-7
Backlight and Keylight Settings .....	9-7
Accelerometer .....	9-8
Display Tab .....	9-8
About Tab .....	9-8
Program Shortcuts Setup .....	9-8
My Apps Window Setup .....	9-9
Card Setup .....	9-10
Re-Order Cards .....	9-10
Configure Cards .....	9-10
Time Tracker Card .....	9-11
Weather Card .....	9-12
Add a New Location .....	9-12
Change Location .....	9-13
Delete a Location .....	9-13
Email Setup .....	9-13
Setting Up an IMAP or POP Account .....	9-13
Automatic Email Setup .....	9-13
Manual Email Setup .....	9-14
Entering Email Settings Manually .....	9-14
Editing an Email Account .....	9-16
Setting Email Signatures .....	9-17
MMS Messaging Setup .....	9-17
Voice Commander .....	9-18
Contacts Settings .....	9-18
Play .....	9-18
Voice Tag .....	9-18
Application Settings .....	9-19
Play .....	9-19
Voice Tag .....	9-19
Music Settings .....	9-19

Play .....	9-19
Voice Tag .....	9-19
Digit Trainer Settings .....	9-20
Digit Setting Settings .....	9-20
Advanced Settings .....	9-20

## Chapter 10: Accessories

Introduction .....	10-1
Accessories .....	10-1
Single Slot USB Cradle .....	10-3
Charging the MC65 Battery .....	10-3
Charging the Spare Battery .....	10-4
Battery Charging Indicators .....	10-4
Charging Temperature .....	10-4
Four Slot Charge Only Cradle .....	10-6
Charging .....	10-6
Battery Charging Indicators .....	10-6
Charging Temperature .....	10-6
Four Slot Ethernet Cradle .....	10-7
Charging .....	10-7
Battery Charging Indicators .....	10-7
Charging Temperature .....	10-7
VCD5000 Vehicle Cradle .....	10-8
Charging the MC65 Battery .....	10-8
Removing the MC65 .....	10-8
Battery Charging Indicators .....	10-9
Charging Temperature .....	10-9
Four Slot Battery Charger .....	10-10
Battery Charging .....	10-10
Battery Charging Indicators .....	10-10
Charging Temperature .....	10-10
Cables .....	10-11
Battery Charging and Operating Power .....	10-11
LED Charge Indications .....	10-12
Charging Temperature .....	10-12
Vehicle Holder .....	10-13
Installation Reminders .....	10-13
Device Mounting Precautions .....	10-13
Installation .....	10-13
Assembly .....	10-14
Windshield Installation .....	10-14
Flat Surface Installation .....	10-15

## Chapter 11: Maintenance & Troubleshooting

Introduction .....	11-1
Maintaining the MC65 .....	11-1
Removing the Screen Protector .....	11-2
Battery Safety Guidelines .....	11-2

Cleaning .....	11-3
Materials Required .....	11-3
Cleaning the MC65 .....	11-4
Housing .....	11-4
Display .....	11-4
Scanner Exit Window .....	11-4
Connector .....	11-4
Cleaning Cradle Connectors .....	11-4
Cleaning Frequency .....	11-5
Troubleshooting .....	11-5
MC65 .....	11-5
Bluetooth Connection .....	11-7
Single Slot USB Cradle .....	11-8
Four Slot Ethernet Cradle .....	11-9
Vehicle Cradle .....	11-9
Four Slot Battery Charger .....	11-10
Cables .....	11-10
Magnetic Stripe Reader .....	11-11

## Appendix A: Technical Specifications

MC65 Technical Specifications .....	A-1
MC65 .....	A-1
MC65 Accessory Specifications .....	A-6
Single Slot USB Cradle .....	A-6
Four Slot Battery Charger .....	A-7
Four Slot Charge Only Cradle .....	A-7
Four Slot Ethernet Cradle .....	A-8
Magstripe Reader .....	A-8
Vehicle Cradle .....	A-9
Cables .....	A-10

## Appendix B: Keypads

Introduction .....	B-1
Numeric Keypad Configuration .....	B-1
Alpha-numeric Keypad Configurations .....	B-4
Special Character Key .....	B-12

## Appendix C: Windows Mobile Home Screen and Dialer

Introduction .....	C-1
Windows Mobile Home Screen .....	C-1
Classic Today Screen .....	C-3
Start Screen .....	C-4
Windows Mobile Dialer .....	C-4
Making a Call .....	C-5
Using the Phone Keypad .....	C-5
Smart Dialing .....	C-5
Using Contacts .....	C-6

Using Call History .....	C-7
Making a Speed Dial Call .....	C-8
Answering a Call .....	C-8
Incoming Call Features .....	C-9
Missed Call Notification .....	C-9
Emergency Calling .....	C-9
Audio Modes .....	C-9
Using a Wired Headset .....	C-10
Using a Bluetooth Headset .....	C-10
Adjusting Audio Volume .....	C-10
Muting a Call .....	C-11
Using Call History .....	C-11
Managing Call History .....	C-11
Changing the Call History View .....	C-11
Resetting the Recent Calls Counter .....	C-11
Deleting All Call History Items .....	C-12
Viewing Call Status .....	C-12
Using the Call History Menu .....	C-13
Swapping Calls (GSM) .....	C-14
Swapping Calls (CDMA) .....	C-14
Conference Calling (GSM) .....	C-15
Three-way Calling (CDMA) .....	C-16

**Glossary**

**Index**

# About This Guide

---

## Introduction

This guide provides information about using the MC65 Enterprise Digital Assistant (EDA) and accessories.

- ✓ **NOTE** Screens and windows pictured in this guide are samples and can differ from actual screens. This guide provides instructions for using the Enterprise Home screen and Dialer. See [Appendix C, Windows Mobile Home Screen and Dialer](#) for information on using the Microsoft Home screen and Dialer.

## Documentation Set

The documentation set for the MC65 provides information for specific user needs, and includes:

- **MC65 Quick Start Guide** - describes how to get the MC65 EDA up and running.
- **MC65 User Guide** - describes how to use the MC65 EDA.
- **MC65 Integrator Guide** - describes how to set up the MC65 EDA and accessories.
- **Enterprise Mobility Developer Kit (EMDK) Help File** - provides API information for writing applications.

---

## Configurations

This guide covers the following configurations:

Configuration	Radios	Display	Memory	Data Capture Options	Operating System	Keypads
MC659B	WLAN: 802.11 a/b/g WPAN: Bluetooth v2.0 EDR WWAN: CDMA or GSM/UMTS GPS: Stand-alone GPS or A-GPS	3.5" VGA Color	128 MB RAM/ 1 GB Flash	2D imager and camera	Windows Mobile 6.5 Professional	Numeric, Alphanumeric, QWERTY, QWERTZ or AZERTY keypad

## Software Versions

This guide covers various software configurations and references are made to operating system or software versions for:

- Adaptation Kit Update (AKU) version
- OEM version
- Fusion software
- Phone software.

### AKU Version

To determine the Adaptation Kit Update (AKU) version:

Tap **Start > Settings > System > About > Version**.

The second line lists the operating system version and the build number. The last part of the build number represents the AKU number. For example, *Build 23121.5.3.6* indicates that the device is running AKU version 5.3.6.

### OEM Version

To determine the OEM software version:

Tap **Start > Settings > System > System Info > System**.



### Fusion Software

To determine the Fusion software version:

Tap **Status Bar >  > Wireless Status > Versions**.

### Phone Software

To determine the Phone software version:

Press  >  > **Phone information**.

---

## Chapter Descriptions

Topics covered in this guide are as follows:

- [Chapter 1, Getting Started](#) provides information on getting the MC65 up and running for the first time.
- [Chapter 2, Using the MC65](#) provides basic instructions for using the MC65, including powering on and resetting the MC65, and entering and capturing data.
- [Chapter 3, Making Calls](#) provides setup instructions for the MC65 phone.
- [Chapter 4, Using WLAN](#) provides information for connection the MC65 to a WLAN.
- [Chapter 5, Messaging](#) provides information for using Email, SMS and MMS messaging.
- [Chapter 6, Using the Camera](#) provides instructions for taking pictures and capturing video.



- [Chapter 7, Using Bluetooth](#) explains Bluetooth functionality on the MC65.
- [Chapter 8, Using GPS Navigation](#) provides information about GPS navigation with the MC65.
- [Chapter 9, Settings](#) provides basic instructions for using the MC65 phone.
- [Chapter 10, Accessories](#) describes the available accessories and how to use them with the MC65.
- [Chapter 11, Maintenance & Troubleshooting](#) includes instructions on cleaning and storing the MC65, and provides troubleshooting solutions for potential problems during MC65 operation.
- [Appendix A, Technical Specifications](#) provides the technical specifications for the MC65.
- [Appendix B, Keypads](#) Provides information on the various keypad configuration.
- [Appendix C, Windows Mobile Home Screen and Dialer](#) provides information for using the Windows Mobile Home screen and Windows Mobile dialer.

---

## Notational Conventions

The following conventions are used in this document:

- “EDA” refers to the Motorola MC65 series of hand-held computers.
- *Italics* are used to highlight the following:
  - Chapters and sections in this and related documents
  - Icons on a screen.
- **Bold** text is used to highlight the following:
  - Dialog box, window, and screen names
  - Drop-down list and list box names
  - Check box and radio button names
  - Key names on a keypad
  - Button names on a screen.
- bullets (•) indicate:
  - Action items
  - Lists of alternatives
  - Lists of required steps that are not necessarily sequential
- Sequential lists (e.g., those that describe step-by-step procedures) appear as numbered lists.

---

## Related Documents

- *MC65 Quick Start Guide*, p/n 72-134041-xx.
- *MC65 Regulatory Guide*, p/n 72-134232-xx.
- *MC65 Integrator Guide*, p/n 72E-142435-xx.
- *Mobility Services Platform User Guide*, p/n 72E-100158-xx.
- *Enterprise Mobility Developer Kits (EMDKs)*, available at: <http://supportcentral.motorola.com>.

- Latest ActiveSync software, available at: <http://www.microsoft.com>.

For the latest version of this guide and all guides, go to: <http://supportcentral.motorola.com>.

---

## Service Information

If you have a problem with your equipment, contact Motorola Enterprise Mobility support for your region. Contact information is available at: <http://www.motorola.com/enterprisemobility/contactsupport>.

When contacting Enterprise Mobility support, please have the following information available:

- Serial number of the unit (found on manufacturing label)
- Model number or product name (found on manufacturing label)
- Software type and version number.

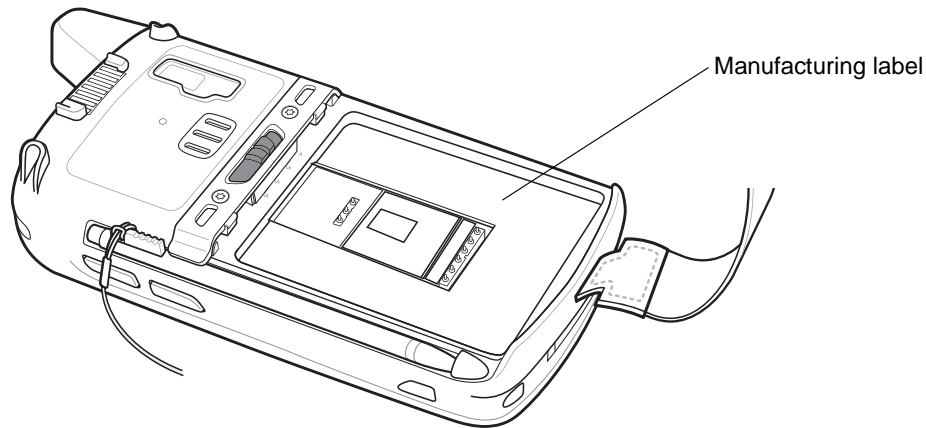

Motorola responds to calls by email, telephone or fax within the time limits set forth in support agreements.

If your problem cannot be solved by Motorola Enterprise Mobility Support, you may need to return your equipment for servicing and will be given specific directions. Motorola is not responsible for any damages incurred during shipment if the approved shipping container is not used. Shipping the units improperly can possibly void the warranty. Remove the SIM card and/or microSD card from the MC65 before shipping for service.

If you purchased your Enterprise Mobility business product from a Motorola business partner, contact that business partner for support.

# Chapter 1 Getting Started

---

## Introduction

This chapter lists the parts and accessories for the MC65 and explains how to set up the MC65 for the first time.

---

## Unpacking

Carefully remove all protective material from the MC65 and save the shipping container for later storage and shipping.

Verify that you received the following:

- MC65 EDA
- 3600 mAh Lithium-ion battery
- stylus with tether (installed)
- screen protector, installed on display window
- Regulatory Guide
- Quick Start Guide.

Inspect the equipment for damage. If any equipment is missing or damaged, contact the Motorola Enterprise Mobility Support center immediately. See [page xvi](#) for contact information.

Prior to using the MC65 for the first time, remove the protective shipping film that covers the scan window, display and camera window.

## Getting Started

To start using the MC65 for the first time:

- Install a microSD card (optional)
- Install the SIM card (GSM only)
- Install the main battery pack.
- Charge the MC65.
- Power on the MC65.

### Installing a microSD Card

The microSD card slot provides secondary non-volatile storage. The slot is located under the battery pack. Refer to the documentation provided with the card for more information, and follow the manufacturer's recommendations for use.



**CAUTION** Follow proper ESD precautions to avoid damaging the SD card. Proper ESD precautions include, but are not limited to, working on an ESD mat and ensuring that the operator is properly grounded.

To install the microSD card:

1. Remove the handstrap.
2. Lift the rubber access door.
3. Slide the SIM card holder door up to unlock.
4. Lift the SIM card holder door.

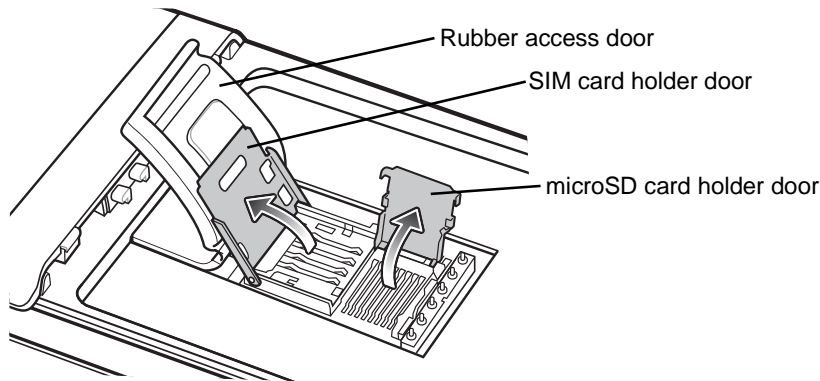

**Figure 1-1** Lift SIM Slot Holder Door

5. Lift the microSD card holder door.
6. Insert the microSD card into the card holder door ensuring that the card slides into the holding tabs on each side of the door.

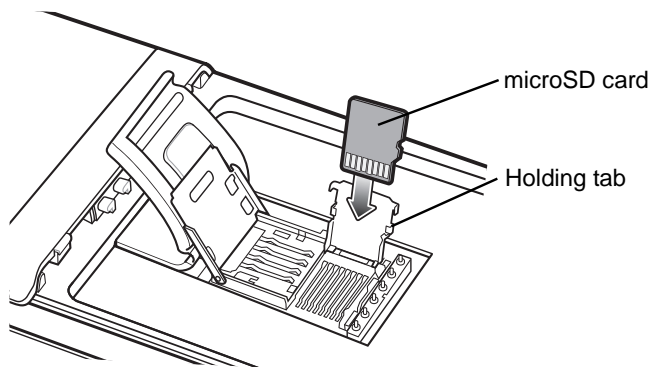

**Figure 1-2** Insert microSD Card in Holder

7. Close the card holder door and push down until it is securely in place.
8. If installing a SIM card, proceed to [Installing the SIM Card](#).
9. Close the SIM card holder door and slide down until it locks into place.
10. Close the rubber access door.

## Installing the SIM Card

✓ **NOTE** GSMs only.

GSM phone service requires a Subscriber Identification Module (SIM) card. Obtain the card from the your service provider. The card fits into the MC65 and can contain the following information:

- Mobile phone service provider account details.
- Information regarding service access and preferences.
- Contact information, which can be moved to Contacts on the MC65.
- Any additional services to which you have subscribed.

✓ **NOTE** For more information about SIM cards, refer to the service provider's documentation.

To install the SIM card:

1. Lift rubber access door.
2. Slide the SIM card holder up to unlock.
3. Lift the SIM card holder door.

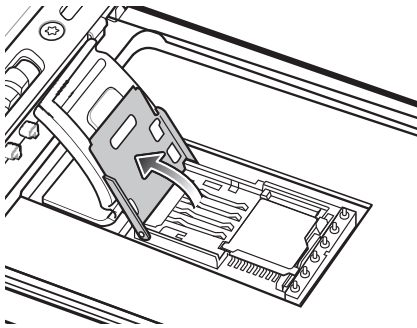

**Figure 1-3** *Lifting the SIM Cover*

4. Insert the SIM card, as shown in [Figure 1-4](#) ensuring that the card slides into the holding tabs on each side of the door.

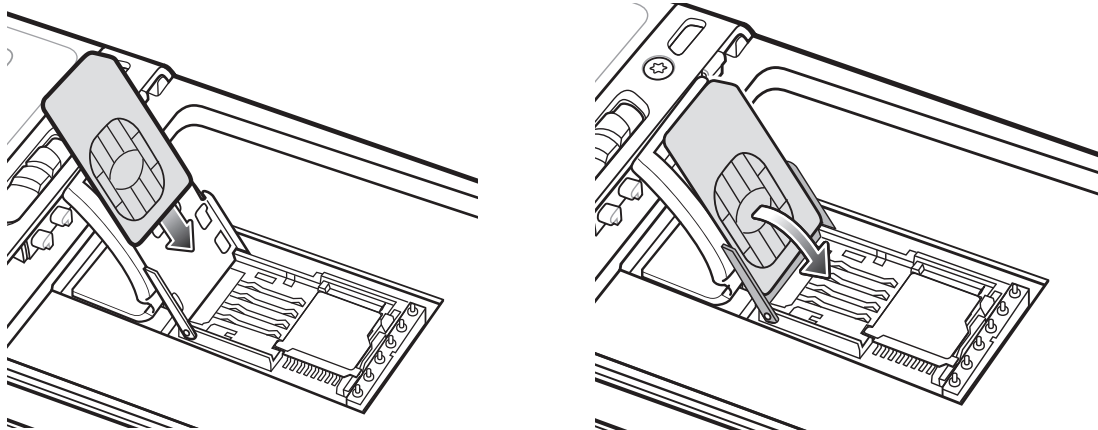

**Figure 1-4** *Inserting the SIM Card*

5. Close the SIM card holder door and slide down to lock into place.
6. Close the rubber access door.
7. Install the battery.

✓ **NOTE** For detailed information about WWAN activation, see [First-time Network Activation on page 1-7](#).

## Installing the Battery

To install the battery.

1. Insert the battery, bottom first, into the battery compartment in the back of the MC65.
2. Press the battery down into the battery compartment until the battery release latch snaps into place.
3. Replace the handstrap.

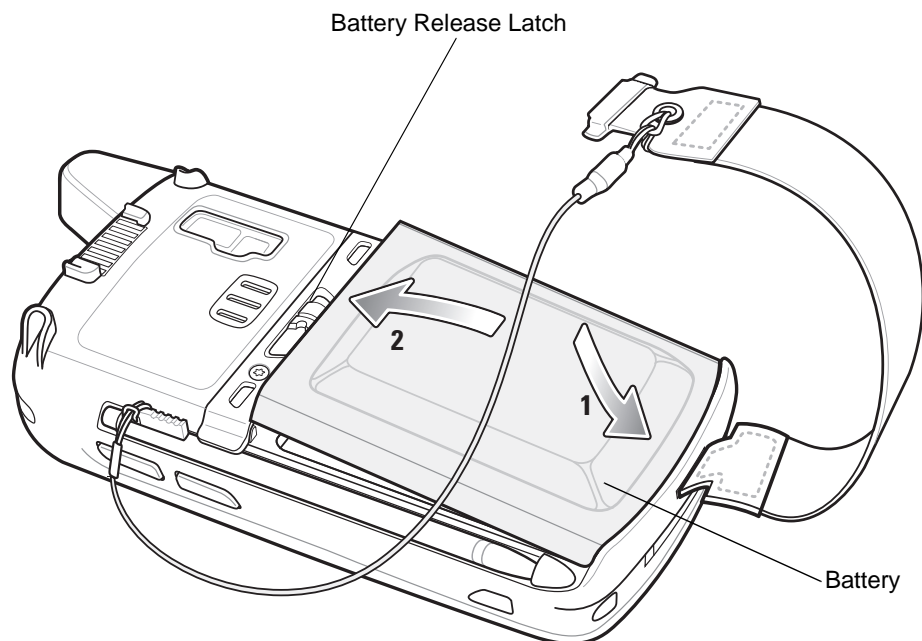

**Figure 1-5** Inserting the Battery

## Charging the Battery



**CAUTION** Ensure that you follow the guidelines for battery safety described in [Battery Safety Guidelines on page 11-2](#).

### Charging the Main Battery

Before using the MC65 for the first time, charge the main battery until the amber Charging/Battery Status LED remains lit (see [Table 1-1 on page 1-6](#) for charge status indications). To charge the MC65, use a cable or a cradle with the appropriate power supply. For information about the accessories available for the MC65, see [Chapter 10, Accessories](#).

The MC65 is equipped with a memory backup battery which automatically charges from the fully-charged main battery. When using the MC65 for the first time, the backup battery requires approximately 36 hours to fully charge. This is also true any time the backup battery is discharged, which occurs when the main battery is removed for several hours. The backup battery retains RAM data in memory for at least 15 minutes (at room temperature) when the MC65's main battery is removed. When the MC65 reaches a very low battery state, the combination of main battery and backup battery retains RAM data in memory for at least 48 hours.

For cable and cradle setup and charging procedures refer to the *MC65 Integrator Guide*.

- USB Charging Cable
- Charge Only Cable
- Single Slot USB Cradle
- Four Slot Charge Only Cradle
- Four Slot Ethernet Cradle.

To charge the main battery:

1. Connect the charging accessory to the appropriate power source.
2. Insert the MC65 into a cradle or attach to a cable. The MC65 begins charging. The Charging/Battery Status LED blinks amber while charging, then turns solid amber when fully charged. See [Table 1-1](#) for charging indications.

The 3600 mAh battery charges in less than six hours.

**Table 1-1** LED Charge Indicators

Charging/Battery Status LED	Indication
Off	MC65 is not charging. MC65 is not inserted correctly in the cradle or connected to a power source. Charger/cradle is not powered.
Slow Blinking Amber (1 blink every 2 seconds)	MC65 is charging.
Solid Amber	Charging complete. Note: When the battery is initially inserted in the MC65, the amber LED flashes once if the battery power is low or the battery is not fully inserted.
Fast Blinking Amber (2 blinks/second)	Charging error, e.g.: <ul style="list-style-type: none"> <li>• Temperature is too low or too high.</li> <li>• Charging has gone on too long without completion (typically eight hours).</li> </ul>

### Charging Spare Batteries

See [Chapter 10, Accessories](#) for information on using accessories to change spare batteries.

### Charging Temperature

Charge batteries in temperatures from 0°C to 40°C (32°F to 104°F). Note that charging is intelligently controlled by the MC65.

To accomplish this, for small periods of time, the MC65 or accessory alternately enables and disables battery charging to keep the battery at acceptable temperatures. The MC65 or accessory indicates when charging is disabled due to abnormal temperatures via its LED. See [Table 1-1](#).

## Powering On the MC65

Press the Power button to turn on the MC65. The splash screen displays for about a minute as the MC65 initializes its flash file system, then the calibration window appears.

### Calibrating the Screen

✓ **NOTE** The Calibration screen can be accessed by pressing **Blue** key then **Backspace** key.

To calibrate the screen so the cursor on the touch screen aligns with the tip of the stylus:

1. Remove the stylus from its holder on the side of the MC65.
2. Carefully press and briefly hold the tip of stylus on the center of each target that appears on the screen.
3. Repeat as the target moves around the screen, then tap the screen to continue.



---

## First-time Network Activation

### GSM/UMTS Activation

#### Network Activation

To activate on a GSM/UMTS network:

1. If an active SIM card was installed in the MC65, the MC65 performs the activation process.
2. The **Phone Network - GSM/UMTS Setup** dialog box displays.
3. Tap **Yes** and then **OK**. For some carriers, the ES400 resets.
4. If during start-up, no update connection settings message appears, tap **Start > Settings > Connection > Phone Network Setup** and tap **Update Connection Settings** button.
5. If the network is unsupported, a message appears with links for manually setting the data connection and MMS settings.

To activate on a CDMA network:

1. If a SIM card was not installed, a **No SIM card found** dialog box displays.
2. Tap **OK**. The **Phone Network - CDMA Activation** dialog box displays.
3. Tap **Yes** to activate on a CDMA network.
4. On the **CDMA Setup** tab, tap the **Preferred network** option and select a network.
5. Tap **Yes**.
6. Tap the **Start Activation** button.
7. Tap **Yes** to activate.
8. Call the carrier from an existing phone to request over-the-air activation.
9. When instructed by the operator press **Activate Now** button.

For detailed information for configuring the phone and activating on a different network, refer to the *MC65 Integrator Guide*.

---

## Checking Battery Status

To check the charge status of the main battery in the MC65, tap **Start > Settings > Power** to display the **Power** window or tap **Status Bar >** .

## Replacing the Battery



**CAUTION** The MC65 backup battery retains data for up to 15 minutes. Replace the battery within 15 minutes to ensure that application states are maintained and that data is not lost.

1. If the MC65 is in suspend mode, press the red **Power** button to wake the device.
2. Press and hold the red **Power** button for approximately 5 seconds.
3. Release the **Power** button. The Data Capture LED lights red.
4. When the LED turns off, remove the handstrap.
5. Slide the battery latch to the right. The battery ejects slightly.

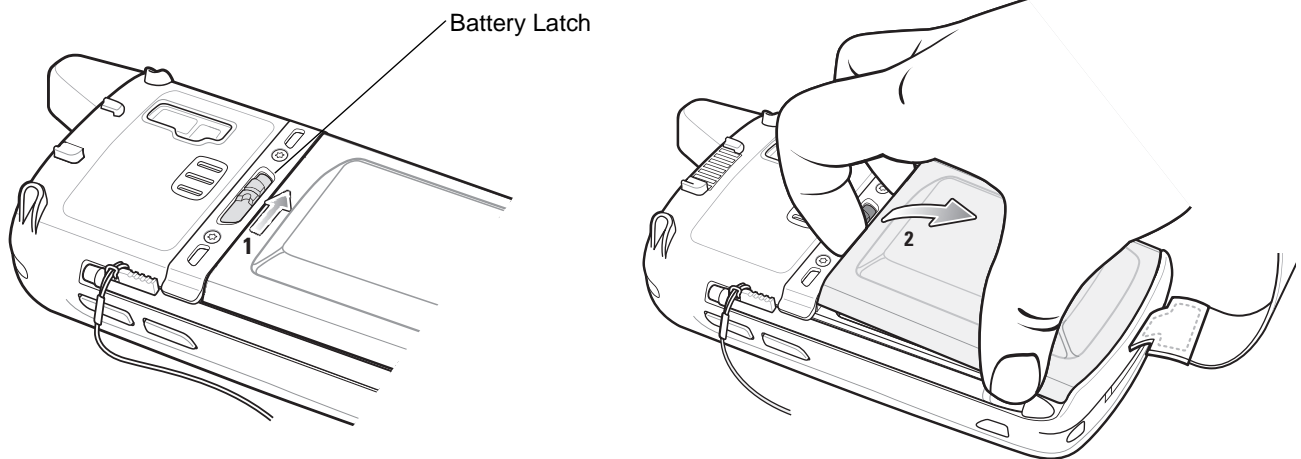

**Figure 1-6** Removing the Battery

6. Lift the battery from the MC65.
7. Insert the replacement battery, bottom first, into the battery compartment in the back of the MC65.
8. Press the battery down until the battery release latch snaps into place.
9. Replace the handstrap.

## Replacing the microSD Card



**CAUTION** The MC65 backup battery retains data for up to 15 minutes. Replace the battery within 15 minutes to ensure that application states are maintained and that data is not lost.

To replace an microSD card:

1. If the MC65 is in suspend mode, press the red **Power** button to wake the device.
2. Press and hold the red **Power** button for approximately 5 seconds.
3. Release the **Power** button. The Data Capture LED lights red.
4. When the LED turns off, remove the handstrap.

5. Remove the battery.
6. Lift the rubber access door.
7. Slide SIM card holder door up to unlock.
8. Lift SIM Card holder door.
9. Lift the microSD card holder door.
10. Remove microSD card from holder.
11. Close microSD card holder door.
12. Close SIM card holder door.
13. Slide SIM card holder door down to lock into place.
14. Close the rubber access door.
15. Replace the battery.
16. Replace the handstrap.
17. If a SIM card is installed, reset the MC65. See [Resetting the MC65 on page 2-19](#).

---

## Replacing the SIM Card

To replace a SIM card:

1. If the MC65 is in suspend mode, press the red **Power** button to wake the device.
2. Press and hold the red **Power** button for approximately 5 seconds.
3. Release the **Power** button. The Data Capture LED lights red.
4. When the LED turns off, remove the handstrap.
5. Remove the battery.
6. Lift the rubber access door.
7. Slide SIM card holder door up to unlock.
8. Lift the SIM Card holder door.
9. Remove SIM card from holder.
10. Close SIM card holder door.
11. Slide SIM card holder door down to lock into place.
12. Close the rubber access door.



**CAUTION** The MC65 backup battery retains data for up to 15 minutes. Replace the battery within 15 minutes to ensure that application states are maintained and that data is not lost.

13. Replace the battery.
14. Replace the handstrap.

15. Reset the MC65. See [Resetting the MC65 on page 2-19](#).

---

## Battery Management

Observe the following battery saving tips:

- Leave the MC65 connected to AC power at all times when not in use.
- Set the MC65 to turn off after a short period of non-use.
- Set the backlight to turn off after a short period of non-use.
- Turn off all wireless activities when not in use.

### Changing the Power Settings

To set the MC65 to turn off after a short period of non-use:

1. Tap **Status Bar** > .
2. Select the **Device timeout** option.
3. Select a value from the list.

### Changing the Backlight Settings

To change the backlight settings in order to conserve more battery power:

1. Tap **Start** > **Status Bar** > .
2. Select the **Backlight** option.
3. Select a value from the list.
4. Select the **Brightness** option.
5. Tap the **Manual** option and use the slider to select a low value.
6. Tap **Back**.

### Changing the Keypad Backlight Settings

To change the keypad backlight settings in order to conserve more battery power:

1. Tap **Start** > **Settings** > **System** > **Backlight & Keylight** > **Battery Power**.
2. Tap the **Keylight** option.
3. Select a value from the list.
4. Tap the **Keylight** option.
5. Select a low value from the list.
6. Tap **OK**.

## Turning Off the Radios

To turn off the radios:

1. Tap **Status Bar** > .
2. Tap **Phone radio** to toggle the phone radio on and off.
3. Tap **Wi-Fi** to toggle the WLAN radio on and off.
4. Tap **Bluetooth** to toggle the Bluetooth radio on and off.

---

## Handstrap Replacement

### Removal

To remove a handstrap from the MC65:



**CAUTION** Close all running applications prior to replacing the handstrap. The backup battery maintains data for up to 15 minutes. If replacement takes longer than 15 minutes data may be lost.

1. If the MC65 is in suspend mode, press the red **Power** button to wake the device.
2. Press and hold the red **Power** button for approximately 5 seconds.
3. Release the **Power** button. The Data Capture LED lights red.
4. When the LED turns off, remove the handstrap.

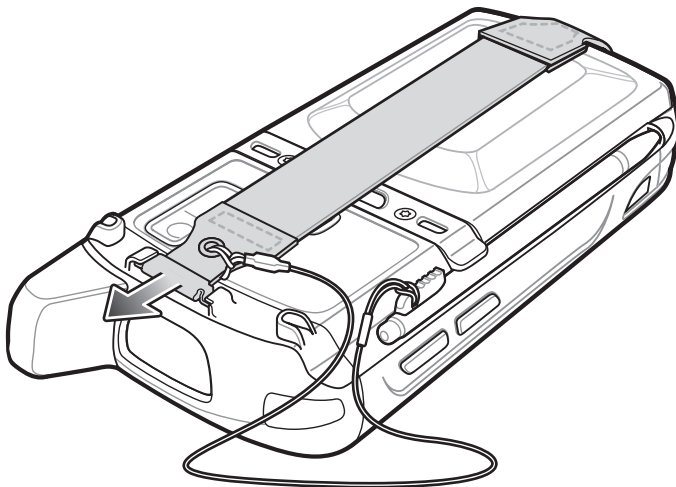

**Figure 1-7** Handstrap Clip Removal

5. Remove the battery.



**CAUTION** When removing handstrap pin, be careful not to damage handstrap mounting area.

6. Using a small flat screwdriver, push the head of the screwdriver between the handstrap pin and the bottom of the housing as shown below.

7. Pry the handstrap and pin up and out of the handstrap mount area.

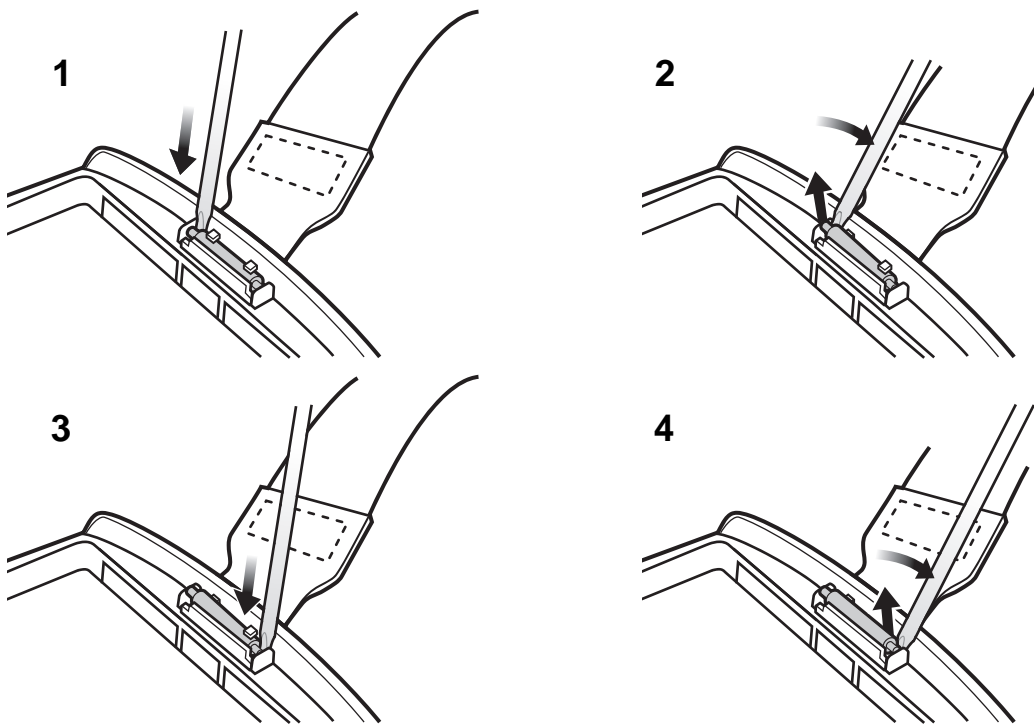

**Figure 1-8** *Handstrap and Pin Removal*

8. Repeat for the other side of the handstrap.
9. Remove pin from the handstrap.

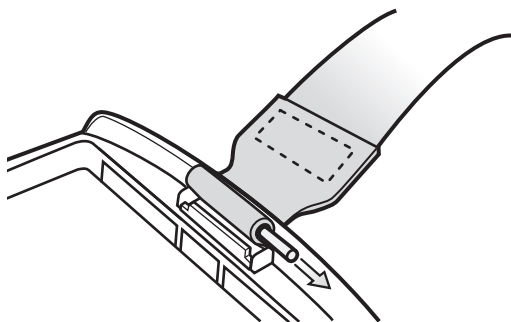

**Figure 1-9** *Pin Removal*

10. Pull handstrap through handstrap slot.

## Installation

To install a new handstrap:

1. Feed bottom end of handstrap into handstrap slot on the bottom of the MC65.

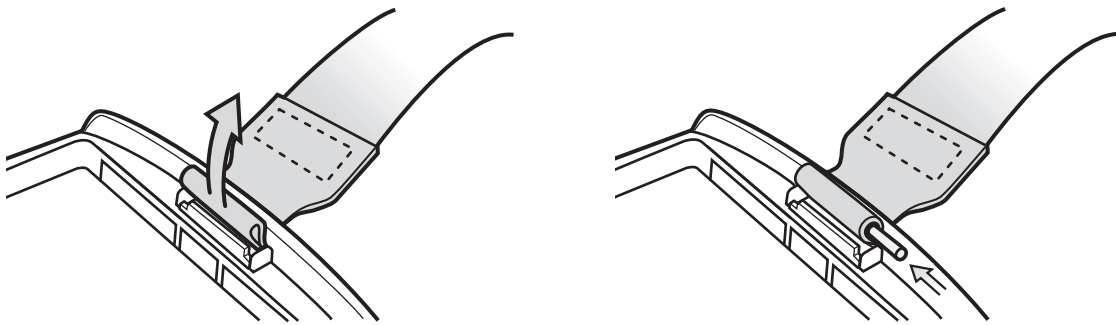
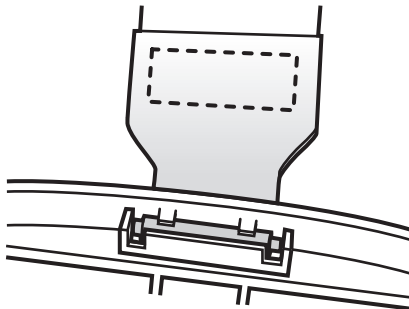

**Figure 1-10** Feed handstrap into Handstrap Slot

2. Slide pin into bottom of handstrap.
3. Center the pin in the handstrap loop.

✓ **NOTE** Handstrap and pin should fit securely into the handstrap mounting area. When pulling on handstrap use enough force to engage pin into place.

4. Pull handstrap so that the pin and bottom of handstrap slide into position in the mounting area.



**Figure 1-11** Pin and Handstrap in Mounting Area

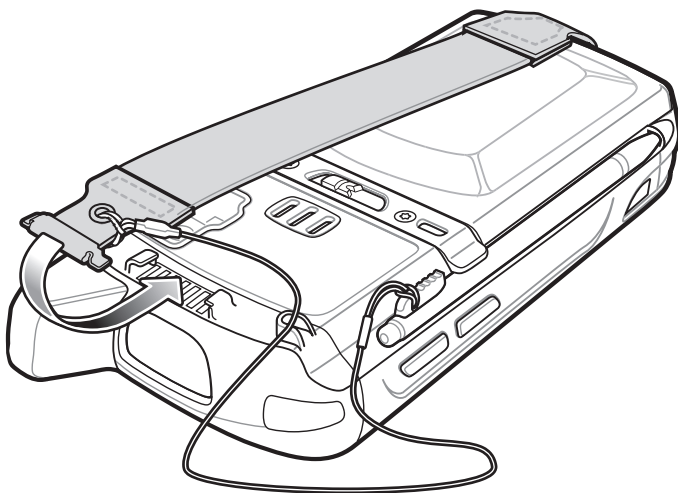

**Figure 1-12** Slide Handstrap and Tether Over Handstrap Mount

5. Slide tether loop over handstrap.
6. Insert the handstrap clip into the slot on the device. Ensure that it is securely in place.





# Chapter 2 Using the MC65

## Introduction

This chapter explains the buttons, status icons, and controls on the MC65, and provides basic instructions for using the MC65, including resetting the MC65 and entering and capturing data.

## Features

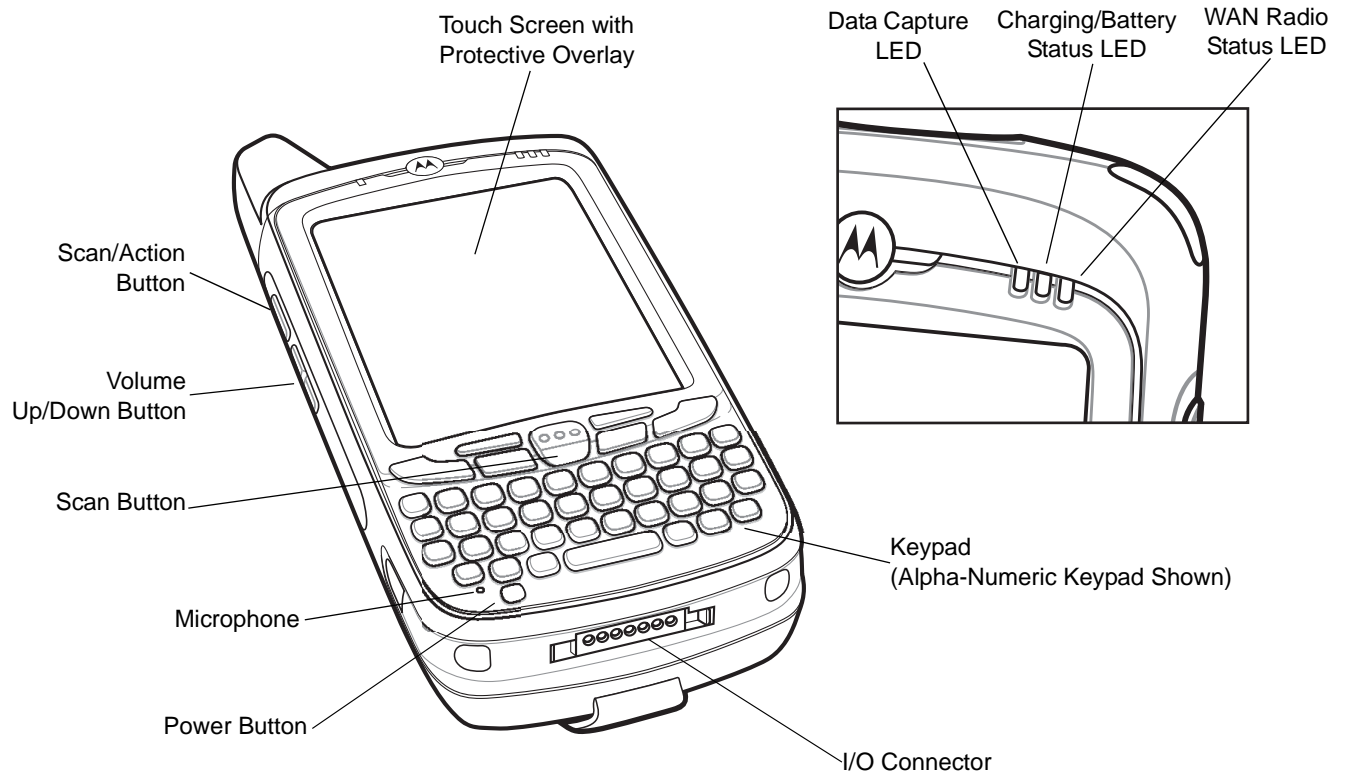
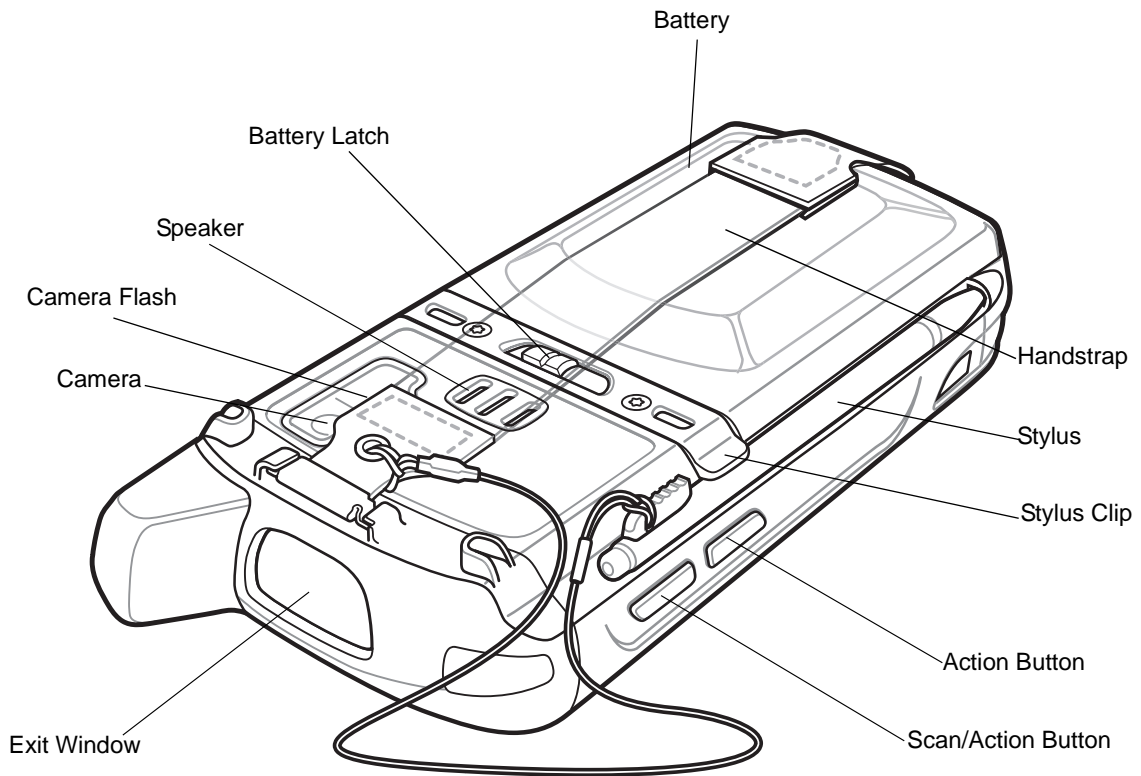

Figure 2-1 MC65 Front View



**Figure 2-2** MC65 Rear View

## Function Buttons

The MC65's buttons perform the following functions.

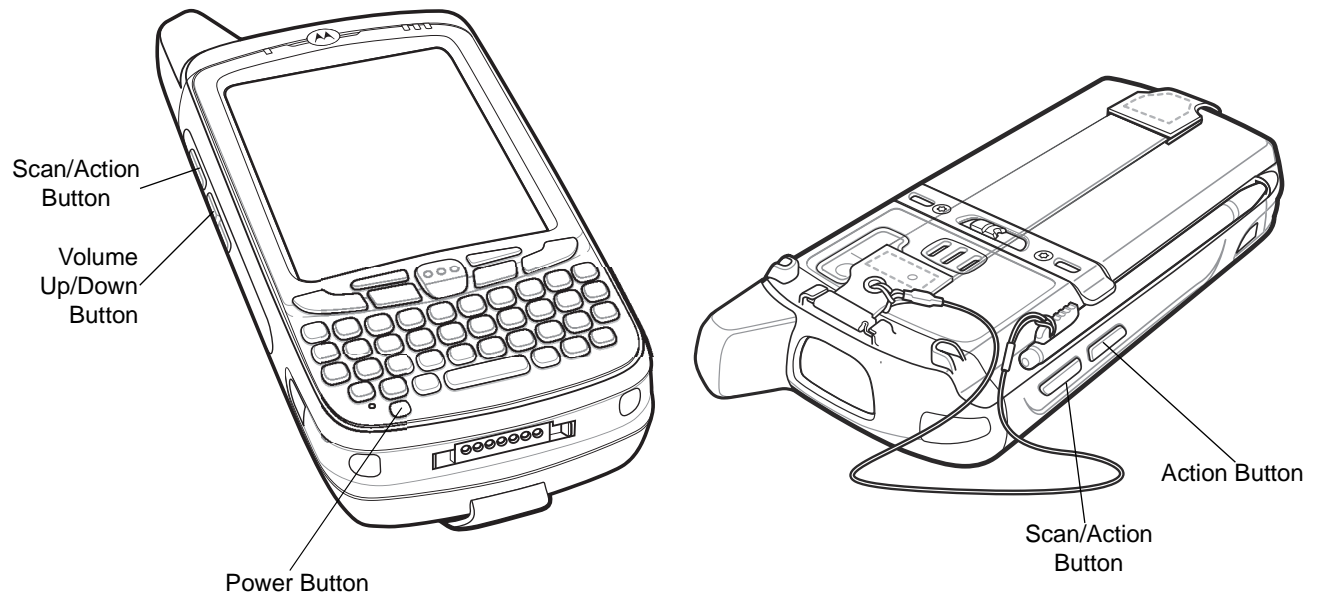

**Figure 2-3** *Function Buttons*

- **Power:** Press the red **Power** button to turn the MC65 screen on and off. The MC65 is in suspend mode when the screen is off. For more information, see [Powering On the MC65 on page 1-6](#). Also use the **Power** button to reset the MC65. See [Resetting the MC65 on page 2-19](#).
- **Scan/Action:** Press to scan bar codes or capture images. See [Data Capture on page 2-22](#). Or, press to open an application or perform a function. See the *Microsoft® Applications for Mobile 6 User Guide* to set an application to open.
- **Volume Up/Down:** Press to increase or decrease the MC65's volume.
- **Action:** Press to open an application or perform a function. See the *Microsoft® Applications for Windows Mobile 6 User Guide* to set an application to open.

---

## Keypads

The MC65 offers two types modular keypad configurations: Numeric and alpha-numeric.

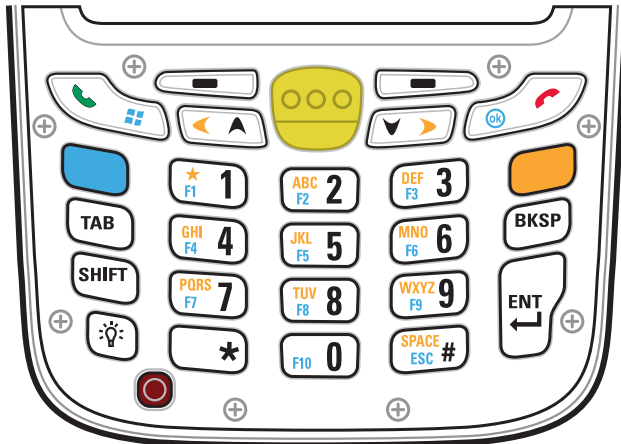

**Figure 2-4** MC65 Numeric Keypad

Refer to [Chapter B, Keypads](#) for detailed information on the keypad configurations.

## Keypad Remapping

The user has the ability to remap the keypad keys to characters or applications. Refer to [Chapter 9, Settings](#) for detailed information on remap keypad keys.

---

## Finger Scrolling

Finger scrolling can be used to scroll up and down web pages, documents, and lists such as the contacts list, file list, message list, calendar appointments list, and more.

When finger scrolling, swipe or flick your finger on the screen.

To scroll down, swipe your finger upward on the screen. To scroll up, swipe your finger downward on the screen.

To auto-scroll, flick your finger upward or downward on the screen. Touch the screen to stop scrolling.

## Motorola Home Screen

The customizable Motorola Home screen provides faster and easier access to features and applications, and allows users to tailor the interface to improve their unique workflow and maximize on-the-job efficiency.

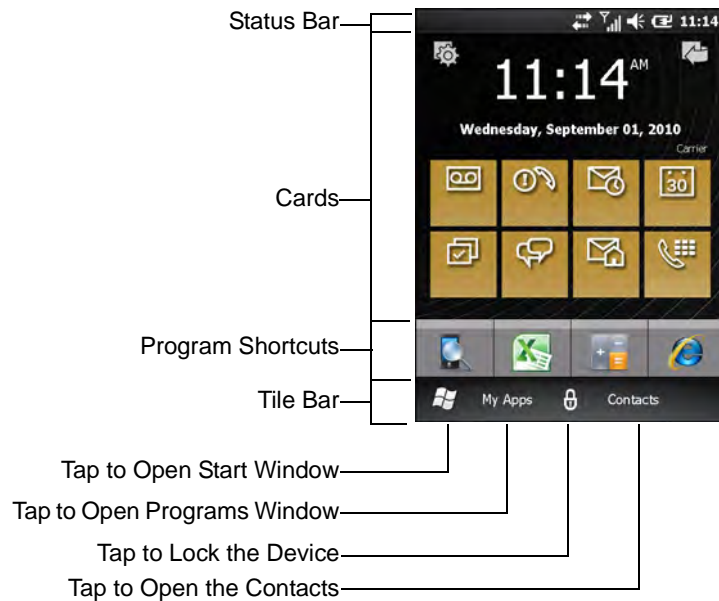

**Figure 2-5** Motorola Home Screen

The **Status Bar** at the top of the screen displays the status icons listed in [Table 2-1](#). Tap anywhere on the **Status Bar** to open the **Device Management** window. Refer to [Device Management on page 2-12](#) for more information.

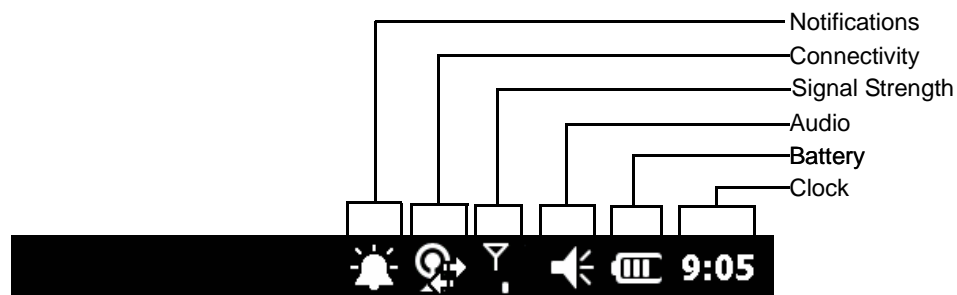















































**Figure 2-6** Status Bar Icons







**Table 2-1** Status Bar Icons

Icon	Description	Icon	Description
<b>Notifications</b>			
	Reminder of an upcoming calendar event.		One or more instant messages were received.
	One or more text messages were received.		One or more voice messages were received.

Table 2-1 Status Bar Icons (Continued)

Icon	Description	Icon	Description
	There are more notification icons than can be displayed.		Bluetooth radio is on.
	One or more Email messages were received.		Receiving MMS message.
	Sending MMS message.		MMS message sent successfully.
	MMS message received successfully.		Microsoft customer feedback alert.
	MMS message received successfully.		
<b>Connectivity</b>			
	Connection is active.		Connection is not active.
	Synchronization is occurring.		Wi-Fi available.
	Wi-Fi in use.		HSDPA available. (GSM only)
	3G available. (GSM only)		GPRS available. (GSM only)
	EGPRS available. (GSM only)		1xRTT available. (CDMA only)
	EVDO Rev. 0 available. (CDMA only)		EVDO Rev. A available. (CDMA only)
	Dormant State - no data transmission during a 1x or EVDO connection. (CDMA only)		Roaming.
<b>WAN</b>			
	Call missed.		Dialing while no SIM card is installed.
	Call in progress.		Calls are forwarded.
	Call on hold.		Speakerphone is on.
	Phone on/good signal.		Phone off.
	No WAN service.		Searching for WAN service.
	HSDPA connecting. (GSM only)		HSDPA in use. (GSM only)
	3G in use. (GSM only)		3G connecting. (GSM only)
	GPRS in use. (GSM only)		GPRS connecting. (GSM only)
	EGPRS in use. (GSM only)		EGPRS connecting. (GSM only)
	EVDO in use. (CDMA only)		EVDO connecting. (CDMA only)
	SIM Card not installed. (GSM only)		
<b>Audio</b>			
	All sounds are on.		All sounds are off.

**Table 2-1** Status Bar Icons (Continued)

Icon	Description	Icon	Description
	Vibrate is on.		
<b>Battery</b>			
	Battery is charging.		Battery has a full charge.
	Battery has a high charge.		Battery has a medium charge.
	Battery has a low charge.		Battery has a very low charge.

## Cards

Cards provide quick access to completing common tasks. The number and type of cards available to an end user are configurable by the system administrator or the end user. By default, the MC65 ships with four cards.

Swipe finger left or right on the screen to view adjacent cards.

Cards can be rearranged, deleted or added to the Home screen. See [Chapter 9, Settings](#) for more information.

### Simple Home Card

The Simple Home card displays the current date and time and notifications.



**Figure 2-7** Simple Home Card

### Full Home Card



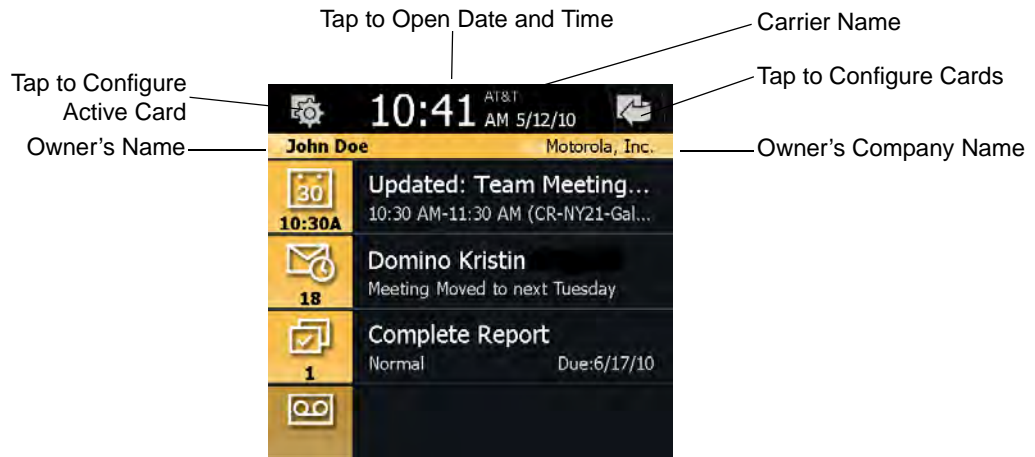





The Full Home card displays the current date and time and notifications with expanded information.



**Figure 2-8** Full Home Card

Table 2-2 lists the Home card shortcut icons.

**Table 2-2** Home Card Icons

Icon	Description
	Calendar: Indicates the next appointment in the calendar. Tap to open the Calendar application.
	Outlook Email: Indicates the number of unread emails in Outlook email. Tap to open the Email application.
	Tasks: Indicates the number of unfinished tasks. Tap to open the Task application.
	Messages: Indicates the number of unread SMS and MMS messages. Tap to open the Messaging application.
	Voicemail: Indicates the number of voice messages in the voicemail box.
	Missed Calls: Indicates the number of missed call.
	Home Email: Indicates the number of unread emails in a personal email account. tap to open the Email application.
	In Call Status: Indicates call status.



## Weather Card

The **Weather** card display the weather for a selected city.

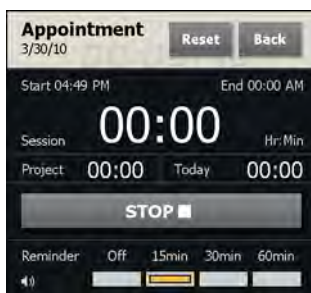

**Figure 2-9** *Weather Card*

See [Weather Card on page 9-12](#) for information on configuring the Weather card.

## Time Tracker Card

The **Time Tracker** card provide a easy way for a worker to log hours spend at a job and output this information in a easy to use format.



**Figure 2-10** *Time Tracker Card*

See [Weather Card on page 9-12](#) for information on configuring the Weather card.

## Card Configuration

Cards can be rearranged, deleted or added to the Home screen. See [Chapter 9, Settings](#) for more information.

## Program Shortcuts

The Program Shortcut buttons provides easy access for four often used applications. Just tap the icon to launch the application. To configure the Program Shortcuts refer to [Program Shortcuts Setup on page 9-8](#).



**Figure 2-11** *My Apps Window*

## My Apps Window

The **My Apps** window provides access to all the applications on the MC65. The window is configurable so that it can display favorite applications. To configure the **My Apps** window refer to [My Apps Window Setup on page 9-9](#).

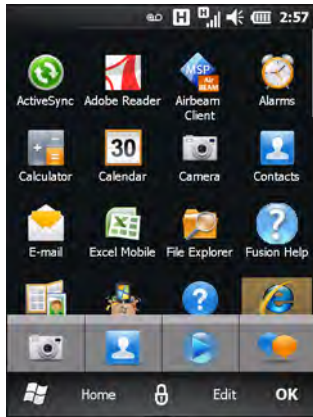

Figure 2-12 My Apps Window

**My Apps** screen is configurable. See [My Apps Window Setup on page 9-9](#) for more information.

## Tile Bar

The **Tile Bar**, located at the bottom of the screen, contains the **Start** tile to open the **Start Menu**. It also displays tiles that vary depending upon the open application.























Figure 2-13 Tile Bar Examples







Table 2-3 Programs Available on the Start Menu

Icon	Description	Icon	Description
	<b>ActiveSync</b> - Synchronize information between the MC65 and a host computer or the Exchange Server.		<b>AirBEAM Client</b> - Allows legacy customers to deploy AirBEAM Smart™ packages to devices.
	<b>Alarms</b> - Set the clock to the date and time of your locale. Alarms can also be set at specified days and times of a week.		<b>Bing</b> - Search the internet.
	<b>Calculator</b> - Perform basic arithmetic and calculations, such as addition, subtraction, multiplication, and division.		<b>Calendar</b> - Keep track of appointments and create meeting requests.
	<b>Contacts</b> - Keep track of friends and colleagues.		<b>E-mail</b> - Send an Email.
	<b>File Explorer</b> - Organize and manage files on the device.		<b>Games</b> - Play games.

Table 2-3 Programs Available on the Start Menu

Icon	Description	Icon	Description
	<b>Getting Started</b> - Launch the Getting Started application.		<b>Help</b> - Access on-line Help topics.
	<b>Internet Explorer</b> - Browse Web and WAP sites as well as download new programs and files from the Internet.		<b>Internet Sharing</b> - Connect a notebook computer to the Internet using the MC65's data connection.
	<b>Marketplace</b> - Purchase applications from the Marketplace.		<b>Messenger</b> - Use the mobile version of Windows Live Messenger.
	<b>Microsoft My Phone</b> - Synchronizes the MC65's contacts, calendar, tasks, text messages, music, photos videos and documents with a Microsoft My Phone account.		<b>MSN Money</b> - Keep track of finances.
	<b>MSN Weather</b> - Check the local weather.		<b>MSP Agent</b> - Enables management of the MC65 from an MSP Server. Requires the purchase of an appropriate MSP client license per device to suit the level of management functionality required.
	<b>Notes</b> - Create handwritten or typed notes, drawings, and voice recordings.		<b>Office Mobile 2010</b> - Provides access to Excel Mobile, PowerPoint Mobile, OneNote Mobile, SharePoint Workspace Mobile and Word Mobile applications.
	<b>Phone</b> - Make calls.		<b>Pictures &amp; Videos</b> - View and manage pictures, animated GIFs, and video files.
	<b>Rapid Deployment Client</b> - Allows the MC65 user to stage a device for initial use by initiating the deployment of settings, firmware, and software. Requires the purchase of an MSP client license per device.		<b>Remote Desktop Mobile</b> - Log onto Windows NT server type computers and use all of the programs that are available on that computer from the MC65.
	<b>Search Phone</b> - Search contacts, data, and other information on the MC65. Refer to the Microsoft Applications for Windows Mobile 6 User Guide for more information.		<b>Settings</b> - Opens the Settings folder. See <a href="#">Chapter 9, Settings</a> for more information.
	<b>SMS Staging</b> - Receives and processes SMS messages from an MSP Server and allows the user to stage an MC65 based on them. Requires the purchase of an MSP client license per device.		<b>Task Manager</b> - Enables viewing of memory and CPU allocations and stops running processes.

**Table 2-3** Programs Available on the Start Menu

Icon	Description	Icon	Description
	<b>Tasks</b> - Keep track of tasks.		<b>Text</b> - Send an SMS or MMS message.
	<b>Toolbox</b> - Contains the <b>Adobe Reader</b> and <b>Voice Commander</b> applications.		<b>Wireless Companion</b> - Opens the Wireless Companion folder.
	<b>Windows Live</b> - Use the mobile version of Windows Live™ to find information on the web.		<b>Windows Media</b> - Play back audio and video files.





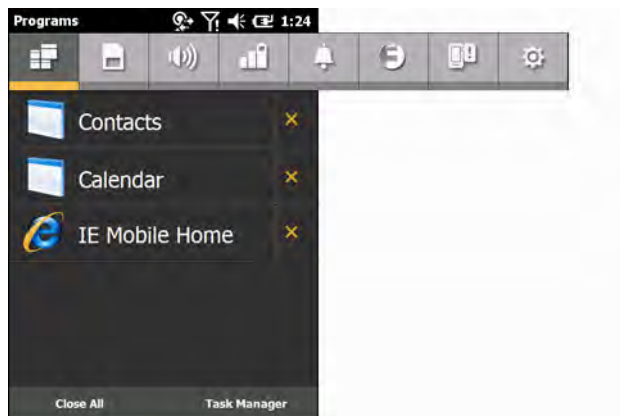

## Device Management



The **Device Management** window provides quick access to information and settings for the MC65.

Tap anywhere on the **Status Bar** to open the **Device Management** window.

**Figure 2-14** Device Management Window

The navigation bar consists of eight tabs:

- Programs 
- Memory Manager 
- Sound Profiles 
- Power & Radio 
- Alarms 
- Fusion 

- Status 
- Settings 

Tap an icon to open the associated tab. Scroll left or right to view more icons.

## Programs

The **Programs** tab lists the programs that are currently running on the MC65 and allows for easy program switching, and a quick way to end processes.

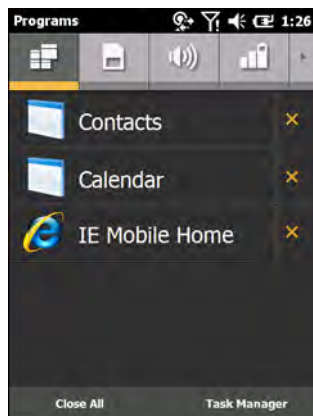
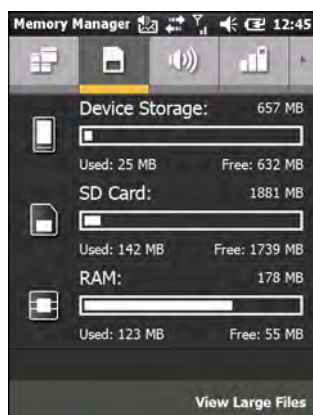

**Figure 2-15** *Programs Tab*

- To switch to a program, tap the name of the program.
- To end a running program, tap the X next to the program name.
- To close all running programs, tap **Close All**.
- To go to the **Task Manager** application, tap **Task Manager**.

## Memory Manager

The **Memory Manager** tab displays an overview of memory utilization, and a quick way to free up space.



**Figure 2-16** *Memory Manager Tab*

- Device Storage - Lists the total available Flash and the amount of Flash that is currently being used.

- SD Card - Lists the total available memory and the amount of memory that is currently being used.
- RAM - Lists the total available RAM and the amount of RAM that is currently being used.

Tap **View Large Files** to display files on the MC65 that are above a specific byte size.

## Sound Profiles

The **Sound Profiles** tab provides direct access to sound-related profiles.



**Figure 2-17** *Sound Profiles Tab*

To select a profile, tap the profile name.

- **Vibrate** - Ring type, reminder and notifications are set to vibrate. Ring and system volumes are set to 0 (off).
- **Silent** - Ring type, reminder and notifications are set to None. Ring and system volumes are set to 0 (off).
- **Schedule** - Ring type, reminder and notifications are set to vibrate when Calendar meeting is in session.
- **Normal** - Ring type is set to Ring, Reminder is set to Vibrate & Sound, Notification is set to Play Sound. Ring and system volumes are set to level 4.
- **Loud** - Ring type is set to Vibrate & Ring, Reminder is set to Vibrate & Sound, Notification is set to Vibrate & Sound. Ring and system volumes are set to level 5.
- **Ambient** - Profile settings are set based on the surrounding environment's sound level.

The **Temporary** profile is created when changes are made by the system, for example: the user adjust the volume using the volume buttons.

Refer to [Sound Profiles on page 9-5](#) for information on creating new sound profiles.

## Power & Radio

The **Power & Radio** tab displays the current battery status and direct access to power profiles and power/radio-related options.

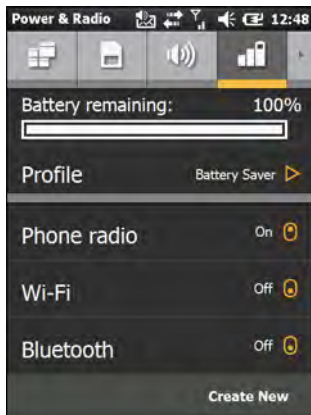

**Figure 2-18** Power & Radio Tab

The **Battery remaining** graphic displays the amount of battery power remaining in the form of a bar graph and also as a percentage.

The Profile row displays the current profile that is being used. To set a defined profile, tap **Profile**. A list of profiles appear. Select a profile from the list. A radio button appears next to the selected profile. To view the properties of a profile in the list, tap ▶ next to the profile.

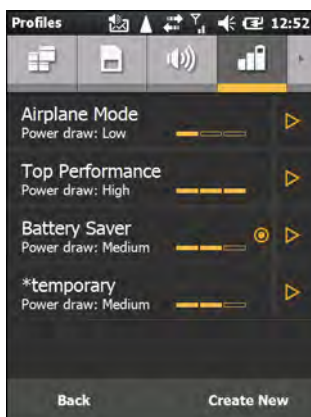

**Figure 2-19** Profiles Page

Tap **Back** to return to the **Profiles** tab.

The user can manually change the following settings (slide the display up to view more options).

- Phone radio - Turns the phone radio on or off.
- Wi-Fi - Turns the Wi-Fi radio on or off.
- Bluetooth - Turns the Bluetooth radio on or off.
- Device timeout - Sets the amount of time after inactivity that the MC65 goes into suspend mode.
- Backlight - Sets the amount of time after inactivity that the MC65 goes into suspend mode.
- Brightness - Sets the display brightness.

- ActiveSync - Set the interval between which the MC65 checks for email and calendar events.
- ActiveSync off - Set the interval between which the MC65 checks for email and calendar events.

Refer to [Power Profiles on page 9-6](#) for information on creating new profiles.

## Alarms

The **Alarms** tab controls the Windows Mobile enabled alarms.

Tap **Status Bar** > .

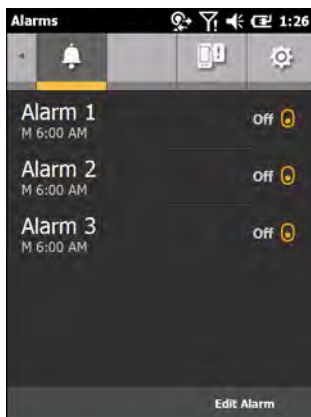

**Figure 2-20** *Alarms Tab*

To turn an alarm on or off tap the alarm name.

To change an alarm setting, tap **Edit Alarm**.

Refer to [Alarms on page 9-7](#) for information on configuring alarms.

## Fusion

The **Fusion** tab provides access to the Fusion interface.

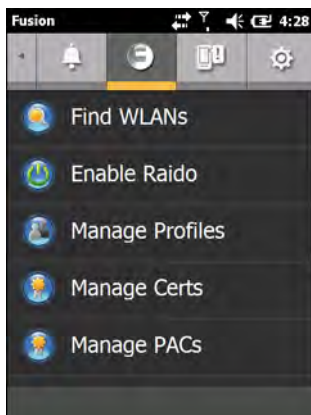

**Figure 2-21** *Fusion Tab*

Refer to [Chapter 4, Using WLAN](#) for information on using and setting up a WLAN.



## Status

The **Status** tab displays all system notifications.

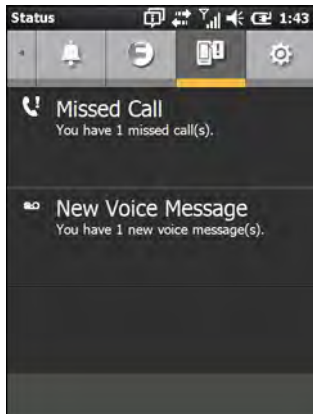
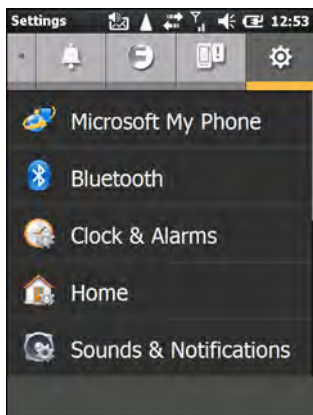

**Figure 2-22** Status Tab

Tap a notification to read the associated information.

## Settings

The **Settings** tab lists the settings applications on the MC65. Tap an item in the list to open the associated setting application or folder. Slide the list up to view more settings icons.



**Figure 2-23** Settings Tab

Refer to [Table 9-1 on page 9-1](#) for a list of setting application icons and their descriptions.

## Adjusting Volume

To adjust the system volume:

1. Press the volume buttons on the right side of the MC65 to increase and decrease the system volume. The **Volume** dialog box appears.
2. As you increase or decrease the volume, the slider moves accordingly. You can also move the slider to adjust the volume.
3. Select the **Vibrate** radio button to turn off the system audio and enable the MC65 to vibrate upon system notifications.
4. Select **Off** radio button to turn off all system audio notifications.

## Battery Status Indications

Battery icons appear on the **Status Bar** indicating the battery power level. When the battery power falls below a predetermined level the icon indicates the status and a battery dialog box appears indicating the status of the battery.

The message displays until the user taps **Dismiss**. Alternately tap the **Status Bar** to display the **Device Management** window. Tap .

## LED Indicators

The MC65 has three LED indicators. The Data Capture LED indicates status for scanning. The Charging/Battery Status LED indicates battery charging and status. The Radio Status LED indicates WWAN radio status. [Table 2-4](#) describes the LED indications.

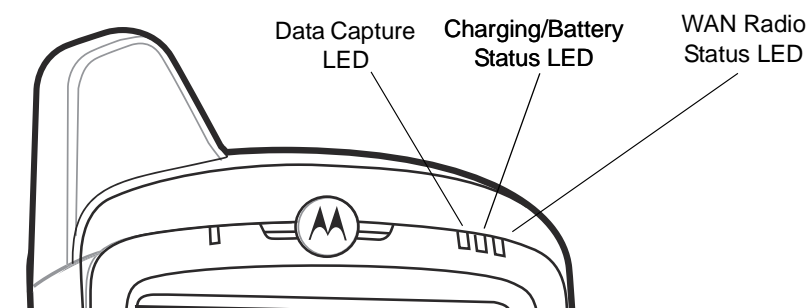

Figure 2-24 LED Indicators

Table 2-4 LED Indications

LED State	Indication
<b>Data Capture LED</b>	
Solid Green	Successful decode/capture.
Solid Red	Laser enabled, scanning/imaging in process.
Flashing Green	Software initiated notification.

**Table 2-4** LED Indications (Continued)

LED State	Indication
Solid Red (after Power button press)	MC65 is shutting down for battery replacement.
Off	Data capture not enabled.
<b>Charging/Battery Status LED</b>	
Slow Blinking Amber	Main battery in MC65 is charging.
Solid Amber	Main battery in MC65 is fully charged.
Fast Blinking Amber	Charging error.
Off	Not charging.
<b>WAN Radio Status LED</b>	
Slow Blinking Green	RF (WWAN) radio is on.
Off	RF (WWAN) radio is off.







**NOTE** For information about scanning/decoding, see [Data Capture on page 2-22](#). For information about WWAN radio status and settings, see [Chapter 3, Making Calls](#), or refer to the *MC65 Integrator Guide*.

## Resetting the MC65

A reset restarts the MC65 by closing all running programs. Data saved in flash memory or a memory card is not lost.

To perform a reset:

- On a numeric keypad, simultaneously press the red **Power** button and the  **1** and  **9** keys.
- On an alphanumeric keypad, simultaneously press the red **Power** button and the  **W** and  **C9** keys.

## Locking the MC65

The user can lock the MC65 to disable key presses and screen tap or by requiring a password to keep your data secure. Refer to [Locking the MC65 on page 9-4](#) for information on setting up device locking.



**NOTE** The user can make emergency calls even when the MC65 is locked.

The lock screen displays whenever the MC65 is locked. When the MC65 is locked, you still receive notifications of new messages, missed calls and upcoming appointments. You can also receive a call when the MC65 is locked. The MC65 locks when a time out has occurred or you lock the MC65 manually.

To manually lock the MC65 tap the lock icon in the center of the Home screen Tile bar.

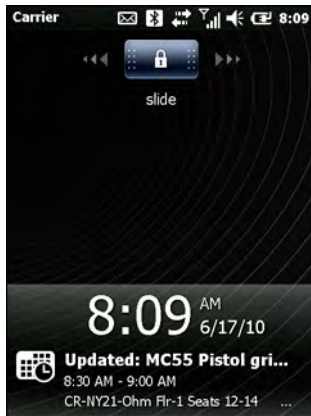

**Figure 2-25** Lock Screen

Drag  to either the right or left side of the screen.

If a password is set up, enter the password and then tap  to unlock and display the Home screen, tap  to unlock and display the Contacts window, tap  to unlock and display the Messaging window.



**Figure 2-26** Password Window

## Stylus

Use the MC65 stylus to select items and enter information. The stylus functions as a mouse.

- Tap: Touch the screen once with the stylus to press option buttons and open menu items.
- Tap and Hold: Tap and hold the stylus on an item to see a list of actions available for that item. On the pop-up menu that appears, tap the action to perform.
- Drag: Hold the stylus on the screen and drag across the screen to select text and images. Drag in a list to select multiple items.



**CAUTION** To prevent damage to the screen, do not use any device other than the Motorola-provided stylus.

---

## Entering Data

When entering data on the keypad, use either the single-hand method or the two-hand method as shown in [Figure 2-27](#).

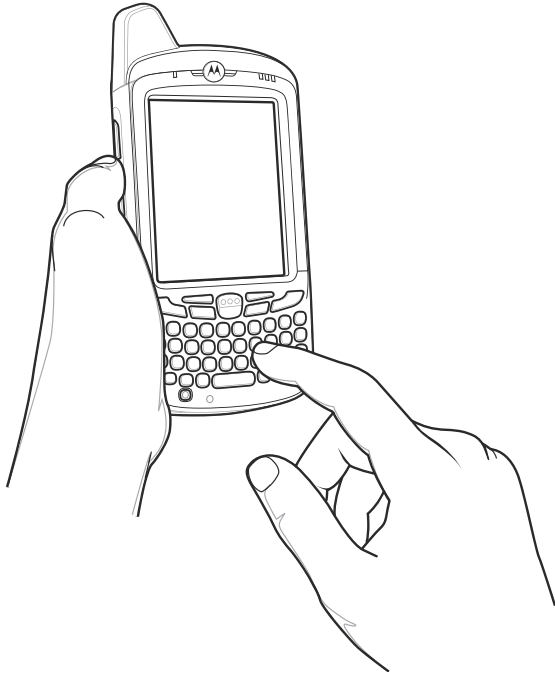

Single-hand Method

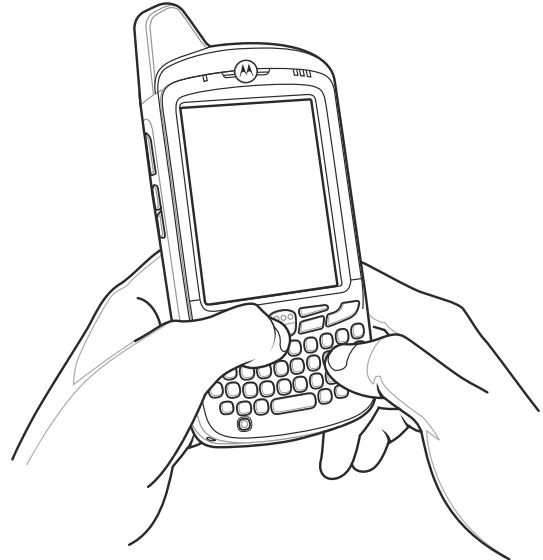

Two-hand Method

**Figure 2-27** *Entering Data on the Keypad*

---

## Data Capture

The MC65 offers two types of data capture options:

- Imaging
- Digital camera.

✓ **NOTE** To perform data capture a scanning enabled application must be installed on the MC65. A sample scanning application can be downloaded from the Motorola Support site at <http://support.symbol.com>.

## Imaging

The MC65 with an integrated imager has the following features:

- Omnidirectional reading of a variety of bar code symbologies, including the most popular linear, postal, PDF417, and 2D matrix code types.
- The ability to capture and download images to a host for a variety of imaging applications.
- Advanced intuitive laser aiming cross-hair and dot aiming) for easy point-and-shoot operation.

The imager uses digital camera technology to take a digital picture of a bar code, stores the resulting image in its memory, and executes state-of-the-art software decoding algorithms to extract the data from the image.

## Operational Modes

The MC65 with an integrated imager supports three modes of operation, listed below. Activate each mode by pressing the **Scan** button.

- **Decode Mode:** In this mode, the MC65 attempts to locate and decode enabled bar codes within its field of view. The imager remains in this mode as long as you hold the scan button, or until it decodes a bar code.

✓ **NOTE** To enable Pick List Mode, download the Control Panel applet from the Support Central web site at <http://support.symbol.com>. Pick List can also be set in an application using a API command.

- **Pick List Mode:** This mode allows you to selectively decode a bar code when more than one bar code is in the MC65's field of view. To accomplish this, move the aiming crosshair or dot over the required bar code to decode only this bar code. This feature is ideal for pick lists containing multiple bar codes and manufacturing or transport labels containing more than one bar code type (either 1D or 2D).
- **Image Capture Mode:** Use this mode to capture an image within the MC65's field of view. This is useful for capturing signatures or images of items like damaged boxes.

## Digital Camera

The MC65 with an integrated digital camera has the following features:

- Omnidirectional reading of a variety of bar code symbologies, including the most popular linear, postal, PDF417, and 2D matrix code types.
- Advanced intuitive aiming for easy point-and-shoot operation.

The camera uses digital camera technology to take a digital picture of a bar code, stores the resulting image in its memory, and executes state-of-the-art software decoding algorithms to extract the data from the image.

## Scanning Considerations

Typically, scanning is a simple matter of aim, scan, and decode and a few quick trial efforts master it. However, consider the following to optimize scanning performance:

- Range

Any scanning device decodes well over a particular working range — minimum and maximum distances from the bar code. This range varies according to bar code density and scanning device optics.

Scanning within range brings quick and constant decodes; scanning too close or too far away prevents decodes. Move the scanner closer and further away to find the right working range for the bar codes being scanned.

- Angle

Scanning angle is important for promoting quick decodes. When laser beams reflect directly back into the scanner from the bar code, this specular reflection can “blind” the scanner.

To avoid this, scan the bar code so that the beam does not bounce directly back. But don't scan at too sharp an angle; the scanner needs to collect scattered reflections from the scan to make a successful decode. Practice quickly shows what tolerances to work within.

- Hold the MC65 farther away for larger symbols.
- Move the MC65 closer for symbols with bars that are close together.

✓ **NOTE** Scanning procedures depend on the application and MC65 configuration. An application may use different scanning procedures from the one listed above.

## Imager Scanning

To read a bar code, a scan-enabled application is required. The MC65 contains the **DataWedge** application that allows the user to enable the camera, decode the bar code data and display the bar code content.

1. Enable **DataWedge**.
  - a. Tap **Start > Settings > System > DataWedge**.
  - b. Tap **Basic configuration > 1. Barcode input > 1. Block Buster Imager**.
  - c. Tap **1. Enabled**.
  - d. Tap **0. Back**.
  - e. Tap **0. Back** and then tap **OK**.
  - f. Tap **Running** to start the DataWedge process. The DataWedge Status changes to **Ready**.
  - g. Tap **OK**.
2. Launch an application that supports text inputs, such as **Word Mobile 2010** or **Excel Mobile 2010**.
3. Point the exit window on the top of the MC65 at a bar code.

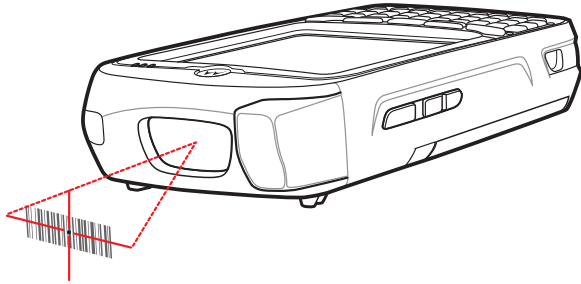

**Figure 2-28** Imager Scanning

4. Press and hold the scan button.

The red laser aiming pattern turns on to assist in aiming. Ensure the bar code is within the area formed by the brackets in the aiming pattern. The aiming dot is used for increased visibility in bright lighting conditions.

The Scan/Decode LED lights red to indicate that scanning is in process, then lights green and a beep sounds, by default, to indicate the bar code was decoded successfully. Note that when the MC65 is in Pick List Mode, the imager does not decode the bar code until the crosshair or aiming dot touches the bar code.



**Figure 2-29** Imager Aiming Pattern: Bar Code Centered



**Figure 2-30** Imager Aiming Pattern: Bar Code Not Centered



**Figure 2-31** Pick List Mode with Multiple Bar Codes in Aiming Pattern

5. Release the scan button.



**NOTE** Imager decoding usually occurs instantaneously. The MC65 repeats the steps required to take a digital picture (image) of a poor or difficult bar code as long as the scan button remains pressed.



6. Disable **DataWedge**.
  - a. Tap **Start > Settings > System > DataWedge**.
  - b. Tap the **Running** option to end the DataWedge process. The DataWedge Status changes to **Stopped**.
  - c. Tap **OK**.

## Digital Camera Scanning

To read a bar code, a scan-enabled application is required. The MC65 contains the **DataWedge** application that allows the user to enable the camera, decode the bar code data and display the bar code content.

1. Enable **DataWedge**.
  - a. Tap **Start > Settings > System > DataWedge**.
  - b. Tap **Basic configuration > 1. Barcode input > 2. Camera Scanner Driver**.
  - c. Tap **1. Enabled**.
  - d. Tap **0. Back**.
  - e. Tap **0. Back** and then tap **OK**.
  - f. Tap **Running** to start the DataWedge process. The DataWedge Status changes to **Ready**.
  - g. Tap **OK**.
2. Launch an application that supports text inputs, such as **Word Mobile 2010** or **Excel Mobile 2010**.
3. Point the camera lens on the back of the MC65 at a bar code.
4. Press and hold . A preview window appears on the display window and a red aiming line emits from the MC65. The LED lights red indicating that the data capture is in process.
5. Move the MC65 until the red aiming line is across the bar code.

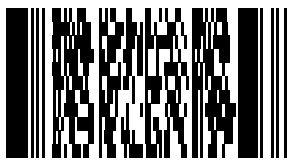

**Figure 2-32** Sample Bar Code

6. The LED lights green and a beep sounds, by default, to indicate the bar code was decoded successfully.
7. The bar code content data displays in the text field.
8. Disable **DataWedge**.
  - a. Tap **Start > Settings > System > DataWedge**.
  - b. Tap the **Running** option to end the DataWedge process. The DataWedge Status changes to **Stopped**.
  - c. Tap **OK**.

---

## Using Voice-Over-IP

The MC65 supports Voice over IP over WLAN (VoWLAN) using Motorola or third party voice clients. The MC65 can communicate using VoIP either using the MC65 supports several audio outputs, including back speaker phone, front receiver or handset, and Bluetooth headset.

It is recommended that the wireless network use the 802.11a (5 GHz) band for voice applications. Using the 5 GHz band avoids some noise sources that may occur on the 802.11b/g (2.4 GHz) band due to wireless interference.

When using a Bluetooth headset with the MC65 and VoWLAN, it is required to use the Bluetooth Headset profile instead of Hands-free profile. Use the buttons on the MC65 to answer and end calls. See [Chapter 7, Using Bluetooth](#) for information on setting up a Bluetooth Headset Profile.

# Chapter 3 Making Calls

---

## Introduction

- ✓ **NOTE** If using the Windows Mobile Dialer, refer to [Windows Mobile Dialer on page C-4](#) for information on using the dialer.

Use the MC65 to make phone calls, keep track of calls, and send text messages. Your wireless service provider may also provide other services such as voice mail, call forwarding, and caller ID.

Also use the phone to connect to an ISP or work network in order to browse the Web and read e-mail over High-Speed Packet Access (HSPA) or Evolution Data-Optimized (EvDO) using Cellular Line.

---

## Making a Call

- ✓ **NOTE** The user can make emergency calls even when the MC65 is locked or when it is not activated. See [Emergency Calling on page 3-5](#) for more information.

With the MC65, the user can make a call from the phone, contacts, and Call Log.

### Using the Phone Keypad

To make a call:

1. Press .



**Figure 3-1** Enterprise Dialer

✓ **NOTE** If the user taps a wrong number, tap the Delete key to erase each subsequent digit. To erase the entire number, tap and hold the Delete key.









2. Enter the phone number on the dialer or keypad. The number appears in the Call Line.
3. Tap the green Call Line or press .
4. Tap **Cancel** to cancel the call or tap **Speaker** to place the MC65 in speakerphone mode.
5. When the call connects, the name or number appears in the Call Line. To place the call on hold tap the Call Line. To return to the call tap the Call Line again.
6. Tap  or press  to end the call.

Table 3-1 lists the Phone dialer icons that appear below the Status bar and above the Call Line. Icons vary depending upon carrier and network.

**Table 3-1** Phone Dialer Status Icons

Icon	Description	Icon	Description
	Bluetooth headset connected.		Location disabled.
	Call Forwarding enabled.		Phone unlocked.
	Phone audio muted.		

## Smart Dialing

Smart Dialing makes it easy to dial a phone number. When the user starts entering numbers or characters, Smart Dialing automatically searches and sorts the contact entries on the SIM card, in Contacts, and the phone numbers in Call Log (including incoming, outgoing, and missed calls). You can then select the desired number or contact from the filtered list to dial.

Press keys on the MC65 keypad that correspond to the phone number or contact to call. The contact panel lists contacts that match the sequence entered.

Smart Dialing starts looking for numbers or contacts that match the sequence entered.

To find a phone number:

- Enter the first one or two digits to find a phone number in Call History.
- Enter the first three digits or more to find a phone number from the saved Contacts and SIM card.

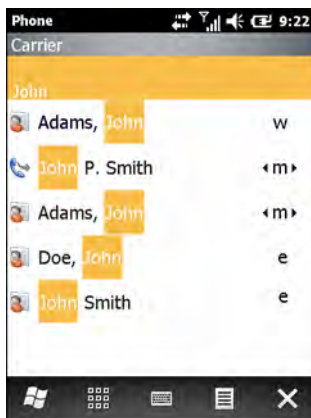

To find a contact name:

- Enter the first letter of a contact's first name or last name. Smart Dialing searches for the letter starting from the first character of a contact name as well as from any character that appears after a space, dash, or underscore in a contact name.
- If the matching list is long, narrow down the search further by entering another letter.



**Figure 3-2** Finding a Contact



To make a call or send a message using Smart Dialing:

1. Begin entering the first few numbers or characters.
2. In the **Smart Dialing** panel, use the navigation keys on the keypad to navigate to the desired contact or phone number.
3. When the correct contact is selected, press  to make a voice call.
4. To send a message to the selected contact, tap  > **Send Text Message** to send a text message or  > **Send MMS** to send an MMS message.
5. To call a different phone number associated with the selected contact, tap the contact name and select the phone number to call.

## Using Contacts

Use **Contacts** to make a call without looking up or entering the phone number.





To make a call from **Contacts**:

1. Press .
2. From the Phone shortcut, tap .
3. From the contact list, tap and hold the contact name.

4. Tap **Call Work**, **Call Home** or **Call Mobile**.

## Using Call Log

To make a call using Call Log:

1. Press .
2. From the Phone shortcut, tap .
3. Tap the contact or phone number.
4. Tap **SEND** or press .
5. Tap **Cancel** or press  to stop dialing or end the call.

---

## Answering a Call



When the MC65 receives an incoming call a dialog box appears. If the phone is set to ring, a ring tone sounds. Answer or ignore the incoming call.

To answer an incoming call tap **Answer** or press .

To ignore the incoming call, tap **Ignore**. This sends the caller to voice mail, depending on the service provider. Otherwise, this presents a busy signal to the calling party.

Tap  or press  to end the call.

## Incoming Call Features

- The user can use other programs on the MC65 during a call. To switch back to the phone, press . Press  to end the call.
- To hold the current call and answer a waiting call, tap **Answer** to place the current call on hold and answer the incoming call.
- To put a call on hold to call another number, tap **Hold**.
- To move from one call to another, tap **Swap**.

---

## Missed Call Notification

When the user does not answer an incoming call, the Home screen displays a **Missed Call** indication.

To view a missed call entry, tap the  on the **Home** screen.

---

## Emergency Calling

The service provider programs one or more emergency phone numbers, such as 911 or 999, that the user can call under any circumstances, even when the phone is locked, a SIM card is not inserted or the phone is not activated. Your service provider can program additional emergency numbers into the SIM card. However, the SIM card must be inserted in the MC65 in order to use the numbers stored on it. See the service provider for additional information.

When the keypad is locked, press the orange key twice to set the keypad to numeric mode and then enter the emergency number.

---

## Audio Modes

The MC65 offers three audio modes for use during phone calls:

- **Handset Mode:** Switches audio to the receiver at the top front of the MC65, so the user can use the MC65 as a handset. This is the default mode.
- **Speaker Mode:** Use the MC65 as if on speaker phone. Tap **Speaker** to activate this mode. Tap **Speaker** again to switch back to handset mode.
- **Headset Mode:** Connect a Bluetooth headset to automatically switch audio to the headset.

The MC65 defaults to handset mode. When a Bluetooth headset is configured for use with the MC65, the earpiece and speakerphone are muted and audio is heard through the headset.

## Using a Bluetooth Headset

You can use a Bluetooth headset for audio communication when using an audio-enabled application. See [Chapter 7, Using Bluetooth](#) for information on connecting a Bluetooth headset to the MC65. Set the MC65's volume appropriately before putting the headset on. When a Bluetooth headset is connected the speakerphone is muted.

## Adjusting Audio Volume

Use the Volume buttons to adjust the volume of the ringer when not in a call and the audio volume when in a call.



**NOTE** Adjust the conversation phone volume during a call. Adjusting the volume while not in a call affects the ring and notification sound levels.

---

## Muting a Call

During a call, the caller can mute the microphone so they can hear the person on the line but he or she cannot hear the caller. This is useful when there is conversation or background noise.

To mute or unmute a call tap **Mute** on the dialer to mute the audio. The **Mute** button becomes yellow.

## Using Call Log





Use Call Log to call someone who was recently called, or recently called in. The **Call Log** provides the time of all incoming, outgoing, and missed calls. [Table 4-1](#) lists the call Log icons that appear in the **Call Log** window.

Press  and then tap  to open the **Call Log** window.



**Figure 3-3** Call Log Window

**Table 3-2** Call Log Icons

Icon	Description
	This icon appears next to the contact information for all outgoing calls.
	This icon appears next to the contact information for all incoming calls.
	This icon appears next to the contact information for all unconnected outgoing calls.
	This icon appears next to the contact information for all missed incoming calls.

## Managing Call Log

Change views, reset the call timer, and delete calls to manage the calls stored in Call Log.

### Using the Call Log Menu

Use the **Call Log** menu to make a call, send an SMS, add to contacts and remove item from the log.

1. Press  and then tap .





**Figure 3-4** Call Log Window

2. Tap an item to call the number or tap ▶ to open the **Options** window for that item.
3. Select an applicable option from the menu.
4. Depending on the option selected, the appropriate window displays. For example, select **SMS** to display the **Text Messages** window.
5. Tap ◀ to close the **Options** window.



## Conference Calling



**NOTE** For use on GSM/UMTS networks.

Conference Calling and the number of conference calls allowed may not be available on all services. Please check with the service provider for Conference Calling availability.

To create a conference phone session with multiple people:

1. Press  to display the dialer.
2. Enter the first phone number and tap the Call Line area. When the call connects, the name or number appears in the Call Line.
3. Tap .
4. Tap . The dialer re-appears.
5. Enter the second number and tap **Send**.
6. When the call connects, the first call is placed on hold and the second call is active.

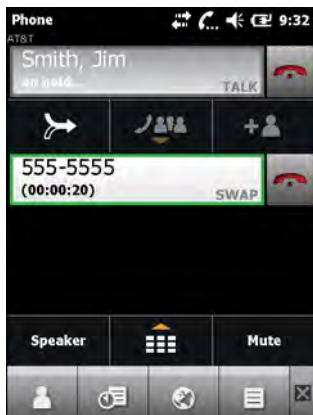

**Figure 3-5** *Two Calls*

7. Tap the Call Line 1 to make that call active. The second call go on hold.
8. Tap  to create a conference call (three callers).

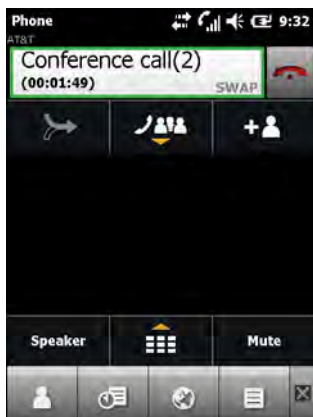

**Figure 3-6** *Two Merged Calls*

9. To add a third caller tap . The dialer appears. When the call connects the new call is active and the conference is on hold.

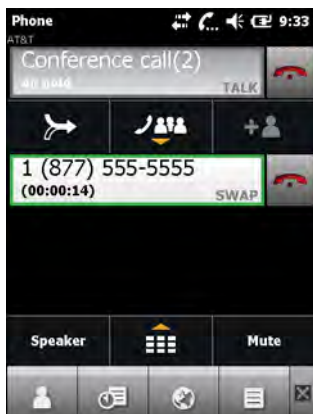

**Figure 3-7** *Adding a Third Call*

10. To add the new caller to the conference tap .

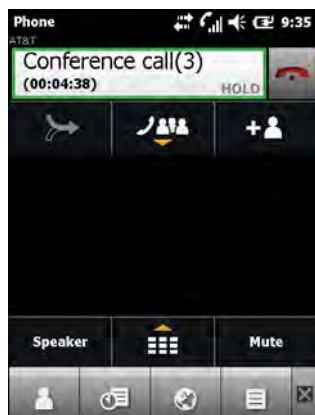

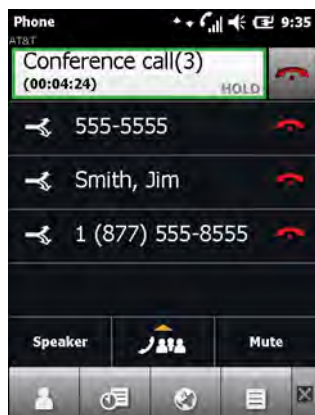

**Figure 3-8** *Three Merged Calls*

11. Tap  to view all callers.





**Figure 3-9** *Un-Merge Calls*

12. Tap  to remove a caller from the conference.

13. To end the conference call, tap  next to the Call Line.

**Calls Complete** dialog appears and then the dialer displays.

✓ **NOTE** To speak privately with one party during a conference call, tap  and then tap  next to the caller.

To include all parties again, tap .

---

## Making a 3-Way Call

✓ **NOTE** For use on CDMA networks.

3-way Calling may not be available on all services. Please check with the service provider for availability.

With 3-Way Calling, you can talk to two people at the same time. When using this feature, the normal airtime rates will be charged for each of the two calls.

1. Enter a number and press  .
2. Once you have established the connection, enter or select a number and tap **Flash**.
3. When you're connected to the second party, tap **Flash** to begin your 3-way call.

If one of the people you called hangs up during your call, you and the remaining caller stay connected. If you initiated the call and are the first to hang up, all callers are disconnected.

---

## Voice Commander

Voice Commander is a speech dialog system that provides natural human interface for users to communicate seamlessly with the MC65. Users can make phone calls, look up contact information, launch programs or check calendars. Voice Commander contains the following features:

- Eyes-free and hands-free voice command and control.
- Speaker-independent speech recognition technology, no training is required.
- Ease of use conversational user interface.
- Personal Voice Tag and Digit Model Adaptation to enhance the usability.

To initiate Voice Commander tap **Start > Toolbox > Voice Commander** or press the call button on a Bluetooth headset. The system says, "Say a Command." The user says one of the following commands:

- Call
- Find
- Redial/Callback
- Play Music
- Play
- Next/Previous
- Start
- Appointments
- Read/Call History
- What time is it?
- What can I say?
- Goodbye

## Call

To call a person by name:

1. Initiate **Voice Commander**. The MC65 responds with “Say command.”
2. Say “Call Michael Archer.” System responds with “Call Michael Archer work, is it correct?”
3. Say “Yes.” MC65 responds with “Dialing.”

To call a person at a location:

1. Initiate **Voice Commander**. The MC65 responds with “Say command.”
2. Say “Call Mary Smith at home.” The MC65 responds with “Call Mary Smith home, is it correct?”
3. Say “Yes.” The MC65 responds with “Dialing.”

To call a person with more than one phone number:

1. Initiate **Voice Commander**. The MC65 responds with “Say command.”
2. Say “Call Alex Jordan.” The MC65 responds with “Call Alex Jordan, home, work, mobile or cancel?”
3. Say “Home.” The MC65 responds with “Dialing.”

If two people have similar names:

1. Initiate **Voice Commander**. The MC65 responds with “Say command.”
2. Say “Call Halley Johnson.” The MC65 responds with “More than one Halley Johnson, please select.”
3. Select the contact intended to call.



**NOTE** **Voice Commander** automatically maintains a maximum of 2000 contacts in the recognition database. To change this setting, see [Contacts Settings on page 9-18](#).

If the command can not be recognized, **Voice Commander** prompts “Please say again.” This situation could happen under the noisy environment, or when user says command before **Voice Commander** starts recording. After hearing the prompt “Say Command”, user should wait one to two seconds to speak the command.

The recognizable contact length is 48 characters. Contacts exceeding 48 characters will be ignored.

## Find

To look up contact information:

1. Initiate **Voice Commander**. The MC65 responds with “Say command.”
2. Say “Find Mary Smith.” The MC65 responds with “Mary Smith home 5555551212.”

To look up a specific number:

1. Initiate **Voice Commander**. The MC65 responds with “Say command.”
2. Say “Find Michael Archer at work.” The MC65 responds with “Michael Archer, work, 5555551212.”

If two contacts have similar names:

1. Initiate **Voice Commander**. The MC65 responds with “Say command.”

2. Say "Find John Smith at work." The MC65 responds with "*More than one John Smith, please select.*" Voice Commander displays a window with the two contacts. (System will show both Halley Johnson and Haley Johnson for user to select.)

If a contact is not found:

1. Initiate **Voice Commander**. The MC65 responds with "*Say command.*"
2. Say "Find Michael Archer at home."
3. MC65 responds with "*Michael Archer has no home number.*"

## Redial

To re-dial a previous number:

1. Initiate **Voice Commander**. The MC65 responds with "*Say command.*"
2. Say "Redial." The MC65 responds with "Call Mary Smith at home, is it correct?"
3. Say "Yes." The MC65 responds with "*Dialing.*"

## Callback

1. Initiate **Voice Commander**. The MC65 responds with "*Say command.*"
2. Say "Callback." The MC65 responds with "Call Mary Smith at home, is it correct?"
3. Say "Yes." The MC65 responds with "*Dialing.*"

## Start

To launch an application:

1. Initiate **Voice Commander**. The MC65 responds with "*Say command.*"
2. Say "Start calendar." The MC65 responds with "*Go to Calendar.*" The **Calendar** application launches.

## Appointments

To read today's, tomorrow's or this week's appointments:

1. Initiate **Voice Commander**. The MC65 responds with "*Say command.*"
2. Say "Today's appointment." The MC65 responds with "*You have 3 appointments*" and reads the appointments.



**NOTE** User can say Previous, Next, Repeat, or Abort to control calendar reading. Voice Commander only plays the new appointments. Older appointments are ignored.

## Read

To read a text message or an email message:

1. Initiate **Voice Commander**. The MC65 responds with "*Say command.*"
2. Say "Read SMS." The MC65 responds with "*You have 3 SMS*" and reads the SMS messages.

## What time is it

To find out the time of day:

1. Initiate **Voice Commander**. The MC65 responds with “*Say command.*”
2. Say “What time is it?” The MC65 responds with “*The time is 3 p.m.*”

## Call History

To view the call history window:

1. Initiate **Voice Commander**. The MC65 responds with “*Say command.*”
2. Say “Call History.” The MC65 responds with “*Call history.*”
3. The Call history page displays.

## Voice Play Music

To play a specific music file:

1. Initiate **Voice Commander**. The MC65 responds with “*Say command.*”
2. Say “Play The Moment.” The MC65 responds with “*The Moment.*”
3. Windows Media starts to play “The Moment.”

To play all music files:

1. Initiate **Voice Commander**. The MC65 responds with “*Say command.*”
2. Say “Play music.” The MC65 responds with “*Play music.*”
3. Windows Media starts to play all music files.

To play a different music file during playing of another:

1. Initiate **Voice Commander**. The MC65 responds with “*Say command.*”
2. Say “Next.” The MC65 responds with “*Next.*”
3. Windows Media starts to play next music file.

To pause or resume a playing music file:

1. Initiate **Voice Commander**. The MC65 responds with “*Say command.*”
2. Say “Pause” or “Resume.” The MC65 pauses or resumes the playing music.



**NOTE** User can say “Pause” or “Resume” to control music playing. The command “Resume” only works when Windows Media is running. The commands “Previous” and “Next” only work when playing all music files.

**Voice Commander** only supports media files with .mp3 and .wma format. **Voice Commander** supports the music files in Playlists or Media files synced by Active Sync, in **My Documents** and its subfolder or on the microSD card and its subfolders.

## What can I say

To view the help information:

1. Initiate **Voice Commander**. The MC65 responds with “*Say command.*”
2. Say “What can I say.” The help file displays.

Alternately tap **Menu > Help** to open the help file.

## Goodbye

To exit the **Voice Commander** application, Say “Goodbye.” The MC65 responds with “*Goodbye*” and the application terminates.

**Voice Commander** can be also terminated manually by tapping **Menu > Exit**. Note that goodbye will not be accepted during voice digit dialing operation.

✓ **NOTE** **Voice Commander** automatically terminates after 10 seconds of silence.



# Chapter 4 Using WLAN

---

## Introduction

WLANs allow the MC65 to communicate wirelessly inside a building. Before using the MC65 on a WLAN, the facility must be set up with the required hardware to run the WLAN (sometimes known as infrastructure). The infrastructure and the MC65 must both be properly configured to enable this communication.

Refer to the documentation provided with the infrastructure (access points (APs), access ports, switches, Radius servers, etc.) for instructions on how to set up the infrastructure.

Once you have set up the infrastructure to enforce your chosen WLAN security scheme, use the Fusion or Wireless Zero Config (WZC) software to configure the MC65 to match.

---

## Fusion Overview

The Fusion software contains applications with which to create wireless profiles. Each profile specifies the security parameters to use for connecting to a particular WLAN as identified by its ESSID. The Fusion software also allows the user to control which profile out of a set of profiles is used to connect. Other Fusion applications allow the user to monitor the status of the current WLAN connection and to invoke diagnostic tools for troubleshooting.

To access Fusion, tap the **Status Bar** > .

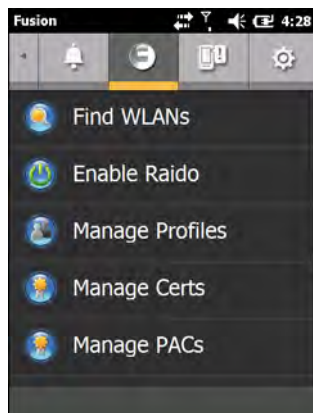

**Figure 4-1** Status - Fusion Tab

Refer to the *Wireless Fusion Enterprise Mobility Suite User Guide for Version 3.20* for detailed information on using and configuring Fusion.

To access the on-device Fusion Help tap **Status Bar** >  > **Help**.

---

## Wireless Zero Config Overview

WZC is a Microsoft wireless connection management utility that dynamically selects a wireless network to connect to based on a user's preferences and various default settings.

---

## Switching Between Fusion and WZC

To switch from Fusion to WZC:

1. Tap the **Status Bar** >  > **Options**.
2. Select **WLAN Management** from the drop-down list.
3. Select **Microsoft Manages WLAN** radio button.
4. Tap **Save**.
5. Tap **OK**.
6. Perform a reboot.

To switch from WZC to Fusion:

1. Tap the **Status Bar** >  > **Options**.
2. Select **WLAN Management** from the drop-down list.
3. Select **Fusion Manages WLAN** radio button.
4. Tap **Save**.
5. Tap **OK**.
6. Perform a reboot.

## Supported Applications

The Fusion menu items and their corresponding applications are summarized in [Table 4-1](#).

**Table 4-1** *Supported Applications*

Application	Description	Fusion Support	WZC Support
Find WLANs	Invokes the <b>Find WLANs</b> application which displays a list of the WLANs active in your area.	Yes	No
Manage Profiles	Invokes the <b>Manage Profiles</b> application (which includes the <b>Profile Editor Wizard</b> ) to manage and edit your list of WLAN profiles.	Yes	No
Wireless Zero Config	Invokes the Wireless Zero Config application to configure the WLAN.	No	Yes
Manage Certs	Invokes the <b>Certificate Manager</b> application which allows you to manage certificates used for authentication.	Yes	Yes
Manage PACs	Invokes the <b>PAC Manager</b> application which helps you manage the list of Protected Access Credentials used with EAP-FAST authentication.	Yes	No
Options	Invokes the <b>Options</b> application which allows you to configure the Fusion option settings.	Yes	Yes
Wireless Status	Invokes the <b>Wireless Status</b> application which allows you to view the status of the current wireless connection.	Yes	Yes
Wireless Diagnostics	Invokes the <b>Wireless Diagnostics</b> application which provides tools with which to diagnose problems with the wireless connection.	Yes	Yes
Log On/Off	Invokes the <b>Network Login</b> dialog which allows you to log on to a particular profile or to log off from the currently active profile	Yes	No

## Fusion Setup

To detailed setup WLAN using Fusion refer to the *Wireless Fusion Enterprise Mobility Suite User Guide for Version 3.2.0* for detailed information on using and configuring Fusion.

To setup WLAN using Fusion:

- ✓ **NOTE** Obtain the proper WLAN configuration information from your system administrator prior to performing the Fusion setup procedures.

The following setup procedure example shows setup of a WLAN using WEP encryption.

1. Tap the **Status Bar** >  > **Manage Profiles**. The **Manage Profiles** window appears.

2. Tap and hold in the window and select **Add** from the pop-up menu. The **Wireless LAN Profile Entry** window appears.
3. In the **Profile Name** text box enter a name for the profile.
4. In the **ESSID** text box enter the ESSID.

Wireless LAN Profile Entry

Profile Name:

ESSID:

1 of 6

**Figure 4-2** Profile ID Dialog Box

5. Tap **Next**. The **Operating Mode** dialog box displays.
6. In the **Operating Mode** drop-down list, select **Infrastructure** or **Ad-hoc**.

Wireless LAN Profile Entry

Operating Mode:

2 of 6

**Figure 4-3** Operating Mode Dialog Box

7. Tap **Next**. The **Security Mode** dialog box displays.
8. In the **Security Mode** drop-down list, select **Legacy (Pre-WPA)**.

Wireless LAN Profile Entry

Security Mode:

Authentication Type:

3 of 6

**Figure 4-4** Security/Authentication Dialog Box

9. In the **Authentication** drop-down list, select **None**.
10. Tap **Next**. The **Encryption** dialog box displays.
11. In the **Encryption Type** drop-down list, select **WEP-40 (40/24)**.



**Figure 4-5** Encryption Dialog Box

12. Select the **Pass-phrase** or **Hexadecimal Keys** radio button to indicate whether a pass-phrase or hexadecimal keys will be entered on the next page.
13. Select the **For added security - Mask characters entered** check box to hide characters entered. Deselect this to show characters entered.
14. Tap **Next**.



**Figure 4-6** WEP-40 WEP Keys Dialog Box

15. In the **Edit Key** drop-down list, select the key to enter.
16. In the **Key** field, enter 10 hexadecimal characters.
17. In the **Confirm** field, re-enter the key. When the keys match, a message appears indicating that the keys match.
18. Repeat for each WEP key.
19. In the **Transmit Key** drop-down list, select the key to transmit.
20. Tap **Next**. The **IPv4 Address Entry** dialog box displays.

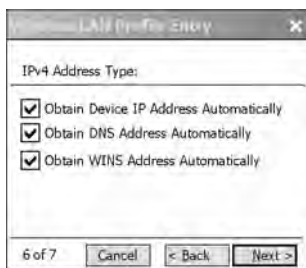

**Figure 4-7** IP Address Entry Dialog Box

21. Ensure that all three check boxes are selected.
22. Tap **Next**. The **Battery Usage** dialog box appears.

23. In the **Battery Usage Mode** dialog box select a power consumption option.

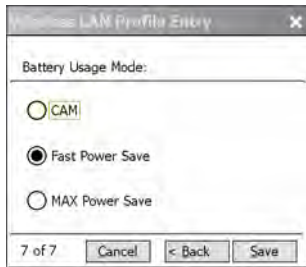

**Figure 4-8** *Battery Usage Dialog Box*

24. Tap **Save**.

---

## Wireless Zero Config Setup

To setup WLAN using WZC:

- ✓ **NOTE** Obtain the proper WLAN configuration information from your system administrator prior to performing the WZC setup procedures.

The following setup procedure example shows setup of a WLAN using WEP encryption.

1. Tap **Status Bar** >  > **Wireless Zero Config**.

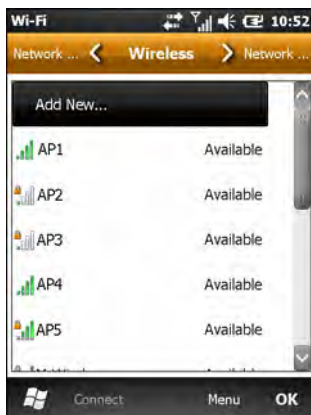

**Figure 4-9** *Wireless Zero Config Window*

2. The MC65 searches for wireless networks in the area and displays them in the window.
3. Tap a network name.



**Figure 4-10** *Configure Wireless Network Window*

4. In the **Connects to** drop-down list, select either **The Internet** or **Work**.
5. Check the **This is a hidden network** checkbox if the network is a hidden network.
6. Tap **Next**.



**Figure 4-11** *Configure Network Authentication Window*

7. In the **Authentication** drop-down list, select the authentication type.
8. In the **Data Encryption** drop-down list, select the data encryption type.
9. If **WEP encryption** is selected, enter an encryption key in the **Network key** text box.
10. Tap **Next**.



**Figure 4-12** *Configure Network Authentication Window*

11. If required, select **Use IEEE 802.1x network access control** check box.
12. In the **EAP type** drop-down list box, select the EAP type.
13. Tap **Finish**.

## More Information on WZC

For more information on Microsoft Wireless Zero Config, see the Microsoft Software Developer Network (MSDN) at <http://msdn.microsoft.com>.



# Chapter 5 Messaging

---

## Introduction

This chapter describes how to use Email, SMS Messaging and MMS Messaging.



---

## Email

Use email to send messages to other users.

### Creating an Email Message

To create an email message:

1. Press **Start > E-mail**.
2. Select an email account.
3. Tap  > **New**.
4. To add recipients, enter their email addresses, separating them with a semicolon ( ; ). Tap **To** to add email addresses stored in **Contacts**.
5. Enter a subject and compose the message.
6. To add an attachment to the message, tap  > **Insert** and tap the item you want to attach: **Picture**, **Voice Note**, or **File**.
7. Tap .





### Viewing an Email Message

To view an email message:

1. On the Home screen, tap  for an Outlook email or  for a personal email account.

2. Tap an email to open it.

## Replying to or Forwarding a Message

1. On the Home screen, tap  for an Outlook email or  for a personal email account.
2. Tap an email to open it.
3. Tap .
4. Enter your reply message, and then tap .

## SMS Messaging

Text messages allow the user to send and receive short text messages (SMS) to and from other mobile devices. The text can contain words, numbers, or an alphanumeric combination no longer than 160 characters.



### Sending a Text Message

To send a text message:

1. Press **Start** > **Text**.
2. Tap  > **New** > **SMS**.



**Figure 5-1** Create Text Message

3. Tap **To** to select a recipient from **Contacts** or enter a phone number in the address area.
4. Compose a message.
  - The auto-correct feature automatically fixes common spelling errors as the user types so that messages are more accurate.
  - The character counter, in the Status Bar, indicates the size of the message being composed.
  - Tap  > **Message Options**, then select the **Request message delivery notification** check box to request notification when the text messages is received.
5. Tap  to send the message.

If the MC65 phone feature is on, the text message is sent. If it's off, a prompt displays to turn on the phone feature. The message is saved in the **Drafts** folder and sent when the MC65 phone feature is turned on.

When outside of coverage area, the message is saved in the **Drafts** folder and sent when back in a coverage area.

## Viewing Text Messages

When an incoming text message arrives, the text notification icon appears in the **Status Bar** and the dialog box displays.

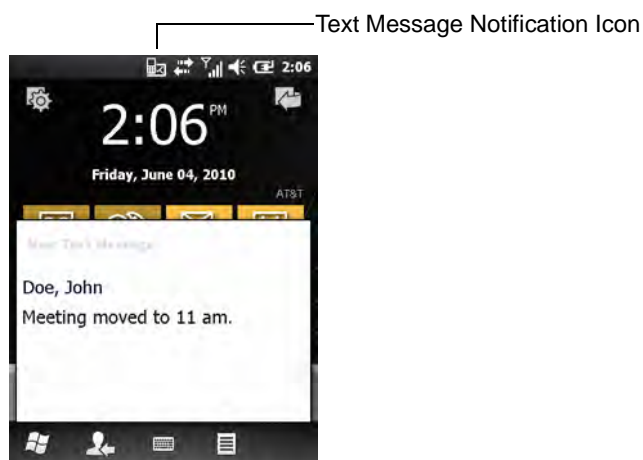
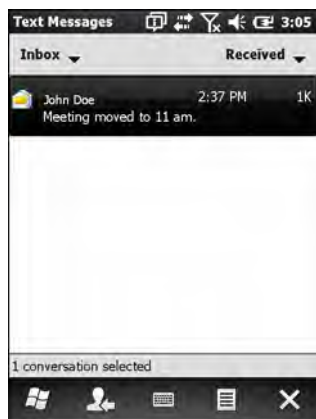

**Figure 5-2** *New Text Message Notification*

The Caller Identification feature matches incoming text message numbers with those stored in **Contacts** indicating who is sending the message. The user can act on the text message right away or read it later. Tap to reply to the message. The **New Text Message** dialog box provides the option to call the sender, or save, dismiss or delete the message. Tap **Menu** > **Delete** to delete the text message. Tap **Menu** > **Call sender** to call the sender. Tap **Menu** > **Save as read** to close the dialog box and read the text message at a later time.

To view previously received text messages:

1. Tap **Start** > **Text**.



**Figure 5-3** *Text Messages Window*

2. In the message list, tap a text message. The window displays previous text conversations.

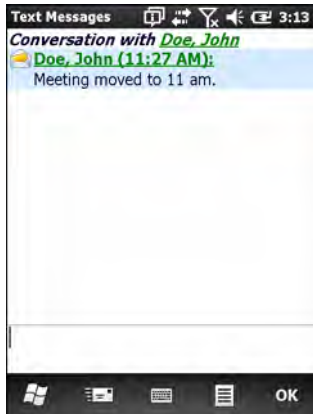



Figure 5-4 Text Message - Conversation

## Replying to an SMS Message

To reply to a text message:

1. Tap **Start > Text**.
2. In the message list, tap a text message. The window displays previous text conversations.
3. Enter text in the reply field.
4. Tap .

---

## MMS Messaging

MMS Messaging allows the user to send a pictures, videos, audio files and other file types to another mobile computer.

### Creating and Sending MMS Messages

To send an MMS message:

1. Tap **Start > Text**.
2. Tap  > **New > MMS**.

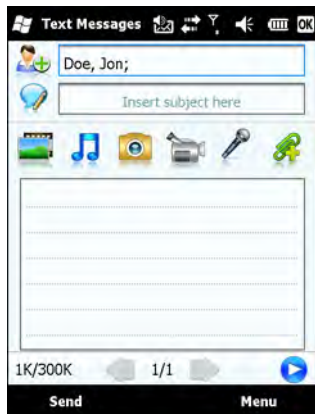

**Figure 5-5** MMS Window

3. To add a contact, tap . A window appears with a list of contacts. Select one or more contacts and then tap **Done**.
4. Tap to add a subject for the message. Enter the subject text in the window and then tap **Done**.
5. Tap in the text window to enter a text message. A window appears allowing you to add a text message plus emoticons, favorite web addresses, pre-defined text, contact information and calendar information. Tap **Done** after adding information.
6. Tap to attach a picture or video stored on the MC65 to the message.
7. Tap to attach a sound file stored on the MC65 to the message.
8. Tap to take a picture and attach it to the message.
9. Tap to capture video and attach it to the message.
10. Tap to record a message and attach it to the message.
11. Tap to add a file stored on the MC65 to the message.
12. After all of the items are attached to the message, tap **Send**.

## Viewing an MMS Message

To view an MMS message:

1. Tap **Start > Text**.
2. Tap the MMS message.
3. In the threaded message, tap the MMS icon to view the message.
4. Tap **Contents** to view a list of files included in the message.

On the **Message Contents** screen:

1. Tap **Menu > Save** to save a file.
2. Tap **Menu > Save into My Text** to save the contents of a text file to the My Text list.
3. Tap **Menu > Assign to Contact** to associate a photo to a contact.

4. Tap **Menu > Set as Ringtone** to associate a audio file as a ringtone.

## Replying to an MMS Message

To reply to an MMS message

1. Tap **Start > Text**.
2. Tap the MMS message.
3. In the threaded message, tap the MMS message to open and view an MMS message.
4. After viewing the MMS message, tap **Menu > Reply > via MMS** to reply with an MMS message or tap **Menu > Reply > via SMS** to reply with a text message.

## Blocking Incoming SMS Messages

To block incoming MMS messages from a specific sender:

1. Open and view the MMS message.
2. Tap **Menu > Show > Contact Details**.
3. Tap **Menu > Save to Blacklist**.
4. Tap **Done**.

To unblock a sender:

1. Tap **Start > Text**.
2. Tap **Menu > MMS Options > Blacklist**.
3. Tap and hold the phone number.
4. Select **Delete** from the pop up menu.
5. Tap **OK**.

# Chapter 6 Using the Camera

---

## Introduction

Use **Pictures & Videos** to take pictures and record videos and to view them on the MC65.

---

## Taking Pictures

To take a picture:

1. Tap **Start > Pictures & Videos**.
2. Tap **Camera**.

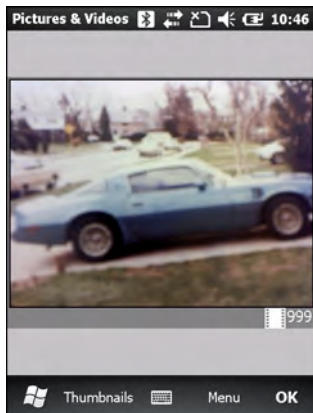

**Figure 6-1** *Camera Window*

The Camera window displays the view finder. Information about the current settings or the remaining number of pictures that can be saved to the MC65 are displayed on the lower right corner of the screen.

3. Check the image on the view finder, adjust if necessary.
4. Press the **Enter** key to take the picture.

## Burst Mode

Burst mode is a way to take a series of quick pictures.

1. Tap **Start > Pictures & Videos**.
2. Tap **Camera**.
3. Tap **Menu > Mode > Burst**.
4. Check the image on the view finder, adjust if necessary.
5. Press the **Enter** key to take the picture.

To stop a burst of pictures before all pictures have been taken tap **OK**.

## Timer Mode

To take pictures using the timer:

1. Tap **Start > Pictures & Videos**.
2. Tap **Camera**.
3. Tap **Menu > Mode > Timer**.

✓ **NOTE** By default, the self timer delay is set at five seconds.

4. Check the image on the view finder, adjust if necessary.
5. Press the **Enter** key to take the picture.

## Editing Pictures

Rotate, crop, zoom, and adjust the brightness and color contrast pictures.

1. Tap **Start > Pictures & Videos**.
2. Tap the thumbnail of the picture to view.
3. Tap **Menu > Zoom** to display the Zoom panel, used to zoom in or out of a picture. Tap **Menu > Zoom** again to close the Zoom panel.
4. To rotate a picture 90 degrees counter-clockwise, tap **Menu > Edit**, then tap **Rotate**.
5. To crop a picture, tap **Menu > Edit**, then tap **Menu > Crop**. Drag the stylus across the screen to select the crop area. Tap inside the area to crop the picture, or outside of the area to cancel cropping.

## Setting a Picture as Wallpaper

To add a custom look to the Home screen of the MC65 (using the Windows Home screen); apply a wallpaper of your choice using any image. To set an image as a Home wallpaper:

1. Tap and hold a thumbnail, then select **Set as Home Background**.
2. Tap the up or down arrows to set the transparency level.
3. Tap **OK**.



## Camera Configuration

To configure the camera settings:

1. Tap **Start > Pictures & Videos**.
2. Tap **Menu**, then configure the device settings.
  - **Video** - Tap to switch to video mode.
  - **Mode** - Select from the following modes to take the picture:
    - **Normal** - Takes picture using the default settings.
    - **Burst** - Takes picture consecutively in continuous mode.
    - **Timer** - Takes picture five seconds after pressing the **Enter** key.
  - **Brightness** - Set the camera brightness level.
  - **Resolution** - Set the camera resolution level. Note that selecting a high resolution picture increases the size of the file significantly.
  - **Flash** - Turns flash on and off.
  - **Auto Focus** - Turns auto focus on and off.
  - **Full Screen** - Toggles the viewfinder between full screen and window modes.
  - **Options** - Displays the camera options window.
3. Tap **OK** to exit.

---

## Recording a Video

To record a video:

1. Tap **Start > Pictures & Videos**.
2. Tap **Camera**.
3. Tap **Menu > Video**.

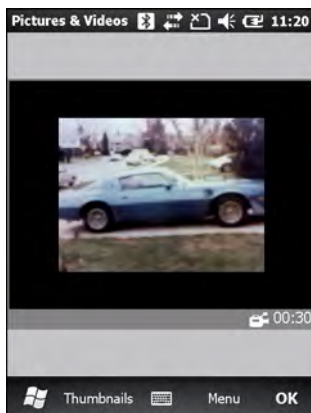

**Figure 6-2** Video Window

The available recording time displays on the screen.

✓ **NOTE** By default, the time limit for recording videos is set to 30 seconds.

4. Press the **Enter** key to begin recording.
5. Press the **Enter** key to stop recording.

## Video Configuration

To configure the video settings:

1. Launch the **Video** application.
2. Tap **Menu**, then configure the device settings.
  - Still - Tap to switch to still (camera) mode.
  - Brightness - Set the video brightness level.
  - Quality - Set the quality (video resolution and sound fidelity) and size of the video clips you record. Video clips of higher quality require more memory.
  - Full Screen - Toggles the viewfinder between full screen and window modes.
  - Options - Displays the video options window.
3. Tap **OK** to exit.

---

## Viewing Pictures and Videos

To view a picture or video:

1. Tap **Start > Pictures & Videos**.
2. Tap the thumbnail of the picture or video:
  - Tap the **Show** drop-down list to browse folders.
  - Tap the **Sort By** drop-down list to sort the files by name, date or size.



**Figure 6-3** *Pictures & Videos*

---

## Customizing Pictures & Videos

Using the **Options** command you can set preference settings on how to use **Pictures & Videos**.

To customize **Pictures & Videos**:

1. On either thumbnail or full screen mode, tap **Menu > Options**.
2. On the **General** tab, set the following options:
  - Select the size of the pictures you want to send through e-mail. Only pictures sent through an e-mail message is resized, the original picture remains unchanged.
  - Resize pictures for faster e-mail transfer.
  - Rotate pictures towards left or right.
3. On the **Slide Show** tab, set the following options:
  - Select the **Portrait pictures** or **Landscape pictures** radio button to set slide show orientation.
  - Select the **Play a screen saver when connected to my PC and idle for 2 minutes** check box to set the image files in the **My Pictures** folder as a screen saver whenever your device is connected to the USB sync cable and is idle for 2 minutes.
4. On the **Camera** tab, set the following options:
  - In the **Type filename prefix** text box, enter the prefix to be used as a default title for the image file.
  - In the **Save files to** drop-down list, select to save image files to onboard memory or built-in storage.
  - In the **Still image compression level** drop-down list, set a compression level when saving the image. The high quality setting provides the best image quality but more memory is required.
5. On the **Video** tab, set the following options:
  - Select the **Include audio when recording video files** check box to record audio along with video.
  - In the **Time limit for videos** drop-down list, set the amount of time for recording video.



# Chapter 7 Using Bluetooth

---

## Introduction

Bluetooth-equipped devices can communicate without wires, using frequency-hopping spread spectrum (FHSS) radio frequency (RF) to transmit and receive data in the 2.4 GHz Industry Scientific and Medical (ISM) band (802.15.1). Bluetooth wireless technology is specifically designed for short-range (10 meters (32.8 feet)) communication and low power consumption.

MC65s with Bluetooth capabilities can exchange information (e.g., files, appointments, and tasks) with other Bluetooth enabled devices such as printers, access points, and other Enterprise Smart Phones. To use the MC65 as a modem, create a dial-up modem connection between a computer and MC65.

---

## Adaptive Frequency Hopping

Adaptive Frequency Hopping (AFH) is a method of avoiding fixed frequency interferers, and can be used with Bluetooth voice. All devices in the piconet (Bluetooth network) must be AFH-capable in order for AFH to work. There is no AFH when connecting and discovering devices. Avoid making Bluetooth connections and discoveries during critical 802.11b communications. AFH for Bluetooth consists of four main sections:

- Channel Classification - A method of detecting an interference on a channel-by-channel basis, or pre-defined channel mask.
- Link Management - Coordinates and distributes the AFH information to the rest of the Bluetooth network.
- Hop Sequence Modification - Avoids interference by selectively reducing the number of hopping channels.
- Channel Maintenance - A method for periodically re-evaluating the channels.

When AFH is enabled, the Bluetooth radio “hops around” (instead of through) the 802.11b high-rate channels. AFH coexistence allows Motorola Enterprise Smart Phones to operate in any infrastructure.

The Bluetooth radio in this MC65 operates as a Class 2 device power class. The maximum output power is 2.5 mW and the expected range is 10 meters (32.8 feet). A definition of ranges based on power class is difficult to obtain due to power and device differences, and whether one measures open space or closed office space.



**NOTE** It is not recommended to perform Bluetooth wireless technology inquiry when high rate 802.11b operation is required.

---

## Security

The current Bluetooth specification defines security at the link level. Application-level security is not specified. This allows application developers to define security mechanisms tailored to their specific need. Link-level security occurs between devices, not users, while application-level security can be implemented on a per-user basis. The Bluetooth specification defines security algorithms and procedures needed to authenticate devices, and if needed, encrypt the data flowing on the link between the devices. Device authentication is a mandatory feature of Bluetooth while link encryption is optional.

Pairing of Bluetooth devices is accomplished by creating an initialization key that is used to authenticate the devices and create a link key for them. Entering a common PIN number in the devices being paired generates the initialization key. The PIN number is never sent over the air. By default, the Bluetooth stack responds with no key when a key is requested (it is up to user to respond to the key request event). Authentication of Bluetooth devices is based-upon a challenge-response transaction. Bluetooth allows for a PIN number or passkey that is used to create other 128-bit keys used for security and encryption. The encryption key is derived from the link key used to authenticate the pairing devices. Also worthy of note is the limited range and fast frequency hopping of the Bluetooth radios that makes long-distance eavesdropping difficult.

Recommendations are:

- Perform pairing in a secure environment
- Keep PIN codes private and don't store the PIN codes in the MC65
- Implement application-level security.

The Microsoft stack supports Smart-pairing. For detailed information, refer to the Microsoft MSDN.

---

## Bluetooth Configuration

The following services are supported:

- OBEX Object Push Services
- Hands-Free Audio Gateway Services
- Serial Port Services
- Personal Area Networking Services
- PBAP Services
- Dial-Up Networking Services
- HID Client Services
- A2DP/AVRCP Services
- File Transfer profile
- General Audio/Video Distribution Profile
- SIM Access Profile
- Headset Profile
- Generic Object Exchange Profile
- Service Discovery Access profile
- Generic Access Profile.

COM ports COM2, COM3, COM4, and COM7 are available unless being used by another service (MSR uses COM2).

---

## Bluetooth Power States

### Suspend

When there is an active Bluetooth connection, the Bluetooth radio goes into low power mode maintaining the active connection.



**NOTE** If there is an active Bluetooth connection between the MC65 and another Bluetooth device and there is no data activity, the MC65 will timeout. However, if the user presses the Power button on the MC65, the MC65 will suspend (except when on a call) and upon receiving data from a remote Bluetooth device, the MC65 will wake from suspend mode. For example, headset redial or Bluetooth scanner sending data to the MC65.

### Resume

When the MC65 resumes, Bluetooth turns on if it was on prior to suspend.

---

## Turning Bluetooth On and Off

Turn off the Bluetooth radio to save power or if entering an area with radio restrictions (e.g., an airplane). When the radio is off, other Bluetooth devices cannot see or connect to the MC65. Turn on the Bluetooth radio to exchange information with other Bluetooth devices (within range). Communicate only with Bluetooth radios in close proximity.

✓ **NOTE** To achieve the best battery life turn off radios not in use.

### Enabling Bluetooth

To enable Bluetooth:

1. Tap **Status Bar** >  > **Bluetooth** > **Mode**.



**Figure 7-1** Bluetooth Mode Tab

2. Check the **Turn On Bluetooth** checkbox.
3. Tap **OK**.

### Disabling Bluetooth

To disable Bluetooth:

1. Tap **Status Bar** >  > **Bluetooth** > **Mode**.
2. Un-check the **Turn On Bluetooth** checkbox.
3. Tap **OK**.

---

## Discovering Bluetooth Device(s)

The MC65 can receive information from discovered devices without pairing. However, once bonded, the MC65 and a paired device exchange information automatically when the Bluetooth radio is on.

To find Bluetooth devices in the area:

1. Ensure that Bluetooth is enabled on both devices.



2. Ensure that the Bluetooth device to discover is in discoverable and connectable modes.
3. Ensure that the two devices are within 32.8 feet (10 meters) of one another.
4. Tap **Status Bar** >  > **Bluetooth** > **Devices**.



**Figure 7-2** *Bluetooth - Devices Tab*

5. Tap **Add new device**. The MC65 begins searching for discoverable Bluetooth devices in the area.
6. Select a device from the list.



**Figure 7-3** *Select a Bluetooth Device*

7. Tap **Next**. The **Enter Passcode** window appears.



**Figure 7-4** *Enter Passcode*

8. Enter the Passcode on the other device. The device is added to the Bluetooth list.

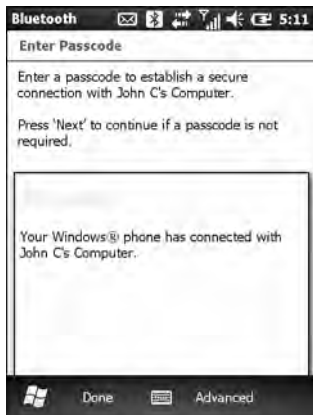

**Figure 7-5** *Bluetooth Connection Confirmation*

The user is prompted to enter a passcode. If the device has a specific passcode, enter it in the Passcode field and tap **Next**. If the device does not have a specific passcode, enter a passcode in the Passcode field and tap **Next**. The Bluetooth radio tries to connect with the device.

9. If the user created a passcode, the user is prompted by the other device to enter the same passcode. Enter the created passcode to establish a paired connection. (If the user entered a passcode from the device, the user shouldn't have to do anything on the other device.)
10. When the connection is complete, a list of matching and supported services on the device appears.
11. Select the services you want to use and tap **Finish**. The services on the new devices have to be selected or else the pairing won't include those services, even though the devices are paired. If services are not selected, the user is continually reprompted for the passcode from the device.
12. The device appears in the list on the main window.

After the passcodes have been accepted on both sides, a trusted (“paired”) connection is established.

## Available Services

✓ **NOTE** Some devices might not require a PIN. This depends upon the device's authentication.

The MC65 with Microsoft Bluetooth stack offers the following services:

- OBEX Object Push Services via Beam
- Hands-Free Audio Gateway Services
- Serial Port Services
- Personal Area Networking Services
- PBAP Services
- Dial-up Networking
- HID Client
- A2DP/AVRCP.

See the following sections for information on these services.

### Object Push Services via Beam

✓ **NOTE** The user can only send files to a remote device using the Beam function.

Use the OBEX Push Service to send files and contacts to another Bluetooth device. To transfer files between the MC65 and another Bluetooth enabled device:

1. Ensure that Bluetooth is enabled and discoverable on both devices.
2. Ensure that the two devices are within 32.8 feet (10 meters) of one another.
3. Tap **My Apps > File Explorer**.
4. Navigate to the file to transfer.
5. Tap and hold on the filename until the pop-up menu appears.

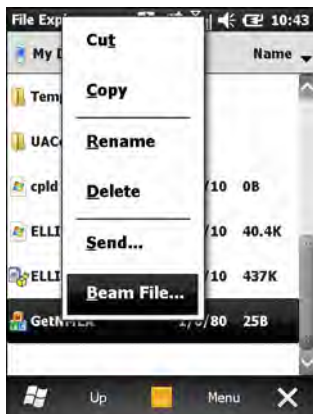

**Figure 7-6** File Explorer Window

6. Select **Beam File**. The MC65 searches for Bluetooth devices in the area.
7. Tap **Tap to send** next to the Bluetooth device to send the file to. The MC65 communicates with the device and sends the file. When completed, **Tap to send** changes to **Done**.

To transfer a contact between the MC65 and another Bluetooth enabled device:

1. Ensure that Bluetooth is enabled and discoverable on both devices.
2. Ensure that the two devices are within 32.8 feet (10 meters) of one another.
3. Tap **Contacts**
4. Navigate to the contact to transfer.
5. Tap and hold on the contact until the pop-up menu appears.
6. Select **Send Contact > Beam**. The MC65 searches for Bluetooth devices in the area.
7. Tap **Tap to send** next to the Bluetooth device. The MC65 communicates with the device and sends the contact. When completed, **Tap to send** changes to **Done**.

## Internet Sharing

Internet Sharing allows the user to connect a computer or laptop to the MC65 and use the MC65 as a modem to connect to an office network or ISP.

To use MC65 as a modem using Bluetooth:

1. Ensure that the device is not connected to the computer or laptop.
2. On the MC65, ensure that the Phone is on and a data connection is configured.
3. Tap **Start > Internet Sharing**.
4. In the **PC Connection** list, select **Bluetooth PAN**.
5. In the **Network Connection** list, select the connection type.  
Select the network connection that the device should use to connect to the Internet.
6. Tap **Connect**.
7. On the computer or laptop, setup a Bluetooth PAN with your device.
  - a. Select **Start > Control Panel > Network Connections**.
  - b. Under **Personal Area Network**, select **Bluetooth Network Connection**.
  - c. Right-click on **Bluetooth Network Connection** and select **View Bluetooth** network devices.
  - d. In the **Bluetooth Personal Area Network Devices** window select your device.
  - e. Click **Connect**. The computer connects to the device via Bluetooth.

✓ **NOTE** If your computer is Bluetooth-enabled and you select Bluetooth as the PC connection, you must initiate and complete the Bluetooth PAN partnership before Internet Sharing will work. For more information, refer to Windows Help and Support.

8. To verify, on the computer, launch **Internet Explorer** and open a web site.
9. To end dial-up networking, on the MC65 tap **Disconnect**.

## Hands-free Services

To connect to a Bluetooth headset:



**NOTE** Newer Bluetooth headsets are device dependant and remember the last device they connected to. If problems occur while connecting to the headset, place the headset in discovery mode. Refer to the headset user manual for more information.

Only WAN audio and Voice Commander audio is routed to the headset. System audio is still emitted through the MC65 speaker.

You can accept calls and re-dial using the Hands-free profile.

Hands-free profile does not support 3-way calling.

1. Ensure that Bluetooth is enabled and discoverable on both devices.
2. Ensure that the two devices are within 32.8 feet (10 meters) of one another.
3. Tap **Start > Settings > Bluetooth > Devices**.
4. Tap **Add new device**. The MC65 searches for Bluetooth devices in the area.
5. Select the headset name and tap **Next**. The Passcode window appears.
6. Enter the headset's passcode, if required.
7. Tap **Next**. The MC65 connects to the headset. Refer to the headset user manual for instructions on communicating with a Bluetooth device.

## Serial Port Services

Use the wireless Bluetooth serial port connection similar to a physical serial cable connection. Configure the application that will use the connection to the correct serial port.

To establish a serial port connection:

1. Ensure that Bluetooth is enabled and discoverable on both devices.
2. Ensure that the two devices are within 32.8 feet (10 meters) of one another.
3. Tap **Start > Settings > Bluetooth > Devices**.
4. Tap **Add new device**. The MC65 begins searching for discoverable Bluetooth devices in the area.
5. Select a device from the list.
6. Tap **Next**. The **Enter Passcode** window appears.
7. Enter the Passcode and the tap **Next**. The device is added to the Bluetooth list.
8. In the device list, tap the serial device. The **Partnership Settings** window displays.
9. Select the **Serial Port** checkbox.
10. Tap **Save**.
11. Tap **COM Ports** tab.
12. Tap **New Outgoing Port**. The add device window appears.

13. Select the serial device in the list and then tap **Next**.
14. Select a COM port from the drop-down list.
15. Tap **Finish**.

✓ **NOTE** No connection is made at this point. An application must open the selected COM port to trigger Microsoft Bluetooth stack to open the connection.

## ActiveSync Using Bluetooth

Use the wireless Bluetooth serial port connection for ActiveSync similar to a physical USB cable connection. Configure the application that will use the connection to the correct serial port.

To set up a Bluetooth ActiveSync connection:

✓ **NOTE** For additional security, disable network bridging on the computer (specifically, bridging to a Remote NDIS adapter) before connecting to the computer to pass through to the Internet or a network. For more information on network bridging, see **Windows Help** on your computer.

The instructions below are for computers that support the Windows XP SP2 or later version operating system.

1. Ensure that Bluetooth is enabled and discoverable on both devices.
2. Ensure that the two devices are within 32.8 feet (10 meters) of one another.
3. On the computer, click **Start > Settings > Control Panel**.
4. Double-click **Bluetooth Devices**.
5. On the **Options** tab, select the **Turn discovery on** and **Allow Bluetooth devices to connect to this computer** checkboxes.

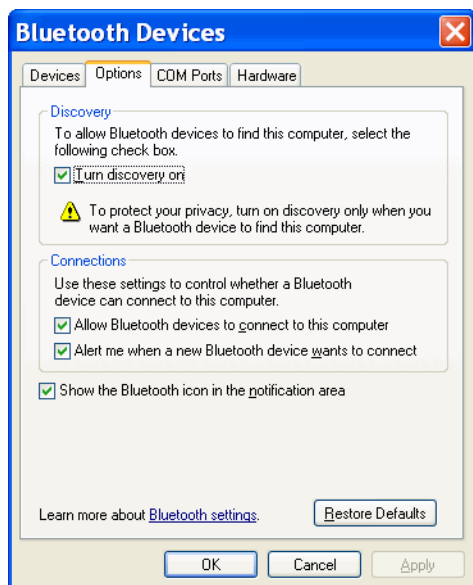

**Figure 7-7** Computer Bluetooth Devices Window

6. On the **COM Ports** tab, click **Add**.

7. Select the **Incoming (device initiates the connection)** option, then click **OK**.  
Note the number of the COM port that was added.
8. Click **OK**.
9. Click **Start > All Programs > Microsoft ActiveSync**.
10. Click **File > Connection Settings**.



**Figure 7-8** ActiveSync Connection Settings

11. On the **Allow connections to one of the following** drop-down list, select the COM port with the number you noted earlier.
12. On the MC65, tap **Start > ActiveSync**.
13. Tap **Menu > Connect via Bluetooth**.  
Synchronization is automatically initiated.  
  
If an Authentication is required, the **Enter Passcode** screen appears, type an alphanumeric passkey (PIN code), then tap **Next**; enter the same passkey on the other device.  
  
The passkey is recommended for enhanced security. The passkey must be between 1 to 16 alphanumeric characters.  
  
If a passkey is not required, tap **Next**.
14. To disconnect the ActiveSync connection, tap **Start > ActiveSync**.
15. Tap **Disconnect**.

## Phone Book Access Profile Services

Phone Book Access profile (PBAP) is used to synchronize contacts between a remote device and the MC65. To establish an PBAP synchronization:

1. Ensure that Bluetooth is enabled and discoverable on both devices.
2. Ensure that the two devices are within 32.8 feet (10 meters) of one another.
3. Tap **Start > Settings > Bluetooth > Devices**.
4. Tap **Add New Device**. The MC65 searches for a Bluetooth device, such as a car kit.
5. Select a device from the list.

6. Tap **Next**. The **Enter Passcode** window appears.
7. Enter the Passcode and the tap **Next**. The device is added to the Bluetooth list.
8. A dialog box appears requesting to transfer contacts to the car kit.
9. Select **Yes** or **No**.
10. If **Yes** is selected, contacts from the MC65 are transferred to the car kit.

## Dial-Up Networking Services

Dial-up networking allows the user to connect a PC or laptop to the MC65 and use the MC65 as a modem to connect to an office network or ISP.

Before setting up dial-up networking, obtain dial-up information and other necessary settings (username, password and domain name, if required) for the office network or ISP. To create a new Bluetooth connection:

1. Ensure the MC65 is discoverable and connectable.
2. On the PC or laptop, set up Bluetooth according to the manufacturer's instructions.
3. On the PC or laptop Bluetooth software, search for the MC65 and select the Dial-up Networking service.
4. Using dial-up software on the PC or laptop, connect to the MC65.
5. The MC65 phone function dials the ISP number and connects to the ISP.
6. To verify, on the PC or laptop, launch Internet Explorer and open a web site.

## Connect to a HID Device

The MC65 can connect to an Human Interface Device (HID) device such as a Bluetooth keyboard or mouse:

1. Ensure that Bluetooth is enabled on both devices.
2. Ensure that the Bluetooth device to discover is in discoverable and connectable modes.
3. Ensure that the two devices are within 10 meters (32.8 feet) of one another.
4. Tap **Start > Settings > Bluetooth > Devices**.
5. Tap **Add new device**. The MC65 begins searching for discoverable Bluetooth devices in the area.
6. Select a HID device from the list.
7. Tap **Next**. The **Enter Passcode** window appears. Refer to the device's User Manuals for more information.
8. Tap **Connect**. The MC65 connects to the HID device.

## A2DP/AVRCP Services

A2DP/AVRCP is used to connect to a high-quality stereo headset:

1. Ensure that Bluetooth is enabled on both devices.
2. Ensure that the Bluetooth device to discover is in discoverable and connectable modes.
3. Ensure that the two devices are within 10 meters (32.8 feet) of one another.



4. Tap **Start > Settings > Bluetooth > Devices**.
5. Tap **Add new device**. The MC65 begins searching for discoverable Bluetooth devices in the area.
6. Select a stereo headset from the list.
7. Tap **Next**. The **Enter Passcode** window appears. Refer to the device's User Manuals for more information.
8. Tap **Connect**. The MC65 connects to the stereo headset.

For stereo headsets that can use hands-free services, connect to the hands-free service after connecting to the A2DP service:

1. Tap **Start > Settings > Bluetooth > Devices**.
2. Tap **Add new device**. The MC65 begins searching for discoverable Bluetooth devices in the area.
3. Select a stereo headset from the list.
4. Tap **Next**. The **Enter Passcode** window appears. Refer to the device's User Manuals for more information.
5. Tap **Connect**. The MC65 connects to the stereo headset.



# Chapter 8 Using GPS Navigation

---

## Introduction

The MC65 includes Global Positioning System (GPS) technology. GPS technology is based on a worldwide system of GPS satellites orbiting the earth that continuously transmit digital radio signals. These radio signals contain data on the satellites' locations and their exact clock time and are used to determine your location on the earth.



**WARNING!** When using the MC65 in a vehicle, it is the user's responsibility to place, secure and use in a manner that will not cause accidents, personal injury or property damage or obstruct their view. It is the responsibility of the driver to operate the vehicle in a safe manner, maintain observation of all driving conditions at all times, and not become distracted by the device to the exclusion of safe driving practices. It is unsafe to operate the controls of the device while driving.

---

## Software Installation

Third-party GPS navigation software is required. Evaluation software is available from various suppliers. For example; VisualGPS, visit: <http://www.visualgps.net/VisualGPSce/>

If interested in purchasing GPS navigation software check with the GPS software vendor (before purchasing, downloading, or installing any software) to determine that the application is compatible with the MC65. Refer to the application's user guide for application installation and setup information.

---

## MC65 GPS Setup

The GPS-enabled MC65 automatically manages access to the GPS receiver to allow multiple programs to simultaneously access GPS data.

By default, the MC65 has the following settings:

1. Tap **Start > Settings > System > External GPS**.
2. In the **Programs** tab, the **GPS program port** is set to **COM6**.
3. In the **Hardware** tab, the **GPS hardware port** is set to **None**.

---

## Operation

Acquiring satellite signals may take several seconds to a few minutes. It is best to be outside and have a clear, unobstructed view of the sky. Without a clear view, acquisition takes much longer and could result in the MC65 being unable to compute the initial position quickly. When operating the device indoors access to the GPS signals may be limited or unavailable.

- ✓ **NOTE** When using a GPS navigation application, ensure that the MC65 does not go into suspend mode. If the MC65 suspends then the power to the GPS radio is removed. Upon resume the GPS receiver must reacquire a valid GPS signal, resulting in a delay of positional information.

### GPS Maps on microSD Cards

GPS navigation software vendors may sell maps on microSD cards. If using a microSD card with the GPS navigation software install the microSD memory card using procedure in [Installing a microSD Card on page 1-2](#).

### Answering a Phone Call While Using GPS

If receiving an incoming phone call while using your GPS navigation software:

1. Answer the phone call by pressing the **Answer** button.
2. Once the phone call ends, press the **End Call** button to resume the audio on the GPS software.

- ✓ **NOTE** Anytime using GPS on the MC65 and you receive a phone call, the audio on the GPS navigation software is muted until you finish the call.

### Losing the GPS Signal While in a Vehicle

GPS performance on the MC65 may be affected if the vehicle has thermal glass windows and windshields, which can block the MC65 from receiving a GPS signal from satellites. To improve GPS signal strength, place the MC65 where there is a clear view of the sky. A direct line of sight is required between the MC65 and the GPS satellites to access information from the satellites.

---

## Assisted GPS

GPS can be used in stand-alone or Assisted GPS (A-GPS) modes. A Stand-alone GPS receiver downloads data from GPS satellites. In certain environments, it can take several minutes to get a fix. By using GPS Location servers, A-GPS dramatically reduces the TTFF (Time To First Fix) and improves the sensitivity of GPS receivers by providing them with data that they would ordinarily have to download from the GPS satellites. With the A-GPS data, GPS receivers can operate faster and more reliably.

The **GPS Assist** application provides the ability to modify the settings associated with obtaining GPS data.

Tap **Start > Settings > Connections > GPS Assist**.

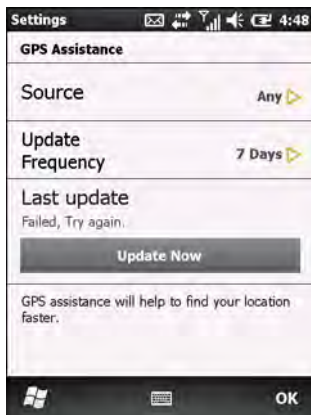

**Figure 8-1** *GPS Assistance Window*

To set the source of the data tap **Source** and select one of the options: **WAN** (default), **WLAN**, **Active Sync**, **Any**, **None**.

To set the frequency of updating the data tap **Update Frequency** and select one of the options: **On Demand** (default), **1 Day**, **2 Days**, **4 Days**, **7 Days**.

To manually update the data tap the **Update Now** button.



# Chapter 9 Settings









## Introduction

This chapter provides information for customizing the MC65.

















## Settings Folder

[Table 9-1](#) lists setting applications pre-installed on the MC65. Tap **Status Bar** >  or tap **Start** > **Settings** to open the **Settings** tab.

**Table 9-1** *Setting Applications*















Icon	Name	Description	Icon	Name	Description
	Bluetooth	Turn on Bluetooth, set the MC65 to visible mode and scan for other Bluetooth devices in the area.		Lock	Set a password for the MC65.
	Clock & Alarms	Set the device clock to the date and time of your locale. Alarms can also be set at specified days and times of a week.		Power	Check battery power and set the time-out for turning off the display to conserve battery power.
	Home	Customize the appearance of the Home screen and the information to display on it.		Sounds & Notifications	Enable sounds for events, notifications, and more, and set the type of notification for different events.
	Connections Folder	Contains connection setting applications.		System Folder	Contains system setting applications.

**Table 9-1** *Setting Applications (Continued)*

Icon	Name	Description	Icon	Name	Description
	Personal Folder	Contains personal setting applications.		Microsoft My Phone	Synchronizes the phone's contacts, calendar, tasks, text messages, music, photos, videos and other documents with your My Phone account at <a href="http://www.microsoft.com">www.microsoft.com</a> .
<b>Connections Folder</b>					
	Beam	Set the MC65 to receive incoming IrDA beams.		Domain Enroll	Make your device an AD domain member for device management and security.
	Connections	Set up one or more types of modem connections for your device, such as phone dial-up, cellular, Bluetooth, and more, so that the MC65 can connect to the Internet or a private local network.		Phone Network Setup	Configure the MC65 network.
	GPS Assist	Modify the settings associated with using other data sources to aid in finding a location.		USB Connect	Configure USB communication port. Refer to <i>MC65 Integrator Guide</i> .
	Wi-Fi	Setup wireless network connection and customize settings.		Wireless Manager	Enables or disables the MC65's wireless radios and customizes Wi-Fi, Bluetooth and Phone settings.
<b>Personal Folder</b>					
	Buttons	Assign a program to a button.		Owner Information	Enter personal information on the MC65.
	Phone	Configure the phone.		Dialer Switcher	Switches between the Microsoft dialer and the Enterprise Dialer.
	Voice Commander Settings	Configure the Voice Commander application.			
<b>System Folder</b>					
	About	View basic information such as the Windows Mobile® version and type of processor used on the MC65.		Accelerometer	Configure how the MC65 behaves. Refer to <a href="#">Accelerometer on page 9-8</a> .



**Table 9-1** *Setting Applications (Continued)*

Icon	Name	Description	Icon	Name	Description
	Backlight & Keylight	Set backlight and keylight settings. Refer to <a href="#">Backlight and Keylight Settings on page 9-7</a> .		Certificates	See information about certificates installed on the MC65.
	Customer Feedback	Submit feedback on the Windows Mobile 6 software.		Encryption	Allow files on a storage card to be encrypted. Encrypted files are readable only on your device.
	External GPS	Set the appropriate GPS communication ports, if required. Refer to <a href="#">MC65 GPS Setup on page 8-1</a> .		Error Reporting	Enable or disable the Microsoft's error reporting function.
	Device Information	Displays the MC65's software and hardware information.		Memory	Check the device memory allocation status and memory card information and stop currently running programs.
	Managed Programs	Displays the programs that were installed on the MC65 using Mobile Device Manager.		Regional Settings	Set the regional configuration to use, including the format for displaying numbers, currency, date, and time on the MC65.
	Screen	Change the screen orientation, re-calibrate the screen, and change the screen text size.		Remove Programs	Remove programs that you installed on the MC65.
	Task Manager	Stop running programs.		System Info	Obtain system information.
	<b>DataWedge</b>	Enable data capture using the camera or imager.			

---

## Locking the MC65

Use the **Password** window to set a password to disable unauthorized access to the MC65.

✓ **NOTE** If the device is configured to connect to a network, use a strong (difficult to figure out) password to help protect network security. Password cracking tools continue to improve and the computers used to crack passwords are more powerful than ever.

1. Tap the **Start > Settings > Lock > Password**.
2. Select **Prompt if device unused for** check box to enable password protection.
3. From the drop-down list, select a time value for the protection to take affect after non-use.
4. From the **Password type:** drop-down list, select either **Simple PIN** or **Strong alphanumeric**.
5. For a simple password, enter a four-digit password in the **Password** field.  
For a stronger password:
  - a. Enter a seven character password in the **Password:** field. A strong password must contain at least seven characters and contain at least three of the following: uppercase and lowercase letters, numerals, and punctuation.
  - b. Re-enter the password in the **Confirm:** field.
6. Tap **OK**.

---

## Switching the Dialer

The MC65 provide an Enterprise Dialer user interface and the standard Microsoft interface.

To switch between the Enterprise Dialer and the Microsoft Dialer:



1. Tap **Start > Settings > Personal > Dialer Switcher**.
2. Select either **Enterprise Dialer** or **Microsoft Dialer**.
3. Tap **Save**.
4. Tap **OK**. The MC65 reboots.

## Device Management

The **Device Management** window provides quick and easy access to common settings and related options. The Device Management Window is accessed by tapping anywhere on the **Status Bar**.

### Sound Profiles

To create a new sound profile or to edit a custom profile:

1. Tap **Status Bar** > .
2. Tap  next to a custom profile or tap **Create New** to create a new profile.

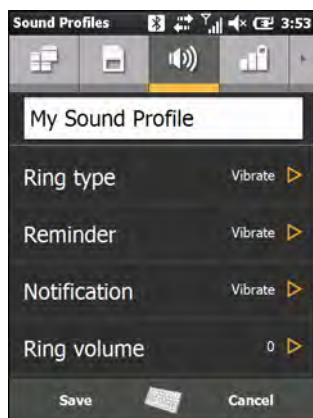

**Figure 9-1** *Sound Window*



3. Edit or enter a new name for the profile in the text box.
4. Select each feature listed and select an available option.
  - **Ring type** - Set the type of ring that occurs when an incoming call is received.
  - **Reminder** - Set the type of ring that occurs when a MC65 generates a reminder.
  - **Notification** - Set the type of ring that occurs when a notification is received.
  - **Ring volume** - Set the volume of the ring.
  - **System volume** - Set the volume of the system audio.
  - **Ringtone** - Set the ringtone for an incoming call.
5. Tap **Save**.

To delete a custom sound profile:

1. Tap  next to the custom profile.
2. Tap **Delete Profile** and then tap **OK**.

## Power Profiles

To edit a power profile:

1. Tap **Status Bar** > .
2. Tap  next to the current profile.
3. Tap  next to a profile to edit or tap **Create New** to create a new profile.

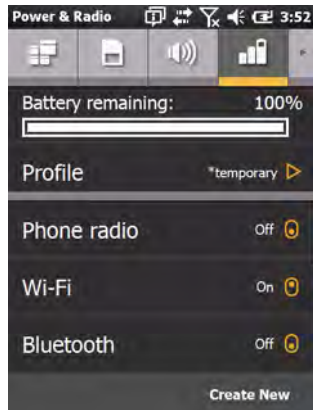

**Figure 9-2** *Edit Profile Window*

4. Edit or enter a new name for the profile in the text box.
5. For each radio, tap the name to toggle the value to **On** or **Off**.
  - Phone radio
  - Wi-Fi
  - Bluetooth.
6. Scroll down to view more options.
7. Tap the option to select each feature listed and select an available option.
  - **Device timeout** - Sets the amount of time after inactivity that the MC65 goes into suspend mode.
  - **Backlight** - Sets the amount of time after inactivity that the MC65 goes into suspend mode.
  - **Brightness** - Set the screen brightness to automatic or manual. If selecting manual, set the brightness level using the slider.
  - **ActiveSync** - Set the amount of time that the MC65 checks for email and calendar events.
  - **ActiveSync Off** - Set the amount of time that the MC65 checks for email and calendar events.
8. Tap **Save**.

## Alarms

To use the MC65 as a clock:

1. Tap the **Status Bar** >  > **Edit Alarm**.
2. Tap one of the three alarm rows.
3. Use the time field up and down arrows to set the time.
4. Highlight the **Description** field, then enter a name for the alarm.
5. Tap the letter(s) representing the day(s) of the week to enable the alarm.
6. From the drop-down list, select the sound that plays when the alarm starts. Tap **Play** to listen to the alarm sounds and tap **Stop** to cancel playback.
7. From the drop-down list, select the repeat sound notification type.
8. Tap **OK**.
9. Set up to two more alarms.
10. Select the checkbox to enable the alarm sound even when the MC65 is set to silent or vibrate.
11. Tap **OK**.

## Backlight and Keylight Settings

The display brightness settings provides the ability to automatically detect the brightness in a specific environment.

Tap **Start** > **Settings** > **System** > **Backlight & Keylight**.

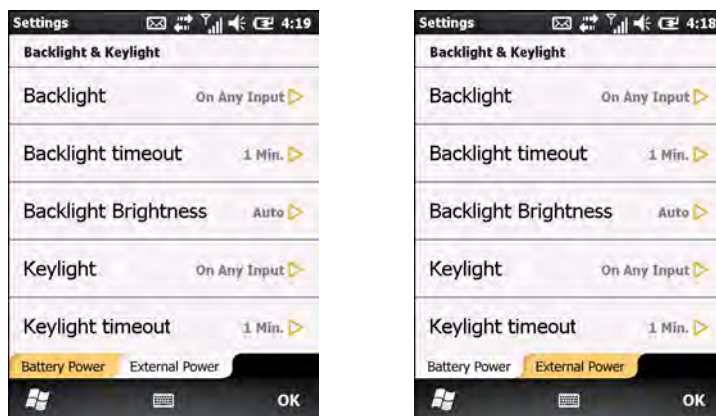

**Figure 9-3** *Backlight & Keylight*

Use the **Battery Power** tab to set the backlight and keylight settings when the MC65 is on battery power.

Use the **External Power** tab to set the backlight and keylight settings when the MC65 is on external power.

- **Backlight** - Set the backlight functionality. Select **On Any Input** to turn on the backlight upon an action or touch of the screen. Select **Always On** to keep the backlight on all the time.
- **Backlight Timeout** - Sets the time of inactivity before the screen backlight turns off.

- **Backlight Brightness** - Select between automatic and manual control. Select Auto to automatically control the backlight. Select Manual set the backlight brightness. Select one of five levels of brightness.
- **Keylight** - Select **On Any Input** to turn on the keylight upon an action or touch of the keypad. Select **Always On** to keep the keylight on all the time. Select **Follow Display** to set the Keylight to follow the same settings as the backlight.
- **Keylight Timeout** - Sets the time of inactivity before the keylight turns off.

---

## Accelerometer

Provides the ability to customize the accelerometer behaviors when in a call or using the display.

The user has the ability to set behaviors when the device is in motion, has a certain orientation of if the device is face down.

## Display Tab

The user has the ability to conserve battery life when using accelerometer behaviors and to set the MC65 to automatic operations.

Tap the **Status Bar** >  > **System** > **Accelerometer**.

- **Suspend when face down** - Places the MC65 in suspend mode when it is placed face down.
- **Screen Rotation** - Enable or disable screen rotation. The screen can be rotated between portrait and landscape modes automatically, depending on the physical orientation of the MC65. For example, if the MC65 is rotated 90° counterclockwise, the display rotates counterclockwise 90°.

## About Tab

Use the **About** tab to view accelerometer information.

---

## Program Shortcuts Setup

To change program shortcuts:



**Figure 9-4** Add Shortcut Icon

1. Tap **My Apps > Edit > Dock**.
2. Tap a shortcut button to remove the assigned shortcut.
3. Tap a new program icon and then tap **Save**.

---

## My Apps Window Setup

To create a customized application list:

1. Tap **My Apps > Edit > View > Create New**.
2. In the text box, enter a name for the list.
3. Scroll through the list and tap an icon to add to the new list. Each icon highlights indicating it is selected.  
As icons are added to the list, the icon counter increments.



**Figure 9-5** *Add Programs*

4. Tap **Save**.

To make the new list the default, tap the name of the list.

To edit a customized application list:

1. Tap **My Apps > Edit > View**.
2. Tap  next to the list to edit.
3. Tap an icon to add or delete from the list.
4. Tap **Save** and then tap **OK**.

## Card Setup

The cards on the Motorola Home screen can be configured and re-ordered:

On any card, tap . The card flips over.

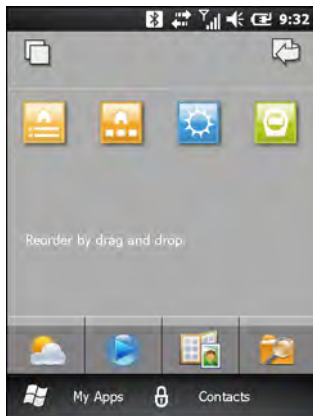

**Figure 9-6** *Back of Card*

## Re-Order Cards

Each icon on the card back represents a card. To re-order the cards, press and hold on an icon and then drag it to a new location. Tap  to return to the front of the card.

## Configure Cards



Cards can be removed so that they do not appear on the Home screen.

On any card, tap  to flip the card over.

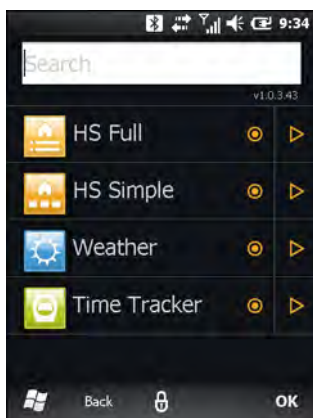
Tap  to configure the cards.



**Figure 9-7** *Card Configuration Window*

The window lists the available cards. A  next to the name indicates that the card is enabled. A  indicates that the card is disabled.

1. Tap the name of the card to enable or disable the card.



2. Tap  to view a description of the card.
3. Tap **OK** to return to the Home screen.

## Time Tracker Card

The Time Tracker card is an application that keep track of time spent on projects. Project data is stored in the /Windows directory in file *TimeTracker\_data\_file.csv*.



**Figure 9-8** *Time Tracker Main Screen*

1. To create a new project, tap the **Settings** icons.

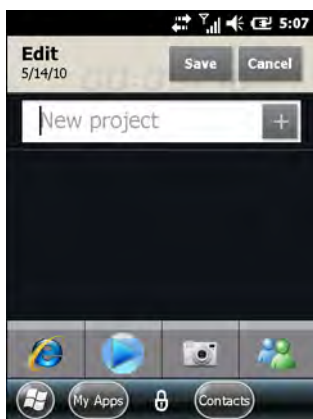

**Figure 9-9** *New Project*

2. In the text box, enter the project name.
3. Tap + to add the project to the list.
4. Tap **Save**.
5. In the main screen, tap the project name to open the project screen.

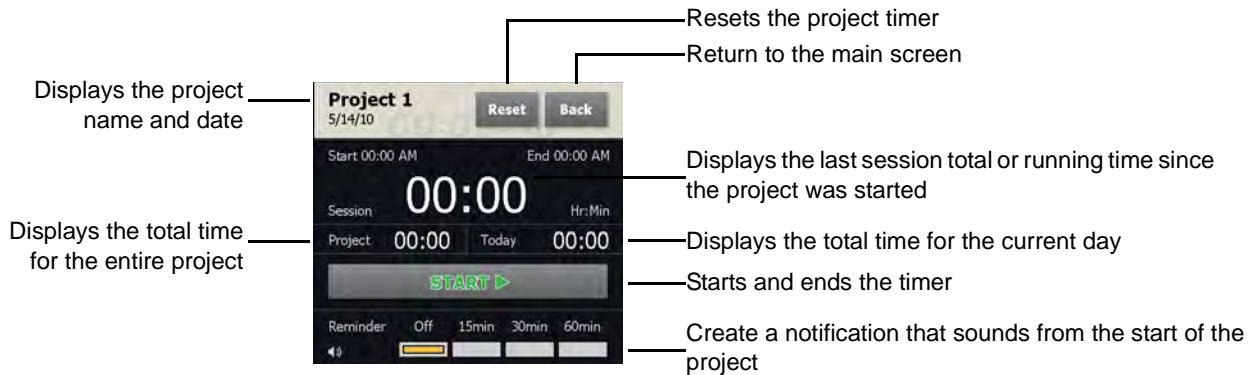

**Figure 9-10** Project Screen

6. Tap the **Start** button to start the project timer.
7. Select a reminder time that will indicate the interval from the start of the project session.
8. Tap **Back** to return to the main screen.

## Weather Card

The Weather card displays the current weather for your location plus the next three days provided by Accuweather.com. Tap  to manually update the data.



**Figure 9-11** Weather Card

### Add a New Location

To add a new location:

1. Tap the Setting icon.
2. In the text field, enter a city or zip code.
3. Tap the Magnifying Glass icon.
4. Select the new location from the list.
5. Tap Back to return to the Weather card front.

### Change Location

To change the location:

1. Tap the Settings icon.
2. Select a location from the list.

### Delete a Location

To delete a location:

1. Tap the Settings icon.
2. Scroll to the desired location.
3. Tap the X. The location is removed from the list.
4. Tap **Back** to return to the Weather card front.

---

## Email Setup

The MC65's **Messaging** application lets users access and manage multiple email accounts simultaneously in one convenient location. To send and receive email messages through an ISP (Internet Service Provider) account, or to use the MC65 to access corporate email through a VPN (Virtual Private Network), first set up an IMAP or POP account.

- IMAP (Internet Message Access Protocol) - This mail retrieval protocol is frequently used in large networks and commercial and institutional settings. IMAP4 is the current standard.
- POP (Post Office Protocol) - This protocol is supported by most ISPs and is currently more common among consumer applications. POP3 is the current standard.

✓ **NOTE** If you have multiple email accounts, configure each account with its own settings.

### Setting Up an IMAP or POP Account

When setting up an IMAP or POP account, the MC65 may be able to retrieve account settings automatically, or you may need to enter certain settings manually.

#### Automatic Email Setup

1. **Start > E-mail.**
2. Tap **Setup E-mail.**
3. In the **E-mail address** text box, enter an email address.
4. In the **Password** text box, enter an associated password.
5. The **Save password** checkbox is checked by default to allow the MC65 to always remember the email account password. To prevent other users from viewing the email account, tap the **Save password** checkbox to remove the checkmark and deactivate the feature.
6. Tap **Next.**

✓ **NOTE** For some common email types, the MC65 automatically detects and configures the email settings without performing this step.

7. Tap the **Try to get e-mail settings automatically from the Internet** checkbox to place a checkmark in the checkbox.  
Tap **Next** to attempt to retrieve these settings automatically. This process may take several minutes. The MC65 attempts to determine the necessary communication settings for both incoming and outgoing email messages.
8. If the MC65 was able to automatically retrieve the necessary settings, tap **Next**.  
If the MC65 was unable to obtain the settings automatically, tap **Next** and proceed to step 8 in [Entering Email Settings Manually on page 9-14](#).
9. In the **Your name:** field, enter the name that displays in the **From** field on outgoing messages.
10. In the **Account display name:** field enter a name for the new email account.  
This name appears within the list of available email accounts on the E-mail page.
11. Tap **Next**.
12. Tap the **Automatic Send/Receive:** field and select the time interval you would like for the MC65 to send and check for new email messages.
13. Tap the **Review all download** settings link for additional download settings and options. See [Editing an Email Account on page 9-16](#) for more details.
14. Tap **Finish**.

## Manual Email Setup

If the Automatic configuration was unsuccessful, or if accessing an account using a VPN server connection, contact your ISP (Internet Service Provider) or network administrator for the following information and enter it manually:

- Account type (IMAP4 or POP3)
- Incoming and outgoing mail server names
- Username and password
- Domain name
- Special security settings (if used).

For more information about configuring email accounts, go to:  
[www.microsoft.com/windowsmobile/help/smartphone/default.mspx](http://www.microsoft.com/windowsmobile/help/smartphone/default.mspx) or [www.windowsmobile.com/getstarted](http://www.windowsmobile.com/getstarted)

## Entering Email Settings Manually

1. **Start > E-mail.**
2. Tap **Setup E-mail.**
3. In the **E-mail address:** field, enter the email address for the account.
4. In the **Password:** fields and the password for the account.

5. The **Save password** checkbox is checked by default to allow the MC65 to always remember the email account password. To prevent other users from viewing your email, tap the **Save password** checkbox to remove the checkmark and deactivate the feature.
6. Tap **Next**.
7. Tap the **Try to get e-mail settings automatically** from the Internet box to remove the checkmark from the box and tap **Next**.
8. In the **Your e-mail provider:** drop-down list, select **Internet e-mail** and tap **Next**.
9. In the **Your name:** field enter the name that will display in the **From** field on outgoing messages.
10. In the **Account display name:** field enter a name for this new email account.  
This name appears within the list of available email accounts on the E-mail page.
11. Tap **Next**.
12. In the **Incoming mail server:** field enter the incoming mail server address.
13. In the **Account Type:** drop-down list, select either **POP3** or **IMAP4**.
14. Tap **Next**.
15. In the **User name:** field enter the username for the account.
16. In the **Password:** field enter the password for the account.
17. Tap **Next**.
18. In the **Outgoing (SMTP) mail server:** field enter the outgoing mail server address.
19. Check the appropriate fields and then tap OK.
  - **Outgoing server requires authentication** is used if a password is required for outgoing mail in addition to incoming mail. (Please contact your System Administrator for detailed server requirements.)  
**Use the same user name and password for sending e-mail** to use the same user name and password for outgoing mail as well as for incoming mail (can only be selected if the **Outgoing server requires authentication** checkbox is checked).
20. Tap the **Advanced Server Settings** link.
  - These allows configuration of server-specific messaging settings such as SSL requirements for both incoming and outgoing email, as well as network firewall profiles.
  - Select the desired options.
  - Tap **Done** once completed making updates to these settings.
21. Tap **Next**.
22. In the **Automatic Send/Receive:** drop-down list select the time interval for the MC65 to send and check for new email.
23. Tap the **Review all download settings** link for additional download settings and options.
24. Tap **Finish**.

## Editing an Email Account

To edit general email settings:

1. **Start > E-mail.**
2. Highlight an account and tap **Menu > Options.**
3. Tap the desired email account from the on screen list.
4. Tap **Edit Account Setup.**
5. Confirm the **email address** and make any changes if necessary. Tap **Next.**
6. Confirm the **Your name** and **Account display name** information and make any changes if necessary. Tap **Next.**
7. Confirm the **Incoming mail server** and **Account type** information and make any changes if necessary. Tap **Next.**
8. Confirm the **User name** and **Password** information and make any changes if necessary (including checking or unchecking the **Save password** checkbox). Tap **Next.**
9. Confirm the **Outgoing (SMTP) mail server** information and make any changes if necessary.
10. Tap the **Advanced Server Settings** link and select any setting on this page to check or uncheck the option.
  - **Require SSL for Incoming e-mail** check box to enable SSL encryption of incoming email (if supported by the mail server).
  - **Require SSL for Outgoing e-mail** checkbox to enable SSL encryption of outgoing email (if supported by the mail server).
  - **Network connection** drop-down list to select a firewall connection setting. Select either **The Internet** (open: no firewall), **Work** (behind a firewall) or a data connection.
11. Tap **Done** and then tap **Next.**
12. In the **Automatic Send/Receive** drop-down list, select the time interval the MC65 sends and checks for new email.
13. In the **Download messages** drop-down list, select the age range of messages to download from the server to the MC65. (The longer the time period, the more messages are downloaded.)
14. Tap the **Advanced Settings** link and select any setting on this page to check or uncheck the option.
  - Select the **Send/receive when I click Send** checkbox to automatically check for and download new messages whenever the user sends a message.
  - Select the **Use automatic send/receive schedule when roaming** checkbox to continue to check the email at predetermined intervals even if in a roaming area.
  - In the **When deleting messages** drop-down list select whether to automatically delete or retain messages on the email server when deleting messages from the MC65.
15. Tap **Done.**
16. Tap **Next.**
17. Tap an on screen field and change any settings you wish. Tap an option to select it.
  - In the **Message format** drop-down list, select to view your email messages as either **HTML** or **plain text** documents.

- In the **Message download limit** drop-down list, select the size limit of files attached to email messages.

18. Tap **Finish**.

## Setting Email Signatures

Signatures are the string of text automatically added to the end of an outgoing emails or messages.

1. **Start > E-mail.**
2. Tap **Menu > Options.**
3. Highlight an account and tap **Signatures.**
4. In the **Select an account** drop-down list, select a pre-existing account.
5. Tap the **Use signature with this account** checkbox to enable a signature to be automatically added to new outgoing messages.
6. Tap the **Use when replying and forwarding** checkbox to enable a signature to be automatically added to any messaging being replied to or being forwarded from the account.
7. Tap in the text field and enter a signature message.
8. Tap **OK** to save the new signature.

---

## MMS Messaging Setup

If a SIM card from a non-supported carrier is installed, the MMS options must be configured manually. To configure the MC65 for MMS messaging:

1. Obtain all necessary information from the carrier.
2. Tap **Start > Text.**
3. Tap  > **MMS Options.**
4. Select **Servers** tab.



The screenshot shows a configuration window titled "Text Messages" with a status bar at the top showing signal strength, battery, and time (6:06). The window contains the following fields and options:

- Server name:** An empty text input field.
- Gateway:** An empty text input field.
- Port number:** A text input field containing the value "80".
- Server address:** A text input field containing "http://".
- Connect via:** A dropdown menu currently set to "The Internet".
- Send limit:** A dropdown menu currently set to "300K".
- WAP Version:** A dropdown menu currently set to "WAP 2.0".

At the bottom of the screen, there is a navigation bar with a Windows logo on the left and two buttons labeled "Done" and "Cancel" on the right.

**Figure 9-12** MMS Options Server Tab

5. Enter the data in the fields and tap **Done**.

---

## Voice Commander

Use the **Voice Commander Settings** to configure the **Voice Commander** application. There are five major functions:

- Contacts
- Applications
- Music
- Digit Trainer
- Advanced Settings.

To configure **Voice Commander** setting tap **Start > Settings > Personal > Voice Commander Settings**.

### Contacts Settings

The **Contacts** tab lists all the names in the MC65 Contacts and SIM card (if installed). When a new contact is created, Voice Commander automatically updates the recognition database.

A check in a box indicates that the contact can be recognized normally. An unchecked box indicates that the contact is not in the recognition range. A grayed box indicates that the name contains some unrecognizable characters, such as symbols or marks. The user can build a voice tag to enable it.

The default recognition database is limited to 2,000 contacts. The user can check the leading checkboxes of the contacts exceeding 2,000 items to enable additional entries.



### Play



Tap  to hear the pronunciation of a contact.

### Voice Tag

The user can record a voice tag for selected contacts to enhance usability and accuracy.  indicates that the voice tag is built.

To record a voice tag:

1. Select a contact.
2. Tap .
3. After the beep, say the contacts name or nickname. For example: *The Boss*.
4. After the second beep, repeat it.
5. Voice Commander builds the recorded voice tag.
6. Voice Commander plays back the recorded voice tag to confirm the voice tag has been created successfully, and  appears to the right of the contact name.

✓ **NOTE** Tap  again rebuild the voice tag. Tap  to delete the voice tag.



## Application Settings

The **Application** tab lists all the applications installed in the **Start** menu. When a new application is installed, **Voice Commander** automatically updates the recognition database.

A check in a box indicates that the application can be recognized normally. An unchecked box indicates that the application is not in the recognition range. A grayed box indicates that the application name contains some unrecognizable characters, such as symbols or marks. The user can build a voice tag to enable it.



### Play



Tap  to hear the pronunciation of an application.

### Voice Tag

The user can record a voice tag for selected applications to enhance usability and accuracy.  indicates that the voice tag is built.

To record a voice tag:

1. Select an application.
2. Tap .
3. After the beep, say the application name. For example: *File Explorer*.
4. After the second beep, repeat it.
5. **Voice Commander** builds the recorded voice tag.
6. **Voice Commander** plays back the recorded voice tag to confirm the voice tag has been created successfully, and  appears to the right of the contact name.

✓ **NOTE** Tap  again to rebuild the voice tag. Tap  to delete the voice tag.

## Music Settings

The **Music** tab lists all the music files found on the MC65. When a media file is downloaded, **Voice Commander** automatically updates the recognition database.

A check in a box indicates that the music file can be recognized normally. An unchecked box indicates that the music file is not in the recognition range. A grayed box indicates that the music file name contains some unrecognizable characters, such as symbols or marks. The user can build a voice tag to enable it.

### Play



Tap  to hear the pronunciation of an application.



### Voice Tag

The user can record a voice tag for selected music file to enhance usability and accuracy.  indicates that the voice tag is built.

To record a voice tag:

1. Select a music file.

2. Tap .
3. After the beep, say the music file name. For example: *Drive*.
4. After the second beep, repeat it.
5. **Voice Commander** builds the recorded voice tag.
6. **Voice Commander** plays back the recorded voice tag to confirm the voice tag has been created successfully, and  appears to the right of the music file name.

✓ **NOTE** Tap  again rebuild the voice tag. Tap  to delete the voice tag.

## Digit Trainer Settings

The user can improve the Voice Commander digit dialing success by performing the Digit Trainer sequence:

1. Tap .
2. Start reading first string after hearing a beep. When finished, the system plays back the recorded voice and ask for confirmation.
3. If the utterance is correct and clear, tap **Yes**. The system moves into next digit string for recording.  
If the utterance is incorrect, tap **No**. The system stays at the current string for re-recording.
4. Repeat steps 1 through 3 for the remainder of the strings (at any time, tap **Cancel** to stop.)
5. After finishing the recording of 10 digit strings, tap **Done** to confirm the adapted model or tap **Remove All** to delete the adapted model and re-train.

## Digit Setting Settings

Use the **Digit Setting** tab to set valid phone number lengths to improve digit recognition accuracy. The user can change the default settings based on the local telecom requirement. The user can also select **No constraint** checkbox to disable this limitation, though with the trade off of increased errors caused by surrounding noises.

✓ **NOTE** The maximum phone number length is 18 digits.

## Advanced Settings

Use the **Advanced Settings** tab to set the voice recognition sensitivity. Select:

- **Sensitive**: makes the recognizer easier to return a recognition result, whenever there is an utterance detected. This setting is used in environment with stationary noises, such as in a car, a bus or a factory.
- **Normal**: this setting is used in most environments.
- **Accurate**: when selected, the recognizer becomes very strict in responding to user's voice commands. This is to reduce misunderstanding calls or actions that could be triggered by unrelated voices issued by surrounding people.

# Chapter 10 Accessories

## Introduction

MC65 accessories, listed below, provide a variety of product support capabilities.

## Accessories

Table 10-1 lists the accessories available for the MC65 EDA.

**Table 10-1** MC65 Accessories

Accessory	Part Number	Description
<b>Cradles</b>		
Single Slot USB Cradle	CRD5500-1000UR	Charges the MC65 main battery and a spare battery. Synchronizes the MC65 with a host computer through a USB connection.
Single Slot Ethernet/Modem/USB Cradle	CRD5500-1000XR	Charges the MC65 main battery and a spare battery. Synchronizes the MC65 with a host computer through an Ethernet, Modem or USB connection.
Four Slot Charge Only Cradle	CRD5500-4000CR	Charges up to four MC65 devices.
Four Slot Ethernet Cradle	CRD5500-4000ER	Charges up to four MC65 devices and connects the MC65 with an Ethernet network.
Vehicle Cradle	VCD5500-1000R	Installs in a vehicle and charges the MC65 main battery.
Vehicle Holder	VCH5500-1000R	Provides an alternative mounting solution for the MC65 in a vehicle. Requires the Auto Charge cable for charging the MC65 battery.
<b>Chargers</b>		
Four Slot Spare Battery Charger	SAC5500-4000CR	Charges up to four MC65 battery packs.
USB Charging Cable	25-108022-01R	Provides power to the MC65 and USB communication with a host computer.
Charge Only Cable	25-112560-01R	Connects to a power supply to provide power to the MC65.

**Table 10-1** MC65 Accessories (Continued)

Accessory	Part Number	Description
Auto Charge Cable	VCA5500-01R	Charges the MC65 using a vehicle's cigarette lighter.
<b>Miscellaneous</b>		
Spare 3600 mAh lithium-ion battery	BTRY-MC55EAB02	Replacement 3600 mAh battery.
DEX Cable	25-127558-01R	For use with electronic data exchange For example, vending machines.
Trigger Handle	TRG5500-100R	Adds a gun-style handle with a scanning trigger for comfortable and productive data capture.
Magnetic Stripe Reader	MSR5500-100R	Captures data from magnetic stripe cards.
Belt Mounted Rigid Holster	SG-MC5511110-01R	Clips onto belt to hold the MC65 when not in use.
Fabric Holster	SG-MC5521110-01R	Soft holder for added protection.
Stylus	KT-119150-03R KT-119150-50R	Replacement stylus (3-pack). Replacement stylus (50-pack).
Spring Loaded Stylus	STYLUS-00001-03R STYLUS-00001-10R	Optional spring loaded stylus (3-pack). Optional spring loaded stylus (10-pack).
Wall Mounting Kit	8710-050006-01R	Use for wall mounting the four slot cradles.
Screen Protector	KT-67525-01R	Package of 3 screen protectors.
Software	-	<i>Enterprise Mobility Developer Kits (EMDKs)</i> , available at: <a href="http://support.symbol.com">http://support.symbol.com</a> .

---

## Single Slot USB Cradle

This section describes how to use a Single Slot USB cradle with the MC65. For USB communication setup procedures refer to the *MC65 Integrator Guide*.

The Single Slot USB Cradle:

- Provides 5.4 VDC power for operating the MC65.
- Synchronizes information between the MC65 and a host computer. Refer to the *MC65 Integrator Guide* for information on setting up a partnership between the MC65 and a host computer.
- Charges the MC65's battery.
- Charges a spare battery.

### Charging the MC65 Battery

Connect the cradle to power. Insert the MC65 into the slot to begin charging.

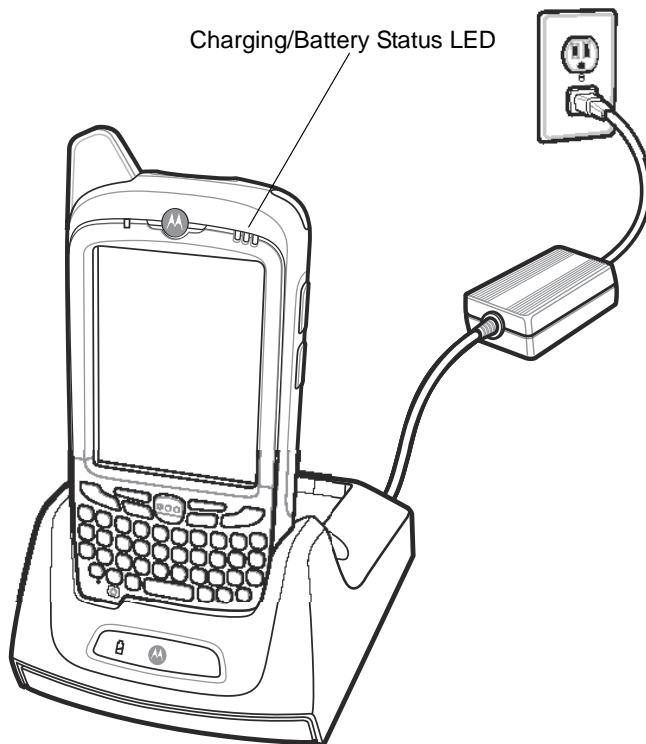

**Figure 10-1** MC65 Battery Charging

## Charging the Spare Battery

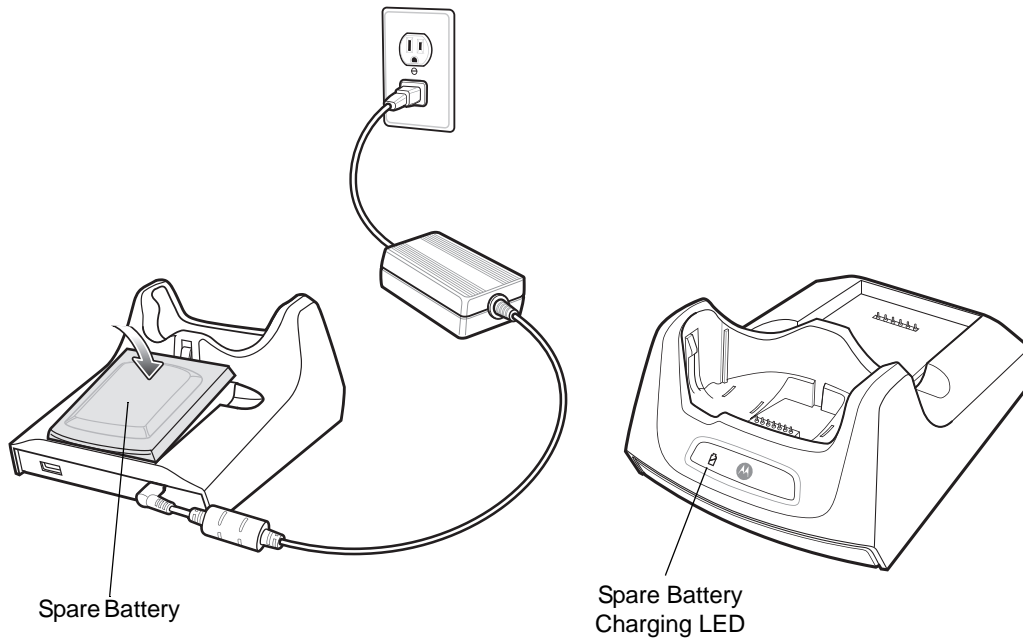

**Figure 10-2** Spare Battery Charging

## Battery Charging Indicators

The Single Slot USB Cradle charges the MC65's main battery and a spare battery simultaneously.

The MC65's charge LED indicates the status of the battery charging in the MC65. See [Table 1-1 on page 1-6](#) for charging status indications.

The spare battery charging LED on the cradle indicates the status of the spare battery charging in the cradle. See [Table 10-2](#) for charging status indications.

The 3600 mAh battery fully charges in less than six hours.

## Charging Temperature

Charge batteries in temperatures from 0°C to 40°C (32°F to 104°F). Charging is intelligently controlled by the MC65.

To accomplish this, for small periods of time, the MC65 or accessory alternately enables and disables battery charging to keep the battery at acceptable temperatures. The MC65 or accessory indicates when charging is disabled due to abnormal temperatures via its LED. See [Table 1-1 on page 1-6](#) and [Table 10-2](#).

**Table 10-2** Spare Battery LED Charging Indicators

Spare Battery LED (on cradle)	Indication
Off	Battery is not charging; battery is not inserted correctly in the cradle; cradle is not powered

**Table 10-2** Spare Battery LED Charging Indicators (Continued)

<b>Spare Battery LED (on cradle)</b>	<b>Indication</b>
Slow Blinking Amber	Spare battery is charging.
Solid Amber	Charging complete.
Fast Blinking Amber	Charging error.

## Four Slot Charge Only Cradle

This section describes how to set up and use a Four Slot Charge Only cradle with the MC65.

The Four Slot Charge Only cradle:

- Provides 5.4 VDC power for operating the MC65.
- Simultaneously charges up to four MC65 devices.

### Charging

Insert the MC65 into a slot to begin charging.

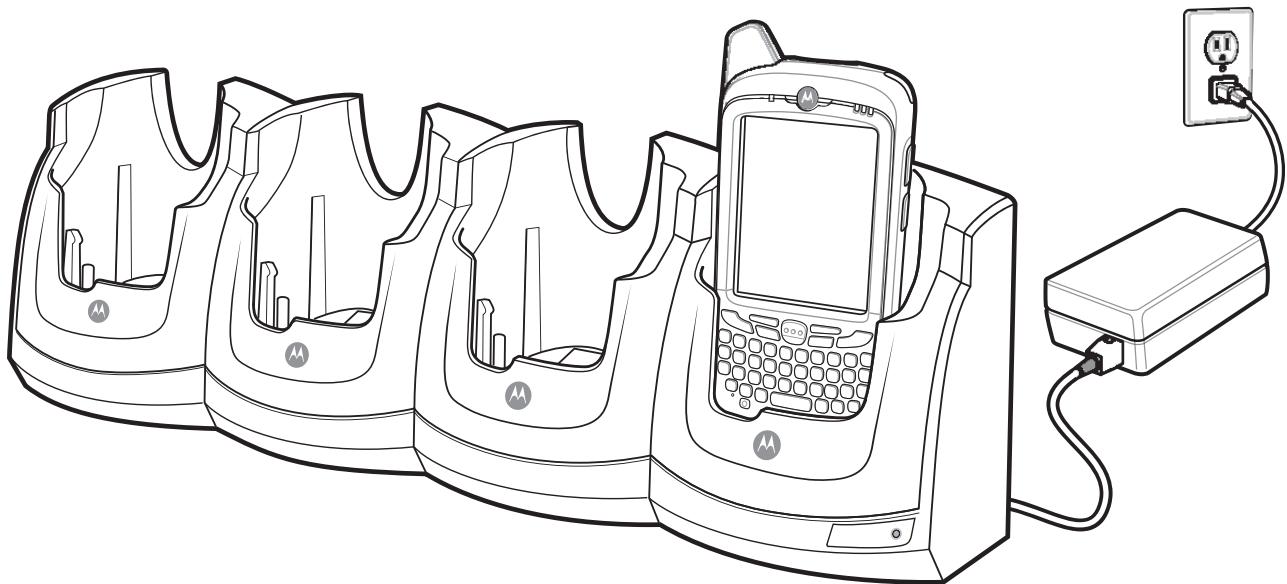

Figure 10-3 MC65 Battery Charging

### Battery Charging Indicators

The MC65's charge LED shows the status of the battery charging in the MC65. See [Table 1-1 on page 1-6](#) for charging status indications.

The 3600 mAh battery fully charges in less than six hours.

### Charging Temperature

Charge batteries in temperatures from 0°C to 40°C (32°F to 104°F). Charging is intelligently controlled by the MC65.

To accomplish this, for small periods of time, the MC65 or accessory alternately enables and disables battery charging to keep the battery at acceptable temperatures. The MC65 or accessory indicates when charging is disabled due to abnormal temperatures via its LED. See [Table 1-1 on page 1-6](#).



---

## Four Slot Ethernet Cradle

This section describes how to set up and use a Four Slot Ethernet cradle with the MC65. For cradle communication setup procedures refer to the *MC65 Integrator Guide*.

The Four Slot Ethernet cradle:

- Provides 5.4 VDC power for operating the MC65.
- Connects the MC65 (up to four) to an Ethernet network.
- Simultaneously charges up to four MC65 devices.

### Charging

Insert the MC65 into a slot to begin charging.

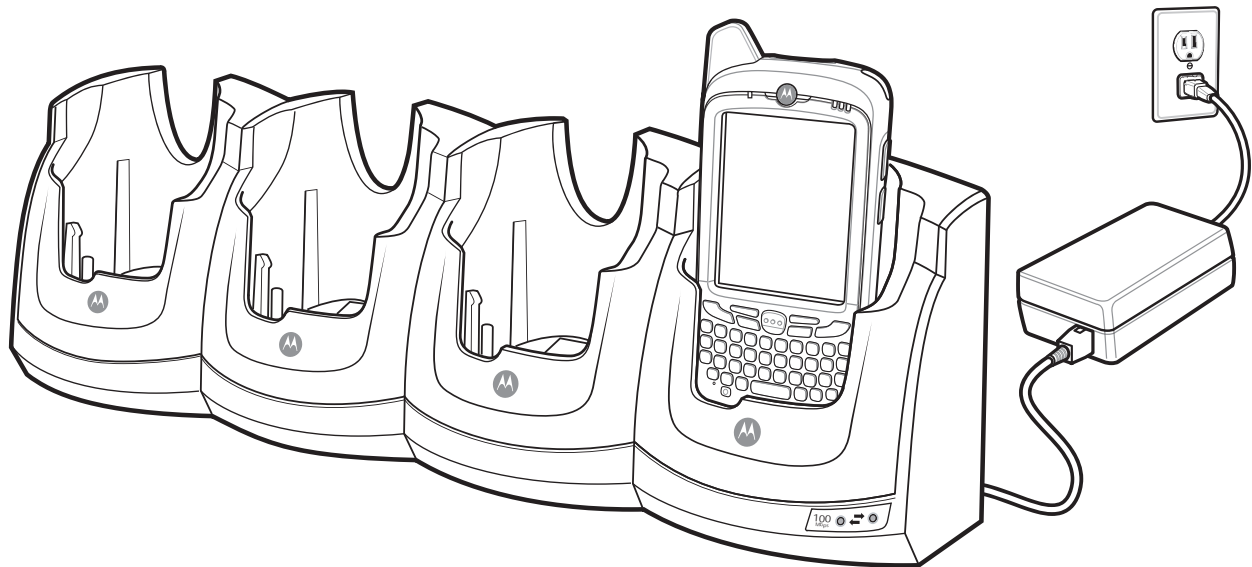

Figure 10-4 MC65 Battery Charging

### Battery Charging Indicators

The MC65's charge LED shows the status of the battery charging in the MC65. See [Table 1-1 on page 1-6](#) for charging status indications.

The 3600 mAh battery fully charges in less than six hours.

### Charging Temperature

Charge batteries in temperatures from 0°C to 40°C (32°F to 104°F). Charging is intelligently controlled by the MC65.

To accomplish this, for small periods of time, the MC65 alternately enables and disables battery charging to keep the battery at acceptable temperatures. The MC65 indicates when charging is disabled due to abnormal temperatures via its LED. See [Table 1-1 on page 1-6](#).

---

## VCD5000 Vehicle Cradle

This section describes how to use a VCD5000 vehicle cradle with the MC65. For cradle installation and communication setup procedures refer to the *MC65 Integrator Guide*.

Once installed in a vehicle, the cradle:

- holds the MC65 securely in place
- provides power for operating the MC65
- re-charges the battery in the MC65.

### Charging the MC65 Battery

Insert the MC65 into the vehicle cradle to begin charging. A click indicates that the MC65 button release locking mechanism is enabled and the MC65 is locked in place.

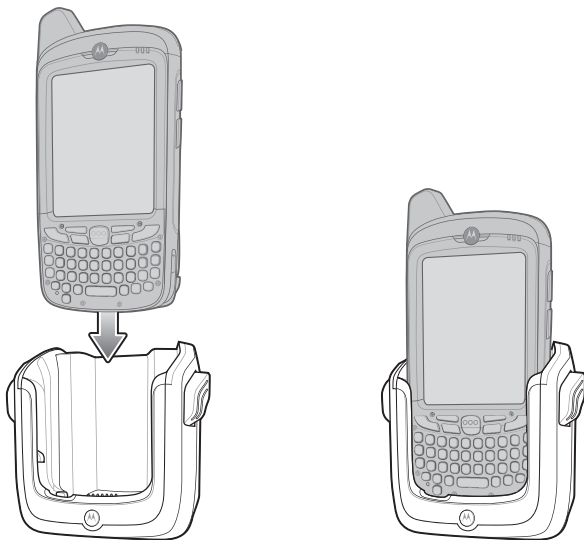

**Figure 10-5** MC65 Battery Charging



**CAUTION** Ensure the MC65 is fully inserted in the cradle. Lack of proper insertion may result in property damage or personal injury. Motorola is not responsible for any loss resulting from the use of the products while driving.

### Removing the MC65

To remove the MC65, hold back the release lever on the cradle and pull the MC65 up and out of the cradle.

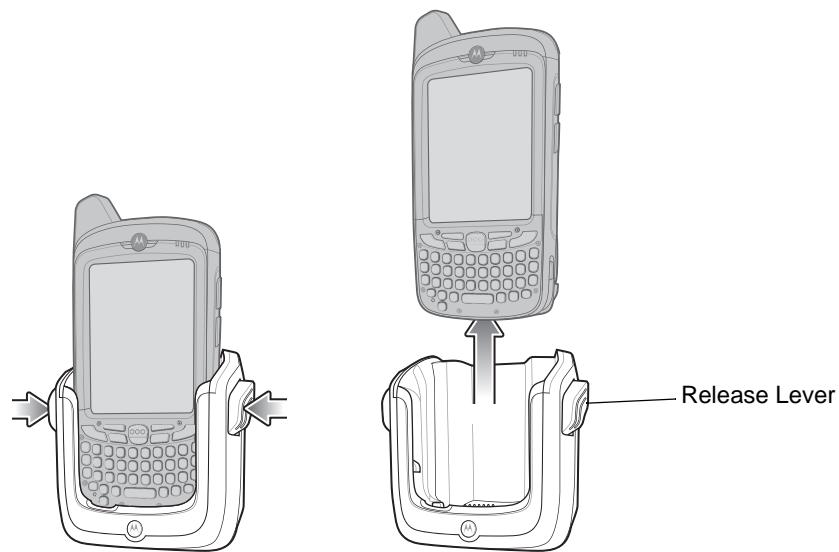

**Figure 10-6** *Removing the MC65*

## Battery Charging Indicators

The MC65's charge LED indicates the status of the battery charging in the MC65. See [Table 1-1 on page 1-6](#) for charging status indications.

The 3600 mAh battery fully charges in less than six hours.

## Charging Temperature

Charge batteries in temperatures from 0°C to 40°C (32°F to 104°F). Charging is intelligently controlled by the MC65.

To accomplish this, for small periods of time, the MC65 alternately enables and disables battery charging to keep the battery at acceptable temperatures. The MC65 indicates when charging is disabled due to abnormal temperatures via its LED. See [Table 1-1 on page 1-6](#).

## Four Slot Battery Charger

This section describes how to use the Four Slot Battery Charger to charge up to four MC65 batteries.

### Battery Charging

1. Connect the charger to a power source.
2. Insert the battery into a battery charging well and gently press down on the battery to ensure proper contact.

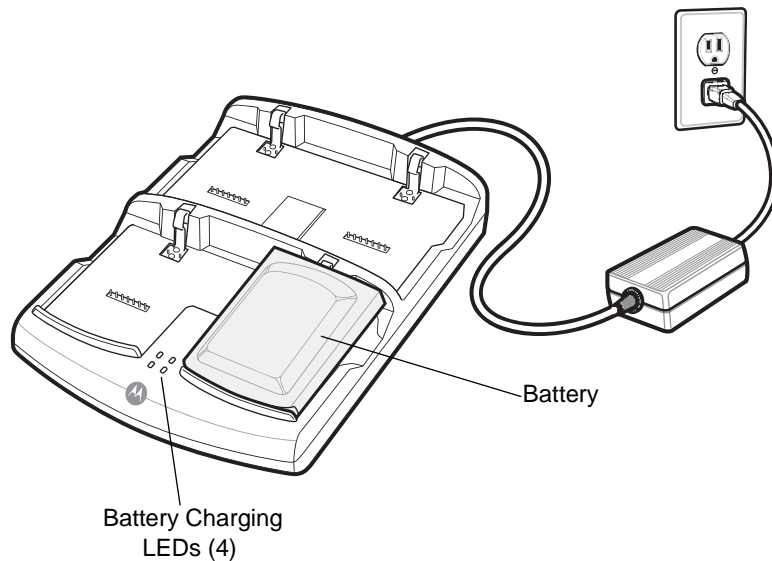

Figure 10-7 Four Slot Battery Charger

### Battery Charging Indicators

The charger has an amber LED for each battery charging well. See [Table 10-3](#) for charging status indications. The 3600 mAh battery fully charges in less than six hours.

#### Charging Temperature

Charge batteries in temperatures from 0°C to 40°C (32°F to 104°F). Charging is intelligently controlled by the MC65.

To accomplish this, for small periods of time, the charger alternately enables and disables battery charging to keep the battery at acceptable temperatures. The charger indicates when charging is disabled due to abnormal temperatures via its LED. See [Table 10-3](#).

Table 10-3 Battery LED Charging Indicators

LED	Indication
Off	No battery in slot; battery is not charging; battery is not inserted correctly in the charger; charger is not powered.

**Table 10-3** Battery LED Charging Indicators (Continued)

LED	Indication
Slow Blinking Amber	Battery is charging.
Solid Amber	Charging complete.
Fast Blinking Amber	Charging error.

---

## Cables

This section describes how to set up and use the cables. The cables are available with a variety of connection capabilities.

The following communication/charge cables are available:

- USB Charging cable
  - Provide the MC65 with operating and charging power when used with the Motorola approved power supply.
  - Synchronize information between the MC65 and a host computer. With customized or third party software, it can also synchronize the MC65 with corporate databases.
- Charge Only cable
  - Provide the MC65 with operating and charging power when used with the Motorola approved power supply.
- Auto Charge cable.
  - Provide the MC65 with operating and charging power when used with the Motorola approved power supply.

## Battery Charging and Operating Power

The communication/charge cables can charge the MC65 battery and supply operating power.

To charge the MC65 battery:

1. Connect the communication/charge cable power input connector to the Motorola approved power source.
2. Slide the bottom of the MC65 into the connector cup end of the communication/charge cable and gently press in until it latches into the MC65.
3. Slide the two locking tabs up until they both lock into position.

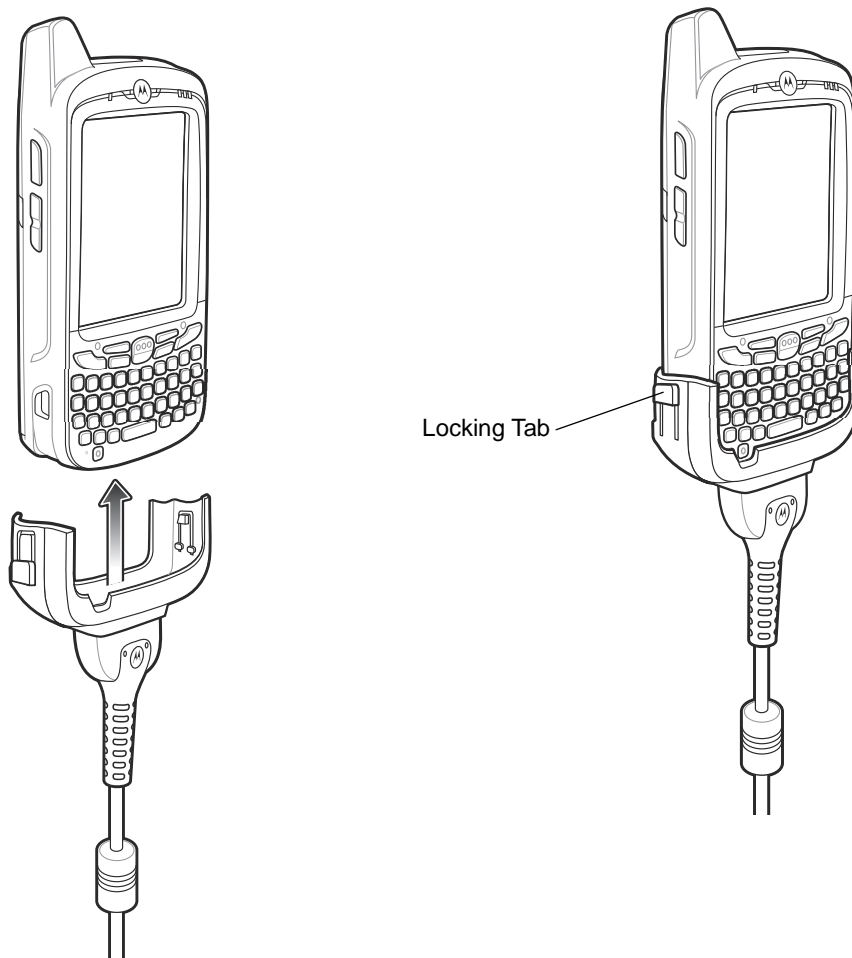

**Figure 10-8** Cable Cup Locking Tabs

The MC65 amber Charge LED indicates the MC65 battery charging status. The 3600 mAh standard battery charges in less than six hours. See [Table 1-1 on page 1-6](#) for charging status indications.

4. When charging is complete, push the two locking tab down and remove the cable from the MC65.

## LED Charge Indications

The amber Charge LED on the MC65 indicates battery charging status. See [Table 1-1 on page 1-6](#) for charging status indications.

### Charging Temperature

Charge batteries in temperatures from 0°C to 40°C (32°F to 104°F). Charging is intelligently controlled by the MC65.

To accomplish this, for small periods of time, the MC65 or accessory alternately enables and disables battery charging to keep the battery at acceptable temperatures. The MC65 or accessory indicates when charging is disabled due to abnormal temperatures via its LED. See [Table 1-1 on page 1-6](#).

## Vehicle Holder



**WARNING!** Some countries prohibit the mounting of any electronic device in any location on the vehicle dashboard and or windshield. Be sure to check your local laws acceptable mounting areas before installing the auto mounting kit.

### Installation Reminders

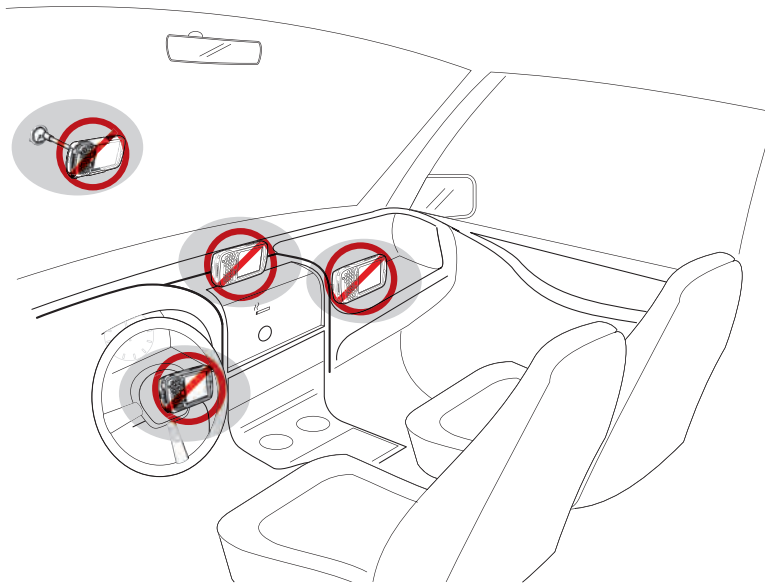

**Figure 10-9** Vehicle Holder Mounting

- Do not mount the vehicle holder where it will obscure the driver's view of the road.
- Do not mount the vehicle holder near the driver seat air bag deployment area.
- Do not place the MC65 on top of the dashboard or anywhere without securing it in the vehicle holder.
- Do not mount the vehicle holder near the passenger seat air bag deployment area.
- Install the vehicle holder on the surface of your vehicle that is reasonably flat and free of dirt and oil.

### Device Mounting Precautions

- Some countries prohibit the mounting of any electronic device in any location on the vehicle dashboard. Be sure to check your local laws acceptable mounting areas before installing the vehicle holder.
- The heating and cooling cycle of a vehicle's interior will in some cases loosen the adhesion of the suction cup. Check the vacuum seal of the vehicle mount kit for adequate adhesion each time you use the unit, and reinstall if necessary.
- If the vehicle holder has problems staying on, clean the plastic suction cup with alcohol, then reinstall.

### Installation

Install the vehicle mount on the surface of your vehicle that is reasonably flat and free of dirt and oil. Clean the mounting surface with a glass cleaner and a clean cotton cloth. Install the vehicle mount on the windshield or other flat car surface using the supplied mounting disc.

### Assembly

1. Insert the vehicle holder's cradle plate to the holes on the back of the cradle.
2. Push the cradle down until both parts are engaged.

### Windshield Installation

1. Fix the suction cup mount to the selected area with the suction lever facing up.

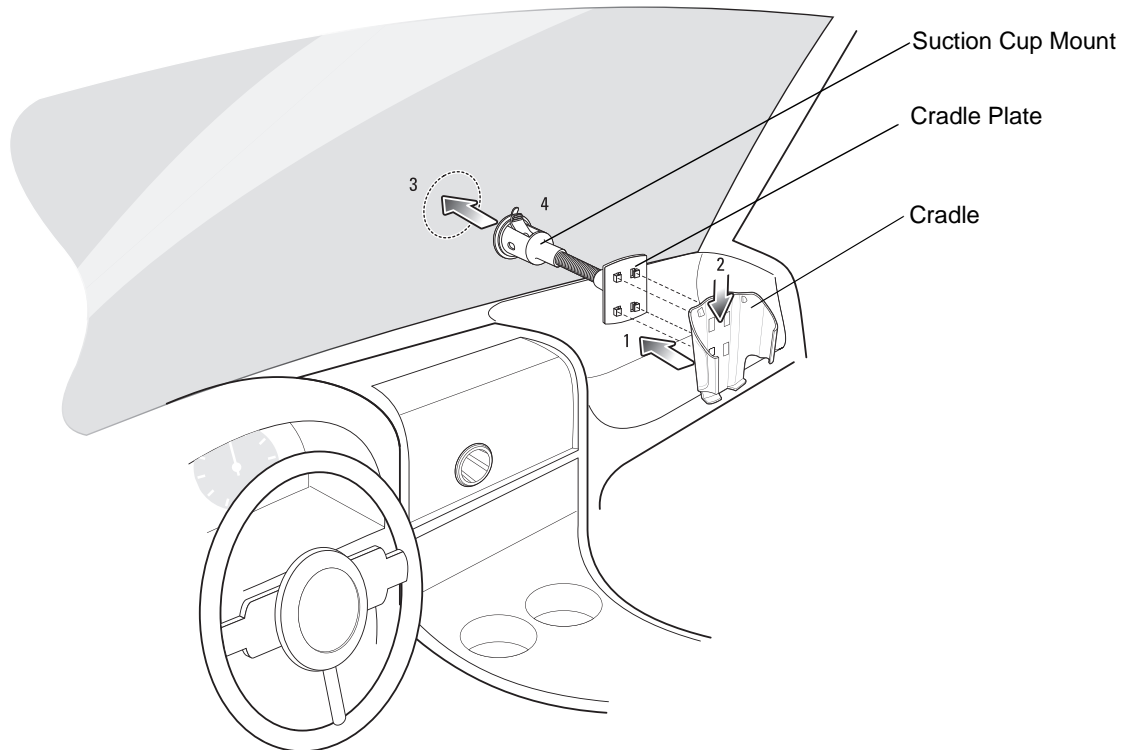

**Figure 10-10** *Windshield Installation*

2. Flip the lever down to create a vacuum between the suction cup and the mounting surface.
3. Make sure that the suction bond is strong enough before proceeding to the next step.
4. Slide the MC65 into the cradle.



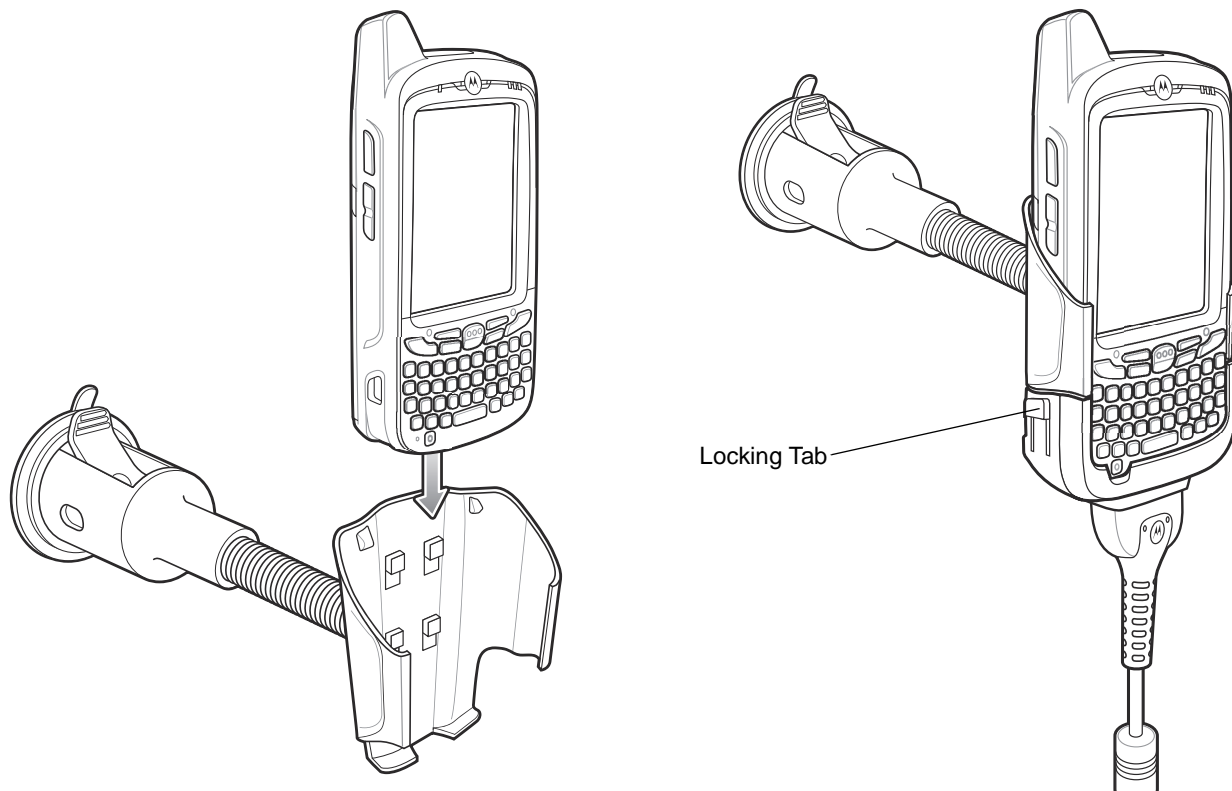
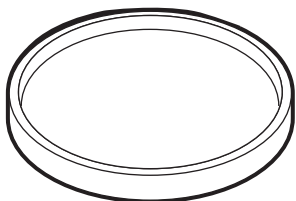

**Figure 10-11** *Insert MC65 into Vehicle Holder*

5. Connect the auto charger cable to the MC65 and slide the two locking tabs up to secure the cable cup to the MC65.
6. Connect the other end to the cigarette lighter socket.  
The LED indicator on the right side of the touch screen lights up orange during charging.

### **Flat Surface Installation**

1. Remove the plastic sheet on the bottom of the mounting disc.
2. Place the disc, sticky side down, on a clean flat surface.



**Figure 10-12** *Mounting Disc*

3. Fix the suction cup mount to the disc with the suction lever facing up.
4. Flip the lever down to create a vacuum between the suction cup and the disc.
5. Make sure that the suction bond is strong enough before proceeding to the next step.
6. Slide the MC65 into the cradle.

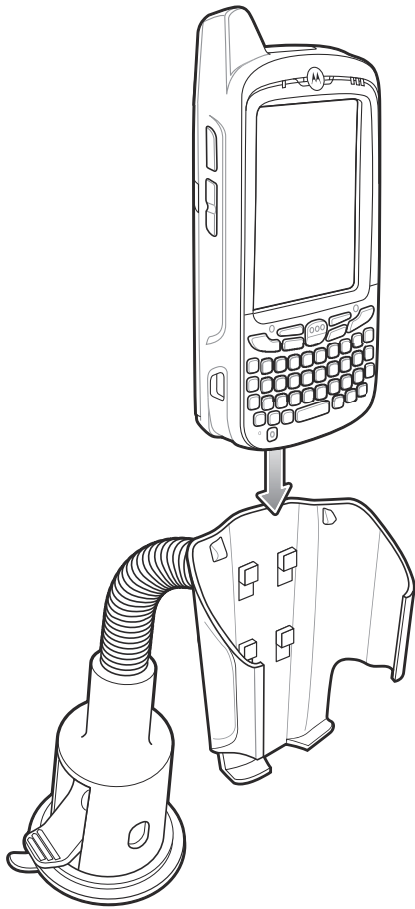

**Figure 10-13** *Vehicle Holder Mounted on Flat Surface*

7. Connect the auto charger cable to the MC65 and slide the two locking tabs up to secure the cable cup to the MC65.
8. Connect the other end to the cigarette lighter socket.  
The LED indicator on the right side of the touch screen lights up orange during charging.

# Chapter 11 Maintenance & Troubleshooting

---

## Introduction

This chapter includes instructions on cleaning and storing the MC65, and provides troubleshooting solutions for potential problems during MC65 operation.

---

## Maintaining the MC65

For trouble-free service, observe the following tips when using the MC65:

- Do not scratch the screen of the MC65. When working with the MC65, use the supplied stylus or plastic-tipped pens intended for use with a touch-sensitive screen. Never use an actual pen or pencil or other sharp object on the surface of the MC65 screen.

Motorola recommends using a screen protector, p/n KT-67525-01R.

- The touch-sensitive screen of the MC65 is glass. Do not drop the MC65 or subject it to strong impact.
- Protect the MC65 from temperature extremes. Do not leave it on the dashboard of a car on a hot day, and keep it away from heat sources.
- Do not store or use the MC65 in any location that is dusty, damp, or wet.
- Use a soft lens cloth to clean the MC65. If the surface of the MC65 screen becomes soiled, clean it with a soft cloth moistened with a diluted window-cleaning solution.
- Periodically replace the rechargeable battery to ensure maximum battery life and product performance. Battery life depends on individual usage patterns.

- A screen protector is applied to the MC65. Motorola recommends using this to minimize wear and tear. Screen protectors enhance the usability and durability of touch screen displays. Benefits include:
  - Protection from scratches and gouges
  - Durable writing and touch surface with tactile feel
  - Abrasion and chemical resistance
  - Glare reduction
  - Keeping the device's screen looking new
  - Quick and easy installation.

---

## Removing the Screen Protector

A screen protector is applied to the MC65. Motorola recommends using this to minimize wear and tear. Screen protectors enhance the usability and durability of touch screen displays.

To remove the screen protector, lift the corner using a thin plastic card, such as a credit card, then carefully lift it off the display.

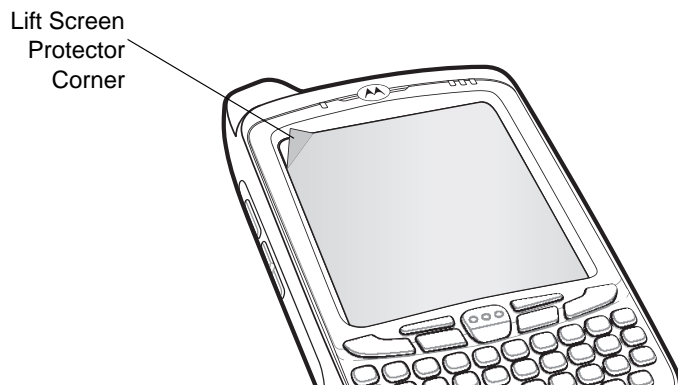

**Figure 11-1** Removing the Screen Protector



**CAUTION** Do not use a sharp object to remove the protector. Doing so can damage the display.



**NOTE** Not using a screen protector can affect warranty coverage. To purchase replacement protectors, contact your local account manager or Motorola, Inc. These include screen protector installation instructions. Part number: KT-67525-01R Screen Protector 3/pk.

---

## Battery Safety Guidelines

- The area in which the units are charged should be clear of debris and combustible materials or chemicals. Particular care should be taken where the device is charged in a non commercial environment.
- Follow battery usage, storage, and charging guidelines found in the user's guide.
- Improper battery use may result in a fire, explosion, or other hazard.

- To charge the mobile device battery, the battery and charger temperatures must be between +32 °F and +104 °F (0 °C and +40 °C)
- Do not use incompatible batteries and chargers. Use of an incompatible battery or charger may present a risk of fire, explosion, leakage, or other hazard. If you have any questions about the compatibility of a battery or a charger, contact Motorola Enterprise Mobility support.
- For devices that utilize a USB port as a charging source, the device shall only be connected to products that bear the USB-IF logo or have completed the USB-IF compliance program.
- To enable authentication of an approved battery, as required by IEEE1725 clause 10.2.1, all batteries will carry a Motorola hologram. Do not fit any battery without checking it has the Motorola authentication hologram.
- Do not disassemble or open, crush, bend or deform, puncture, or shred.
- Severe impact from dropping any battery-operated device on a hard surface could cause the battery to overheat.
- Do not short circuit a battery or allow metallic or conductive objects to contact the battery terminals.
- Do not modify or remanufacture, attempt to insert foreign objects into the battery, immerse or expose to water or other liquids, or expose to fire, explosion, or other hazard.
- Do not leave or store the equipment in or near areas that might get very hot, such as in a parked vehicle or near a radiator or other heat source. Do not place battery into a microwave oven or dryer.
- Battery usage by children should be supervised.
- Please follow local regulations to properly dispose of used re-chargeable batteries.
- Do not dispose of batteries in fire.
- In the event of a battery leak, do not allow the liquid to come in contact with the skin or eyes. If contact has been made, wash the affected area with large amounts of water and seek medical advice.
- If you suspect damage to your equipment or battery, contact Motorola Enterprise Mobility support to arrange for inspection.

---

## Cleaning



**CAUTION** Always wear eye protection.

Read warning label on compressed air and alcohol product before using.

If you have to use any other solution for medical reasons please contact Motorola for more information.



**WARNING!** Avoid exposing this product to contact with hot oil or other flammable liquids. If such exposure occurs, unplug the device and clean the product immediately in accordance with these guidelines.

## Materials Required

- Alcohol wipes
- Lens tissue
- Cotton tipped applicators

- Isopropyl alcohol
- Can of compressed air with a tube.

## Cleaning the MC65

### Housing

Using the alcohol wipes, wipe the housing including keys and in-between keys.

### Display

The display can be wiped down with the alcohol wipes, but care should be taken not to allow any pooling of liquid around the edges of the display. Immediately dry the display with a soft, non-abrasive cloth to prevent streaking.

### Scanner Exit Window

Wipe the scanner exit window periodically with a lens tissue or other material suitable for cleaning optical material such as eyeglasses.

### Connector

1. Remove the main battery from mobile computer. See [Replacing the Battery on page 1-8](#).
2. Dip the cotton portion of the cotton tipped applicator in isopropyl alcohol.
3. Rub the cotton portion of the cotton tipped applicator back-and-forth across the connector on the bottom of the MC65. Do not leave any cotton residue on the connector.
4. Repeat at least three times.
5. Use the cotton tipped applicator dipped in alcohol to remove any grease and dirt near the connector area.
6. Use a dry cotton tipped applicator and repeat steps 4 through 6.
7. Spray compressed air on the connector area by pointing the tube/nozzle about ½ inch away from the surface.



**CAUTION** Do not point nozzle at yourself and others, ensure the nozzle or tube is away from your face.

8. Inspect the area for any grease or dirt, repeat if required.

## Cleaning Cradle Connectors

To clean the connectors on a cradle:

1. Remove the DC power cable from the cradle.
2. Dip the cotton portion of the cotton tipped applicator in isopropyl alcohol.
3. Rub the cotton portion of the cotton tipped applicator along the pins of the connector. Slowly move the applicator back-and-forth from one side of the connector to the other. Do not let any cotton residue on the connector.
4. All sides of the connector should also be rubbed with the cotton tipped applicator.
5. Spray compressed air in the connector area by pointing the tube/nozzle about ½ inch away from the surface.



**CAUTION** Do not point nozzle at yourself and others, ensure the nozzle or tube is away from your face.

6. Ensure that there is no lint left by the cotton tipped applicator, remove lint if found.
7. If grease and other dirt can be found on other areas of the cradle, use lint free cloth and alcohol to remove.
8. Allow at least 10 to 30 minutes (depending on ambient temperature and humidity) for the alcohol to air dry before applying power to cradle.

If the temperature is low and humidity is high, longer drying time is required. Warm temperature and dry humidity requires less drying time.

## Cleaning Frequency

The cleaning frequency is up to the customer's discretion due to the varied environments in which the mobile devices are used. They may be cleaned as frequently as required. However when used in dirty environments it may be advisable to periodically clean the scanner exit window to ensure optimum scanning performance.

## Troubleshooting

### MC65

**Table 11-1** Troubleshooting the MC65

Problem	Cause	Solution
When pressing the power button the MC65 does not turn on.	Battery not charged.	Charge or replace the battery in the MC65.
	Battery not installed properly.	Install the battery properly. See <a href="#">Installing the Battery on page 1-4</a> .
	System crash.	Perform a reset. See <a href="#">Resetting the MC65 on page 2-19</a> .
When pressing the power button the MC65 does not turn on but two LEDs blink.	Battery charge is at a level where data is maintained but battery should be re-charged.	Charge or replace the battery in the MC65.
Rechargeable battery did not charge.	Battery failed.	Replace battery. If the MC65 still does not operate, perform a reset. See <a href="#">Resetting the MC65 on page 2-19</a> .
	MC65 removed from cradle while battery was charging.	Insert MC65 in cradle. The 3600 mAh battery fully charges in less than six hours.
	Extreme battery temperature.	Battery does not charge if ambient temperature is below 0°C (32°F) or above 40°C (104°F).
Cannot see characters on display.	MC65 not powered on.	Press the <b>Power</b> button.

**Table 11-1** Troubleshooting the MC65 (Continued)

Problem	Cause	Solution
During data communication, no data transmitted, or transmitted data was incomplete.	MC65 removed from cradle or disconnected from host computer during communication.	Replace the MC65 in the cradle, or reattach the communication cable and re-transmit.
	Incorrect cable configuration.	See the system administrator.
	Communication software was incorrectly installed or configured.	Perform setup. Refer to the <i>MC65 Integrator Guide</i> for details.
No sound.	Volume setting is low or turned off.	Adjust the volume. See <a href="#">Adjusting Volume on page 2-18</a> .
MC65 shuts off.	MC65 is inactive.	The MC65 turns off after a period of inactivity. If the MC65 is running on battery power, set this period from 1 to 5 minutes, in one-minute intervals. Check the <i>Power</i> window by selecting Tap <b>Status Bar</b> >  .
	Battery is depleted.	Replace the battery.
	Battery is not inserted properly.	Insert the battery properly. See <a href="#">Installing the Battery on page 1-4</a> .
Tapping the window buttons or icons does not activate the corresponding feature.	Screen is not calibrated correctly.	Re-calibrate the screen. Press <b>Blue</b> key - <b>Backspace</b> key.
	The device is not responding.	Reset the device. See <a href="#">Resetting the MC65 on page 2-19</a> .
A message appears stating that the MC65 memory is full.	Too many files stored on the MC65.	Delete unused memos and records. If necessary, save these records on the host computer (or use an SD card for additional memory).
	Too many applications installed on the MC65.	Remove user-installed applications on the MC65 to recover memory. Select <b>Start</b> > <b>Settings</b> > <b>System</b> tab and tap the <b>Remove Programs</b> icon. Select the unused program and tap <b>Remove</b> .
Camera application does not launch.	DataWedge application running.	Stop DataWedge application. Tap <b>Start</b> > <b>Settings</b> > <b>System</b> > <b>Task Manager</b> . Select DataWedge application and tap <b>End Task</b> .



**Table 11-1** *Troubleshooting the MC65 (Continued)*

<b>Problem</b>	<b>Cause</b>	<b>Solution</b>
The MC65 does not decode with reading bar code.	Scanning application is not loaded.	Load a scanning application on the MC65. See your system administrator.
	Unreadable bar code.	Ensure the symbol is not defaced.
	Distance between exit window and bar code is incorrect.	Place the MC65 within proper scanning range.
	MC65 is not programmed for the bar code.	Program the MC65 to accept the type of bar code being scanned. Refer to the EMDK or Control Panel application.
	MC65 is not programmed to generate a beep.	If the MC65 does not beep on a good decode, set the application to generate a beep on good decode.
	Battery is low.	If the scanner stops emitting a laser beam upon a trigger press, check the battery level. When the battery is low, the scanner shuts off before the MC65 low battery condition notification. Note: If the scanner is still not reading symbols, contact the distributor or Motorola.

## Bluetooth Connection

**Table 11-2** *Troubleshooting Bluetooth Connection*

<b>Problem</b>	<b>Cause</b>	<b>Solution</b>
MC65 cannot find any Bluetooth devices nearby.	Too far from other Bluetooth devices.	Move closer to the other Bluetooth device(s), within a range of 10 meters (32.8 feet).
	The Bluetooth device(s) nearby are not turned on.	Turn on the Bluetooth device(s) to find.
	The Bluetooth device(s) are not in discoverable mode.	Set the Bluetooth device(s) to discoverable mode. If needed, refer to the device's user documentation for help.



## Single Slot USB Cradle

**Table 11-3** Troubleshooting the Single Slot USB Cradle

Symptom	Possible Cause	Action
LEDs do not light when MC65 or spare battery is inserted.	Cradle is not receiving power.	Ensure the power cable is connected securely to both the cradle and to AC power.
	MC65 is not seated firmly in the cradle.	Remove and re-insert the MC65 into the cradle, ensuring it is firmly seated.
	Spare battery is not seated firmly in the cradle.	Remove and re-insert the spare battery into the charging slot, ensuring it is firmly seated.
MC65 battery is not charging.	MC65 was removed from cradle or cradle was unplugged from AC power too soon.	Ensure cradle is receiving power. Ensure MC65 is seated correctly. Confirm main battery is charging under Tap <b>Status Bar</b> >  . The 3600 mAh battery fully charges in less than six hours.
	Battery is faulty.	Verify that other batteries charge properly. If so, replace the faulty battery.
	The MC65 is not fully seated in the cradle.	Remove and re-insert the MC65 into the cradle, ensuring it is firmly seated.
	Extreme battery temperature.	Battery does not charge if ambient temperature is below 0°C (32°F) or above 40°C (104°F).
Spare battery is not charging.	Battery not fully seated in charging slot.	Remove and re-insert the spare battery in the cradle, ensuring it is firmly seated.
	Battery inserted incorrectly.	Re-insert the battery so the charging contacts on the battery align with the contacts on the cradle.
	Battery is faulty.	Verify that other batteries charge properly. If so, replace the faulty battery.
During data communication, no data transmits, or transmitted data was incomplete.	MC65 removed from cradle during communications.	Replace MC65 in cradle and retransmit.
	Communication software is not installed or configured properly.	Perform setup as described in the <i>MC65 Integrator Guide</i> .

## Four Slot Ethernet Cradle

**Table 11-4** *Troubleshooting the Four Slot Ethernet Cradle*

Symptom	Cause	Solution
During communication, no data transmits, or transmitted data was incomplete.	MC65 removed from cradle during communications.	Replace MC65 in cradle and retransmit.
	MC65 has no active connection.	An icon is visible in the status bar if a connection is currently active.
Battery is not charging.	MC65 removed from the cradle too soon.	Replace the MC65 in the cradle. The 3600 mAh battery fully charges in less than six hours. Tap <b>Status Bar</b> >  to view battery status.
	Battery is faulty.	Verify that other batteries charge properly. If so, replace the faulty battery.
	MC65 is not inserted correctly in the cradle.	Remove the MC65 and reinsert it correctly. Verify charging is active. Tap <b>Status Bar</b> >  to view battery status.
	Ambient temperature of the cradle is too warm.	Move the cradle to an area where the ambient temperature is between 0°C (32°F) and 50°C (122°F).

## Vehicle Cradle

**Table 11-5** *Troubleshooting the Vehicle Cradle*

Symptom	Possible Cause	Action
MC65 battery charging LED does not light up.	Cradle is not receiving power.	Ensure the power input cable is securely connected to the cradle's power port.
MC65 battery is not recharging.	MC65 was removed from the cradle too soon.	Replace the MC65 in the cradle. The 3600 mAh battery fully charges in less than six hours.
	Battery is faulty.	Replace the battery.
	MC65 is not placed correctly in the cradle.	Remove the MC65 from the cradle, and re-insert correctly. If the battery still does not charge, contact customer support. The MC65 battery charging LED slowly blinks amber when the MC65 is correctly inserted and charging.
	Ambient temperature of the cradle is too warm.	Move to an area where the ambient temperature is between -20°C and 50°C (-4°F and 122°F).

## Four Slot Battery Charger

**Table 11-6** *Troubleshooting The Four Slot Battery Charger*

Symptom	Possible Cause	Action
Battery not charging.	Battery was removed from the charger or charger was unplugged from AC power too soon.	Re-insert the battery in the charger or re-connect the charger's power supply. The 3600 mAh battery fully charges in less than six hours.
	Battery is faulty.	Verify that other batteries charge properly. If so, replace the faulty battery.
	Battery contacts not connected to charger.	Verify that the battery is seated in the battery well correctly with the contacts facing down.

## Cables

**Table 11-7** *Troubleshooting the Cables*

Symptom	Possible Cause	Action
MC65 battery is not charging.	MC65 was disconnected from AC power too soon.	Connect the power cable correctly. Confirm main battery is charging under Tap <b>Status Bar</b> >  . The 3600 mAh battery fully charges in less than six hours.
	Battery is faulty.	Verify that other batteries charge properly. If so, replace the faulty battery.
	The MC65 is not fully attached to power.	Detach and re-attach the power cable to the MC65, ensuring it is firmly connected.
During data communication, no data transmits, or transmitted data was incomplete.	Cable was disconnected from MC65 during communications.	Re-attach the cable and retransmit.
	Incorrect cable configuration.	See the system administrator.
	Communication software is not installed or configured properly.	Perform setup as described in the <i>MC65 Integrator Guide</i> .

## Magnetic Stripe Reader

**Table 11-8** *Troubleshooting the Magnetic Stripe Reader*

Symptom	Possible Cause	Action
MSR cannot read card.	MSR removed from MC65 during card swipe.	Reattach MSR to MC65 and reswipe the card.
	Faulty magnetic stripe on card.	See the system administrator.
	MSR application is not installed or configured properly.	Ensure the MSR application is installed on the MC65. Ensure the MSR application is configured correctly.
MC65 battery is not charging.	MC65 was removed from MSR or MSR was unplugged from AC power too soon.	Ensure MSR is receiving power. Ensure MC65 is attached correctly. Confirm main battery is charging under <b>Start &gt; Settings &gt; System &gt; Power</b> . The 3600 mAh battery fully charges in less than six hours.
	Battery is faulty.	Verify that other batteries charge properly. If so, replace the faulty battery.
	The MC65 is not fully attached to the MSR.	Detach and re-attach the MSR to the MC65, ensuring it is firmly connected.
During data communication, no data transmits, or transmitted data was incomplete.	MC65 detached from MSR during communications.	Reattach MC65 to MSR and retransmit.
	Incorrect cable configuration.	See the system administrator.
	Communication software is not installed or configured properly.	Perform setup as described in the <i>MC65 Integrator Guide</i> .



# Appendix A Technical Specifications

## MC65 Technical Specifications

The following tables summarize the EDA's intended operating environment and technical hardware specifications.

### MC65

**Table A-1** MC65 EDA Technical Specifications

Item	Description
<b>Physical Characteristics</b>	
Dimensions	Height: 16.2 cm (6.38 in.) Width: 7.7 cm (3.03 in.) Depth: 3.4 cm (1.32 in.)
Weight	359 g (12.5 oz.)
Display	Transflective color 3.5" VGA with backlight, TFT-LCD, 65K colors, 480 W x 640 L
Touch Panel	Glass analog resistive touch
Backlight	LED backlight
Battery Pack	Rechargeable Lithium Ion 3.7V, 3600 mAh battery
Expansion Slot	microSD slot (supports up to 32 GB).
Connection Interface	USB 2.0 High Speed (host and client)
Notification	Audible tone plus multi-color LEDs
Keypad Options	numeric, QWERTY, AZERTY or QWERTZ
Audio	Dual microphone support with noise cancellation; vibrate alert; speaker; Bluetooth headset

**Table A-1** MC65 EDA Technical Specifications (Continued)

Item	Description
<b>Performance Characteristics</b>	
CPU	MSM Qualcomm 7627 @ 600 MHz (multi-processor architecture)
Operating System	Microsoft® Windows Mobile™ 6.5 Professional
Memory	256 MB RAM/1 GB Flash
Output Power	USB - 5 VDC @ 300 mA max.
<b>User Environment</b>	
Operating Temperature	-10°C to 50°C (14°F to 122°F)
Storage Temperature	-40°C to 70°C (-40°F to 158°F)
Charging Temperature	0° C to 40° C (32°F to 104°F)
Humidity	5 to 95% non-condensing
Drop Specification	Multiple 6 ft. drops per MIL-STD 810G specifications Multiple 5 ft. drops to concrete at room temperature Multiple 4 ft. drops to concrete across the operating temperature range
Tumble	1,000 1.6 ft./0.5 meter tumbles at room temperature; per applicable IEC tumble specifications
Electrostatic Discharge (ESD)	+/-15kVdc air discharge, +/-8kVdc direct discharge, +/-8kVdc indirect discharge
Sealing	IP64; per applicable IEC sealing specifications
Vibration	4g's PK Sine (5Hz to 2KHz); 0.04g2/Hz Random (20Hz to 2KHz); 60 minute duration per axis, 3 axis
Thermal Shock	-40° C to 70° C (-40° F to 158° F) rapid transition
<b>Battery Performance</b>	
Standby Time	100 hours
Talk Time	6 hours
User Profiles	8 hours
<b>Motorola Interactive Sensor Technology (IST)</b>	
Motion Sensor	3-axis accelerometer that enables motion-sensing applications for dynamic screen orientation and power management.
Light Sensor	Ambient light sensor to auto adjust display and keypad backlight brightness.
<b>Wireless WAN Data and Voice Communications</b>	
Radio	Dual 3.5G: GSM HSPA/HSUPA and CDMA EVDO Rev A



**Table A-1** MC65 EDA Technical Specifications (Continued)

Item	Description
Frequency Band	UMTS/HSDPA and HSUPA: 850, 1900 and 2100 MHz GSM/EDGE: 850, 900, 1800 and 1900 MHz CDMA/EVDO Rev A: 850 and 1900 MHz
Antenna	External
<b>Wireless LAN Data and Voice Communications</b>	
Radio	Tri-mode IEEE® 802.11a/b/g
Data Rates Supported	1, 2, 5.5, 6, 9, 11, 12, 18, 24, 36, 48, and 54 Mbps
Operating Channels	Chan 36-165 (5180 – 5825 MHz) Chan 1-13 (2412-2472 MHz) Chan 14 (2484 MHz) Japan only Actual operating channels/frequencies depend on regulatory rules and certification agency
Security	WPA2 (Personal or Enterprise); 802.1x; EAP-TLS; TTLS (CHAP, MS-CHAP, MS-CHAPv2, PAP or MD5); PEAP (TLS, MSCHAPv2, EAP-GTC); LEAP, EAP-FAST (TLS, MS-CHAPv2, EAP-GTC)
Antenna	Internal antenna
Voice Communications	Voice-over-IP ready, Wi-Fi™-certified, IEEE 802.11a/b/g direct sequence wireless LAN, Wi-Fi Multimedia™ (WMM and WMM-PS) Motorola Voice Quality Manager (VQM), Motorola TEAM Express Ready
<b>Wireless PAN Data and Voice Communications</b>	
Bluetooth	Class II, v2.1 with Enhanced Data Rate (EDR); integrated antenna
<b>Global Positioning System</b>	
GPS	Integrated stand-alone or Assisted-GPS (A-GPS).
<b>Regulatory</b>	
Electrical Safety	IEC/UL/CSA/EN 60950-1
Environmental	RoHS/WEEE compliant
WLAN and Bluetooth (PAN)	<b>USA:</b> FCC Part 15.247, 15.407 <b>Canada:</b> RSS-210 <b>EU:</b> EN 300 328, EN 301 893 <b>Japan:</b> ARIB STD-T33, T66, T70, T71 <b>Australia:</b> AS/NZS 4268

**Table A-1** MC65 EDA Technical Specifications (Continued)

Item	Description
Wireless Wide Area Network	GSM-HSDPA <b>Global:</b> 3GPP TS 51.010, 3GPP TS 34.121, 3GPP TS 34.123, GCF and PTCRB approved module <b>USA:</b> FCC Part 22, Part 24 <b>Canada:</b> RSS-132, RSS-133 <b>EU:</b> EN 301 511, EN 301 908 <b>Australia:</b> AS/ACIF S 024.1 & 3 CDMA-EvDO Rev A <b>USA:</b> FCC Part 22, Part 24 <b>Canada:</b> RSS-132, RSS-133
RF Exposure	<b>USA:</b> FCC Part 2, FCC OET Bulletin 65 Supplement C <b>Canada:</b> RSS-102 <b>EU:</b> EN 50360, EN62311 <b>Australia:</b> Radio communications Standard 2003
EMI/RFI	<b>USA:</b> FCC Part 15, Class B <b>Canada:</b> ICES 003 Class B <b>EU:</b> EN55022 Class B, EN55024, EN 301 489-1, EN 301 489-3, EN 301 489-7, EN 301 489-17, EN 301 489-24, EN 60601-1-2, EN 50121-3-2, EN 50121-4 <b>Australia:</b> AS/NZS CISPR-22
<b>Data Capture Specifications</b>	
Options	2D imager, 2D imager and color camera
<b>2D Imager Engine (SE4600) Specifications</b>	
Field of View	Horizontal - 39.6° Vertical - 25.7°
Optical Resolution	WVGA 752 H x 480 V pixels (gray scale)
Roll	360°
Pitch Angle	+/- 60° from normal
Skew Tolerance	+/- 60° from normal
Ambient Light	Indoor: 450 ft. candles (4845 lux) Outdoor: 9000 ft. candles (96,900 lux) Sunlight: 8000 ft. candles Fluorescent: 450 ft. candles
Focal Distance	From center of exit window: SR - 7.5 in. (19 cm)
Aiming Element (VLD)	655 nm +/- 10 nm

**Table A-1** MC65 EDA Technical Specifications (Continued)

Item	Description
Illumination Element (LED)	625 nm +/- 5 nm
<b>Camera Specifications</b>	
Resolution	3.2 Mega pixel

**Table A-2** Data Capture Options

Item	Description		
Laser Decode Capability	Code 39 Codabar Interleaved 2 of 5 MSI UPC/EAN supplementals Webcode GS1 DataBar Truncated GS1 DataBar Expanded GS1 DataBar Stacked Omni	Code 128 Code 11 EAN-8 UPCA Coupon Code Chinese 2 of 5 GS1 DataBar Limited GS1 DataBar Expanded Stacked	Code 93 Discrete 2 of 5 EAN-13 UPCE Trioptic 39 GS1 DataBar GS1 DataBar Stacked
Imaging Decode Capability	Code 39 Codabar Discrete 2 of 5 EAN-13 UPC/EAN supplementals Webcode Composite C Macro PDF-417 Data Matrix US Planet Canadian 4-state Chinese 2 of 5 microQR GS1 DataBar Truncated GS1 DataBar Expanded GS1 DataBar Stacked Omni	Code 128 Code 11 MSI UPCA Coupon Code TLC39 Micro PDF-417 (Macro) Micro PDF-417 Maxi Code UK 4-state Japanese 4-state USPS 4-state (US4CB) GS1 DataBar GS1 DataBar Limited GS1 DataBar Expanded Stacked	Code 93 Interleaved 2 of 5 EAN-8 UPCE Trioptic 39 Composite AB PDF-417 QR Code US Postnet Australian 4-state Dutch Kix Aztec GS1 DataBar Stacked

**Table A-2** Data Capture Options (Continued)

Item	Description		
Camera Decode Capability	Code 39	Code 128	Code 93
	Codabar	Code 11	Interleaved 2 of 5
	Discrete 2 of 5	MSI	EAN-8
	EAN-13	UPCA	UPCE
	UPC/EAN supplementals	Coupon Code	Trioptic 39
	Webcode	TLC39	Composite AB
	Composite C	Micro PDF-417	PDF-417
	Macro PDF-417	(Macro) Micro PDF-417	QR Code
	Data Matrix	Maxi Code	US Postnet
	US Planet	UK 4-state	Australian 4-state
	Canadian 4-state	Japanese 4-state	Dutch Kix
	GS1 DataBar		
	GS1 DataBar Truncated	GS1 DataBar Limited	GS1 DataBar Stacked
	GS1 DataBar Expanded	GS1 DataBar Expanded Stacked	
	GS1 DataBar Stacked Omni		

## MC65 Accessory Specifications

### Single Slot USB Cradle

**Table A-3** Single Slot USB Cradle Technical Specifications

Feature	Description
Dimensions	Height: 7.1 cm (2.80 in.) Width: 11.0 cm (4.33 in.) Depth: 15.0 cm (5.91 in.)
Weight	210 g (7.41 oz)
Input Voltage	12 VDC
Power Consumption	30 watts
Interface	USB
Operating Temperature	0°C to 50°C (32°F to 122°F)
Storage Temperature	-40°C to 70°C (-40°F to 158°F)
Charging Temperature	0°C to 40°C (32°F to 104°F)
Humidity	5% to 95% non-condensing
Drop	76.2 cm (30.0 in.) drops to vinyl tiled concrete at room temperature
Electrostatic Discharge (ESD)	+/- 15 kV air +/- 8 kV contact

## Four Slot Battery Charger

**Table A-4** *Four Slot Battery Charger Technical Specifications*

Feature	Description
Dimensions	Height: 4.7 cm (1.85 in.) Width: 15.5 cm (6.10 in.) Depth: 21.0 cm (8.27 in.)
Weight	384 g (13.55 oz)
Input Voltage	12 VDC
Power Consumption	30 watts
Operating Temperature	0°C to 40°C (32°F to 104°F)
Storage Temperature	-40°C to 70°C (-40°F to 158°F)
Charging Temperature	0°C to 40°C (32°F to 104°F)
Humidity	5% to 95% non-condensing
Drop	76.2 cm (30.0 in.) drops to vinyl tiled concrete at room temperature
Electrostatic Discharge (ESD)	+/- 15 kV air +/- 8 kV contact

## Four Slot Charge Only Cradle

**Table A-5** *Four Slot Charge Only Cradle Technical Specifications*

Feature	Description
Dimensions	Height: 13.7 cm (5.39 in.) Width: 46.8 cm (18.43 in.) Depth: 9.9 cm (3.90 in.)
Weight	1115 g (39.33 oz)
Input Voltage	12 VDC
Power Consumption	100 watts
Operating Temperature	0°C to 50°C (32°F to 122°F)
Storage Temperature	-40°C to 70°C (-40°F to 158°F)
Charging Temperature	0°C to 40°C (32°F to 104°F)

**Table A-5** *Four Slot Charge Only Cradle Technical Specifications (Continued)*

Feature	Description
Humidity	5% to 95% non-condensing
Drop	76.2 cm (30.0 in.) drops to vinyl tiled concrete at room temperature
Electrostatic Discharge (ESD)	+/- 15 kV air +/- 8 kV contact

## Four Slot Ethernet Cradle

**Table A-6** *Four Slot Ethernet Cradle Technical Specifications*

Feature	Description
Dimensions	Height: 13.7 cm (5.39 in.) Width: 46.8 cm (18.43 in.) Depth: 9.9 cm (3.90 in.)
Weight	1115 g (39.33 oz)
Power	12 VDC
Operating Temperature	0°C to 50°C (32°F to 122°F)
Storage Temperature	-40°C to 70°C (-40°F to 158°F)
Charging Temperature	0°C to 40°C (32°F to 104°F)
Humidity	5% to 95% non-condensing
Drop	76.2 cm (30.0 in.) drops to vinyl tiled concrete at room temperature
Electrostatic Discharge (ESD)	+/- 15 kV air +/- 8 kV contact

## Magstripe Reader

**Table A-7** *Magstripe Reader (MSR) Technical Specifications*

Feature	Description
Dimensions	TBD
Weight	TBD
Interface	Serial with baud rate up to 19,200
Format	ANSI, ISO, AAMVA, CA DMV, user-configurable generic format
Swipe Speed	5 to 50 in. (127 to 1270 mm) /sec, bi-directional
Decoders	Generic, Raw Data

**Table A-7** *Magstripe Reader (MSR) Technical Specifications (Continued)*

Feature	Description
Mode	Buffered, unbuffered
Track Reading Capabilities	Tracks 1 and 3: 210 bpi Track 2: 75 and 210 bpi, autodetect
Operating Temperature	32° to 122° F (0° to 50° C)
Storage Temperature	-40° to 158° F (-40° to 70° C)
Humidity	5% to 95% non-condensing
Drop	4 ft. (1.22 m) drops to concrete
Electrostatic Discharge (ESD)	+/- 15 kV air +/- 8 kV contact

## Vehicle Cradle

**Table A-8** *Vehicle Cradle Technical Specifications*

Feature	Description
Dimensions	Height: 10.4 cm (4.09 in.) Width: 11.1 cm (4.37 in.) Depth: 6.9 cm (2.72 in.)
Weight	240 g (8.47 oz)
Power	9- 32 VDC
Operating Temperature	-20°C to 50°C (-4°F to 122°F)
Storage Temperature	-40°C to 70°C (-40°F to 158°F)
Charging Temperature	0°C to 40°C (32°C to 104°F)
Humidity	10% to 95% non-condensing
Drop	76.2 cm (30.0 in.) drops to vinyl tiled concrete at room temperature
Electrostatic Discharge (ESD)	+/- 15 kV air +/- 8 kV contact

## Cables

**Table A-9** *USB Charging Cable Technical Specifications*

Feature	Description
Length	161.9 cm (63.74 in.)
Operating Temperature	-10°C to 50°C (14°F to 122°F)
Storage Temperature	-40°C to 70°C (-40°F to 158°F)
Humidity	10% to 95% non-condensing
Electrostatic Discharge (ESD)	+/- 15 kV air +/- 8 kV contact

**Table A-10** *Charge Only Cable Technical Specifications*

Feature	Description
Length	28.0 cm (11.00 in.)
Operating Temperature	-10°C to 50°C (14°F to 122°F)
Storage Temperature	-40°C to 70°C (-40°F to 158°F)
Humidity	10% to 95% non-condensing
Electrostatic Discharge (ESD)	+/- 15 kV air +/- 8 kV contact

**Table A-11** *Auto Charge Cable Technical Specifications*

Feature	Description
Length	169.0 cm (66.54 in.)
Input Voltage	12 - 24 VDC
Operating Temperature	-10°C to 50°C (14°F to 122°F)
Storage Temperature	-40°C to 70°C (-40°F to 158°F)
Humidity	10% to 95% non-condensing
Electrostatic Discharge (ESD)	+/- 15 kV air +/- 8 kV contact



# Appendix B Keypads

## Introduction

The MC65 offers four types of keypad configurations: Numeric, QWERTY, QWERTZ and AZERTY.

### Numeric Keypad Configuration

The numeric keypad contains application keys, scroll keys, and function keys. The keypad is color-coded to indicate the alternate function key (blue) values. Note that an application can change keypad functions so the MC65's keypad may not function exactly as described. See [Table B-1](#) for key and button descriptions and [Table B-2 on page B-4](#) for the keypad's special functions.

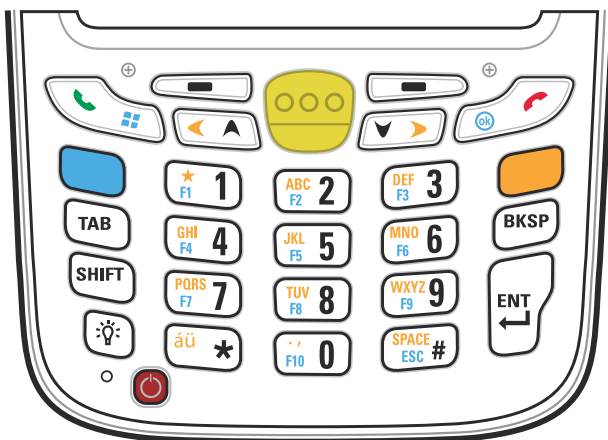

Figure B-1 MC65 Numeric Keypad

**Table B-1** MC65 Numeric Keypad Descriptions

















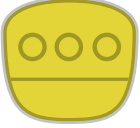

Key	Description
<p>Blue Key</p> 	<p>Use this key to launch applications or access items (shown on the keypad in blue). Press the Blue key once to activate this mode, followed by another key.</p> <p>A single press illuminates the key and displays the following icon at the bottom of the screen, until a second key is pressed: </p>
<p>Orange Key</p> 	<p>Use this key to access the secondary layer of characters and actions (shown on the keypad in orange). Press the Orange key once to lock the keypad into Alpha state. A single press illuminates the key and displays the following icon at the bottom of the screen: </p> <p>Press the Orange key a second time to return to the normal state.</p> <p>Press the Orange key, then the Shift key to add a temporary shift (that applies only to the next key pressed) to the orange lock state. This displays the following icon at the bottom of the screen: </p>
<p>Talk/Start Menu</p> 	<p>Talk (Green Phone): press to display the phone keypad window or to dial a phone number (from the phone keypad window).</p> <p>When on a phone call, press to place the call on hold.</p> <p>Use this key in conjunction with the Blue key to instantly display the <i>Start</i> menu from any application without tapping the screen. This function is user programmable.</p>
<p>Scan (yellow)</p> 	<p>Activates the scanner/imager in a scan enabled application.</p>
<p>End/OK</p> 	<p>End (Red Phone): press when the phone keypad window displays to stop dialing or end a call.</p> <p>Use this key in conjunction with the Blue key as an OK or close button. This function is user programmable.</p>
<p>Scroll Up and Left</p> 	<p>Moves up one item.</p> <p>Moves left one item when pressed with the Orange key.</p>
<p>Scroll Down and Right</p> 	<p>Moves down one item.</p> <p>Moves right one item when pressed with the Orange key.</p>

Table B-1 MC65 Numeric Keypad Descriptions (Continued)

Key	Description
Soft Keys 	Accesses the command or menu above it on the screen.
Star 	Produces an asterisk in default state. Press and release the blue key, then press the Star key to open the <i>Start</i> menu.
Alphanumeric 	In default state, produces the numeric value on the key. In Alpha state, produces the lower case alphabetic characters on the key. Each key press produces the next alphabetic character in sequence. For example, press and release the Orange key and then press the '4' key once to produce the letter 'g'; press and release the Orange key and then press the '4' key three times to produce the letter 'i'. Press the SHIFT key in Alpha state to produce the upper case alphabetic characters on the key. For example, press and release the Orange key, press and release the SHIFT key, and then press the '4' key once to produce the letter 'G'; press and release the Orange key, press and release the SHIFT key and then press the '4' key three times to produce the letter 'I'.
Backspace 	Produces a backspace.
SHIFT 	Press and release the SHIFT key to activate the keypad alternate SHIFT functions. A single press displays the following icon at the bottom of the screen, until a second key is pressed:  Press the Orange key, then the Shift key to add a temporary shift (that applies only to the next key pressed) to the orange lock state. This displays the following icon at the bottom of the screen: 
Enter 	Executes a selected item or function.

**Table B-2** Numeric Keypad Input Modes

Key	Numeric Mode			Orange Key (Alpha Lowercase Mode)				Orange + Shift Keys (Alpha Uppercase Mode)			
		Blue+ Key	SHIFT + Key	1st Press	2nd Press	3rd Press	4th Press	1st Press	2nd Press	3rd Press	4th Press
1	1	F1	!	*	*	*	*	*	*	*	*
2	2	F2	@	a	b	c		A	B	C	
3	3	F3	#	d	e	f		D	E	F	
4	4	F4	\$	g	h	i		G	H	I	
5	5	F5	%	j	k	l		J	K	L	
6	6	F6	^	m	n	o		M	N	O	
7	7	F7	&	p	q	r	s	P	Q	R	S
8	8	F8	*	t	u	v		T	U	V	
9	9	F9	(	w	x	y	z	W	X	Y	Z
0	0	F10	)	.				>			
Up	Up	Up	Hilight Up	Left				Left			
Down	Down	Down	Hilight Down	Right				Right			
Enter	Action	Action	Action	Action				Action			

Note: An application can change the key functions. The keypad may not function exactly as described.

## Alpha-numeric Keypad Configurations

The three types of alpha-numeric keypads (QWERTY, AZERTY and QWERTZ) produce the 26-character alphabet (A-Z, both lowercase and uppercase), numbers (0-9), and assorted characters. The keypad is color-coded to indicate which modifier key to press to produce a particular character or action. The keypad default is alphabetic, producing lowercase letters. See [Table B-3](#) for key and button descriptions and [Table B-4 on page B-8](#) for the keypad's special functions. AZERTY keypad is used on configurations installed with the French operating system. QWERTZ keypad is used on configurations installed with the German operating system.



Figure B-2 QWERTY Keypad Configuration







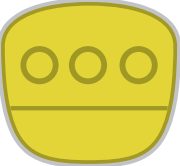



Figure B-3 AZERTY Keypad Configuration













Figure B-4 QWERTZ Keypad Configuration

**Table B-3** Alpha-numeric Keypad Descriptions

Key	Action
<p>Blue Key</p> 	<p>Press the Blue key once to activate this mode temporarily, followed by another key. This displays the following icon at the bottom of the screen, until a second key is pressed: </p> <p>Press the Blue key twice to lock this mode. This displays the following icon at the bottom of the screen: </p> <p>Press the Blue key a third time to unlock.</p>
<p>Orange Key</p> 	<p>Accesses the secondary layer of characters and actions (shown on the keypad in orange).</p> <p>Press the Orange key once to activate this mode temporarily, followed by another key. This displays the following icon at the bottom of the screen, until a second key is pressed: </p> <p>Press the Orange key twice to lock this mode. This displays the following icon at the bottom of the screen: </p> <p>Press the Orange key a third time to unlock.</p>
<p>Talk/Start Menu</p> 	<p>Talk (Green Phone): press to display the phone keypad window or to dial a phone number (from the phone keypad window).</p> <p>When on a phone call, press to place the call on hold.</p> <p>Use this key in conjunction with the Blue key to instantly display the <i>Start</i> menu from any application without tapping the screen. This function is user programmable.</p>
<p>Scan (yellow)</p> 	<p>Activates the scanner/imager in a scan enabled application.</p>
<p>End/OK</p> 	<p>End (Red Phone): press when the phone keypad window displays to stop dialing or end a call.</p> <p>Use this key in conjunction with the Blue key as an OK or close button. This function is user programmable.</p>
<p>Scroll Up and Left</p> 	<p>Moves up one item.</p> <p>Moves left one item when pressed with the Orange key.</p>

**Table B-3** Alpha-numeric Keypad Descriptions (Continued)

Key	Action
Scroll Down and Right 	Moves down one item. Moves right one item when pressed with the Orange key.
Soft Keys 	Accesses the command or menu above it on the screen.
Shift 	Changes the state of the alpha characters from lowercase to uppercase. <ul style="list-style-type: none"> <li>• Press the Shift key to activate this mode temporarily, followed by another key. This displays the following icon at the bottom of the screen, until a second key is pressed: </li> <li>• Press the Shift key twice to lock this mode. This displays the following icon at the bottom of the screen: </li> </ul> Press the Shift key a third time to unlock.
Backlight 	Turns the display backlight on and off.
Backspace 	Produces a backspace.
Enter 	Executes a selected item or function.
Star 	Produces an asterisk.
au 	Creates special characters.

**Table B-4** QWERTY Keypad Input Modes

Key	Normal	Shift + Key	Orange + Key	Blue + Key
Q	q	Q	*	q
W	w	W	1	w
E	e	E	2	e
R	r	R	3	r
T	t	T	+	t
Y	y	Y	_	y
U	u	U	-	u
I	i	I	=	i
O	o	O	"	o
P	p	P	áü	p
A	a	A	#	a
S	s	S	4	s
D	d	D	5	d
F	f	F	6	f
G	g	G	(	g
H	h	H	)	h
J	j	J	/	j
K	k	K	:	k
L	l	L	'	l
Backspace	Backspace	Backspace	Backspace	Backspace
Shift	Shift	Shift-Lock	Shift	Shift
Z	z	Z	7	z
X	x	X	8	x
C	c	C	9	c
V	v	V	%	v
B	b	B	&	b
N	n	N	!	n
M	m	M	?	m

Note: An application can change the key functions. The keypad may not function exactly as described.



**Table B-4** QWERTY Keypad Input Modes (Continued)

Key	Normal	Shift + Key	Orange + Key	Blue + Key
,	,	<	@	,
ENTER	Enter	Enter	Enter	Enter
0	0	)	0	0
TAB	Tab	Tab	Back tab	Tab
SPACE	Space	Space	Space	Space
Backlight	Backlight	Backlight	Backlight	Backlight
. (Period)	.	>	.	.

Note: An application can change the key functions. The keypad may not function exactly as described.

**Table B-5** AZERTY Keypad Input Modes

Key	Normal	Shift + Key	Orange + Key	Blue + Key
A	a	A	*	a
Z	z	Z	1	z
E	e	E	2	e
R	r	R	3	r
T	t	T	+	t
Y	y	Y	_	y
U	u	U	-	u
I	i	I	=	i
O	o	O	"	o
P	p	P	áü	p
Q	q	Q	#	q
S	s	S	4	s
D	d	D	5	d
F	f	F	6	f
G	g	G	(	g
H	h	H	)	h
J	j	J	/	j
K	k	K	:	k

Note: An application can change the key functions. The keypad may not function exactly as described.

**Table B-5** AZERTY Keypad Input Modes (Continued)

Key	Normal	Shift + Key	Orange + Key	Blue + Key
L	l	L	‘	l
Backspace	Backspace	Backspace	Backspace	Backspace
Shift	Shift	Shift-Lock	Shift	Shift
W	w	W	7	w
X	x	X	8	x
C	c	C	9	c
V	v	V	%	v
B	b	B	&	b
N	n	N	!	n
M	m	M	?	m
,	,	<	@	
Enter	Enter	Enter	Enter	Enter
0	0	)	0	0
TAB	Tab	Tab	Back tab	Tab
SPACE	Space	Space	Space	Space
Backlight	Backlight	Backlight	Backlight	Backlight
. (Period)	.	>	.	.

Note: An application can change the key functions. The keypad may not function exactly as described.

**Table B-6** QWERTZ Keypad Input Modes

Key	Normal	Shift + Key	Orange + Key	Blue + Key
Q	q	Q	*	q
W	w	W	1	w
E	e	E	2	e
R	r	R	3	r
T	t	T	+	t
Z	z	Z	_	z
U	u	U	-	u
I	i	I	=	i

Note: An application can change the key functions. The keypad may not function exactly as described.

**Table B-6** QWERTZ Keypad Input Modes (Continued)

Key	Normal	Shift + Key	Orange + Key	Blue + Key
O	o	O	“	o
P	p	P	áü	p
A	a	A	#	a
S	s	S	4	s
D	d	D	5	d
F	f	F	6	f
G	g	G	(	g
H	h	H	)	h
J	j	J	/	j
K	k	K	:	k
L	l	L	‘	l
Backspace	Backspace			
Shift	Shift			
Y	y	Y	7	y
X	x	X	8	x
C	c	C	9	c
V	v	V	%	v
B	b	B	&	b
N	n	N	!	n
M	m	M	?	m
,	,	<	@	,
ENTER	Enter	ENTER	ENTER	Enter
0	0	)	0	0
TAB	Tab	Tab	Back tab	Tab
SPACE	Space	Space	Space	Space
Backlight	Backlight	Backlight	Backlight	Backlight
. (Period)	.	>	.	.

Note: An application can change the key functions. The keypad may not function exactly as described.

### Special Character Key

✓ **NOTE** Special characters are only available on the alpha-numeric keypad configurations.

To add special characters using the MC65 **áü** key, type the related character first, then press the Orange twice followed by the **áü (P)** key. Continue pressing the **áü** key until the special character displays. To modify an existing character, move the cursor to the right of the character then press the Orange key twice and then press the **áü** key until the special character replaces the original character. [Table B-7](#) lists the special characters you can generate.

**Table B-7** Special Characters

Key	Special Characters		Key	Special Characters
a	à á â ã ä å æ		A	À Á Â Ã Ä Å Æ
c	ç ć ċ ©		C	Ç Ć Ć ©
d	ð		D	Ð
e	è é ê ë ě		E	È É Ê Ë Ě
i	ì í î ï		I	Ì Í Î Ï
l	ł		L	Ł
n	ñ		N	Ñ
o	ò ó ô õ ö ø œ		O	Ò Ó Ô Õ Ö Ø Œ
p	þ		P	Þ
r	®		R	®
s	ş š ß		S	Ş Š ß
t	ţ		T	Ţ
u	ù ú û ü		U	Ù Ú Û Ü
y	ý		Y	Ý
z	ź ź		Z	Ź Ź
\$	€ £ ¥		/	\
"	' « ' »		(	[ { < «
)	] } > »		+	± & - _
!	! ? ¿		.	! ;
*	#		@	~ %
%	^		,	; . :
#	*		&	- _ + ±
_	+ ± & -		'	« » "

**Table B-7** *Special Characters (Continued)*

Key	Special Characters		Key	Special Characters
?	¿ !		:	, ; .
-	_ + ± &			





Touch and hold the screen with your finger and move the Home screen up and down. As the application names move under the Information Status bar, information relevant to that application appear in the bar.



**Figure C-2** *Moving Today Screen*

You can also touch and hold the Information Status bar and move it up and down over an application name. Remove your finger and the Information Status bar and application name center in the screen.



**Figure C-3** *Moving Information Status Bar*



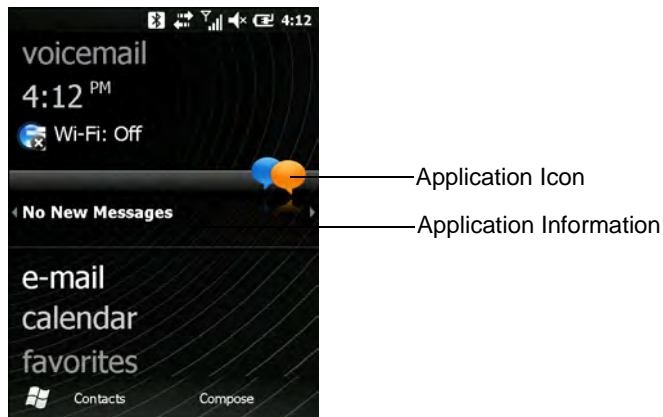
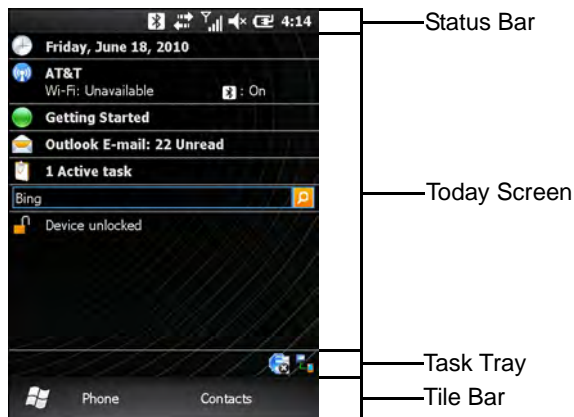

**Figure C-4** Information Bar Example

To customize the Home screen, tap **Start > Settings > Today**. On the horizontal scroll, use **Appearance** to customize the background and the **Items** to change the display format.

### Classic Today Screen

The user can change the Today screen to the classic layout that is used in Windows Mobile 6.1.



**Figure C-5** Classic Today Screen

To change to the classic view tap **Start > Settings > Home > Items**.





**Figure C-6** Home Screen Settings

Deselect the **Windows Default** checkbox and select any of the other checkboxes except for **Motorola Home**.

Tap **OK**.

The task bar at the bottom of the screen can contain the task tray icons listed in [Table C-1](#).

**Table C-1** Task Tray Icons

Icon	Name	Description
	Wireless connection status	Indicates WLAN signal strength.
	ActiveSync	Active serial connection between the MC75A and the host computer.

## Start Screen

To open the **Start** screen, tap **Start** at the bottom left corner of the screen, or press the START key on the keypad.

Swipe upward to view more program and folder icons.

You can move often-used program and folder icons anywhere on the Start screen for easy access. Press and hold the icon that you want to move. Drag the icon to a new location and release.

---

## Windows Mobile Dialer

Use the MC65 to make phone calls, set up speed dials, keep track of calls, and send text messages. Your wireless service provider may also provide other services such as voice mail, call forwarding, and caller ID.

Also use the integrated phone to connect to an ISP or work network in order to browse the Web and read e-mail. Connect to the Internet or work network over High-Speed Downlink Packet Access (HSDPA) or Evolution Data-Optimized (EvDO) using Cellular Line.

1. To enable the Windows Mobile Dialer:
2. Tap **Start > Settings > Personal > Dialer Switcher**.

3. Select **Microsoft Dialer**.
4. Tap **Save**.
5. Tap **OK**. The MC65 reboots.

---



## Making a Call

- ✓ **NOTE** You can make emergency calls even when the MC65 is locked or when a SIM card is not installed. See [Emergency Calling on page C-9](#) for more information.

With the MC65, you can make a call from the phone, contacts, speed dial and call history.

## Using the Phone Keypad

To make a call using the phone keypad:

1. Press .
2. Enter the phone number on the dialer or keypad. The number appears in the call line.
3. Press .
4. Press  to stop dialing or end the call.

- ✓ **NOTE** If the user taps a wrong number, tap Delete key to erase each subsequent digit of a number. To erase the entire number, tap and hold the Delete key.

## Smart Dialing

Smart Dialing makes it easy to dial a phone number. When the user starts entering numbers or characters, Smart Dialing automatically searches and sorts the contact entries on the SIM card, in Contacts, and the phone numbers in Call History (including incoming, outgoing, and missed calls). The user can then select the desired number or contact from the filtered list to dial.

Open the Phone screen, then tap the keys on the Phone keypad that correspond to the phone number or contact to call. The contact panel lists contacts that match the sequence that you entered.

Smart Dialing starts looking for numbers or contacts that match the sequence entered.

To find a phone number:

- Enter the first one or two digits to find a phone number in Call History.
- Enter the first three digits or more to find a phone number from the saved Contacts and SIM card.

To find a contact name:

- Enter the first letter of a contact's first name or last name. Smart Dialing searches for the letter starting from the first character of a contact name as well as from the character that appears after a space, dash, or underscore in a contact name. For example, if you tap number "2" which is associated with [a, b, c] on

the Phone keypad, contact names such as the following will be considered matches: “Smith, Bernard”, “Adams, John”, “Carlson, Eileen”, “Dillon, Albert”, “Childs, Larry”, “Cooper, Robert” and “Parks, Celine”.

- If the matching list is long narrow down the search further by entering another letter. Using the same example above, tap “3” which is associated with (d, e, f), the matching list is narrowed down to the following names: “Smith, Bernard”, “Adams, John”, and “Parks, Celine”.

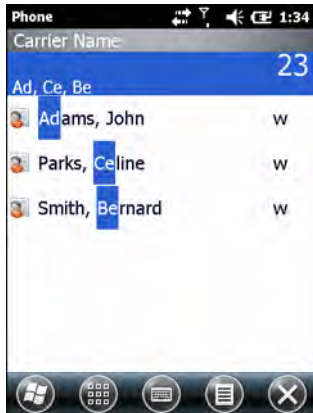

**Figure C-7** Finding a Contact

To make a call or send a text message using Smart Dialing:

1. Begin entering the first few numbers or characters.
2. In the Smart Dialing panel, use the up and down arrows on the keypad to navigate to the desired contact or phone number.
3. When the correct contact is selected, press **TALK** to make a voice call.
4. To send a text message to the selected contact, tap  > **Send Text Message**.
5. To call a different phone number associated with the selected contact, tap the contact name and select the phone number to call.

## Using Contacts

Use Contacts to make a call without looking up or entering the phone number.

To make a call from Contacts:

1. Tap **Contacts**.
2. From the contact list, tap and hold the contact name.

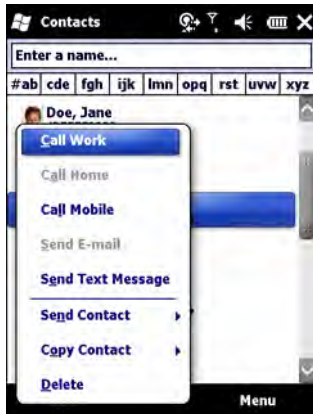



Figure C-8 Contacts Menu

3. Tap **Call Work**, **Call Home** or **Call Mobile**.

✓ **NOTE** To make a call from an open contact, tap the number to call. See On-Device Help for more information about Contacts.

## Using Call History

To make a call using Call History:

1. Press .
2. From the Phone keypad, tap **Call History**.

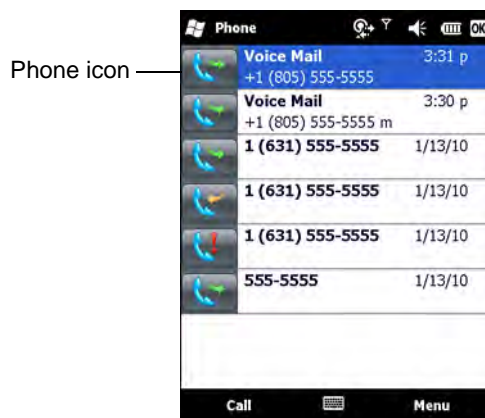



Figure C-9 Call History Window

3. Tap the phone icon next to the number to begin dialing and return to the phone keypad.
4. Tap **End** or press the red phone key on the MC65 keypad to stop dialing or end the call.

## Making a Speed Dial Call

Use Speed Dial to call someone saved in the speed dial directory.

To make a speed dial call:

1. Press .
2. From the keypad, tap and hold the speed dial location number assigned to a contact. (To dial a one-digit speed dial location number, tap and hold the speed dial number. To dial a two-digit speed dial location number, tap the first digit and then tap and hold the second digit.)

or

From the keypad, tap **Speed Dial** and tap the speed dial location number of the desired contact in the list.



**Figure C-10** Speed Dial Contact List

3. To stop dialing or end the call, press .



## Answering a Call

A dialog box appears on the MC65 when it receives an incoming call. If the phone is set to ring, a ring tone sounds. Answer or ignore the incoming call.

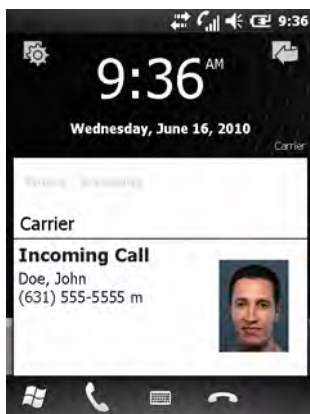
To answer an incoming call tap **Answer** on the dialog box or press .





**Figure C-11** Incoming Call

To ignore the incoming call tap  or press . This sends the caller to voice mail, depending on the service provider. Otherwise, this presents a busy signal to the calling party.

To end the call press .

## Incoming Call Features

- You can use other programs on the MC65 during a call. To switch back to the Phone, press  or tap **Start > Phone**. Tap  to end the call.
- If a caller isn't in your contact list, create a contact during the call or from Call History by tapping **Menu > Save to Contacts**.
- To terminate a call when a second call comes in and answer the waiting call, tap **End** on the Phone keypad to disconnect the active call, then tap **Answer** or press the **Send** key to answer the waiting call.
- To hold the current call and answer a waiting call, tap **Answer** or press the **Send** key to place the current call on hold and answer the incoming call.
- To put a call on hold to call another number or answer an incoming call, tap **Hold**. To move from one call to another, tap **Swap**.

---

## Missed Call Notification

When you do not answer an incoming call, the Home screen displays a **Missed Call** indication.

To display a missed call entry tap the **Missed Call** box on the **Home** screen.

---

## Emergency Calling

Your service provider programs one or more emergency phone numbers, such as 911 or 999, that you can call under any circumstances, even when your phone is locked or the SIM card is not inserted. Your service provider can program additional emergency numbers into your SIM card. However, your SIM card must be inserted in your phone in order to use the numbers stored on it. See your service provider for additional information.

When the alpha primary keypad is locked, press the Orange key twice to set the keypad to numeric mode and then enter the emergency number.

- ✓ **NOTE** Emergency numbers vary by country. Your phone's pre-programmed emergency number(s) may not work in all locations, and sometimes an emergency call cannot be placed due to network, environmental, or interference issues.

---

## Audio Modes

The MC65 offers three audio modes for use during phone calls:

- **Handset Mode:** Switches audio to the speaker at the top front of the MC65, so you can use the MC65 as a handset. This is the default mode.
- **Speaker Mode:** Use the MC65 as if on speaker phone. Tap the **Speaker On** button to activate this mode. Tap the **Speaker Off** button to switch back to handset mode.

- **Headset Mode:** Connect a Bluetooth headset or a wired headset to automatically switch audio to the headset.

The MC65 defaults to handset mode. When a wired headset is plugged into the MC65 headset connector or a Bluetooth headset is configured for use with the MC65, the earpiece and speakerphone are muted and audio is heard through the headset.

✓ **NOTE** While using a Bluetooth headset during a call, the MC65 will not go into suspend mode.

## Using a Wired Headset

✓ **NOTE** Remove the headset jack plug before connecting the Headset Adapter to the MC65.

You can use a stereo headset for audio communication when using an audio-enabled application. To use a headset, plug the headset jack of the Headset Adapter Cable into the headset connector on the side of the MC65. Plug the Headset connector into the connector on the Headset Adapter Cable. Set the MC65's volume appropriately before putting the headset on. Plugging a headset into the jack mutes the speaker.

## Using a Bluetooth Headset

You can use a Bluetooth headset for audio communication when using an audio-enabled application. See [Chapter 7, Using Bluetooth](#) for information on connecting a Bluetooth headset to the MC65. Set the MC65's volume appropriately before putting the headset on. When a Bluetooth headset is connected the speakerphone is muted.

## Adjusting Audio Volume

Use the Volume Control Slider or the Volume buttons to adjust the volume of the ringer when not in a call and the audio volume when in a call.

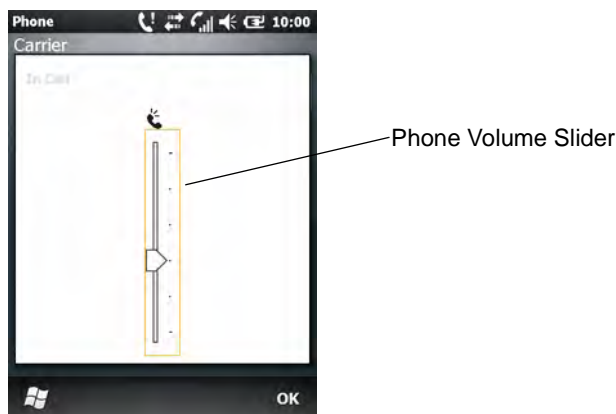

**Figure C-12** Phone Volume Slider

To adjust the volume press the Volume Up or Down buttons on the side of the MC65. Move the slider up or down to adjust the volume.





**NOTE** Adjust the conversation phone volume during a call. Adjusting the volume while not in a call affects the ring and notification sound levels.

---

## Muting a Call

During a call, you can mute the microphone so you can hear the person on the line but he or she cannot hear conversation from the microphone. This is useful when there is conversation or background noise on your end.

To mute or unmute a call, tap **Mute** on the dialer to mute the audio. The **Mute** button become **Unmute**.

---

## Using Call History

Use Call History to call someone who was recently called, or recently called in. Call History provides the time and duration of all incoming, outgoing, and missed calls. It also provides a summary of total calls and easy access to notes taken during a call. [Table 4-1](#) lists the call history icons that appear in the **Call History** window.

**Table C-2** *Call History Icons*

Icon	Description
	This icon appears next to the contact information for all <b>outgoing</b> calls.
	This icon appears next to the contact information for all <b>incoming</b> calls.
	This icon appears next to the contact information for all <b>missed</b> calls.

## Managing Call History

Change views, reset the call timer, and delete calls to manage the calls stored in Call History.

### Changing the Call History View

1. Press to display the Phone dialer.
2. From the Phone dialer, tap **Call History**.
3. Tap > **Filter** to show the menu.
4. Select a view type from the menu to display only missed calls, outgoing calls, incoming calls, or calls listed alphabetically by caller name.
5. Tap **OK** to exit the **Call History** window.

### Resetting the Recent Calls Counter

1. Press to display the Phone dialer.
2. From the Phone dialer, tap **Call History**.

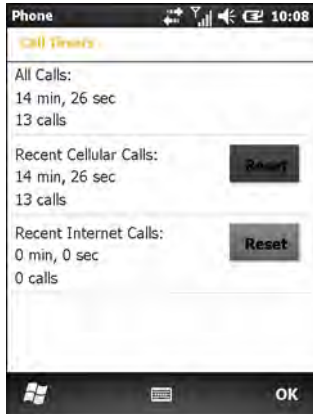

3. Tap .
4. Select **Call Timers...**



**Figure C-13** Call History - Call Timers

5. Tap **Reset**. (The **All Calls**: counter cannot be reset.)
6. Tap **OK** to exit the **Call Timers** window.

### Deleting All Call History Items

1. Press  to display the Phone dialer.
2. From the Phone dialer, tap **Call History**.
3. Tap .
4. Select **Delete all calls**.
5. Tap **Yes**.
6. Tap **OK** to exit the **Call History** window.

### Viewing Call Status

1. Press  to display the Phone dialer.
2. From the Phone dialer, tap **Call History**.
3. Tap an entry. The **Call Status** window appears.

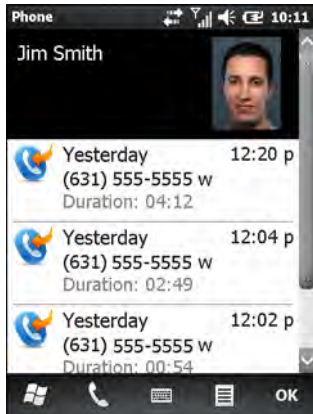

**Figure C-14** Call History - Detail

✓ **NOTE** When more than one call is on the phone line, only the duration of the first call is recorded.

4. Tap **OK** and then **OK** to exit.

### Using the Call History Menu

Use the **Call History** menu to dial voice mail, access the Activation Wizard, save to contacts, view a note, delete a listing, send an SMS, and make a call.

1. Press  to display the Phone dialer.
2. From the Phone dialer, tap **Call History**.
3. Tap and hold an item in the list.

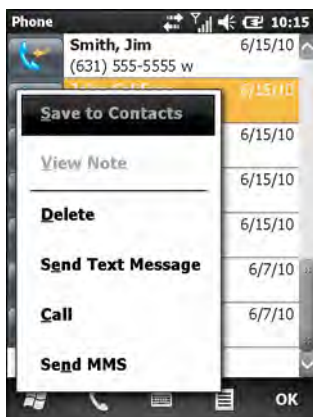

**Figure C-15** Call History - Menu

4. Select an applicable item from the menu, as needed.
5. Depending on the item selected, the appropriate window displays. For example, select **Send Text message** to display the **Text Messages** window.
6. Tap **OK** to exit the **Call History** window.

## Swapping Calls (GSM)

To move between two phone calls:

1. Press  to display the Phone dialer.
2. Enter the first phone number and press **Talk**. When the call connects, **Hold** appears on the dialer.
3. Tap **Hold** on to place the first number on hold.
4. Enter the second number and tap **Talk**.

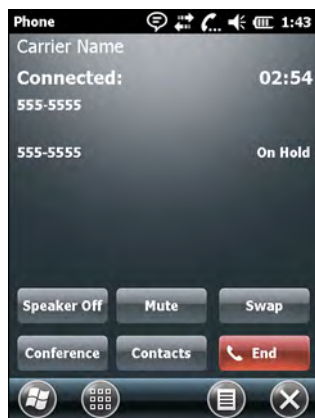

**Figure C-16** Call Conferencing - Conferencing

5. Tap **Swap** to move from one call to the other.
6. Tap **End** or press  to end each call.

## Swapping Calls (CDMA)

To swap between two incoming phone calls:

1. Tap **Answer** to connect to the first call.

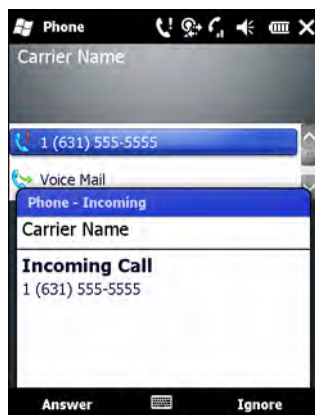

**Figure C-17** Answer a Call

- When a second call arrives, tap **Answer**. The first call is placed on hold.
- Tap **Flash** to swap from one call to the other.

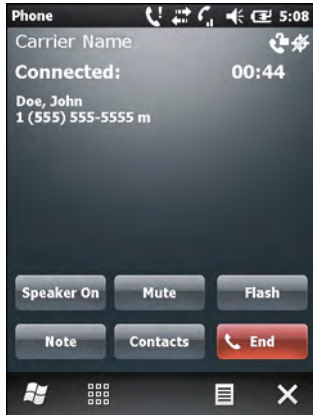

**Figure C-18** Call Swapping



- Tap **End** or press the red phone key on the keypad to end active call. The remaining call re-connects, tap **Answer** to connect to the call.
- Tap **End** or press the red phone key on the keypad to end the last call.



---

## Conference Calling (GSM)

- ✓ **NOTE** Conference Calling and the number of conference calls allowed may not be available on all services. Please check with your service provider for Conference Calling availability.

To create a conference phone session with multiple people:

- Press  to display the Phone dialer.
- Enter the first phone number and press **Talk**. When the call connects, **Hold** appears on the dialer.
- Tap **Hold** to place the first call on hold.
- Enter the second phone number and tap **Talk**.
- After the call is answered, tap  > **Conference** to place the calls in conference mode.
- Tap **Hold** to place the conference on hold.
- Enter another phone number and tap **Talk**.
- After the call is answered, tap  > **Conference** to place all the calls in conference mode.
- Repeat steps 6 through 8 for up to six phone numbers.
- Tap **End** or press the red phone key on the keypad to end the conference call.



- ✓ **NOTE** To speak privately with one party during a conference call, tap  > **Private**. To include all parties again, tap  > **Conference**.

---

## Three-way Calling (CDMA)

- ✓ **NOTE** Three-way Calling may not be available on all services. Please check with your service provider for availability.

To create a three-way phone session with two people and you as the initiator:

1. Press  to display the Phone dialer.
2. Enter the first phone number and press **Flash**.
3. To call a second person, tap **Keypad**. Enter the second number and tap **Flash**.
4. When the second person answers the call, tap **Flash** to create a three-way calling session.
5. Tap **Flash** to drop the last call.
6. Press  to drop the first call.

# Glossary

---

## A

**API.** (Application Programming Interface) An interface by means of which one software component communicates with or controls another. Usually used to refer to services provided by one software component to another, usually via software interrupts or function calls

**AZERTY.** A standard keyboard commonly used on French keyboards. “AZERTY” refers to the arrangement of keys on the top row of keys.

**AKU.** (Adaptation Kit Update) Updates to the Windows Mobile operating system.

**AFH.** Adaptive Frequency Hopping

**ActiveSync.** ActiveSync is a data synchronization program developed by Microsoft for use with Windows Mobile operating systems.

---

## B

**Bar Code.** A pattern of variable-width bars and spaces which represents numeric or alphanumeric data in machine-readable form. The general format of a bar code symbol consists of a leading margin, start character, data or message character, check character (if any), stop character, and trailing margin. Within this framework, each recognizable symbology uses its own unique format. See **Symbology**.

**Bit.** Binary digit. One bit is the basic unit of binary information. Generally, eight consecutive bits compose one byte of data. The pattern of 0 and 1 values within the byte determines its meaning.

**Bits per Second (bps).** Bits transmitted or received.

**Bluetooth.** A wireless protocol utilizing short-range communications technology facilitating data transmission over short distances.

**boot or boot-up.** The process a computer goes through when it starts. During boot-up, the computer can run self-diagnostic tests and configure hardware and software.

**bps.** See **Bits Per Second**.

**Byte.** On an addressable boundary, eight adjacent binary digits (0 and 1) combined in a pattern to represent a specific character or numeric value. Bits are numbered from the right, 0 through 7, with bit 0 the low-order bit. One byte in memory is used to store one ASCII character.

---

## C

**CDRH.** Center for Devices and Radiological Health. A federal agency responsible for regulating laser product safety. This agency specifies various laser operation classes based on power output during operation.

**CDRH Class 1.** This is the lowest power CDRH laser classification. This class is considered intrinsically safe, even if all laser output were directed into the eye's pupil. There are no special operating procedures for this class.

**CDRH Class 2.** No additional software mechanisms are needed to conform to this limit. Laser operation in this class poses no danger for unintentional direct human exposure.

**Character.** A pattern of bars and spaces which either directly represents data or indicates a control function, such as a number, letter, punctuation mark, or communications control contained in a message.

**Codabar.** A discrete self-checking code with a character set consisting of digits 0 to 9 and six additional characters: ("-", "\$", ":", "/", ",", and "+").

**Code 128.** A high density symbology which allows the controller to encode all 128 ASCII characters without adding extra symbol elements.

**Code 3 of 9 (Code 39).** A versatile and widely used alphanumeric bar code symbology with a set of 43 character types, including all uppercase letters, numerals from 0 to 9 and 7 special characters ("-", ".", "/", "+", "%", "\$" and space). The code name is derived from the fact that 3 of 9 elements representing a character are wide, while the remaining 6 are narrow.

**Code 93.** An industrial symbology compatible with Code 39 but offering a full character ASCII set and a higher coding density than Code 39.

**COM port.** Communication port; ports are identified by number, e.g., COM1, COM2.

**Cradle.** A cradle is used for charging the terminal battery and for communicating with a host computer, and provides a storage place for the terminal when not in use.

---

## D

**DCP.** See **Device Configuration Package**.

**Decode.** To recognize a bar code symbology (e.g., UPC/EAN) and then analyze the content of the specific bar code scanned.

**Decode Algorithm.** A decoding scheme that converts pulse widths into data representation of the letters or numbers encoded within a bar code symbol.



**Decryption.** Decryption is the decoding and unscrambling of received encrypted data. Also see, **Encryption** and **Key**.

**Depth of Field.** The range between minimum and maximum distances at which a scanner can read a symbol with a certain minimum element width.

**Device Configuration Package.** The Symbol Device Configuration Package provides the Product Reference Guide (PRG), flash partitions, Terminal Configuration Manager (TCM) and the associated TCM scripts. With this package hex images that represent flash partitions can be created and downloaded to the mobile computer.

**Discrete 2 of 5.** A binary bar code symbology representing each character by a group of five bars, two of which are wide. The location of wide bars in the group determines which character is encoded; spaces are insignificant. Only numeric characters (0 to 9) and START/STOP characters may be encoded.

---

## E

**EAN.** European Article Number. This European/International version of the UPC provides its own coding format and symbology standards. Element dimensions are specified metrically. EAN is used primarily in retail.

**EMDK.** Enterprise Mobility Developer's Kit.

**ESD.** Electro-Static Discharge

---

## F

**File Transfer Protocol (FTP).** A TCP/IP application protocol governing file transfer via network or telephone lines. See **TCP/IP**.

**Flash Memory.** Flash memory is nonvolatile, semi-permanent storage that can be electronically erased in the circuit and reprogrammed.

**FHSS (Frequency Hopping Spread Spectrum).** A method of transmitting radio signals by rapidly switching a carrier among many frequency channels, using a pseudorandom sequence known to both transmitter and receiver.

---

## G

**GPS (Global Positioning System).** A satellite-based navigation system made up of a network of 24 satellites. GPS satellites circle the earth and transmit signal information to earth. GPS receivers take this information and use triangulation to calculate the user's exact location.

---

## H

**Hz.** Hertz; A unit of frequency equal to one cycle per second.

**Host Computer.** A computer that serves other terminals in a network, providing such services as computation, database access, supervisory programs and network control.

---

## I

**IEC.** International Electrotechnical Commission. This international agency regulates laser safety by specifying various laser operation classes based on power output during operation.

**IEC (825) Class 1.** This is the lowest power IEC laser classification. Conformity is ensured through a software restriction of 120 seconds of laser operation within any 1000 second window and an automatic laser shutdown if the scanner's oscillating mirror fails.

**IEEE Address.** See **MAC Address**.

**Input/Output Ports.** I/O ports are primarily dedicated to passing information into or out of the terminal's memory. MC65 mobile computers include USB ports.

**Interleaved 2 of 5.** A binary bar code symbology representing character pairs in groups of five bars and five interleaved spaces. Interleaving provides for greater information density. The location of wide elements (bar/spaces) within each group determines which characters are encoded. This continuous code type uses no intercharacter spaces. Only numeric (0 to 9) and START/STOP characters may be encoded.

**Internet Protocol Address.** See **IP**.

**I/O Ports.** The connection between two devices, defined by common physical characteristics, signal characteristics, and signal meanings. Types of interfaces include RS-232 and USB.

**IP.** Internet Protocol. The IP part of the TCP/IP communications protocol. IP implements the network layer (layer 3) of the protocol, which contains a network address and is used to route a message to a different network or subnetwork. IP accepts "packets" from the layer 4 transport protocol (TCP or UDP), adds its own header to it and delivers a "datagram" to the layer 2 data link protocol. It may also break the packet into fragments to support the maximum transmission unit (MTU) of the network.

**IP Address.** (Internet Protocol address) The address of a computer attached to an IP network. Every client and server station must have a unique IP address. A 32-bit address used by a computer on a IP network. Client workstations have either a permanent address or one that is dynamically assigned to them each session. IP addresses are written as four sets of numbers separated by periods; for example, 204.171.64.2.

**IPX/SPX.** Internet Package Exchange/Sequential Packet Exchange. A communications protocol for Novell. IPX is Novell's Layer 3 protocol, similar to XNS and IP, and used in NetWare networks. SPX is Novell's version of the Xerox SPP protocol.

**ISM.** Industry Scientific and Medical

---

## K

**Key.** A key is the specific code used by the algorithm to encrypt or decrypt the data. Also see, **Encryption** and **Decrypting**.

---

## L

**LASER.** Light Amplification by Stimulated Emission of Radiation. The laser is an intense light source. Light from a laser is all the same frequency, unlike the output of an incandescent bulb. Laser light is typically coherent and has a high energy density.

**laser scanner.** A type of bar code reader that uses a beam of laser light.

**LCD.** See **Liquid Crystal Display**.

**LED Indicator.** A semiconductor diode (LED - Light Emitting Diode) used as an indicator, often in digital displays. The semiconductor uses applied voltage to produce light of a certain frequency determined by the semiconductor's particular chemical composition.

**Light Emitting Diode.** See **LED**.

**Liquid Crystal Display (LCD).** A display that uses liquid crystal sealed between two glass plates. The crystals are excited by precise electrical charges, causing them to reflect light outside according to their bias. They use little electricity and react relatively quickly. They require external light to reflect their information to the user.

---

## M

**MC.** Mobile Computer.

**MDN.** Mobile Directory Number. The directory listing telephone number that is dialed (generally using POTS) to reach a mobile unit. The MDN is usually associated with a MIN in a cellular telephone -- in the US and Canada, the MDN and MIN are the same value for voice cellular users. International roaming considerations often result in the MDN being different from the MIN.

**MIN.** Mobile Identification Number. The unique account number associated with a cellular device. It is broadcast by the cellular device when accessing the cellular system.

**Mobile Computer.** In this text, *mobile computer* refers to the MC65. It can be set up to run as a stand-alone device, or it can be set up to communicate with a network, using wireless radio technology.

---

## N

**Nominal.** The exact (or ideal) intended value for a specified parameter. Tolerances are specified as positive and negative deviations from this value.

**NVM.** Non-Volatile Memory.

---

## O

**Open System Authentication.** Open System authentication is a null authentication algorithm.

---

## P

**PAN .** Personal Area Network. Using Bluetooth wireless technology, PANs enable devices to communicate wirelessly. Generally, a wireless PAN consists of a dynamic group of less than 255 devices that communicate within about a 33-foot range. Only devices within this limited area typically participate in the network.

**PING.** (Packet Internet Groper) An Internet utility used to determine whether a particular IP address is online. It is used to test and debug a network by sending out a packet and waiting for a response.

---

## Q

**QWERTY.** A standard keyboard commonly used on European keyboards. "QWERTY" refers to the arrangement of keys on the top row of keys.

**QWERTZ.** A standard keyboard commonly used on German keyboards. "QWERTZ" refers to the arrangement of keys on the top row of keys.

---

## R

**RAM.** Random Access Memory. Data in RAM can be accessed in random order, and quickly written and read.

**RF.** Radio Frequency.

**ROM.** Read-Only Memory. Data stored in ROM cannot be changed or removed.

**Router.** A device that connects networks and supports the required protocols for packet filtering. Routers are typically used to extend the range of cabling and to organize the topology of a network into subnets. See **Subnet**.

---

## S

**Scanner.** An electronic device used to scan bar code symbols and produce a digitized pattern that corresponds to the bars and spaces of the symbol. Its three main components are: 1) Light source (laser or photoelectric cell) - illuminates a bar code,; 2) Photodetector - registers the difference in reflected light (more light reflected from spaces); 3) Signal conditioning circuit - transforms optical detector output into a digitized bar pattern.

**SDK.** Software Development Kit

**Shared Key.** Shared Key authentication is an algorithm where both the AP and the MU share an authentication key.

**SID.** System Identification code. An identifier issued by the FCC for each market. It is also broadcast by the cellular carriers to allow cellular devices to distinguish between the home and roaming service.

**Space.** The lighter element of a bar code formed by the background between bars.

**Specular Reflection.** The mirror-like direct reflection of light from a surface, which can cause difficulty decoding a bar code.

**Start/Stop Character.** A pattern of bars and spaces that provides the scanner with start and stop reading instructions and scanning direction. The start and stop characters are normally to the left and right margins of a horizontal code.

**Subnet.** A subset of nodes on a network that are serviced by the same router. See **Router**.

**Subnet Mask.** A 32-bit number used to separate the network and host sections of an IP address. A custom subnet mask subdivides an IP network into smaller subsections. The mask is a binary pattern that is matched up with the IP address to turn part of the host ID address field into a field for subnets. Default is often 255.255.255.0.

**Substrate.** A foundation material on which a substance or image is placed.

**Symbol.** A scannable unit that encodes data within the conventions of a certain symbology, usually including start/stop characters, quiet zones, data characters and check characters.

**Symbol Aspect Ratio.** The ratio of symbol height to symbol width.

**Symbol Height.** The distance between the outside edges of the quiet zones of the first row and the last row.

**Symbol Length.** Length of symbol measured from the beginning of the quiet zone (margin) adjacent to the start character to the end of the quiet zone (margin) adjacent to a stop character.

**Symbology.** The structural rules and conventions for representing data within a particular bar code type (e.g. UPC/EAN, Code 39, PDF417, etc.).

---

## T

**TCP/IP.** (Transmission Control Protocol/Internet Protocol) A communications protocol used to internetwork dissimilar systems. This standard is the protocol of the Internet and has become the global standard for communications. TCP provides transport functions, which ensures that the total amount of bytes sent is received correctly at the other end. UDP is an alternate transport that does not guarantee delivery. It is widely used for real-time voice and video transmissions where erroneous packets are not retransmitted. IP provides the routing mechanism. TCP/IP is a routable protocol, which means that all messages contain not only the address of the destination station, but the address of a destination network. This allows TCP/IP messages to be sent to multiple networks within an organization or around the world, hence its use in the worldwide Internet. Every client and server in a TCP/IP network requires an IP address, which is either permanently assigned or dynamically assigned at startup.

**Telnet.** A terminal emulation protocol commonly used on the Internet and TCP/IP-based networks. It allows a user at a terminal or computer to log onto a remote device and run a program.

**Terminal.** See **Mobile Computer**.

**Terminal Emulation.** A "terminal emulation" emulates a character-based mainframe session on a remote non-mainframe terminal, including all display features, commands and function keys. The VC5000 Series supports Terminal Emulations in 3270, 5250 and VT220.

**TFTP.** (Trivial File Transfer Protocol) A version of the TCP/IP FTP (File Transfer Protocol) protocol that has no directory or password capability. It is the protocol used for upgrading firmware, downloading software and remote booting of diskless devices.

**Tolerance.** Allowable deviation from the nominal bar or space width.

**Transmission Control Protocol/Internet Protocol.** See **TCP/IP**.

**Trivial File Transfer Protocol.** See **TFTP**.

---

## U

**UDP.** User Datagram Protocol. A protocol within the IP protocol suite that is used in place of TCP when a reliable delivery is not required. For example, UDP is used for real-time audio and video traffic where lost packets are simply ignored, because there is no time to retransmit. If UDP is used and a reliable delivery is required, packet sequence checking and error notification must be written into the applications.

**UPC.** Universal Product Code. A relatively complex numeric symbology. Each character consists of two bars and two spaces, each of which is any of four widths. The standard symbology for retail food packages in the United States.

---

## V

**Visible Laser Diode (VLD).** A solid state device which produces visible laser light.

# Index

## Numerics

- 2-D bar codes ..... 2-22
- 3-Way Calling ..... 3-10

## A

- accessories ..... 10-1
  - auto charge cable ..... 10-2
  - cables ..... 10-11
  - charge only cable ..... 10-1
  - communication/charge cables
    - battery charging ..... 10-11
    - LED indicators ..... 10-12
  - fabric holster ..... 10-2
  - four slot charge only cradle ..... 10-1, 10-6
  - four slot Ethernet cradle ..... 10-1, 10-7
  - four slot spare battery charger ..... 10-1, 10-10
  - holster ..... 10-2
  - MMC ..... 1-2, 10-3
  - screen protector ..... 10-2
  - SD card ..... 10-3
  - SIM card ..... 1-3
  - single slot USB cradle ..... 10-3
  - spare battery ..... 10-2
  - specifications ..... A-6
  - spring loaded stylus ..... 10-2
  - stylus ..... 10-2
  - USB charging cable ..... 10-1
  - USB cradle ..... 10-1
  - vehicle cradle ..... 10-1, 10-8
  - vehicle holder ..... 10-1
  - wall mounting kit, cradle ..... 10-2
- action button ..... 2-3
- ActiveSync ..... 2-10
  - icon ..... C-4
- adaptive frequency hopping ..... 7-1

- adjusting volume ..... 2-18
- AFH ..... 7-1
- AirBEAM ..... 2-10
- Alpha-numeric keypad ..... B-4
- alpha-numeric keypad
  - key descriptions ..... B-6
- answering a call ..... 3-4, C-8
- auto charge cable ..... 10-2, 10-11
- AZERTY ..... B-4

## B

- bar codes
  - two dimensional ..... 2-22
- battery
  - charging ..... 1-5, 10-3, 10-6, 10-7, 10-8, 10-10
  - check status ..... 1-7
  - installing ..... 1-4
  - removing ..... 1-8
- battery chargers
  - communication/charge cables ..... 10-11
  - LED indicators ..... 10-12
  - four slot ..... 10-10
- battery charging
  - communication/charge cables ..... 10-11
  - using four slot charge only cradle ..... 10-6
  - using four slot Ethernet cradle ..... 10-7
  - using four slot spare battery charger ..... 10-10
  - using single slot USB cradle ..... 10-3
  - using vehicle cradle ..... 10-8
- battery icon ..... 2-7, 2-18
- Bluetooth ..... 7-1
  - adaptive frequency hopping ..... 7-1
  - security ..... 7-2
  - turning off ..... 7-4
  - turning on ..... 7-4
- bluetooth

- discovering devices ..... 7-4
- turning on and off ..... 7-4
- bullets ..... xv
- buttons
  - action ..... 2-3
  - function ..... 2-3
  - power ..... 2-3, 2-20
  - scan ..... 2-3
  - up and down ..... 2-3

**C**

- cables ..... 10-11
  - auto charge cable ..... 10-2
  - connecting ..... 10-11
- calculator ..... 2-10
- calendar ..... 2-10
- calibrating the screen ..... 1-6
- call history ..... 3-6, C-11
- charge only cable ..... 10-1, 10-11
- charge only cradle ..... 10-1
- charging
  - spare batteries ..... 1-6, 10-4, 10-10
  - using four slot charge only cradle ..... 10-6
  - using four slot Ethernet cradle ..... 10-7
  - using four slot spare battery charger ..... 10-10
  - using single slot USB cradle ..... 10-3
  - using vehicle cradle ..... 10-8
- charging indicators ..... 2-18, 10-12
  - four slot charge only cradle ..... 10-6
  - four slot Ethernet cradle ..... 10-7
  - four slot spare battery charger ..... 10-10
  - single slot USB cradle ..... 10-4
  - vehicle cradle ..... 10-9
- charging temperature ..... 1-6, 10-4
- cleaning ..... 11-1
- clock & alarms ..... 9-1
- command bar
  - icons ..... C-4
- communication ..... 10-11
- communication/charge cables ..... 10-11
  - battery charging ..... 10-11
  - LED indicators ..... 10-12
- conference call ..... 3-7, 3-10, C-15, C-16
- configuration ..... xiii
- Contacts ..... 2-10
- contacts ..... 2-10
- contacts application ..... 3-3, C-6
- conventions
  - notational ..... xv
- cradles
  - four slot charge only ..... 10-1, 10-6
  - four slot charge only cradle ..... 10-6
  - four slot Ethernet ..... 10-1, 10-7

- four slot spare battery charger ..... 10-10
- single slot USB ..... 10-3
- vehicle ..... 10-8

**D**

- data capture ..... xiii
- digital camera ..... 2-22
- dot aiming ..... 2-24
- imager operational modes
  - decode mode ..... 2-22
  - image capture mode ..... 2-22
  - pick list mode ..... 2-22
- imaging ..... 2-22
- scan angle ..... 2-23
- scan button ..... 2-3
- scan range ..... 2-23
- scanning ..... 2-23, 2-25
  - two dimensional bar codes ..... 2-22
- display ..... xiii

**E**

- emergency calls ..... 3-5, C-9
- ESD ..... 1-2
- Ethernet cradle ..... 10-7
- Evolution Data-Optimized ..... 3-1, C-4

**F**

- fabric holster ..... 10-2
- file explorer ..... 2-10
- four slot charge only cradle ..... 10-6
  - charging ..... 10-6
  - charging indicators ..... 10-6
- four slot Ethernet cradle ..... 10-1, 10-7
  - charging ..... 10-7
  - charging indicators ..... 10-7
- four slot spare battery charger ..... 10-1, 10-10
  - charging ..... 10-10
  - charging indicators ..... 10-10
  - setup ..... 10-10
- function buttons ..... 2-3

**H**

- headset ..... 3-5, C-10
- hexadecimal keys ..... 4-5
- High-Speed Downlink Packet Access ..... 3-1, C-4
- holster ..... 10-2

**I**

- icons



- ActiveSync ..... C-4
- battery ..... 2-7, 2-18
- speaker ..... 2-18
- status ..... 2-5
- task tray ..... C-4
- wireless status ..... C-4
- imager. *See* data capture, imaging
- imager. *See* data capture, imaging, imagersample
- imaging ..... 2-22
- information, service ..... xvi
- installing battery ..... 1-4
- Internet Explorer Mobile ..... 2-11
- internet sharing ..... 2-11
- IrDA ..... 9-2

## K

- key descriptions
  - alpha-numeric keypad ..... B-6
  - numeric keypad ..... B-2
- keypads ..... xiii
  - input modes ..... B-4, B-8, B-9, B-10
  - key descriptions ..... B-2, B-6
  - numeric ..... B-1
  - QWERTY ..... B-4
  - special character key ..... B-12
  - types ..... 2-4, B-1

## L

- laser scanning
  - See* data capture ..... 2-22
- LEDs ..... 2-18
  - battery status ..... 2-19
  - charging ..... 2-19, 10-4, 10-6, 10-7, 10-9, 10-10, 10-12
  - radio status ..... 2-19
  - scan and decode ..... 2-18, 2-24, 2-25
- lithium-ion battery ..... 1-1
- locking the MC65 keypad ..... 2-19, 9-4

## M

- main battery
  - charging ..... 1-2, 1-5
  - installing ..... 1-2
- maintenance ..... 11-1
- masked characters ..... 4-5
- Media Player ..... 2-12
- memory ..... xiii
- messaging ..... 2-11
- MMC ..... 1-2, 10-3
- MSP Agent ..... 2-11
- multi media card ..... 1-2, 10-3
- muting a call ..... 3-5, C-11

## N

- navigation bar
  - icons ..... 2-5
- notational conventions ..... xv
- notes ..... 2-11
- numeric keypad ..... B-1
  - input modes ..... B-4
  - key descriptions ..... B-2

## O

- operating environment ..... A-1
- operating system ..... xiii

## P

- pass-phrase ..... 4-5
- passwords ..... 9-4
- phone
  - answering a call ..... 3-4, C-8
  - call history ..... 3-6, C-11
  - call swapping ..... C-14
  - conference call ..... 3-7, 3-10, C-15, C-16
  - contacts ..... 3-3, C-6
  - muting a call ..... 3-5, C-11
  - speed dial
    - calling ..... C-8
  - text messaging ..... 5-2
  - three-way call ..... 3-7, 3-10, C-15, C-16
  - using keypad ..... 3-1, C-5
- pictures ..... 2-11
  - editing ..... 6-2
- power button ..... 2-3, 2-20

## Q

- QWERTY keypad
  - input modes ..... B-8, B-9, B-10
- QWERTZ keypad ..... B-4

## R

- radios ..... xiii
- rapid deployment ..... 2-11
- removing main battery ..... 1-8
- reset ..... 2-19
- resume ..... 7-3
- rigid holster ..... 10-2

## S

- scan button ..... 2-3
- scanning

- button ..... 2-3
- imaging ..... 2-22
- See data capture ..... 2-22
- screen
  - calibration ..... 1-6
- screen protector ..... 10-2
- SD ..... 10-3
- secure digital card ..... 10-3
- security
  - Bluetooth ..... 7-2
- service information .....xvi
- settings ..... 9-1
  - about ..... 9-2
  - beam ..... 9-2
  - buttons ..... 9-2
  - certificates ..... 9-3
  - connections ..... 9-2
  - customer feedback ..... 9-3
  - encryption ..... 9-3
  - error reporting ..... 9-3
  - external GPS ..... 9-3
  - lock ..... 9-1
  - memory ..... 9-3
  - owner information ..... 9-2
  - power ..... 9-1
  - regional settings ..... 9-3
  - remove programs ..... 9-3
  - screen ..... 9-3
  - sounds & notifications ..... 9-1
  - Wi-Fi ..... 9-2
  - wireless manager ..... 9-2
- SIM card
  - accessories ..... 1-3
  - install ..... 1-3
- single slot USB cradle ..... 10-3
  - charging ..... 10-3
  - charging indicators ..... 10-4
- spare battery
  - 3600 mAh ..... 10-2
  - charging ..... 1-6, 10-4, 10-10
- spare battery charger
  - charging ..... 10-10
  - charging indicators ..... 10-10
  - setup ..... 10-10
- speaker icon ..... 2-18
- special character key ..... B-12
- speed dial ..... C-8
- spring loaded stylus ..... 10-2
- starting the EDA ..... 1-2, 1-6
- status icon ..... 2-5
  - battery ..... 2-7, 2-18
  - speaker ..... 2-18
- strap ..... 1-1
- stylus ..... 1-1, 2-20, 10-2

- subscriber identification module ..... 1-3
- suspend ..... 1-8, 1-9, 1-11, 2-3, 7-3
- synchronize with PC
  - using Bluetooth ..... 7-10

## T

- task tray icons ..... C-4
- tasks ..... 2-12
- technical specifications ..... A-1
  - accessories ..... A-6
- temperature ..... A-2
  - charging ..... 1-6, 10-4
- three-way call ..... 3-7, 3-10, C-15, C-16
- Three-Way Calling ..... 3-10
- troubleshooting ..... 11-5

## U

- unpacking ..... 1-1
- up and down button ..... 2-3
- USB charge cable ..... 10-11
- USB charging cable ..... 10-1
- USB client charge cable ..... 10-11
- USB cradle ..... 10-1
- using stylus ..... 2-20
- using wired headset ..... 3-5, C-10

## V

- vehicle cradle ..... 10-1, 10-8
  - charging indicators ..... 10-9
- vehicle holder ..... 10-1
- videos ..... 2-11
- voice commander
  - settings ..... 9-18

## W

- wall mounting kit, cradle ..... 10-2
- Windows Live ..... 2-12
- Windows Live Messenger ..... 2-11
- wired headset ..... 3-5, C-10
- wireless manager ..... 9-2
- wireless status ..... C-4
- WLAN 802.11a/b/g .....xiii
- WPAN Bluetooth .....xiii





**MOTOROLA**

Motorola, Inc.  
One Motorola Plaza  
Holtsville, New York 11742, USA  
1-800-927-9626  
<http://www.motorola.com/enterprisemobility>

MOTOROLA and the Stylized M Logo and Symbol and the Symbol logo are registered in the U.S. Patent and Trademark Office.  
All other product or service names are the property of their registered owners.  
© Motorola, Inc. 2010