

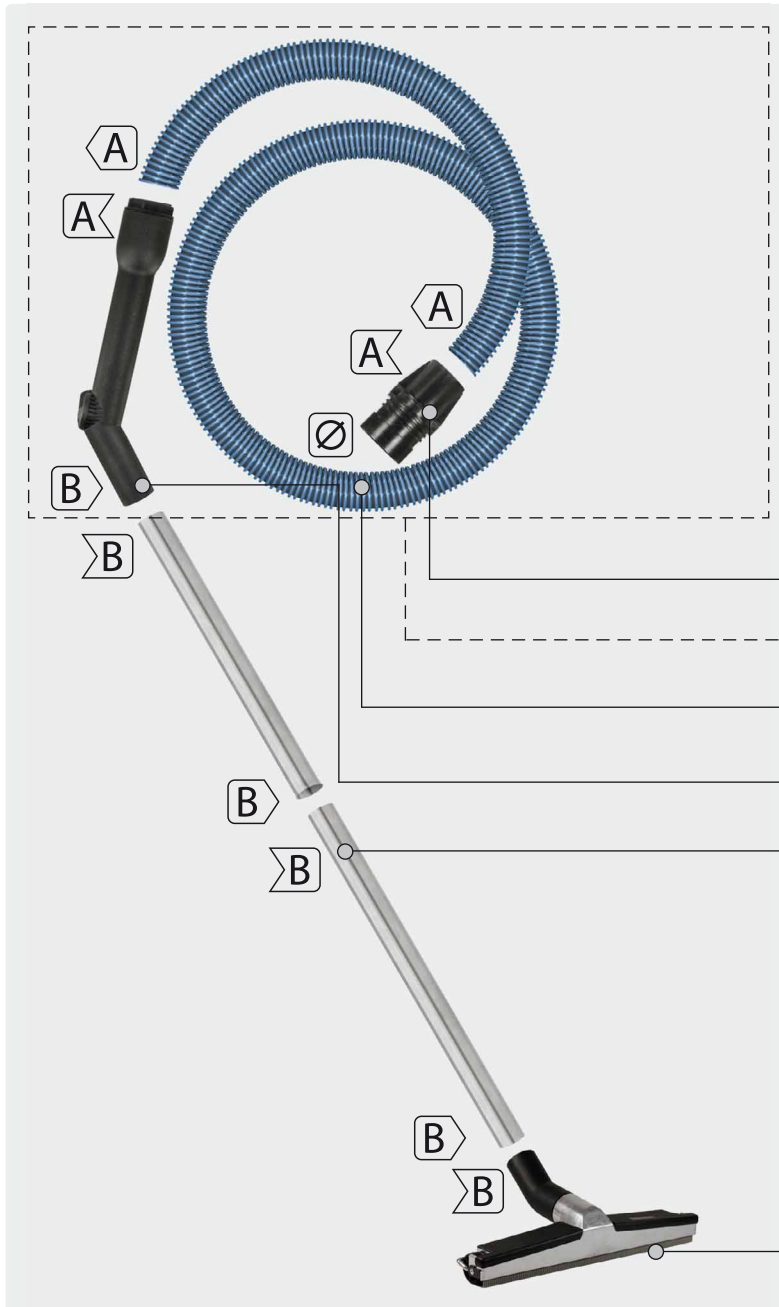

Accessories antistatic	490
Accessories for floor cleaning machines	510
Accessories for spray-ex-sucker	510
Car Wash vacuum hoses	489
Carbon brushes	501
Cartridge filter allocation for cleaning devices	493-498
Cartridge filter for cleaning devices	491-492
Electric appliance adapter	487
Floor tools	487
Hose connectors	487
Motor allocation for vacuum motors	502-509
Motor cover	501
Reducing pieces	487
Rubber tool sleeve	482
Seal	501
Suction swivel arm	488
Tank sleeve	481
Tool sleeve PVC	482
Vacuum filter	510
Vacuum hoses	481
Vacuum hoses assembled	480
Vacuum hoses oil-resistant	488
Vacuum motor cable	501
Vacuum motors	499-501
Vacuum tools	483-486
Vacuum tubes	482



S	A	= DN 32		
F	R	H	P	= DN 38
L	M	T	= DN 50	

B	= 35 mm
G	= 45 mm
O	= 58 mm

- Tank sleeve
- Hose assembled
- Vacuum hoses
- Handle with adjustment. Tool sleeve PVC / rubber
- Vacuum tubes

A	x	A
A	✓	A
B	x	B
B	✓	B
A	x	B
B	x	B

Vacuum hoses assembled



(265 054 + 263 253)

R+M Nr.	↔	DN	Ø	S
263 240	2 m	32	58 mm	32 mm



(265 054 + 263 653)

R+M Nr.	↔	DN	Ø	B
263 640	2 m	32	58 mm	35 mm



(265 053 + 264 051)

R+M Nr.	↔	DN	Ø	H	G
264 040	2.5 m	38	58	38	45

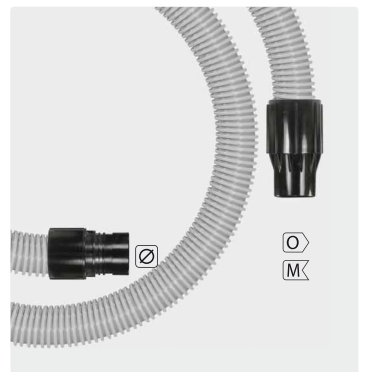

(265 055 + 265 051)

R+M Nr.	↔	DN	Ø	O	M
265 040	2 m	50	58	58	50

Symbols ↔ length Ø diameter in mm DN nominal diameter in mm TYP type 🚚 shipment by truck

Tank sleeve



Ghibli

R+M Nr.	∅	▷F
264 054	49 mm	38 mm



R+M Nr.	∅	▷F
264 055	49 mm	38 mm



R+M Nr.	∅	▷A
263 655**	49 mm	32 mm



R+M Nr.	∅	▷A
265 054	58 mm	32 mm



R+M Nr.	∅	▷L
265 055	58 mm	50 mm



R+M Nr.	∅	▷F
265 053	58 mm	38 mm

Vacuum hoses

Black

- 25 °C - + 60 °C



R+M Nr.	TYP	DN	Outer ∅	↔
262 548 20	A	25 mm	32.0 mm	20 m
263 648 20	A	32 mm	40.0 mm	20 m
263 548 20	A	35 mm	43.3 mm	20 m
264 048 *	F	38 mm	47.0 mm	1 - 20 m
264 048 20	F	38 mm	47.0 mm	20 m
265 048 *	L	50 mm	60.0 mm	1 - 20 m
265 048 20	L	50 mm	60.0 mm	20 m

Grey

- 25 °C - + 60 °C



R+M Nr.	TYP	DN	Outer ∅	↔
263 645 *	A	32 mm	40.0 mm	1 - 20 m
263 645 20	A	32 mm	40.0 mm	20 m
264 045 *	F	38 mm	47.0 mm	1 - 20 m
264 045 20	F	38 mm	47.0 mm	20 m
265 045 *	L	50 mm	60.0 mm	1 - 20 m
265 045 20	L	50 mm	60.0 mm	20 m

Silver

- 25 °C - + 60 °C



R+M Nr.	TYP	DN	Outer ∅	↔
262 549 20 **	A	25 mm	32.0 mm	20 m
262 749 20		27 mm	34.5 mm	20 m
263 249 20	A	32 mm	40.0 mm	20 m
263 649 20	A	36 mm	44.3 mm	20 m
264 049 20	F	38 mm	47.0 mm	20 m
265 049 20	L	50 mm	60.0 mm	20 m

Blue

- 25 °C - + 60 °C

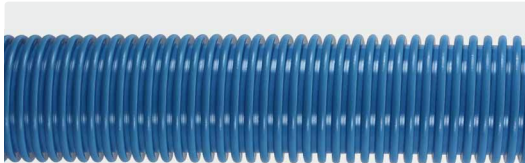

R+M Nr.	TYP	DN	Outer ∅	↔
264 047 20	F	38 mm	47.0 mm	20 m

Black antistatic

- 50 °C - + 60 °C. 10⁶ Ω/m electrically efferent



R+M Nr.	TYP	DN	Outer ∅	↔
262 548 30	A	25 mm	35,5 mm	30 m
263 646 30	A	32 mm	40,5 mm	30 m
264 046 30	F	38 mm	48,0 mm	30 m
265 046 30	L	50 mm	61,0 mm	30 m

EVA Silver - blue

- 45 °C - + 65 °C

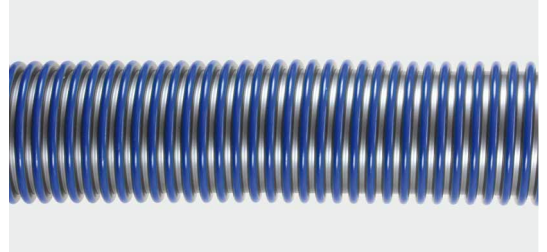

R+M Nr.	TYP	DN	Outer ∅	↔
263 660 01* **	A	35 mm	42.4 mm	1 - 30 m
263 660 30	A	35 mm	42.4 mm	30 m
264 060 01 *	F	38 mm	47.6 mm	1 - 30 m
264 060 30	F	38 mm	47.6 mm	30 m
265 060 01 *	L	50 mm	60.0 mm	1 - 30 m
265 060 30	L	50 mm	60.0 mm	30 m

Brown

- 60 °C - + 120 °C (temporary up to + 150 °C)



Oil and temperature resistant

R+M Nr.	TYP	DN	Outer ∅	↔
263 644 *		36 mm	44.7 mm	1 - 20 m
263 644 20	A	36 mm	44.7 mm	20 m
265 044 *	A	50 mm	61.0 mm	1 - 25 m
265 044 25	L	50 mm	61.0 mm	25 m

** limited stock
* per metre

Tool sleeve PVC



R+M Nr.		Ø
263 250	A 32 mm S 32 mm	32 mm
263 650	A 32 mm B 36 mm	35 - 36 mm



R+M Nr.	F	Ø
264 052	38 mm	45 mm



R+M Nr.	F	Ø
264 050	38 mm	58 mm



R+M Nr.	A	Ø
263 658	32 mm	58 mm



R+M Nr.	L	Ø
265 050	50 mm	58 mm

Handle with adjustment



R+M Nr.			
263 253	A 32 mm	S 32 mm	
263 653	A 32 mm	B 35 mm	
263 653 1	A 32 mm	B 36 mm	
264 053	F 38 mm	G 45 mm	

Rubber tool sleeve



R+M Nr.	F	H	G
264 051	38 mm	38 mm	45 mm



R+M Nr.	L	O	M
265 051	50 mm	58 mm	50 mm

for 265 021

R+M Nr.	L	O	M
265 051	50 mm	58 mm	50 mm

Vacuum tubes



R+M Nr.	M	↔	Ø
263 623	chrome-plated	480 mm	35 mm



R+M Nr.	M	↔	Ø
264 021	chrome-plated	1,200 mm	38 mm

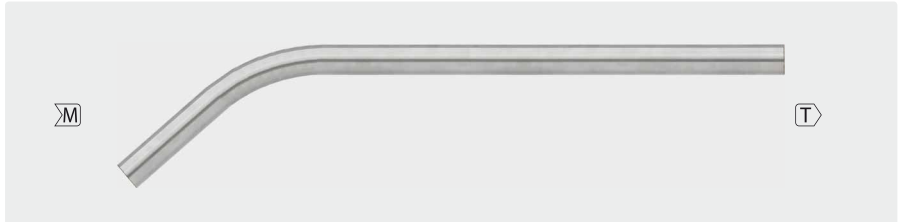

R+M Nr.	M	↔	Ø
265 021	chrome-plated	1,200 mm	50 mm



R+M Nr.	M	↔	Ø
263 223	PVC	450 mm	32 mm
263 623 1	PVC	450 mm	35 mm



R+M Nr.	M	↔	Ø
264 023	PVC	500 mm	45 mm



R+M Nr.	M	↔	Ø
265 023	PVC	500 mm	58 mm

Symbols M material ↔ length Ø diameter in mm DN nominal diameter TYP type

Vacuum tools

Combi-nozzle dry. Switchable. For all carpets and hard covers. Plastic



R+M Nr.	TYP	↔	∅	
263 611	vacuum tool dry	285 mm	35 mm	B
263 211	vacuum tool dry	285 mm	32 mm	S

Combi-nozzle dry for parquet with long and soft horsehair for gentle cleaning applications on sensitive surfaces. Plastic. Soft rollers



R+M Nr.	TYP	↔	∅	
263 612 2	combi-nozzle dry	300 mm	35 mm	B

All-purpose nozzle D300. Vacuum tool with brush strips or rubber lips and height adjustable rollers. Plastic. For all carpets and hard covers



R+M Nr.	TYP	↔	∅	
263 612 31	dry tool	300 mm	35 mm	B
263 612 38	wet tool	300 mm	35 mm	B
263 612 32	set of brush strips	300 mm		
263 612 33	set of rubber lips	300 mm		

All-purpose nozzle. Vacuum tool with grooved rubber lips and height adjustable rollers. Plastic



R+M Nr.	TYP	↔	∅	
263 612 1	vacuum tool wet/dry	400 mm	35 mm	B
263 612 13	rubber lip (1 piece)		35 mm	

All-purpose nozzle D360. Vacuum tool with brush strips, rubber lips and height adjustable rollers. Plastic. For all carpets and hard covers.



R+M Nr.	TYP	↔	∅	
263 612 41	vacuum tool dry	360 mm	35 mm	B
263 612 48	vacuum tool wet	360 mm	35 mm	B
263 812 41	vacuum tool dry	360 mm	38 mm	P
263 812 48	vacuum tool wet	360 mm	38 mm	P
263 612 42	set of brush strips			
263 612 43	set of rubber lips			

Floor body with exchangeable vacuum tool



R+M Nr.	TYP	↔	∅	
264 005	floor body		38 mm	P
264 007	dry tool	375 mm	38 mm	
264 006	wet tool	375 mm	38 mm	

Floor body with exchangeable vacuum tool



R+M Nr.	TYP	↔	∅	
263 605	floor body		35 mm	B
263 205	floor body		32 mm	S
263 610	dry tool	320 mm		
263 609	wet tool	320 mm		



S A = DN 32 . F = DN 38 . L = DN 50 . R = DN 38 . B = 35 mm . G = 45 mm . H = 38 mm . M = 50 mm . Q = 58 mm

Vacuum tools



T S P B

All-purpose nozzle M400. Vacuum tool with brush strips, rubber lips and height adjustable rollers. Plastic. For all carpets and hard covers

R+M Nr.	TYP	↔	∅		
263 213	vacuum tool wet/dry	400 mm	32 mm	S	
263 613	vacuum tool wet/dry	400 mm	35 mm	B	
263 813	vacuum tool wet/dry	400 mm	38 mm	P	
264 013	vacuum tool wet/dry	400 mm	40 mm		K
265 013	vacuum tool wet/dry	400 mm	50 mm	T	
265 000 401	set of rubber lips				
265 000 402	set of brush strips				



T

All-purpose nozzle with brush strips, rubber lips and height adjustable rollers. Plastic

R+M Nr.	TYP	↔	∅		
265 005	vacuum tool wet/dry	450 mm	50 mm	T	
265 006	set of brush strips				
265 007	set of rubber lips				
265 007 3	oil-resistant squeegee blades				



T O P B

All-purpose nozzle M450. Vacuum tool with brush strips, rubber lips and height adjustable rollers. Plastic. For all carpets and hard covers

R+M Nr.	TYP	↔	∅		
263 614	vacuum tool wet/dry	450 mm	35 mm	B	
263 814	vacuum tool wet/dry	450 mm	38 mm	P	
264 014	vacuum tool wet/dry	450 mm	40 mm		K
265 014	vacuum tool wet/dry	450 mm	50 mm	T	
265 814	vacuum tool wet/dry	450 mm	58 mm	O	A
265 000 451	set of rubber lips				
265 000 452	set of brush strips				



B

All-purpose nozzle GRD 370. Vacuum tool with brush strips, rubber lips and height adjustable rollers. Aluminium. For all carpets and hard covers

R+M Nr.	TYP	↔	∅		
263 612 60	vacuum tool wet	370 mm	35 mm	B	
263 612 61	vacuum tool dry	370 mm	35 mm	B	
263 612 62	set of brush strips				
263 612 63	set of rubber lips				
263 612 70	oil-resistant squeegee blades				



P B

All-purpose nozzle GRD 450. Vacuum tool with brush strips, rubber lips and height adjustable rollers. Aluminium. For all carpets and hard covers

R+M Nr.	TYP	↔	∅		
263 612 51	vacuum tool dry	450 mm	35 mm	B	
263 612 52	vacuum tool wet	450 mm	35 mm	B	
263 812 51	vacuum tool dry	450 mm	38 mm	P	
263 812 52	vacuum tool wet	450 mm	38 mm	P	
264 012 51	vacuum tool dry	450 mm	40 mm		K
264 012 52	vacuum tool wet	450 mm	40 mm		K
265 006	set of brush strips				
265 007	set of rubber lips				
265 007 3	oil-resistant squeegee blades				



T

All-purpose nozzle IRD 500. Vacuum tool with brush strips, rubber lips and height adjustable rollers. Aluminium. For all carpets and hard covers

R+M Nr.	TYP	↔	∅		
265 008 1	vacuum tool dry	500 mm	50 mm	T	
265 008 8	vacuum tool wet	500 mm	50 mm	T	
265 008 2	set of brush strips				
265 008 3	set of rubber lips				
265 009 0	oil-resistant squeegee blades				

Symbols height length diameter TYP type

Vacuum tools

Upholstery suction nozzle



Brush oval

R+M Nr.		
263 618	240 mm	35 mm



R+M Nr.		
263 215	100 mm	32 mm



R+M Nr.		
263 615	130 mm	35 mm



Upholstery / mattress tool with thread lifter

R+M Nr.		
263 615 1	90 mm	35 mm



Brush rotating. Suitable for sensitive parts, upholstery & furniture

R+M Nr.		
263 617 1	220 mm	35 mm

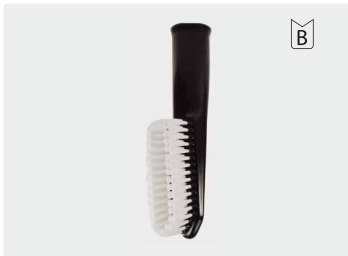

All-purpose brush. USB

R+M Nr.		
263 618 1	230 mm	35 mm

Furniture brush



R+M Nr.	
263 217	32 mm



R+M Nr.	
263 617	35 mm

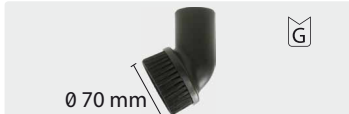

R+M Nr.	
264 017	45 mm



R+M Nr.	
265 017	58 mm



Furniture brush rotating

R+M Nr.	
263 617 2	35 mm

Radiator brush



For grout nozzles 263 619 1 and 263 619 2, 35 mm

R+M Nr.	
263 620	140 mm



For grout nozzle 263 219, 32 mm

R+M Nr.	
263 220	140 mm

Animal care set



Body brush

R+M Nr.		
263 624 1	240 mm	35 mm



Curry-cumb

R+M Nr.		
263 624 2	240 mm	35 mm



Curry-cumb with knobs

R+M Nr.		
263 624 3	240 mm	35 mm

Rubber suction pipe



R+M Nr.	
264 028	45 mm

Nozzle for coarse dirt



R+M Nr.	
265 016	58 mm



Triangle tool

R+M Nr.	
265 015	58 mm

Pipe dusting nozzle



= DN 32 . = DN 38 . = DN 50 . = DN 38 . = 35 mm . = 45 mm . = 38 mm . = 50 mm . = 58 mm

Vacuum tools

Grout nozzles



R+M Nr.	↔	∅
263 219	200 mm	32 mm



R+M Nr.	↔	∅
263 619	200 mm	35 mm
263 619 1	300 mm	35 mm
263 619 2	370 mm	35 mm



R+M Nr.	↔	∅
264 020	305 mm	38 mm



R+M Nr.	↔	∅
264 019	245 mm	45 mm



R+M Nr.	↔	∅
264 019 3	350 mm	45 mm



R+M Nr.	↔	∅
264 019 4	350 mm	45 mm



R+M Nr.	↔	∅
265 018	270 mm	58 mm



Glass fibre reinforced

R+M Nr.	↔	∅
265 019	230 mm	58 mm

R+M Nr.	↔	∅
265 022 1	370 mm	58 mm



R+M Nr.	↔	∅
265 020	370 mm	58 mm



R+M Nr.	↔	∅
265 022	370 mm	58 mm



Flexible grout nozzles



Rotating. Anti-theft protection due to three-part clip locking system

R+M Nr.	↔	∅
264 019 12	375 mm	DN 38



Rotating. Anti-theft protection due to three-part clip locking system

R+M Nr.	↔	∅
264 019 13	375 mm	DN 38



Rotating. Easy assembly due to screw thread

R+M Nr.	↔	∅
264 019 1	420 mm	DN 38



With inner bar 18 cm. Rotating. Rotating. Easy assembly due to screw thread

R+M Nr.	↔	∅
264 019 11	420 mm	DN 38

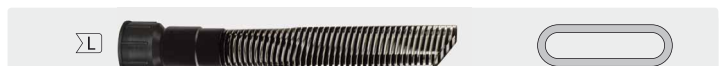

Rotating. Easy assembly due to screw thread

R+M Nr.	↔	∅
265 019 1	420 mm	DN 50



With inner bar 18 cm. Rotating. Easy assembly due to screw thread

R+M Nr.	↔	∅
265 019 11	420 mm	DN 50



Flexible. PVC

R+M Nr.	↔	∅
263 621	630 mm	35 mm

Reducing pieces



R+M Nr.	G	B
264 025	45 mm	35 / 36 mm



R+M Nr.	O	B
265 025	58 mm	35 / 36 mm

Hose connectors



R+M Nr.	Ø
263 656	32 mm



R+M Nr.	Ø
264 056	38 mm



R+M Nr.	Ø
265 056	50 mm

Electric appliance adapter

- Ø 26 mm
- Ø 32 mm
- Ø 35 mm



R+M Nr.	Ø
263 625	35 mm

Floor tools

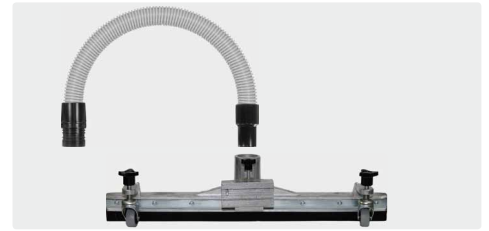

Floor tool dry. Height adjustable rollers. Tank sleeve 58 mm

R+M Nr.	TYP
264 032 *	vacuum hose 600 mm
264 030 *	floor tool 600 mm
264 030 1 *	set of brush stripes

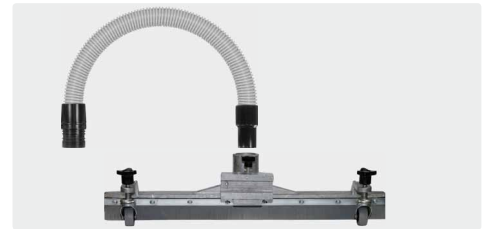

Floor tool wet. Height adjustable rollers. Tank sleeve 58 mm

R+M Nr.	TYP
264 032 *	vacuum hose 600 mm
264 031 *	floor tool 600 mm
264 031 1 *	set of rubber lips

* limited stock

S A = DN 32 . F = DN 38 . L = DN 50 . R = DN 38 . B = 35 mm . G = 45 mm . H = 38 mm . M = 50 mm . O = 58 mm



Symbols ⇄ length Ø diameter in mm TYP type

Vacuum hoses oil-resistant

Hose profile-coiled made out of polyester-elastomer.
 Features: An internally smooth profile hose made out of full plastic having a very low flow resistance and a good reset force (after pressing it together or bending it over) with excellent flexibility, high resistance to oil and fuel.
 Range of applications: industrial vacuum cleaner, chemical plant engineering, conveyor and extraction systems, car exhaust systems, hot air.
 Temperature range: - 60 °C - + 120 °C (temporary up to + 150 °C)



R+M Nr.	TYP	DN	Outer ∅	↔
263 644 *	A	36 mm	44.7 mm	1 - 20 m
263 644 20	A	36 mm	44.7 mm	20 m
265 044 *	L	50 mm	61.0 mm	1 - 25 m
265 044 25	L	50 mm	61.0 mm	25 m

Suction swivel arm

easywash365+

New for self-service vacuum cleaning

- » entirely made out of stainless steel
- » solid construction
- » suspension

The vertical **easywash365 +** suction swivel arm for self-service!
 This cost-effective solution is ideal for single suction places.
 In this case, the arm does not necessarily have to be integrated into the cabinet technology, but can be easily mounted on a wall. Perfect if space might be limited, because due to its construction this boom needs little space and bending over offers a lot of mobility.
 The built-in spring prevents kinking of the suction hose and allows a barrier-free handling with optional freedom of mobility.
 The vertical **easywash365 +** suction swivel arm is completely made out of stainless steel and is supplied including a mounting bracket.

Height 2,320 mm.
 Tube height 1,500 mm.
 Internal tube diameter of 65 mm.
 Weight 10.1 kg



R+M Nr.
109 001 500

* per metre

Ⓢ A = DN 32 . Ⓣ = DN 38 . Ⓛ = DN 50 . Ⓡ = DN 38 . ⓑ = 35 mm . ⓐ = 45 mm . ⓗ = 38 mm . Ⓜ = 50 mm . Ⓞ = 58 mm



Car Wash vacuum hoses

The Car Wash vacuum hoses are equipped with a highly abrasion- and dirt-resistant plastic coil (non marking).

- » Extremely light and very flexible structure
- » A smooth interior for small pressure drops
- » High elastic recovery in case of radial deformation
- » UV-resistant, weatherproof and flexible at low temperatures

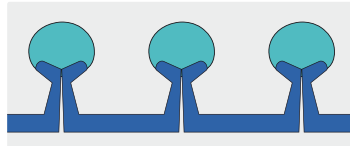

Car Wash vacuum hoses

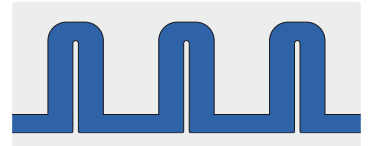

Standard vacuum hoses

Blue



R+M Nr.	TYP	DN	Outer Ø	↔
264 049 1	R	38	50 mm	16 m

Blue - turquoise

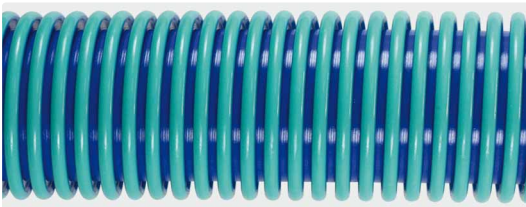

R+M Nr.	TYP	DN	Outer Ø	↔
264 049 2	R	38	50 mm	16 m

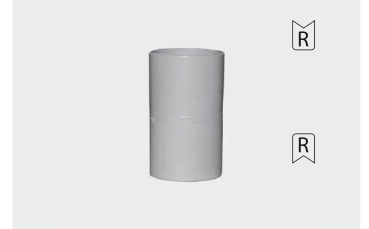

Hose connectors

R+M Nr.	Ø
264 056 1	38 mm

Sleeve



R+M Nr.	Ø	R
264 052 6	50 / 58 mm	38 mm



R+M Nr.	Ø	R
264 052 7	50 / 58 mm	38 mm



swiveling

R+M Nr.	G H	R
264 052 1	45 / 38 mm	38 mm



R+M Nr.	G H	R
264 052 4	45 / 38 mm	38 mm

Grout nozzles



R+M Nr.	l	Ø
264 019	245 mm	45 mm



R+M Nr.	l	Ø
264 019 2	420 mm	38 mm



R+M Nr.	l	Ø
265 020	370 mm	58 mm

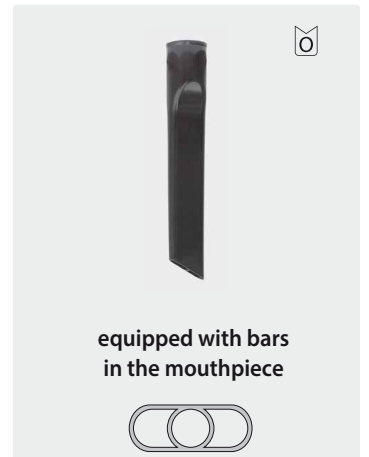

equipped with bars in the mouthpiece

R+M Nr.	l	Ø
265 022	370 mm	58 mm

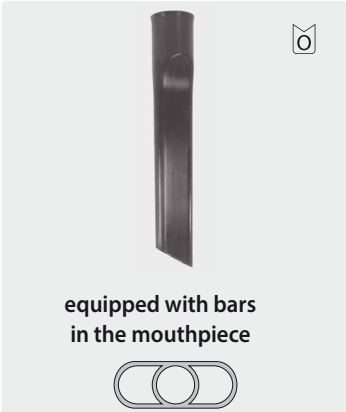

equipped with bars in the mouthpiece

Glass fibre reinforced

R+M Nr.	l	Ø
265 022 1	370 mm	58 mm



Angle nozzle

R+M Nr.	Ø
264 052 2	38 mm

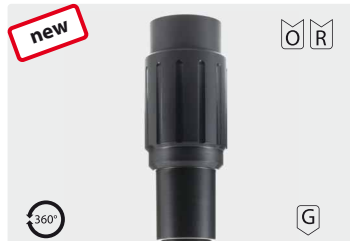

new

swiveling

R+M Nr.	G	R	Ø
264 052 9	45 mm	38 mm	
264 053 0	58 mm	38 mm	

Symbols **l** height **↔** length **DN** nominal diameter **TYP** type

Accessories antistatic

Vacuum tubes antistatic



R+M Nr.	\overline{M}	$\overline{\leftarrow}$	$\overline{\varnothing}$
264 023 01	$\leq 10^4 \Omega/m$ electrically efferent	500 mm	45 mm



R+M Nr.	\overline{M}	$\overline{\leftarrow}$	$\overline{\varnothing}$
265 023 01	$\leq 10^4 \Omega/m$ electrically efferent	500 mm	58 mm

Hose coupling antistatic



R+M Nr.	\overline{M}	\overline{F}	\overline{G}
264 052 01	$10^4 \Omega/m$	38 mm	45 mm



R+M Nr.	\overline{M}	\overline{L}	\overline{O}
265 050 01	$10^4 \Omega/m$	50 mm	58 mm

Vacuum tools antistatic



R+M Nr.	\overline{M}	\overline{I}	$\overline{\varnothing}$
264 019 01	$10^4 \Omega/m$	250 mm	45 mm



R+M Nr.	\overline{M}	\overline{I}	$\overline{\varnothing}$
265 019 01	$10^4 \Omega/m$	230 mm	58 mm

Vacuum hoses black antistatic

- 50 °C - + 60 °C. $10^6 \Omega/m$ electrically efferent

Black

















R+M Nr.	TYP	DN	Outer \varnothing	$\overline{\leftarrow}$
262 548 30	A	25 mm	35.5 mm	30 m
263 646 30	$\langle A \rangle$	32 mm	40.5 mm	30 m
264 046 30	$\langle F \rangle$	38 mm	48.0 mm	30 m
265 046 30	$\langle L \rangle$	50 mm	61.0 mm	30 m

\overline{S} \overline{A} = DN 32 . \overline{F} = DN 38 . \overline{L} = DN 50 . \overline{R} = DN 38 . \overline{B} = 35 mm . \overline{G} = 45 mm . \overline{H} = 38 mm . \overline{M} = 50 mm . \overline{O} = 58 mm













Symbols \overline{I} height $\overline{\leftarrow}$ length $\overline{\varnothing}$ diameter in mm $\overline{\odot}$ internal diameter TYP type \overline{M} material DN nominal diameter shipment by truck

Cartridge filter for cleaning devices

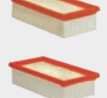
	R+M Nr. 268 263 510	TYP paper	\varnothing 185 mm	\odot 145 mm	I 140 mm	dust class M	manufacturer number Festool: 485 808 Protool: 625 324 ALTO/WAP: 11753
	R+M Nr. 268 263 520	TYP PET	\varnothing 185 mm	\odot 145 mm	I 140 mm	dust class M	manufacturer number Protool: 625 324 ALTO/ WAP: 302 000 490
	R+M Nr. 268 263 610	TYP paper	\varnothing 185 mm	\odot 145 mm	I 233 mm	dust class M	manufacturer number Festool: 486 241 ALTO/WAP: 30063
	R+M Nr. 268 263 620	TYP paper	\varnothing 185 mm	\odot 145 mm	I 233 mm	dust class H	manufacturer number Festool: 486 145 ALTO/WAP: 11618
	R+M Nr. 268 263 700	TYP paper / screen	\varnothing 185 mm	\odot 142 mm	I 250 mm	dust class M	manufacturer number ALTO/WAP: 41164
	R+M Nr. 268 263 710	TYP PET / screen	\varnothing 185 mm	\odot 142 mm	I 250 mm	dust class M	manufacturer number ALTO/WAP: 41164
	R+M Nr. 268 263 800	TYP paper / screen	\varnothing 185 mm	\odot 150 mm	I 190 mm	dust class M	manufacturer number ALTO/WAP: 34641
	R+M Nr. 268 263 810	TYP paper / screen	\varnothing 185 mm	\odot 150 mm	I 160 mm	dust class M	manufacturer number Lavor: 3.752.0032
	R+M Nr. 268 263 820	TYP paper / screen	\varnothing 185 mm	\odot 150 mm	I 163 mm	dust class M	manufacturer number AquaVac: AZ91171175
	R+M Nr. 268 264 000	TYP PET	\varnothing 185 mm	\odot 140 mm	I 115 mm	dust class M	manufacturer number Festool: 488 461 ALTO/WAP: 29747
	R+M Nr. 268 264 200	TYP paper	\varnothing 203 mm	\odot 140 mm	I 171 mm	dust class M	manufacturer number Festool: 488 924 ALTO/WAP: 60077
	R+M Nr. 268 264 210	TYP paper	\varnothing 203 mm	\odot 140 mm	I 171 mm	dust class H	manufacturer number Festool: 489 221 ALTO/WAP: 60076
	R+M Nr. 268 264 300	TYP screen	\varnothing 185 mm	\odot 142 mm	I 250 mm	dust class -	manufacturer number ALTO/WAP: 10022
	R+M Nr. 268 264 310	TYP screen	\varnothing 185 mm	\odot 142 mm	I 140 mm	dust class -	manufacturer number ALTO/WAP: 15475
	R+M Nr. 268 268 600	TYP paper	\varnothing 210 mm	\odot 140 mm	I 140 mm	dust class H	manufacturer number Protool: 625 372 ALTO/WAP: 302000658

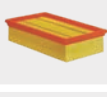
dust class	transmittance	endangerings	dust class	transmittance	endangerings
L	max. 1 %	keeps 99.995 % back from: » dusts with max. concentration of > 1 mg/m ³	H	max. 0.01 %	keeps 99.995 % back from: » dusts with max. concentration » cancer-causing dusts » dusts with pathogenic germs
M	max. 0.10 %	keeps 99.9 % back from: » dusts with max. concentration of > 0.1 mg/m ³ » wood dusts (up to 1200 W/50 l)			

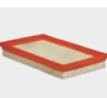
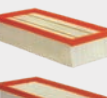
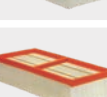
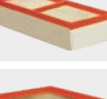
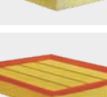
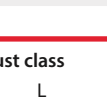
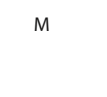
Cartridge filter for cleaning devices

	R+M Nr.	TYP	∅	⊙	I	dust class	manufacturer number
	268 268 710	PET / screen	275 mm	218 mm	183 mm	M	ALTO/WAP: 107400562 Protool: 626 437
	R+M Nr.	TYP	∅	⊙	I	dust class	manufacturer number
	268 269 000	paper / screen	185 mm	150 mm	201 mm	M	Rowenta ZR-70
	R+M Nr.	TYP	∅	⊙	I	dust class	manufacturer number
	268 269 100	paper / screen	190 mm	145 mm	166 mm	M	Thomas: 787 421
	R+M Nr.	TYP	∅	⊙	I	dust class	manufacturer number
	268 269 300	paper	122 mm	79 mm	113 mm	M	Top-Craft (NT 0506)
	R+M Nr.	TYP	length	↔	I	dust class	manufacturer number
	268 280 210	paper	215 mm	115 mm	58 mm	M	Festool: 452 065 Kärcher: 6.904-068
	R+M Nr.	TYP	length	↔	I	dust class	manufacturer number
	268 280 220	PES	215 mm	115 mm	58 mm	M	Kärcher: 6.904-123
	R+M Nr.	TYP	length	↔	I	dust class	manufacturer number
	268 228 200	paper	202 mm	75 mm	70 mm	L	Kärcher: 6.414-498
	R+M Nr.	TYP	length	↔	I	dust class	manufacturer number
	268 228 300	paper	239 mm	140 mm	56 mm	L	Kärcher: 6.904-206
	R+M Nr.	TYP	length	↔	I	dust class	manufacturer number
	268 228 310	paper	239 mm	140 mm	56 mm	M	Kärcher: 6.904-367
	R+M Nr.	TYP	length	↔	I	dust class	manufacturer number
	268 228 330	PES	239 mm	140 mm	56 mm	M	Kärcher: 6.904-360
	R+M Nr.	TYP	length	↔	I	dust class	manufacturer number
	268 228 340	PES	239 mm	140 mm	56 mm	M	Kärcher: 6.904-360
	R+M Nr.	TYP	length	↔	I	dust class	manufacturer number
	268 228 400	paper	250 mm	150 mm	35 mm	M	Festool: 456 077
	R+M Nr.	TYP	length	↔	I	dust class	manufacturer number
	268 228 600	paper	300 mm	140 mm	68 mm	M	Kärcher: 6.904-283
	R+M Nr.	TYP	length	↔	I	dust class	manufacturer number
	268 228 620	PES	300 mm	140 mm	68 mm	M	Kärcher: 6.904-284
	R+M Nr.	TYP	length	↔	I	dust class	manufacturer number
	268 228 900	paper	300 mm	140 mm	68 mm	M	Kärcher: 6.907-276
	R+M Nr.	TYP	length	↔	I	dust class	manufacturer number
	268 228 910	PES	300 mm	140 mm	68 mm	M	Kärcher: 6.907-277
	R+M Nr.	TYP	length	↔	I	dust class	manufacturer number
	268 228 700	paper	278 mm	216 mm	54 mm	L	Kärcher: 5.731-020
	R+M Nr.	TYP	length	↔	I	dust class	manufacturer number
	268 289 400	paper	328 mm	290 mm	50 mm	L	ALTO/WAP: 61605

dust class	transmittance	endangerings	dust class	transmittance	endangerings
L	max. 1 %	keeps 99.995 % back from: » dusts with max. concentration of > 1 mg/m ³	H	max. 0.01 %	keeps 99.995 % back from: » dusts with max. concentration » cancer-causing dusts » dusts with pathogenic germs
M	max. 0.10 %	keeps 99.9 % back from: » dusts with max. concentration of > 0.1 mg/m ³ » wood dusts (up to 1200 W/50 l)			

Cartridge filter allocation for cleaning devices

Manufacturer	TYP	device	absolute filter	micro filter	filter screen
ALTO / NILFISK	wet/dry vacuum cleaner	aero 400	268 263 510		
ALTO / NILFISK	wet/dry vacuum cleaner	aero 440	268 263 510		
ALTO / NILFISK	wet/dry vacuum cleaner	aero 5 Gallon	268 263 510		
ALTO / NILFISK	wet/dry vacuum cleaner	aero 600	268 263 510		
ALTO / NILFISK	wet/dry vacuum cleaner	aero 640	268 263 510		
ALTO / NILFISK	wet/dry vacuum cleaner	aero 7 Gallon AS/E	268 263 510		
ALTO / NILFISK	wet/dry vacuum cleaner	aero 800A	268 263 510		
ALTO / NILFISK	wet/dry vacuum cleaner	aero 840A	268 263 510		
ALTO / NILFISK	wet/dry vacuum cleaner	Attix 30-01 PC	268 263 520		268 264 310
ALTO / NILFISK	safety vacuum cleaner	Attix 30-0H PC		268 268 600	
ALTO / NILFISK	wet/dry vacuum cleaner	Attix 30-11 PC	268 263 520		268 264 310
ALTO / NILFISK	wet/dry vacuum cleaner	Attix 30-21 PC	268 263 520		268 264 310
ALTO / NILFISK	safety vacuum cleaner	Attix 30-2H PC		268 268 600	
ALTO / NILFISK	special vacuum cleaner	Attix 30-2M PC	268 263 520		
ALTO / NILFISK	wet/dry vacuum cleaner	Attix 350-01	268 263 520		
ALTO / NILFISK	safety vacuum cleaner	Attix 350-0H		268 268 600	
ALTO / NILFISK	wet/dry vacuum cleaner	Attix 360-11	268 263 520		
ALTO / NILFISK	wet/dry vacuum cleaner	Attix 360-21	268 263 520		
ALTO / NILFISK	safety vacuum cleaner	Attix 360-2H		268 268 600	
ALTO / NILFISK	wet/dry vacuum cleaner	Attix 40-01 PC	268 263 520		268 264 310
ALTO / NILFISK	wet/dry vacuum cleaner	Attix 40-21 PC	268 263 520		268 264 310
ALTO / NILFISK	wet/dry vacuum cleaner	Attix 50-01 PC	268 263 520		268 264 310
ALTO / NILFISK	safety vacuum cleaner	Attix 50-0H PC		268 268 600	
ALTO / NILFISK	wet/dry vacuum cleaner	Attix 50-21 PC	268 263 520		268 264 310
ALTO / NILFISK	safety vacuum cleaner	Attix 50-2H PC		268 268 600	
ALTO / NILFISK	special vacuum cleaner	Attix 50-2M PC	268 263 520		268 264 310
ALTO / NILFISK	wet/dry vacuum cleaner	Attix 550-01	268 263 520		
ALTO / NILFISK	safety vacuum cleaner	Attix 550-0H		268 268 600	
ALTO / NILFISK	wet/dry vacuum cleaner	Attix 550-21	268 263 520		
ALTO / NILFISK	safety vacuum cleaner	Attix 550-2H		268 268 600	
ALTO / NILFISK	wet/dry vacuum cleaner	Attix 560-21 XC	268 268 710		
ALTO / NILFISK	wet/dry vacuum cleaner	Attix 560-2M XC	268 268 710		
ALTO / NILFISK	wet/dry vacuum cleaner	Attix 560-31 XC	268 268 710		
ALTO / NILFISK	wet/dry vacuum cleaner	Attix 590-21	268 263 520		
ALTO / NILFISK	safety vacuum cleaner	Attix 751-0H		268 268 600	
ALTO / NILFISK	wet/dry vacuum cleaner	Attix 751-11	268 263 520		268 264 310
ALTO / NILFISK	wet/dry vacuum cleaner	Attix 751-21	268 263 520		268 264 310
ALTO / NILFISK	safety vacuum cleaner	Attix 751-2M	268 263 520		
ALTO / NILFISK	water vacuum cleaner	Attix 751-61			268 264 310
ALTO / NILFISK	water vacuum cleaner	Attix 751-71			268 264 310
ALTO / NILFISK	wet/dry vacuum cleaner	Attix 761-21 XC	268 268 710		
ALTO / NILFISK	special vacuum cleaner	Attix 763-2M ED	268 268 710		
ALTO / NILFISK	wet/dry vacuum cleaner	Attix 791-21 EC	268 263 520		
ALTO / NILFISK	high-performance vacuum cleaner	Attix 961-01	268 268 710		
ALTO / NILFISK	high-performance vacuum cleaner	Attix 963-21 ED XC	268 268 710		
ALTO / NILFISK	high-performance vacuum cleaner	Attix 965-21 SD SC	268 268 710		
ALTO / NILFISK	high-performance vacuum cleaner	EC 380-E	268 263 510		268 264 310
ALTO / NILFISK	safety vacuum cleaner	EC 380-SW/B1	268 263 610	268 263 620	
ALTO / NILFISK	high-performance vacuum cleaner	EC 480	268 263 610	268 263 620	
ALTO / NILFISK	safety vacuum cleaner	EC 480 E/IH/B1	268 263 610	268 263 620	
ALTO / NILFISK	safety vacuum cleaner	EC 480-SW/B1	268 263 610	268 263 620	
ALTO / NILFISK	high-performance vacuum cleaner	EC 850	268 263 700		268 264 300
ALTO / NILFISK	high-performance vacuum cleaner	EC 850-E	268 263 700		268 264 300
ALTO / NILFISK	self-service vacuums	SB-Saugstation	268 263 610	268 263 620	
ALTO / NILFISK	self-service vacuums	SB-Saugstation EC	268 263 610	268 263 620	
ALTO / NILFISK	self-service vacuums	SB-Saugstation Tandem	268 263 610	268 263 620	
ALTO / NILFISK	self-service vacuums	SB-Saugstation Tandem EC	268 263 610	268 263 620	
ALTO / NILFISK	wet/dry vacuum cleaner	SQ 450-11/21/31	268 264 000		268 264 310
ALTO / NILFISK	wet/dry vacuum cleaner	SQ 490-31	268 264 000		268 264 310

Symbols  height  length  diameter in mm  internal diameter TYP type

Cartridge filter allocation for cleaning devices

Manufacturer	(TYP)	device	absolute filter	micro filter	filter screen
ALTO / NILFISK	wet/dry vacuum cleaner	SQ 550-11/21/31	268 263 510		268 264 310
ALTO / NILFISK	wet/dry vacuum cleaner	SQ 650-11	268 263 510	268 263 520	268 264 310
ALTO / NILFISK	safety vacuum cleaner	SQ 650-1H		268 264 210	
ALTO / NILFISK	safety vacuum cleaner	SQ 650-1M	268 264 200		
ALTO / NILFISK	safety vacuum cleaner	SQ 650-3H		268 264 210	
ALTO / NILFISK	safety vacuum cleaner	SQ 650-3M	268 264 200		
ALTO / NILFISK	water vacuum cleaner	SQ 650-61			268 264 310
ALTO / NILFISK	water vacuum cleaner	SQ 650-71			268 264 310
ALTO / NILFISK	wet/dry vacuum cleaner	SQ 651-11	268 263 510		268 264 310
ALTO / NILFISK	wet/dry vacuum cleaner	SQ 690-21	268 263 510		
ALTO / NILFISK	wet/dry vacuum cleaner	SQ 690-31	268 263 510		
ALTO / NILFISK	safety vacuum cleaner	SQ 690-3M/B1	268 264 200		268 264 210
ALTO / NILFISK	safety vacuum cleaner	SQ 691-9M/B1	268 264 200		268 264 210
ALTO / NILFISK	wet/dry vacuum cleaner	SQ 850-11	268 289 400		
ALTO / NILFISK	wet/dry vacuum cleaner	ST 10	268 263 510		
ALTO / NILFISK	wet/dry vacuum cleaner	ST 15	268 263 510		
ALTO / NILFISK	wet/dry vacuum cleaner	ST 20	268 263 510		
ALTO / NILFISK	wet/dry vacuum cleaner	ST 25	268 263 510		
ALTO / NILFISK	wet/dry vacuum cleaner	ST 35E	268 263 510		
ALTO / NILFISK	high-performance vacuum cleaner	turbo 1001	268 263 610	268 263 620	
ALTO / NILFISK	special water vacuum cleaner	turbo 1001 AE			268 264 310
ALTO / NILFISK	special water vacuum cleaner	turbo 1001 AE-F			268 264 310
ALTO / NILFISK	high-performance vacuum cleaner	turbo 1001 Ki	268 263 610	268 263 620	
ALTO / NILFISK	safety vacuum cleaner	turbo 1001 SA	268 263 610	268 263 620	
ALTO / NILFISK	safety vacuum cleaner	turbo 1001 SA/K1	268 263 610	268 263 620	
ALTO / NILFISK	safety vacuum cleaner	turbo 1001 SW/IH	268 263 610	268 263 620	
ALTO / NILFISK	safety vacuum cleaner	turbo 1001 SWE/I	268 263 610	268 263 620	
ALTO / NILFISK	high-performance vacuum cleaner	turbo D	268 263 700		268 264 300
ALTO / NILFISK	safety vacuum cleaner	turbo D/X-B1	268 263 700		
ALTO / NILFISK	high-performance vacuum cleaner	turbo D2	268 263 700		268 264 300
ALTO / NILFISK	safety vacuum cleaner	turbo D-B1	268 263 700		
ALTO / NILFISK	high-performance vacuum cleaner	turbo GT	268 263 800		
ALTO / NILFISK	high-performance vacuum cleaner	turbo M2	268 263 700		268 264 300
ALTO / NILFISK	high-performance vacuum cleaner	turbo M2 L	268 263 700		268 264 300
ALTO / NILFISK	safety vacuum cleaner	turbo M2 S-FA	268 263 700		268 264 300
ALTO / NILFISK	special water vacuum cleaner	turbo M2-AE			268 264 300
ALTO / NILFISK	safety vacuum cleaner	turbo SSR	268 263 510		
ALTO / NILFISK	high-performance vacuum cleaner	turbo XL	268 263 510		268 264 310
ALTO / NILFISK	high-performance vacuum cleaner	turbo XL 25	268 263 510		268 264 310
ALTO / NILFISK	safety vacuum cleaner	turbo XL-SW	268 263 510	268 263 620	
ALTO / NILFISK	safety vacuum cleaner	turbo XL-SW/IH	268 263 610	268 263 620	
ALTO / NILFISK	safety vacuum cleaner	turbo XL-SW/K1		268 263 620	
AQUAVAC	wet/dry vacuum cleaner	1000	268 263 820		
AQUAVAC	wet/dry vacuum cleaner	2000 plera 6160 F	268 263 820		
AQUAVAC	wet/dry vacuum cleaner	6160 F	268 263 820		
AQUAVAC	wet/dry vacuum cleaner	6160 P dustri	268 263 820		
AQUAVAC	wet/dry vacuum cleaner	6200 P Bulldog 6201 A	268 263 820		
AQUAVAC	wet/dry vacuum cleaner	6201 A	268 263 820		
AQUAVAC	wet/dry vacuum cleaner	6400 F	268 263 820		
AQUAVAC	wet/dry vacuum cleaner	7402 B	268 263 820		
AQUAVAC	wet/dry vacuum cleaner	7402 P	268 263 820		
AQUAVAC	wet/dry vacuum cleaner	7403 B	268 263 820		
AQUAVAC	wet/dry vacuum cleaner	7403 P	268 263 820		
AQUAVAC	wet/dry vacuum cleaner	7408 P	268 263 820		
AQUAVAC	wet/dry vacuum cleaner	7409 P	268 263 820		
AQUAVAC	wet/dry vacuum cleaner	7413 B	268 263 820		
AQUAVAC	wet/dry vacuum cleaner	8103 B	268 263 820		
AQUAVAC	wet/dry vacuum cleaner	8202 B	268 263 820		
AQUAVAC	wet/dry vacuum cleaner	8203 P	268 263 820		
AQUAVAC	wet/dry vacuum cleaner	8204 B	268 263 820		
AQUAVAC	wet/dry vacuum cleaner	9121 P	268 263 820		

Cartridge filter allocation for cleaning devices

Manufacturer	TYP	device	absolute filter	micro filter	filter screen
AQUAVAC	wet/dry vacuum cleaner	9127 P	268 263 820		
AQUAVAC	wet/dry vacuum cleaner	AZ 90304-12	268 263 820		
AQUAVAC	wet/dry vacuum cleaner	AZ 90304-75	268 263 820		
AQUAVAC	wet/dry vacuum cleaner	AZ 90306-12A	268 263 820		
AQUAVAC	wet/dry vacuum cleaner	AZ 91951-10	268 263 820		
AQUAVAC	wet/dry vacuum cleaner	euromac v10	268 263 820		
AQUAVAC	wet/dry vacuum cleaner	Hobby 11	268 263 820		
AQUAVAC	wet/dry vacuum cleaner	Hobby 22	268 263 820		
AQUAVAC	wet/dry vacuum cleaner	Hobby 24	268 263 820		
AQUAVAC	wet/dry vacuum cleaner	Hobby 33	268 263 820		
AQUAVAC	wet/dry vacuum cleaner	Hobby 36	268 263 820		
AQUAVAC	wet/dry vacuum cleaner	Hobby 44	268 263 820		
AQUAVAC	wet/dry vacuum cleaner	Hobby Vac 1000	268 263 820		
AQUAVAC	wet/dry vacuum cleaner	Max 630	268 263 820		
AQUAVAC	wet/dry vacuum cleaner	Max 7	268 263 820		
AQUAVAC	wet/dry vacuum cleaner	Multisystem 3000	268 263 820		
AQUAVAC	wet/dry vacuum cleaner	Multisystem 4000	268 263 820		
AQUAVAC	wet/dry vacuum cleaner	Multisystem 500i	268 263 820		
AQUAVAC	wet/dry vacuum cleaner	Plus 1000	268 263 820		
AQUAVAC	wet/dry vacuum cleaner	Super 615 S1	268 263 820		
AQUAVAC	wet/dry vacuum cleaner	Super 760	268 263 820		
AQUAVAC	wet/dry vacuum cleaner	Synchro 22	268 263 820		
AQUAVAC	wet/dry vacuum cleaner	Synchro 30	268 263 820		
AQUAVAC	wet/dry vacuum cleaner	Synchro 30 A	268 263 820		
AQUAVAC	wet/dry vacuum cleaner	Synchro 40 A	268 263 820		
FESTOOL	mobile dust extractor	CT 11 E	268 280 212		
FESTOOL	mobile dust extractor	CT 22 E	268 280 212		
FESTOOL	mobile dust extractor	CT 33 E/LE	268 280 212		
FESTOOL	mobile dust extractor	CT 44 E/LE	268 280 212		
FESTOOL	mobile dust extractor	CT 55 E	268 280 212		
FESTOOL	mobile dust extractor	CT Mini	268 228 400		
FESTOOL	mobile dust extractor	CTL 11 E	268 280 212		
FESTOOL	mobile dust extractor	CTL 22 E	268 280 212		
FESTOOL	mobile dust extractor	CTL 33 E/LE	268 280 212		
FESTOOL	mobile dust extractor	CTL 44 E/LE	268 280 212		
FESTOOL	mobile dust extractor	CTL 55 E	268 280 212		
FESTOOL	mobile dust extractor	CTL Mini	268 228 400		
FESTOOL	mobile dust extractor	CTM 11 E	268 280 212		
FESTOOL	mobile dust extractor	CTM 22 E	268 280 212		
FESTOOL	mobile dust extractor	CTM 33 E/LE	268 280 212		
FESTOOL	mobile dust extractor	CTM 44 E/LE	268 280 212		
FESTOOL	mobile dust extractor	CTM 55 E	268 280 212		
FESTOOL	special vacuum cleaner	SR 12 /14/15	268 263 610	268 263 620	
FESTOOL	special vacuum cleaner	SR 200/201	268 263 510		
FESTOOL	special vacuum cleaner	SR 202 /203/212	268 263 610	268 263 620	
FESTOOL	special vacuum cleaner	SR 301 /302/303	268 263 610	268 263 620	
FESTOOL	special vacuum cleaner	SR 5	268 263 510		
FESTOOL	special vacuum cleaner	SR 6	268 263 610	268 263 620	
FESTOOL	special vacuum cleaner	SRH 204 E-AS		268 264 210	
FESTOOL	special vacuum cleaner	SRH 45 E		268 264 210	
FESTOOL	special vacuum cleaner	SRM 152	268 264 200		
FESTOOL	special vacuum cleaner	SRM 212 LE-AS	268 263 610	268 263 620	
FESTOOL	special vacuum cleaner	SRM 312 LE-AS	268 263 610	268 263 620	
FESTOOL	special vacuum cleaner	SRM 45 E-AS	268 264 200		
FESTOOL	special vacuum cleaner	SRM 70 LE-EC/B1	268 264 200		
Kärcher	wet/dry vacuum cleaner	A 2701	268 228 200		
Kärcher	wet/dry vacuum cleaner	A 2731 pt	268 228 200		
Kärcher	wet/dry vacuum cleaner	A 2801 plus	268 228 200		
Kärcher	wet/dry vacuum cleaner	K 2000 E	268 280 210		

Symbols TYP type

Cartridge filter allocation for cleaning devices

Manufacturer	TYP	device	absolute filter	micro filter	filter screen
Kärcher	wet/dry vacuum cleaner	K 2000 E	268 280 220		
Kärcher	wet/dry vacuum cleaner	K 2000 TE	268 280 210		
Kärcher	wet/dry vacuum cleaner	K 2000 TE	268 280 220		
Kärcher	wet/dry vacuum cleaner	K 2501	268 228 200		
Kärcher	wet/dry vacuum cleaner	K 2501 TE	268 228 200		
Kärcher	wet/dry vacuum cleaner	K 2601 plus	268 228 200		
Kärcher	hard cover/carpet cleaner	K 3001	268 228 200		
Kärcher	wet/dry vacuum cleaner	K 3500 E	268 280 210		
Kärcher	wet/dry vacuum cleaner	K 3500 E	268 280 220		
Kärcher	wet/dry vacuum cleaner	K 3501	268 280 210		
Kärcher	wet/dry vacuum cleaner	K 3501	268 280 220		
Kärcher	wet/dry vacuum cleaner	NT 14/1 Eco Te	268 280 220		
Kärcher	wet/dry vacuum cleaner	NT 181 profi	268 228 200		
Kärcher	wet/dry vacuum cleaner	NT 35 I Eco	268 228 330		
Kärcher	wet/dry vacuum cleaner	NT 35/1 Eco	268 228 330		
Kärcher	wet/dry vacuum cleaner	NT 35/1 Eco Bs	268 228 330		
Kärcher	wet/dry vacuum cleaner	NT 35/1 Eco M	268 228 310		
Kärcher	wet/dry vacuum cleaner	NT 35/1 Eco M	268 228 330		
Kärcher	wet/dry vacuum cleaner	NT 35/1 Eco Te	268 228 330		
Kärcher	wet/dry vacuum cleaner	NT 351 Eco	268 280 220		
Kärcher	wet/dry vacuum cleaner	NT 361 Eco	268 228 300		
Kärcher	wet/dry vacuum cleaner	NT 361 Eco BE	268 228 300		
Kärcher	wet/dry vacuum cleaner	NT 361 Eco Bs	268 228 330		
Kärcher	safety vacuum cleaner	NT 361 Eco M	268 228 300		
Kärcher	wet/dry vacuum cleaner	NT 361 Eco M	268 228 330		
Kärcher	wet/dry vacuum cleaner	NT 361 Eco TE	268 228 300		
Kärcher	wet/dry vacuum cleaner	NT 45/1 Eco	268 228 330		
Kärcher	wet/dry vacuum cleaner	NT 45/1 Eco M	268 228 310		
Kärcher	wet/dry vacuum cleaner	NT 45/1 Eco M	268 228 330		
Kärcher	wet/dry vacuum cleaner	NT 45/1 Eco Te	268 228 330		
Kärcher	wet/dry vacuum cleaner	NT 55/1 Eco	268 228 330		
Kärcher	wet/dry vacuum cleaner	NT 55/1 Eco Bs	268 228 330		
Kärcher	wet/dry vacuum cleaner	NT 55/1 Eco M	268 228 310		
Kärcher	wet/dry vacuum cleaner	NT 55/1 Eco M	268 228 330		
Kärcher	wet/dry vacuum cleaner	NT 551 Eco	268 228 700		
Kärcher	wet/dry vacuum cleaner	NT 551 Eco M	268 228 700		
Kärcher	wet/dry vacuum cleaner	NT 561 Eco	268 228 330		
Kärcher	wet/dry vacuum cleaner	NT 561 Eco	268 228 300		
Kärcher	safety vacuum cleaner	NT 561 Eco M	268 228 300		
Kärcher	wet/dry vacuum cleaner	NT 561 Eco M	268 228 330		
Kärcher	wet/dry vacuum cleaner	NT 561 Eco TE	268 228 300		
Kärcher	wet/dry vacuum cleaner	NT 611 Eco	268 228 330		
Kärcher	wet/dry vacuum cleaner	NT 611 Eco	268 228 300		
Kärcher	wet/dry vacuum cleaner	NT 611 Eco BS	268 228 330		
Kärcher	wet/dry vacuum cleaner	NT 611 Eco K	268 228 330		
Kärcher	wet/dry vacuum cleaner	NT 611 Eco KF	268 228 330		
Kärcher	wet/dry vacuum cleaner	NT 611 Eco M	268 228 330		
Kärcher	wet/dry vacuum cleaner	NT 611 Eco TE	268 228 300		
Kärcher	wet/dry vacuum cleaner	NT 65/2 Eco	268 228 600		
Kärcher	wet/dry vacuum cleaner	NT 65/2 Eco	268 228 620		
Kärcher	wet/dry vacuum cleaner	NT 65/2 Eco TC	268 228 600		
Kärcher	wet/dry vacuum cleaner	NT 65/2 Eco TC	268 228 620		
Kärcher	wet/dry vacuum cleaner	NT 700 Eco	268 228 700		
Kärcher	wet/dry vacuum cleaner	NT 702 Eco	268 228 700		
Kärcher	wet/dry vacuum cleaner	NT 72/2 Eco Tc	268 228 620		
Kärcher	wet/dry vacuum cleaner	NT 72/2 Eco TC	268 228 600		
Kärcher	wet/dry vacuum cleaner	IVC 60/12-1 Tact Ec	268 228 900		
Kärcher	wet/dry vacuum cleaner	IVC60/24-2 Tact ²	268 228 900		
Kärcher	wet/dry vacuum cleaner	IVC 60/24-2 TactLp	268 228 900		
Kärcher	wet/dry vacuum cleaner	IVC60/24-2 Tact ² M	268 228 900		
Kärcher	wet/dry vacuum cleaner	IVC 60/30 Tact ²	268 228 900		

Cartridge filter allocation for cleaning devices

Manufacturer	TYP	device	absolute filter	micro filter	filter screen
Kärcher	wet/dry vacuum cleaner	NT55/2 Tact ² Mel	268 228 900		
Kärcher	wet/dry vacuum cleaner	NT65/2 Tact ²	268 228 900		
Kärcher	wet/dry vacuum cleaner	NT65/2 Tact ² Tc	268 228 900		
Kärcher	wet/dry vacuum cleaner	NT75/2 Tact ² Me	268 228 900		
Kärcher	wet/dry vacuum cleaner	NT75/2 Tact ² MeTc	268 228 900		
Kärcher	wet/dry vacuum cleaner	IVC 60/12-1Tact EC	268 228 910		
Kärcher	wet/dry vacuum cleaner	IVC60/24-2 Tact ²	268 228 910		
Kärcher	wet/dry vacuum cleaner	IVC60/24-2 Tact ² Lp	268 228 910		
Kärcher	wet/dry vacuum cleaner	IVC60/30 Tact ²	268 228 910		
Kärcher	wet/dry vacuum cleaner	NT65/2 Tact ²	268 228 910		
Kärcher	wet/dry vacuum cleaner	NT65/2 Tact ² Tc	268 228 910		
Kärcher	wet/dry vacuum cleaner	NT75/2 Tact ² Me	268 228 910		
Kärcher	wet/dry vacuum cleaner	NT75/2 tact ² MeTc	268 228 910		
LAVOR	vacuum cleaner	GBX 22; GBX 32	268 263 810		
LAVOR	vacuum cleaner	Genio	268 263 810		
LAVOR	vacuum cleaner	GN 22; GN 32	268 263 810		
LAVOR	vacuum cleaner	GNX 22; GNX 32	268 263 810		
LAVOR	vacuum cleaner	Nilo	268 263 810		
PROTOOL	vacuum cleaner	VCP 250 E	268 263 510		
PROTOOL	vacuum cleaner	VCP 260 E-L		268 263 520	
PROTOOL	vacuum cleaner	VCP 260 E-M		268 263 520	
PROTOOL	vacuum cleaner	VCP 32 E			
ROWENTA	multipurpose vacuum cleaner	BP 61	268 269 000		
ROWENTA	multipurpose vacuum cleaner	Bully	268 269 000		
ROWENTA	multipurpose vacuum cleaner	Collecto	268 269 000		
ROWENTA	multipurpose vacuum cleaner	Multicraft (ZR-70)	268 269 000		
ROWENTA	multipurpose vacuum cleaner	NT-Serie (ZR-70)	268 269 000		
ROWENTA	multipurpose vacuum cleaner	RB-Serie (ZR-70)	268 269 000		
ROWENTA	multipurpose vacuum cleaner	ZR 80; ZR 81	268 269 000		
THOMAS	wet/dry vacuum cleaner	820	268 269 100		
THOMAS	wet/dry vacuum cleaner	1620	268 269 100		
THOMAS	wet/dry vacuum cleaner	1020; 1030; 1031	268 269 100		
THOMAS	wet/dry vacuum cleaner	1043 LG	268 269 100		
THOMAS	wet/dry vacuum cleaner	1120 comfort	268 269 100		
THOMAS	wet/dry vacuum cleaner	1120; 1130	268 269 100		
THOMAS	wet/dry vacuum cleaner	1218 plus	268 269 100		
THOMAS	wet/dry vacuum cleaner	1220 plus	268 269 100		
THOMAS	wet/dry vacuum cleaner	1220 S	268 269 100		
THOMAS	wet/dry vacuum cleaner	1220; 1231; 1243	268 269 100		
THOMAS	wet/dry vacuum cleaner	1231 E	268 269 100		
THOMAS	wet/dry vacuum cleaner	1250 S	268 269 100		
THOMAS	wet/dry vacuum cleaner	1320; 1330	268 269 100		
THOMAS	wet/dry vacuum cleaner	1445 S	268 269 100		
THOMAS	wet/dry vacuum cleaner	1518; 1520	268 269 100		
THOMAS	wet/dry vacuum cleaner	1520 C	268 269 100		
THOMAS	wet/dry vacuum cleaner	1520 plus	268 269 100		
THOMAS	wet/dry vacuum cleaner	1620 C	268 269 100		
THOMAS	wet/dry vacuum cleaner	786/B	268 269 100		
THOMAS	wet/dry vacuum cleaner	826 SD; 826 SDE	268 269 100		
THOMAS	wet/dry vacuum cleaner	920; 926	268 269 100		
THOMAS	wet/dry vacuum cleaner	931 SL	268 269 100		
THOMAS	wet/dry vacuum cleaner	Bravo 20 Biturbo	268 269 100		
THOMAS	wet/dry vacuum cleaner	Compact 20; 20R; 20S	268 269 100		
THOMAS	wet/dry vacuum cleaner	Hobby 1000	268 269 100		
THOMAS	wet/dry vacuum cleaner	Hobby Vac	268 269 100		
THOMAS	wet/dry vacuum cleaner	Inox 1220	268 269 100		
THOMAS	wet/dry vacuum cleaner	Inox 20 Professional	268 269 100		
THOMAS	wet/dry vacuum cleaner	Inox 30 Professional	268 269 100		
THOMAS	wet/dry vacuum cleaner	Junior 1216; 1230; 1516	268 269 100		

Symbols TYP type

Cartridge filter allocation for cleaning devices

Manufacturer	TYP	device	absolute filter	micro filter	filter screen
THOMAS	wet/dry vacuum cleaner	Multivac Studio 1030 E	268 269 100		
THOMAS	wet/dry vacuum cleaner	Multivac Studio 1035	268 269 100		
THOMAS	wet/dry vacuum cleaner	Multivac Studio 1235	268 269 100		
THOMAS	wet/dry vacuum cleaner	Power Boy 1218	268 269 100		
THOMAS	wet/dry vacuum cleaner	Power Edition 1530	268 269 100		
THOMAS	wet/dry vacuum cleaner	Silverstar 1220; 1235	268 269 100		
THOMAS	wet/dry vacuum cleaner	Studio 1030	268 269 100		
THOMAS	wet/dry vacuum cleaner	Super 30	268 269 100		
THOMAS	wet/dry vacuum cleaner	Super 30 R	268 269 100		
THOMAS	wet/dry vacuum cleaner	Super 30 S	268 269 100		
THOMAS	wet/dry vacuum cleaner	Syntho	268 269 100		
THOMAS	wet/dry vacuum cleaner	Twin	268 269 100		
THOMAS	wet/dry vacuum cleaner	Vario 20	268 269 100		
THOMAS	wet/dry vacuum cleaner	Vario 20 S	268 269 100		
TOP-CRAFT	wet/dry vacuum cleaner	NT 0506; NT 0507; NT 0609	268 269 300		

Symbols W watt I height TI turbine height ∅ diameter TYP type VPE Verpackungseinheit

Vacuum motors

Applies to all wet and dry motors

- » 2-ball bearings
- » Double insulation
- » Insulation class "B"



1 stage. 230 V / 50 Hz.
Cable type 3 enclosed

R+M Nr.	TYP	W	I	TI	Ø
262 101	universal	1,000	144	45	144



2 stage. 230 V / 50 Hz.
Cable type 1 enclosed

R+M Nr.	TYP	W	I	TI	Ø
262 080 102	361	800	163	72	144
262 100 102	7568	1,000	170	72	144
262 120 102	7778-5	1,200	178	72	144
262 120 302	7363-12	1,200	163	72	144
262 120 702	586-2	1,200	170	67	144

With thermal safety device

R+M Nr.	TYP	W	I	TI	Ø
262 120 202	7778-4	1,200	178	72	144
262 140 102	7788	1,400	176	72	144

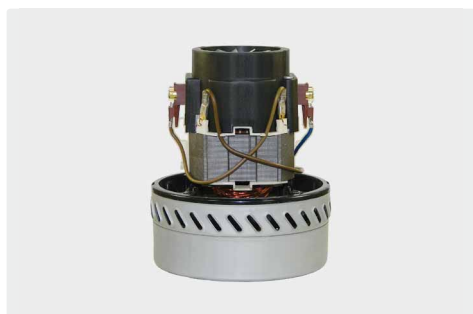

2 stage. 230 V / 50 Hz.
Cable type 2 enclosed

R+M Nr.	TYP	W	I	TI	Ø
262 120 502	A210	1,200	181	67	144



1 stage. 230 V / 50 Hz.
Cable type 2 enclosed

R+M Nr.	TYP	W	I	TI	Ø
262 110 101	061200219	1,100	133	49	148



2 stage. 230 V / 50 Hz.
Cable type 2 enclosed

R+M Nr.	TYP	W	I	TI	Ø
262 100 202	BDS 10302	1,000	167	70	144
262 120 602	BDS 12382	1,200	176	70	144



2 stage. 230 V / 50 Hz.
Cable type 3 enclosed

R+M Nr.	TYP	W	I	TI	Ø
262 120	069203004	1,200	176	67	144



2 stage. 230 V / 50 Hz.
Cable pre-installed

R+M Nr.	TYP	W	I	TI	Ø
262 120 802	universal	1,200	170	66	144



1 stage. 230 V / 50 Hz.
Cable pre-installed

R+M Nr.	TYP	W	I	TI	Ø
262 110 001	061200043	1,100	136	50	144



2 stage. 24 V.
Cable pre-installed

R+M Nr.	TYP	W	I	TI	Ø
262 050 230	069103006	500	171	68	144



2 stage. 230 V / 50 Hz.
Cable pre-installed

R+M Nr.	TYP	W	I	TI	Ø
262 110 102	116 110-01	1,100	170	69	145



2 stage. 230 V / 50 Hz. Cable pre-installed.
TYP Universal

R+M Nr.	VPE	W	I	TI	Ø
262 120 902	1	1,200	172	66	148
262 120 902 006	6	1,200	172	66	148

Vacuum motors



1 stage with waste air pipe & base. Voltage: 24 V.
Cable pre-installed

R+M Nr.	TYP	W	I	TI	∅
262 037 131	119 652-29	370	166	52	144



3 stage with waste air pipe. 230 V / 50 Hz. Cable pre-installed

R+M Nr.	TYP	W	I	TI	∅
262 160 103	116 136-00	1,600	198	87	183



2 stage with waste air pipe. 230 V / 50 Hz. Cable pre-installed

R+M Nr.	TYP	W	I	TI	∅
262 100 112	061500048	1,000	172	69	144



2 stage with waste air pipe and base.
Voltage: 24 V.
Cable pre-installed

R+M Nr.	TYP	W	I	TI	∅
262 043 212	116 157-29	430	165	69	145



1 stage with waste air pipe and base.
230 V / 50 Hz.
Cable type 3 enclosed

R+M Nr.	TYP	W	I	TI	∅
262 090 131	069400001	1,000	147	49	144



3 stage with waste air pipe. Cable pre-installed.
262 064 113 : 24/50 Hz.
262 074 113 : 36/50 Hz

R+M Nr.	TYP	W	I	TI	∅
262 064 113	116 515-13	640	199	91	144
262 074 113	116 513-13	740	199	91	144



2 stage with waste air pipe. 24 V.
Cable pre-installed

R+M Nr.	TYP	W	I	TI	∅
262 043 112	116 157-00	430	165	69	145



2 stage with waste air pipe. 24 V.
Cable pre-installed

R+M Nr.	TYP	W	I	TI	∅
262 050 112	63265R	500	168	72	144



2 stage. 230 V / 50 Hz.
Cable pre-installed

R+M Nr.	TYP	W	I	TI	∅
262 110 002	570	1,100	175	60	144



1 stage. 230 V / 50 Hz.
Cable pre-installed

R+M Nr.	TYP	W	I	TI	∅
262 120 104	402-6	1,200	128	42	134



1 stage. 230 V / 50 Hz.
Cable type 1 enclosed

R+M Nr.	TYP	W	I	TI	∅
262 150 104	404-2	1,500	128	42	134



1 stage. 230 V / 50 Hz.
Without cable, (Cable type 1 optional)

R+M Nr.	TYP	W	I	TI	∅
262 120 703	063700003	1,200	136	46	143
262 120 701	064200001	1,200	131	45	127

Symbols W watt I height TI turbine height ∅ diameter TYP type

Vacuum motors



1 stage. 230 V / 50 Hz. Cable enclosed.
With thermo switch

R+M Nr.	TYP	W	I	TI	∅
262 080 101	203-19	800	110	30	110



1 stage. 230 V / 50 Hz.
Without cable, (Cable type 1 optional)

R+M Nr.	TYP	W	I	TI	∅
262 100 001	063200074	1,050	122	45	132



1 stage. 230 V / 50 Hz.
Without cable, (Cable type 1 optional)

R+M Nr.	TYP	W	I	TI	∅
262 120 801	063200085	1,200	128	51	132

Further vacuum motors are available on request.

Vacuum motor cable

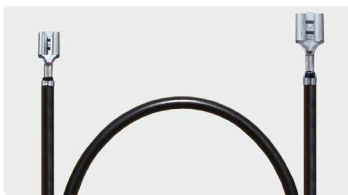

Cable lug 6.3 : cable lug 4.8.
Cable 500 mm.
Cable type 1

R+M Nr.
262 000 001



Fork 3.5 : open.
Cable 300 mm.
Cable type 2

R+M Nr.
262 000 002

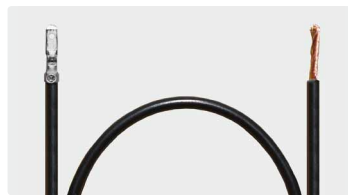

Wire end ferrule 2.8 : open.
Cable 300 mm.
Cable type 3

R+M Nr.
262 000 003

Carbon brushes



R+M Nr.	suitable for R+M Nr.
262 000 102	262 080 102
262 000 102	262 100 102
262 000 102	262 120 102
262 000 102	262 120 202
262 000 102	262 120 302
262 000 202	262 140 102
262 000 202	262 120 702
262 000 402	262 100 202
262 000 402	262 120 602



R+M Nr.	suitable for R+M Nr.
262 000 502	262 100 001
262 000 101	262 110 002
262 120 1	262 101
262 120 1	262 120
262 120 3	262 120 902

Seal



Rubber ring. For sealing and heightening the motor

R+M Nr.	∅	I
267 158 0	144 mm	20 mm

Motor cover



Cover for vacuum motors: 262 101, 262 120, 262 120 402, 262 120 502, 262 120 104

R+M Nr.
262 000 600

Motor allocation for vacuum motors

There are many new vacuum motors in the range - further models are available on request!

R+M Nr.	suitable for	VPE	TYP
262 100 102	Ackermann & Schmitt	1	Flex S 34
262 100 103 006	Ackermann & Schmitt	6	Flex S 34
262 120 802	Ackermann & Schmitt	1	Flex S 36 . S 38 K
262 120 804 006	Ackermann & Schmitt	6	Flex S 36 . S 38 K
262 160 103	Active	1	Pro . Pro Plus
262 050 230	Adiatek	1	Amber 66 - 24 Volt . Jade 50 . Jade 55 . Jade 55 C . Ruby 45 . Ruby 55
262 064 113	Adiatek	1	Coral 65
262 100 102	AL-CO	1	Jet Stream
262 100 103 006	AL-CO	6	Jet Stream
262 110 001	AL-CO	1	Alto-Nr. 47751
262 110 004 006	AL-CO	6	Alto-Nr. 47751
262 043 212	Alto	1	Encore L 17 . Encore S 17
262 043 213 006	Alto	6	Encore L 17 . Encore S 17
262 050 112	Alto	1	SSB 430 . SSB 540 . SSB 540 S . SSB 600 . SSE 600 . SSB 660 M . SSB 800 . SSE 800
262 050 112	Alto	1	Vision 17 E . Vision 17 B . Vision 20 E . Vision 21i . Vision V . Vision 26i . Vision 26 ix
262 080 102	Alto	1	M 1 . M 2 . M 2S-FA . M 2 AE . M 2 SW-K1
262 080 103 006	Alto	6	M 1 . M 2 . M 2S-FA . M 2 AE . M 2 SW-K1
262 100 102	Alto	1	1001 . 1001 Euro . 1001 KL . 1001 SA . 1001AE . 1001AE F . 1001 SA-K1 . 1001-SW-ICH . 1001-SWE-ICH
262 100 102	Alto	1	XL . XL-E . XL-25 . XL-SW-IH . XL-SWE-IH . XL-SW-K1
262 100 102	Alto	1	SQ 450-1H . SQ 650-1H . turbo 1001 . turbo 1001 Euro . turbo 1001 KI . turbo 1001 SA . turbo 1001 AE . turbo 1001 AE/F . turbo 1001 SA/KI . turbo 1001 SW/ICH . turbo 1001 SWE/ICH . turbo M1 . turbo M2 . turbo XL...
262 100 103 006	Alto	6	1001 . 1001 Euro . 1001 KL . 1001 SA . 1001AE . 1001AE F . 1001 SA-K1 . 1001-SW-ICH . 1001-SWE-ICH
262 100 103 006	Alto	6	XL . XL-E . XL-25 . XL-SW-IH . XL-SWE-IH . XL-SW-K1
262 100 103 006	Alto	6	SQ 450-1H . SQ 650-1H . turbo 1001 . turbo 1001 Euro . turbo 1001 KI . turbo 1001 SA . turbo 1001 AE . turbo 1001 AE/F . turbo 1001 SA/KI . turbo 1001 SW/ICH . turbo 1001 SWE/ICH . turbo M1 . turbo M2 . turbo XL...
262 120 202	Alto	1	SB 680 . SB 710 . SB 711
262 120 203 006	Alto	6	SB 680 . SB 710 . SB 711
262 120 202	Alto	1	Attix 3 (until Modell 2007) . Attix 4 . Attix 5 (until Modell 2007) . Attix 6 . Attix 7 . Attix 9 (until Modell 2007) . Attix 350-01/Attix 360-21/Attix 360-2M
262 120 203 006	Alto	6	Attix 3 (until Modell 2007) . Attix 4 . Attix 5 (until Modell 2007) . Attix 6 . Attix 7 . Attix 9 (until Modell 2007) . Attix 350-01/Attix 360-21/Attix 360-2M
262 120 202	Alto	1	SQ 400 . SQ 450 . SQ 450 . SQ 500 . SQ 550 . SQ 600 . SQ 650 . SQ 651-11 . Turbo SR-C . Turbo SR-U
262 120 203 006	Alto	6	SQ 400 . SQ 450 . SQ 450 . SQ 500 . SQ 550 . SQ 600 . SQ 650 . SQ 651-11 . Turbo SR-C . Turbo SR-U
262 120 102	Alto	1	Attix 3.. (until 2007), Attix 4., Attix 5.. (until 2007), Attix 6., Attix 7., Attix 9.. (until 2007), SB 710, SB 711, SB 680, SQ 400, SQ 450-11, SQ 450-21, SQ 450-31, SQ 450-1M, SQ 450-3M, SQ 450-3H, SQ 500, SQ 550-11, SQ 550-21, SQ 550-31, SQ 600, SQ 650-11, SQ 650-61, SQ 650-71, SQ 650-1M, SQ 650-3M, SQ 650-3H, SQ 651-11, Turbo SR-C, Turbo SR-U
262 120 103 006	Alto	6	Attix 3.. (until 2007), Attix 4., Attix 5.. (until 2007), Attix 6., Attix 7., Attix 9.. (until 2007), SB 710, SB 711, SB 680, SQ 400, SQ 450-11, SQ 450-21, SQ 450-31, SQ 450-1M, SQ 450-3M, SQ 450-3H, SQ 500, SQ 550-11, SQ 550-21, SQ 550-31, SQ 600, SQ 650-11, SQ 650-61, SQ 650-71, SQ 650-1M, SQ 650-3M, SQ 650-3H, SQ 651-11, Turbo SR-C, Turbo SR-U
262 140 102	Alto	1	SB Station 2000 . SB Station TA 00 . SQ 850-11
262 140 103 006	Alto	6	SB Station 2000 . SB Station TA 00 . SQ 850-11
262 064 113	Alto Clarke	1	V17 . V20 . V21 . Vision V . Encore 24 . Encore 26 . Encore 20L . Encore 20S
262 074 113	Alto Clarke	1	V26 . V32 . Encore 28 . Encore 33 . Encore 38
262 110 001	Alto Wap	1	ST 10.20
262 110 004 006	Alto Wap	6	ST 10.20
262 120 701	Alto Wap	1	Maxxi WD
262 160 103	Ashbys	1	Commander
262 080 102	AWA	1	Saugboy
262 080 103 006	AWA	6	Saugboy
262 100 102	AWA	1	Saugboy Compact
262 100 103 006	AWA	6	Saugboy Compact

Symbols **TYP** type **VPE** packing unit

Motor allocation for vacuum motors

R+M Nr.	suitable for	VPE	TYP
262 120 102	BOSCH	1	GAS 25 GAS 50 GAS 50M
262 120 103 006	BOSCH	6	GAS 25 GAS 50 GAS 50M
262 110 102	CFM	1	127 (2 motors) . 137 (3 motors)
262 110 103 006	CFM	6	127 (2 motors) . 137 (3 motors)
262 050 230	Cimex	1	EB 600
262 043 112	Clarke	1	1700 . 2000
262 043 113 006	Clarke	6	1700 . 2000
262 043 212	Clarke	1	2000
262 043 213 006	Clarke	6	
262 050 112	Clarke	1	1700
262 050 230	Clarke	1	TB 18
262 064 113	Clarke	1	AD 240 . V 20 . V 21 . Vision V
262 074 113	Clarke	1	AD 280 . V 26 . V 32
262 043 212	Cleanfix	1	RA 400 . RA 530 B
262 043 213 006	Cleanfix	6	RA 400 . RA 530 B
262 050 112	Cleanfix	1	RA 55 B 50 . RA 80 B . RA 410 B . RA 430 B . RA 501 B . RA 561 B . RA 700 B . RA 800 . RA 900
262 100 001	Cleanfix	1	RS 05 . S 12+
262 100 002 006	Cleanfix	6	RS 05 . S 12+
262 043 112	Cleanfix	1	RA 430 B
262 043 113 006	Cleanfix	6	RA 430 B
262 100 001	Cleanfix	1	RS 05 . S 12+ . RA 430 B
262 100 002 006	Cleanfix	6	RS 05 . S 12+ . RA 430 B
262 100 112	Cleanfix	1	Compact 1
262 043 112	Columbus	1	RA 55 B 50 . RA 80 B
262 043 113 006	Columbus	6	RA 55 B 50 . RA 80 B
262 050 112	Columbus	1	RA 55 B 50 . RA 80 B
262 050 230	Columbus	1	BF 42
262 064 113	Columbus	1	RA 66 . ARA 80 BM 100 . ARA 80 BM 150
262 110 102	Columbus	1	RA 43 . SW 2000 . SW 3000 . SW 53
262 110 103 006	Columbus	6	RA 43 . SW 2000 . SW 3000 . SW 53
262 120 801	Columbus	1	ST 7
262 120 701	Columbus	1	RS 27 . ST 22
262 120 702	Columbus	1	RS 27 . ST 22
262 120 704 006	Columbus	6	RS 27 . ST 22
262 037 131	Comac	1	Abila 17 . Abila 42 . Abila 45 . Abila 52
262 037 132 006	Comac	6	Abila 17 . Abila 42 . Abila 45 . Abila 52
262 043 112	Comac	1	CB 40 . CB 50 . L 17 B . L 17-41 B . S 42 B . L17 . 41B . Simpla 45 . Simpla 50
262 043 113 006	Comac	6	CB 40 . CB 50 . L 17 B . L 17-41 B . S 42 B . L17 . 41B . Simpla 45 . Simpla 50
262 050 112	Comac	1	CB 40 . CB 50 . L 17 B . L 17-41 B . S 42 B . L17 . 41B . Simpla 45 . Simpla 50
262 050 230	Comac	1	L 20 . L 24 B . LB 20
262 074 113	Comac	1	C 83 B . C 85 B . C 100 B . C 104 B . C 125 . Flexy 75 . Flexy 85 . Tripla 65 . Tripla 75
262 100 102	Comac	1	CA 30 . CA 80
262 100 103 006	Comac	6	CA 30 . CA 80
262 043 212	Comac	1	Simpla 45 . Simpla 50
262 043 213 006	Comac	6	Simpla 45 . Simpla 50
262 043 112	Dulevo	1	Hydro 18 . Hydro 20
262 043 113 006	Dulevo	6	Hydro 18 . Hydro 20
262 043 212	Electrolux	1	34 SB . 355 B
262 043 213 006	Electrolux	6	34 SB . 355 B
262 100 001	Elektrolux	1	Z 910
262 100 002 006	Elektrolux	6	Z 910
262 160 103	Elite	1	dl . 2000
262 120 102	Fein	1	SQ 450-21
262 120 103 006	Fein	6	SQ 450-21
262 120 202	Fein	1	SQ 450-21
262 120 203 006	Fein	6	SQ 450-21
262 110 001	Festo / Festool	1	CTL Midi
262 110 004 006	Festo / Festool	6	CTL Midi
262 100 102	Festool	1	SR 5 E . SR 5 E-AS . SR 5 LE-AS . SR 6 E-AS . SR 12 E-AS . SR 12 LE-AS . SR 13 E . SR 14 E-AS
262 100 103 006	Festool	6	SR 5 E . SR 5 E-AS . SR 5 LE-AS . SR 6 E-AS . SR 12 E-AS . SR 12 LE-AS . SR 13 E . SR 14 E-AS
262 100 102	Festool	1	SR 14 LE-AS . SR 15 E

Motor allocation for vacuum motors

There are many new vacuum motors in the range - further models are available on request!

R+M Nr.	suitable for	VPE	TYP
262 100 103 006	Festool	6	SR 14 LE-AS . SR 15 E
262 120 102	Festool	1	CTL 22 E . SR 212 LE-AS . SRH 204 E-AS
262 120 103 006	Festool	6	CTL 22 E . SR 212 LE-AS . SRH 204 E-AS
262 120 202	Festool	1	SR 151E-AS . SR 151 LE-AS . SRM 152 E-AS . SRH 153 . SR 200 E . SR 201 E-AS . SR 201 LE-AS
262 120 203 006	Festool	6	SR 151E-AS . SR 151 LE-AS . SRM 152 E-AS . SRH 153 . SR 200 E . SR 201 E-AS . SR 201 LE-AS
262 120 202	Festool	1	SR 202 E-AS . SE 203 E-AS . SR 203 LE-AS . SR 301 L-AS . SE 301 LE-AS . SR 302 E-AS . SR 303 E-AS
262 120 203 006	Festool	6	SR 202 E-AS . SE 203 E-AS . SR 203 LE-AS . SR 301 L-AS . SE 301 LE-AS . SR 302 E-AS . SR 303 E-AS
262 120 202	Festool	1	SR 212 . SR 312 . SRH 204 E-AS . SR 212 LE-AS . SRH 204 E-AS
262 120 203 006	Festool	6	SR 212 . SR 312 . SRH 204 E-AS . SR 212 LE-AS . SRH 204 E-AS
262 120 802	Festool	1	CT 22, CT 33, CTL 22 E/SR 15 TE-AS, SR 151 LE-AS, SR 200 E, SR 201 LE-AS, SR 202 LE-AS, SR 202 E-AS, SR 212,
262 120 804 006	Festool	6	CT 22, CT 33, CTL 22 E/SR 15 TE-AS, SR 151 LE-AS, SR 200 E, SR 201 LE-AS, SR 202 LE-AS, SR 202 E-AS, SR 212
262 120 802	Festool	1	SR 212 LE-AS, SR 301 L-AS, SR 302 E-AS, SR 303 E-AS, SRM152 E-AS, SRH 153, SHR 201 E-AS, SE 203 E-AS, SE 203
262 120 804 006	Festool	6	SR 212 LE-AS, SR 301 L-AS, SR 302 E-AS, SR 303 E-AS, SRM152 E-AS, SRH 153, SHR 201 E-AS, SE 203 E-AS, SE 203
262 120 802	Festool	1	LE-AS, SHR 204 E-AS, SE 301 LE-AS
262 120 804 006	Festool	6	LE-AS, SHR 204 E-AS, SE 301 LE-AS
262 037 131	Fimap	1	Mini
262 037 132 006	Fimap	6	Mini
262 043 212	Fimap	1	42 . 452 . 52 . 502 . 53 BTM . Gamma 50
262 043 213 006	Fimap	6	42 . 452 . 52 . 502 . 53 BTM . Gamma 50
262 064 113	Fimap	1	Gamma 65
262 074 113	Fimap	1	Magna 100 S
262 050 112	Fiorentini	1	Monodisco S 45 B . Monodisco S 53 B
262 050 230	Fiorentini	1	ICM 21 . ICM 26 B
262 120 702	Flex	1	S 47
262 120 704 006	Flex	6	S 47
262 100 102	Flex-Ackermann	1	Flex S 34
262 100 103 006	Flex-Ackermann	6	Flex S 34
262 120 102	Flex-Ackermann	1	Flex S 38 K
262 120 103 006	Flex-Ackermann	6	Flex S 38 K
262 120 202	Flex-Ackermann	1	Flex S 38 K
262 120 203 006	Flex-Ackermann	6	Flex S 38 K
262 043 212	Floor	1	Shark 45 . Shark 54 . Shark 60
262 043 213 006	Floor	6	Shark 45 . Shark 54 . Shark 60
262 050 112	Floor	1	54 ECO
262 074 113	Floor	1	450 . 530
262 100 112	Floor	1	F 43 . 450 CD
262 037 131	Floordress	1	S 12 +
262 037 132 006	Floordress	6	S 12 +
262 100 001	Floordress	1	S 12 +
262 100 002 006	Floordress	6	S 12 +
262 043 112	Floorpul	1	AM116157.13
262 043 113 006	Floorpul	6	AM116157.13
262 043 212	Floorpul	1	AM116157.29
262 043 213 006	Floorpul	6	AM116157.29
262 050 230	Floorpul	1	Stars 50 . Stars 60
262 064 113	Floorpul	1	AM116515.13
262 074 113	Floorpul	1	AM116513.13
262 120 502	Früh	1	Ronda 200
262 043 112	Gansow	1	35 BF 46
262 043 113 006	Gansow	6	35 BF 46
262 050 112	Gansow	1	35 BF 46
262 110 102	Ghibli	1	AS10 . AS27 . AS59 . AS59P . AS60
262 110 103 006	Ghibli	6	AS10 . AS27 . AS59 . AS59P . AS60
262 120 502	Ghibli	1	AS 400
262 120 701	Ghibli	1	GHIBLI 2505325

Symbols TYP type VPE packing unit

Motor allocation for vacuum motors

R+M Nr.	suitable for	VPE	TYP
262 120 702	Ghibli	1	Hilti VC20 . VC 40 (older model)
262 120 704 006	Ghibli	6	Hilti VC20 . VC 40 (older model)
262 120 902	Ghibli	1	AS 400
262 100 001	Ghibli	1	AS 6
262 100 002 006	Ghibli	6	AS 6
262 120 701	Ghibli	1	AS 9 . SP 8
262 064 113	Gutbrod	1	NRA 600 BAE
262 043 212	Hako	1	B 43 . B 43 Super . B 55 . B 65 . B 75 . B 85 . B 450 . B 530 . B 550 . B 650 . B 750 . B 850
262 043 213 006	Hako	6	B 43 . B 43 Super . B 55 . B 65 . B 75 . B 85 . B 450 . B 530 . B 550 . B 650 . B 750 . B 850
262 050 230	Hako	1	SBR 50 . SBR 60
262 074 113	Hako	1	B 90 . BS 100 . Hakomatic 100 . Hakomatic 130 . Hakomatic 1000-100 . Hakomatic 1000-130
262 110 102	Hako	1	E 350
262 110 103 006	Hako	6	E 350
262 120 102	Hako	1	VC 380 H . VC 380 W . VC 500 W . VC 640 S . VC 640 W
262 120 103 006	Hako	6	VC 380 H . VC 380 W . VC 500 W . VC 640 S . VC 640 W
262 120 202	Hako	1	VC 380 H . VC 380 W . VC 500 W . VC 640 S . VC 640 W
262 120 203 006	Hako	6	VC 380 H . VC 380 W . VC 500 W . VC 640 S . VC 640 W
262 120 701	Hako	1	Super Vac L 1-30
262 120 802	Hako	1	VC 380 H, VC 380 W, VC 500 W, VC 640 S, VC 640 W
262 120 804 006	Hako	6	VC 380 H, VC 380 W, VC 500 W, VC 640 S, VC 640 W
262 140 102	Hako	1	VC 800 W
262 140 103 006	Hako	6	VC 800 W
262 064 113	Hefter	1	ST 81 . ST 111
262 043 112	Henkel	1	BA 4300
262 043 113 006	Henkel	6	BA 4300
262 120 102	Hilti	1	WVC 40-M
262 120 103 006	Hilti	6	WVC 40-M
262 120 202	Hilti	1	WVC 40-M
262 120 203 006	Hilti	6	WVC 40-M
262 120 802	Hilti	1	WVC 40-M
262 120 804 006	Hilti	6	WVC 40-M
262 100 001	Hitachi	1	CV 200 CV 300
262 100 002 006	Hitachi	6	CV 200 CV 300
262 120 801	Igefa	1	VC 14
262 100 001	Igefa	1	VC 14
262 100 002 006	Igefa	6	VC 14
262 110 102	IPC	1	Cleantime 12
262 110 103 006	IPC	6	Cleantime 12
262 043 112	Kärcher	1	BD 450 . BD 550 . BR 530 . BR 550 . BR 700 (24V-BAT)
262 043 113 006	Kärcher	6	BD 450 . BD 550 . BR 530 . BR 550 . BR 700 (24V-BAT)
262 050 112	Kärcher	1	B 60 . BD 90/140 R . BD 550 . BD 750 . BR 75/140 R ECO . BR 90/140 R . BR 530 . BR 550 (24V-BAT) . BR 700 . BR 750
262 074 113	Kärcher	1	BD 700 . BR 700
262 080 101	Kärcher	1	T 7/1 . T 10/1 . T 12/1 . T 15/1 . T 17/1
262 080 102	Kärcher	1	BR 400 . DUO SB
262 080 103 006	Kärcher	6	BR 400 . DUO SB
262 101	Kärcher	1	NT 221 . NT 351 . NT 361
262 110 101	Kärcher	1	6.490-110
262 110 102	Kärcher	1	NT 601 . NT 651 . NT 800 . NT 801
262 110 103 006	Kärcher	6	NT 601 . NT 651 . NT 800 . NT 801
262 120 102	Kärcher	1	DUO SB Serie
262 120 103 006	Kärcher	6	DUO SB Serie
262 120 104	Kärcher	1	A 2200 . WD 5.400 . WD 5.500 . WD 5.600
262 120 702	Kärcher	1	NT 361 ECO . NT 561 ECO . NT65/2 ECO . NT 72/2 ECO
262 120 703	Kärcher	1	NT 14-1 . NT 25-1 . NT 35-1 . NT 45-1 . NT 55-1 . 6.490-166.0
262 120 704 006	Kärcher	6	NT 14-1 . NT 25-1 . NT 35-1 . NT 45-1 . NT 55-1 . 6.490-166.0
262 120 802	Kärcher	1	T 201
262 120 804 006	Kärcher	6	T 201
262 160 103	Kärcher	1	Puzzi Profi K . Puzzi Profi 200
262 110 001	Kärcher	1	2501 . 2801 . A 2800 . 2001 . 2501 . NT 200 . NT 221 . NT 301 . NT 351 . NT 27-1
262 110 004 006	Kärcher	6	2501 . 2801 . A 2800 . 2001 . 2501 . NT 200 . NT 221 . NT 301 . NT 351 . NT 27-1

Motor allocation for vacuum motors

R+M Nr.	suitable for	VPE	TYP
262 100 001	Kärcher	1	T12-1
262 100 002 006	Kärcher	6	T12-1
262 100 112	Kärcher	1	BR 530 (230V/50Hz) . BR 550 (230V/50Hz)
262 120 701	Kärcher	1	SV 1902 . SV 1820
262 100 001	Kenter Kenbo	1	Silent 25 S Plus
262 100 002 006	Kenter Kenbo	6	Silent 25 S Plus
262 140 102	Kistool	1	1515 N
262 140 103 006	Kistool	6	1515 N
262 074 113	Kleenrite	1	HX 5120
262 100 102	Makita	1	441
262 100 103 006	Makita	6	441
262 120 102	Makita	1	443 . 444 M . 447 L
262 120 103 006	Makita	6	443 . 444 M . 447 L
262 120 202	Makita	1	443 . 444 M . 447 L
262 120 203 006	Makita	6	443 . 444 M . 447 L
262 120 802	Makita	1	443, 444 M
262 120 804 006	Makita	6	443, 444 M
262 043 112	Minuteman	1	170
262 043 113 006	Minuteman	6	170
262 064 113	Minuteman	1	200 . 340
262 074 113	Minuteman	1	320 . 3200 . 3800
262 043 212	Nilco	1	E 400 . E 410 . E480
262 043 213 006	Nilco	6	E 400 . E 410 . E480
262 050 112	Nilco	1	430 B
262 101	Nilco	1	S 18
262 110 102	Nilco	1	445
262 110 103 006	Nilco	6	445
262 140 102	Nilco	1	GS 1725
262 140 103 006	Nilco	6	GS 1725
262 110 001	Nilco	1	S 17 NT . S 18 . S 32
262 110 004 006	Nilco	6	S 17 NT . S 18 . S 32
262 043 112	Nilfisk-Advance	1	BA 450 . BA 530 . BA 600 . BA 650 . SSB 430 . SSB 480 . SSB 540 . SSB 540 S . SSB 600 . SSE
262 043 113 006	Nilfisk-Advance	6	BA 450 . BA 530 . BA 600 . BA 650 . SSB 430 . SSB 480 . SSB 540 . SSB 540 S . SSB 600 . SSE
262 043 212	Nilfisk-Advance	1	W 345
262 043 213 006	Nilfisk-Advance	6	W 345
262 050 112	Nilfisk-Advance	1	BA 430 . BA 450 . BA 451 . BA 530 . BA 531 . BA 600 . BA 650
262 064 113	Nilfisk-Advance	1	BR 700 . BR 750 . BR 850 . BR 1000 . Trac 240
262 074 113	Nilfisk-Advance	1	AR 4100 . Trac 280 . BA 700 S . BA 800 . BR 850
262 100 001	Nilfisk-Advance	1	GD 1000 . GMP Serie . Viking GD 110 . GM 80
262 100 002 006	Nilfisk-Advance	6	GD 1000 . GMP Serie . Viking GD 110 . GM 80
262 100 102	Nilfisk-Advance	1	UZ 878
262 100 103 006	Nilfisk-Advance	6	UZ 878
262 120 102	Nilfisk-Advance	1	IVB . 3
262 120 103 006	Nilfisk-Advance	6	IVB . 3
262 120 202	Nilfisk-Advance	1	IVB . 3
262 120 203 006	Nilfisk-Advance	6	IVB . 3
262 120 502	Nilfisk-Advance	1	WD 200
262 120 701	Nilfisk-Advance	1	GWD 375 . GWD 350
262 120 801	Nilfisk-Advance	1	Bacuum . GD 1000 . GD 2000 . GMP Serie . GS 82 . King GM 200 . King GM 300 . GM 80
262 120 802	Nilfisk-Advance	1	IVB/3
262 120 804 006	Nilfisk-Advance	6	IVB/3
262 120 902	Nilfisk-Advance	1	WD 200
262 043 212	Nilfisk-Alto	1	2000 . Encore S 17 . L 17
262 043 213 006	Nilfisk-Alto	6	2000 . Encore S 17 . L 17
262 050 112	Nilfisk-Alto	1	SSB 400 . SSB 430 . SSB 480 . SSB 480 W . SSB 540 . SSB 540 S . SSB 600 . SSE 600 . SSB 660 M . SSB 80 [...]
262 050 112	Nilfisk-Alto	1	Scrubtec 343 B . B Combi . E . Vision 17 E+B . Vision 20 E . Vision 21i . Vision V . Vision 26i + [...]
262 064 113	Nilfisk-Alto	1	Encore 24 . Encore 26 . Encore L 20 (24 version) . Encore S 20 (24 volt)
262 074 113	Nilfisk-Alto	1	Encore 28 . Encore 33 . Encore 38 . R 38 . Scrubtec 770 S . Vision 26 . Vision 32

Symbols TYP type VPE packing unit

Motor allocation for vacuum motors

R+M Nr.	suitable for	VPE	TYP
262 110 001	Nilfisk-Alto	1	ST 10.20 . ST Aero . Alto-Nr. 47751
262 110 004 006	Nilfisk-Alto	6	ST 10.20 . ST Aero . Alto-Nr. 47751
262 080 102	Nilfisk-Alto	1	M 1 . M 2 . M 2S-FA . M 2 AE . M 2 SW-K1
262 080 103 006	Nilfisk-Alto	6	M 1 . M 2 . M 2S-FA . M 2 AE . M 2 SW-K1
262 100 102	Nilfisk-Alto	1	SQ 450-1H . SQ 650-1H . turbo 1001 . turbo 1001 Euro . turbo 1001 KI . turbo 1001 SA . turbo 1001 AE
262 100 102	Nilfisk-Alto	1	turbo 1001 AE/F . turbo 1001 SA/KI . turbo 1001 SW/ICH . turbo 1001 SWE/ICH . turbo M1 . turbo M2 turbo XL...
262 100 103 006	Nilfisk-Alto	6	SQ 450-1H . SQ 650-1H . turbo 1001 . turbo 1001 Euro . turbo 1001 KI . turbo 1001 SA . turbo 1001 AE
262 100 103 006	Nilfisk-Alto	6	turbo 1001 AE/F . turbo 1001 SA/KI . turbo 1001 SW/ICH . turbo 1001 SWE/ICH . turbo M1 . turbo M2
262 100 103 006	Nilfisk-Alto	6	turbo XL...
262 120 102	Nilfisk-Alto	1	SB 680 . SB 710 . SB 711
262 120 103 006	Nilfisk-Alto	6	SB 680 . SB 710 . SB 711
262 120 102	Nilfisk-Alto	1	Attix 3 (until 2007) . Attix 4 . Attix 5 (until Modell 2007) . Attix 6 . Attix 7 . Attix 9 (until 2007)
262 120 103 006	Nilfisk-Alto	6	Attix 3 (until 2007) . Attix 4 . Attix 5 (until 2007) . Attix 6 . Attix 7 . Attix 9 (until 2007)
262 120 102	Nilfisk-Alto	1	Attix 350-01/Attix 360-21/Attix 360-2M
262 120 103 006	Nilfisk-Alto	6	Attix 350-01/Attix 360-21/Attix 360-2M
262 120 102	Nilfisk-Alto	1	SQ 400 . SQ 450 . SQ 450 . SQ 500 . SQ 550 . SQ 600 . SQ 650 . SQ 651-11 . Turbo SR-C . Turbo SR-U
262 120 103 006	Nilfisk-Alto	6	SQ 400 . SQ 450 . SQ 450 . SQ 500 . SQ 550 . SQ 600 . SQ 650 . SQ 651-11 . Turbo SR-C . Turbo SR-U
262 120 202	Nilfisk-Alto	1	SB 680 . SB 710 . SB 711
262 120 203 006	Nilfisk-Alto	6	SB 680 . SB 710 . SB 711
262 120 202	Nilfisk-Alto	1	Attix 3 (until 2007) . Attix 4 . Attix 5 (until 2007) . Attix 6 . Attix 7 . Attix 9 (until 2007)
262 120 203 006	Nilfisk-Alto	6	Attix 3 (until 2007) . Attix 4 . Attix 5 (until 2007) . Attix 6 . Attix 7 . Attix 9 (until 2007)
262 120 202	Nilfisk-Alto	1	Attix 350-01/Attix 360-21/Attix 360-2M
262 120 203 006	Nilfisk-Alto	6	Attix 350-01/Attix 360-21/Attix 360-2M
262 120 202	Nilfisk-Alto	1	SQ 400 . SQ 450 . SQ 450 . SQ 500 . SQ 550 . SQ 600 . SQ 650 . SQ 651-11 . Turbo SR-C . Turbo SR-U
262 120 203 006	Nilfisk-Alto	6	SQ 400 . SQ 450 . SQ 450 . SQ 500 . SQ 550 . SQ 600 . SQ 650 . SQ 651-11 . Turbo SR-C . Turbo SR-U
262 120 701	Nilfisk-Alto	1	Maxxi WD . Maxxi WD 7
262 120 702	Nilfisk-Alto	1	Maxxi GWD 300 . GWD 375
262 120 704 006	Nilfisk-Alto	6	Maxxi GWD 300 . GWD 375
262 120 802	Nilfisk-Alto	1	Attix 3.. (until 2007), Attix 4.., Attix 5.. (until 2007), Attix 6.., Attix 7.., Attix 9.. (until 2007), SB 710, SB 711, SB 680
262 120 804 006	Nilfisk-Alto	6	Attix 3.. (until 2007), Attix 4.., Attix 5.. (until 2007), Attix 6.., Attix 7.., Attix 9.. (until 2007), SB 710, SB 711, SB 680
262 120 802	Nilfisk-Alto	1	SQ 400, SQ 450-11, SQ 450-21, SQ 450-31, SQ 450-1M, SQ 450-3M, SQ 450-3H, SQ 500, SQ 550-11 SQ 550-21,
262 120 804 006	Nilfisk-Alto	6	SQ 400, SQ 450-11, SQ 450-21, SQ 450-31, SQ 450-1M, SQ 450-3M, SQ 450-3H, SQ 500, SQ 550-11 SQ 550-21
262 120 802	Nilfisk-Alto	1	SQ 550-31, SQ 600, SQ 650-11, SQ 650-61, SQ 650-71, SQ 650-1M, SQ 650-3M, SQ 650-3H, SQ 651-11
262 120 804 006	Nilfisk-Alto	6	SQ 550-31, SQ 600, SQ 650-11, SQ 650-61, SQ 650-71, SQ 650-1M, SQ 650-3M, SQ 650-3H, SQ 651-11
262 120 802	Nilfisk-Alto	1	Turbo SR-C, Turbo SR-U
262 120 804 006	Nilfisk-Alto	6	Turbo SR-C, Turbo SR-U
262 140 102	Nilfisk-Alto	1	SB Station 2000 . SB Station TA 00 . SQ 850-11
262 140 103 006	Nilfisk-Alto	6	SB Station 2000 . SB Station TA 00 . SQ 850-11
262 043 112	Nobles	1	1700 . 2000
262 043 113 006	Nobles	6	1700 . 2000
262 050 112	Nobles	1	1700 . 2000
262 064 113	Nobles	1	2400 . 2700
262 080 102	Numatic	1	WVD 2002 P
262 080 103 006	Numatic	6	WVD 2002 P
262 100 001	Numatic	1	Henry HVR 200
262 100 002 006	Numatic	6	Henry HVR 200
262 100 102	Numatic	1	WVD 900
262 100 103 006	Numatic	6	WVD 900
262 110 102	Numatic	1	WVD572 . WV 900
262 110 103 006	Numatic	6	WVD572 . WV 900
262 120 802	Numatic	1	TTB 3450
262 120 804 006	Numatic	6	TTB 3450
262 100 001	Numatic	1	Henry HVR 200
262 100 002 006	Numatic	6	Henry HVR 200
262 120 502	Portotecnica	1	Lavamatic 450
262 074 113	Power Boss	1	TSS 65

Motor allocation for vacuum motors

R+M Nr.	suitable for	VPE	TYP
262 120 801	Profi-Europe	1	Profi 1
262 120 102	Protool	1	VCP 450 E-L
262 120 103 006	Protool	6	VCP 450 E-L
262 110 001	Protool	1	VCP 30 E
262 110 004 006	Protool	6	VCP 30 E
262 043 212	Pulimat	1	345
262 043 213 006	Pulimat	6	
262 050 230	Pulimat	1	355 . 365 . 375
262 050 230	RCM	1	LB 530
262 120 102	Renfert	1	Vortex Compact 2 L 230 . Vortex Compact 2 EC 230 . Vortex Compact 2 L 120 . Vortex EC 2 M 230 V
262 120 103 006	Renfert	6	Vortex Compact 2 L 230 . Vortex Compact 2 EC 230 . Vortex Compact 2 L 120 . Vortex EC 2 M 230 V
262 120 202	Renfert	1	Vortex Compact 2 L 230 . Vortex Compact 2 EC 230 . Vortex Compact 2 L 120 . Vortex EC 2 M 230 V
262 120 203 006	Renfert	6	Vortex Compact 2 L 230 . Vortex Compact 2 EC 230 . Vortex Compact 2 L 120 . Vortex EC 2 M 230 V
262 120 802	Renfert	1	Vortex Compact 2 L 230 . Vortex Compact 2 EC 230 . Vortex Compact 2 L 120 . Vortex EC 2 M 230 V
262 120 804 006	Renfert	6	Vortex Compact 2 L 230 . Vortex Compact 2 EC 230 . Vortex Compact 2 L 120 . Vortex EC 2 M 230 V
262 050 112	Rotofill	1	R 36 AT SS
262 120 502	Rotofill	1	R 31 AL SS
262 120 502	Ruwac	1	WS 2000
262 120 902	Ruwac	1	WS 2000
262 120 102	Scheppach	1	Wovota 4
262 120 103 006	Scheppach	6	Wovota 4
262 120 202	Scheppach	1	Wovota 4
262 120 203 006	Scheppach	6	Wovota 4
262 100 102	SIA	1	Siaclean UE-1
262 100 103 006	SIA	6	Siaclean UE-1
262 120 102	SIA	1	Siaclean CE 3H . Siaclean CP 3 H
262 120 103 006	SIA	6	Siaclean CE 3H . Siaclean CP 3 H
262 120 202	SIA	1	Siaclean CE 3H . Siaclean CP 3 H
262 120 203 006	SIA	6	Siaclean CE 3H . Siaclean CP 3 H
262 050 230	Sorma	1	Kobra 5064 . Kobra 4100
262 064 113	Sorma	1	Kobra 5560
262 074 113	Sorma	1	5152 K
262 120 102	Sorma	1	520
262 120 103 006	Sorma	6	520
262 120 202	Sorma	1	520
262 120 203 006	Sorma	6	520
262 120 802	Sorma	1	520
262 120 804 006	Sorma	6	520
262 120 502	Sorma	1	Kobra 600
262 100 202	Soteco	1	BDS35
262 120 602	Soteco	1	BDS45
262 120 801	Sprintus	1	T 11
262 110 001	Starmix	1	AS 1232
262 110 004 006	Starmix	6	AS 1232
262 100 102	Stihl	1	SE 100, SE 200, SE 201, SE 202
262 100 103 006	Stihl	6	SE 100, SE 200, SE 201, SE 202
262 101	Stihl	1	SE 50-90 . SE 60-60E
262 120 102	Stihl	1	SE 120 . SE 120 E . SE 121 . SE 121 E . SE 122 . SE 122 E . SE 61 . SE 61 E
262 120 103 006	Stihl	6	SE 120 . SE 120 E . SE 121 . SE 121 E . SE 122 . SE 122 E . SE 61 . SE 61 E
262 120 202	Stihl	1	SE 120 . SE 120 E . SE 121 . SE 121 E . SE 122 . SE 122 E . SE 61 . SE 61 E
262 120 203 006	Stihl	6	SE 120 . SE 120 E . SE 121 . SE 121 E . SE 122 . SE 122 E . SE 61 . SE 61 E
262 120 802	Stihl	1	SE 61, SE 61 E, SE 120, SE 120 E, SE 121, SE 121 E, SE 122, SE 122 E, SE 121
262 120 804 006	Stihl	6	SE 61, SE 61 E, SE 120, SE 120 E, SE 121, SE 121 E, SE 122, SE 122 E, SE 121
262 110 001	Stihl	1	SE 50 - 90 . SE 60 - 60 E
262 110 004 006	Stihl	6	SE 50 - 90 . SE 60 - 60 E
262 140 102	Swiss Vacuum	1	PU 120
262 140 103 006	Swiss Vacuum	6	PU 120

Symbols TYP type VPE packing unit

Motor allocation for vacuum motors

R+M Nr.	suitable for	VPE	TYP
262 043 112	Taski	1	110 . Combimat 600 . Combimat 800 BMS . 600 . 1100
262 043 113 006	Taski	6	110 . Combimat 600 . Combimat 800 BMS . 600 . 1100
262 050 112	Taski	1	110 . Combimat 600 . Combimat 800 BMS
262 050 230	Taski	1	Swingo 750 . Swingo 1250
262 110 102	Taski	1	S 3 K
262 110 103 006	Taski	6	S 3 K
262 043 112	Tennant	1	T 3
262 043 113 006	Tennant	6	T 3
262 043 212	Tennant	1	5100
262 043 213 006	Tennant	6	5100
262 064 113	Tennant	1	2001 . 2401 . 5400 . T5
262 074 113	Tennant	1	510 . 515 . 5680 . 5700 . 7100 . 7200 . 7300 . 7400
262 160 103	Truvox	1	Valet
262 100 001	Vermop	1	Jet Vac
262 100 002 006	Vermop	6	Jet Vac
262 120 102	WAP	1	SQ 4 . SQ 450-11 . SQ 550-11 . SQ 650-11 . SQ 651-11 . SQ 850-11
262 120 103 006	WAP	6	SQ 4 . SQ 450-11 . SQ 550-11 . SQ 650-11 . SQ 651-11 . SQ 850-11
262 120 802	WAP	1	M2 L
262 120 804 006	WAP	6	M2 L
262 110 001	WAP	1	RA 500 E
262 110 004 006	WAP	6	RA 500 E
262 101	WAP Alto	1	ST . Aero
262 120 102	WAP Alto	1	SQ 400 . SQ 450 . SQ 450 . SQ 500 . SQ 550 . SQ 600 . SQ 650 . SQ 651-11 . Turbo SR-C . Turbo SR-U
262 120 103 006	WAP Alto	6	SQ 400 . SQ 450 . SQ 450 . SQ 500 . SQ 550 . SQ 600 . SQ 650 . SQ 651-11 . Turbo SR-C . Turbo SR-U
262 120 104	WAP Alto	1	Attix 30 . 40 . 50
262 120 202	WAP Alto	1	SQ 400-600 . Attix 350 . 550 . 560 . 7
262 120 203 006	WAP Alto	6	SQ 400-600 . Attix 350 . 550 . 560 . 7
262 140 102	WAP Alto	1	SQ 651-11 . SQ 850
262 140 103 006	WAP Alto	6	SQ 651-11 . SQ 850
262 100 102	Wap-ALTO	1	SQ 450-1H . SQ 650-1H . turbo 1001 . turbo 1001 Euro . turbo 1001 KI . turbo 1001 SA . turbo 1001 AE . turbo 1001 AE/F . turbo 1001 SA/KI . turbo 1001 SW/ICH . turbo 1001 SWE/ICH . turbo M1 . turbo M2 . turbo XL...
262 100 103 006	Wap-ALTO	6	SQ 450-1H . SQ 650-1H . turbo 1001 . turbo 1001 Euro . turbo 1001 KI . turbo 1001 SA . turbo 1001 AE . turbo 1001 AE/F . turbo 1001 SA/KI . turbo 1001 SW/ICH . turbo 1001 SWE/ICH . turbo M1 . turbo M2 . turbo XL...
262 043 112	Weidner	1	Comet (all battery-powered models)
262 043 113 006	Weidner	6	Comet (all battery-powered models)
262 050 112	Weidner	1	Comet (all battery-powered models)
262 100 001	Wetroc	1	Monovac 6 . Monovac 9
262 100 002 006	Wetroc	1	Monovac 6 . Monovac 9
262 050 230	Wetrok	1	Duomatic 430 B . Duomatic 501 BM
262 064 113	Wetrok	1	500 . 650
262 074 113	Wetrok	1	800
262 100 001	Wetrok	1	Monovac 6 . Monovac 9
262 100 002 006	Wetrok	1	Monovac 6 . Monovac 9
262 110 102	Wetrok	1	Duovack 18 . 34
262 110 103 006	Wetrok	6	Duovack 18 . 34
262 120 701	Wetrok	1	Twin Vac 18
262 120 701	Wetrok	1	Twin Vac 18
262 120 702	Wetrok	1	Twin Vac
262 120 704 006	Wetrok	6	Twin Vac
262 050 230	Wirbel	1	Rapid 380 24 Volt version
262 130 103	Wirbel	1	960 . 962
262 100 112	Wirbel	1	Rapid 380 (230V/50Hz)
262 120 102	Würth	1	ISS 35 . ISS 35-S
262 120 103 006	Würth	6	ISS 35 . ISS 35-S
262 120 202	Würth	1	ISS 35 . ISS 35-S
262 120 203 006	Würth	6	ISS 35 . ISS 35-S
262 120 702	Würth	1	ISS 35-S . ISS 45 . ISS 55
262 120 704 006	Würth	6	ISS 35-S . ISS 45 . ISS 55

Vacuum filter

Filter cloth with frame



2 micron

R+M Nr.	∅	h
267 073 0	400 mm	340 mm

Diaphragm fabric filter



R+M Nr.	∅	h
267 070 5	330 mm	400 mm
267 070 6	360 mm	500 mm

Accessories for spray-ex-sucker

Pre-spraying pumps



Pump for spray-ex-sucker EP7

R+M Nr.
267 191 0

Upholstery tools



R+M Nr.	∅
263 626	36 + 40 mm

Accessories for floor cleaning machines

Superpads

white = soft . black = hard

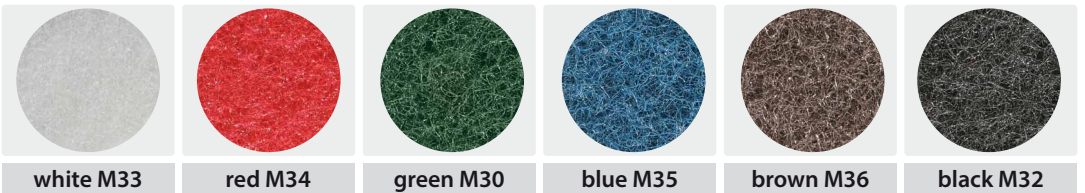

∅	VPE *	white M33	red M34	green M30	blue M35	brown M36	black M32
12" - 305 mm	5 pieces	930 101 019	930 102 019	930 103 019	930 104 019	930 105 019	930 106 019
13" - 325 mm	5 pieces	930 101 021	930 102 021	930 103 021	930 104 021	930 105 021	930 106 021
14" - 355 mm	5 pieces	930 101 025	930 102 025	930 103 025	930 104 025	930 105 025	930 106 025
15" - 380 mm	5 pieces	930 101 027	930 102 027	930 103 027	930 104 027	930 105 027	930 106 027
16" - 410 mm	5 pieces	930 101 029	930 102 029	930 103 029	930 104 029	930 105 029	930 106 029
17" - 430 mm	5 pieces	930 101 031	930 102 031	930 103 031	930 104 031	930 105 031	930 106 031
18" - 460 mm	5 pieces	930 101 033	930 102 033	930 103 033	930 104 033	930 105 033	930 106 033
19" - 480 mm	5 pieces	930 101 035	930 102 035	930 103 035	930 104 035	930 105 035	930 106 035
20" - 510 mm	5 pieces	930 101 037	930 102 037	930 103 037	930 104 037	930 105 037	930 106 037
21" - 530 mm	5 pieces	930 101 039	930 102 039	930 103 039	930 104 039	930 105 039	930 106 039

Attractive bulk prices for Superpads are available on request.

Vacuum bags

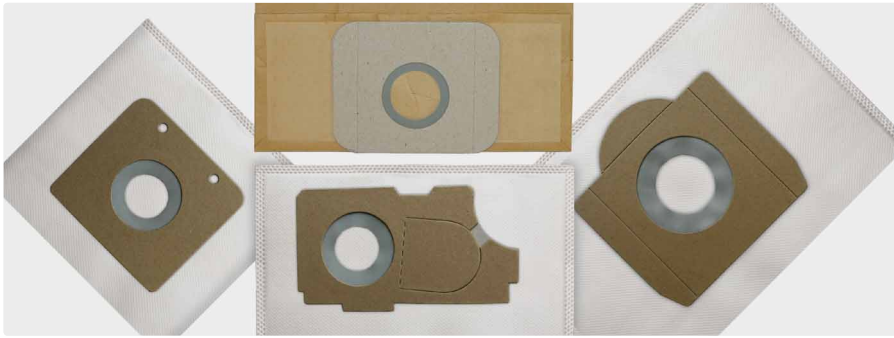

Ordering example for paper filter:
 10 x 268 143 7 paper filter 10 pieces = 1 VPE
 350 x 268 143 7 paper filter 350 pieces = 1 VPE

Ordering example for fleece filter:
 1 x 268 304 708 0 fleece filter 80 pieces = 1 VPE
 1 x 268 304 700 5 fleece filter 5 pieces = 1 VPE

R+M Nr.	suitable for	TYP	V = fleece filter . P1 = one-ply paper . P2 = two-ply paper		M	D	VPE *	VPE *	VPE **	ME
268 304 700 5	ALTO	Aero 20-01, 20-11, 20-21, 25-11, 25-21, Buddy 15, 18	V	✓					5	VPE
268 304 708 0	ALTO	Aero 20-01, 20-11, 20-21, 25-11, 25-21, Buddy 15, 18	V	✓				80 (4x20)		VPE
268 164 8	ALTO	Aero 400/440 (61.156)	P2	✓	10	140				pieces
268 164 9	ALTO	Aero 640/840 (60.910)	P2	✓	10	120				pieces
268 156 7	ALTO	Attix 3 (30.2000.449)	P2		10	150				pieces
268 300 800 5	ALTO	Attix 30, Attix 350/360, Attix 8 Gallon, Centix 60	V	✓					5	VPE
268 304 809 0	ALTO	Attix 30, Attix 350/360, Attix 8 Gallon, Centix 60	V	✓					90	VPE
268 300 200 5	ALTO	Attix 40/50, Attix 550/560/590, Attix 12 Gallon	V	✓					5	VPE
268 300 206 0	ALTO	Attix 40/50, Attix 550/560/590, Attix 12 Gallon	V	✓					60	VPE
268 156 8	ALTO	Attix 5	P2	✓	10	80				pieces
268 300 000 5	ALTO	Attix 751/761/791/19 Gallon/961/965	V	✓					5	VPE
268 300 003 5	ALTO	Attix 751/761/791/19 Gallon/961/965	V	✓					35	VPE
268 156 9	ALTO	Saltix	P2		10	200				pieces
268 301 501 0	ALTO	Saltix 10	V	✓					10	VPE
268 301 511 0	ALTO	Saltix 10	V	✓					110	VPE
268 149 9	ALTO	Saltix 10; 9 liter	P2	✓	10	200				pieces
268 100 1	BLACK & DECKER	Super 18	P1	✓	10	250				pieces
268 150 2	BLITZ	T 5	P2	✓	10	300				pieces
268 301 600 5	BLITZ	T 6	V	✓					5	VPE
268 301 608 0	BLITZ	T 6	V	✓					80	VPE
268 156 2	BLITZ	T 6	P2	✓	10	200				pieces
268 301 700 5	BLITZ	T 9	V	✓					5	VPE
268 301 709 0	BLITZ	T 9	V	✓					90	VPE
268 157 4	BLITZ	T 9	P2	✓	10	280				pieces
268 131 0	BOSCH	SK 2	P2		10	280				pieces
268 301 200 5	BROENDUM	Ronda 200	V	✓					5	VPE
268 301 206 0	BROENDUM	Ronda 200	V	✓					60	VPE
268 133 5	CIMEX	C 55	P1		10	450				pieces
268 141 0	CLEANFIX	BS 350/460 (355.001)	P2	✓	10	350				pieces
268 300 401 0	CLEANFIX	BS 350/460	V	✓					10	VPE
268 300 415 0	CLEANFIX	BS 350/460	V	✓					150	VPE
268 155 3	CLEANFIX	RS 05 (025.430)	P2		10	280				pieces
268 155 31	CLEANFIX	RS 05 (025.430); 10 pieces in PE-bag incl. 2 motor protection filter	P2	✓	10+2	250				pieces
268 301 800 5	CLEANFIX	RS 05	V	✓					5	VPE
268 301 817 0	CLEANFIX	RS 05	V	✓					170	VPE
268 301 917 0	CLEANFIX	RS 05; 5 pieces in PE-bag incl. 1 motor protection filter	V	✓					170	VPE
268 301 900 5	CLEANFIX	RS 05; 5 pieces in PE-bag incl. 1 motor protection filter	V	✓					5+1	VPE
268 157 9	CLEANFIX	S 05 (010.430)	P2		10	200				pieces
268 161 71	CLEANFIX	S 10 plus Hepa (022.433); 10 pieces in PE-bag incl. 2 motor protection filter	P2	✓	10+2	250				pieces
268 302 000 5	CLEANFIX	S 10 plus Hepa	V	✓					5	VPE
268 302 010 0	CLEANFIX	S 10 plus Hepa	V	✓					100	VPE
268 302 101 0	CLEANFIX	S 10, SW 15 (022.431)	V	✓					10	VPE
268 302 113 0	CLEANFIX	S 10, SW 15 (022.431)	V	✓					130	VPE
268 302 212 0	CLEANFIX	S 10, SW 15 (022.431); 10 pieces in PE-bag incl. 2 motor protection filter	V	✓					120	VPE
268 302 201 0	CLEANFIX	S 10, SW 15 (022.431); 10 pieces in PE-bag incl. 2 motor protection filter	V	✓					10+2	VPE
268 102 300 1	CLEANFIX	S 10, SW 15, (022.430)	P2	✓	10	200				pieces

* Price per piece ** Price per VPE

Symbols I height D diameter TYP type M material D sealable ME quantity unit VPE packing unit

Vacuum bags

R+M Nr.	suitable for	TYP	V = fleece filter . P1 = one-ply paper . P2 = two-ply paper	M	D	VPE *	VPE *	VPE **	ME
268 102 300 11	CLEANFIX	S 10, SW 15, (022.430); 10 pieces in PE-bag incl. 2 motor protection filter	P2	✓	10+2	200			pieces
268 161 7	CLEANFIX	S10 plus Hepa (022.433)	P2	✓	10	280			pieces
268 302 301 0	CLEANFIX	Silence 180	V	✓				10	VPE
268 302 318 0	CLEANFIX	Silence 180	V	✓				80	VPE
268 142 7	CLEANFIX	Silence 180	P2		10	180			pieces
268 302 400 5	CLEANFIX	SW 60	V					5	VPE
268 302 406 0	CLEANFIX	SW 60	V					60	VPE
268 142 21	COLUMBUS	Junior (= Elfo Junior 15 S + 28 SLB)	P2		10	220			pieces
268 142 2	COLUMBUS	Junior (= Elfo Junior 15 S + 28 SLB)	P1		10	250			pieces
268 100 1	COLUMBUS	KSM 150/156-159	P1	✓	10	250			pieces
268 155 31	COLUMBUS	RS 27 (20.811.530); 10 pieces in PE-bag incl. 2 motor protection filter	P2	✓	10+2	250			pieces
268 301 800 5	COLUMBUS	RS 27	V	✓				5	VPE
268 301 817 0	COLUMBUS	RS 27	V	✓				170	VPE
268 155 3	COLUMBUS	RS 27	P2	✓	10	280			pieces
268 301 917 0	COLUMBUS	RS 27; 5 pieces in PE-bag incl. 1 motor protection filter	V	✓				170	VPE
268 301 900 5	COLUMBUS	RS 27; 5 pieces in PE-bag incl. 1 motor protection filter	V	✓				5+1	VPE
268 102 300 1	COLUMBUS	ST 1000, 3000, M 157, 158, 159 (20.237.230)	P2	✓	10	200			pieces
268 302 101 0	COLUMBUS	ST 1000, 3000, M 157, 158, 159	V	✓				10	VPE
268 302 113 0	COLUMBUS	ST 1000, 3000, M 157, 158, 159	V	✓				130	VPE
268 302 212 0	COLUMBUS	ST 1000, 3000, M 157, 158, 159; 10 pieces in PE-bag incl. 2 motor protection filter	V	✓				120	VPE
268 302 201 0	COLUMBUS	ST 1000, 3000, M 157, 158, 159; 10 pieces in PE-bag incl. 2 motor protection filter	V	✓				10+2	VPE
268 302 310 0	COLUMBUS	ST 11, ST 11 pro, ST 11 pro+; 10 pieces in PE-bag incl. 1 motor protection filter	V	✓				100	VPE
268 302 301 0	COLUMBUS	ST 11, ST 11 pro, ST 11 pro+; 10 pieces in PE-bag incl. 1 motor protection filter	V	✓				10+1	VPE
268 111 9	COLUMBUS	ST 12 (old version 20511230)	P2		10	180			pieces
268 301 000 5	COLUMBUS	ST 12 (old version)	V					5	VPE
268 301 006 0	COLUMBUS	ST 12 (old version)	V					60	VPE
268 302 401 0	COLUMBUS	ST 12 (new version), SW 20, SW 20 P	V	✓				10	VPE
268 302 418 0	COLUMBUS	ST 12 (new version), SW 20, SW 20 P	V	✓				80	VPE
268 150 9	COLUMBUS	ST 12 (new version), SW 20	P2		10	200			pieces
268 161 8	COLUMBUS	ST 2000 (20.236.630)	P2	✓	10	200			pieces
268 302 000 5	COLUMBUS	ST 22	V	✓				5	VPE
268 302 010 0	COLUMBUS	ST 22	V	✓				100	VPE
268 157 6	COLUMBUS	ST 22	P2	✓	10	260			pieces
268 302 716 0	COLUMBUS	ST 7; 10 pieces in PE-bag incl. 1 motor protection filter	V	✓				160	VPE
268 302 701 0	COLUMBUS	ST 7; 10 pieces in PE-bag incl. 1 motor protection filter	V	✓				10+1	VPE
268 302 500 5	COLUMBUS	SW 30, SW 30 P, SW 30 S	V					5	VPE
268 302 506 0	COLUMBUS	SW 30, SW 30 P, SW 30 S	V					60	VPE
268 302 801 0	COLUMBUS	SW 32 P	V					10	VPE
268 302 808 0	COLUMBUS	SW 32 P	V					80	VPE
268 301 100 5	COLUMBUS	SW 50 P, SW 50 S, SW 52 P, SW 52 S, SW 53 P, SW 53 S	V					5	VPE
268 301 104 0	COLUMBUS	SW 50 P, SW 50 S, SW 52 P, SW 52 S, SW 53 P, SW 53 S	V					40	VPE
268 141 0	COLUMBUS	TK 25, 25e, 36, 36e, 46e, BS 360/460 (20.208.430)	P2	✓	10	350			pieces
268 300 401 0	COLUMBUS	TK 25, 25e, 36, 36e, 46e, BS 360/460	V	✓				10	VPE
268 300 415 0	COLUMBUS	TK 25, 25e, 36, 36e, 46e, BS 360/460	V	✓				150	VPE
268 101 2	COLUMBUS	TK 30, TK 60, RS 35	P2		10	180			pieces
268 302 000 5	COMAC	CA 15, CA 15P, CA 15S, CA 15 Silenzio, 15 Ecoplus	V	✓				5	VPE
268 302 010 0	COMAC	CA 15, CA 15P, CA 15S, CA 15 Silenzio, 15 Ecoplus	V	✓				100	VPE
268 158 8	COMAC	CA 15, CA 15P, CA 15S, CA 15 Silenzio, 15 Ecoplus	P2	✓	10	260			pieces
268 301 200 5	COMAC	CA 60	V	✓				5	VPE
268 301 206 0	COMAC	CA 60	V	✓				60	VPE
268 301 300 5	COMAC	CA 80, CA 100	V	✓				5	VPE
268 301 304 0	COMAC	CA 80, CA 100	V	✓				40	VPE
268 302 901 0	COMAC	Silent 25 S plus, CA 30	V	✓				10	VPE
268 302 908 0	COMAC	Silent 25 S plus, CA 30	V	✓				80	VPE
268 131 0	ELEKTROLUX	L/Z 169-SK 2	P2		10	280			pieces
268 303 001 0	ELEKTROLUX	UZ 873, UZ 932, UZ 934	V					10	VPE
268 303 014 0	ELEKTROLUX	UZ 873, UZ 932, UZ 934	V					140	VPE
268 143 0	ELEKTROLUX	UZ 964	P2		10	400			pieces

Vacuum bags

R+M Nr.	suitable for	TYP	V = fleece filter . P1 = one-ply paper . P2 = two-ply paper	M	D	VPE *	VPE *	VPE **	ME
268 143 7	ELEKTROLUX	DU 135		P2	✓	10	350		pieces
268 101 2	ELEKTROLUX	UZ 860		P2		10	180		pieces
268 142 9	ELEKTROLUX	UZ 873, UZ 932, UZ 934		P2		10	160		pieces
268 303 101 0	ELEKTROLUX	UZ 920, 921, 922, 923, 925, 930, 930/S, 945, Z 951, HZ 173, DP 9000, DP 9000 D, P 9000 Classic, Panther, Powerprof		V				10	VPE
268 303 112 0	ELEKTROLUX	UZ 920, 921, 922, 923, 925, 930, 930/S, 945, Z 951, HZ 173, DP 9000, DP 9000 D, P 9000 Classic, Panther, Powerprof		V				120	VPE
268 110 9	ELEKTROLUX	UZ 920, 921, 922, 923, 925, 930, 930/S, 945, Z 951, HZ 173, DP 9000, DP 9000 D, P 9000 Classic, Panther, Powerprof		P2		10	200		pieces
268 133 5	ELEKTROLUX	Z 65, 71, 73, 85, 87, 91, 94, 96, 289, 301, 302, 319, 324		P1		10	450		pieces
268 302 101 0	ELEKTROMA	S 100		V				10	VPE
268 302 113 0	ELEKTROMA	S 100		V				130	VPE
268 102 300 1	ELEKTROMA	S 100		P2	✓	10	200		pieces
268 302 212 0	ELEKTROMA	S 100; 10 pieces in PE-bag incl. 2 motor protection filter		V	✓			120	VPE
268 302 201 0	ELEKTROMA	S 100; 10 pieces in PE-bag incl. 2 motor protection filter		V	✓			10+2	VPE
268 107 5	ELEKTROMA	S 120		P2	✓	10	240		pieces
268 111 3	FAKIR	07, 1107, 1207, 1407; 10 pieces in PE-bag with round motor protection filter		P2	✓	10+1	300		pieces
268 111 31	FAKIR	1117, 1217, 1417; 10 pieces in PE-bag with square motor protection filter		P2	✓	10+1	300		pieces
268 131 0	FAKIR	200-250, 300-350, 380, 400, 420, 450, Automatic 500, 520, 530, SEL 380, 430, 550, 2 S, 3 SE, 3 SF, 3 SL, 171, 271, 275, 300 RX, 325 RX+, 350 RX		P2		10	280		pieces
268 300 900 5	FAKIR	IC 314, IC 315		V				5	VPE
268 300 905 0	FAKIR	IC 314, IC 315		V				50	VPE
268 111 8	FAKIR	IC 314, IC 315		P2		10	120		pieces
268 136 1	FAKIR	S 12, S 20, S 20 L, S 20 Super, S 22, S 30, S 38, S 120, GS 1700		P2	✓	10	200		pieces
268 301 000 5	FAKIR	S 17, S 18, IC 215		V				5	VPE
268 301 006 0	FAKIR	S 17, S 18, IC 215		V				60	VPE
268 111 9	FAKIR	S 17, S 18, IC 215		P2		10	180		pieces
268 161 2	FAST	Free Vac 2.5		P1		10	350		pieces
268 166 4	FAST	pure Q, C6		P2	✓	10	200		pieces
268 303 300 5	FESTOOL	Midi CT/CTL # 494105, Mini CT/CTL # 498410		V	✓			5	VPE
268 303 306 0	FESTOOL	Midi CT/CTL # 494105, Mini CT/CTL # 498410		V	✓			60	VPE
268 167 2L	FESTOOL	Midi CT/CTL # 494105		P2	✓	10	180		pieces
268 302 000 5	FIMAP	FA 15 Eco, FA 15 Plus, FA 15 Silenzio		V	✓			5	VPE
268 302 010 0	FIMAP	FA 15 Eco, FA 15 Plus, FA 15 Silenzio		V	✓			100	VPE
268 155 5	FIMAP	FA 15 Eco, FA 15 Plus, FA 15 Silenzio		P2	✓	10	260		pieces
268 167 5	FIMAP	FV 10, FV 10 Eco Energy; 5 L.		P2		10	320		pieces
268 167 6	FIMAP	FV 15, FV 15 Eco Energy; 10 L.		P2		10	300		pieces
268 157 3	FIMAP	FV 30		P2	✓	10	180		pieces
268 301 200 5	FIMAP	FV 60		V	✓			5	VPE
268 301 206 0	FIMAP	FV 60		V	✓			60	VPE
268 157 3	FIMAP	FV 60		P2	✓	10	180		pieces
268 301 300 5	FIMAP	FV 80		V	✓			5	VPE
268 301 304 0	FIMAP	FV 80		V	✓			40	VPE
268 111 3e	FIMAP	UP36/46; 10 pieces in PE-bag with square motor protection filter		P2	✓	10+1	300		pieces
268 147 8	FLOORDRESS	35/46, QFM 35/46		P2	✓	10	300		pieces
268 100 1	FLOORDRESS	S 132		P1	✓	10	250		pieces
268 143 3	FLOORDRESS	S 142/152, QP 152, S 12, S 22		P2	✓	10	300		pieces
268 163 5	FLOORMATIC	Blue Vac XL		P2	✓	10	120		pieces
268 154 3	FLOORMATIC	BP 100		P2	✓	10	500		pieces
268 302 000 5	FLOORMATIC	FBV 10, Blue Vac 11, Piccolo		V	✓			5	VPE
268 302 010 0	FLOORMATIC	FBV 10, Blue Vac 11, Piccolo		V	✓			100	VPE
268 155 5	FLOORMATIC	FBV 10, Blue Vac 11, Piccolo		P2	✓	10	260		pieces
268 302 000 5	GANSOW	Glob, Yvo		V	✓			5	VPE
268 302 010 0	GANSOW	Glob, Yvo		V	✓			100	VPE
268 157 6	GANSOW	Glob, Yvo		P2	✓	10	260		pieces
268 300 900 5	GANSOW	Jet Line NT 127		V				5	VPE

* Price per piece ** Price per VPE

Symbols TYP type M material D sealable ME quantity unit VPE packing unit

Vacuum bags

R+M Nr.	suitable for	TYP	V = fleece filter . P1 = one-ply paper . P2 = two-ply paper . P3 = three-ply paper	M	D	VPE *	VPE *	VPE **	ME
268 300 905 0	GANSOW	Jet Line NT 127		V				50	VPE
268 111 8	GANSOW	Jet Line NT 127		P2		10	120		pieces
268 301 100 5	GANSOW	Jet NT 278, Jet NT 378		V				5	VPE
268 301 104 0	GANSOW	Jet NT 278, Jet NT 378		V				40	VPE
268 302 401 0	GANSOW	Jet T 117, YP1300/9, G 10 P+		V				10	VPE
268 302 418 0	GANSOW	Jet T 117, YP1300/9, G 10 P+		V				80	VPE
268 142 71	GANSOW	Jet T 117, YP1300/9, G 10 P+		P2		10	220		pieces
268 150 2	GHIBLI	AS 5, Cod. (P.N.) 2512043		P2	✓	10	300		pieces
268 301 300 5	GHIBLI	AS 59, AS 590, AS 60 P, AS 600 P		V	✓			5	VPE
268 301 304 0	GHIBLI	AS 59, AS 590, AS 60 P, AS 600 P		V	✓			40	VPE
268 156 2	GHIBLI	AS 6, Cod. (P.N.) 2512044		P2	✓	10	200		pieces
268 301 600 5	GHIBLI	AS 6		V	✓			5	VPE
268 301 608 0	GHIBLI	AS 6		V	✓			80	VPE
268 302 901 0	GHIBLI	AS 7, AS 10, AS 10 P, ASL 7, ASL 10, M 7		V	✓			10	VPE
268 302 908 0	GHIBLI	AS 7, AS 10, AS 10 P, ASL 7, ASL 10, M 7		V	✓			80	VPE
268 102 336 1	GHIBLI	AS 7, AS 10, AS 10 P, ASL 7, ASL 10, M 7		P2	✓	10	180		pieces
268 301 200 5	GHIBLI	AS 8, AS 9, AS 12, AS 27, AS 30, AS 400, SP 8, SP 9		V	✓			5	VPE
268 301 206 0	GHIBLI	AS 8, AS 9, AS 12, AS 27, AS 30, AS 400, SP 8, SP 9		V	✓			60	VPE
268 157 3	GHIBLI	AS 8, AS 9, AS 27		P2	✓	10	180		pieces
268 301 400 5	GHIBLI	T 1		V				5	VPE
268 301 412 0	GHIBLI	T 1		V				120	VPE
268 162 41	GHIBLI	T 1		P2		10	240		pieces
268 300 401 0	HAKO	440		V	✓			10	VPE
268 300 415 0	HAKO	440		V	✓			150	VPE
268 141 0	HAKO	440		P2	✓	10	350		pieces
268 143 7	HAKO	Carpovac		P2	✓	10	350		pieces
268 302 901 0	HAKO	Clean 7231		V	✓			10	VPE
268 302 908 0	HAKO	Clean 7231		V	✓			80	VPE
268 102 336 1	HAKO	Clean 7231		P2	✓	10	180		pieces
268 302 101 0	HAKO	Supervac 100		V	✓			10	VPE
268 302 113 0	HAKO	Supervac 100		V	✓			130	VPE
268 102 300 1	HAKO	Supervac 100		P2	✓	10	200		pieces
268 302 212 0	HAKO	Supervac 100; 10 pieces in PE-bag incl. 2 motor protection filter		V	✓			120	VPE
268 302 201 0	HAKO	Supervac 100; 10 pieces in PE-bag incl. 2 motor protection filter		V	✓			10+2	VPE
268 302 000 5	HAKO	Supervac D 5 (7206-00)		V	✓			5	VPE
268 302 010 0	HAKO	Supervac D 5 (7206-00)		V	✓			100	VPE
268 155 5	HAKO	Supervac D 5 (7206-00)		P2	✓	10	260		pieces
268 301 600 5	HAREMA	HV 13 S		V	✓			5	VPE
268 301 608 0	HAREMA	HV 13 S		V	✓			80	VPE
268 156 2	HAREMA	HV 13 S		P2	✓	10	200		pieces
268 302 101 0	HAREMA	HV 9 S		V	✓			10	VPE
268 302 113 0	HAREMA	HV 9 S		V	✓			130	VPE
268 102 300 1	HAREMA	HV 9 S		P2	✓	10	200		pieces
268 302 212 0	HAREMA	HV 9 S; 10 pieces in PE-bag incl. 2 motor protection filter		V	✓			120	VPE
268 302 201 0	HAREMA	HV 9 S; 10 pieces in PE-bag incl. 2 motor protection filter		V	✓			10+2	VPE
268 303 400 5	HERKULES	Bauhaus SR 20, SR 30		V				5	VPE
268 303 414 0	HERKULES	Bauhaus SR 20, SR 30		V				140	VPE
268 303 501 0	HITACHI	CV-200 P, CV-300 P		V				10	VPE
268 303 524 0	HITACHI	CV-200 P, CV-300 P		V				240	VPE
268 155 21	HITACHI	CV-200 P, CV-300 P		P3		10	400		pieces
268 155 2	HITACHI	CV-200 P, CV-300 P		P2		10	400		pieces
268 133 5	HOOVER	Junior 652, 938, 6525-26, U 1012-1096, U 1104-1120, U 1194, U 1346-1358, U 4002-4058, H 1		P1		10	450		pieces
268 161 2	IVAC	Free Vac 2.5, Back Vac		P1		10	350		pieces
268 154 5	IVAC	Major		P2	✓	10	150		pieces
268 302 901 0	JANSER	Janvac 1600		V	✓			10	VPE
268 302 908 0	JANSER	Janvac 1600		V	✓			80	VPE
268 150 6	KÄRCHER	2001, 3011		P2		10	200		pieces
268 150 71	KÄRCHER	2101, 2101 TE, 2301, 2111, 2105, 4000 plus, 4000 TE, A 2101, A 2131 pt, A 2111		P2	✓	10	240		pieces
268 150 7	KÄRCHER	2501, 2501 TE, 2601, 2601 plus, 3001, SE 3001, 3001 hot		P2	✓	10	160		pieces

Vacuum bags

R+M Nr.	suitable for	TYP	V = fleece filter . P1 = one-ply paper . P2 = two-ply paper	M	D	VPE *	VPE *	VPE **	ME
268 150 7V	KÄRCHER	2501, 2501 TE, 2601, 2601 plus, 3001, SE 3001, 3001 hot; 10 pieces in PE-bag incl. 2 motor protection filter	P2	✓	10+2	160			pieces
268 301 000 5	KÄRCHER	2701	V					5	VPE
268 301 006 0	KÄRCHER	2701	V					60	VPE
268 111 9	KÄRCHER	2701	P2		10	180			pieces
268 150 72	KÄRCHER	A 2003, A 2004, A 2014 CV, A 2024 pt, A 2054 Me, A 2064 pt, A 2074 pt	P2	✓	10	250			pieces
268 159 8	KÄRCHER	A 2204, A 2254 Me, A 2234 pt, A 2504, A 2534 pt, A 2554 Me, A 2604, A 2654 Me, 2201 F, A 2201, A 2231 pt, A 2251 Me, A 2901, 2901 F, 3000 plus, A 3100, K 2150	P2		10	150			pieces
268 300 301 0	KÄRCHER	CV 30/1, CV 38/1, CV 38/2, CV 48/2	V					10	VPE
268 300 320 0	KÄRCHER	CV 30/1, CV 38/1, CV 38/2, CV 48/2	V					200	VPE
268 160 3	KÄRCHER	CV 30/1, CV 38/1, CV 38/2, CV 48/2	P2		10	350			pieces
268 300 401 0	KÄRCHER	CV 36/2 (CW 50), CV 46/2 (CW 100)	V	✓				10	VPE
268 300 415 0	KÄRCHER	CV 36/2 (CW 50), CV 46/2 (CW 100)	V	✓				150	VPE
268 158 7	KÄRCHER	NT 27/1	P2		10	140			pieces
268 300 900 5	KÄRCHER	NT 301, 2801	V					5	VPE
268 300 905 0	KÄRCHER	NT 301, 2801	V					50	VPE
268 111 8	KÄRCHER	NT 301, 2801	P2		10	120			pieces
268 151 9	KÄRCHER	NT 351 eco, 2000 E	P2	✓	10	150			pieces
268 300 700 5	KÄRCHER	NT 361 Eco/Eco TE/Eco M/Eco TEA/Eco MA	V					5	VPE
268 300 707 0	KÄRCHER	NT 361 Eco/Eco TE/Eco M/Eco TEA/Eco MA	V					70	VPE
268 154 2	KÄRCHER	NT 361, NT 35/1	P2	✓	10	120			pieces
268 303 600 5	KÄRCHER	NT 48/1, NT 65/2 Eco, NT 65/2 Eco Me, NT 65/2 Eco Tc, NT 72/2 Eco Tc	V					5	VPE
268 303 605 0	KÄRCHER	NT 48/1, NT 65/2 Eco, NT 65/2 Eco Me, NT 65/2 Eco Tc, NT 72/2 Eco Tc	V					50	VPE
268 152 3	KÄRCHER	NT 501/551	P2		10	100			pieces
268 153 2	KÄRCHER	NT 561	P2	✓	10	120			pieces
268 152 2	KÄRCHER	NT 700, NT 702	P2		10	90			pieces
268 300 501 0	KÄRCHER	T 10/1, T 12/1	V	✓				10	VPE
268 300 511 0	KÄRCHER	T 10/1, T 12/1	V	✓				110	VPE
268 143 5	KÄRCHER	T 101, T 151, Europa T 111	P2		10	250			VPE
268 157 8	KÄRCHER	T 12/1	P2	✓	10	200			pieces
268 100 1	KÄRCHER	T 140	P1	✓	10	250			pieces
268 300 801 0	KÄRCHER	T 15/1, T 17/1	V	✓				10	VPE
268 300 807 0	KÄRCHER	T 15/1, T 17/1	V	✓				70	VPE
268 164 7	KÄRCHER	T 15/1	P2	✓	10	150			pieces
268 152 7	KÄRCHER	T 171, BV 111	P2		10	360			pieces
268 152 8	KÄRCHER	T 191, T 191 K	P2		10	320			pieces
268 143 6	KÄRCHER	T 201, T 201 + ESB 24	P2		10	200			pieces
268 143 61	KÄRCHER	T 201, T 201 + ESB 24; 10 pieces in PE-bag incl. 2 motor protection filter	P2		10+2	200			pieces
268 159 0	KÄRCHER	T 7/1, T 10/1	P2		10	250			pieces
268 300 601 0	KÄRCHER	T 7/1, T 9/1 Bp, BV 5/1, BV 5/1 Bp	V					10	VPE
268 300 616 0	KÄRCHER	T 7/1, T 9/1 Bp, BV 5/1, BV 5/1 Bp	V					160	VPE
268 141 0	KÄRCHER	TBS 32 e, 42 e, TBS 25-35, CV 36/2, CV 46/2, CW 50, CW 100	P2	✓	10	350			pieces
268 303 701 0	KÄRCHER	VC 6, VC 6 Premium, VC 6100, VC 6150, VC 6200, VC 6250 PET, VC 6300, VC 6300 B, VC 6350, VC 6400, VC 6400 ESB; 10 pieces in PE-bag incl. 1 motor protection filter	V					10+1	VPE
268 302 000 5	KENBO	Eco plus 15	V	✓				5	VPE
268 302 010 0	KENBO	Eco plus 15	V	✓				100	VPE
268 158 8	KENBO	Eco plus 15	P2	✓	10	260			pieces
268 163 5	KENBO	Eco plus 25	P2	✓	10	120			pieces
268 157 7	KENBO	Micro S	P2	✓	10	280			pieces
268 154 1	KENBO	Silent 25 S plus	P2	✓	10	160			pieces
268 143 7	LINDHAUS	RX 4, RX 380	P2	✓	10	350			pieces
268 300 401 0	LORITO	250/450	V	✓				10	VPE
268 300 415 0	LORITO	250/450	V	✓				150	VPE
268 141 0	LORITO	250/450	P2	✓	10	350			pieces
268 166 4	LORITO	Compacto 6	P2	✓	10	200			pieces
268 154 4	LORITO	Compacto 9	P2	✓	10	200			pieces
268 161 2	LORITO	Free Vac 2.5	P1		10	350			pieces

* Price per piece ** Price per VPE

Symbols TYP type M material D sealable ME quantity unit VPE packing unit

Vacuum bags

R+M Nr.	suitable for	TYP	V = fleece filter . P1 = one-ply paper . P2 = two-ply paper	M	☐	VPE *	VPE *	VPE **	ME
268 157 9	LORITO	Otto 300 K		P2		10	200		pieces
268 154 5	LORITO	S 1, S 2, S 11		P2	✓	10	150		pieces
268 165 8	LORITO	Silent 10		P2		10	250		pieces
268 147 8	LORITO	UP 350/450, BS 35/46		P2	✓	10	300		pieces
268 150 9	MARCO	Modell Luxus		P2	✓	10	200		pieces
268 163 2	MINATOL	RS Micro		P1		10	230		pieces
268 100 1	MOBILO	S 1000		P1	✓	10	250		pieces
268 301 000 5	MOBILO	S 900		V				5	VPE
268 301 006 0	MOBILO	S 900		V				60	VPE
268 111 9	MOBILO	S 900		P2		10	180		pieces
268 111 3	NILCO	07, 1107, 1207, 1407; 10 pieces in PE-bag with round motor protection filter		P2	✓	10+1	300		pieces
268 111 3e	NILCO	1117, 1217, 1417; 10 pieces in PE-bag with square motor protection filter		P2	✓	10+1	300		pieces
268 131 0	NILCO	171/271/275		P2		10	280		pieces
268 302 401 0	NILCO	IC 213		V				10	VPE
268 302 418 0	NILCO	IC 213		V				80	VPE
268 142 71	NILCO	IC 213		P2		10	220		pieces
268 301 000 5	NILCO	IC 215, S 17, S 18, S 26 NT		V				5	VPE
268 301 006 0	NILCO	IC 215, S 17, S 18, S 26 NT		V				60	VPE
268 111 9	NILCO	IC 215, S 17, S 18, S 26 NT		P2		10	180		pieces
268 300 900 5	NILCO	IC 314, IC 315		V				5	VPE
268 300 905 0	NILCO	IC 314, IC 315		V				50	VPE
268 111 8	NILCO	IC 314, IC 315		P2		10	120		pieces
268 163 2	NILCO	Micro		P1		10	230		pieces
268 136 1	NILCO	S 20, S 20 E, S 20 el., S 20 Eco Power, S 30, S 38, GS 1025, GS 1700		P2	✓	10	200		pieces
268 304 700 5	NILFISK	Aero 20-01, 20-11, 20-21, 25-11, 25-21, Buddy 15, 18, VL 200 30 PC INOX		V	✓			5	VPE
268 304 708 0	NILFISK	Aero 20-01, 20-11, 20-21, 25-11, 25-21, Buddy 15, 18, VL 200 30 PC INOX		V	✓			80	VPE
268 164 8	NILFISK	Aero 400/440		P2		10	150		pieces
268 164 9	NILFISK	Aero 640/840		P2		10	120		pieces
268 156 7	NILFISK	Attix 3		P2	✓	10	150		pieces
268 156 8	NILFISK	Attix 5		P2	✓	10	80		pieces
268 303 101 0	NILFISK	GD 930 (1.407.019.040), GD 930 S, GD 930 S2 Panther, GD 936		V				10	VPE
268 303 112 0	NILFISK	GD 930 (1.407.019.040), GD 930 S, GD 930 S2 Panther, GD 936		V				120	VPE
268 110 9	NILFISK	GD 930 (1.407.019.040), GD 930 S, GD 930 S2 Panther, GD 936		P2		10	200		pieces
268 303 001 0	NILFISK	GM, 110, GM 130, Cubic, UZ 934		V				10	VPE
268 303 014 0	NILFISK	GM, 110, GM 130, Cubic, UZ 934		V				140	VPE
268 142 9	NILFISK	GM, 110, GM 130, Cubic, UZ 934		P2		10	160		pieces
268 300 200 5	NILFISK	IVB 5, IVB 40, IVB 50		V	✓			5	VPE
268 300 206 0	NILFISK	IVB 5, IVB 40, IVB 50		V	✓			60	VPE
268 303 400 5	NILFISK	Multi 20, Multi 30		V				5	VPE
268 303 414 0	NILFISK	Multi 20, Multi 30		V				140	VPE
268 302 500 5	NILFISK	VL 500-35 BSF, VL 500-35 EDF, VL 500-55-1 BDF, VL 500-55-1 EDF, VL 500-55-2 EDF, MAXXI II 35-1, MAXXI II 55-1, MAXXI II 55-2		V				5	VPE
268 302 506 0	NILFISK	VL 500-35 BSF, VL 500-35 EDF, VL 500-55-1 BDF, VL 500-55-1 EDF, VL 500-55-2 EDF, MAXXI II 35-1, MAXXI II 55-1, MAXXI II 55-2		V				60	VPE
268 301 100 5	NILFISK	VL 500-75-1 BSF, VL 500-75-2 BSF, VL 500-75-2 EDF, MAXXI II 75-1, MAXXI II 75-2		V				5	VPE
268 301 104 0	NILFISK	VL 500-75-1 BSF, VL 500-75-2 BSF, VL 500-75-2 EDF, MAXXI II 75-1, MAXXI II 75-2		V				40	VPE
268 151 1	NILFISK	Dorsal Backuum (22.198.000); 5 pieces in PE-bag incl. 1 motor protection filter		P2		5+1	200		pieces
268 136 7	NILFISK	GA 70, GS 80, GM 80, GD 90, GM 90, GS 90, BRM 545, (816.200)		P2		10	280		pieces
268 165 4	NILFISK	GD 10 Back, Ref. 1471097500; 5 pieces in PE-bag incl. 1 motor protection filter		P2		5+1	150		pieces
268 150 8	NILFISK	GD 1000 series, GD 1005, (82.017.201), VP 600 Basic EU, VP 600 STD 2 EU, VP 600 STD 3 EU; 6 L.		P2	✓	10	250		pieces
268 301 501 0	NILFISK	GD 111, GD 710, GD 910, GD 911, GD 1000 series, GD 1005, GD 1010, GNS 1010, GD 2000, HDS 2000, Saltix 3, Saltix 10, VC 300, VC 300 Hepa, VP 300, VP 300 Hepa, VP 600 Basic EU, VP 600 STD 2 EU, VP 600 STD 3 EU		V	✓			10	VPE
268 301 511 0	NILFISK	GD 111, GD 710, GD 910, GD 911, GD 1000 series, GD 1005, GD 1010, GNS 1010, GD 2000, HDS 2000, Saltix 3, Saltix 10, VC 300, VC 300 Hepa, VP 300, VP 300 Hepa, VP 600 Basic EU, VP 600 STD 2 EU, VP 600 STD 3 EU		V	✓			110	VPE

* Price per piece ** Price per VPESymbols TYP type M material ☐ sealable ME quantity unit VPE packing unit

Vacuum bags

R+M Nr.	suitable for	TYP	V = fleece filter . P1 = one-ply paper . P2 = two-ply paper	M	D	VPE *	VPE *	VPE **	ME
268 149 9	NILFISK	GD 111, GD 710, GD 910, GD 911, GD 1010, GNS 1010, GD 2000, HDS 2000, Saltix 3, Saltix 10, VC 300, VC 300 Hepa, VP 300, VP 300 Hepa, (82.017.401); 9 L.	P2			10	200		pieces
268 165 3	NILFISK	GD 5 Back, Ref.Nr. 1471098500; 5 pieces in PE-bag incl. 1 motor protection filter	P2			5+1	200		pieces
268 163 0	NILFISK	GU 305/355/455 Dual, GU 15 DMU, Nr. 1471058000	P2			10	350		pieces
268 143 7	NILFISK	GU 350A/450A (82.040.400)	P2	✓		10	350		pieces
268 300 800 5	NILFISK	IVB 3, IVB 30	V	✓				5	VPE
268 304 809 0	NILFISK	IVB 3, IVB 30	V	✓				90	VPE
268 153 3	NILFISK	Viking, GD 110, VD 10 (1.408.007.020)	P2	✓		10	240		pieces
268 100 1	NOVIMEX	Picovac	P1	✓		10	250		pieces
268 108 6	NUMATIC	NVM-1C/2 (604.100) NVH 180-2, NVP 180-2, NRV 200-22, NRV 200 T-2, Henry HVR 200-22, NVQ 200-22, Henry Xtra HVX 200-22, NQS 250 B-22, SSV 250-22, AVQ 250, RSAV 130, RSB 140, RSV 130, RSV 200, Nuvac Plus NNR 200-2, Nuvac NNH 180-2	P2	✓		10	300		pieces
268 303 901 0	NUMATIC	NVM-1CH (604.015), Hepa-Flo NVH 180-2, NVP 180-2, NRV 200-22, NRV 200 T-2, Henry HVR 200-22, NVQ 200-22, Henry Xtra HVX 200-22, NQS 250 B-22, SSV 250-22, AVQ 250, RSAV 130, RSB 140, RSV 130, RSV 200, Nuvac Plus NNR 200-2, Nuvac NNH 180-2	V	✓				10	VPE
268 303 920 0	NUMATIC	NVM-1CH (604.015), Hepa-Flo NVH 180-2, NVP 180-2, NRV 200-22, NRV 200 T-2, Henry HVR 200-22, NVQ 200-22, Henry Xtra HVX 200-22, NQS 250 B-22, SSV 250-22, AVQ 250, RSAV 130, RSB 140, RSV 130, RSV 200, Nuvac Plus NNR 200-2, Nuvac NNH 180-2	V	✓				200	VPE
268 144 3	NUMATIC	NVM-2B/2 (604.102) NVP 370-2, NRV 370-22, NVQ 370-22, NVQ 370T-2, MFQ 370-22, NQS 350B-22, WV 370-2, George GVE 370-2	P2	✓		10	250		pieces
268 304 000 5	NUMATIC	NVM-2BH (604.016), Hepa-Flo NVP 370-2, NRV 370-22, NVQ 370-22, NVQ 370 T-2, MFQ 370-22, NQS 350B-22, WV 370-2, George GVE 370-2	V	✓				5	VPE
268 304 008 0	NUMATIC	NVM-2BH (604.016), Hepa-Flo NVP 370-2, NRV 370-22, NVQ 370-22, NVQ 370 T-2, MFQ 370-22, NQS 350B-22, WV 370-2, George GVE 370-2	V	✓				80	VPE
268 304 101 0	NUMATIC	RSB 140-1, RSB 140-2, RSAV 130, RSV 130, RSV 130-1, RSV 130-11	V	✓				10	VPE
268 304 120 0	NUMATIC	RSB 140-1, RSB 140-2, RSAV 130, RSV 130, RSV 130-1, RSV 130-11	V	✓				200	VPE
268 143 3	NUMATIC	System 12	P2	✓		10	300		pieces
268 162 3	OMEGA	Contur HSS 09/3, HSS 09/4; 10 pieces in PE-bag incl. 1 motor protection filter	P2			10+1	500		pieces
268 302 401 0	POOL	T 110	V					10	VPE
268 302 418 0	POOL	T 110	V					80	VPE
268 144 4	POOL	T 110	P2			10	220		pieces
268 136 1	POOL	T 115	P2	✓		10	200		pieces
268 154 4	POOL	T 210	P2			10	200		pieces
268 107 5	PROCLEAN	PC 20 K	P2	✓		10	240		pieces
268 301 600 5	PROCLEAN	T 111 Piccolino	V	✓				5	VPE
268 301 608 0	PROCLEAN	T 111 Piccolino	V	✓				80	VPE
268 156 2	PROCLEAN	T 111 Piccolino	P2	✓		10	200		pieces
268 301 700 5	PROFI-EUROPE	Profi 1, Profi 1.1, Profi 1 Lux, Profi 3	V					5	VPE
268 301 709 0	PROFI-EUROPE	Profi 1, Profi 1.1, Profi 1 Lux, Profi 3	V					90	VPE
268 157 4	PROFI-EUROPE	Profi 1, Profi 1.1, Profi 1 Lux, Profi 3	P2			10	280		pieces
268 100 1	PROGRESS	Mercedes KS plus, TK, SB, SB2, SBZ	P1	✓		10	250		pieces
268 131 0	ROWENTA	Rotocraft RK 20 S, RK 21, RK 30 SL, RK 31, RK 40 SLX	P2			10	280		pieces
268 300 900 5	ROWENTA	ZR 80, Vorace, RU 30-46, RU 520 S, RU 521, BP 61, Allround W&D-Models, (29 ltr.)	V					5	VPE
268 300 905 0	ROWENTA	ZR 80, Vorace, RU 30-46, RU 520 S, RU 521, BP 61, Allround W&D-Models, (29 ltr.)	V					50	VPE
268 111 8	ROWENTA	ZR 80, Vorace, RU 30-46, RU 520 S, RU 521, BP 61, Allround W&D-Models, (29 ltr.)	P2			10	120		pieces
268 301 000 5	ROWENTA	ZR 81, RU 01-15, RB 50-52, Collecto, (19 ltr.)	V					5	VPE
268 301 006 0	ROWENTA	ZR 81, RU 01-15, RB 50-52, Collecto, (19 ltr.)	V					60	VPE
268 111 9	ROWENTA	ZR 81, RU 01-15, RB 50-52, Collecto, (19 ltr.)	P2			10	180		pieces
268 144 5	SEBO	automatic X1, X2, X3, 370/470	P2			10	300		pieces
268 300 401 0	SEBO	Evolution 300/350/450, 360/460	V	✓				10	VPE
268 300 415 0	SEBO	Evolution 300/350/450, 360/460	V	✓				150	VPE
268 141 0	SEBO	Evolution 300/350/450, 360/460	P2	✓		10	350		pieces
268 100 1	SELCO	Noiseless	P1	✓		10	250		pieces
268 111 9	SIEMENS	VM 10000	P2			10	180		pieces
268 131 0	SIEMENS	VU 30	P2			10	280		pieces
268 300 401 0	SORMA	RS 310, TM 430, TM 260	V	✓				10	VPE

Vacuum bags

R+M Nr.	suitable for	TYP	V = fleece filter . P1 = one-ply paper . P2 = two-ply paper	M	D	VPE *	VPE *	VPE **	ME
268 300 415 0	SORMA	RS 310, TM 430, TM 260		V	✓			150	VPE
268 141 0	SORMA	RS 310, TM 430, TM 260		P2	✓	10	350		pieces
268 302 401 0	SORMA	SM 110		V				10	VPE
268 302 418 0	SORMA	SM 110		V				80	VPE
268 144 4	SORMA	SM 110		P2		10	220		pieces
268 302 212 0	SORMA	SM 115, 118, 515; 10 pieces in PE-bag incl. 2 motor protection filter		V	✓			120	VPE
268 302 201 0	SORMA	SM 115, 118, 515; 10 pieces in PE-bag incl. 2 motor protection filter		V	✓			10+2	VPE
268 302 101 0	SORMA	SM 115, SM 118, SM 515		V	✓			10	VPE
268 302 113 0	SORMA	SM 115, SM 118, SM 515		V	✓			130	VPE
268 102 300 1	SORMA	SM 115, SM 118, SM 515		P2	✓	10	200		pieces
268 100 1	SORMA	SM 115, SM 118		P1	✓	10	250		pieces
268 150 2	SORMA	SM 125		P2	✓	10	300		pieces
268 151 2	SORMA	SM 505 (=Tennant 3400)		P2	✓	10	200		pieces
268 107 5	SORMA	SM 510 (=Tennant 3410)		P2	✓	10	240		pieces
268 154 4	SORMA	SM 510 (=Tennant 3410)		P2	✓	10	200		pieces
268 107 4	SORMA	SM 515, 520, (=Tennant 3800)		P1		10	200		pieces
268 144 5	SORMA	TM 375/455 (sebo automatic)		P2		10	300		pieces
268 302 401 0	SOTECO	15-20 Liter, 2er Serie, Base 101, 103, Supercondor, Amsterdam 115 HP, Europa Rocky I, Yes Play 202		V				10	VPE
268 302 418 0	SOTECO	15-20 Liter, 2er Serie, Base 101, 103, Supercondor, Amsterdam 115 HP, Europa Rocky I, Yes Play 202		V				80	VPE
268 302 500 5	SOTECO	20-45 L., 3er & 5er Serie		V				5	VPE
268 302 506 0	SOTECO	20-45 L., 3er & 5er Serie		V				60	VPE
268 301 100 5	SOTECO	45-90 L., 4er & 6er Serie		V				5	VPE
268 301 104 0	SOTECO	45-90 L., 4er & 6er Serie		V				40	VPE
268 142 7	SOTECO	Base 101, 103, Supercondor, Amsterdam 115 HP, Europa Rocky I		P2		10	180		pieces
268 142 21	SOTECO	Box		P2		10	220		pieces
268 142 2	SOTECO	Box		P1		10	250		pieces
268 149 7	SOTECO	Europa 115/300, Rocky II		P2		10	140		pieces
268 302 000 5	SOTECO	Leo, Leo Eco		V	✓			5	VPE
268 302 010 0	SOTECO	Leo, Leo Eco		V	✓			100	VPE
268 157 6	SOTECO	Leo, Leo Eco		P2	✓	10	260		pieces
268 163 2	SOTECO	Micro		P1		10	230		pieces
268 300 900 5	SOTECO	Nevada 215, 503 R		V				5	VPE
268 300 905 0	SOTECO	Nevada 215, 503 R		V				50	VPE
268 111 8	SOTECO	Nevada 215, 503 R		P2		10	120		pieces
268 301 000 5	SOTECO	T 110, Nevada 103 RAD		V				5	VPE
268 301 006 0	SOTECO	T 110, Nevada 103 RAD		V				60	VPE
268 111 9	SOTECO	T 110, Nevada 103 RAD		P2		10	180		pieces
268 142 71	SOTECO	Yes Play 202		P2		10	220		pieces
268 144 4	SOTECO	Yes Play 202		P2		10	220		pieces
268 302 310 0	SPRINTUS	Maximus, Maximus pro, Maximus pt, T 11 EVO; 10 pieces in PE-bag incl. 1 motor protection filter		V	✓			100	VPE
268 302 301 0	SPRINTUS	Maximus, Maximus pro, Maximus pt, T 11 EVO; 10 pieces in PE-bag incl. 1 motor protection filter		V	✓			10+1	VPE
268 304 301 0	SPRINTUS	N 20/1 K, N 27/1 E, N 27/1 ERT, N 30/1 KPT, N 30/1 KS		V	✓			10	VPE
268 304 308 0	SPRINTUS	N 20/1 K, N 27/1 E, N 27/1 ERT, N 30/1 KPT, N 30/1 KS		V	✓			80	VPE
268 302 716 0	SPRINTUS	T 11; 10 pieces in PE-bag incl. 1 motor protection filter		V	✓			160	VPE
268 302 701 0	SPRINTUS	T 11; 10 pieces in PE-bag incl. 1 motor protection filter		V	✓			10+1	VPE
268 148 6	TASKI	Bora 12 "S" (8504150)		P2	✓	10	200		pieces
268 149 5	TASKI	Dorsalino (8504190)		P2	✓	10	400		pieces
268 302 101 0	TASKI	S 4, S 6, Babybora, Hurricane (8.500.600)		V	✓			10	VPE
268 302 113 0	TASKI	S 4, S 6, Babybora, Hurricane (8.500.600)		V	✓			130	VPE
268 102 300 1	TASKI	S 4, S 6, Babybora, Hurricane (8.500.600)		P2	✓	10	200		pieces
268 100 1	TASKI	S 4, S 6, Bora		P1	✓	10	250		pieces
268 302 212 0	TASKI	S 4, S 6, babybora, Hurricane; 10 pieces in PE-bag incl. 2 motor protection filter		V	✓			120	VPE

Vacuum bags

R+M Nr.	suitable for	TYP	V = fleece filter . P1 = one-ply paper . P2 = two-ply paper . P3 = three-ply paper	M	D	VPE *	VPE *	VPE **	ME
268 302 201 0	TASKI	S4, S6, babybora, Hurricane; 10 pieces in PE-bag incl. 2 motor protection filter	V	✓				10+2	VPE
268 143 7	TASKI	Tapitronic, Tapiset 38/45 (8502160)	P2	✓	10	350			pieces
268 304 401 0	TASKI	Vento 15 (7514888), Vento 15 S	V					10	VPE
268 304 405 0	TASKI	Vento 15 (7514888), Vento 15 S	V					50	VPE
268 161 6	TASKI	Vento 15 (7514888), Vento 15 S	P2		10	100			pieces
268 160 6	TASKI	Vento 8 (7514886), Vento 8 S	V					100	VPE
268 160 9	TASKI	Vento 8 (7514886), Vento 8 S	P2		10	200			pieces
268 151 2	TENNANT	3400 (=Sorma SM 505), V 5	P2	✓	10	200			pieces
268 154 4	TENNANT	3410 (=Sorma SM 510)	P2	✓	10	200			pieces
268 107 5	TENNANT	3410 (Sorma SM 510)	P2		10	240			pieces
268 107 4	TENNANT	3800 (=Sorma SM 515, 520)	P1		10	200			pieces
268 147 8	TENNANT	CV 141	P2	✓	10	300			pieces
268 149 7	TENNANT	V 10	P2		10	140			pieces
268 300 900 5	TENNANT	V 12	V					5	VPE
268 300 905 0	TENNANT	V 12	V					50	VPE
268 111 8	TENNANT	V 12	P2		10	120			pieces
268 301 100 5	TENNANT	V 14	V					5	VPE
268 301 104 0	TENNANT	V 14	V					40	VPE
268 166 9	TENNANT	V 6	P2		12	240			pieces
268 167 5	TMB	Dryver 10 R, 10 RE; 5 L.	P2		10	320			pieces
268 167 6	TMB	Dryver 15 R, 15 RE; 10 L.	P2		10	300			pieces
268 158 11	VERMOP	Jetvac	P2		10	220			pieces
268 303 901 0	VIPER	DSU 1, DSU 8, DSU 10, Smartness DV-10, GVD 10	V	✓				10	VPE
268 303 920 0	VIPER	DSU 1, DSU 8, DSU 10, Smartness DV-10, GVD 10	V	✓				200	VPE
268 304 000 5	VIPER	DSU 12, DSU 15	V	✓				5	VPE
268 304 008 0	VIPER	DSU 12, DSU 15	V	✓				80	VPE
268 166 7	VIPER	Eco 15	P2	✓	10	220			pieces
268 301 200 5	VIPER	LSU 135, LSU 135P	V	✓				5	VPE
268 301 206 0	VIPER	LSU 135, LSU 135P	V	✓				60	VPE
268 301 300 5	VIPER	LSU 155, LSU 155P, LSU 255, LSU 255P, LSU 275, LSU 275P,	V	✓				5	VPE
268 301 304 0	VIPER	LSU 155, LSU 155P, LSU 255, LSU 255P, LSU 275, LSU 275P,	V	✓				40	VPE
268 108 6	VIPER	Smartness DV-10, GVD 10	P2	✓	10	300			pieces
268 133 5	VOLTA	U 149, U 157, U 165, U 167, U 173, U 178, U 179, U 196, U 200, U 201, U 203, U 215, TR 6/7	P1		10	450			pieces
268 139 2	VORWERK	Kobold VK 118-122	P2	✓	10	300			pieces
268 139 4	VORWERK	Tiger VK 250-252	P2	✓	10	250			pieces
268 139 0	VORWERK	VK 130/131	P3	✓	8	224			pieces
268 304 700 5	WAP	Aero 20-01, 20-11, 20-21, 25-11, 25-21, Buddy 15, 18	V	✓				5	VPE
268 304 708 0	WAP	Aero 20-01, 20-11, 20-21, 25-11, 25-21, Buddy 15, 18	V	✓				80	VPE
268 164 8	WAP	Aero 400/440	P2	✓	10	140			pieces
268 164 9	WAP	Aero 640/840	P2	✓	10	120			pieces
268 156 7	WAP	Attix 3	P2	✓	10			150	VPE
268 304 800 5	WAP	Attix 30, Attix 350/360, Attix 8 Gallon, Centix 60	V	✓				5	VPE
268 304 809 0	WAP	Attix 30, Attix 350/360, Attix 8 Gallon, Centix 60	V	✓				90	VPE
268 300 200 5	WAP	Attix 40/50, Attix 550/560/590, Attix 12 Gallon	V	✓				5	VPE
268 300 206 0	WAP	Attix 40/50, Attix 550/560/590, Attix 12 Gallon	V	✓				60	VPE
268 156 8	WAP	Attix 5	P2	✓	10	80			pieces
268 301 501 0	WAP	Saltix 10; 9 L.	V	✓				10	VPE
268 301 511 0	WAP	Saltix 10; 9 L.	V	✓				110	VPE
268 149 9	WAP	Saltix 10; 9 L.	P2	✓	10	200			pieces
268 156 9	WAP	Saltix	P2		10	200			pieces
268 161 5	WAP	SQ4, SQ450-11, SQ450-21, SQ450-31, SQ4501M, SQ4502M, SQ4503M, SQ490-31	P2	✓	10	160			pieces
268 302 901 0	WEBER	15-1 STBL Jack Line, 15-1 STBL Vac Line	V	✓				10	VPE
268 302 908 0	WEBER	15-1 STBL Jack Line, 15-1 STBL Vac Line	V	✓				80	VPE
268 102 336 1	WEBER	15-1 STBL Jack Line, 15-1 STBL Vac Line	P2	✓	10	180			pieces

* Price per piece ** Price per VPE

Symbols TYP type M material D sealable ME quantity unit VPE packing unit

Vacuum bags

R+M Nr.	suitable for	TYP	V = fleece filter . P1 = one-ply paper . P2 = two-ply paper	M	D	VPE *	VPE *	VPE **	ME
268 301 200 5	WEBER	30-1-STBL Jack Line, 30-1-STBL Vac Line	V	✓				5	VPE
268 301 206 0	WEBER	30-1-STBL Jack Line, 30-1-STBL Vac Line	V	✓				60	VPE
268 301 100 5	WEBER	90-3-STBL, 90-3-PTBL	V					5	VPE
268 301 104 0	WEBER	90-3-STBL, 90-3-PTBL	V					40	VPE
268 301 300 5	WEBER	Vac Line 70-2-STBL, 70-2-STBL SF, 70-3-STBL, 70-3-PTBL, 80-3-STBL	V	✓				5	VPE
268 301 304 0	WEBER	Vac Line 70-2-STBL, 70-2-STBL SF, 70-3-STBL, 70-3-PTBL, 80-3-STBL	V	✓				40	VPE
268 302 716 0	WEBER	Vac-Line 12-1 PLBL, S1 Secco; 10 pieces in PE-bag incl. 1 motor protection filter	V	✓				160	VPE
268 302 701 0	WEBER	Vac-Line 12-1 PLBL, S1 Secco; 10 pieces in PE-bag incl. 1 motor protection filter	V	✓				10+1	VPE
268 302 801 0	WEBER	x2-Aqua	V					10	VPE
268 302 808 0	WEBER	x2-Aqua	V					80	VPE
268 139 7	WETROK	Duovac, Duovac 18, Bantam 18, Silento 2000, Twinvac 18	P2	✓		10	150		VPE
268 111 3	WETROK	Karpawel 350; Combisauger, 10 pieces in PE-bag with round motor protection filter	P2	✓		10+1	300		VPE
268 304 600 5	WETROK	Monovac 6, Monovac 6 Plus, Bantam 6/9	V	✓				5	VPE
268 304 610 0	WETROK	Monovac 6, Monovac 6 Plus, Bantam 6/9	V	✓				100	VPE
268 139 61	WETROK	Monovac 6, Monovac 6 Plus, Bantam 6/9	P2	✓		10	150		pieces
268 153 01	WETROK	Monovac 9, Monovac 11 Plus	P2	✓		10	120		pieces
268 100 1	WETROK	Picovac	P1	✓		10	250		pieces
268 302 401 0	WIRBEL	814, 815	V					10	VPE
268 302 418 0	WIRBEL	814, 815	V					80	VPE
268 301 000 5	WIRBEL	814, 815	V	✓				5	VPE
268 301 006 0	WIRBEL	814, 815	V	✓				60	VPE
268 111 9	WIRBEL	814, 815	P2			10	180		pieces
268 302 500 5	WIRBEL	819, 829	V					5	VPE
268 302 506 0	WIRBEL	819, 829	V					60	VPE
268 300 900 5	WIRBEL	819, 829	V					5	VPE
268 300 905 0	WIRBEL	819, 829	V					50	VPE
268 111 8	WIRBEL	819, 829	P2			10	120		pieces
268 157 7	WIRBEL	909 Plus, Mikros K12	P2	✓		10	280		pieces
268 144 6	WIRBEL	909	P2			10	280		pieces
268 301 200 5	WIRBEL	935, 936, 938	V	✓				5	VPE
268 301 206 0	WIRBEL	935, 936, 938	V	✓				60	VPE
268 301 300 5	WIRBEL	98, 960, 962, 980	V	✓				5	VPE
268 301 304 0	WIRBEL	98, 960, 962, 980	V	✓				40	VPE
268 301 400 5	WIRBEL	W 1	V					5	VPE
268 301 412 0	WIRBEL	W 1	V					120	VPE
268 162 41	WIRBEL	W 1	P2			10	240		pieces

* Price per piece ** Price per VPE

Symbols TYP type M material D sealable ME quantity unit VPE packing unit