

H.264 Network DVR

User Manual

GUI Display with USB Mouse Control

Please read instructions thoroughly before operation and retain it for future reference.

For the actual display & operation, please refer to your DVR in hand.

IMPORTANT SAFEGUARD



CAUTION

RISK OF ELECTRIC SHOCK



CAUTION:

To reduce the risk of electric shock, do not expose this apparatus to rain or moisture. Only operate this apparatus from the type of power source indicated on the label. The company shall not be liable for any damages arising out of any improper use, even if we have been advised of the possibility of such damages.



The lightning flash with arrowhead symbol, within an equilateral triangle, is intended to alert the user to the presence of uninsulated "dangerous voltage" within the product's enclosure that may be of sufficient magnitude to constitute a risk of electric shock to persons.



This exclamation point within an equilateral triangle is intended to alert the user to the presence of important operating and maintenance (servicing) instructions in the literature accompanying the appliance.



All lead-free products offered by the company comply with the requirements of the European law on the Restriction of Hazardous Substances (RoHS) directive, which means our manufacture processes and products are strictly "lead-free" and without the hazardous substances cited in the directive.



The crossed-out wheeled bin mark symbolizes that within the European Union the product must be collected separately at the product end-of-life. This applies to your product and any peripherals marked with this symbol. Do not dispose of these products as unsorted municipal waste. Contact your local dealer for procedures for recycling this equipment.



This apparatus is manufactured to comply with the radio interference requirements.

Trademark Acknowledgements

iPhone® is the registered trademark of Apple Inc.

BlackBerry® and related trademarks, names and logos are the property of Research In Motion Limited and are registered and/or used in the U.S. and countries around the world. Used under license from Research In Motion Limited.

Microsoft®, Windows®, Internet Explorer®, Mozilla® Firefox®, Google Chrome™, QuickTime®, Windows® Mobile & Symbian® mentioned in this document are the registered trademarks of their respective holders.

Disclaimer

The information in this manual was current when released. We reserve the right to revise or remove any content in this manual at any time. We do not warrant or assume any legal liability or responsibility for the accuracy, completeness, or usefulness of this manual. For the actual display & operation, please refer to your DVR in hand. The content of this manual is subject to change without notice.

Grounding

This is a Safety Class 1 Product (provided with a protective earthing ground incorporated in the power cord). The mains plug shall only be inserted in a socket outlet provided with a protective earth contact. Any interruption of the protective conductor inside or outside of the instrument is likely to make the instrument dangerous. Intentional interruption is prohibited.

Water & Moisture

Do not expose this product to dripping or splashing and that no objects filled with liquids, such as vases, shall be placed on the product.

MPEG4 Licensing

THIS PRODUCT IS LICENSED UNDER THE MPEG-4 VISUAL PATENT PORTFOLIO LICENSE FOR THE PERSONAL AND NON-COMMERCIAL USE OF A CONSUMER FOR (i) ENCODING VIDEO IN COMPLIANCE WITH THE MPEG-4 VISUAL STANDARD ("MPEG-4 VIDEO") AND/OR (ii) DECODING MPEG-4 VIDEO THAT WAS ENCODED BY A CONSUMER ENGAGED IN A PERSONAL AND NON-COMMERCIAL ACTIVITY AND/OR WAS OBTAINED FROM A VIDEO PROVIDER LICENSED BY MPEG LA TO PROVIDE MPEG-4 VIDEO. NO LICENSE IS GRANTED OR SHALL BE IMPLIED FOR ANY OTHER USE. ADDITIONAL INFORMATION INCLUDING THAT RELATING TO PROMOTIONAL INTERNAL AND COMMERCIAL USES AND LICENSING MAY BE OBTAINED FROM MPEG LA, LLC. SEE [HTTP://WWW.MPEGLA.COM](http://www.mpegla.com).

GPL Licensing



This product contains codes which are developed by Third-Party-Companies and which are subject to the GNU General Public License ("GPL") or the GNU Lesser Public License ("LGPL").

The GPL Code used in this product is released without warranty and is subject to the copyright of the corresponding author.

Further source codes which are subject to the GPL-licenses are available upon request.

We are pleased to provide our modifications to the Linux Kernel, as well as a few new commands, and some tools to get you into the code. The codes are provided on the FTP site, and please download them from the following site or you can refer to your distributor:

http://download.dvrtw.com.tw/GPL/076D_Series/arm-linux-2.6.tar.gz

TABLE OF CONTENTS

1. BEFORE USING THIS DVR	1
1.1 Package Content	1
1.2 Front Panel	1
1.3 Rear Panel	2
2. CONNECTION AND SETUP	4
2.1 SATA HDD Installation.....	4
2.2 Camera Connection	6
2.2.1 Normal Camera Connection	6
2.2.2 PTZ Camera Connection (<i>For Selected Models Only</i>)	7
2.3 DVR Power On	8
2.4 Date and Time Setting.....	9
2.5 Clear Hard Disk.....	9
2.6 Password Setting	10
3. GUI DISPLAY WITH USB MOUSE CONTROL	11
3.1 Connect USB Mouse.....	11
3.2 Quick Menu Bar	11
3.2.1 Channel Switch.....	12
3.2.2 PTZ Control Panel	12
3.3 Main Menu	13
4. BASIC OPERATION	14
4.1 Live Page	14
4.2 Record Icon.....	14
4.3 Playback	15
4.3.1 Playback Control.....	15
4.3.2 Event Search	16
4.3.3 Audio Playback	16
4.4 User Level Switch	16
5. FREQUENTLY-USED FUNCTIONS	17
5.1 Quick Search	17
5.2 Record	18
5.2.1 Quick record setting.....	18
5.2.2 Detailed record setting.....	19
5.3 Schedule Setting	20
5.3.1 Record Timer	20
5.3.2 Detection Timer.....	21

5.3.3 Alarm Timer	21
5.4 Detection Setting.....	22
5.5 PTZ Camera Setting	23
5.6 System Setting	24
5.6.1 Password Setting.....	24
5.6.2 System Upgrade.....	24
5.6.3 Backup & Restore Configurations.....	25
5.6.4 Video Backup.....	25
5.6.5 Clear All HDD Data	27
5.7 Network.....	27
5.8 Event Notifications	28
5.8.1 FTP.....	28
5.8.2 E-MAIL.....	29
5.9 VGA Output Resolution Support	29
6. REMOTE OPERATION.....	30
6.1 Supplied Licensed Software.....	30
6.1.1 Installation & Network Connection	30
6.1.2 Control Panel Overview	32
6.1.3. General Operation	34
6.1.4. E-Map	38
6.2 Web Browser	43
6.2.1 Event Download & Playback.....	45
APPENDIX 1 SPECIFICATIONS.....	47
APPENDIX 2 COMPATIBLE USB FLASH DRIVE LIST	53
APPENDIX 3 COMPATIBLE SATA HDD LIST	54
APPENDIX 4 MAIN MENU STRUCTURE.....	55
APPENDIX 5 DVR BATTERY REPLACEMENT	57
APPENDIX 6 PIN CONFIGURATION.....	58
APPENDIX 7 DVD WRITER INSTALLATION	61
APPENDIX 8 DVD- / CD-ROM COMPATIBLE LIST	62

1. BEFORE USING THIS DVR

1.1 Package Content

➤ Standard Package





- | | |
|---|-------------------------------------|
| <input type="checkbox"/> DVR | <input type="checkbox"/> HDD screws |
| <input type="checkbox"/> Adapter & Power cord | <input type="checkbox"/> CD Manual |

➤ Optional Accessories

- | | |
|--|---|
| <input type="checkbox"/> IR Remote Controller | <input type="checkbox"/> USB Mouse |
| <input type="checkbox"/> Manual for IR Remote Controller | <input type="checkbox"/> DSUB Connector |
| <input type="checkbox"/> IR Receiver Extension Cable | |

1.2 Front Panel

1) LED Indicators

-  HDD is reading or recording.
-  An alarm is triggered.
-  Timer recording is on.
-  Under playback status.
-  DVR is powered on.

2) || (▲) / ■ (▼) / ◀ (◀) / ▶ (▶)

Press ▲ / ▼ / ◀ / ▶ to move up / down / left / right.

In the playback mode:

- Press “ || ” to pause playback.
- Press “ ■ ” to stop playback.
- Press “ ▶▶ ” to fast forward.
- Press “ ◀◀ ” to fast rewind.

3) MENU

Press “MENU” to enter the main menu.

4) ENTER

Press “ENTER” to confirm the setting.







5) LIST (Event List Search)

Press to quickly search the recorded files by event lists: RECORD / MOTION / ALARM / TIME, or select FULL to show all the event logs.

To quickly search the time you want, select “QUICK SEARCH”. Set the time range you want, and select “Start” to play the recorded video clip during the specified time.



6) PLAY

Press to playback the latest recorded data.

- 7) SLOW
In the playback mode, press to show slow playback.
- 8) ZOOM
Press to enlarge the picture of selected channel in the FRAME or FIELD recording mode.
- 9) SEQ
Press to display each channel in full screen one by one starting from CH1. When the last channel is displayed, it will repeat from CH1 again. To exit this mode, press “SEQ” again.
- 10) 
Press to show the 4-channel display mode.
- 11) CH1 ~ 16 / 1 ~ 8 / 1 ~ 4
Press the channel number keys to select the channel to display.
- 12) SEARCH (For Selected Models Only)
Press to enter the time search menu. Set the time range you want, and select “START” to play the recorded video clip during the specified time.
- 13) AUDIO (SLOW + ZOOM)
Press “SLOW” + “ZOOM” to select live or playback audio from audio channel 1~4.
- | | |
|--|---|
|  Live audio from audio channel 1~4 (indicated in white) |  Playback audio from audio channel 1~4 (indicated in yellow) |
|  Audio channel unselected | |
- 14) P.T.Z. ( + SEQ)
Press “” + “SEQ” at the same time to enter / exit the PTZ control mode.
- 15) USB port
There are two USB ports on the front panel, one for connecting your USB mouse for mouse control, and the other one for connecting your USB flash drive for video backup.

Note: It's not allowed to have two USB mice or two USB flash drives connected on the front panel.

For the compatible USB flash drive list, please refer to “APPENDIX 2 COMPATIBLE USB FLASH DRIVE LIST” at page 53.

- 16)  (For selected models only)
Press “” to open / close the DVD writer.

1.3 Rear Panel

- 1) 75Ω / HI-IMPEDANCE (For Selected Models Only)
When using Loop function, please switch to HI-IMPEDANCE. When you don't use Loop function, please switch to 75Ω.

- 2) VIDEO IN (1 ~ 16 / 1 ~ 8 / 1 ~ 4): Connect to the video connector of a camera.
VIDEO LOOP (1 ~ 16 / 1 ~ 8): Video output connector. *(For Selected Models Only)*

Note: The DVR will automatically detect the video system of the camera, please make sure that the cameras are properly connected to the DVR and power-supplied before the DVR is turned on.

- 3) AUDIO IN (1 ~ 4)
 Connect to the audio connector of a camera if the camera supports audio recording.

Note: To make a video backup with audio, make sure the camera which supports the audio function is connected to the video-in channel and audio-in channel. For example, the audio data from audio CH1 will be recorded with the video data from video CH1.

- 4) AUDIO OUT
 Connect to a speaker with 1 mono audio output.

Note: To know how many audio outputs your DVR supports, please refer to its specifications.

- 5) MONITOR
 Connect to a CRT monitor for video output.

- 6) CALL *(For Selected Models Only)*
 Connect to a monitor specific for sequence display.

- 7) VGA
 Connect to a LCD monitor directly.

- 8) IR *(For Selected Models Only)*
 Connect the optional IR receiver extension cable for remote control.

- 9) EXTERNAL I/O
 This port is used to connect external devices (such as speed dome cameras or external alarm, etc).

For detailed I/O port PIN configuration, please refer to "APPENDIX 6 PIN CONFIGURATION" at page 58.

- 10) LAN
 Connect to Internet by LAN cable.

- 11) DC 19V
 Connect to the supplied adapter.

- 12)  Power Switch

Switch to "I" to turn on the power, and "O" to turn off the power.

2. CONNECTION AND SETUP

Before the DVR is powered on, make sure you have installed a hard disk and connected at least one camera. For details, please refer to the following sections.

Note: The DVR is designed to automatically detect the video system of the connected cameras (NTSC or PAL). To make sure the system detection is correct, please check if the cameras are connected to the DVR and power-supplied before the DVR is powered on.

2.1 SATA HDD Installation

A SATA HDD must be installed before the DVR is powered on.

Note: It's recommended to clear all data in the hard disk when the DVR is powered on and the date & time are set correctly to ensure the recorded data are not mixed with other data previously saved in the same hard disk. For details, please refer to "5.6.5 Clear All HDD Data" at page 27.

➤ For 2-HDDs Models

Step1: Loose the screws on the upper cover and open the upper cover of the DVR.

Note: The DVR cover is made of metal. Please be careful with its edge when you remove the cover.

Step2: There are two HDD brackets for this DVR as indicated on the right picture.

2-1 To install on the first bracket

Remove the bracket, and align the screw holes of the bracket with the HDD's screw holes. Make sure the PCB side of the HDD is facing up.

Fasten the HDD to the bracket, and connect the power connector and data bus connector to the HDD.

Then, replace the bracket to DVR.



2-2 To install on the second bracket

Connect the power connector and data bus connector to the HDD.

When connecting the power cable, make sure the cable is passed through the power cable of DVD writer. This is to prevent the HDD power cable from interfering with the fan spinning.

Align the screw holes of the bracket with the HDD's screw holes. Make sure the PCB side of the HDD is facing up. Then, fasten the HDD to the bracket.



Note: For DVD writer installation, please refer to "APPENDIX 7 DVD WRITER INSTALLATION" at page 61.

Step3: Close the upper cover of the DVR, and fasten all the screws you loosened in Step1.

➤ **For 1-HDD Model**

Step1: Loose the screws on the upper cover and remove it from the DVR. Find the two HDD brackets located on the DVR base.

Step2: Get a compatible HDD, and connect it to the power connector and data bus connector.

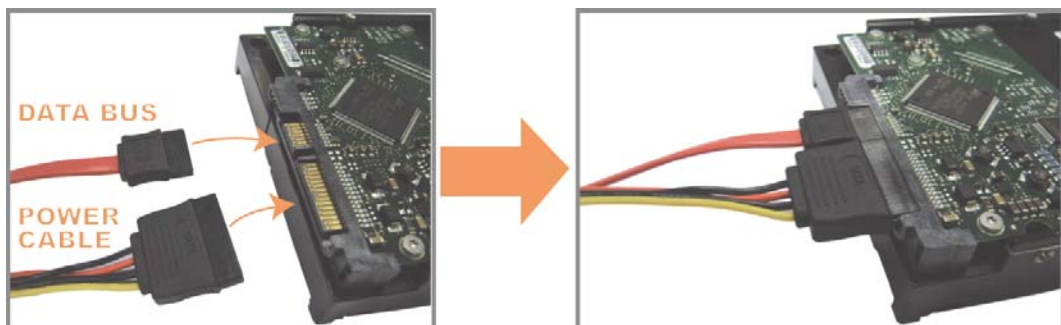

Step3: Make sure the PCB side is facing up, and place the HDD between the HDD brackets on the DVR base as shown below.

Make sure the other side of the HDD is contacted with the DVR base for heat conduction.



Step4: Align the screw hole on the each bracket with the screw hole on the each side of the HDD as shown below, and fix the HDD to the bracket with a HDD screw supplied.

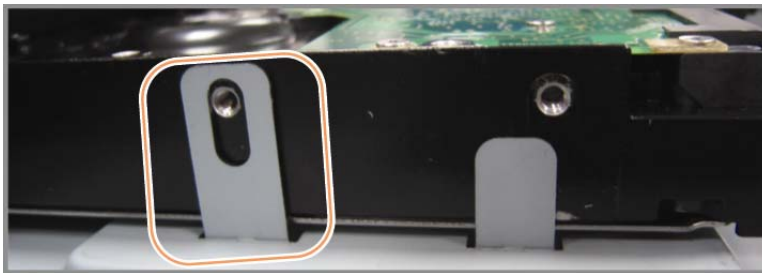

Step5: Close the upper cover of the DVR, and fasten all the screws you loosened in Step 1.

2.2 Camera Connection

The cameras must be connected and power-supplied before the DVR is powered on. Connect the camera with the indicated power supply. Then, connect the camera video output to the DVR video input port with a coaxial cable or RCA cable with BNC connectors.

Note: For detailed DVR video input ports, please refer to "1.3 Rear Panel" at page 2.

2.2.1 Normal Camera Connection

Note: For detailed camera installation and connection, please refer to its own user manual.

1) Connecting to DVR video input

Connect the camera video output to the DVR video input port with a coaxial cable or RCA line with BNC connector.

2) Connecting to DVR audio input (Optional)

Connect the camera audio output to the DVR audio input port with a coaxial cable or RCA cable with BNC connectors.

3) Connecting to power

Connect the camera with indicated power supply and make sure it's power-supplied.

2.2.2 PTZ Camera Connection *(For Selected Models Only)*

The following description is taking our brand's PTZ camera as an example.

For DVR setting to control the PTZ camera, please refer to "5.5 PTZ Camera Setting" at page 23. For detailed PTZ camera control and operation, please refer to its own user manual.

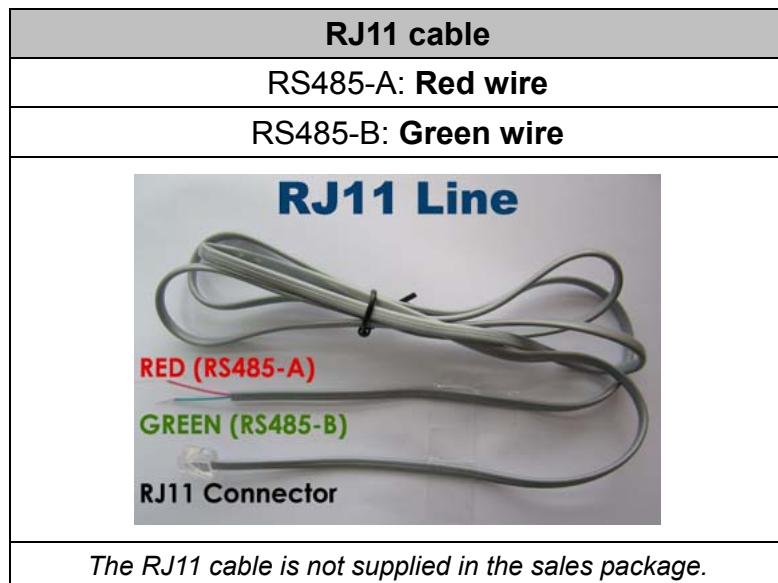

STEP 1: Get a RJ11 cable with the proper length to your connection.

Different RJ11 connector may have different wire layout, so the connection might be different. If you cannot control the DVR after connection, please reverse the RJ11 cable connection with the DVR.

STEP 2: Remove one end of the insulating coating of the RJ11 cable.

Remove one end of the insulating coating of the RJ11 cable to find the RS485-A and the RS485-B wires, and remove the insulating coating to reveal the naked wires for further connection.

STEP 3: Twist the RS485-A and RS485-B wires of the RJ11 cable and the speed dome camera together.

Twist the RS485-A (red) and RS485-B (green) wires of the RJ11 cable to the RS485-A (brown) and RS485-B (orange) wires of the speed dome camera. To protect the naked wires, use the insulation tape to cover on the twisted wires.

STEP 4: Connect the other end of the RJ11 cable to DVR.

Solder the RS485-A (red) and RS485-B (green) wires of the RJ11 cable to the corresponding pins on the solder side of the optional D-Sub connector.

For DVR PIN configuration, please refer to “APPENDIX 6 PIN CONFIGURATION” at page 58. For connection details, please check with your installer.

STEP 5: Set the speed dome camera at the DVR side.

Go to “ADVANCED CONFIG” → “REMOTE” to set the speed dome camera.

- a) Select the device to “PTZ”.
- b) Set the ID to the value the same as the one set in the speed dome camera.
The default ID of the camera is 000.
- c) Select the protocol to “NORMAL”.
- d) Set the baud rate to the value the same as the one set in the speed dome camera. The default baud rate of the camera is 2400.

ADVANCED CONFIG												
CAMERA	CH1	CH2	CH3	CH4	CH5	CH6	CH7	CH8	CH9	CH10	CH11	◀ ▶
DETECTION	DEVICE										PTZ	
ALERT	ID										000	
NETWORK	PROTOCOL										NORMAL	
DISPLAY	RATE										2400	
RECORD												
REMOTE												
EXIT												

2.3 DVR Power On

This device should be operated only with the type of power source indicated on the manufacturer’s label. Connect the indicated AC power cord to the power adapter, and plug into an electrical outlet. The power LED will be on.

Note: Before the DVR is powered on, make sure the cameras are connected and power-supplied for the detection of the camera video system to be correct, and check the monitor (either LCD or CRT monitor) is connected to the DVR before the DVR is powered on for correct video output detection.



Note: To ensure that your DVR works constantly and properly, it's recommended to use an UPS, Uninterruptible Power Supply (Optional), for continuously operation.

2.4 Date and Time Setting

Before operating your DVR, please set the date and time on your DVR **FIRST**.

Note: Please DO NOT change the date or time of your DVR after the recording function is activated. Otherwise, the recorded data will be disordered and you will not be able to find the recorded file to backup by time search. If users change the date or time accidentally when the recording function is activated, it's recommended to clear all HDD data, and start recording again.

Note: For the first time to use the DVR, please power it on for at least 48 hours continuously after the date & time is set correctly. It helps to prevent DVR time from resetting after the disconnecting of DVR power. If the DVR time resets after the disconnecting of DVR power, for example, caused by a power outage, the battery might run out and please replace the battery as described in "APPENDIX 5 DVR BATTERY REPLACEMENT" at page 57.

Right-click to enter the DVR password with the password keypad. The default administrator password is 0000. The status will be changed from  (key lock) to  (administrator). Then, right-click to show the main menu, and select "QUICK START" → "TIME SETUP" to set the date & time.

QUICK START	
GENERAL	DATE 2009 / NOV / 17
TIME SETUP	TIME 15 : 35 : 53
EXIT	

2.5 Clear Hard Disk

It's recommended to clear all data in the hard disk for the first time to use this DVR to ensure the recorded data are not mixed with other data previously saved in the same hard disk.

Right-click to show the main menu, and select "SYSTEM" → "SYSTEM INFO" → "CLEAR HDD". The DVR will reboot when HDD data are cleared.

SYSTEM		
TOOLS	BAUD RATE	2400
SYSTEM INFO	HOST ID	000
USB BACKUP	R.E.T.R. <i>(For Selected Models Only)</i>	5
	AUTO KEY LOCK	NEVER
	CLEAR HDD	HDD-0
	RESET DEFAULT	SUBMIT
	REMOTE CONTROL ID	000
	SERIAL TYPE	RS485
	VIDEO FORMAT	NTSC
	VERSION	1025-1011-1011-1012
EXIT		

2.6 Password Setting

Right-click to show the main menu, and select "SYSTEM" → "TOOLS" to change the DVR password.

There are two user levels: ADMIN & OPERATOR. For details, please refer to "4.4 User Level Switch" at page 16.

SYSTEM		
TOOLS	LANGUAGE	ENGLISH
SYSTEM INFO	ADMIN PASSWORD	SETUP
USB BACKUP	OPERATOR PASSWORD	SETUP
	UPGRADE	SUBMIT
	BACKUP CONFIG	SUBMIT
	RESTORE CONFIG	SUBMIT
EXIT		

3. GUI DISPLAY WITH USB MOUSE CONTROL

3.1 Connect USB Mouse

Connect your USB mouse to one of the USB ports on the DVR front panel, and check if there's a mouse icon (🖱️) on the screen, indicating the USB mouse is detected properly.

Move your mouse to enter the DVR password with the password keypad. The default administrator password is **0000**. The status will be changed from 🔒 (key lock) to 🗝️ (administrator), and the quick menu bar appears on the left side of the screen.

Note: There are two user levels for DVR access which can be set in the main menu "SYSTEM" → "TOOLS". For details, please refer to "4.4 User Level Switch" at page 16.

Password Input



Quick Menu: Close



3.2 Quick Menu Bar

Move to the arrow mark to extend the quick menu bar and show the five functions as follows:

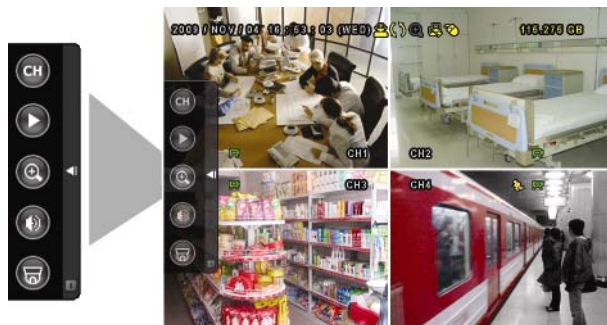

Quick Menu: Open



CH Click to show the channel switch panel and select the channel you want. For details, please refer to "3.2.1 Channel Switch" at page 12.

▶ Click to display the playback control panel, and click **▶** to play the latest recorded video clip, or click **📄** to enter the search list. For details, please refer to "4.3 Playback" at page 15.

🔍 Switch to the channel you want first, and click **🔍** to enter the zoom-in mode. In this mode, click and drag the red frame on the bottom left of the screen to move to the place you want to see. To exit this mode, click **☒**.





-  Click to select the audio channel you want:
 In the live mode, only the live audio channels can be selected.
 In the playback mode, live and playback audio channels can be selected.
-  Click to enter the PTZ mode and show the PTZ camera control panel. For details, please refer to “3.2.2 PTZ Control Panel” at page 12.
-  Click to show the power off panel to either halt or reboot the system.

3.2.1 Channel Switch

Click  on the quick menu bar to display the panel as follows:

Note: The buttons available depend on the model you have.



1~16	Video Channel Number	Click to switch to the channel you want in full screen.
	Sequence Display	Click to display each channel in full screen one by one starting from CH1. When the last channel is displayed, it will repeat from CH1 again. When this function is on,  will be shown on the status bar.
	Quad Display	Press to show the 4-channel display mode.
	9-Cut Display	Press to show the 9-channel display mode.
	16-Cut Display	Press to show the 16-channel display mode.

3.2.2 PTZ Control Panel

Note: In the PTZ control mode, hot point is supported to move the camera view to the specified point after a click.

Click  on the quick menu bar to display the panel as follows:



	Camera Menu	Click to enter the camera main menu. For details about each camera menu, please refer to its own user manual.
	Enter	Click to confirm your selection / enter the menu.
	Up / Down / Left / Right	Click to move your selection up / down / left / right, or change settings.
	Zoom in / out max	Click to zoom in on the image to the largest / zoom out on the image to its original size.
	Zoom in / out	Click to zoom in / out the image.
	Focus near / far	Click to adjust the focus of the image.
	Auto mode	Click to activate the auto function. Before using it, you need to assign a specific function that will be enabled when "AUTO" is clicked. For details, please refer to the user manual of the PTZ camera.
	Preset point	Click to enter the PTZ preset point you want to see.

3.3 Main Menu

Right-click anywhere on the screen to show the main menu as follows, and right-click again to exit.

For details about the menu structure, please refer to "APPENDIX 4 MAIN MENU STRUCTURE" at page 55.

Main Menu



	QUICK START	Click to set the status display, image settings, and date & time.
	DATE SETUP	Click to set the date display and daylight saving.
	SYSTEM	Click to set the system configurations.
	EVENT INFORMATION	Click to enter the event search menu.
	ADVANCED CONFIG	Click to set CAMERA, DETECTION, ALERT, NETWORK, DISPLAY, RECORD and REMOTE.
	SCHEDULE SETTING	Click to set record timer and detection timer.

4. BASIC OPERATION

4.1 Live Page





Icon	Function	Icon	Function	Icon	Function
	Live audio channel (1~4)		Playback audio channel (1~4)		Audio channel off
	Digital zoom on		Digital zoom off		Timer recording
	Network disconnected		Internet connected		LAN connected
	USB mouse connected		USB flash drive / device connected		No USB device connected
	Key lock		PTZ mode on		HDD overwrite
	Administrator		Operator		Sequence
	Motion		Recording		Alarm

4.2 Record Icon

1) Manual Recording

By defaults, manual recording is on () when the DVR is powered on and a HDD is installed.

2) Event Recording

When the motion detection or alarm is on, the motion icon () or alarm icon () shows on the screen for any motion or alarm event.

3) Timer Recording

When timer recording is on, you will see "" on the screen.

4) HDD Overwritten

By defaults, the HDD overwritten function is set to ON, and "" will be shown on the screen.

4.3 Playback

Click “▶” on the quick menu bar to display the playback control panel, and click ▶ to play the latest recorded video clip, or click 📄 to enter the search list.



Note: There must be at least 8192 images of recorded data for playback to work properly. If not, the device will stop playback. For example, if the IPS is set to 30, the recording time should be at least 273 seconds (8192 images / 30 IPS) for the playback to work properly.

Note: During playback, the image size of the recording (FRAME, FIELD or CIF) will be shown on the screen.

4.3.1 Playback Control

▶▶	Fast Forward	Increase the speed for fast forward. Click once to get 4X speed forward and click twice to get 8X speed, etc., and the maximum speed is 32X.
◀◀	Fast Rewind	Increase the speed for fast rewind. Click once to get 4X speed rewind and click twice to get 8X speed, etc., and the maximum speed is 32X.
▶ / ⏸	Play / Pause	Click to play the latest recorded video clip immediately, and click again to pause. In the pause mode, click ▶▶ once to get one frame forward, and click ◀◀ to get one frame rewind.
■	Stop	Click to stop the video playback.
▶▶▶	Slow Playback	Click once to get 1/4X speed playback, and click twice to get 1/8X speed playback.
◀ / ▶	Previous / Next Hour	Click to jump to the next / previous time interval in an hour, for example, 11:00 ~ 12:00 or 14:00 ~ 15:00, and start playing the earliest event video clip recorded during this whole hour.



4.3.2 Event Search

Click  to quickly search the recorded files by event lists: RECORD / MOTION / ALARM / TIME, or select FULL to show all the event logs.

To quickly search the time you want, select “QUICK SEARCH”. Set the time range you want, and select “Start” to play the recorded video clip during the specified time.



4.3.3 Audio Playback

In the playback mode, click  on the quick menu bar as many times as needed to select live or playback audio from audio channel 1~4.

-  Live audio from audio channel 1~4 (indicated in white).
-  Playback audio from audio channel 1~4 (indicated in yellow).
-  Audio channel unselected

Note: To make a video backup with audio, make sure the camera which supports the audio function is connected to the video-in channel and audio-in channel. For example, the audio data from audio CH1 will be recorded with the video data from video CH1.

4.4 User Level Switch

In the key lock mode () , move your USB mouse to display the password input keypad. There are two user levels for accessing the DVR: Administrator () & Operator () .

When the administrator password is entered,  will be shown on the status bar of the screen and all operations are allowed. The default administrator password is 0000.

When the operator password is entered,  will be shown on the status bar of the screen, and the main menu is **NOT** allowed to access. The operator user level needs to be set in the main menu “SYSTEM” → “TOOLS”.

To switch between these two user levels, click the current user level icon to switch to the key lock mode, and move your mouse to show the password input keypad, and enter the password of the user level you want.

5.2 Record

5.2.1 Quick record setting

Right-click to display the main menu, and select “QUICK START” → “GENERAL” → “RECORD CONFIGURATION”.

Click “SETUP” to enter the setting page individually for manual record, event record and timer record.

QUICK START	
GENERAL	CHANNEL TITLE ON
TIME SETUP	EVENT STATUS ON
	DATE DISPLAY ON
	RECORD CONFIGURATION SETUP
EXIT	

- a) Select the record type you want to set.
- b) In “CHANNEL”, select “ALL” to apply the changes here to all channels.

QUICK START				
MANUAL	EVENT	TIMER		
CHANNEL		IMAGE SIZE	I.P.S.	QUALITY
ALL		CIF	100	SUPER BEST
				EXIT

Or, select “BY CHANNEL” to set the image size, image per second & image quality individually for each channel.

QUICK START					
MANUAL	EVENT	TIMER			
CHANNEL		IMAGE SIZE	I.P.S.	QUALITY	LOCK
CH1		CIF	25	SUPER BEST	<input type="checkbox"/>
CH2		CIF	25	SUPER BEST	<input checked="" type="checkbox"/>
CH3		CIF	6	HIGH	<input checked="" type="checkbox"/>
CH4		FIELD	25	SUPER BEST	<input type="checkbox"/>
AVAILABLE IPS: CIF 69 / FIELD 34 / FRAME 17					
			APPLY	EXIT	

Note: The allocatable IPS (image per second) in each image size for a DVR is fixed. When allocating IPS to each channel, select “LOCK” to remind you of the remaining IPS in each image size available for the rest of the channels.

5.2.2 Detailed record setting

Right-click to display the main menu, and select “ADVANCED CONFIG” → “RECORD”.

Note: Please DO NOT change the date or time of your DVR after the recording function is activated. Otherwise, the recorded data will be disordered and you will not be able to find the recorded file to backup by time search. If users change the date or time accidentally when the recording function is activated, it’s recommended to clear all HDD data, and start recording again.

ADVANCED CONFIG		
CAMERA	MANUAL RECORD ENABLE	ON
DETECTION	EVENT RECORD ENABLE	ON
ALERT	TIMER RECORD ENABLE	ON
NETWORK	PRE-ALARM RECORD	ON
DISPLAY	OVERWRITE	ON
RECORD	EVENT RECORD ALL CHANNEL	OFF
REMOTE	KEEP DATA LIMIT (DAYS)	OFF
	RECORD CONFIGURATION	SETUP
EXIT		

1) MANUAL RECORD ENABLE

Set the manual recording function on / off.

2) EVENT RECORD ENABLE

Set the event recording function on / off.

3) TIMER RECORD ENABLE

Set the timer recording function on / off.

4) PRE-ALARM RECORD

Select to enable or disable the pre-alarm function (ON / OFF).

When pre-alarm and event recording functions are both activated, the DVR will record 8MB data before an alarm / motion event is triggered.

5) OVERWRITE

Select “ON” to overwrite previous recorded data in your HDD when the HDD is full. When this function is on and the HDD is full, the DVR will clear 8GB data from the oldest for continuous recording without notice.

6) EVENT RECORD ALL CHANNEL

Select to record all channels (ON) or record the channel with an event only (OFF) for any event.

7) KEEP DATA LIMIT (DAYS)

Assign the maximum recording days from 01 to 31 after which all the recorded data will be removed, or select "OFF" to disable this function.

8) RECORD CONFIGURATION

Please refer to "5.2.1 Quick record setting".

5.3 Schedule Setting

Right-click to display the main menu, and select "SCHEDULE SETTING".

5.3.1 Record Timer

Click "RECORD". In "RECORD TIMER", select "ON" to enable record timer, and select the day and time for this function.

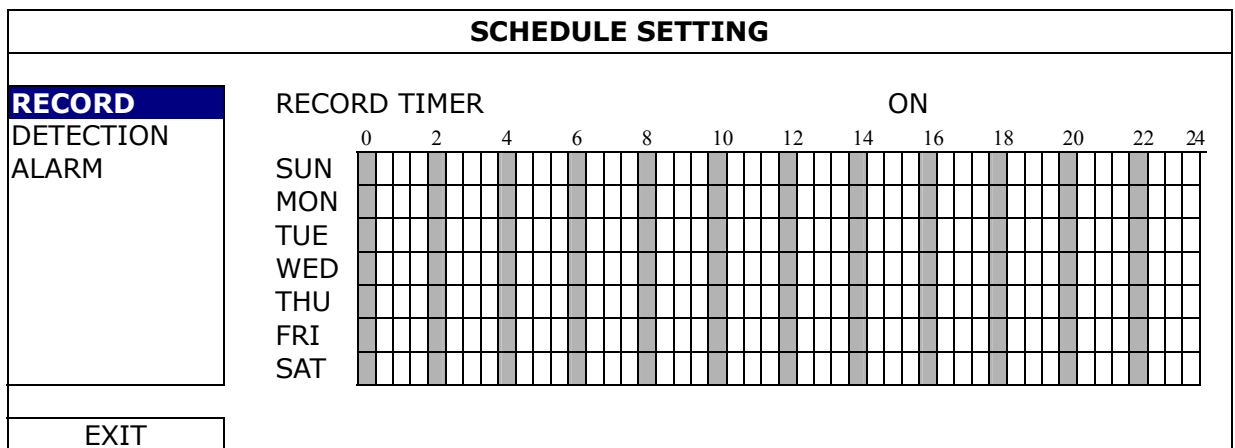

X axis 0 ~ 24 hours. Each time bar is 30 minutes.

Y axis Monday ~ Sunday.

5.3.2 Detection Timer

Click “DETECTION”. In “DETECTION TIMER”, select “ON” to enable record timer, and select the day and time for this function.

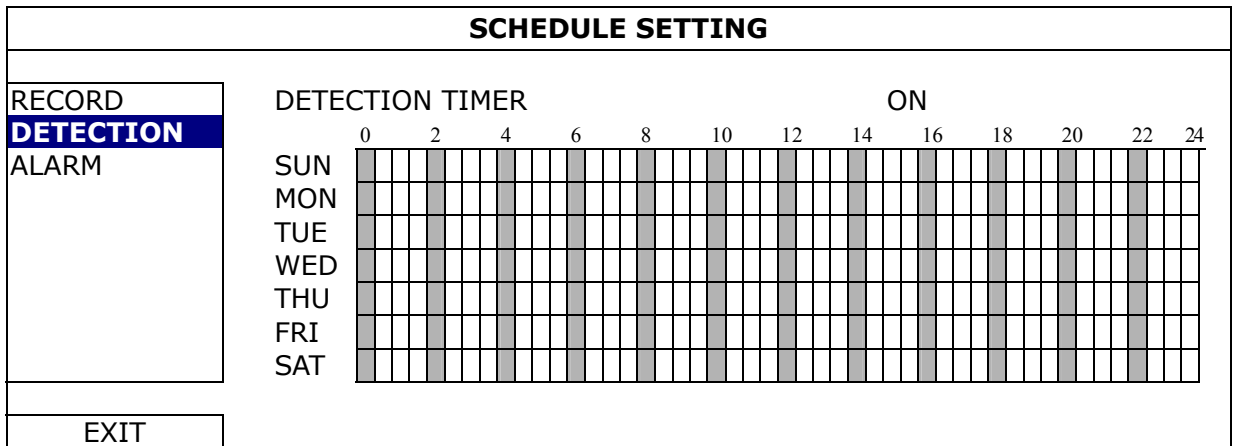

X axis 0 ~ 24 hours. Each time bar is 20 minutes.

Y axis Monday ~ Sunday.

5.3.3 Alarm Timer

Click “ALARM”. In “ALARM TIMER”, select “ON” to enable record timer, and select the day and time for this function.

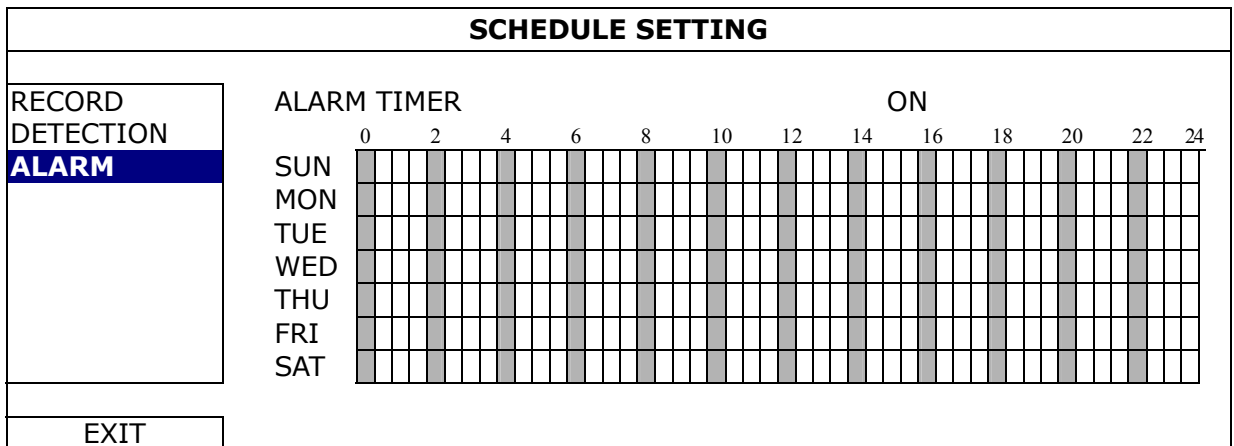

X axis 0 ~ 24 hours. Each time bar is 20 minutes.

Y axis Monday ~ Sunday.

5.4 Detection Setting

Right-click to display the main menu, and select “ADVANCED CONFIG” → “DETECTION”.

ADVANCED CONFIG												
CAMERA	CH1	CH2	CH3	CH4	CH5	CH6	CH7	CH8	CH9	CH10	CH11	◀ ▶
DETECTION	LS									07		
ALERT	SS									03		
NETWORK	TS									02		
DISPLAY	DETECT									OFF		
RECORD	ALARM									OFF		
REMOTE	AREA									EDIT		
EXIT												

1) LS (Level of Sensitivity)

“LS” is to set the sensitivity of comparing two different images. The smaller the value is, the higher sensitivity for motion detection. The highest sensitivity setting is 00, and the lowest sensitivity setting is 15. The default value is 07.

2) SS (Spatial Sensitivity)

“SS” is to set the sensitivity for detecting the size of one object (the number of the grids) on the screen. The smaller the value is, the higher sensitivity for motion detection.

The highest sensitivity setting is 00, and the lowest sensitivity setting is 15. The default setting is 03.

Note: The default setting of SS is 03, which means once an object is detected more than 3 grids, the system will get triggered. So the value of SS must be less than the number of grids that you set up for the motion detection area.

3) TS (Time of Sensitivity)

“TS” is to set the sensitivity regarding how long one object stays in the detection area and triggers the recording. The smaller the value is, the higher sensitivity for motion detection.

The highest sensitivity setting is 00, and the lowest sensitivity setting is 15. The default setting is 02.

4) DETECT

Select if you want to activate the motion detection function for the selected channel (ON/OFF).

5) ALARM

Select N.C./ N.O depending on your installation need. The default alarm value is OFF.

6) AREA

Click “EDIT” to set the motion detection area.

There are 16 × 12 grids per camera for all channels. Pink blocks represent the area that is not being detected while the transparent blocks are the area under detection.

5.5 PTZ Camera Setting

Right-click to display the main menu, and select “ADVANCED CONFIG” → “REMOTE”.

ADVANCED CONFIG													
CAMERA	CH1	CH2	CH3	CH4	CH5	CH6	CH7	CH8	CH9	CH10	CH11	◀	▶
DETECTION	DEVICE							PTZ					
ALERT	ID							00					
NETWORK	PROTOCOL							NORMAL					
DISPLAY	RATE							2400					
RECORD													
REMOTE													
EXIT													

1) DEVICE

For the PTZ camera, select “PTZ”.

2) ID

Click the current value to set the ID number (0 ~ 255) for the connected PTZ camera if necessary.

Make sure the ID setting of the camera is the same as the setting here, or the DVR will not be able to control the device.

Note: To know the default ID of the PTZ camera, please refer to its user manual.

3) PROTOCOL

Select NORMAL (our protocol), P-D (PELCO-D) or P-P (PELCO-P) protocol.

4) RATE

Select the baud rate for the connected PTZ camera (2400 / 4800 / 9600 / 19200 / 57600 / 115200).

Make sure the baud rate setting of the camera is the same as the setting here, or the DVR will not be able to control the device.

Note: To know the default baud rate of the PTZ camera, please refer to its user manual.

5.6 System Setting

5.6.1 Password Setting

Right-click to display the main menu, and select “SYSTEM” → “TOOLS”.

SYSTEM		
TOOLS	LANGUAGE	ENGLISH
SYSTEM INFO	ADMIN PASSWORD	SETUP
USB BACKUP	OPERATOR PASSWORD	SETUP
	UPGRADE	SUBMIT
	BACKUP CONFIG	SUBMIT
	RESTORE CONFIG	SUBMIT
EXIT		

1) ADMIN PASSWORD

Click “SETUP” to change the administrator password. The default administrator password is **0000**.

When you’re prompted to enter the DVR password, enter the administrator password, and  will be shown on the status bar of the screen and all operations are allowed.

2) OPERATOR PASSWORD

Click “SETUP” to set or change the operator password. .

When you’re prompted to enter the DVR password, enter the operator password, and  will be shown on the status bar of the screen and the main menu is **NOT** allowed to access.

5.6.2 System Upgrade

Note: DVR system upgrade might cause all HDD data cleared when your current system version is too old from the latest version. Therefore, before upgrading the DVR system, check your current firmware version with your installer or distributor, and make video backup if necessary.

Right-click to display the main menu, and select “SYSTEM” → “TOOLS” → “UPGRADE”.

Save the upgrade files obtained from your installer or distributor in a compatible USB flash drive, and insert it into the USB port at the front panel.

Then, click “SUBMIT” to start upgrading.

Note: Before using the USB flash drive, please use your PC to format the USB flash drive to FAT32 format first. For the list of compatible USB flash drives, please refer to "APPENDIX 2 COMPATIBLE USB FLASH DRIVE LIST" at page 53.

5.6.3 Backup & Restore Configurations

Right-click to display the main menu, and select "SYSTEM" → "TOOLS" → "BACKUP CONFIG" or "RESTORE CONFIG".

These two functions allows users to keep the current configurations after DVR upgrade, or copy one DVR configurations to another DVR if necessary.

Insert a compatible USB flash drive into the USB port *before upgrading DVR*, and select "SUBMIT" in "BACKUP CONFIG" to copy the current DVR configurations to a file "System.bin" and save to your USB flash drive.

To restore DVR configurations after upgrading DVR, insert the USB flash drive including "System.bin" to the USB port, and select "SUBMIT" in "RESTORE CONFIG".

5.6.4 Video Backup

Right-click to display the main menu, and select "SYSTEM" → "USB BACKUP" or "DVD BACKUP".

Note: DVD BACKUP is only available for selected models. Please check the specifications of your DVR model for details.

Insert a compatible USB flash drive to the USB port at the front panel, or press ▲ to eject the DVD writer and place a DVD-ROM or CD-ROM to it.

Note: Before using the USB flash drive, please use your PC to format the USB flash drive to FAT32 format first. For the list of compatible USB flash drives, please refer to "APPENDIX 2 COMPATIBLE USB FLASH DRIVE LIST" at page 53.

Note: For the compatible CD- / DVD-ROM list, please refer to "APPENDIX 8 DVD- / CD-ROM COMPATIBLE LIST" at page 62.

SYSTEM	
TOOLS SYSTEM INFO USB BACKUP DVD BACKUP	START DATE 2009/NOV/19 START TIME 08:30:21 END DATE 2009/NOV/19 END TIME 17:59:29 CHANNEL <input checked="" type="checkbox"/> 01 <input type="checkbox"/> 02 <input type="checkbox"/> 03 <input type="checkbox"/> 04 <input checked="" type="checkbox"/> 05 <input type="checkbox"/> 06 <input type="checkbox"/> 07 <input type="checkbox"/> 08 <input checked="" type="checkbox"/> 09 <input type="checkbox"/> 10 <input type="checkbox"/> 11 <input type="checkbox"/> 12 <input checked="" type="checkbox"/> 13 <input type="checkbox"/> 14 <input type="checkbox"/> 15 <input type="checkbox"/> 16 HARD DISK ALL HDD BACKUP SUBMIT REQUIRE SIZE: 554MB SUBMIT
EXIT	AVAILABLE SIZE: 3788.0MB

- 1) START DATE / START TIME
Select the start date & time.
- 2) END DATE / TIME
Select the end date & time.
- 3) CHANNEL
Click to select the channel(s).
- 4) HARD DISK
Select the hard disk containing the video data you need or "ALL HDD".
- 5) BACKUP
Click "SUBMIT" to start backup.
- 6) REQUIRE SIZE
To know the size of the expected backup video before backup, click "SUBMIT" to start calculating.

■ Backup File Playback

During the backup process, a file player installer "PLAYER.EXE" will also be copied into your USB flash drive or disk, and you will see the message "CHECK PLAYER" shown on the screen.

Note: The maximum number of backup files in the CD-ROM or DVD-ROM is 41.

Insert your USB flash drive or place the CD or DVD into the DVD-ROM drive of your PC. Install the file player "PLAYER.EXE", and double click a backup file to play it directly in your PC and see if the backup is successful.

Note: The supported PC operating systems are Windows 7, Vista, XP & 2000.

5.6.5 Clear All HDD Data

Right-click to show the main menu, and select “SYSTEM” → “SYSTEM INFO” → “CLEAR HDD”.

SYSTEM		
TOOLS	BAUD RATE	2400
SYSTEM INFO	HOST ID	000
USB BACKUP	R.E.T.R. <i>(For Selected Models Only)</i>	5
	AUTO KEY LOCK	NEVER
	CLEAR HDD	HDD-0
	RESET DEFAULT	SUBMIT
	REMOTE CONTROL ID	000
	SERIAL TYPE	RS485
	VIDEO FORMAT	NTSC
	VERSION	1010-1005-1006-1007
EXIT		

Select the HDD you want to clear, and click “YES” to confirm or “NO” to cancel.

It’s recommended to clear all data in the hard disk when:

- It’s the first time to use this DVR to ensure the recorded data are not mixed with other data previously saved in the same hard disk.
- DVR date and time are changed accidentally when the recording function is activated. Otherwise, the recorded data will be disordered and you will not be able to find the recorded file to backup by time search.

5.7 Network

The description below is only for STATIC network type. For PPPOE and DHCP settings, you need to set from “Video Viewer”.

For details, please download the extended user manual for “Video Viewer” from <http://www.surveillance-download.com/user/CMS.pdf>.

STATIC

ADVANCED CONFIG		
CAMERA DETECTION ALERT	NETWORK TYPE	STATIC
NETWORK	IP	192.168.001.010
DISPLAY	GATEWAY	192.168.001.254
RECORD	NETMASK	255.255.255.000
REMOTE	PRIMARY DNS	168.095.001.001
	SECONDARY DNS	139.175.055.244
	PORT	0080
	SAVE NETWORK SETTING	APPLY
EXIT		

- 1) NETWORK TYPE
Select the network type as STATIC and set all the information needed in the DVR.
- 3) NETWORK INFORMATION (IP / GATEWAY / NETMASK)
Key in all the network information obtained from your ISP (Internet Service Provider).
- 4) DNS (PRIMARY DNS / SECONDARY DNS)
Key in the IP address of the domain name server obtained from your ISP (Internet Service Provider).
- 5) PORT
The valid number ranges from 1 to 9999. The default value is 80. Typically, the TCP port used by HTTP is 80. However in some cases, it is better to change this port number for added flexibility or security.
- 6) SAVE NETWORK SETTING
Click "APPLY" to confirm the settings.

5.8 Event Notifications

It's available to set event notifications to FTP / E-Mail from this DVR.

Note: This function requires Internet access. Please make sure your Internet access is available for this function to work properly.

5.8.1 FTP

When this function is enabled and an event occurs, a html file including a link will be sent to the specified FTP site. Click the link to access to this DVR and check the event recording.

ADVANCED CONFIG	
CAMERA	NETWORK SNTP FTP E-MAIL
DETECTION	FTP ALERT ON
ALERT	USER NAME MANAGER
NETWORK	PASSWORD ●●●●●●●●
DISPLAY	SERVER 192.168.2.32
RECORD	PORT 0021
REMOTE	DIRECTORY UPLOAD
EXIT	

5.8.2 E-MAIL

When this function is enabled and an event occurs, a html file including a link will be sent to the specified E-mail address. Click the link to access to this DVR and check the event recording.

ADVANCED CONFIG		
CAMERA	NETWORK	
DETECTION	E-MAIL ALERT	ON
ALERT	SMTP SERVER	SNTP.GMAIL.COM
NETWORK	PORT	465
DISPLAY	MAIL FROM	MANAGER
RECORD	SSL ENCRYPTION	ON
REMOTE	VERIFY PASSWORD	ON
	USER NAME	MANAGER
	PASSWORD	●●●●●●
	RECEIVER	SETUP
EXIT		

5.9 VGA Output Resolution Support

Users are allowed to change the resolution depending on their display monitor.

Right-click to display the main menu, and select “ADVANCED CONFIG” → “DISPLAY”.

ADVANCED CONFIG		
CAMERA	DE-INTERLACE	OFF
DETECTION	FULL SCREEN DURATION	03
ALERT	QUAD SCREEN DURATION	03
NETWORK	DWELL SCREEN DURATION	03
DISPLAY	DISPLAY COVERT	ON
RECORD	HDD DISPLAY MODE	HDD SIZE
REMOTE	VGA OUTPUT	1024 x 768
	ALPHA BLENDING	200
EXIT		

Move to “VGA OUTPUT”, and select the VGA resolution you want. There are three options as follows:

- 1024 x 768 (default)
- 1280 x 1024
- 1600 x 1200

Note: To have the best image quality on your LCD monitor, make sure (1) the selected DVR VGA output resolution is supported by your monitor, and (2) the VGA output settings on both the LCD monitor and DVR are consistent. If the image is not positioned or scaled properly, please go to your monitor’s menu for adjustment. For details, please refer to the user manual of your LCD monitor.

6. REMOTE OPERATION

You can also control the DVR remotely via the supplied licensed software “Video Viewer”, Internet Explorer web browser, and Apple’s QuickTime player.

6.1 Supplied Licensed Software

The sections below describe frequently-used functions of the Video Viewer. For details about this software and network settings, please download its extended user manual from the following link:

<http://www.surveillance-download.com/user/CMS.pdf>

6.1.1 Installation & Network Connection

1) Install the software

Step1: Place the supplied CD into your CD-ROM or DVD-ROM drive. The program will be automatically run.

Step2: Click “Download The Latest Version” under “Licensed Software AP” to download the latest version of Video Viewer from the Internet.

Step3: Follow the on-screen instructions to finish the installation. When the installation is completed, a shortcut icon  will be placed on your PC desktop.

2) Network Connection

➤ Local Connection (via LAN)

LAN is used when it’s the first time to remotely access the DVR and you need to configure the network setting of your DVR based on your network type in advance.



a) Connect the DVR to your PC via a RJ45 network cable. The default DVR values are as follows:

Item	Default Value
IP address	192.168.1.10
User name	admin
Password	admin
Port	80



b) Set the PC’s IP address as “192.168.1.XXX” (1~255, except 10) in order to make the PC and DVR under the same domain.

c) Double-click  icon on your PC desktop to enter the control panel. By defaults, the “Address Book” panel will be displayed on the right side of the

control panel.

- d) Click " → " to key in the default IP address, user name, password, and port number of the DVR you intend to connect.

OR



Click " → " to search the available IP address(es) of other DVR(s) under the same domain as your PC's IP address. The found address(es) will be listed, and can be added into the address book by clicking "".

- e) Double-click the IP address you just added into the address book to log in.



➤ Remote Connection (via Internet)

When the network configuration of your DVR is completed, you can access your DVR remotely via Internet.

- a) Double-click " icon on your PC desktop to enter the control panel. By defaults, the "Address Book" panel will be displayed on the right side of the control panel.

- b) Click " → " to key in the IP address, user name, password, and port number of the DVR you intend to connect.

OR

Click " → " to search the available IP address(es) of other DVR(s) under the same domain as your PC's IP address. The found address(es) will be listed, and can be added into the address book by clicking "".

- c) Double-click the IP address you just added into the address book to log in.

6.1.2 Control Panel Overview







Two control panels are available and can be switched depending on your use habit.





Simplified Version (Default)

-  Address Book
-  Miscellaneous Control
-  Log
-  Record
-  Snapshot
-  Information
-  DVR Control

Event Notification & Quick Checklist 



-  Version
-  Minimize
-  Full Function Display Switch
-  Close Program
-  180° Counterclockwise Image Rotation
-  Snapshot

-  Close All Display Views
-  Close Current View
-  Original Size
-  Full Screen
-  Display Mode Switch

 Audio Volume
(For selected models only)

Full Function Version

Event Notification & Quick Checklist

180° Counterclockwise Image Rotation

Snapshot

Information

Close Program

Simplified Display Switch

Minimize

Version

Setting

DVR Control

PTZ control

Close All Display Views

Close Current View

Original Size

Full Screen

Display View: 1-Cut

Display View: 4-Cut

Display View: 6-Cut

Display View: 9-Cut

Display View: 13-Cut

Display View: 16-Cut

Emap

Audio Volume
(For selected models only)

Record









Snapshot

Miscellaneous Control

Log



Main Button Overview

Button		Function	Description		
Simplified	Full Function				
		Address Book	Click to show the predefined IP address(es). You can add, remove or search the IP address to log in the DVR remotely.		
		Miscellaneous Control		Remote Config	Click to go into the detailed DVR setting.
				Record Setting	Click to go to the detailed record setting.
				Custom Setting	Click to choose the language of this program. The language change will take effect when this program is closed and executed again.
		Log	Click to view all event and recording logs, search the desired log(s) by date, or playback the		

Button		Function	Description
Simplified	Full Function		
			recording of the selected log.
		Record / Record Stop	Click to start / stop the manual recording.
		Snapshot	Click to take a snapshot of the current view. The snapshot will be saved in the path you specified in "Record Setting".
		Information	Click to show the current network connection details.
		DVR Control	Click to go to the DVR control panel to operate the DVR remotely.

6.1.3. General Operation

Record

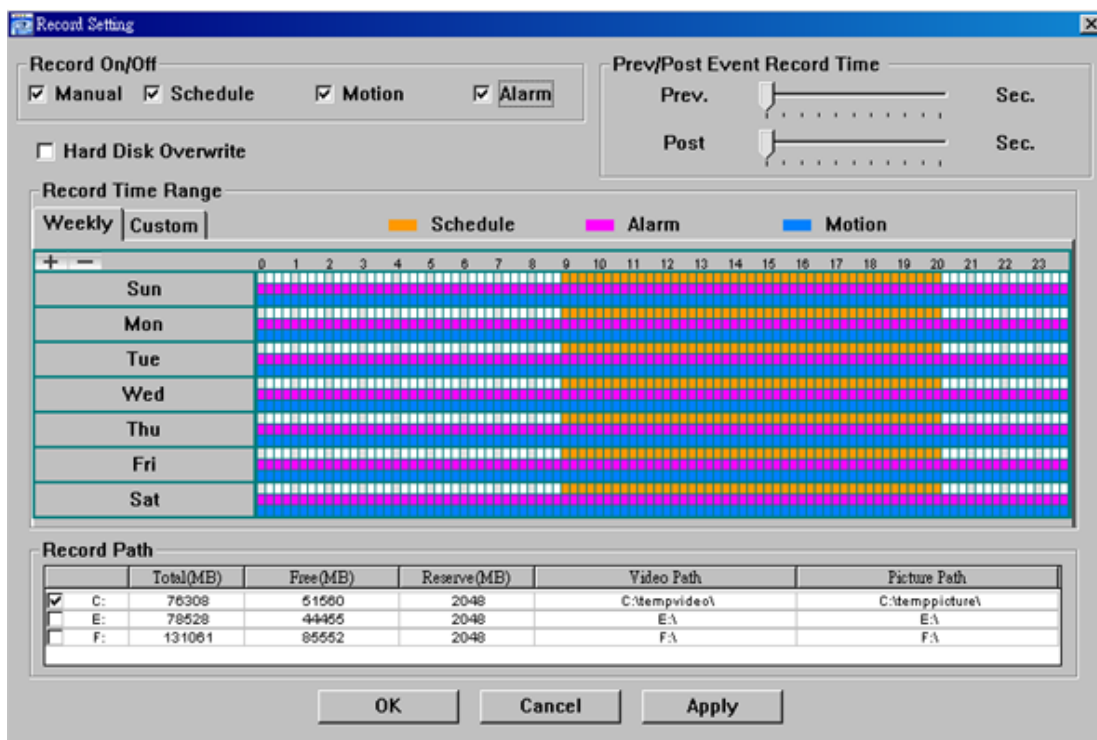

To record remotely at the same time for any event or alarm at the DVR side, click  or  →  to go to the "Record Setting" page.



In the "Record Setting" page, you can set the following items:



- Record type
- Hard disk overwriting
- Pre- / post-alarm record time
- Record time setting

- Record path

If “Manual” is checked, click  or  on the main control panel to start the manual recording immediately, and the recordings will be saved in the specified location.

If “Motion” and / or “Alarm” are checked, the recording function will also be enabled at the remote side when any event is triggered at the DVR side, and the recordings will be saved in the specified location.

Playback

To play a recording, click  or , and select the “Record” tab or “Backup” tab. A list of all the recordings will be shown by defaults, and you can also sort out the logs you want to speed up the search time.

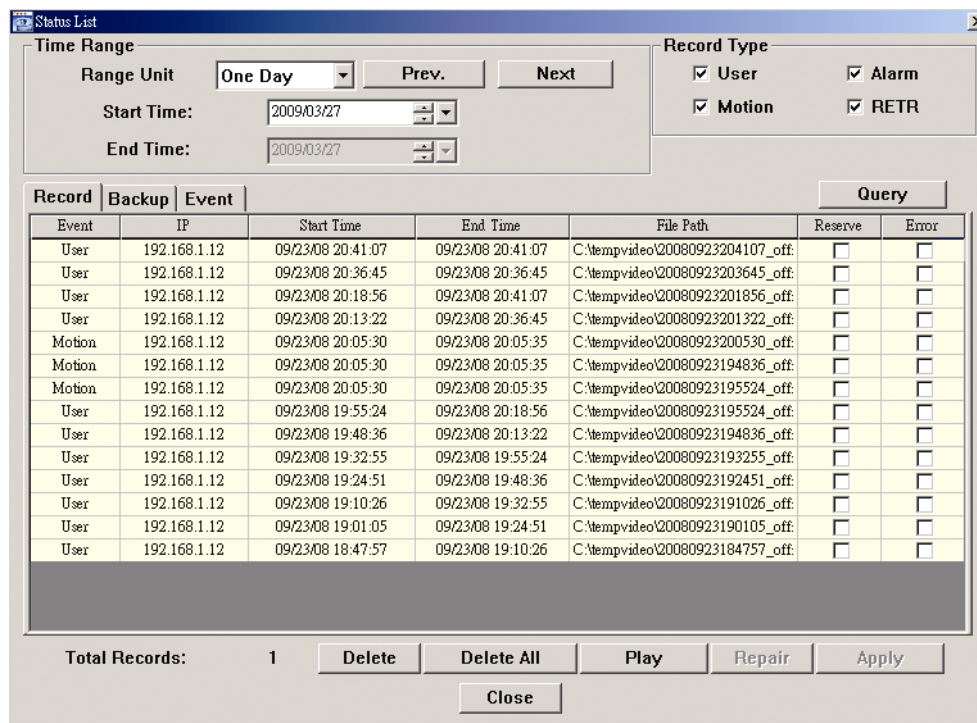



The screenshot shows the 'Status List' window with the following data in the table:

Event	IP	Start Time	End Time	File Path	Reserve	Error
User	192.168.1.12	09/23/08 20:41:07	09/23/08 20:41:07	C:\tempvideo\20080923\204107_off	<input type="checkbox"/>	<input type="checkbox"/>
User	192.168.1.12	09/23/08 20:36:45	09/23/08 20:36:45	C:\tempvideo\20080923\203645_off	<input type="checkbox"/>	<input type="checkbox"/>
User	192.168.1.12	09/23/08 20:18:56	09/23/08 20:41:07	C:\tempvideo\20080923\201856_off	<input type="checkbox"/>	<input type="checkbox"/>
User	192.168.1.12	09/23/08 20:13:22	09/23/08 20:36:45	C:\tempvideo\20080923\201322_off	<input type="checkbox"/>	<input type="checkbox"/>
Motion	192.168.1.12	09/23/08 20:05:30	09/23/08 20:05:35	C:\tempvideo\20080923\200530_off	<input type="checkbox"/>	<input type="checkbox"/>
Motion	192.168.1.12	09/23/08 20:05:30	09/23/08 20:05:35	C:\tempvideo\20080923\194836_off	<input type="checkbox"/>	<input type="checkbox"/>
Motion	192.168.1.12	09/23/08 20:05:30	09/23/08 20:05:35	C:\tempvideo\20080923\195524_off	<input type="checkbox"/>	<input type="checkbox"/>
User	192.168.1.12	09/23/08 19:55:24	09/23/08 20:18:56	C:\tempvideo\20080923\195524_off	<input type="checkbox"/>	<input type="checkbox"/>
User	192.168.1.12	09/23/08 19:48:36	09/23/08 20:13:22	C:\tempvideo\20080923\194836_off	<input type="checkbox"/>	<input type="checkbox"/>
User	192.168.1.12	09/23/08 19:32:55	09/23/08 19:55:24	C:\tempvideo\20080923\193255_off	<input type="checkbox"/>	<input type="checkbox"/>
User	192.168.1.12	09/23/08 19:24:51	09/23/08 19:48:36	C:\tempvideo\20080923\192451_off	<input type="checkbox"/>	<input type="checkbox"/>
User	192.168.1.12	09/23/08 19:10:26	09/23/08 19:32:55	C:\tempvideo\20080923\191026_off	<input type="checkbox"/>	<input type="checkbox"/>
User	192.168.1.12	09/23/08 19:01:05	09/23/08 19:24:51	C:\tempvideo\20080923\190105_off	<input type="checkbox"/>	<input type="checkbox"/>
User	192.168.1.12	09/23/08 18:47:57	09/23/08 19:10:26	C:\tempvideo\20080923\184757_off	<input type="checkbox"/>	<input type="checkbox"/>

To immediately play a recording, select a log from the list, and click “Play”, or double-click the selected log.

Network Backup

Click  → , or click  to go into the “Backup” page as follows, and you can select a specific time range or event to make a video backup remotely.

The file(s) you backup will be from the currently selected IP address.

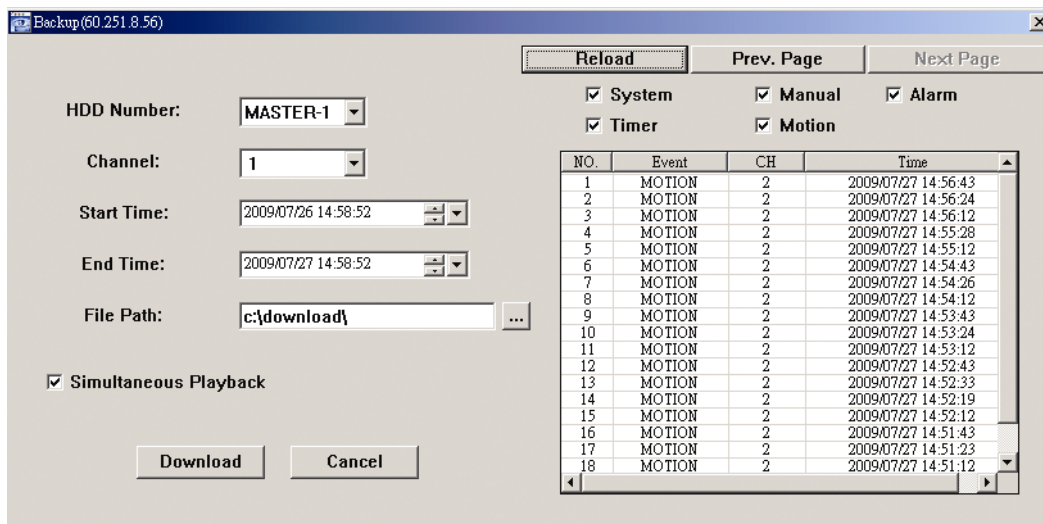

Function	Description
HDD Number / Channel	Specify the hard disk (HDD Number) and channel number (Channel) within which have the video data you need.
Download by Time	Specify the time range within which has the video data you want in the “Start Time” and “End Time” columns.
Download by Event	<p>Select an event log from the event list. This list shows all logs in the specified DVR from the latest to the earliest.</p> <ul style="list-style-type: none"> To quickly find the events you need, check or uncheck the event type “System” / “Manual” / “Alarm” / “Motion”, and select the log you want. To view the earlier or later logs that are not shown in the current page, click “Prev. Page” or “Next Page”. To refresh the event list, click “Reload”.
File Path	Assign the location where the backup files are saved.
Simultaneous Playback	<p>To view the backup images simultaneously when the download process is in progress, select the checkbox “Simultaneous Playback”. You will see the backup images while the images are being downloaded to the PC or notebook.</p> <p>To simply backup images without previewing, deselect the checkbox “Simultaneous Playback”. You will only see a message box indicating the total time needed, the current status and the saving location.</p>
Download / Cancel	Click “Download” to start or “Cancel” to discard the video backup.

Firmware Upgrade

This function is used to grade your DVR for function scalability.

Note: Before using this function, make sure you have the correct upgrade files provided by your installer or distributor.

Step1: Click “”, and select the IP address of your device in the address book.

Step2: Click “” to show the upgrade page, “Update Server”.

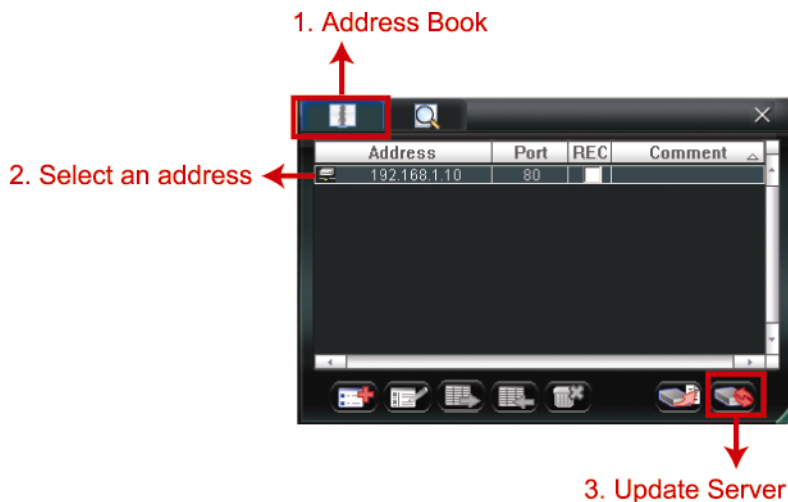

Step3: Click “Add” to browse to the upgrade files.

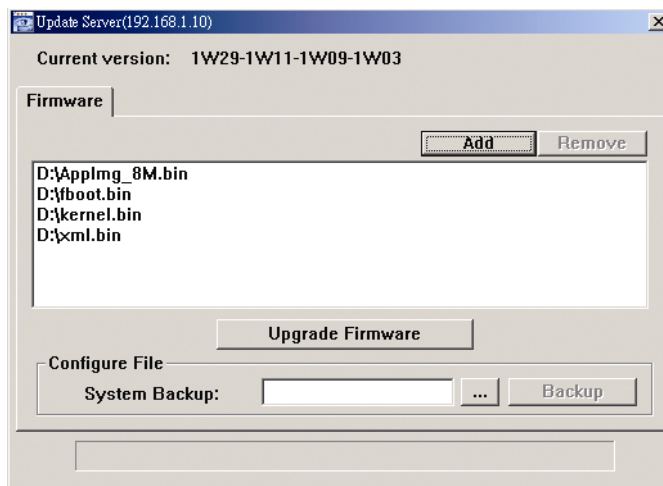

Step4: Click “Upgrade Firmware” to start firmware upgrade.

Note: It takes a few minutes to finish the upgrade process. Do not disconnect the power during firmware upgrade, or the upgrade may be failed. The device will reboot after the upgrade.

Step5: Select the IP address of the device and click “” again to check if the firmware is upgraded.



6.1.4. E-Map

Video Viewer is also a Central Management System (CMS) software, which allows network device control & management for up to 16 devices simultaneously.

Note: Before using this function, make sure Video Viewer is connected to all the devices (up to 16) you want to monitor.

E-Map is **ONLY** available when the control panel is switch to the full function version.

How to Add an E-Map Group

STEP1: In the simplified version, click “” to switch the control panel to the full function version, and click “” to enter the E-Map page as follows.

Note: To know where the buttons are, please refer to “Simplified Version (Default)” at page 32, and “Full Function Version” at page 33.

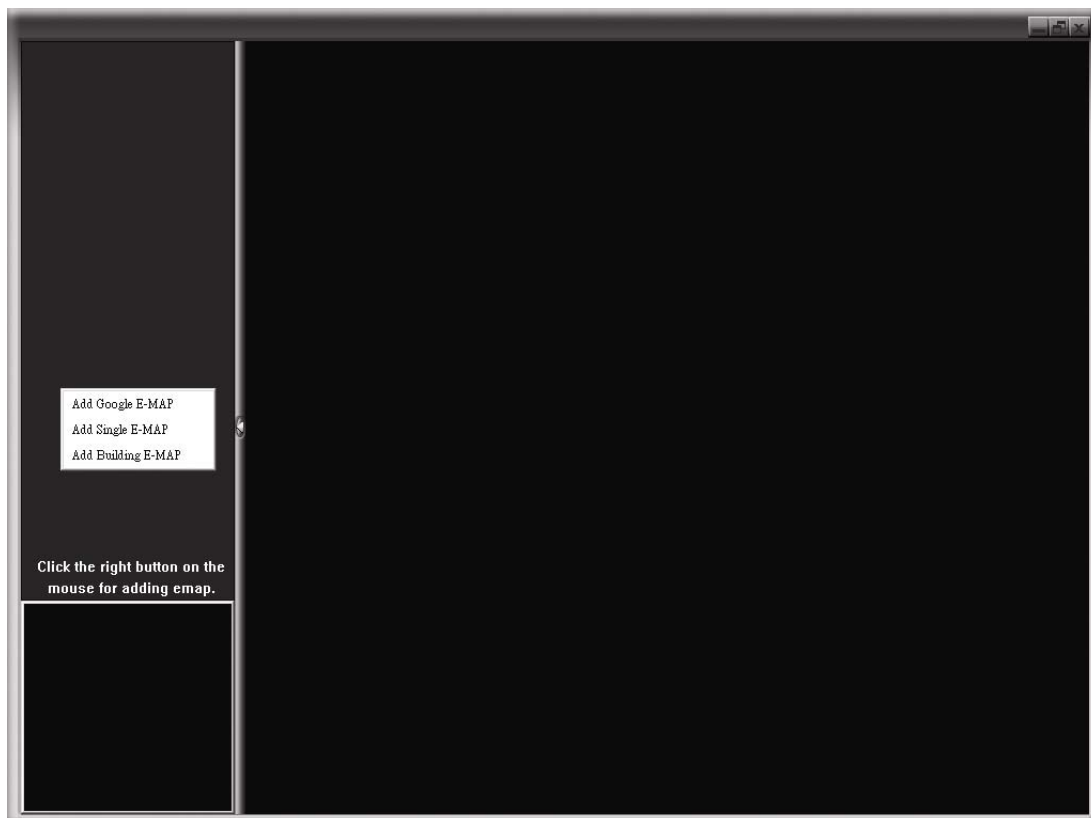

STEP2: Right-click to show the shortcut menu on the top-left panel, and select the E-Map group you want to add. There are three E-Map groups you can add: Google E-MAP, Single E-MAP, and Building E-MAP.

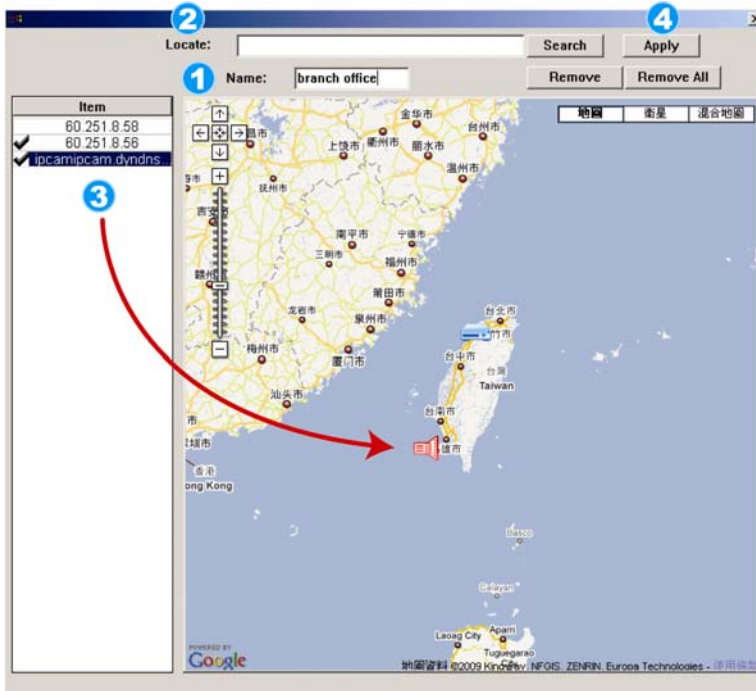

How to add a Google E-Map group:

- 1 Enter the name of this Google E-Map group.
- 2 Enter a specific address or landmark, and click "Search".
OR
Move to the map and drag to the location you want.
- 3 Click and drag the IP address to where it's located in the current level.
- 4 Click "Apply" to save and finish.

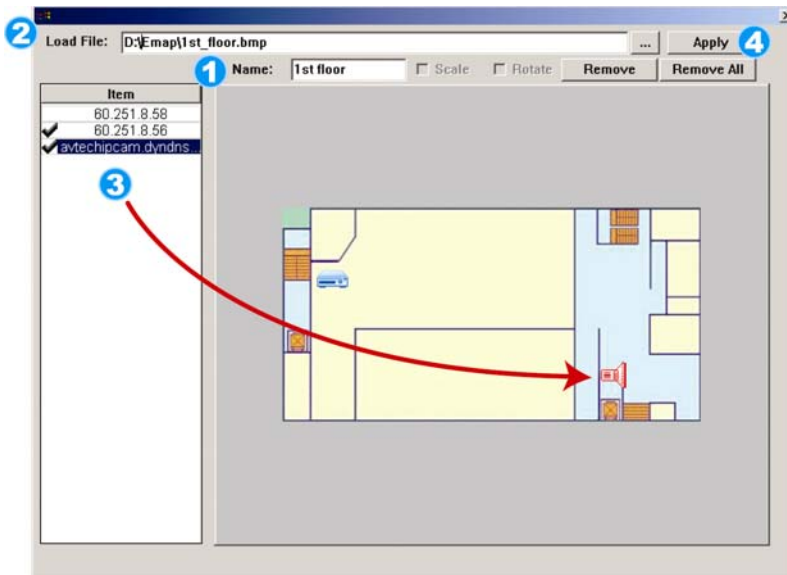

How to add a single E-Map group:

- 1 Enter the name of this single E-Map group.
- 2 Click "..." to browse the map file in BMP or JPEG.
- 3 Click and drag the IP address to where it's located in the current level.
- 4 Click "Apply" to save and finish.

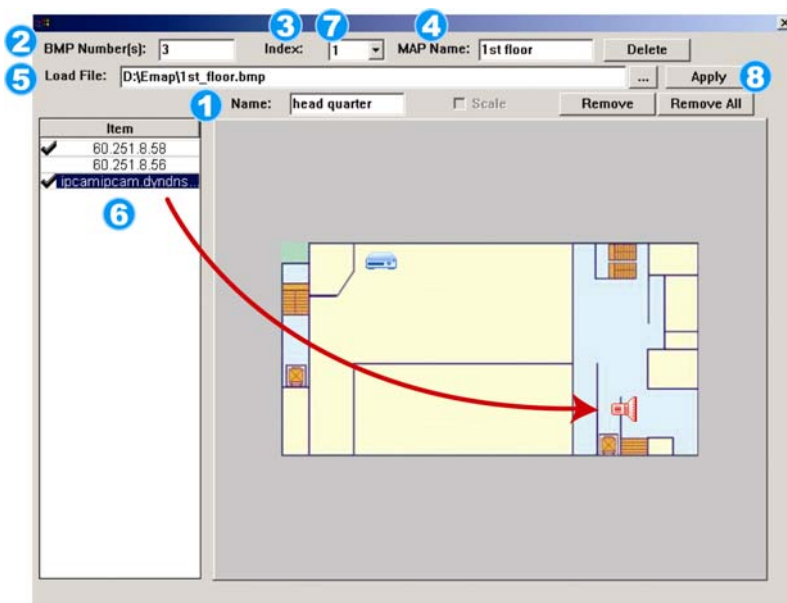



How to add a building E-Map group:

- 1 Enter the name of this building E-Map group.
- 2 Enter the total levels of this building.
- 3 Select the level of the building from the drop-down list.
- 4 Enter the name of the level.
- 5 Click "..." to browse the map file in BMP or JPEG.
- 6 Click and drag the IP address to where it's located in the current level.
- 7 Go back to STEP 3 to select other level of the building, and repeat from STEP 3 to 6 until the setup for all levels are finished.
- 8 Click "Apply" to save and finish.

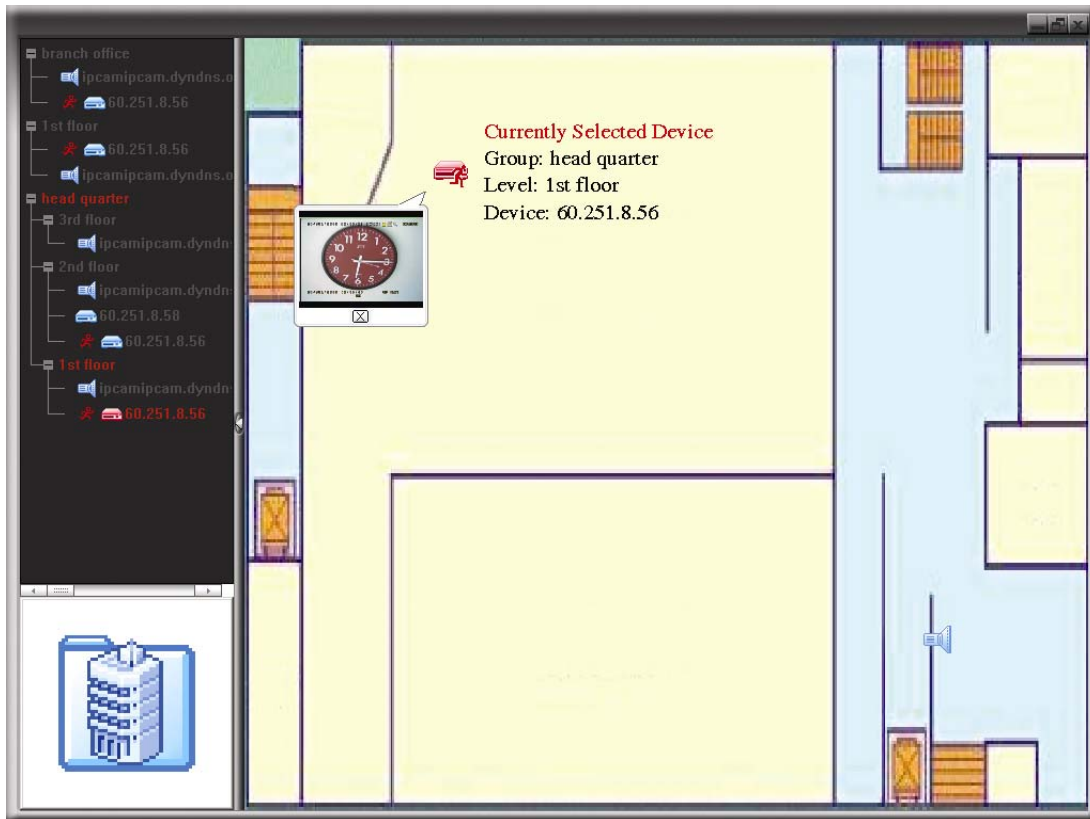
STEP3: When the E-Map group is created, you will see the tree on the top-left panel, showing all the devices you've added to this group.



Icon	Description
	The connected device is camera. When it's selected, it will become red.
	The connected device is DVR. When it's selected, it will become red.
	For any motion or alarm event, it will appear on the screen to catch your attention. To know what's happening quickly, double-click the device icon on the E-Map to show the live view.

How to Edit / Remove an Existing E-Map Group

➤ For Google E-Map Group

Right-click on the group name to show the shortcut menu list, and select "Edit E-MAP" or "Remove E-MAP" as needed.

You can also add a single E-Map group (Add Single E-MAP) or Building E-Map group (Add Building E-MAP) into the existing Google E-Map group.

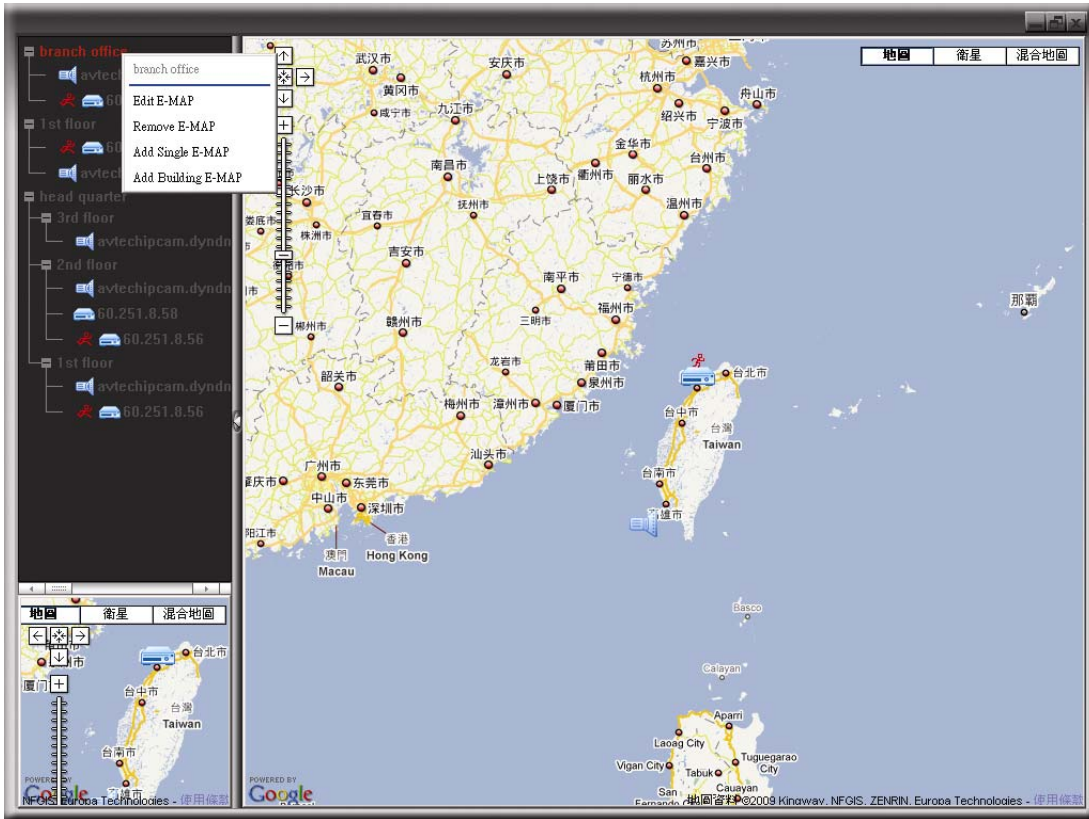

➤ For Single E-Map Group

Right-click on the group name to show the shortcut menu list, and select “Edit E-MAP” or “Remove E-MAP” as needed.

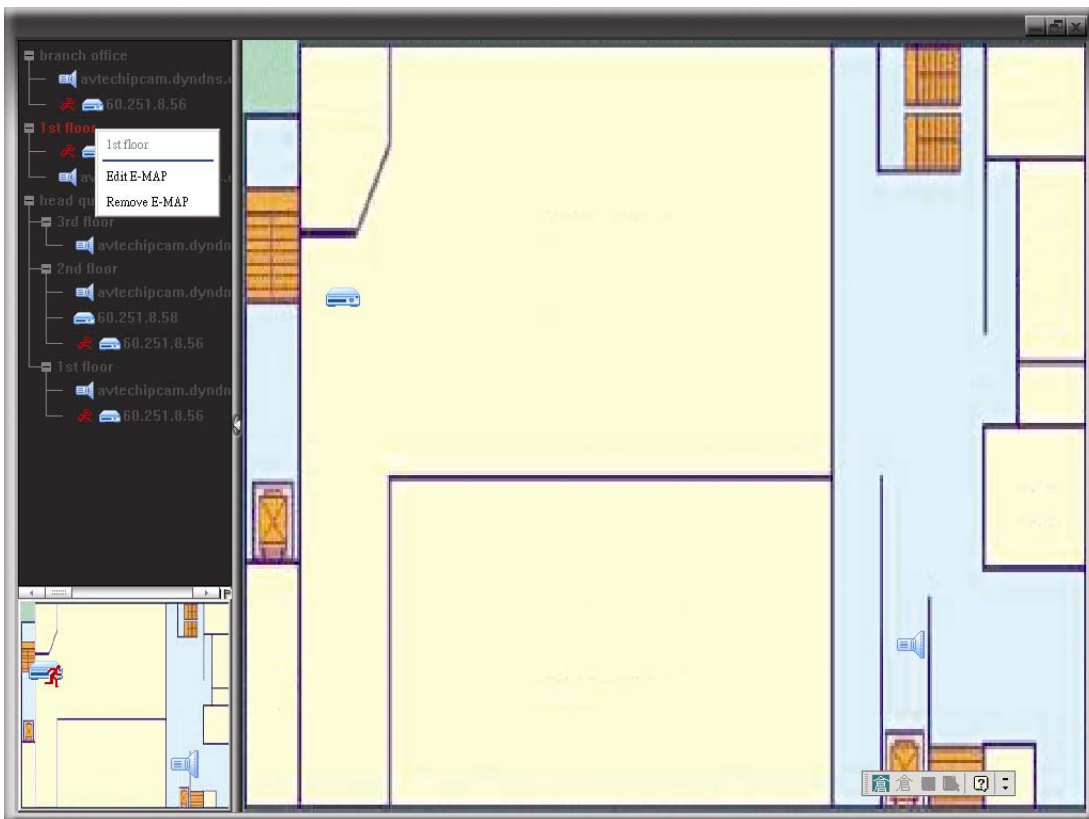

➤ For Building E-Map Group

Right-click on the group name to show the shortcut menu list, and select “Edit Building E-MAP” or “Remove E-MAP” as needed.

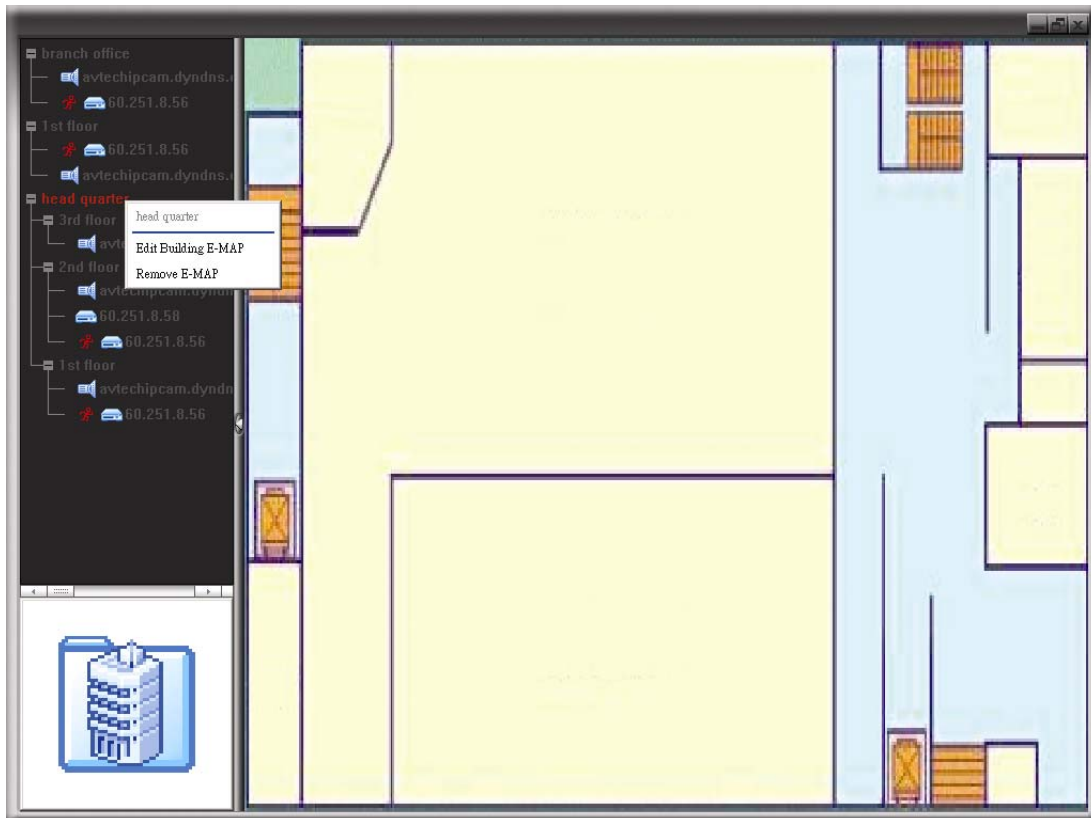

To edit or remove a certain level of the building E-Map group, right click on the level name, and select “Edit E-MAP” or “Remove E-MAP” as needed.

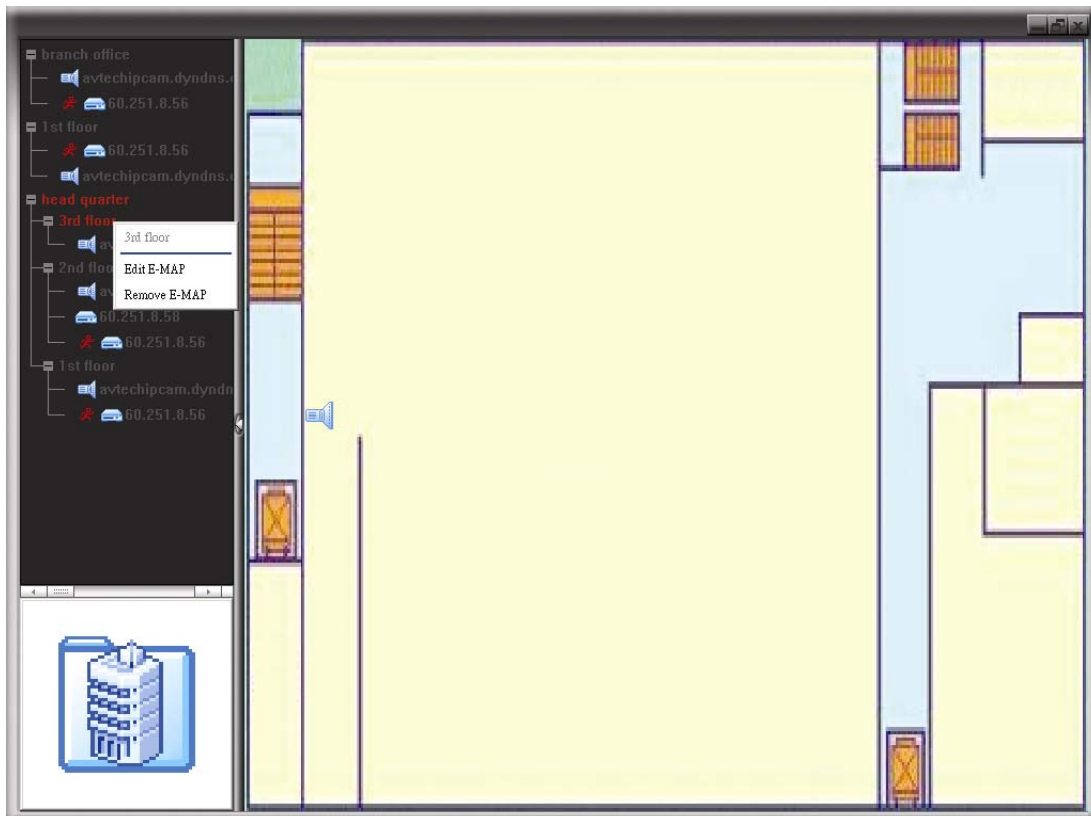

6.2 Web Browser

You can view the images or operate your DVR with a web browser, such as Internet Explorer, Mozilla Firefox or Google Chrome.

Note: The supported PC operation systems are Windows 7, Vista, XP and 2000.

Note: To use Mozilla Firefox or Google Chrome for remote access, please go to Apple's official website (<http://www.apple.com/quicktime/win.html>) to download and install QuickTime first.









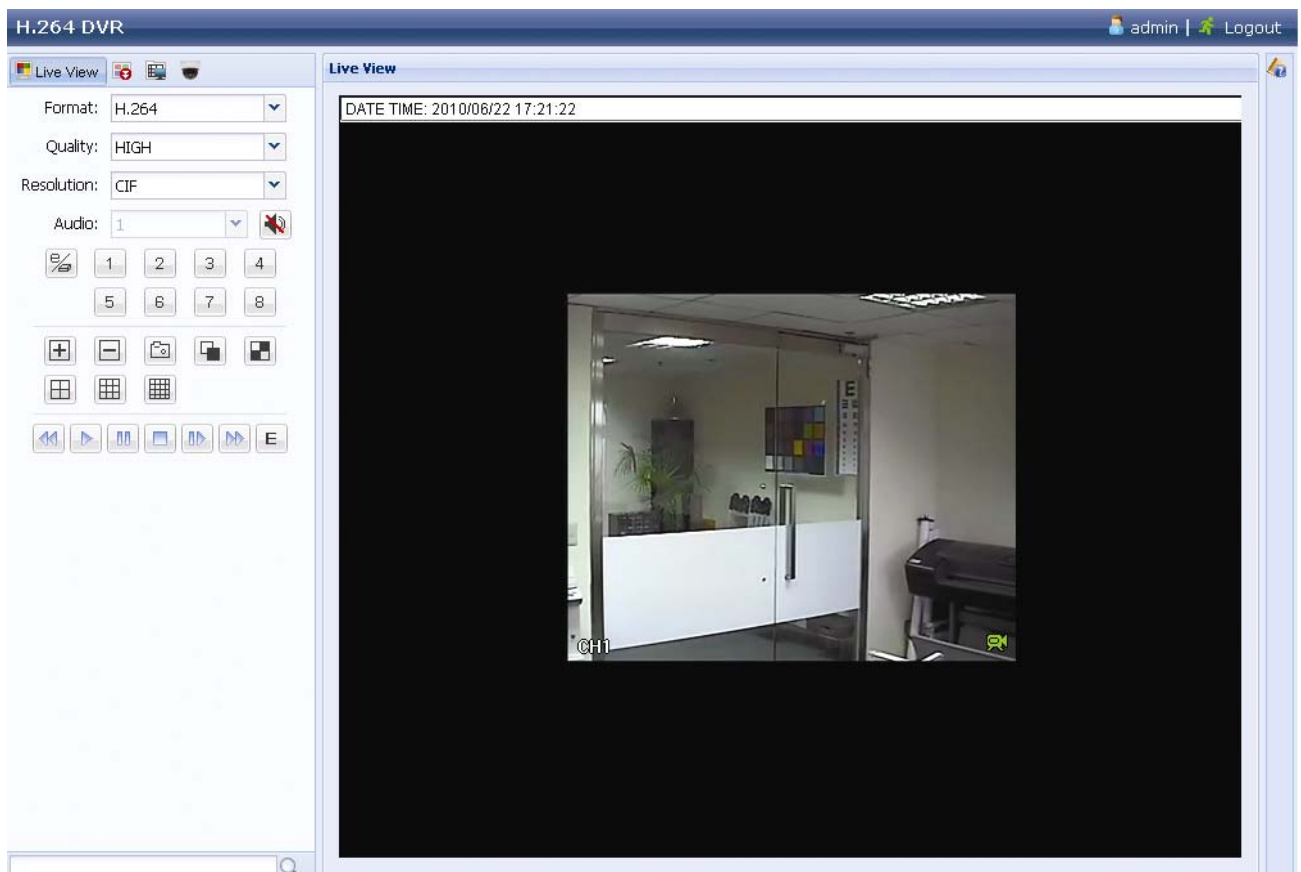











Note: The illustration below is just for your reference and may be different from what you actually see on your DVR. Some functions and buttons are for selected models only.





Step 1: Key in the IP address used by your DVR in the URL address box, such as 60.121.46.236, and press Enter. You will be prompted to enter the user name and password to access the DVR.

If the port number your DVR used is NOT 80, you need to key in the port number additionally. The format is ***ipaddress:portnum***. For example, for IP address 60.121.46.236 and port No. 888, please key in "http://60.121.46.236:888" into the URL address box, and press "Enter".

Step 2: Enter the user name and password, the same as the ones used for video viewer login, and click "OK". You will see a similar screen as the following when the login information is correct.



Icon	Description
	Click to go to the live view of the DVR.
	Click to enter the playback panel where you can search or select the event you want to play and download to your PC simultaneously. For details, please refer to “6.2.1 Event Download & Playback” at page 45.
	Click to go to the detailed DVR setting.
	Click to enter the PTZ mode.
<p>Video / Audio Control</p> <p>Format</p> <p>Quality</p> <p>Resolution</p> <p>Audio <i>(For Selected Models Only)</i></p>	<p><u>H.264 / QuickTime</u></p> <p>QuickTime is Apple Inc.’s multimedia software. You need to have QuickTime installed in you operation system first. When “QuickTime” is selected, you will be promoted to enter the user name and password to access the server of the DVR.</p> <p><u>BEST / HIGH / NORMAL / BASIC</u></p> <p>Select the image quality.</p> <p>4CIF: 704*480 pixels / CIF: 352*240 pixels</p> <p>Select the audio channel you want for listening to the live audio.</p> <p>Note: Your camera must support audio recording, and connect to the video channel which supports audio recording and the audio input of the DVR. For details, please refer to “1.3 Rear Panel” at page 2.</p> <p> means mute.</p> <p>To disable the mute status, click this icon again and select the audio channel you want.</p>
<p>Channel Control</p> <p> <i>(For Selected Models Only)</i></p>	Click to enable the remote independent operation. This icon will turn to blue, and only the available function icons will be shown.
<p>Channel Selection</p>	Click one of the channel numbers to switch to the channel you want to see in full screen.
<p> / </p>	Click to go to the previous / next channel, or change setting.
<p></p>	Click to take a snapshot of the current view, and save it to the specified path in your PC set in  → “General”.
<p> / </p>	<p>: Click to display four channels at a time. When the last channel is displayed, it will start from CH1 again.</p> <p>: Click to display each channel one by one, starting from CH1. When the last channel is displayed, it will start from CH1 again.</p> <p>To exit from this display mode, press any other channel display button.</p>
<p> /  / </p>	Click to show 4-cut / 9-cut / 16-cut display.
<p>Playback Control</p> <p></p> <p></p> <p></p>	<p>Increase the speed for fast rewind. Click once to get 4X speed rewind and click twice to get 8X speed, etc., and the maximum speed is 16X.</p> <p>Increase the speed for fast forward. Click once to get 4X speed forward and click twice to get 8X speed, etc., and the maximum speed is 16X.</p> <p>Click to play the current video clip.</p>

Icon	Description
	Click to pause the video playback.
	Click to stop the video playback.
	Click to play the video clip slowly, once to get 4X slower, twice get 8X slower.
	Click to open the playback search panel.

6.2.1 Event Download & Playback

Cut: 4

Mode: Time

HDD No.: HDD-0

Start Time: 2010/05/14

16 : 41 : 58

Channel: 1

Quick Search

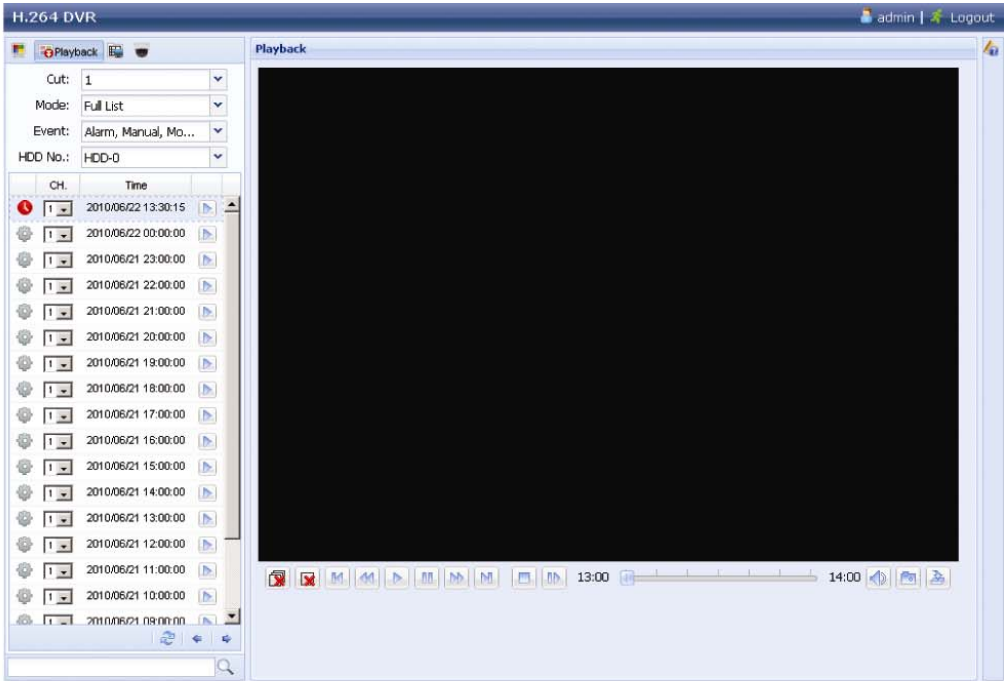

Mode: Calendar

HDD No.: HDD-0

Channel: 1 2 3 4

Search

2010

Jan Feb Mar Apr **May** Jun

Jul Aug Sep Oct Nov Dec

May

1 2 3 4 5 6 7 8

9 10 11 12 13 14 15 16



17 18 19 20 21 22 23 24



25 26 27 28 29 30 31













Select Time: 00:00 - 00:00





Start

Event Icon

 Timer  Manual

 System  Motion

 / 	Close all / Close	Click  to close the current playback video clip (in the red frame), or  to close all playback video clips.
 / 	Previous / Next Hour	Click to jump to the next / previous time interval in an hour, for example, 11:00 ~ 12:00 or 14:00 ~ 15:00, and start playing the earliest event video clip recorded during this whole hour.
	Fast Forward	Increase the speed for fast rewind. Click once to get 4X speed rewind and click twice to get 8X speed, etc., and the maximum speed is 16X.
	Fast Rewind	Increase the speed for fast forward. Click once to get 4X speed forward and click twice to get 8X speed, etc., and the maximum speed is 16X.
	Play	Click to play the current video clip.
	Pause	Click to pause the video playback.
	Stop	Click to stop the video playback.
	Step	In the pause mode, click to get one frame forward.

	Audio <i>(For Selected Models Only)</i>	Click to mute the playback if necessary, and click again to restore. Note: Audio is available when your camera supports audio recording, and connects to the video channel which supports audio recording and the audio input of the DVR. For details, please refer to "1.3 Rear Panel" at page 2.
	Snapshot	Click to take a snapshot of the current view, and save it to the specified path in your PC set in "  " → "General".
	Download	Click to download the current video clip to the specified path in your PC.

APPENDIX 1 SPECIFICATIONS

➤ For 16CH Models

		Model 1	Model 2	Model 3
Video System		NTSC / PAL (auto detection)		
Video Compression Format		H.264		
Video Input (composite video signal 1 Vp-p 75Ω BNC)		16 channels		
Video Loop Output (composite video signal 1 Vp-p 75Ω BNC)		--		16 channels
Video Output (BNC)	Main Monitor	For stable display		
	Call Monitor	--		For sequence display
Video Output (VGA)		Built-in (Resolution support up to 1600 x 1200)		
Audio Input / Output		4 audio inputs / 1 audio output (Mono)	4 audio inputs / 2 audio outputs (Mono)	
Maximum Recording Rate	Frame	704×480 pixels with 120 IPS <NTSC> / 704×576 pixels with 100 IPS <PAL>		
	Field	--	704×240 pixels with 240 IPS <NTSC> / 704×288 pixels with 200 IPS <PAL>	
	CIF	352×240 pixels with 480 IPS <NTSC> / 352×288 pixels with 400 IPS <PAL>		
Image Quality Setting		SUPER BEST / BEST / HIGH / NORMAL		
Hard Disk Storage**		Accommodates 2 SATA HDDs		
Quick Search		Time / Motion / Alarm search mode		
SATA Interface		Built-in		
Recording Mode		Manual / Timer / Motion / Alarm / Remote		
Multiplex Operation		Live display / record / playback / backup / network operations		
USB Mouse Control		YES		
Motion Detection Area		16 × 12 grids per camera for all channels		
Motion Detection Sensitivity		3 adjustable parameters for accurate detection		
Pre-alarm Recording		YES		
Backup Device		USB 2.0 flash drive / Network	DVD Writer (Optional) / Flash drive / Network	
Web Transmitting Compression Format		H.264		
Ethernet		10/100 Base-T. Supports remote control and live view via Ethernet		
Web Interface		Supports licensed software "Video Viewer" / Internet Explorer, Mozilla Firefox, Safari & Google Chrome web browsers / QuickTime player		
		*Operating System: Windows 7 / Vista / XP / 2000		
Max. Online User		5	10	
Network Protocol		TCP/IP, PPPOE, DHCP and DDNS		
Remote Independent Operation		YES		
Remote Live Audio		NO	YES	
Remote Event Download & Playback		YES		
Event Notification		By FTP / E-Mail		
IR Remote Control		YES (IR receiver built-in)		

	Model 1	Model 2	Model 3
Mobile Surveillance	YES		
Picture Zoom	2X digital zoom		
PTZ Control	YES		
Alarm I/O	16 inputs, 1 output		
Key Lock (Password Protection)	YES		
Local User Level	Administrator & Operator		
Video Loss Detection	YES		
Camera Title	Supports up to 12 letters		
Video Adjustable	Hue / Saturation / Contrast / Brightness		
Date Display Format	YY/MM/DD, DD/MM/YY & MM/DD/YY		
Daylight Saving	YES		
Power Source ($\pm 10\%$)	DC 19V		
Power Consumption ($\pm 10\%$)	< 64 W		
Operating Temperature	10°C ~ 40°C (50°F~104°F)		
Dimensions (mm) ^{***}	430(W) x 65(H) x 338(D)	432(W) x 90(H) x 326(D)	
System Recovery	System auto recovery after power failure		
Optional Peripherals	Keyboard controller		

* The specifications are subject to change without notice.

** 1 HDD capacity up to 2TB

*** Dimensional Tolerance: $\pm 5\text{mm}$

➤ **For 8CH Models**

		Model 4	Model 5	Model 6
Video System		NTSC / PAL (auto detection)		
Video Compression Format		H.264		
Video Input (composite video signal 1 Vp-p 75Ω BNC)		8 channels		
Video Loop Output (composite video signal 1 Vp-p 75Ω BNC)		--		8 channels
Video Output (BNC)	Main Monitor	For stable display		
	Call Monitor	--		For sequence display
Video Output (VGA)		Built-in (Resolution support up to 1600 x 1200)		
Audio Input / Output		4 audio inputs / 1 audio output (Mono)		4 audio inputs / 2 audio outputs (Mono)
Maximum Recording Rate	Frame	704×480 pixels with 120 IPS <NTSC> / 704×576 pixels with 100 IPS <PAL>		
	Field	--		704×240 pixels with 240 IPS <NTSC> / 704×288 pixels with 200 IPS <PAL>
	CIF	352×240 pixels with 480 IPS <NTSC> / 352×288 pixels with 400 IPS <PAL>		
Image Quality Setting		SUPER BEST / BEST / HIGH /NORMAL		
Hard Disk Storage**		Accommodates 2 SATA HDDs		
Quick Search		Time / Motion / Alarm search mode		
SATA Interface		Built-in		
Recording Mode		Manual / Timer / Motion / Alarm / Remote		
Multiplex Operation		Live display / record / playback / backup / network operations		
USB Mouse Control		YES		
Motion Detection Area		16 × 12 grids per camera for all channels		
Motion Detection Sensitivity		3 adjustable parameters for accurate detection		
Pre-alarm Recording		YES		
Backup Device		USB 2.0 flash drive / Network		DVD Writer (Optional) / Flash drive / Network
Web Transmitting Compression Format		H.264		
Ethernet		10/100 Base-T. Supports remote control and live view via Ethernet		
Web Interface		Supports licensed software "Video Viewer" / Internet Explorer, Mozilla Firefox, Safari & Google Chrome web browsers / QuickTime player		
		*Operating System: Windows 7 / Vista / XP / 2000		
Max. Online User		5		10
Network Protocol		TCP/IP, PPPOE, DHCP and DDNS		
Remote Independent Operation		YES		
Remote Live Audio		NO		YES
Remote Event Download & Playback		YES		
Event Notification		By FTP / E-Mail		
IR Remote Control		YES (IR receiver built-in)		
Mobile Surveillance		YES		
Picture Zoom		2X digital zoom		
PTZ Control		YES		
Alarm I/O		8 inputs, 1 output		

	Model 4	Model 5	Model 6
Key Lock (Password Protection)	YES		
Local User Level	Administrator & Operator		
Video Loss Detection	YES		
Camera Title	Supports up to 12 letters		
Video Adjustable	Hue / Saturation / Contrast / Brightness		
Date Display Format	YY/MM/DD, DD/MM/YY & MM/DD/YY		
Daylight Saving	YES		
Power Source ($\pm 10\%$)	DC 19V		
Power Consumption ($\pm 10\%$)	< 64 W		
Operating Temperature	10°C ~ 40°C (50°F~104°F)		
Dimensions (mm) ^{***}	430(W) x 65(H) x 338(D)	432(W) x 90(H) x 326(D)	
System Recovery	System auto recovery after power failure		
Optional Peripherals	Keyboard controller		

* The specifications are subject to change without notice.

** 1 HDD capacity up to 2TB

*** Dimensional Tolerance: $\pm 5\text{mm}$

➤ **For 4CH Model**

		Model 7
Video System		NTSC / PAL (auto detection)
Video Compression Format		H.264
Video Input (composite video signal 1 Vp-p 75Ω BNC)		4 channels
Video Output (BNC)		Main Monitor: For stable display
Video Output (VGA)		Built-in (Resolution support up to 1600 x 1200)
Audio (Mono)	Input	4 audio inputs
	Output	1 audio output
Maximum Recording Rate	Frame	704×480 pixels with 30 IPS <NTSC> / 704×576 with 25 IPS <PAL>
	Field	704×240 pixels with 60 IPS <NTSC> / 704×288 pixels with 50 IPS <PAL>
	CIF	352×240 pixels with 120 IPS <NTSC> / 352×288 pixels with 100 IPS <PAL>
Image Quality Setting		SUPER BEST / BEST / HIGH / NORMAL
Hard Disk Storage**		Accommodates 1 SATA HDD
Quick Search		Time / Motion / Alarm search mode
SATA Interface		Built-in
Recording Mode		Manual / Timer / Motion / Alarm / Remote
Multiplex Operation		Live display / record / playback / backup / network operations
USB Mouse Control		YES
Motion Detection Area		16 × 12 grids per camera for all channels
Motion Detection Sensitivity		3 adjustable parameters for accurate detection
Pre-alarm Recording		YES
Backup Device		USB 2.0 flash drive / Network
Web Transmitting Compression Format		H.264
Ethernet		10/100 Base-T. Supports remote control and live view via Ethernet
Remote Surveillance (Operating System: Windows 7 / Vista / XP / 2000)	CMS:	Our self-developed and free software, "Video Viewer"
	Web Browser:	Internet Explorer, Mozilla Firefox, Google Chrome & Safari
	Media Player:	QuickTime
	Max. on-line user:	10
Network Protocol		TCP/IP, PPPOE, DHCP and DDNS
Remote Independent Operation		YES
Remote Live Audio		YES
Remote Event Download & Playback		YES
Event Notification		By FTP / E-Mail
IR Remote Control		YES (IR receiver built-in)
Mobile Surveillance		YES
Picture Zoom		2X digital zoom
PTZ Control		YES
Alarm I/O		4 inputs, 1 output

	Model 7
Key Lock (Password Protection)	YES
Local User Level	Administrator & Operator
Video Loss Detection	YES
Camera Title	Supports up to 12 letters
Video Adjustable	Hue / Saturation / Contrast / Brightness
Date Display Format	YY/MM/DD, DD/MM/YY & MM/DD/YY
Daylight Saving	YES
Power Source ($\pm 10\%$)	DC 19V
Power Consumption ($\pm 10\%$)	< 42 W
Operating Temperature	10°C ~ 40°C (50°F~104°F)
Dimensions (mm) ^{***}	343(W) × 59(H) × 223(D)
System Recovery	System auto recovery after power failure
Optional Peripherals	Keyboard controller

* The specifications are subject to change without notice.

** 1 HDD capacity up to 2TB

*** Dimensional Tolerance: $\pm 5\text{mm}$

APPENDIX 2 COMPATIBLE USB FLASH DRIVE LIST

Please upgrade the firmware of the DVR to the latest version to ensure the accuracy of the following table. If the USB flash drive is not supported by the DVR, the "USB ERROR" message will be shown on the screen.

Note: Please use your PC to format the USB flash drive as "FAT32".

Note: You can backup up to 2GB video data for one-time USB backup. To backup more data, please set the time & channel(s) you want, and start USB backup again.





MANUFACTURER	MODEL	CAPACITY
Transcend	JFV35	4G
	JFV30	8G
Kingston	DataTraveler	1G
PQI	U172P	4G
Apacer	AH320	2GB
	AH320A	8GB
	AH220	1GB
	AH320	4GB
A-data	RB-18	1GB
Sandisk	Cruzer Micro	2G
	Cruzer Micro	4G
	Cruzer4-pk	2G
Netac	U208	1G
MSI	F200	4G
SONY	Micro Vault Tiny 2G	2G
	Micro Vault Tiny 4G	4G
	Micro Vault Tiny	1G

APPENDIX 3 COMPATIBLE SATA HDD LIST

Please upgrade the firmware of the DVR to the latest version to ensure the accuracy of the following table.

MANUFACTURER	MODEL	CAPACITY	ROTATION
Seagate	ST3320613AS	320GB	7200 rpm
	ST33500320AS	500GB	7200 rpm
	ST3500410SV	500GB	7200 rpm
	ST3750330AS	750GB	7200 rpm
	ST31000525SV	1000GB	7200 rpm
	ST31000340AS	1000GB	7200 rpm
WD	WD3200AAKS	320GB	7200 rpm
	WD5000AACS	500GB	7200 rpm
	WD6400AAKS	640GB	7200 rpm
	WD7500AAKS	750GB	7200 rpm
	WD10EADS	1TB	7200 rpm
	WD15EADS	1.5TB	7200 rpm
	WD20EADS	2TB	7200 rpm
Maxtor	STM3500320AS	500GB	7200 rpm
	STM3750330AS	750GB	7200 rpm
HITACHI	HDT725032VLA360	320GB	7200 rpm
	HDS721010KLA330	1000GB	7200 rpm

APPENDIX 4 MAIN MENU STRUCTURE

	QUICK START	GENERAL	CHANNEL TITLE
			EVENT STATUS
		DATE DISPLAY	
		RECORD CONFIGURATION	
	TIME SETUP	DATE	
		TIME	
	DATE SETUP	DATE INFO	DISPLAY DATE OF MODE
		FORMAT	
	DAYLIGHT	DAYLIGHT SAVING	
	SYSTEM	TOOLS	LANGUAGE
			ADMIN PASSWORD
			OPERATOR PASSWORD
			UPGRADE
			BACKUP CONFIG
			RESTORE CONFIG
		SYSTEM INFO	BAUD RATE
			HOST ID
			R.E.T.R. <i>(For Selected Models Only)</i>
			AUTO KEY LOCK
			CLEAR HDD
RESET DEFAULT			
REMOTE CONTROL ID			
SERIAL TYPE			
VIDEO FORMAT			
VERSION			
	USB BACKUP		
	DVD BACKUP		
	<i>(For Selected Models Only)</i>		
	EVENT INFORMATION	QUICK SEARCH	
		EVENT SEARCH	
		HDD INFO	
		EVENT LOG	
	ADVANCED CONFIG	CAMERA	BRIGHTNESS
			CONTRAST
			SATURATION
			HUE
			COV.
			REC
			CHANNEL TITLE
		DETECTION	LS
			SS
			TS
			DETECT
			ALARM
			AREA
		ALERT	EXT. ALERT
			INT. BUZZER
			KEY BUZZER
			VLOSS BUZZER
			MOTION BUZZER
			ALARM BUZZER
HDD BUZZER			
ALARM DURATION (SEC)			
HDD NEARLY FULL (GB)			
NETWORK	NETWORK		
	SNTP		
	FTP		
	E-MAIL		

APPENDIX 4 MAIN MENU STRUCTURE

	ADVANCED CONFIG	DISPLAY	DE-INTERLACE <i>(For Selected Models Only)</i>
			FULL SCREEN DURATION
			QUAD SCREEN DURATION <i>(For Selected Models Only)</i>
			DWELL SCREEN DURATION <i>(For Selected Models Only)</i>
			DISPLAY COVERT
			HDD DISPLAY MODE
			VGA OUTPUT
			ALPHA BLENDING
			RECORD
		MANUAL RECORD ENABLE	
		EVENT RECORD ENABLE	
		TIMER RECORD ENABLE	
		PRE-ALARM RECORD	
OVERWRITE			
EVENT RECORD ALL CHANNEL			
KEEP DATA LIMIT (DAYS)			
RECORD CONFIGURATION			
REMOTE <i>(For Selected Models Only)</i>			
	SCHEDULE SETTING	RECORD	
		DETECTION	
		ALARM	

APPENDIX 5 DVR BATTERY REPLACEMENT

DVR time reset after power failure, for example, caused by a power outage, will cause the disorder of the recorded data, and users may have problems in searching the event clip they want. To keep the DVR time from resetting, a non-chargeable lithium battery, CR2032, is installed in the DVR.

However, the DVR time might still get reset when the DVR battery is low or even running out of power. If so, please replace the DVR battery, CR2032, **right away** as instructed below.

➤ How to replace CR2032

Note: The lithium battery, CR2032, is a non-chargeable battery, and should be purchased separately. Please replace only with the same or equivalent type battery in case of danger.

Step1: Stop all DVR recording **immediately** to prevent the disorder of the recorded data. Then, back up the recorded data if necessary.

Step2: Power off the DVR, and disconnect the DVR power.

Step3: Remove the DVR cover, and find the battery on the mainboard.

Step4: Push the release as indicated below to remove the battery.



Step5: Get a new battery with the side of “CR2032” facing up, and install it to the mainboard.

Step6: Replace the DVR cover and connect to power.

Step7: Set DVR date & time, and resume recording. For details, please refer to “2.4 Date and Time Setting” at page 9, and “5.2 Record” at page 18.

APPENDIX 6 PIN CONFIGURATION

- For 16CH Model

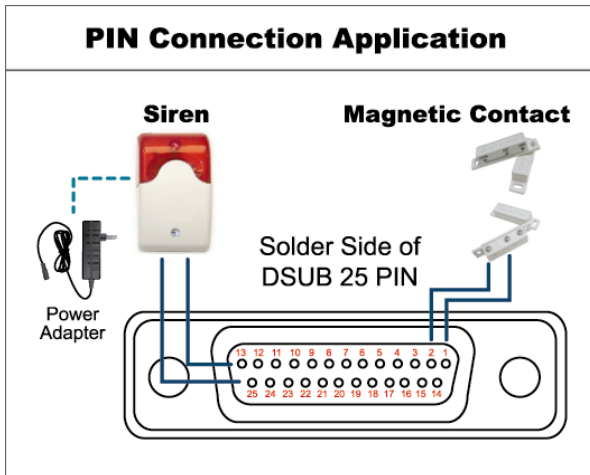

Siren:

When the DVR is triggered by alarm or motion, the COM connects with NO and the siren with strobe starts wailing and flashing.

Magnetic Contact:

When the magnetic contact is opened, the alarm will be triggered and the recording is on.

* The D-Sub connector shown above is optional.

PIN	FUNCTION	DESCRIPTION																											
1	GND	GROUND																											
2~9	ALARM INPUT	<p>Connect ALARM INPUT (PIN 2 -- 9) and GND (PIN 1) connector with wires. Once an alarm is triggered, the DVR will start recording and the buzzer will be on.</p> <table border="1"> <thead> <tr> <th>PIN</th> <th>Alarm</th> <th>Corresponding video channel</th> </tr> </thead> <tbody> <tr> <td>PIN 2</td> <td>1</td> <td>CH1</td> </tr> <tr> <td>PIN 3</td> <td>3</td> <td>CH3</td> </tr> <tr> <td>PIN 4</td> <td>5</td> <td>CH5</td> </tr> <tr> <td>PIN 5</td> <td>7</td> <td>CH7</td> </tr> <tr> <td>PIN 6</td> <td>9</td> <td>CH9</td> </tr> <tr> <td>PIN 7</td> <td>11</td> <td>CH11</td> </tr> <tr> <td>PIN 8</td> <td>13</td> <td>CH13</td> </tr> <tr> <td>PIN 9</td> <td>15</td> <td>CH15</td> </tr> </tbody> </table>	PIN	Alarm	Corresponding video channel	PIN 2	1	CH1	PIN 3	3	CH3	PIN 4	5	CH5	PIN 5	7	CH7	PIN 6	9	CH9	PIN 7	11	CH11	PIN 8	13	CH13	PIN 9	15	CH15
PIN	Alarm	Corresponding video channel																											
PIN 2	1	CH1																											
PIN 3	3	CH3																											
PIN 4	5	CH5																											
PIN 5	7	CH7																											
PIN 6	9	CH9																											
PIN 7	11	CH11																											
PIN 8	13	CH13																											
PIN 9	15	CH15																											
10~11	PIN OFF	NA																											
12	RS485-A																												
13	EXTERNAL ALARM NO	Under the normal operation, COM disconnects with NO. But when any alarm is triggered, COM connects with NO. Attention: The voltage restriction is under DC24V 1A.																											
14	PIN OFF	NA																											
15~22	ALARM INPUT	<p>Connect ALARM INPUT (PIN 15 – 22) and GND (PIN 1) connector with wires. Once an alarm is triggered, the DVR will start recording and the buzzer will be on.</p> <table border="1"> <thead> <tr> <th>PIN</th> <th>Alarm</th> <th>Corresponding video channel</th> </tr> </thead> <tbody> <tr> <td>PIN 15</td> <td>2</td> <td>CH2</td> </tr> <tr> <td>PIN 16</td> <td>4</td> <td>CH4</td> </tr> <tr> <td>PIN 17</td> <td>6</td> <td>CH6</td> </tr> <tr> <td>PIN 18</td> <td>8</td> <td>CH8</td> </tr> <tr> <td>PIN 19</td> <td>10</td> <td>CH10</td> </tr> <tr> <td>PIN 20</td> <td>12</td> <td>CH12</td> </tr> <tr> <td>PIN 21</td> <td>14</td> <td>CH14</td> </tr> <tr> <td>PIN 22</td> <td>16</td> <td>CH16</td> </tr> </tbody> </table>	PIN	Alarm	Corresponding video channel	PIN 15	2	CH2	PIN 16	4	CH4	PIN 17	6	CH6	PIN 18	8	CH8	PIN 19	10	CH10	PIN 20	12	CH12	PIN 21	14	CH14	PIN 22	16	CH16
PIN	Alarm	Corresponding video channel																											
PIN 15	2	CH2																											
PIN 16	4	CH4																											
PIN 17	6	CH6																											
PIN 18	8	CH8																											
PIN 19	10	CH10																											
PIN 20	12	CH12																											
PIN 21	14	CH14																											
PIN 22	16	CH16																											
23~23	PIN OFF	NA																											
24	RS485-B																												
25	EXTERNAL ALARM COM	Under the normal operation, COM disconnects with NO. But when any alarm is triggered, COM connects with NO. Attention: The voltage restriction is under DC24V 1A.																											

• For 8CH Model

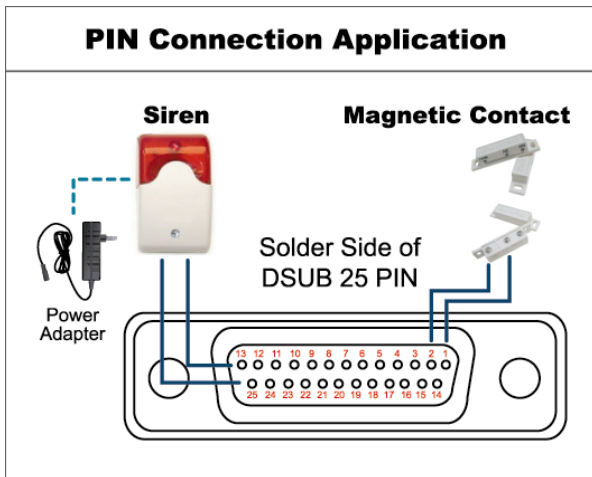

Siren:

When the DVR is triggered by alarm or motion, the COM connects with NO and the siren with strobe starts wailing and flashing.

Magnetic Contact:

When the magnetic contact is opened, the alarm will be triggered and the recording is on.

* The D-Sub connector shown above is optional.

PIN	FUNCTION	DESCRIPTION															
1	GND	GROUND															
2~5	ALARM INPUT	Connect ALARM INPUT (PIN 2 – 5) and GND (PIN 1) connector with wires. Once an alarm is triggered, the DVR will start recording and the buzzer will be on. <table border="1"> <thead> <tr> <th>PIN</th> <th>Alarm</th> <th>Corresponding video channel</th> </tr> </thead> <tbody> <tr> <td>PIN 2</td> <td>1</td> <td>CH1</td> </tr> <tr> <td>PIN 3</td> <td>3</td> <td>CH3</td> </tr> <tr> <td>PIN 4</td> <td>5</td> <td>CH5</td> </tr> <tr> <td>PIN 5</td> <td>7</td> <td>CH7</td> </tr> </tbody> </table>	PIN	Alarm	Corresponding video channel	PIN 2	1	CH1	PIN 3	3	CH3	PIN 4	5	CH5	PIN 5	7	CH7
PIN	Alarm	Corresponding video channel															
PIN 2	1	CH1															
PIN 3	3	CH3															
PIN 4	5	CH5															
PIN 5	7	CH7															
6 ~ 11	PIN OFF	NA															
12	RS485-A																
13	EXTERNAL ALARM NO.	Under the normal operation, COM disconnects with NO. But when any alarm is triggered, COM connects with NO. Attention: The voltage restriction is under DC24V 1A.															
14	PIN OFF	NA															
15~18	ALARM INPUT	Connect ALARM INPUT (PIN 15 – 18) and GND (PIN 1) connector with wires. Once an alarm is triggered, the DVR will start recording and the buzzer will be on. <table border="1"> <thead> <tr> <th>PIN</th> <th>Alarm</th> <th>Corresponding video channel</th> </tr> </thead> <tbody> <tr> <td>PIN 15</td> <td>2</td> <td>CH2</td> </tr> <tr> <td>PIN 16</td> <td>4</td> <td>CH4</td> </tr> <tr> <td>PIN 17</td> <td>6</td> <td>CH6</td> </tr> <tr> <td>PIN 18</td> <td>8</td> <td>CH8</td> </tr> </tbody> </table>	PIN	Alarm	Corresponding video channel	PIN 15	2	CH2	PIN 16	4	CH4	PIN 17	6	CH6	PIN 18	8	CH8
PIN	Alarm	Corresponding video channel															
PIN 15	2	CH2															
PIN 16	4	CH4															
PIN 17	6	CH6															
PIN 18	8	CH8															
19~23	PIN OFF	NA															
24	RS485-B																
25	EXTERNAL ALARM COM	Under the normal operation, COM disconnects with NO. But when any alarm is triggered, COM connects with NO. Attention: The voltage restriction is under DC24V 1A.															

• For 4CH Model

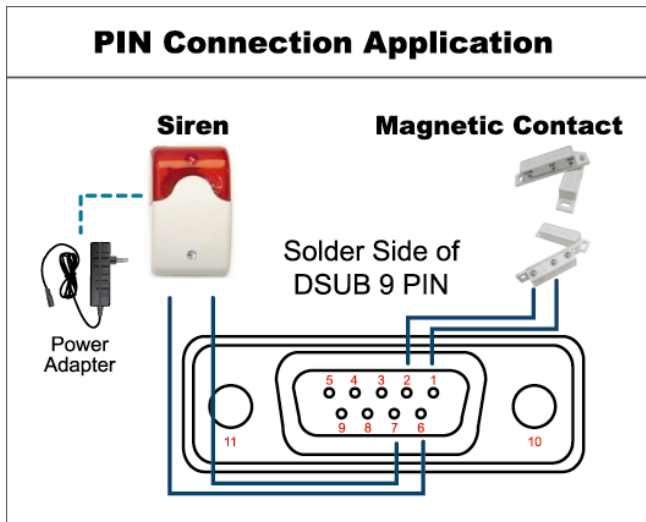

Siren:

When the DVR is triggered by alarm or motion, the COM connects with NO and the siren with strobe starts wailing and flashing.

Magnetic Contact:

When the magnetic contact is opened, the alarm will be triggered and the recording is on.

* The D-Sub connector shown above is optional.

PIN	FUNCTION	DESCRIPTION															
1~4	ALARM INPUT	Connect ALARM INPUT (PIN1 – 4) and GND (PIN5) connector with wires. Once an alarm is triggered, the DVR will start recording and the buzzer will be on. <table border="1" style="margin-left: 20px;"> <thead> <tr> <th>PIN</th> <th>Alarm</th> <th>Corresponding video channel</th> </tr> </thead> <tbody> <tr> <td>PIN 1</td> <td>1</td> <td>CH1</td> </tr> <tr> <td>PIN 2</td> <td>2</td> <td>CH2</td> </tr> <tr> <td>PIN 3</td> <td>3</td> <td>CH3</td> </tr> <tr> <td>PIN 4</td> <td>4</td> <td>CH4</td> </tr> </tbody> </table>	PIN	Alarm	Corresponding video channel	PIN 1	1	CH1	PIN 2	2	CH2	PIN 3	3	CH3	PIN 4	4	CH4
PIN	Alarm	Corresponding video channel															
PIN 1	1	CH1															
PIN 2	2	CH2															
PIN 3	3	CH3															
PIN 4	4	CH4															
5	GND	GROUND															
6	EXTERNAL ALARM COM	Under the normal operation, COM disconnects with NO. But when any alarm is triggered, COM connects with NO. Attention: The voltage restriction is under DC24V 1A.															
7	EXTERNAL ALARM NO	Under the normal operation, COM disconnects with NO. But when any alarm is triggered, COM connects with NO. Attention: The voltage restriction is under DC24V 1A.															
8	RS485-A																
9	RS485-B																
10~11	GND	GROUND															

APPENDIX 7 DVD WRITER INSTALLATION

Some DVR models allow users to install a DVD writer by themselves. To know whether your DVR supports this feature, please check with your local distributor or retailer.

The supported DVD writer models are as follows. Please use only the suggested DVD writer models to ensure the compatibility.

Type	Brand	Model
SATA	Liteon	iHAS120
	SONY	AD-7240S

Note: Before installing the DVD writer, make sure your DVR is powered off and your DVR supports this feature.

Step1: Remove the DVR cover, and find the DVD writer bracket to remove it.

Step2: Put the DVD writer in the bracket, and fix it to the bracket with two screws (optional) on each side.

Step3: Connect the data bus and power cables* to the SATA DVD writer.



**Data bus & power cables are optional.*

Step4: Connect the data bus and power cables to the data bus and power jack on the DVR main board.

Note: Make sure the power cable of the DVD writer is plugged into the **black** jack on the DVR main board. This power jack can supply power to one hard disk and one DVD writer simultaneously. The white jack is used to supply power to only one hard disk.



Step5: Replace the bracket to the DVR base and fix it.

APPENDIX 8 DVD- / CD-ROM COMPATIBLE LIST

• DVD-ROM List

Disc Type	Manufacturer	Disc MID-TID Code
20X DVD+R	RITEK	RITEK R05 (rev.och)
16X DVD+R	SONY	SONY....-D21
	TAIYO YUDEN	YUDEN000-T03
	mitsubishi	MCC.....-004
	TDK	TDK.....-003
	MAXELL	MAXELL..003
	MBI	MBIPG101-R05
	CMC	CMC MAG.-M01
	DAXON	DAXON...-AZ3
	RITEK	RITEK...-R05
	PRODISC	PRODISC.-R05
8X DVD+R	TAIYO YUDEN	YUDEN000-T02
	mitsubishi	MCC.....-003
	CMC	CMC MAG.-E01
	PRODISC	PRODISC.-R03
8x DVD+RW	Ritek	RITEK...-008
	mitsubishi	MKM.....-A03
4X DVD+RW	SONY	SONY....-S11
	mitsubishi	MKM.....-A02
	RITEK	RITEK...-004
16X DVD+R9	RITEK	RITEK S06
8X DVD+R9	mitsubishi	MKM.....-003
	CMC	CMC MAG-D02
	RITEK	RITEK...-D03
2.4X DVD+R9	mitsubishi	MKM.....-001
20X DVD-R	RITEK	RITEKF-2
16x DVD-R	SONY	SONY16-D1
	TAIYO YUDEN	TYG03
	mitsubishi	MCC 03 RG20
	TDK	TTH02
	MAXELL	MXL RG04
	MBI	MBI 01-RG40
	CMC	CMC MAG.AM3
	RITEK	RITEK F1
8X DVD-R	RITEK	RITEKG 05
	SONY	SONY08 D1
	PRODISC	PRODISCS04
	TAIYO YUDEN	TYG02
	mitsubishi	MCC 02RG20
	TDK	TTH01
	MAXELL	MXL RG03
	CMC	CMC MAG.AE1

Disc Type	Manufacturer	Disc MID-TID Code
6X DVD-RW	MITSUBISHI	MCC 01RW6X01
	JVC	JVC1Victord7
	RITEK	RITEK W06
4X DVD-RW	MITSUBISHI	MCC 01RW4X
	TDK	TDK601saku
	RITEK	RITEKW04
2X DVD-RW	MITSUBISHI	MCC 01RW11N9
	JVC	JVC_VictorW7
	TDK	TDK502 sakuM3
	CMC	CMCW02
	RITEK	RITEK W01
12X DVD-R9	MKM	MKM 04 RD30
8X DVD-R9	TY	TYG11
	MITSUBISHI	MKM 03 RD30
	RITEK	RITEKP 02
4X DVD-R9	MITSUBISHI	MKM 01 RD30
	RITEK	RITEKP 01
12X DVD-RAM	MAXELL	MXL22.
5X DVD-RAM	Matsushita	Matsushita-M01J5006
	MAXELL	MXL16.
3X DVD-RAM	MAXELL	MXL9.
	Matsushita	Matsushita-M01J3003

• **CD-ROM List**

Disc Type	Manufacturer	Disc Type	Manufacturer
52X CD-R	MCC	12X CD-RW	MCC
	MBI		MBI
	TAIYO YUDEN		DAXON
	RITEK		RITEK
	UME		MCC
	PRODISC		DAXON
	DAXON		Lead Data
	TDK	PRINCO	
	CMC	10X CD-RW	CMC
	Princo	4X CD-RW	MCC
	Lead Data		DAXON
	Postec		CMC
	Giga		RITEK
TAIYO YUDEN	DAXON		
32X CD-R	TAIYO YUDEN	4X CD-RW (8 cm)	INFODISC
24X CD-RW	MCC		
	INFODISC		