



# HUMMINBIRD®

## Product Manual



**Installation and Operations Manual**  
••••• **1158c Combo & 1198c SI Combo**

## Thank You!

---

Thank you for choosing Humminbird®, America's #1 name in fishfinders. Humminbird® has built its reputation by designing and manufacturing top-quality, thoroughly reliable marine equipment. Your Humminbird® is designed for trouble-free use in even the harshest marine environment. In the unlikely event that your Humminbird® does require repairs, we offer an exclusive Service Policy - free of charge during the first year after purchase, and available at a reasonable rate after the one-year period. For complete details, see the **Warranty** section in this manual. We encourage you to read this installation and operations manual carefully in order to get full benefit from all the features and applications of your Humminbird® product.

Contact our Customer Resource Center at **1-800-633-1468** or visit our Web site at **humminbird.com**.

**WARNING!** *This device should not be used as a navigational aid to prevent collision, grounding, boat damage, or personal injury. When the boat is moving, water depth may change too quickly to allow time for you to react. Always operate the boat at very slow speeds if you suspect shallow water or submerged objects.*

**WARNING!** *The electronic chart in your Humminbird® unit is an aid to navigation designed to facilitate the use of authorized government charts, not to replace them. Only official government charts and notices to mariners contain all of the current information needed for the safety of navigation, and the captain is responsible for their prudent use.*

**WARNING!** *Disassembly and repair of this electronic unit should only be performed by authorized service personnel. Any modification of the serial number or attempt to repair the original equipment or accessories by unauthorized individuals will void the warranty.*

**WARNING!** *This product contains chemicals known to the State of California to cause cancer and/or reproductive harm.*

**WARNING!** *Do not travel at high speed with the unit cover installed. Remove the unit cover before traveling at speeds above 20 mph.*

**NOTE:** *Some features discussed in this manual require a separate purchase, and some features are only available on international models. Every effort has been made to clearly identify those features. Please read the manual carefully in order to understand the full capabilities of your model.*

**ATTENTION INTERNATIONAL CUSTOMERS:** Products sold in the U.S. are not intended for use in the international market. Humminbird® international units provide international features and are designed to meet country and regional regulations. Languages, maps, time zones, units of measurement, and warranty are examples of features that are customized for Humminbird® international units purchased through our authorized international distributors.

To obtain a list of authorized international distributors, please visit our Web site at **humminbird.com** or contact our Customer Resource Center at **(334) 687-6613**.

XM WX® is a registered trademark of XM Satellite Radio and Weather to the Power of X® is a registered trademark of XM Satellite Radio Inc. All rights reserved.

ProMap™ and LakeMaster® are trademarked by or registered trademarks of Waypoint Technologies, Inc.

Navionics® Gold, HotMaps™, and HotMaps™ Premium, Navionics® Classic Charts, and Platinum™ Cartography are trademarked by or registered trademarks of Navionics®.

1100 Series™, Cannon®, CannonLink™, Contour XD™, Down Imaging™, DualBeam PLUS™, Fish ID+™, HumminbirdPC™, Humminbird®, InterLink™, QuadraBeam PLUS™, RTS™ Window, Side Imaging®, SwitchFire™, Structure ID®, Total Screen Update™, UniMap™, WeatherSense®, WhiteLine™, and X-Press™ Menu are trademarked by or registered trademarks of Humminbird®.

© 2010 Humminbird®, Eufaula AL, USA. All rights reserved.

# Table of Contents

---

<b>1100 Series™ Introduction</b>	<b>1</b>
How Sonar Works .....	1
High Definition Side Imaging® Sonar ( <i>1198c SI Combo models only</i> ) .....	3
DualBeam PLUS™ Sonar ( <i>1158c, 1198c SI</i> ) .....	3
QuadraBeam PLUS™ Sonar ( <i>optional-purchase QuadraBeam PLUS™ transducer only</i> ) .....	4
<b>Universal Sonar 2</b>	<b>4</b>
<b>How GPS and Cartography Work</b>	<b>5</b>
<b>Fishing System Configuration</b>	<b>6</b>
Video-Out and RS 232 Connectors .....	7
Ethernet Connector .....	7
Accessory Bus .....	8
<b>Installation Overview</b>	<b>9</b>
<b>Control Head Installation</b>	<b>9</b>
Gimbal Mounting the Control Head .....	9
In-Dash Mounting the Control Head .....	15
Connecting the Control Head Power Cable to the Boat .....	18
<b>Transducer Installation Overview</b>	<b>19</b>
1198c SI Transom Mount Transducer Installation <i>Side Imaging® Transducer, XHS 9 HDSI 180T (1198c SI only)</i> .....	20
Overview <i>Side Imaging® Transducer, XHS 9 HDSI 180T (1198c SI only)</i> .....	21
1158c Transom Mount Transducer Installation <i>DualBeam PLUS™ Transducer, XNT 9 20 T (1158c only)</i> .....	28
Locking Down the Transducer ( <i>Optional</i> ) .....	39
1158c Inside the Hull Transducer Installation <i>DualBeam PLUS™ Transducer, XNT 9 20 T (1158c only)</i> .....	40
Trolling Motor Transducer Installation .....	44
Trolling Motor Transducer Options .....	44
<b>GPS Receiver Installation Overview</b>	<b>45</b>
1. GPS Receiver Cable Wires ( <i>optional</i> ) .....	45
2a. Stem Mounting with an Existing 1" - 14 Thread Stem .....	45
2b. Access Under Mounting Location .....	46
2c. No Access Under Mounting Location .....	47
3. Finish Routing the Cable and Check GPS Receiver Operation .....	48
<b>Testing the System Installation</b>	<b>49</b>

---



# Table of Contents

---

<b>Power On the Control Head</b>	<b>50</b>
<b>What's on the Control Head</b>	<b>51</b>
<b>Key Functions</b>	<b>52</b>
POWER/LIGHT Key .....	52
VIEW Key .....	52
MENU Key.....	53
4-WAY Cursor Control Key ( <i>RIGHT, LEFT, UP, or DOWN Cursor Keys</i> ) .....	53
VIEW PRESET Keys .....	54
EXIT Key.....	54
INFO Key .....	54
MARK Key .....	55
GOTO Key.....	55
ZOOM (+/-) Keys.....	55
<b>SD Memory Card Slots</b>	<b>56</b>
Add Maps to Your Fishing System .....	57
Update Software.....	58
Export Navigation Data.....	59
<b>What's on the Sonar Display</b>	<b>60</b>
Understanding the Sonar Display .....	62
Real Time Sonar (RTS™) Window .....	62
SwitchFire™ .....	63
Freeze Frame and Active Cursor.....	63
Instant Image Update.....	63
Sonar Bottom Presentation .....	64
<b>What's on the Side Imaging® Display (1198c SI Combo models only)</b>	<b>66</b>
Understanding the Side Imaging® Display .....	68
Side Imaging® Frequencies and Coverage.....	69
For Best Performance .....	70
On the Water Interpretation.....	71
<b>Views</b>	<b>74</b>
Side Imaging® View (1198c SI only) .....	76
Down Imaging™ View (1198c SI only).....	79
Sonar View .....	82
Sonar Zoom View .....	84

# Table of Contents

---

Split Sonar View .....	86
Snapshot and Recording View <i>(optional-purchase SD memory card required)</i> .....	87
Side Beam View <i>(optional-purchase QuadraBeam PLUS™ transducer required)</i> .....	93
Bird's Eye View .....	97
Chart View <i>(Chart Views and Chart Combo Views)</i> .....	99
Combo Views .....	101
Combo Views: Functions .....	101
Side Imaging®/Sonar Combo View <i>(1198c SI only)</i> .....	102
Chart/Bird's Eye Combo View .....	103
Chart/Chart Combo View .....	104
Chart/Sonar Combo View .....	105
Chart/Side Imaging® Combo View <i>(1198c SI only)</i> .....	106
Down Imaging™/Side Imaging® Combo View <i>(1198c SI only)</i> .....	107
Chart/Down Imaging™ Combo View <i>(1198c SI only)</i> .....	108
Down Imaging™/Sonar Combo View <i>(1198c SI only)</i> .....	109
Down Imaging™/Side Imaging®/Sonar Combo View <i>(1198c SI only)</i> .....	110
Chart Orientation .....	111

---

## Viewing Cartography **111**

---

### Introduction to Navigation **113**

Waypoints, Routes, and Tracks .....	113
Save, Edit, or Delete a Waypoint .....	115
Navigate to a Waypoint or Position .....	116
Add a Waypoint Target or Trolling Grid .....	117
Save, Edit or Delete a Route .....	120
Save or Clear a Current Track.....	121
Edit, Delete, or Hide Saved Tracks .....	121
Man Overboard (MOB) Navigation .....	122

---

### The Menu System **124**

---

#### Start-Up Options Menu **125**

Normal.....	125
Simulator .....	126
System Status .....	127
Accessory Test.....	128
GPS Diagnostic View .....	129

# Table of Contents

---

<b>X-Press™ Menu</b>	<b>130</b>
<b>Main Menu</b>	<b>131</b>
Quick Tips for the Main Menu .....	132
Note for all Menu Settings.....	132
User Mode (Normal or Advanced) .....	133
<b>Sonar X-Press™ Menu</b>	<b>135</b>
Active Side ( <i>Combo Views only</i> ) .....	136
Split Position ( <i>Combo Views only</i> ) .....	136
Sensitivity .....	137
Upper Range ( <i>Advanced: Sonar, Split Sonar and Active Sonar Side Views only</i> ) .....	138
Lower Range .....	138
Chart Speed .....	139
Quad Layout ( <i>with optional-purchase QuadraBeam PLUS™ Transducer, Side Beam View only</i> ) .....	139
Bottom Lock ( <i>Sonar Zoom View only</i> ) .....	139
Bottom Range ( <i>Sonar Zoom View only, when Bottom Lock is On</i> ) .....	140
Cancel Navigation ( <i>only when Navigating</i> ) .....	140
<b>Side Imaging® X-Press™ Menu (<i>Side Imaging® Views only [1198c SI]</i>)</b>	<b>141</b>
Active Side ( <i>Combo Views only</i> ) .....	142
Split Position ( <i>Combo Views only</i> ) .....	142
SI Side .....	142
SI Sensitivity .....	142
SI Enhance .....	143
SI Range .....	143
Chart Speed .....	144
SI Colors .....	144
Cancel Navigation ( <i>only when Navigating</i> ) .....	144
<b>Down Imaging™ X-Press™ Menu (<i>Down Imaging™ Views only [1198c SI]</i>)</b>	<b>145</b>
Active Side ( <i>Combo Views only</i> ) .....	146
Split Position ( <i>Combo Views only</i> ) .....	146
Down Sensitivity .....	146
Upper Range ( <i>Advanced: Down Imaging™ Views only</i> ) .....	147
Lower Range .....	147
Chart Speed .....	148
SI Colors .....	148
Down Imaging Beam Width ( <i>Advanced, Down Imaging™ View only</i> ) .....	148
Cancel Navigation ( <i>only when Navigating</i> ) .....	148

# Table of Contents

---

<b>Navigation X-Press™ Menu</b>	<b>149</b>
Active Side <i>(Combo Views only)</i> .....	150
Split Position <i>(Combo Views only)</i> .....	150
Waypoint [Name] <i>(Only with an active cursor on a waypoint)</i> .....	150
Cursor to Waypoint <i>(Chart or Combo View only)</i> .....	151
Save Current Track .....	151
Clear Current Track .....	151
Save Current Route <i>(only when Navigating)</i> .....	151
Skip Next Waypoint <i>(only when Navigating)</i> .....	151
Cancel Navigation <i>(only when Navigating)</i> .....	152
Cancel MOB Navigation <i>(only when MOB Navigation is activated)</i> .....	152
Remove Target <i>(only if a Target is Active)</i> .....	152
Remove Grid <i>(only if a Grid is Active)</i> .....	152
Waypoint [Name] <i>(Most recently-created waypoint)</i> .....	153
<b>Snapshot and Recording X-Press™ Menu <i>(Snapshot and Recording View only)</i></b>	<b>154</b>
Start Recording <i>(optional-purchase SD Card, Snapshot and Recording View only)</i> .....	155
Stop Recording <i>(optional-purchase SD Card only)</i> .....	155
Delete Image <i>(optional-purchase SD Card, Snapshot and Recording View only)</i> .....	155
Delete All Images <i>(optional-purchase SD Card, Snapshot and Recording View only)</i> .....	155
Delete Recording <i>(optional-purchase SD Card, Snapshot and Recording View only)</i> .....	155
Delete All Recordings <i>(optional-purchase SD Card, Snapshot and Recording View only)</i> .....	156
Pings Per Second <i>(optional-purchase SD Card, Snapshot and Recording View only)</i> .....	156
Playback Speed <i>(optional-purchase SD Card, Snapshot and Recording View only)</i> .....	156
Stop Playback <i>(optional-purchase SD Card only)</i> .....	157
<b>Alarms Menu Tab</b>	<b>158</b>
Alarm Volume .....	159
Depth Alarm .....	159
Fish ID Alarm .....	159
Low Battery Alarm .....	160
Aux. Temp Alarm <i>(with optional-purchase Temp. probe or Temp/Speed only)</i> .....	160
Temp. Alarm .....	160
Off Course Alarm .....	161
Arrival Alarm .....	161
Drift Alarm .....	162

# Table of Contents

---

<b>Sonar Menu Tab</b>	<b>163</b>
Beam Select .....	164
Side View Frequency ( <i>Side Imaging® and Down Imaging™ Views only [1198c SI]</i> ) .....	164
Surface Clutter .....	165
SwitchFire™ .....	165
Fish ID+ .....	166
Fish ID Sensitivity .....	166
Real Time Sonar (RTS™) Window .....	167
Sonar Colors .....	168
Bottom View .....	168
Zoom Width ( <i>Sonar Zoom View only</i> ) .....	168
83 kHz Sensitivity ( <i>Advanced</i> ) .....	168
455 kHz Sensitivity ( <i>Advanced, with optional purchase QuadraBeam PLUS™ transducer</i> ) .....	169
Depth Lines ( <i>Advanced</i> ) .....	169
SI Range Lines ( <i>Advanced, Side Imaging® View only</i> ) .....	170
Noise Filter ( <i>Advanced</i> ) .....	170
Max Depth ( <i>Advanced</i> ) .....	171
Water Type ( <i>Advanced</i> ) .....	171
Transducer Select .....	172
Color Bar .....	172
Temperature Graph ( <i>Sonar View only, with Temperature input</i> ) .....	173
Down Imaging Beam Width ( <i>Advanced</i> ) .....	173
Contour Mode ( <i>Side Imaging® View only</i> ) .....	173
<b>Navigation Menu Tab</b>	<b>174</b>
Current Track .....	175
Saved Tracks .....	175
Waypoints .....	176
Routes .....	177
Chart Orientation .....	177
North Reference .....	177
Waypoint Decluttering ( <i>Advanced</i> ) .....	178
Trolling Grid Rotation .....	178
Trackpoint Interval .....	178
Track Min Distance ( <i>Advanced</i> ) .....	178
Track Color Range .....	179

# Table of Contents

---

Map Datum ( <i>Advanced</i> ) .....	179
Course Projection Line .....	179
3D View Outline .....	179
Export All Nav Data .....	179
Delete All Nav Data ( <i>Advanced</i> ) .....	179
Continuous Navigation Mode .....	180
GPS Receiver Override ( <i>Advanced</i> ) .....	180

## **Chart Menu Tab** **181**

---

Lat/Lon Grid .....	182
Nav aids on Bird's Eye View .....	182
Chart Select.....	182
Set Simulation Position ( <i>Advanced</i> ).....	182
Set Map Offset ( <i>Advanced</i> ) .....	183
Clear Map Offset ( <i>Advanced</i> ).....	183
Shaded Depth .....	183
Chart Detail Level ( <i>optional-purchase Navionics® charts only</i> ) .....	183
Map Borders .....	184
Spot Soundings ( <i>optional-purchase Navionics® charts only</i> ) .....	184
NVB Chart Preference.....	184
Contour Lines ( <i>optional-purchase LakeMaster® charts only</i> ) .....	185
Depth Colors ( <i>optional-purchase LakeMaster® charts only</i> ) .....	185
Depth Highlight ( <i>optional-purchase LakeMaster® charts only</i> ) .....	185
Depth Highlight Range (+/-) ( <i>optional-purchase LakeMaster® charts only</i> ) .....	185
Water Level Offset ( <i>optional-purchase LakeMaster® charts only</i> ) .....	185
Shallow Water Highlight ( <i>optional-purchase LakeMaster® charts only</i> ) .....	186
Lake List ( <i>optional-purchase LakeMaster® charts only</i> ) .....	186

## **Setup Menu Tab** **187**

---

Sound Volume .....	188
Units - Depth.....	188
Units - Temp ( <i>International only</i> ).....	188
Units - Distance ( <i>with Speed input only</i> ) .....	188
Units - Speed ( <i>with Speed input only</i> ) .....	188
User Mode .....	189
Language ( <i>International only</i> ) .....	189

# Table of Contents

---

Triplog Reset ( <i>with Speed input only</i> ) .....	189
Restore Defaults .....	189
Select Readouts ( <i>Advanced, Non-Navigation Mode</i> ) .....	190
Select Nav Readouts ( <i>Advanced, Navigation Mode</i> ) .....	192
Depth Offset ( <i>Advanced</i> ) .....	194
Aux. Temp Offset ( <i>Advanced</i> ).....	194
Temp. Offset ( <i>Advanced</i> ) .....	194
Speed Calibration ( <i>Advanced, with Speed paddlewheel only</i> ) .....	194
Local Time Zone ( <i>Advanced</i> ) .....	194
Daylight Saving Time ( <i>Advanced</i> ) .....	194
Position Format ( <i>Advanced</i> ) .....	195
Time Format ( <i>Advanced, International only</i> ) .....	195
Date Format ( <i>Advanced, International only</i> ) .....	195
Digits Format ( <i>Advanced</i> ).....	195
NMEA Output ( <i>Advanced</i> ) .....	196
Sonar .....	196
Demonstration.....	196
Video Out.....	196
<b>Views Menu Tab</b> .....	<b>197</b>
<b>Accessories Menu Tab</b> .....	<b>198</b>
Screen Snapshot ( <i>optional-purchase SD Cards only</i> ) .....	199
AIS ( <i>optional-purchase AIS equipment only</i> ) .....	199
<b>Troubleshooting</b> .....	<b>203</b>
1100 Series™ Doesn't Power Up .....	203
1100 Series™ Defaults to Simulator with a Transducer Attached .....	203
<b>Display Problems</b> .....	<b>204</b>
<b>Finding the Cause of Noise</b> .....	<b>205</b>
<b>1-Year Limited Warranty</b> .....	<b>206</b>
<b>Humminbird® Service Policy</b> .....	<b>206</b>
<b>Returning Your Unit for Service</b> .....	<b>207</b>
<b>1100 Series™ Fishing System Accessories</b> .....	<b>209</b>

---

# Table of Contents

---

<b>Specifications</b>	<b>211</b>
<b>Glossary</b>	<b>213</b>
<b>Appendix A - Transducer Mounting Template: XHS 9 HDSI 180 T</b>	<b>219</b>
<b>Contact Humminbird®</b>	<b>220</b>

**NOTE:** Entries in this Table of Contents which list (International only) are only available on products sold outside of the U.S. by our authorized international distributors. To obtain a list of authorized international distributors, please visit our Web site at [humminbird.com](http://humminbird.com) or contact our Customer Resource Center at (334) 687-6613.

**NOTE:** Entries in this Table of Contents which list (with Speed Input) or (with Temperature Input) may require the purchase of separate accessories. You can visit our Web site at [humminbird.com](http://humminbird.com) to order these accessories online or contact our Customer Resource Center at 1-800-633-1468.



## 1100 Series™ Introduction

---

Your 1100 Series™ Ultra Wide Screen Fishing System comes in several different configurations. See the following list of products, all of which are covered by this manual, to find your 1100 Series™ configuration:

- **Humminbird® 1158c Combo:** Ultra wide screen Fishing System with DualBeam PLUS™ sonar and chartplotting. GPS receiver included.
- **Humminbird® 1198c SI Combo/1198c SI Combo NVB:** Ultra wide screen Fishing System with Side Imaging® Sonar, DualBeam PLUS™ Sonar, and chartplotting. GPS receiver included.

## How Sonar Works

---

Sonar technology is based on sound waves. The 1100 Series™ Fishing System uses sonar to locate and define structure, bottom contour and composition, as well as depth directly below the transducer.

Your 1100 Series™ Fishing System sends a sound wave signal and determines distance by measuring the time between the transmission of the sound wave and when the sound wave is reflected off of an object; it then uses the reflected signal to interpret location, size, and composition of an object.

Sonar is very fast. A sound wave can travel from the surface to a depth of 240 ft (70 m) and back again in less than 1/4 of a second. It is unlikely that your boat can "outrun" this sonar signal.

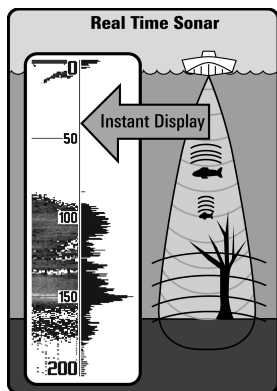

SONAR is an acronym for SOund and NAVigation Ranging. Sonar utilizes precision sound pulses or "pings" which are emitted into the water in a teardrop-shaped beam.

The sound pulses "echo" back from objects in the water such as the bottom, fish, and other submerged objects. The returned echoes are displayed on the LCD screen. Each time a new echo is received, the old echoes are moved across the LCD, creating a scrolling effect.

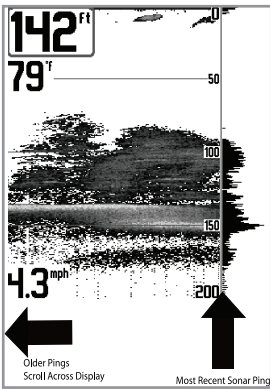

When all the echoes are viewed side by side, an easy to interpret "graph" of the bottom, fish, and structure appears.

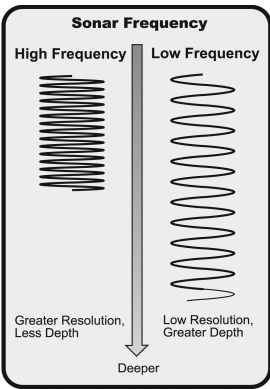

The sound pulses are transmitted at various frequencies depending on the application. Very high frequencies (455 kHz) are used for greatest definition but the operating depth is limited. High frequencies (200 kHz) are commonly used on consumer sonar and provide a good balance between depth performance and resolution. Low frequencies (83 kHz) are typically used to achieve greater depth capability.

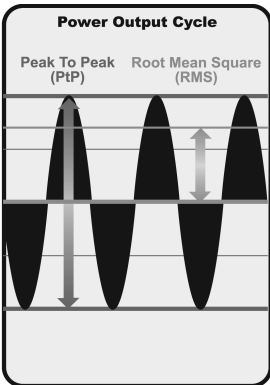

The power output is the amount of energy generated by the sonar transmitter. It is commonly measured using two methods:

- **Root Mean Square (RMS)** measures power output over the entire transmit cycle.
- **Peak to Peak** measures power output at the highest points.

The benefits of increased power output are the ability to detect smaller targets at greater distances, ability to overcome noise, better high speed performance, and enhanced depth capability.

# High Definition Side Imaging® Sonar

(1198c SI Combo models only)

Your 1198c SI Combo uses Side Imaging® sonar to provide a wide yet precise survey of a large area of water, including detailed bottom topography and fish-attracting structure orientation. The Side Imaging® transducer returns are processed into an image similar to an aerial photograph.

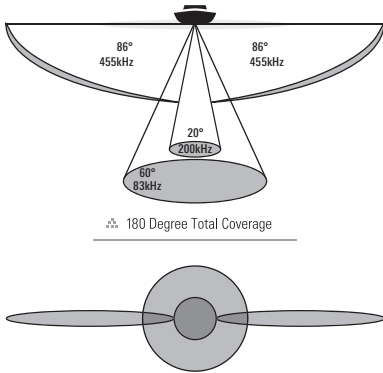

Typically, the Side Imaging® sonar can search an area that is 480 feet wide (240 to each side), with a typical depth performance of 150 feet when the Side Imaging® Sonar frequency is set for 455 kHz. The side beams can be operated at one of two frequencies: 455 kHz or 800 kHz. Selecting 800 kHz produces the sharpest image but the search area to each side and the depth capability are limited as compared to the 455 kHz frequency. See *What's on the Side Imaging® Display* and *Understanding the Side Imaging® Display* for more information.

# DualBeam PLUS™ Sonar (1158c, 1198c SI)

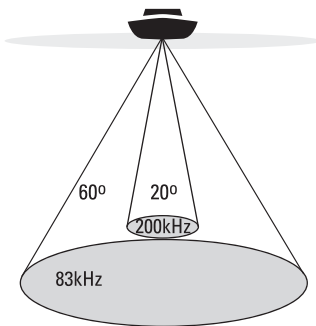

❖ 60 Degree Total Coverage

❖ Bottom Coverage = 1 x Depth

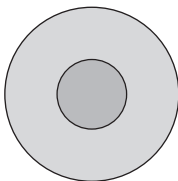

Your 1100 Series™ Fishing System uses a 200/83 kHz DualBeam PLUS™ sonar system with a wide (60°) area of coverage. DualBeam PLUS™ sonar has a narrowly focused 20° center beam, surrounded by a second beam of 60°, expanding your coverage to an area equal to your depth. In 20 feet of water, the wider beam covers an area 20 feet wide. DualBeam PLUS™ sonar returns can be blended together, viewed separately, or compared side-by-side. DualBeam PLUS™ is ideal for a wide range of conditions - from shallow to very deep water in both fresh and salt water. Depth capability is affected by such factors as boat speed, wave action, bottom hardness, water conditions and transducer installation.

## QuadraBeam PLUS™ Sonar

*(optional-purchase QuadraBeam PLUS™ transducer only)*

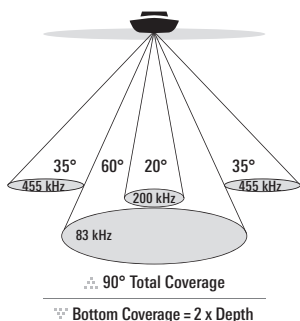

Your Fishing System supports the optional-purchase QuadraBeam PLUS™ transducer. QuadraBeam PLUS™ sonar provides a wide (90°) area of coverage. QuadraBeam PLUS™ starts with two fan-shaped 35° 455 kHz Side Structure locating sonar beams to spot fish, bait, and structure to the left and right of the boat over an area of the bottom that's always equal to twice your depth.

For a detailed view below the boat, QuadraBeam PLUS™ uses DualBeam PLUS™ technology, with precision 20° and wide 60° beams. QuadraBeam PLUS™ finds more fish faster and can even tell you where to put your bait by showing if fish are to the left, right, or directly beneath your boat.

## Universal Sonar 2

Your 1100 Series™ Fishing System supports Universal Sonar 2, a state-of-the-art, integrated and protected transducer that is built into the lower unit of Minn Kota® trolling motors. With Universal Sonar 2, all wiring is concealed inside the indestructible composite shaft—out of sight and out of harm's way, with no clamps, ties, or exposed wires. Universal Sonar 2 features new temperature sensing and the performance of DualBeam PLUS™ technology. An expanded view and greater bottom detail gives you a totally new perspective of the water below, along with optimal sonar performance to help you find fish.

## How GPS and Cartography Work

---

Your Fishing System also supports GPS (Global Positioning System) and chartplotting. It uses GPS and sonar to determine your position, display it on a grid, and provide detailed underwater information.



GPS uses a constellation of satellites that continually send radio signals to the earth. The GPS receiver on your boat receives signals from satellites that are visible to it. Based on time differences between each received signal, the GPS receiver determines its distance to each satellite. With distances known, the GPS receiver mathematically triangulates its own position. With once per second updates, the GPS receiver then calculates its velocity and bearing.

GPS was originally intended for military use; however, civilians may also take advantage of its highly accurate position capabilities, typically within +/- 4.5 meters, depending on conditions. This means that 95% of the time, the GPS receiver will read a location within 4.5 meters of your actual position. Your GPS Receiver also uses information from WAAS (the Wide Area Augmentation System), EGNOS (the European Geostationary Navigation Overlay Service), and MSAS (the MTSAT Satellite Augmentation System) satellites if they are available in your area.

The following GPS functionality is currently supported by the Fishing System when it is connected to the included GPS receiver:

- View current position
- View current track (breadcrumb trail)
- View precision speed and heading from your GPS receiver
- Save tracks, waypoints, and routes
- Travel a route and navigate from one waypoint to the next

See *Chart View* and *SD Memory Card Slots: Add Maps to Your Fishing System* for more information.

# Fishing System Configuration

The Fishing System has a wide variety of configurations that will influence the installation. The accessory bus, video output, ethernet connector, and RS 232 connectors allow you to expand your Fishing System capabilities. As you expand the configuration, the menu options that correspond with the connected accessory will be added to the menu system.

Please read all instructions that are relevant for your configuration before beginning the installation process.

The 1100 Series™ has a wide variety of configurations.

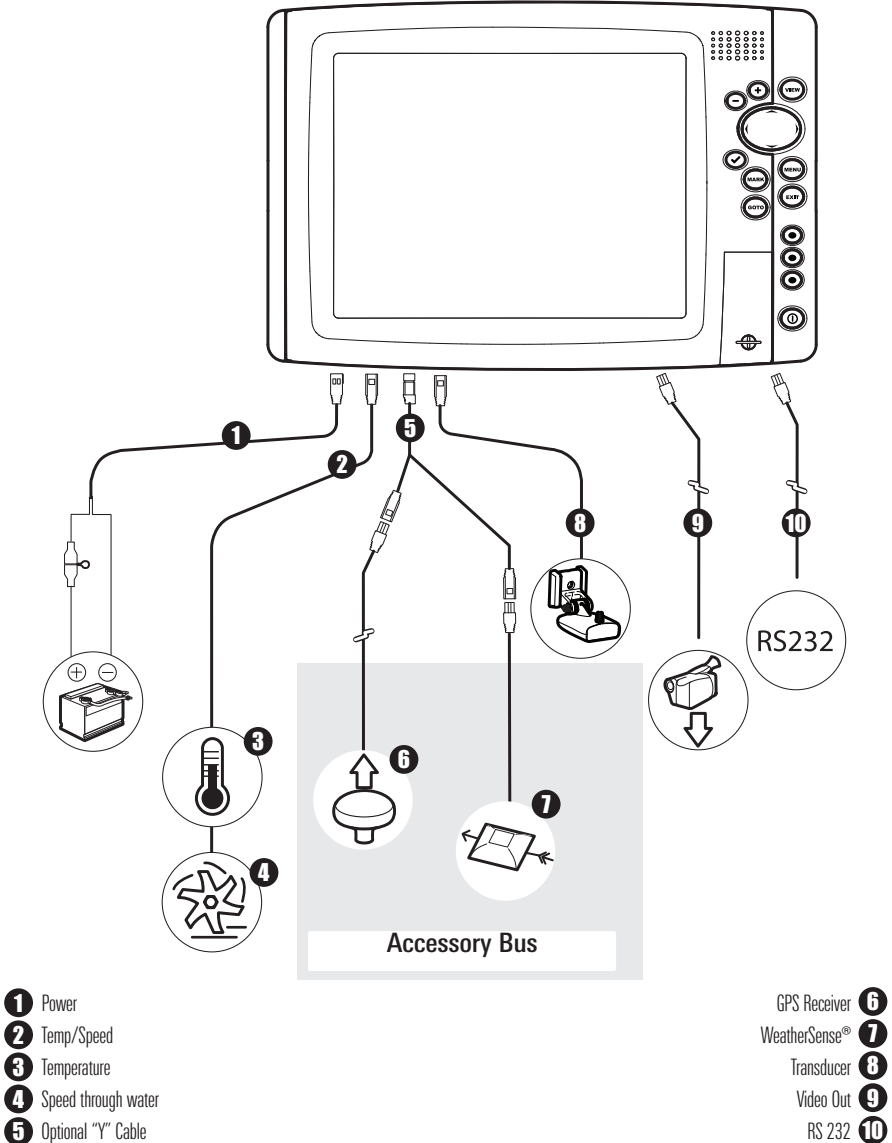

## 1100 Series™ Rear View

- 1 RS 232
- 2 Power
- 3 Communications/GPS
- 4 Video Out
- 5 Ethernet
- 6 Temp/Speed
- 7 Transducer

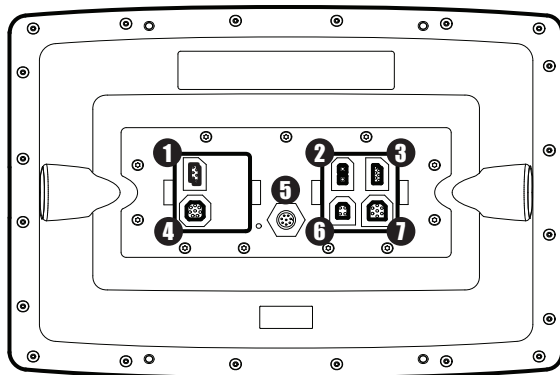

**NOTE:** Accessories connected to the RS 232 or Video-Out connectors require a separate power source.

### Video-Out and RS 232 Connectors

Your unit has a built-in Video Out connector and a dual RS 232 connector, which can be used with optional-purchase equipment such as AIS (Automatic Identification System). If you purchase a video monitor and attach it to your control head using the Video Out connector, your unit will send a video signal if it detects a monitor. See **Setup Menu Tab: Video Out** for more information.

**NOTE:** To purchase a connection cable for an optional-purchase AIS, visit our Web site at [humminbird.com](http://humminbird.com) or contact our Customer Resource Center at **1-800-633-1468**.

**NOTE:** Accessories connected to the RS 232 or Video-Out connectors require a separate power source.

### Ethernet Connector

Your unit has a built-in Ethernet connector so that you can network two Humminbird® units. When you connect the units together using the optional-purchase Humminbird® Ethernet cable, data is shared across the two units and additional menu options are added to the Menu System. See the Ethernet Operations Manual for details.

**NOTE:** The Ethernet cable requires a separate purchase. Visit our Web site at [humminbird.com](http://humminbird.com) or contact our Customer Resource Center at **1-800-633-1468** for details.

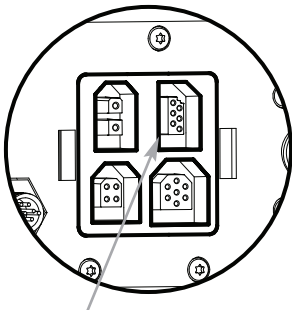

Accessory Bus

## Accessory Bus

---

Use the Accessory Bus to expand the functionality of your Fishing System. Accessories plug directly into the Fishing System and enable advanced features such as WeatherSense® and the AS WX 1 Satellite Weather Receiver.

When an accessory is plugged into the Fishing System, additional functions will be added to the menu system automatically. See **Accessories Menu Tab** and **Fishing System Accessories** in this manual. Also, see the accessory's operations manual for additional details.

**NOTE:** Accessories to enable WeatherSense® and the AS WX 1 Satellite Weather Receiver require separate purchases. Visit our Web site at [humminbird.com](http://humminbird.com) or contact our Customer Resource Center at 1-800-633-1468 for details.



## Installation Overview

---

Inside the boat there is often a channel or conduit used for other wiring, this can be used to route cables. Be sure to route the cable as far as practical from the antenna cable of VHF radios or tachometer cables to reduce the possibility of interference. The transducer and GPS receiver cables should not be cut, and care should be used not to damage the cable insulation.

Basic installation tasks that you must perform include the following:

- **Installing the control head** (choose gimbal or in-dash mounting)
- **Installing the transducer** (choose the installation method that matches your transducer)
- **Installing the GPS Receiver**
- **Testing the complete installation and locking the transducer position**

***NOTE:** Accessories may require a separate purchase. You can visit our Web site at [humminbird.com](http://humminbird.com) to order these accessories online or contact our Customer Resource Center at 1-800-633-1468.*

## Control Head Installation

---

You have two choices for mounting your 1100 Series™ control head, **Gimbal mounting**, where you use a surface on the boat, such as the dash, to mount the control head so that it can be tilted up or down, or **In-dash mounting**.

### Gimbal Mounting the Control Head

---

If you are gimbal mounting the Humminbird® 1100 Series™, you can pre-assemble the unit in order to plan the best mounting location.

- 1 Washer
- 2 Gimbal Knob
- 3 Gimbal Mounting Bracket

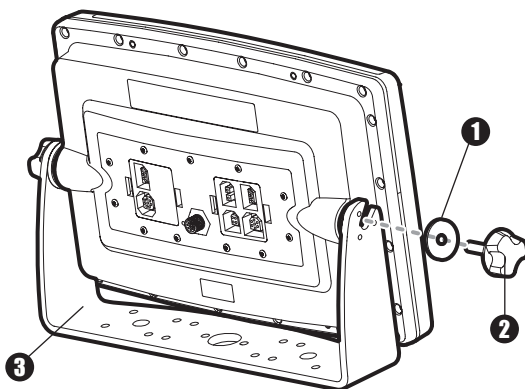

**Supplies:** In addition to the hardware supplied with your control head, you will need a powered hand drill and various drill bits, various hand tools, including a Phillips head screwdriver, a socket wrench and a flat head screwdriver, a marker or pencil, safety glasses and dust mask, and marine-grade silicone sealant.

1. Place the control head into the gimbal bracket. Make sure that the straight side of the gimbal arm is against the back side of the control head.
2. Place a 1" (25 mm) diameter black washer on the gimbal knob and then thread the knob and washer into the housing. Tighten the gimbal knob to secure the control head to the mount. Repeat step 2 for the other side.

You can now place the control head in various locations to decide which is best for mounting. Rotating the mounting bracket to the top of the control head will allow for overhead mounting. The chosen mounting area should allow for sufficient room so the control head can pivot through the full tilt range and allow for easy removal and installation.

**NOTE:** You can drill the cable pass hole underneath the gimbal bracket, allowing you to thread the cables through the hole in the center of the mount; however, if you cannot drill the hole directly under the mounting bracket, then you will need to drill the cable pass hole behind the bracket, and will need to mount the hole cover there instead.

**NOTE:** When drilling holes in fiberglass hulls, it is best to start with a smaller bit and use progressively larger drill bits to reduce the chance of chipping or flaking the outer coating. Fill all holes with marine grade silicone sealant.

**NOTE:** You must have underside access to the mounting location to pass the cables through to the surface. Also, make sure that the mounting surface is adequately supported to protect the control head from excessive wave shock and vibration and provide visibility while in operation.

**NOTE:** Go to the installation instructions applicable to your GPS Receiver and accessories. Make the required installations and then run the cables to your control head mounting location. Do not cut any cabling (except the power cable). If your cables are too short, extensions are available from your local dealer or online from [humminbird.com](http://humminbird.com).

3. After the mounting location has been determined, loosen the gimbal knobs and remove the control head from the gimbal bracket.

**NOTE:** Alternate hole patterns are available on the gimbal mounting bracket, and may match existing holes on the boat. You may choose to use one of these alternate hole patterns.

4. Place the gimbal bracket in the chosen position on the mounting surface and mark the four mounting screw locations using a pencil or center punch.

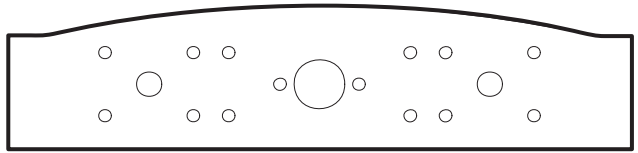

- 1 Mounting Screws
- 2 Washer
- 3 Gimbal Mounting Bracket

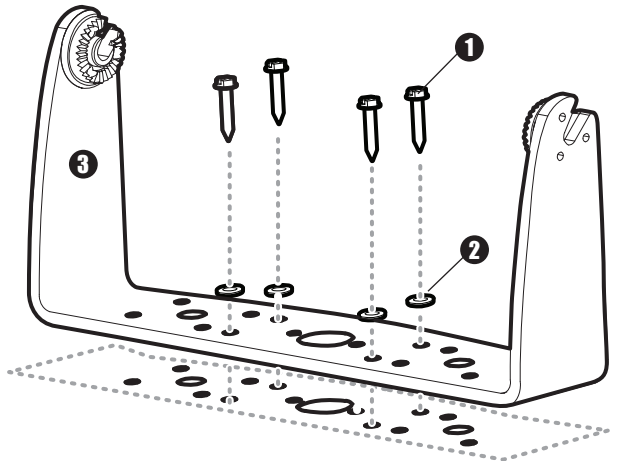

5. Set the gimbal bracket aside and drill the four mounting screw holes using a 5/32" (4.0 mm) drill bit.
- 6a. If the cables must pass through a hole directly beneath the mounting bracket, mark and drill an additional 1" (25 mm) hole centered between the four mounting holes. Route the cables through the 1" hole. Place the gimbal over the mounting surface hole, then use it to mark the position of the two mounting screws, closest to the center large hole. Remove the gimbal and drill the two mounting holes using a 9/64" (3.5 mm) bit. Do not install the hole cover at this time. **or...**
- 6b. If the cables cannot be routed directly beneath the mounting bracket, mark and drill a 1" (25 mm) hole that will allow you to run the cables close to the bracket. Pass the cables through the 1" (25 mm) hole, routing the cables through the grommet and pressing the grommet into place. Place the hole cover over the mounting surface hole, then use it to mark the position of the two mounting screws. Remove the hole cover, drill the two mounting holes using a 9/64" (3.5 mm) bit, fill them with marine-grade silicone sealant, then replace the hole cover and insert the #8 Phillips countersink wood screws. **Hand-tighten only.**
7. Place the mounting bracket on the mounting surface aligned with the drilled holes and fill the mounting holes with marine grade silicone sealant. Insert the four #10 Slotted-Hex wood screws into the mounting holes. **Hand-tighten only.**

8. If the cable pass through hole is beneath the mounting bracket, you will need to install the hole cover after you have routed all cables. Place the hole cover over the mounting bracket cable pass thru hole and align with holes drilled in step 6a. Insert the #8 Phillips countersink wood screws. **Hand tighten only.**

**NOTE:** Be sure that the cables pass through the slots on the hole cover and that there is enough cable slack to allow for the control head to pivot through its full tilt range. Extra cable slack will also help when connecting or disconnecting the cables.

#### Cables Routed Directly Beneath Mounting Bracket

- 1 Gimbal Mounting Bracket
- 2 Hole Cover

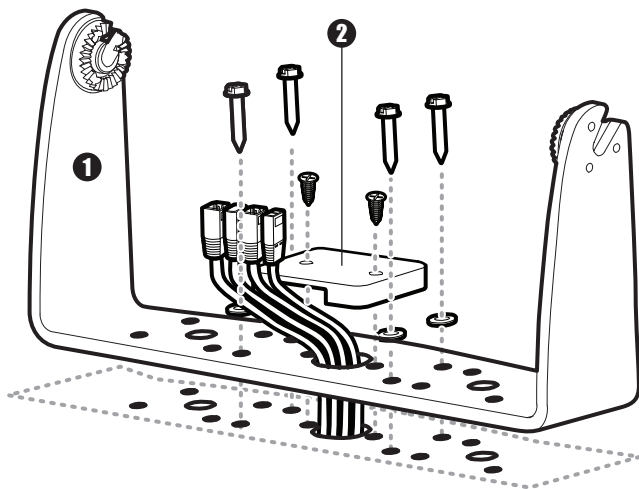

#### Cables Routed Behind Mounting Bracket

- 1 Gimbal Mounting Bracket
- 2 Grommet
- 3 Hole Cover

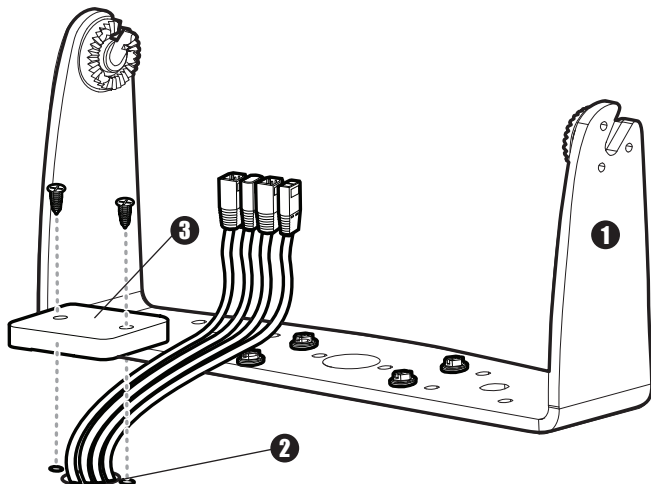

9. Thread the cables through the opening in the back of the cable collector cover.

10. Insert cable connectors into the proper recesses on the cable collector insert. The cable connectors are keyed to prevent reverse installation, so be careful not to force the connectors into the wrong slots. If you don't have a cable for every hole in the insert, install the blank plugs to protect the control head from the weather.

### Inserting the Cables into the Cable Connector Insert

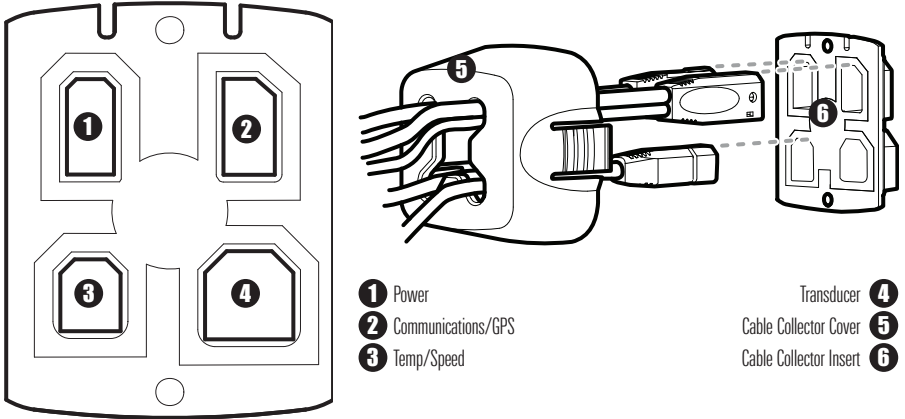

11. Line up the cable collector insert and cover, with the keying feature, then slide the cover into place on the insert.

### Assembling the Cable Collector

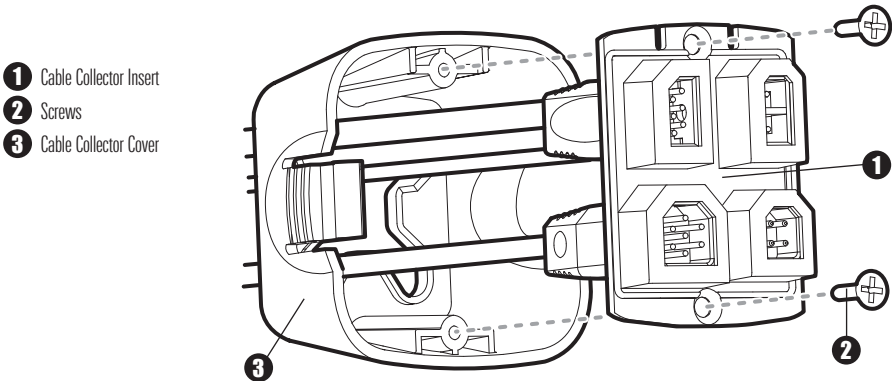

12. Attach the cable collector insert to the cable collector cover using the (2) #6 Phillips screws provided.
13. Place the control head back onto the mounting bracket. Plug the assembled cable collector into the back of the control head, pushing gently but steadily until you feel the collector snap into place. Cable connectors and cable sockets are keyed to prevent reverse installation, so be careful not to force the connectors into the wrong sockets. Adjust the control head to the desired viewing angle and secure by tightening the gimbal knobs.

## Plugging the Assembled Cable Connector into the Back of the Control Head

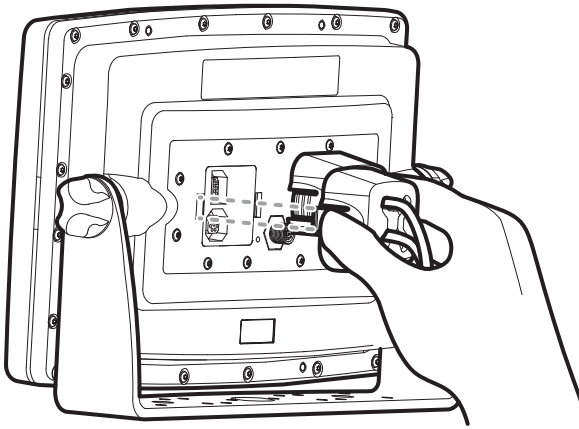

**NOTE:** You may wish to dress the cabling with nylon wire ties in order to hold the cables together and create a cleaner assembly.

## In-Dash Mounting the Control Head

If you are in-dash mounting the control head, start by placing the components on the surfaces where you intend to install them before installation. Make sure that the surfaces you have chosen provide adequate protection from wave shock and that all cables can reach the control head.

**NOTE:** If a cable is too short for your application, extension cables are available. Call Humminbird® Customer Support at 1-800-633-1468 for more information.

Parts and tools specific to In-dash mounting are:

- Threaded rods and hardware
- In-dash mounting foam pads
- In-dash mounting template
- Reciprocating saw for cutting dash material
- Masking tape to hold mounting template in place

1. Locate a suitable, flat area of the dash to mount the control head. The control head requires a depth of at least 4 inches (102 mm).
2. Tape the paper In-Dash Mounting template to the desired in-dash mounting location.
3. At a location inside the dotted line on the template, drill a hole large enough to insert blade of reciprocating saw. In addition, drill the 4 mounting hole locations using a 3/16" drill bit. Carefully begin cutting toward the dotted line, then follow the dotted line around the template. Remove the template when finished.
4. Insert and tighten the four threaded rods into the four threaded inserts located on the back side of the control head. Peel off the adhesive-backed foam pads and place them on the back of the control head; make sure you notice the difference between the longer top/bottom and shorter side pads.

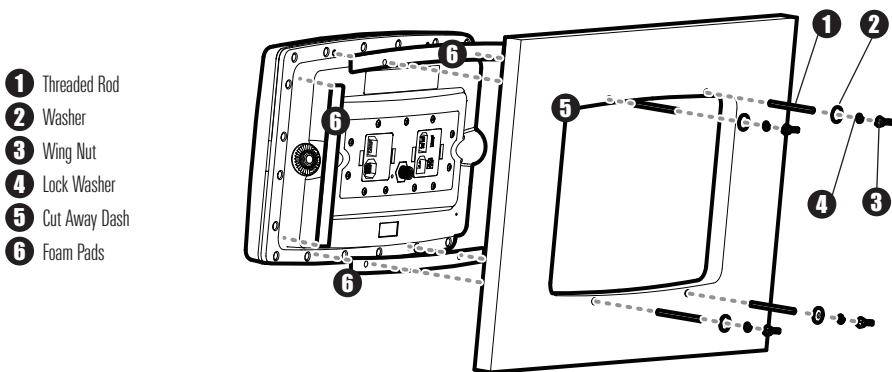

5. Insert the control head through the mounting hole from the front side of the dash. Place a washer, lock washer, and wing nut onto each threaded rod and tighten fully.
6. Thread the cables through the opening in the back of the cable collector cover.
7. Insert cable connectors into the proper recesses on the cable collector insert. The cable connectors are keyed to prevent reverse installation, so be careful not to force the connectors into the wrong slots. If you don't have a cable for every hole in the insert, install the blank plugs to protect the control head from the weather.

### Inserting the Cables into the Cable Connector Insert

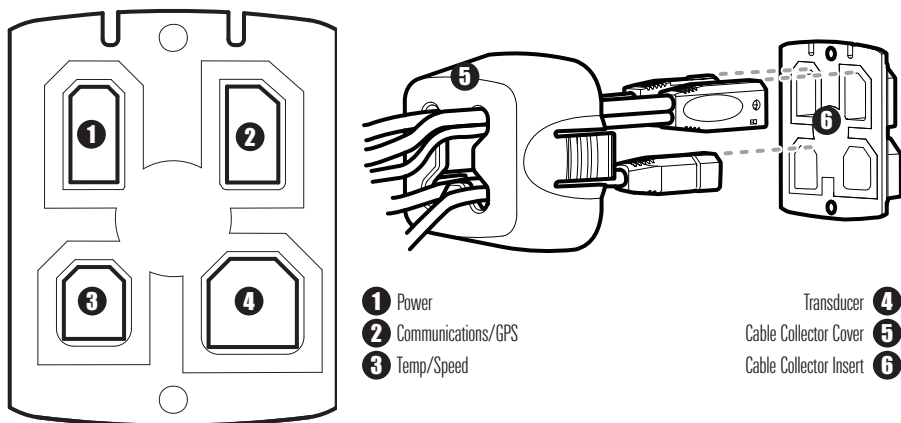

8. Line up the cable collector insert and cover, with the keying feature, then slide the cover into place on the insert.

### Assembling the Cable Collector

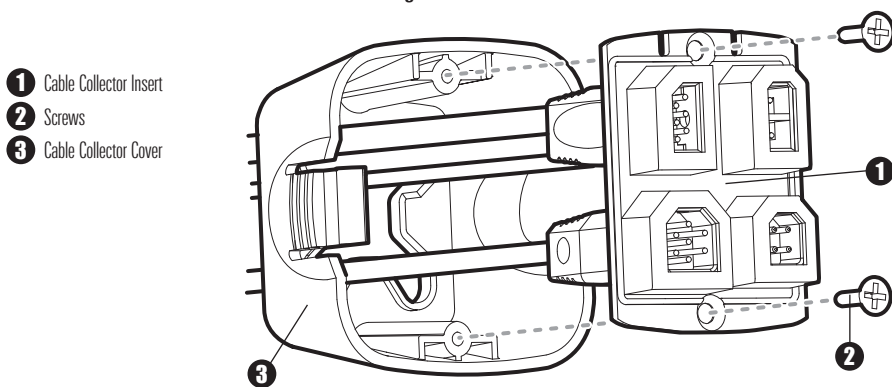



9. Attach the cable collector insert to the cable collector cover using the (2) #6 Phillips screws provided.
10. Plug the assembled cable collector into the back of the control head, pushing gently but steadily until you feel the collector snap into place. Cable connectors and cable sockets are keyed to prevent reverse installation, so be careful not to force the connectors into the wrong sockets.

#### Plugging the Assembled Cable Connector into the Back of the Control Head

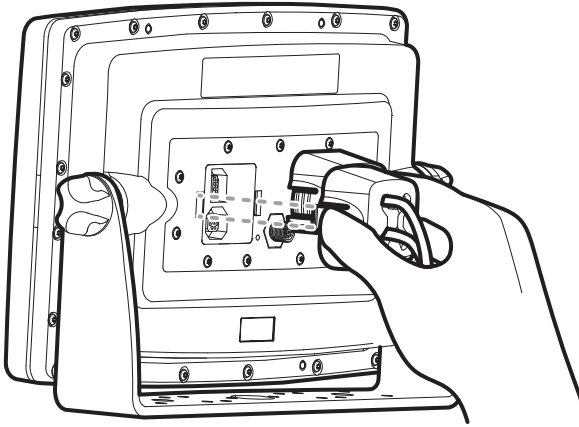

**NOTE:** You may wish to dress the cabling with nylon wire ties in order to hold the cables together and create a cleaner assembly.

**NOTE:** It is very important that the cable collector is used and secured in place in the In-Dash installation.

## Connecting the Control Head Power Cable to the Boat

A 6' (2 m) long power cable is included to supply power to the control head. You may shorten or lengthen the cable using 18 gauge multi-stranded copper wire.

**CAUTION:** Some boats have 24 or 36 Volt electric systems, but the control head **MUST** be connected to a 12 VDC power supply.

The control head power cable can be connected to the electrical system of the boat at one of two places: a fuse panel usually located near the console, or directly to the battery.

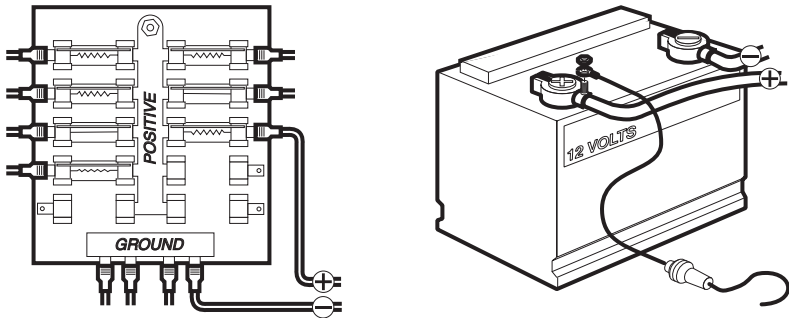

**NOTE:** Make sure that the power cable is disconnected from the control head at the beginning of this procedure.

**NOTE:** Humminbird® is not responsible for over-voltage or over-current failures. The control head must have adequate protection through the proper selection and installation of a 3 Amp fuse.

1a. If a fuse terminal is available, use crimp-on type electrical connectors (not included) that match the terminal on the fuse panel. Attach the black wire to ground (-), and the red wire to positive (+) 12 VDC power. Install a 3 Amp fuse (not included) for protection of the unit. Humminbird® is not responsible for over-voltage or over-current failures.

or...

1b. If you need to wire the control head directly to a battery, obtain and install an inline fuse holder and a 3 Amp fuse (not included) for the protection of the unit. Humminbird® is not responsible for overvoltage or over-current failures.

**NOTE:** Your unit will detect when your battery voltage is too low or too high, and will display either *Input Voltage Low* or *Input Voltage High* messages if these limits are exceeded. If you turn the *Low Battery Alarm* on using the *Alarms Main Menu*, your unit will use your settings. If you do not turn the *Low Battery Alarm* on, the unit will use these limits: 7.5 to 7.9 VDC for the low end, and 21 to 21.2 VDC for the high end.

**NOTE:** In order to minimize the potential for interference with other marine electronics, a separate power source (such as a second battery) may be necessary.

## Transducer Installation Overview

---

Proceed to the installation section that matches your transducer type. Your choices are as follows:

- **1198c SI:** Side Imaging® (XHS 9 HDSI 180T), Transom Mount
- **1158c:** DualBeam PLUS™ (XNT 9 20 T), Transom Mount
- **1158c:** DualBeam PLUS™ (XNT 9 20 T), Inside the Hull Mount
- **All units:** Trolling Motor Transducer Installation

***NOTE:** Due to the wide variety of hulls, only general instructions are presented in this installation guide. Each boat hull represents a unique set of requirements that should be evaluated prior to installation. It is important to read the instructions completely and understand the mounting guidelines before beginning installation.*

***NOTE:** If the included transducer will not work for your application, you may exchange it, NEW and UNASSEMBLED, with mounting hardware included, for a transducer appropriate for your application - often at very little or no charge depending on the transducer. Call the Humminbird® Customer Resource Center at **1-800-633-1468** for details and pricing, or visit **humminbird.com**.*

## 1198c SI Transom Mount Transducer Installation

Side Imaging® Transducer, XHS 9 HDSI 180T (1198c SI only)

**Supplies:** In addition to the hardware supplied with your transducer, you will need a powered hand drill and various drill bits, various hand tools, including a ruler or straightedge, a marker or pencil, safety glasses and dust mask, and marine-grade silicone sealant.

The Side Imaging® transducer has some special requirements because of its side viewing capabilities:

- The Side Imaging® transducer must NOT have anything obstructing the 'view' of the side looking beams, i.e. nothing can be in the line of sight of these beams (not a hull, motor, or other transducer, etc).

**NOTE:** You may need to tilt the motor up and out of the way when using the side looking beams.

- In order for the side beams to be displayed accurately, the transducer must be mounted so that it is looking straight down in the water when the boat is in the water.

Transducer Mount Position

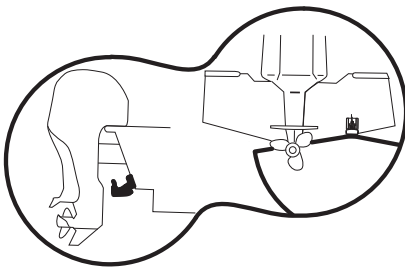

**Unobstructed View:** The jack plate gives the transducer safe distance from the motor and turbulence. The Side Imaging® has a clear view side-to-side.

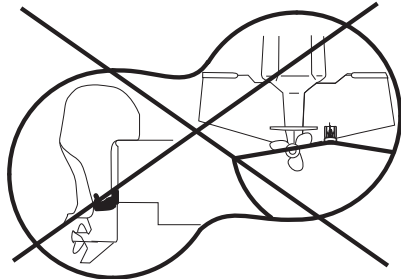

**Obstructed View:** The transducer is too close to motor turbulence, and the Side Imaging® view is blocked by the motor. The view cannot extend from side-to-side.

**NOTE:** If the included transducer will not work for your application, you may exchange it, NEW and UNASSEMBLED, with mounting hardware included, for a transducer appropriate for your application - often at very little or no charge depending on the transducer. Call the Humminbird® Customer Resource Center at 1-800-633-1468 for details and pricing, or visit [humminbird.com](http://humminbird.com).

**NOTE:** When drilling holes in fiberglass hulls, it is best to start with a smaller bit and use progressively larger drill bits to reduce the chance of chipping or flaking the outer coating.

**NOTE:** Due to the wide variety of hulls, only general instructions are presented in this installation guide. Each boat hull represents a unique set of requirements that should be evaluated prior to installation. It is important to read the instructions completely and understand the mounting guidelines before beginning installation.

## Overview *Side Imaging® Transducer, XHS 9 HDSI 180T (1198c SI only)*

If you will be installing a transom mounted transducer, use the procedures in this section. There are two pieces to the transducer mount assembly: the pivot, and the bracket. Your transducer comes with a two-piece metal and plastic bracket assembly. There are several procedures you will have to perform in order to install a transom-mounted transducer. They are as follows:

- Determine transducer mounting location
- Mount the bracket to the boat
- Attach the pivot to the transducer
- Mount the transducer pivot assembly to the bracket
- Adjust the running position of the transducer
- Route the transducer cable
- Perform a final test of the transom transducer installation.

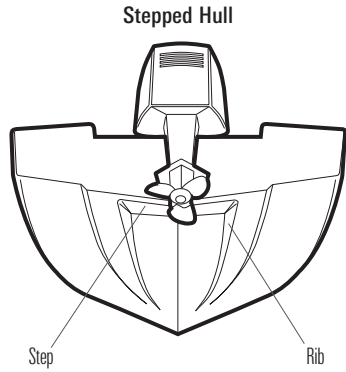
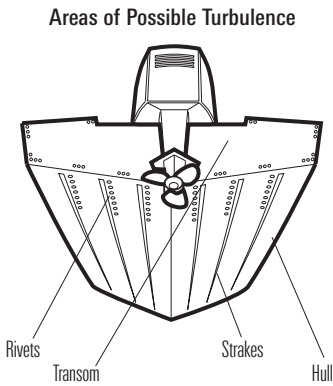

## 1. Locating the Transducer Mounting Location

---

**NOTE:** If transom mounting is not possible because of a stepped hull or cavitation noise, trolling motor installation may be an option. See **Trolling Motor Transducer Installation** for more information.

1. First, determine the best location on the transom to install the transducer. Consider the following to find the best location:

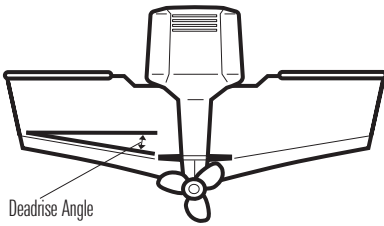

- It is very important to locate the transducer in an area which is relatively free of turbulent water. As a boat moves through the water, turbulence is generated by the weight of the boat, and the thrust of the propeller(s) - either clockwise or counter-clockwise. This turbulent water is normally confined to areas immediately aft of ribs, strakes or rows of rivets on the bottom of the boat, and in the immediate area of the propeller(s). Clockwise propellers create more turbulence on the port side. On outboard or inboard/outboard boats, it is best to locate the transducer at least 15" (380 mm) to the side of the propeller(s).
- The best way to locate turbulence-free water is to view the transom while the boat is moving. This method is recommended if maximum high-speed operation is a high priority. If this is not possible, select a location on the transom where the hull forward of this location is smooth, flat and free of protrusions or ribs.
- The hydrodynamic shape of your transducer allows it to point straight down without deadrise adjustment.
- On boats with stepped hulls, it may be possible to mount the transducer on the step. Do not mount the transducer on the transom behind a step to avoid popping the transducer out of the water at higher speeds; the transducer must remain in the water for the control head to maintain the sonar signal.
- If the transom is behind the propeller(s), it may be impossible to find an area clear from turbulence, and a different mounting technique or transducer type should be considered (see **Trolling Motor Transducer Installation**).
- The Side Imaging transducer must NOT have anything obstructing the 'view' of the side looking beams, i.e. nothing can be in the line of sight of these beams (not a hull, motor, or other transducer, etc).

## 2. Mounting the Transducer Bracket to the Boat

1. Remove the transducer mounting template from this manual. See **Appendix A** for the Transducer Mounting Template.

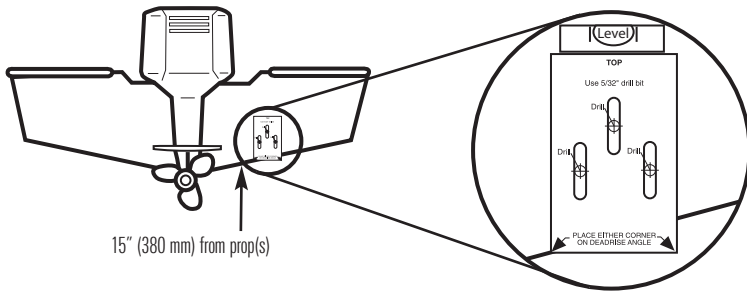

2. Hold the template on the transom of the boat in the location where the transducer will be installed. Align the template vertically, matching the lower edge of the transom with the bottom corner of the template. If your propeller moves clockwise as the boat moves forward, mount the transducer on the starboard side, and use the bottom left corner of the template. If your propeller moves counter-clockwise as the boat moves forward, mount the transducer on the port side, and use the bottom right corner of the template.
3. Using a pencil or punch, mark the three mounting holes on the transom. Do not mark or drill any other holes at this time.

### Attaching the Bracket

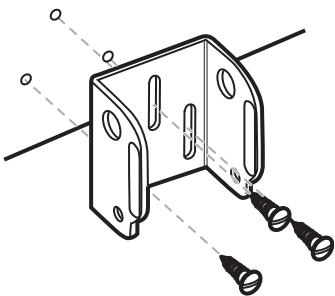

4. Using a 5/32" (4.0 mm) bit, drill the three holes to a depth of approximately 1" (25 mm). On fiberglass hulls, it is best to use progressively larger drill bits to reduce the chance of chipping or flaking the outer coating. Use a marine-grade silicone sealant to fill the drilled holes.
5. Align the metal mounting bracket with the mounting holes. The center slot should be above the two outer slots. (This bracket and all other hardware supplied is top quality stainless steel for maximum strength and corrosion protection.) Insert the three 1" (25 mm) flat head wood screws into the drilled holes, but do not completely tighten.

### 3. Attaching the Pivot to the Transducer

1. Attach the pivot to the transducer body, using the two 1/4"-20 x 5/8" (16 mm) machine screws, toothed washers, and square nuts. The toothed washers must fit on the inside of the transducer knuckle, between the pivot and the knuckle. The square nuts will be prevented from rotating by the pocket in the back of the pivot. An Allen wrench is provided which fits all the 1/4"-20 screws, but do not fully tighten the screws at this time.

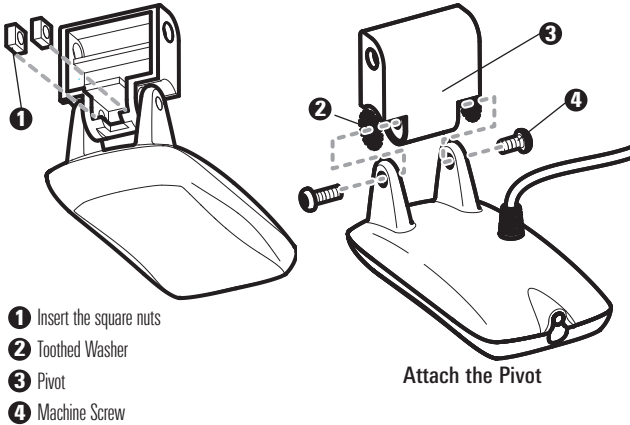

### 4. Mounting the Transducer Pivot Assembly to the Bracket

1. Slide the assembled transducer into the metal bracket from the bottom, aligning the large hole at the top of the bracket with the hole in the pivot.
2. Insert the headed pin through the pivot holes in the bracket and pivot. The headed pin can be inserted from either side of the bracket.
3. Place the nylon washer over the opposite end of the headed pin. Place the stainless washer over the 1/4"-20 x 5/8" (16 mm) screw threads, then insert into the opposite end of the headed pin and finger tighten only. The screw has a thread locking compound on the threads to prevent loosening, and should not be fully tightened until all adjustments are made.

**NOTE:** The running position of the transducer is now completely adjustable. Subsequent adjustment may be necessary to tweak the installation after high speed testing.

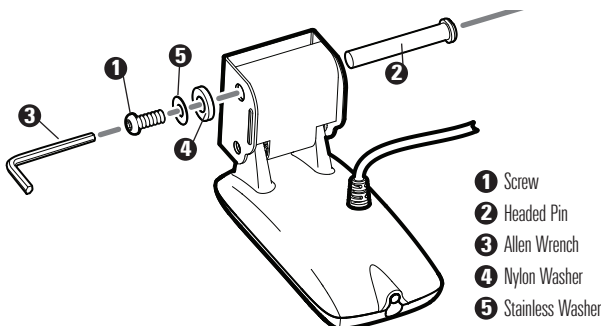



## 5. Adjusting the Running Position of the Transducer

The transducer mounting bracket allows height and tilt adjustment, while the pivot bolt allows angular adjustment. These adjustments will help reduce cavitation. Initially, adjust the transducer as described in the following paragraphs. Further adjustment may be necessary to refine the installation after high-speed testing.

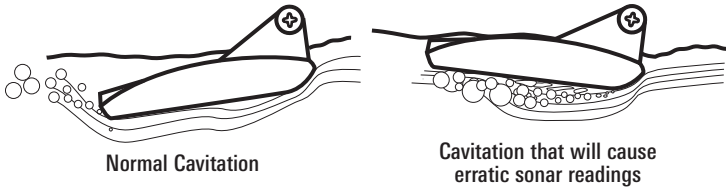

1. First, adjust the pivot angle of the transducer body, so it is parallel with the length of the hull of the boat.
2. Fully tighten the two pivot screws, using the supplied Allen wrench. Access to the pivot screws is provided by the lower holes in the side of the mounting bracket. It may be necessary to re-tighten the pivot bolt after initial use as the plastic may still be conforming to the pressure from the lock washers.



3. Adjust the height of the assembly so the face of the transducer is 1/8" (3 mm) to 1/4" (6 mm) beneath the bottom of the transom, and fully tighten the three mounting screws.
4. In order to gain access to the mounting screws, the transducer assembly must be pivoted up in the bracket as shown. Be careful not to alter the running angle as some force is necessary to pivot the assembly.

5. If access to the top mounting hole is not possible due to the selected height of the transducer, fully tighten the two lower screws, then simply remove the headed pivot pin and the transducer assembly, and tighten the top screw, then reassemble.
6. Confirm that the pivot angle has not changed and that all mounting screws are fully tightened.

## 6. Routing the Transom Transducer Cable

The transducer cable has a low profile connector that must be routed to the point where the control head is mounted. There are several ways to route the transducer cable to the area where the control head will be installed. The most common procedure routes the cable through the transom into the boat.

**NOTE:** Your boat may have a pre-existing wiring channel or conduit that you can use for the transducer cable.

1. Unplug the other end of the transducer cable from the control head. Make sure that the cable is long enough to accommodate the planned route by running the cable over the transom.

**CAUTION!** Do not cut or shorten the transducer cable, and try not to damage the cable insulation. Route the cable as far as possible from any VHF radio antenna cables or tachometer cables to reduce the possibility of interference. If the cable is too short, extension cables are available to extend the transducer cable up to a total of 50' (15 m). For assistance, contact the Customer Resource Center at [humminbird.com](http://humminbird.com) or call 1-800-633-1468 for more information.

**NOTE:** Since the transducer may need to pivot up to 90° in the bracket if it strikes an object, make sure there is sufficient cable slack to accommodate this motion. It is best to route the cable to the side of the transducer so the cable will not be damaged by the rotation of the transducer.

- 2a. If you are routing the cable over the transom of the boat, secure the cable by attaching the cable clamp to the transom, drilling 9/64" diameter holes for #8 x 5/8" wood screws, then skip directly to procedure 5, **Connecting the Cable**.

or...

#### Routing the Cable

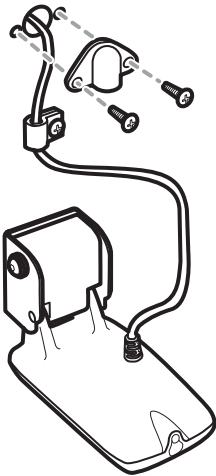

- 2b. If you will be routing the cable through a hole in the transom, drill a 5/8" diameter hole above the waterline. Route the cable through this hole, then fill the hole with marine-grade silicone sealant and proceed to the next step immediately.
3. Place the escutcheon plate over the cable hole and use it as a guide to mark the two escutcheon plate mounting holes. Remove the plate, drill two 9/64" diameter x 5/8" deep holes, and then fill both holes with marine-grade silicone sealant. Place the escutcheon plate over the cable hole and attach with two #8 x 5/8" wood screws.
4. Route and secure the cable by attaching the cable clamp to the transom; drill one 9/64" diameter x 5/8" deep hole, then fill the hole with marine-grade silicone sealant, then attach the cable clamp using a #8 x 5/8" screw.
5. Plug the other end of the transducer cable back into the control head connection holder.

#### Storing Excess Cable

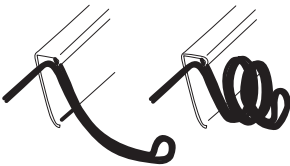

**NOTE:** If there is excess cable that needs to be gathered at one location (as shown in the illustration), dress the cable routed from both directions so that a single loop is left extending from the storage location. Doubling the cable up from this point, form the cable into a coil. Storing excess cable using this method can reduce electronic interference.

## 7. Test and Finish the Transducer Installation

---

When you have installed both the control head, the transducer, and accessories and have routed all the cables, you must perform a final test before locking the transducer in place. Testing should be performed with the boat in the water, although you can initially confirm basic operation with the boat out of the water.

1. Press the POWER/LIGHT key once to turn on the control head. There will be an audible chirp when the key is pressed correctly. If the unit does not power-up, make sure that the connector holder is fully seated and that power is available.
2. If all connections are correct and power is available, the control head will enter Normal operation. If no transducer is detected (or one is not connected), the unit will go into Simulator mode and will indicate this by displaying the word Simulator on the control head display.

***NOTE:** The transducer must be submerged in water for reliable transducer detection.*

3. If the bottom is visible on-screen with a digital depth readout, the unit is working properly. Make sure that the boat is in water greater than 2 ft (.6 m) but less than the depth capability of the unit, and that the transducer is fully submerged, since the sonar signal cannot pass through air.
4. If the unit is working properly, gradually increase the boat speed to test high-speed performance. If the unit functions well at low speeds but begins to skip or miss the bottom at higher speeds, the transducer requires adjustment. Angling the rear of the transducer downward and/or lowering the transducer farther into the water will help achieve depth readings at high speeds. If the left side of the fish arch is longer than the right side, then the back of the transducer is angled too far downward. If the right side of the fish arch is longer than the left side, then the back of the transducer is angled too far upwards.

***NOTE:** Due to the wide variety of boat hulls, it may not always be possible to get symmetrical fish arches and high speed depth readings at the same time.*

***NOTE:** It is often necessary to make several incremental transducer adjustments before optimum high speed performance is achieved.*

Once you have reached a consistently good sonar signal at the desired speeds, you are ready to lock down the transducer settings.

5. Mark the transducer bracket location on the transom with a pencil, then pop up the bracket to reveal the mounting screws. Tighten the stainless steel mounting bracket screws to secure in place. **Hand-tighten only!**

# 1158c Transom Mount Transducer Installation

*DualBeam PLUS™ Transducer, XNT 9 20 T (1158c only)*

---

The DualBeam PLUS™ transducer uses a Two Piece Kick-up transducer mounting bracket.

**NOTE:** *Due to the wide variety of hulls, only general instructions are presented in this installation guide. Each boat hull represents a unique set of requirements that should be evaluated prior to installation. It is important to read the instructions completely and understand the mounting guidelines before beginning installation.*

**NOTE:** *Your transducer may not look exactly like the transducer shown in the illustrations, but it will mount in exactly the same way.*

## Overview

---

If you will be installing a DualBeam PLUS™ transom mounted transducer, use the procedures in this section. There are several procedures you will have to perform in order to install a transom-mounted transducer. They are as follows:

- Locate the transducer mounting location
- Prepare the mounting location
- Assemble the transducer and perform initial mounting
- Route the transducer cable
- Connect the transducer cable
- Perform a final test of the transom transducer installation.

**Supplies:** In addition to the hardware supplied with your transducer, you will need a powered hand drill and various drill bits, various hand tools, including a ruler or straightedge, a level, a 12" plumb line (weighted string or monofilament line), marker or pencil, safety glasses and dust mask, and marine-grade silicone sealant.

**NOTE:** *When drilling holes in fiberglass hulls, it is best to start with a smaller bit and use progressively larger drill bits to reduce the chance of chipping or flaking the outer coating.*

# 1. Locating the transducer mounting location

**NOTE:** If transom mounting is not possible because of a stepped hull or cavitation noise, and you have a single layer fiberglass hull, In-hull installation is an option. See **Inside the Hull Transducer Installation** for more information.

**Turbulence:** You must first determine the best location on the transom to install the transducer. It is very important to locate the transducer in an area that is relatively free of turbulent water. Consider the following to find the best location with the least amount of turbulence:

- As the boat moves through the water, turbulence is generated by the weight of the boat and the thrust of the propeller(s) - either clockwise or counter-clockwise. This turbulent water is normally confined to areas immediately aft of ribs, strakes or rows of rivets on the bottom of the boat, and in the immediate area of the propeller(s). Clockwise propellers create more turbulence on the port side.

On outboard or inboard/outboard boats, it is best to locate the transducer at least 15" to the side of the propeller(s).

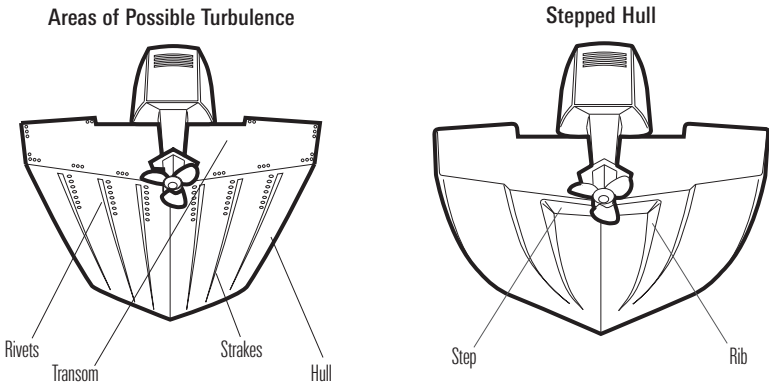

- The best way to locate turbulence-free water is to view the transom while the boat is moving. This method is recommended if maximum high-speed operation is a high priority. If this is not possible, select a location on the transom where the hull forward of this location is smooth, flat and free of protrusions or ribs.

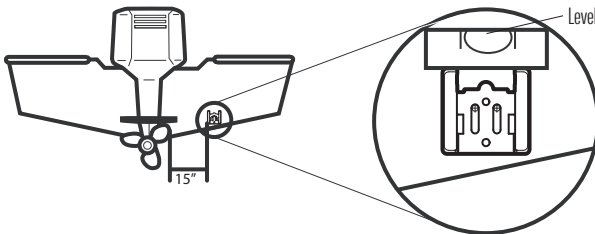

Find a turbulence-free location at least 15" from the propeller(s) and not in line with trailer bunks or rollers.

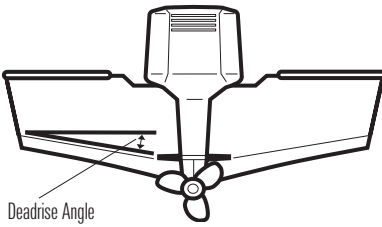

- On boats with stepped hulls, it may be possible to mount the transducer on the step. Do not mount the transducer on the transom behind a step to avoid popping the transducer out of the water at higher speeds; the transducer must remain in the water for the control head to maintain the sonar signal.

- If the transom is behind the propeller(s), it may be impossible to find an area clear from turbulence, and a different mounting technique or transducer type should be considered, such as an Inside the Hull Transducer (see *Inside the Hull Transducer Installation*).
- If you plan to trailer your boat, do not mount the transducer too close to trailer bunks or rollers to avoid moving or damaging the transducer during loading and unloading of the boat.
- If high speed operation is critical, you may want to consider using an In-Hull transducer instead of this Transom Mount transducer.

**NOTE:** The hydrodynamic shape of your transducer allows it to point straight down without deadrise adjustment.

**NOTE:** If you cannot find a transom mount location that will work for your high-speed application, find an In-Hull Transducer by contacting our Customer Resource Center at either **1-800-633-1468** or by visiting our Web site at **humminbird.com**.

## 2. Preparing the Mounting Location

---

In this procedure, you will determine the mounting location and drill two mounting holes, using the transducer mounting bracket as a guide.

1. Make sure that the boat is level on the trailer, both from port to starboard and from bow to stern, by placing your level on the deck of the boat, first in one direction, then in the other.
2. Hold the mounting bracket against the transom of the boat in the location you have selected. Align the bracket horizontally, using the level; make sure that the lower corner of the bracket does not protrude past the bottom of the hull, and there is at least 1/4" clearance between the bottom of the bracket and the bottom of the transom for fiberglass boats, and 1/8" clearance for aluminum boats.

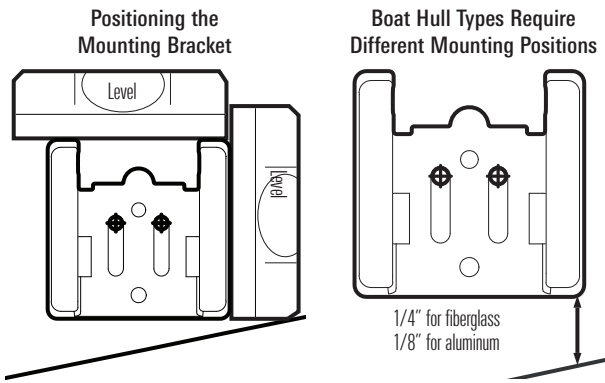

**NOTE:** If you have a flat-bottomed aluminum boat, some additional adjustment may be needed to accommodate the rivets on the bottom of the boat (i.e. the gap may need to be a little smaller than 1/8"). This will help you to avoid excessive turbulence at high speeds.

**NOTE:** If your propeller moves clockwise (in forward, as you're facing the stern of the boat from behind), mount the transducer on the starboard side, and align the bottom right corner of the mounting bracket with the bottom of the boat. If your propeller moves counter-clockwise (in forward, as you're facing the stern of the boat from behind), mount the transducer on the port side, and align the bottom left corner of the mounting bracket with the bottom of the boat.

### Using the Mounting Bracket to Mark the Initial Drill Holes

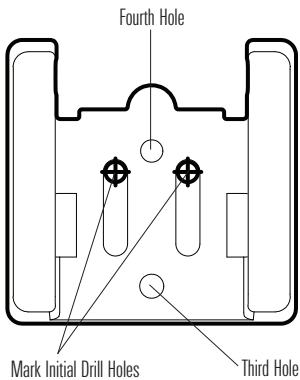

3. Continue to hold the bracket on the transom of the boat, and use a pencil or marker to mark where to drill the two mounting holes. Mark the drill holes near the top of each slot, making sure that your mark is centered in the slot.

**NOTE:** The third hole should not be drilled until the angle and height of the transducer is finalized, which you will not do until a later procedure.

4. Make sure that the drill bit is perpendicular to the actual surface of the transom, NOT parallel to the ground, before you drill. Using a 5/32" bit, drill the two holes only to a depth of approximately 1".

**NOTE:** On fiberglass hulls, it is best to use progressively larger drill bits to reduce the chance of chipping or flaking the outer coating.

### 3. Assembling the Transducer and Initial Mounting

In this procedure, you will assemble the transducer using the hardware provided, then mount it and make adjustments to its position without locking it in place.

**NOTE:** You will initially assemble the transducer and the pivot arm by matching the two ratchets to a numbered position on the transducer knuckle. Further adjustments may be necessary.

- 1a. If you already know your transom angle, refer to the chart below for the initial position to use to set the ratchets. If your transom is angled at 14 degrees (a common transom angle for many boats) use position 1 for the ratchets. In either case, go to step 2. If you do not know your transom angle, go to step 1b.

or...

Bead Alignment Number	1		4		2		5		3		1		4		2		5		3		1												
Transom Angle (°)	-2	-1	0	1	2	3	4	5	6	7	8	9	10	11	12	13	14	15	16	17	18	19	20	21	22	23	24	25	26	27	28	29	30
Measured Distance (x)	0.0 cm 0"			1.1 cm 1/2"		2.5 cm 1"		4.3 cm 1 5/8"		5.9 cm 2 3/8"		7.6 cm 3"		9.3 cm 3 5/8"		11.1 cm 4 3/8"		12.9 cm 5"		14.9 cm 5 7/8"		16.9 cm 6 5/8"											

- 1b. If you do not know your transom angle, measure it using a plumb line (weighted nylon string or monofilament line) exactly 12 inches long. Hold the top of the plumb line against the top of the transom with your finger, and wait until the line hangs straight down. Using a ruler, measure the distance from the **bottom** of the plumb line to the back of the transom, then use the chart.

#### Measuring the Transom Angle

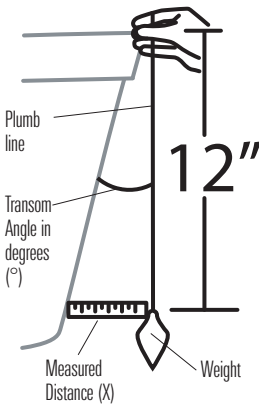

**NOTE:** It is important to take your measurement in the figure showing **Measuring the Transom Angle**, from exactly 12 inches down from the top of the transom.

2. Place the two ratchets, one on either side of the transducer knuckle, so that the beads on each ratchet line up with the desired position number on the knuckle. If you are setting the ratchets at position 1, the beads on each ratchet will line up with the rib on the transducer knuckle to form one continuous line on the assembly.

**NOTE:** The ratchets are keyed; make sure that the square teeth on each ratchet face the square teeth on the transducer knuckle, and the triangular teeth face outward.



Hold the ratchets on the transducer knuckle with one hand and fit the pivot arm over them until it snaps into place with the other hand. Refer to the illustration.

**Transducer Knuckle Positions**

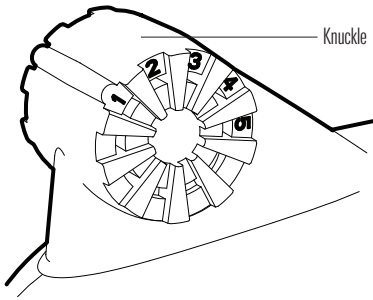

**Ratchets Placed in Position 1**

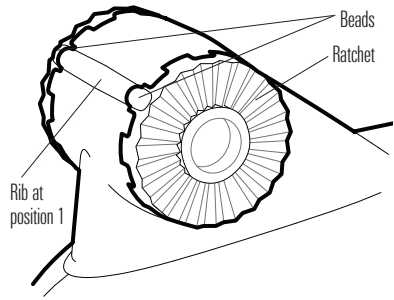

**Ratchets Placed in Position 2**

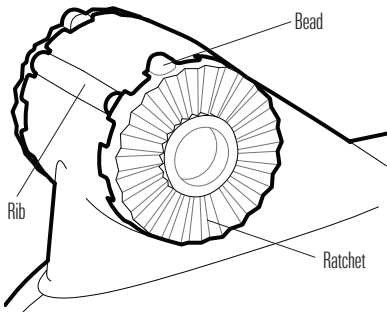

**Fitting the Pivot Arm Over the Ratchet**

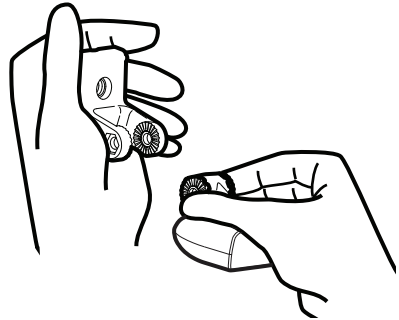

- Put the pivot bolt through the assembly to hold it in position and loosely install the nut, but do NOT tighten the nut at this time. Insert the pivot arm assembly into the mounting bracket. Do NOT snap the assembly closed, as you will need to access the mounting bracket in the next step.

Inserting the Pivot Bolt

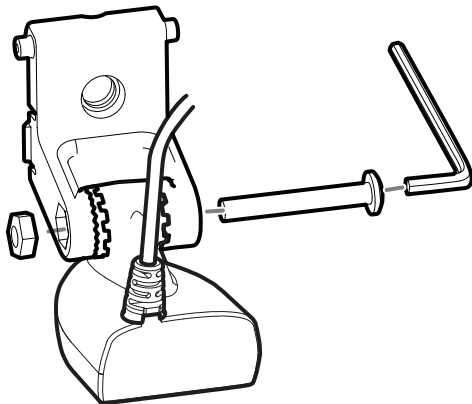

Inserting the Pivot Arm Assembly Into the Mounting Bracket

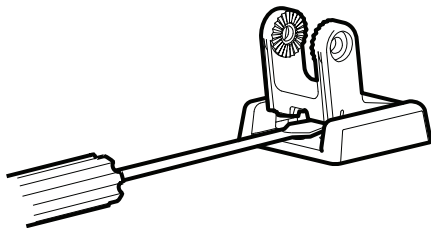
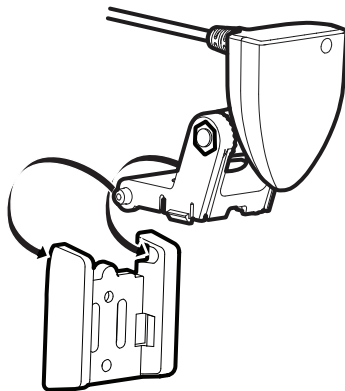

**NOTE:** If the pivot assembly is snapped closed over the mounting bracket, use a flat head screwdriver or similar tool to gently pry the assembly away from the mounting bracket.

Mounting the Assembly to the Transom

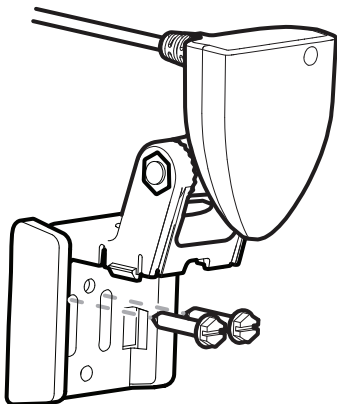

- Align the mounting bracket transducer assembly with the drilled holes in the transom. With a 5/16" socket driver, mount the assembly to the transom using the two #10 - 1" long screws provided.

**NOTE:** Make sure that the mounting screws are snug, but do not fully tighten the mounting screws at this time to allow the transducer assembly to slide for adjustment purposes.

- Snap the pivot arm down into place.

- Adjust the initial angle of the transducer from back to front by rotating the transducer until the side seam on the transducer is almost parallel with the bottom of the boat, one click at a time in either direction.

#### Adjusting the Initial Transducer Angle

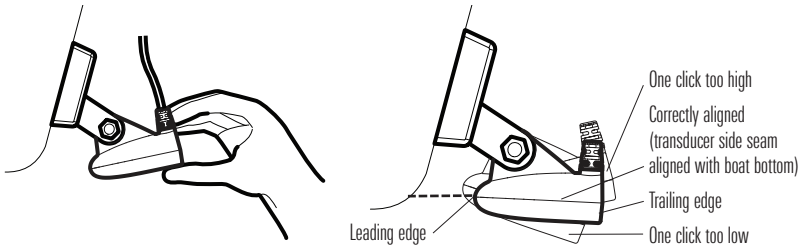

- Adjust the transducer assembly vertically, until the seam on the leading edge of the transducer (the edge closest to the transom of the boat) is level and just slightly below the hull.

#### Adjusting the Transducer Mounting Position

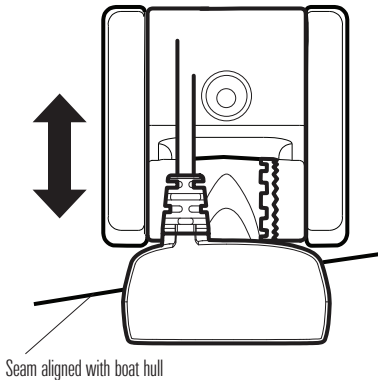

#### Leveling the Mounting Assembly Horizontally

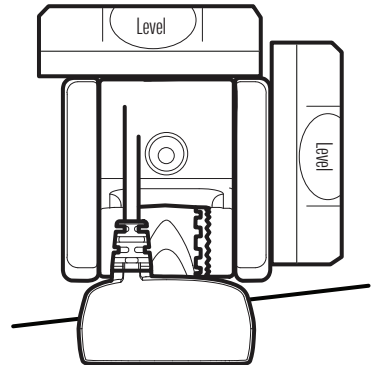

**NOTE:** The transducer has a natural downward slant of 4-5 degrees from leading edge (closest to the boat transom) to trailing edge (farthest away from the boat). Looking at the back of the transducer, the seam should be slightly below the bottom of the hull.

- Continue to adjust until the bracket is also level from port to starboard (horizontally level as you look at the transducer from behind the boat).
- Mark the correct position on the transom by tracing the silhouette of the transducer mounting bracket with a pencil or marker.
- Tighten the pivot bolt, using the pivot screw and nut to lock the assembly. **Hand tighten only!**
- Snap open the assembly and hand-tighten the two mounting screws, then snap the assembly closed.

**NOTE:** You will drill the third mounting hole and finalize the installation after you route the cable and test and finish the installation in the following procedures.

## 4. Routing the Cable

The transducer cable has a low profile connector, which must be routed to the point where the control head is mounted. There are several ways to route the transducer cable to the area where the control head is installed. The most common procedure routes the cable through the transom into the boat.

**NOTE:** Your boat may have a pre-existing wiring channel or conduit that you can use for the transducer cable.

1. Unplug the other end of the transducer cable from the control head. Make sure that the cable is long enough to accommodate the planned route by running the cable over the transom.

**CAUTION!** Do not cut or shorten the transducer cable, and try not to damage the cable insulation. Route the cable as far as possible from any VHF radio antenna cables or tachometer cables to reduce the possibility of interference. If the cable is too short, extension cables are available to extend the transducer cable up to a total of 50'. For assistance, contact the Customer Resource Center at [humminbird.com](http://humminbird.com) or call 1-800-633-1468 for more information.

**NOTE:** The transducer can pivot up to 90 degrees in the bracket. Allow enough slack in the cable for this movement. It is best to route the cable to the side of the transducer so the transducer will not damage the cable during movement.

- 2a. If you are routing the cable over the transom of the boat, secure the cable by attaching the cable clamp to the transom, drilling 9/64" diameter holes for #8 x 5/8" wood screws, then skip directly to procedure 5, **Connecting the Cable**.

or...

### Routing the Cable

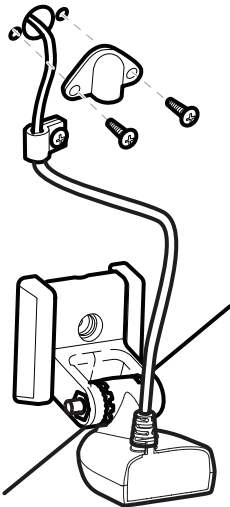

- 2b. If you will be routing the cable through a hole in the transom, drill a 5/8" diameter hole above the waterline. Route the cable through this hole, then fill the hole with marine-grade silicone sealant and proceed to the next step immediately.
3. Place the escutcheon plate over the cable hole and use it as a guide to mark the two escutcheon plate mounting holes. Remove the plate, drill two 9/64" diameter x 5/8" deep holes, and then fill both holes with marine-grade silicone sealant. Place the escutcheon plate over the cable hole and attach with two #8 x 5/8" wood screws.
4. Route and secure the cable by attaching the cable clamp to the transom; drill one 9/64" diameter x 5/8" deep hole, then fill the hole with marine-grade silicone sealant, then attach the cable clamp using a #8 x 5/8" screw.
5. Plug the other end of the transducer cable back into the control head connection holder.

### Storing Excess Cable

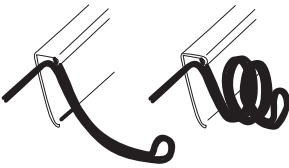

**NOTE:** If there is excess cable that needs to be gathered at one location (as shown in the illustration), dress the cable routed from both directions so that a single loop is left extending from the storage location. Doubling the cable up from this point, form the cable into a coil. Storing excess cable using this method can reduce electronic interference.

## 5. Connecting the Cable

---

Insert the transducer cable into the appropriate terminal slot. The cable connectors are labeled, and there are corresponding labels on the cable holder on the rear of the control head. The slots are keyed to prevent reversed installation, so be careful not to force the connector into the holder. Refer to your manual and/or control head installation guide for the correct procedure for installing the cable connectors to the control head.

1. Plug the other end of the transducer cable back into the control head connection holder.

Your control head is now ready for operation.

## 6. Test and Finish the Installation

---

Once you have installed both the control head and the transom transducer, and have routed all the cables, you must perform a final test before locking the transducer in place. Testing should be performed with the boat in the water, although you can initially confirm basic operation with the boat out of the water.

1. Press POWER once to turn the control head on. If the unit does not power up, make sure that the connector holder is fully seated in the receptacle and that power is available.
2. If all connections are correct and power is available, the Humminbird® control head will enter Normal operation.
3. If the bottom is visible on-screen with a digital depth readout, the unit is working properly. Make sure that the boat is in water greater than 2' but less than the depth capability of the unit, and that the transducer is fully submerged, since the sonar signal cannot pass through air.

**NOTE:** The transducer must be submerged in water for reliable transducer detection.

4. If the unit is working properly, gradually increase the boat speed to test high-speed performance. If the unit functions well at low speeds, but begins to skip or miss the bottom at higher speeds, the transducer requires adjustment.

5. If you have the correct angle set on the transducer, yet lose a bottom reading at high speed, adjust the height and the running angle in small increments to give you the ideal transducer position for your boat. First, adjust the height in small increments.

**NOTE:** *The deeper the transducer is in the water, the more likely that a rooster tail of spray will be generated at high speeds, so make sure that the transducer is as high as it can be and still be submerged in the water.*

If you are still not getting good high speed readings, you may need to disassemble the transducer mounting assembly and re-position the ratchets.

If you do change the transducer position, re-trace the position of the mounting bracket before proceeding.

**NOTE:** *It is often necessary to make several incremental transducer adjustments before optimum high speed performance is achieved. Due to the wide variety of boat hulls, however, it is not always possible to obtain high speed depth readings.*

6. Once you have reached a consistently good sonar signal at the desired speeds, you are ready to lock down the transducer settings. Force the pivot to the Up position to gain access to the mounting screws, then re-align the mounting bracket against the transom of the boat to match the traced silhouette. Check the bracket position with the level again to make sure it is still level, then mark the third mounting hole using a pencil or marker. Unscrew and remove the mounting screws and the transducer assembly and set aside.
7. Drill the third mounting hole, using a 5/32" drill bit. Use a marine-grade silicone sealant to fill all three drilled mounting holes, especially if the holes penetrated the transom wall.

**NOTE:** *On fiberglass hulls, it is best to use progressively larger drill bits to reduce the chance of chipping or flaking the outer coating.*

#### Fully Tighten All Three Mounting Screws

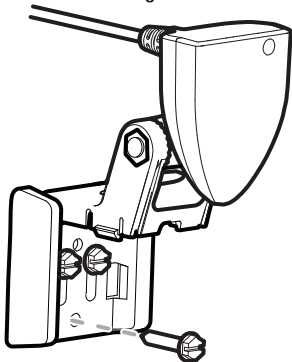

8. Re-position the transducer assembly against the transom of the boat, then hand-install all three screws. Make sure that the transducer location and the pivot angle have not changed, then fully tighten all three mounting screws. Snap the pivot back down. If you have performed the preceding procedures correctly, the transducer should be level and at the right height for optimal operation.

## Locking Down the Transducer (Optional)

**NOTE:** You have the option to lock down the Two Piece Kick Up bracket if you do not want the transducer to kick up. Please be aware, however, that the transducer can be damaged if it is locked down and it strikes debris in the water.

### Marking the Fourth Drill Hole for Optional Lock Down

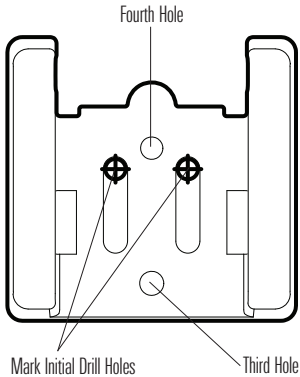

1. To lock down the transducer, trace the position of the mounting bracket. Force the pivot to the Up position to gain access to the mounting screws, then re-align the mounting bracket against the transom of the boat to match the traced silhouette. Check the bracket position with the level again to make sure it is still level, then mark the fourth mounting hole using a pencil or marker. Unscrew and remove the mounting screws and the transducer assembly and set aside.
2. Drill the fourth mounting hole, using a 9/64" drill bit. Use a marine grade silicone sealant to fill all four drilled mounting holes, especially if the holes penetrate the transom wall.

### Fully Tighten All Three Mounting Screws

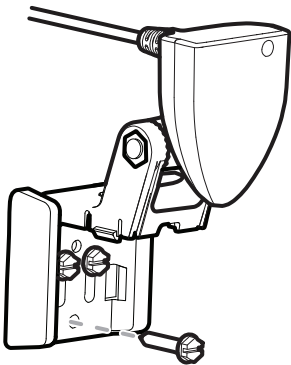

3. Re-position the transducer assembly against the transom of the boat, then hand install the first three screws (two on the outside edges and one in the 3rd mounting hole). Make sure that the transducer location and the pivot angle have not changed, then fully tighten all three mounting screws. **Hand-tighten only!**
4. Snap the pivot back down. Install #8 x 1" wood screw into the 4th hole to lock down the pivot arm. **Hand-tighten only!**

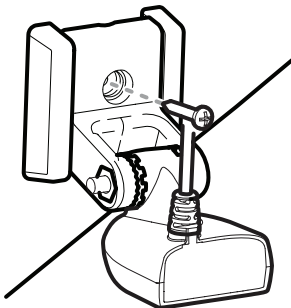

## 1158c Inside the Hull Transducer Installation

*DualBeam PLUS™ Transducer, XNT 9 20 T (1158c only)*

---

**NOTE:** Do NOT install the Side Imaging® transducer inside the hull, as the side looking beams cannot penetrate the hull. Only the DualBeam PLUS™ transducer can be mounted inside the hull.

If you choose to mount your transducer **inside the hull** of your boat, perform the procedures in this section. In-hull mounting generally produces good results in single thickness fiberglass-hulled boats. Humminbird® cannot guarantee depth performance when transmitting and receiving through the hull of the boat, since some signal loss occurs. The amount of loss depends on hull construction and thickness, as well as the installation position and process.

This installation requires slow-cure two-part epoxy. Do not use silicone or any other soft adhesive to install the transducer, as this material reduces the sensitivity of the unit. Do not use five-minute epoxy, as it has a tendency to cure before all the air bubbles can be purged, thus reducing signal strength.

**NOTE:** In-hull mounting requires an installed and operational control head.

**NOTE:** The integral temperature probe will not work with in-hull mounting, so you may either want to consider purchasing a Temperature/Speed accessory, a Temp. Sensor, or obtaining a different transducer. Humminbird® offers a transducer exchange program to swap the NEW and UNASSEMBLED transducer, accompanied by mounting hardware, for one without an integral temperature probe. Call the Humminbird® Customer Resource Center at **1-800-633-1468** for details, or visit **humminbird.com** for more information.

**NOTE:** Your transducer may not look exactly like the transducer shown in the illustrations, but it will mount in exactly the same way.

**There are several procedures you will have to perform in order to install a transducer inside the hull. They are as follows:**

- Locate transducer mounting location
- Perform a trial installation
- Route the transducer cable
- Permanently mount the transducer



## 1. Locating the Transducer Mounting Location

---

Decide where to install the transducer on the inside of the hull. Consider the following to find the best location:

- Observe the outside of the boat hull to find the areas that are mostly free from turbulent water. Avoid ribs, strakes and other protrusions, as these create turbulence.

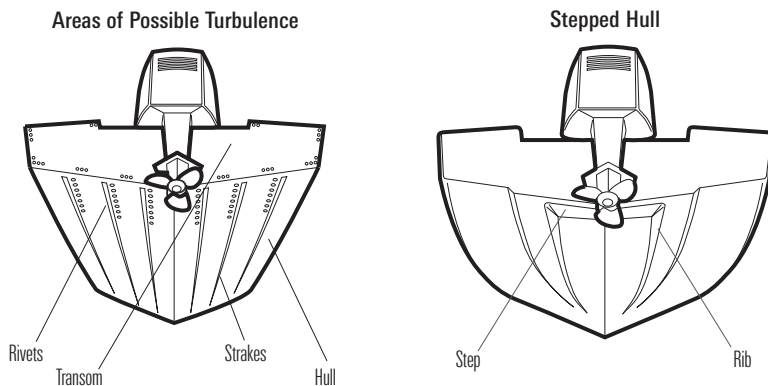

- As a general rule, the faster the boat can travel, the further aft and closer to the centerline of the hull the transducer has to be located in order to remain in contact with the water at high speeds.

## 2. Trial Installation

---

You will not be able to adjust the mounting after an inside the hull transducer is installed. It is best, therefore, to perform a trial installation first that includes running the boat at various speeds, in order to determine the best mounting area before permanently mounting the transducer.

1. Plug the transducer into the control head, then power up the control head. When the control head detects a functioning transducer, it will automatically enter Normal operating mode.
2. View the sonar signal at its best by holding the transducer over the side, immersed in the water, so that it is pointing straight down over a known flat bottom. Use the display to benchmark against the sonar signal that will be detected once the transducer is placed in the hull.
3. Place the transducer body face down at the identified mounting location inside the hull, with the end that has the mounting knuckle pointed towards the bow of the boat.

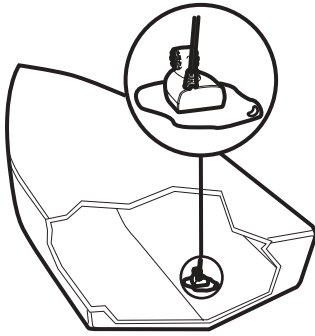

#### Preferred Mounting Area

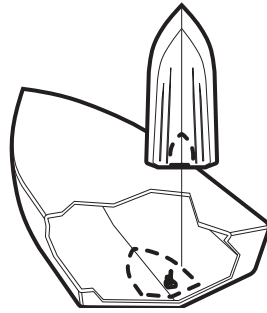

4. Fill the hull with enough water to submerge the transducer body. Use a sand-filled bag or other heavy object to hold the transducer in position. The transducer cannot transmit through air, and the water purges any air from between the transducer and the hull, and fills any voids in the coarse fiberglass surface.
5. View the sonar signal on the display and compare against what you observed in Step 2, making sure that the boat is in the same location as it was during your observations in Step 2. If the results are comparable, move on to Step 6. Otherwise, locate a new position in the hull and repeat Steps 3 through 5.
6. Run the boat at various speeds and water depths while observing the screen on the control head. If depth performance is required, test the transducer in water at the desired depth. If the performance is acceptable, move on to Step 7. If the performance is not acceptable, repeat Steps 3 through 6.
7. Once you have determined the best mounting location using the above steps, mark the position of the transducer.

### 3. Routing the Cable

---

1. Once the mounting location is determined and you have marked the position of the transducer, route the cable from the transducer to the control head.

## 4. Permanently Mounting the Transducer

---

1. Make sure the position of the transducer is marked.
2. You may have to disconnect the cable to the control head and reconnect it at the end of this procedure.
3. Remove the water from inside the hull and thoroughly dry the mounting surface. If the surface is excessively rough, it may be necessary to sand the area to create a smooth mounting surface.
4. Slowly and thoroughly mix an ample quantity of two-part slow cure epoxy. Avoid trapping air bubbles.

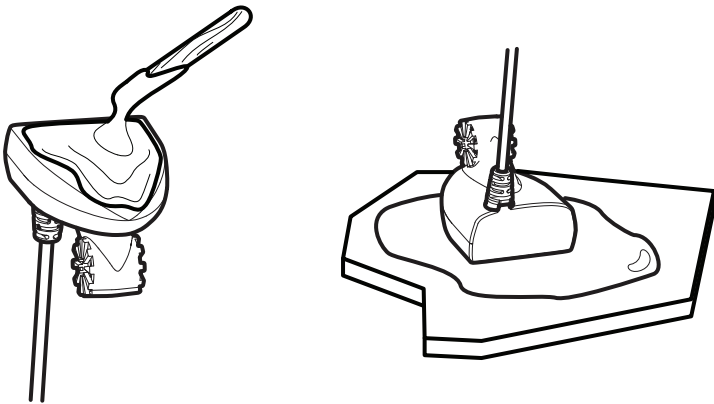

5. Coat the face of the transducer and the inside of the hull with epoxy.
6. Press the transducer into place with a slight twisting motion to purge any trapped air from underneath, keeping the end of the transducer that has the mounting knuckle pointed forward, towards the bow of the boat.

**NOTE:** Proper operation requires the end of the transducer that has the mounting knuckle to face towards the bow of the boat.

7. Weight the transducer so that it will not move while the epoxy is curing.

**NOTE:** When the epoxy cures, no water is necessary inside the hull.

8. If you unplugged the transducer cable at the beginning of this procedure, plug it back into the control head.

**NOTE:** Neither water, spilled gasoline, nor oil will affect the performance of the transducer.

## Trolling Motor Transducer Installation

---

Several styles of the transducer are compatible with trolling motor mounting. If you have a trolling motor bracket, refer to the separate installation instructions that are included with the bracket.

## Trolling Motor Transducer Options

---

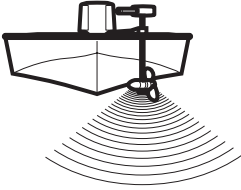

If you don't have a trolling motor transducer, there are several options:

- You may purchase a Trolling Motor Adapter kit that will allow you to mount the transducer on the trolling motor.
- You may also exchange your NEW and UNASSEMBLED transducer (with mounting hardware included) for a trolling motor transducer.

There are also several transducer switches available that support the following configurations:

- Two control heads with one transducer
- Two transducers with one control head

**NOTE:** Call the Humminbird® Customer Resource Center at **1-800-633-1468** for details and pricing, or visit **humminbird.com** for more information.

## GPS Receiver Installation Overview

---

The GPS receiver installation method is determined by the hardware you purchased and the chosen mounting location. Review the following table to choose which installation instructions you should use.

### If you have...

An existing antenna stem with standard 1" – 14 thread stem

Access for cable routing under the mounting location

No access under the mounting location

### Use the following section:

**2a. Stem Mount with Existing 1" - 14 Thread Stem**

**2b. Access Under Mounting Location**

**2c. No Access Under Mounting Location**

To optimize performance of the GPS receiver, mount it in an area that has full exposure to the sky. The effective area of reception is 10° above the horizon. Do not install the GPS receiver close to a VHF antenna or within the active area of a radar.

## 1. GPS Receiver Cable Wires *(optional)*

---

If the GPS receiver will be connected to a NMEA 0183 device, the pinouts are as follows:

- Green Wire: GPS NMEA Out
- Black Wire: Ground
- White Wire: Control Head NMEA Out

## 2a. Stem Mounting with an Existing 1" - 14 Thread Stem

---

Follow these steps to stem mount the GPS receiver:

**NOTE:** *If you have an existing stem for mounting the GPS receiver, proceed directly to step 2 of the following procedure.*

1. Determine the best location to mount your GPS receiver. Preplan and test the cable routing to your control head before any drilling or cutting of your boat surfaces. If you have purchased hardware to stem mount your GPS receiver, follow the instructions included with that hardware to mount the stem (antenna pole).

**NOTE:** *AS-EC10 10' extension cables are available from Humminbird® if your planned routing exceeds 20' (6 m). Maximum cable length, including extensions, should not exceed 50' (16 m).*

**NOTE:** *Remember to seal screw holes and drilled holes as needed with marine-grade silicone sealant to protect your boat from water damage.*

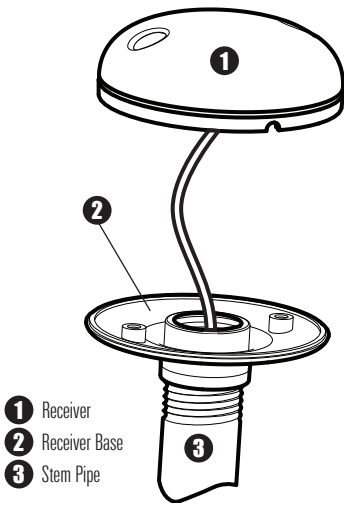

2. Screw on the receiver base to the stem first, making sure that the stem pipe does not protrude from the receiver base. This adds protection to the cable when pulling it through the pipe stem. In addition to this, de-burr the pipe edges to reduce cable abrasion.

3. Use electrical tape to secure the NMEA cable to the receiver cable as shown.

**NOTE:** Leave the NMEA cable secured to the receiver cable unless needed. This will make removing the receiver easier.

4. Route the GPS receiver cable through the stem and continue with the planned route you chose in step 1.

5. Attach the GPS receiver to its base using the included #6 - 7/8" screws.

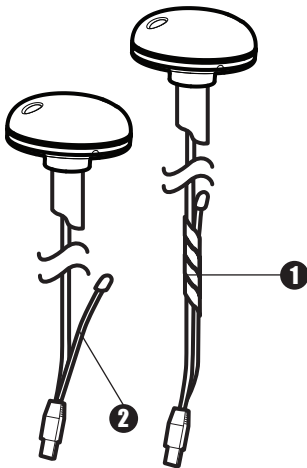

NMEA Cable Taped **1**  
 NMEA Cable Out **2**  
 Mounting Screws **3**

## 2b. Access Under Mounting Location

Follow these steps to deck mount the GPS receiver when routing the cable down through the mounting location:

1. Determine the best location, then test route the 20' (6 m) cable from the mounting location to the control head.

**NOTE:** Installation details may vary with unit configuration.

2. Mark the mounting location and drill a 3/4" (19 mm) hole for the cable and cable plug. Route the cable.

3. Cover the cable hole with the receiver. Make sure the receiver is flush on the surface and mark the two mounting holes with a pencil or punch.

4. Move the receiver to the side and drill two pilot holes using a 9/64" (3.5 mm) bit.

*NOTE: Remember to seal screw holes and drilled holes as needed with marine-grade silicone sealant to protect your boat from water damage.*

5. Align the GPS receiver screw holes over the pilot screw holes and attach with the #8 - 1 1/4" Phillips head screws. **Hand tighten only!**

*NOTE: If the mounting surface is thin and made of a lighter material, a backing material may be needed below the mounting surface.*

Access Under Mounting Location

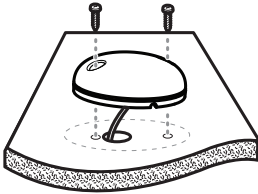

No Access Under Mounting Location

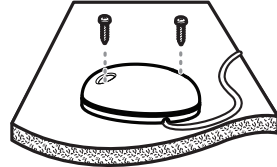

## 2c. No Access Under Mounting Location

---

Follow these steps to deck mount the GPS receiver in a situation where you must route the cable to the side because there is no space for a cable underneath the mounting location.

1. Determine the best location, then test route the cable from the mounting location to the control head.

*NOTE: AS-EC10 10' extension cables are available from Humminbird® if your planned routing exceeds 20' (6 m). Maximum cable length, including extensions, should not exceed 50' (16 m).*

2. Confirm the cable length is good and route the cable from the receiver to the control head. If holes are required to route the cable, they must be 3/4" (19 mm) to allow for the cable connector. Secure the NMEA cable with electrical tape.

*NOTE: Remember to seal screw holes and drilled holes as needed with marine-grade silicone sealant to protect your boat from water damage.*

3. The GPS receiver has two wire routing notches. Use the cable notch closest to the intended cable route.
4. With the cable routed, position the GPS receiver in the planned mounting location and mark the mounting holes with a pencil or punch.
5. Move the GPS receiver to the side and drill the two 9/64" (3.5 mm) pilot holes.
6. Align the GPS receiver's screw holes over the pilot screw holes and attach with the #8 - 1 1/4" Phillips head screws. **Hand tighten only!**

### 3. Finish Routing the Cable and Check GPS Receiver Operation

After installing a GPS receiver, you should perform the following procedure to finish routing the GPS cable to the control head and to check to make sure that the control head is working correctly.

1. Secure the cable along its path to the control head as needed with cable ties.
2. Plug the GPS receiver cable into the Communications port on the control head. See **Testing the System Installation** to use the System Status start-up option and/or the GPS Diagnostic View to confirm a good installation.

Inserting the Cables into the Cable Connector Insert

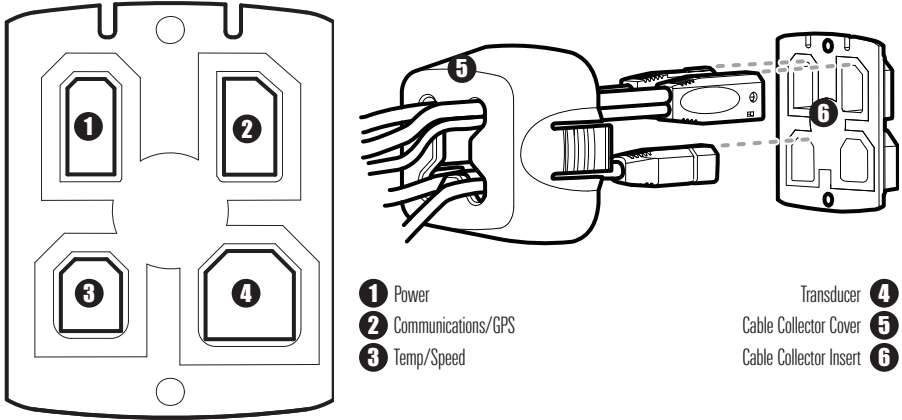



## Testing the System Installation

---

After you have completed the installation of the control head and any other accessories such as the GPS receiver, and have made all the required cabling connections, you must test the installation before using the system.

### To test the installation:

---

1. **Press the POWER/LIGHT key** on the control head once to turn on the control head. There will be an audible sound to let you know that you pressed the key, and the initial Title screen will appear. If the unit does not power up, make sure that power is available.

**While the Title screen is shown on the display**, press the MENU key to display the Start-Up Options menu. Press the UP or DOWN Cursor keys to position the cursor, then the RIGHT Cursor key to select System Status from the Start-Up Options menu (see the **Start-Up Options Menu** section for more information about these menu choices). The System Status Self Test screen will appear.

***NOTE:** If you wait too long, the system will default to whichever menu mode happens to be highlighted, and you will have to start again.*

2. Self Test displays results from the internal diagnostic self test, including unit serial number, Printed Circuit Board (PCB) serial number, software revision, total hours of operation and the input voltage. See **System Status** for more information about the Self Test.
3. From the System Status screen, view accessory connections by pressing the VIEW key. See **System Status** for more information about the Accessory Test.

***NOTE:** The speed will be detected only if the paddlewheel has moved since the 1100 Series™ has been powered up.*

4. From the System Status screen, see a GPS Diagnostic View by pressing the View key. GPS Diagnostic View shows a sky chart and numerical data from the GPS receiver. The sky chart shows the location of each visible GPS satellite with its satellite number and a signal strength bar. A dark gray bar indicates that the satellite is being used to determine your current position. A light gray bar indicates that the satellite is being monitored, but is not yet being used. See **System Status** for more information about the GPS Diagnostic View.
5. You are ready for on the water operation.

## Power On the Control Head

---

Follow the instructions below to power on your Humminbird® control head.

### 1100 Series™ Title Screen



1. Press the  POWER/LIGHT key.
2. When the Title screen is displayed, press the MENU key to access the Start-Up Options Menu.
3. Use the 4-WAY Cursor Control key to select Normal (if there is a transducer attached to the control head), or Simulator (if there isn't a transducer attached to the control head).

**NOTE:** See *Start-Up Options Menu* for more information.

- If a functioning transducer is connected, Normal operation will be selected automatically at power up, and your Fishing System can be used on the water.
- If a transducer is not connected and you wait too long to select a Start-Up Option, the system will default to whichever menu is already highlighted.
- In Simulator you can learn how to use your control head and save settings in advance for later use.

## What's on the Control Head

Your 1100 Series™ user interface is easy to use. A combination of keys, different views, and situation-specific, customizable menus allows you to control what you see on the color display. Refer to the following illustration and see *Key Functions*, *Views*, and *The Menu System* for more information.

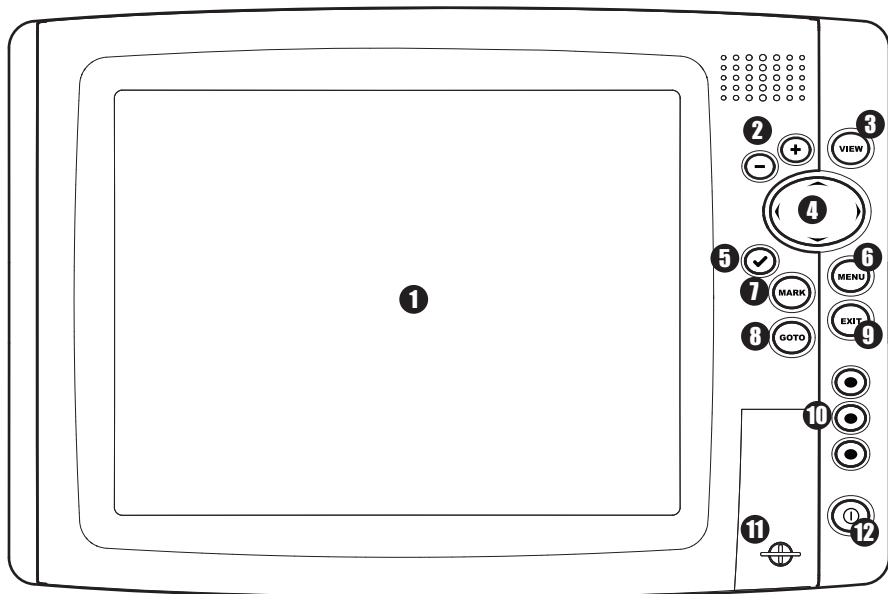

- 1 Screen
- 2 ZOOM (+/-) Keys
- 3 VIEW Key
- 4 4-WAY Cursor Control Key (LEFT, RIGHT, UP, or DOWN)
- 5 INFO Key
- 6 MENU Key

- 7 MARK Key
- 8 GOTO Key
- 9 EXIT Key
- 10 View Preset Keys
- 11 SD Card Slots
- 12 POWER/LIGHT Key

## Key Functions

---

Your Fishing System has a set of easy to use keys that give you flexibility and control over your fishing experience.



### POWER/LIGHT Key

---

The **POWER/LIGHT key** is used to power the Fishing System on and off. You can also use the POWER/LIGHT key to adjust the backlight and contrast of the display.

**Power On the Control Head:** Press the POWER/LIGHT key to power on the unit. When the Title screen is displayed, press the MENU key to access the Start-Up Options Menu.

**Power Off the Control Head:** Press and hold the POWER/LIGHT key for 3 seconds. A message will appear to indicate how many seconds there are until shutdown occurs. To ensure that shutdown occurs properly and any menu settings will be saved, your Fishing System should always be turned off using the POWER/LIGHT key.



**Adjust the Backlight or the Display Background Color:** Press the POWER/LIGHT key to access the Light and Background submenu. Use the 4-WAY Cursor Control key to select Light or Background, and then use the LEFT or RIGHT Cursor key to change the settings. Press EXIT to exit the Light and Background submenu.

***NOTE:** Your control head will start up with the backlight on and will automatically turn it off to conserve power.*



### VIEW Key

---

The **VIEW key** is used to cycle through all available views. Press the VIEW key to advance to the next view. Press the VIEW key repeatedly to cycle through all available views. Views can be hidden to optimize the system to your fishing requirements (see *Views* or *View Menu Tab*).



## MENU Key

---

The **MENU key** is used to access the menu system. See *The Menu System* for more information.

**Start-Up Options Menu:** Press the MENU key during the power up sequence to view the Start-Up Options menu.

**X-Press™ Menu:** Press the MENU key once in any view to access the X-Press™ Menu, which provides frequently-used menu settings that correspond with the current view or navigation mode.

**Main Menu:** Press the MENU key twice in any view to access the Main Menu, which is organized under tabbed headings to help you find a specific menu item quickly.



## 4-WAY Cursor Control Key

*(RIGHT, LEFT, UP, or DOWN Cursor Keys)*

---

The **4-WAY Cursor Control key** has multiple functions, which depend on the view, menu, or situation.

- **Menu Selection:** Press the DOWN or UP Cursor keys to highlight a menu option, then press the RIGHT or LEFT Cursor keys to change a menu setting. The changes will be activated and saved immediately.
- **Freeze Frame:** In Sonar View, Side Imaging® View, and Down Imaging™ View, press any arrow on the 4-WAY Cursor Control key to freeze the display and move the active cursor to a location on the screen. A cursor dialog box will display to show the depth of the location you choose.
- **Active Cursor:** Press any arrow on the 4-WAY Cursor Control key, and the active cursor will appear on the screen.
- **Chart Views:** The 4-WAY Cursor Control key also pans the charts and highlights decluttered waypoint icons.

***NOTE:** In Freeze Frame or Active Cursor mode, you can also make the cursor move diagonally by pressing in between two of the arrows on the 4-WAY Cursor Control key.*

- **Bird's Eye View:** The 4-WAY Cursor Control key controls the motion of the eye point.
- **Snapshot and Recording View:** Press the UP or DOWN Cursor keys to highlight a recording icon, and then press the RIGHT Cursor key to start recording playback. Press the RIGHT or LEFT Cursor keys to control the speed of playback.



## VIEW PRESET Keys

---

The **VIEW PRESET keys** are used to save your three favorite views for quick retrieval. Instead of using the VIEW key to cycle through all the views to find the one you want, you can program the VIEW PRESET keys to display a specific view immediately. See *Views* for more information.



## EXIT Key

---

The **EXIT key** has multiple functions, which depend on the situation.

- **If an alarm is sounding**, press the EXIT key to cancel the alarm.
- **If a menu tab is selected**, press the EXIT key to exit the menu mode and return to the view.
- **If a menu is active**, press the EXIT key to return to the previous level in the menu system.
- **From any view**, press the EXIT key to cycle through the available views in reverse order.
- **If Freeze Frame is active**, press the EXIT key to return to a scrolling display.
- **If the Cursor is active**, press the EXIT key to remove the cursor from the display.



## INFO Key

---

The **INFO key** has multiple functions, which depend on the active view and situation.

**Chart Views:** Press the **INFO key** while in any navigation view to display information about objects that are near the active cursor. If the cursor is not active, the Chart Info submenu will be displayed. See *Views: Viewing Cartography* for more information.

**Screen Snapshots:** In Chart views, highlight a screen snapshot or recording icon and press the Info key. Select Chart Info or View Snapshot from the submenu. See *Snapshot and Recording View* for more information.



## MARK Key

---

Press the **MARK key** while in any view to mark the position of a waypoint. The MARK key function is available if the GPS receiver connected.

- **Active Cursor:** The waypoint will be marked at the cursor location.
- **Without Active Cursor:** The waypoint will be marked at the boat location.
- **If Screen Snapshot is active,** a waypoint will be created, and a screen snapshot will also be saved to the optional-purchase SD card (see **Views: Snapshot and Recording View**). Navigation is not affected by the Screen Snapshot feature.

*NOTE: If Screen Snapshot is enabled but there is not a GPS receiver connected, pressing the MARK key will capture the screen image and display an error saying that a GPS position fix is required to create a waypoint.*

*NOTE: You must have an optional-purchase SD card installed for the screen snapshot feature to work.*



## GOTO Key

---

The **GOTO key** has multiple functions, which depend on the situation.

- **Active Cursor:** Press the GOTO key while in any view to create a waypoint and start navigation towards that waypoint.
- **Without Active Cursor:** Press the GOTO key to display the saved waypoints list, and then highlight a waypoint. Press the RIGHT Cursor key to begin navigation.
- **Man Overboard:** Press and hold the GOTO key for more than 1.5 seconds to activate the Man Overboard (MOB) function. Once MOB is activated, any current navigation will be cancelled and the current route will be discarded without notification (see **Man Overboard (MOB) Navigation**).

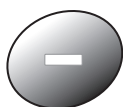

## ZOOM (+/-) Keys

---

The **Zoom keys** function in different ways which depend on the view displayed.



- **Navigation Views or the Sonar Zoom View:** Press the +/- ZOOM key to change the scale of the view to appear closer or farther away.
- **Side Imaging® View or Down Imaging™ View:** Use the 4-WAY Cursor Control key to move the active cursor to a position on the screen. Press the + ZOOM key to magnify your selection. Press the -Zoom key to decrease the scale.

*NOTE: The cursor must be active for the zoom feature to work in the Side Imaging® or Down Imaging™ View.*

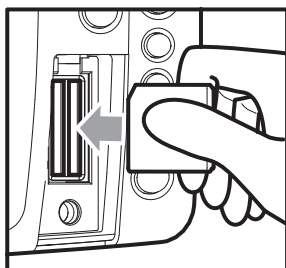

Inserting an SD  
into the Card Slot

## SD Memory Card Slots

The **two SD card slots** on your control head can be used with SD cards (optional-purchase required) to add detailed charts to your Fishing System, update your Fishing System software, or export navigation data from your Fishing System.

**NOTE:** The SD Cards require a separate purchase. For more information, visit our Web site at [humminbird.com](http://humminbird.com) or contact our Customer Resource Center at **1-800-633-1468**.

### To insert an SD memory card:

1. Remove the SD memory card slot cover.
2. Position the SD memory card so that the label faces the left side of the unit, and insert the card into the slot. Press down on the card until it clicks into place.
3. Close the slot cover and turn the knob just 1/4 of a turn to close. Do NOT overtighten, as this will not improve water resistance and may damage the cover.
4. **To Remove:** Press the SD memory card into the slot and then release. The card will eject, and you can then pull the card from the slot.



## Add Maps to Your Fishing System

---

Your Fishing System includes a built-in Contour XD™ or UniMap™ with a more detailed map of North America (Domestic models) or a detailed map of Europe and Southeast Asia, including Australia and New Zealand (International models).

You can also purchase SD cards with additional chart information for a particular location.

***NOTE:** The SD Cards require a separate purchase. Your Fishing system supports LakeMaster® and Navionics® Cartography on SD card media.*

***NOTE:** The 1100 Series™ supports Navionics® Gold, HotMaps™, HotMaps™ Premium, and Platinum™ Cartography on SD card media. The 1100 Series™ does not support Navionics® Classic Charts. NVB models are pre-loaded with Navionics® cartography and are available in the U.S. only. Currently, there are no international NVB models available.*

- **Auto Select:** When you install the SD card in your control head, your Fishing System will retrieve the chart and display it automatically.
- **Chart Select:** You can also choose which chart to display with the Chart Select menu option in the Chart Menu Tab. Choose Right (card slot) or Left (card slot) to select the SD card you'd like to use (see **Chart Menu Tab: Chart Select**). **NVB Units:** See **Chart Menu Tab: NVB Chart Preference** for details.
- **Map Borders:** Use the 4-WAY Cursor Control key to move the active cursor within a map border, and press the ZOOM + key to view the different map (see **Chart Menu Tab: Map Borders**).
- **Menu Options:** The Chart Menu Tab will change to display menu options that correspond with the active chart (see **Chart Menu Tab**).

## Update Software

---

Set up an online account at **humminbird.com** so that you will receive the latest Humminbird® news and software upgrades for your Fishing System. You can also download HumminbirdPC™ from your account, which allows you to manage your waypoints, routes, and tracks on your personal computer.

**Required Equipment:** Personal computer with Internet access, a formatted SD memory card, and an SD Memory Card Reader.

***NOTE:** To purchase the USB Memory Card Reader (AS CR) visit our Web site at **humminbird.com** or contact our Customer Resource Center at **1-800-633-1468**. Our Customer Resource Center will also assist you with any questions you might have about updating your Humminbird® Fishfinder.*

### To update the control head software:

1. Install a formatted SD memory card into the card reader connected to your PC.
2. **Register your Fishing System:** Log on to humminbird.com. Click My Account. Set up a new account.
3. **Download:** From My Account\My Profile\My Equipment, click the file name of the latest software update [unit name (version #)].
  - Read the instructions in the dialog box and click Download.
  - Follow the prompts to save the software file directly to the SD Card.
4. Install the SD card with the updated software file into the control head card slot.
5. Power on your Fishfinder. The control head will recognize the new software and run through a series of prompts to confirm software installation.

## Export Navigation Data

---

You can export all saved tracks, waypoints, and routes from your Fishing System to an optional-purchase SD memory card.

### **To export all navigation data:**

1. Make sure that an optional-purchase SD memory card is installed in the slot.
2. Press the MENU key twice to access the Main Menu, then press the RIGHT Cursor key until the Navigation tab is selected.
3. Highlight Export All Nav Data and press the RIGHT Cursor key. The Confirm dialog box will appear. To confirm export, press the RIGHT Cursor key once more. To cancel export, press the LEFT Cursor key.

**NOTE:** If an SD memory card is not installed, an error message will be displayed. Insert the SD memory card and try again.

**NOTE:** The SD memory cards and USB Memory Card Reader require separate purchases. The USB Memory Card Reader accessory can be used in conjunction with your personal computer to view and organize your exported navigation data. To purchase this accessory, visit our Web site at [humminbird.com](http://humminbird.com) or contact our Customer Resource Center at **1-800-633-1468**.

# What's on the Sonar Display

The Fishing System can display a variety of useful information about the area under and adjacent

- 1** **Depth** - Water depth; can be set to alarm when the water becomes too shallow.
- 2** **Temperature** - Water surface temperature
- 3** **Speed** - If a Speed accessory or GPS Receiver is attached, the 1100 Series™ can display the speed of the boat and can keep a triplog of nautical or statute miles traveled.
- 4** **Course** - The current direction the boat is traveling measured in degrees from North.
- 5** **Voltage**
- 6** **Sonar Color Bar** - Color spectrum indicating low to high sonar intensity returns, where red indicates high intensity and white indicates low intensity.
- 7** **RTS™ (Real Time Sonar) Window**
- 8** **Thermoclines** - Layers of water with different temperatures that appear at different depths and different times of the year. A thermocline typically appears as a continuous band of many colors moving across the display at the same depth.
- 9** **Bait Ball**
- 10** **Cursor** - Available in Freeze Frame and can be positioned in the Sonar View to provide depth of a sonar return and bottom depth below the cursor. The Latitude and Longitude of the cursor position, the distance to travel to the cursor position, and the bearing to the cursor position are shown with a GPS receiver attached. Cursor information is displayed at the top of the screen.
- 11** **Second Sonar Return** - When the sonar signal bounces between the bottom and the surface of the water and back again. Use the appearance of the second return to determine bottom hardness. Hard bottoms will show a strong second return, while soft bottoms will show a very weak one or none at all.

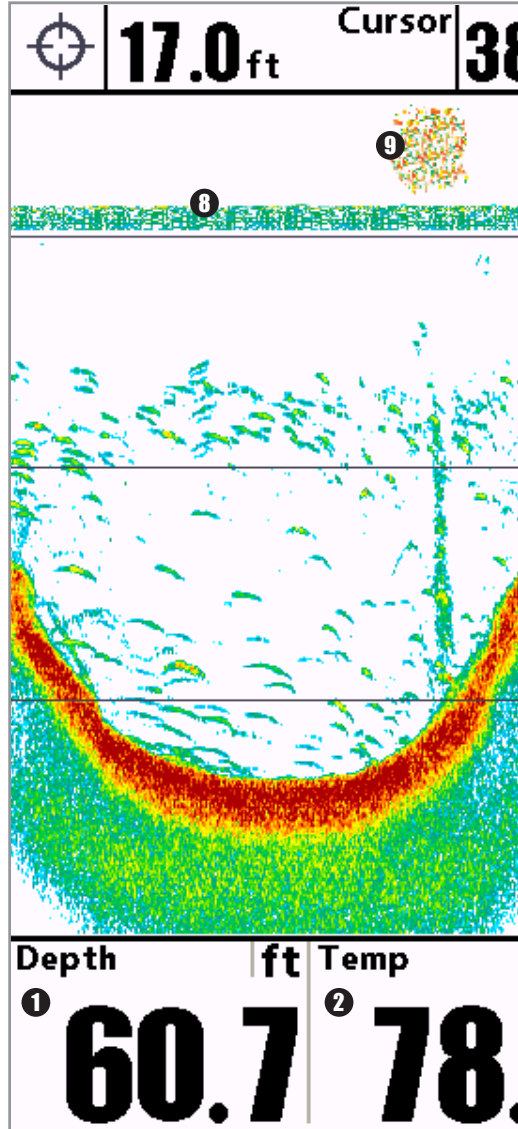

to your boat, including the following items:

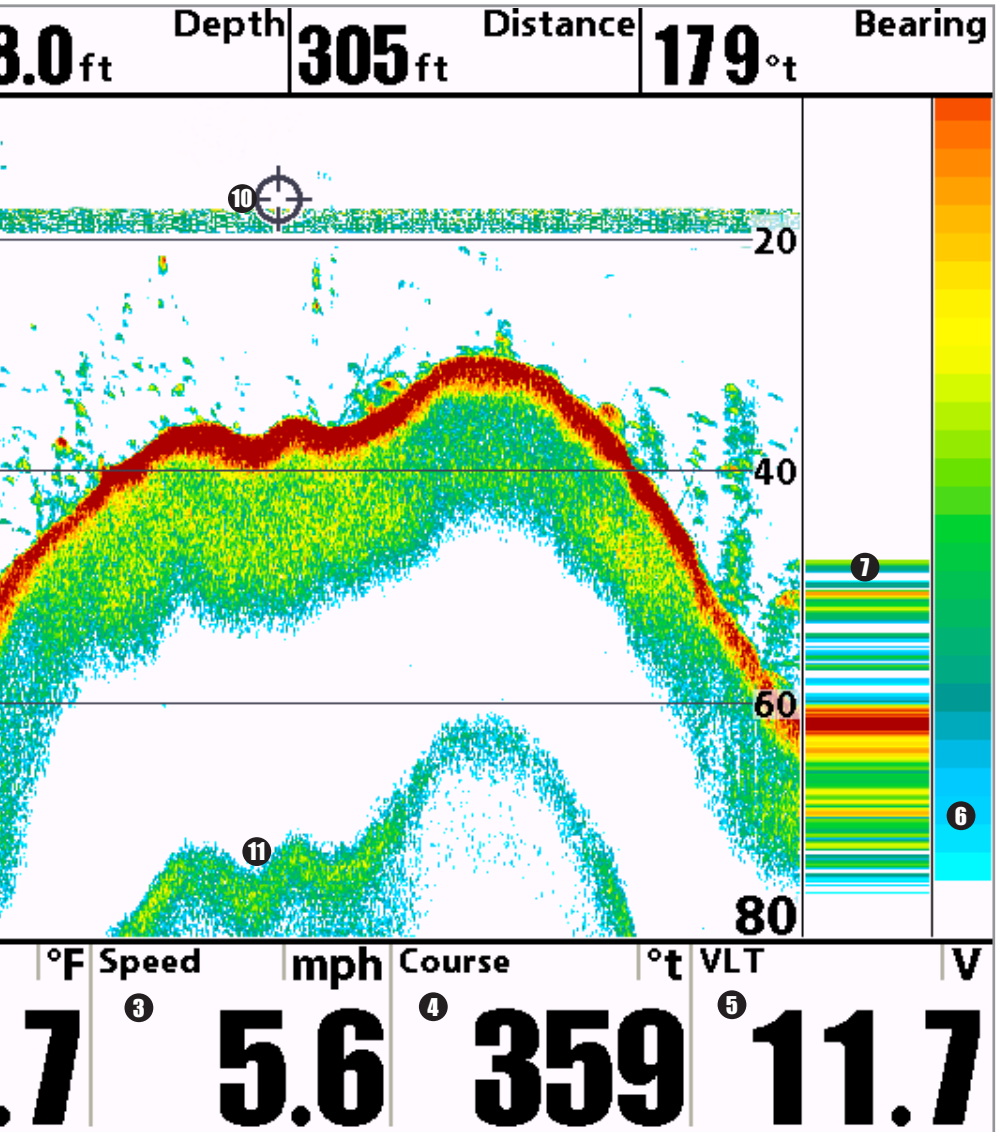

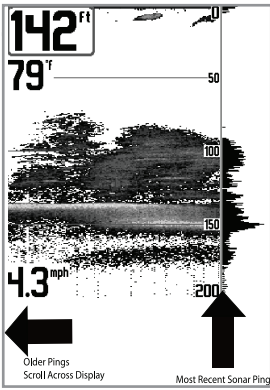

## Understanding the Sonar Display

It is important to understand the significance of the display. The display does NOT show a literal 3-dimensional representation of what is under the water. Each vertical band of data received by the control head and plotted on the display represents something that was detected by a sonar return at a particular time. As both the boat and the targets (fish) may be moving, the returns are only showing a particular segment of time when objects were detected, not exactly where those objects are in relation to other objects shown on the display.

The returned sonar echoes are displayed on the screen. As a new echo is received, the historical data scrolls left across the display.

## Real Time Sonar (RTS™) Window

A **Real Time Sonar (RTS™) Window** appears on the right side of the display in the Sonar View only. The RTS™ Window always updates at the fastest rate possible for depth conditions and shows only the returns from the bottom, structure and fish that are within the transducer beam. The RTS™ Window plots the depth and intensity of a sonar return. (See *Sonar Menu Tab: Real Time Sonar (RTS™) Window*).

The **Narrow RTS™ Window** indicates the sonar intensity through the use of colors. Red indicates a strong return and blue indicates a weak return. The depth of the sonar return is indicated by the vertical placement of the return on the display depth scale.

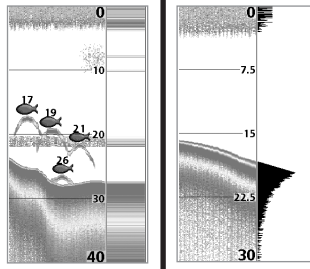

The **Wide RTS™ Window** indicates the sonar intensity through the use of a bar graph. The length of the plotted return provides an indication of whether the return is weak or strong. The depth of the sonar return is indicated by the vertical placement of the return on the display depth scale.

## SwitchFire™

---

**SwitchFire™** controls how the sonar returns are displayed in the Sonar Views. SwitchFire™ settings are available in the Sonar Menu Tab.

To see the maximum sonar information available within the transducer beam so more fish arches and better jig tracking are shown, choose Max Mode.

To see less clutter and more fish size accuracy interpreted from the transducer beam, choose Clear Mode. See ***Sonar Menu Tab: SwitchFire™*** for more information.

## Freeze Frame and Active Cursor

---

**Freeze Frame & Active Cursor** - Press any arrow on the 4-WAY Cursor Control key, and the screen will freeze and a cursor will be displayed. Use the 4-WAY Cursor Control key to move the cursor over a sonar return, and the depth of the sonar return will be displayed in the cursor dialog box.

The **RTS Window™** continues to update in Freeze Frame. To return to a scrolling display and exit Freeze Frame, press the EXIT key. Freeze Frame is available in the Sonar, Split Sonar, and Sonar Zoom Views.

## Instant Image Update

---

**Instant Image Update** - You can change a variety of sonar menu settings (such as Sensitivity or Upper Range), and the adjustments will be shown instantly on the screen.

## Sonar Bottom Presentation

As the boat moves, the unit charts the changes in depth on the display to create a profile of the **Bottom Contour**. The type of bottom can be determined from the return charted on the display. A **Hard Bottom** such as compacted sediment or flat rock appears as a thinner line across the display. A **Soft Bottom** such as mud or sand appears as a thicker line across the display. **Rocky Bottoms** have a broken, random appearance.

*NOTE: A sloping bottom will be represented as a thicker line across the display. Harder bottoms typically will be displayed with red and softer bottoms typically will be displayed with blue.*

The sonar returns from the bottom, structure, and fish can be represented as **Structure ID®** or **WhiteLine™**. See *Sonar Menu: Bottom View* to set the Bottom View.

**Structure ID®** represents weak returns in blue and strong returns in red.

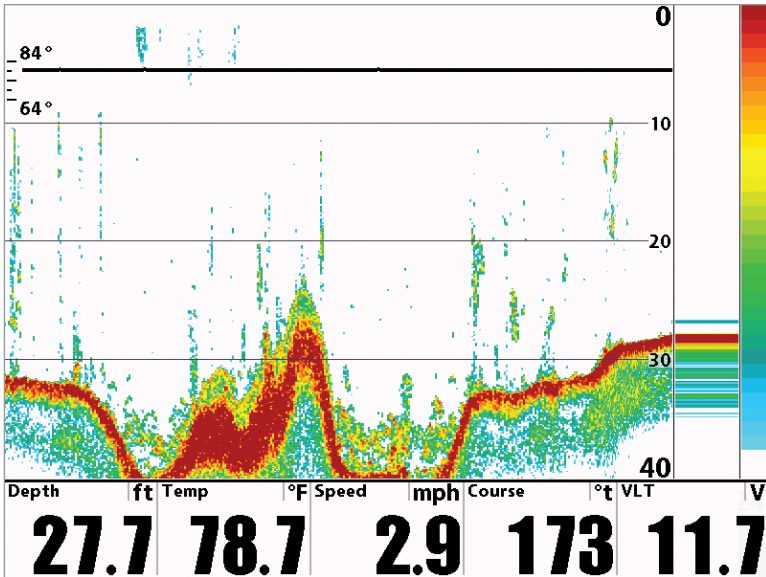



**WhiteLine™** highlights the strongest sonar returns in white, resulting in a distinctive outline. This has the benefit of clearly defining the bottom on the display.

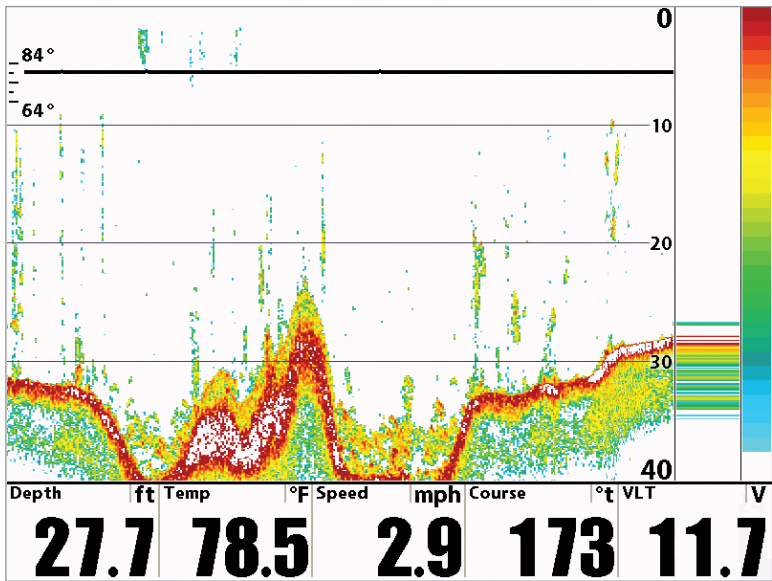

## What's on the Side Imaging® Display (1198c SI Combo models only)

Side Imaging® displays a number of easily recognizable features that allow for accurate interpretation intensity of the sonar return. For example, rock and gravel provide a clearer sonar return than mud better than downward slopes that face away from the transducer. You can find a number of easily contour and structure, including the following items:

- 1 Depth** - Water depth; can be set to alarm when the water becomes too shallow.
- 2 Temperature** - Water surface temperature
- 3 Speed** - If a Speed accessory or GPS Receiver is attached, the 1100 Series™ can display the speed of the boat and can keep a triplog of nautical or statute miles traveled.
- 4 Course** - The current direction the boat is traveling measured in degrees from North.
- 5 Voltage**
- 6 Bottom Return**
- 7 Topography Changes**- The light part of the screen shows where the beam is hitting hard bottom or rising terrain. The dark part of the screen indicates soft bottom (sand, mud) or descending terrain.
- 8** The **water column** shows the relative depth of the water under the boat at a given time. Variations in the width of the water column show variations in the distance to the bottom as the boat passes over.
- 9 Shadows** result from a lack of reflected sonar from a particular area and can be more valuable for interpretation than the sonar reflected by the object itself. Use shadows to help you see the image in 3 dimensions, oriented in space. You can gain insight into the actual shape of an object, or the depth to which it has sunk into the bottom, through shadows on the display. Objects standing on the bottom cast a sonar shadow. The longer the shadow, the taller the object. Fish also cast shadows. You can use the shadow to interpret how close the fish is to the bottom.

142 Left ⑩

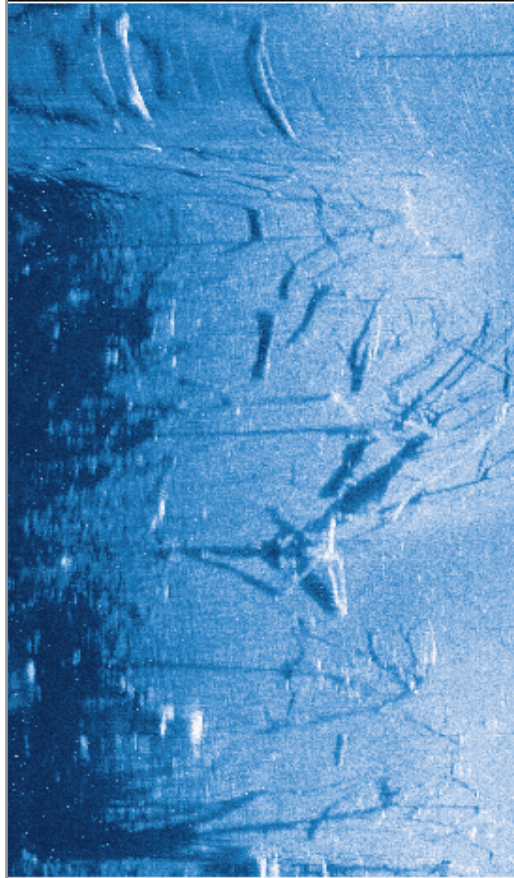

Depth	ft	Temp
① 31.1		② 74.

- 10 Side Imaging® Range** - Images shown on the right side of the screen are located on the right side of your boat, and images shown on the left side of the screen are located on the left side of your boat. In this illustration, the sonar is pinging 142 feet on each side.

of bottom contour and structure. For Side Imaging®, the bottom composition determines the and sand because of their relative density. Upward slopes that face the transducer reflect sonar recognizable features on the Side Imaging® display that allow for accurate interpretation of bottom

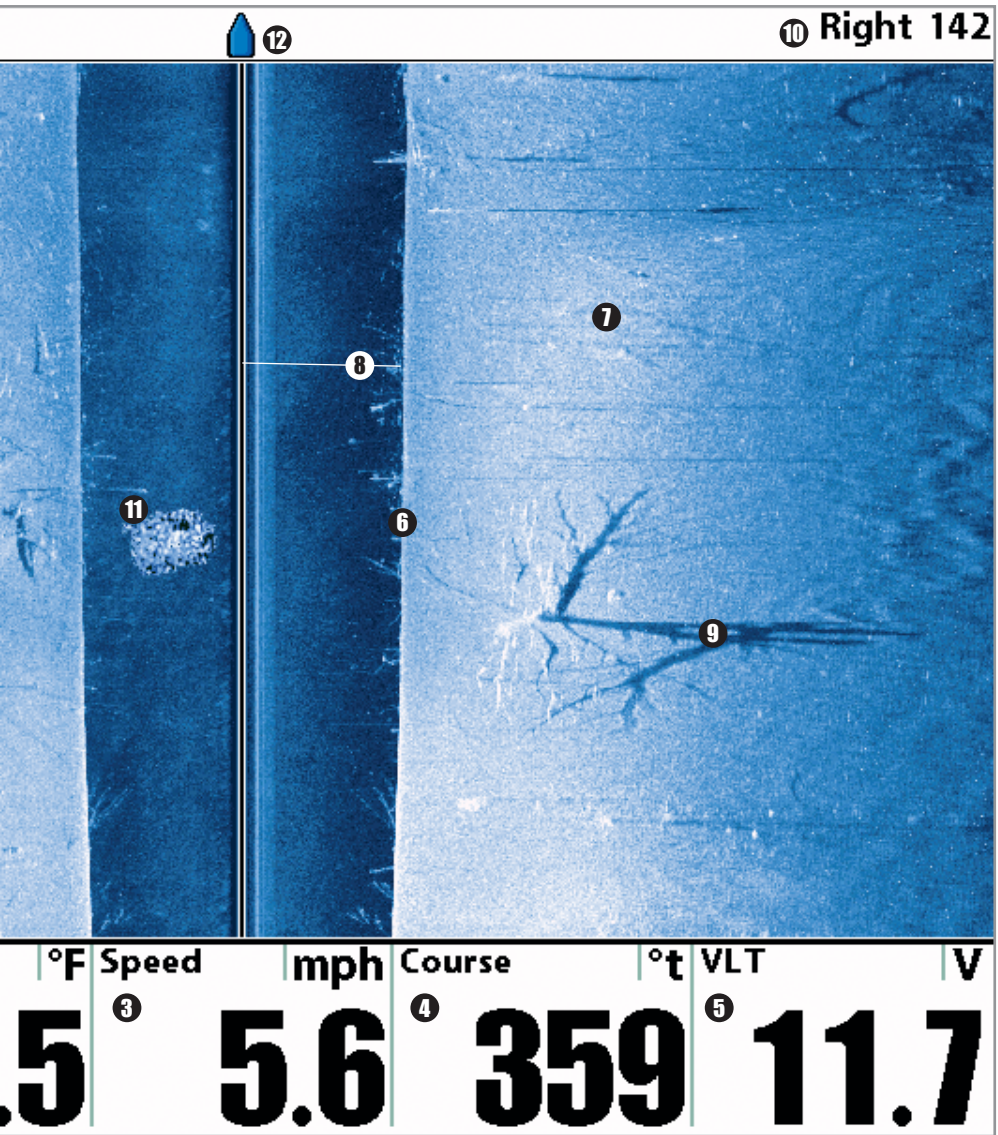

- 11 Clouded Area - May indicate a bait ball and White Streaks may indicate fish.
- 12 Boat Icon & Top of the Display - Information from the side beams are displayed at the top of the screen. As new information is received, the historical data scrolls down the screen. The boat icon will turn to indicate the direction of navigation.

## Understanding the Side Imaging® Display

It is important to understand how Side Imaging® technology produces the display. The images you see on the display are produced using sonar technology. The special transducer projects three distinct beams – one beam facing down and two beams pointing out to the side.

**Down Beam** is aimed directly below the boat and provides conical coverage.

**Side Beams** are aimed at right angles to the path of the boat. The side beam coverage is very thin from front to back, yet very wide top to bottom. The narrow aspect (front to back) of the beam illuminates a small strip of the bottom perpendicular to the direction of the boat.

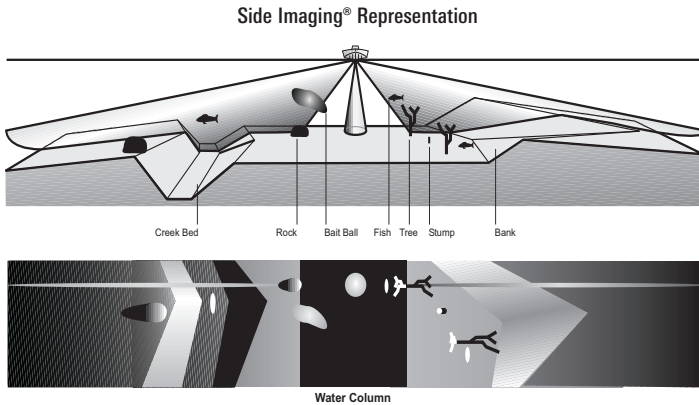

*As the unit pings, a strip of data is displayed at the top of the Side Imaging® view.*

**Each time the unit pings**, a strip of data representing all the echoes received by the transducer are put together on the display to form the image that you see.

**The rows closest to the boat icon** at the top of the view are the most recent sonar data. The information is scrolled down the screen as new data, drawn at the top of the screen, becomes available.

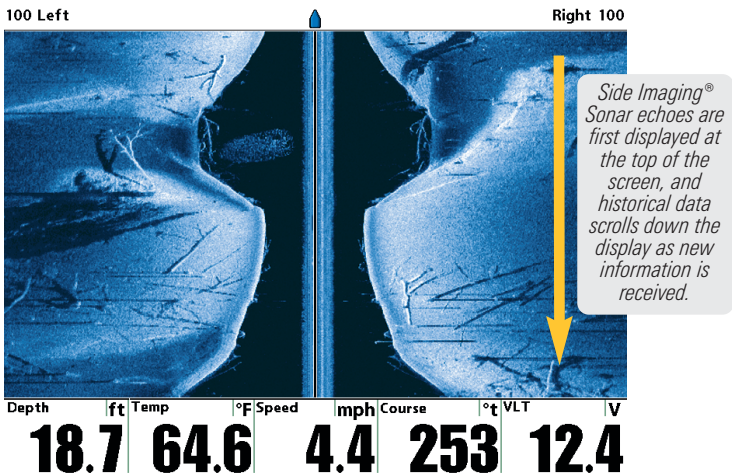



The main benefit of Side Imaging® sonar to anglers is that it provides an overall survey of a large area of water. This gives you a better understanding of the bottom topography and how structure is oriented for more efficient fishing.

**Saltwater anglers** pick up precise details of popular fishing structure like wrecks, reefs, humps and drop-offs, as well as being able to spot bait balls in open water. **Freshwater anglers** can see fish-attracting structure such as timber, stumps, rocks, and creek beds.

## Side Imaging® Frequencies and Coverage

Side Imaging® sonar uses two very precise sonar beams that are directed to either side of the boat. The beams “illuminate” the bottom contour, structure, and fish, and the results are displayed in a “picture-like” image on the screen.

- **Frequencies:** The side beams can be operated at one of two frequencies: 455 kHz or 800 kHz. Your Side Imaging® transducer also provides DualBeam PLUS™ at 200/83 kHz. Selecting 800 kHz produces the sharpest image, while selecting 455 kHz provides greater bottom coverage area.
- **Side Imaging® Beams** are extremely narrow from front to back, and provide “thin slices” of the bottom for high resolution imaging.
- **Side Imaging® Range:** 240 feet to each side, with a total side coverage of 480 feet, with a depth limitation of 150 feet, depending on the contour of the bottom and when the side beam frequency selection is set to 455 kHz.

455 kHz provides maximum coverage with 180° total beam width

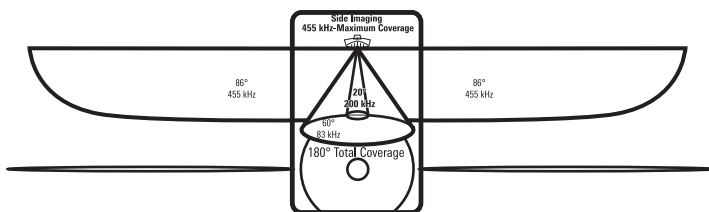

800 kHz provides highest resolution with 130° total beam width

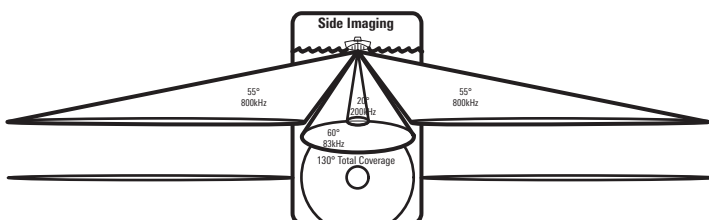

## For Best Performance

---

Use the following tips and examples to help you interpret the Side Imaging® display.

### Side Imaging® Tips

**Boat speed: 2 to 6 mph**

**Straight line navigation**

**Minimum turning time and wave turbulence**

**Boat speed:** Side Imaging® is best performed at boat speeds between 2 to 6 mph. If the boat is stationary, the same information is displayed over and over. If the boat is moving very quickly, there will be gaps between the strips of information. The best boat speed to use will depend on the side range selected. Slower speeds are good for longer ranges, while faster speeds can be used at shorter ranges.

**Boat navigation:** It is important to understand that when the boat turns, successive beam strips to one side will begin to overlap and the strips on the other side will fan out, providing some distortion to the image. Because of this, the best imaging performance is produced by straight line navigation and minimal side-to-side boat motion (i.e. wave induced, etc.). This applies to navigation by either the main engine or the trolling motor. Minimize turning time and avoid wave action that induces large side-to-side rocking of the boat. For example, if there is a lot of wave activity, try to move the boat so that it is perpendicular to the waves instead of parallel with the waves in order to minimize the side-to-side rocking of the boat.

**Beam Coverage:** When there is an area directly under the boat that does not have SI beam coverage, this area will be covered by the standard 200/83 kHz down-looking beam and displayed in the Sonar views. The net effect of this, on the display, is that a single object may appear as two separate entities, when in reality, it is one continuous object. See *Submerged Bridge: A Closer Perspective* and the *Submerged Bridge: Alternative Perspective* illustrations for examples of this.

See [humminbird.com](http://humminbird.com) and [sideimaging.com](http://sideimaging.com) for a side imaging sonar tutorial and additional information.

# On the Water Interpretation

## Submerged Bridge, Creek Channel and New Bridge Pilings

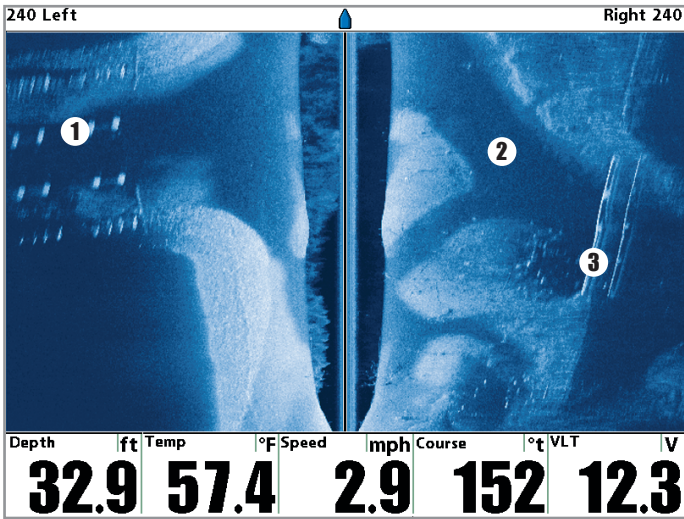

- 1 New Bridge Pilings
- 2 Creek Channel

Submerged Bridge 3

## Submerged Ravine with Timber

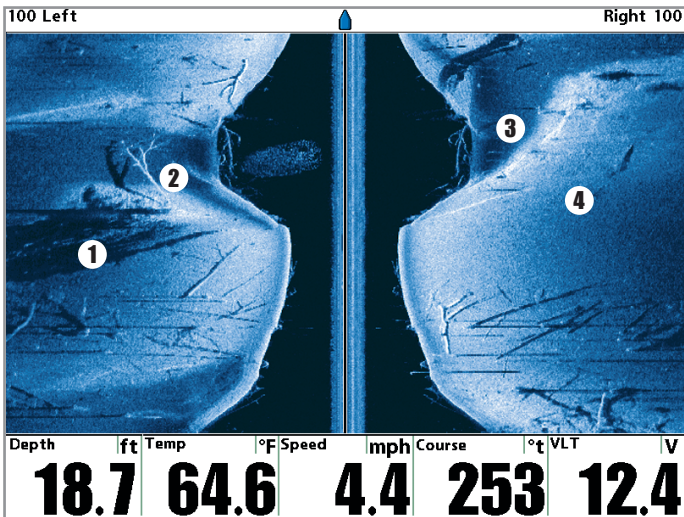

- 1 Submerged Timber
- 2 Submerged Tree

Submerged Ravine 3

Possible Drop Off 4

### Submerged Bridge, Alternative Perspective

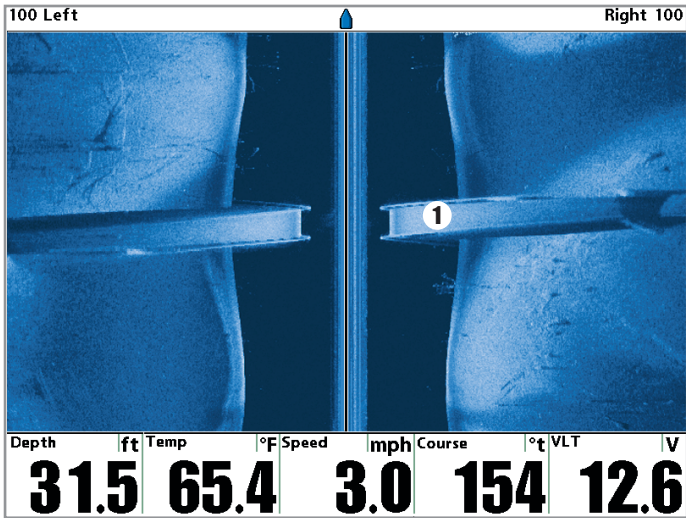

① Submerged Bridge

### Submerged Standing and Fallen Timber, plus Bait Fish

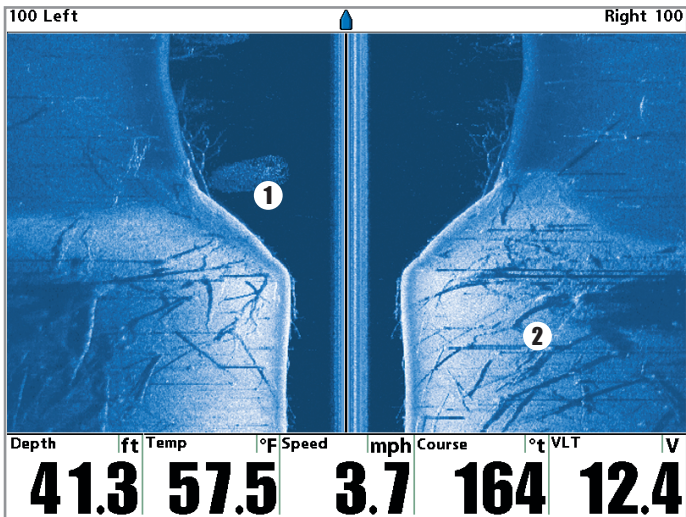

① Bait Fish

Standing and Fallen Timber ②



## Submerged Swimming Pool

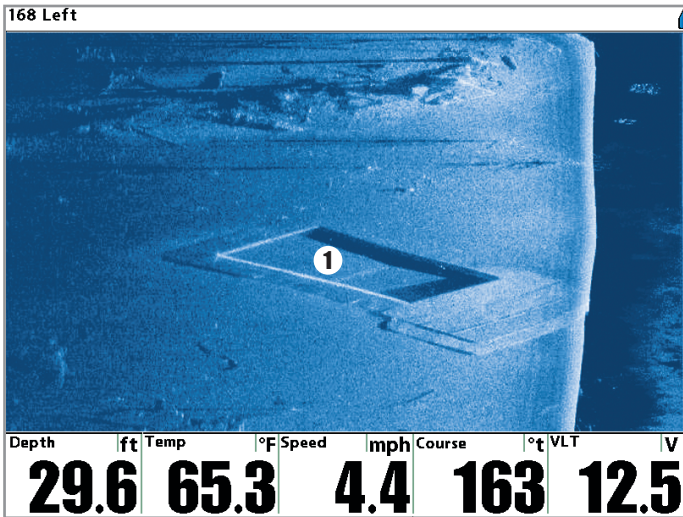

① Swimming Pool

## Submerged Barge with Dumped Logs

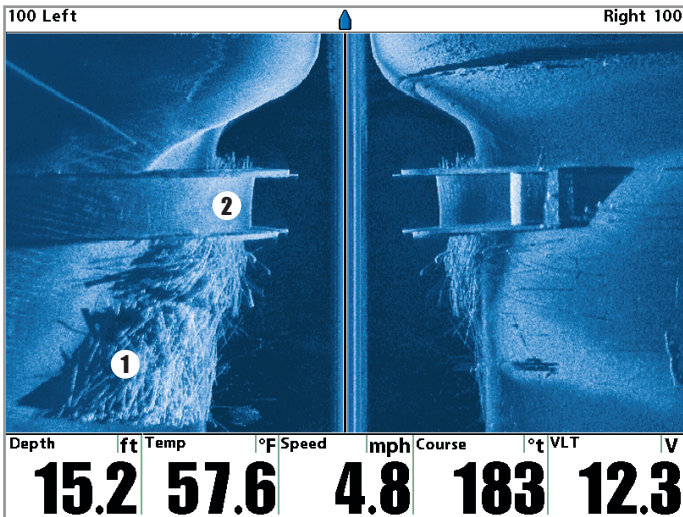

① Dumped Logs

Submerged Barge ②



## Views

---

The sonar and navigation information from your Fishing System are displayed on the screen in a variety of easy-to-read views. Many of these views are also available as a Combo View, which shows two views on the screen at the same time.

- **Default View:** When you first power up the control head, Chart/Side Combo View will be the default view for the 1198c SI Combo. Sonar/Chart View will be the default view for the 1158c.
- **Available Views:** The available Views on your Humminbird® unit will vary with the model and the transducer attached to your control head. Side Imaging® and Down Imaging™ Views are only available in the 1198c SI Combo, and Side Beam View is only available when an optional-purchase QuadraBeam PLUS™ transducer is attached to the control head. See *Views Menu Tab* and the following pages for more information.
- **Cycle:** When you press the VIEW key repeatedly, the display cycles through the available views on your screen. When you press the EXIT key, the display cycles through the available views in reverse order.
- **Customize:** You can display or hide any view to suit your fishing preferences. See the following pages for more information about each View.

### To customize your view rotation:

You can choose which views are hidden or visible in your view rotation.

1. Press the MENU key twice to access the tabbed Main Menu, then press the RIGHT Cursor key until the Views tab is selected.
2. Press the UP or DOWN Cursor keys to select a View.
3. Press the LEFT or RIGHT Cursor keys to change the status of the view from Hidden to Visible or vice versa.

### To program each PRESET key:

Another way to access your favorite views quickly is to store them on the VIEW PRESET keys. Instead of using the VIEW key to cycle through every view to find the one you want, you can program the VIEW PRESET keys to display a specific view immediately.

1. Press the VIEW key to cycle to the view you want to store.
2. Press and hold one of the VIEW PRESET keys for several seconds. A chime will indicate that the view has been saved. You can store up to three views, one on each key.

### To change the Digital Readouts:

Each view displays digital readout information (such as speed or time), which varies with the view selected, the accessory attached, and whether or not you are navigating. See **Setup Menu Tab: Select Readouts** and **Setup Menu: Select Nav Readouts** for more information about which digital readout windows can be customized.

1. Press the MENU key twice to access the tabbed Main Menu, then press the RIGHT Cursor key until the Setup tab is selected.
2. Press the DOWN key to highlight Select Readouts or Select Nav Readouts, and press the RIGHT Cursor key.

**NOTE:** *If the Select Readouts option does not appear under the Setup Tab, change the User Mode to Advanced.*

3. Press the UP or DOWN Cursor keys to select a Readout position, then press the RIGHT or LEFT Cursor keys to choose what will be displayed in that position. To hide the data window, select Off.

## Side Imaging® View (1198c SI only)

---

**Side Imaging® View** shows a shadowed right- and left-looking view from the boat as the boat passes over the bottom. See *Understanding the Side Imaging® Display* for more information about interpreting the Side Imaging® View.

- **Side Imaging® X-Press™ Menu:** Press the MENU key once to access the Side Imaging® X-Press™ Menu. You can choose a side of the water to view, the sensitivity of the sonar to see more or less detail, the side beam range, the chart scrolling speed, and the display color scheme. See *Side Imaging® X-Press™ Menu* and *Understanding the Side Imaging® Display* for more information.
- **Sonar Menu Tab:** Add SI Range Lines to the display, or turn on Contour Mode to change how the water column is displayed. See *Sonar Menu Tab* for more information.
- **Freeze Frame:** Press any arrow on the 4-WAY Cursor Control key, and the SI View will freeze and a cursor will appear on the screen. Use the 4-WAY Cursor Control key to move the cursor over a sonar return, and observe the following:
  - The **depth of the sonar return** you choose will be displayed in the cursor information box.
  - **Zoom+:** Press the ZOOM+ key, and a zoom box will appear and magnify the area you choose, providing more detail in the individual sonar returns. The zoom scale will increase or decrease as you press + or - repeatedly. Press EXIT to remove the zoom box and return to Side Imaging® View.
- **Navigation:** You can mark waypoints (press the MARK key), start navigation to a specified waypoint, or navigate to the cursor location. See *Introduction to Navigation: Navigate to a Waypoint or Position* for more information.
  - **Navigation readouts** will display at the bottom of the screen when navigation starts.
  - **Go To Waypoint Submenu:** When you select a waypoint from the list and start navigation, the **boat icon** at the top of the screen will indicate the direction the boat needs to turn to reach the waypoint.

Side Imaging® View

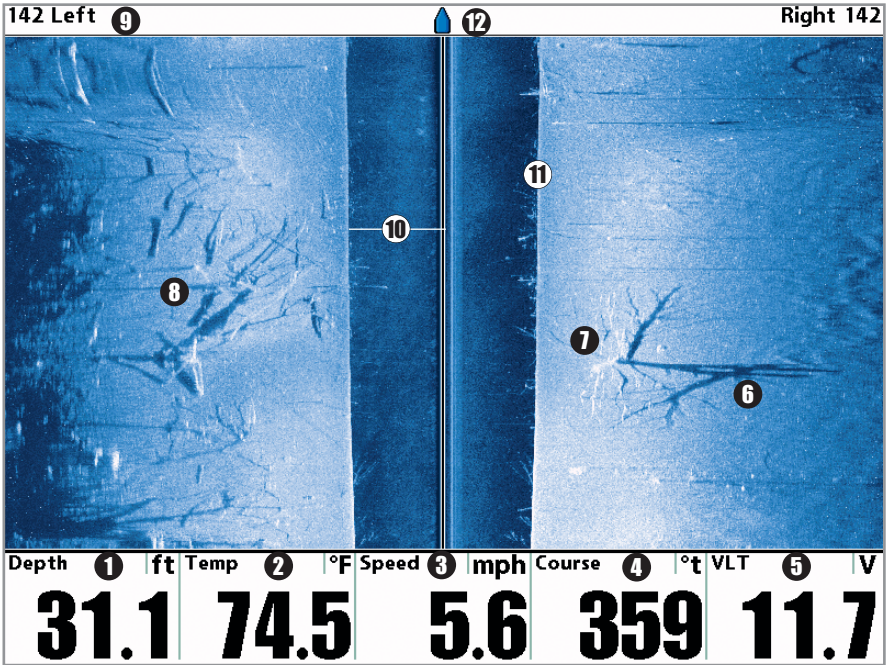

- ① Depth: water depth
- ② Temp: water surface temperature
- ③ Speed: speed of boat
- ④ Course: the current direction the boat is traveling measured in degrees from North.
- ⑤ VLT: Voltage
- ⑥ Shadows
- Submerged Tree ⑦
- Standing and Fallen Timber ⑧
- Side Beam Range ⑨
- Water Column ⑩
- Bottom Return ⑪
- Boat Icon ⑫

Side Imaging® View, with Active Cursor and Zoom

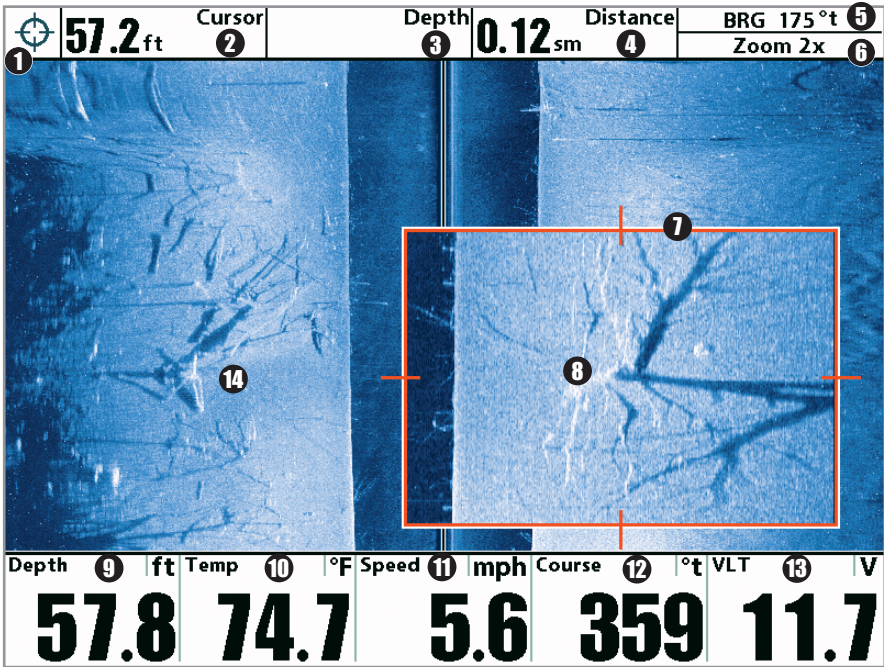

- 1** Cursor Info Box
- 2** Depth of Cursor
- 3** Depth Below Cursor
- 4** Distance to Cursor
- 5** Bearing to Cursor
- 6** Zoom Level
- 7** Zoom Preview Box
- 8** Zoomed View

- Depth **9**
- Temp: water surface temperature **10**
- Speed: speed of boat **11**
- Course: the current direction the boat is traveling measured in degrees from North **12**
- VLT: Voltage **13**
- Full Range View **14**



## Down Imaging™ View *(1198c SI only)*

---

**Down Imaging™ View** displays the down beam portion of the data from the Side Imaging® beams. The Down Imaging™ results are displayed in a “picture-like” image on the screen in 2D format. Sonar returns are charted on the right side of the display. As new information is received, the historical information scrolls left across the display.

- **Coverage:** The Down Imaging™ coverage is always very thin front to back, and the side to side width can be adjusted (see *Sonar Menu Tab: Down Imaging™ Beam Width*).
- **Down Imaging™ X-Press™ Menu:** Press the MENU key once to access the Down Imaging™ X-Press™ Menu. You can set the sensitivity of the sonar to see more or less detail, the chart scrolling speed, and the display color palette (see *Down Imaging™ X-Press™ Menu*).
- **Freeze Frame:** Press any arrow on the 4-WAY Cursor Control key, and the Down Imaging™ View will freeze and a cursor will appear on the screen. Use the 4-WAY Cursor Control key to move the cursor over a sonar return, and observe the following:
  - The **depth of the sonar return** you choose will be displayed in the cursor information box.
  - **Zoom+:** Press the ZOOM+ key, and a zoom box will appear and magnify the area you choose, providing more detail in the individual sonar returns. The zoom scale will increase or decrease as you press + or - repeatedly. Press EXIT to remove the zoom box and return to Down Imaging™ View.

## Down Imaging™ View

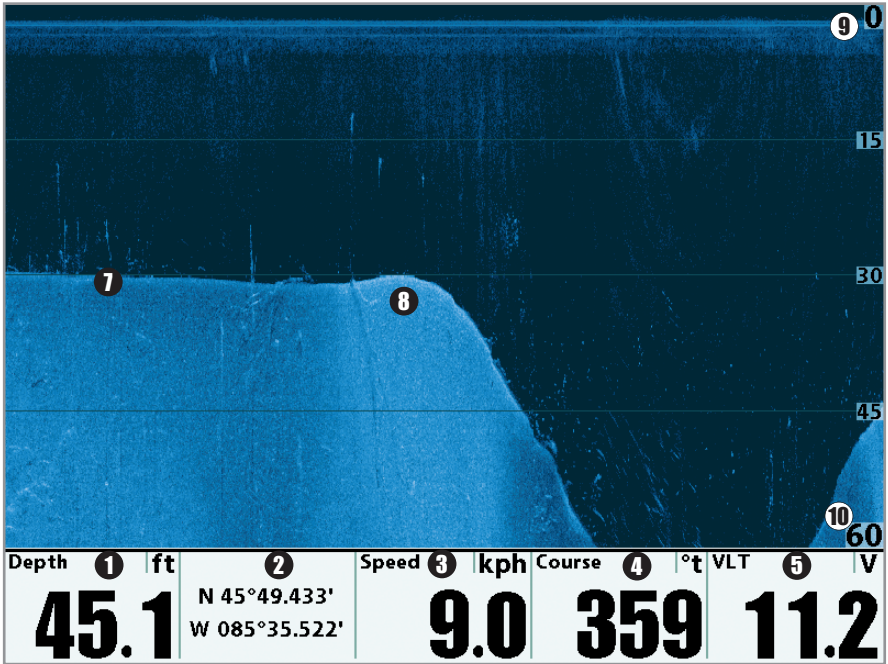

① Depth: water depth

② Boat Position: Latitude/Longitude

③ Speed: speed of boat

④ Course: the current direction the boat is traveling measured in degrees from North.

⑤ VLT: Voltage

Bottom Return ⑦

Topography Changes ⑧

Upper Range ⑨

Lower Range ⑩



Down Imaging™ View, with Active Cursor and Zoom

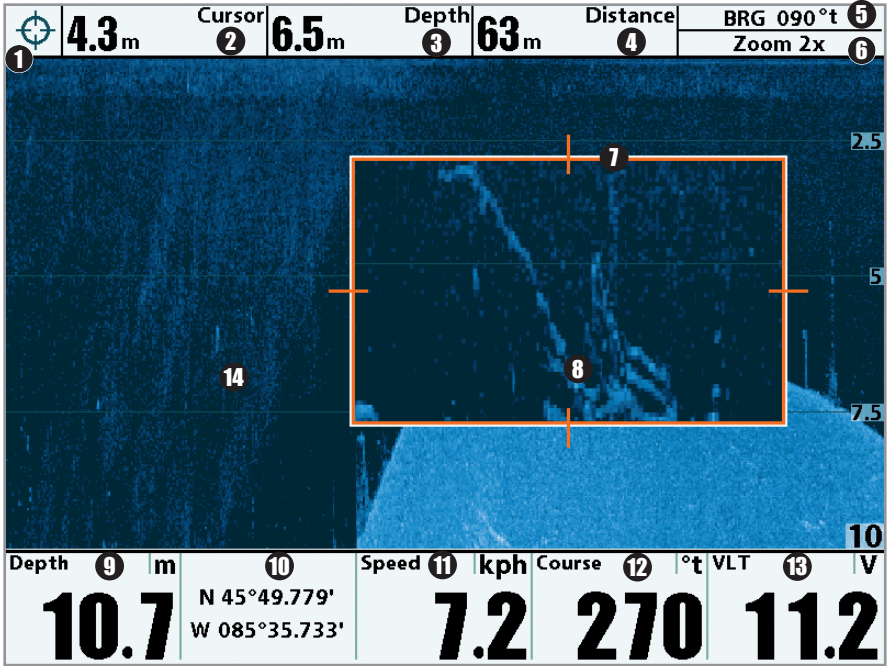

- 1** Cursor Info Box
- 2** Depth of Cursor
- 3** Depth Below Cursor
- 4** Distance to Cursor
- 5** Bearing to Cursor
- 6** Zoom Level
- 7** Zoom Preview Box
- 8** Zoomed View

- Depth **9**
- Boat Position: Latitude/Longitude **10**
- Speed: speed of boat **11**
- Course: the current direction the boat is traveling measured in degrees from North **12**
- VLT: Voltage **13**
- Full Range View **14**

## Sonar View

---

**Sonar View** presents a historical log of sonar returns. The most recent sonar returns are charted on the right side of the display. As new information is received, the historical information scrolls left across the display.

- **Upper and Lower Depth Range numbers** indicate the distance from the surface of the water to a depth range sufficient to show the bottom.
- **Depth** is automatically selected to keep the bottom visible on the display, although you can adjust it manually as well (see *Sonar X-Press™ Menu*).
- **Digital Readouts** shown on the display will change based on the Select Readouts settings or the optional-purchase accessories attached. Also, on any 2D Sonar view, the whole height of the screen can be used to display sonar. Simply turn off the selectable readout that is below the water column. (see *Setup Menu Tab: Select Readouts*).
- **Freeze Frame:** Use the 4-WAY Cursor Control key to freeze the display and move the cursor over a sonar return. The depth of the sonar return will be displayed in the cursor dialog box.

## Sonar View

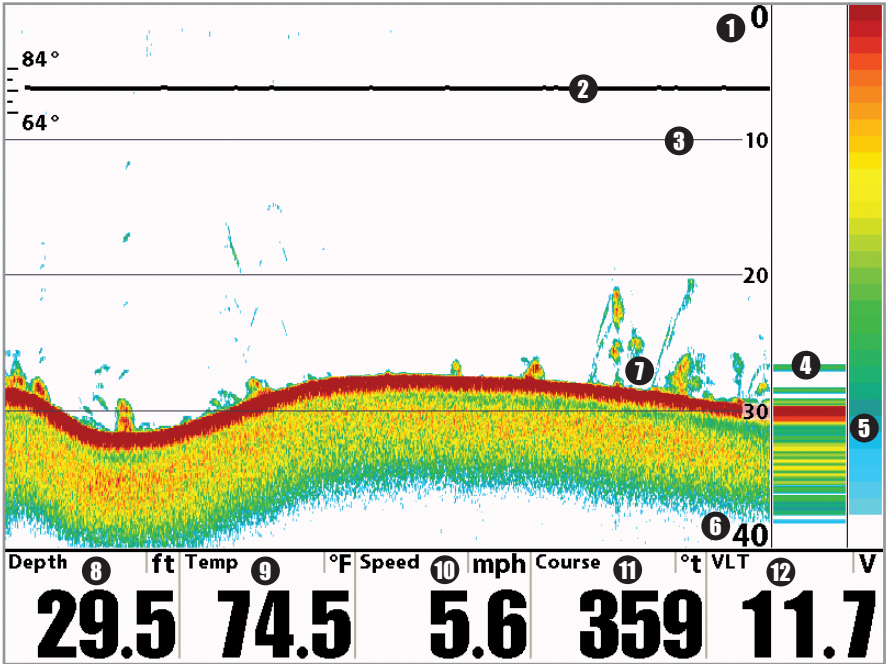

- 1 Upper Depth Range
- 2 Temperature Graph
- 3 Depth Lines
- 4 RTS® Window
- 5 Sonar Color Bar
- 6 Lower Depth Range

- 7 Structure
- 8 Depth
- 9 Temp: Water Surface Temperature
- 10 Speed: Speed of Boat
- 11 Course: the current direction the boat is traveling measured in degrees from North
- 12 VLT: Voltage

**NOTE:** If the Depth number is flashing, it means that the unit is having trouble locating the bottom. This usually happens if the water is too deep, the transducer is out of the water, the boat is moving too fast, or for any other reason that the unit can't accurately receive continuous data.

## Sonar Zoom View

---

**Sonar Zoom View** provides a magnified view of the bottom and structure. The Sonar Zoom View makes it easier to see separate sonar returns that would usually be displayed close together, such as those caused by fish suspended close to the bottom or within structure.

- The **Zoom Level**, or magnification, is displayed in the top left corner of the display. Press the + or - ZOOM keys to increase or decrease the zoom level.
- The **Zoomed View** is displayed on the left side of the screen. As the depth changes, the zoomed view updates automatically.
- The **Full Range View** is displayed on the right side of the screen. The Full Range View includes the Zoom Preview Box, which shows where the zoomed view is in relation to the full range view.
- The **Upper and Lower Depth Range numbers** indicate the high and low range of the water which is being viewed.
- **Digital Readouts** shown on the display will change based on the Select Readouts settings or the optional-purchase accessories attached (see *Setup Menu Tab: Select Readouts*).
- **Freeze Frame:** Use the 4-WAY Cursor Control key to freeze the display and move the cursor over a sonar return. The depth of the sonar return will be displayed in the cursor dialog box.

## Sonar Zoom View

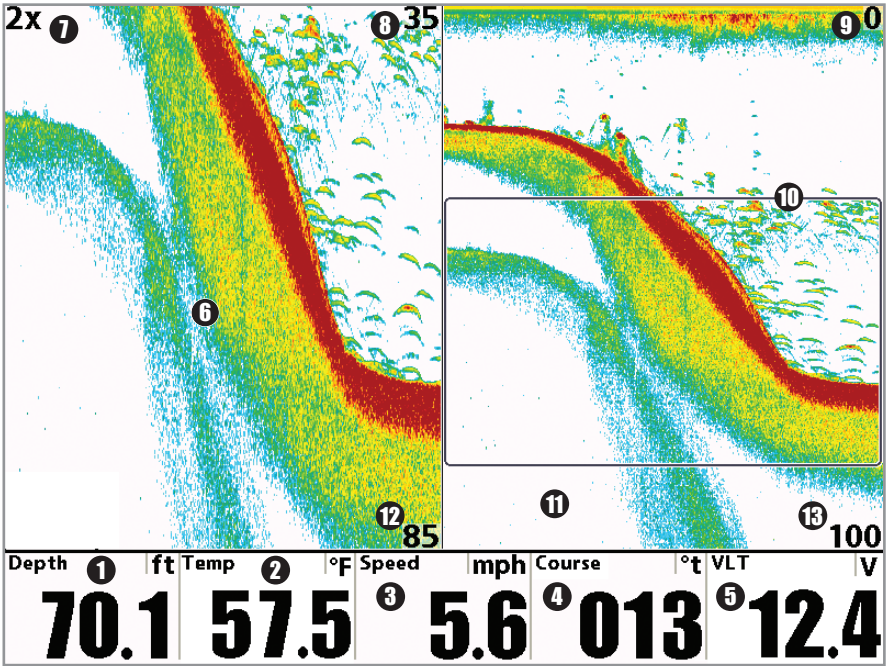

- ① Depth
- ② Temp: water surface temperature
- ③ Speed: speed of boat
- ④ Course: the current direction the boat is traveling measured in degrees from North
- ⑤ VLT: Voltage
- ⑥ Zoomed View
- ⑦ Zoom Level
- Upper Depth Range, Zoom View ⑧
- Upper Depth Range, Full Range View ⑨
- Zoom Preview Box ⑩
- Full Range View ⑪
- Lower Depth Range, Zoom View ⑫
- Lower Depth Range, Full Range View ⑬

# Split Sonar View

**Split Sonar View** displays sonar returns from the 83 kHz wide beam on the left side of the screen and sonar returns from the 200 kHz narrow beam on the right side of the screen. You can use the Split Sonar View to make side by side comparisons between the sonar returns from both beams.

- **Depth** is displayed in the upper left hand corner.
- The **Digital Readouts** in the Split Sonar View cannot be customized; therefore, information such as water temperature and voltage are unavailable in the Split Sonar View.
- **Freeze Frame:** Use the 4-WAY Cursor Control key to freeze the display and move the cursor over a sonar return. The depth of the sonar return will be displayed in the cursor dialog box.

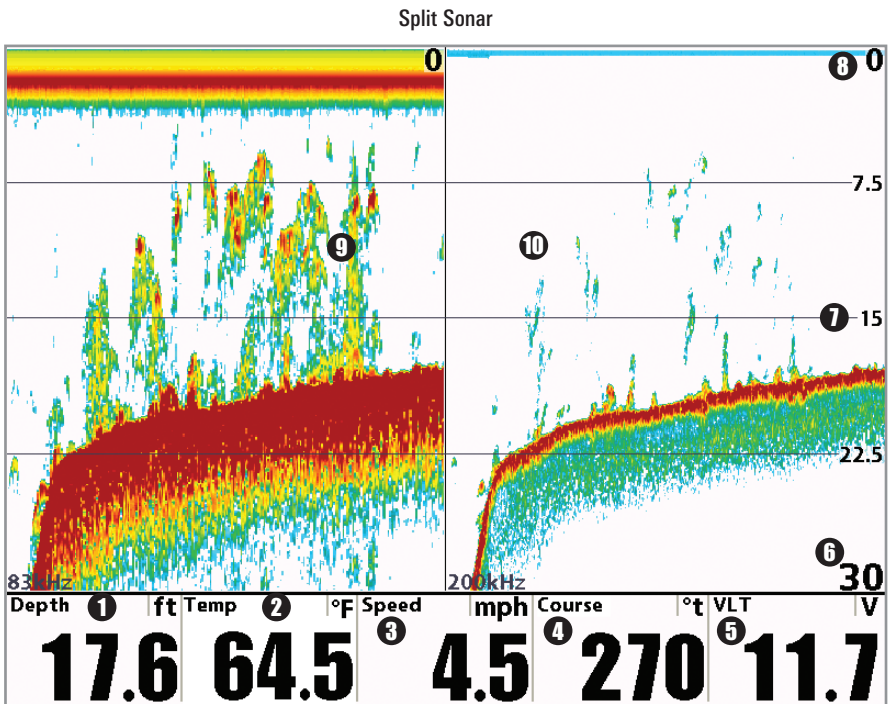

- ① Depth
- ② Temp: water surface temperature
- ③ Speed: speed of boat
- ④ Course: the current direction the boat is traveling measured in degrees from North
- ⑤ VLT: Voltage
- ⑥ Lower Depth Range
- ⑦ Depth Lines
- ⑧ Upper Depth Range
- ⑨ 83 kHz Sonar History Window
- ⑩ 200 kHz Sonar History Window

# Snapshot and Recording View

*(optional-purchase SD memory card required)*

Snapshot and Recording View displays the screen snapshots and recordings that are saved on the optional-purchase SD card installed in the control head. Use this view to review the snapshot and recording file details, start recording, and adjust the recording settings.

- **Activate Screen Snapshot:** Select Screen Snapshot from the Accessories Menu Tab, and select On. Also, install an optional-purchase SD card in the control head, and make sure Snapshot and Recording View is set to Visible on the Views Menu Tab.
- **Scroll and View:** Use the UP and DOWN Cursor keys to scroll through the saved Screen Snapshots and Recordings. The active file is highlighted with arrows. Press the RIGHT Cursor key to view the file.
- **Snapshot and Recording X-Press™ Menu:** Press the MENU key once in this view to open the X-Press™ Menu. Use the X-Press™ Menu to Start Recording, Delete Images, or adjust the Recording and Playback settings (see *Recording and Playback* or *Snapshot and Recording X-Press™ Menu*).

*NOTE: The speed of the screen capture or the recording depends on the type of card you use; in general, SD cards capture the screen faster than MMC cards.*

Snapshot and Recording View

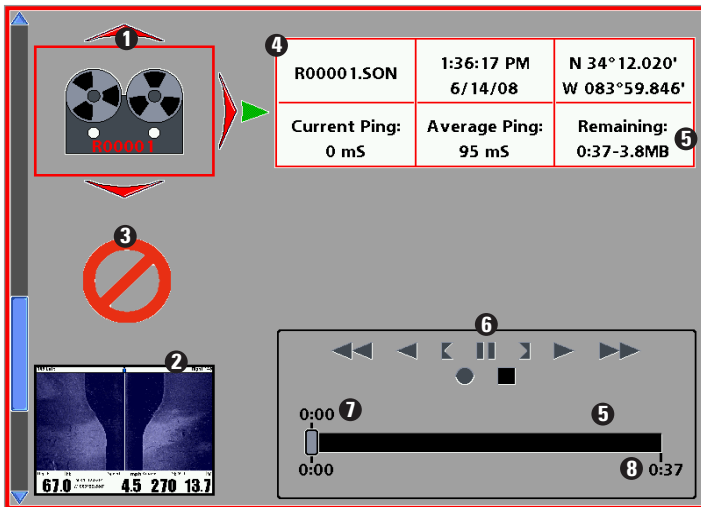

- 1 Recording icon
- 2 Snapshot thumbnail
- 3 Unavailable icon
- 4 Information box
- 5 Amount of recording left to play
- 6 Recording mode icons
- 7 Amount of recording that has been played
- 8 Amount of space used for this recording

*NOTE: For snapshots and recordings, the indicator bar has several states: during recording, the amount of space remaining on the SD card is indicated on the status bar. During playback, the amount of time/memory remaining to play is indicated on the status bar. When a snapshot thumbnail is highlighted, the amount of room remaining on the SD card is indicated.*

## Screen Snapshots

**Screen Snapshots** are saved pictures of the view on the screen. The screen snapshot will include the menus, dialog boxes, warnings, and messages that were active when the screen snapshot was taken. Saved Screen Snapshots can be viewed from the Snapshot and Recording View or Chart View.

The Screen Snapshot feature is available when an optional-purchase SD card is installed and Screen Snapshot is On (see *Accessories Menu Tab: Screen Snapshot*).

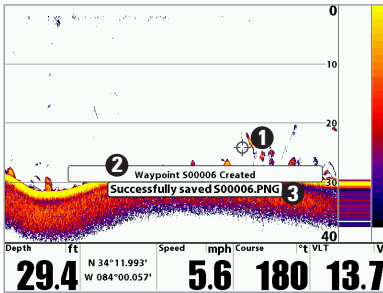

- 1 Waypoint saved at Cursor Location
- 2 Screen Snapshot Confirmation
- 3 File Name

### Make a Screen Snapshot:

1. Activate Screen Snapshot and install an SD card.
2. From any view or cursor location you want to capture, press the MARK key. The screen will pause while the image is saved.

A waypoint will also be created at the boat or active cursor location. The screen snapshot shares the same file name (.PNG).

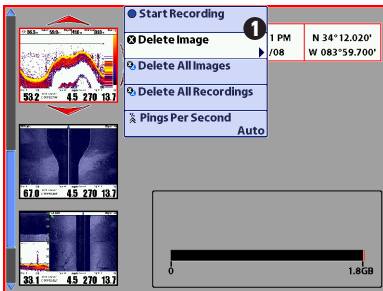

- 1 From Snapshot and Recording View, select Delete Image from the X-Press™ Menu.

### Delete a Screen Snapshot:

1. From the Snapshot and Recording View, press the UP or DOWN Cursor keys to scroll through the saved files and highlight a snapshot file.
2. Press the Menu key once, and select Delete Image from the X-Press™ Menu.
3. Press the RIGHT Cursor key.

**NOTE:** Navigation is not affected by the Screen Snapshot feature. Also, if Screen Snapshot is enabled, but a GPS receiver is not connected, pressing the MARK key will capture the screen image but an error will display that says a GPS position fix is required to create a waypoint.



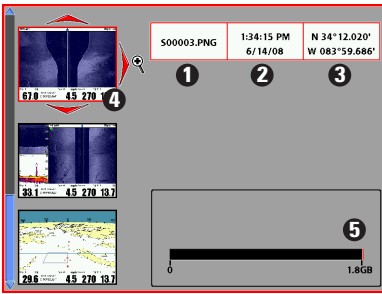

- 1 Snapshot File Name
- 2 Time + Date of Snapshot
- 3 Waypoint Position
- 4 Highlighted Snapshot File
- 5 SD card available storage

## View a saved Screen Snapshot from Snapshot and Recording View:

1. From the Snapshot and Recording View, press the UP or DOWN Cursor keys to scroll through the saved files and highlight a snapshot file.
2. Press the RIGHT Cursor key.

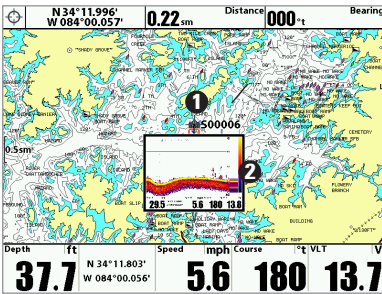

- 1 Screen Snapshot Icon and Waypoint Name
- 2 Thumbnail Preview  
(press the INFO key to view at full size)

## View a saved Screen Snapshot from Chart View:

1. In Chart View, use the 4-WAY Cursor Control key to move the active cursor onto a Screen Snapshot Icon .

When the cursor snaps onto the Screen Snapshot Icon, a thumbnail preview of the Screen Snapshot will be displayed on the screen.

2. Press the INFO key, and select View Snapshot.
3. Press the EXIT key to return to Chart View.

## Notes about Screen Snapshots:

- A border around the full screen indicates that the view is a saved screen snapshot and not a "live" view.
- If you press the INFO key, and the snapshot file connected to the icon is not saved on the installed SD card, the Chart Information box will display instead of the screen snapshot.
- Use an optional-purchase SD card reader connected to a PC to view the saved screen snapshot data files on your optional-purchase SD card (see [humminbird.com](http://humminbird.com) for details). You will notice that a .DAT (or a .TXT) file is created for every .PNG screen snapshot. This data file is required for viewing the screen snapshots from your control head, so don't delete these files.

## Recording and Playback

The **Recording** feature records active sonar information. When the recording is played back, the views that were active during the recording are available in Playback. The Recording and Playback feature is available when an optional-purchase SD card is installed and Screen Snapshot is On (see *Accessories Menu Tab: Screen Snapshot*). Saved Recordings can be played back from the Snapshot and Recording View.

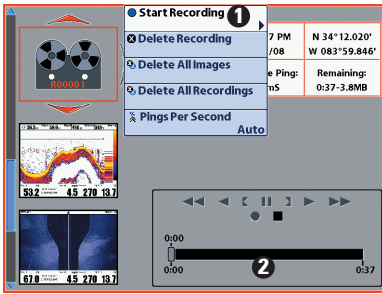

1 From Snapshot and Recording View, select Start Recording from the X-Press™ Menu

2 Slider Bar

### Start recording:

1. From the Snapshot and Recording View, press the MENU key once to open the Snapshot and Recording X-Press™ Menu.
2. Highlight Start Recording, and press the RIGHT Cursor key. A waypoint will also be created at the boat location, and the recording shares the same file name (.SON).

### Stop recording:

1. In any view, press the MENU key once to open the Snapshot and Recording X-Press™ Menu.
2. Highlight Stop Recording and press the RIGHT Cursor key.

### Notes about Recording:

- **While recording**, press the EXIT key to exit the Snapshot and Recording X-Press™ Menu and scroll to a different view. Recording will continue.
- The **slider bar** at the bottom of the Snapshot and Recording View shows the recording progress and remaining space on the SD card.
- **Pings Per Second**: For maximum performance, keep the Pings Per Second setting on Auto (see *Snapshot and Recording X-Press™ Menu*).
- **Viewing saved Screen Snapshots and Recording Playback** are not available while in recording mode.

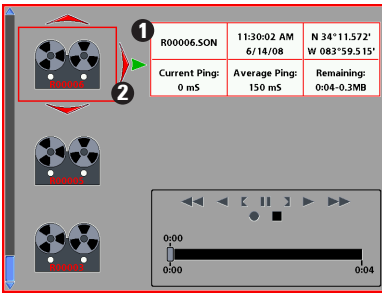

- 1 Recording File Information
- 2 Highlighted Recording File

## Playback a Recording:

1. From the Snapshot and Recording View, press the UP or DOWN Cursor keys to scroll through the saved files and highlight a saved Recording.
2. Press the RIGHT Cursor key.

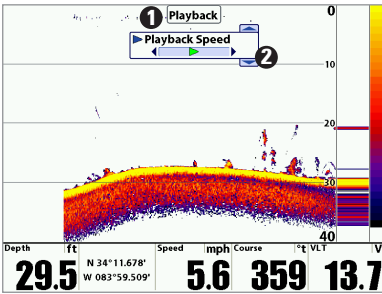

- 1 "Playback" indicates the control head is playing a saved recording.
- 2 Open the X-Press™ Menu to adjust Playback settings.  
You can also use Freeze Frame and mark waypoints.

## Change Playback Settings:

1. Press the MENU key once to open the Snapshot and Recording X-Press™ Menu.
2. Use the X-Press™ Menu to adjust the Sonar Recording's Sensitivity, Upper Range, Lower Range, and the Playback Speed. See *Snapshot and Recording X-Press™ Menu* for details.

*NOTE: Sonar chart speed is increased during Fast Forward and reversed during Rewind. This may reduce the quality of the sonar image, since at higher speeds, not every sonar return can be processed and displayed.*

## Stop Playback:

1. Press the MENU key once to open the Snapshot and Recording X-Press™ Menu.
2. Highlight Stop Playback, and press the RIGHT Cursor key.

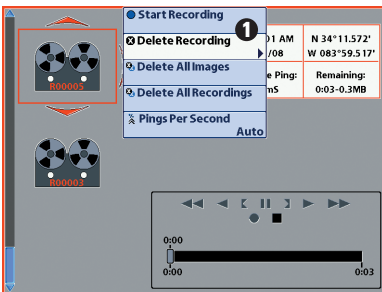

- 1 From Snapshot and Recording View, select Delete Recording from the X-Press™ Menu.

## Delete a Recording:

1. From the Snapshot and Recording View, press the UP or DOWN Cursor keys to scroll through the saved files and highlight a saved Recording.
2. Press the Menu key once, and select Delete Recording from the X-Press™ Menu. Press the RIGHT Cursor key.

## Notes about Playback:

- **“Playback”** will flash periodically on the screen to indicate that the control head is playing a saved recording and not a “live” view.
- **Navigation** is not affected by the Sonar Recording feature, but any active navigation is cancelled and thumbnails and icons disappear when Playback begins or ends.
- **Playback is paused** automatically at the end of the recording.
- **Freeze Frame:** Press the 4-WAY Cursor Control key to pause Playback and move the Active Cursor to a location on the sonar view. The Cursor dialog box will show the depth and information for the location you choose. Press Exit to resume Playback.
- **Press the MARK key during Playback** to save a Screen Snapshot and/or mark a waypoint in the view or active cursor location you choose.

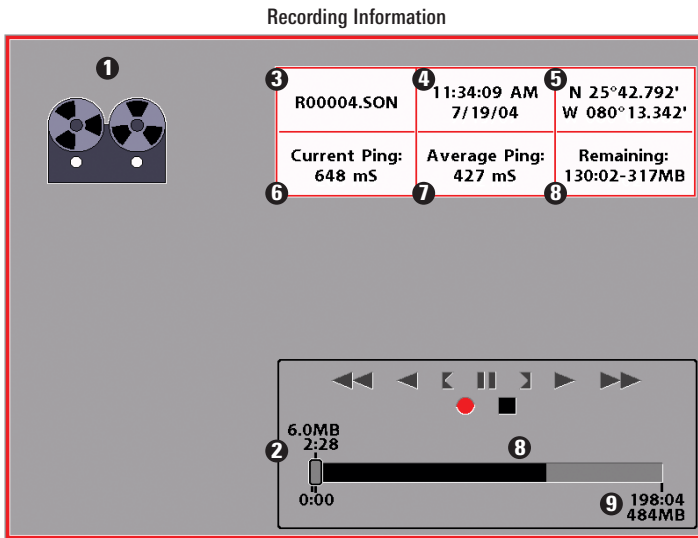

- |  |  |
|--|--|
| <b>1</b> Recording Indicator                             | Current Ping Rate <b>6</b>                 |
| <b>2</b> Amount of space and time used by this recording | Average Ping Rate <b>7</b>                 |
| <b>3</b> Name of recording                               | Amount of space remaining on card <b>8</b> |
| <b>4</b> Time and Date recording was started             | Total amount of space on card <b>9</b>     |
| <b>5</b> Position where recording was started            |  |

## Side Beam View

*(optional-purchase QuadraBeam PLUS™ transducer required)*

---

**Side Beam View** displays sonar data from the left and right 455 kHz beams and the 200 kHz down-looking beam in one view. This view is available if an optional-purchase QuadraBeam PLUS™ transducer accessory is connected and Transducer Select is set to QuadraBeam (see *Sonar Menu Tab: Transducer Select*).

*NOTE: The QuadraBeam PLUS™ transducer requires a separate purchase.*

- **Coverage:** The sonar information from the side-looking beams reveals bottom contour, structure, and fish similar to the down-looking beam, but the area covered is to the left and right, which gives you a wider view of the bottom.
- **Range:** The distance covered by the right and left side-looking beams is controlled by the Lower Range setting for the down-looking beam, up to a maximum of 160 feet (see *Sonar X-Press™ Menu: Lower Range*).
- **Layout:** The Side Beam View can be arranged in any of the following layouts: Default, Classic, and Slanted. Press the MENU key once, and select Quad Layout from the X-Press™ Menu to choose a layout for this view.

**Default layout:** The top portion of the display presents a historical log of sonar returns from the 200 kHz down-looking sonar beam. New information in the down beam panel scrolls from right to left. The bottom portion of the display presents a historical log of sonar returns from the 455 kHz right- and left-looking sonar beams. New information in the side beam panels scrolls from the center out.

Side Beam View, Default Layout

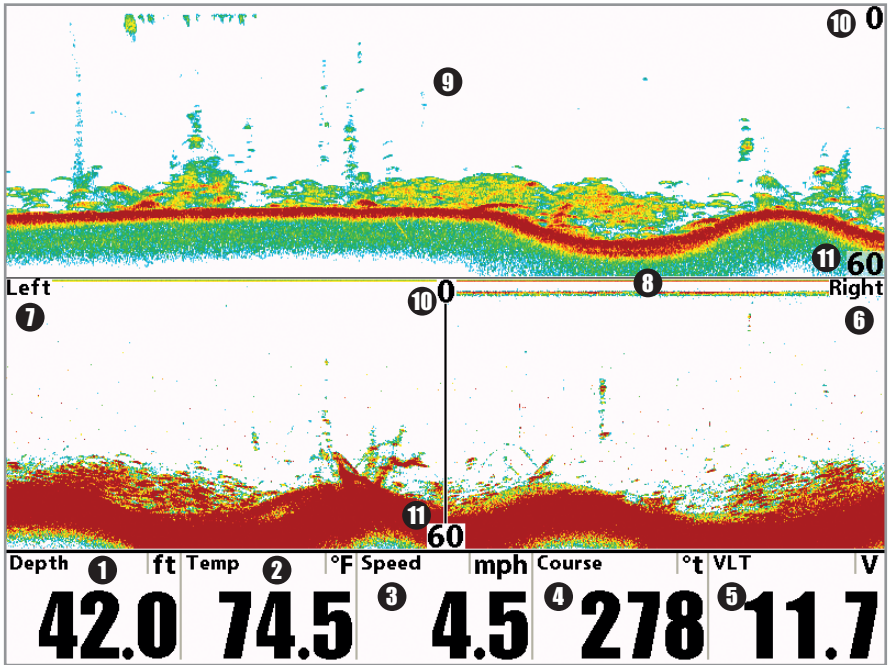

- ① Depth
- ② Temp: water surface temperature
- ③ Speed: speed of boat
- ④ Course: the current direction the boat is traveling measured in degrees from North
- ⑤ VLT: Voltage
- ⑥ Right Side 455 kHz Sonar History Window
- ⑦ Left Side 455 kHz Sonar History Window
- ⑧ Water Surface Line for 455 kHz Sonar History Windows
- ⑨ 200 kHz Sonar History Window
- ⑩ Upper Depth Range
- ⑪ Lower Depth Range

**Classic layout:** The top portion of the display presents a historical log of sonar returns from the 200 kHz down-looking sonar beam. New information in the down beam panel scrolls from right to left. The bottom portion of the display presents a historical log of sonar returns from the 455 kHz right- and left-looking sonar beams. New information appears at the top and scrolls down the display.

Side Beam View, Classic Layout

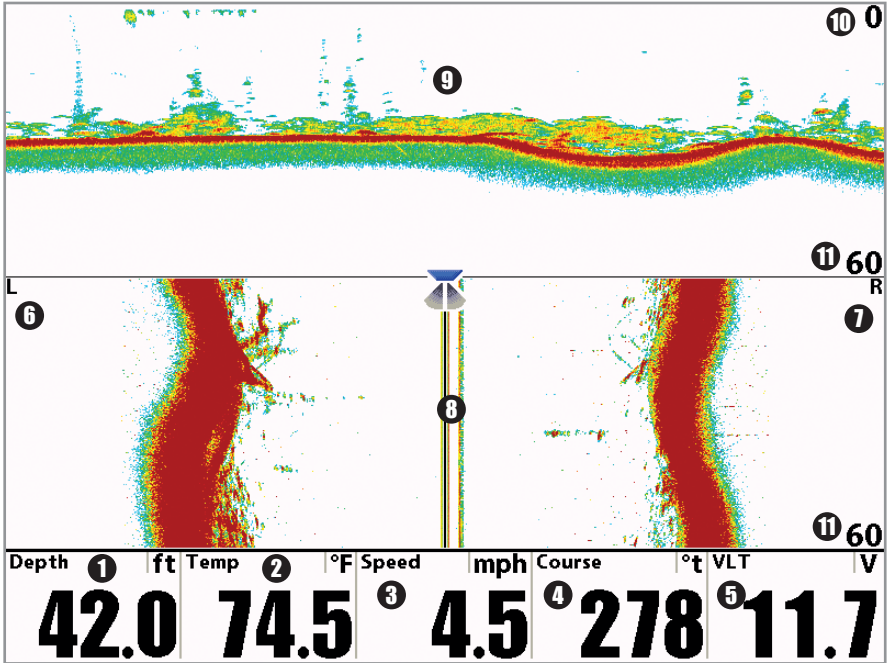

- 1 Depth
- 2 Temp: water surface temperature
- 3 Speed: speed of boat
- 4 Course: the current direction the boat is traveling measured in degrees from North
- 5 VLT: Voltage
- 6 Left Side 455 kHz Sonar History Window
- 7 Right Side 455 kHz Sonar History Window
- 8 Water Surface Line for 455 kHz Sonar History Windows
- 9 200 kHz Sonar History Window
- 10 Upper Depth Range
- 11 Lower Depth Range

**Slanted layout:** This layout presents the two 455 kHz side sonar beams and the 200 kHz down-looking sonar beam as three panels of historical data. This layout is presented as three slanted panels. New information appears on the right and scrolls to the left.

Side Beam View, Slanted Layout

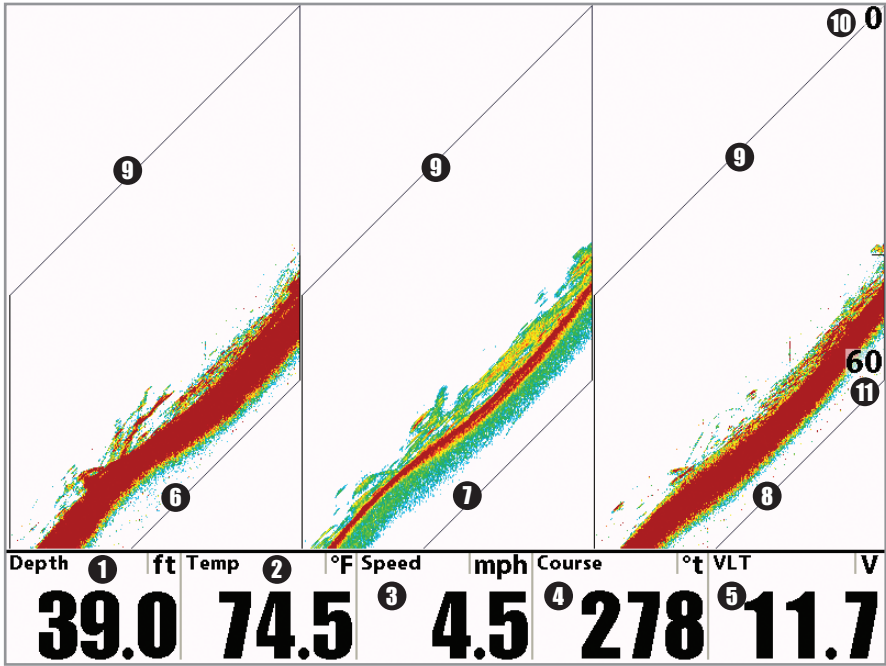

- 1** Depth
- 2** Temp: water surface temperature
- 3** Speed: speed of boat
- 4** Course: the current direction the boat is traveling measured in degrees from North
- 5** VLT: Voltage
- 6** Left Side 455 kHz Sonar History Window
- 200 kHz Sonar History Window **7**
- Right Side 455 kHz Sonar History Window **8**
- Water Surface Line **9**
- Upper Depth Range **10**
- Lower Depth Range **11**



## Bird's Eye View

**Bird's Eye View** shows a 3D perspective view of the track and the chart's land contour from a point above and behind the boat (the eye point). As the boat turns, the eye point moves to follow the boat.

- To **shift the eye point position** so that you can look off to the sides, or even behind the boat: Press the RIGHT or LEFT Cursor keys to turn the eye point right or left. Press the UP Cursor key to move the eye point forward, and press the DOWN Cursor key to move the eye point backward.
- Press the EXIT key to **move the eye point back** to its original position behind and above the boat.
- **Digital Readouts:** If all selectable readout boxes are turned off below the Bird's Eye pane, the window will stretch to fill the whole vertical pane. See **Setup Menu Tab: Select Readouts** for more information.

Bird's Eye View (Standard)

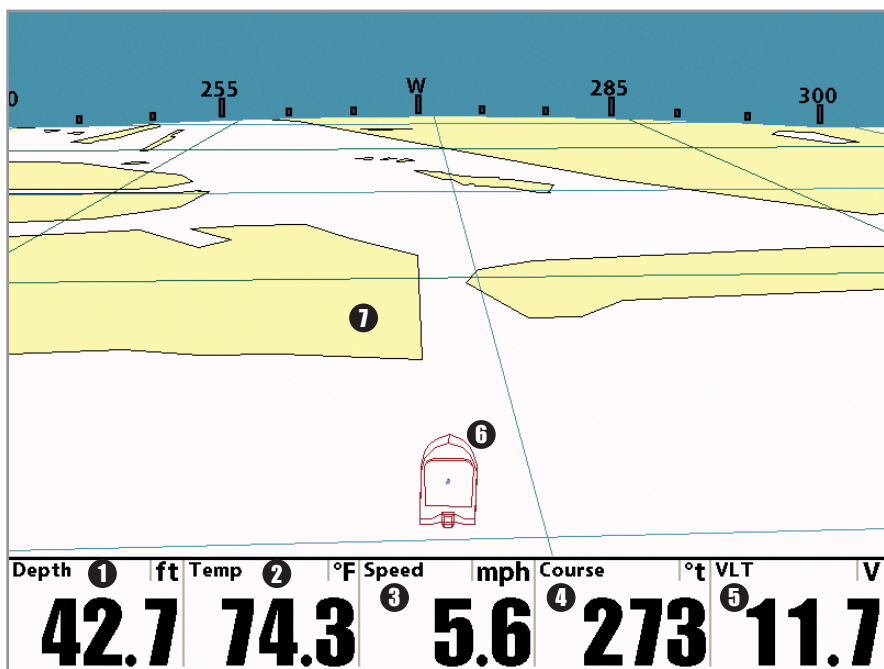

- ① Depth
- ② Temp: water surface temperature
- ③ Speed: speed of boat
- ④ Course: the current direction the boat is traveling measured in degrees from North

- VLT: Voltage ⑤
- Boat Icon ⑥
- Cartography ⑦

## Bird's Eye View (Navigating)

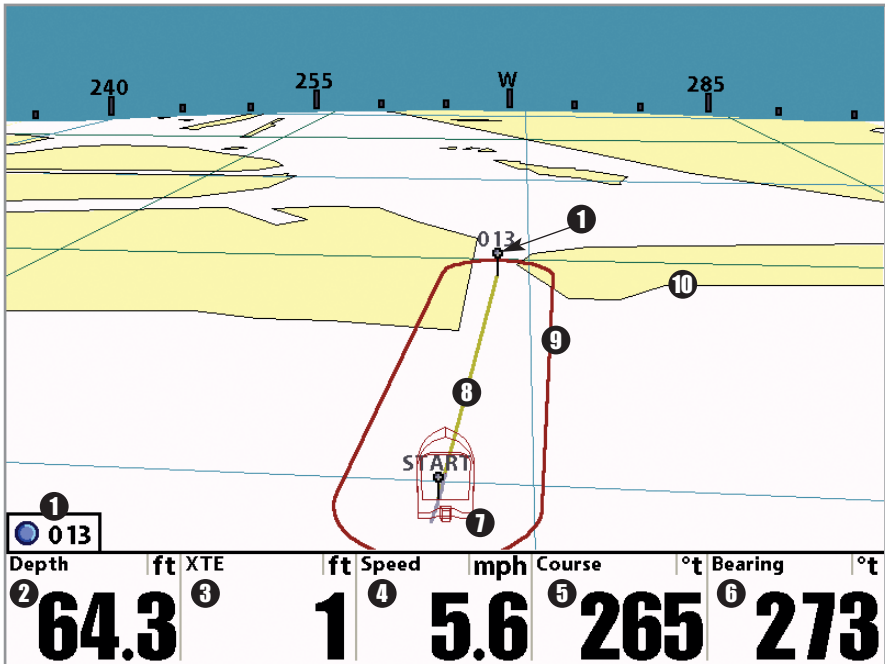

**1** Next Waypoint

**2** Depth

**3** XTE (Cross Track Error): Distance of Boat from Route

**4** Speed: the measurement of the boat's progress across a given distance, and is the speed measurement provided by GPS

**5** Course: the current direction the boat is traveling measured in degrees from North

Bearing: Direction to Destination Waypoint measured in degrees from North **6**

Boat Icon **7**

Route **8**

Off Course Limits **9**

Cartography **10**

## Chart View

**Chart View** shows cartography from the built-in Contour XD™, built-in UniMap™, or an optional SD map for the area surrounding your current position. The cartography is applied to any standard Chart View or Combo view that displays a chart. The current track (also known as the position history or breadcrumb trail) showing where the boat has been, along with saved tracks, waypoints, and the current route (when navigating), are overlaid on the chart.

*NOTE: See **Chart Menu tab** and **Navigation Menu tab** for more information.*

- **Shift/Pan:** Use the 4-WAY Cursor Control key to shift/pan the chart to another area.
- **Zoom:** Press the ZOOM (+/-) keys to zoom in and out.
- **Information:** Press the INFO key to get information about the chart objects near the cursor.

**Chart View (Standard) with optional-purchase Navionics® Cartography**

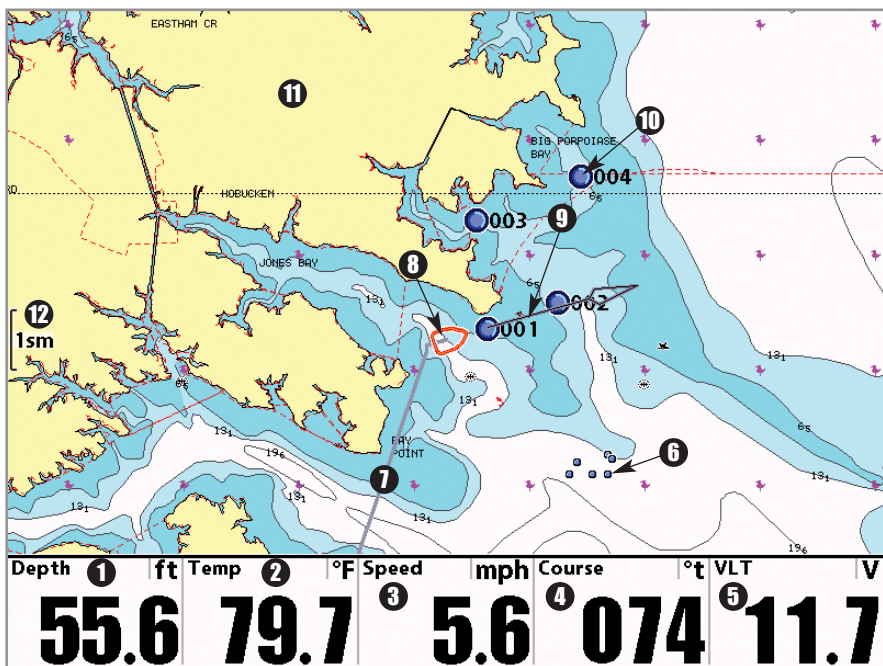

- 1** Depth
- 2** Temp: water surface temperature
- 3** Speed: speed of boat
- 4** Course: the current direction the boat is traveling measured in degrees from North
- 5** VLT: Voltage
- 6** Declutter Icons

- Track **7**
- Boat Icon **8**
- Course Projection Line **9**
- Waypoint **10**
- Cartography **11**
- Map Scale **12**

Chart View (with Cursor) with optional-purchase Navionics® Cartography

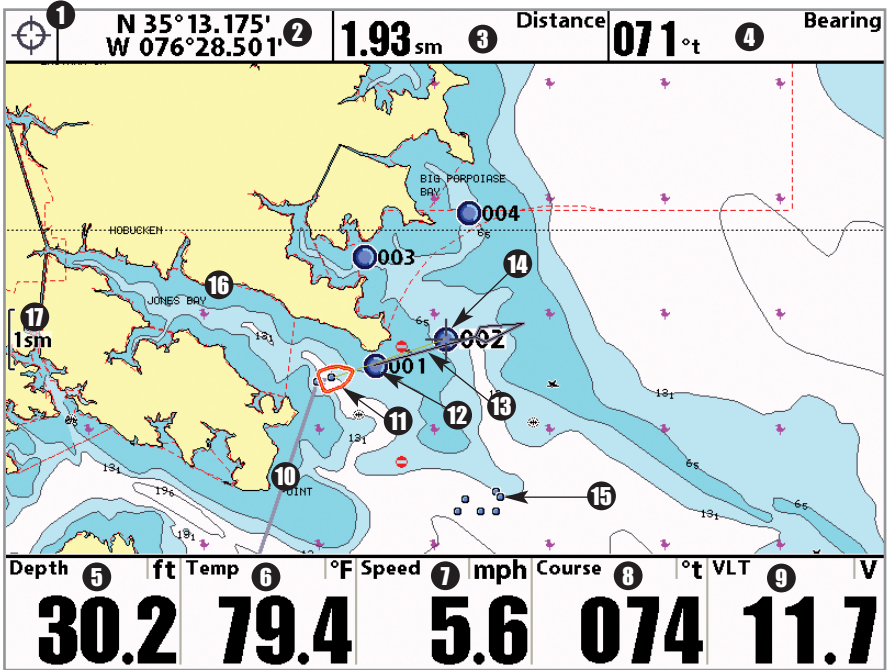

- 1** Cursor Info Box
- 2** Latitude and Longitude Position of Cursor
- 3** Distance to Cursor
- 4** Bearing to Cursor
- 5** Depth
- 6** Temp: Water Surface Temperature
- 7** Speed: Speed of Boat
- 8** Course: the current direction the boat is traveling measured in degrees from North
- 9** VLT: Voltage
- 10** Track
- 11** Boat Icon
- 12** Waypoint
- 13** Course Projection Line
- 14** Active Cursor
- 15** Decluttered Waypoint icons
- 16** Cartography
- 17** Map Scale

## Combo Views

---

**Combo Views** display two views (or more) on the screen at the same time. You can perform functions for either side of the view, access the X-Press™ Menu, and change the left view display size. The available combo views are shown on the following pages.

### Combo Views: Functions

---

The Combo Views allow you to observe and control two views at once. To change the settings for either side of the view, the individual view must be selected as the active side.

- The **green arrow** points to the active side.
- **Active Side:** Press the MENU key once and select Active Side from the X-Press™ Menu. Choose RIGHT or LEFT to set the active side.
- **X-Press™ Menu:** After you set the Active Side, press the MENU key once to access the X-Press™ Menu. The X-Press™ Menu provides settings for the active view, and the display updates immediately with your changes.
- **Display Size:** Press the MENU key once and select Split Position from the X-Press™ Menu. Split Position allows you to adjust the size of the left side of the display.
- **Active Cursor:** Press any arrow on the 4-WAY Cursor Control key, and the cursor will appear on the active side of the view.

## Side Imaging®/Sonar Combo View (1198c SI only)

**Side/Sonar Combo View** shows sonar information and Side Imaging® sonar information in a combination split screen, where the Sonar View is displayed on the left and the Side Imaging® View is displayed on the right.

Select an Active Side, and you can adjust the sensitivity, the side beam range, the chart scrolling speed, and the color scheme of the display. For more information about each side of this combo view, see *Sonar View* and *Side Imaging® View*.

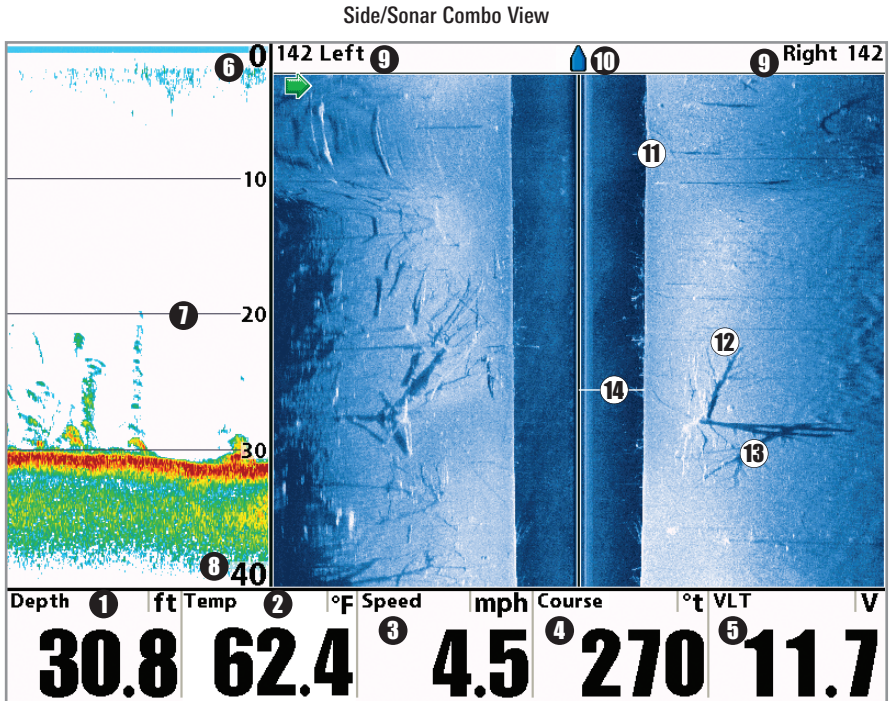

- |  |   |
|--|---|
| <ul style="list-style-type: none"> <li>① Depth</li> <li>② Temp: water surface temperature</li> <li>③ Speed: speed of boat</li> <li>④ Course: the current direction the boat is traveling measured in degrees from North</li> <li>⑤ VLT: Voltage</li> <li>⑥ Upper Depth Range</li> <li>⑦ Depth Lines</li> </ul> | <ul style="list-style-type: none"> <li>⑧ Lower Depth Range</li> <li>⑨ Side Imaging® Range</li> <li>⑩ Boat Icon</li> <li>⑪ Bottom Return</li> <li>⑫ Tree</li> <li>⑬ Shadows</li> <li>⑭ Water Column</li> </ul> |
|--|---|

# Chart/Bird's Eye Combo View

Chart/Bird's Eye Combo View shows the Chart and Bird's Eye views in a combination split screen, where the Bird's Eye View is displayed on the left and the Chart View is displayed on the right. For more information about each side of this combo view, see *Chart View* and *Bird's Eye View*.

Chart/Bird's Eye Combo View (Standard)

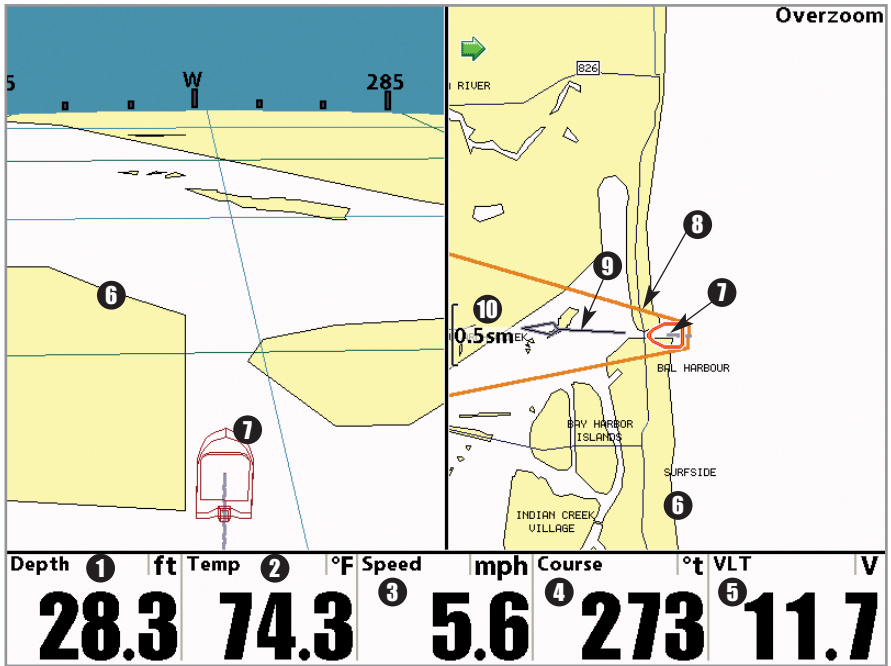

- 1 Depth
- 2 Temp: water surface temperature
- 3 Speed: speed of boat
- 4 Course: the current direction the boat is traveling measured in degrees from North
- 5 VLT: Voltage
- 6 Cartography
- 7 Boat Icon
- 8 3D View Outline
- 9 Course Projection Line
- 10 Map Scale

## Chart/Chart Combo View

**Chart/Chart Combo View** shows two versions of the Chart view in a combination split screen so that you can see the position of the boat on one side while you zoom in or perform other functions on the other. See **Chart View** for more information.

Chart/Chart Combo View (Navigating)

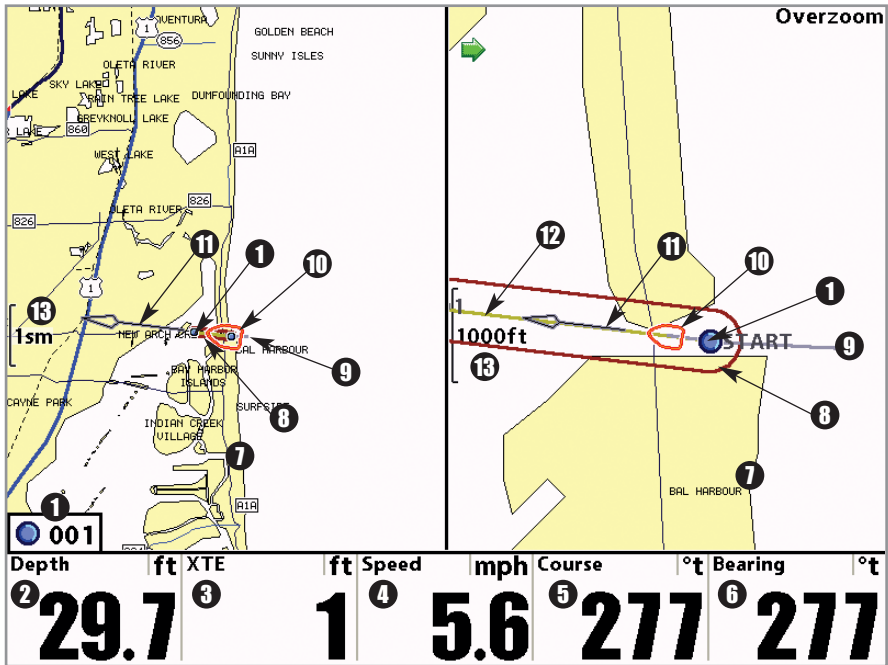

- 1 Next Waypoint
- 2 Depth
- 3 XTE (Cross Track Error): Distance of Boat from Route
- 4 Speed: the measurement of the boat's progress across a given distance, and is the speed measurement provided by GPS
- 5 Course: the current direction the boat is traveling measured in degrees from North
- 6 Bearing: Direction to Destination Waypoint measured in degrees from North
- 7 Cartography
- 8 Off Course Limits
- 9 Track
- 10 Boat Icon
- 11 Course Projection Line
- 12 Route
- 13 Map Scale



## Chart/Sonar Combo View

**Chart/Sonar Combo View** shows both the Chart and Sonar views in a combination split screen, where the Sonar View is displayed on the left and the Chart View is displayed on the right. For more information about each side of this combo view, see *Chart View* and *Sonar View*.

Chart/Sonar Combo View

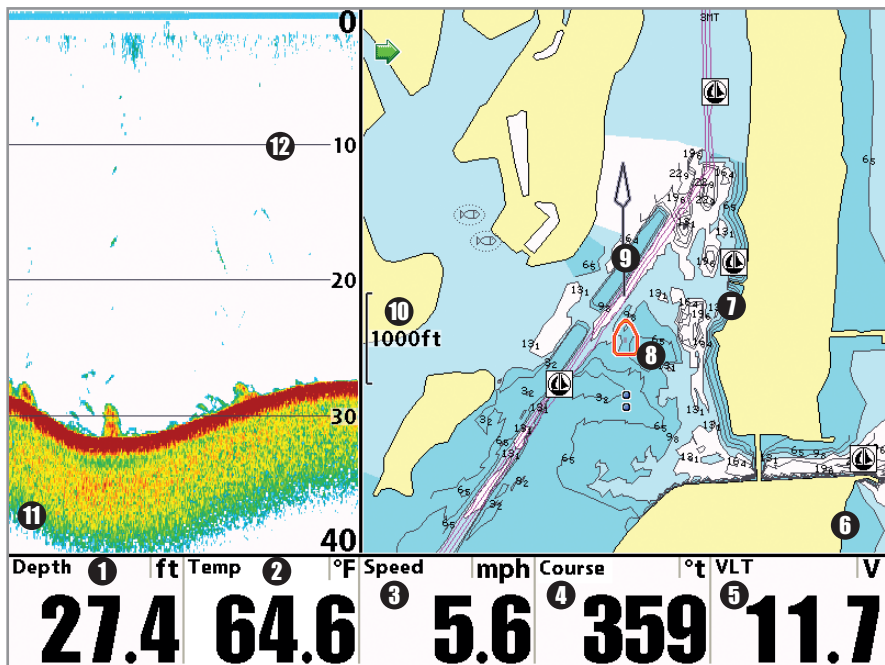

- ① Depth
- ② Temp: water surface temperature
- ③ Speed: speed of boat
- ④ Course: the current direction the boat is traveling measured in degrees from North
- ⑤ VLT: Voltage
- ⑥ Chart Window

- Cartography ⑦
- Boat Icon ⑧
- Course Projection Line ⑨
- Map Scale ⑩
- Sonar Window ⑪
- Depth Lines ⑫

# Chart/Side Imaging® Combo View (1198c SI only)

Chart/Side Imaging® Combo View shows chart information and Side Imaging® sonar information in a combination split screen, where the Side Imaging® View is displayed on the left and the Chart View is displayed on the right. For more information about each side of this combo view, see *Chart View* and *Side Imaging® View*.

Chart/Side Combo View

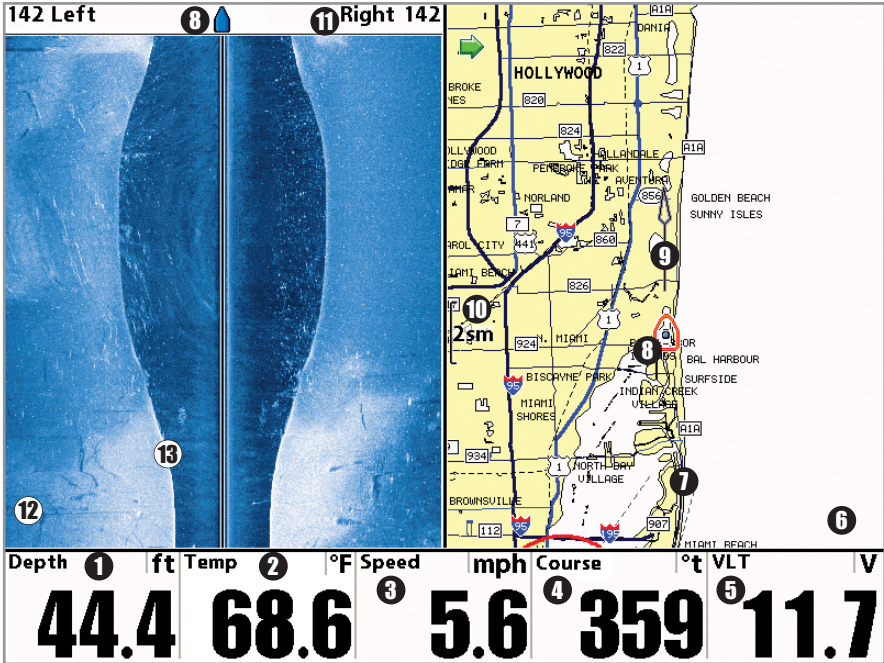

- ① Depth
- ② Temp: water surface temperature
- ③ Speed: speed of boat
- ④ Course: the current direction the boat is traveling measured in degrees from North
- ⑤ VLT: Voltage
- ⑥ Chart Window
- ⑦ Cartography
- ⑧ Boat Icon
- ⑨ Course Projection Line
- ⑩ Map Scale
- ⑪ Side View Range
- ⑫ Side View Window
- ⑬ Bottom Return

## Down Imaging™/Side Imaging® Combo View (1198c SI only)

Down/Side Imaging® Combo View shows Down Imaging™ and Side Imaging® sonar information in a combination split screen, where the Down Imaging™ View is displayed on the left and the Side Imaging® View is displayed on the right. For more information about each side of this combo view, see *Down Imaging™ View* and *Side Imaging® View*.

Down Imaging™/Side Imaging® Combo View

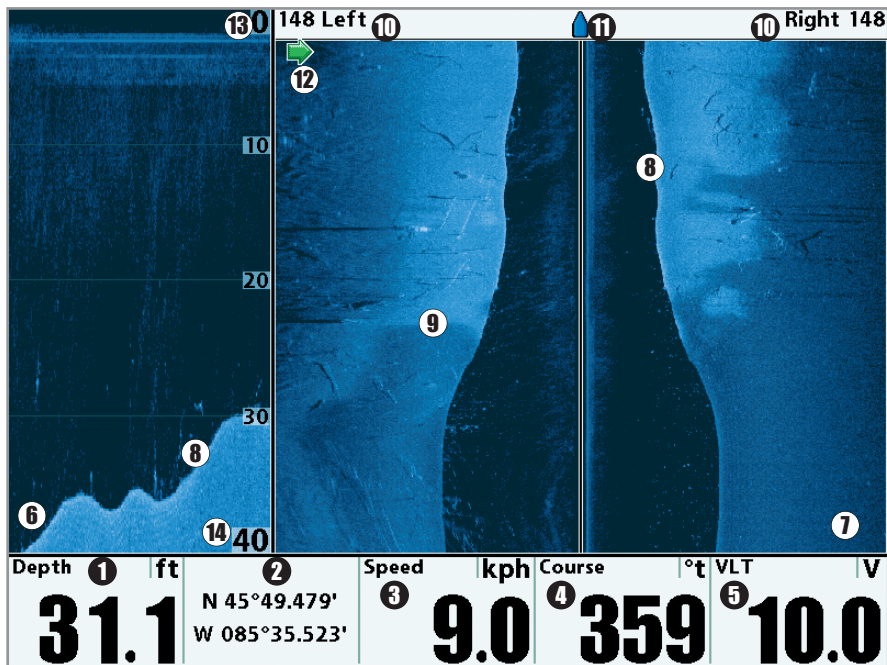

- |  |                            |
|--|----------------------------|
| ① Depth  | ⑧ Bottom Return            |
| ② Boat Position: Latitude/Longitude  | ⑨ Topography Changes       |
| ③ Speed: speed of boat   | ⑩ Side view Range          |
| ④ Course: the current direction the boat is traveling measured in degrees from North | ⑪ Boat Icon                |
| ⑤ VLT: Voltage   | ⑫ Green Arrow: Active Side |
| ⑥ Down Imaging™ Window   | ⑬ Upper Range              |
| ⑦ Side Imaging® Window   | ⑭ Lower Range              |

# Chart/Down Imaging™ Combo View (1198c SI only)

Chart/Down Imaging™ Combo View shows Chart and Down Imaging™ information in a combination split screen, where the Down Imaging™ View is displayed on the left and the Chart View is displayed on the right. For more information about each side of this combo view, see *Down Imaging™ View* and *Chart View*.

Chart/Down Imaging™ Combo View

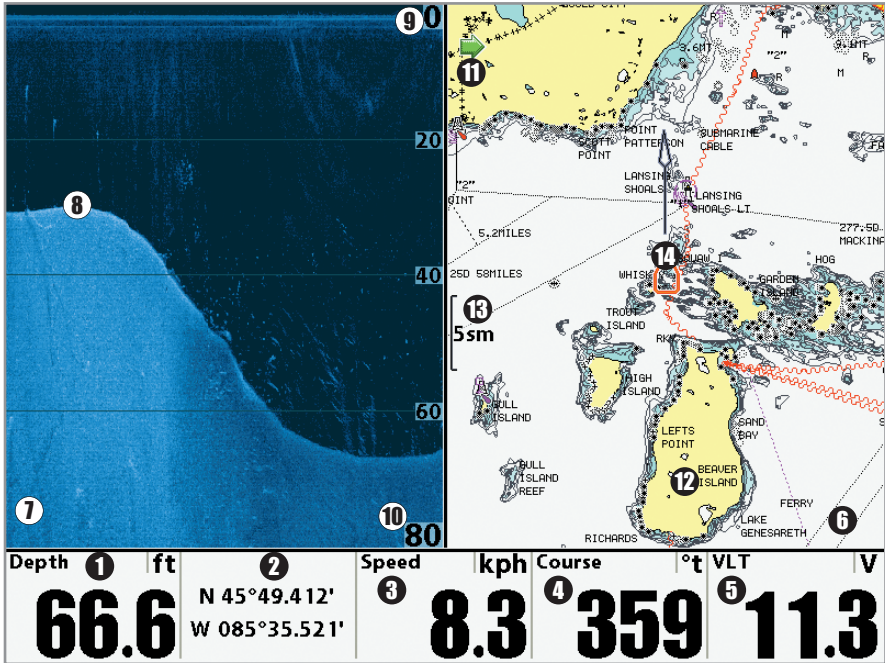

- ① Depth
- ② Boat Position: Latitude/Longitude
- ③ Speed: speed of boat
- ④ Course: the current direction the boat is traveling measured in degrees from North
- ⑤ VLT: Voltage
- ⑥ Chart Window
- ⑦ Down Imaging™ Window
- ⑧ Bottom Return
- ⑨ Upper Range
- ⑩ Lower Range
- ⑪ Green Arrow: Active Side
- ⑫ Cartography
- ⑬ Map Scale
- ⑭ Boat Icon

## Down Imaging™/Sonar Combo View (1198c SI only)

Down Imaging™/Sonar Combo View shows traditional Sonar information on the left and Down Imaging™ sonar information on the right. For more information about each side of this combo view, see *Down Imaging™ View* and *Sonar View*.

Down Imaging™/Sonar Combo View

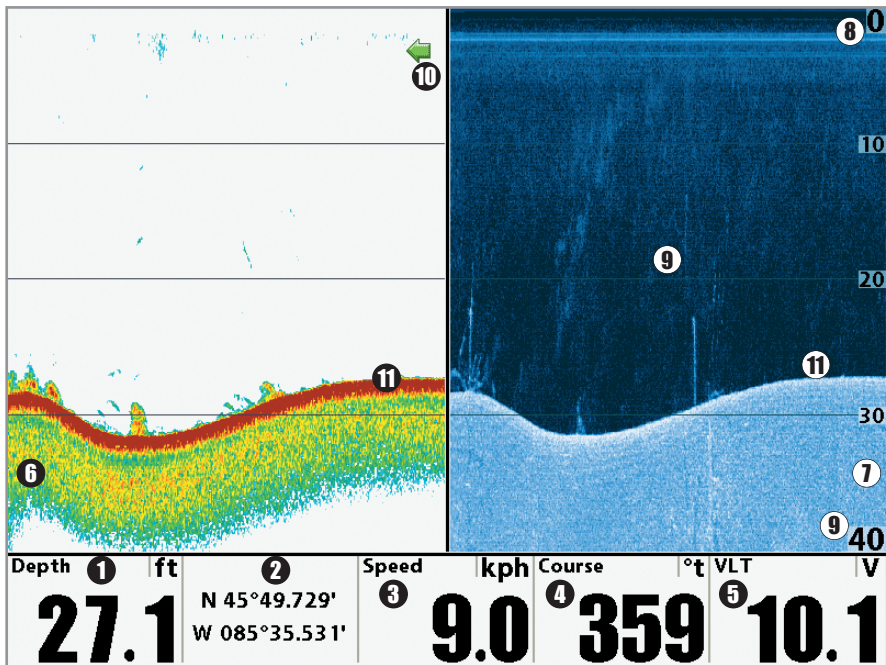

- ① Depth
- ② Boat Position: Latitude/Longitude
- ③ Speed: speed of boat
- ④ Course: the current direction the boat is traveling measured in degrees from North
- ⑤ VLT: Voltage
- ⑥ Sonar Window
- Down Imaging™ Window ⑦
- Upper Range ⑧
- Lower Range ⑨
- Green Arrow: Active Side ⑩
- Bottom Return ⑪



## Down Imaging™/Side Imaging®/Sonar Combo View (1198c SI only)

Down/Side Imaging®/Sonar Combo View shows Down Imaging™ and traditional Sonar information on the left side of the screen, and Side Imaging® on the right side of the screen. If you use the active cursor on the left side of the screen, a cursor will appear in both the Sonar and Down Imaging™ views. For more information about each side of this combo view, see *Down Imaging™ View*, *Side Imaging® View*, and *Sonar View*.

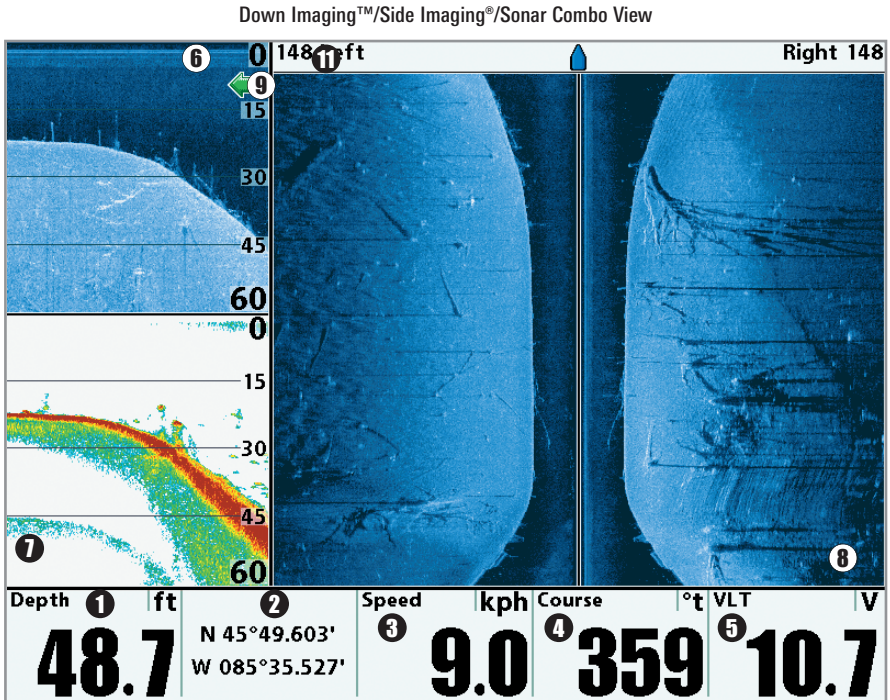

- ①** Depth
- ②** Boat Position: Latitude/Longitude
- ③** Speed: speed of boat
- ④** Course: the current direction the boat is traveling measured in degrees from North
- ⑤** VLT: Voltage

- Down Imaging™ Window **⑥**
- Sonar Window **⑦**
- Side Imaging® Window **⑧**
- Green Arrow: Active Side **⑨**

## Chart Orientation

All of the chart views allow you to choose the orientation of the chart. In both orientations, the view pans automatically so that the boat is always centered on the display.

**NOTE:** The Chart Orientation setting does not apply to the Bird's Eye View.

- **North-Up:** True North is shown at the top of the display. Objects located to the north of the boat are drawn above the boat.
- **Course-Up:** The direction of motion of the boat is shown at the top of the display. Objects ahead of the boat are drawn above the boat.

 **When the boat is stationary**, it is drawn as a circle.

 **When the boat is in motion**, it takes on a boat shape, pointed in the direction of motion (always Up in the Course-Up orientation).

## Viewing Cartography

In the **Chart** or **Combo** Views, there are several cartography-related functions that you can access using various keys.

**Panning:** Use the 4-WAY Cursor Control key to move the chart around on the display in the direction of the key being pressed. When you do this, a Bullseye Cursor is drawn at the top of the screen and is linked to the boat by a yellow line, even if the boat is off the screen. At the same time, a cursor dialog box is displayed with the distance and bearing from the boat to the cursor position and the latitude/longitude coordinates of the cursor. When the cursor is active on the display, you can also use the 4-WAY Cursor Control key to move the cursor diagonally.

Chart View with Cursor Present, with optional-purchase Navionics® cartography

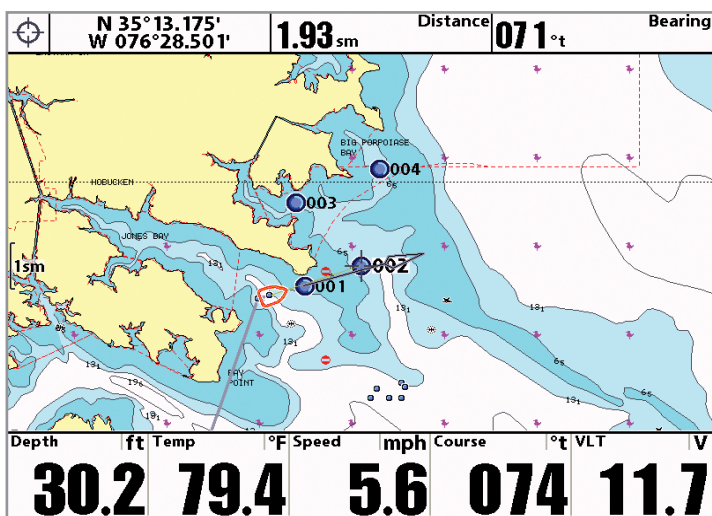

**Zooming:** Press the Plus (+) key to Zoom In and the Minus (-) key to Zoom Out to see the cartography at different magnification levels. The zoom level is indicated on the left side of the display. If you zoom in beyond the available chart data, the display will go into Overzoom mode whereby the last available chart data is amplified to reflect the level selected. If you zoom in so far that no cartography is available, a lat/long grid will be drawn instead.

**Screen Snapshots and Recording Icons:** When a waypoint is created while Screen Snapshot and Recording is active, the waypoint will appear as a snapshot icon or recording icon in chart views. See *Views: Snapshot and Recording View* for more information.

**Chart Info:** Press the INFO key to get detailed information about the chart. **If the cursor is active**, you will see information about the chart objects located near the cursor.

Chart Info
Nearest Port
Nearest Tide Station
Nearest Current Station

**If the cursor is not active**, the Chart Info submenu will appear. Use the 4-WAY Cursor Control key to select the Nearest Port, the Nearest Tide Station, or the Nearest Current Station and see information about any of these objects.

*NOTE: In Non-NVB models, the built-in UniMap™ does not contain any Port, Tide, or Current information. This information is only available from optional-purchase SD cards. In NVB models, your unit also includes a built-in UniMap™ that contains Port, Tide, or Current information.*

**Nearest Port:** The position and services information for the nearest port to your present position will be displayed. Press the EXIT key to remove the information box and the cursor bull's eye will be centered over the port position. The cursor information boxes will indicate the distance and bearing to the port from your present position.

**Nearest Tide Station:** Tide information for the nearest tide station to your present position will be displayed. This includes the position of the station and the times of the high and low tides for today's date. A tide graph is also displayed showing the rise and fall of the tides for the 24 hour time period encompassing the date. You can change the date to look at tide information before or after the date displayed by pressing the LEFT or RIGHT Cursor key respectively. Press the EXIT key to remove the information box, and the cursor bull's eye will be centered over the tide station position. The cursor information boxes indicate the distance and bearing to the tide station from your present position.

**Nearest Current Station:** Current information for the nearest current station to your present position will be displayed. This includes the position of the station and the current changes for today. Two graphs are also presented that show the time, direction, and flow speed of the current changes for the 24 hour time period of today's date. You can change the date to look at current information before or after the date displayed by pressing the LEFT or RIGHT Cursor key respectively. Press the EXIT key to remove the information box, and the cursor bull's eye will be centered over the current station position. The cursor information boxes will indicate the distance and bearing to the current station from your present position.



## Introduction to Navigation

---

Use the 1100 Series™ to establish waypoints at areas of interest and to navigate to those waypoints via a saveable route (representing the shortest intended distance between waypoints). You can also view and save tracks, which represent the actual path of the boat.

### Waypoints, Routes, and Tracks

---

**Waypoints** are stored positions that allow you to mark areas of interest or navigation points. Your 1100 Series™ can store up to 3000 waypoints.

**Routes** link two or more waypoints together to create a path for navigation, and are used in trip planning. You can link individual waypoints together by using the GOTO key. A route represents your intended navigation and shows the shortest path from each waypoint to the next. As you travel a route, staying on the route line is the most efficient way to get to your destination, although you should always look out for obstacles not shown on the chart. Your 1100 Series™ can store up to 50 routes that can each contain up to 50 waypoints.

**Tracks** consist of detailed position history, and are displayed as a breadcrumb trail of trackpoints. The Current Track shows the position history since the unit was powered up (maximum of 20,000 trackpoints displayed). You can clear the Current Track or save it at any time. Your 1100 Series™ can store up to 50 saved tracks, each containing 20,000 trackpoints. The current track represents your actual path so far.

## Waypoints, Routes and Tracks

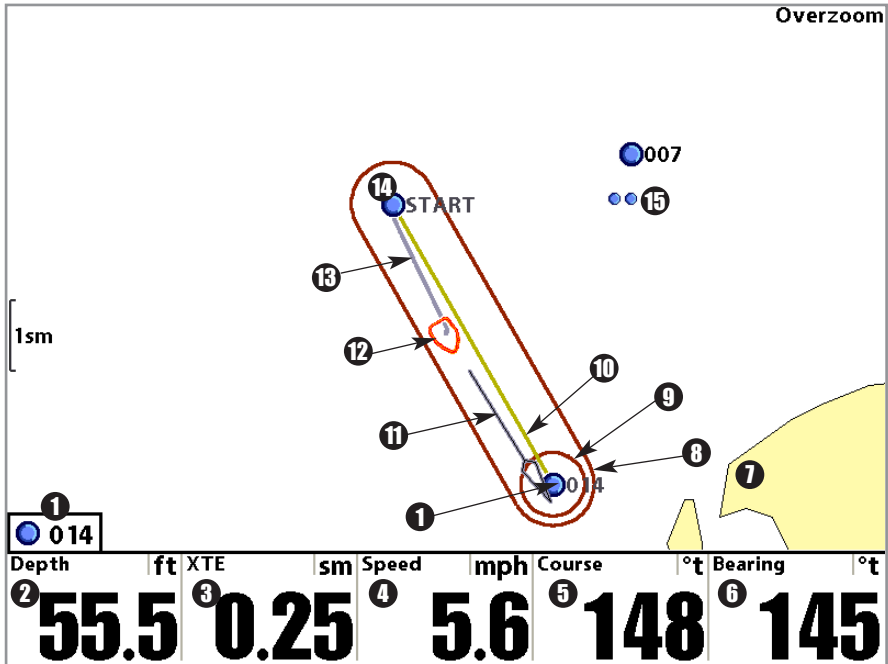

- 1 Next Waypoint
- 2 Depth
- 3 XTE (Cross Track Error): Distance of Boat from Route
- 4 Speed: the measurement of the boat's progress across a given distance, and is the speed measurement provided by GPS
- 5 Course: the current direction the boat is traveling measured in degrees from North
- 6 Bearing: Direction to Destination Waypoint measured in degrees from North
- 7 Cartography
- 8 Off Course Limits
- 9 Arrival Alarm Limits
- 10 Route
- 11 Course Projection Line
- 12 Boat Icon
- 13 Track
- 14 Waypoint
- 15 Decluttered Waypoints

**NOTE:** When two or more waypoints overlap, or are displayed close together on a chart view, the screen will automatically declutter—waypoint names will shorten and the waypoint icons will change into small blue icons.

To view a **Decluttered Waypoint** at full size, use the 4-WAY Cursor Control key to move the cursor onto a decluttered waypoint icon. When the cursor snaps onto the icon, the full-size waypoint name and icon will be displayed. You can also press the ZOOM+ key until you can see the individual waypoints on the screen. See **Navigation Menu Tab: Waypoint Decluttering** to turn off this feature.

## Save, Edit, or Delete a Waypoint

---

**Save your current position as a waypoint:** On any view, press the MARK key to save the current position of the boat as a waypoint.

**Save the cursor position as a waypoint:** On the Chart or Combo View, use the 4-WAY Cursor Control key to move the cursor to the position you want to save as a waypoint. Then press the MARK key to save the position as a waypoint.

**Save a position from the sonar history:** On any Sonar View, Side Imaging® View, or Down Imaging™ View, use the 4-WAY Cursor Control key to move the cursor to a feature in the sonar history. Press the MARK key to create a waypoint at the location where that sonar reading was taken. The new waypoint will also record the depth at that location.

***NOTE:** When you save a waypoint by any of these methods, a numerical waypoint name is automatically assigned. You can edit the waypoint information later to give it a different name and select an icon to represent it (see **Program or Edit the waypoint fields**).*

**Display the Waypoints Submenu:** From any view, press the MENU key twice to display the Main Menu, then press the RIGHT Cursor key to select the Navigation tab. Select Waypoints, and press the RIGHT Cursor key to display the Waypoints submenu.

**Program a specific position as a waypoint:** To create a waypoint that is NOT your current position, from the Waypoints submenu select Create, and press the RIGHT Cursor key. Use the 4-WAY Cursor Control key to program a waypoint name, latitude, longitude, and icon before selecting Save.

**Edit a waypoint:** From the Waypoints submenu, select Edit and press the RIGHT Cursor key to display the saved waypoints list. Select the waypoint you want to edit and press the RIGHT Cursor key. Use the 4-WAY Cursor Control key to edit a waypoint name, latitude, longitude, and icon before selecting Save.

To make it easier to select a waypoint to edit, select **Sort By** and press the RIGHT or LEFT Cursor keys to select a sort order:

- **Name** shows the waypoints alphabetically.
- **Time** shows the most recently-created waypoint first.
- **Distance** shows the closest waypoint first.

**Program or Edit the waypoint fields:** Use the 4-WAY Cursor Control key to move from field to field, and the UP and DOWN Cursor keys to change values once you are in a field.

In the Waypoint Name, Latitude, and Longitude fields, press the UP and DOWN Cursor keys to change the letter or number. All upper and lower case letters are available, as well as digits 0-9 and some punctuation characters.

In the Waypoint Icon field, press the UP and DOWN Cursor keys to change the icon used to represent the waypoint on the Combo and Chart Views. You can exit these fields with the LEFT and RIGHT Cursor keys or by pressing the EXIT key.

## **Navigate to a Waypoint or Position**

---

**Navigate to the cursor position:** From the Chart View, Side Imaging® View, Chart Combo Views, or Side Imaging® Combo Views, use the 4-WAY Cursor Control key to move the cursor to a position or waypoint on the display. Press the GOTO key. Navigation will begin immediately.

**Navigate to a specified waypoint:** Press the GOTO key. Press the DOWN Cursor key to highlight a waypoint from the saved waypoints list, and press the RIGHT Cursor key to start navigation.

***NOTE:** By repeating the previous instructions, you can add more waypoints to create a longer multi-segment route.*

**Skip a waypoint:** From the Navigation X-Press™ Menu, select Skip Next Waypoint, and press the RIGHT Cursor key. If there is not another waypoint to skip to, navigation will be cancelled.

**Cancel navigation:** From the Navigation X-Press™ Menu, select Cancel Navigation, and press the RIGHT Cursor key. Canceling navigation removes the route and any waypoints created using the GOTO key, but it does not remove any saved routes from memory. You will be prompted to save the current route when you cancel navigation.

## Add a Waypoint Target or Trolling Grid

---

The **Waypoint Target** shows a target consisting of concentric circles in various distance ranges centered on the waypoint you choose. The **Trolling Grid** shows various distance ranges in grid format from the waypoint you choose. The trolling grid can be used as a guide when trolling around a waypoint.

**Add a Waypoint Target:** From the Waypoints submenu, select Target, and press the RIGHT Cursor key to display the saved waypoints list. Select a waypoint and press the RIGHT Cursor key.

**Add a Trolling Grid:** From the Waypoints submenu, select Grid, and press the RIGHT Cursor key to display the saved waypoints list. Select a waypoint and press the RIGHT Cursor key. The grid can also be rotated to any heading by adjusting the Grid Rotation setting on the Navigation Menu Tab.

**Remove Target or Trolling Grid:** Press the MENU key once, and choose Remove Target or Remove Grid from the Navigation X-Press™ Menu.

*NOTE: Only one waypoint can have either a target or a grid applied to it at one time. If you apply a target or a grid to a new waypoint, the original waypoint will lose its target or grid.*

*NOTE: The spacing of the rings on the waypoint target and the spacing of the grid lines on the trolling grid are the same as the length of the scale bar on the left edge of the display. Zooming in or out will decrease or increase the spacing, respectively.*

### Chart View with Target

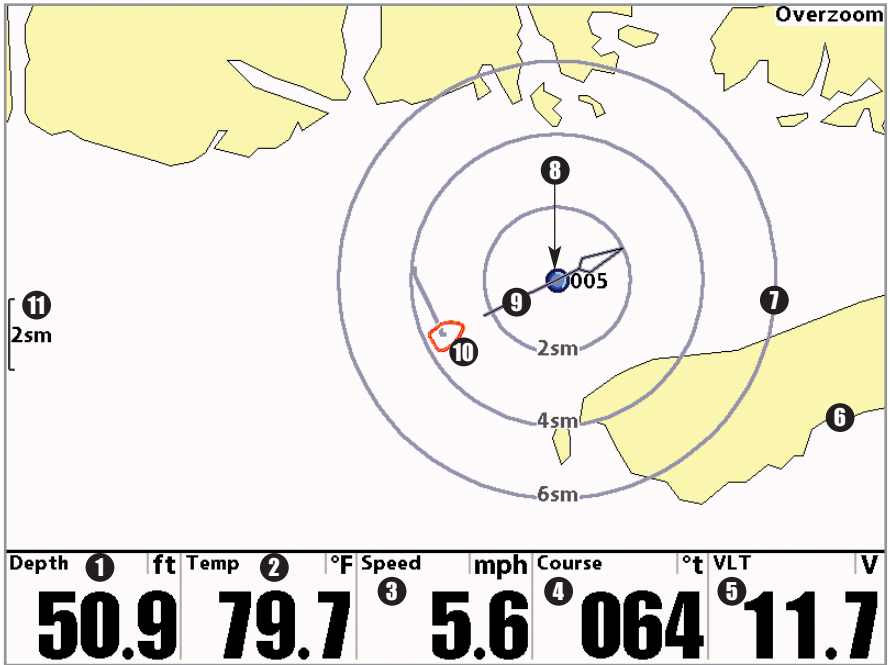

① Depth

② Temp: water surface temperature

③ Speed: speed of boat

④ Course: the current direction the boat is traveling measured in degrees from North

⑤ VLT: Voltage

⑥ Cartography

Waypoint Target ⑦

Targeted Waypoint ⑧

Course Projection Line ⑨

Boat Icon ⑩

Map Scale ⑪

### Chart View with Grid

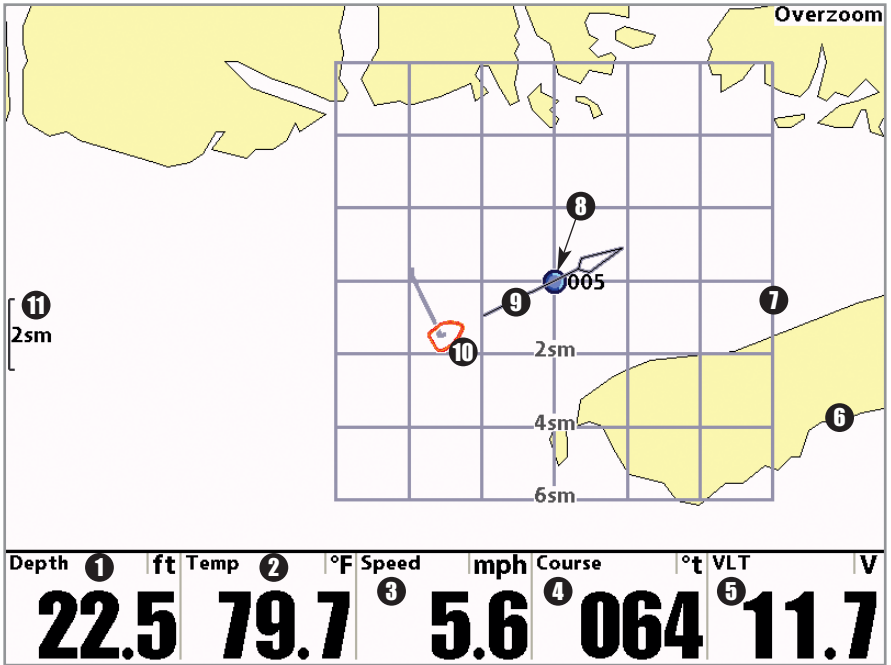

- ① Depth
- ② Temp: water surface temperature
- ③ Speed: speed of boat
- ④ Course: the current direction the boat is traveling measured in degrees from North
- ⑤ VLT: Voltage
- ⑥ Cartography
- Waypoint Trolling Grid ⑦
- Waypoint for Grid ⑧
- Course Projection Line ⑨
- Boat Icon ⑩
- Map Scale ⑪

## Save, Edit, or Delete a Route

---

**Save the current route:** While you are navigating, the current route can be saved. From the Navigation X-Press™ Menu, select Save Current Route, and press the RIGHT Cursor key. Navigation will continue.

**Display the Routes submenu:** From any view, press the MENU key twice to display the Main Menu, then press the RIGHT Cursor key to select the Navigation tab. Press the DOWN Cursor key until Routes is highlighted, and press the RIGHT Cursor key to display the Routes submenu.

**Create a route:** From the Routes submenu, select Create and press the RIGHT Cursor key. A Route Edit dialog box will be displayed with an empty route. You can name the route, add waypoints to the route from the saved waypoints list, and order the waypoints in the route using the 4-WAY Cursor Control key to move between fields.

**Edit a saved route:** From the Routes submenu, select Edit and press the RIGHT Cursor key. A Route Edit dialog box will be displayed. Select the route you want to edit and press the RIGHT Cursor key. Re-name the route or change, delete, or re-order the waypoints used in the route.

**Edit waypoint order in a route:** From the Route Edit dialog box, highlight a waypoint in the In Route list, and press the RIGHT Cursor key to access the Waypoint In Route submenu. From this submenu, you can move the waypoint up or down in the route order or delete it from the list.

**Delete a saved route:** From the Routes submenu, select Delete and press the RIGHT Cursor key. Select the route you want to delete and press the RIGHT Cursor key. You will be asked to confirm your choice by pressing the RIGHT Cursor key again before the route is deleted.

**Travel a saved route:** From the Routes submenu, select Travel, and press the RIGHT Cursor key. The saved routes list will appear. Select the route you want to travel, and press the RIGHT Cursor key to make this route the current route and begin navigation. You may also travel the route in forward or reverse order by changing the Direction setting in the saved routes list.

**Route Info:** From the Routes submenu, select Info, and press the RIGHT Cursor key. The saved routes list will appear. Select a route, and press the RIGHT Cursor key. The following information will be displayed for the route you select: The waypoints in the route, with the distance and bearing from each waypoint to the next, as well as the distance and bearing from the current position to the first waypoint in the route.



## Save or Clear a Current Track

---

**Save the current track:** From the Navigation X-Press™ Menu, select Save Current Track, and press the RIGHT Cursor key. The track will remain on the display but will change from black to gray. To remove the track completely from the display, see *Edit, Delete, or Hide Saved Tracks*.

*NOTE: When you save a track, a name is automatically assigned. The track name consists of a date/time stamp, but can be re-named later (see *Edit, Delete, or Hide Saved Tracks*).*

**Clear the current track:** From the Navigation X-Press™ Menu, select Clear Current Track, and press the RIGHT Cursor key. The track will be removed from the display and permanently deleted.

## Edit, Delete, or Hide Saved Tracks

---

**Display the Saved Tracks Submenu:** From any view, press the MENU key twice to display the Main Menu, then press the RIGHT Cursor key to select the Navigation tab. Select Saved Tracks, and press the RIGHT Cursor key to display the Saved Tracks submenu.

**Edit a saved track:** From the Saved Tracks submenu, select Edit, and press the RIGHT Cursor key to display the saved tracks list. Select the track you want to edit and press the RIGHT Cursor key.

When the **Edit Track** dialog box appears, use the Cursor keys to move between fields. In the Name field, the UP and DOWN Cursor keys change the letter or number. All upper and lower case letters are available, as well as digits 0-9 and some punctuation characters. You can exit the Name field with the LEFT and RIGHT Cursor keys or by pressing the EXIT key. Select Save and press the RIGHT Cursor key to save your changes.

**Delete a saved track:** From the Saved Tracks submenu, select Delete, and press the RIGHT Cursor key to display the saved tracks list. Select the track you want to delete and press the RIGHT Cursor key. You will be asked to confirm deletion before the track is permanently deleted.

**Hide or display a saved track:** From the Saved Tracks submenu, select Visibility, and press the RIGHT Cursor key to display the saved tracks list. Select the track you want to hide or display and press the RIGHT or LEFT Cursor keys to select Hidden or Visible. Press the EXIT key to return to the Saved Tracks submenu.

## Man Overboard (MOB) Navigation

---

As soon as you know that you have a man overboard (MOB), you should activate MOB navigation to maximize the chances for a successful rescue. MOB navigation allows you to create an MOB waypoint to locate the point at which your man went overboard and the relation of the boat to that point.

**Activate MOB navigation:** Press and hold the GOTO key for more than 1.5 seconds to activate the Man Overboard (MOB) function.

When MOB is activated, a MOB waypoint is created at the boat's current position, regardless of whether the chart cursor is active or not. The MOB waypoint has a large, distinctive icon. Once MOB is activated, any current navigation will be cancelled and the current route will be discarded without user notification. MOB navigation will begin immediately, and the MOB View will show the following:

- The view will switch to the Chart View, and the elapsed time since MOB was activated will be displayed.
- A line will be drawn from the boat's current position to the MOB waypoint, and the MOB waypoint will be targeted.
- The latitude/longitude position of the MOB waypoint will be displayed in an additional information box.

**Cancel MOB Navigation:** From the Navigation X-Press™ Menu, select Cancel MOB, and press the RIGHT Cursor key. Canceling MOB navigation removes the route and any waypoints created using the GOTO key but does not remove any saved routes from memory.

It is not possible to re-activate MOB or modify the current route without first canceling MOB navigation. The Off Course trigger is also disabled and the Off Course Alarm circle is not drawn. Any press of the GOTO key, or selection of a GOTO menu option, will cause an error beep and a short message will be displayed that will disappear after 2 seconds.

## MOB Navigation

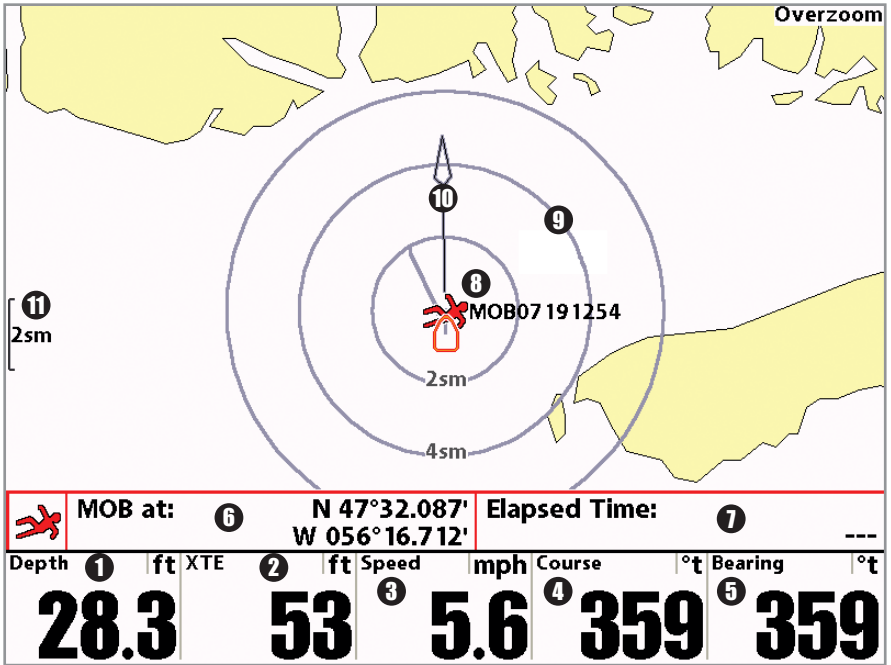

- 1** Depth
- 2** XTE (Cross Track Error): Distance of Boat from Route
- 3** Speed: speed of boat
- 4** Course: the current direction the boat is traveling measured in degrees from North
- 5** Bearing: Direction to Destination Waypoint measured in degrees from North

- Position where Man Overboard was activated **6**
- Elapsed Time since MOB was activated **7**
- MOB Waypoint **8**
- Target Surrounding MOB Waypoint **9**
- Course Projection Line **10**
- Map Scale **11**

# The Menu System

---

The Menu System is divided into easy-to-use menu modules as follows:

- **Start-Up Options Menu:** Press the MENU key during the power on sequence to view the Start-Up Options Menu. From the Start-Up Options Menu, you can choose the following Fishfinder Modes: Normal, Simulator, and System Status.
- **X-Press™ Menu:** The X-Press™ Menu provides a shortcut to the most frequently-used settings, and the options on the X-Press™ Menu correspond with the current view.
- **Main Menu:** The Main Menu is a standard set of menu settings which are organized under the following tabbed headings: Alarms, Sonar, Navigation, Chart, Setup, Views, and Accessories.

***NOTE:** The X-Press™ Menu(s) and the Main Menu options can also be expanded or simplified by setting the User Mode to Advanced or Normal (see **Main Menu: User Mode**).*

## Start-Up Options Menu

---

Press the MENU key during the power on sequence to view the **Start-Up Options Menu**, and select one of the modes described on the following pages. Also, see *Power On the Control Head* for more information.

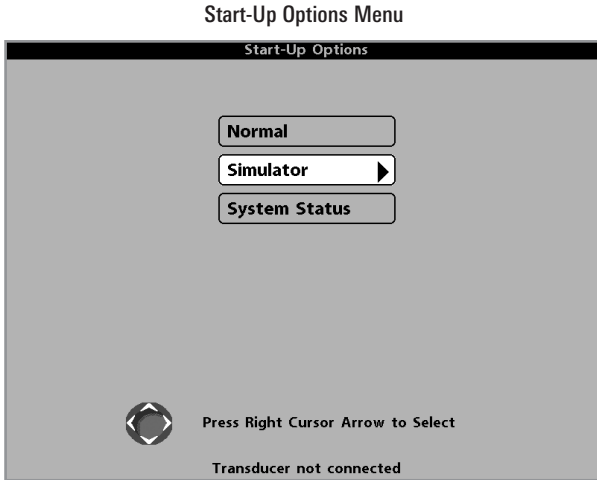

### Normal

---

Use **Normal** for on-the-water operation with a transducer connected. If a functioning transducer is connected, Normal operation will be selected automatically at power up, and your Fishing System can be used on the water.

To exit Normal operation, power off your Fishing System.

## Simulator

Use **Simulator** to learn how to use your Fishfinder before taking your boat on the water. The Simulator is a very powerful tool that provides a randomly-updated display which simulates on the water operation.

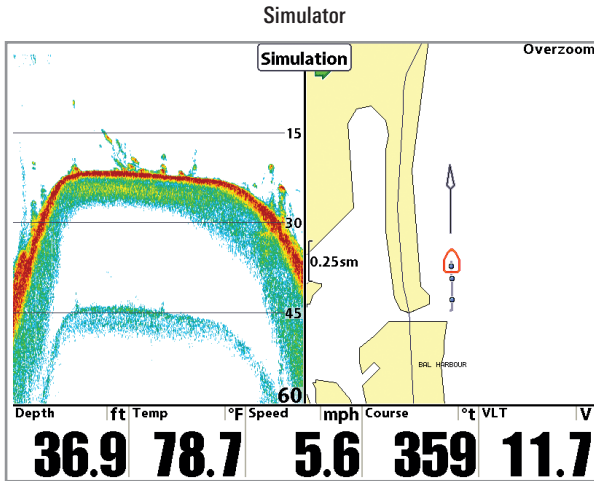

We recommend going through this manual while using the Simulator, since all of the menus function and affect the display in the same way as they would in Normal operation. Any menu changes you make will be saved for later use.

- A **message** will appear often on the display to indicate Simulator mode.
- **To exit Simulator**, power off your Fishfinder.

**NOTE:** It is important to select Simulator manually from the Start-Up Options Menu as opposed to letting the Fishfinder enter Simulator automatically (as it will if a transducer is not connected and you do nothing during power up). See **Power on the Control Head** for more information.

## System Status

Use **System Status** to view system connections and to conduct a unit self-test.

After you select System Status from the Start-Up Options Menu, press the VIEW key to display the following options:

- Self Test
- Accessory Test
- GPS Diagnostic View

To exit System Status, power off your Fishfinder.

**Self Test** displays results from the internal diagnostic self test, including unit serial number, Printed Circuit Board (PCB) serial number, software revision, total hours of operation, and the input voltage. IP and MAC addresses are also displayed.

### Self Test Screen

SYSTEM STATUS				
Self Test				
PASSED				
S/N		PCB S/N		
<b>-1-11324049487</b>		<b>-1-0001-001</b>		
SOFTWARE VERSION				
<b>5.005</b>				
VOLTAGE		TOTAL TIME		
<b>11.4<sup>V</sup></b>		<b>2083<sup>hrs</sup></b>		
IP ADDRESS		MAC ADDRESS		
<b>-----</b>		<b>00-1a-29-00-00-00</b>		
Depth	ft	Speed	kph	Course
<b>29.7</b>	N 45°49.779' W 085°35.548'	<b>9.0</b>	<b>240</b>	<b>11.4</b>
			VLT	V

Accessory Test lists the accessories connected to the system.

Accessory Test Screen

SYSTEM STATUS		
ACCESSORY TEST		
Aux. Temperature		UNCONNECTED
CannonLink		UNCONNECTED
GPS		CONNECTED
InterLink		UNCONNECTED
Speed		UNCONNECTED
Temperature		UNCONNECTED
WeatherSense		UNCONNECTED
XM Weather		UNCONNECTED
Depth	ft	Speed kph Course °t VLT IV
<b>30.0</b>	N 45°49.766' W 085°35.567'	<b>9.0</b> <b>224</b> <b>10.5</b>

*NOTE: The speed accessory will be detected only if the paddlewheel has moved since your Fishfinder was powered up.*



**GPS Diagnostic View** shows a sky chart and numerical data from the GPS receiver. The sky chart shows the location of each visible GPS satellite with its satellite number and a signal strength bar. A dark gray bar indicates that the satellite is being used to determine your current position. A light gray bar indicates that the satellite is being monitored, but is not yet being used.

This view also reports the current position, local time and date, and other numeric information. The current GPS Fix Type is reported as No Fix, 2D Fix, 3D Fix, or Enhanced. An Enhanced fix has been augmented using information from WAAS, EGNOS, or MSAS. A 3D or Enhanced Fix is required for navigation. HDOP (the Horizontal Dilution of Precision) is a GPS system parameter which depends on the current satellite configuration. HDOP is used to calculate the Estimated Position Error.

*NOTE: This view is only available when a GPS Receiver is attached to the control head.*

GPS Diagnostic View

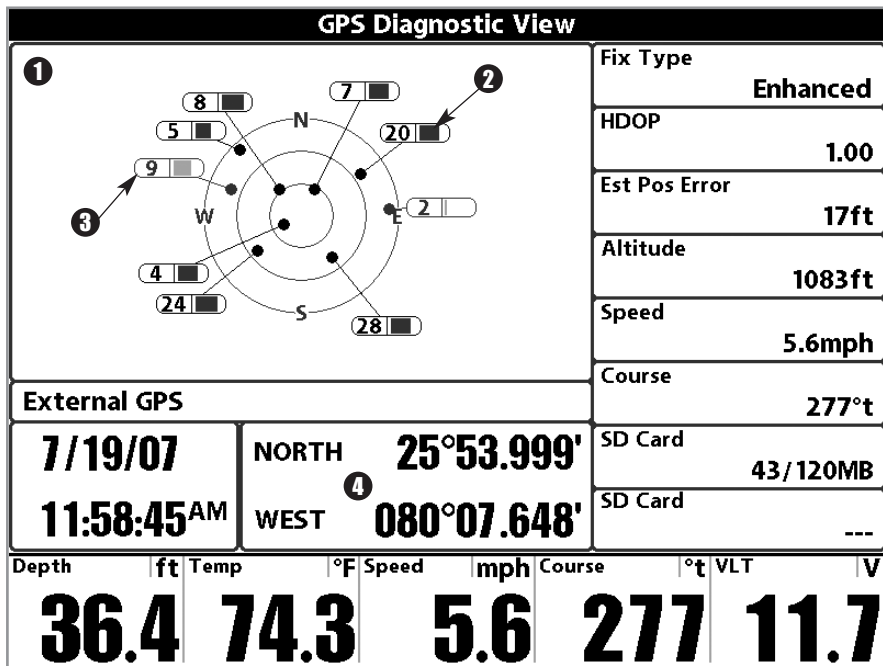





1 Sky Chart

2 Satellite Being Used

Satellite Being Monitored 3

Current Latitude and Longitude 4

 <b>Sensitivity</b>	<b>10</b>
1  20	
 <b>Upper Range</b>	<b>0ft</b>
 <b>Lower Range</b>	<b>Auto</b>
 <b>Chart Speed</b>	<b>5</b>
<b>Sonar Colors</b>	<b>Standard</b>

X-Press™ Menu

## X-Press™ Menu

The X-Press™ Menu provides a shortcut to your most frequently-used settings. The options provided on the X-Press™ Menu correspond with the current view. For example, if you are in a Sonar View and press the MENU key once, the Sonar X-Press™ Menu will display.

### To use an X-Press™ Menu:

1. In any view, press the MENU key once.
2. Press the UP or DOWN Cursor keys to highlight an X-Press™ Menu option, then use the RIGHT or LEFT Cursor keys to change the menu setting.

*NOTE: The X-Press™ Menu will collapse temporarily and the screen will update if it is affected by your menu setting change, which allows you to see the effects of your change immediately.*

3. Reactivate the X-Press™ Menu by pressing the UP or DOWN Cursor keys.

**Total Screen Update™** - When you change any menu settings that affect the current view, the view will update immediately (i.e. you don't have to exit the menu to apply the change to the screen).

Menu options can be simplified or expanded by setting the User Mode to Normal or Advanced. See *Main Menu: User Mode* for details.

Alarms	
Depth Alarm	Off
Fish ID Alarm	<input type="radio"/>
Low Battery Alarm	Off
Aux. Temp. Alarm	Off
Temp. Alarm	Off
Off Course Alarm	300ft
Arrival Alarm	150ft

Main Menu System  
Normal User Mode

## Main Menu

The **Main Menu** provides the standard set of menu options, including the settings that are changed less frequently. The Main Menu is organized under the following tabs to help you find a specific menu item quickly: Alarms, Sonar, Navigation, Chart, Setup, Views, and Accessories.

**NOTE:** Menu options can be expanded or simplified by setting the User Mode to Advanced or Normal. See **Main Menu: User Mode** for details.

### To use the Main Menu:

1. In any view, press the MENU key twice.
2. Press the RIGHT or LEFT Cursor keys to highlight a menu tab.
3. Press the DOWN or UP Cursor keys to select a specific menu option under that tab.
4. Press the RIGHT or LEFT Cursor keys again to change a menu setting.
  - A down arrow at the bottom of a menu means that you can scroll to additional menu options using the DOWN Cursor key.
  - A right or left arrow on a menu option means that you can use the RIGHT or LEFT Cursor keys to make changes or to see more information.
  - Press the EXIT key to move quickly to the top of the tab.

**Total Screen Update™** - When you change any menu settings that affect the current view, the view will update immediately (i.e. you don't have to exit the menu to apply the change to the screen).

## Quick Tips for the Main Menu

---

- **From any menu option on a menu tab**, press the EXIT key to jump directly to the top of the tab.
- **From the bottom of a menu tab**, press the DOWN Cursor key to jump directly to the top of the tab.
- **From the top of a menu tab**, press the LEFT or RIGHT Cursor keys to scroll to the next tab. You can also jump to the beginning or end of the tab rotation by repeatedly pressing the RIGHT or LEFT Cursor keys.
- If there is a **down arrow at the bottom of a menu tab**, press the DOWN Cursor key to scroll to additional menu options.
- If there is a **right or left arrow on a menu option**, press the RIGHT or LEFT Cursor keys to make setting changes or see more information.
- If you press MENU or EXIT to leave the Main Menu and then **return to the Main Menu** at a later time, the menu will open to the same tab as the last time the Main Menu was displayed.

## Note for all Menu Settings

---

The settings in all menus are adjusted in the same way. Simply use the 4-WAY Cursor Control key to highlight a menu option, and then change the settings or activate the option (see *Main Menu* or *X-Press™ Menu*).

Below is an example of how the menu options are described in this manual. Each description shows the menu option appearance, the available settings, and the specific control head settings required (i.e. advanced user mode, international only, view, navigation, or accessory).

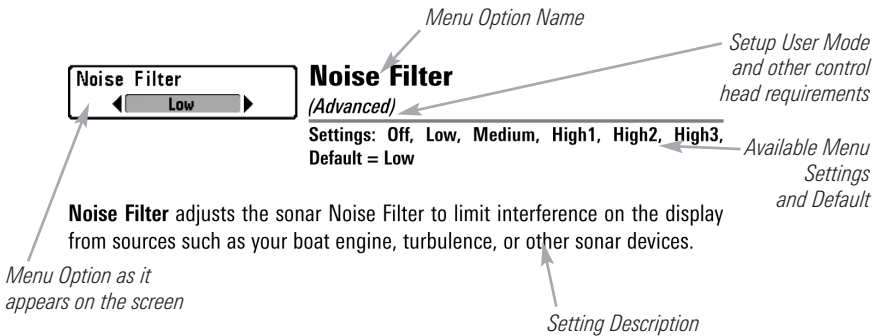

## **User Mode (Normal or Advanced)**

---

Menu options can be simplified or expanded by setting your Fishing System User Mode to Normal or Advanced.

**Normal Mode** is provided for users who want greater simplicity and fewer menu choices.

**Advanced Mode** is provided for users who want the highest level of control over the Fishing System. Several menu settings are added to the Main Menu when the User Mode is changed to Advanced. Advanced mode is the default setting when you first power on your Humminbird® Fishing System.

### **To change the User Mode setting:**

1. Press the MENU key twice to access the Main Menu.
2. Press the RIGHT Cursor key until the Setup tab is selected.
3. Press the DOWN Cursor key to highlight User Mode on the Setup main menu.
4. Press the LEFT or RIGHT Cursor keys to change the User Mode setting. (Normal, Advanced, Default = Advanced)

***NOTE:** Any changes made while in Advanced Mode will remain in effect after you switch back to Normal Mode.*

*For example, the Select Readouts menu option is available when the User Mode is set to Advanced. If you change the Select Readouts settings while operating in Advanced User mode, the Select Readouts you choose will continue to display on the screen even if you switch back to Normal User Mode.*

Sonar	
Beam Select	200kHz
Side View Frequency	455kHz
Surface Clutter	5
SwitchFire	Clear Mode
Fish ID +	Off
Fish ID Sensitivity	5
RTS Window	Narrow
Sonar Colors	Original Palette
Bottom View	Structure ID
Zoom Width	Narrow
Transducer Select	Quad Beam
Color Bar	On
Temperature Graph	On

Sonar Tab, Normal Mode

Sonar	
Beam Select	83kHz
Side View Frequency	455kHz
Surface Clutter	5
SwitchFire	Clear Mode
Fish ID +	Off
Fish ID Sensitivity	5
RTS Window	Narrow
Sonar Colors	Original Palette
Bottom View	Structure ID
Zoom Width	Narrow
83kHz Sensitivity	0
455kHz Sensitivity	0
Depth Lines	On
SI Range Lines	Off
Noise Filter	Off
Max Depth	Auto
Water Type	Fresh
Transducer Select	Hi-Def Sidescan
Color Bar	On
Temperature Graph	Off
Down Imaging Beam Width	Wide
Contour Mode	Off

Sonar Tab, Advanced Mode

## Sonar X-Press™ Menu

◀▶ Active Side	
◀ Left ▶	
▶▶ Split Position	50
⚙ Sensitivity	10
↕ Upper Range	0ft
↕ Lower Range	Auto
▶▶ Chart Speed	5
📐 Quad Layout	Default
🔒 Bottom Lock	Off
↕ Bottom Range	15ft
⊠ Cancel Navigation	

Sonar X-Press™ Menu

The **Sonar X-Press™ Menu** provides a shortcut to your most frequently-used settings. Press the MENU key once while in any of the Sonar Views to access the Sonar X-Press™ Menu.

*NOTE: Menu options can be expanded or simplified by setting the User Mode to Advanced or Normal. See **Main Menu: User Mode** for details.*

*NOTE: Quad Layout only appears in Side Beam View when the optional-purchase QuadraBeam PLUS™ transducer is attached and selected.*



## Active Side

*(Combo Views only)*

**Settings: Left, Right; Default = Left**

---

**Active Side** allows you to select a side of the screen in Combo View. After you choose an active side, you can apply menu settings and key commands to the view you've selected. The Active Side menu option is only available when a Combo View is on the screen (see *Views: Combo Views*).

- A green arrow on the Combo View points to the active side.
- When a menu is displayed in the active side, the non-active side of the screen will be grayed out.



## Split Position

*(Combo Views only)*

**Settings: Left, 30, 40, 50, 60, 70, Right; Default = Various**

---

**Split Position** sets the size of the left side of the Combo View. Each Combo View can be set individually. The Split Position menu option is only available when a Combo View is on the screen (see *Views: Combo Views*).

- The number setting indicates the percentage taken up by the left side of the Combo View.
- Selecting Left sets the left side of the screen to its smallest setting.



**Sensitivity** 10  
 1  20

## Sensitivity

Settings: Low = 1, High = 20; Default = 10

**Sensitivity** controls how much detail is shown on the display and will adjust the sensitivity of all sonar frequencies.

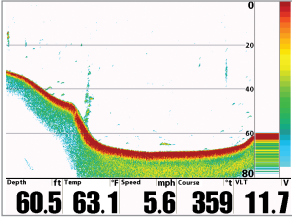

Sensitivity at Low

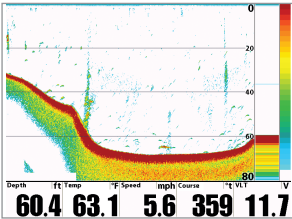

Sensitivity at Medium

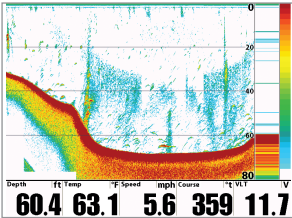

Sensitivity at High

Decrease the sensitivity to eliminate the clutter from the display that is sometimes present in murky or muddy water. If Sensitivity is adjusted too low, the display may not show many sonar returns that could be fish.

When operating in very clear water or greater depths, increase the sensitivity to see weaker returns that may be of interest. If the sensitivity is adjusted too high, the display may become too cluttered.

**NOTE:** The Sensitivity setting is a global setting and will adjust the sensitivity of all sonar frequencies.



## Upper Range

*(Advanced: Sonar, Split Sonar and Active Sonar Side Views only)*

**Settings: 0 to 1490 or 0 to 497 meters [International models only];  
Default = 0**

**Upper Range** sets the shallowest depth range that will be displayed on the Sonar, Split Sonar, and Active Sonar Side Views. Upper Range is often used with Lower Range.

For example, if you are only interested in the area between 20 and 50 feet deep, you should set the Upper Depth Range to 20 and the Lower Depth Range to 50. The Sonar View will then show the 30 foot area between 20 and 50, and will not show the surface or the bottom (assuming the bottom is deeper than 50 feet), and will show greater detail for that area between 20 and 50 feet.

**NOTE:** A minimum distance of 10 feet will be maintained between the Upper and Lower Range regardless of the manual settings entered.



## Lower Range

**Settings: AUTO, 10 to 1500 ft, 3 to 500 m [International Models only];  
Default = AUTO**

**Lower Range** sets the deepest depth range that will be displayed by the unit.

**Auto:** The Lower Range will be adjusted by the unit to follow the bottom automatically. Auto is the default setting.

**Manual:** You can adjust the Lower Range to lock the unit on a particular depth. **M** will be displayed in the lower right corner of the screen to indicate the unit is in Manual mode. Adjust the Upper and Lower Range together to view a specific depth range, especially when looking for fish or bottom structure.

For example, if you are fishing in 60 feet of water but are only interested in the first 30 feet (surface to a depth of 30 feet) you should set the Lower Depth Range limit to 30. The display will show the 0 to 30 foot range, which allows you to see a more detailed view than you would see if the display went all the way to the bottom.

**NOTE:** A minimum distance of 10 feet will be maintained between the Upper and Lower Range regardless of the settings entered manually.



## Chart Speed

Settings: 1-10, where 1 = Slow, 10 = Fastest; Default = 5

---

**Chart Speed** determines the speed at which the sonar information moves across the display, and consequently the amount of detail shown.

A faster speed shows more information and is preferred by most anglers; however, the sonar information moves across the display quickly. A slower speed keeps the information on the display longer, but the bottom and fish details become compressed and may be difficult to interpret. Regardless of the Chart Speed setting, the RTS Window™ will update at the maximum rate possible for the depth conditions.



## Quad Layout

(with optional-purchase QuadraBeam PLUS™ Transducer, Side Beam View only)

---

Settings: Default, Classic, Slanted; Default = Default

**Quad Layout** allows you to choose how sonar information is displayed in the Side Beam View. The Side Beam View displays sonar data from the left and right 455 kHz beams, as well as the 200 kHz down-looking beam. The sonar data can be displayed in any of the following layouts by changing the Quad Layout setting: Default, Classic, and Slanted. See *Views: Side Beam View* for more information.

*NOTE: Quad Layout is only available when an optional-purchase QuadraBeam PLUS™ transducer is attached and the Side Beam View is active (see **Sonar Menu Tab: Transducer Select**).*



## Bottom Lock

(Sonar Zoom View only)

---

Settings: Off, On; Default = Off

**Bottom Lock** changes the mode of the zoomed view in the Sonar Zoom View. Bottom Lock continuously graphs the bottom at a constant point on the display regardless of changes in depth. This “flattens” out the bottom contour but is effective at showing fish on or near the bottom.



## Bottom Range

*(Sonar Zoom View only, when Bottom Lock is On)*

**Settings: 10 - 60 feet, 2-10 fathoms, or 3-20 meters [International Models only]; Default = 15 feet**

**Bottom Range** allows you to control how much of the water column, measured up from the bottom, is shown in the Sonar Zoom View. Choose a small value to see low-lying bottom structure or details of the bottom return. Choose a larger value to see large structure in deeper water.

***NOTE:** It is possible to set the Bottom Range to be greater than the depth. In this case, you may see surface clutter in a wavy band that mirrors changes in the depth.*



## Cancel Navigation

*(only when Navigating)*

**Settings: Press the RIGHT Cursor key and follow screen instructions.**

**Cancel Navigation** discards the current route and exits Navigation Mode. This menu option will only appear when you are currently navigating a route. This will not delete a previously-saved route.

◀▶	<b>Active Side</b>	
	◀ Left ▶	
◀▶	<b>Split Position</b>	<b>50</b>
◀▶	<b>SI Side</b>	<b>Both</b>
⊞	<b>SI Sensitivity</b>	<b>Auto</b>
+	<b>SI Enhance</b>	
↔	<b>SI Range</b>	<b>150ft</b>
▶▶	<b>Chart Speed</b>	<b>5</b>
▣	<b>SI Colors</b>	<b>Blue</b>
⊠	<b>Cancel Navigation</b>	

Side Imaging® X-Press™ Menu

## Side Imaging® X-Press™ Menu

*(Side Imaging® Views only [1198c SI])*

The **Side Imaging® X-Press™ Menu** provides a shortcut to your most frequently-used settings. Press the MENU key once while in any of the Side Imaging® Views to access the Side Imaging® X-Press™ Menu.

*NOTE: Menu options can be expanded or simplified by setting the User Mode to Advanced or Normal. See **Main Menu: User Mode** for details.*



## Active Side

(Combo Views only)

Settings: Left, Right; Default = Left

**Active Side** allows you to select a side of the screen in Combo View. After you choose an active side, you can apply menu settings and key commands to the view you've selected. The Active Side menu option is only available when a Combo View is on the screen (see *Views: Combo Views*).

- A green arrow on the Combo View points to the active side.
- When a menu is displayed in the active side, the non-active side of the screen will be grayed out.



## Split Position

(Combo Views only)

Settings: Left, 30, 40, 50, 60, 70, Right; Default = Various

**Split Position** sets the size of the left side of the Combo View. Each Combo View can be set individually. The Split Position menu option is only available when a Combo View is on the screen (see *Views: Combo Views*).

- The number setting indicates the percentage taken up by the left side of the Combo View.
- Selecting Left sets the left side of the screen to its smallest setting.

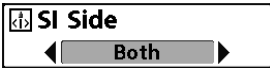

## SI Side

Settings: Left, Both, Right; Default = Both

**SI Side** sets which transducer beam from the Side Imaging® beams will be shown on the display.



## SI Sensitivity

Settings: Auto, 1 to 20, where Low = 1, High = 20; Default = 10

**SI Sensitivity** controls how much detail is shown on the display.

**Increase the SI Sensitivity** to reveal weaker returns that may be of interest, especially in very clear water or greater depths. A high SI Sensitivity setting shows more sonar returns from small baitfish and suspended debris in the water; however if the SI Sensitivity is adjusted too high, the display may become too cluttered.

**Decrease the SI Sensitivity** to eliminate the clutter from the display that is sometimes present in murky or muddy water. If SI Sensitivity is adjusted too low, the display may not show many sonar returns that could be fish.

Settings: Press the RIGHT Cursor key.

SI Enhance allows you to adjust your Side Imaging® View in three categories: Sensitivity, Contrast, and Sharpness.

Whether you're searching the Side Imaging® data for fish or certain bottom contour, the most effective settings will vary with the situation. The display will update as you adjust each category. SI Enhance can also be used during Recording Playback (see *Snapshot and Recording View*).



SI Enhance Submenu

- **Sensitivity** - Controls how much detail is shown on the display. When operating in very clear water or greater depths, increased sensitivity shows weaker returns that may be of interest. Decreasing the sensitivity eliminates the clutter from the display that is sometimes present in murky or muddy water. (1 to 20, where Low = 1, High = 20, Default = 10)

*NOTE: The Sensitivity can be adjusted from the SI Enhance dialog box or the Side Imaging® X-Press™ Menu. The Sensitivity setting is provided here so that you can easily adjust the Side Imaging® data with the other settings. See Side Imaging® X-Press™ Menu: SI Sensitivity for more information.*

- **Contrast:** Accents the light and dark parts of the Side Imaging® data to provide greater definition. (1-20, Default = 10)
- **Sharpness:** Filters the view and sharpens the edges of the Side Imaging® data. (Low (L), Medium (M), High (H), Default = Off)

2  120

Settings: 6 to 360 feet, or 2 to 120 meters [International Models only]; Default = 150 feet, 50 meters

SI Range sets the deepest range that will displayed in the Side Imaging® views. The range must be set manually.

*Choose a low range number to focus on a shorter distance of the water column and see greater detail on the screen. Choose a higher range number to view farther into the water and see an overview of details on the screen.*

 **Chart Speed** 5  
1  10

## Chart Speed

---

Settings: 1- 10, where 1 = Slow, 10 Fastest, Default = 5

**Chart Speed** determines the speed at which the side sonar information moves down the display, and consequently the amount of detail shown. A **faster speed** shows more information in the Side Imaging® Views and is preferred by most anglers; however, the sonar information moves across the display quickly. A **slower speed** keeps the information on the display longer, which allows you to see an entire area.

 **SI Colors**  
◀  ▶

## SI Colors

---

Settings: Blue, Amber1, Amber2, Brown, Green, Inverse, Gray, Green/Red, Default = Blue

**SI Colors** allows you to select which color palette you would like to use for the Side Imaging® display.

 **Cancel Navigation** ▶

## Cancel Navigation

---

*(only when Navigating)*

Settings: Press the RIGHT Cursor key and follow screen instructions.

**Cancel Navigation** discards the current route and exits Navigation Mode. This menu option will only appear when you are currently navigating a route. This will not delete a previously-saved route.



◀▶ Active Side	◀ Left ▶	
◀▶ Split Position	50	50
⚙️ Down Sensitivity	Auto	
↔️ Upper Range	0ft	
↔️ Lower Range	Auto	
▶▶ Chart Speed	5	
🎨 SI Colors	Blue	
⌛ Cancel Navigation		
⚠️ Down Imaging Beam Width	Wide	

Down Imaging™ X-Press™ Menu

## Down Imaging™ X-Press™ Menu

*(Down Imaging™ Views only [1198c SI])*

The Down Imaging™ X-Press™ Menu provides a shortcut to your most frequently-used settings. Press the MENU key once while in any of the Down Imaging™ Views to access the Down Imaging™ X-Press™ Menu.

*NOTE: Menu options can be expanded or simplified by setting the User Mode to Advanced or Normal. See **Main Menu: User Mode** for details.*



## Active Side

(Combo Views only)

Settings: Left, Right; Default = Left

**Active Side** allows you to select a side of the screen in Combo View. After you choose an active side, you can apply menu settings and key commands to the view you've selected. The Active Side menu option is only available when a Combo View is on the screen (see *Views: Combo Views*).

- A green arrow on the Combo View points to the active side.
- When a menu is displayed in the active side, the non-active side of the screen will be grayed out.



## Split Position

(Combo Views only)

Settings: Left, 30, 40, 50, 60, 70, Right; Default = Various

**Split Position** sets the size of the left side of the Combo View. Each Combo View can be set individually. The Split Position menu option is only available when a Combo View is on the screen (see *Views: Combo Views*).

- The number setting indicates the percentage taken up by the left side of the Combo View.
- Selecting Left sets the left side of the screen to its smallest setting.



## Down Sensitivity

Settings: Auto, 1 to 20, where Low = 1, High = 20; Default = 10

**Down Sensitivity** controls how much detail is shown on the display.

**Increase the Down Sensitivity** to reveal weaker returns that may be of interest, especially in very clear water or greater depths. A high Down Imaging™ Sensitivity setting shows more sonar returns from small baitfish and suspended debris in the water; however if the Down Imaging™ Sensitivity is adjusted too high, the display may become too cluttered.

**Decrease the Down Sensitivity** to eliminate the clutter from the display that is sometimes present in murky or muddy water. If Down Imaging™ Sensitivity is adjusted too low, the display may not show many sonar returns that could be fish.



## Upper Range

(Advanced: Down Imaging™ Views only)

Settings: 0 to 1490 or 0 to 497 meters [International models only],  
Default = 0

**Upper Range** sets the shallowest depth range that will be displayed on the Down Imaging™ Views. Upper Range is often used with Lower Range.

For example, if you are only interested in the area between 20 and 50 feet deep, you should set the Upper Depth Range to 20 and the Lower Depth Range to 50. The Down Imaging™ View will then show the 30 foot area between 20 and 50, and will not show the surface or the bottom (assuming the bottom is deeper than 50 feet), and will show greater detail for that area between 20 and 50 feet.

*NOTE: A minimum distance of 10 feet will be maintained between the Upper and Lower Range regardless of the manual settings entered.*



## Lower Range

Settings: AUTO, 10 to 1500 ft, 3 to 500 m [International Models only];  
Default = AUTO

**Lower Range** sets the deepest depth range that will be displayed by the unit.

**Auto:** The Lower Range will be adjusted by the unit to follow the bottom automatically. Auto is the default setting.

**Manual:** You can adjust the Lower Range to lock the unit on a particular depth. **M** will be displayed in the lower right corner of the screen to indicate the unit is in Manual mode. Adjust the Upper and Lower Range together to view a specific depth range, especially when looking for fish or bottom structure.

For example, if you are fishing in 60 feet of water but are only interested in the first 30 feet (surface to a depth of 30 feet) you should set the Lower Depth Range limit to 30. The display will show the 0 to 30 foot range, which allows you to see a more detailed view than you would see if the display went all the way to the bottom.

*NOTE: A minimum distance of 10 feet will be maintained between the Upper and Lower Range regardless of the settings entered manually.*



## Chart Speed

Settings: 1-10, where 1 = Slow, 10 = Fastest; Default = 5

**Chart Speed** determines the speed at which the sonar information moves across the display, and consequently the amount of detail shown.

A faster speed shows more information and is preferred by most anglers; however, the sonar information moves across the display quickly. A slower speed keeps the information on the display longer, but the bottom and fish details become compressed and may be difficult to interpret.



## SI Colors

Settings: Blue, Amber1, Amber2, Brown, Green, Inverse, Gray, Green/Red; Default = Blue

**SI Colors** allows you to select which color palette you would like to use for the Side Imaging<sup>®</sup> and Down Imaging<sup>™</sup> display.



## Down Imaging Beam Width

*(Advanced, Down Imaging<sup>™</sup> View only)*

Settings: Narrow, Medium, Wide; Default = Wide

**Down Imaging Beam Width** controls the width of the beam (side to side) for the Down Imaging<sup>™</sup> View and sets the amount of information shown on the display.

To see only the data directly under your boat, select Narrow. Medium reveals more information, while Wide displays the maximum information available from the Down Imaging<sup>™</sup> beam width.



## Cancel Navigation

*(only when Navigating)*

Settings: Press the **RIGHT** Cursor key and follow screen instructions.

**Cancel Navigation** discards the current route and exits Navigation Mode. This menu option will only appear when you are currently navigating a route. This will not delete a previously-saved route.

<div style="display: flex; justify-content: space-between; align-items: center;"> <span>Active Side</span> <div style="border: 1px solid black; padding: 2px;"> <span style="font-size: 0.8em;">Left</span> <span style="font-size: 0.8em;">Right</span> <span style="font-size: 0.8em;">Right</span> <span style="font-size: 0.8em;">▶</span> </div> </div>
<div style="display: flex; justify-content: space-between; align-items: center;"> <span>Split Position</span> <span>50</span> </div>
Waypoint 001
Cursor To Waypoint
Save Current Track
Clear Current Track
Save Current Route
Skip Next Waypoint
Cancel Navigation
Cancel MOB Navigation
Remove Target
Remove Grid
Waypoint 001

## Navigation X-Press™ Menu

The **Navigation X-Press™ Menu** provides a shortcut to your most frequently-used settings. Press the MENU key once while in the Bird's Eye View, Chart Views, or Chart Combo Views to access the Navigation X-Press™ Menu.

*NOTE: Menu choices will vary depending on system settings, such as whether you are currently navigating.*

*NOTE: To see the Navigation X-Press™ Menu in a Combo View, change the Active Side setting to the side you want to adjust.*

Navigation X-Press™ Menu



## Active Side

*(Combo Views only)*

**Settings: Left, Right, Default = Left**

**Active Side** allows you to select a side of the screen in Combo View. After you choose an active side, you can apply menu settings and key commands to the view you've selected. The Active Side menu option is only available when a Combo View is on the screen (see *Views: Combo Views*).

- A green arrow on the Combo View points to the active side.
- When a menu is displayed in the active side, the non-active side of the screen will be grayed out.



## Split Position

*(Combo Views only)*

**Settings: Left, 30, 40, 50, 60, 70, Right; Default = Various**

**Split Position** sets the size of the left side of the Combo View. Each Combo View can be set individually. The Split Position menu option is only available when a Combo View is on the screen (see *Views: Combo Views*).

- The number setting indicates the percentage taken up by the left side of the Combo View.
- Selecting Left sets the left side of the screen to its smallest setting.

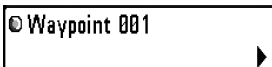

## Waypoint [Name]

*(Only with an active cursor on a waypoint)*

**Settings: Edit, Delete, Target, Grid**

**Waypoint [Name]** allows you to view the Waypoints submenu for the waypoint under your cursor. You can move the cursor onto an existing waypoint and press the MENU key once, or use Cursor to Waypoint to select a waypoint from the saved waypoints list.

*NOTE: See Introduction to Navigation for more Waypoints information.*

### The Waypoint Submenu contains the following menu options:

**Edit** allows you to edit the Name, Position (Latitude and Longitude), and select the Icon that will be used to represent the waypoint in the Chart and Combo Views.

**Delete** allows you to delete a waypoint from the saved waypoints list.

**Target** allows you to apply a target to a waypoint selected from the saved waypoints list.

**Grid** allows you to apply a trolling grid to a waypoint selected from the saved waypoints list.

 **Cursor To Waypoint**



## Cursor to Waypoint

*(Chart or Combo View only)*

**Settings:** Press the RIGHT Cursor key and follow screen instructions.

**Cursor to Waypoint** allows you to quickly move the cursor to any saved waypoint so that you can locate it or edit it. This X-Press™ Menu option only appears if you have saved waypoints.

 **Save Current Track**



## Save Current Track

**Settings:** Press the RIGHT Cursor key and follow screen instructions.

**Save Current Track** allows you to save the current track on the display. After the current track is saved, a new current track is started. Save Current Track appears on the Navigation X-Press™ Menu after navigation is stopped.

***NOTE:** To save the depth information with the current track, it is important to save the track and also edit the name before powering off the control head.*

 **Clear Current Track**



## Clear Current Track

**Settings:** Press the RIGHT Cursor key and follow screen instructions.

**Clear Current Track** allows you to clear the current track on the display and start a new track at the present position.

 **Save Current Route**



## Save Current Route

*(only when Navigating)*

**Settings:** Press the RIGHT Cursor key and follow screen instructions.

**Save Current Route** allows you to save the current route being displayed. This menu option will only appear when you are currently navigating a route.

 **Skip Next Waypoint**



## Skip Next Waypoint

*(only when Navigating)*

**Settings:** Press the RIGHT Cursor key and follow screen instructions.

**Skip Next Waypoint** removes the next waypoint from the current route. This menu option will only appear when you are currently navigating a route.

 **Cancel Navigation** 

## Cancel Navigation

*(only when Navigating)*

**Settings:** Press the RIGHT Cursor key and follow screen instructions.

---

**Cancel Navigation** discards the current route and exits Navigation Mode. This menu option will only appear when you are currently navigating a route. This will not delete a previously-saved route.

 **Cancel MOB Navigation** 

## Cancel MOB Navigation

*(only when MOB Navigation is activated)*

**Settings:** Press the RIGHT Cursor key and follow screen instructions.

---

**Cancel MOB Navigation** removes the Man Overboard (MOB) waypoint and exits Man Overboard mode. This menu option will only appear when you are currently navigating in Man Overboard mode.

 **Remove Target** 

## Remove Target

*(only if a Target is Active)*

**Settings:** Press the RIGHT Cursor key to activate.

---

**Remove Target** removes the waypoint target from the display. This menu option will only appear when a target has already been applied to a waypoint.

*NOTE: See Introduction to Navigation: Add a Waypoint Target or Trolling Grid for more information.*

 **Remove Grid** 

## Remove Grid

*(only if a Grid is Active)*

**Settings:** Press the RIGHT Cursor key to activate.

---

**Remove Grid** removes the waypoint grid from the display. This menu option will only appear when a grid has already been applied to a waypoint.

*NOTE: See Introduction to Navigation: Add a Waypoint Target or Trolling Grid for more information.*



**Waypoint [Name]** allows you to view the waypoints submenu for the most recently created waypoint. You must have pressed the MARK key at least once since you last powered up the Fishfinder for this menu option to appear.

*NOTE: See **Introduction to Navigation** for more information.*

**The Waypoint Submenu contains the following menu options:**

**Edit** allows you to edit the Name, Position (Latitude and Longitude), and select the Icon that will be used to represent the waypoint in the Chart and Combo Views.

**Delete** allows you to delete a waypoint from the saved waypoints list.

**Go To** allows you to select a waypoint and start navigation toward that waypoint, or add that waypoint to the end of the current route.

**Target** allows you to apply a target to a waypoint selected from the saved waypoints list.

**Grid** allows you to apply a trolling grid to a waypoint selected from the saved waypoints list.

<input type="radio"/> Start Recording
<input type="checkbox"/> Stop Recording
<input checked="" type="checkbox"/> Delete Image
<input checked="" type="checkbox"/> Delete All Images
<input checked="" type="checkbox"/> Delete Recording
<input checked="" type="checkbox"/> Delete All Recordings
<input checked="" type="checkbox"/> Pings Per Second Auto
<input type="checkbox"/> Playback Speed <span style="float: right;">▶</span>
<input type="checkbox"/> Stop Playback

Snapshot and Recording  
X-Press™ Menu

## Snapshot and Recording X-Press™ Menu

*(Snapshot and Recording View only)*

The **Snapshot and Recording X-Press™ Menu** provides access to the snapshot management and sonar recording functions. Press the MENU key once while in the Snapshot and Recording View to access the Snapshot and Recording X-Press™ Menu.

*NOTE: For more information, see **Views: Snapshot and Recording View**.*

○ Start Recording ▶

## Start Recording

*(optional-purchase SD Card, Snapshot and Recording View only)*

**Settings:** Press the RIGHT Cursor key to activate.

---

**Start Recording** allows you to start sonar recording from the Snapshot and Recording View. This menu option is only available when an optional-purchase SD card is installed and Snapshot and Recording View is on the screen.

□ Stop Recording ▶

## Stop Recording

*(optional-purchase SD Card only)*

**Settings:** Press the RIGHT Cursor key to activate.

---

**Stop Recording** allows you to stop sonar recording. This menu option is only available when an optional-purchase SD card is installed and the control head is actively recording.

⊗ Delete Image ▶

## Delete Image

*(optional-purchase SD Card, Snapshot and Recording View only)*

**Settings:** Press the RIGHT Cursor key and follow screen instructions.

---

**Delete Image** allows you to delete a single screen capture image. This menu option is only available when an optional-purchase SD card is installed, Snapshot and Recording View is on the screen, and you have selected an image thumbnail.

⊗ Delete All Images ▶

## Delete All Images

*(optional-purchase SD Card, Snapshot and Recording View only)*

**Settings:** Press the RIGHT Cursor key and follow screen instructions.

---

**Delete All Images** allows you to delete all the images at once. This menu option is only available when an optional-purchase SD card is installed and Snapshot and Recording View is on the screen.

⊗ Delete Recording ▶

## Delete Recording

*(optional-purchase SD Card, Snapshot and Recording View only)*

**Settings:** Press the RIGHT Cursor key and follow screen instructions.

---

**Delete Recording** allows you to delete a single sonar recording. This menu option is only available when an optional-purchase SD card is installed, Snapshot and Recording View is on the screen, and you have selected a recording file.

 **Delete All Recordings**



## Delete All Recordings

*(optional-purchase SD Card, Snapshot and Recording View only)*

**Settings:** Press the **RIGHT** Cursor key and follow screen instructions.

**Delete All Recordings** allows you to delete all the recordings at once. This menu option is only available when an optional-purchase SD card is installed and Snapshot and Recording View is on the screen.

 **Pings Per Second** 10

1  Auto

## Pings Per Second

*(optional-purchase SD Card, Snapshot and Recording View only)*

**Settings:** 1-10, AUTO, Default = AUTO

**Pings Per Second** allows you to specify the ping rate for an active sonar recording.

*NOTE: Pings Per Second is available when an optional-purchase SD card is installed, Snapshot and Recording View is on the screen, and the control head is actively recording (not playing back).*

**Auto** is the default setting for Pings Per Second and automatically adjusts the ping rate for best recording quality. If there is limited memory on your SD card, you can slow the ping rate by setting the Pings Per Second manually, but the recording will capture less sonar detail. For maximum performance, keep the Pings Per Second setting on Auto.

 **Playback Speed**













## Playback Speed

*(optional-purchase SD Card, Snapshot and Recording View only)*

**Settings:** Record, Rewind1, Rewind2, Slow Play Reverse, Pause, Slow Play, Normal Play, Fast Forward1, Fast Forward2, Stop

**Playback Speed** allows you to specify the playback speed for a sonar recording from the Snapshot and Recording View. This menu option is only available when an optional-purchase SD card is installed and Recording Playback is active.

**Playback Speed Icons:**

 <b>Record</b>	 <b>Slow Play</b>
 <b>Rewind, Reverse</b>	 <b>Normal Play</b>
 <b>Rewind2</b>	 <b>Fast Forward</b>
 <b>Slow Play Reverse</b>	 <b>Fast Forward2</b>
 <b>Pause</b>	 <b>Stop</b>

***NOTE:** You can also change playback speed in the Snapshot and Recording View using the LEFT and RIGHT Cursor keys, although you cannot skip to the beginning or end of a recording using these keys.*

***NOTE:** Sonar chart speed is increased during Fast Forward and reversed during Rewind. This may result in a reduced quality sonar image, since at higher speeds, not every sonar return can be processed.*

▣ Stop Playback



## Stop Playback

*(optional-purchase SD Card only)*

---

**Settings:** Press the RIGHT Cursor key to activate.

**Stop Playback** allows you to stop playback of a sonar recording from any view. This menu option is only available when an optional-purchase SD card is installed and Recording Playback is active.

***NOTE:** During playback, the amount of time/memory left to play is indicated by the status bar. For more information, see **Views: Snapshot and Recording View**.*

Alarms	
Alarm Volume	5
Depth Alarm	Off
Fish ID Alarm	0
Low Battery Alarm	Off
Aux. Temp. Alarm	Off
Temp. Alarm	Off
Off Course Alarm	328ft
Arrival Alarm	164ft
Drift Alarm	Off

Alarms Menu

## Alarms Menu Tab

From any view, press the MENU key twice to access the Main Menu System. The Alarms tab will be the default selection.

*NOTE: When an alarm is triggered, you can silence it by pressing any key. The alarm will be silenced, and will not be triggered again until a new instance of the alarm condition is detected.*

**Alarm Volume** 5  
 1  10

## Alarm Volume

Settings: Mute, 1 - 10; Default = 5

Alarm Volume allows you to adjust the volume of the alarms.

**Depth Alarm** Off  
 Off  100

## Depth Alarm

Settings: OFF, 1 to 100 feet, or 0.5 to 30 meters [International Models only]; Default = OFF

Depth Alarm sounds when the depth becomes equal to or less than the menu setting.

**Fish ID Alarm**  

## Fish ID Alarm

Settings: Off, All, Large/Medium, Large; Default = Off

Fish ID Alarm sounds when the Fishfinder detects fish that correspond to the alarm setting. Fish ID Alarm will only sound if Fish ID+™ is on.

For example, if you've set the Fish ID Alarm to sound for Large fish only, the Fish ID alarm will sound when a large-sized fish is detected.

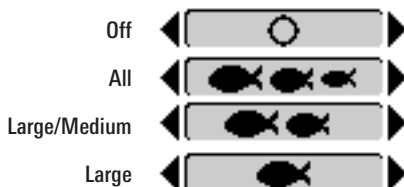

Low Battery Alarm	Off
Off	13.5

## Low Battery Alarm

Settings: Off, 8.5V - 13.5V; Default = Off

**Low Battery Alarm** sounds when the input battery voltage is equal to or less than the menu setting. The battery alarm will only sound for the battery that is connected to the Fishfinder. The Low Battery Alarm should be set to warn you when the battery voltage drops below the safety margin that you have determined.

The Fishing System will detect when the connected battery voltage is too low or too high, and it will display Input Voltage Low or Input Voltage High messages if these limits are exceeded. If you turn on the Low Battery Alarm using the Alarms Main Menu, the unit will use your settings. If you do not turn on the Low Battery Alarm, the unit will use the following limits: 7.5 to 7.9 VDC (low) and 21 to 21.2 VDC (high).

For example, if you are running a trolling motor (battery operated), you would want to set the Low Battery Alarm to sound before the battery voltage drops too low for it to be used to start your main, gasoline-powered engine.

Aux. Temp. Alarm	Off
Off	120

## Aux. Temp Alarm

(with optional-purchase Temp. probe or Temp/Speed only)

Settings: Off, 33-120 [Fahrenheit], 0-50 [Celsius], Default = Off

**Aux Temp Alarm** sounds when the water temperature from the Paddlewheel/Temperature Probe detected by the Fishing System reaches the Aux Temp Alarm setting, which is set in degrees Fahrenheit or Celsius [*International Models only*].

For example, if the Aux Temp Alarm is set to 58 degrees Fahrenheit, and the water temperature falls from 60 degrees to 58 degrees, the Aux Temp Alarm will sound. Similarly, if the water temperature rises from 56 degrees to 58 degrees, the Temp Alarm will also sound.

Temp. Alarm	Off
Off	120

## Temp. Alarm

Settings: Off, 33-120 Fahrenheit, 0-50 Celsius [*International Models only*]; Default = Off

**Temp. Alarm** sounds when the water temperature detected by the Fishfinder reaches the Temp. Alarm setting, which is either set in degrees Fahrenheit or Celsius [*International Models only*].

For example, if the Temp. Alarm is set to 58 degrees Fahrenheit, and the water temperature falls from 60 degrees to 58 degrees, the Temp. Alarm will sound. Similarly, if the water temperature rises from 56 degrees to 58 degrees, the Temp. Alarm will also sound.





<b>Drift Alarm</b>	<b>Off</b>
Off	3000

## Drift Alarm

Settings: Off, 25 to 3000 ft, 10 to 1000 m [International Models only];  
Default = Off

**Drift Alarm** allows you to set the size of a perimeter around the boat's anchored position. If the anchored boat drifts outside of that perimeter, the Drift Alarm will sound.

### Drift Alarm

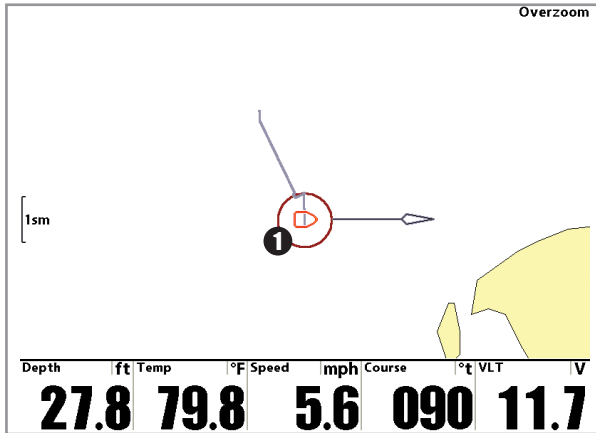

① Drift Alarm Circle

Sonar	
Beam Select	83kHz
Side View Frequency	455kHz
Surface Clutter	5
SwitchFire	Clear Mode
Fish ID +	Off
Fish ID Sensitivity	5
RTS Window	Narrow
Sonar Colors	Original Palette
Bottom View	Structure ID
Zoom Width	Narrow
83kHz Sensitivity	0
455kHz Sensitivity	0
Depth Lines	On
SI Range Lines	Off
Noise Filter	Off
Max Depth	Auto
Water Type	Fresh
Transducer Select	Hi-Def Sidescan
Color Bar	On
Temperature Graph	Off
Down Imaging Beam Width	Wide
Contour Mode	Off

Sonar Menu (Advanced)

## Sonar Menu Tab

Press the MENU key twice to access the Main Menu and then press the RIGHT Cursor key until the Sonar tab is selected.

*NOTE: Menu options can be expanded or simplified by setting the User Mode to Advanced or Normal. See **Main Menu: User Mode** for details.*

*NOTE: The Sonar Menu Tab will change to display menu options that correspond with the selected transducer (see **Transducer Select**).*

**Beam Select**

200kHz

**Beam Select****Settings: 200/83 kHz, 200 kHz, 83 kHz, Default = 200 kHz**

**Beam Select** sets which sonar returns from the DualBeam PLUS™ transducer will be displayed on the screen.

When set to **200/83 kHz**, the returns from both beams are blended. The Split Sonar View continues to display the sonar returns from each beam in their respective windows. The blended information is shown in the Sonar View. The RTS® Window in the Sonar View will only show the returns from the 200 kHz narrow beam.

When set to **200 kHz**, only the returns from the 200 kHz narrow beam will be displayed in the Sonar View. The Split Sonar View will continue to display returns from both beams in their respective windows. The RTS® Window in the Sonar View will display the returns from the 200 kHz narrow beam.

When set to **83 kHz**, the returns from the 83 kHz wide beam will be displayed in the Sonar View. The Split Sonar View will continue to display returns from both beams in their respective windows. The RTS® Window will display the returns from the 83 kHz wide beam.

**Side View Frequency**

455kHz

**Side View Frequency***(Side Imaging® and Down Imaging™ Views only [1198c SI])***Settings: 800 kHz or 455 kHz; Default = 455 kHz**

**Side View Frequency** allows you to select which frequency to apply to the Side Imaging® beams (800 kHz or 455 kHz).

Surface Clutter 5

1  10

## Surface Clutter

Settings: Low = 1 to High = 10; Default = 5

**Surface Clutter** adjusts the filter that removes surface clutter noise caused by algae and aeration. The lower the setting, the less surface clutter will be displayed.

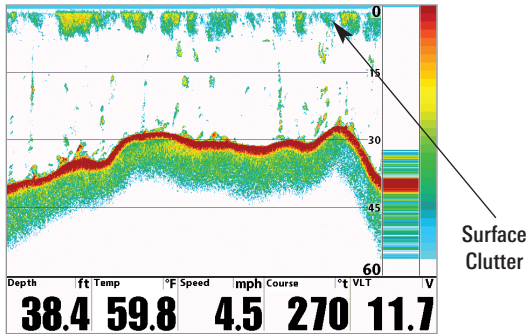

SwitchFire

◀ Clear Mode ▶

## SwitchFire™

Settings: Clear Mode, Max Mode; Default = Clear Mode

**SwitchFire™** controls how the sonar returns are displayed in the Sonar Views.

Choose **Max Mode** to see only raw sonar returns on the display. When Max Mode is selected, you will see the maximum sonar information available within the transducer beam, so more fish arches and better jig tracking are shown.

Choose **Clear Mode** to see less clutter and more fish size accuracy on the display. When Clear Mode is selected, the clutter is filtered, and sonar returns are interpreted to provide more details about the objects within the transducer beam, regardless of their location. In other words, a large arch on the display means a large fish has been detected.

Fish ID +



## Fish ID+™

Settings: Off, On; Default = Off

Fish ID+™ uses advanced signal processing to interpret sonar returns and will display a Fish Symbol when very selective requirements are met. When a fish is detected, a fish icon and its depth are displayed above the return that has been classified as being a fish. Three different fish size icons represent the intensity of the sonar return and provide an indicator of relative fish size.

DualBeam PLUS™ sonar models represent targets detected in the 200 kHz narrow beam as Orange Fish Symbols and targets detected in the 83 kHz wide beam as Blue Fish Symbols.



200 kHz, narrow beam  
orange fish symbols



83 kHz, wide beam  
blue fish symbols

When Fish ID+™ is turned off, the Fishfinder shows only the raw sonar returns on the display. These returns will often result in “arches” forming on the display, indicating potential targets. Due to the transducer beam angle, the distance to a fish decreases as the fish moves into the beam, and then increases as it moves out again, creating a Fish Arch when this distance change is shown on the display. Boat speed, chart speed, and the position of the fish within the sonar beam greatly affect the shape of the arch.

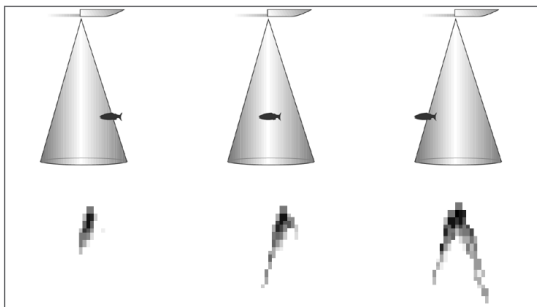

Transducer Cone and Fish Arches

Fish ID Sensitivity



## Fish ID Sensitivity

Settings: Low = 1, High = 10; Default = 5

Fish ID Sensitivity adjusts the threshold of the Fish ID+™ detection algorithms. Selecting a higher setting allows weaker returns to be displayed as fish. This is useful for identifying smaller fish species or baitfish. Selecting a lower setting displays fewer fish from weak sonar returns. This is helpful when seeking larger species of fish.

Fish ID Sensitivity is used in conjunction with Fish ID+™. Fish ID+™ must be On for Fish ID Sensitivity to affect the ability of the Fishfinder to identify sonar returns as fish.

## RTS Window

◀ Narrow ▶

# Real Time Sonar (RTS™) Window

Settings: Wide, Narrow, Off; Default = Narrow

RTS Window™ sets the RTS Window™ to Wide or Narrow, or turns it off in the Sonar View. The RTS Window™ always updates at the fastest rate possible and only displays returns that are within the transducer beam. See *What's on the Sonar Display* for more information.

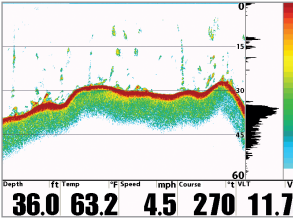

RTS® Window (Wide)

*NOTE: The Wide RTS Window™ does not use grayscale.*

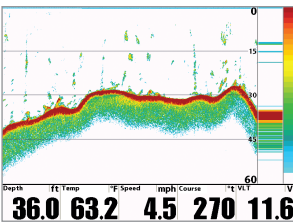

RTS® Window (Narrow)

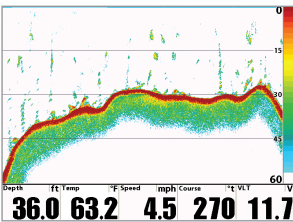

RTS® Window (Off)

 **Sonar Colors** Standard

## Sonar Colors

Settings: Gray, Green, Inverse, Original Palette, Palette 1, Palette 2, Palette 3; Default = Original Palette

**Sonar Colors** allows you to select which color palette you would like to use for the display. The palette you choose will be applied to the Sonar Views.

- **Gray:** Light Gray (weak) to Black (strong)
- **Green:** Dark Green (weak) to Light Green (strong)
- **Inverse:** Black (weak) to White (strong)
- **Original Palette:** Cyan (weak) to Red (strong)
- **Palette 1:** Navy Blue (weak), Purple (medium), Yellow (strong)
- **Palette 2:** Navy Blue (weak), Green (medium), Yellow (strong)
- **Palette 3:** Navy Blue (weak) to Red (strong)

 **Bottom View** Structure ID

## Bottom View

Settings: Structure ID, WhiteLine; Default = Structure ID

**Bottom View** selects the method used to represent bottom and structure on the display. See *What's on the Sonar Display: Sonar Bottom Presentation* for more information.

 **Zoom Width** Narrow

## Zoom Width

(Sonar Zoom View only)

Settings: Narrow, Medium, Wide; Default = Wide

**Zoom Width** adjusts the width of the zoomed view on the Sonar Zoom View, which is on the left side of the display. See *Views: Sonar Zoom View* for more information.

 **83kHz Sensitivity** -10  10

## 83 kHz Sensitivity

(Advanced)

Settings: -10 to +10, Default = 0

**83 kHz Sensitivity** changes the sensitivity of the 83 kHz beam. Increasing the 83 kHz Sensitivity will display additional weak returns, and decreasing the 83 kHz Sensitivity will display fewer weak returns.

*NOTE: 83 kHz Sensitivity is particularly useful for adjusting the sensitivity of the 83 kHz sonar returns in the 200/83kHz Split Sonar View. The 83kHz sensitivity can be adjusted without affecting the sensitivity of the 200 kHz returns shown in the 200 kHz sonar window.*



455kHz Sensitivity 0  
-10 10

## 455 kHz Sensitivity

(Advanced, with optional purchase QuadraBeam PLUS™ transducer)

Settings: -10 to +10, Default = 0

**455 kHz Sensitivity** adjusts the sensitivity of the 455 kHz beam. Increase the sensitivity to display additional weak returns and decrease the sensitivity to display fewer weak returns.

***NOTE:** 455 kHz Sensitivity is particularly useful for adjusting the sensitivity of the 455 kHz sonar returns in the Side Beam View. The 455 kHz sensitivity can be adjusted without affecting the sensitivity of the 200 kHz returns shown in the 200 kHz sonar window.*

A QuadraBeam PLUS™ transducer must be attached to the Fishing System. The 455 kHz Sensitivity menu option is available when Transducer Select is set to QuadraBeam (see **Sonar Menu Tab: Transducer Select**) and User Mode is set to Advanced (see **Setup Menu Tab: User Mode**).

***NOTE:** Visit our Web site at [humminbird.com](http://humminbird.com) to order this accessory online or contact our Customer Resource Center at 1-800-633-1468.*

Depth Lines  
On

## Depth Lines

(Advanced)

Settings: Off, On; Default = On

**Depth Lines** divide the display into four equal sections which are separated by three horizontal depth lines. The depth of each line is displayed along the depth scale. You can turn Depth Lines On or Off.

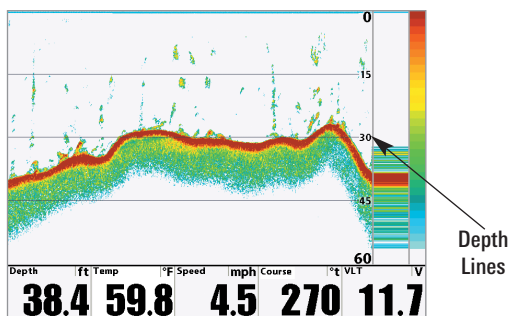

**SI Range Lines**

Off

**SI Range Lines***(Advanced, Side Imaging® View only)***Settings: On, Off; Default = Off**

**SI Range Lines** divide each side beam range into 4 equal sections on the display. SI Range Lines can be used to interpret the location of objects on the display. You can turn SI Range Lines On (visible) or Off (hidden).

*NOTE: The range numbers are estimated and should not be used for measurement.*

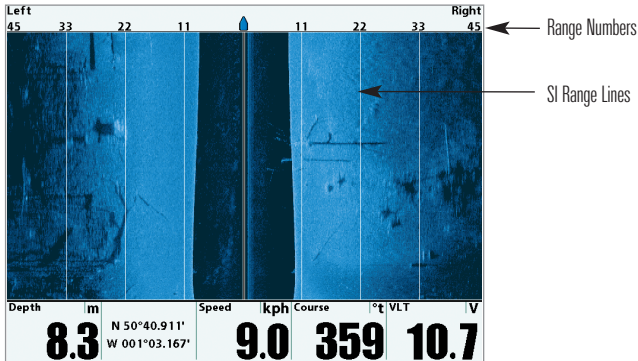
**Noise Filter**

Off

**Noise Filter***(Advanced)***Settings: Off, Low, Medium, High1, High2, High3; Default = Low**

**Noise Filter** adjusts the sonar Noise Filter to limit interference on the display from sources such as your boat engine, turbulence, or other sonar devices.

The Off setting removes all filtering. Low, Medium, and High1, High2, High3 settings add progressive filtering of the sonar returns. High1, High2, and High3 are useful when there is excessive trolling motor noise, but in some deep water situations, the High settings may actually hinder your unit's ability to find the bottom.

<b>Max Depth</b>	<b>Auto</b>
Auto	1500

## Max Depth

(Advanced)

**Settings: AUTO, 10 to 1500 feet; 3 to 500 meters [International models only], Default = AUTO**

**Max Depth** controls the maximum depth of operation. When Max Depth is set to Auto, the Fishfinder will acquire bottom readings as needed (within the capacity of the unit). When Max Depth is set to match your fishing maximum depth, your Fishfinder will not attempt to acquire sonar data below that depth, so more detail will be shown on the screen.

***NOTE:** If the bottom is deeper than the Max Depth setting, the digital depth readout will flash, indicating that the Fishfinder cannot locate the bottom.*

Max Depth controls the down beam reading. The SI Range (Side Imaging® Range) controls the side beams and down beam reading at the same time. If SI Range is set to a deeper range than the Max Depth setting, your 1198c SI Combo will default to the SI Range setting. For example, if you set the Max Depth to 50 feet and then set the SI Range to 150 feet, your unit will acquire bottom readings from 150 feet (see *Side Imaging® X-Press™ Menu: SI Range*).

<b>Water Type</b>
◀ Fresh ▶

## Water Type

(Advanced)

**Settings: Fresh, Salt (shallow), Salt (deep); Default = Fresh**

**Water Type** configures your unit for operation in fresh or salt water. In salt water, you can also choose the shallow or deep setting.

Water Type affects the accuracy of deep water depth readings. In salt water, what would be considered a large fish might be 2 to 10 times bigger than a large fish in fresh water (depending on the type of fish you are seeking). The salt water setting allows for a greater range in fish size adjustment to account for this difference.

**Transducer Select**A rectangular menu box with a black border. The text "Dual 50/200" is centered in a grey bar, with a left-pointing arrow on the left and a right-pointing arrow on the right.**Transducer Select**

---

**1198c:** Hi-Def Sidescan, Compact Sidescan, Sidescan, Quad Beam, Dual Beam, Dual 50/200, Universal Sonar 2; Default = Hi-Def Sidescan.

**1158c:** Quad Beam, Dual Beam, Dual 50/200, Universal Sonar 2; Default = Dual Beam

**Transducer Select** allows you to select which transducer you want to use. The transducer setting must correspond to the transducer type connected to your system.

- **1198c SI:** Hi-Def Sidescan is the default selection. The Compact Sidescan, Sidescan, QuadraBeam Plus™, and other transducers require a separate purchase.
- **1158c:** Dual Beam is the default selection. The QuadraBeam PLUS™, Dual 50/200 kHz and Universal Sonar 2 transducers require a separate purchase. The 1158c does not support High-Definition Sidescan, Compact Sidescan, or Sidescan transducers.

***NOTE:** To purchase transducers, visit our Web site at [humminbird.com](http://humminbird.com) or call our Customer Resource Center at 1-800-633-1468.*

**Color Bar**A rectangular menu box with a black border. The text "On" is centered in a grey bar, with a left-pointing arrow on the left and a right-pointing arrow on the right.**Color Bar**

---

**Settings:** Off, On; Default = On

**Color Bar** allows you to display or suppress the display of the color bar shown in the full screen Sonar View.

**Temperature Graph**Off**Temperature Graph***(Sonar View only, with Temperature input)***Settings: Off, On, Default = On**

---

**Temperature Graph** allows you to display or suppress a water temperature graph over the main Sonar View to show temperature changes correlated to recent sonar history.

**Down Imaging Beam Width**Wide**Down Imaging Beam Width***(Advanced)***Settings: Narrow, Medium, Wide; Default = Wide**

---

**Down Imaging Beam Width** controls the width of the beam (side to side) for the Down Imaging™ View and sets the amount of information shown on the display.

To see only the data directly under your boat, select Narrow. Medium reveals more information, while Wide displays the maximum information available from the Down Imaging™ beam width.

**Contour Mode**Off**Contour Mode***(Side Imaging® View only)***Settings: On, Off; Default = Off**

---

**Contour Mode** allows you to display or hide the water column on the Side Imaging® View. When Contour Mode is Off, the water column is displayed on the Side Imaging® View.

When Contour Mode is On, the bottom is graphed at a constant point on the display regardless of changes in depth. The Side Imaging beams are divided by a vertical line on the display.



## Navigation Menu Tab

<b>Current Track</b>
<b>Saved Tracks</b>
<b>Waypoints</b>
<b>Routes</b>
<b>Chart Orientation</b> <b>North-Up</b>
<b>North Reference</b> <b>True</b>
<b>Waypoint Decluttering</b> <b>On</b>
<b>Trolling Grid Rotation</b> <b>0°</b>
<b>Trackpoint Interval</b> <b>1 second</b>
<b>Track Min Distance</b> <b>5m</b>
<b>Track Color Range</b> <b>20m</b>
<b>Map Datum</b> <b>WGS 84 (Default)</b>
<b>Course Projection Line</b> <b>Visible</b>
<b>3D View Outline</b> <b>Visible</b>
<b>Export All Nav Data</b>
<b>Delete All Nav Data</b>
<b>Continuous Navigation Mode</b> <b>Off</b>
<b>GPS Receiver Override</b> <b>Auto</b>

Press the MENU key twice to access the Main Menu, then press the RIGHT Cursor key until the Navigation tab is selected.

*NOTE: Menu options will vary depending on system settings, such as whether you are currently navigating.*

*NOTE: Menu options can be expanded or simplified by setting the User Mode to Advanced or Normal. See **Main Menu: User Mode** for details.*

Navigation Menu (Advanced)

Current Track	Save	<b>Current Track</b> Settings: Save, Clear, Appearance
	Clear	
	Appearance	

---

**Current Track** allows you to view the Current Track submenu. See *Introduction to Navigation: Save or Clear a Current Track* for more information.

**The Current Track Submenu contains the following menu options:**

**Save** allows you to save the current track.

**Clear** allows you to delete the current track.

**Appearance** allows you to change the style and color of the current track. (Breadcrumb Trail, Dashed Line, Solid Line or Wide Line, and if a line, the color of the line, or Color By Depth).

If you choose **Color By Depth**, you cannot choose one color to represent the track; a color range will represent the different depths on the track instead, from light green (shallowest) to black (deepest). You can change the depth range associated with black by using Track Color Range menu setting (see *Navigation Menu Tab: Track Color Range*).

***NOTE:** To save the depth information with the Current Track, it is important to save the track and also edit the name before powering off the control head.*

Saved Tracks	Edit	<b>Saved Tracks</b> Settings: Edit, Delete, Default
	Delete	
	Default	

---

**Saved Tracks** allows you view the Saved Tracks submenu. See *Introduction to Navigation: Edit, Delete, or Hide Saved Tracks* for more information.

**The Saved Tracks Submenu contains the following menu options:**

**Edit** allows you to select a saved track and change its Name, Visibility (hidden or visible), Style, and Color (for track line styles only).

**Delete** allows you to delete a track from the saved tracks list.

**Default** sets the default appearance of your tracks, including Visibility (hidden or visible), Style, and Color (for track line styles only).

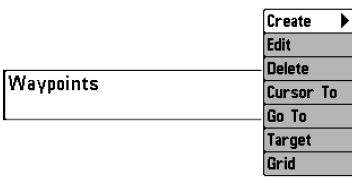

## Waypoints

Settings: Create, Edit, Delete, Cursor To, Go To, Target, Grid

**Waypoints** allows you to view the Waypoints submenu. See *Introduction to Navigation* for more information.

### The Waypoints Submenu contains the following menu options:

**Create** allows you to create a new waypoint, name it, and edit it immediately. The current boat position will be used as the default, but you can set the coordinates to any valid position. The icon used to represent the waypoint in the Chart and Combo Views can also be changed.

**Edit** allows you to choose from the saved waypoints list, and then edit the Name and Position (Latitude and Longitude), as well as assign an Icon to represent the waypoint in the Chart and Combo Views.

**Delete** allows you to delete a waypoint from the saved waypoints list.

**Cursor To** allows you to move the cursor quickly to a waypoint from the saved waypoints list.

**Go To** allows you to select a waypoint and start navigation toward that waypoint or add that waypoint to the end of the current route.

**Target** allows you to apply a target to a waypoint selected from the saved waypoints list.

**Grid** allows you to apply a trolling grid to a waypoint selected from the saved waypoints list.

***NOTE:** Only one waypoint can have either a target or a grid applied to it at one time. If you apply a target or a grid to a new waypoint, the original waypoint will lose its target or grid.*

***NOTE:** The spacing of the rings on the waypoint target and the spacing of the gridlines on the trolling grid is the same as the length of the scale bar on the left edge of the display. Zooming in or out will decrease or increase the spacing, respectively.*



Routes	Create ▶	<b>Routes</b> Settings: Create, Edit, Delete, Travel, Info
	Edit	
	Delete	
	Travel	
	Info	

**Routes** allows you to view the Routes submenu. See *Introduction to Navigation: Save, Edit, or Delete a Route* for more information.

The Routes Submenu contains the following menu options:

**Create** allows you to create a new route from an empty route, name it, and add saved waypoints to it immediately. You can also change the waypoint order of the route from this menu.

**Edit** allows you to select a saved route and change its name and the waypoints in it.

**Delete** allows you to delete a route from the saved routes list.

**Travel** allows you to choose a route from the saved routes list and use it as your current route. Routes can be traveled in either the forward or reverse direction. When you select a route, navigation begins immediately.

**Info** provides information about the route you choose from the saved routes list, including the distance and bearing from each waypoint to the next.

Chart Orientation ◀ North-Up ▶	<b>Chart Orientation</b> Settings: North-Up, Course-Up; Default = North-Up
-----------------------------------	---

**Chart Orientation** allows you to select whether the Chart and Combo Views should be drawn North-Up or Course-Up. The Chart Orientation setting does not apply to the Bird's Eye View (see *Viewing Cartography*).

North Reference ◀ True ▶	<b>North Reference</b> Settings: True, Magnetic; Default = True
-----------------------------	--

**North Reference** allows you to have bearings displayed with one of two orientations: True North or Magnetic North.

**Waypoint Decluttering****Waypoint Decluttering***(Advanced)***Settings: On, Off; Default = On**

**Waypoint Decluttering** allows you to set the declutter feature On or Off. When two or more waypoints overlap, or are displayed close together on a chart view, the screen will automatically declutter—waypoint names will shorten and the waypoint icons will change into small blue icons. Select Off to display waypoints at regular size.

**Trolling Grid Rotation**

0°

**Trolling Grid Rotation****Settings: 0° to 89°, Default = 0°**

**Trolling Grid Rotation** allows you to set the orientation of the trolling grid in degrees, where a setting of 0° displays a standard North, South, East, West alignment. See *Introduction to Navigation: Add a Waypoint Target or Trolling Grid* for information.

*NOTE: This feature may appear as either Trolling Grid Rotation or Grid Rotation, depending on your model.*

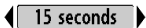
**Trackpoint Interval****Trackpoint Interval****Settings: 1 second, 5 seconds, 10 seconds, 15 seconds, 30 seconds, or 60 seconds; Default = 1 second**

**Trackpoint Interval** allows you to select the time period between trackpoints. The current track can only contain up to 20,000 trackpoints, so longer time periods cause the track to extend back further in time, but will be less detailed.

Trackpoint Interval works in conjunction with Track Min Distance. Both conditions must be met before a trackpoint is added to the current track. During slow travel or drift, setting both Trackpoint Interval and Track Min Distance to small values will allow you to increase the track resolution.

**Track Min Distance**

16ft

**Track Min Distance***(Advanced)***Settings: 1 to 300 ft, or 1 to 100 m [International Units only]; Default = 16 ft, 5 m**

**Track Min Distance** allows you to set a minimum distance of travel before a trackpoint is added to the track.

Track Min Distance works in conjunction with Trackpoint Interval. Both conditions must be met before a trackpoint is added to the current track. During slow travel or drift, setting both Trackpoint Interval and Track Min Distance to small values will allow you to increase the track resolution.

**Track Color Range**

50 | 3000

**Track Color Range****Settings: 50 to 3000\* feet or 20 to 1000 meters [International Units only], Default = 50 ft, 20 m**

**Track Color Range** allows you to set the depth range that will be displayed as black, the deepest depth, when Color By Depth is selected as the style for the current track (see *Navigation Menu Tab: Current Track*).

*\*NOTE: Only an optional-purchase transducer with a 50 kHz frequency will allow you to track to 3000 feet.*

**Map Datum**

◀ WGS 84 (Default) ▶

**Map Datum***(Advanced)***Settings: Various, Default = WGS 84**

**Map Datum** allows you to change the map coordinate system used by the Fishfinder to match those of a paper map.

**Course Projection Line**

◀ Visible ▶

**Course Projection Line****Settings: Hidden, Visible; Default = Visible**

**Course Projection Line** allows you to display or hide an arrow extending from the bow of the boat that projects your current course, and shows where the boat will go if you continue on your present course.

**3D View Outline**

◀ Visible ▶

**3D View Outline****Settings: Hidden, Visible, Default = Visible**

**3D View Outline** allows you to display or hide an outline on the Chart side of the Chart or Bird's Eye Combo Views that shows what you're viewing on the Bird's Eye side of the view.

**Export All Nav Data****Export All Nav Data****Settings: Press the RIGHT Cursor key and follow screen instructions.**

**Export All Nav Data** allows you to export all saved Tracks, Waypoints, and Routes to an SD card. If an MMC card isn't installed, an error message will be displayed. Insert the MMC card and try again. See *SD Memory Card Slots* for more information.

**Delete All Nav Data****Delete All Nav Data***(Advanced)***Settings: Press the RIGHT Cursor key and follow screen instructions.**

This menu option should be used with caution!

**Delete All Nav Data** allows you to delete all saved Tracks, Waypoints, and Routes.

**Continuous Navigation Mode**Off**Continuous Navigation Mode**

---

Settings: Off, On, Default = Off

**Continuous Navigation Mode** allows you to continue to navigate and fish around a particular waypoint, even if you pass over it multiple times.

**GPS Receiver Override**Auto**GPS Receiver Override**

---

*(Advanced)*

Settings: Internal, External, Auto; Default = Auto

**GPS Receiver Override** allows you to set which GPS receiver to use if you have multiple GPS receivers plugged into the system. These multiple GPS receivers may be internal, external, or connected via the InterLink™. If you select Auto, your unit will select a GPS receiver automatically.

***NOTE:** If only one GPS receiver is plugged into your system, then Auto will be the only option shown.*

Chart Menu Tab	
Lat/Lon Grid	Hidden
Nav aids on Bird's Eye View	Visible
Chart Select	Auto
Set Simulation Position	
Set Map Offset	
Clear Map Offset	
Shaded Depth	5m
Chart Detail Level	All
Map Borders	MMC/SD Only
Spot Soundings	Hidden
NVB Chart Preference	Auto
Contour Lines	Visible
Depth Colors	Shaded
Depth Highlight	Off
Depth Highlight Range (+/-)	5ft
Water Level Offset	0
Shallow Water Highlight	0
Lake List	

Chart Menu, Advanced  
 (shown with optional Navionics®  
 and LakeMaster® menu options)

## Chart Menu Tab

Press the MENU key twice to access the Main Menu and then press the RIGHT Cursor key until the Chart tab is selected.

**NOTE:** Menu options can be expanded or simplified by setting the User Mode to Advanced or Normal. See **Main Menu: User Mode** for details.

**NOTE:** When a map from an optional-purchase SD card is installed, the Chart Menu Tab will change to display menu options that correspond with the active chart. To manually select a chart card, see **Chart Select**. Also, see **Add Maps to the Fishing System** for more information.

Lat/Lon Grid
◀ Hidden ▶

## Lat/Lon Grid

Settings: Hidden, Visible, Default = Hidden

Lat/Lon Grid allows you to display or hide a grid showing latitude and longitude lines.

Nav aids on Bird's Eye View
◀ Hidden ▶

## Nav aids on Bird's Eye View

Settings: Hidden, Visible, Default = Visible

Nav aids on Bird's Eye View allows you to display or hide additional navigational aids in Bird's Eye View, such as lights and buoys.

*NOTE: You will see more navigational aids with an optional-purchase SD card.*

Chart Select
◀ Auto ▶

## Chart Select

Settings: Auto, Contour XD, Left Chart Card, Right Chart Card; Default = Auto

Chart Select allows you to choose which chart to use if you have built-in charts or a map card. If you select Auto, your unit will select a chart automatically. Select Right to use the SD card installed in the right card slot, and select Left to use the SD card installed in the left card slot (see *SD Memory Card Slots: Add Maps to Your Fishing System*).

*NOTE: The SD Cards require a separate purchase. For more information, visit our Web site at [humminbird.com](http://humminbird.com) or contact our Customer Resource Center at 1-800-633-1468.*

Set Simulation Position
▶

## Set Simulation Position

(Advanced)

Settings: Press the RIGHT Cursor key and follow screen instructions to activate.

Set Simulation Position allows you to set the position of the boat used in the Simulator. Press any arrow on the 4-WAY Cursor Control key to activate the cursor and move it to the coordinates where you want start the simulation. Then confirm the position using the Set Simulation menu setting.

*NOTE: The cursor must be active in order for this procedure to work. If the cursor was not active before you began this procedure, an error message will appear. Exit the menu, set the cursor, then try again.*

Set Map Offset

## Set Map Offset

(Advanced)

**Settings:** Press the RIGHT Cursor key and follow screen instructions to activate.

**Set Map Offset** allows you to change the map offset used by your Fishing System. Press the 4-WAY Cursor Control key to activate the cursor and move it to the location where the Map Offset will be applied. Then, confirm the map offset position using the Set Map Offset menu setting.

The Map Offset will be applied to all maps and not just the map that requires the correction. The Map Offset should be cleared if a different map is to be used.

*NOTE: The cursor must be active in order for this procedure to work. If the cursor was not active before you began this procedure, an error message will appear. Exit the menu, set the cursor, then try again.*

Clear Map Offset

## Clear Map Offset

(Advanced)

**Settings:** Follow screen instructions to activate.

**Clear Map Offset** allows you to clear the Map Offset. The Clear Map Offset menu option is available when Map Offset is active.

Shaded Depth 16ft  
Off  60

## Shaded Depth

**Settings:** Off, 1 to 180 Feet, or 1 to 60 Meters [International Units only], Default = 15 ft, 5 m

**Shaded Depth** allows you to change the depth used for shading on the Chart Views.

Chart Detail Level  
◀ All ▶

## Chart Detail Level

(optional-purchase Navionics® charts only)

**Settings:** Basic, Navigation, Underwater, All; Default = All

**Chart Detail Level** allows you to select how much chart detail you want displayed on the Navigation Views.

*NOTE: Some chart details are only available with optional-purchase SD cards.*

**Basic** shows land areas, ports, obstructions, and restricted areas.

**Navigation** shows navaid, landmarks, ferryways, and navigation routes in addition to the Basic information.

**Underwater** shows depth contours, fishing areas, underwater wrecks, tides and currents in addition to the Basic and Navigation information.

**All** shows roads, buildings, railways, and other notations in addition to the Basic, Navigation, and Underwater information.

## Map Borders

Hidden

## Map Borders

Settings: Hidden, MMC/SD Only, All Visible; Default = MMC/SD Only

Map Borders allows you to display or hide map borders. The dotted lines of a Map Border indicate an area which contains a different map. Use the 4-WAY Cursor Control key to move the active cursor within a map border, and press the ZOOM + key to view the different map.

### Map Borders, shown with optional-purchase Navionics® Cartography

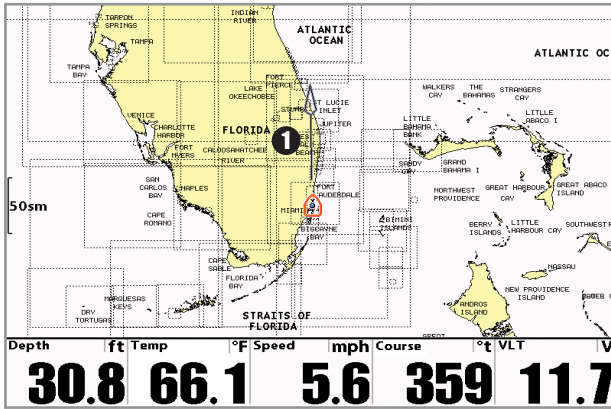

1 Map Borders

## Spot Soundings

Hidden

## Spot Soundings

(optional-purchase Navionics® charts only)

Settings: Hidden, Visible, Default = Hidden

Spot Soundings allows you to display or hide spot soundings, which are depth measurements shown on the chart.

*NOTE: Spot Soundings are only available with optional-purchase SD cards.*

## NVB Chart Preference

Auto

## NVB Chart Preference

Default = Auto

NVB Chart Preference allows you to select a built-in chart if you have an NVB (Navionics® Value Bundle) unit. If you select Auto, your NVB unit will select a chart automatically.



## Contour Lines

Visible

## Contour Lines

*(optional-purchase LakeMaster® charts only)*

Settings: Hidden, Visible; Default = Visible

**Contour Lines** sets whether the water contour lines are visible or hidden in the Chart Views. Contour Lines are also affected by the Water Level Offset setting.

## Depth Colors

Shaded

## Depth Colors

*(optional-purchase LakeMaster® charts only)*

Settings: Off, 1-10; Default = Off

**Depth Color** sets the depth shading in the Chart views to Off or Shaded.

## Depth Highlight Off

Off 180

## Depth Highlight

*(optional-purchase LakeMaster® charts only)*

Settings: Off, 1 - 180 ft, 1 - 30 fathoms, 1 - 60 m (International Models only); Default = Off

**Depth Highlight** allows you to highlight a depth setting in the chart views. The depth you set will be highlighted in green. Use Depth Highlight with Depth Highlight Range.

## Depth Highlight Range (+/-) 5ft

0 60

## Depth Highlight Range (+/-)

*(optional-purchase LakeMaster® charts only)*

Settings: 0 - 60 ft, 0 - 30 fathoms, 0 - 20 m (International Models only); Default = 5 ft, 2m

**Depth Highlight Range** adjusts the range on each side of the highlighted depth, when a Depth Highlight is active in the chart views.

For example, if you know a certain fish is holding at 18 - 20 feet, you can set the Depth Highlight at 19 feet, and the Depth Highlight Range a +/- 1 foot. The view will show a green band from 18 - 20 feet.

## Water Level Offset 0ft

-30 30

## Water Level Offset

*(optional-purchase LakeMaster® charts only)*

Settings: -30 to +30 ft, -5 to +5 fathoms, -10 to +10 m (International Models only); Default = 0

**Water Level Offset** allows you to change the level of the water being read from the control head. The displayed numbers on the Contour Lines will adjust from the Water Level Offset setting, and the water level offset will be highlighted in dark brown.

For example, if the lake is down 5 feet, set the Water Level Offset setting to -5.

**Shallow Water Highlight** 0ft  
 0  30

## Shallow Water Highlight

(optional-purchase LakeMaster® charts only)

Settings: 0 - 30 ft, 0 - 5 fathoms, 0 - 10 m (International Models only);  
 Default = 0

**Shallow Water Highlight** allows you to select a minimum shallow depth setting so that the depth is highlighted in red in the Chart Views.

For example, if your boat has a draft of 3 feet, set the Shallow Water Highlight feature to 3 feet, and the unit will draw a red band from 0 - 3 feet. Use this setting with Water Level Offset.

**Lake List**

## Lake List

(optional-purchase LakeMaster® charts only)

Settings: Press the **RIGHT** Cursor key to activate.

**Lake List** allows you to view the list of lakes included on the installed SD card.

**Sort By:** Highlight Sort By, and use the **RIGHT** or **LEFT** Cursor keys to select a sort option for the list.

**Scroll:** Use the **UP** or **DOWN** Cursor keys to scroll through the list. As each lake is highlighted, you can view information about the lake in the white box displayed on the screen.

**Cursor To:** Highlight a lake on the list and press the **RIGHT** Cursor key to move the active cursor to the location you've chosen. You can then mark waypoints, or press the **GOTO** key to start navigation toward a waypoint, or press the **INFO** key for more information.

Chart View with LakeMaster®

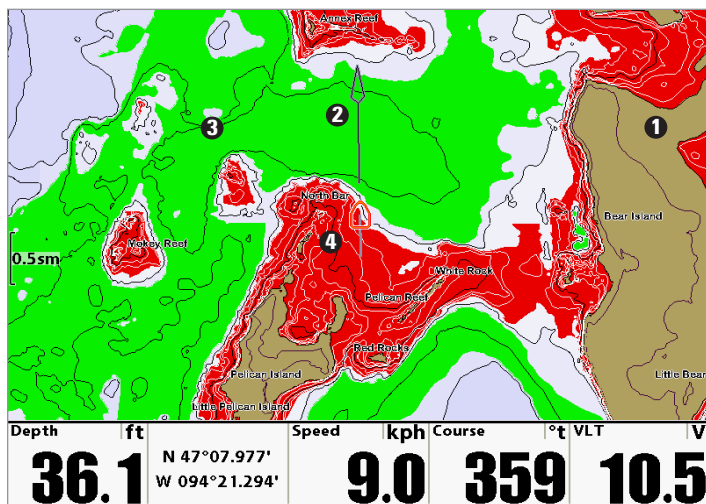

① Water Level Offset

② Depth Highlight

Contour Lines ③

Shallow Water Highlight ④

Sound Volume	5
Units - Depth	Feet
Units - Temp	°F
Units - Distance	Statute Miles
Units - Speed	mph
User Mode	Advanced
Language	English
Triplog Reset	
Restore Defaults	
Select Readouts	
Select Nav Readouts	
Depth Offset	0.0ft
Aux. Temp. Offset	0.0°
Temp. Offset	0.0°
Speed Calibration	0%
Local Time Zone	EST (UTC-5)
Daylight Saving Time	Off
Position Format	dd°mm.mmm'
Time Format	12-Hour
Date Format	mm/dd/yy
Digits Format	Small tenths
NMEA Output	Off
Sonar	On
Demonstration	Visible
Video Out	NTSC

## Setup Menu Tab

From any view, press the MENU key twice to access the tabbed Main Menu, then press the RIGHT Cursor key until the Setup tab is selected.

*NOTE: Menu options will vary depending on which accessories are attached to the unit.*

*NOTE: Menu options can be expanded or simplified by setting the User Mode to Advanced or Normal. See **Main Menu: User Mode** for details.*

## Sound Volume

## 5 Sound Volume

1  10

Settings: Mute, 1 - 10, Default = 5

**Sound Volume** allows you to control the volume of all sounds emitted by the control head (except for the volume of the alarms, which is controlled by Alarm Volume Control).

## Units - Depth

◀ Feet ▶

## Units - Depth

Settings: Domestic Models: Feet, Fathoms; International Models: Meters; Default = Feet/Meters

**Units - Depth** selects the units of measure for all depth-related readouts.

## Units - Temp

◀ °F ▶

## Units - Temp

*(International only)*

Settings: Celsius, Fahrenheit; Default = Celsius

**Units - Temp** selects the units of measure for all temperature-related readouts. *International Models only.*

## Units - Distance

◀ Feet/Statute Miles ▶

## Units - Distance

*(with Speed input only)*

Settings: Domestic Models: Statute Miles, Nautical Miles, Default = Statute Miles; International Models: Meters/Kilometers, Meters/Nautical Miles, Feet/Statute Miles, Feet/Nautical Miles, Default = Meters/Kilometers

**Units - Distance** selects the units of measure for all distance-related readouts, and will appear in the menu if a Temp/Speed Accessory is connected and the paddlewheel has moved at least once, or if the GPS Receiver is connected.

## Units - Speed

◀ mph ▶

## Units - Speed

*(with Speed input only)*

Settings: Domestic Models: mph, kts; International Models: kph; Default = mph/kph

**Units - Speed** selects the units of measure for speed-related readouts, and will appear in the menu if a Temp/Speed Accessory is connected and the paddlewheel has moved at least once, or if the GPS Receiver is connected.

**User Mode**

◀ Advanced ▶

**User Mode****Settings: Normal, Advanced; Default = Advanced**

**User Mode** sets the menu system to Normal or Advanced. When set to Normal, the basic set of menu options are shown in the menu system. When set to Advanced (default setting), additional menu options are added to the menu system. See *Main Menu: User Mode* for details.

**Language**

◀ English ▶

**Language***(International only)***Settings: Various, Default = English**

**Language** selects the display language for menus. *International Models only.*

**Triplog Reset****Triplog Reset***(with Speed input only)***Settings: Press the RIGHT Cursor key and follow screen instructions to activate.**

**Triplog Reset** resets the Triplog to zero. The Triplog provides the following information: timer for elapsed time, distance traveled since last reset, and average speed.

**Restore Defaults****Restore Defaults****Settings: Press the RIGHT Cursor key and follow screen instructions to activate.**

**Use this menu choice with caution!**

**Restore Defaults** resets ALL menu settings to their factory defaults.

## Select Readouts

*(Advanced, Non-navigation Mode)*

Select Readouts
<b>Readout 1</b>
◀ Depth ▶
<b>Readout 2</b>
Triplog
<b>Readout 3</b>
WeatherSense
<b>Readout 4</b>
Temperature
<b>Readout 5</b>
Speed

Select Readouts

**Select Readouts** sets individual digital readouts on all the views that can display readouts. This feature allows you to select what information will be displayed in each of a variable number of fixed-position readouts arranged at the bottom of the screen. To leave the data window blank, select Off. See *Views* to change the Select Readouts.

- Data windows can display readouts from supported accessories such as a Speed accessory.
- All views share the same set of 5 readouts that can be set one way for navigation mode using Select Nav Readouts and another way for non-navigation mode using Select Readouts. Non-navigation readouts are automatically replaced on the display when navigating. However, Navigating readouts can have any type of information in them allowing you to see navigation or standard information while navigating. To set Navigation readouts, see *Select Nav Readouts*.

**NOTE:** The availability of the digital readout information corresponds with the view selected, the accessory attached, and whether or not you are navigating.

Each readout position can be empty or contain one of the following:

## 5 Selectable Readouts; Non-Navigation Mode

<b>Aux. Temp</b>	The current detected water temperature from an optional-purchase Temperature Probe or Temp/Speed accessory.
<b>Course</b>	Course is the current direction the boat is traveling measured in degrees from North (i.e. 321°, where 000° is North, 090° East, 180° is South, 270° is West). When the Course Over Ground is equal to Bearing, the boat is said to be "On Course" and will arrive at the destination in the most efficient manner. See the Glossary for more information.
<b>Depth</b>	Displays the depth of the water.
<b>Off</b>	Suppresses the readout so that no data shows in that position.
<b>Position</b>	Position is the current location (latitude, longitude) determined by GPS.
<b>Speed</b>	Speed is the measurement of the boat's progress across a given distance, and is the speed measurement provided by GPS; accurate destination times can be derived from this measurement. See the Glossary for more information.
<b>Speed N Temp 1</b>	Displays the water temperature and current speed measured at the depth of the downrigger when using an optional-purchase Speed-n-Temp sensor with a downrigger and the CannonLink™ accessory.
<b>Temp</b>	The current detected water temperature from an optional-purchase Temperature Probe or Temp/Speed accessory.
<b>Time</b>	The current time.
<b>Time + Date</b>	The current time and date.
<b>Triplog</b>	Displays the triplog, which measures the elapsed time since last reset, the distance traveled since last reset, and average speed during timed interval.
<b>Voltage</b>	Power supplied to the control head.
<b>Water Speed</b>	The current speed of the water as it flows past the boat.

**NOTE:** You can set a second set of 5 readouts with navigation mode settings as well, so that, when you are navigating, these views contain navigation data instead of the regular settings. See **Setup Menu Tab: Select Nav Readouts** for more information.

**NOTE:** Some readout boxes are limited to display non-navigation information only.

Default Sonar View

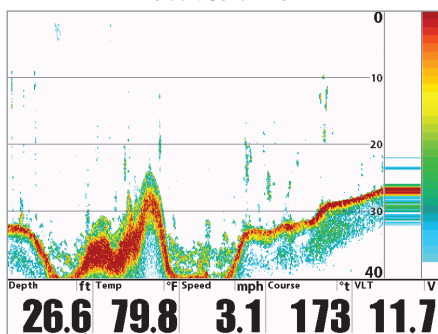

Digital Readouts

Custom Sonar View

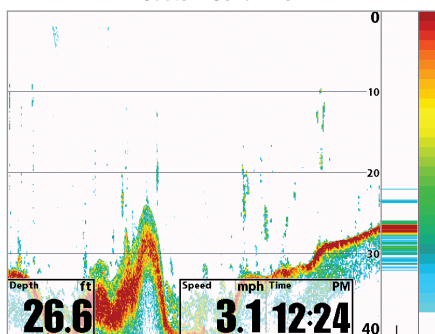

Digital Readouts

Readout Off

**NOTE:** When the readout under the water column is turned off (as shown in the illustration), the sonar display will expand to fill the screen.

**Select Nav Readouts** sets the individual digital readouts that will be used only during navigation. This feature allows you to select what information will be displayed in each of a variable number of fixed-position readouts arranged at the bottom of the screen on various views. To leave the data window blank, select Off. See **Views** to change the Select Nav Readouts.

- Readout positions can also display information from supported accessories such as Temp/Speed.
- All views share the same set of 5 readouts that can be set one way for navigation mode using Select Nav Readouts and another way for non-navigation mode using Select Readouts. Non-navigation readouts are automatically replaced on the display when navigating. However, Navigating readouts can have any type of information in them allowing you to see navigation or standard information while navigating. To set Non-Navigation readouts, see **Setup Menu Tab: Select Readouts**.

**NOTE:** *The availability of the digital readout information corresponds with the view selected, the accessory attached, and whether or not you are navigating.*



Each readout position can either be empty or contain one of the items from the following table:

## 5 Selectable Readouts; Navigation Mode

<b>Bearing</b>	Bearing is the direction to a destination waypoint measured in degrees from North (i.e. 321°, where 000° is North, 090° East, 180° is South, 270° is West).
<b>CMG/SMG</b>	Course Made Good/Speed Made Good. Course Made Good is the angle between the starting point on a route and the current position of the boat. The goal is to have CMG and Track equal to the same number. See the Course Made Good illustration. Speed Made Good is the distance from the starting waypoint on the route divided by the time elapsed since starting navigation on the route.
<b>Course</b>	Course is the current direction the boat is traveling measured in degrees from North (i.e. 321°, where 000° is North, 090° East, 180° is South, 270° is West). When the Course Over Ground is equal to Bearing, the boat is said to be "On Course" and will arrive at the destination in the most efficient manner. See the Glossary for more information.
<b>Depth</b>	Displays the depth of the water.
<b>Off</b>	Suppresses the readout so that no data shows in that position.
<b>Position</b>	Position is the current location (latitude, longitude) determined by GPS.
<b>Speed</b>	Speed is the measurement of the boat's progress across a given distance; the speed measurement provided by GPS; accurate destination times can be derived from this measurement. See the Glossary for more information.
<b>Speed N Temp 1</b>	Displays the water temperature and current speed measured at the depth of the downrigger when using an optional-purchase Speed-n-Temp sensor with a downrigger and the CannonLink™ accessory.
<b>TRK/CMG</b>	Track/Course Made Good. The Track Line is the desired line of travel between two waypoints, and represents the most efficient path between the two points because it is a straight line. The TRK is measured in degrees. See above for an explanation of Course Made Good.
<b>Temp</b>	The current detected water temperature.
<b>Aux. Temp</b>	The current detected water temperature from an optional-purchase Temperature Probe or Temp/Speed accessory.
<b>Time</b>	The current time.
<b>Time + Date</b>	The current time and date.
<b>Triplog</b>	Displays the triplog, which measures the elapsed time since last reset, the distance traveled since last reset, and average speed during timed interval.
<b>VMG</b>	Velocity Made Good. Velocity Made Good is the speed of travel relative to the next waypoint on the route. The goal is for VMG to equal Speed.
<b>Voltage</b>	Power supplied to the control head.
<b>WPTend/ETA/DTG</b>	Waypoint End/Estimated Time of Arrival/Distance to Go. Waypoint End is the last waypoint on the route. Estimated Time of Arrival is the estimated time of arrival to the last waypoint on the route. Distance To Go is the distance between the current position of the boat and the last waypoint on the route.
<b>WPTend/TTG/DTG</b>	Waypoint End/Time To Go/Distance to Go. Waypoint End is the last waypoint on the route. Time To Go is the estimated time required to reach the last waypoint on the route. TTG is calculated using the SOG and DTG. Distance To Go is the distance between the current position of the boat and the last waypoint on the route.
<b>WPTnext/ETA/DTG</b>	Waypoint Next/Estimated Time of Arrival/Distance to Go. Waypoint Next is the next waypoint on the route. Estimated Time of Arrival is the estimated time of arrival to the next waypoint on the route. Distance To Go is the distance between the current position of the boat and the next waypoint on the route.
<b>WPTnext/TTG/DTG</b>	Waypoint Next/Time To Go/Distance to Go. Waypoint Next is the next waypoint on the route. Time To Go is the estimated time required to reach the next waypoint on the route. TTG is calculated using the SOG and DTG. Distance To Go is the distance between the current position of the boat and the next waypoint on the route.
<b>Water Speed</b>	The current speed of the water as it flows past the boat.
<b>XTE</b>	Cross Track Error is the straight-line distance of the boat from the intended Track. XTE measures how far the boat is off course, and also triggers the Off Course Alarm.

<b>Depth Offset</b>	0.0ft
-10.0	10.0

## Depth Offset

(Advanced)

Settings: -10.0 to +10.0 feet or -3 to 3 meters [International models only], Default = 0.0, or Off

**Depth Offset** will adjust the digital depth readout to indicate depth from the waterline or boats keel. Enter a positive vertical measurement from the transducer to the waterline to read the depth from the waterline. Enter a negative vertical measurement from the transducer to keel to read the depth from the keel.

<b>Aux. Temp. Offset</b>	0.0°
-10.0	10.0

## Aux. Temp Offset

(Advanced)

Settings: -10.0 to +10.0 degrees, Default = 0

**Aux Temp Offset** will adjust the aux temperature readout (the temperature on the optional-purchase temperature probe or Temp/Speed accessory) by the amount entered.

<b>Temp. Offset</b>	0.0°
-10.0	10.0

## Temp. Offset

(Advanced)

Settings: -10.0 to +10.0 degrees, Default = 0, or Off

**Temp Offset** will adjust the temperature readout by the amount entered.

<b>Speed Calibration</b>	0%
-20	20

## Speed Calibration

(Advanced, with Speed paddlewheel only)

Settings: -20% to +20%, Default = 0%

**Speed Calibration** will adjust the speed readout by the percentage entered, and will appear in the menu if a Speed accessory is connected and the paddlewheel has moved at least once.

<b>Local Time Zone</b>
◀ EST (UTC-5) ▶

## Local Time Zone

(Advanced)

Settings: Various; Default = EST [UTC-5] - Eastern Standard Time

**Local Time Zone** selects your time zone in reference to the time reported by the GPS receiver when Time+Date is selected as a Digital Readout (see *Setup Menu Tab: Select Readouts*).

<b>Daylight Saving Time</b>
◀ Off ▶

## Daylight Saving Time

(Advanced)

Settings: Off, On; Default = Off

**Daylight Saving Time** adjusts the time display to account for local Daylight Saving Time when Time+Date is selected as a Digital Readout (see *Setup Menu Tab: Select Readouts*).

Selecting On adds one hour to the time display adjusted for your local time zone. Selecting Off leaves the time display as adjusted for your local time zone.

**Position Format****Position Format***(Advanced)*

Settings: dd.ddddd°, dd°mm.mmm', or dd°mm'ss"; Default = dd°mm.mmm'

**Position Format** selects the format of the latitude and longitude position display.

**Time Format****Time Format***(Advanced, International only)*

Settings: 12 hour, 24 hour; Default = 12 hour

**Time Format** changes the time format used by the unit. Time Format selects a 12 hour or 24 hour format for the time of day displayed when Time + Date is selected as a Digital Readout (see *Setup Menu Tab: Select Readouts*).

**Date Format****Date Format***(Advanced, International only)*

Settings: mm/dd/yy, dd.mm.yy, yy.mm.dd; Default = mm/dd/yy

**Date Format** changes the date format used by the unit. Date Format selects the format for the date display when Time + Date is selected as a Digital Readout (see *Setup Menu Tab: Select Readouts*).

**Digits Format****Digits Format***(Advanced)*

Settings: Small tenths, Large tenths, No tenths, Default = Small tenths

**Digits Format** adds a tenth decimal place to readouts such as Temperature and Depth. The format can be changed to small format, large format or no format.

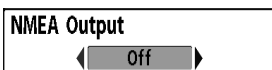

## NMEA Output

(Advanced)

Settings: Off, On; Default = Off

---

**NMEA Output** turns the NMEA\* output on or off. NMEA Output should be turned On if you connect the NMEA Output wires of the GPS Receiver cable to another NMEA-compatible device, such as an autopilot.

*\*NMEA 0183 is a National Marine Electronics Association standard for data communication.*

### The following NMEA sentences are output:

DPT - Depth  
MTW - Water Temperature  
GLL - Lat/Lon Position  
GGA - GPS Fix Data  
RMC - Recommended Minimum Specific GNSS Data  
VTG - Course Over Ground and Ground Speed  
ZDA - Time and Date

### When navigating, the following NMEA sentences are also output:

APB - Autopilot Sentence B  
BWR - Bearing and Distance to Waypoint  
RMB - Recommended Minimum Navigation Info

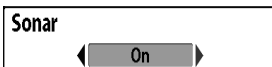

## Sonar

Settings: Off, On, Default = On

---

**Sonar** deactivates Sonar and removes the Sonar Views from the view rotation.

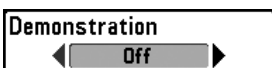

## Demonstration

Settings: Off, Visible; Default = Visible

---

**Demonstration** controls whether the Demonstration Mode is visible or off. The Demonstration Mode appears on the screen if you don't press any keys during the warning screen at power up. Menu settings cannot be saved in Demonstration (see *Power On the Control Head* and *Start-Up Options Menu*).

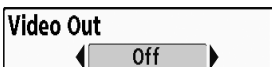

## Video Out

Settings: Domestic Models: NTSC, Off; International Models: NTSC, PAL, PAL M, Off; Default = Off

---

**Video Out** allows you to set the video format that will be sent to your remote monitor.

Views	
Bird's Eye View	Visible
Chart/Bird's Eye Combo View	Visible
Chart/Chart Combo View	Visible
Chart View	Visible
Chart/Down Combo View	Visible
Chart/Sonar Combo View	Visible
Chart/Side Combo View	Visible
Down Imaging View	Visible
Down/Side Combo View	Visible

Views Menu

*The down arrow indicates more menu options. Press the DOWN Cursor key to scroll through the full menu list.*

## Views Menu Tab

From any view, press the MENU key twice to access the tabbed Main Menu, then press the RIGHT Cursor key until the Views tab is selected.

This menu tab allows you to set the available views to hidden or visible in the view rotation. The view will be removed from the view rotation if it is set to Hidden and will be displayed in the view rotation if it is set to Visible.

*NOTE: See **Views** for more information.*

## Accessories Menu Tab

From any view, press the MENU key twice to access the Main Menu, then press the RIGHT cursor key until the Accessories tab is selected.

Screen Snapshot will always appear under the Accessories tab. If you attach additional accessories to the control head, the menu choices that support the accessory will be added automatically. See the Operations Manual that comes with your accessory for detailed information.



Accessories Menu  
(no accessories attached)

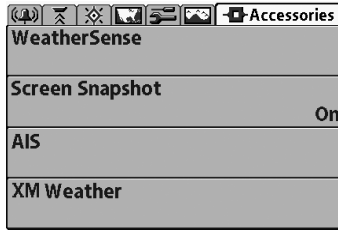

Accessories Menu  
(with accessories attached)

**NOTE:** Accessories to enable WeatherSense®, AIS, and XM WX® Weather require separate purchases. Visit our Web site at [humminbird.com](http://humminbird.com) or contact our Customer Resource Center at 1-800-633-1468 for details.

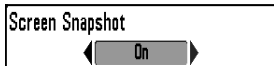

## Screen Snapshot

*(optional-purchase SD Cards only)*

**Settings: Off, On; Default = Off**

**Screen Snapshot** activates the screen snapshot function. When Screen Snapshot is enabled, pressing the MARK key creates a saved screen snapshot on the optional-purchase SD card installed in your unit's card slot. All active menus, dialog boxes, warnings and messages are captured and saved automatically.

**NOTE:** For more information, see **Snapshot and Recording View and Snapshot and Recording X-Press™ Menu**.

**NOTE:** You must have an optional-purchase SD card installed for the Screen Snapshot feature to work.

**NOTE:** If you use your SD card in two different Fishfinder units that have different screen sizes, the recordings made on one unit will still be present on the card, but they will be represented by the Unavailable icon (circle with a slanted line through it) on the Snapshot and Recording View on the other unit.



## AIS

*(optional-purchase AIS equipment only)*

**Settings: Press the RIGHT Cursor key to activate.**

Your Fishing system is compatible with AIS technology. This equipment must be purchased separately and connected properly to the control head for AIS to be activated in your Fishing System.

**When an AIS is connected to the Fishing System**, AIS will appear as a menu option in the Accessories Menu Tab. AIS allows you to locate and monitor other vessels, or Targets, within range of the VHF signal. The AIS then exchanges information with those targets, including vessel identification, position, course, and speed.

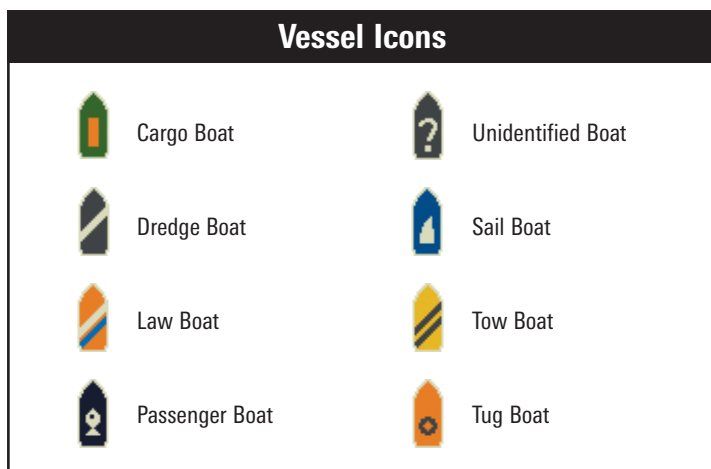

As target information is received, the information is displayed in the Chart Views. In Bird's Eye View, only the target position is displayed.

- **Vessel Icons** identify the type of target.
- **Alarm & Red Vessel Icon** identify a target that has exceeded the CPA (Closest Point of Approach) setting. The alarm sound and banner will display on the screen. Press any key to stop the alarm, but the vessel icon will continue to display as red until it is out of the CPA alarm zone.
- **Available Targets:** If the AIS has not received information from a target within 10 minutes, the target will turn gray. If information is not received after 15 minutes, the target will disappear from the view. Also, if there are several targets on the view, and a new target message is received, the oldest target will disappear from the view.
- **MMSI Tag (Maritime Mobile Service Identity)** will be displayed if it is available for each target.
- **Target Course Lines** point in the direction of a vessel's course. The length of the line can be adjusted in the Target Course Line setting in the AIS Submenu.
- **Target Details:** Information about each target can be found in the Target List in the AIS submenu. You can also use the 4-WAY Cursor Control key to move the active cursor onto a vessel icon. Press the INFO key to view available information, including target name, speed, course, latitude/longitude position, registration, call sign, and more.
- **AIS Submenu** allows you to control and view AIS information.

Chart View with AIS

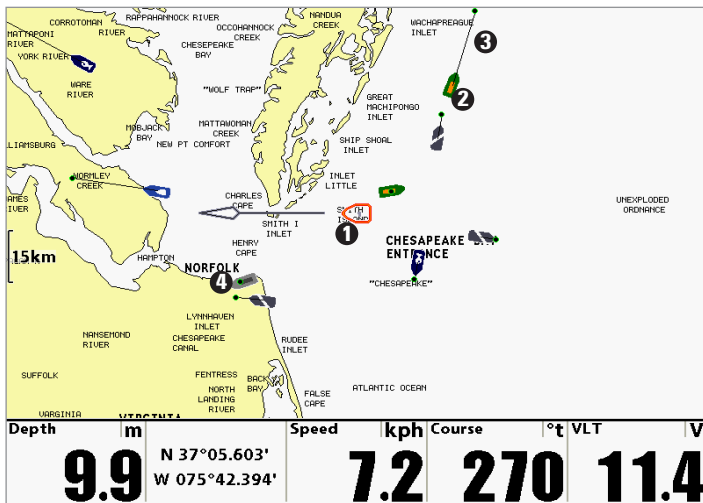

- ① Your Boat icon
- ② Target (Vessel in the area)
- ③ Target Course Line
- ④ Gray Target (information unavailable)



<b>AIS</b>	
<b>Tracking Target</b>	<b>On</b>
<b>CPA Limits</b>	
<b>Target List</b>	
<b>Target Course Line</b>	<b>60:00</b>
<b>MMSI Label</b>	<b>Visible</b>

**AIS Submenu:** The AIS submenu allows you to track targets, receive alerts when targets are within the distance you set, and display targets in Chart Views. In Bird's Eye View, only the position will be displayed.

### To change settings in the AIS Submenu:

Highlight AIS in the Accessories MENU Tab, and press the RIGHT Cursor key to access the AIS Submenu.

**Tracking Target** sets targets and related information to be visible (On) or hidden (Off) in the Chart Views. In Bird's Eye View, only target position will be displayed. (Settings: On, Off; Default = On)

**CPA (Closest Point of Approach) Limits** sets how close a vessel can approach. The amount can be set in nautical miles or time. When the vessel has traveled past the set limit, the Vessel Icon will turn red in the view and an alarm will sound. Press any key to turn off the alarm. Press the RIGHT Cursor key to open the dialog box.

CPA sets the closest point of approach, measured in nautical miles.

TCPA sets the closest point of approach, measured in time.

**Target List** shows active targets and related information that is available with each AIS update. Press the RIGHT Cursor key to open the Target List.

Sort: The list is sorted by MMSI number (if available). Targets without an MMSI will be shown at the bottom of the list.

Scroll: Use the UP or DOWN Cursor keys to scroll through the list and highlight targets. Press and hold the DOWN Cursor key to scroll through all the targets on the list quickly.

Target Highlight: Highlight a target on the Target List, and press the RIGHT Cursor key. The Target List will close and the active cursor will go to the target you highlighted. Press the EXIT key to remove the active cursor from the screen.

**Target Course Line** turns course lines off or sets the amount of time represented on the target course line. The length of the course line indicates the last known ship speed, while the direction of the arrow shows heading. (Settings: Off, 00:00 - 59:59; Default = 5:00)

**MMSI Label (Maritime Mobile Service Identity)** sets the MMSI label information to be Visible or Hidden. (Settings: Visible, Hidden; Default = Visible)

### AIS Target List

Name	MMSI	IMO	Last Message	Speed	TCPA	Registration
SANDY HOOK	101	91628226	11:36:39 AM	3.00		UnKnown
HURTIGRUTEN	102	77660349	11:36:30 AM	0.00		UnKnown
TANKER	103	77658844	11:36:32 AM	3.30		UnKnown
AIS VESSEL 4	104	10004	11:36:33 AM	5.70		UnKnown
AIS VESSEL 5	105	10005	11:36:37 AM	16.20		UnKnown
AIS VESSEL 6	106	10006	11:36:33 AM	15.80		UnKnown
AIS VESSEL 7	107	10007	11:36:34 AM	18.90		UnKnown
AIS VESSEL 8	108	10008	11:36:29 AM	11.80		UnKnown
AIS VESSEL 9	109	10009	11:36:30 AM	5.20		UnKnown

Depth	m	Speed	kph	Course	°t	VLT
9.2	N 37°05.603' W 075°42.229'	7.2	270	10.7		

## Troubleshooting

---

Before contacting the Humminbird® Customer Resource Center, please read the following section. Taking the time to review these troubleshooting guidelines may allow you to solve a performance problem yourself, and therefore avoid sending your unit back for repair.

### 1100 Series™ Doesn't Power Up

---

If your 1100 Series™ doesn't power up, use the Installation section of this manual for specific confirmation details, making sure that:

- the power cable is properly connected to the 1100 Series™ control head,
- the power cable is wired correctly, with red to positive battery terminal and black to negative terminal or ground
- the fuse is operational
- the battery voltage of the power connector is at least 10 Volts.

Correct any known problems, including removing corrosion from the battery terminals or wiring, or actually replacing the battery if necessary.

### 1100 Series™ Defaults to Simulator with a Transducer Attached

---

A connected and functioning transducer will cause the newly-started 1100 Series™ to go into Normal operating mode automatically. If, when you power up the 1100 Series™, it goes into Simulator mode automatically, even though a transducer is already connected, this means that the control head is not detecting the transducer. Perform the following troubleshooting tasks:

- Using the Installation section of this manual, check to make sure that the transducer cable is securely connected to the 1100 Series. Reconnect if necessary, and power up the 1100 Series™ again to see if this fixes the problem.
- Replace the non-functioning transducer with a known good transducer if available and power up the control head again.
- Check the transducer cable. Replace the transducer if the cable is damaged or corroded.

## Display Problems

---

There are several main conditions or sources of possible interference that may cause problems with the quality of the information displayed on the control head. Look in the following table for some symptoms of display problems and possible solutions:

<b>Problem</b>	<b>Possible Cause</b>
<b>The control head loses power at high speeds.</b>	If the power output of your boat's engine is unregulated, the control head may be protecting itself using its over-voltage protection feature. Make sure the input voltage does not exceed 20 Volts.
<b>When the boat moves at higher speeds, the bottom disappears or suddenly weakens, or the display contains gaps.</b>	<p>The transducer position may need to be adjusted. A mix of air and water flowing around the transducer (cavitation) may be interfering with the interpretation of sonar data. See your Installation Guide for suggestions on adjusting the transducer position.</p> <p>Electrical noise from the boat's engine may be interfering with sonar reception. See <i>Finding the Cause of Noise</i> for more information.</p>
<b>There are no fish detected, even when you know they are in the water under the boat, or sonar readings seem weak or faulty.</b>	<p>Sonar readings may be affected if the transducer is not positioned correctly (i.e. mounted at an angle, not straight down), or there is some kind of mechanical interference, either because it is mounted inside a hull that is too thick for proper sonar transmission, the bond between the transducer and the hull is not airtight, or because the transducer is dirty. Check with your Installation Guide for guidance on re-positioning the transducer, and make sure the transducer is clean.</p> <p>Low battery voltage may be affecting the power of signal transmission.</p> <p>Electrical noise from the boats engine may be interfering with sonar reception. See <i>Finding the Cause of Noise</i> for more information.</p>

## Finding the Cause of Noise

---

Electrical noise usually affects the display with many black dots at high speeds, and high sensitivity readings. One or more of the following sources can cause noise or interference:

Possible Source of Noise	Isolation
<b>Other electronic devices</b>	Turn off any nearby electronic devices to see if the problem goes away, then turn them on one at a time to see if the noise re-appears.
<b>The boat's engine</b>	To determine whether the boat's engine is the source of the noise, increase the RPMs while the boat is in neutral and stationary to see if the noise increases proportionately; if noise appears when you rev the engine, the problem could be the spark plugs, alternator, or tachometer wiring. Replace the spark plugs with resistor plugs, install an alternator filter, or route the control head power and transducer cables away from the engine wiring.
<b>Cavitation from the boat's propeller</b>	Turbulence created by the propeller can cause noise; make sure the transducer is mounted at least 15" (38 cm) from the propeller, and that the water flows smoothly over the face of the transducer at all times.

## 1-Year Limited Warranty

---

We warrant the original retail purchaser that products made by Humminbird® have been manufactured free from defects in materials and workmanship. This warranty is effective for one year from the date of original retail purchase. Humminbird® products found to be defective and covered by this warranty will be replaced or repaired free of charge at Humminbird's option and returned to the customer freight prepaid. Humminbird's sole responsibility under this warranty is limited to the repair or replacement of a product that has been deemed defective by Humminbird®. Humminbird® is not responsible for charges connected with the removal of such product or reinstallation of replaced or repaired parts.

This warranty does not apply to a product that has been:

- Improperly installed;
- Used in an installation other than that recommended in the product installation and operation instructions;
- Damaged or has failed because of an accident or abnormal operation;
- Repaired or modified by entities other than Humminbird®.

Please retain your original receipt as a proof of the purchase date. This will be required for in-warranty service.

THIS WARRANTY IS EXPRESSLY IN LIEU OF ANY OTHER WARRANTIES, OBLIGATIONS OR LIABILITIES ON THE PART OF HUMMINBIRD® AND WILL BE THE CUSTOMER'S EXCLUSIVE REMEDY, EXCEPT FOR ANY APPLICABLE IMPLIED WARRANTIES UNDER STATE LAW WHICH ARE HEREBY LIMITED IN DURATION TO ONE YEAR FROM THE DATE OF ORIGINAL PURCHASE. IN NO EVENT WILL HUMMINBIRD® BE LIABLE FOR ANY INCIDENTAL OR CONSEQUENTIAL DAMAGES FOR BREACH OF ANY EXPRESS OR IMPLIED WARRANTY RELATING TO THE PRODUCTS.

Some states do not allow limitations on an implied warranty, or the exclusion of incidental or consequential damages, so the above exclusions may not apply to you. You may also have other rights, which vary from state to state.

## Humminbird® Service Policy

---

Even though you'll probably never need to take advantage of our incredible service policy, it's good to know that we back our products this confidently. We do it because you deserve the best. We will make every effort to repair your unit within three business days from the receipt of your unit at our factory. This does not include shipping time to and from our factory. Units received on Friday are typically shipped by the following Wednesday, units received Monday are typically shipped by Thursday, etc.

All repair work is performed by factory-trained technicians to meet exacting factory specifications. Factory-serviced units go through the same rigorous testing and quality control inspections as new production units.

After the original warranty period, a standard flat rate service charge will be assessed for each repair (physical damage and missing parts are not included).

Any repairs made after the original warranty will be warranted for an additional 90 days after service has been performed by our factory technicians. You can contact our Customer Resource Center or visit our Web site to verify the flat rate repair fee for your product (visit the Product Support section):

<http://www.humminbird.com>

We reserve the right to deem any product unserviceable when replacement parts are no longer available or impossible to obtain. This Service Policy is valid in the United States only. This applies only to Humminbird® products returned to our factory in Eufaula, Alabama. This Service Policy is subject to change without notice.

**DOMESTIC (USA) CUSTOMERS:**

**PLEASE DO NOT RETURN THIS PRODUCT TO STORE FOR SERVICE**

For all technical issues please call **1-800-633-1468**  
or visit [www.humminbird.com](http://www.humminbird.com), click **SUPPORT**.

Please reference product serial number and model number when contacting Humminbird®.

## **Returning Your Unit for Service**

---

Before sending your unit in for repair, please contact the factory, either by phone or by email, to obtain a Repair Authorization Number for your unit.

***NOTE:** Please do not return your Humminbird® product to the store for service.*

Please have your product model name and serial number available before calling the factory. If you contact the factory by e-mail, please include your product model name and serial number in the e-mail, and use Request for Repair Authorization Number for your e-mail subject header. You should include your Repair Authorization Number in all subsequent communications about your unit.

**For IN-WARRANTY service, complete the following steps:**

- Obtain a Repair Authorization Number from the Humminbird® Customer Resource Center.
- Tag product with your name, street address, phone number and your assigned Repair Authorization Number.
- Include a brief written description of the problem.
- Include a copy of your receipt (to show proof and date of purchase).
- Return product freight prepaid to Humminbird®, using an insured carrier with delivery confirmation.

**For OUT-OF-WARRANTY service, complete the following steps:**

- Obtain a Repair Authorization Number from the Humminbird® Customer Resource Center.
- Include payment in the form of credit card number and expiration date, money order or personal check. Please do not send cash.
- Tag product with your name, street address, phone number and your assigned Repair Authorization Number.
- Include a brief written description of the problem.
- Return product freight prepaid to Humminbird®, using an insured carrier with delivery confirmation.



## 1100 Series™ Fishing System Accessories

---

Accessories customize the 1100 Series™ to your needs and enable you to stay on the edge of new technology. When an accessory is connected to the 1100 Series™, additional menus and readouts are added automatically to the Main Menu System. Accessories available today that are supported by your 1100 Series™ include:

**QuadraBeam PLUS™ transducer:** purchase and connect the QuadraBeam PLUS™ transducer to your 1100 Series™ Fishing System to access specialized QuadraBeam PLUS™ functions such as two 45° fan-shaped 35° 455 kHz Side Structure locating sonar beams to spot fish, bait and structure to the left and right of the boat over an area of the bottom that's always equal to twice your depth, for a continuous 90° of uninterrupted side to side coverage to 160 feet.

**WeatherSense® Fishing Condition Monitor:** purchase and plug in the WeatherSense® accessory to your 1100 Series™ to obtain barometric pressure readouts and trend data in real time.

**GPS Connection Cable:** purchase the GPS Connection Cable in order to connect a handheld or other NMEA\* GPS-compatible device that you may already own to your 1100 Series™.

*\*NMEA 0183 is a National Marine Electronics Association standard for data communication.*

**Universal Sonar 2:** Your 1100 Series™ Fishing System supports Universal Sonar 2, a state-of-the-art, integrated and protected transducer that is built into the lower unit of Minnkota trolling motors. With Universal Sonar 2, all wiring is concealed inside the indestructible composite shaft—out of sight and out of harm's way, with no clamps, ties, or exposed wires. Universal Sonar 2 features new temperature sensing and the performance of DualBeam PLUS™ technology (available with all Humminbird® DualBeam PLUS™ models). An expanded view and greater bottom detail gives you a totally new perspective of the water below, along with optimal sonar performance to help you find fish.

**Downriggers** are the key to catching fish you otherwise couldn't even touch. And now Humminbird's **CannonLink™** Downrigger Controller makes operation of up to six Cannon® Mag 20 DT or Mag 20 DT/HS downriggers incredibly easy. Using the controls on your Fishing System, deploy or retrieve downriggers, hold a specific distance off the bottom, cycle downriggers between two depths, and adjust the Positive Ion Control. Even see temperature and water clarity at depth and speed at the ball right on-screen when using the Cannon® Speed-n-Temp. You'll never be shorthanded again, just make adjustments from the helm, while your mate rigs the lines and brings in the fish!

With the new **InterLink™ Network Connection**, you can now share GPS position, waypoints, routes and your current track between two Humminbird® Fishing Systems in real time. Mark a waypoint at the console, and it's instantly available on the second unit. No matter where you're at on the boat, you'll have access to your critical fishing and navigation information. Plus, daisy chain InterLink™ with other System Modules and you'll have a network that lets you share digital data around the boat. It's a simply, clearly, better networking solution!

Humminbird's **AS WX 1** weather accessory provides anglers with access to continuously-updating weather conditions. The AS WX 1 uses sophisticated technology to track nationwide

weather information for more than 20 different weather conditions, including precipitation, wind, lightning, and full forecasts for more than 150 cities across the country, then scales and customizes this detail to the angler's specific location. See the AS WX 1 accessory guide for details.

**PC Connect Cable:** Purchase the PC Connect Cable to connect the Fishing System to a PC in order to upload product software updates and new features obtained from **humminbird.com**. This accessory requires the MSWindows-compatible HumminbirdPC™ software downloaded from our Web site to your PC in order to communicate with the Fishing System.

Be sure to check out our Web site **humminbird.com** for additional new and exciting accessories to grow your 1100 Series™.

***NOTE:** Each accessory requires a separate purchase. You can visit our Web site at **humminbird.com** or contact our Customer Resource Center at **1-800-633-1468** for additional details.*

## Specifications

---

Depth Capability	1500 ft (500 m)
Power Output	500 Watts (RMS); 4000 Watts (Peak-To-Peak)
Operating Frequency	
DualBeam PLUS™:	200 kHz and 83 kHz
Side Imaging® (1198c SI Combo models only):	455 kHz/800 kHz
Area of Coverage	
DualBeam PLUS™:	60° @ -10 dB in 83 kHz and 20° @ -10 dB in 200 kHz
Side Imaging® (1198c SI Combo models only):	455 kHz: (2) 86° @ -10 db (180° Total Coverage) 800 kHz: (2) 55° @ -10 db (130° Total Coverage)
Target Separation	2 1/2 Inches (63.5 mm)
Power Requirement	12-20 VDC
LCD	600 V x 800 H; 10.4" Diagonal Color TFT
Current Draw	1.4 A
Transducer	
1198c SI Combo:	XHS 9 HDSI 180 T
1158c DualBeam Combo:	XNT 9 20 T
Transducer Cable Length	20 ft (6 m)
IPX Rating	IP67 Waterproof/Submersible @ 1m for 30 minutes and dust tight

***NOTE:** Product specifications and features are subject to change without notice.*

***NOTE:** Humminbird® verifies maximum stated depth in saltwater conditions, however actual depth performance may vary due to transducer installation, water type, thermal layers, bottom composition and slope.*

***ENVIRONMENTAL COMPLIANCE STATEMENT:** It is the intention of Humminbird® to be a responsible corporate citizen, operating in compliance with known and applicable environmental regulations, and a good neighbor in the communities where we make or sell our products.*

***WEEE DIRECTIVE:** EU Directive 2002/96/EC "Waste of Electrical and Electronic Equipment Directive (WEEE)" impacts most distributors, sellers, and manufacturers of consumer electronics in the European Union. The WEEE Directive requires the producer of consumer electronics to take responsibility for the management of waste from their products to achieve environmentally responsible disposal during the product life cycle.*

*WEEE compliance may not be required in your location for electrical & electronic equipment (EEE), nor may it be required for EEE designed and intended as fixed or temporary installation in transportation vehicles such as automobiles, aircraft, and boats. In some European Union member states, these vehicles are considered outside of the scope of the Directive, and EEE for those applications can be considered excluded from the WEEE Directive requirement.*



This symbol (WEEE wheelee bin) on product indicates the product must not be disposed of with other household refuse. It must be disposed of and collected for recycling and recovery of waste EEE. Humminbird® will mark all EEE products in accordance with the WEEE Directive. It is our goal to comply in the collection, treatment, recovery, and environmentally sound disposal of those products; however, these requirements do vary within European Union member states. For more information about where you should dispose of your waste equipment for recycling and recovery and/or your European Union member state requirements, please contact your dealer or distributor from which your product was purchased.

**ROHS STATEMENT:** Product designed and intended as a fixed installation or part of a system in a vessel may be considered beyond the scope of Directive 2002/95/EC of the European Parliament and of the Council of 27 January 2003 on the restriction of the use of certain hazardous substances in electrical and electronic equipment.

**NOTE:** This product uses the Linux operating system. This portion of the software is free software; you can redistribute it and/or modify it under the terms of the GNU General Public License as published by the Free Software Foundation; either version 2 of the License, or (at your option) any later version. This program is distributed in the hope that it will be useful, but WITHOUT ANY WARRANTY; without even the implied warranty of MERCHANTABILITY or FITNESS FOR A PARTICULAR PURPOSE. See the GNU General Public License for more details.

You may receive a copy of the GNU General Public License along with this program; if not, write to the Free Software Foundation, Inc., 51 Franklin Street, Fifth Floor, Boston, MA 02110-1301 USA.

To receive a free copy of the Linux software used in this system, please send a letter of request\* with the following information:

Name (First & Last)

Phone Number

E-mail Address

Mailing Address

Humminbird® serial number

(Your Humminbird® unit must be registered at [humminbird.com/support/productregistration.aspx](http://humminbird.com/support/productregistration.aspx).)

Shipping and Handling: We can only accept requests that include a money order in the amount of \$9.99 to cover shipping and handling. Please allow 4-6 weeks for processing.

Send the letter of request\* to the following address:

Linux Software Request

Humminbird

678 Humminbird Lane

Eufaula, AL 36027

**\*NOTE:** A copy of the Linux operating system is not required to upgrade your fishing system. The Humminbird® application software and control head include a separate service warranty. Please see [humminbird.com](http://humminbird.com) and the **Warranty** section of this manual for details.

**Beam (Sonar Beam)** The wide, cone-shaped projection of sound waves formed as sound travels underwater. See *Cone Angle*.

**Bottom Contour** The profile of the bottom graphed to the display as the depth changes.

**Bottom Hardness** The density (or composition) of the bottom. Varying levels of hardness can be determined by interpreting the “thickness” of the main sonar return. Hard returns appear thin and black, softer returns appear thicker and less black. It is important to note that a sonar return from a sloping bottom can have the appearance of a softer bottom.

**Cavitation** The effect of air bubbles created as the propeller rotates and the boat moves through the water.

**Cone Angle** The angular measurement of the sonar beam at a specific dB down point (i.e. -10 dB). See *dB Down Point*.

**Dead Zone** The area of the sonar beam that receives the sonar signal after the main bottom return. Fish and other objects close to the bottom that fall within the dead zone will probably not be visible in the sonar beam. Precision sonar beams, such as the Humminbird® 20° beam, have a smaller dead zone than wider sonar beams.

**Decibel** The measurement for sound pressure level, or “intensity” of the sonar return. See *dB Down Point*.

**dB Down Point** The standard decibel level at which the sonar cone angle is measured, and is written as “@ -10 dB” or “@ -3 dB”. Measurements at smaller down points (bigger negative numbers) indicate that the less intensive sonar signals are being used for the measurement.

**Display, FSTN (Film Super-Twist Nematic)** FSTN is a monochrome display technology characterized by black, high-contrast pixels. All monochrome fixed mount Humminbird® products use FSTN technology.

**Frequency** A measure of the number of sound wave cycles per second of a sound impulse transmitted underwater. A typical frequency for fishfinders is 200 kHz, which offers a good balance of performance under many conditions. Lower frequencies, such as 50 kHz, are capable of penetrating to greater depths, but with less resolution. Higher frequencies, such as 455 kHz, offer greater resolution, but are limited in depth performance. Humminbird® uses a variety of frequencies that are optimized for specific applications.

**Grayscale** The use of varying shades of gray to represent the strength of the sonar signal on the display. Traditionally, the strongest sonar signals are represented in black, and progressively weaker signals are represented in progressively lighter shades of gray.

**Noise** The unintentional, external sound waves that interfere with the optimal operation of sonar. Noise appears as random “dots” on the display and is caused by a variety of sources. Many Humminbird® products have a Noise Filter menu setting that allows the user to clear the screen of noise that is difficult to eliminate (also, see *Troubleshooting*).

**Pixels** The “picture elements”, or small square blocks, that make up the image on the LCD. Measured as a vertical by horizontal number (i.e. 640V x 320H), this key specification typically indicates the quality of resolution. In fishfinders, the total resolution (vertical multiplied by horizontal) is often less important than the “Vertical Pixel” resolution because a greater number of vertical pixels provide finer resolution of targets detected by sonar. Sonar information on the horizontal axis can vary greatly, depending on boat speed and the Chart Speed setting.

**Power Output** The amount of sound energy emitted into the water by the transducer's transmitter. Power output is measured using either RMS (Root Mean Square) or P-T-P (Peak-to-Peak) measurement systems. Either method is acceptable, but it is important when comparing power outputs, to make sure that the same measurement system is being used for both outputs, because P-T-P numbers are 8 times higher than RMS numbers. Greater power output allows the sonar signal to penetrate through weeds and thermoclines, reach deeper depths and operate more effectively in noisy environments, such as when the boat is running at high speed.

**Pulse Width (Pulse Length)** The length of time that a sonar sound burst is transmitted into the water. Shorter pulse widths provide better target separation, but cannot travel to great depths. Longer pulse widths provide better depth penetration, but result in poorer target separation. Humminbird® varies pulse width based on depth to optimize both target separation and depth performance. See *Target Separation*.

**Second Return** Describes the appearance of a second sonar return below the primary sonar return (bottom contour) at exactly twice the true depth. The second return is caused by the same sonar energy bouncing off the bottom once, rebounding to the water surface and then traveling back down to the bottom to be reflected again. Second returns are more common in shallow water and over hard bottoms; it is possible to see a third sonar return under some circumstances. The second return provides useful information to help determine bottom hardness, as areas with harder bottoms will generally create a second return. The second return can be used as a guide to set Sensitivity when in shallower water.

**SONAR (SOUND and NAVIGATION RANGING)** Sonar technology uses precision sound bursts transmitted underwater to determine the distance and other attributes of objects in the water. Distance can be determined because the speed of sound in water is constant, and the time for the signal to return is measured. Sound also travels very quickly underwater, making sonar a responsive, cost-effective tool. Sonar is the basic technology behind all recreational and commercial fishfinding and depthfinding devices.

**Sonar Update Rate** The number of times per second that the transducer's transmitter/receiver sends and receives sonar signals. A very fast sonar update rate collects more information and provides a more detailed image of the bottom, fish, and structure. Many Humminbird® units operate at up to 40 times per second when in single frequency operation. Due to the limitation of the speed of sound in water, the update rate begins to slow as depth increases to deeper than 50 feet. In very shallow water (less than 10 feet), however, update rates as much as 60 times per second can be achieved.

**Speed** The rate at which the boat moves through the water. Boat speed can be measured as Speed Over Ground or Speed Through Water. Speed Over Ground is provided by GPS, and is the measurement of the boat's progress across a given distance. Speed Through Water is provided by a speed paddlewheel, and is the measurement of the flow past the boat, which may vary depending on current speed and direction. Speed Through Water is most critical for anglers using downriggers, as it impacts the running depth of the down riggers. Speed Over Ground is optimal for navigation, as accurate destination times can be derived from this measurement. Humminbird® products allow for input and display of both sources.

**Structure** A general term for objects on the bottom that present a discontinuity and are a likely attractor for fish. This includes bottom contour features (drop-offs, humps, and holes), standing structure (stumps, timbers, brush piles), and a wide range of other potential objects (sunken boats, reefs).

**Surface Clutter** A phenomenon where sonar returns are reflected off of tiny objects near the surface of the water, including algae and even air bubbles. Typically, saltwater environments have significantly greater surface clutter than freshwater due to continuous wind and wave action that causes aeration at the surface.

**Target Separation** The measurement of minimum distance that a fishfinder needs to be able to recognize two very close objects as two distinct targets (i.e. two fish hanging very close, or a fish hanging very close to structure). Humminbird® fishfinders provide a very good 2 1/2 inches of target separation in shallower than 100 feet of depth. Target separation decreases as depth increases due to the need for longer Pulse Width to achieve greater depth. See *Pulse Width*.

**Thermoclines** Water layer(s) of distinctly different temperatures that create a sonar reflection due to the density of the differing water temperatures. Typically a thermocline will appear as a continuous band across the display at some distance above the bottom contour. Thermoclines are of interest to anglers because fish will suspend above or below the thermocline as they seek the optimum temperature and oxygen levels.

**Time Variable Gain (TVG)** A processing step applied to the sonar return to “normalize” the data so that objects of equal size (i.e. fish) appear to be the same size, even if they are separated by a good distance.

**Transducer** The transducer is part of the sonar system, which mounts on the boat and is in contact with the water, that converts the electrical energy from the transmitter into sound energy, and that forms the sonar beam in turn. Internally, the transducer consists of one or more piezo electric disks that expand by very minute amounts to create the sound wave. This element also works in reverse, converting the returned sound energy back into an electrical signal that the receiver interprets. See *SONAR*.

**Zoom** A feature that focuses on a smaller area of the bottom to provide enhanced resolution. With enhanced resolution, the angler can more easily see fish hanging in structure or multiple fish hanging close together.

**Zoom, Bottom Lock** Bottom Lock Zoom is a feature that focuses on a smaller area just above the bottom to provide enhanced resolution. Unlike regular zoom, it continuously graphs the bottom at a constant point on the display regardless of changes in depth. This “flattens” out the bottom contour, but is effective at showing fish on or near the bottom, and is preferred by many saltwater anglers.

**Acquisition Time** The length of time that a GPS receiver typically takes to determine a position from at least three satellites. Humminbird® GPS receivers provide very fast acquisition times (under one minute), permitting users to get out on the water faster.

**Altitude** The height measurement above sea level. Altitude is a measurement that can be provided by GPS.

**Bearing (BRG)** The direction to a destination waypoint measured in degrees from North (i.e. 321°, where 000° is North, 090° East, 180° is South, 270° is West).

**Chartplotter** A navigation device that shows Present Position on a Map, along with Tracks, Waypoints, and Routes. All Chartplotters are also considered Trackplotters.

**Cold Start** The procedure that a GPS receiver must perform when it does not have historical information regarding its current location. This procedure typically lasts for several minutes, and may be experienced upon first power up of the receiver, or if the receiver has been moved a great distance.

**Course Over Ground (COG)** The current direction the boat is traveling measured in degrees from North (i.e. 321°, where 000° is North, 090° East, 180° is South, 270° is West). When the Course Over Ground is equal to Bearing, the boat is said to be "On Course" and will arrive at the destination in the most efficient manner. COG is often confused with Heading. See *Heading*.

**Cross Track Error (XTE)** The straight-line distance of the boat from the intended Track. XTE measures how far the boat is off course and also triggers the Off Course Alarm. See *Track*.

**Differential GPS (DGPS)** A system used to improve the position accuracy of the Department of Defense GPS through the use of secondary "correction signals" broadcast from ground stations around the coastal United States and on some inland waterways. These correction signals are provided by the USCG and received by an auxiliary Differential Beacon Receiver (DBR) that connects to the GPS receiver. The advent of WAAS has largely negated the need for the added expense of a DBR in the United States.

**Distance To Go** The straight-line distance between Present Position and the Destination Waypoint. DTG and SOG (Speed Over Ground) are used to calculate Time To Go. See *Time to Go* and *Speed Over Ground*.

**Estimated Position Error (EPE)** A calculation that indicates the potential position inaccuracy the user may experience due to a variety of GPS factors which include satellite position in the sky, signal strength, and others factors.

**Fix Type** Indicates whether the GPS receiver is providing 2D fix or 3D fix. A 2D fix requires only three satellites and provides only latitude and longitude. A 3D fix requires four or more satellites, and provides latitude, longitude, and altitude.

**GPS (Global Positioning System)** GPS provides accurate position (latitude, longitude, altitude) information virtually anywhere on the earth through satellite technology and personal receivers on the ground. See *How GPS Works*.

**Heading** The direction the boat is pointing and is measured in degrees (i.e. 321°, where 000° is North, 090° East, 180° is South, 270° is West). Due to wind and waves, the boat is often traveling in a slightly different direction than it is heading, and therefore Heading is often confused with Course Over Ground. See *Course Over Ground*.

**Map Datum** Refers to a particular survey of the earth's surface that was referenced when creating a chart (i.e. WGS84). It is important to select the correct Map Datum setting in your fishfinder when comparing GPS position to a paper chart to avoid slight position inaccuracies. Almost all electronic charts use the WGS84 Map Datum and therefore, they do not require setting changes.



**MMC (Multi Media Card)** An MMC is a postage stamp-sized memory device used to store electronic data such as maps, waypoints, routes, and other information. MMC is a very rugged format suitable for the marine environment, but it is not waterproof. MMC is the same format that many digital cameras use. See *SD*.

**North, Magnetic** The principle reference point of the compass (i.e. North is 000°). Magnetic North relies on the earth's magnetic field to align a metal pointer generally towards True North. However, due to local variations in the earth's magnetic field around the globe, the difference between True North and Magnetic North can be greater than 10°. See *True North*.

**North, True** The principle reference point of the compass (i.e. North is 000°). True North uses the axis of the rotation of the earth as the reference for North and is constant for all points on the earth. Most GPS units default to True North as the setting. The GPS heading may vary from the boat compass heading because the compass uses Magnetic North. See *Magnetic North*.

**Present Position** The current location (latitude, longitude) determined by GPS. The Present Position is indicated on-screen by a directional boat icon if the boat is moving or a round symbol if the boat is stationary.

**Route** A series of waypoints linked together in a specific sequence to define a navigation path between two points, and saved in the fishfinder's memory. Routes are often used when frequently traveling between two or more locations because it is a faster and more accurate method than repeatedly selecting individual waypoints each time one travels through the same area. Routes consist of a Start Waypoint, an End Waypoint, and a series of waypoints in between. Users can begin navigation at the beginning, the end (to run the route in reverse) or at any waypoint in between. See *Waypoint*.

**SD (Secure Digital)** An SD card is virtually identical in function to an MMC; however, the speed at which information can be accessed is generally faster, the storage capacity is generally larger, and the card has security features which can be used to prevent extracting the data from the card. SD is the same format that many digital cameras use. See *MMC*.

**Selective Availability (SA)** A GPS system "feature" that can be implemented by the U.S. Department of Defense (DoD) to degrade the accuracy of GPS positioning information. With SA active, the GPS is accurate to within 100 meters 95% of the time. With SA inactive, the GPS is accurate to within 45 meters 95% of the time. Currently, SA is inactive and the consumer can enjoy the greater precision GPS provides; however, the DoD reserves the right to activate SA at any time.

**Speed Over Ground (SOG)** The measurement of the boat's progress across a given distance and the speed measurement provided by GPS. An alternate, Speed Through Water, is provided by a speed paddlewheel, and is the measurement of the flow past the boat, which may vary depending on current speed and direction. Speed Over Ground is optimal for navigation because accurate destination times can be derived from this measurement. Humminbird® products allow for input and display of both speed measurements.

**Time To Go (TTG)** The estimated time required to reach the destination waypoint. TTG is calculated using the SOG and DTG. See *SOG* and *DTG*.

**Track** A series of saved points that define the past path of the boat. These Track Points are saved at regular time intervals. Tracks are a useful and quick method to see where you've been, and an easy guide to follow to get you back to the starting point. Generally, all GPS units have a limited number of Track Points that can be saved before the unit runs out of memory and begins erasing the first track points saved. Because of this, the user can adjust the Track Point Interval menu to increase the amount of time between when points are saved, and thus extend the distance covered by a track. Tracks can also be permanently saved to memory and re-displayed at the user's option.

**Track Line (TRK)** The planned line of travel between two waypoints, and it represents the most efficient path between the two points because it is a straight line. The TRK is measured in degrees (i.e. 321°, where 000° is North, 090° East, 180° is South, 270° is West). See *Cross Track Error* and *Course Over Ground*.

**Trackplotter** A navigation device that shows Present Position, along with Track, Waypoint, and Routes, but NO MAP in the background. See *Chartplotter*.

**Trolling Grid** A Humminbird® feature that displays a precise reference grid around a waypoint. This grid is used as a guide pattern for trolling around a specific area to assure a more efficient and complete coverage of that area.

**UTC (Universal Time Constant)** UTC is the “standard time” used in navigation and is the local time in Greenwich England. (UTC is equivalent to Greenwich Mean Time (GMT)).

**WAAS (Wide Area Augmentation System)** WAAS is complementary technology to GPS that provides enhanced accuracy through correction signals broadcast from Federal Aviation Administration WAAS satellites stationed over the USA. These secondary signals are automatically received by the standard Humminbird® GPS Receiver. With WAAS signal, GPS accuracy is improved to within 3 meters 95% of the time. Outside the United States, regional governmental coalitions have created similar systems such as EGNOS (Europe) and MSAS (Japan).

**Waypoint** The saved location (latitude, longitude) of a point of interest that is stored in a GPS receiver’s memory. This can include a marker buoy, dock, fishing hole, or anywhere else the user may want to return to. Humminbird® products offer the ability to name and assign a symbol to the saved location. Depth, Date, and Time of Day when the waypoint was created is also saved.

**Waypoint Target** A Humminbird® feature that displays a precise “bull’s eye” around a selected waypoint. This bull’s eye is used to easily monitor boat position relative to a waypoint, and is useful for fishing over submerged structure. With Waypoint Targets, a quick look at the screen lets you know how far off the waypoint the boat has drifted.

Remove and use for  
Transducer Installation

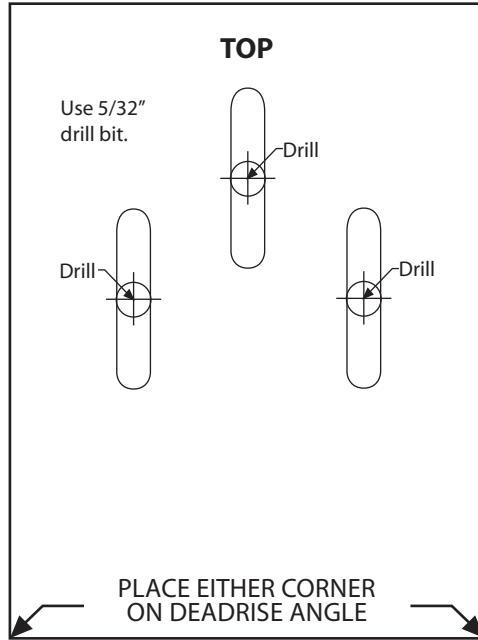

***NOTE:** If you are reproducing or printing this template from an electronic file, start with the following print settings: Scale = None, Paper = 8.5 x 11 inches, Layout = Portrait. Confirm that the template matches the transducer bracket slots and adjust the print as needed.*

## Contact Humminbird®

Contact the Humminbird® Customer Resource Center  
in any of the following ways:

By Telephone

(Monday - Friday 8:00 a.m. to 4:30 p.m. Central Standard Time):

**1-800-633-1468**

By e-mail

(typically we respond to your e-mail within three business days):

**[service@humminbird.com](mailto:service@humminbird.com)**

For direct shipping, our address is:

**Humminbird®**

Service Department  
678 Humminbird Lane  
Eufaula, AL 36027 USA

