

Dell EMC PowerEdge T340

Technical Guide

Notes, cautions, and warnings

 **NOTE:** A NOTE indicates important information that helps you make better use of your product.

 **CAUTION:** A CAUTION indicates either potential damage to hardware or loss of data and tells you how to avoid the problem.

 **WARNING:** A WARNING indicates a potential for property damage, personal injury, or death.

Product Overview

Topics:

- [Introduction](#)
- [New technologies](#)

Introduction

The Dell EMC PowerEdge T340 is the reliable, easy to manage, and scalable 1-socket tower server for growing businesses and remote offices/ branch offices.

New technologies

The PowerEdge T340 equipped with Intel® Xeon® E-2100 and E-2200 product family processors support to help run applications faster and support for full-feature remote management (iDRAC9).

The T340 is versatile enough to address many customer segments and workloads. Target workloads include

- Small and medium businesses and organizations: Collaboration/sharing productivity applications, databases, web serving, backup/recovery, and mail and messaging.
- ROBO: Applications and workloads specific to the particular industry, e.g. Retail, Healthcare, Finance, Education, etc.

The following table shows the list of new technologies offered by the PowerEdge T340:

New Technologies	Detailed Descriptions
Intel® C246 series chipset	Please refer to the chipset section for details.
Intel® Xeon® processor E- 2100 and E-2200 Product Family	The Intel® processor that works with Intel® C246 series chipset. The Xeon® E-2100 and E-2200 processors have increased core count and embedded PCIe lanes that will improve the IO performance and a lot more features. Please refer to section 8, Processors for details.
Next Generation SW RAID, PERC S140	The new 1-socket servers support the latest S140 software RAID along with H330 and H730P controller cards with improved functionality and faster performance. New SW RAID supports RAID 0, 1, 5 and 10.
iDRAC 9	The new embedded system management solution for Dell EMC server features hardware and firmware inventory and alerting, in depth memory alerting, faster performance, dedicated gigabit port, email alerts, electronic licensing, editable user work notes log and more. Dedicated iDRAC Direct microUSB port improves at-the-box management.

Product features

Topics:

- [Product comparison](#)
- [Product specifications](#)

Product comparison

The following table shows the comparison between the PowerEdge T330 and PowerEdge T340:

Table 1. Product comparison with predecessor

Feature	PowerEdge T330	PowerEdge T340
Processor	<ul style="list-style-type: none"> • Intel® Xeon® E3-1200 v6 Processor family • Intel® Pentium® • Intel® Celeron® • Intel® Core™ i3® 	<ul style="list-style-type: none"> • Intel® Xeon® E-2100 and E-2200 Processor family • Intel® Pentium® • Intel® Celeron® • Intel® Core™ i3®
Front Side Bus	DMI 3.0	DMI 3.0
Number of processors	<ul style="list-style-type: none"> • 1 	<ul style="list-style-type: none"> • 1
Number of cores	<ul style="list-style-type: none"> • Up to 4 cores 	<ul style="list-style-type: none"> • Up to 8 cores
L2/L3 cache	<ul style="list-style-type: none"> • 2.0 MB per core • 4 MB or 8 MB 	<ul style="list-style-type: none"> • 2.0 MB per core • 8 MB or 12 MB
Chipset	<ul style="list-style-type: none"> • Intel® C236 	<ul style="list-style-type: none"> • Intel® C246
Memory Module	<ul style="list-style-type: none"> • DDR4: 4 UDIMMs with ECC • Speed: Up to 2400MT/s • Min RAM: 4 GB • Max RAM: 64 GB 	<ul style="list-style-type: none"> • DDR4: 4 UDIMMs with ECC • Speed: Up to 2666MT/s • Min RAM: 8GB • Max RAM: 64 GB
Hard drive bays	<ul style="list-style-type: none"> • 8 x 3.5-inch hot plug • 8 x 2.5-inch hot plug (in 3.5-inch carrier) 	<ul style="list-style-type: none"> • 8 x 3.5-inch hot plug • 8 x 2.5-inch hot plug (in 3.5-inch carrier)
Hard drive types	<ul style="list-style-type: none"> • 2.5-inch SATA 7.2K HDDs • 2.5-inch Near Line SAS 7.2K HDDs • 2.5-inch SAS 10K HDDs • 2.5-inch SAS 15K HDDs • 3.5-inch Enterprise SATA 7.2K HDDs • 3.5-inch Near Line SAS 7.2K HDDs • 2.5-inch SATA SSDs 	<ul style="list-style-type: none"> • 2.5-inch SATA 7.2K HDDs • 2.5-inch Near Line SAS 7.2K HDDs • 2.5-inch SAS 10K HDDs • 2.5-inch SAS 15K HDDs • 3.5-inch Enterprise SATA 7.2K HDDs • 3.5-inch Near Line SAS 7.2K HDDs • 2.5-inch SATA SSDs
External hard drive bays	<ul style="list-style-type: none"> • 3 x 5.25-inch bay 	<ul style="list-style-type: none"> • 3 x 5.25-inch bay
RAID controllers	<ul style="list-style-type: none"> • Chipset based SATA, PERC S130 • Non RAID controller: 12GB SAS HBA 	<ul style="list-style-type: none"> • Chipset based SATA, PERC S140

Table 1. Product comparison with predecessor (continued)

Feature	PowerEdge T330	PowerEdge T340
	<ul style="list-style-type: none"> • PERC H330 • PERC H730 • PERC H830 	<ul style="list-style-type: none"> • Non RAID controller: 12GB SAS HBA, PERC HBA330 • PERC H330 • PERC H730P
Boot optimized storage subsystem	<ul style="list-style-type: none"> • Not supported 	<ul style="list-style-type: none"> • 2x M.2 240GB (RAID 1 or No RAID) • 1x M.2 240GB (No RAID only)
Server management	<ul style="list-style-type: none"> • Dell Open Manage featuring Dell Management Console • Lifecycle Controller 3.0 • iDRAC8 Enterprise 	<ul style="list-style-type: none"> • Dell Open Manage featuring Dell Management Console • Lifecycle Controller 3.0 • iDRAC9 Enterprise
I/O slots	<ul style="list-style-type: none"> • 1 x 8 PCIe Gen3 (x16 connector) FH/HL • 1 x 4 PCIe Gen3 (x8 connector) FH/HL • 1 x 4 PCIe Gen3 (x8 connector) FH/HL • 1 x 1 PCIe Gen3 (x1 connector) FH/HL 	<ul style="list-style-type: none"> • 1 x 8 PCIe Gen3 (x16 connector) FH/HL • 1 x 8 PCIe Gen3 (x8 connector) FH/HL • 1 x 4 PCIe Gen3 (x8 connector) FH/HL • 1 x 1 PCIe Gen3 (x1 connector) FH/HL
NIC/LOM	<ul style="list-style-type: none"> • 2 x 1GbE LOM 	<ul style="list-style-type: none"> • 2 x 1GbE LOM
USB	Rear I/O <ul style="list-style-type: none"> • 2 x USB3.0 + 4 x USB 2.0 Front I/O <ul style="list-style-type: none"> • 1 x USB3.0 + 1 x USB 2.0 Internal <ul style="list-style-type: none"> • 1 x Internal USB 3.0 	Rear I/O <ul style="list-style-type: none"> • 2 x USB3.0 + 4 x USB 2.0 Front I/O <ul style="list-style-type: none"> • 1 x USB3.0 • 1 x Micro USB 2.0 (dedicated iDRAC Direct) Internal <ul style="list-style-type: none"> • 1 x Internal USB 3.0
Power supplies	<ul style="list-style-type: none"> • Single or Dual Redundant 495W power supply or single 350W cabled power supply 	<ul style="list-style-type: none"> • Single or Dual Redundant 495W power supply or single 350W cabled power supply
Fans	<ul style="list-style-type: none"> • No Fan fault tolerance 	<ul style="list-style-type: none"> • No Fan fault tolerance
SD module	<ul style="list-style-type: none"> • IDSDM 	<ul style="list-style-type: none"> • IDSDM
Dimensions (HxWxD)	<ul style="list-style-type: none"> • Height 16.94 inch / 43.0 cm • Width 8.58 inch / 21.8 cm • Height 23.8 inch / 60.5 cm 	<ul style="list-style-type: none"> • Height 16.94 inch / 43.0 cm • Width 8.58 inch / 21.8 cm • Height 23.7 inch / 60.3 cm
Weight	<ul style="list-style-type: none"> • Max 26 Kg 	<ul style="list-style-type: none"> • Max 26 Kg

Product specifications

The following table lists the technical specifications for the PowerEdge T340:

Table 2. Technical specifications

Features	Specifications
Form Factor	<ul style="list-style-type: none"> • Tower Server
Processors	<ul style="list-style-type: none"> • Intel® Xeon® processor E-2100 and E-2200 product family

Table 2. Technical specifications (continued)

Features	Specifications
	<ul style="list-style-type: none"> ● Intel® Core™ i3 ● Intel® Pentium® ● Intel® Celeron
Processor sockets	<ul style="list-style-type: none"> ● 1
Front Side Bus or HyperTransport	<ul style="list-style-type: none"> ● DMI
Cache	<ul style="list-style-type: none"> ● 2.0 MB per core ● 8 MB or 12 MB
Chipset	<ul style="list-style-type: none"> ● Intel C246 Chipset
Memory	<ul style="list-style-type: none"> ● Up to 64GB (4 DIMM Slots) ● 8GB/16GB 2666MT/s Unbuffered with ECC only ● MIN/ MAX RAM: 8GB/64GB
I/O slots	<ul style="list-style-type: none"> ● 4 GEN3 PCIe slots: <ul style="list-style-type: none"> ○ One x8 slot (with x16 Connector) ○ Two x4 slot(with x8 connector) ○ One x1 slot
RAID controller	<ul style="list-style-type: none"> ● Internal controllers: PERC S140, PERC H330, H730P ● External HBAs (non-RAID): 12GB SAS HBA
Drive bays	<ul style="list-style-type: none"> ● Up to 8 x 2.5-inch Hot-Plug drives(in 3.5-inch carrier) ● Up to 8 x 3.5-inch Hot-Plug drives
Maximum internal storage	<ul style="list-style-type: none"> ● 112TB for 8 HDD config
Hard drives	<ul style="list-style-type: none"> ● 2.5-inch SATA 7.2K HDDs ● 2.5-inch Near Line SAS 7.2K HDDs ● 2.5-inch SAS 10K HDDs ● 2.5-inch SAS 15K HDDs ● 3.5-inch Enterprise SATA 7.2K HDDs ● 3.5-inch Near Line SAS 7.2K HDDs ● 2.5-inch SATA SSDs ● 2.5-inch SAS SSDs <p>HDDs capacities: 300GB, 600GB, 900GB, 1TB, 1.2TB, 1.8TB, 2TB, 2.4TB, 4TB, 6TB, 8TB, 10TB, 12TB, 14TB</p> <p>SSD capacities: 240GB, 480GB, 960GB, 1.2TB, 1.6TB, 1.92TB, 3.84TB, and 7.68TB</p>
Embedded LOM/NIC	<ul style="list-style-type: none"> ● Integrated BROADCOM BCM5720 Gigabit Ethernet Controller
Communications	<p>Optional add-in cards:</p> <ul style="list-style-type: none"> ● 10GbE Intel (Dual) Sageville Sage Pond Dual port 10Gb Base-T adapter – FH ● 10GbE Intel (Dual) Fortville Eagle Fountain Dual port 10Gb SFP+ adapter – FH

Table 2. Technical specifications (continued)

Features	Specifications
	<ul style="list-style-type: none"> ● 1GbE Intel (Dual) Powerville Troi-Stony Dual port 1Gb Base-T adapter – FH ● 1GbE Intel (Quad) Powerville Lore-Stony Quad port 1Gb Base-T adapter – FH ● 1GbE Broadcom (Dual) 5720 Bashir Dual port 1Gb Base-T adapter – FH ● 1GbE Broadcom (Quad) 5719 Cardassia Quad port 1Gb Base-T adapter – FH ● FC8 Emulex (Dual) Saturn Wildfire Dual port FC8 SFP+ adapter – FH
Power supply	<ul style="list-style-type: none"> ● 350W cable PSU auto sensing ● Hot Plug RDNT Common PSU 495W
Availability	<ul style="list-style-type: none"> ● TPM/No TPM ● Cluster support ● ECC memory, UDIMM ● Hot-plug hard drives, redundant power ● Internal Dual SD Module(IDSDM)
Video	<ul style="list-style-type: none"> ● Integrated Matrox G200 with iDRAC9
Remote management	<ul style="list-style-type: none"> ● Base Management Console ● iDRAC9 Express ● iDRAC9 Enterprise
Systems management	<ul style="list-style-type: none"> ● Dell Open Manage featuring Dell Management Console ● Lifecycle Controller 3.0 ● iDRAC9 Enterprise
Featured database applications	<ul style="list-style-type: none"> ● Microsoft® SQL Server® solutions

Chassis views and features

Topics:

- [Front view of the system](#)
- [Rear view of the system](#)
- [Inside the system](#)
- [Locating the Service Tag of your system](#)

Front view of the system

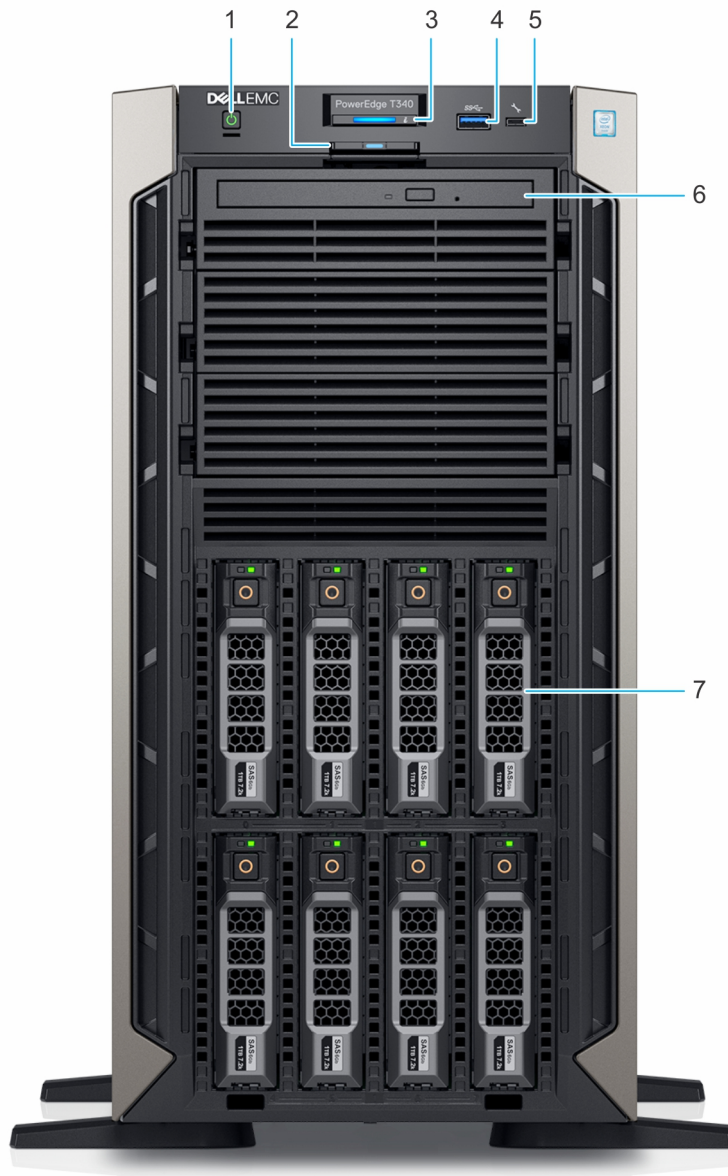

Figure 1. Front view of 8 x 3.5-inch drive system

- 1. Power button
- 2. Information tag
- 3. System health and system ID indicator
- 4. USB 3.0 port
- 5. iDRAC direct micro USB port
- 6. Optical drive (optional)
- 7. Drive (8)

For more information about the ports, see the [Technical Specifications](#) section.

Rear view of the system

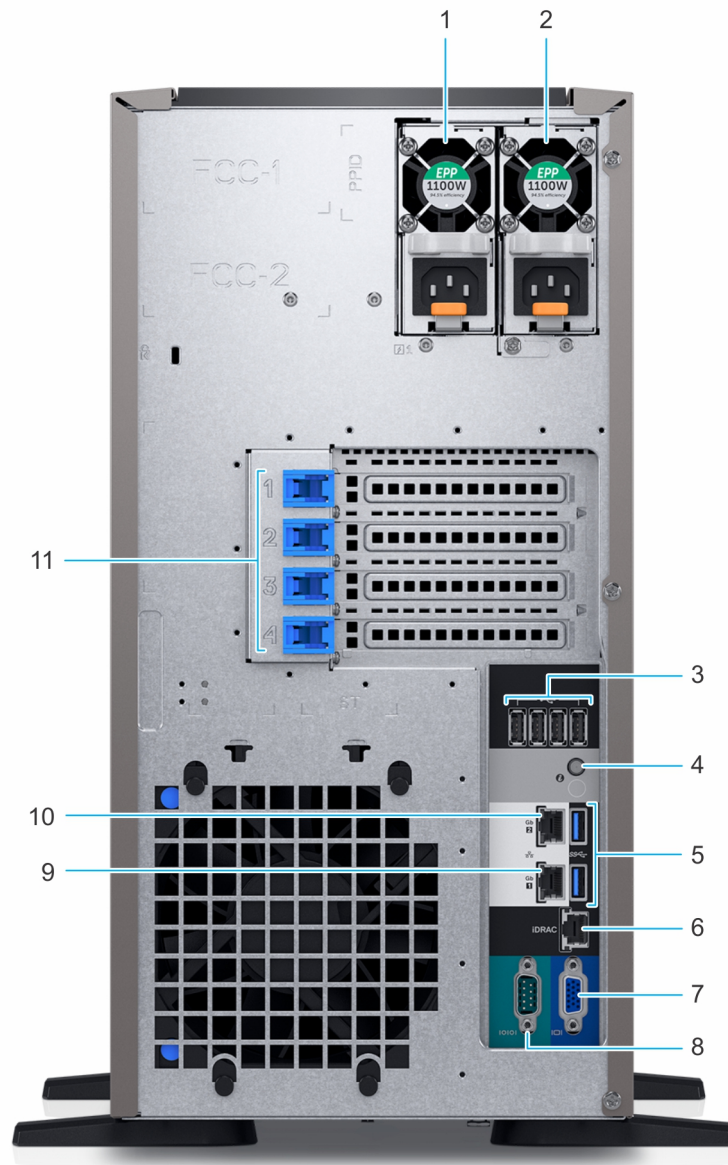

Figure 2. Rear view of 8 x 3.5-inch drive system

- | | |
|-----------------------------------|---------------------------------|
| 1. Power supply unit (PSU 1) | 2. Power supply unit (PSU 2) |
| 3. USB 2.0 port (4) | 4. System Identification button |
| 5. USB 3.0 port (2) | 6. iDRAC dedicated NIC port |
| 7. VGA port | 8. Serial port |
| 9. NIC port (Gb1) | 10. NIC port (Gb2) |
| 11. PCIe expansion card slots (4) | |

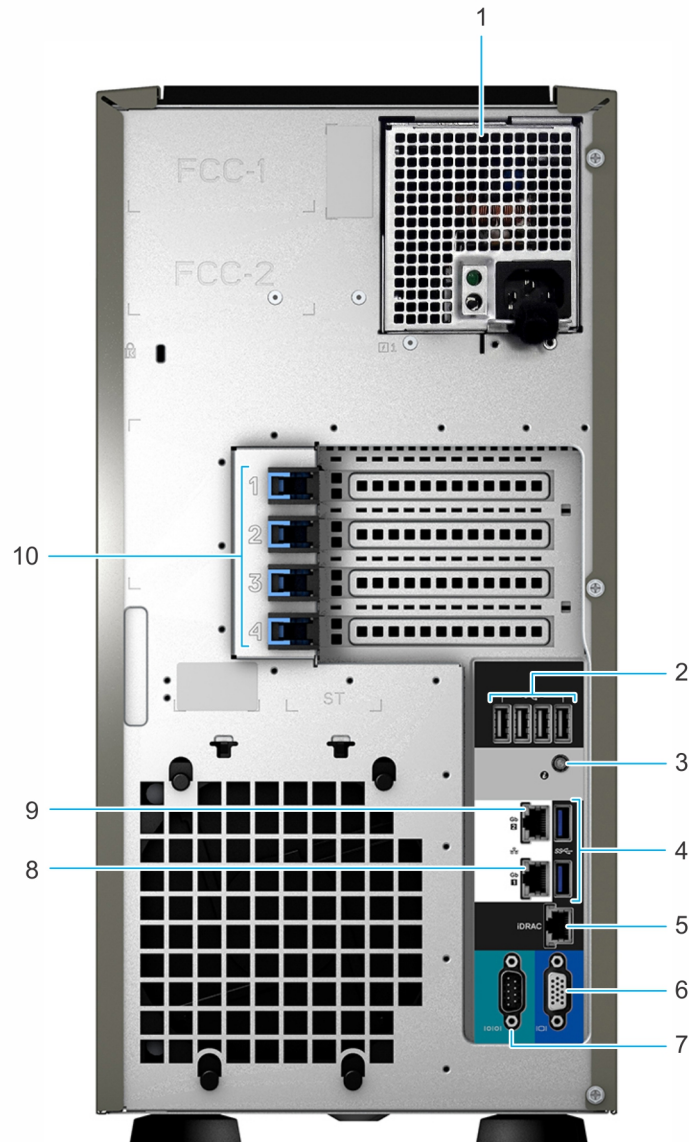

Figure 3. Rear view of 4 x 3.5-inch drive system

- | | |
|-----------------------------------|-----------------------------------|
| 1. Cabled power supply unit (PSU) | 2. USB 2.0 port (4) |
| 3. System identification button | 4. USB 3.0 port (2) |
| 5. iDRAC dedicated NIC port | 6. VGA port |
| 7. Serial port | 8. NIC port (Gb1) |
| 9. NIC port (Gb2) | 10. PCIe expansion card slots (4) |

NOTE: For more information about the ports and connectors, see the [Technical Specifications](#) section.

Inside the system

NOTE: Components that are hot swappable are marked orange and touch points on the components are marked blue.

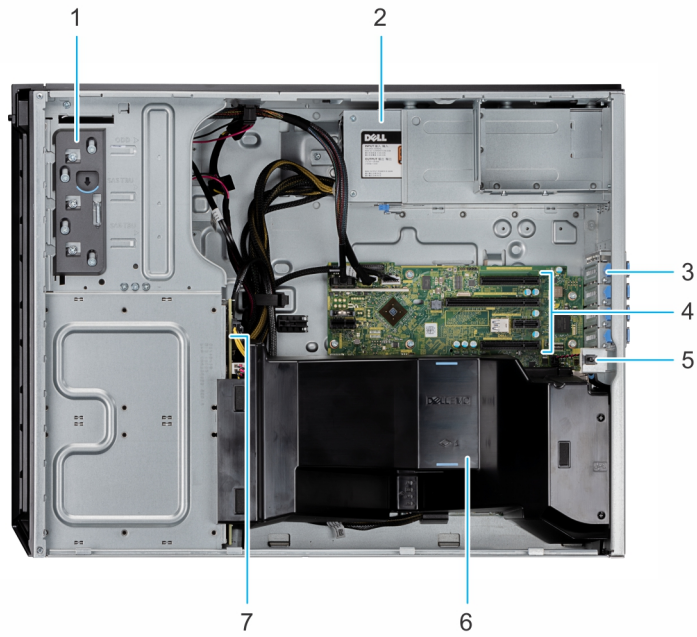

Figure 4. Inside the system with cabled power supply unit (PSU)

- | | |
|----------------------------------|----------------------------------|
| 1. Optical drive or tape drive | 2. Power supply unit (cabled) |
| 3. PCIe Expansion card latch (4) | 4. PCIe Expansion card slots (4) |
| 5. Intrusion switch | 6. Air shroud |
| 7. Drive backplane | |

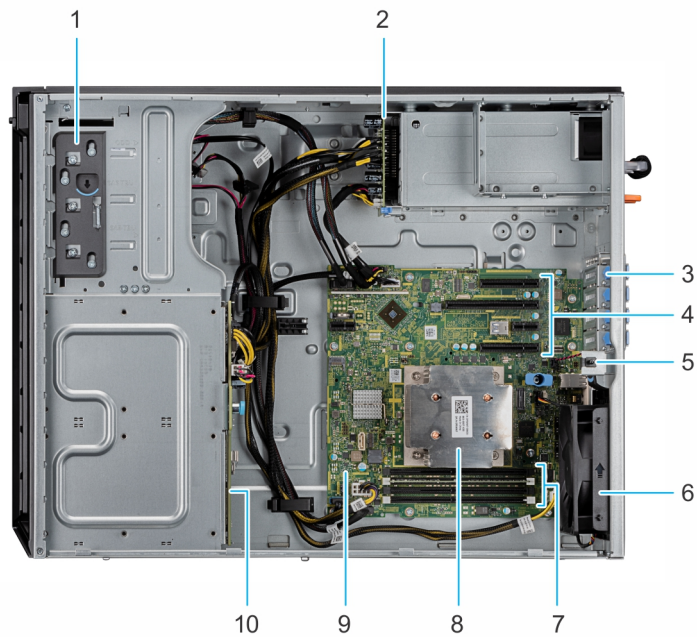

Figure 5. Inside the system with redundant power supply unit (PSU)

- | | |
|----------------------------------|----------------------------------|
| 1. Optical drive or tape drive | 2. Power interposer board |
| 3. PCIe Expansion card latch (4) | 4. PCIe Expansion card slots (4) |
| 5. Intrusion switch | 6. Fan |
| 7. Memory module socket (4) | 8. Processor and heat sink |
| 9. System board | 10. Drive backplane |

Locating the Service Tag of your system

You can identify your system using the unique Express Service Code and Service Tag. Pull out the information tag in front of the system to view the Express Service Code and Service Tag. Alternatively, the information may be on a sticker on the chassis of the system. The mini Enterprise Service Tag (EST) is found on the back of the system. This information is used by Dell to route support calls to the appropriate personnel.

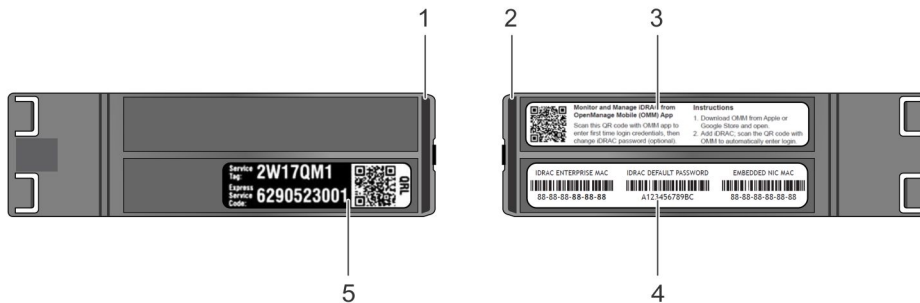

Figure 6. Locating Service Tag of your system

1. Information tag (top view)
2. Information tag (back view)
3. OpenManage Mobile (OMM) label
4. iDRAC MAC address and iDRAC secure password label
5. Service Tag

Processor

The PowerEdge T340 is a single-socket entry-level tower server with high availability features based on the Intel® Xeon® E-2100 and E-2200 processor family.

Topics:

- [Processor features](#)
- [Supported processors](#)
- [Chipset](#)

Processor features

The following list highlights the features of the Intel® Xeon E-2100 and E-2200 processor family:

- Up to eight execution cores per processor
- Four DMI3 lanes
- 16 PCIe Gen 3 links capable of 8.0 GT/s
- Socket H4, LGA package (LGA1151)
- Integrated 2 channel DDR4 memory controller
- Execute Disable Bit
- Support Turbo Boost Technology 2.0
- Increases CPU frequency if operating below thermal, power, and current limits
- Intel® Virtualization Technology (Intel® VT)

NOTE: We do not support graphics with E-2100 and E-2200 processors, Graphics cannot be enabled on Dell servers using this processor due to technical restrictions.

Supported processors

The following table lists the supported processors for the PowerEdge T340:

Model	Speed (GHz)	Power (Watts)	Cores	L3 Cache (MB)	Threads	Turbo	Max Memory Speed (MT/s)	Hyper-threading	Intel Software Guard Extensions support
E-2288G	3.7	95	8	16	16	Yes	2666	Yes	Yes
E-2286G	4	95	6	12	12	Yes	2666	Yes	Yes
E-2278G	3.4	80	8	16	16	Yes	2666	Yes	No
E-2276G	3.8	80	6	12	12	Yes	2666	Yes	Yes
E-2274G	4	83	4	8	8	Yes	2666	Yes	Yes
E-2246G	3.6	80	6	12	12	Yes	2666	Yes	No
E-2244G	3.8	71	4	8	8	Yes	2666	Yes	No
E-2236	3.4	80	6	12	12	Yes	2666	Yes	No
E-2234	3.6	71	4	8	8	Yes	2666	Yes	No
E-2226G	3.4	80	6	12	6	Yes	2666	Yes	No
E-2224	3.4	71	4	8	4	Yes	2666	Yes	No

Model	Speed (GHz)	Power (Watts)	Cores	L3 Cache (MB)	Threads	Turbo	Max Memory Speed (MT/s)	Hyper-threading	Intel Software Guard Extensions support
Core i3 9100	3.6	65	4	6	4	Yes	2666	No	No
Pentium G5420	3.8	58	2	4	4	Yes	2666	No	No
Celeron G4930	3.2	54	2	2	4	Yes	2666	No	No
E-2186G	3.8	95	6	12	12	Yes	2666	Yes	Yes
E-2176G	3.7	80	6	12	12	Yes	2666	Yes	Yes
E-2174G	3.8	71	4	8	8	Yes	2666	Yes	Yes
E-2146G	3.5	80	6	12	12	Yes	2666	Yes	No
E-2144G	3.6	71	4	8	8	Yes	2666	Yes	No
E-2136	3.3	80	6	12	12	Yes	2666	Yes	No
E-2134	3.5	71	4	8	8	Yes	2666	Yes	No
E-2126G	3.3	80	6	12	6	Yes	2666	No	No
E-2124	3.3	71	4	8	4	Yes	2666	No	No
Core i3 8100	3.6	65	4	6	4	No	2666	No	No
Pentium G5500	3.8	54	2	4	2	No	2666	No	No
Celeron G4900	3.1	54	2	2	2	No	2666	No	No

Chipset

The following table shows the high level features supported by the C246 chipset implemented on the PowerEdge T340:

PCH feature	C246	T340
TXT	Y	Y
Node Manager	Y	N
ECC	Y	Y
FlexIO - USB3.0 - 10 (means 6 is enough)	10	3
USB 2.0	4	4
FlexIO - 8 SATA ports	8	5
FlexIO - SATA Express	3	0
FlexIO - PCIE 3.0 ports - additional required	20	8
SPI (MB) FW image	7	UI
Intel vPRO/AMT11	Y	N
Rapid Storage technology	Y	N

PCH feature	C246	T340
Rapid Storage technology enterprise	Y	N
Data Center Graphics	N	N
supported displays	3	N
Int. Gbe MAC	Y	N
eSPI	Y	N
IO Flex - ability to change SATA/PCIE/USB	Y	N
Software Guard Extensions (SGX)	N	Y

The following table shows the features supported by the T340 chipset:

Table 3. Chipset features

Features	Description
DMI interface	Direct Media Interface 3 (DMI3) connects the CPU1 to the chipset. DMI3 is similar to a four lane PCI Express supporting a speed of 8 GT/s per lane.
PCI Express interface	PCI Express Generation 3 (PCIe Gen3) is capable of 8 GT/s bit rate (compared to PCIe Gen 2's 5 GT/s) per lane. Because PCIe Gen3 uses a "scrambling" encoding instead of PCIe Gen2's 8b/10b encoding, it is able to have double the bandwidth of PCIe Gen2. The PCIe Gen 3 will be fully compatible with prior generations of this technology, from software to clocking architecture to mechanical interfaces.
AHCI	The chipset SATA controller provides hardware support for Advanced Host Controller Interface (AHCI), a standardized programming interface for SATA host controllers developed through a joint industry effort. Platforms supporting AHCI may take advantage of performance features such as port independent DMA Engines—each device is treated as a master—and hardware-assisted native command queuing.
Low Pin Count Interface (LPC)	The chipset implements an LPC interface.
Serial Peripheral Interface (SPI)	The chipset provides one Serial Peripheral Interface (SPI). The interface implements 3 Chip Select signals (CS#), allowing up to two flash devices and one TPM device to be connected to the PCH. The CS0# and CS1# are used for flash devices and CS2# is dedicated to TPM.
Advanced Programmable Interrupt Controller (APIC)	The I/O APIC within the chipset supports 40 APIC interrupts. Each interrupt has its own unique vector assigned by software.
Real Time Clock (RTC)	The Real-Time Clock (RTC) performs two key functions—keeping track of the time of day and storing system data, even when the system is powered down. The RTC operates on a 32.768-KHz crystal and a 3V battery.
General-Purpose Input/Output (GPIO)	GPIO Serial Expander (GSX) is the capability provided by the PCH to expand the GPIOs on a platform that needs more GPIOs than the ones provided by the PCH. The solution requires external shift register discrete components.
System Management Bus (SMBus 2.0)	The chipset provides a System Management Bus (SMBus) 2.0 host controller as well as an SMBus Slave Interface. The chipset is also capable of operating in a mode in which it can

Table 3. Chipset features (continued)

Features	Description
	communicate with I2C compatible devices. The host SMBus controller supports up to 100- KHz clock speed.
JTAG Boundary-Scan	This section contains information regarding the chipset testability signals that provides access to JTAG, run control, system control, and observation resources. PCH JTAG (TAP) ports are compatible with the IEEE Standard Test Access Port and Boundary Scan Architecture 1149.1 and 1149.6 Specification, as detailed per device in each BSDL file. JTAG Pin definitions are from IEEE Standard Test Access Port and Boundary-Scan.

Memory

The PowerEdge T340 supports up to 4 DDR4 DIMMs. The T340 is designed to support the socket H4, Intel® Xeon® processor E-2100 and E-2200 product family CPU, which has 2 memory channels per CPU, with each channel supporting up to 2 DIMMs.

The maximum system population at launch will be 64GB. The minimum system population is one 8GB DIMM.

Supported memory

The PowerEdge T340 supports memory with the following features:

- Unbuffer (UDIMM) ECC DDR4 technology
- Each channel carries 64 data and 8 ECC bits
- Up to 64 GB of UDIMM memory (4 x 16GB UDIMM)
- Up to 2666 MT/s DIMMs
- Flexible Memory Configuration
- ODT (On Die Termination)
- Clock gating (CKE) to conserve power when DIMMs are not accessed - DIMMs enter a low power self-refresh mode
- I²C access to SPD EEPROM for access to thermal sensors
- Memory Optimized (Independent Channel) Mode
- 100% Single Bit Error Correction
- Memory Off-lining is NOT supported

Memory speed

The system will run all memory on all CPUs and channels at the same speed and voltage. By default the system will run at the highest speed for the lowest voltage of the worst case channel DIMM configuration.

Operating speed of the memory is determined by:

- Supported speed of the DIMMs
- DIMM configuration on any channel
- Max speed supported by the CPU
- Speed requested by user in BIOS setup screen

Operating voltage of the system is determined by:

- Voltages supported by the DIMMs which is 1.2V
- Voltage supported by the platform

Memory population and configuration

The following table shows the supported memory configurations for the PowerEdge T340

DIMM Speed	DIMM Type	DIMM Capacity (GB)	Ranks per DIMM	Data Width	SDDC Support	DIMM Volts
2666	UDIMM	8	1	x8	Advanced ECC	1.2
2666	UDIMM	8	1	x8	Advanced ECC	1.2
2666	UDIMM	16	1	x8	Advanced ECC	1.2
2666	UDIMM	16	1	x8	Advanced ECC	1.2

DIMM Speed	DIMM Type	DIMM Capacity (GB)	Ranks per DIMM	Data Width	SDDC Support	DIMM Volts
2400	UDIMM	4	1	x8	Advanced ECC	1.2
2400	UDIMM	8	1	x8	Advanced ECC	1.2
2400	UDIMM	8	1	x8	Advanced ECC	1.2
2400	UDIMM	16	2	x8	Advanced ECC	1.2
2400	UDIMM	16	2	x8	Advanced ECC	1.2
2133	UDIMM	4	1	x8	Advanced ECC	1.2
2133	UDIMM	4	1	x8	Advanced ECC	1.2
2133	UDIMM	8	2	x8	Advanced ECC	1.2
2133	UDIMM	8	1	x8	Advanced ECC	1.2
2133	UDIMM	16	2	x8	Advanced ECC	1.2
2133	UDIMM	16	2	x8	Advanced ECC	1.2

The following table shows the memory populations and the system speed:

Table 4. Memory populations and system speed

DIMM Type	DIMM Ranking	Capacity	DIMM Rated voltage	1 DIMM per channel	2 DIMMs per channel
UDIMM	1R/2R	8GB, and 16GB	DDR4 (1.2V)	2666	2666

Storage

The PowerEdge T340 supports up to 8 x 3.5-inch or 2.5-inch hot plug hard drives.

NOTE: Systems with x8 hard drive backplanes configured for software RAID supports only 4 hard drives. The remaining hard drive slots are pre-installed with the four-slot hard drive blank, and cannot be upgraded for additional storage

Both 6Gbps and 12Gbps hard drives are supported. The following table shows the form factor and hard drive type supported by the T340:

	x8 hot plug hard drive with Redundant PSU	x4 hot plug hard drive (system ordered with Software RAID)
Hard drive form factor	3.5-inch or 2.5-inch	3.5-inch or 2.5-inch
Hard drive type	SATA, Nearline SAS, SAS, SSD	SATA, Nearline SAS, SAS, SSD

Topics:

- [Storage controller specifications](#)
- [Optical Drives](#)
- [Tape Drives](#)
- [Internal Dual SD Module](#)

Storage controller specifications

The Dell EMC PowerEdge T340 system supports S140 Software RAID, and H330, H730P RAID controllers. The PowerEdgeT340 systems supports HBA330 for Non-RAID (passthrough) configuration.

NOTE: Dell RAID controller cards purchased after point-of-sell (APOS CUST Kits) are meant to replace or upgrade an existing RAID controller card which would have been factory installed at the time the system was purchased. They are not intended to be purchased for any system that was set up at the factory in a Software RAID configuration over to Hardware RAID.

Optical Drives

One ultra-slim type, 9.5mm, ODD is supported on the PowerEdge T340 via the motherboard embedded SATA. The PowerEdge T340 supports both the ultra-slim SATA DVD-ROM and DVD+/-RW.

If the drive is not ordered with the system, a blank should be installed in its place. ODD cable is 100% included in the chassis even if no ODD is ordered. The PowerEdge T340 has 3 Half height 5.25" bays.

Tape Drives

The Dell EMC PowerEdge T340 supports internal and external tape drives.

The following table lists the supported tape drives for T340:

Internal tape drives	LTO-6, LTO-7, LTO-8 SAS
External tape backup unit	<ul style="list-style-type: none"> • RD1000 USB 3.0 • LTO-6, LTO-7, LTO-8 SAS

Internal Dual SD Module

The Internal Dual SD Module (IDSDM) is optional. The IDSDM contains two SD ports directly on the motherboard. The modules are redundant. Supported iDSDM microSD cards capacity are 8/16/32/64GB

The IDSDM card provides the following functions:

- Dual SD interface is maintained in a mirrored configuration (primary and secondary SD)
- Provides full RAID1 functionality
- Dual SD cards are not required; the module can operate with only one card but will provide no redundancy
- Enables support for Secure Digital eXtended Capacity (SDXC) cards
- USB interface to host system
- I²C interface to host system and onboard EEPROM for out-of-band status reporting
- Onboard LEDs show status of each SD card
- A BIOS Setup Redundancy setting supports Mirror Mode or Disabled

Boot Optimized Storage Subsystem (BOSS)

BOSS is offered as a means of booting the PowerEdge T340 servers to a full OS when:

- A solution such as IDSDM may be desired, but the target OS for BOSS is a full OS (not just a hypervisor)
- The user needs to maximize their number of drive bays

BOSS cards take up a PCIe slot and are not hot-plug capable. 1x or 2x 240GB modules are available. Dual (2x) module configs can be set up for either RAID 1 or No RAID. Single (1x) module configs can only be set up in a No RAID config.

Networking and PCIe

The following lists the supported add in communication cards:

- 10GbE Intel (Dual) Sageville Sage Pond Dual port 10Gb Base-T adapter – FH
- 10GbE Intel (Dual) Fortville Eagle Fountain Dual port 10Gb SFP+ adapter – FH
- 1GbE Intel (Dual) Powerville Troi-Stony Dual port 1Gb Base-T adapter – FH
- 1GbE Intel (Quad) Powerville Lore-Stony Quad port 1Gb Base-T adapter – FH
- 1GbE Broadcom (Dual) 5720 Bashir Dual port 1Gb Base-T adapter – FH
- 1GbE Broadcom (Quad) 5719 Cardassia Quad port 1Gb Base-T adapter – FH
- FC8 Emulex (Dual) Saturn Wildfire Dual port FC8 SFP+ adapter – FH

PCIe slots

The PowerEdge T340 provides four PCI Express expansion slots as follows:

- Slot 1 : x8 PCIe Gen3 for FH/HL from CPU (x8 lanes)
- Slot 2 : x16 PCIe Gen3 for FH/HL from CPU (x8 lanes)
- Slot 3 : x1 PCIe Gen3 for FH/HL from PCH (x1 lanes)
- Slot 4 : x8 PCIe Gen3 for FH/HL from PCH (x4 lanes)

The following table shows the PCIe slot location and specifications:

PCI Slot	Mechanical	Electrical	Height	Length
1	PCIe x 8	PCIe x 8 Gen 3	Full Height	Half Length
2	PCIe x16	PCIe x 8 Gen 3	Full Height	Half Length
3	PCIe x 1	PCIe x 1 Gen 3	Full Height	Half Length
4	PCIe x 8	PCIe x 4 Gen 3	Full Height	Half Length

PCI card dimensions

The PCI card dimensions allowed in the PowerEdge T340 are as below:

Table 5. PCI card dimensions

Card type	Height	Length
Slot 1 (Full-Height, half length card)	69.37 mm (2.731 inches) max	167.65 mm (6.600 inches) max
Slot 2 (Full-Height, half length card)	69.37 mm (2.731 inches) max	167.65 mm (6.600 inches) max
Slot 3 (Full-Height, half length card)	69.37 mm (2.731 inches) max	167.65 mm (6.600 inches) max
Slot 4 (Full-Height, half length card)	69.37 mm (2.731 inches) max	167.65 mm (6.600 inches) max

Power, thermal, and acoustics

Topics:

- [Power supply units](#)
- [Thermal](#)
- [Acoustics](#)

Power supply units

The PowerEdge T340 power supply subsystem consists of one or two AC-DC power supplies (1+1 redundant configuration only support on 86mm PSU). The power supply provides +12V and +12Vaux for non-redundant and redundant design. There are several voltage regulators in the system to supply different voltage levels needed by different logic devices. The redundant power supplies are managed through a PMBus interface.

There are two power supplies supported by the T340 :

Table 6. T340 Power supply units

	T340 Cable PSU	T340 Redundant PSU
350W AC 2U Cable Bronze	v	
495W AC 1U Redundant Platinum		v

A redundant system consists of two power supplies in a 1+1 configuration. The power supplies connect directly to the system board.

Thermal

Heat dissipation i NOTE: Heat dissipation is calculated using the power supply wattage rating.	1455 BTU/hr maximum (350 W PSU) 1908 BTU/hr maximum (495 W PSU)
Voltage i NOTE: This system is also designed to be connected to IT power systems with a phase-to-phase voltage not exceeding 230 V.	100–240 V AC, autoranging, 50/60 Hz

Acoustics

PowerEdge T340 acoustics

Dell EMC PowerEdge T340 is a tower server appropriate for typical environment. However, lower acoustical output is attainable with proper hardware or software configurations. For example, the minimum configuration of T340 is quiet enough for a quieter office environment

PowerEdge T340 acoustical dependencies

- **Ambient Temperature.** For a similar workload fan speeds (and thus, acoustical noise) may increase as ambient temperature increases.
- **High Wattage CPU.** High-power (TDP) CPU parts may result in higher acoustical noise output.
- **System Thermal Profile Selected in BIOS.** The default setting is “Power Optimized (DAPC)”, which generally means lower fan speed and acoustics. If “Performance Optimized” is selected, fan speed and acoustical noise may increase.

Methods to reduce acoustical output of the T340

- Although the T340 is designed for use in typical office environment, some users may prefer a quieter output. Dell EMC suggests the following. It is important to note that in most cases, the baseline idle fan speed of the system cannot be lowered without changing the configuration of the system, and in some cases, even a configuration change may not reduce idle fan speeds.
- Reduce Ambient Temperature. Lowering the ambient temperature allows the system to cool components more efficiently than at higher ambient temperatures.
- Optimize Third Party PCI Card Options.
- Replace Third Party PCI Cards with similar Dell Supported Temperature PCI Controlled Cards, if available. Dell EMC works diligently with card vendors to validate and develop PCI cards to meet Dell EMC’s exacting standards for thermal performance.
- HDD Quantity. An incremental reduction in acoustical output may be gained by reducing the quantity of HDDs.

PowerEdge T340 Acoustical performance data

Acoustical performance for two configurations are provided: typical and feature rich. The following tables contains a summary of the configuration and acoustical performance of the PE T340. Each configuration has been tested according to Dell EMC acoustical standards for tower servers

Configuration	Minimum	Typical	Feature Rich
CPU Type	Intel E2124	Intel E2124	Intel E2146G
CPU TDP	71 W	71 W	80 W
CPU Quantity	1	1	1
Memory Type	8GB, UDIMM	16GB, UDIMM	32GB, UDIMM
DIMM Quantity	1	2	4
Back Plane Type	4x 3.5"	8x 3.5"	8x 3.5"
HDD Type	7.2K RPM SATA	7.2K RPM SATA	10K RPM SAS
HDD Quantity	1	4	8
PSU Type	350W Cabled	495W Hot-Swap	495W Hot-Swap
PSU Quantity	1	2	2
Internal PERC	None	None	PERC H330

Acoustical Performance: Idle/ Operating @ 25 °C Ambient				
LwA-UL ² (Bels)	Idle ¹	3.8	3.9	4.3
	Operating ¹	4.3	4.8	4.8
LpA ³ (dBA)	Idle ¹	23	26	27
	Operating ¹	30	31	34

Acoustical Performance: Idle/ Operating @ 28 °C Ambient			
LwA-UL ² (Bels)	5.1	5.1	5.1

Acoustical Performance: Idle/ Operating @ 28 °C Ambient			
LpA ³ (dBA)	35	35	35

Acoustical Performance: Max. Loading @ 35 °C Ambient			
LwA-UL ² (Bels)	6.8	6.8	6.8
LpA ³ (dBA)	52	52	52

- i** **NOTE:** 1. Idle means the state in which the product is doing nothing but running OS, and values for Operating are the maximum of acoustical output for active HDDs or active processors.
- i** **NOTE:** 2. LwA-UL is the upper limit sound power levels (LwA) calculated per section 4.4.1 of ISO 9296 (1988) with data collected in accordance with ISO 7779 (2010) from a single sample with a total 0.3 bel production deviation applied.
- i** **NOTE:** 3. LpA is the A-weighted sound pressure level at the bystander position per section 4.3 of ISO 9296 (1988) and measured in accordance to ISO 7779 (2010).

Supported operating systems

The following lists the supported operating systems for the PowerEdge T340:

- Windows 2019 with Hyper-V Standard
- Windows 2019 Essentials
- Windows 2016 with Hyper-V Standard
- Windows 2016 Essentials
- Windows 2012 R2 Essentials
- Windows 2012 R2 Standard

 **NOTE:** Windows 2012 R2 is not supported with E-2200 processor configurations.

- RHEL 7.5
- SLES 15
- Ubuntu server 18.04.1
- Citrix XenServer 7.1
- VMWare ESXi 6.7
- VMWare ESXi 6.5

Dell EMC OpenManage systems management

Dell EMC OpenManage Portfolio

Simplifying hardware management through ease of use and automation

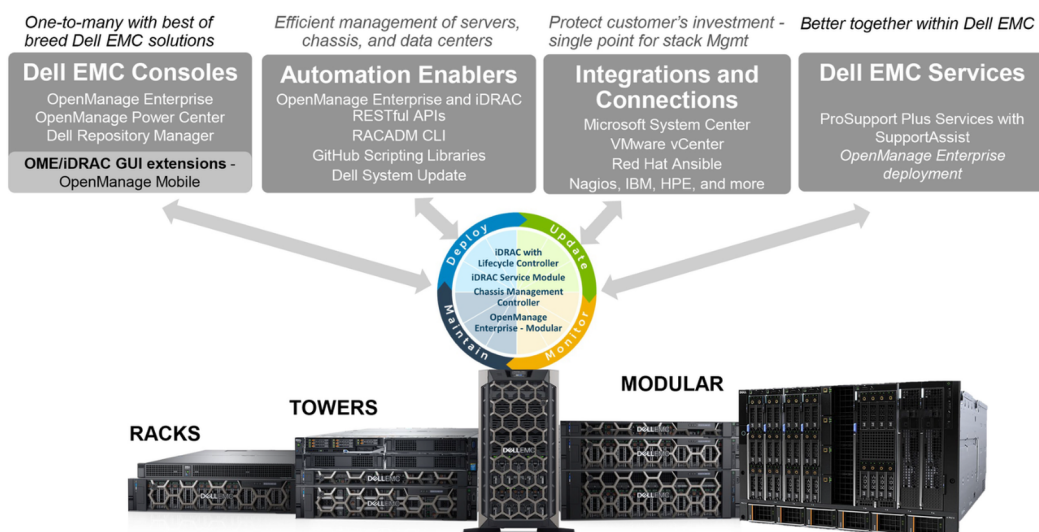

Figure 7. Dell EMC OpenManage Portfolio

Dell EMC delivers management solutions that help IT Administrators effectively deploy, update, monitor, and manage IT assets. OpenManage solutions and tools enable you to quickly respond to problems by helping them to manage Dell EMC servers effectively and efficiently; in physical, virtual, local, and remote environments, operating in-band, and out-of-band (agent-free). The OpenManage portfolio includes innovative embedded management tools such as the integrated Dell Remote Access Controller (iDRAC), Chassis Management Controller and Consoles like OpenManage Enterprise, OpenManage Power Manager plug in, and tools like Repository Manager.

Dell EMC has developed comprehensive systems management solutions based on open standards and has integrated with management consoles that can perform advanced management of Dell hardware. Dell EMC has connected or integrated the advanced management capabilities of Dell hardware into offerings from the industry's top systems management vendors and frameworks such as Ansible, thus making Dell EMC platforms easy to deploy, update, monitor, and manage.

The key tools for managing Dell EMC PowerEdge servers are iDRAC and the one-to-many OpenManage Enterprise console. OpenManage Enterprise helps the system administrators in complete lifecycle management of multiple generations of PowerEdge servers. Other tools such as Repository Manager, which enables simple yet comprehensive change management.

OpenManage tools integrate with systems management framework from other vendors such as VMware, Microsoft, Ansible, and ServiceNow. This enables you to use the skills of the IT staff to efficiently manage Dell EMC PowerEdge servers.

Topics:

- [Server and Chassis Managers](#)
- [Dell EMC consoles](#)
- [Automation Enablers](#)
- [Integration with third-party consoles](#)
- [Connections for third-party consoles](#)
- [Dell EMC Update Utilities](#)
- [Dell resources](#)

Server and Chassis Managers

- Integrated Dell Remote Access Controller (iDRAC)
- iDRAC Service Module (iSM)

Dell EMC consoles

- Dell EMC OpenManage Enterprise
- Dell EMC Repository Manager (DRM)
- Dell EMC OpenManage Enterprise Power Manager plugin to OpenManage Enterprise
- Dell EMC OpenManage Mobile (OMM)

Automation Enablers

- OpenManage Ansible Modules
- iDRAC RESTful APIs (Redfish)
- Standards-based APIs (Python, PowerShell)
- RACADM Command Line Interface (CLI)
- GitHub Scripting Libraries

Integration with third-party consoles

- Dell EMC OpenManage Integrations with Microsoft System Center
- Dell EMC OpenManage Integration for VMware vCenter (OMIVV)
- Dell EMC OpenManage Ansible Modules
- Dell EMC OpenManage Integration with ServiceNow

Connections for third-party consoles

- Micro Focus and other HPE tools
- OpenManage Connection for IBM Tivoli
- OpenManage Plug-in for Nagios Core and XI

Dell EMC Update Utilities

- Dell System Update (DSU)
- Dell EMC Repository Manager (DRM)
- Dell EMC Update Packages (DUP)
- Dell EMC Server Update Utility (SUU)
- Dell EMC Platform Specific Bootable ISO (PSBI)

Dell resources

For additional information about white papers, videos, blogs, forums, technical material, tools, usage examples, and other information, go to the OpenManage page at <https://www.dell.com/openmanagemanuals> or the following product pages:

Table 7. Dell resources

Resource	Location
Integrated Dell Remote Access Controller (iDRAC)	https://www.dell.com/idracmanuals
iDRAC Service Module (iSM)	https://www.dell.com/support/article/sln310557
OpenManage Ansible Modules	https://www.dell.com/support/article/sln310720
OpenManage Essentials (OME)	https://www.dell.com/support/article/sln310714
OpenManage Mobile (OMM)	https://www.dell.com/support/article/sln310980
OpenManage Integration for VMware vCenter (OMIVV)	https://www.dell.com/support/article/sln311238
OpenManage Integration for Microsoft System Center (OMIMSSC)	https://www.dell.com/support/article/sln312177
Dell EMC Repository Manager (DRM)	https://www.dell.com/support/article/sln312652
Dell EMC System Update (DSU)	https://www.dell.com/support/article/sln310654
Dell EMC Platform Specific Bootable ISO (PSBI)	Dell.com/support/article/sln296511
Dell EMC Chassis Management Controller (CMC)	www.dell.com/support/article/sln311283
OpenManage Connections for Partner Consoles	https://www.dell.com/support/article/sln312320
OpenManage Enterprise Power Manager	https://www.dell.com/solutions/openmanage/power-management.htm
OpenManage Integration with ServiceNow (OMISNOW)	Dell.com/support/article/sln317784

 **NOTE:** Features may vary by server. Please refer to the product page on <https://www.dell.com/manuals> for details.

Appendix A. Additional specifications

The following sections contain information about additional system specifications.

Topics:

- [Technical specifications](#)

Technical specifications

The technical and environmental specifications of your system are outlined in this section.

Chassis dimensions

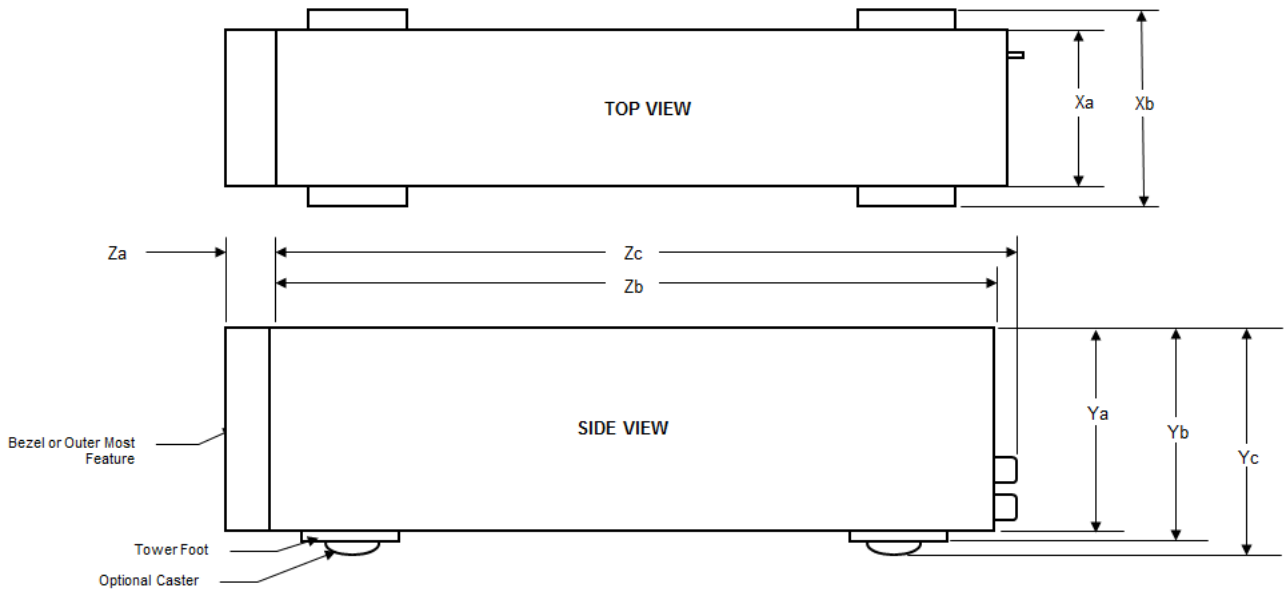

Figure 8. Chassis dimensions

Table 8. Dell EMC PowerEdge T340 chassis dimensions

Xa	Xb	Ya	Yb	Yc	Za	Zb	Zc
218 mm (8.58 inches)	307.9 mm (12.12 inches)	430.3 mm (16.94 inches)	443.3 mm (17.45 inches)	471.3 mm (18.56 inches)	With bezel: 14.1 mm (0.56 inches)	545.4 mm (21.47 inches)	589.1 mm (23.19 inches)

System weight

Table 9. Dell EMC PowerEdge T340 system chassis weight

System configuration	Maximum weight (with all drives/SSDs)
8 x 3.5-inch drives	26 Kg (57.32 lb)

Video specifications

The Dell EMC PowerEdge T340 system supports integrated Matrox G200 graphics controller with 16 MB of video frame buffer.

Table 10. Supported video resolution options

Resolution	Refresh rate (Hz)	Color depth (bits)
640 x 480	60, 72	8, 16, 24
800 x 600	60, 75, 85	8, 16, 24
1024 x 768	60, 75, 85	8, 16, 24
1152 x 864	60, 75, 85	8, 16, 24
1280 x 1024	60, 75	8, 16, 24

USB ports specifications

Table 11. Dell EMC PowerEdge T340 system USB port specifications

Front panel	Back panel	Internal USB
<ul style="list-style-type: none"> One USB 3.0-compliant port One iDRAC USB MGMT port (USB 2.0) <p>NOTE: The micro USB 2.0 compliant port can only be used as an iDRAC Direct or a management port.</p>	<ul style="list-style-type: none"> Two USB 3.0-compliant ports Four USB 2.0-compliant ports 	<ul style="list-style-type: none"> One internal USB 3.0-compliant port

NIC ports specifications

The Dell EMC PowerEdge T340 system supports up to two 10/100/1000 Mbps Network Interface Controller (NIC) ports that are located on the back panel.

Environmental specifications

This section includes the environmental specifications for the PowerEdge T340

Feature	Descriptions
Temperature	<ul style="list-style-type: none"> Maximum temperature gradient (Operating and storage) <ul style="list-style-type: none"> 20 °C/h (36 °F/h) Storage temperature limits <ul style="list-style-type: none"> -40 °C to 65 °C (-40 °F to 149 °F)
Relative humidity	<ul style="list-style-type: none"> 5% to 95% RH with 33 °C (91 °F) maximum dew point. Atmosphere must be noncondensing at all times.

Feature	Descriptions
Temperature (continuous operation)	<ul style="list-style-type: none"> ● Temperature ranges (for altitude less than 950 m or 3117 ft) <ul style="list-style-type: none"> ○ 10 °C to 35 °C (50 °F to 95 °F) with no direct sunlight on the equipment. ● Humidity percentage range <ul style="list-style-type: none"> ○ 10% to 80% Relative Humidity with 29 °C(84.2 °F) maximum dew point.
Maximum vibration	<ul style="list-style-type: none"> ● Operating <ul style="list-style-type: none"> ○ 0.26 Grms at 5 Hz to 350 Hz (operationorientation). ● Storage <ul style="list-style-type: none"> ○ 1.88 Grms at 10 Hz to 500 Hz for 15 min (allsix sides tested).
Maximum shock	<ul style="list-style-type: none"> ● Operating <ul style="list-style-type: none"> ○ Six consecutively executed shock pulses in the positive and negative x, y, and z axes of 40 G for up to 2.3 ms. ● Storage <ul style="list-style-type: none"> ○ One pulse on each side of the system of 71 G up to 2 ms.
Maximum altitude	<ul style="list-style-type: none"> ● Operating <ul style="list-style-type: none"> ○ 3,048 m (10,000 ft) ● Storage <ul style="list-style-type: none"> ○ 12,000 m (39,370 ft)
Operating Altitude De-rating, Up to 35 °C (95 °F)	<ul style="list-style-type: none"> ● Maximum temperature is reduced by 1°C/300 m (1 °F/547 ft) above 950 m (3,117 ft).
Operating Altitude De-rating, 35 °C to 40 °C (95 °F to 104 °F)	<ul style="list-style-type: none"> ● Maximum temperature is reduced by 1°C/175 m (1 °F/319 ft) above 950 (3,117 ft)
Operating Altitude De-rating, 40 °C to 45 °C (104 °F to 113 °F)	<ul style="list-style-type: none"> ● Maximum temperature is reduced by 1°C/125 m (1 °F/228 ft) above 950 m (3,117 ft).

Appendix B. Standards compliance

Table 12. Industry standard documents

Standard	URL for information and specifications
ACPI Advance Configuration and Power Interface Specification, v2.0c	acpi.info
Ethernet IEEE 802.3-2005	standards.ieee.org/getieee802/802.3.html
HDG Hardware Design Guide Version 3.0 for Microsoft Windows Server	microsoft.com/whdc/system/platform/pcdesign/desguide/serverdg.msp
IPMI Intelligent Platform Management Interface, v2.0	intel.com/design/servers/ipmi
DDR4 Memory DDR4 SDRAM Specification	jedec.org/standards-documents/docs/jesd79-4.pdf
PCI Express PCI Express Base Specification Rev. 2.0 and 3.0	pcisig.com/specifications/pciexpress
PMBus Power System Management Protocol Specification, v1.2	pmbus.info/specs.html
SAS Serial Attached SCSI, v1.1	t10.org
SATA Serial ATA Rev. 2.6; SATA II, SATA 1.0a Extensions, Rev. 1.2	sata-io.org
SMBIOS System Management BIOS Reference Specification, v2.7	dmtf.org/standards/smbios
TPM Trusted Platform Module Specification, v1.2 and v2.0	trustedcomputinggroup.org
UEFI Unified Extensible Firmware Interface Specification, v2.1	uefi.org/specifications
USB Universal Serial Bus Specification, Rev. 2.0	usb.org/developers/docs

Appendix C Additional resources

Table 13. Additional resources

Resource	Description of contents	Location
Installation and Service Manual	This manual, available in PDF format, provides the following information: <ul style="list-style-type: none"> • Chassis features • System Setup program • System messages • System codes and indicators • System BIOS • Remove and replace procedures • Troubleshooting • Diagnostics • Jumpers and connectors 	Dell.com/Support/Manuals
Getting Started Guide	This guide ships with the system, and is also available in PDF format. This guide provides the following information: <ul style="list-style-type: none"> • Initial setup steps • Key system features • Technical specifications 	Dell.com/Support/Manuals
Rack Installation Instructions	This document ships with the rack kits, and provides instructions for installing a server in a rack.	Dell.com/Support/Manuals
Information Update	This document ships with the system, is also available in PDF format online, and provides information on system updates.	Dell.com/Support/Manuals
System Information Label	The system information label documents the system board layout and system jumper settings. Text is minimized due to space limitations and translation considerations. The label size is standardized across platforms.	Inside the system chassis cover
Quick Resource Locator (QRL)	This code on the chassis can be scanned by a phone application to access additional information and resources for the server, including videos, reference materials, service tag information, and Dell EMC contact information.	Inside the system chassis cover
Energy Smart Solution Advisor (ESSA)	The Dell EMC online ESSA enables easier and more meaningful estimates to help you determine the most efficient configuration possible. Use ESSA to calculate the power consumption of your hardware, power infrastructure, and storage.	Dell.com/calc

Appendix D. Support and deployment services

Topics:

- Dell EMC ProDeploy Enterprise Suite
- Deployment services
- Dell EMC Remote Consulting Services
- Dell EMC Data Migration Service
- ProSupport Enterprise Suite
- ProSupport Plus
- ProSupport
- ProSupport One for Data Center
- Support Technologies
- Additional professional services
- Dell Education Services
- Dell EMC Global Infrastructure Consulting Services
- Dell EMC Managed Services

Dell EMC ProDeploy Enterprise Suite

ProDeploy Enterprise Suite gets your server out of the box and into optimized production—fast. Our elite deployment engineers with broad and deep experience utilizing best-in-class processes along with our established global scale can help you around the clock and around the globe. From simple to the most complex server installations and software integration, we take the guess work and risk out of deploying your new server technology.

		Basic Deployment	ProDeploy	ProDeploy Plus
Pre-deployment	Single point of contact for project management		•	In-region
	Site readiness review		•	•
	Implementation planning		•	•
	Technology Service Manager (TSM) engagement for ProSupport Plus entitled devices			•
Deployment	Deployment service hours	Business hours	24x7	24x7
	Onsite hardware installation*	•	•	•
	Packaging materials disposal	•	•	•
	Install and configure system software		•	Onsite
Post-deployment	Project documentation with knowledge transfer		•	•
	Deployment verification		•	•
	Configuration data transfer to Dell EMC technical support		•	•
	30-days of post-deployment configuration assistance			•
	Training credits for Dell EMC Education Services			•

Figure 9. ProDeploy Enterprise Suite capabilities

NOTE: Hardware installation not applicable on selected software products.

Dell EMC ProDeploy Plus

From beginning to end, ProDeploy Plus provides the skill and scale needed to successfully execute demanding deployments in today's complex IT environments. Certified Dell EMC experts start with extensive environmental assessments and detailed migration planning and recommendations. Software installation includes set up of most versions of Dell EMC SupportAssist and

OpenManage system management utilities. Post-deployment configuration assistance, testing, and product orientation services are also available.

Dell EMC ProDeploy

ProDeploy provides full service installation and configuration of both server hardware and system software by certified deployment engineers including set up of leading operating systems and hypervisors as well as most versions of Dell EMC SupportAssist and OpenManage system management utilities. To prepare for the deployment, we conduct a site readiness review and implementation planning exercise. System testing, validation, and full project documentation with knowledge transfer complete the process.

Dell EMC Basic Deployment

Basic Deployment delivers worry-free professional installation by experienced technicians who know Dell EMC servers inside and out.

Dell EMC Residency Services

Residency Services helps customers transition to new capabilities quickly with the assistance of on-site or remote Dell EMC experts whose priorities and time you control. Residency experts can provide post implementation management and knowledge transfer related to a new technology acquisition or day-to-day operational management of the IT infrastructure.

Deployment services

Deployment services details and exceptions can be found in service description documents at the Enterprise Configuration and Deployment page on Dell.com.

Dell EMC Remote Consulting Services

When you are in the final stages of your PowerEdge server implementation, you can rely on Dell EMC Remote Consulting Services and our certified technical experts to help you optimize your configuration with best practices for your software, virtualization, server, storage, networking, and systems management.

Dell EMC Data Migration Service

Protect your business and data with our single point of contact to manage your data migration project. Your project manager will work with our experienced team of experts to create a plan using industry-leading tools and proven processes based on global best practices to migrate your existing files and data so your business system get up and running quickly and smoothly.

ProSupport Enterprise Suite

With the ProSupport Enterprise Suite, we can help you keep your operation running smoothly, so you can focus on running your business. We will help you maintain peak performance and availability of your most essential workloads. ProSupport Enterprise Suite is a suite of support services that enable you to build the solution that is right for your organization. Choose support models based on how you use technology and where you want to allocate resources. From the desktop to the data center, address everyday IT challenges, such as unplanned downtime, mission-critical needs, data and asset protection, support planning, resource allocation, software application management and more. Optimize your IT resources by choosing the right support model.



Figure 10. ProSupport Enterprise Suite

ProSupport Plus

When you purchase PowerEdge servers, we recommend ProSupport Plus, our proactive and preventative support, for business-critical systems. ProSupport Plus provides all the benefits of ProSupport, plus the following:

- An assigned Services Account Manager (SAM) who knows your business and your environment
- Access to senior ProSupport engineers for faster issue resolution
- Personalized, preventive recommendations based on analysis of support trends and best practices from across the Dell EMC customer base to reduce support issues and improve performance
- Predictive analysis for issue prevention and optimization enabled by SupportAssist
- Proactive monitoring, issue detection, notification and automated case creation for accelerated issue resolution enabled by SupportAssist
- On-demand reporting and analytics-based recommendations enabled by SupportAssist and TechDirect

ProSupport

Our ProSupport service offers highly trained experts around the clock and around the globe to address your IT needs. We will help you minimize disruptions and maximize availability of your PowerEdge server workloads with:

- 24x7x365 access to certified hardware and software experts
- Collaborative 3rd party support
- Hypervisor and OS support
- Consistent level of support available for Dell EMC hardware, software and solutions
- Onsite parts and labor response options including next business day or four-hour mission critical

ProSupport One for Data Center

ProSupport One for Data Center offers flexible site-wide support for large and distributed data centers with more than 1,000 assets. This offering is built on standard ProSupport components that leverage our global scale but are tailored to your

company's needs. While not for everyone, it offers a truly unique solution for Dell EMC's largest customers with the most complex environments.

- Team of assigned Services Account Managers (SAM) with remote, on-site options
- Assigned ProSupport One technical and field engineers who are trained on your environment and configurations
- On-demand reporting and analytics-based recommendations enabled by SupportAssist and TechDirect
- Flexible on-site support and parts options that fit your operational model
- A tailored support plan and training for your operations staff

Enterprise Support Services Feature Comparison

	ProSupport	ProSupport Plus	ProSupport One for Data Center
Remote technical support	24x7	24x7	24x7
Onsite support	Next business day or Mission Critical	Next business day or Mission Critical	Flexible
Automated issue detection and case creation	•	•	•
Self-service case initiation and management	•	•	•
Hypervisor, Operating Environment Software and OS support	•	•	•
Priority access to specialized support experts		•	•
Designated Technology Service Manager		•	•
Personalized assessments and recommendations		•	•
On-demand support and utilization reports		•	•
Systems Maintenance guidance		Semiannual	Optional
Designated technical and field support teams			•

Figure 11. ProSupport One for Data Center model

Support Technologies

Powering your support experience with predictive, data-driven technologies.

SupportAssist

The best time to solve a problem is before it happens. The automated proactive and predictive technology SupportAssist* helps reduce steps and time to resolution, often detecting issues before they become a crisis. Benefits include:

- Value - SupportAssist is available to all customers at no additional charge.
- Improve productivity - replace manual, high-effort routines with automated support.
- Accelerate time to resolution - receive issue alerts, automatic case creation and proactive contact from Dell EMC experts.
- Gain insight and control - optimize enterprise devices with on-demand ProSupport Plus reporting in TechDirect and get predictive issue detection before the problem starts.

SupportAssist is included with all support plans but features vary based on service level agreement.

	Basic Hardware Warranty	ProSupport	ProSupport Plus
Automated issue detection and system state information collection	•	•	•
Proactive, automated case creation and notification		•	•
Predictive issue detection for failure prevention			•
Recommendation reporting available on-demand in TechDirect			•

Figure 12. SupportAssist model

Get started at Dell.com/SupportAssist

TechDirect

Boost your IT teams productivity when supporting Dell EMC systems. With over 1.4 million self-dispatches processed each year, TechDirect has proven its effectiveness as a support tool. You can:

- Self-dispatch replacement parts
- Request technical support
- Integrate APIs into your help desk

Or, access all your Dell EMC certification and authorization needs. Train your staff on Dell EMC products as TechDirect allows you to:

- Download study guides
- Schedule certification and authorization exams
- View transcripts of completed courses and exams

Register at techdirect.dell.com

Additional professional services

Dell Education Services

Dell Education Services offers the PowerEdge server training courses designed to help you achieve more with your hardware investment. The curriculum is designed in conjunction with the server development team, as well as Dell EMC's technical support team, to ensure that the training delivers the information and practical, hands-on skills you and your team need to confidently manage and maintain your Dell EMC server solution. To learn more or register for a class today, visit LearnDell.com/Server.

Dell EMC Global Infrastructure Consulting Services

Dell EMC Global Infrastructure Consulting Services use skilled solution architects, innovative tools, automated analysis and Dell EMC's intellectual property to give rapid insight into the root causes of unnecessary complexity. We seek better answers than traditional service models, and our strategy is to help quickly identify high-impact, short-duration projects that deliver return on investment (ROI) and free up resources. The results are practical, action-oriented plans with specific, predictable, measurable outcomes. From data center optimization to server virtualization to systems management, our consulting services can help build a more efficient enterprise.

Dell EMC Managed Services

Dell EMC Managed Services are a modular set of lifecycle services designed to help you automate and centrally configure, deploy, and manage your day-to-day data center operations. These services extend your existing on-premise IT infrastructure with off-premise cloud services designed to better address challenges with mobility, highly distributed organizations, security, compliance, business continuity, and disaster preparedness.