



THE  
AMERICAN  
JOURNAL OF SCIENCE.

EDITOR: EDWARD S. DANA.

ASSOCIATE EDITORS

PROFESSORS GEORGE L. GOODALE, JOHN TROWBRIDGE,  
W. G. FARLOW AND WM. M. DAVIS, OF CAMBRIDGE,

PROFESSORS ADDISON E. VERRILL, HORACE L. WELLS,  
L. V. PIRSSON AND H. E. GREGORY, OF NEW HAVEN,

PROFESSOR GEORGE F. BARKER, OF PHILADELPHIA,

PROFESSOR HENRY S. WILLIAMS, OF ITHACA,

PROFESSOR JOSEPH S. AMES, OF BALTIMORE,

MR. J. S. DILLER, OF WASHINGTON.

---

FOURTH SERIES

VOL. XXV—[WHOLE NUMBER, CLXXV.]

WITH PLATES I-III.

---

NEW HAVEN, CONNECTICUT.

1908

203298

THE TUTTLE, MOREHOUSE & TAYLOR COMPANY,  
NEW HAVEN



## CONTENTS TO VOLUME XXV.

Number 145.

	Page
ART. I.—Contributions to the Geology of Rhode Island ; by B. L. JOHNSON and C. H. WARREN .....	1
II.—Esterification of Benzoic Acid ; by I. K. and M. A. PHELPS, and R. W. OSBORNE .....	39
III.—Description of the Williamstown Meteorite ; by E. E. HOWELL .....	49
IV.—Descriptions of Tertiary Insects ; by T. D. A. Cock- ERELL .....	51
V.—Stratigraphy of the Mt. Taylor Region, New Mexico ; by H. W. SHIMER and M. E. BLODGETT .....	53
VI.—Mammalian Migrations between Europe and North America ; by W. D. MATTHEW .....	68
VII.—Notes on Powellite and Molybdate ; by W. T. SCHALLER .....	71
VIII.—Hydrolysis of Ammonium Molybdate in the Presence of Iodides and Iodates ; by S. E. MOODY.....	76

### SCIENTIFIC INTELLIGENCE.

*Chemistry and Physics*—Parent-Substance of Radium, HAHN : Reduction of Arsenic Trisulphide and Pentasulphide to Disulphide, EHRENFELD, 79.—Titanium trichloride for Volumetric Analysis, KNECHT and HIBBERT : *Traité de Chemie Analytique Qualitative*, DUPARC et MONNIER : *Kurzes Lehrbuch der organischen Chemie*, W. A. NOYES, 80.—History of Chemistry, H. BAUER : *Beiträge zur chemischen Physiologie*, F. HOFMEISTER : *Immuno-Chemistry*, S. ARRHENIUS, 81.

*Geology and Mineralogy*—Geological Survey of New Jersey, H. B. KÜMMEL : *Geology and Natural Resources of Indiana*, W. S. BLATCHLEY, 82.—West Virginia Geological Survey County Reports, G. P. GRIMSLEY and I. C. WHITE : *Geological Map of the Colony of the Cape of Good Hope*, A. L. DU TOIT : *Geology of the Parapara subdivision, Karamea, Nelson*, J. MACKINTOSH BELL, 83.—Om Fladdale og Randmoræner i Jylland ; N. V. USSING : *Die Alpen im Eiszeitalter*, A. PENCK und E. BRÜCKNER : *Revision of the Pelycosauria of North America*, E. C. CASE, 84.—Skull of *Brachauchenius*, S. W. WILLISTON, 85.—Hell Creek Beds of the Upper Cretaceous of Montana, B. BROWN : *Ueber die Dinosaurier der Ausserenropäischen Trias*, F. v. HUENE, 86.—Diamonds in garnet-pyroxene nodules in Kimberlite, 87.

*Miscellaneous Scientific Intelligence*—*Microscopy of Technical Products*, T. F. HANAUSEK, 87.—*Lehrbuch der Mikroskopischen Technik*, B. RAWITZ, 88.—*Souvenirs Entomologiques*, J. H. FABRE : *Papers and Addresses of the Ninth Annual Session of the American Mining Congress, 1906* : *Ricerche Lagunari per cura di G. P. MAGRINI, L. DE MARCHI, T. GNESOTTA* : *Die Eistrift aus dem Bereich der Baffin-Bai beherrscht von Strom und Wetter*, L. MECKING : *Ostwald's Klassiker der Exakten Wissenschaften*, 89.

*Obituary*—Professor A. HALL, 90.—Dr. B. J. HARRINGTON, 91.—LORD KELVIN : Dr. L. M. UNDERWOOD, 92.

## Number 146.

	Page
ART. IX.—Historic Fossil Cycads; by G. R. WIELAND.....	93
X.—Accelerated Cone Growth in Pinus; by G. R. WIELAND	102
XI.—Ainsworth Meteorite; by E. E. HOWELL.....	105
XII.—High Level Terraces in Southeastern Ohio; by G. D. HUBBARD.....	108
XIII.—Triassic Reptile, Hallopus Victor, Marsh; by F. R. VON HUENE and R. S. LULL.....	113
XIV.—Species of Grapsoid Crustacean; by A. E. VERRILL	119
XV.—Tourmaline of Crown Point, N. Y.; by W. M. P. BLAKE	123
XVI.—Silurian Fauna in Western America; by E. M. KINDLE	125
XVII.—Method for the Volumetric Estimation of Titanium; by H. D. NEWTON.....	130
XVIII.—Isopyrum biternatum Torr. et Gr.; by T. HOLM..	133
XIX.—Phosphorescence Produced by the Canal Rays; by J. TROWBRIDGE.....	141
XX.—Application of a Longitudinal Magnetic Field to X-ray Tubes; by J. TROWBRIDGE.....	143

## SCIENTIFIC INTELLIGENCE.

- Chemistry and Physics*—Condensation of Water Vapor in the Presence of Radium Emanation, MME. CURIE: Gaseous Nitrogen Trioxide, BAKER and BAKER, 145.—Atomic Weight of Tellurium, BAKER and BENNETT: New Element, Lutecium, G. URBAIN: Association of Helium and Thorium, STRUTT: Organic Chemistry for Advanced Students, J. B. COHEN, 146.—Radio-activity of Lead and Other Metals, J. C. McLENNAN: Production and Origin of Radium, E. RUTHERFORD: Radium Emanation in the Atmosphere near the Earth's Surface, A. S. EVE: Anomalies in the Behavior of Dielectrics, E. R. v. SCHWEIDLER: Effect of Pressure upon Arc Spectra, W. G. DUFFIELD, 147.—Modification of the First Linear Spectrum of Mercury, E. CASTELLI: Gas from Aluminum Electrodes, R. v. HIRSCH and F. SODDY: Two New Worlds, E. E. FOURNIER D'ALBE, 148.
- Geology*—United States Geological Survey, G. O. SMITH, 149, 150.—Report on the Cretaceous Paleontology of New Jersey, 152.—Die Gastropoden des Karnischen Unterdevon, A. SPITZ, 153.—Geologic Map of the Rochester and Ontario Beach Quadrangles, C. A. HARTNAGEL: Scapolite Rocks, J. E. SPURR: Geological Structure of the Highlands of Scotland, PEACH and HORNE: Geological Sections of the Alps: Südafrika, S. PASSARGE, 155.—Production of Gold and Silver in 1906, LINDGREN: Origin of Meteor Crater, Arizona, H. L. FAIRCHILD, 156.—Granite and Gneiss, J. J. SEDERHOLM, 157.
- Zoology*—Madreporaria of the Hawaiian Islands and Laysan, T. W. VAUGHAN: Madreporaires d'Amboine, M. BEDOT: Crustacea of Norway, G. O. SARS: North American Parasitic Copepods, C. B. WILSON, 158.—Echinoidea of the Danish Ingolf Expedition, T. MORTENSEN: Bermuda in Periodical Literature, G. W. COLE: Parasites of Bermuda Fishes, E. B. LINTON: Fishes of North Carolina, H. M. SMITH, 159.—Comparative Anatomy of Vertebrates, W. N. PARKER: Natural History Essays, G. RENSRAW, 160.
- Miscellaneous Scientific Intelligence*—Report of the Secretary of the Smithsonian Institution, 160.—Report of the U. S. National Museum: Carnegie Institution of Washington; Year Book No. 6, 162.—Carnegie Foundation for the Advancement of Teaching, 164.—Bulletin of the Mount Weather Observatory: Publications of the Allegheny Observatory: Les Prix Nobel, 165.—Mechanics, W. S. FRANKLIN and B. MACNUTT, 166.
- Obituary*—C. A. YOUNG, 166.—P. J. C. JANSSEN: P. T. AUSTIN, 168.

## Number 147.

	Page
ART. XXI.—Evolution of the Elephant ; by R. S. LULL . . . .	169
XXII.—Manganese Ore Deposits of Brazil ; by O. A. DERBY	213
XXIII.—Possible Overflow Channel of Pondered Waters Antedating the Recession of Wisconsin Ice ; by F. CARNEY	217
XXIV.—Axial Colors of the Steam Jet and of Coronas ; by C. BARUS . . . . .	224
XXV.—Descriptions of Tertiary Insects, II ; by T. D. A. COCKERELL . . . . .	227
XXVI.—Reduction of Vanadic Acid by Zinc and Magnesium ; by F. A. GOOCH and G. EDGAR . . . . .	233
XXVII.—Ancient Finger Lakes in Ohio ; by G. D. HUBBARD	239
XXVIII.—Stephanite Crystals from Arizpe, Sonora, Mexico ; by W. E. FORD . . . . .	244
XXIX.—Use of the Filtering Crucible in Electrolytic Analysis ; by F. A. GOOCH and F. B. BEYER . . . . .	249

## SCIENTIFIC INTELLIGENCE.

*Chemistry and Physics*—Phosphorescent Elements, G. URBAIN : Metallic Vacuum Vessels for Liquid Air, J. DEWAR : Manganese and the Periodic Law, REYNOLDS, 256.—Higher Oxides of Manganese, MEYER and RÖTGER : White Phosphorus, LLEWELLYN, 257.—Radiometer for Measurement of Low Pressures, J. DEWAR : Existence of Positive Electrons in the Sodium Atom, R. W. WOOD : Magnetic Effect of Cathode Rays, E. KLUPATHY : Practical Physics, W. S. FRANKLIN, C. M. CRAWFORD and B. MACNUTT : Praktische Photometrie, E. LIEBENTHAL, 258.—Principles of Physics, A. P. GAGE : Text-book in Physics for Secondary Schools, W. N. MUMPER : Laboratory Exercises in Elementary Physics, H. NEWMAN, 259.

*Geology and Mineralogy*—Earthquakes, an Introduction to Seismic Geology, W. H. HOBBS, 259.—Glaciers of the Canadian Rockies and Selkirks, W. H. SCHERZER : Traité de Géologie, E. HAUG, 261.—La Science Séismologique Les Tremblements de Terre, M. de BALLORE : Lower Paleozoic Fossils of the Northern Shan States, Burma, F. R. COWPER REED, 262.—Summary of the Geology of India, E. W. VREDENBURG : Die Fossilen Insecten, A. HANDLIRSCH : Evolution of Mammalian Molar Teeth to and from the Triangular Type, H. F. OSBORN : Mineral Resources of the United States, Calendar Year 1906, 264.—Handbuch der Mineralogie, C. HINTZE : Meteor Crater of Canyon Diablo, Arizona, G. P. MERRILL, 265.—Foyer Collection of Meteorites, 266.

*Miscellaneous Scientific Intelligence*—Introduction to Higher Algebra, M. BÔCHER, 266.—Observations simultanées de la Surface de Jupiter, 267.—L'Heure à Paris, JEAN MASCART : Globus-karte, F. SIPMAN, 268.

## Number 148.

	Page
ART. XXX.—Radio-activity of Uranium Minerals; by B. B. BOLTWOOD .....	269
XXXI.—Heating Effects produced by Röntgen Rays in Lead and Zinc; by H. A. BUMSTEAD .....	299
XXXII.—Review of the Minerals Tungstite and Meymacite; by T. L. WALKER .....	305
XXXIII.—Descriptions of Tertiary Insects; by T. D. A. COCKERELL .....	309
XXXIV.—New Devonian Brachiopod Retaining the Original Color Markings; by D. K. GREGER .....	313
XXXV.—Method of Hibernation and Vegetative Reproduction in North American Species of <i>Stellaria</i> ; by T. HOLM .....	315
XXXVI.—Two New Boron Minerals of Contact-Metamorphic Origin; by A. KNOPF and W. T. SCHALLER .....	323
XXXVII.—Determination of Vanadic and Molybdic Acids in the Presence of One Another; by G. EDGAR .....	332
XXXVIII.—Constituents of Atmospheric Radio-activity; by H. M. DADOURIAN .....	335
XXXIX.—Estimation of Iron by Potassium Permanganate after Reduction with Titanous Sulphate; by H. D. NEWTON .....	343

## SCIENTIFIC INTELLIGENCE.

- Chemistry and Physics*—Lithium in Radio-active Minerals, MCCOY: Radium in the Earth, STRUTT, 346.—Iodine, MARCKWALD and KEETMAN: Sodium Fluoride, LACROIX: Effect of Temperature on a Gold Leaf Electrometer, BOTTOMLEY, 347.—Effect of a Magnetic Field on Ionized Air, BLANC: Mechanical Working of Canal Rays, CAMPBELL SWINTON: Velocity of Sound in Fluids, DÖRSING: Direction of Sound, BOWKLER, 348.
- Geology*—Research in China, WILLIS, BLACKWELDER, and SARGENT, 349.—Patuxent Folio, SHATTUCK, MILLER, and BIBBINS: Ouray Folio, Colorado, CROSS, HOWE and IRVING, 352.—Characteristics of the Glacial Period in non-glaciated Regions, E. HUNTINGTON: Mauch Chunk Shale, J. BARRELL: Water Resources of the East St. Louis District, BOWMAN and REEDS, 353.—Geol. Survey of Michigan: Geol. Survey of Wisconsin: Earthquakes, HOBBS, 354.
- Paleobotany*—Mesozoic Flowering Plants, SCOTT, 354.—Morphogenie der Sporophylle, etc., HALLIER, 355.—Pteridosperms and Angiosperms, OLIVER: Origin of Angiosperms, ARBER, 356.—Végétaux Fossiles, etc., RENÉ ZEILLER, 357.—Végétaux Fossiles du Trieu de Leval, MARTY: Plant remains in Scottish Peat Mosses, LEWIS: Cycadaceæ, WORSDELL, 358.—Flora Fossile de l'Argonne, FLICHE: Paleobotanische Mittheilungen, NATHORST, 359.—Trias und Jurapflanzen von Kotelny, NATHORST: Zamites and Pterophyllum: Cycadophyta: Végétaux Fossiles de Normandie, LIGNIER: Ginkgo-växter, NATHORST: Taxoidæ, ROBERTSON, 360.
- Natural History*—The Cahow in Bermuda, 361.—Principles of Breeding, DAVENPORT: Mechanismus und Vitalismus in der Biologie, 362.—Plant Anatomy, STEVENS: Lichtgenuss der Pflanzen, WIESNER, 363.—Chemie der Höheren Pilze, ZELLNER, 364.
- Miscellaneous Scientific Intelligence*—Library of Congress: Metric and British Systems of Weights, Measures and Coinage, F. M. PERKIN, 364.

## Number 149.

	Page
ART. XL.—Ionium, a New Radio-active Element ; by B. B. BOLTWOOD .....	365
XLI.—Mid-Cretaceous Species of <i>Torreya</i> ; by E. W. BERRY	382
XLII.—Cranial Musculature and the Origin of the Frill in the Ceratopsian Dinosaurs ; by R. S. LULL. (With Plates I—III.) .....	387
XLIII.—Desiccation Conglomerates in the Coal-measures Limestone of Ohio ; by J. E. HYDE .....	400
XLIV.—Behavior of Nuclei of Pure Water ; by C. BARUS.	409
XLV.—Relations between the Meteorological Elements of the United States and the Solar Radiation ; by F. H. BIGELOW .....	413
XLVI.—Lower Paleozoic Stratigraphy of Southwestern Illinois ; by T. E. SAVAGE .....	431
XLVII.—Separation of Magnesium from the Alkalies by Alcoholic Ammonium Carbonate ; by F. A. GOOCH and E. A. EDDY .....	444

## SCIENTIFIC INTELLIGENCE.

*Chemistry and Physics*—Determination of Small Amounts of Iron in Copper Alloys, A. W. GREGORY : Action of Carbonates upon Tetrathionates, A. GUTMANN, 449.—Percarbonates, WOLFFENSTEIN and PELTNER : Practical Methods for the Iron and Steel Works Chemist, J. K. HEES : Laboratory Exercises in Physical Chemistry, F. H. GETMAN : Quantitative Chemical Analyses, A. F. GILMAN : Flame Spectra obtained by Electrical Means, G. A. HEMSALECH and C. DE WATTEVILLE, 450.—Electric Furnace Reactions under High Pressure, R. S. HUTTON and J. E. PETAVEL : Positive Column in Oxygen, P. J. KIRBY : Quadrant Electrometers, H. SCHULZE : Reception of Electric Waves in Wireless Telegraphy, REINHOLD-RÜDENBERG : Velocity of Sound, M. THIESEN : Diffraction of X-rays, B. WALTER and R. POHL, 451.—Electrolitic Rectification of Niobium, G. SCHULZE : A Manual of Practical Physics, E. S. FERRY and A. T. JONES : La Telegraphie sans Fil, I. VAN DAM, 452.

*Geology*—Shepard on the Underground Waters of Missouri, C. A. DAVIS, 452.—Falls of the Niagara, J. W. W. SPENCER, 455.—Michigan State Geological Survey, A. C. LANE, 456.—Illinois State Geological Map, STUART WELLER : North Dakota Geological Survey, A. G. LEONARD : Sur la Fixation des Coquilles de quelques Strophomenacea, N. YAKOVLEV, 457.—The Data of Geochemistry, F. W. CLARKE, 458.

*Miscellaneous Scientific Intelligence*—National Academy of Sciences, 458.—Report of the Superintendent of the Coast and Geodetic Survey, O. A. TITTMANN, 459.—Harvard College Observatory, E. C. PICKERING : Publications of the Allegheny Observatory of the Western University of Pennsylvania, F. SCHLESINGER : Darwin Celebration at Cambridge, 460.

## Number 150.

	Page
ART. XLVIII.—Determination of the Molecular Weight of Radium Emanation by the Comparison of its Rate of Diffusion with that of Mercury Vapor; by P. B. PERKINS .....	461
XLIX.—Paleozoic Formations in Trans-Pecos, Texas; by G. B. RICHARDSON .....	474
L.—Rectification Effect in a Vacuum Tube; by H. A. PERKINS .....	485
LI.—Life of Radium; by B. B. BOLTWOOD .....	493
LII.—New Occurrence of Proustite and Argentite; by F. R. VAN HORN .....	507
LIII.—Occurrence of Gedrite in Canada; by N. N. EVANS and J. A. BANCROFT .....	509
LIV.—Iodometric Determination of Arsenic and Antimony Associated with Copper; by F. H. HEATH. ....	513

## SCIENTIFIC INTELLIGENCE.

*Chemistry and Physics*—Crystallized Chlorophyll, WILLSTÄTTER and BENZ: Mercury Peroxide, VON ANTROPOFF, 520.—Supposed New Element in Thorianite, C. DE B. EVANS: Stereochemistry, A. W. STEWART, 521.—Condensation of Water Vapor in the Presence of Radium Emanation, Mme. CURIE: Anode Rays, GEHRCKE and REICHENHEIM: Handbuch der Spectroscopie, H. KAYSER, 522.—Refrigeration, J. W. ANDERSON: Introduction to Metallography, P. GOERENS, 524.—Lehrbuch der theoretischen Electrochemie auf thermodynamischer Grundlage, J. J. VAN LAAR: Comparative Electro-Physiology, J. C. BOSE, 525.

*Geology*—New Zealand Geological Survey, 526.—Geological Survey of Western Australia: Geological Survey of Canada, 527.—The Ankylosauridae, B. BROWN: Revision of the American Eocene Horses, W. GRANGER: Ideas on the Origin of Flight, Dr. B. F. NOPCSA, 528.—Traité de Géologie I, Les Phénomènes géologiques, E. HAUG: Key for the Determination of the Rock-forming Minerals in Thin Sections, A. JOHANSEN, 529.

*Miscellaneous Scientific Intelligence*—Monograph of the British Annelids, W. C. MCINTOSH, 530—Selectionsprinzip und Probleme der Artbildung, Dr. L. PLATE: Annals of the Astrophysical Observatory of the Smithsonian Institution, C. G. ABBOT, 531.—Bulletin of the Mount Weather Observatory, W. L. MOORE: Field Columbian Museum, O. C. FARRINGTON, 532.—Museum of the Brooklyn Institute of Arts and Sciences: University of California Publications in American Archaeology and Ethnology: Medico-Physical Works of John Mayow, 533.—Graphic Algebra, A. SCHULTZE: Ostwald's Klassiker der Exakten Wissenschaften: Decapod Crustacea of the Bermudas, Part 1, A. E. VERRILL, 534.

Established by **BENJAMIN SILLIMAN** in 1818.

THE  
AMERICAN  
JOURNAL OF SCIENCE.

EDITOR: EDWARD S. DANA.

ASSOCIATE EDITORS

PROFESSORS GEORGE L. GOODALE, JOHN TROWBRIDGE,  
W. G. FARLOW AND WM. M. DAVIS, OF CAMBRIDGE,

PROFESSORS ADDISON E. VERRILL, HORACE L. WELLS,  
L. V. PIRSSON AND H. E. GREGORY, OF NEW HAVEN,

PROFESSOR GEORGE F. BARKER, OF PHILADELPHIA,

PROFESSOR HENRY S. WILLIAMS, OF ITHACA,

PROFESSOR JOSEPH S. AMES, OF BALTIMORE,

MR. J. S. DILLER, OF WASHINGTON.

FOURTH SERIES

VOL. XXV—[WHOLE NUMBER, CLXXV.]

No. 145—JANUARY, 1908.

NEW HAVEN, CONNECTICUT.

1908

THE TUTTLE, MOREHOUSE & TAYLOR CO., PRINTERS, 123 TEMPLE STREET.

# REMARKABLE CONSIGNMENT

## OF

# Rare and Choice Minerals.

This remarkable consignment consists of so many fine specimens that our limited space will not permit us to do justice to them. We are therefore preparing a descriptive list which can be had for the asking, and will be ready for mailing on January 1st.

At the same time if you are interested in any of these specimens it would be well to lose no time, but either call, or order them sent on approval, as most of them cannot be duplicated for any money when those on hand are sold.

We call especial attention to the fine Euclase crystals, advertised, three of which are believed to be the largest in the world. Also to the Russian minerals and the remarkable California and Texas Mercury specimens. There are also a fine lot of English and Hungarian minerals.

We give below a brief list of the most remarkable of them ; the figure in front represents the number of specimens :

- |  |  |
|--|--|
| 10 Emeralds, Bogota ; Siberia ; Salzburg                                     | 2 Polybasite, Durango, Mexico.                                 |
| 8 Aquamarines, Siberia ; Brazil.   | 7 Benitoite, San Benito Co., Cal.                              |
| 6 Alexandrites, Ural.  | 3 Semseyite, and Galenite, Felsőbanya.                         |
| 100 Topaz, Schneckenstein.   | 2 Hessite, Botes, Hungary.                                     |
| 8 Anatase, Binnenthal, and Kollergraben.                                     | 5 Cryst. Gold in matrix.                                       |
| 5 Euclase, largest ever found, Brazil.                                       | 30 Silver specimens, Calumet, Mich.                            |
| 5 Torbernite, Tincroft, Cornwall.  | 10 Cryst. Silver, Mexico.                                      |
| 6 Staurolite and Cyanite, Mt. Campione.                                      | 6 Choice Aragonite, different local.                           |
| 3 Dioptase, Kirghes Steppes.   | 20 Choice Garnets, different local.                            |
| 8 Crocoite, Ural ; Tasmania.   | 15 Diamond, crystals, different colors, Africa.                |
| 3 Chalcophyllite, Redruth,   | 25 Remarkable Tourmalines, different colors, Mesa Grande, Cal. |
| 8 Chrysoprase, Silesia, gem material.  | 6 Zinkenite, Nevada.   |
| 6 Beautiful groups of Quartz, Dauphiné.                                      | 3 Copalite on coal, Castle Gate, Utah.                         |
| 5 Hyacinth in basalt, Oelberg, Siebengebirge ; in lava, Niedermendig, Eifel. | 10 Hausmannite, new locality, Cumberland.                      |
| 6 Pyropes in serpentine, Zoebnitz.   | 3 Cerargyrite, Leadville, Colo.                                |
| 6 Essonite, Ala, Piedmont, choice.   | 6 Zeophyllite, new, from Radzein.                              |
| 2 Terlinguaite, Terlingua, Texas.  | 8 Herderite, Poland, Maine.                                    |
| 2 Montroydite, " "   | 6 Blue & White Topax xls, Romana Co., Cal.                     |
| 2 Calomel, Terlingua, Texas.   | Fine lot of Turquoise, Mexico and California.                  |
|  | Fine lot of Cobalt minerals.                                   |

### CUT GEMS.

We have every known cut gem and semi-precious stones.

### SCIENTIFIC RUBIES.

We have a fine lot of these fine gems, from Paris, from 1/2 to 4 k. Further particulars cheerfully furnished.

**A. H. PETEREIT,**  
81—83 Fulton Street, New York City.



THE

# AMERICAN JOURNAL OF SCIENCE

[FOURTH SERIES.]

---

ART. I.—*Contributions to the Geology of Rhode Island:*  
I. *Notes on the History and Geology of Iron Mine Hill, Cumberland;* by B. L. JOHNSON. II. *The Petrography and Mineralogy of Iron Mine Hill, Cumberland;* by C. H. WARREN.

*Introduction.*—During the spring of 1905, one of the authors (Johnson) made a geological study of the occurrence of the ultra-basic, titaniferous rock, familiar to petrographers, from the publications of Professor M. E. Wadsworth, under the name of cumberlandite. A geological map of the region and a brief petrographical study of the surrounding rocks as well as of the cumberlandite itself was made. The results of this work were presented as a graduating thesis in the geological option of the course in Mining Engineering at the Massachusetts Institute of Technology.

In comparing the results with those of other observers in the field, it was found that a fuller knowledge of the relations existing between the cumberlandite and the surrounding formations had been secured, and it was deemed desirable to place these on record. It was also noted that no satisfactory chemical analysis of the cumberlandite had ever been made, and that consequently the existing petrographical descriptions are all inadequate for so interesting and unusual a rock. Accordingly, a rather complete petrological study of the rock and its altered forms has been made by one of the authors (Warren), the results of which are also presented in the following pages.

AM. JOUR. SCI.—FOURTH SERIES, VOL. XXV, NO. 145.—JANUARY, 1908.

**PART I—Notes on the History and Geology of Iron Mine Hill, Cumberland, R. I.**

*Location and Topography.*—The cumberlandite forms a rather conspicuous ridge, known locally as “Iron Mine Hill,” situated in the northeastern corner of the state of Rhode Island, in the town of Cumberland, and about three miles in a nearly easterly direction from the town of Woonsocket. The locality is easily reached from the latter city by taking a trolley car marked “Manville” for a distance of about two miles to a point known as Chipman’s Corner, and thence walking for about a mile due east. The locality may also be reached by leaving the Boston and Providence R.R., Franklin Div., at a station known as “Diamond Hill” and walking thence for about two miles along the main Woonsocket road, taking the first turn to the left and following it for a few rods.

An idea of the general topography of the region may be obtained from an examination of the Providence and Franklin quadrangles of the topographical map of the U. S. Geological Survey. The relief is not great and the hills for the most part rise to approximately the same altitude, which will not exceed much over 100 feet above the surrounding country nor 400 to 500 feet above the sea-level. The country is heavily drift-covered, and much of the present topography is due to the glacial deposits. The area is drained by the Blackstone river, which runs in a southerly direction a mile to the west.

*Historical.*—The existence of an entire hill composed of a rock of such high density and unusual appearance as the cumberlandite doubtless attracted attention to it at an early date. That it was a possible ore of iron appears to have been known at the beginning of the eighteenth century, for in 1703 the rock was mixed with hematite from Cranston, R. I., and smelted for iron by one Philip Brown. It is stated that his foundry was located in the town of Cumberland, but just where, the writer has so far been unable to discover. It is also said that a part of the cannon used against Louisburg in 1745 were cast at this forge.

From time to time since, mostly in the early and middle part of the present century, attempts have been made to use the rock as an ore of iron by mixing it with high grade ores at many smelters in New York, Pennsylvania, and New England. Old excavations on the side of the hill indicate that a total of at least several thousand tons has been taken out, and according to Professor Shaler, loose boulders of the rock, which were once abundant on and about the hill, have been extensively collected and shipped away for use as ore and for other purposes. The relatively low percentage of iron (30 to

32 per cent) in the rock and the high percentage of titanium appear to have prevented any considerable use of it for the production of iron notwithstanding the enormous amount easily available.

More recently, the "Cumberland Iron Trap Rock Company" attempted to work the deposits for road-metal and erected a plant for crushing the rock, but for one reason or another the enterprise failed.

Many references to the geology, petrology, and economic aspects of the cumberlandite may be found in the literature. For a list of the more important papers the reader is referred to the bibliography which will be found at the end of the article.

Dr. Robinson, in his book entitled "A Catalog of American Minerals, with their localities," published about 1825, writes under "Cumberland, R. I., magnetic oxide of iron; two miles N.N.E. of the meeting house on the left of the Wrentham road, is an immense bed constituting a hill. Most of this ore is a metalliferous porphyry, having crystals of feldspar in the iron."

Professor Edward Hitchcock in 1833, in his report on the geology of Massachusetts, gives a brief description of the rock and its occurrence. Dr. Charles T. Jackson was, however, the first to give a description of the hill in any detail. In his report on the geology of Rhode Island published in 1840, we find the general dimensions of the hill given and a geological section along a north-south line. He also comments briefly on its origin, expressing the belief that it was "protruded through the granite and gneiss at the same epoch with the elevation of numerous serpentine veins which occur in this vicinity." He gives a chemical analysis, the first, it is believed, that is recorded.

In 1841 Professor Hitchcock expresses himself as believing that the iron ore should be looked upon as belonging to the metamorphic slates of the region, "or rather lying at their juncture with the unstratified rocks (granites, etc.)." He seems for some reason inclined to the belief that the rock will be found to be strongly impregnated with manganese.

Benjamin Silliman, Jr., in reviewing Dr. Jackson's book shortly after its publication, appears to agree with him as to its origin, and believes that in this respect it may resemble the iron ores of Missouri.

In 1869, and again in 1872, Mr. R. H. Thurston published a chemical analysis, the mean of several (source unknown to the author), and seems to have been the first to have mentioned the presence of ilmenite in the rock. Analyses of the ore by one, Dr. Chilton, were also published in the New York Tribune

of 1873 and reproduced with slight changes by Mr. Holley in 1879 in the Transactions of the American Institute of Mining Engineers. He also gives figures for phosphorus, total iron, and silica, as determined at the laboratory of the Bethlehem Steel works.

The first good description of the cumberlandite was made by Professor M. E. Wadsworth in 1881. He gives its microscopical characteristics for the first time, describing it as a rock composed essentially of olivine, or its alteration products, and titaniferous magnetite, containing locally porphyritically-developed feldspar as an abnormal constituent. He concludes that it is a basic eruptive rock. A short historical account of the hill accompanies the description.

In 1881, J. D. Dana, reviewing Wadsworth's paper, concludes that the "Rhode Island magnetite is also of metamorphic origin," basing his conclusion partly on Wadsworth's statement that the nearest rock is a mica schist some hundreds of feet distant, and partly on a comparison of the occurrence with those of certain New Jersey magnetite deposits to which a metamorphic origin was assigned by Professor C. H. Cook.

In 1884 Wadsworth published his "Lithological Studies," etc., and in them he devotes considerable space to the macro- and microscopic description of the rock. He classes it as a "Terrestrial Pallasite," viz., a rock possessing a texture similar to the meteorites and composed of a sponge-like matrix of native iron, pyrrhotite, or their secondary products such as magnetite, enclosing olivine with or without other accessory minerals. He expresses the belief that the matrix, in the present case magnetite, will be found to pass in depth into the unoxidized metallic iron. He proposed the name *Cumberlandite* for this and closely similar rocks. The altered types of the cumberlandite are described in some detail in this paper as well as the feldspathic, original type. He seems here to have looked upon the feldspar as an abnormal constituent of the rock. In an appendix he gives a tabulated list of the existing analyses, but makes no particular use of them, doubtless recognizing their poor character. Dr. Wadsworth seems later to have become aware of the original rôle of the feldspar in the rock and its subsequent replacement by alteration products, for in 1889 he writes of it,—“a rock composed of a spongiform mass of titaniferous magnetite, containing abundant olivine and more or less feldspar. This is the ore in its unchanged condition as found on one side of the hill, but it passes into more altered forms on the top and other side. In the altered forms the feldspar and olivine are changed to serpentine, actinolite, and even into talc and dolomite, while the magnetite is diminished in quantity. In the hand-specimens the least altered condition

shows as a dark resinous, crystalline, splintery and compact mass, holding porphyritically enclosed feldspar. This, in the altered forms, passes into a rock, having the same groundmass but with the feldspar altered into patches of a dark green, fine-grained, serpentine product. By further alteration the rock changes to a dark grey, serpentinous rock, spotted with the decomposition products of iron. In the altered forms short brilliant crystals of actinolite are to be seen and the rock often shows a schistose structure."

Again in 1893 he again refers to the cumberlandite in one of his reports to the Michigan Geological Survey and gives two analyses by Professor R. L. Packard to show the general composition of the rock. These analyses are the best analyses of the rock heretofore made, and appear to be essentially correct except for certain omissions, notably the alkalis. A partial analysis of a very impure feldspar separated from the rock is also given. No statement as to the true composition of feldspar present in the rock appears in any of the papers cited, and as no attempt was made, so far as known, to determine sodium, it is inferred that the feldspar was generally supposed to be anorthite.

In the same report he states that, "the form containing feldspar was found by field observation in 1885 to pass into the form containing only greenish spots of serpentine and amphibole. Feldspars were then found showing various gradations in the alteration to the serpentinous products." In comparing the altered types with the feldspathic, the relation existing between the feldspar phenocrysts and the green spots is so obvious that it is a little surprising that so important a fact was not pointed out before.

In 1883, Professor N. S. Shaler published a paper on "The conditions of erosion beneath the deep glaciers, based upon a study of the boulder train from Iron Hill, Cumberland, R. I." In the course of the paper he devotes considerable space to a description of the hill. He states that the dipping magnetic needle indicates that the rock mass has an extent about equal to the one assigned to it from surface showings, and that there is no evidence that similar masses exist, at least within an area of many miles about the hill. After a brief review of the facts in hand, he concludes that the cumberlandite rock mass is dike-like in its mode of occurrence and that it is an igneous intrusion. His discussion of the glacial phenomena about the hill and of the remarkable boulder train from the hill traced as far south as the island of Martha's Vineyard, is exhaustive. He estimates from his observations that probably 300 feet in vertical thickness have been removed from the rock mass by the glacial erosion, assuming that the original area

was about the same as at present. He also expresses his belief that not over six inches have been removed by erosion since. Several sketches of the hill as it appeared in 1883 and a map of the boulder train accompany the article.

At a later date, the same writer expresses the belief that the rock might continue downward to an indefinite depth and to the north and south, beneath the drift, in the direction of its strike, an opinion shared by the present author.

Professors F. D. Adams, J. H. L. Vogt, J. F. Kemp, and Richard Beck, in the publications given after their names at the end of this paper, all mention the cumberlandite as a probable segregation from a gabbroitic stock and class it with the similar rock from Taberg, Sweden and other rocks of like origin.

*General Description of the Iron Mine Hill and adjacent Formations.*—The cumberlandite is a dike-like boss of igneous rock which consisted originally of olivine (hyalosiderite), magnetite, ilmenite, labradorite, and accessory spinel.

From surface indications and magnetic observations it appears to have a rudely elliptical cross section with a major axis of about 1200 ft. and a minor axis of from 500 to 600 ft. The direction of the major axis lies nearly north and south. From the position of boulders in the drift to the west of the hill, it seems likely that the mass may extend under the drift to the north farther than is indicated by its present outcrop. There may also be a southward extension of the mass, but the nearest outcrops of adjacent rocks on the north and south certainly limit the length to a maximum of about 2500 ft. and probably a much less smaller figure is the correct one. That the maximum width is much greater than the figure given seems improbable from considerations that will appear later.

The cumberlandite is now exposed in an unaltered condition at only one point on the western side of the main ridge, a little below the middle and a few feet below the top. With reference to the probable dimensions of the rock mass as indicated above, the unaltered portion is very nearly central. It occupies an area of from 300 to 400 square feet and passes, with a relatively narrow transition zone, into the more or less altered types which constitute by far the greater portion of the present hill.

The Hill rises rather abruptly to a height of about 100 ft. above the surrounding country, and of about 60 ft. above its own base. Its upper portions, except where altered by quarrying operations, consist of rounded, irregular prominences having a dark brown to black color. Their rounded outlines are

due to glacial action and many fine examples of glacial marking may be noted over most of the surface.

The hill is traversed by a nearly vertical system of main joints running nearly south and north. Roughly perpendicular to these is a system of minor joints which cut the hill up into small, rudely prismatic blocks. On the eastern side of the hill the minor jointing is rather thinly parallel in places. Many blocks have been torn out and carried away by the ice, leaving troughs and irregular breaks in the surface.

At several points along the exposed ledges on the western side, distinct inclusions of a feldspathic rock may be seen. These vary in size, so far as observed, from two to six inches in diameter. They are always much rounded in outline, evidently from alteration, and are surrounded by a variable amount of green chloritic material. Macroscopically, they resemble the gabbro noted beyond as being the nearest rock to the cumberlandite on the west, and microscopically, they were found to be practically identical with it. On a recently uncovered, glaciated surface at the northeast end of the hill, two subangular inclusions composed of a compact, greenish grey mass of chloritic material mixed with some actinolite and magnetite, were observed. Under the microscope indications of some previously existing, rather coarse textured rock were observed, and it is thought that these inclusions may also be gabbro, now strongly altered like the inclosing rock.

These inclusions, now noted for the first time as belonging to the gabbro, are the only evidence that the cumberlandite is *younger* than a portion at least of the adjacent igneous rocks.

The rock has suffered to some extent from shearing movements which have produced a schistose structure in the actinolite and chlorite commonly found along the joint planes. Many of the joints contain crystals of these minerals of considerable size, and weathered faces are sometimes thickly studded with well-developed crystals of clinocllore. Less commonly crystals of a dark glassy, amber colored olivine, the rare species *hortonolite*, are associated with the other two minerals. Veins, sometimes as much as an inch in thickness, containing varying proportions of these three minerals, cut irregularly through the rock.

As a whole the hill has resisted the action of weathering to a remarkable degree considering its mineral character. Its surface is not decomposed in general to a depth of over one-half an inch, and Professor Shaler's observation that the surface of the hill has probably not lost more than six inches by weathering alone since glacial times, seems entirely probable.

The base of the hill on its northern and western sides has a heavy covering of drift, which widens out rapidly toward the south and southwest, forming a gently rising slope. The ridge itself grows gradually lower toward the south and disappears under the drift near a road which runs across the strike at this point. On its eastern side, the foot of the ridge is marked by a rather heavy talus of large and small boulders, beyond which a narrow strip of swampy land and a meadow extend the next ridge. Beyond the drift to the north and west, a broad stretch of low land completely isolates the hill. At the present time, the lower portions and a good part of the top are covered with a thick growth of small timber and heavy underbrush.

The cumberlandite is nowhere exposed in contact with any other rock, and is separated from the nearest outcrops by barren areas for a distance of at least 700 feet.

On the east, a ridge somewhat lower than the hill runs parallel to it. This is the nearest rock seen in place to the cumberlandite and consists of a fine-grained, green, chlorite-epidote schist. It is cut by numerous quartz veins and granite dikes. A little specular hematite may be found along the joints, and small pockets of brilliant epidote crystals are often associated with the veins. The lamination of the schist is at a steep angle and the general trend of the formation is N.W. This ridge also passes under the drift to the south. Farther to the south granite comes in with abundant inclusions of schist. The schist formation extends for some distance to the east and is succeeded by granite. On the south the granite approaches the hill to within 400 or 500 yards. It is a medium-grained, biotite granite always showing strong evidences of shearing and possesses very generally a gneissoid and in places a schistose structure. To the southwest near the road to Cumberland Hills, the granite is highly gneissoid and has a pinkish color and is suggestive of the Milford granite several miles to the north. A considerable amount of a purple fluorite is not uncommon in some parts of the granite. Just north of Cumberland Hill, three large dikes of granite or quartz-porphry intrude the schists parallel to their schistosity. These dikes contain numerous inclusions of the schist and also of the granite. They appear to be the youngest rocks in the area. Beyond the granite on the south, a dark green hornblende schist, evidently a less metamorphosed form of the schist on the east, comes in.

On the southwest of the cumberlandite, some 350 yards distant, several large ledges of a rather coarse-grained, metamorphosed gabbro are met with. As may be seen from the map the gabbro occupies a considerable area to the west of the hill, about  $\frac{1}{4}$  a mile wide by  $\frac{3}{4}$  long. It outcrops in a series of heavily glaciated ledges between which are considerable stretches of low land or swamp. The eastern margin of the gabbro as



a whole takes a concave outline toward the cumberlandite and in one place, almost directly west, a ridge rises to very nearly the same height as the hill. It is everywhere separated from the cumberlandite by drift or by swampy land entirely devoid of outcrops. On the south the gabbro is bounded by the granite mentioned above, but the actual contact, like so many others in this region, is effectually masked by a small, drift-filled valley. The western boundary is somewhat indefinite, but

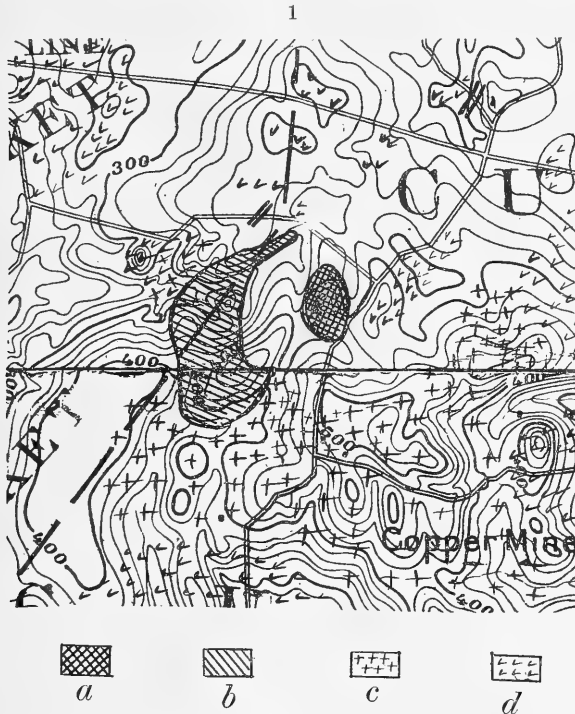

*a*, Rhodose (Cumberlandite). *b*, Gabbro. *c*, Granite. *d*, Metamorphic sedimentaries cut by granite and quartz veins.

The map indicates the position of the surrounding rocks as shown by outcrops.

judging from the position of the granite outcrops on the southwest and northwest, its position cannot be very far from that assigned to it on the map.

On the north and northwest, the gabbro is bounded by metamorphic sedimentary rocks—a quartzose-biotite schist chiefly—or by granite, the latter cutting through the former in the form of dikes and larger irregular masses, and lithologically like the granite on the south. Near the contact the

granite has become highly schistose and fissile. A small patch of a highly metamorphosed conglomerate, cut by quartz veins and filled with epidote in their neighborhood, outcrops in the fields just north of the gabbro. Farther east, along the road that runs by the hill, a fine, chloritic schist comes in. This is very similar to the schist on the east. At this point, also, a small outcrop of a rather coarse-grained diabase is seen. Thin sections show that this rock has been much changed from its original form, consisting now essentially of crushed and recrystallized feldspar, secondary hornblende and altered ilmenite. It has been mapped as a dike, similar in occurrence to one that comes in a little to the north and perhaps continuous with it.\*

Still farther north, beyond the immediate neighborhood of the hill, schist and granite outcrop at various places through the drift, while to the west, toward the Blackstone river, a quartzite appears. The exact relations of the sedimentaries to each other are of little importance in the present connection. The schists and quartzites are placed by Woodworth in what he has termed the "Blackstone Series" supposed to be of Algonkin age, and have been named the Blackstone Quartzite and the Ashton Schist respectively. The conglomerate appears to conform to the strike of the schists and to be a bed in them. It may, however, be a remnant of the supposed carboniferous conglomerate which appears near Woonsocket.

So far as known, only one dike cuts the gabbro, and that is a short one, a few inches in width, situated near the southeastern edge of the mass. Originally this was a very fine-grained trap containing porphyritic crystals of plagioclase and augite. Like the inclosing gabbro, the dike has been greatly altered, but little of the original minerals, except portions of the porphyritic feldspar, remaining fresh. So far as known no especial significance can be attached to this dike. The gabbro is not cut by the surrounding granite nor are any inclusions of the granite nor of the invaded sedimentaries known, although an examination of the contacts, were any exposed, might reveal them. There seems to be no positive evidence to show that the gabbro and cumberlandite are either older or younger than the surrounding formations. The study† of a mass of gabbro, also surrounded by schist and

\* Dr. Jackson, in an early article on the cumberlandite, speaks of the occurrence of veins of serpentine on the land of a Mr. Whipple near the hill. Careful search has been made for these veins but without success. Several good sized bowlders of a dark green, massive serpentine have, however, been found in the lots northwest of the hill. These are probably from the veins referred to by Jackson, which have doubtless been blasted out and removed in the clearing and improvement of the land carried on here in recent years. What relation these veins may have had with the surrounding formations cannot now be told.

† Private contribution from Dr. G. F. Loughlin.

granite, near Norwich, Conn., distant some eighty miles in a southwesterly direction from Cumberland, has shown that the gabbro was intrusive into the schist but earlier than the granite, which evidently found its way through the easily ruptured schists, but could not penetrate the more massive and resistant gabbro. This gabbro was intruded into the sediments prior to regional metamorphism, during which it appears to have acted as a resistant plug against which the surrounding rocks were compressed. It seems not unlikely that similar relations are true in the case of the gabbro and cumberlandite, both of which have clearly suffered from extensive metamorphism.

Finally it is to be noted that the gabbro extends around to the northeast and reaches a point about northwest of Iron Mine Hill.

The mineral composition of the gabbro is of especial interest in connection with the latter's relation to the cumberlandite. A study of the rock in the field and laboratory show that it was originally a rather coarse (millimeter) grained rock, consisting of labradorite (averaging about  $Ab_1An_1$ ), a purplish augite of distinctly diabasic habit, an unusual amount of ilmenite in the form of large conspicuous grains closely associated with the augite and accessory apatite. Olivine or pyroxenes, other than augite, and original hornblende are entirely lacking. Original magnetite was very sparingly present if at all. Shearing and metamorphism appear to have affected the rock quite unevenly. The central and southern portions are the least affected. On the eastern side, along the ridge facing the hill and in the ledges which mark the northeastern extension of the mass, the rock is profoundly altered. The feldspar has gone over to a dull white saussuritic substance, the secondary hornblende and biotite formed from the first alteration of the augite and ilmenite have altered almost completely to chlorite and epidote, and the remaining ilmenite has changed to leucoxene. The rock is now somewhat schistose, the original texture having practically disappeared so far as its macroscopic appearance is concerned, although it is easily made out microscopically. The rock has assumed a greenish white color in striking contrast to the dark, greenish brown of the least altered forms. Various gradations between these forms can be seen in the field. Toward the granite and schist on the northwest, the gabbro has been severely sheared and has become a fissile green schist, while in the extreme northeast extension of the gabbro it has passed into a pale greenish white, schistose rock composed of finely crushed feldspar, saussuritic products, chlorite, epidote, leucoxene and some sericite. The light color and feldspathic appearance of the more highly altered forms of the gabbro doubtless account for

its classification as a syenite by some of the earlier investigators in the region.

*Conclusions as to the relations of the two basic rocks.*—The presence of numerous inclusions of the gabbro in the cumberlandite, particularly on its western side, argues in favor of a not very distant contact between the two rocks. — If we connect the north- and southeastern ends of the gabbro as shown on the map, it can be seen that the contact with the cumberlandite would lie near to what, from other considerations, is thought to be the western limit of the latter. If the gabbro extends somewhat farther northeast than its present outcrops show, as is very probable, the line of contact would lie still closer to the present hill. The inclusions of the gabbro in the rock of the hill show clearly the latter is the younger of the two, and that they do not grade into one another, as is the case with so many occurrences of “titaniferous iron ores” associated with gabbroitic rocks. The basic character of both, their large content of ilmenite and their occurrence as adjoining masses entirely surrounded by genetically unrelated rocks is strongly suggestive that they are offshoots from a common magma.

## PART II—*The Petrography and Mineralogy of Iron Mine Hill, Cumberland, R. I.*

*The Rhodose (Cumberlandite).*—Macroscopically the typical rhodose may be described as a rock composed of colorless to white plagioclase crystals, embedded in a black, granular groundmass possessing a metallic to resinous luster and a tough, irregular fracture. The appearance either in the ledge or hand-specimen is highly characteristic and with a specific gravity of almost exactly four the rhodose is exceptional in character.

On weathering, the feldspar whitens and assumes a chalky appearance. The olivine alters readily to a reddish or brownish ferruginous clay, leaving the black ilmenite and magnetite in granular relief. The weathered layer, once formed, acts like a blanket and serves to protect the rock beneath very effectually from further action.

The groundmass is easily resolved with the aid of a lens, less easily with the eye alone, into two constituents, one, a yellowish, glassy olivine (hyalosiderite) exhibiting frequently well developed cleavage surfaces, and the other, a grayish black mass of magnetite and ilmenite. In slightly weathered specimens the olivine assumes a yellowish green to brownish color and is then easily distinguished by the eye.

*The feldspar.*—The plagioclase makes up about 13 per cent by volume of the rock. The crystals have generally a thin tabular habit parallel to 010, and vary considerably in size from minute

grains up to individuals 2 or 3<sup>mm</sup> thick by 2<sup>cm</sup> square. The average, and likewise the most common size, is perhaps about 2<sup>mm</sup> thick by 1<sup>cm</sup> square. By the very general segregation of two or more of the feldspar crystals together, the rock assumes what may be termed a "cumulophytic" texture.\* A more or less distinct parallel (fluidal) arrangement of the feldspars may be noted in portions of the ledge and in individual specimens, but no single direction of orientation has been made out in the rock as a whole. The direction, therefore, which any particular surface of the ledge or of a hand-specimen makes with the local direction of flow, taken in connection with the tabular habit of the feldspar, determines very often the apparent abundance or paucity of the feldspar phenocrysts on the surface in question. In some of the boulders found on the edge of the swamp to the west and believed to have been loose boulders taken from the old talus or drift about the hill, the feldspars have a very marked parallel arrangement. While a careful study of the outcrop shows that the feldspar is more abundant in some places than others, it seems highly probable if not certain that the feldspar had a fairly uniform distribution in the rock as a whole.

Although the characteristic tabular habit of plagioclase is strongly developed it is rather surprising to note, particularly in thin section, that the crystal outlines are always rounded toward the minerals of the enclosing groundmass. The rounded ends may be sometimes seen buried in an olivine or ilmenite-magnetite† grain and actual inclusion of small feldspar anhedrons by the olivine are not uncommon. On the other hand, the margins of the feldspars are indented by the groundmass grains, and as noted by Wadsworth, small "tongues" of feldspar run out into the groundmass. Occasional irregular pieces of feldspar may also be seen in the interstices between the olivine and ore. Olivine and ore grains are also imbedded in the feldspar, but so far as observed, these are always situated either on the contacts between individuals, along fracture lines, or in fractured portions of the feldspar near the border. Their mode of occurrence has led to the conclusion that they have reached their present positions not through crystallographic inclusion but by mechanical means. The feldspar crystals are bent, broken, the parts deorientated and recemented; again they are jammed into other feldspars as well as into the surrounding groundmass. Everywhere there is abundant evidence of movement.

\* See The Texture of Igneous Rocks, Jour. Geol., vol. xiv, No. 8, 1906.

† The ilmenite-magnetite will for brevity hereafter be generally referred to simply as ore.

Some idea of this texture may be obtained from the accompanying sketch.

The feldspars are beautifully twinned after the albite and carlsbad laws, rarely after the pericline. Extinction angles measured in sections perpendicular to the albite lamellæ after the method of Michel Lévy, indicated a labradorite, varying in composition from  $Ab_1An_1$  to  $Ab_3An_1$ . Plates parallel to  $b, 010$ , show the emergence of a bisectrix inclined to the normal.

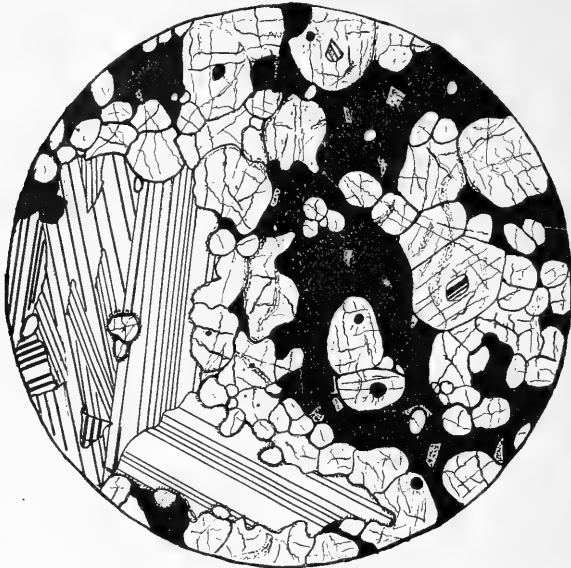

FIG. 2. The sketch shows the textural relations of the minerals in the rhodose. The feldspar is ruled to show the position of the twinning lamellæ and the peculiar arrangement of the deorientated parts. The black represents the ore with inclusions of olivine and spinel (dotted). The olivine is shown with inclusions of ore and feldspar.

Extinction angles measured on basal cleavage plates gave values of from 5 to 8 degrees. Homogeneous fragments of the feldspar free from inclusions sank in the Thoulet solution from 2.687 to 2.706, an average of 2.69.

The chemical composition of the feldspar as calculated from the rock analysis is that of a labradorite  $Ab_3An_1$ , a figure in agreement with the composition indicated by the optical properties and the density. A well marked although somewhat irregular zonal structure has been noted in sections cut parallel to  $(b)010$ . The variation in the optical properties of the different zones is, however, very slight and the variation in chemical

composition must, therefore, be also small. No orthoclase has been observed.

Along the fractures in the feldspar crystals some alteration material is noticeable. This consists largely of actinolite mixed with some kaolinite and a little calcite or dolomite; otherwise the feldspars are quite fresh. Where the plagioclase comes in contact with the groundmass, a characteristic reaction rim is always developed. The reaction material consists essentially of pale green to colorless actinolite needles orientated perpendicular to the contact. When in contact with the ilmenite-magnetite, shreds of biotite frequently make their appearance and sometimes constitute the entire rim. The biotite often lies next the ore, as a narrow border, and a change into actinolite may sometimes be seen on the side towards the feldspar. The width of the reaction rims appears to be somewhat greater about the ore than about the olivine, but in any case they are exceedingly narrow, varying between approximately  $\cdot003^{\text{mm}}$  and  $\cdot01^{\text{mm}}$ , rarely exceeding the latter figure. The rims are too narrow to in any measure account for the rounded character of the feldspar outlines. The formation of the reaction rims appears to have been quite distinct from the more extensive metamorphic alteration which replaced the feldspar with chloritic material.

A few crystals of biotite, exactly like the biotite shreds associated with the actinolite in the reaction rims, are met with throughout the rock. They are always associated with the ore and are clearly secondary. This suggests, at least, that the biotite observed in the closely related rock from Täberg, Sweden, may also be secondary.

Enclosed in one or two of the feldspar crystals, several irregular grains, of a colorless to brownish, highly refracting, isotropic substance were observed. They have not been positively identified, but are thought to be garnet.

*The groundmass.*—A polished surface of the rock serves admirably to bring out the texture of the groundmass. The ore, if looked at directly, possesses a grayish black color, but if viewed at an angle, shows a peculiar and characteristic bronze tint. It forms a more or less continuous network through the rock and serves as a matrix for the olivine. No crystallographic outlines have been identified with certainty in the ore. The olivine occupies somewhat more than one-half of the surface, possesses a dark, glassy appearance, in sharp contrast to the ore, and is characteristically rounded in outline.

*The ore.*—On etching the polished surface with hydrochloric acid, a delicate reticulate structure is developed in the ore. With a direct illumination under the microscope, this structure is seen to consist of an intersecting series of bright gray, narrow bands or lamellæ enclosing dull black depressions. This struc-

ture extends everywhere through the ore except over occasional small areas which have a smooth surface and are identical with the bands in appearance and presumably in composition. The lamellæ are frequently observed to cross at angles of nearly or exactly 60 degrees; again they form a nearly rectangular grating. This structure taken in connection with the well known tendency of ilmenite to develop a reticulate structure parallel to the rhombohedral planes, suggests at once that the lamellæ are ilmenite enclosing the more easily dissolved magnetite. The change in direction of the bands in different parts of the ore matrix is the only indication of the existence of individual grains in the ore.

The ratios derived from the rock analysis show conclusively that the two molecules,  $R^{IV}TiO_3$  and  $R^{IV}R^{III}_2O_4$ , are present, and in about equal proportions. The magnetic susceptibility of particles of the ore, free from olivine and feldspar, was found to be intermediate between that of pure magnetite and ilmenite. It appears, therefore, that the ore matrix consists essentially of an intimate intergrowth of magnetite and ilmenite with an occasional grain of what is probably pure ilmenite. The parallel intergrowth of members of the spinel family with ilmenite has long been familiar to mineralogists and a similar intergrowth has been suggested by a number of petrographers to explain the composition of the "titaniferous magnetites" of many rocks. Quite recently Hussak\* has shown by the study of etched surfaces that intergrowths of ilmenite and spinel minerals, particularly magnetite, are very general in the titaniferous ores of Brazil. He also gives a full bibliography of the literature on the subject. It would be extremely interesting to extend the study of titaniferous magnetites still further and ascertain to what extent, if at all, an intergrowth like the one described in the present instance exists in other occurrences. There is still, in spite of the considerable amount of investigation which has been carried on upon "titaniferous-magnetites," much uncertainty regarding the exact relations of these two mineral molecules when occurring together.

*Spinel.*—Examined in thin section the edges of the ore show a fine granularity under high powers. Numerous small crystals of a dark green, feebly transparent, isotropic mineral of an angular or sub-angular habit are enclosed at random in the ore. They are never found outside of it. A few of the grains have distinct crystallographic outlines suggestive of isometric crystal sections, and many are crossed by sharp, straight (cleavage?) cracks. The crystals vary in size from exceedingly minute individuals up to those measuring  $0.45^{mm}$  long by  $0.12^{mm}$  wide. They occur

\*Jahrb. f. Min., etc., Bd. I, Heft II, 1904, pp. 94-113.



more commonly, however, as roughly equidimensional grains from 0.10 to 0.20<sup>mm</sup> in average diameter. They were called glass by Wadsworth and were thought to be hercynite by Geo. H. Williams, to whom they were submitted by Wadsworth for examination. The crystals are very refractory to chemical decomposition since a few were found undecomposed by sulphuric and hydrofluoric acid in some of the ferrous iron determinations made on the rock. They are undoubtedly spinels (pleonaste), an identification substantiated by the ratios derived from the rock analysis given beyond. Spinel is lacking in sections cut from some of the boulders previously referred to, but appears, however, to have been generally present in the rock of the hill, and its absence in the boulders probably indicates only a local variation in the composition of the magma.

*The olivine.*—The olivine is nearly colorless in thin section with but a slight brownish or yellowish tint, and is remarkably fresh throughout. Fractures are abundant, and the basal and brachy-pinacoidal cleavages are better developed than with ordinary olivine. Between crossed nicols the olivine is broken up into a mosaic of anhedral grains, showing all gradations in size from mere points up to individuals 5<sup>mm</sup> long and 2.5<sup>mm</sup> wide. In a few instances an olivine grain has been observed with a distinct crystallographic outline against the ore, but in general the olivine, like the other constituents (except the spinel), are conspicuously lacking in crystallographic outlines. Single olivine anhedrons are everywhere to be seen *enclosed* in the ore, and throughout the rock the latter acts always as the matrix.

The olivine anhedrons are often separated from one another by strongly marked black borders, consisting of minute opaque, black grains, accompanied by some that are reddish or brownish by transmitted light, and very similar in appearance to the inclusions in the olivine. These borders are commonly *continuous* with the ore matrix.

As previously noted, the olivine anhedrons are traversed by many fractures. These often extend through several individuals, and more rarely form a series of rudely parallel fractures, extending across the entire section. In the latter case they are sometimes filled with granulated material of the mineral, through which they pass, and are more or less discolored with serpentinous matter. More commonly they are filled with the same black, finely granular material that lies between the crystals. In several slides examined, numerous fractures were observed, radiating outward into the surrounding olivine from an ore grain. It appeared as if the olivine had been

shattered against the ore and the resulting fractures filled with oxides derived from it. The *olivine* crystals *very generally enclose* small anhedral ore grains, and are rich in other inclusions. These consist in part of minute black particles and in part of cavities. Many of the latter contain ferruginous matter. While the cavities occur at random through the crystals, they are commonly arranged along curious, wavy, ribbon-like lines which do not, so far as observed, follow any crystallographic directions and often extend across more than a single individual. In form the cavities are similar to those noted by various authors in the olivine from other rocks—round, elliptical, or irregular, branching and amoeba-like in shape. Their general appearance and their ferruginous filling point to their being solution cavities formed, perhaps, along old healed-up fracture lines. Many of the opaque particles have the same shape and mode of occurrence, and are, perhaps, cavities entirely filled with ore derived from the matrix. It is possible that others are true crystallites of magnetite and ilmenite included by the olivine. It is noticeable that the strings of inclusions and the material distributed along the fracture lines, like those between the crystals, tend to merge to a greater or less extent into the main body of the ore matrix. Although part, perhaps most of these perplexing inclusions, are probably of secondary origin, it is impossible to escape the feeling that many of them, like the larger included ore grains, represent crystallizations from the magma which were caught by the rapidly crystallizing olivine.

The mean index of refraction of the olivine was found by the immersion method to be about 1.712, which is considerably above that for ordinary olivine, as is also its specific gravity, 3.728, as determined by the pycnometer at 20 C. on carefully selected material separated from the crushed rock by magnetic treatment.\*

A chemical analysis (by Warren) of this material gave the following results:

\*Several hundred grams of the crushed rock, from which the finest dust had been removed by washing, was passed through an 80 mesh screen and subjected to a magnetic treatment by which three fractions were made:—No. 1 ilmenite-magnetite mixture; No. 2 olivine; No. 3 feldspar and other non-magnetic materials. Fraction No. 2 was again fractionated with great care, using a magnetic field of varying intensity, until a small fraction of clear yellowish olivine grains was obtained, which showed under the microscope almost none of the ferruginous material so abundant in the greater proportion of them. The material thus obtained was used for the analysis. The mean index of refraction of this material was found to be the same (by the immersion method) as that of the olivine taken out with a weaker magnetic flux because of included ore, indicating that the olivine is of uniform composition.

	I	Ratio	II Calculated to 100%	III Kaiserstuhl
SiO <sub>2</sub> -----	37.16%	.619	.619	37.3
TiO <sub>2</sub> -----	.07			
Fe <sub>2</sub> O <sub>3</sub> -----	.12			
FeO-----	31.38	.436	} 1.220	31.5
MnO-----	.40	.005		
CaO-----	tr.			
MgO-----	31.16	.779		
Feldspar }	34			
Insoluble }				
	<hr/>			
	100.63			
				<hr/>
				100.0
				<hr/>
				98.67

The ratio RO : SiO<sub>2</sub> = 1.97 : 1.0, or very nearly 2 : 1.

The olivine of the rock is, therefore, a *hyalosiderite*, or iron rich variety, and corresponds very closely in composition to that of a *hyalosiderite* (see column III above) given by Dana (p. 453, Analysis No. 32), from a basalt described by Rosenbusch from the Kaiserstuhl.\* The specific gravity of the latter is given as 3.566, which is considerably lower than that of the one just described. An estimate of the specific gravity of an olivine of this composition based on the specific gravity of fayalite, fosterite and certain common chrysolites, gave 3.70, which is in good agreement with the value found experimentally in the present investigation. It would therefore seem that 3.7 represents the true specific gravity of an *hyalosiderite* of about the above composition.

*The Crystallization of the Rhodose.*†—The unusual mineral composition of the rhodose and its peculiar texture raise many interesting questions regarding the manner of its crystallization from a molten condition which are deserving of careful consideration. The cumulophyric arrangement of the feldspar and the undoubted inclusion of crystals of the latter within the olivine indicate that the feldspar was the first mineral to separate from the magma. In order for the feldspars to have attained so large a size and to segregate into isolated groups, a considerable degree of molecular mobility is demanded, which could have hardly obtained if the surrounding minerals, con-

\* Jahrb. f. Min., etc., p. 50, 1872.

† The writer is fully aware that he is not in possession of the thermal data, and other physical constants, nor of a knowledge of the possible equilibrium conditions that might exist between the various components of the magma, so essential for an exact and satisfactory discussion of its consolidation. The purely petrographical evidence in the present case is of such a character, that notwithstanding an insufficient basis, a guarded discussion of the problem will be entered into, believing that it may contribute something of value to the more general problem of rock crystallization.

stituting by volume upwards of 85 per cent of the solid rock, were in the act of solidifying or had already done so. Whether the feldspar did separate first or not, its final outlines were determined by the surrounding minerals. It is to be noted that the feldspar exists only as the pure phase-feldspar—and is not seen in any relation to the other minerals which can be interpreted as a eutectic structure. Feldspar is not seen within the body of the ore.

The ore, although it consists of three distinct minerals, so far as its textural relations to the other minerals are concerned, behaves as a textural unit and will be looked upon as such. Within the olivine are included ore grains of some size not to mention the finer grained inclusions which may be in part secondary. Besides inclosing the olivine collectively as a matrix, the ore contains many single crystals of olivine inclosed in the body of its substance. Nevertheless the ore and the olivine have as a whole separated from each other and the olivine has clearly dominated the situation, forcing the ore into the rôle of a containing matrix. Here again there is nothing that suggests a eutectic structure.

The constituent minerals of the ore matrix also bear very interesting relations to one another. The spinel, or a part of it, and a little of the ilmenite crystallized first. The remainder consolidated as an intimate intergrowth of ilmenite and magnetite in which the ilmenite acted as the host. To those familiar with the solidification of alloys or salts, this intergrowth suggests by its appearance a eutectic mixture of ilmenite and magnetite. The exact quantity of spinel which exists as a pure phase has not been estimated, but it is likely that some of the spinel molecule remains in isomorphous relations with the magnetite. Whether the intergrowth is a true eutectic mixture or not can of course only be told by experiment, and so far as the writer is aware, no experimental study of the system ilmenite-magnetite has ever been made. It seems likely that such a study would throw not a little light on the character of "titaniferous magnetites" and steps have been taken toward carrying one out. It may be remarked in passing, that the relatively low consolidating temperature of eutectic mixtures compared with those of the individual constituents is in keeping with the fact that the ore was the last portion of the rock to consolidate.

It appears clear to the writer that the feldspar was the first mineral to separate from the magma and that the olivine and the ore then separated in some manner from each other and crystallized. The crystallization of so large a proportion of the magma (ore plus olivine nearly 85 per cent) must have given rise to a considerable evolution of heat, in

amount perhaps sufficient to again raise the feldspar above its melting point. It has been shown by Day and Allen\* in their paper on the "Isomorphism and Thermal Properties of the Feldspars," that a plagioclase crystal of acid composition if raised to a temperature somewhat above its true melting point, persists for a time as a metastable phase without the crystal as a whole undergoing molecular deorientation. The crystals in such a condition behave like hyperviscous liquids and are capable of yielding to mechanical deformation. If then the feldspar in the rhodose were in such a condition, the crystallization of the olivine and ore under pressure might reasonably be expected to cause marked changes in the outlines of the feldspar crystals. Add to these conditions the effect of movements in the mass, even if slight, and we have a very probable explanation of the relations between the feldspar and the groundmass minerals. The indentation and molding of the feldspar outlines by the other minerals, the occurrence of small crystals of olivine and ore within the feldspar substance along boundaries, between crystals, near the margins and along fractures, the bending, deorientation and recementing of parts of the feldspar crystals, in short, all the peculiar textural features of the feldspar crystals and their relations to the other minerals as seen in thin section are what might be expected if such a state of affairs as outlined above had obtained.

One can hardly escape contrasting the conditions of stable equilibrium which obtained in this rock with those existing in the much better understood systems of salts and alloys of the laboratory. The phases found here are, plagioclase, olivine and ore, the latter, as pointed out, existing texturally as a unit although it is made up of three distinct minerals. We have in the rock no textural evidence of the existence of eutectic structures nor of solid solutions between the phases. The ore alone bears a possible analogy to the cases of salts and alloys. In the case of the feldspar it is perhaps not difficult to understand how it might develop relatively large crystals or groups of crystals in a comparatively mobile magma, such as the molten olivine and ore would make when melted. The feldspar is apparently entirely immiscible in the magma, or the solid phases resulting from the latter's consolidation, by the time it has reached its freezing point. With the ore and olivine it is more difficult to see how they could have separated in the way they have if the separation

\* This Jour. (4), xix, 1905. It is assumed by the writer that the high viscosity of the plagioclase  $Ab_1 An_1$  would be sufficient to cause it to behave in a degree like the more highly acid feldspars.

was wholly a part of the act of crystallization. Whether the olivine preceded the ore in time of crystallization or whether the two crystallized at the same time, we have to explain how a material in the act of orientating its molecules can forcibly expel another and move it through a molecularly great distance. If the expulsion is a part of the act of crystallization then it must have begun about a great number of irregularly situated centers and proceeded gradually outward, the growth of the one mineral (in the present case the olivine) forcing the other toward the surrounding centers until finally the expelled material from the many centers would necessarily occupy an interstitial position with reference to the first mineral. If the interstitial material were still liquid it would then solidify when its own freezing point was reached. The position and character of the ore is quite in keeping with such a procedure. Another supposition which is possible is that the minerals become immiscible before their freezing point is reached and being then in a relatively mobile condition they would segregate readily, and subsequently solidify independently, their textural relations to each other being in such case determined by their individual freezing points, their relative velocity and power of crystallization, and their relative volumes. The inclusion of ore grains, as well as that of the minute opaque particles, a part of which may reasonably be considered as primary crystallizations, within the olivine crystals and along their boundaries, is quite in keeping with either of the above suppositions. The inclusions are merely a portion of the ore which was prevented from segregating with the rest by the decreasing mobility of the crystallizing olivine.

This last supposition involves the idea of liquid immiscibility in silicate melts. This has been proposed by some to explain rock differentiation,\* but there appears to be no convincing evidence, certainly not experimental,† of immiscibility in molten silicate mixtures. Nevertheless, the mechanical difficulties involved in the segregation of the various minerals into the positions occupied by them in the rhodose (as well as of the minerals in many other rocks) seem to be considerably less if liquid immiscibility can obtain, than would be the case if the separation took place during crystallization, at which time one would expect, in most instances, great resistance to freedom of motion and the minerals might be expected to crystallize as a fine-grained, intimately mingled aggregate such as is the case with eutectic mixtures. The idea of liquid immiscibility seems at least worthy of careful consideration.

\* See H. Bäckström, *Jour. of Geol.*, vol. i, 1893, p. 778.

† See Vogt, *Die Silicatschmelzlosungen*, vol. i, p. 100, vol. ii, p. 228, and A. L. Day and E. S. Shepard, *Econ. Geol.*, vol. i, 1905, p. 286.

*Chemical Composition and Quantitative Classification.*—Material for chemical analysis was obtained by breaking off a large number of good-sized fragments from the parts of the ledge where quarrying had exposed a comparatively fresh surface. These fragments were broken into smaller pieces and of these about 3 kilos were crushed in a chilled steel mortar, care being taken to avoid pieces showing any signs of alteration. The entire lot was then sampled so as to yield a product representative of the average composition of the rock.

The presence of so much titanium\* makes the analysis of this rock of more than usual difficulty, and accordingly especial pains were taken to insure the correctness of the various determinations. The results of the analysis with the molecular ratios and their apportionment to the various "normal" minerals are as follows:—

\*The writer is indebted to Professor Henry Fay of the chemical department of the Massachusetts Institute of Technology for the details of a highly satisfactory method, both in point of simplicity and accuracy, for the determination of the titanium. The principles involved present nothing new, but the exact details of the method do not appear to be known to petrographers at least, and for the benefit of those who may have occasion to analyze rocks rich in  $TiO_2$  the directions for the carrying out of this method are given herewith. By observing these carefully, excellent results will be obtained. Where extremely accurate determinations are desired, a third repetition of the separation may be made. In two made during the present investigation, only one one-hundredth of one per cent of iron could be detected in the  $TiO_2$  precipitate. Aluminium and manganese are probably included to about the same amount.

Fuse 0.4 to 0.6 gms. of finely ground ore with 6 to 8 times its weight of sodium carbonate. Extract the mass with hot water, and decant the solution through a filter. Boil the residue with 25 cc. of sodium carbonate solution, filter, and then wash the residue on the filter paper several times with dilute sodium carbonate solution. Ignite the filter and residue in a platinum crucible at a low temperature until the filter paper is burned. Fuse with 12 to 15 parts of dry acid potassium sulphate for one-half hour. The temperature of the fusion should be so regulated that the mass is kept in the molten condition, but fumes of sulphur trioxide should escape only when the lid of the crucible is removed. Cool and remove the fusion from the crucible by means of a platinum wire. Suspend the fusion in 200 cc. of cold water to which has been added 100 cc. of sulphurous acid and allow to stand in a cool place until solution is complete.

Filter if necessary. To the solution add 125 cc. of acetic acid (sp. gr. 1.04) and dilute to 800 cc. in a liter beaker. Add 20 gms. of sodium acetate dissolved in a small amount of water and boil from 3 to 5 minutes, adding just before the boiling point is reached an additional 25 cc. of sulphurous acid. Allow to stand in a warm place for one-half hour and then filter by means of a siphon through a 9<sup>cm</sup> paper.

Wash the precipitate with 5 per cent acetic acid solution until most of the sulphate has been removed and then ignite the paper and precipitate and fuse with acid potassium sulphate again. Proceed exactly as before, wash thoroughly, finally igniting and weighing the precipitate as  $TiO_2$ . The latter in the writer's experience always has a light to dark gray color.

	Per cent	Mol.	Ilmen-ite	Magne-tite	Ortho- class	Albite	Anor- thite	Oli- vine	Spinel
SiO <sub>2</sub> .....	22·35	·372			·006	·042	·040	·284	
Al <sub>2</sub> O <sub>3</sub> .....	5·26	·051			·001	·007	·020		·023
Fe <sub>2</sub> O <sub>3</sub> .....	14·05	·088		·088					
V <sub>2</sub> O <sub>5</sub> .....	·18	·001		·001					
Cr <sub>2</sub> O <sub>3</sub> .....	tr.								
FeO .....	28·84	·400	·125	·089				1·86	
MgO .....	16·10	·402						·377	·025
CaO* .....	1·17	·020					·020		
Na <sub>2</sub> O .....	·44	·007				·007			
K <sub>2</sub> O .....	·10	·001			·001				
H <sub>2</sub> O— .....	·42								
CO <sub>2</sub> .....	·02								
TiO <sub>2</sub> .....	10·11	·125	·125						
P <sub>2</sub> O <sub>5</sub> .....	·02								
S .....	·38	·012							
MnO .....	·43	·005							·005
Zn* .....	·71	·010							
Cu .....	·08	·001							
(Co&Ni) .....	·08	·001							
Pb .....	tr.								

Total .. 100·74

In the non-magnetic residue obtained in isolating the olivine previously described, some sphalerite and chalcopyrite as well as a few galena and pyrite grains were identified. The sulphur is therefore not all present in the sphalerite and chalcopyrite. Some of the zinc may also enter into the spinel molecule. The amount of sulphides found may be in excess of the amount really in the normal rock. Since the analysis was completed a minute vein of sulphides has been observed in a specimen similar to those used for analysis, but no trace of sulphide has been noted in the rock outside of this vein. It is possible that such a vein slipped unnoticed in to the sample analyzed. In such case, however, the classification is not materially affected thereby. The classification is as follows :

Or .....	0·56		sal	$\frac{9·79}{90·0} = 0·10 = 5$ , Perfemane.
Ab .....	3·67	9·79 sal.	fem	
An .....	5·56		P + O	$\frac{45·70}{39·65} = 1·1 = 3$ , Rhodare.
Ol .....	45·70		M	
Mt .....	20·65	90·05 fem.	(MgFe)O + CaO	$\frac{807}{8} > \frac{7}{1} = 1$ , Rhodase.
Ilm .....	19·00		K <sub>2</sub> O + Na <sub>2</sub> O	
Spinel ..	3·55		MgO	$\frac{402}{405} = 0·99 = 2$ , Rhodose.
Sulphides	1·15		FeO	
<hr/>				
99·84†				

\* Sphalerite .....

Chalcopyrite .....

† After the completion of the calculation it was noticed that the dropping off of fractional parts in several instances had resulted in reducing the total of the norm and making a small discrepancy between it and the total of the



The rock is therefore perfermic, polmitic, permirlic, and magnesiferous, its coördinates in the quantitative classification being 5, 3, 1, 2. Furthermore it falls in section 5 of its order, and in section 1 of its rang, and may therefore be further defined as perolic and permiric. As there is as yet no name in the quantitative classification for either the order or rang in which this rock falls, it is necessary to choose a name. Rhodare\* and Rhodase (-ose) have been chosen, using the name of the state in which the rock occurs for a stem to which the appropriate termination may be affixed. This has been chosen in place of Cumberland—since the latter is the name of an obscure and almost unknown town and might be confused with Cumberland, England, a well known locality.

The rock finds a place in the classification in which there are practically no heretofore adequately studied rocks and is therefore of particular interest.

As the olivine is the only one of the groundmass minerals whose exact chemical composition has been determined directly, it was assumed, in apportioning the FeO, MgO, and MnO between the four modal minerals, olivine, magnetite, ilmenite, and spinel, that the magnetite is represented by the formula  $Fe^{II}Fe^{III}O_4$ , the spinel by  $MgAl_2O_4$ , and that the remaining MgO and the small amount of MnO are contained entirely in the olivine and ilmenite. It seems unlikely, however, that any considerable error is involved in this assumption. Adjusting, therefore, the above mentioned oxides between the olivine and the ilmenite in accordance with the ratios obtained from the mineral of the olivine, we obtain the following as the true composition, or mode, for the rock :

Mineral.	Mode.		Sp. gr. used.	Composition of the ilmenite calculated to 100%.	
	Per cent. by weight.	Per cent. by volume to 100%.		TiO <sub>2</sub>	FeO
Orthoclase	0.56	0.8	2.55	53.6	42.5
Labradorite					1.3
Ab <sub>3</sub> An <sub>4</sub>	9.23	13.7	2.69	MgO	2.6
Olivine					
(hyalosiderite)	46.08	49.4	3.73		
Magnetite	20.65	15.9	5.17		100.00
Ilmenite	18.63	15.2	5.0		
Spinel	3.55	3.9	3.6		
Sulphides	1.15	1.1	4.1		
	99.85	100.00			

analysis (less H<sub>2</sub>O = 0.42 per cent). It does not affect dependent figures materially and it has not been thought worth while to recalculate the whole for so trifling a matter.

\* The use of the name Rhodare, etc. was first suggested by Professor L. V. Pirsson, to whom the writer's thanks are due.

A computation of the specific gravity of the rock, from its percentage composition and the specific gravities of the individual minerals given above, gives 4.003, which is in close agreement with the figure obtained experimentally, 4.005, by J. E. Wolff, quoted by Wadsworth, and of 3.92 by the writer.

With regard to the volume percentage (see above table) of the different minerals, it is to be noted that the olivine makes up one-half of the volume of the rock, while the magnetite and ilmenite occupy, relative to each other, almost exactly the same space, and make up a total of 31.1 per cent. In the last column of the above table is given the percentage composition of the ilmenite calculated to 100 per cent.

*Transition Type.*—In going either north along the ledge from the exposure of the unaltered rock, or downward and to the west (outward), within a few yards one comes upon what is a transition into the more highly altered types of the hill. The transition zone seems to be of variable width, but never exceeds a few yards in actual measure. The rock is distinguished macroscopically from the original by the presence of a dark green, amorphous border of alteration material about the plagioclase crystals. This border is the first indication of a change, and as one goes farther from the unaltered rock it grows broader, spreading out irregularly into the ground-mass, while at the same time the core of feldspar grows smaller.

As seen in thin sections without crossed nicols, the alteration border is apparently homogeneous except for occasional specks of actinolite or ore, and differs in appearance from the core of unaltered feldspar in being less transparent, in possessing a pale yellowish-green discoloration, a somewhat higher index of refraction and consequently a different surface. That its index is higher than the feldspar was proved by observing the total reflection phenomena at the contact between the two after the method developed by Van der Kolk and elaborated by F. E. Wright\* and also by the well-known method of Becke. Between crossed nicols the border is resolved into two distinct substances.

One is seen directly in contact with the feldspar and is clearly the first product formed. The structure is more or less confused but may be described as semi-compact to sub-fibrous and often shows a divergent structure (plumose). Distant from the feldspar the structure becomes still more confused but at times approaches a granular texture. As near as can be told, the extinction is parallel to the elongation, as is also the direction of vibration of the slower ray (C). The interference colors have never been noted higher than yellow of the first order in sec-

\* This Journal, No. 167, vol. xvii, pp. 385-7, 1904.

tions about  $0.03^{\text{mm}}$  thick. This would indicate a double refraction a little higher than the feldspar.

The second substance is in part enclosed in the first in the form of irregular patches. It replaces the first substance entirely toward the margins and where the feldspar has entirely disappeared it occupies the center of the area. With high powers between crossed nicols it is seen to consist of an aggregate of minute fibers and crystal plates often closely thatched. Individual crystals have a distinct cleavage or lamination parallel to their length, to which the extinction is parallel and which is also the direction of the vibrations of the faster ray (A). The interference colors are a peculiar dull, dusty gray, for  $0.03^{\text{mm}}$  thickness. With low powers the aggregates appear almost isotropic. The characters of this mineral indicate that it belongs to the chlorite family, probably near the variety clinochlore. This identification has been repeatedly confirmed by study of the same mineral, more coarsely crystalline, in the altered types described beyond, and is strongly supported by chemical considerations (see later) as well as by the occurrence of clinochlore in the veins which cut the rock of the hill. The identity of the first mineral substance is not so clear, but its easy passage into the chlorite as the alteration progresses points to a very close relationship between the two. The identification of chlorite, previously supposed to be serpentine, adds not a little interest to the chemical aspects of the alteration process.

Enclosed in this pseudomorphic material, at or near the feldspar, are occasional irregular apparently isotropic bodies of a brownish color and a high single-refraction. They have not been positively identified. More or less actinolite in the form of minute prisms and a few black particles are scattered through the chlorite.

About the spaces originally occupied by the feldspar, the ore is more or less frayed out and finely granular, and clearly shows the effects of alteration. Here too the olivine grains are to a greater or less extent replaced by the chlorite. This replacement begins at the borders, and while there is a well marked tendency for the fibers to follow the direction of the basal cleavage, their direction is often irregular. This chloritic replacement is often either accompanied by, or immediately followed by an *actinolitic* one. The latter is strongest in the neighborhood of the chloritic areas, but occurs to a variable degree elsewhere. Olivine crystals surrounded by a border of chlorite may be seen containing one or two well-developed crystals of actinolite, or the crystal, within the border, may have been wholly replaced by one, two, or a greater number of actinolite crystals. The actinolite retains many of the original

inclusions of the olivine, which have, however, undergone more or less rearrangement and recrystallization. Between the olivine, which is now very often somewhat discolored, and the ore, and sometimes between the olivine crystals where these are near the ore, there is everywhere developed a narrow band of chlorite crystals. The continuity of the ore matrix is now somewhat broken, probably along the boundaries of individual grains, and the breaks are filled with chloritic material. The spinel is also replaced by chlorite, and can be seen in various stages of alteration. Although the ore has clearly contributed to the formation of the secondary minerals, the olivine and the feldspar have furnished by far the greater portion of the materials.

*Altered Types—“Chloritic.”*—Beyond the transition type we find the plagioclase phenocrysts entirely replaced by the dark green, amorphous material. The greater part of the olivine is still unaltered, and is easily detected macroscopically. Crystals of a pale green to yellowish actinolite are now conspicuous in the rock, and are particularly numerous in the neighborhood of the pseudomorphous areas of chloritic material. Freshly broken specimens of the rock have a greenish black color, broken by the occasional bright cleavages of olivine, or actinolite, and indistinctly mottled by the chloritic areas. On smooth glaciated surfaces recently cleared of soil, the appearance of the thickly scattered chloritic spots whitened by exposure is strikingly suggestive of the cumulophyric texture of the original rock. Surfaces long exposed to weathering become deeply pitted where the soft chloritic spots wear away and the olivine rusts out, leaving the ore in relief. This type, which we will designate the “*chloritic type*” for convenience, as near as can be told from the exposures, makes up the greater portion of the present hill. It is most typically exposed in the large old quarry on the western side.

An examination of thin sections of this type shows that the first formed product of the alteration has entirely disappeared. Different pseudomorphous areas differ more or less in detail, but all consist essentially of chlorite and a variable amount of actinolite in the form of minute prisms. The latter are apt to be segregated particularly toward the center, which then gives a lighter color to the green areas in the hand specimen. The chlorite crystals vary considerably in size, but are on the average larger than in the previous type and show their distinctive properties more clearly. A well-developed cleavage may be seen and many crystals are twinned. There is rarely a feeble pleochroism visible. Some areas consist throughout of a finely thatched mass of chlorite, others consist of a granular aggregate of chlorite and actinolite centrally, surrounded

by a much finer grained border. Traces of the original feldspar cleavage and twinning structures are often preserved in the arrangement of the secondary minerals. On the whole the areas appear to have enlarged somewhat and to have suffered more or less recrystallization and rearrangement within their borders.

The olivine is now commonly filled with a brownish dust, and has suffered from chloritic and actinolitic replacement as in the previous type, except that the process has gone further. Many olivine crystals about the chloritic areas have

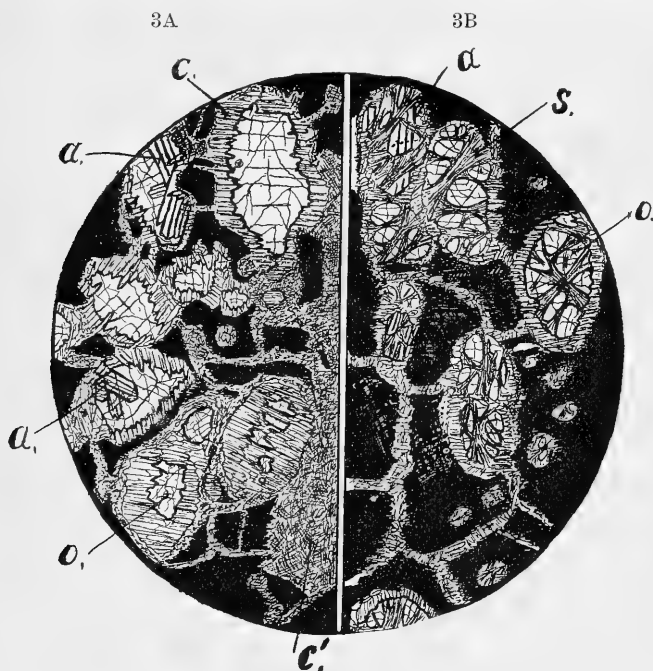

FIG. 3A. The sketch shows the relations of the minerals in the chloritic type. *o*, Unaltered olivine. *c*, Chlorite lamellæ replacing olivine; commonly lie parallel to the basal cleavage. *c'*, Fine chlorite aggregate replacing the plagioclase; only the edge of the area is shown. *a*, Actinolite prisms replacing the olivine. The black is the ore; note that the continuity of the ore is broken.

FIG. 3B. This shows the olivine (or actinolite) with the border of chloritic material lying between it and the ore, being replaced by a fibrous or lamellar serpentine, (*s*). Here again the ore is broken and in places shows its reticulate structure.

been entirely replaced by chlorite as well as actinolite, and fine examples showing various stages of replacement may be seen. The continuity of the ore-matrix is more often broken in this

type, and the chloritic border between the ore and the olivine is more pronounced than before. Minute veinlets, similar in character to the larger veins of the hill, are occasionally seen macroscopically and in the slides. The accompanying figure (3A) will illustrate the relations of the various minerals as seen in thin section.

*Actinolitic Type.*—By a considerable increase in the amount of actinolite, we pass into what may be called the “*actinolitic*” type. So far as quantity goes, it is much less important than any of the other types. It occurs locally in irregular patches or streaks through the hill. Compared with other types, specimens of it are lighter and more yellowish in color and possess also more glistening surfaces, by reason of the presence of abundant actinolite crystals of a pale yellowish green color and with highly developed cleavages. The ore is much less conspicuous as a rule. In fact, in extreme cases it is hardly noticeable, and the rock then consists practically of actinolite and the compact chloritic material. The chloritic areas seem to be rather more abundant, somewhat less distinct in outline, and show a tendency to merge into one another. The actinolite crystals rarely exceed 2 or 3<sup>mm</sup> in length.

In thin section the green areas appear much the same as in the previous type. In their neighborhood the olivine is strongly replaced by chlorite as before. The actinolitic replacement, however, reaches a maximum development and frequently displaces all of the olivine. The ore-matrix, although considerably broken, preserves very well its original outlines. The chloritic borders about the olivine grains persist even where the olivine has been entirely replaced by the actinolite. Whether or not the latter mineral is affected by the chloritic alteration has not been definitely made out, but if such is the case, the process has gone on only to a very slight degree. Except in extreme cases the texture of the rock in section differs but little from that of the preceding type, and in general appearance they are also similar—actinolite lying in the place of the olivine.

The actinolite possesses a very pale greenish pleochroism and a rather high extinction angle, 20 degrees measured on the prismatic cleavage cracks. It was found by comparison (immersion method) with the vein actinolite described beyond that the two possess practically the same index of refraction. Fragments of the actinolite from the rock sank in the Thoulet solution a little more readily than that from the veins, although this may be accounted for by the presence of included ore particles without which the mineral from the rock could not be obtained. For this reason no attempt was made to analyze the mineral. The rock and vein minerals appear, however, to be essentially

identical, and no great error can be made by looking upon the composition of the vein actinolite, given beyond, as representing closely that of the mineral from the rock.

*Serpentine type.*—Both the chloritic and the actinolitic types by the replacement of the remaining olivine, or of the actinolite, by serpentine, pass gradually into what will be called the *serpentine type*. This represents a more advanced stage in the alteration and is the predominant type at the northern end of the hill. It is also found along the eastern side, locally on top, and was probably characteristic of the peripheral portions of the mass. In appearance it resembles the chloritic type, from which it can be distinguished by its somewhat greener color and by noting with a lens the presence of a leek-green, foliated serpentine in place of the original olivine of the groundmass. The ore preserves its characteristic appearance, but has a more noticeable bronzy tint on broken surfaces than the unaltered rock.

Thin sections show that the chlorite and actinolite of the pseudomorphic areas are much the same as in the other types, although the crystals of the chlorite are commonly larger and occasionally show a delicate plumose texture while the actinolite is more strongly segregated. A variable amount of finely crystalline serpentine and ore, the latter both residual or secondary, is now mingled with the other constituents. The areas themselves appear to have encroached on the groundmass more extensively than elsewhere except perhaps in extreme cases of the actinolitic replacement.

The olivine is seen in all stages of replacement by a finely lamellar to fibrous serpentine having a beautiful divergent texture. The serpentine starts at or in the chloritic borders and shoots out at random into the olivine grains, which here are filled with a brown dust. The serpentine shows gray polarization colors, a parallel extinction and a positive elongation. The actinolite crystals seem to have undergone replacement in the same manner as the olivine. In most of the slides examined considerable residual olivine and actinolite remain in the interstices between the serpentine lamellæ, and form, with their brilliant polarization colors, a striking contrast to the dull gray serpentine.

Although the ore matrix has suffered some absorption and removal during the serpentinization, and its continuity has been more or less broken, it still retains its original outlines and therefore preserves to a remarkable degree the peculiar texture of the unaltered rock. Few rocks if any that have come under the writer's observation show phenomena of alteration and replacement in so beautiful and convincing a manner. Figure

3B will serve to give some idea of the relations of the different minerals.

Professor Wadsworth has noted the occurrence of talc and dolomite as extreme alteration products of the rock. These minerals seem, however, to be exceptional and are certainly not characteristic of the alteration as now exposed.

*Conclusions regarding the alteration process.*—The profound alteration which has taken place in the rhodose appears to have been affected by the long-continued action of waters from the surface. It is most severe in the peripheral portions of the rock mass and its progress seems to have been gradually inward from the margins.

The first change effected in the rock was the destruction of the plagioclase and of the olivine and ore immediately adjoining. The first product formed in the place of the feldspar is of uncertain composition, but very readily changes into chlorite and actinolite; at least these two minerals appear almost immediately. The chlorite can derive its aluminium *only* from the feldspar, its magnesium from the olivine; its iron may and undoubtedly does come from both the olivine and the ore. The lime from the plagioclase goes to form actinolite whose other bases seem to come principally from the olivine since it is the olivine that is replaced by the actinolite. The alkalis and a part of the lime have been removed. The titanium has either remained in the form of ilmenite or else has passed into the composition of the chlorite. It is perhaps remarkable that rutile\* or other oxides of titanium are characteristically absent from all of the altered types.

That the solutions carrying the alumina, lime and soda and other products were diffused very generally through the rock is proved by the bands of chlorite almost everywhere developed between the ore and the olivine, as well as by the presence of actinolite distributed through the rock. The veins carrying actinolite, chlorite and hornolite also bear evidence that material was being actively transported. That these solutions should deposit a mineral belonging to a group of minerals so characteristic of igneous origin is of especial interest.

The greater abundance of actinolite in certain portions of the hill may be accounted for by supposing that the feldspar was there more abundant and the supply of material for secondary minerals therefore more abundant. On the other hand, it is supposable that the actinolitic portions represent merely places where the mineralizing solutions were for some reason more abundant.

After the series of reactions which gave rise to the chlorite and actinolite were completed, *further alteration* resulted

\* In one or two instances reddish grains associated with the ore have been noted which may be rutile.



chiefly in the replacement of the remaining olivine and actinolite with *serpentine*.

The magnetite-ilmenite matrix seems to have been the part of the rock least affected.

For the purpose of checking in a general way the conclusions reached through microscopic study as to the mineral and chemical changes that have taken place in the rock, two partial chemical analyses have been made, one of the "chloritic" type, and the other of the "serpentinic," the later showing very little actinolite. A single specimen cannot of course be expected to represent the exact altered product of a rock of the composition of the representative sample taken for the original type, and an extensive sampling of the altered types, had there been time and opportunity to do it, would undoubtedly have yielded more satisfactory results. Nevertheless the two analyses given in the accompanying table, together with that of the unaltered rock, serve to sustain the conclusions already reached, and are instructive in showing the general character of the chemical changes which have taken place.

Sp. Gr. ....	Unaltered type	*Chloritic type	Serpentine type
Sp. Gr. ....	4.005-3.92	3.85-3.80	3.65-3.56
SiO <sub>2</sub> .....	22.35	20.89	19.98
TiO <sub>2</sub> .....	10.00	9.57	9.76
Al <sub>2</sub> O <sub>3</sub> .....	5.26	6.93	6.75
Fe <sub>2</sub> O <sub>3</sub> .....	14.05	17.81	19.25
FeO .....	28.84	26.04	21.42
Fe met. ....	(32.26)	(32.71)	(30.13)
MnO .....	.43	....	.40
MgO .....	16.10	15.65	16.83
CaO .....	1.17	.96	†lost
K <sub>2</sub> O .....	.10	none	tr.
Na <sub>2</sub> O .....	.44	tr.	tr.
H <sub>2</sub> O .....	.42	2.71	4.77
	99.26	100.54	99.32

Comparing the three analyses we see that there has been comparatively little material actually removed from the rock during the extensive alteration process. The alkalis, some lime and silica, have been removed, and also some of the iron in the serpentine type. The iron has suffered some oxidation. The alumina seems to have increased relatively, and its presence

\* This analysis was made by Mr. J. W. Shaw, formerly assistant in the department of Geology.

† The amount of lime ppt. was very small indeed.

points conclusively to the presence of *chlorite* so generally looked upon as serpentine heretofore.

*The Vein Minerals.*—As noted in Part I, small veins of varying sizes, sometimes attaining a width of an inch, and consisting essentially of actinolite, clinochlore, and hortonolite, are found following the directions of the joints and also cutting irregularly through the rock. Furthermore, these veins are confined in their occurrence to the “chloritic” and “actinolitic” types of the partially altered rock and must be looked upon as one expression of the alteration phenomena of the rhodose. The vein minerals are quite irregular in their arrangement and start immediately from among the grains of olivine and ore in the wall rock. They appear to have formed along joint or fracture lines which afforded easy channels for the mineral-bearing solutions.

*The Actinolite.*—The actinolite is the most abundant mineral and its crystals attain a relatively large size, being often from 1<sup>cm</sup> to 2<sup>cm</sup> in length. It is light green to yellowish green in color, prismatic in habit, and is conspicuous by reason of its highly perfect prismatic cleavages. Terminal crystal planes are lacking. Fragments of it under the microscope show a feeble pleochroism from pale to yellowish green and an extinction angle of 15 degrees measured in fragments lying on their cleavage faces. The specific gravity was found with the pycnometer to be 3.062 at 20 degrees. A chemical analysis was made of selected crystals of the actinolite which, after crushing to a small grain and handpicking, had been digested in dilute hydrochloric to remove ferruginous matter. The material thus prepared showed no trace of impurity. The analysis and ratios derived from it are given below in column I. It is interesting to note that the ratios bear a close resemblance to those derived by Penfield\* from the analysis of actinolite by Stanley, especially to No. III (p. 32), an actinolite associated with talc from Greiner in Tyrol. For comparison these are given below:

	SiO <sub>2</sub>	R <sup>III</sup> O <sub>3</sub>	R <sup>II</sup> O + (F.OH)	SiO <sub>2</sub>	R <sup>II</sup> O + (F + OH)
Greiner	.938	.017	.935	1	.997
Cumberland	.933	.010	.916	1	.982

No determination of fluorine was made in the case of the Cumberland actinolite but intense ignition in a hard glass tube gave some slight trace of etching, indicating that fluorine is probably present to a slight extent in this actinolite as in all of those studied by Penfield and Stanley.

*The Clinochlore.*—The clinochlore is found in the form of pseudo-hexagonal or rhombic tables penetrating the other minerals and not uncommonly attaining a diameter of from 2 to 5<sup>mm</sup>.

\* This Journal, xxiii, 1907.

They are of a dark green to almost black color. Many of them are twinned after the characteristic manner of the chlorite group. Under the microscope the crystals show a strong pleochroism, brownish red parallel to  $c'$  (C), dark emerald-green perpendicular to  $c'$ . The crystals show an optically positive interference figure with an axial ( $2E$ ) angle varying considerably but running as high as 23 degrees according to an approximate measurement made with the aid of a Schwarzmännische Axenwinkel scale. Several exposed and strongly rusted joint surfaces are thickly studied with these clinocllore crystals. In such cases the other minerals have either entirely weathered away or were originally absent.

*The Hortonolite.*—In examining one of the best exposed of the veins, situated on the western side of the hill somewhat south of the center, Professor Charles Palache, of Cambridge, discovered a dark resinous-looking mineral associated with the actinolite and clinocllore which he correctly referred to the olivine group and which subsequently proved on analysis to be hortonolite. The material collected by Professor Palache was very generously placed by him at the writer's disposal for investigation and has proved the best so far obtained. No crystallographic outlines have been noted on the hortonolite and its relations to the other minerals are distinctly xenomorphic. It possesses two well-marked cleavages at right angles to each other, and, when fresh, small fragments have a light yellow color by transmitted light. The mineral tends to decompose readily to a reddish brown, ferruginous earth with an accompanying discoloration of the actinolite and eventual disintegration of the vein. An examination of a large number of specimens, collected from different veins, shows that the hortonolite is very generally present, and when not actually seen the characteristic ferruginous alteration material indicates that it was originally present. It is, therefore, to be looked upon as a normal constituent of the veins of the hill. With the aid of a microscope a sufficient number of clear yellow particles were picked out with considerable labor from some of the larger fragments, and analyzed. The results are given in column II. The specific gravity was found with the pycnometer to be 4.054 at 20 degrees C.

The ratio  $\text{SiO}_2 : \text{RO}$  is very nearly 1:2, the olivine ratio, and the composition is close to that of the hortonolite from Munroe, Orange Co., N. J., analyzed by Penfield and Forbes\* and given in column III. The occurrence of this rare mineral species at a new locality as a distinctly secondary mineral in veins traversing an ultrabasic olivine rock is of special interest to mineralogists. The occurrence of a member of the olivine group as a vein mineral has been noted and described by E.

\* This Journal, No. 151, p. 132, 1896.

Weinschenk\* in veins associated with antigorite, diopside, calcite, amianthus and magnetite, traversing both the unaltered and altered portions of a peridotite (Stubachite) which originally consisted essentially of olivine with some antigorite, the later said to be of primary origin. Weinschenk ascribes the origin of this secondary olivine to the action of deep-seated, pneumatohydro-metamorphic processes following the volcanic period during which the intrusion of the peridotite took place.

*Serpentine Veins.*—At the northern end of the hill near the foot of the ledge, a few narrow veins of a grayish-green, fibrous, and rather brittle serpentine were observed. Small magnetite grains are embedded in the serpentine.

## I. Actinolite Analysis (Warren).

		Ratio	
SiO <sub>2</sub> .....	56.00%	.933	.933
TiO <sub>2</sub> .....	tr.		
Al <sub>2</sub> O <sub>3</sub> .....	1.00	.000	.010
Fe <sub>2</sub> O <sub>3</sub> .....	.10	.001	
FeO .....	7.14	.100	
MnO .....	.10	.001	
CaO .....	14.03	.250	
MgO .....	20.52	.513	.916
K <sub>2</sub> O .....	tr.		
Na <sub>2</sub> O .....	.50	.008	
H <sub>2</sub> O .....	.80	.044	
F .....	?	?	

100.19

II. Hortonolite Analysis (Warren)  
Cumberland, R. I.

	Ratio	
SiO <sub>2</sub> .....	33.27%	.554
TiO <sub>2</sub> .....	tr.	
Fe <sub>2</sub> O <sub>3</sub> .....	.37	
FeO .....	49.32	.685
MnO .....	1.50	.018
MgO .....	16.08	.402
H <sub>2</sub> O .....	undet.	

100.54

III. Hortonolite Analysis (Penfield  
and Forbes.) Munroe, Orange  
Co., N. J.

SiO <sub>2</sub> .....	33.94
FeO .....	47.32
MnO .....	4.32
MgO .....	13.74
H <sub>2</sub> O .....	.48
	<hr/>
	99.80

Laboratory of Mineralogy

Massachusetts Institute of Technology, Boston, Mass.,

Sept., 1907.

\* Beiträge zur Petrographie der östlichen Centralalpen, u. s. w., Abh. Kgl. bayer. Akad. Wiss., II, Cl. 1894, 18, 651; also shorter papers—Zeitschr. für Kryst. und Min., No. 26 and Neues Jahrb. f. Min. u. s. w., 1895, Bd. 1.

BIBLIOGRAPHY.

- 1825(?) Robinson (Samuel)—A Catalogue of American minerals with their localities.
- 1833,5 Hitchcock (Edward)—Report on the geology, mineralogy, botany and zoology of Massachusetts. Amherst, 1833, 700 pp. (1st edition). (See pages 22, 54, 154, 359-360.) Also, 2d edition, 1835, 702 pp. (See pages 33, 64, 160, and 357.)
- 1840 Jackson (Charles T.)—Report on the geological and agricultural survey of the State of Rhode Island. Providence, 1840, 312 pp., 2 maps. (See pages 42-43, 52-54, 84, 105.)
- 1841 Hitchcock (Edward)—Final report on the geology of Massachusetts. 1841. (See pages 195, 380, 553-554.)  
Silliman (Benjamin, jr.)—Review of Dr. C. T. Jackson's Report on the geology of Rhode Island. *This Journal* (1), xl, 182-194, 1841.
- 1843 Reports of the first, second, and third meetings of the Association of American Geologists and Naturalists, at Philadelphia in 1840 and 1841, and at Boston in 1842. Embracing its Proceedings and Transactions. Boston, 1843, 544 pp. (See page 28.)
- 1861 Hitchcock (Charles H.)—Geology of the Island of Aquidneck. *Proc. Amer. Assoc. Adv. Sci.*, xiv, 112-137, 1860, Cambridge, 1861. (See page 133.)
- 1872 Thurston (R. H.)—Iron-making in Rhode Island. *Eng. and Min. Jour.*, xiii, 386, June 18, 1872.
- 1873 *New York Daily Tribune*, October 15, 1873.
- 1876 Report of the Rhode Island Commission to prepare a plan for a thorough geological and scientific survey of the State. Presented to the General Assembly at its January session, A. D. 1876. (See page 11.)
- 1881 Wadsworth (M. E.)—A microscopical study of the iron ore, or peridotite, of Iron-Mine Hill, Cumberland, Rhode Island. *Bull. Mus. Comp. Zool.*, Harvard College, vii, 183-187, 1881. Abstracted in *Proc. Bos. Soc. Nat. Hist.*, xxi, 195-197, 1881. Contains Historical sketch.  
Dana (James D.)—Iron ore of Iron Mine Mill, Cumberland, Rhode Island. *This Journal* (3), xxii, 152, 1881.  
Salisbury (Chas. M.)—Geology of the valley of the Narragansett. *Science Advocate*, 1881.
- 1883 Wadsworth (M. E.)—Meteoric and terrestrial rocks. *Science*, i, 127-130, 1883.
- 1884 Eddy (E. B.)—Porphyritic iron ore of Cumberland. *Random Notes on Natural History*, i, No. 4, 1884.  
Wadsworth (M. E.)—Lithological Studies. *Harv. Coll. Mem. Mus. Comp. Zool.*, xi, 208 pp., 8 pls., 1884. (See pages 74-83, table III, pp. xvi-xvii, and plates 1 and 2.)  
Wadsworth (M. E.)—The theories of ore deposits. *Proc. Bos. Soc. Nat. Hist.*, xviii, pp. 197-208. 1884. (See page 207.)
- 1885 Wadsworth (M. E.)—Descriptive catalogue of one hundred thin sections of American and foreign rocks. (See page 5.)
- 1887 Wadsworth (M. E.)—Preliminary description of the peridotites, gabbros, diabases and andesytes of Minnesota. *Geol. and Nat. Hist. Survey of Minnesota*, Bull. No. 2, St. Paul, 1887, 158 pp., 12 pls. (See pages 65 and 90.)
- 1889 Wadsworth (M. E.)—(Letter to the editor.) *Bulletin American Iron and Steel Association*, Nov. 20, 1889.
- 1893 Wadsworth (M. E.)—A sketch of the geology of the iron, gold and copper districts of Michigan. Report of the State Board (of Michigan) Geological Survey for the years 1891 and 1892. Lansing, 1893, pp. 75-186. (See pages 90, 95-96, 97.)  
Shaler (N. S.)—The conditions of erosion beneath deep glaciers, based upon a study of the boulder train from Iron Mine Hill, Cumberland, Rhode Island. *Bull. Mus. Com. Zool.*, Harvard College, xvi, pp. 185-225, pls. 1-4, and map, 1893.

- 1895 Adams (Frank D.)—On the igneous origin of certain ore deposits. *Journal of the General Mining Association of the Province of Quebec.* 1894-1895. ii, pp. 35-53. (See page 38.)
- Shaler (N. S.)—The geology of the road-building stones of Massachusetts, with some consideration of similar materials from other parts of the United States. *U. S. G. S., 16th Ann. Rept.*; pt. 2, 1895, pp. 277-341, pls. xviii-xxiv. (See page 321.)
- 1896 Vogt (J. H. L.)—The formation of eruptive ore deposits. *Min. Industry for 1895*, iv, pp. 743-754, New York and London, 1896. (See page 745.)
- 1898 *Engineering and Mining Journal*, lxvi, 768, 1898.
- 1899 Shaler (N. S.)—General geology (of the Narragansett Basin) *U. S. G. S., Mon.* 33, 1899, pp. 1-90. (See pages 72-73, 75-76, 88-89.)
- Kemp (James Furman)—The titaniferous iron ores of the Adirondacks. *U. S. G. S., 19th Ann. Rept.*, 1897-98, Part 3, 1899, pp. 377-422. (See pages 384, 388-389, 390, 391, 401, 419.)
- Kemp (James Furman)—A brief review of the titaniferous magnetites. *Columbia School of Mines Quarterly*, xx, 323-356, 1899, and xxi, 56-65, 1899. (See pages 349-351.)
- 1903 Kemp (James Furman)—The ore deposits of the United States and Canada, 1903, 481 pp. 5th edition, New York, 1903. (See pages 57, 63, 61, 66, 173 and 181.)
- 1905 Beck (Richard)—The nature of ore deposits, translated by Walter Harvey Weed. 1st edition, 1905. (See pages 21-25.)

ART. II.—*On the Esterification of Benzoic Acid*; by  
I. K. and M. A. PHELPS, and R. W. OSBORNE.

[Contributions from the Kent Chemical Laboratory of Yale Univ.—clxviii.]

It has been stated by Fischer and Speier\* that benzoic acid heated in certain proportions on a return condenser for some hours with ethyl alcohol containing one or three per cent of hydrochloric acid gives either 64.5 per cent or 76 per cent of the ethyl benzoic ester theoretically possible, the amount obtained being increased by the presence of the larger amount of hydrochloric acid. By the use of 10 grm. of sulphuric acid with 100<sup>cm</sup><sup>3</sup> of ethyl alcohol and 50 grm. of benzoic acid Fischer and Speier were able on heating for three hours to obtain nearly 90 per cent of ester; and they gave it as their opinion that by increasing the amount of alcohol used nearly quantitative amounts of ester should be formed. Goldschmidt† and Kailan‡ have measured the rate of esterification under certain conditions of benzoic acid with ethyl alcohol and hydrochloric acid, but, so far as we are aware, no one has shown any method of predicting the yield when a large percentage of ethyl benzoic ester is to be obtained. In a former paper§ from this laboratory a procedure has been outlined by which succinic ethyl ester can be obtained in almost quantitative amounts from succinic acid by leading alcoholic vapor charged with dry hydrochloric acid from one flask into a second flask, heated at 100° to 110°, containing the succinic acid with some of the alcoholic mixture. In somewhat later work|| from this laboratory it has been shown that succinic acid in the presence of zinc chloride is esterified much more rapidly by the alcoholic mixture. This esterification was made in flasks specially arranged as illustrated in that paper.

In the work given here, with the arrangement of flasks referred to above, the esterification of benzoic acid has been studied under the conditions recorded in the table; first with ethyl alcohol alone, then with ethyl alcohol containing zinc chloride, then with ethyl alcohol containing hydrochloric acid, then with the same mixture in the presence of zinc chloride, and, finally, with ethyl alcohol containing sulphuric acid.

The pure benzoic acid of commerce was used in all of the work recorded here. The alcohol was either the alcohol of commerce 88.8 per cent, or alcohol made as free from water as possible by repeated distillations from calcium oxide. The sul-

\* *Berichte*, xxviii, 3252.

† *Ibid.*, xxviii, 3218.

‡ *Monatscheft f. Chemie*, xxvii, 543.

§ *This Journal*, xxiii, 368.

|| *Ibid.*, xxiv, 194.

phuric acid was the pure, concentrated acid of commerce, sp. gr. 1.84. The alcohol was charged with dry hydrochloric acid by saturating in the cold a given weight of alcohol with a known amount of dry hydrochloric acid, and then diluting to definite concentration. Pure anhydrous zinc chloride was melted and treated at the same time with hydrochloric acid gas dried by means of sulphuric acid.

In every experiment recorded in Table I alcohol alone or alcohol charged with dry hydrochloric acid was boiled in a 500<sup>cm</sup><sup>3</sup> round-bottomed flask, fitted with an outlet tube and a separating funnel carrying a drying tube, and passed in vapor at a uniform rate during the entire time to the bottom of another 500<sup>cm</sup><sup>3</sup> round-bottomed flask containing a definite weight of benzoic acid and a definite volume—40<sup>cm</sup><sup>3</sup>—of alcohol alone or charged with a definite weight of dry hydrochloric acid as indicated in the table. The temperature of the mixture in the flask in which esterification took place was kept between 100° and 110° by heating the flask in a bath of sulphuric acid and potassium sulphate, and this temperature was indicated by a thermometer dipping in the mixture and held in a three-bored rubber stopper fitted to the second flask and carrying also the glass tube for the introduction of the vapor. The vapor liberated in the second flask passed by means of a Hempel column, arranged as described in the paper to which reference has been made, to a condenser and was collected as the liquid distillate.

In general, the mass of ester with its impurities was poured into a separating funnel containing a little ice, the last traces of the liquid being transferred from the flask to the funnel by successive rinsings with ether. The impure ester in the funnel was treated with an excess of dissolved sodium carbonate, and the water solution was drained off from the supernatant mixture. This mixture was washed once with a water solution of sodium chloride of sufficient density to separate it easily from the mixture. To recover any portion of the ester carried along in the water solution of sodium carbonate and the wash water containing sodium chloride, each solution was shaken out separately three times with fresh portions of ether and these were added to the mixture. These mixtures of ester in the ethereal solutions were gathered in a 250<sup>cm</sup><sup>3</sup> side-necked flask connected with a 100<sup>cm</sup><sup>3</sup> side-necked flask as a receiver in the usual way for a vacuum distillation. The impurities of lower boiling point, presumably composed chiefly of ether, alcohol, and water, were removed from the benzoic ester by allowing a gentle current of air to pass through the apparatus, while the flask containing the ester solution was heated in a water bath raised finally to 60° until the pressure shown



on the manometer.—15<sup>mm</sup>—indicated that only benzoic ester remained in the flask to be distilled. The ester was then distilled over by heating the 250<sup>cm</sup><sup>3</sup> flask in a bath of sulphuric acid and potassium sulphate at 140°–150°, and collected in the 100<sup>cm</sup><sup>3</sup> flask, which was cooled by allowing a current of cold water to strike it constantly during distillation. The last traces of ester left on the distilling flask were removed by flaming the flask and at the same time increasing the current of air that was passing through the apparatus. The increase in weight of the receiver gave the weight of the benzoic ester in the flask in which esterification took place.

TABLE I.

No.	Benzoic acid gram.	Alcohol with HCl		A Reaction time		Benzoic ester		
		cm <sup>3</sup>	per cent	hr.	mi.	Theory gram.	Found gram.	per cent
( 1 )	50	300	---	3		61.48	trace	
( 2 )	50	200	1.25	3	30	61.48	50.88	82.8
( 3 )	50	200	1.25	4		61.48	51.53	83.8
( 4 )	50	200	10	3		61.48	52.60	85.9
( 5 )	50	200	25	3		61.48	47.12	76.6
B								
( 6 )	50	200	1.25	1		61.48	43.80	71.2
		200	1.25	1	30			
( 7 )	50	200	1.25	2		61.48	48.78	79.3
		200	1.25	2				
( 8 )	50	200	1.25	2	30	61.48	49.70	80.8
		200	1.25	2	30			
( 9 )	50	200	10	1		61.48	52.17	84.9
		200	10	2				
(10)	50	200	10	1		61.48	52.48	85.4
		200	10	2				
(11)	50	200	10	1	30	61.48	52.89	86.2
		200	10	3				
(12)	50	200	10	2	10	61.48	54.85	89.2
		200	10	3	30			
(13)	50	200	25	2	30	61.48	54.89	89.3
		200	25	2	30			
		200	10	2				
(14)	50	200	10	1	30	61.48	55.34	90.0
		200	10	2	30			
		200	25	2	--			
(15)	50	200	25	3	--	61.48	55.57	90.4
		200	25	5	30			

To learn whether any traces of benzoic ester had been carried along with the alcoholic vapors to the condenser during

esterification, the acid alcoholic distillate was chilled with ice, diluted with three or four times its volume of water, and shaken out three times in a separating funnel with fresh portions of ether. The ethereal solution thus obtained was treated with an excess of sodium carbonate in solution, washed with distilled water and fractioned *in vacuo* in the manner described above, to separate the low-boiling impurities, largely ether, alcohol, and water, and finally to distil any benzoic ester. The distillates in case of experiments (2), (4), (6), (8), (10) and (13) of Table I were tested in this way. In no case was there evidence of even the faintest trace of benzoic ester in the distillate. When 1 grm. of benzoic ester was mixed with 200<sup>cm</sup><sup>3</sup> of ordinary alcohol containing 1 per cent of hydrochloric acid, diluted, and treated as described in case of the distillates mentioned above, it was found that ester to the amount of 0.85 grm. was recovered.

The sources of loss in the recovery of benzoic ester were studied. When 75 grm. of pure benzoic ester were shaken out in a separating funnel with a solution of sodium carbonate containing ice, separated from this solution, washed with distilled water, and united with the portions of ester carried on mechanically and recovered from the water solutions by shaking out three times with fresh portions of ether, it was found that the weight of ester recovered on distilling the ethereal solution under diminished pressure was less than the amount taken by only 0.25 grm.

In all of the experiments of Table I alcohol as free from water as it can be made by repeated distillations over calcium oxide was used. This was used alone or was charged with dry hydrochloric acid in the proportions indicated in the table. In experiment (1) of Table I all low-boiling impurities were removed from the material remaining in the second flask by a vacuum fractionation. Then all material that would distil at the higher heat (150°) of the acid bath was collected in the 100<sup>cm</sup><sup>3</sup> flask. After diluting this material with water, extracting with ether three times and fractioning *in vacuo*, it was found that only enough benzoic ester remained in the receiver to give odor. In the remaining experiments of series A of the table the ester found in the second flask at the end of the time indicated was recovered without further treatment; in series B water and all other material found with the ester were removed so far as possible by fractioning *in vacuo*. This was done by heating the flask in which esterification took place in a water bath finally at 60° with the pressure on the manometer registering 15<sup>mm</sup>, this pressure and temperature being maintained fifteen minutes. A fresh portion of alcohol with hydrochloric acid was then driven into the portion remaining

in the flask, as was done when the first masses of benzoic acid were esterified. In case of experiments (14) and (15) the vacuum fractionation was repeated, and a third portion of the alcoholic mixture was driven as before into the esterifying mass.

It would seem from experiment (1) of series A of Table I that under the conditions imposed the esterification of benzoic acid with ethyl alcohol alone does not proceed far enough to produce benzoic ester in appreciable amounts. The presence of hydrochloric acid as shown by the remaining experiments of series A causes the esterification to proceed, but so large an amount of it as 25 per cent is not advantageous if the time of sending all vapors into the esterifying mass is the same in all cases; for, it was observed that on heating the alcoholic hydrochloric acid of so high concentration as 25 per cent only the acid was driven over during the first part of the experiment, and consequently the time of the action of the alcohol on the benzoic acid was made correspondingly shorter. Results in series B seem to indicate that removing by a vacuum fractionation the water formed during the esterification that takes place with a given alcoholic mixture driven more rapidly into the flask containing the benzoic acid is not so efficient in producing esterification as is allowing half that amount of alcoholic vapor with the hydrochloric acid to act for the same interval. This is shown by comparing (3) with (7), and (4) with (9) and (10), although in the last cases the difference is not so marked as perhaps might be expected from a consideration of the amounts of hydrochloric acid introduced. The difference in the yield where 25 per cent acid was used, in experiments (5) and (13), is due probably to the difference in the times during which the alcoholic mixture was passing into the flask containing the benzoic acid. Experiments (14) and (15) seem to indicate that with the concentrations used, removing the water a second time does not increase the efficiency of the process for the same time of action, even though more of the alcoholic mixture is used. This is seen by comparing experiments (12) and (14). On comparing (13) and (15) it is seen that neither increasing the amount of alcohol, lengthening the time beyond three hours, nor removing the water a second time materially helps esterification. It seems clear that the complete esterification of a given mass of benzoic acid with ethyl alcohol and hydrochloric acid would be a matter of some difficulty.

All of the experiments of series A in Table II show the action of zinc chloride in assisting the esterification of benzoic acid with alcohol alone as well as with the same alcoholic mixtures used for the work given in Table I; and in series B the action of zinc chloride in ethyl alcohol of 88.8 per cent purity

made to contain 1.25 per cent of hydrochloric acid by the addition of enough pure, concentrated, aqueous hydrochloric acid is given. The benzoic acid was esterified in the apparatus described above for the experiments recorded in Table I. In experiments (1) to (9) and (19) the ester was purified in the same way as stated above for the experiments in Table I. In all remaining experiments excepting (10) in which zinc chloride was present in amounts larger than 1 gm., the process of purification was the same excepting that the mass was washed as free from zinc salt as possible by shaking in the separating funnel with water before neutralizing with sodium carbonate. In experiment (10) the process of purification was peculiar: after all the alcohol had been driven over into the second flask the mass of material was freed from low-boiling impurities by a vacuum fractionation, then whatever ester had been produced was distilled into the receiver by heating the 250<sup>cm</sup> flask to 150° for some time, the ester was extracted with ether from this solution after diluting with water, the extract was fractioned *in vacuo*, and the ester recovered in this way was weighed.

It is evident from experiment (10) of Table II that zinc chloride with ethyl alcohol esterifies benzoic acid only in small amount. In presence of hydrochloric acid, however, it tends to make the esterification more complete. In experiment (3) of Table II the presence of 0.5 gm. of zinc chloride so influences the course of action that a yield of benzoic ester greater by 2.8 per cent is obtained in half the time from given amounts of ethyl alcohol and hydrochloric acid than in experiment (3) of Table I, where conditions were otherwise similar. In experiment (1) of Table II, in the presence of 1 gm. of zinc chloride, in a little more than half the time and with twenty per cent of the hydrochloric acid, the amount of alcohol being the same, the yield was larger by 1.1 per cent than in experiment (2) of Table I. In experiment (3) of Table II, in the presence of 0.5 gm. of zinc chloride and in a little more than half the time, the increase in the yield amounted to 3.8 per cent over that obtained in experiment (2) of Table I under conditions otherwise similar. In experiment (8) of Table II, in which 10 per cent of hydrochloric acid and 1 gm. of zinc chloride were used, the amount of alcohol being the same, there is an increase of 6.4 per cent of ester over the amount found in experiment (4) of Table I, although the time is a third less. In experiment (12), in which 10 gm. of zinc chloride were used, the yield is 13 per cent better than in experiment (4) of Table I, made under conditions otherwise similar. A comparison of experiment (15) of Table II with (5) of Table I shows that, with 10 gm. of zinc chloride and

TABLE II.

No.	Benzoic acid gram.	ZnCl <sub>2</sub> gram.	A		Reaction time hr. mi.	Benzoic ester		
			Alcohol with HCl cm <sup>3</sup> .	per cent		Theory gram.	Found gram.	Per cent
( 1)	50	1	40	1.25		61.48	51.58	83.9
			160	---	2			
( 2)	50	1	40	1.25		61.48	56.71	92.2
			260	---	3			
( 3)	50	0.5	200	1.25	2	61.48	53.26	86.6
( 4)	50	1	200	1.25		61.48	44.81	72.9
( 5)	50	1	200	1.25	2	61.48	52.86	86.0
( 6)	50	1	300	1.25	2	61.48	59.23	96.3
( 7)	50	1	300	1.25	3	61.48	60.27	98.0
( 8)	50	1	200	10	2	61.48	56.73	92.3
( 9)	50	1	200	25	2	61.48	51.48	83.7
(10)	50	10	300	--	1	61.48	0.86	1.4
(11)	50	10	200	1.25		61.48	53.42	86.9
(12)	50	10	200	1.25	2	61.48	60.79	98.9
(13)	50	10	300	1.25	2	61.48	60.91	99.1
(14)	50	10	200	10	2	61.48	53.18	86.5
(15)	50	10	200	25	2	61.48	55.23	89.8
(16)	50	10	400	1.25	4	61.48	61.48	100.0
(17)	50	25	200	1.25	1	61.48	52.30	85.1
(18)	50	25	200	1.25	5	61.48	53.30	86.7
B								
(19)	50	1	200	1.25	2	61.48	38.10	62.0
(20)	50	10	200	1.25	2	61.48	52.40	85.2
(21)	50	10	400	1.25	2	61.48	53.33	86.8
(22)	50	10	400	1.25	5	61.48	56.48	91.8
(23)	50	25	200	1.25	2	61.48	52.83	85.9

the same amounts of alcohol containing 25 per cent of hydrochloric acid, the esterification is better by 13.2 per cent in one-third less time.

In studying the results recorded in Table II, a comparison of experiments (4) with (5), (6) with (7), (11) with (12), (17) with (18), and (21) with (22) shows that esterification is more complete if the time of the reaction is reasonably prolonged. It is not possible to control suitably a uniform flow of vapors to the second flask if the action is very greatly prolonged. The total amount of alcohol passed in a given time into the second flask regulates the yield of ester, as is seen from a comparison of experiments (5) and (6). The amount of zinc chloride, in the concentrations used, affects the amount of the final product, as is shown in comparing (3) and (5) with (12), and (4) with (11). The increase of zinc chloride to 25 gram. does not seem to offer any advantage over the use of 10 gram., as is

evident from a comparison of (17) and (18) with (12), and of (20) with (23). If certain concentrations of zinc chloride and hydrochloric acid are taken with a suitable amount of alcohol it is possible to obtain yields of ester either theoretical or very nearly so, as is seen in (12), (13) and (16). With greater concentrations of mineral acid and the same amount of zinc chloride more alcohol and longer time for the esterification are required. With a smaller amount of zinc chloride more alcohol and a longer time are necessary to obtain equally desirable results.

From a comparison of the results in series A with those of series B it is clear that the alcoholic mixture made of alcohol

TABLE III.

No.	Benzoic acid gram.	Alcohol cm <sup>3</sup>	H <sub>2</sub> SO <sub>4</sub> gram.	A		Benzoic ester		
				Reaction time		Theory	Found	per cent
				hr.	mi.	gram.	gram.	
(1)	50	200	0.5	2	20	61.48	56.14	91.3
(2)	50	300	0.5	2	30	61.48	59.82	97.3
(3)	50	200	1		45	61.48	50.59	82.3
(4)	50	200	1	2	30	61.48	61.15	99.5
(5)	50	300	1		45	61.48	53.43	86.9
(6)	50	100	2	2		61.48	55.80	90.8
(7)	50	200	2		45	61.48	60.18	97.9
(8)	50	200	2	3		61.48	61.52	100.0
(9)	50	200	2	3	15	61.48	61.83	100.0
(10)	50	120	10	1	45	61.48	58.38	95.0
(11)	50	200	25	5	20	61.48	57.81	94.0
(12)	50	200	50	3		61.48	57.81	94.0
(13)	50	200	50	3		61.48	57.88	94.2
(14)	50	100	20	2		61.48	59.95	97.5
		100		3				
B								
(15)	50	300	2	3		61.48	58.00	94.3
(16)	50	300	2	3		61.48	57.98	94.3
(17)	50	300	50	3		61.48	53.11	86.4

of 88.8 per cent purity does not esterify the benzoic acid as completely as does the purer alcohol. The time during which esterification goes on is also a factor. By comparing (20) and (21) it is seen that the yield of ester is increased 5 per cent by increasing the time during which the reaction was allowed to take place. It is clear here, too, that the increase, within limits, in the proportion of zinc chloride to the other reagents produces a larger amount of ester, as may be seen by comparing (18), (19) and (22).

In the work given in Table III the arrangement of flasks described above was made use of; and the ester was recovered as stated above except in case of experiments (13) and (17), where the mass of impure ester was shaken in the separating funnel with ice before neutralizing with sodium carbonate in solution, and the strongly acid wash water was neutralized with sodium carbonate before extracting with ether. In the experiments of series A ethyl alcohol made as free from water as possible was used, and in those of series B alcohol 88.8 per cent pure. It was observed that ethyl ether could be detected by its characteristic odor in the distillate, and the amount seemed to be proportional to the quantity of sulphuric acid used. From the results recorded it is evident here, also, that the esterification goes on slowly. For, though a larger amount of alcohol is used in experiment (5), 13.4 per cent less of ester is obtained than in (4), where the time was more than three times as long. Too great concentration of the mineral acid is not desirable, and this becomes obvious when experiments (8) and (9) are compared with (12) and (13), or when (15) and (16) are compared with (17). For some reason, with the absolute alcohol the greater concentration of the sulphuric acid has diminished the yield 6 per cent from the theoretical yield obtained under the other conditions, and with alcohol of 88.8 per cent purity 8 per cent less of the ester is obtained. In experiments (13) and (17) the mass of sulphuric acid was removed by shaking first with ice before neutralizing with sodium carbonate. It is interesting to note that in a given time, as is seen in experiments (5) and (7), that with a smaller amount of alcohol and twice as much sulphuric acid the ester produced is 11 per cent greater; in experiments (7), (8), and (9) it is interesting to see that with the same proportions of all reagents the increase of time is alone enough to completely esterify all of the benzoic acid. In comparing (11) and (14) it is seen that the vacuum fractionation seems to have been advantageous. From the experiments of series B, where a larger amount of 88.8 per cent alcohol was used with 2 grm. of sulphuric acid, the yield is almost 6 per cent poorer than in the cases where, with other conditions remaining the same, it was theoretical, and 8 per cent poorer where the larger masses of sulphuric acid were used.

Although the impure ester was always treated with an excess of sodium carbonate and the shaking vigorous and prolonged for some minutes to neutralize all acidic substances, it was sometimes found that the ester held a small amount of benzoic acid. This showed itself as a residue in the flask from which the ester was distilled under diminished pressure. It was identified by the melting point, 121°, after recrystallizing from

water. This was done in experiment (3) of Table I, (14) of Table II, and (16) of Table III.

Special tests were made to ascertain whether the ester might contain condensation products. The boiling point observed on redistillation of the ester obtained in experiment (8) of Table II was found to be constant within two-tenths of a degree. There was no evidence of condensation products of higher boiling point in the material remaining in the flask from which the ester was distilled. Nor were indications of material of different character obtained in redistilling the combined products of all remaining experiments recorded in this paper. The experience was similar when the crude ester produced in presence of 25 gm. of zinc chloride was distilled at once after shaking with water in a separating funnel. Seventy-five grams of redistilled ethyl benzoic ester boiling within two-tenths of a degree were treated for three-quarters of an hour in the apparatus for esterification, in presence of 25 gm. of zinc chloride with 200<sup>cm<sup>3</sup></sup> of absolute alcohol containing 1.25 per cent of hydrochloric acid, and then recovered in the usual way. The recovered product weighed 74.7 gm., and upon redistillation it appeared to be pure ethyl benzoate.

It is evident that in esterifying benzoic acid by the use of ethyl alcohol and hydrochloric acid, or ethyl alcohol and zinc chloride with hydrochloric acid, the amount of ethyl benzoate produced will, naturally, vary with the proportions of the reagents used and with the time during which the action takes place. Further, with the time of action given and such proportions as are here used, if the conditions as to the amount of alcohol in the first place, the amount of either hydrochloric acid, zinc chloride and hydrochloric acid, or sulphuric acid in the second case, and the length of time of the action in the third case are considered by themselves, it appears that, within limits, an increase in the proportion of any allows a falling off in the proportion of any other of these. Finally, it is plain that with certain proportions of reagents and sufficient time of action, a quantitative yield, or nearly such, of ethyl benzoic ester is easily obtainable. In our experiments the yield of ester never exceeded 90 per cent when benzoic acid, alcohol, and hydrochloric acid were the reagents. The theoretical yield was obtained when 50 gm. of benzoic acid and 2 gm. of sulphuric acid were treated for three hours with 200<sup>cm<sup>3</sup></sup> of absolute alcohol, or for four hours with 400<sup>cm<sup>3</sup></sup> of absolute alcohol charged with 1.25 per cent of hydrochloric acid and 10 gm. of zinc chloride.



ART. III.—Description of the Williamstown Meteorite; by  
EDWIN E. HOWELL.

THIS siderite was secured from A. E. Ashcraft, who found it April 25, 1892, on his farm in Grant Co., Kentucky, three miles north of Williamstown. It is a thin flat rectangular mass, measuring  $12 \times 16$  inches; it is  $2\frac{1}{2}$  inches thick in the center thinning to a blunt edge at either end, looking not unlike a large double-edged ax. The total weight of the mass was 68 lbs., or about 31 kilos, and had a specific gravity of 8.1. It was entire when it reached me with the exception of a few ounces broken from one of the thin edges. We have cut the iron into a number of sections which etch very readily, showing it to be a typical octahedrite, of medium coarseness, as seen in the accompanying full-size cut of one of the smaller sections. It will be seen from this cut also that the kamacite bands are massed together to a considerable extent, leaving an unusually small number of plessite blocks; these when deeply etched are seen to be crossed by minute parallel, broken threads of ténite. In addition to the three regular distinct systems of kamacite bands there is another, less regular, system of broader bands averaging in width about  $3^{\text{mm}}$ , which cross the other bands, uninterruptedly in some cases, for a distance of  $4^{\text{cm}}$ . The apparent thickness of these bands is greatly exaggerated by the angle at which they are cut. Comparison of sections shows that while the other systems are cut at approximately



right angles, these broader bands are cut at an angle of  $60^\circ$  or  $70^\circ$ , which would seem to show that in reality they are no thicker than the others. Unfortunately our cut shows these bands but faintly.

Troilite seems to be pretty generally distributed through the mass, but mostly in very small grains, although the cuttings revealed one nodule  $\frac{3}{4}$  inches in diameter and two others of about  $\frac{1}{2}$  inch each. The total amount of this mineral, however, is small, as might have been inferred from the specific gravity, and the general smoothness of the surface.

I am indebted to Mr. Wirt Tassin of the U. S. National Museum for a chemical analysis of this iron and some notes on its structure as follows:

The structure of the etched face is octahedral. The three alloys—kamacite, tænite and plessite—are present. The kamacite bands are of average length, and the lamellæ vary in width from  $0.5$  to  $1.5^{\text{mm}}$ . The tænite bands are of capillary size and are often irregular in trend and distribution. Occasionally the fairly uniform crystalline structure is interrupted by broad irregular bands which have a length about twice that of their width. Here and there are nodules of troilite, some of which enclose carbonaceous matter. These troilite nodules are usually bounded by a thin line of schreibersite. The material available for analysis gave:—

Fe .....	91.54
Ni .....	7.26
Co .....	0.52
Cu .....	0.03
Cr .....	0.05
P .....	0.12
S .....	0.17
C .....	0.004
Si .....	trace
	<hr/>
	99.694

ART. IV.—Descriptions of Tertiary Insects; by T. D. A. COCKERELL.

(1) A COLEOPTEROUS LARVA FROM THE GREEN RIVER SHALES.

THE larva here described occurs in the red shales of Green River, Wyoming, and is represented in the Yale University Museum by a good specimen, with the reverse. The name of the collector is unknown. In appearance the insect very closely resembles the larva of *Carabus truncaticollis* Fisch., well figured by Kincaid in Proc. Wash. Acad. Sci., vol. 2, pl. xxii.

*Carabites kincaidi* sp. nov. Fig. 3.

Length about 22<sup>mm</sup>, width in the middle a trifle over 4,

1

2

3

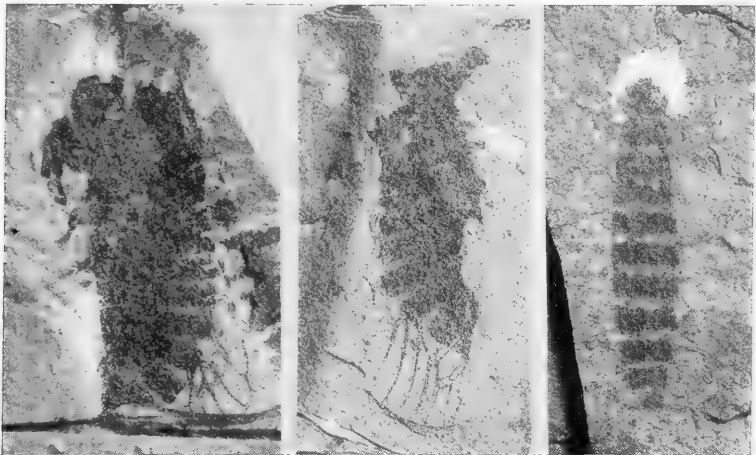

Figs. 1, 2. *Platypedia primigenia* × 2.

Fig. 3. *Carabites kincaidi* × 2.

narrowing somewhat caudally, the widest point however a little posterior to the middle; head small, about  $1\frac{2}{3}$ <sup>mm</sup> diameter; pronotum about 3<sup>mm</sup> broad and 2<sup>mm</sup> long, thus much shorter than in modern *Carabus*, and not especially differentiated from the other segments; segments formed as in *Carabus*, more than twice as broad as long, with the lateral hind margins angulate in the same manner and degree as in *C. truncaticollis*. The segments are dark, with the sections colorless, and there are indications of a median longitudinal light line. The details of the caudal end cannot be made out.

This may well be the larva of the genus *Neothanes* Scudder, described from the Green River beds; but as this cannot be demonstrated, I leave it in the blanket genus *Carabites*. It is dedicated to the writer who first described and figured the larva of an American *Carabus*.

It is to be remarked that the *Mormolucoides articulatus* Hitchcock, from the Trias of Turner's Falls, Mass., is extraordinarily like a Carabid larva, and resembles the present insect in the relatively small head and short prothorax. The lateral hind corners of the segments in the *Mormolucoides* are very much more produced, herein agreeing better with the larva of *Silpha*.

(2) A CICADA FROM FLORISSANT, COLORADO.

*Platypedia primigenia* sp. nov. Figs. 1, 2.

Length about 23<sup>mm</sup> (the apex of abdomen is lost); thorax 9<sup>mm</sup> long and 8 high (deep); compared with the living *P. putnami* Uhler, the body is larger and more robust, and the head is directed downwards, so that the frontal outline, in lateral view, is much more nearly vertical; the robust anterior legs are well preserved, and appear to be as in *P. putnami*; as in the living species, the femora are black, and the coxæ, seen from behind, pallid; length of anterior femur and coxa 4<sup>mm</sup>, of tibia 3½; wings hyaline, with dark veins, as in the recent species, the large triangular second ulnar cell being normal for the genus. Compared with *P. putnami*, the following differences in the details of the venation are apparent:—

(1) The fourth apical cell has its inner point lower, so that the lower side of its basal end is not quite half as long as the upper.

(2) The seventh apical is narrower, its length being at least twice its breadth.

(3) The eighth apical is longer.

Florissant, Station 14 (*Wilmatte P. Cockerell*, 1907). One specimen, with reverse, in Yale University Museum.

*P. putnami* Uhler is found in Colorado to-day; a specimen before me was collected by Mr. C. DeVoss in Gregory Cañon, Boulder Co., Colorado, July, 1907.

*P. primigenia* will be easily known from *Lithocicada perita* Ckll. by the shape of the eighth apical cell, and from *Cicada grandiosa* Scudd. by the much smaller size.

ART. V.—*The Stratigraphy of the Mt. Taylor Region, New Mexico*,\* by H. W. SHIMER and MILDRED E. BLODGETT.

Introduction  
Description of localities  
Summary  
Description of species  
Summary

INTRODUCTION.

THIS paper grew out of a week's trip in central New Mexico from Albuquerque to Great Neck and Cabezon, remnants of



\*The field work was done by the senior author in connection with a geological excursion through New Mexico, Arizona, and Utah in the summer of 1906. The trip was largely made possible through the kindness of the Mass. Institute of Technology, Harvard University, and private individuals.

ancient volcanoes. After leaving the Albuquerque mesa (Tertiary) the only sedimentary rocks crossed were grayish brown Cretaceous sandstones and shales. These strata have the slight but prevailing northerly dip of the plateau province, except where given a westerly dip through the influence of the Nacimiento mountain uplift to the east. This slight dip helps to make the country one of flat-topped mesas and broad level valleys; to this general appearance the old level flood plain of the Rio Puerco contributes. The mesas are frequently capped with lava flows.

Projecting up through these strata in the Puerco valley, west and northwest of Prieta mesa, are the many volcanic necks and dikes for which this region is famous.\*

These strata are mostly unfossiliferous, but when remains of organisms do occur they are present in considerable numbers; examples of such fossil-bearing horizons are the "gastropod zone" and the "cephalopod zone," as given in the generalized sections of Herrick and Johnson.†

In the region traversed the most conspicuous zone was a well-marked bed of friable shale, frequently 25 to 50 feet thick, carrying calcareous concretions (septaria) and bearing both in the concretions and in the surrounding bed an abundant fauna, consisting mainly of well preserved cephalopods, gastropods and pelecypods.

The concretions average  $1\frac{1}{2}$  to 3 feet in diameter and are seamed by dark calcite bands. They consist of a yellowish-brown shale with a calcareous cement.

In all the sections examined this zone occurs between beds of a dark, friable, easily eroded shale. The shale above has a thickness of 50 to 75 feet and is capped by a 5 to 10-foot bed of a brownish yellow sandstone; this latter, being more resistant than the dark shale below, caps the cliffs. The septaria zone shows at times as the top of a cliff but more usually as a line of small hummocks, due to the fact that the septaria weather more slowly than the embedding shales.

Upon this series of beds rests to the west about 100 feet of black shale, capped by about 50 feet of very resistant sandstone.

These characters of the septaria zone remain approximately constant wherever examined,—the northwest corner of the Albuquerque sheet, the southwest portion of the Jemez sheet, and the eastern part of the Mt. Taylor sheet. The more detailed descriptions of the various portions are given below.

\* A paper on these necks by Douglas W. Johnson will appear in the bulletin of the G. S. A.

† C. L. Herrick and D. W. Johnson. The geology of the Albuquerque sheet, Bull. Univ. New Mexico, vol. ii, part 1.

Fossils were collected at Great Neck, Neck 14 (a mile southwest of Casa Salazar), Neck 3, and at three localities on the road southeast of Cabezón.

*Description of Localities.*

Great Neck.—The almost horizontal Cretaceous strata show at its base the septaria zone with a thickness of about 50 feet

1



The septaria zone south of Salazar; the septaria lie weathered out upon the surface.

occupying the upper portion. The only fossil found here was *Gryphaea newberryi* Stanton. This was found below the septaria zone in the plain at the foot of Great Neck.

As viewed from the foot of Great Neck, the strata at the sides of Chivato and Prieta mesas dip gently north. Upon their beveled edges rest remnants of the once extensive lava flows.

The septaria zone at Great Neck is about 700 feet higher, according to the map contours, than at Salazar, eight miles north, where it is found at the level of the town. From Great Neck to Salazar its thickness of about 50 feet continues rather constant. It is below the middle of a dark shale about 100 feet thick; this shale is capped by a more resistant sandy bed of 10 feet (this is the top bed of fig. 2).

Neck 8, south of Salazar, has Cretaceous strata extending almost to the top on the eastern side. The septaria zone lies at its base.

Salazar.—Fossils were collected from the septaria zone at

the base of the agglomerate neck illustrated in fig. 2, on the western side of the road. This neck is composed almost entirely of agglomerate with very many huge boulders of sandstone, shale, etc. The approximately horizontal shaly sandstone of

2



A volcanic neck of agglomerate, one mile southwest of Salazar. The septaria bed is somewhat in the foreground. The black shale occupies the main portion of the slope and is capped by a resistant sandy bed.

the surrounding strata has been baked black for three feet from the neck. The fossils identified from this locality were :

- Placenticerus ? rotundatum* Johnson
- ? *Prionocyclus wyomingensis* Meek
- Lima utahensis* Stanton
- Stantonoceras stantoni* Johnson
- Scaphites* sp.
- Turritella whitei* var. *stantoni* S. and B.
- ? *Ostrea lugubris* Conrad

*Turritella whitei* and *Ostrea lugubris*, according to Stanton, do not occur above the Colorado formation. *Prionocyclus wyomingensis* is characteristic of the Fort Benton. *Lima utahensis* occurs with a Colorado fauna in the upper Kanab valley, Utah. *Placenticerus ? rotundatum* is found by Johnson in the Fort Pierre of the Cerrillos Hills, New Mexico, while



he cites *Stantonoceras stantoni* as from strata of Cretaceous age. The fauna is thus of undoubted Colorado age, though the presence of the *Placentoceras ? rotundatum* would indicate that it was not of the lowest Fort Benton.

The slight northerly dip of these beds causes the septaria zone with its capping of sandstone, seen immediately south of Salazar at about the level of the town, to disappear a short distance north of the town beneath the flood plain of the Rio Puerco. The succeeding strata thus brought into view consist of an alternation of dark shales and brownish yellow shaly sandstones. This alternation continues practically to the divide southwest of Cabezon peak with a much greater predominance of sandstone in the upper beds entered to the north. Thus as the river flows south it enters lower and lower beds.

Neck 3.—At the eastern side of this neck some fossils were collected from the strata on the western side of the road at distances varying from 30 to 100 feet from the base of the neck. These fossiliferous beds are yellowish shaly sandstones. The following fossils were found here :

- Trigonarca depressa* White
- Lucina* cf. *subundata* H. and M.
- Pteria linguiformis* (E. and S.)
- Solemya ? obscura* Stanton
- Pinna* sp.
- Actæon propinquus* Stanton

Plant remains in extremely minute fragments are very abundant in many strata.

*Actæon propinquus* and *Solemya ? obscura* were found by Stanton in the Pugnellus sandstone (upper Fort Benton) of Colorado, and thus are there characteristic of the Fort Benton. *Pteria linguiformis* is of Montana age and the type of *Lucina subundata* of Fort Pierre, though this latter is found at Upper Kanab, associated also with a Colorado fauna. *Trigonarca depressa* has apparently not been found outside the valley of the Rio Puerco; the type was found in lower strata six miles south of Salazar on the east side of the river. While thus two species are characteristic of the upper Fort Benton and one of the Montana, with one occurring in both, an uppermost Fort Benton age for the fauna would appear to be indicated, unless we suppose that the apparent absence of clear water here during Niobrara time would cause the absence of the typical Niobrara fauna and a persistence of the Fort Benton fauna to Montana times. These strata under such a supposition might represent the Niobrara time without the typical Niobrara fauna.

*Fossiliferous stations southeast of Cabezon peak.*—A little northeast of Prieta mesa, as the road enters the Jemez sheet, and thence to Sierrita mesa, the strata have a slight westerly

dip; this dip increases toward the Nacimientto mountains lying to the east. Thus under the influence of the Nacimientto mountain uplift, these strata have a westerly dip practically to the western limits of the Albuquerque and Jemez sheets, though at this distance from the mountains it is very faint. West of this, the strata take again the slight but dominant northward dip characteristic of the plateau strata as a whole, lying north of the old land of southern New Mexico and Arizona.

A fossiliferous septaria zone appears again on the southwestern corner of the Jemez sheet (locality A). It forms a solid stratum about five feet thick and occurs in the midst of a dark shale which is capped by a thin sandstone stratum. Above this sandstone to the west is seen the steep eastern face of another dark shale capped by a thick, heavy-bedded sandstone. The two following fossils were found in this locality:

*Prionotropis woolgari* (Mantell)

*Placenticerus placenta* (Dekay)

The first species is a good Fort Benton index fossil. The second, though much more characteristic of the Montana, is also rarely found in the Colorado formation. These fossils thus indicate an age not earlier than upper Fort Benton. This finds confirmation in the presence of the Fort Pierre species, *Astarte evansi*, in but slightly higher strata to the northwest, though this would leave but little thickness for the presence of Niobrara between.

Along the Cabezon road a short distance east of Cabezon peak, a specimen of *Astarte evansi* (H. and M.) Whitfield was found in thin-bedded sandstone. This species, so far as the writers know, is restricted to the Fort Pierre.

On the northwestern portion of the Albuquerque sheet at locality B the following section was noted:

Brownish yellow sandstone; fossiliferous . . . . 10 feet.

Yellow shales; fossiliferous in layers . . . . . 30 feet.

Black shale; apparently unfossiliferous . . . . . 20 feet.

The following fossils were collected here:

*Gryphæa newberryi* Stanton

*Inoceramus labiatus* (Schlotheim)

*I. dimidius* var. *labiatoides* S. and B.

? *Yoldia subelliptica* Stanton

*Anomia propatoris* White

*Ostrea lugubris* Conrad

*O. anomioides* var. *nanus* Johnson

*Cardium pauperculum* Meek

*Turritella whitei* var. *stantoni* S. and B.

*Lunatia concinna* (H. and M.)

*Prionotropis hyatti* Stanton

*P. woolgari* (Mantell)

Of these fossils the following are cited by Stanton\* as not ranging above the Colorado: *Gryphæa newberryi*, *Inoceramus labiatus*, *I. dimidius*, *Ostrea lugubris*, *Cardium pauperculum*; this is also true of the genus *Prionotropis*, while *P. woolgari* is characteristic of the Fort Benton. *Yoldia subelliptica* and *Anomia propatoris* are characteristic of the Pugnellus sandstone (upper Fort Benton) in Colorado. *Lunaticia concinna* occurs in the upper Kanab valley in Utah associated with a Colorado fauna. *Ostrea anomiooides* var. *nanus* has been found only in the Fort Pierre of the Cerrillos Hills, New Mexico.†

Thus all except the last indicate a Colorado age for the strata, while the presence of this last variety and the forms characteristic of the Pugnellus sandstone give it a late Fort Benton aspect.

#### *Summary.*

The area under consideration is near the central part of New Mexico and is mapped on the eastern edge of the Mt. Taylor sheet and the southwestern and northwestern corners respectively of the Jemez and Albuquerque sheets. The road traveled followed up the Puerco river valley, on the western side of the Prieta mesa, as far as the village of Cabezón, thence bending southeast down the eastern side of the mesa.

A well-marked zone bearing calcareous septaria was observed along the western side of the mesa from the base of Great Neck near contour line 6500, north to Salazar at contour line 5800, where it disappears from view beneath the old flood plain of the Rio Puerco.

The fossils collected from this zone show the strata to be of Colorado age, probably of the Fort Benton.

A fossiliferous zone likewise characterized by septaria similar to those on the western side of the Prieta mesa was noted on the northeastern side. The fauna, however, is entirely different from that on the opposite side and the beds were found at an altitude 300 feet higher than that southwest of Salazar,—a difference too great to be offset by the slight westerly dip.

Hence it is evident that at least two septaria zones are present in the Cretaceous strata of the Puerco valley, though in no one place were two such zones noted even in sections of a thousand feet. Evidence of still another such zone is suggested in the almost totally distinct fauna of the "cephalopod zone" mentioned by Herrick and Johnson as occurring on the southwest corner of the Albuquerque sheet. Their faunal list is as follows :

\* U. S. G. S. Bull. 106, p. 48.

† D. W. Johnson, *Geology of the Cerrillos Hills, New Mexico* School of Mines Quart. 1903, Jan.-Oct.

- Ostrea lugubris* Conrad  
*O. translucida* M. and H.  
 ? *O. sammionensis* White  
*Caryates veta* Whitfield  
*Pinna petrina* White  
*Sphenodiscus lenticulare* (Owen)  
*Buchiceras swallovi* (Shumard)  
*Placenticeras placenta* (Dekay)  
*P. costata* Herrick and Johnson  
*Exogyra leviuscula* Roemer  
*E. columbella* Meek  
*Liopistha concentrica* Stanton  
*Camptonectes symmetricus* Herrick and Johnson  
*Baculites gracilis* Shumard  
*Prionotropis woolgari* (Mantell)

The strata vary in age from the Fort Benton at Great Neck to doubtful Fort Pierre east of Cabezon; this latter determination was made upon but one fossil, *Astarte evansi*. The other faunas, especially those from Necks 14, 3 and from locality B show a commingling of many specimens of the Colorado formation with a few of the Montana. This would apparently indicate an upper Fort Benton age for the beds, unless we suppose that the apparent absence of clear water in this region during Niobrara times would cause the absence of the typical Niobrara fauna and the persistence of the Fort Benton fauna to Montana times. Under such a supposition, some of these intermediate strata would represent the Niobrara time, without the presence of the typical Niobrara fauna.

The strata where penetrated by the igneous rocks (dikes, necks, etc.) maintain their normal dip even up to contact with the igneous rock, nor do they show much more jointing near such contact than away from it. The baking of these sandy shales is comparatively slight. At Neck 4, south of Salazar, contact metamorphism is shown for only three feet from the narrow igneous intrusion. At Neck 5 an excellent contact is seen on the western side. The shales are here baked black for 10 feet; for the next 15 feet the baking is slight, the shales being darker than the unaltered beds, while beyond 25 or 30 feet the strata are practically unchanged.

#### DESCRIPTION OF SPECIES.

##### *Mollusca.*

##### PELECYPODA.

*Ostrea lugubris* Conrad.

(Bull. U. S. G. S. 106, p. 48.)

Agrees with description in size, general shape, and in plications and concentric lines.

One specimen of larger size than *O. lugubris* as described by Conrad may be classed with *O. bellaplicata* or *O. blackii*, although Stanton regards all as the same species, *O. lugubris* being a form dwarfed by conditions.

Locality and position,—Found rarely in brownish shales along the road fifteen miles southeast of Cabezon in the northwestern part of the Albuquerque sheet, and in similar shales along the road one mile southwest of Casa Salazar. The strata of both localities are Fort Benton.

*O. anomioides* var. *nanus* Johnson.

(The Geology of the Cerrillos Hills, New Mexico, by Douglas W. Johnson. School of Mines Quart. 1903, p. 113.)

Specimens agree with type description. This variety differs from the species *anomioides* only in being smaller and thus more delicate.

Locality and position,—Common in a dark sandy shale in the northwest corner of the Albuquerque sheet, fifteen miles southeast of Cabezon. The strata are of uppermost Fort Benton age.

*Gryphæa newberryi* Stanton.

(Bull. U. S. G. S. 106, p. 60.)

Agrees with description in all respects except the radiating striæ, which are absent in our specimens. This may be due to imperfect preservation.

Locality and position,—A single specimen was found in the sandy shales of Fort Benton age at the foot of Great Neck, and several in the brownish shales of upper Fort Benton along the road fifteen miles southeast of Cabezon.

*Inoceramus labiatus* Schlotheim.

(Bull. U. S. G. S. 106, p. 77.)

Well preserved internal mold of one specimen.

Locality and position,—The specimen was found east of the road in brownish yellow sandy shales of upper Fort Benton or possibly Niobrara age, fifteen miles southeast of Cabezon.

*I. dimidius* var. *labiatoides* nov. var. (Fig. 3.)

The specimens are well preserved and agree with the species description in every particular except the surface markings. Here minor concentric folds cover the larger folds and interspaces alike. There are usually from two to four minor folds between consecutive major ones. The major ones become less and less prominent toward the beak, but the minor ones continue to be almost as strong over the umbo. Named from *I. labiatus* because of similarity of surface markings.

Locality and position,—This variety occurs rather abundantly in a gray shaly sandstone of upper Fort Benton age.

The specimens were found along the road fifteen miles southeast of Cabezón on the northwestern part of the Albuquerque sheet.

The type specimen is now in the collection of the Boston Society of Natural History; catalogue number 13,342.



*Inoceramus dimidius* var. *labiatoides* nov. var.

*Pteria linguiformis* E. and S.

(U. S. G. S. Terr. ix, p. 32.)

A somewhat imperfect right valve of a young specimen. As far as can be seen it agrees with the original description in shape of shell, relative length of hinge line, position and obliquity of beaks, and, as far as preserved, the surface ornamentation.

Locality and position,—A single specimen was found in a yellowish, rather heavy-bedded sandstone at the foot of Neck 3, on its northwestern side. The strata are of uppermost Fort Benton or possibly of Niobrara age.

*Trigonarca depressa* White.

(U. S. G. S. Bull. 106, p. 93.)

The specimens agree closely with the original description in size and shape of shell, and in ornamentation, though the broad, flat, radiating costæ are faintly visible only upon the younger shells. The prominent, radiating, raised line on the flattened triangular space posterior to the umbonal ridge is wanting. A ridge covered with radiating vascular grooves extends around the interior of the valve some distance from its margin; this shows rather conspicuously on the internal mold.

Locality and position,—This species is present in very great numbers in the heavy-bedded brownish sandstone at the northwestern foot of Neck 3 in strata of upper Fort Benton or possibly of Niobrara age. In layers it occurs so abundantly as to make up the rock mass. The type of the species was found some fifteen miles farther down the Rio Puerco valley. It has also been found by Herrick and Johnson southeast of the Prieta mesa.

*Astarte evansi* (II. and M.) Whitfield.

(Rep. Geol. Black Hills, p. 413.)

The individuals of this species are well preserved. The surface ornamentation is usually of broad, concentric undulations, separated by narrow interspaces.

Locality and position,—This species is abundant in the yellowish sandy shales along the road five miles southeast of Cabezon. It is a fairly good index fossil of the Fort Pierre which, taken with its stratigraphic position, may be sufficient to refer these strata provisionally to the Fort Pierre, even though but this one species was found here.

*Lima utahensis* Stanton.

(Bull. U. S. G. S. 106, p. 71.)

Two specimens, an internal and an external mold, are represented in our collection. They agree perfectly with the description in every respect except size, our specimens being less than half as large as Stanton's type, which is from the upper Kanab valley of Utah.

Locality and position,—In dark sandy shales of Fort Benton age, one mile southwest of Casa Salazar at Neck 14. Only two specimens were found.

*Cardium pauperculum* Meek.

(Bull. U. S. G. S. 106, p. 99.)

A single well preserved internal mold of this species was found in brownish shales on the eastern side of the road fifteen miles southeast of Cabezon at locality B. The strata are uppermost Fort Benton.

? *Yoldia subelliptica* Stanton.

(Bull. U. S. G. S. 106, p. 94.)

A poorly preserved internal mold is referred with extreme doubt to this species. It occurs in a dark brown sandstone at locality B.

*Lucina* cf. *subundata* H. and M.

(Bull. U. S. G. S. 106, p. 97.)

An internal and a poor external mold. Specimens imperfect. Agree with original description in marginal outline as far as retained, position, shape and prominence of the beaks. Slight traces of concentric striæ are present near the margin, but no radiating striæ. Shells slightly smaller than those of original description.

Locality and position,—This species was found associated with *Trigonarca depressa* at the foot of Neck 3. Age is uppermost Fort Benton or possibly Niobrara.

*Solemya ? obscura* Stanton.

(Bull. U. S. G. S. 106, p. 95.)

Our single specimen agrees with the original description in size, general shape, growth lines, and in the position of the beak.

Locality and position,—Occurs with *Trigonaarca depressa* at Neck 3.

*Anomia propatoris* White.

(Bull. U. S. G. S. 106, p. 67.)

Specimens agree closely with the type except that they are slightly irregular in shape.

Locality and position,—This species is rather abundant in layers in a dark sandy shale on the eastern side of the road fifteen miles southeast of Cabezón on the northwestern portion of the Albuquerque sheet. The strata are uppermost Fort Benton.

GASTROPODA.

*Turritella whitei* var *stantoni* n. var.

Shell rather large, 20 to 35<sup>mm</sup> long with diameter of the last whorl 10 to 12<sup>mm</sup>. Sides straight. Sutures broadly but rather shallowly impressed. Larger shells have from 18 to 20 whorls. Surface of each whorl marked with three to five compressed and elevated spirals, separated by wider interspaces which are either smooth or covered by finer revolving striæ. The larger spirals upon the larger whorls are rarely nodose. The apical angle varies from 15° to 17°.

This variety differs from the species *T. whitei* in that it has fewer large spirals, the smaller ones usually absent, and the larger ones very seldom nodose (but one nodose spiral was noted). This form evidently completely agrees with the varietal form from Colorado noted by Stanton but not named by him.\*

With these differences so constant over such a wide territory, it seems to us that for the sake of stratigraphic exactness a distinction should be made.

This variety differs from *T. galisteoensis* Johnson in its shorter whorls and smaller apical angle. That form has 10 whorls in a length of 30<sup>mm</sup> from the apex of the shell, and according to the pictures the apical angle is about 20°. The finer intermediate revolving striæ are totally absent in that species.

\*U. S. G. S. Bull. 106, p. 131.



Locality and position.—This variety occurs in very great abundance in layers in a dark shaly sandstone, one mile southwest of Casa Salazar at Neck 14. In places it constitutes the mass of the rock. In age the strata are Fort Benton. It is also found quite abundantly southeast of Cabezon at locality B associated with *Ostrea anomiooides* var. *nanus*.

The type specimen is now in the collection of the Boston Society of Natural History; catalogue number 13,343.

*Lunatia concinna* M. and H.

(Bull. U. S. G. S. 106, p. 134.)

A single specimen of this species was found.

Locality and position,—In a brownish sandstone of uppermost Fort Benton age.

*Actæon propinquus* Stanton.

(Bull. U. S. G. S. 106, p. 161.)

Specimen imperfect and only a small portion of the shell retained upon the internal mold. Agrees with the description in size, shape, ornamentation, as far as visible, and in shape and size of aperture. The columella is not visible.

Locality and position,—Found rarely in the brownish sandstones at Neck 3<sub>2</sub> northwestern side, in strata of uppermost Fort Benton or possibly Niobrara age.

CEPHALOPODA.

AMMONOIDEA.

*Placenticeræ placenta* Dekay.

(Bull. U. S. G. S. 106, p. 169.)

Our specimen measures in width of last whorl 2.6 inches; in thickness of shell 1.5 inches. It agrees with Meek's description in general form, size of umbilicus, nature of volutions, shape of aperture and condition of the surface. There is, however, no evidence of nodes or other prominences, and the periphery is more narrowly truncate than is shown in Meek's figure. Septa not very clearly shown.

Locality and position,—The single specimen was found in a brownish yellow sandstone twelve miles southeast of Cabezon at locality A. Associated with it was *Prionotropis woolgari*, a typical Fort Benton species, but the stratigraphic relations in the field are such as to make the formation either uppermost Fort Benton or Niobrara, since *Astarte evansi* was found in abundance in slightly higher strata a short distance to the northwest, while slightly lower strata to the southeast contain a mixture of Fort Benton and Montana species.

*P. ? rotundatum* Johnson.

(Geol. Cerrillos Hills, p. 135.)

Our specimens agree quite closely with the type description.

Locality and position,—They were found in a septarium in the midst of a dark shaly sandstone a mile southwest of Casa Salazar at Neck 14. Age of strata is Fort Benton.

? *Prionocyclus wyomingensis* Meek.

(Bull. U. S. G. S. 106, p. 171.)

External mold of a part of a volution. May be referred to this species.

Locality and position,—It was found in a brownish yellow sandstone at the foot of Neck 14, one mile southwest of Casa Salazar. The strata are Fort Benton.

*Prionotropis hyatti* Stanton.

(Bull. U. S. G. S. 106, p. 176.)

A young specimen of this species measures  $\frac{3}{4}$  inch in diameter and consists of four whorls. The costæ are too unequal for the form to be the young of *P. woolgari* and the keel is too prominent. This species was found by Stanton in the Pugnellus sandstone (upper Fort Benton) of Colorado. The genus, according to him, is not found above the Colorado formation.

Locality and position,—Two young specimens of this species were found at locality B on the northwestern corner of the Albuquerque sheet, in a dark shaly sandstone of uppermost Fort Benton age.

*P. woolgari* Mantell.

(Bull. U. S. G. S. 106, p. 174.)

Three specimens were found with diameter 7, 5, and  $\frac{1}{2}$  inches respectively. The largest specimen agrees with Meek's description in general size and shape. The outer whorl, however, shows a flattening and broadening of costæ unlike the wing-like appearance noted in his description, and is more quadrangular in outline. The specimen of medium size resembles the first and second whorls of the larger except that the whole is flatter, with larger umbilicus and less prominent nodes and costæ. This larger specimen seems to show gerontic characteristics and to be intermediate in stage between the type specimen and the gerontic individual described by Johnson in the Geology of the Cerrillos Hills, page 142.

The smallest specimen of this species is a little over a half inch in diameter, and is composed of three whorls. It has developed no nodes on the simple ribs, while the keel is low with a well developed flattening of the shell on each side of it.

Locality and position,—Two specimens of this species were found in a brownish yellow sandstone at locality A, twelve miles southeast of Cabezón. The strata are of uppermost Fort Benton age or possibly Niobrara. A fragment of another specimen was found at locality B in a brown sandstone of upper Fort Benton age.

*Scaphites* sp.

Several external molds, with a narrow but deep umbilicus and radiating ribs increasing by implantation are referred to this genus. One looks very much like *S. ventricosum*.

Locality and position,—Found in a dark calcareous shale, one mile southwest of Casa Salazar, at Neck 14; they were associated with fossils of Fort Benton age.

*Summary.*

The specimens are, as a rule, comparatively well preserved considering that they usually occur on arenaceous beds. The character of the beds likewise explains the predominance of pelecypods over other classes. Moreover the presence in several of the beds of an abundance of plant fragments indicates also the comparative nearness of land areas.

As suggestive of an unfavorable environment, it is interesting to note the presence of several dwarf varieties of mollusks in various localities in New Mexico, as well as at times extending north into Colorado. *Lima utahensis* Stanton attained here only about one half the size to which it grew at the type locality "southeast of Paria, Utah," and in the upper Kanab valley, Utah. *Ostrea anomioides* var. *nanus* Johnson is a dwarf form of the species *O. anomioides* Meek. *Lucina subundata* H. and M. occurs in the Rio Puerco valley slightly smaller than in Utah. The type of *Ostrea lugubris* Conrad was obtained from the old Santa Fé trail east of Canadian river, New Mexico; it is spoken of by Stanton as a dwarfed form which, under favorable conditions, grows much larger into the forms *O. blackii* and *O. bellaplicata*. This small form of *O. lugubris* is somewhat common also in the Mt. Taylor region of New Mexico.

ART. VI.—*Mammalian Migrations between Europe and North America*; by W. D. MATTHEW.\*

DEPÉRET advocates a more continuous interchange of faunæ during the Tertiary between Europe and North America than we of the American Museum of Natural History are disposed to admit. But not so much more as one might infer. He pointed out evidences for interchange in Puerco and Torrejon, Wasatch, Wind River, then a break, then in Lower and Middle Oligocene and, I think, in Middle and Upper Miocene, in Pliocene and Pleistocene. This is not very far from Osborn's view. Personally, I think there is no good evidence for Wind River connection, for Middle Oligocene or for Upper Eocene connection. To me the evidence appears thus:—In the Basal Eocene the faunæ were closely related, the results presumably of an extensive migration at the *end* of the Cretaceous. In the Wasatch a large immigrant fauna appears in both countries which I regard provisionally as of Asiatic origin; then independent development till the end of the Eocene. At the beginning of the Oligocene here, and in the Upper Eocene of Europe and North America, there appears a large new immigrant fauna, which may also be referred to Asiatic origin. Then as far as I can see, there was independent development until the Middle Miocene, when several important, modernized types appear in this country, which had been appearing in Europe in the Oligocene, Lower and Middle Miocene. The fauna of the Upper Miocene in America seems to me mainly or entirely of autochthonic origin, but in the Pliocene a further interchange takes place, again in the Lower Pleistocene, and in the late Pleistocene, between Old and New world.

This means practically continuous interchange in the late Tertiary, more interrupted in the early part. As for the route, as I recall Depéret's remarks, he spoke of that across Bering straits as the most probable, and regretted that our lack of knowledge of the Tertiary land formations of Asia prevented us from proving or disproving this route.

I admit quite freely that Depéret's conclusions follow from his data, on the face of the evidence. But when the returns are as fragmentary as in the European Eocene, I think we have a right to go behind them. His assumption is that because a

\* This important statement is in response to a letter asking for further information in regard to the view expressed by Depéret, at the recent Seventh International Zoological Congress, that there was constant intermigration of mammals between Europe and America. The same authority further believes that the great similarities between the faunæ of Europe and America can not be explained on the basis of considerable parallel development.—C. SCHUCHERT.

group of admittedly American origin does not appear in Europe until the Middle Eocene, that there must have been a connection in the Middle Eocene. But, unless we find also groups of European (Old World) origin which first appear in America in the Middle Eocene, we should look into the matter and test the possibility of the first group having migrated from America to Europe in the Lower Eocene, but not being as yet reported from the Lower Eocene formations of Europe. The test would of course be identity of the Middle Eocene genus in Europe and America. If divergent, or merely paralleling in certain respects the evolution of the North American series as observed in Lower and Middle Eocene stages, I think its occurrence may be explained as a consequence of Lower Eocene rather than of Middle Eocene migration.

In illustration of these statements, the following example will explain my meaning: *Sinopa* and *Tritemnodon* occur in Lower and Middle Eocene in North America,—fairly distinct genera in the Bridger; almost indistinguishable in Lower Eocene. American species have peculiarly elongate premolars, throwing them a little out of the direct ancestry of later Hyænodonts. *Sinopa* occurs in the Middle Eocene of Switzerland. "*Sinopa*" *ethiopica* occurs in the Upper Eocene of Africa. The European and African species apparently do not have the elongate premolars; they are known only from jaws but apparently correspond with *Sinopa* and *Tritemnodon*, respectively, in stage of evolution towards *Hyænodon*. *Cynohyænodon* of European Oligocene is very little advanced over "*S.*" *ethiopica*, and might be directly descended from the European or African species.

Now if we simply take the recorded occurrence of genera as a basis, we must conclude that *Sinopa* originated in North America in Lower Eocene, crossed over to Europe in the Middle Eocene and thence to Africa in the Upper Eocene. A more detailed study brings out the following points:

(1) The American species of *Sinopa* and *Tritemnodon* paralleled the Old World series, but developed independently from their sudden appearance in the Lower Eocene (Wasatch) to their disappearance in the Middle Eocene (Washakie). They cannot have been directly ancestral to the later Hyænodonts, but represent side branches which left no descendants.

(2) The European and African species are more nearly in the line of ancestry of the later Hyænodonts, but are too conservative to be ancestral to the large and highly specialized *Hyænodon* and *Pterodon*.

(3) The latter genera appear in the Upper Eocene and Oligocene of Europe and Africa, and Oligocene of North America, accompanying and soon displacing smaller and more conserva-

tive genera (*Cynohyænodon*, *Quercyrtherium*) in Europe, which may be of autochthonic origin.

(4) No Hyænodonts are found in the Middle Eocene of Africa.

These facts seem to indicate an outside region, probably Asia, for the center of development and dispersion of the Hyænodonts. Thence they reached North America in Lower Eocene, developed till Middle Eocene and became extinct. They reached Europe in Middle or\* Lower Eocene and Africa in Upper Eocene. In Upper Eocene higher stages in the evolution of the race (*Pterodon*, *Hyænodon*) invade Europe and Africa and spread to America in Lower Oligocene. The distribution of this family is more or less completely paralleled by several other faunal groups.

Inference from the above as to early Tertiary continental connections: [|| = separation;  $\leftarrow \rightarrow$  = union permitting intermigration; ? = doubtful.]

Middle Oligocene,	North America    Asia $\leftarrow \rightarrow$ Europe ? Africa
Lower Oligocene,	North America $\leftarrow \rightarrow$ Asia $\leftarrow \rightarrow$ Europe ? Africa
Upper Eocene,	North America    Asia $\leftarrow \rightarrow$ Europe    Asia $\leftarrow \rightarrow$ Africa
Middle “	North America    Asia $\leftarrow \rightarrow$ Europe    Africa
Lower “	North America $\leftarrow \rightarrow$ Asia $\leftarrow \rightarrow$ Europe    Africa
Basal “	Asia    North America $\leftarrow \rightarrow$ Europe    Africa

This is of course only a working hypothesis which, in my opinion, accords best with the data as far as I know them. In brief, it is that Asia is and has been the great center of evolution and dispersion of the dominant mammalian types; in the other continents, the course of evolution has been—aside from a few well-known exceptions—alternately an autochthonic faunal development and a series of waves of migration from the highly progressive faunas of the great Asiatic land mass, according as the continents were separated from or connected with it. The principal exceptions are the Proboscidea, of African origin, the true Edentates of South American development and doubtful origin, the Camels, of North American origin,—probably other groups, if we knew something about the fauna of the early Tertiary of Asia.

\* “Or Lower” because, although *Sinopa* has not been found in strata of Sparnacien time of Europe, several of its associated genera of the Wasatch do occur there and the fauna is very imperfectly known.

ART. VII. — *Notes on Powellite and Molybdite*; by  
WALDEMAR T. SCHALLER.\*

1. *Powellite from Llano Co., Texas.*—The specimens of powellite from Barringer Hill, Texas, described in this paper were received through the kindness of Mr. Wm. E. Hidden and represent a small lot that was found in January, 1907. According to Mr. Hidden, who generously placed the material at the writer's disposal, the specimens are similar to those found by him in 1889 and referred to molybdite.† The reinvestigation of this mineral was undertaken as it had been suggested that it was probably a natural occurrence of the trioxide of molybdenum, the writer having shown in a previous paper‡ that molybdite was a hydrous ferric molybdate. Analysis showed, however, that this mineral from Barringer Hill is a calcium molybdate and is referable to powellite.

As received by the writer, the mineral is in loose pieces, some over a centimeter wide, associated with, coating and often entirely replacing, molybdenite. In fact, the powellite forms a pseudomorph after the sulphide of molybdenum, the foliated structure of the latter being frequently retained. The dirty white to gray mineral, sometimes stained brown by iron oxide, breaks up into small glistening scales which, when rubbed between the fingers, crumble to a pearly powder which adheres to the skin and resembles in appearance some varieties of fine-grained talc. Under the microscope, the mineral shows double refraction but no crystal outline. The individual crystal units are very minute, the specimens being aggregates of very fine scales.

A density determination was made on about 0.8 gram of the powdered sample. The pycnometer method was used and the determination was carried out with care at a temperature of 25°. The value obtained for the sample is 4.153, which when corrected for impurities, as described beyond, gives 4.23. Hidden§ found the value 4.004, which would indicate that his sample contained more impurities than the writer's.

Analysis of this mineral gave the following results, the mineral dissolving readily in HCl. Qualitative tests failed to show the presence of any tungstic oxide. The mineral is difficultly fusible and gives, at the most, only a trace of water in the closed tube.

CaO .....	27.46
MoO <sub>3</sub> .....	67.90
Loss on ign. ....	2.33
MoS <sub>2</sub> .....	1.50
SiO <sub>2</sub> .....	.88

---

100.07

\* Published by permission of the Director of the U. S. Geological Survey.

† This Journal, xxxviii, 485, 1889.

‡ Ibid., xxiii, 297, 1907.

§ Ibid., xxxviii, 485, 1889.

The ratio of CaO to MoO<sub>3</sub> is 1:0.96, giving the formula CaMoO<sub>4</sub>.

What is probably a similar occurrence of powellite has recently been described\* as possibly a natural occurrence of MoO<sub>3</sub>, the mineral differing in its physical properties from the hydrous ferric molybdate. It forms a white or grayish alteration product of molybdenite, which it sometimes covers and after which it is pseudomorphous, preserving the form of the molybdenite. The luster is pearly and the mineral is semi-translucent, difficultly fusible to a gray scoria, soluble in nitric acid and does not contain any iron or water. The material was too scanty for analysis.

2. *Powellite from Nye Co., Nevada.*—The powellite from Nevada was received through Mr. F. L. Hess of the U. S. Geological Survey, who states that the specimens were sent him by Mr. F. O. Byor of Columbia, Nevada. The locality is given as 2 miles south of Oak Springs, Nye County, Nevada.

The powellite occurs in a vein about 1½<sup>cm</sup> wide in a soft earthy mass which seems to be some altered rock. In this rock are occasionally found irregular masses of powellite which sometimes are several centimeters across. The mineral is dull in appearance, grey in color, and occurs in platy masses often bent and twisted in different directions.

Imbedded in this vein of powellite and also as small masses and veins in the altered rock matrix, are found grey to white masses of scheelite showing good cleavage surfaces with a highly vitreous to adamantine luster, often having also a decided greasy appearance. The association of scheelite with powellite side by side was thought to be a most unusual one, but other specimens showed that the powellite, like the Texas mineral, was a secondary one being formed, *in situ*, from molybdenite; it is in fact a pseudomorph after the sulphide of molybdenum. Some other specimens showed the various stages of alteration very well, the amount of unaltered molybdenite varying from considerable to none at all. The association of molybdenite with scheelite is one well known and when the molybdenite alters to powellite the association, powellite-scheelite, necessarily follows. The agencies affecting the change from molybdenum sulphide to calcium molybdate are apparently without effect on the scheelite. This pseudomorphous character of the powellite accounts for its occurrence in platy masses, the structure of the original molybdenite being retained. On some of the specimens, notably those on which there is still a considerable amount of molybdenite remaining, the powellite often has a reddish color due to iron stain.

\* Molybdate from the Ilmen Mts., G. Gagarine, Bull. Acad. Imp. Sci., St. Petersburg, 6 ser., 287-88, 1907.



The dull grey powellite can easily be separated by hand picking from the shining greasy scheelite, and a sample so selected was used for analysis. A thin section showed, under the microscope, some quartz, hematite and limonite as impurity.

The density of the mineral was determined by weighing a test tube containing about six grams of the mineral in water. The value obtained is 4.026, which when corrected for impurities, as described beyond, becomes 4.24.

The analysis yielded the following figures, the small amount of tungstic oxide present being probably due to admixed scheelite.

CaO .....	26.44
MoO <sub>3</sub> .....	62.43
Fe <sub>2</sub> O <sub>3</sub> .....	1.17
Loss on ign. ....	2.69
SiO <sub>2</sub> .....	6.80
WO <sub>3</sub> .....	trace
	99.53

The material insoluble in HCl was tested with HF and found to be almost entirely silica. The ratio CaO to MoO<sub>3</sub> is 1:0.92, giving the formula CaMoO<sub>4</sub>.

3. *Density of Powellite.*—The sample of powellite from Texas gave the value 4.153 as its density. This figure is corrected on the basis of the following composition of the sample to 4.23.

Silica	density	2.65	=	.88
Water	"	1.	=	2.33
Molybdenite	"	4.7	=	1.50
Powellite			=	95.29
				100.00

The presence of the water as such is, of course, an assumption and the final value, 4.23, is necessarily uncertain, depending on the assumptions made.

The powellite from Nevada gave 4.026 as its density and from the analysis the composition of the sample was found to be as follows:

Silica	density	2.65	=	6.80
Water	"	1.	=	2.69
Iron oxide	"	3.	=	1.17
Powellite			=	89.34
				100.00

Allowing for impurities, the value is raised to 4.24, which, like the preceding case, is dependent on certain assumptions.

As powellite and scheelite are doubtless isomorphous we may be justified in assuming that they have nearly the same molecular volume. Considering the molecular volumes as identical and taking the gravity of scheelite as 6.14, the density of powellite then becomes as calculated by Melville,\* 4.267.

As all previous analyses of powellite showed the presence of tungstic oxide, the densities given are all too high for the pure calcium molybdate. The two values obtained by the writer, though uncertain as they are based on some assumptions made in applying the corrections, agree so well not alone with each other, but also with the calculated value, that the average of the three values (4.24, 4.23, 4.27), namely 4.25, may be taken as being very close to the true density of the pure calcium molybdate,  $\text{CaMoO}_4$ .

4. *Molybdite from a new locality.*—A sample of molybdite from Hortense, Colorado, was received through the kindness of Mr. F. L. Hess. The yellow mineral occurs in lumps, several of which have a diameter of over 2<sup>cm</sup>. With the molybdite are associated molybdenite, quartz and a mica. The sample looks earthy, but under the microscope is seen to be well crystallized and shows the characteristic optical properties of molybdite as described in a previous paper. A sample was selected as pure as possible, but which was found on analysis to still contain a large amount of insoluble matter. The powdered specimen caked together in the sample tube and probably contained some extraneous water. The analysis also showed too high a water content for molybdite. Below are given (I) the analysis; (II) the same with the insoluble matter deducted and the analysis recalculated to 100 per cent; and (III) the percentage calculated for  $\text{Fe}_2\text{O}_3 \cdot 3\text{MoO}_3 \cdot 7\frac{1}{2}\text{H}_2\text{O}$ .

	I	II	III
$\text{H}_2\text{O}$ .....	15.87	20.19	18.57
$\text{Fe}_2\text{O}_3$ .....	15.95	20.30	22.01
$\text{MoO}_3$ .....	46.77	59.51	59.42
$\text{MoS}_2$ .....	5.50		
$\text{SiO}_2$ .....	16.51		
	100.60	100.00	100.00

The residue, insoluble in HCl, was roasted in an open crucible to change the  $\text{MoS}_2$  into  $\text{MoO}_3$  and then weighed. The oxide of molybdenum was then dissolved by HCl, leaving the silica, which was tested with HF for its purity. The determination of water was made in two ways, by loss in weight and

\* This Journal, xli, 138, 1891.

by direct weighing. It was found that the water given off at 110° by heating the mineral in a glass tube in a toluene bath while a current of dry air was passed over the mineral and collecting and weighing the water (shown in *a* below), was considerably greater than the amount given off at 110° by heating the mineral in a crucible in a toluene bath, and determining the water by loss in weight (shown in *b* below). The results are shown below :

	Amt. given off at 110°	at 200°	total
<i>a</i> -----	13.77	2.23	16.00
<i>b</i> -----	11.39	4.34	15.73

In the previous paper on the composition of molybdic ocher, the writer determined the water given off at 110° by loss in weight to be six molecules of the total  $7\frac{1}{2}$ . From the results given above, it seems probable that this is not necessarily the correct amount and that the temperature at which different parts of the entire water content are given off still remains to be determined.

The density of the powdered sample was determined with a pycnometer, using 3 grams of material. The value obtained is 3.026. This is corrected on the following basis, the sample being composed of

Molybdenite density	4.7 =	5.50
Silica	“ 2.65 =	16.51
Molybdate		= 77.99
		<hr style="width: 50px; margin: 0 auto;"/>
		100.00

The corrected value becomes 2.99, in which, however, no allowance is made for the extraneous moisture.

An experiment was made to determine approximately the solubility of molybdate in water. About 3 grams of the mineral were stirred in a beaker for a day with 760° distilled water at room temp. (about 25°), and then filtered repeatedly. The final filtrate showed a very faint cloudiness. It was evaporated down in platinum, the residue dissolved in HCl and the iron precipitated as hydroxide with ammonia and weighed. The 760° of water contained .0051 gram of Fe<sub>2</sub>O<sub>3</sub>. On the assumption that this all came from the mineral, it is calculated that the solubility of molybdate in water is approximately 1 to 33,000, so that the mineral is rather insoluble.

Continued attempts to form the crystallized mineral Fe<sub>2</sub>O<sub>3</sub>.3MoO<sub>3</sub>.7 $\frac{1}{2}$ H<sub>2</sub>O, by heating the amorphous precipitated ferric molybdate in a closed tube at a high temperature have so far been completely unsuccessful, and the writer does not, at present, intend to continue the attempts to prepare this mineral artificially in a crystallized condition.

ART. VIII.—*The Hydrolysis of Ammonium Molybdate in the Presence of Iodides and Iodates*; by SETH E. MOODY.

GLASSMAN\* makes the statement that ordinary ammonium molybdate is hydrolyzed according to the following equation:



and that the molybdic acid thus set free reacts with a mixture of potassium iodide and potassium iodate, liberating iodine according to the equation:



The elimination of the iodine was accomplished by means of a Bunsen's distilling apparatus and standard sodium thiosulphate was used for its measurement.

In a previous article† the writer showed that certain salts of ammonium may be completely hydrolyzed in the presence of a mixture of potassium iodide and potassium iodate and that the iodine liberated in the reaction between the freed acid and the mixture may be eliminated and transferred in a current of hydrogen to a receiver charged with potassium iodide and there measured with a standard solution of sodium thiosulphate. It was discovered that in the direct distillation of the iodine, ammonia passes simultaneously into the receiver and there acts upon some of the free iodine; but that loss of iodine may be obviated by first passing the gaseous products through hot standard sulphuric acid, which holds the ammonia while allowing the iodine to pass uncombined into the receiver.

Similar experiments upon ammonium molybdate have now been carried out by the method and with the apparatus formerly described. It appears that, as in the case of the salts previously examined, iodine may be set free in amount indicating the complete hydrolysis of this salt, but that unless special precautions are taken the ammonia likewise liberated acts upon a portion of the iodine and so falsifies the indication of hydrolysis.

Table I shows results of experiments carried out according to the method of Glassman, except that the distillation apparatus consisted of a Voit flask used as a retort, a Drexel bottle used as a receiver, and that a current of hydrogen was sent cautiously through the apparatus.

These results, taken by themselves, would appear to show that hydrolysis of the ammonium molybdate in the receiver had taken place to about the degree indicated by Glassman's equation; but the liberation of more iodine upon acidifying the solution after titration with sodium thiosulphate shows that

\* Ber. 1905, 38, I, p. 193.

† This Journal, xxii, p. 379, 1906.

TABLE I.

Ammonium molybdate grm.	KI grm.	KIO <sub>3</sub> cm <sup>3</sup> .	Time in min.	Na <sub>2</sub> S <sub>2</sub> O <sub>3</sub> cm <sup>3</sup> .	I found grm.	Mean of entire series
0·2000	1·0	10	80	12·85	0·1580	} 0·1609
0·2000	1·0	10	100	13·10	0·1610	
0·2000	1·0	15	90	13·12	0·1614	
0·2000	1·0	10	90	13·08	0·1609	
0·2000	1·0	10	90	13·15	0·1618	
0·2000	1·0	10	90	13·13	0·1615	
0·2000	1·0	15	90	13·11	0·1613	

the amounts of iodine first found do not indicate correctly the actual degree of hydrolysis.

In another series of experiments in which the products of distillation were received in a solution of potassium iodide acidulated with sulphuric acid, the amounts of iodine obtained corresponded very closely to the complete hydrolysis of the ammonium molybdate according to the equation :

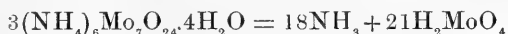

and the liberation of iodine according to the equation



TABLE II.

Ammonium molybdate grm.	KI grm.	KIO <sub>3</sub> cm <sup>3</sup> .	Time in min.	Na <sub>2</sub> S <sub>2</sub> O <sub>3</sub> cm <sup>3</sup> .	I found grm.	Mean of entire series grm.
0·2000	1·0	15	80	22·10	0·2777	} 0·2808
0·2000	1·0	15	90	22·40	0·2815	
0·2000	1·0	15	100	22·42	0·2818	
0·2000	1·0	15	90	22·37	0·2811	
0·2000	1·0	15	90	22·36	0·2810	
0·2000	1·0	15	90	22·39	0·2814	

In still another series of experiments the apparatus was modified as in the work previously described,\* by inserting between the retort and the receiver a Voit flask containing a definite amount of standard sulphuric acid, in excess of that necessary to combine with the ammonia set free from the molybdate. The value of the standard acid was obtained from the iodine liberated by the addition of a measured portion of it to an iodide-iodate mixture, and the value of the residual acid after the passage of the distillate was similarly measured. The differ-

\* Loc. cit.

ence between the value of the standard acid and the residual acid is the equivalent of the acid neutralized by the ammonia produced in the process of hydrolysis. The results of the experiments so modified are contained in the following table.

TABLE III.

Ammonium molybdate gram.	KI gram.	KIO <sub>3</sub> cm <sup>3</sup>	Time in min.	H <sub>2</sub> SO <sub>4</sub> neutralized, in terms of I gram.	Drexel flask I found gram.	Mean of entire series gram.
0.2000	1.0	15	80	0.1213	0.2802	} 0.2808
0.2000	1.0	15	90	0.1197	0.2809	
0.2000	1.0	15	90	0.1195	0.2812	
0.2000	1.0	15	90	0.1207	0.2810	
0.2000	1.0	15	90	0.1202	0.2807	
0.2000	1.0	15	90	0.1207	0.2811	
0.2000	1.0	15	90	0.1197	0.2810	
0.2000	1.0	15	90	0.1206	0.2810	
0.2000	1.0	15	90	0.1197	0.2806	

Thus it appears that ammonium molybdate may be hydrolyzed completely in the presence of potassium iodide and potassium iodate and that the reaction does not proceed according to the equation given by Glassman. Upon boiling a mixture containing the molybdate, the iodide and the iodate, ammonia passes to the distillate with the iodine liberated and there acts upon three-sevenths of the iodine. The apparatus described makes possible the determination of the total hydrolytic action of the salt, the determination of the ammonia, and, by calculation, the complete analysis of ammonium molybdate. A single operation requires about two hours.

University of Wisconsin, Madison.

## SCIENTIFIC INTELLIGENCE.

## I. CHEMISTRY AND PHYSICS.

1. *The Parent-Substance of Radium.*—HAHN has given an account of the views that have been brought forward in regard to the origin of radium, together with some of his own recent observations. As soon as its rate of decay was observed, it was necessary to suppose that radium is being formed from something else, for the solid crust of the earth is so very old that even if the whole earth had been originally composed of this substance it would long since have disappeared. After some time it was established that radium was produced by the much more slowly decaying element uranium, but it was shown also that there must be one or more intermediate products between the two. It was observed by Boltwood in 1906 that an actinium solution showed an undoubted increase in radium, and he believed that actinium must be the direct mother substance, but Rutherford soon showed that it was not actinium, but some unknown substance present with the actinium. Boltwood has since found that the hypothetical element follows the reactions of thorium, and gives peculiar  $\alpha$ -rays, and he has named the new element ionium. Hahn now states that he also has found in another way that the direct parent of radium follows the chemical reactions of thorium, and may thus be obtained from uranium minerals. He has found, in fact, that old preparations of thorium salts from monazite contain considerable amounts of radium, while newer preparations from the same source contain much less, and he has succeeded in showing an increase, in the course of a few months, in individual samples of these thorium salts. In an indirect way Hahn has calculated the period of decay of radium from the results of his experiments with the monazite product, and has obtained 3250, 2840, and 2630 years as the result. These figures correspond as closely as could be expected with Rutherford's calculation, 2600 years, and are entirely at variance with the results recently obtained by Cameron and Ramsay, 163 years.—*Berichte*, xi, 4415.

H. L. W.

2. *The Reduction of Arsenic Trisulphide and Pentasulphide to Disulphide.*—It was noticed by EHRENFELD that in a certain qualitative test for arsenic a red precipitate was obtained, when a stannous salt was present, in the place of the usual yellow precipitate of sulphide of arsenic. This led him to examine the action of stannous chloride in the presence of strong hot hydrochloric acid upon the two sulphides of arsenic, and he found that both were thus readily and completely converted into the red disulphide :

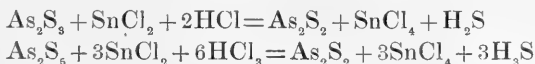

These results are interesting inasmuch as they show a new and convenient method of producing the compound corresponding to the mineral realgar. It may be mentioned that a red modification of  $As_2S_3$  is known, which is entirely distinct from the red disulphide.—*Berichte*, xl, 3962. H. L. W.

3. *Titanium trichloride for Volumetric Analysis*.—KNECHT and HIBBERT recommend the use of a solution of  $TiCl_3$  for various volumetric operations where a powerful reducing agent is required. Its use has given good results with organic nitro-compounds, such as picric acid, and also with a number of dyes, including indigo and azo-dyes. Another important application of the reagent is in the determination of iron, where the authors, in the place of the somewhat unsatisfactory dipping test formerly employed, now add potassium thiocyanate in considerable excess directly to the liquid to be titrated. The results of test analyses made in this way show excellent results, and it may be mentioned that where iron is partly or wholly in the ferrous condition it is oxidized before titration by an exact addition of a permanganate solution. The titanous chloride solution is drawn directly from a reservoir into the burette, and the space above the liquid in the reservoir is kept full of hydrogen by means of a small automatic generator supplied with zinc and hydrochloric acid.—*Automatische*, xl, 3819. H. L. W.

4. *Traité de Chimie Analytique Qualitative*; par DUPARC et MONNIER. 8vo, pp. 374. Geneva, 1908 (Librairie Kundig).—This is the second edition, revised and enlarged, of a text-book on qualitative analysis containing an unusually large amount of introductory and descriptive matter. The first 74 pages are devoted to theoretical chemistry, including some of the more important topics of modern physical chemistry. The next 40 pages are devoted to the reagents, apparatus, and methods of qualitative analysis. Then comes the descriptive part, occupying the greater portion of the book, giving an account of the qualitative reactions, and including a very full list of equations. A chapter in this part gives the reactions of the more common organic acids, while separate sections describe the reactions of the rare metals and the alkaloids. The practical part of the book, comprising about 30 pages, gives an elaborate series of systematic tables for mineral analysis, with references to the descriptive part. H. L. W.

5. *Kurzes Lehrbuch der organischen Chemie*; von WILLIAM A. NOYES. 8vo, pp. 722. Leipzig, 1907 (Akademische Verlagsgesellschaft).—The appearance of a German translation by Walter Ostwald of this American text-book of organic chemistry is worthy of mention. The book is introduced to the German-reading public by a preface by the eminent chemist, Wilhelm Ostwald, who speaks in high terms of its independence and originality, and of its suitability as a guide for the student. He considers that its translation was desirable, even in view of the exceedingly abundant German literature of organic chemistry text-books. H. L. W.



6. *A History of Chemistry*; by HUGO BAUER, translated by R. V. STANFORD. 12mo, pp. 232. London, 1907, Edward Arnold (Longmans, Green & Co., New York).—This book gives a very readable, well-balanced account of the development of chemical science. The chemistry of the ancients as well as the periods of alchemy and iatrochemistry are rather briefly treated, while the more important modern epochs, here called the period of Lavoisier, and the period of organic chemistry, take up more than two-thirds of the space in the book. The period of modern chemistry, which the author considers as beginning about 1885, is very briefly touched upon.

H. L. W.

7. *Beiträge zur chemischen Physiologie*, herausgegeben von FRANZ HOFMEISTER. Band X. Pp. 500. Braunschweig, 1907 (F. Vieweg und Sohn).—Among the thirty-two contributions in this volume, including eight from the Vienna laboratory of Professor v. Fürth, several papers deserve specific reference here. Knoop has finally determined the constitution of histidine as  $\beta$ -imidazolalanine:



and the long known inosic acid discovered by Liebig has been shown by Fr. Bauer to be a crystalline compound of hypoxanthine, arabinose, and phosphoric acid of the probable structure:  $(\text{HO})_2\text{P.O.CH}_2(\text{CHOH})_3\text{CH}:(\text{C}_4\text{H}_3\text{N}_4\text{O})$ . A study of pancreatic nucleic acid by v. Fürth and Jerusalem has shown that it yields adenine and guanine as its sole purine bases, and that glycerol is not present in the molecule. Among the numerous investigations on enzymes reported, the careful research on the animal peroxydases, by v. Czyhlarz and v. Fürth, deserves notice. They have reviewed the literature on this perplexing topic very thoroughly and have added new reactions and a new method of quantitative study. The peroxydases are distinct from the catalases and the glycolytic enzymes. The papers on intermediary metabolism are likewise of interest; for example, Pfeiffer's failure to obtain synthesis of uric acid in man and the mammals, and various papers on acidosis from Professor v. Krehl's Strassburg clinic. Several researches on carbohydrate metabolism are also reported; Bang's studies on glycogen transformation by the liver; Embden, Lüthje and Liefmann's on the sugar content of the blood; and Spiro's on the direct relation between carbohydrate and protein in metabolism.

L. B. M.

8. *Immuno-Chemistry. The Application of the Principles of Physical Chemistry to the Study of the Biological Antibodies*; by SVANTE ARRHENIUS. Pp. ix, 309. New York, 1907 (The Macmillan Company).—The book comprises a series of six lectures given at the University of California in 1904. Although

AM. JOUR. SCI.—FOURTH SERIES, VOL. XXV, No. 145.—JANUARY, 1908.

bearing on the complex problems of the inter-reactions of toxins and anti-toxins, from the standpoint of the physical chemist, the subject matter is presented in a clear and precise manner. The introductory portion is devoted largely to a general discussion of toxins, agglutinins, hemolysins, etc., and their anti-bodies. Throughout the book the writer emphasizes the possibilities and value of representing by formulæ the reactions that take place among the anti-bodies, and which he regards as being of a strictly chemical nature. The principles of physical chemistry are applied to the following topics: Reversibility of Reactions between Anti-bodies; Velocity of Reactions; Equilibria in Absorption Processes; Neutralization of Hemolytic Properties and of Toxins; Compound Hemolysins, and Precipitins and their Antibodies. The book contains a comprehensive bibliography as well as an index of authors and of subject matter. L. F. R.

## II. GEOLOGY AND MINERALOGY.

1. *Geological Survey of New Jersey: Annual Report of the State Geologist, HENRY B. KÜMMEL, for the year 1906.* Pp. vii+192 with 32 plates and 9 figures. Trenton, New Jersey.—This volume contains, beside the administrative report, papers by four authors, as follows: The fire-resisting qualities of some New Jersey Building Stones by W. E. MCCOURT (pp. 17-76). The resistance to fire was found to be greater in rocks of fine texture and small porosity. Clay and limonite were the least resistant cementing materials. The Glass-sand Industry of New Jersey, by HENRY B. KÜMMEL and R. B. GAGE (pp. 77-98). The Origin and Relations of the Newark Rocks, The Newark (Triassic) Copper Ores of New Jersey, Properties of Trap Rocks for Road Construction, are three papers by J. VOLNEY LEWIS (pp. 97-172). In the discussion of the various hypotheses of the mode of origin of the Newark Rocks, Professor Lewis shows reasons for abandoning the *tidal estuary* and the *lake basin* hypotheses and favors the hypothesis that these rocks were laid down by rivers on a piedmont plain, accumulating to a great thickness on certain areas of subsidence. Notes on the Mining Industry, by HENRY B. KÜMMEL (pp. 173-181). J. B.

2. *Indiana. Department of Geology and Natural Resources.* Thirty-first annual report. W. S. BLATCHLEY, State Geologist. Pp. 772, many maps and illustrations. Indianapolis, 1907.—This report includes ten papers by eight authors. Beside the introductory chapter there are seven papers of an economic character on peat, iron ore, petroleum, natural gas, and mine inspection. The volume closes with the following papers of a biological character. A preliminary list of the Arachnida of Indiana, with keys to families and genera of spiders, by NATHAN BANKS; and Notes on the Crayfish of Wells County, Indiana, with description of a new species, by E. B. WILLIAMSON. J. B.

3. *West Virginia Geological Survey County Reports and maps. Ohio, Brooke and Hancock Counties*; by G. P. GRIMSELEY, Assistant State Geologist. *Introduction*, by I. C. WHITE, State Geologist. Morgantown, West Virginia, 1907. Pp. xxix + 378, with 16 plates and 37 figures; 8 maps in accompanying atlas.—This volume is mostly economic in character, containing studies of the coals, petroleum, natural gas, clays, stones, climate, and soils of the Panhandle area. In addition a chapter is devoted to the historical and industrial development of the Panhandle counties and another to the physiography of the same.

J. B.

4. *Geological map of the Colony of the Cape of Good Hope, sheet XLVI*. Published by the Geological Commission, 1907. *Geology* by A. L. DU TOIT.—The area covered by this map is a square degree immediately northwest of Kimberley; the map is published on a scale of 1:238,000 or about four miles to the inch. The region is overlaid by the older Paleozoic series of diabases, amygdaloids, volcanic breccias, and tuffs of the Ventersdorp system, these strata outcropping on the east. Into them the Vaal river has cut a deep gorge. On the west this basal eruptive system is covered by dolomites, limestones, cherts and shales of the Campbell-Rand series, forming the Kaap plateau. Between the two and occupying depressions in the volcanic series occur broad areas of the Dwyka system of Carboniferous-Permian age. Sheets of diabase which were formerly intrusive in the Dwyka are now broadly exposed as high plateaus within those areas.

J. B.

5. *The Geology of the Parapara subdivision, Karamea, Nelson*; by JAMES MACKINTOSH BELL, assisted by ERNEST JOHN HERBERT WEBB and EDWARD DE COURCY CLARKE. Bulletin No. 3 (New Series) New Zealand Geological Survey. Pp. x + 111 with 26 plates, 2 figures, 11 maps, 7 cross-sections.—This report deals with the geology of a district facing Golden Bay, lying consequently in the extreme northerly portion of the South Island of New Zealand. The particular economic interest of the region centers in the deposit of iron ore, though coal and metaliferous deposits are also present. The region is of mountainous character and extremely wild but stands in marked contrast to the bolder and more magnificent scenery of the Southern Alps. The geological formations of the district comprise a basement of highly metamorphic rocks of Ordovician age, or older. Upon these are laid down argillites, grauwackes, and quartzites of Ordovician age; then the Haupiri series of conglomerates, breccias and argillites of later Paleozoic age. Upon these were deposited Miocene sediments, the lower portions holding coal and the whole still nearly horizontal.

Physiographically the region consists of an old mountainous land of pre-Miocene formations which had probably been maturely dissected prior to Miocene times. The mountains are surrounded by an upland country which was once entirely, and

is still in part, mantled by Miocene formations. The disjointed faulted and elevated blocks of this ancient coastal plain show that the old land owes its present comparatively great elevation not so much to the original folding as to bodily secular movements since the Miocene period. Narrow coastal belts, hardly to be called coastal plains, stand between the uplands and the sea.

J. B.  
6. *Om Fladdale og Randmoræner i Jylland*; af N. V. USSING. *Résumé Sur les Alluvions Glaciaires et les Moraines Terminales en Jutland*; K. Dansk. Videnskab. Forhandling, 1907. No. 4. Pp. 53 and pl. 1.—This paper deals with the moraines of recession in Jutland and their outwash plains. The outermost of these was formed during a prolonged period of arrest named the Baltic epoch of arrest. The later recessional moraines present a much younger appearance. A résumé in French is given at the end.

J. B.  
7. *Die Alpen im Eiszeitalter*; von Dr. ALBRECHT PENCK und Dr. EDUARD BRÜCKNER. Part 8, in two sub-parts, pp. 785–896. Leipzig, 1907 (Chr. Herm. Tauchnitz).—It is announced that this work is to include ten parts and that it will probably be soon completed. In part 8 the Pleistocene history of the Lombardy Alps is treated with the same clearness and thoroughness which have marked the study of other sections of the Alps by these authors. The older and younger moraines are separated and the outwash plains and terraces are also mapped. The glaciated and non-glaciated positions of the Alps are discriminated, allowing the profile of the former glaciers and the snow line of glacial times to be restored. The inter-glacial deposits are also studied.

J. B.  
8. *Revision of the Pelycosauria of North America*; by E. C. CASE. Carnegie Institution of Washington, Publication No. 55. Quarto, 176 pages, 35 plates and 73 text-figures.—This important monograph deals with the Permian suborder Pelycosauria and is based mainly upon the collections preserved in the American Museum of Natural History collected by Professor Cope and by the author himself, as well as upon two collections made by the latter for the University of Chicago.

Following the introduction there is an historical review of the Pelycosauria in which former classifications are discussed. The next section is given to a systematic revision of the suborder, which includes, according to Case, three families, seven genera, and 18 species. The morphological revision gives one an admirable idea of the peculiarities of this remarkable group, which contains some of the most bizarre and grotesque of reptiles. Occasional restorations of the skeleton throw a great deal of light upon the proper interpretation of the remains. In summing up, Case tells us that the Pelycosauria constitute a highly specialized and short-lived branch from the beginning of the Rhynchocephalian stem, a striking example of rapid evolution to extreme specialization from very primitive and generalized conditions. In

relationship, these forms are not far from the Proterosauria and Proganosauria, but differ from the former in the higher degree of ossification, especially of the pelvic and pectoral girdles, and from the latter in the lack of adaptation to a water life. The most striking feature of the group is the enormous development of neural spines to which it is impossible to assign any utilitarian value. The animals were fiercely carnivorous, with enormous teeth. The spines may be mere exuberance of growth from a possible utilitarian beginning; they may be an illustration of Beecher's law that the development of spines and excrescences accompanies the approaching extinction of a group.

Geographically, the Pelycosauria are distributed in north central Texas and some of the adjacent states and in Illinois; also in Prince Edward's Island. Abroad they occur in Bohemia and, less certainly, in central Germany and in France. The remains always occur mingled with an abundant fauna of fishes, amphibians, and other reptiles.

Geologically, the suborder is confined in North America entirely to the Permian, though in Europe *Otenosaurus*, an ally of *Naosaurus* and *Dimetrodon*, is found in the Muschelkalk. An ample bibliography of 141 titles closes the work. R. S. L.

9. *The Skull of Brachuchenius, with observations on the relationships of the Plesiosaurs*; by SAMUEL W. WILLISTON, Proc. U. S. National Museum, vol. xxxii, pp. 477-489, with plates xxxiv-xxxvii.—The type specimen of the genus and species under consideration comes from the Benton Cretaceous of Western Kansas and is distinguished from other plesiosaurs by several remarkable characters, in particular the union of the palatine bones in the middle line, and the very short neck.

In discussing the relationship of the Plesiosaurs, Professor Williston refers to certain marked resemblances in form and mode of progression between the oar-propelling plesiosaurs and turtles, as contrasted with the tail-propelling type represented by the ichthyosaurs, mosasaurs and thalattosuchians which Fraas uses as a support for the diphyletic grouping of the Reptilia by Osborn. These resemblances Williston thinks no more imply a common phyletic origin than do the much more marked resemblances of the ichthyosaurs and dolphins. He further states that there is only a remote relationship between the two orders (turtles and plesiosaurs) in osteological structure, and is still strongly of the opinion that the Sauropterygia were derived from a primitive therocephalian ancestry; the turtles having had a quite independent origin from some primitive cotylosaurian, like the Chelydosauria. The turtles occupy a phylum distinctly their own, no more intimately related to the plesiosaurs than they are to the ichthyosaurs or rhyngocephalians, and the ichthyosaurs, too, enjoy a geological line from the most primitive type of reptiles, and should no more be grouped with the dinosaurs and crocodiles than with the plesiosaurs and theriodonts. R. S. L.

10. *The Hell Creek Beds of the Upper Cretaceous of Montana*; by BARNUM BROWN. Bull. Amer. Mus. Nat. Hist., vol. xxiii, art. xxxiii, pp. 823-845.—In an excellent paper, Mr. Brown unravels the rather perplexing stratigraphy of the Hell Creek beds, which seem to be of similar age to the famous Ceratops beds of Converse county, Wyoming. The evidences for this comparison are lithological similarity and the fact that most of the genera and many species of vertebrates and invertebrates are common to both localities.

Of the vertebrate fauna, mammals are extremely rare, being found always in water-worn debris. They may represent river arboreal types. Of the dinosaurs, the Ceratopsia are the most abundant, remains of *Triceratops* being found from the very base to the top of the beds. At least 200 skulls have been found, but in nearly every case very badly broken. The genus *Torosaurus* does not occur in the Hell Creek region, although represented by several specimens from the Converse county beds. (The reviewer would add that none of the later species of *Triceratops* which were contemporaneous with *Torosaurus* have been recognized at Hell Creek, but the earlier forms like *Triceratops serratus*, *brevicornus* and possibly *horridus* were evidently abundant.) The Trachodontidæ are also of frequent occurrence and, while rare, the carnivorous dinosaurs were majestically represented by the great *Tyrannosaurus rex* which also occurs in the Converse county beds.

In summing up, Brown states that the Denver, Converse county and Hell Creek beds are of contemporaneous age and are all post-Laramie. "Considering the evidence of the organic remains, the invertebrates plainly foreshadow Tertiary and living species. The flora, on the other hand, shows very little affinity with that of the true Laramie below and even less with the Fort Union above. The vertebrates are clearly of Mesozoic affinity."

R. S. L.

11. *Ueber die Dinosaurier der Ausseuropäischen Trias*; von Dr. F. v. HUENE. Geologische und Palæontologische Abhandlungen. Neue Folge, Band viii, Heft 2, 1906, pp. 99-156, pls. viii-xxiii, 102 figures in the text.—This valuable quarto, which has since been followed by a somewhat larger paper on the Triassic dinosaurs of Europe, devotes a goodly portion to the American types, especially those of the Connecticut valley, most of which are preserved in the Peabody Museum of Yale University. Following the list of genera and species referred to extra-European Triassic Dinosauria is a section disposing of forms wrongly referred to this group. Of these the American types are *Clepsyrosaurus pennsylvanicus* Lea, which v. Huene refers to the Parasuchia; *Bathygnathus borealis* Leidy, which, in agreement with Case, is referred to the Pelycosauria. *Arctosaurus osborni* Adams is not a dinosaur, while *Dystrophæus vicemalæ* Cope proves to be a Jurassic Sauropod.

The second section includes an excellent discussion of the so-called Connecticut valley forms in which the very complete speci-

men of *Anchisaurus colurus* Marsh is treated at length, the others more briefly. *Anchisaurus solus* Marsh is doubtfully referred to that genus. *Ammosaurus major* Marsh completes the list of the types preserved at Yale, while *Megadactylus polyzelus* Hitchcock, which Marsh finally referred to *Anchisaurus*, v. Huene places in the European genus *Thecodontosaurus*, the fourth genus to which this interesting type has been referred.

The remaining American species are *Coelophysis longicollis* Cope, *C. bauri* Cope, and *C. Willistoni* Cope, all of which come from Mexico. The remaining species discussed are confined to South Africa and Australia.

An interesting feature of the final summary is the placing of *Ammosaurus* among the plant-feeding Orthopoda (Predentata), the first Triassic dinosaurian, known from the skeleton, to be referred to that suborder. The presence of predentates during Triassic times, however, has already been proven from the footprints.

R. S. L.

12. *Diamonds in garnet-pyroxene nodules in Kimberlite.*—The Roberts Victor Diamond Mine at Boshof, Orange River Colony, was opened in 1905. Since then numerous nodular masses, consisting of garnet and an emerald-green pyroxene with cyanite, have been frequently found in the "yellow ground." The interesting observation is now recorded by G. S. CORSTORPINE that one of these nodules has been found to contain eight diamonds, one or two of them well-formed octahedrons of  $\frac{1}{8}$  to  $\frac{1}{6}$  carat. The origin of these eclogite bowlders, as they have been called, has been disputed, but the author regards them as concretionary nodules formed by segregation or differentiation in the original magma, comparable with the olivine nodules observed in some basalts. The presence of diamonds in these nodules supports the theory that they originated in the firmer rock material called the "blue ground," and have not been carried in from some foreign source. Graphite is also occasionally found in the nodules, and this may represent carbon which, under different conditions, might have appeared as the diamond.—*Trans. Geol. Soc. So. Africa*, x, 65, 1907.

### III. MISCELLANEOUS SCIENTIFIC INTELLIGENCE.

1. *The Microscopy of Technical Products*; by Dr. T. F. HANAUSEK, revised by the author and translated by ANDREW J. WINTON with the collaboration of KATE G. BARBER. Pp xii, 471 with 276 figures. New York, 1907 (John Wiley & Sons).—The preparation of a treatise of this kind presents peculiar difficulties. From the nature of the case, it cannot be encyclopædic, for in these days of extreme specialization the encyclopædia has given place to exhaustive essays covering very limited fields. Hence there has arisen in every department of applied science a demand for some safe guide in technique, which shall train the observer

to construct his own private cyclopædia, so to speak, and which, by indicating the best methods of research and bibliographical work, shall keep the investigator in touch with every part of the field. Such a guide requires for its preparation not only a wide acquaintance with the subject and its allied topics, but also a remarkable power of selection by which only the best types for illustration shall be chosen. Without this sense of perspective and proportion, an author will give us an unsatisfactory guide, disappointing at every stage. For instance, in the fields occupied by raw commercial products there are many extremely diversified subjects, such as vegetable fibers. These fibers are numbered by the hundred. Among them are a few which have a commanding position on account of their wide use, and these are fully described in every work of reference. Of the remainder, there are some which cannot be referred to any of the great types, and these puzzling cases are likely to be the first ones which come in the observer's path. But if in the hand-book there has been described a type nearly allied to the one in hand, most of the difficulty vanishes. Dr. Hanausek has been very discriminating in the selection of his types and their striking variants, so that his work is of great value. We could wish that in some cases more space had been given to some of the more important subjects of interest in this country, for example the species of woods employed in our vast industries of mechanical and chemical wood-pulp manufacture. Certainly more space could have been advantageously given to the spruces. But on the whole, the selection has been admirable and the technical treatment very satisfactory. The translation is good throughout, and wholly free from obscurities. It remains to say that the index is copious and helpful, placing within easy reach of the student the immense mass of useful material contained in the 448 pages. The treatise is a distinct addition to the list of helpful guides in applied Botany and, we may add, in applied Zoology.

G. L. G.

2. *Lehrbuch der Mikroskopischen Technik*; von BERNHARD RAWITZ. Pp. 438. Leipzig, 1907 (Wilhelm Engelmann).—Nearly every advance in biological knowledge at the present day is dependent upon the ability of the investigator either to make use of the complicated technique which has been developed in the biological laboratory or to devise new and improved methods for himself. Each line of investigation requiring the use of the microscope necessitates a knowledge of the special methods by which the particular object to be studied is best prepared for microscopical investigation. Descriptions of these methods as they have been employed or devised by the most successful investigators have been brought together in this book, and are presented to the reader in systematic arrangement. Although by no means supplanting the works of Fol, Lee and Mayer, Röhlig, Fischer, and others, yet each succeeding year brings some improvements on so many of the older methods that a work of this sort is quickly out of date. The present book is so thoroughly up with the times



that it deserves a place in every laboratory where microscopical investigations are pursued.

W. R. C.

3. *Souvenirs Entomologiques: Études sur l'Instinct et les Mœurs des Insectes* (Dixième série); par J. H. FABRE. Pp. 353. Paris (Ch. Delagrave).—The present work comprises the tenth volume of studies by this author on the instincts and habits of insects. The enthusiasm of the true naturalist appears on every page, and the accounts of his interesting observations on the family life of some of the common insects of Europe are written in popular language with all the charm of a story book.

W. R. C.

4. *Papers and Addresses of the Ninth Annual Session of the American Mining Congress, 1906*. Pp. 151. Denver, 1907 (published by the Congress at the office of the Secretary).—The ninth annual meeting of the American Mining Congress was held in Denver from October 16th to 19th, 1906. The volume now issued contains the annual address of the President, J. H. Richards, with a series of papers by different authors. Among the latter may be noted one on the Development of Metal Mining in the Western States, by W. Lindgren; another on the Mineral Resources of Utah, by J. Derne; on the Geological Distribution of Gold, by T. A. Rickard; on the Copper Deposits of Washington, by A. W. McIntyre.

5. *Ricerche Lagunari per cura di G. P. MAGRINI, L. DE MARCHI, T. GNESOTTO*. N. 4-5 (N. 1-2 della serie biologica), Programma di ricerche biologiche Lagunari. N. 6, Le attuali conoscenze sulla flora Lagunare ed i problemi che ad essa si collegano di A. BEGUINOT. N. 7, Prima relazione annuale.—These papers, as the titles indicate, are parts of a series of studies on the fauna, the flora, and their physical and chemical environments; as found in the lagoons at the head of the Adriatic Sea.

J. B.

6. *Die Eistrift aus dem Bereich der Baffin-Bai beherrscht von Strom und Wetter*; von Dr. LUDWIG MECKING. Pp. 135 with 2 plates and 3 figures. Part 7, January 1906 (Siegfried Mittler und Sohn), Berlin.—This work is a critical study of the part played by ocean currents and by winds in governing the paths of ice drift around Greenland and in the Arctic Archipelago. A bibliography of the subject is appended.

J. B.

7. *Ostwald's Klassiker der Exakten Wissenschaften*. Leipzig (Wilhelm Engelmann); 1907.—Recent publications are the following (see also p. 40, May, 1907):

Nr. 159.—Chymische Versuche, einen wahren Zucker aus verschiedenen Pflanzen, die in unseren Ländern wachsen, zu ziehen; von A. S. MARGGRAF.

Anleitung zum Anbau der zur Zuckerfabrication anwendbaren Runkelrüben und zur vortheilhaften Gewinnung des Zuckers aus denselben; von F. O. ACHARD.

Die beiden Grundscriften der Rübenzuckerfabrikation. Herausgegeben von Edmund O. von Lippmann.

## OBITUARY.

Professor ASAPH HALL, the astronomer, died at Annapolis on November 22, at the age of seventy-eight years.

Prof. Hall's first ancestor of the family name in this country, John Hall, landed in Massachusetts about 1630 and afterwards moved to Connecticut, making his home in the town of Wallingford. Thence Prof. Hall's grandfather, Asaph Hall, moved to Goshen, Litchfield County, about 1755. He was with Ethan Allen at the capture of Ticonderoga, and afterwards became a captain. Prof. Hall's father was also named Asaph Hall. The professor was born in Goshen, Oct. 15, 1829. His mother was a Palmer, descended from the Palmers of Stonington. His father manufactured clocks at Hart Hollow in Goshen and traveled with wagon and team selling them through the South. In one of these trips he died in Georgia, leaving scanty means to his widow. In consequence young Hall had to be removed from school and apprenticed to a carpenter. But he seems to have early formed the resolution of devoting himself to a scientific career. The narrowness of his circumstances, however, prevented any move in this direction until he had reached the age of 25 years, when, having learned the existence of a sort of communistic college at McGrawville, Cortland County, N. Y., where the students paid for their board and tuition by manual labor, and the higher classes lent a helping hand in teaching the lower, he repaired thither. Here, in a couple of years, although the educational appliances must have been meager, he succeeded in acquiring a fair acquaintance with French, German, Latin, and the elements of mathematics. Here, too, he met Miss Angeline Stickney, who was on a quest similar to his. After her graduation they were married and went to Ann Arbor, Mich., where, for a little time, Prof. Hall enjoyed the instruction of Prof. Franz Brünnow. Then they taught school at Shalersville, Ohio. The next step was to Cambridge, Mass., to Harvard College Observatory. This was in the summer of 1857. Prof. W. C. Bond set him to work reducing a large mass of moon-culminations which the Bonds had accumulated as a contribution to the knowledge of the difference of longitude between Europe and America. Prof. Hall's pay was exceedingly scanty, and the utmost economy was necessary to make both ends meet. Fortunately, Congress in 1862 authorized four aidships for the Naval Observatory. For one of these Prof. Hall applied and obtained the appointment.

This proved to be the turning point in Prof. Hall's career. He was soon made Professor of Mathematics in the Navy, and his skill and adroitness in the management of all scientific matters, coming under his hand, won for him universal regard, especially that of Joseph Henry, so that, in 1875, he was elected into the National Academy of Sciences. In 1877 occurred a favorable opposition of Mars, and with the larger equatorial of the Naval Observatory, of which he was then in charge, he subjected the planet and its vicinity to rigid scrutiny, with the shining success

of the discovery of the satellites Deimos and Phobos. Although some may say this was only good luck, Prof. Hall deserved all the praise accorded him by his extreme industry in accumulating the measures serving to determine the orbits of these bodies. Prof. Hall undertook long journeys for the sake of observing important phenomena; the transits of Venus were observed at Vladivostok and San Antonio; solar eclipses at Plover Bay, in Sicily and Colorado. In 1891 he was retired. In 1896 he received an invitation to give instruction in celestial mechanics at Harvard University, which he accepted, and performed the duty for five years. His lectures were addressed to undergraduates as an elective course; he was under the necessity of accommodating his teaching to the capacity of his pupils, who seldom exceeded seven. The subject was treated on the line of Gauss' *Theoria Motus*. In 1901 he thought himself warranted in retiring to his native town, Goshen, in quietness, retaining, however, his innate propensity for investigating all matters that interested him. This he kept up till within about ten months of his decease, when, the physician being called in, he was pronounced to be suffering from heart trouble, and absolute quiet was prescribed. He passed away on November 22, 1907, at the house of his son in Annapolis, Md., whither he had gone to escape the rigors of the Goshen winter.

With his fine temperament for social intercourse he had no difficulty in being popular wherever he went. In this connection I can only think of the exclamation of one of the watchmen at the Observatory just after he had passed, "What a nice man he is!"

G. W. HILL.

Dr. BERNARD J. HARRINGTON, Professor of Chemistry and Mineralogy in McGill University, Montreal, died on November 29 at the age of fifty-nine years. In him Canada loses not only a well known chemist and mineralogist, but one who had endeared himself to a large circle of friends and acquaintances by his sterling worth of character and charming personality. His death took place at his home in Montreal, after a long illness of some fifteen months' duration.

Dr. Harrington was born at St. Andrews, P. Q., on August 5th, 1848. Not being very strong as a boy, his early education was obtained chiefly from private tutors. He then entered McGill University, where he graduated with honors in natural science and taking the Logan medal in geology. He then proceeded to the degree of Master of Arts in this University and subsequently continued his studies in the Sheffield Scientific School of Yale University, from which in 1871 he obtained the degree of Doctor of Philosophy, taking the prize in mineralogy. At Yale he was a classmate of Professor H. S. Williams of Cornell, these two gentlemen being the first candidates to receive the degree of Doctor of Philosophy at the School in question.

His first fieldwork was carried out in Prince Edward's Island, where he assisted Sir William Dawson in the preparation of a

report on the geology of the island for the Geological Survey of Canada.

He was appointed lecturer in mineralogy at McGill University in 1871, and in the following year succeeded Dr. Sterry Hunt as chemist and mineralogist to the Geological Survey of Canada, discharging the duties of both positions for several years. In 1879 he retired from the Geological Survey of Canada and devoted his whole attention to teaching work at McGill University where he was subsequently appointed David Greenshields Professor of Chemistry and Mineralogy. In these pioneer days of University work, he also lectured on mining and metallurgy, in which subjects he proved to be a very able teacher, as shown by the fact that many of his students in these subjects have since risen to occupy foremost positions in the mining world. He was also an enthusiastic botanist.

Dr. Harrington was the author of several important reports published by the Geological Survey of Canada, as well as of many papers, chiefly dealing with mineralogy, which appeared in various scientific publications. We are also indebted to him for an excellent Life of Sir William Logan, the first Director of the Geological Survey of Canada.

He planned the Chemistry and Mining Building which was erected for the University by Sir William Macdonald, and was its Director until the time of his death.

Dr. Harrington was a Fellow of the Royal Society of Canada, being President of Section III of this Society for several years. He was also President of the Natural History Society of Montreal, and Vice-President of the Chemical Section of the British Association for the Advancement of Science (Toronto meeting).

In 1876 he married Anna Lois, daughter of Sir William Dawson, and leaves three sons and four daughters to mourn his loss.

He was a man of retiring disposition, but warm-hearted and unselfish to a degree,—a personal friend of all his students, and beloved by all who were fortunate enough to make his acquaintance.

FRANK D. ADAMS.

LORD KELVIN, the eminent English physicist, died on December 17 in his eighty-fourth year. He was one of the intellectual giants of his time, alike prominent for his contributions to the higher mathematics and physics, and for his remarkable achievements in the practical applications of science, as shown conspicuously, for example, in his work in connection with submarine cable telegraphy. His greatness received full recognition at home and abroad: he was made Sir William Thomson in 1886 and in 1892 received the title by which he has been known in recent years; he receives also a resting place in Westminster Abbey, the first scientific man to be so honored since Darwin was buried there in 1882. Of the details of his long and fruitful life, of his wonderful power for work, his simplicity of character, and his charming personality, this is not the place to speak.

Dr. L. M. UNDERWOOD, Professor of Botany in Columbia University, died on November 16 at the age of fifty-four years.

# Relief Map of the United States

We have just prepared a new relief map of the United States, 48 x 32 inches in size, made of a special composition which is hard and durable, and at the same time light. The map is described in detail in circular No. 77, which will be sent on request. Price, \$16.00.

---

WARD'S NATURAL SCIENCE ESTABLISHMENT,

76-104 College Ave., ROCHESTER, N. Y.

---

---

## WARD'S NATURAL SCIENCE ESTABLISHMENT

A Supply-House for Scientific Material.

Founded 1862.

Incorporated 1890.

### DEPARTMENTS:

*Geology*, including Phenomenal and Physiographic.

*Mineralogy*, including also Rocks, Meteorites, etc.

*Palaeontology*. *Archaeology* and *Ethnology*.

*Invertebrates*, including Biology, Conchology, etc.

*Zoology*, including Osteology and Taxidermy.

*Human Anatomy*, including Craniology, Odontology, etc.

Models, Plaster Casts and Wall-Charts in all departments.

---

Circulars in any department free on request; address

Ward's Natural Science Establishment,

76-104 College Ave., Rochester, New York, U. S. A.

## CONTENTS.

	Page
ART. I.—Contributions to the Geology of Rhode Island ; by B. L. JOHNSON and C. H. WARREN .....	1
II.—Esterification of Benzoic Acid ; by I. K. and M. A. PHELPS, and R. W. OSBORNE .....	39
III.—Description of the Williamstown Meteorite ; by E. E. HOWELL .....	49
IV.—Descriptions of Tertiary Insects ; by T. D. A. COCK- ERELL .....	51
V.—Stratigraphy of the Mt. Taylor Region, New Mexico ; by H. W. SHIMER and M. E. BLODGETT .....	53
VI.—Mammalian Migrations between Europe and North America ; by W. D. MATTHEW .....	68
VII.—Notes on Powellite and Molybdate ; by W. T. SCHALLER .....	71
VIII.—Hydrolysis of Ammonium Molybdate in the Presence of Iodides and Iodates ; by S. E. MOODY .....	76

### SCIENTIFIC INTELLIGENCE.

*Chemistry and Physics*—Parent-Substance of Radium, HAHN : Reduction of Arsenic Trisulphide and Pentasulphide to Disulphide, EHRENFELD, 79.—Titanium trichloride for Volumetric Analysis, KNECHT and HIBBERT : *Traité de Chemie Analytique Qualitative*, DUPARC et MONNIER : *Kurzes Lehrbuch der organischen Chemie*, W. A. NOYES, 80.—History of Chemistry, H. BAUER : *Beiträge zur chemischen Physiologie*, F. HOFMEISTER : *Immuno-Chemistry*, S. ARRHENIUS, 81.

*Geology and Mineralogy*—Geological Survey of New Jersey, H. B. KÜMMEL : Geology and Natural Resources of Indiana, W. S. BLATCHLEY, 82.—West Virginia Geological Survey County Reports, G. P. GRIMSLEY and I. C. WHITE : Geological Map of the Colony of the Cape of Good Hope, A. L. DU TOIT : Geology of the Parapara subdivision, Karamea, Nelson, J. MACKINTOSH BELL, 83.—Om Fladdale og Randmoræner i Jylland ; N. V. USSING : Die Alpen im Eiszeitalter, A. PENCK und E. BRÜCKNER : Revision of the Pelycosauria of North America, E. C. CASE, 84.—Skull of *Brachuchenius*, S. W. WILLISTON, 85.—Hell Creek Beds of the Upper Cretaceous of Montana, B. BROWN : Ueber die Dinosaurier der Aussereuropäischen Trias, F. v. HUENE, 86.—Diamonds in garnet-pyroxene nodules in Kimberlite, 87.

*Miscellaneous Scientific Intelligence*—Microscopy of Technical Products, T. F. HANAUSEK, 87.—Lehrbuch der Mikroskopischen Technik, B. RAWITZ, 88.—Souvenirs Entomologiques, J. H. FABRE : Papers and Addresses of the Ninth Annual Session of the American Mining Congress, 1906 : *Ricerche Lagunari per cura di G. P. MAGRINI, L. DE MARCHI, T. GNESOTTA* : Die Eistrift aus dem Bereich der Baffin-Bai beherrscht von Strom und Wetter, L. MECKING : *Ostwald's Klassiker der Exakten Wissenschaften*, 89.

*Obituary*—Professor A. HALL, 90.—Dr. B. J. HARRINGTON, 91.—LORD KELVIN : Dr. L. M. UNDERWOOD, 92.

Established by BENJAMIN SILLIMAN in 1818.

---

THE  
AMERICAN  
JOURNAL OF SCIENCE.

EDITOR: EDWARD S. DANA.

ASSOCIATE EDITORS

PROFESSORS GEORGE L. GOODALE, JOHN TROWBRIDGE,  
W. G. FARLOW AND WM. M. DAVIS, OF CAMBRIDGE,

PROFESSORS ADDISON E. VERRILL, HORACE L. WELLS,  
L. V. PIRSSON AND H. E. GREGORY, OF NEW HAVEN,

PROFESSOR GEORGE F. BARKER, OF PHILADELPHIA,  
PROFESSOR HENRY S. WILLIAMS, OF ITHACA,  
PROFESSOR JOSEPH S. AMES, OF BALTIMORE,  
MR. J. S. DILLER, OF WASHINGTON.

---

FOURTH SERIES

VOL. XXV—[WHOLE NUMBER, CLXXV.]

No. 146—FEBRUARY, 1908.

---

NEW HAVEN, CONNECTICUT.

1908

---

THE TUTTLE, MOREHOUSE & TAYLOR CO., PRINTERS, 123 TEMPLE STREET.

# REMARKABLE CONSIGNMENT OF Rare and Choice Minerals.

We would again call your attention to this remarkable consignment, which has created a stir among the more advanced collectors. Descriptive lists are now ready for mailing, so if you are interested, send for one of them. We give below a brief list of the most remarkable of them:—

Fine lot of Diamond crystals, from East India, in shades of pink, yellow, purple, and light green, \$3 to \$5 each; Euclase, Capiò do Lane, Brazil, one \$75 (white), \$55 (blue) and \$45 (blue); Emeralds, in matrix, Bogota, Columbia, S. A., \$35 to \$250; Takovaya, Ural, \$2 to \$15; Aquamarine, Nertschinsk, Ural, loose crystals and matrix, 50c. to \$15; Alexandrite, Takovaya, Ural, matrix specimens and loose xls, \$3 to \$25; Diopase, Kirghes Steppes, \$15 to \$22.50; Crocoite, with Vauquelinite, Ural, also Tasmania, \$5 to \$10; Topaz, Schneckenstein, matrix specimens, 75c. to \$7.50; Blue and white Topaz, Romana, Cal., \$8 to \$10; Tourmalines, Mesa Grande and Pala, Cal., matrix specimens and loose crystals, \$1 to \$150; Chrysoprase, Silesia, and Pala, Cal., polished, \$2 to \$4; Hyacinth in basalt, Siebengebirge; in lava, Niedermendig, \$2 to \$2.50; Pyropes in serpentine, Zoebnitz, 50c. to 75c.; Essonite, Ala, Piedmont, \$1.75 to \$2.50; Garnet, Bodö, Norway, loose crystals, 25c. to 75c.; Cyanite and Staurolite, Mt. Campione, \$2 to \$2.50; Hederite, on quartz, Poland, \$1 to \$15; Zeophyllite, new mineral, Radzein, Bohemia, \$1 to \$5; Benitoite in matrix, San Benito Co., Cal., \$5 to \$7.50; Polybasite, xls, Durango, Mexico, \$4 to \$6; Hausmannite, new locality, Cumberland, 50c. to \$3; Zinkenite, Nevada, \$1.50 to \$3; Copalite on Coal, new mineral, Castle Gate, Utah, \$1.50 to \$2; Torbernite, Tincroft, \$5 to \$10; Semseyite, on Galena, Felsöbanya, \$2.50 to \$10; Chalcophyllite, Redruth, Cornwall, \$8 to \$10; Crystal Gold, in leaves, Vöröspatak, \$15 to \$25; and in the matrix, from Siebenburgen, \$15; Sylvanite, Nagyag, \$5 to \$7.50; Crystal Silver, Calumet, Michigan, 75c. to \$20; Libethenite, Libethen, \$2.50 to \$5. We still have a fine lot of Hungarian and English Minerals.

## Ore Collection of 220 Specimens.

We have just secured a collection of rich ores, all hand size, and all fine examples, from American Mines. They will be sold singly or as a whole.

## Another Old Collection.

We have secured still another collection of what have come to be known as old collections, that is collections that are rich in examples, from exhausted localities. Particulars on application.

## Cut Gems.

We have every known gem and semi-precious stones.

## Scientific Rubies.

We have a fine lot of these fine gems, from Paris, from 1/2 to 4 k.

Send for lists of our Brooklyn and other collections.

**A. H. PETEREIT,**  
81—83 Fulton Street, New York City.



THE

# AMERICAN JOURNAL OF SCIENCE

[FOURTH SERIES.]

ART. IX.—*Historic Fossil Cycads*; by G. R. WIELAND.

THE silicified cycadeoidean trunks, *Cycadeoidea etrusca* Capellini et Solms, conserved in the Aldrovandi Museum at Bologna, and *C. Reichenbachiana* (Goepfert) Solms of the Zwinger Museum at Dresden, must certainly be reckoned amongst the most distinctly famous of all fossil plants.\* For both these fossils are of the greatest structural interest; and while the former has a fair claim to be regarded as the most anciently collected of all geological specimens, the latter has the double distinction of having been longer conserved in museums than any other cycad trunk, and of long having been the largest known specimen of its kind. In fact it still remains in the foremost rank among the very largest of all silicified cycads, since it is only a segment of a single trunk; whereas our American specimens of a greater size are either *complete* columnar trunks or else great branching trunks. Furthermore, while *Cycadeoidea etrusca* has the distinction of having yielded the first clue to the approximate position of staminate fructification in the Cycadeoideæ through Count Solms' discovery of its pollen grains, the great Zwinger Museum trunk is in no small measure notorious as an unstudied specimen which has urgently demanded study for quite a hundred years,—that is, ever since

\* The original description of *Cycadeoidea etrusca* is given in the contribution of Capellini and Solms, I tronchi di Bennettitee dei Musei Italiani, Notizie storiche, geologiche, botaniche, Mem. d. R. Accad. d. Sc. dell' Ist. di Bologna, Ser. IV, vol. x, 1890.

The chief data relating to the history of *Cycadeoidea Reichenbachiana* have been brought together by Professor Ward under the caption "A Famous Fossil Cycad," in this Journal, vol. xviii, July, 1904. Direct references to these and other papers mentioned, or facts cited here, may be found in the writer's work, "American Fossil Cycads," Publication No. 34 of the Carnegie Institution of Washington. Washington, August, 1906.

the development of methods for the study of rocks in thin sections. It is hence of some interest to record that, following my studies of American Cycads, I have recently had the opportunity of seeing both of these famous fossil plants, as well as the equally interesting *Williamsonia* casts of the James Yates series of the *Jardin des Plantes* and other collections, and also the unique Triassic form *Anomozamites* of the Natural History Museum at Stockholm. And indeed all of these fossils have proven so unexpectedly characteristic that I deem it of use to give here a brief account from my notes as intended mainly for a taxonomic study of the American Fossil Cycads, now in course of preparation for the Carnegie Institution of Washington.

(1) *Cycadeoidea etrusca*.—The features of this segment of a columnar trunk are already familiar through the descriptions and figures of Capellini and Solms. The specimen is of great beauty, the texture dense, the color quite dark, the general outer appearance somewhat intermediate to the Wyoming *Cycadella* and *Cycadeoidea nigra* from Colorado. Numerous young fruits are present, and through the great courtesy of Senator Capellini I was enabled to study thin sections prepared from one of these some years since. Especially the thin section of the young axis figured by Solms is of even greater interest than I had anticipated; for although the tissues of the sporophyll rachides are mostly broken down, the entire and uncompressed outlines of both the sporangia and the walls of the synangia of the usual *Cycadeoidea* (Marattiaceoid) form seen in the American specimens, are certainly often present. Only the individual cells of the outer or palisade layer of the synangia do not seem to be conserved. An outline of a synangium cut in the longitudinal transverse direction is quite distinct; while an obliquely cut synangium shows three adjacent sporangia filled full of collapsed (or desiccated) pollen grains, the enclosing locular walls being very perfectly conserved. The pollen is seemingly mature, and the synangia are even larger than in *C. dacotensis*, although the fruits are of a much smaller size.

The small central ovulate cone, no more than a centimeter long, is very perfectly outlined, the short stalked and minute ovules distinct. In size and general structure these fruits may eventually prove more like those of *Cycadella* than *C. dacotensis*. From the rather small size of the staminate fronds, it seems that these were more reduced than in *C. dacotensis* or *C. ingens*; but whether they were bipinnate, pinnate, or simply consisted in a single blade, bearing synangia laterally inserted, much as the megaspores are borne by the carpophylls of *Cycas*, remains impossible to say. These small fructifi-

cations may at least prove to have a rather more reduced form than those of *Cycadeoidea dactensis*. Transverse sections of *C. etrusca* fruits are lacking, but should be made, as they may show the disk features much better than do longitudinal sections. The vegetative structures, however, agree with those of the Maryland cycads very closely throughout,—only the species remaining fairly distinct from *Cycadeoidea marylandica*, if we hypothetically consider the plant on the basis of vegetative features alone.

I may add that I also had the pleasure of visiting the wonderfully interesting and picturesque Etruscan town site and necropolis where *C. etrusca* was found. These ancient ruins are situated in the grounds of Count Aria in the picturesque valley of the Reno, 20 miles west of Bologna in the foot-hills of the Apennines. After seeing how the stream is there cutting away the last remnants of what was once a regularly laid out town of considerable size, I am still more impressed with the likelihood of the suggestion I have once made that not a few of the fossil cycad trunks were gathered into towns or cities now in ruins or long since destroyed. That *C. etrusca* is at least as ancient as the old River Reno Etruscan village and necropolis of 4,000 years ago is certain; for it bears near its base, as noted by Capellini, an elliptical polished-out depression of considerable size, due to use as a smoothing or a sharpening stone, which may just as well have been of neolithic as later date. At any rate, the great perfection of the specimen indicates that in all probability it did not occur alone; and perchance the occurrence of associated silicified conifers may yet aid in giving some clue to the original locality, which, if found, would doubtless yield yet other cycad specimens of rare perfection and interest. The same remark applies even more pointedly to the great Dresden trunk, concerning the macroscopic features of which I proceed to give additional facts.

(2) *Cycadeoidea Reichenbachiana*.—This notable type, now in the paleontological collections of the Zwinger Museum at Dresden, was found not far from Lednice near Cracow about 1753. It consists in the basal segment of an immense silicified cycad trunk a full half-meter in diameter and of noticeably but not markedly compressed unbranched columnar form. In life it may have been more than a meter high, as the segment recovered is over a half-meter in height and without tapering.

The leaf bases are a little smaller than those of *C. Jerneyana* and *C. ingens*, and of much the same size as those of *C. gigantea* of Seward from the Isle of Portland, and the very similar *C. excelsa* of Ward from the Black Hills. The trunk has just emerged from its pulcherrima stage of growth, that pre-fructi-

fication period well illustrated by *Cycadeoidea megalophylla* Buckland; and, as indicated by large groups of bracts marking the individual axes of fructification, and especially by the manner in which the bracts close in compactly at the center of the bract groups, many young fruits are present. Of these fruits three, and perhaps more, are very clearly in the bisporangiate or nondehiscent-disk or flower-bud stage so well exhibited by our American specimens. Moreover, in one of these three buds the disk structure is strikingly clear. In it the curved middle portions of the unexpanded and presumably bipinnate microsporophylls have been so eroded away as to clearly reveal in transverse section sixteen circularly disposed microsporophyll rachides. And one may plainly see that these sections of the rachides of triangular outline abut and enclose an inner mass of closely packed and wonderfully conserved synangia of large size, rising above and concealing a central ovulate cone. The individual synangia are evidently attached to the rachides in normal position. This is the first time that the presence of such silicified flowers has been definitely confirmed in European trunks.\*

In size and general structure the bisporangiate strobilus of *C. Reichenbachiana* with its 16 microsporophylls closely agrees with that of *C. dacotensis* with 17 or 18, with perhaps a decidedly interesting difference in the apparently larger size of the synangia. The structure of the synangia is unquestionably preserved; indeed, although familiar with quite 1,000 trunks, I know of no other fossil cycad so beautifully and magnificently silicified as *C. Reichenbachiana*. It is even probable that the entire structure of the staminate fronds as well as the synangia is preserved in the greatest perfection, whence it is of very distinct interest to paleobotanists that, as I was informed at Dresden, Solms-Laubach is soon to carry out an exhaustive histologic study of this famous fossil cycad.

\*I am unable to reconcile the features of *C. Reichenbachiana* with the drawing of the "Bruchstück" given by Goeppert on Plate IX of the Jubiläums Denkschrift, published in 1853. In fact not only this, but all the accompanying figures are of that uncertain value so characteristic of most illustrations of fossils previous to the extended use of photography,—and that they are quite inexact has already been observed by Professor Ward.

With the Dresden cycad before me it seemed that the large *Williamsonia*-like fruit nearly 5 centimeters in diameter and so prominent in Goeppert's Plate IX must pertain to an accompanying fragment, or even to another specimen; but as the text of the Denkschrift gives no clue to any such, I must conclude that during or since the time of Goeppert the fruit illustrated was partly or wholly broken away.

Goeppert supposed these axes to be vegetative and like the lateral buds of old *Cycas* stems; but Professor Ward notes that they are fruits and thought seeds must be found in some. In which he is wholly correct, since nearly all must bear young ovulate cones hidden beneath the thick husk of enclosing bracts, which is in the great majority of cases all that can be seen at the surface of the trunk. Fully fifty young floral axes are present.

As we have seen, *Cycadeoidea Reichenbachiana* adds another member to the long series of trunks extending from columnar types which have mostly, though not always, large leaf bases, to the great branching types from America, which are mostly characterized by leaf bases of moderate or small size. Moreover, while *C. Reichenbachiana* is a columnar form, its flower bud agrees closely with that of the branching cycads of the Black Hills, especially *C. dacotensis*. It therefore remains to add that in the light of these new facts concerning long known European cycads, the family name Cycadeoideæ used by Robert Brown (1828) certainly includes all the forms which English writers on fossil plants have much later mistakenly placed in their so-called Bennettitæ. Similarly, the proposal that *Cycadeoidea* (1827) shall be the generic term used for stems without recognizable fructifications cannot be accepted for the simple reason that not only are the Buckland specimens vegetatively like the other trunks from Europe as well as the American forms, but, to go no further than the evidence afforded by the original descriptions, the tangential section figured by Buckland eighty years ago clearly shows a large and characteristic peduncular bundle. As to the genus *Bennettites* (1867), this can at the very most include two or three species so far as known, the great majority of the species of Cycadeoideæ falling within other genera. And so far as truly problematic trunks of unknown fructification and really doubtful vegetative characters are concerned, it only needs to be remarked that there is already at hand for their reception a plethora of such names as *Yatesia*, *Withamia*, *Becklesia*, *Fittonia*, *Clathraria*, *Cylindropodium*, and *Bolbopodium*. It would certainly be as illogical to insist that we require to relegate to a minor position a correctly used generic name for the sake of a handy nomenclature for cycad trunks without distinct or distinctly conserved fructifications, as it would be to say that we can never learn the fructification of a fossil whose vegetative features are the first to be discovered, or are, as in this case, the *first to be understood*. Clearly, therefore, those who would further use the family name Bennettitæ, or the generic name *Bennettites*, in other than a wholly restricted sense, must err in both these respects.

Let us now turn our attention briefly to two of the cycadeoid imprints and casts, which are quite as famous as the silicified trunks just discussed, and which supplement and add to our knowledge of the Cycadeoideæ in such a remarkable manner,—namely *Williamsonia* and *Anomozamites*.

(3) *Williamsonia gigas* (Paris Museum specimen with leaves attached).\*—This is by far the most important specimen of the James Yates collection of *Williamsonias* from the Juras-



*Williamsonia gigas* (Echantillon No. 2399a *Jardin des Plantes*, Paris, Collection Yates, 1827). Terrainoolithique inférieure, Scarborough et Whitby.

The fronds to the right are of an old series; above these are large scale leaves somewhat interiorly to which rise the petioles evidently of a younger series of full grown fronds,—the main axis ending in a forked bract enveloped peduncle and possibly being capable of further growth after the production of its flowers, just as is the *Cycas* axis. ( $\frac{2}{3}$  natural size.)

\*The present drawing of this remarkable cycad is superposed on a photograph furnished to me through the great liberality of the officials at the *Jardin des Plantes*.

sic sandstones of Hawkser and Runswick cliffs, secured by Brongniart. Imperfectly figured by Saporta in the *Plantes Jurassiques*, vol. ii, it was casually mentioned by Solms-Laubach in his *Fossil Botany* as the only cycadean stem known to him with leaves attached, and later still by Seward, who observed the presence of the terminal and typical *Williamsonia* peduncle. Yet we remain without an adequate description; for, although a silicified *Ptilophyllum* stem with frond bases bearing a few pinnules has been reported from India, and though many of the silicified stems from the Black Hills bear entire crowns of young fronds, here is the only cycadophyte known in all the world's museums with quite complete mature fronds plainly attached to the parent stem. Moreover, the present plant differs markedly from the above forms in its stem characters only, and is a fundamentally important connecting link between *Cycas* and those *Cycadeoidean* types with much reduced laterally-borne fructifications. It is, too, a fossil of great beauty;—conserved as a semi-cast, or combination of cast and imprint in a block of grayish white sandstone (Lower sandstone of Phillips), traces of the original carbon add very markedly to the clearness of the outlines of the stem, fronds, bracts, and peduncle. All of the features are exposed by a single fortunate split of the matrix which reveals the connection of the stem and petioles of at least three of the fronds, one above the other; while various other fronds traversing the matrix make it clear that all of the fronds of a sparse crown are present and, in most cases, connected. That is, an entire plant with mature fronds and large fruits, as indicated by the prolongation of the stem as a peduncle, is surprisingly well shown. In life the foliar crown was of the same size as one of our Florida *Zamias*, with fronds a little less than two feet in length; but the stem, the basal portion of which is broken away, was slenderer—less than five centimeters in diameter, armor and all, and may have been long. Easily the most striking feature is the continuation of the main axis with but slight constriction and no evidence of lateral budding, as a bract-covered peduncle. This rises to a height of some ten centimeters above the leafy crown and then forks just where cut off by a transverse fracture studded by small barnacles. As thus plainly indicated, the fossil came from a point on the Hawkser or Runswick cliffs between high and low tide, and may even have been found *in situ*, rather than as talus material, if the fruits were turned toward the cliff-face. The barnacle-studded fracture is but little water-worn, and the forked peduncle appears to be broken off just at the base of two large fruits, or, as is quite as likely, a single fruit and the new phytaxis.

In short, it seems highly probable that had the importance of the specimen been at once realized when collected some

eighty years ago, it would have been possible to find, either associated with it or remaining behind in the cliff, the block containing the entire summit. Indeed, in looking through the other James Yates specimens of the *Jardin des Plantes*, I could not help hoping every moment to find the barnacle-covered end of a block matching the broken end of that of the main stem, and containing the missing flowers. And, although I failed to observe any such with certainty, there still remains a suspicion that the iron mountings of the specimen prevented my search from being wholly conclusive, and that some one of the beautiful accompanying series of *Williamsonia* flower buds was really borne on the forked peduncle. At least, this not proving so, it seems to me that if there exists at Cambridge or elsewhere in England a slab bearing a pair of *Williamsonia* fructifications, with the peduncles broken away at their bases and ending on a transverse fracture of the matrix, dotted over with barnacles, or similarly, a fruit and a bud lying side by side and oriented alike, it ought in the interests of paleontology to be carried to Paris and compared with the *Jardin des Plantes* specimen.

I do not think I am deceived in stating that the peduncle forks; although whether it is at first a true monopod or integral prolongation of the stem instead of a lateral branch, is more uncertain. As already suggested, however, it appears to rise monopodially, and to thus exhibit precisely that form of fruiting hypothetically intermediate between *Cycas* and the reduced laterally-borne cones and flowers of *Cycadeoidea*. If, as must be borne in mind, the peduncular prolongation of the stem bore one flower and a new phytaxis, instead of two flowers, we of course have here repeated in the Jura very nearly the same fruit-bearing and branching habit as in that remarkable related form of the Triassic, *Anomozamites*. In either case, however, the condition observed forms, *a fortiori*, a connecting link of profound interest between the *Cycadeoideæ* and the *Cycadaceæ*. For, restating the case: in the female *Cycas*, strobilar elongation of the stem following a bract series or scale-leaf series, is integral—monopodial; while here there appears to be a partially restricted elongation of the stem which likewise follows a bract series and is presumably capable of producing a fruit-bearing branch, and also of subsequent growth as a new phytaxis. There is little suggestion of a fruit-bearing sympode or flowering stalk.

Much more,—if we begin to think out hypothetically related forms with much branched yet slenderer stems, netted veined (*Dictyozamites*) leaves and primitively plastic multiovulate sporophylls, we soon arrive at a remote type of Proangiospermous plant near to or actually a true *pre*-Angiosperm, or Hemiangiosperm, as named by Newell-Arber from what is justly



my own point of view. But this line of inquiry is more appropriate to another chapter. Meantime, it seems extraordinary that the fossil before us has received such scant notice in texts, and that just as if it had never existed, the correctness of Williamson's restoration was so long called in question despite the added authority of Brongniart.

(4) *Anomozamites minor* Nathorst.—The accurate descriptions of the original types given thirty years since by Nathorst, and more recently in his contribution on *Einige Mosozoischen Cycadophyten*, leave little to add here, except by way of emphasis of the great botanical importance of this oldest of known cycadeoids. These specimens, still unfortunately few in number, are not only among the most priceless in the superb collections of fossil plants in the Natural History Museum at Stockholm, but deserve a foremost position amongst all fossil cycadophytes.

In my American Fossil Cycads I have in unmistakable terms urged the great importance of *Anomozamites*, which by reason of its slender much branched stem, its small blade-like leaves, and its small fruits of *Williamsonia* type (apparently with 18 microsporophylls), is certainly more suggestive of relationships to primitive Angiosperms, that is to the Magnoliaceæ as determined independently by both Hallier and myself, than is any other of the better known cycadeoids. Indeed the only possible contestant for this position of primary importance which can so far be suggested is *Dictyozamites*. Because of its netted veined leaves, we may well suspect that this cycadophyte, now known to be one of the cosmopolitan forms, may show yet closer approximations to Dicotyls—once we are fortunate enough to find its fruits. For it need surprise no one if these should for instance exhibit that more primitive bisporangiate combination of the *Cycas*-like, or *multiovulate carpophyll*, with *reduced microsporophylls*, or stamens, which one may safely predict will be yet discovered in considerable variety amongst the cycadeoids.\*

\* With the present additions, the known species of Cycadeoidean amphisporengiate flowers now number quite a dozen distributed in five more or less cosmopolitan genera, ranging through the entire Mesozoic, and antedating the angiosperms in the most suggestive manner as follows :

1.	<i>Anomozamites minor</i> ;	Microsporophylls 17 or 18.—	Trias.
2.	<i>Cycadella wyomingensis</i> ;	“ 13	—U. Jura.
3.	<i>Cycadeoidea dacotensis</i> ;	“ 18	—Wealden.
4.	“ <i>etrusca</i> ;	“ —	—L. Cretaceous (?)
5.	“ <i>ingens</i> ;	“ 13	—Wealden.
6.	“ <i>Jenneyana</i> ;	“ 10 or 11.	“ “
7.	“ <i>Paynei</i> ;	“ —	“ “
8.	“ <i>Reichenbachiana</i> ;	“ 16	— “
9.	“ <i>Superba</i> ;	“ —	— “
10.	“ (Species) ;	“ —	— “
11.	<i>Cycadocephalus Sewardi</i> ;	“ 17 or 18.—	Trias.
12.	<i>Williamsonia gigas</i> ;	“ 15 or 20.—	Jura.

ART. X.—Accelerated Cone Growth in *Pinus*; by G. R. WIELAND.

THE rare but suggestive instance of multiseriate production of ovulate cones in *Pinus rigida*, illustrated in the accompanying figure, has been recently brought to my notice by one of my colleagues.\* This conspicuous group of cones appears to have been derived from some New England source many years ago, having been found with a series of geological specimens collected or left in the Peabody Museum by Professor Benjamin Silliman and probably not examined since his day.

As appears in the figure, the individual cones, of which there are fifty-three in all, are nearly all of normal or approximately normal development and so regularly crowded together on their common axis as to simulate, taken *en masse*, some such single huge cone as that of *Pinus Coulteri*. It is clear enough, however, that the entire growth of cones is not in any complete sense an abnormality; for each cone must appear normally in the axil of a bract, just as do the several up to half a dozen cones in the usual ovulate clusters [or whorls], and exactly as in the case of the far more numerous cones of the corresponding staminate groups.

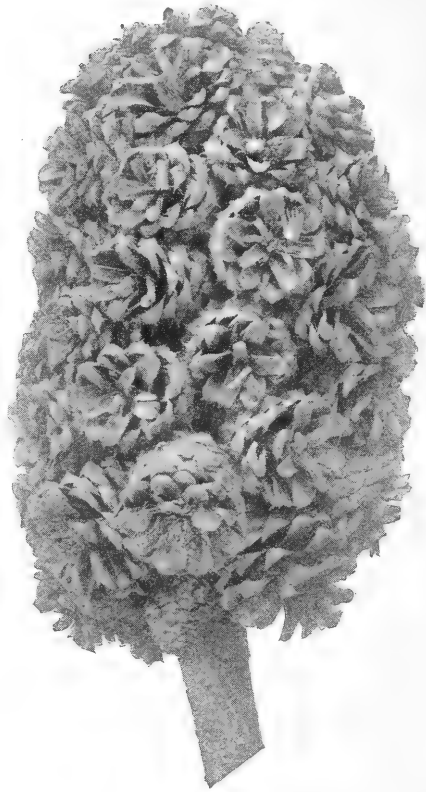

\* At the time this note was first written it seemed to me that its interest was somewhat lessened by the fact that after diligent search and inquiry I failed to learn of additional examples of clustered *Pinus* cones. Since then, however, I have seen three large and even finer clusters in the collections of the *Jardin des Plantes*, Paris. No label accompanied these specimens, which represent at least two more species of *Pinus* exhibiting accelerated cone growth.

Also, similarly to both ovulate and staminate cone-bearing axes, as well as to occasional single ovulate cones, the main or vegetative axis was prolonged; although, having been broken away, this feature does not appear in the figure. The present very unusual or even unique group of cones has therefore been produced in the simplest possible manner, namely, by increase in number and crowding to the extent of about a dozen of the ordinary ovulate clusters.

Moreover, it is from its very simplicity of origin that this fine example of accelerated proliferation appears to me to derive an instructive interest; for of late there have been accumulating various significant facts pointing toward a derivation of all existing spermatophytes from primitive ferns by way of pteridospermous types. Indeed, it now appears quite probable that the production of ferns may well have been Nature's fundamentally greatest achievement in vegetal evolution, and that following this great step, perhaps thoroughly accomplished in Silurian time, advance in reproductive structures was largely along lines of lesser resistance rather than by sheer forward movement. That is, broadly as well as theoretically speaking, the hiatus between monœcious fern prothalli and the seeds of pteridosperms and finally of gymnosperms and angiosperms; or, more definitely still, the hiatus between asexual fertile fern fronds, and the microsporophyll and carpellary leaf, the stamen and carpel, as seen in their thousand-and-one combinations in strobili flowers and inflorescences, was bridged not so much by the outright evolution of new organs as by more roundabout methods. Such, for instance, are, following the development of either generalized types or organs, extreme reductions, the secondary requisition of organs not originally evolved for the specific purpose or use finally assumed, and especially rearrangements or regroupings of fertile axes with sporophyll changes sequent to accelerated branching.

Now, if such conceptions of the descent of the higher types of existing plants from the ferns can in any sense approximate the truth, then the question as to the extent to which sporophyll reduction entered into the evolution of primitive types of cones from a main terminal strobilus like that of *Cycas* at once arises. And directly corollary to this inquiry there immediately comes up for discussion the further possibility of accelerated branching with marked increase in number of partially reduced fertile axes. Such, whenever assuming a more or less compacted order constituting in reality primitive types of inflorescences, would, if once coming to appear habitually, readily undergo still other subsequent mutations of form. For example, how else than by some such course of evolution as that here briefly suggested, has the male cone (inflorescence)

of *Welwitschia* arisen? It is certainly thinkable that an initial period of sporophyll reduction and accelerated branching in some ancient pteridospermous ancestor characterized by large bractlike leaves, could result in a *growth* of fertile axes in compacted groups more or less analogous to that before us, and that a secondary course of reductions may then have intervened and produced the condition we now see. In other words, we imagine that in the dioecious *Welwitschia* single flowers originally derived from fertile terminal buds of vegetative form have, following increase in number, undergone extreme reduction and modification into "cones," the ovulate forms of which have lost their microsporophylls. Furthermore, if each cone of a group more essentially like that illustrated were to be reduced so as to produce but a single seed, another interesting type of conoid inflorescence would be outlined; though such a form could scarcely be as capable of wide variation as a still more primitive series of spirally inserted multiovulate sporophylls.\*

It is thus of decided interest to have clearly brought home to us by such a simple form of accelerated branching as that of *Pinus*, the very interesting fact that by reason of new *emplacements* wholly new series of modifications in organs of reproduction may take place. These hypothetical *en masse* changes following the earlier evolutionary stages of primitive sporophylls pointedly suggest how the endless variety of angiospermous fructifications can have arisen from plant types not very remote from but still more primitive than the Cycadeoideæ; while contrariwise in races with few ovules to the carpel and little phytologic plasticity like the conifers, such realignments and modifications have in post-Triassic time seldom appeared or become habitual with a resultant displacement of the plastic stock by its better equipped descendants.

[April 25, 1906.]

\* The gymnosperm cone itself, both simple and compound, is throughout derived by branching from a primitive main axis. The sporophylls of both sexes are of course all derivatives of pteridospermous fronds; and dorsal, ventral, or lateral insertion of sporangia is of purely secondary import, since resulting in the simplest possible manner during the process of extreme reduction in which all circinnate prefloration was displaced by obscured conduplicate, or direct forms, with formation of various types of appression faces. Finally, in the Coniferales, sclerotization into regularly interlocking spirally inserted prismoids resulted in the nearly aplastic bracts and carpels, which have changed but little since the Jura. Appositely it is hypothesized that a diminution in the number of primitive sporophylls, followed only secondarily by spore decrease in number, would conserve the requirements of carpellary plasticity.

ART. XI.—*The Ainsworth Meteorite*; by EDWIN E. HOWELL.

THIS siderite, for which I propose the name of the town near which it was found, was purchased from Mr. J. C. Toliver. It was found last winter by one of Mr. W. G. Townsend's little boys, who called his father's attention to it as it lay partly buried in the sand beside a small creek in Brown Co., Nebraska, about six miles N.W. of Ainsworth. It measured approximately  $4\frac{1}{2} \times 6 \times 7$  in. and weighed  $23\frac{1}{2}$  lbs. (10.65 kilo.) with a specific gravity for the whole mass of 7.85. Two of the

1

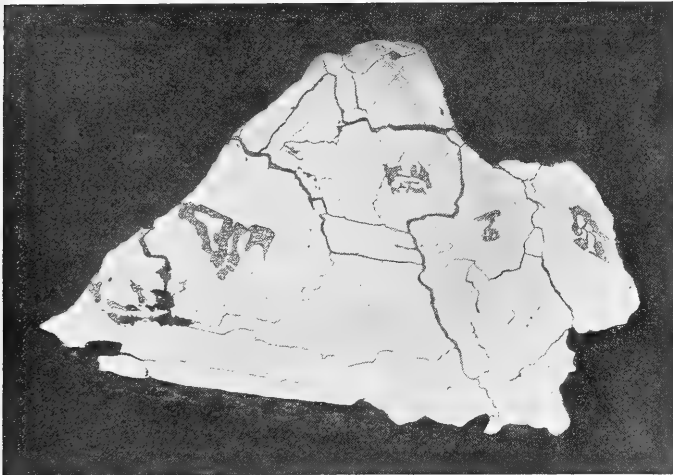

Section 1. The Ainsworth Meteorite, half nat. size.

projections on one side are flattened, as if by pounding, but closer examination shows fine striæ running evenly across both surfaces, which are in the same plane, suggesting that the meteorite in falling may have glanced on a rock—making a slickensided surface. The most noticeable feature, however, is the presence, in a number of places on the surface, of bright unaltered troilite and schreibersite. This fact, in connection with the general freshness of the mass, would indicate that the “fall” was a comparatively recent one. A fractured surface on one of the sharp corners, and adjoining flat side, shows where perhaps two lbs. had been broken from the mass antecedent to its burial, probably when it fell. The fractured

corner exhibits the coarse octahedral structure, while the fractured side has the appearance of columnar structure, and there seems to be considerable tendency to columnar fracturing at this particular part of the iron, columnar-like pieces breaking from the sections as they were cut. Eight sections have been cut all parallel to the first—the one figured. The principal veins and the mixed figures of troilite and schreibersite continue through them all; in addition, however, three typical nodules of troilite were encountered, which contrast strongly in color and form with those in which the schreibersite forms a prominent part. The sections etch very slowly; in time, however, lines appear which I did not hesitate to call Neumann lines until Mr. Tassin proved the iron to be an octahedrite, as was at first indicated by the fracture. These lines do not cross the veins referred to, and they are differently oriented in each of the blocks outlined by these veins, making the blocks appear as separate units. Mr. Tassin finds the structure of this iron to be unique, although in general appearance—especially in the irregular graphic segregations of schreibersite and troilite—it very closely resembles the São Julião, and in a less degree the Tombigbee River, and in some respects the Kendall County.

Mr. Wirt Tassin of the U. S. National Museum has devoted considerable time to the study of this iron and gives a summary of his results as follows:

ANALYSIS AND NOTES ON THE AINSWORTH METEORITE,  
BY WIRT TASSIN.

*Meteorite Iron from Ainsworth, Nebraska.*

The iron (fig. 1) here described is triangular in outline and shows a well-marked octahedral fracture on one edge, in fact the three edges of the section approximate three directions of an octahedron with the cut surface forming a fourth, giving the mass as a whole the appearance of a flattened octahedron. The surface as cut shows octahedral lamellæ of the largest size, so large that they are not at once apparent, as the specimen is not big enough to contain more than a few of them. Careful etching develops a surface having in places a mottled or dappled appearance. These mottlings when magnified under a vertical illumination show a definite octahedral structure and an etch figure (fig. 2) directly comparable with that of other octahedrites, and may be regarded as centers of crystallization, which though minute, possess a well-defined lamellar structure and usually show the three characteristic alloys. The accessory constituent, shown in the figure as rows of crystals in relief, is unknown but is here assumed to be nickel-free iron. Such a structure, a most coarse octahedrite containing very minute octahedrites, has never before been observed by the writer. Contained in the mass

as a whole are irregularly shaped segregations of troilite, in forms suggesting graphic characters. These troilite areas contain more or less carbon with grains of nickel-iron and phosphide of iron and they are commonly bounded with a thin wall of schreibersite. This compound also appears abundantly elsewhere on the surface, usually as bright points which under the microscope

2



Section magnified 1500 diameters.

appear to be cross-sections of the lath-like form known as rhabdite.

The surface is also marked by veins or fissures of varying widths, certain of which are parallel to the several directions of the octahedron and form octahedral partings. These veins are commonly bounded by schreibersite and are filled with a carbonaceous material containing phosphorus, sulphur and iron.

The material available for analysis gave the following values :

Iron .....	92.22
Nickel .....	6.49
Cobalt .....	0.42
Copper .....	0.01
Phosphorus .....	—0.28
Sulphur .....	0.07
Chromium .....	—0.01
Silicon .....	0.049
Carbon .....	0.09

ART. XII.—*Some High Level Terraces in Southeastern Ohio*;\*  
by GEORGE D. HUBBARD.

ABOUT thirty years ago Professor J. J. Stevenson† called attention to a considerable number of high level terraces or benches occurring in the upper Ohio river region, "almost absolutely level" and ranging in height from 1100 to 2580 feet above sea level. They were more widespread than the river terraces of outwash gravel, and consisted of rock benches well covered with mantle rock. The latter "contained little clay and no transported material but was mostly sand." Although always above all the outwash terraces, they descend nearly to the upper ones, but never merge with them. They seem to consist of a rock notch, and the removed material laid just below the notch. These high level terraces are recent, having been made since the latest warpings of the region, and being very well preserved.

Professor Stevenson explained that they are due to wave work on the valley walls and hillsides when the region was deeply submerged subsequent to the retreat of the ice sheet. The upper one was formed when the region was depressed nearly 2600 feet below the present level, admitting the sea into a complex, branching system of valleys; and the lower terraces developed at successive halts as the land slowly emerged from the sea.‡

These terraces have probably never been causally connected with the Cincinnati ice dam theory, but in 1890 Professor Chamberlin§ discussed them in connection with that theory, stating that the land on which the dam occurred is 440 feet above sea level and that the dam as described by other students, and as required to force the water over the cols to the southward, was probably 500–625 feet thick, placing its summit at 1000–1100 feet above sea level. He concludes that such an obstruction could scarcely make a series of terraces, ranging in altitude from 1100–2580 feet. He shows that some of the terraces are structural or gradational and perfectly related to the strata.||

In 1903 W. G. Tight¶ also discussed the high-level terraces especially from southeastern Ohio, and considers them to be

\* By permission of the Director of the Ohio Geological Survey. Read at the annual meeting of the Ohio State Academy of Sciences, November 30, 1907.

† This Journal (3), xv, p. 245, 1878.

‡ Ibid. 246-250: also Proc. Phil. Soc. xviii, pp. 302, 303, 1880; Penn. Geol. Surv., K<sub>3</sub>, pp. 251-263.

§ Introd. Bull. 58, U. S. G. S., p. 22 f.

|| Ibid. p. 38.

¶ U. S. G. S., Prof. Paper 13, p. 104.



wave-cut forms, and suggests lake conditions due "to obstructions to the drainage beyond the limits of the basin." He further states that they bear no relation to the ice dam of Wright. The author does not believe an ice dam was ever effective near Cincinnati nor that any of the phenomena up the valley require such a dam for explanation.

To sum up the previous literature on the subject. There have been described, slender, high-level horizontal terraces from the upper Ohio river region and from southeastern Ohio. They have been generally ascribed to wave work, but a few are due to structure and degradation or bear perfect relation to the strata. Sea invasion to an altitude of 2600 feet for those in the upper Ohio region, and lake conditions for the others, have been invoked to explain them. The ice dam theory has evidently been considered but has been discarded as insufficient.

During the past summer a number of examples of these neat, slender, hillside terraces have been seen and carefully examined. The following descriptions will suffice to show the character of the forms seen.

In Monroe county, southeast of Woodsfield about 12-13 miles, and northwest of Hannibal about five miles along a little branch of Opossum creek near Winkler's Mill, are three horizontal terraces on a rather steep slope near the summit of a hillside. Two little brooks run down over them and these have cut notches down into the terrace tops and terrace fronts. Careful examination of these cuts showed the whole terrace in each case to be of bed-rock with a thin cover of mantle rock. There is no possibility that these terraces are wave-cut unless the waste removed to make them has been entirely removed. They are due to the weathering of alternate hard and soft layers of the prevalent shaly sandstones of the Pennsylvanian formations.

In Washington county back of the village of Lowell two localities possessed terraces. In the first place the general survey of the conditions led to the conclusion that there was a single, horizontal rock-fronted terrace and a waste slope below, but a close examination disclosed the fact that a landslide was the cause of the terrace. A long horizontal strip of rock and waste had broken loose from the firmer bed-rock and had fallen a few feet. At the second place, the semblance of terraces, at a distance, was striking, but on going up among them there was absolutely no question but that they were caused by landslides. An acre or more slid down, crowding into the road and pushing a rail fence down. The vertical slip was probably three or four feet. Earth came down in blocks or sections, three larger ones and several minor ones, extending north and south horizontally along the valley wall. Cracks opened be-

tween the blocks, which gaped to a depth of from 3 to 6 feet and wide enough, in places, to receive a man. From below, the series looked extremely like wave-cut terraces, but from above they looked just as much like landslide forms. A number of other slides in the vicinity were old enough to have become wholly healed.

In Gallia county, near Gallipolis on the walls of a little brook leading into Raccoon creek, two terraces were seen. They rose slightly, southward as did the strata. Careful examination revealed the coincidence of one with a hard calcareous layer among softer shaly layers and of the other with a soft layer between two harder series of layers. Apparently there was in the latter case an accumulation of detritus as if the material taken out of the hillside to make the notch had been piled below to build up a terrace, but examination showed that the terrace, from below the notch, was of rock with a thin covering of residual rock waste. It became apparent that a soft layer among hard layers could so weather out as to leave a terrace below.

The author has seen a number of such terraces as these two types in central New York, notably in and around Newark Valley 15–20 miles northwest of Binghamton. In Gallia county, 6–8 miles from Gallipolis along the pike to Cora, one fine terrace was seen on two sides of a hill. It was horizontal on the south side and synclined on the east side and followed the same soft statum on both sides. This was throughout a slender rock terrace, with no mantle accumulation at all commensurate with the notch. About a mile down the Raccoon\* from Northup on the left side of the valley, at altitudes of 570–620 feet U. S. G. S., were found four terraces. The upper one was perfect, the second poor, and the two lower ones good. The upper one now shows rock along its crest instead of waste, and the steep slope back of it is also of rock. A little rill over the top and crest of the second shows rock all the way beneath a foot or less of waste, and similarly two rills across the front of the third reveal bed-rock, while one rill over the front of the lower one likewise discloses the rock in place. There has been some sliding in connection with the second terrace from the top. These beautiful slender forms at this point then are rock terraces in shales of varying hardness. They all extend along the hill side a hundred yards, and the third is more persistent—perhaps to 250 yards.

The valley of Raccoon creek was examined for seven miles, partly above and partly below Northup, and those described

\* This valley was visited in this connection because it is thought by Tilt to be one of the best localities to study the terrace. U. S. G. S. Prof. Paper 13, p. 89.

above are the best terraces seen. Others were noted, one or two in a place, at several points, but in every case except one they turned out to be rock terraces. In the one case, the terrace was due to landslide. It is not common for landsliding to give a form even resembling the neat terraces, but in at least three examples such was the case. There may be shoreline terraces in this valley, but the author failed during a careful search to find them. All the highland terraces seen are above the outwash, and are in the region of continuous Pennsylvanian rocks whose chief characteristic is their variableness as evidenced by their relative resistance to weathering.

In closing, I desire to call attention to a few facts which it may be well to bear in mind when further reviewing the problem of the high-level, slender terraces.

Terraces may often be due to wave work. As fine terraces as have ever been described have undoubtedly been developed by this physiographic process along shore lines.\* It has been stated by other observers, and I concur, that the terraces of the Ohio valley are commonly on the steeper slopes and along the smaller valleys. Wave-made terraces would be slow in forming on steep rock slopes, because there would be little rock mantle, and any material derived by wave action would, by the same agent, be easily scattered down the steep, submerged slopes, without forming terraces. The walls of smaller (narrower) valleys would be among the least propitious places for wave terraces to develop because the waves would here be weakest. On the other hand, gentler slopes, soil covered and lying along the larger valleys, would be very proper places for wave-cut terraces; but under such conditions terraces rarely occur. Further, their preservation in such places would be easier because erosion is less active on gentle slopes.

Granting that terraces, due to wave action, have been formed along the walls of partly submerged valleys, other related features should also have been formed. Deltas, at bay heads, or along the sides of the larger bodies of water where streams entered, should be common. Not one has ever been reported. Probably some streams were too short to construct deltas, but many were not. Lake clays and sands should have been deposited, especially near where the smaller streams entered the drowned valleys. They also have never been reported. In Central New York† in the finger lake region deltas occur in profusion and associated lake clays occur to depths of 10–15 feet down slope from many delta series. But only in rare instances are cliffs or wave-cut terraces found. They have

\* U. S. G. S., Monographs I and XI.

† Watson, T. L., N. Y. State Mus., 51st Ann. Rpt., vol. i, pp. 165–117, 1899; and several other authors.

been recognized at a few points, but, as a rule, no trace of them can be found at the levels of the deltas. If there has been time enough for shoreline cliffs and terraces in the Ohio valley why not time for deltas, clays, etc.? In New York, there was plenty of time during the higher stands of the lakes for a splendid development of deltas and lake clays, but rarely any beach terraces or cliffs can be found.

It is also rather remarkable, if the terraces of the Ohio valley are due to wave work, that they only occur along the smaller valleys and never along the larger valleys where the opportunity for strong wave work was best. If the few that do occur are mainly due to differential weathering, it is not to be expected that they should occur in the main valleys but rather back in the smaller ones, where the opportunity for long continued preservation of differential weathering is best.

Ohio State University,  
Columbus, O.

ART. XIII.—*On the Triassic Reptile, Hallopus Victor* Marsh;  
by F. R. VON HUENE, Tübingen, Germany, and R. S. LULL,  
New Haven, Conn.

A REEXAMINATION of the type specimen of *Hallopus*, preserved in the Peabody Museum at Yale, has brought forth some interesting new facts. We are giving here a short preliminary description and intend later to write a fully illustrated, detailed treatise in which *Hallopus* will be compared with other reptiles and its true relationships investigated.

Following Williston,\* the *Hallopus* beds at Garden Park, near Laramie City, Wyoming, supposed by Marsh to be Jurassic, are Upper Triassic. The type specimen is contained in two slabs of red sandstone fitting together and, while fairly well preserved, in some instances only the impression of the bone upon the matrix remains, adding to the difficulty of an exact interpretation.

*Vertebræ.*—There is one doubtful cervical vertebra, a doubtful broad and low neural spine of a dorsal vertebra, two sacrals and four anterior caudals, the latter still in connection with each other.

The sacrals show their upper surface in the smaller slab, but the greater part of the upper arches is missing. They are coössified, slightly elongated and possess strong sacral ribs, the second one being much stronger than the first. The direction of the first sacral rib is a little forward and that of the second more backward, the latter being longer than the former. The ventral part of the second sacral rib expands towards the first sacral rib so that they come in connection.

Length of both sacral vertebræ together .....	20 <sup>mm</sup>
Their width where they are coössified .....	6
Length of the right first sacral rib from the median line of the neural canal .....	11.5
Length of the left second sacral rib from the median line of the neural canal .....	16
Width of the first sacral rib at its narrowest place in the middle.....	4.5
Width of the second sacral rib at its narrowest place in the middle .....	7.5
From the anterior edge of distal extremity of the first to the posterior edge of distal extremity of the second sacral rib .....	30

The caudal centra are not constricted in the middle and only little longer than high. The neural spines are broad and bent backward; the zygapophyses are fairly large.

\* Williston, 1905.

Length of caudal centra .....	7 <sup>mm</sup>
Height of caudal centra .....	5
From centro-neural suture to top of neural spine (in the 3rd of these vertebræ) .....	10

*Ribs and Hæmapophyses.*—There are several dorsal ribs; one of them shows the proximal extremity with two widely separated heads, as in the Dinosauria. The longest rib lying in the rock near the scapula and tibia is 33<sup>mm</sup> in length without proximal end. One hæmapophysis, or chevron bone, lies below the preserved caudal vertebra; it is marked by length and slenderness. The opening is very long; both branches are connected by a clasp.

Length (probably not complete) of hæmapophysis,	32 <sup>mm</sup>
Width at articular face (only half of it preserved)	6
Width of the foramen .....	3
Length of the foramen .....	9
Thickness of the distal end of hæmapophysis ...	1·2

*Scapula.*—An isolated and peculiar-shaped scapula lies beneath the complete hind leg. We think it is quite complete and resembles most nearly that of *Erpetosuchus*. The extremity having a halfmoon-like depression, taken by Marsh as the articular cavity (glenoid fossa), we consider the distal end. At the other end of the bone is a narrow and thin but high process which we take as *processus deltoideus scapulæ*. It is very similar to that of *Erpetosuchus*. At the other edge of the same extremity is the articular face. Here and at the distal extremity the bone is thicker than in other places. What Marsh took for the articular end we think cannot be that, because there would be no space for the articulation with the coracoid.

Length of scapula from <i>processus deltoideus</i> to upper corner of distal end .....	28 <sup>mm</sup>
Length of scapula from articular face to lower corner of distal end .....	24
Width from articular face to <i>processus deltoideus</i> ,	12
Width at distal end .....	10·5
Width at narrowest place .....	4·5

*Humerus.*—In one corner of the larger slab is an impression which Marsh took for that of the humerus. He is possibly right, but it could also be the impression of the distal end of the second pubis.

*Radius, Ulna and Manus.*—The forearm with the manus of one side is still nearly in connection, lying beside the crushed tibia. The ulna is thicker than the radius, the latter being very thin.

Length of radius, .....	28 <sup>mm</sup>
Length of ulna, .....	29

*Ilium*.—Both ilia are preserved, one of them showing the inner, the other the outer surface. They are a little different from Marsh's figure, because he omitted the very sharp anterior edge of the *spina anterior*. Both ilia taken together complete each other, because in one of them the anterior and in the

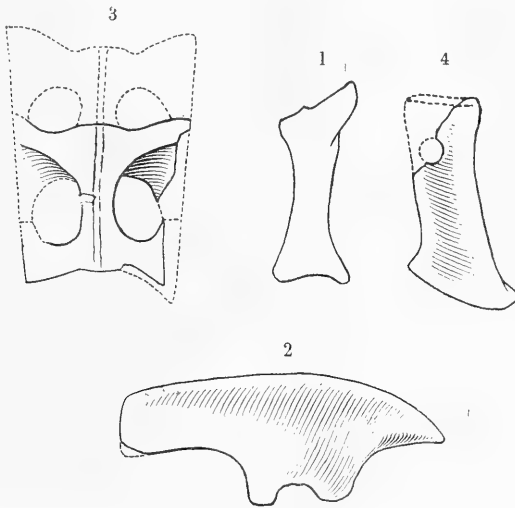

FIG. 1. (?left) *Scapula*, natural size. The articular end is the upper one in the figure with the *processus deltoideus* at the right upper corner.

FIG. 2. *Ilium*, natural size. The *spina anterior* is at the right side of the figure. The outlines are a combination of both ilia. The acetabulum was probably nearly or quite closed.

FIG. 3. *Sacrum*, seen from above. Natural size. The first sacral vertebra is at the top of the figure. The dotted lines are reconstructed exactly the same size as fig. 2 (ileum) to show that there must have been three sacral vertebrae. Drawn from the small slab.

FIG. 4. Right *pubis*, natural size. Partly reconstructed (dotted line).

other the posterior part is missing. The *processes pro-* and *post-acetabularis* are short and directed downward. The ilium extends very far back and nearly as far forward.

Length of (restored) ilium .....	45 <sup>mm</sup>
Height of <i>processus post-acetabularis</i> .....	12
Width of acetabulum .....	7

Marsh thought the two sacral vertebrae were the complete sacrum, but upon comparing the measurements with those of the ilium we find that there were, necessarily, three sacrals. Our reconstruction of the sacrum is given in fig. 3.

*Pubis and Ischium*.—There is one broad and two long and slender bones belonging to the pelvis. Marsh took the former for the ischium and the rod-like bones for pubic bones. We

cannot imagine that what Marsh took for the ischium can really be that bone. It is too long for a plate-like ischium, and a distally expanded ischium together with rod-like pubes would be too peculiar and without parallel among other reptiles. Therefore we take the two rod-like but proximally expanded bones as ischia and the broad bone as the pubis with complete distal but imperfect proximal extremity. The distal end of the pubis is obliquely broadened and thicker than the other parts of the bone. The proximal end is broken off in an oblique line through the middle of the obturator foramen.

Length of pubis .....	32 <sup>mm</sup>
Width in the middle .....	11
Length of distal border .....	16

The ischium is very slender and of oval section; near the proximal end it becomes a little broader and in the last (proximal) 10<sup>mm</sup> it is curved and slightly expanded. Both ischium and pubis are hollow.

Length of ischium .....	49 <sup>mm</sup>
Its diameter at distal end .....	3
Its diameter near proximal end .....	4
Its diameter at proximal end .....	7

*Femur.*—The right femur is a strongly built but quite hollow bone, curved in the upper third. The proximal extremity is broken off, but it still shows the beginning of the high *trochanter major*. The *trochanter quartus* is not visible. In the smaller slab the bone shows its posterior, in the greater its anterior aspect. The condyles at the distal end (the end Marsh figured as the proximal one) are small.

Length of femur .....	71 <sup>mm</sup>
Diameter in the middle .....	7-8
Longest diameter at the proximal end .....	12·5

*Tibia.*—Both tibiae are preserved. In the left one the proximal end is missing, the right one is complete and still in connection with the other bones, but lying beside the right femur. It is very slender and quite as hollow as the femur. The proximal end is anteriorly thickened and the articular face is prominent backwards. The distal end is broadened and flattened in a transverse direction.

Length of tibia .....	97 <sup>mm</sup>
Supero-posterior diameter at proximal end .....	12
Diameter in the middle .....	7
Antero-posterior diameter at distal end .....	4·5
Transverse diameter at distal end .....	9-10

*Fibula.*—There is only the distal (following Marsh it would be proximal) part of the left fibula lying beside the left crushed tibia. It is very thin and the distal end only is a little enlarged. The preserved length of it is 65<sup>mm</sup>.



Diameter 33<sup>mm</sup> above the distal end..... 2<sup>mm</sup>  
 Diameter at the distal end..... 5·5

*Tarsus*.—In the right foot the astragalus, calcaneum and cuboid still remain.

The *astragalus* is a very thick bone, rounded beneath. It is

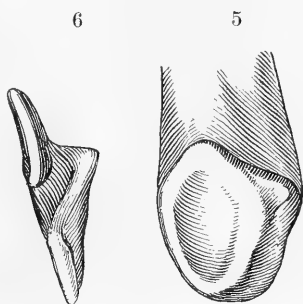

FIG. 5. Left *astragalus* in its natural connection with the tibia. Twice natural size. Seen obliquely from lateral side and behind.

FIG. 6. Left *calcaneum*, twice natural size. Seen from above. The lower edge of the figure is the *tuber calcanei* and the long straight border is the lateral one.

as broad as the distal end of the tibia and it has a short and thin ascending process at the posterior corner of the lateral border. Below that process the surface of the astragalus is concave for the articulation with the fibula and calcaneum.

Transverse diameter of astragalus..... 9<sup>mm</sup>  
 Supero-posterior diameter of astragalus..... 4  
 Height with ascending process..... 10  
 Height without ascending process (medial border) 6·5

The *calcaneum* is a very large but strongly compressed bone. Except for the compression it is like the same bone in crocodiles, but with a large tuber. It is not preserved in the natural position, but turned downwards with the metatarsus.

Greatest length of calcaneum..... 15<sup>mm</sup>  
 Its thickness near astragalus..... 4·5  
 Its thickness at the tuber..... 1·5

The *cuboid* is only recognizable by its position on the top of metatarsal IV. It is a thick, cushion-like bone rounded beneath, 6<sup>mm</sup> broad and 3·5<sup>mm</sup> thick, laterally with a face for metatarsal V.

*Metatarsus*.—The foot had five toes but the first is not preserved. The fifth is vestigial and short, but the others are extremely long and slender. In the right foot there are in position, metatarsal II, III (better seen on the small slab) proximal end of IV, and V (only in the great slab). There lies also,

near the good dorsal rib, the other (left) metatarsal III and, near the ischia, the left fourth metatarsal with fragments of phalanges. Metatarsal II and III are straight, while metatarsal IV is a little curved near the proximal extremity. The second one is the broadest and the third the longest. Metatarsal IV is probably only little shorter than metatarsal II. Very short, but broad at the proximal end, is metatarsal V.

All of the metatarsals are hollow.

Length of metatarsal II .....	41 <sup>mm</sup>
Length of metatarsal III .....	48
Length of left metatarsal IV (preserved portion) 30 (incomplete at proximal end)	
Length of metatarsal V .....	15
Breadth of proximal end of metatarsal V .....	6

One of the *phalanges* of the left fourth digit seems to be 7<sup>mm</sup> long and about 2<sup>mm</sup> broad. The other remains of phalanges are too fragmentary to be measured.

In addition to the described bones and impressions there are still a few impressions which we are not yet able to determine.

#### *Conclusions.*

Marsh placed *Hallopus* among the theropodous Dinosauria. The pelvic bones, as Marsh determined them, are quite different from all Theropoda and other Dinosaurs. Following our interpretation of the ischium and pubis, the pelvis is more dinosaurian. The long and slender *spina anterior ilai* is impossible for a theropodous dinosaur, and resembles nearly that of the Orthopoda. But there are some other facts which would be very striking even for the Orthopoda: the pubis, the calcaneum, the extreme thickness of the astralagus, the form of the scapula, also the surprisingly high ilium, are different from those of the Orthopoda. We find *Hallopus* more naturally placed with *Scleromorphus*,\* *Ornithosuchus*, *Erpetosuchus* and *Aëtosaurus*. These systematic and phylogenetic views we shall present in detail in our forthcoming memoir.

#### *Bibliography.*

- Marsh, 1877, this Journal, xiv, p. 255.  
 " 1881, " " xxi, p. 422-423.  
 " 1882, " " xxiii, p. 85, 86.†  
 " 1890, " " xxxix, p. 415-417, 1 fig.‡  
 " 1895, The Dinosaurs of North America, p. 153-155,  
 1 fig. p. 233, 240, 241, pl. vi.§  
 Willistón, 1905, Jour. of Geol., xiii, p. 338-341.§

\*The senior author has been able to study all these type specimens and has found some new evidence.

†As distinct order, doubtful if dinosaurian or not.

‡As theropod.

§As Triassic, recognized for the first time.

ART. XIV.—*Notable Case of a Species of Grapsoid Crustacean apparently in actual process of Evolution*;\* by  
A. E. VERRILL.

[Brief Contributions to Zoology from the Museum of Yale University—lxviii.]

WHILE collecting crustacea, etc., in Bermuda during the spring of 1901, I was particularly interested in a grapsoid crab of the genus *Sesarma*, which has acquired terrestrial habits in a remarkable degree, as compared with the most nearly allied form (*S. Ricordi*), which lives on the adjacent shores, at about high-tide level.

The large genus *Sesarma* is distributed all around the world in the warmer latitudes. There are about twenty American species. All the species have a broad network of hairs on the external under surface of the branchial areas, for the purpose of purifying and aërating the water used in the branchial cavity to keep the gills moist. The length of time that they can remain away from a supply of water largely depends, therefore, on the size of the branchial cavities and the extent of the external aërating areas. Many species never live away from the sea shore. Some, like the *S. reticulatus* of the Atlantic coast, from Connecticut to Florida, live in holes in wet salt marshes, associated with "fiddler-crabs," their holes descending to permanent water level. Others, like *S. cinerea* of the Carolina coasts, live just above high-tide level, hiding under stones, driftwood, lumber, etc. Several species in the tropics live among the tangled roots of mangroves, in the swamps, mostly just above high-water level, but within easy reach of water. Some species, like *S. Roberti*, of the Antilles, have acquired more arboreal habits and climb into the upper branches of trees, often going far away from water, especially in those islands having abundant rains.†

The common species in Bermuda (*S. Ricordi*) lives ordinarily at and just above high-tide level, within easy reach of water. It is often seen running actively about among the stones and dead seaweeds, usually associated with *Pachygrapsus transversus*. It may almost always be found under masses of *Sargassum* cast up on the shores, as well as under stones.

\* Abstract of a paper read before the American Society of Naturalists, Dec. 27, 1907. For illustration see Trans. Conn. Acad., vol. xiiij, plate x, fig. 3.

† My son, Mr. A. H. Verrill, who collected this species in Dominica Island, states that while riding along the roads he often took it from the overhanging branches of trees; others were taken from the branches of fruit trees. This species has a very large branchial chamber.

Its range extends from Florida through the West Indies to Trinidad.

The new form seems to be a subspecies or a variety of *S. Ricordi*, which may be actually in process of development into a genuine species, by natural selection and physiological isolation.

It was found living under stones in dry upland fields and nearly barren waste lands with thin soil, where the scanty vegetation consisted of wiry grasses and dwarfed shrubs and weeds. It was associated with a few species of ants, beetles, cockroaches, spiders, land-shells, etc. When the stones were turned over it usually ran away very actively and sought shelter under other stones, but did not seek the water, as most species do. Its general appearance was very unlike *S. Ricordi*. It usually had a sordid dirty color, due largely to adherent particles of soil. It may be described as follows:

*Sesarma Ricordi*, var. *terrestris*, subspecies or var. nov.

The carapace appears more rough and uneven than in the ordinary form, for it is more strongly areolated and the branchial areas are more swollen, so that the vertical thickness is greater and the reticulated areas of the sides are broader, giving a larger surface for aëration of the water, and indicating larger gill cavities and gills. The dorsal surface of the carapace is covered with more numerous and larger granules, bearing numerous short dark hairs, very evident under a lens of low power, and capable of holding adherent dirt; the plicæ on the postero-lateral sides are stronger and more granulous; the lateral marginal edges are more sinuous anteriorly, owing to the more swollen branchial chambers. The anterior frontal margin is less sinuous, the median indentation often being obsolete or faint.

The ambulatory legs are distinctly larger and longer than in the common form. When the legs are folded the tooth on the distal angle of the merus joint of the legs of the third and fourth pairs reaches considerably (2–3<sup>mm</sup>) beyond the outer orbital angle, while in *Ricordi* it just reaches it, or only slightly exceeds it (·5<sup>mm</sup> or less). The proportion of the merus joints of these legs to the breadth of the carapace is 1:1·36. In *Ricordi*, 1:1·5. Ratio of same to length of carapace, 1:1·2. In *Ricordi*, 1:1·4.

The colors, when living, appear dull or sordid yellowish brown, or mud-color, due partly to adherent dirt, often specked or mottled with red or reddish brown. Fresh specimens cleaned in alcohol were variegated with pale bluish gray, dark brownish gray, and blackish, with some red and yellowish

white; an irregular pale band, specked with dark gray, extends from eye to eye. Legs above variegated with similar colors, but paler, the dark brown color mostly in irregular transverse bands. Chelæ whitish or pale yellow; legs bluish white beneath. The colors are evidently imitative of the surroundings and probably protective.

*Measurements of Bermuda Specimens.*

Number	Sex	Carapace length	Carapace breadth	Front breadth	Chelæ length	Chelæ breadth
3148a	♂	18.0	20.0	11.0	15	8.5
3148b	♂	16.0	17.0	9.0	12	7.0
3148c	♀	17.5	18.5	9.7	10	5.5
d	♀	17.0	19.0	11.0	10	5.5
e	♂	13.5	15.5	8.0	10	7.0

Although there are several distinctive characters, as shown above, it agrees so well in most other respects with *S. Ricordi*, that it does not seem to have become of actual specific rank. We found no intermediate specimens, but it is possible that a more extended search might reveal such. None were found with eggs. It is probable that its breeding season is in mid-summer.

It is not improbable that it has the habit of eating different food from its parent species, and also a somewhat different breeding season, so that the two forms may no longer interbreed. This could not be determined at the season of the year when we were in Bermuda.

It is also possible that it has acquired a somewhat different larval life, for in some other genera of grapsoid crabs (e. g. *Pinnixia*) the species differ widely in their metamorphoses.

No doubt it goes into the sea at the breeding season, and the young probably pass through zoëa and megalops stages, as in allied species, but these stages may be abbreviated.

The young crabs, moulting from the megalops at the shore, have evidently inherited the instinct to seek the higher and drier localities, where they probably have fewer enemies. The modifications that have taken place are in accordance with the change in habitat. The increased hairiness of the carapace and legs serves to retain the dirt that aids materially in their concealment when exposed. Probably they feed mostly at night. The larger gill capacity and longer legs have evident advantages.

That it is not a casual or transitory variation is evident from the fact that there are, in the Museum of Yale University, several good characteristic adult specimens sent to us before

1866 (perhaps collected as early as 1855), by J. Matthew Jones, Esq., who resided in Bermuda for many years, during the colder seasons, and whose first book on Bermuda was published in 1859.

It is certain that all the more terrestrial and arboreal species of this genus must have been derived originally from aquatic species, much in the same way that this form has been developed. Several of those now regarded as distinct species on the American mainland and in the West Indies may even have descended from *S. Ricordi* or some very similar species. Thus *S. cinerea* of our southern coasts is very closely related to *S. Ricordi*, with which it has often been confounded and from which it cannot always be distinguished, unless by experts.

ART. XV.—*Tourmaline of Crown Point, N. Y.*; by WM. P. BLAKE.

THE tourmaline of Crown Point, Essex County, N. Y., is interesting by reason of its peculiar occurrence, association, gem-like characters, color, and crystallization. It occurs in the midst of the concretionary and investing form of phosphate of lime described by Dr. E. Emmons as eupyrochroite. The locality, about a mile south of the Crown Point village, was worked in the year 1852 to obtain the phosphate for the manufacture of fertilizers but was soon abandoned.

The material thrown out yielded many fragments of tourmaline, light clove-brown in color, transparent and valuable as gems. Fragments having terminal planes have recently been submitted by me to Mr. John Marcus Blake of New Haven for crystallographic study. He has drawn the accompanying figure representing the antilogous terminal. In the number and relative size of the planes this closely resembles the figure from Rose of the antilogous pole of a crystal from Gouverneur, N. Y.,\* but the cross-section of the prism of the Crown Point crystals is hexagonal rather than triangular, and in this respect resembles the figure of the crystal from Hunterstown, C. E.†

Mr. Blake writes :

“Rose’s specimen from Gouverneur had a greater development of the prismatic planes *m*, which gives a triangular appearance to the prismatic section, whereas these Crown Point specimens show an almost complete suppression of these *m* planes, while the complementary *m* planes which come opposite the plane *o*, on the antilogous pole, are here moderately developed, while they do not show at all in Rose’s drawing. These latter *m* planes are, however, shown on drawings of crystals from Gouverneur, N. Y., figs. 8, 9, 10, Dana’s Mineralogy drawn by Farrington. Here, also, the *m* planes first named are shown large, as in Rose’s drawing.

The hexagonal section of the Crown Point specimens is caused by the large development of the *a* planes. These

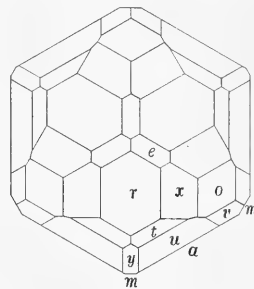

\* Dana’s Mineralogy (E. S. Dana), 6th edit., p. 552, fig. 11.

† Ibid., 5th edit., p. 366, fig. 336.

planes are bright and flat and the meeting of these six planes gives, as a rule, sharp intersections, the *m* planes being represented by reflections from striæ where they were found at all. On the contrary, the complementary *m* planes show in two instances as bright well-defined planes. The large development of *o* and *u*, in figs. 8, 9, and 10 by Farrington, are represented on one fragment of the Crown Point material, but were attributed to accident of growth, and were taken as exceptional in view of their smaller development on the other specimens."



ART. XVI.—*Occurrence of the Silurian Fauna in Western America*; by EDWARD M. KINDLE.

*Introduction.*—Several references to Silurian strata in the Rocky Mountain region occur in the earlier papers relating to Western geology. Dana's Manual, fourth edition, while discrediting the authenticity of some of these,\* records the occurrence of Niagara strata in the Black Hills region on the authority of the late Prof. C. E. Beecher.† Afterwards Professor Beecher‡ became convinced that the supposed Silurian of the Black Hills was of Ordovician age. In recent years most geologists who have had occasion to discuss the distribution of the Silurian fauna have expressed doubt or disbelief in the occurrence of Silurian strata in the western part of the continent. The general attitude toward the early determination of the Silurian in the West is indicated in Chamberlin and Salisbury's statement that "like the older formations of the Silurian, the Niagara has not been identified with certainty in the western part of the continent."§ Weller has stated "that the greater part of this region (west of the Mississippi) was above sea level during Silurian time."|| The rather common disbelief in the authenticity of the recorded occurrences of the Silurian in the West has arisen largely through the fact that the occurrence of *Halysites catenulatus* constitutes the chief or only evidence for the presence of the Silurian fauna in many cases in the West. This fossil, which formerly was supposed to be diagnostic of the Silurian, is now known to be common to both the Silurian and Ordovician faunas; consequently, as pointed out by Beecher, "the discovery of *Halysites* in the Wasatch range by Hayden; in the Wind River mountains by Comstock; in Nevada by Hague; and in the Teton range by Brady, does not necessarily imply the presence of Niagara strata at these localities."¶

In view of the prevailing skepticism regarding the presence of Silurian strata in the western part of the continent, it seems desirable to present briefly the evidence of its occurrence there, which has come under the writer's observation during the last three field seasons. Silurian faunas have been recognized in the West independently of the long-ranging *Halysites*, by the writer. Decisive evidence of the occurrence of Silurian faunas has been obtained in three widely separated regions.

\* Page 541.

† *Ibid.*, p. 543.

‡ *Am. Geol.*, vol. xviii, p. 33, 1896.

§ Chamberlin, T. C., and Salisbury, R. D., *Geology*, vol. ii, Chicago, p. 384, 1905.

|| *Jour. Geol.*, vol. vi, p. 696, 1898.

¶ *Am. Geol.*, vol. xviii, p. 32, 1896.

They have been found in northeastern Alaska, in southeastern Alaska, and in northern Utah.

*Alaskan fauna.*—Just within the Arctic circle in eastern Alaska, in the Lower Ramparts of the Porcupine River, the writer has collected a fauna of distinctly Middle Silurian age and closely allied to the Niagaran fauna of the eastern United States. A partial list of this fauna follows.

*Silurian fossils from the Lower Ramparts, Porcupine River, Alaska.*

<i>Lichenaria</i> cf. <i>concentrica</i> Hall	<i>Atrypa reticularis</i> (Linn.)
<i>Favosites</i> cf. <i>favosus</i> Goldf.	<i>Atrypa</i> cf. <i>calvini</i> Nettleroth.
<i>Columnaria</i> sp.	<i>Leptaena rhomboidalis</i> (Wilek-ens)
<i>Alveolites</i> sp.	<i>Leptaena</i> cf. <i>quinquecostata</i> McCoy
<i>Diphyphyllum</i> sp.	<i>Leptaena</i> n. sp.
<i>Zaphrentis</i> ? sp.	<i>Nucleospira pisiformis</i> Hall
<i>Camarotoechia</i> cf. <i>borealis</i> (Schl.)	<i>Dalmanella</i> cf. <i>elegantula</i> (Dalman)
<i>Rhynchotretra cuneata</i> Dalm.	<i>Streptis greyi</i> Davidson
<i>Camarotoechia</i> sp.	<i>Barrandella linguifera</i> Sow.
<i>Camarotoechia neglecta</i> Hall	<i>Spirifer nobilis</i> Barr
<i>Stricklandinia</i> sp.	<i>Strophostylus</i> sp.
<i>Meristella</i> ? cf. <i>subundata</i> McCoy	<i>Cypricardinia arata</i> Hall
<i>Meristina nitida</i> Hall	<i>Cypricardinia</i> n. sp.
<i>Meristina</i> sp.	<i>Illænus armatus</i> Hall
<i>Atrypina</i> , n. sp.	<i>Sphærexochus</i> cf. <i>romingeri</i> Hall
<i>Reticularia</i> cf. <i>proxima</i> Kindle	<i>Encrinurus</i> sp.
<i>Anastrophia</i> cf. <i>brevirostris</i> (Sow.?) Hall	<i>Prætus</i> sp.
<i>Pentamerus oblongus</i> (Sow.)	
<i>Stropheodontu</i> sp.	
<i>Strophonella</i> cf. <i>macra</i> M. & W.	

The Porcupine River fauna contains species which link it with the Silurian faunas of both Europe and America. Of these *Rhynchotretra cuneata*, *Spirifer nobilis*, and *Pentamerus oblongus* have long been known in both European and American faunas. The peculiar little twisted brachiopod *Streptis greyi* has been recognized at but one other American locality, however. Williams\* has reported it from the St. Clair limestone fauna of Arkansas. In Europe it occurs in the Silurian of Bohemia, in England, and at the island of Gotland.

The Silurian fauna of the type represented by the species listed here is known to have a wide distribution throughout the world. It is well known in various parts of Europe and has been recognized in regions as remote as China,† New Zea-

\* This Journal, vol. xiviii, p. 331, 1894.

† Richthofen, F. von, China, vol. iv, pp. 34-74; Mem. de la Soc. Roy. des Sci. de Liege, 2d ser., vol. vi, 1876.

land,\* and Australia.† This fauna occurs in a magnesian limestone of considerable thickness—probably 2,000 feet. It is preceded in the section by Ordovician limestones containing *Maclureas*. It is followed by a somewhat later phase of the Silurian and by the Devonian.

Another but smaller Silurian fauna has been found in south-eastern Alaska, on Kuiu Island, nearly a thousand miles south-east of the Porcupine River locality. It contains :

- Diphyphyllum?* sp.
- Conchidium knighti* (Sow.)
- Whitfieldella* sp.
- Holopea* cf. *servius* Barr.
- Murchisonia* sp.

None of the species is abundant, with the exception of *C. knighti*, which is represented by great numbers of large shells.

*C. knighti* is one of the characteristic fossils of the Aymestry limestone of the Ludlow group of England. It is known also from Russia and Bohemia. There appears to be no authentic records of its occurrence in the Silurian faunas of the United States. The nearest equivalent of this fauna in eastern America is the Niagara fauna. While none of the species collected are identical with Niagara species, *Conchidium knighti* is very closely related to *C. nysius* of the Niagara fauna.

The Kuiu Island fauna occurs in the midst of a limestone series which appears to be 2,000 feet or more in thickness. Other portions of the series which were examined appeared to be barren. Upward these limestones seem to terminate with volcanic breccias, while below they pass into cherts and argillites of undetermined age.

*Utah fauna.*—The third locality to which attention is invited is in the Wasatch Mountains, in northeastern Utah.‡ In Green Canyon, east of Cache Valley, the following fauna was obtained :

- Favosites gothlandica* Lamarck
- Favosites* cf. *niagarensis* Hall
- Halysites catenularia* Linn.
- Zaphrentis* sp.
- Pentamerus oblongus* Sow.

This fauna, though containing a small number of species, is represented by a great number of individuals. *Pentamerus oblongus* is the most abundant species. The presence of this

\* Quart. Jour. Geol. Soc. London, vol. xli, p. 199, 1885.

† Mem. Geol. Surv. N. S. Wales, Pal., No. 6, 1898.

‡ The writer is indebted to Mr. F. B. Weeks for information regarding the location of sections in this region.

brachiopod, which is one of the most common and widely distributed Silurian species in the Eastern States, places the Silurian age of this fauna beyond question.

This fauna occurs in a light-colored magnesian limestone in which local developments of siliceous or quartzitic lenses occur. The fossils were obtained from one of these siliceous beds. The same fauna was seen in Logan Canyon, 12 miles to the north of the locality from which the collection was made. The magnesian limestone formation holding this fauna has a thickness of from 200 to 300 feet. Below the Silurian limestone is a limestone of much darker color and of undetermined age. Above the Silurian limestone lies a series of dark magnesian limestones 800 to 1000 feet thick, carrying a Devonian fauna. A band of thin-bedded or laminated limestone in which no fossils have been found separates the dark magnesian limestones from the Silurian beds in some of the sections, while in others it is absent.

The three localities which have been cited are widely separated from one another, but it is most probable that numerous other occurrences of the Silurian fauna will be found in the intervening areas.\* The absence of the Silurian from many of the carefully studied sections in the Front Range region of the Rockies would seem to justify the prevailing view that a land area occupied that region in Silurian times. What the extent of that area may have been it is hardly profitable to guess with our present knowledge. That it occupied much of the present area of Colorado is most probable. It seems to have been bordered by a Silurian sea on the west and southwest.

The occurrence of a Silurian fauna in northern Alaska has a direct bearing on one of the interesting problems of Silurian paleogeography, the route of intermigration between the Silurian faunas of Europe and America. The composition of the Porcupine River fauna indicates quite clearly that it represents the general Silurian fauna of Europe and the interior of America.

Professor Weller has attempted to point out the path of migration by which the cosmopolitan Middle Silurian fauna reached eastern America from northern Europe, where it is so well developed. The hypothetical western shore line of the Silurian sea as drawn by Weller runs northward of Arkansas, slightly to the west of the Mississippi in the United States,

\* Diller has found a Silurian fauna in California (Bull. Geol. Soc. Am., vol. iii, p. 376, 1892, and Bull. U. S. Geol. Survey No. 323, 1907). In New Mexico Gordon and Graton have reported Silurian rocks at Silver City (this Journal (4), vol. xxi, p. 394, 1906). Richardson reports the same fauna at El Paso, Tex. (Univ. Texas Min. Surv., Bull. No. 9, p. 31, 1904).

and well to the eastward of the McKenzie River in British America. The conclusion reached by Weller is that the route of migration between Europe and America was northeastward, by way of Hudson Bay, northern Greenland, and Spitzbergen to northern Europe. The presence of a Silurian fauna in northern Alaska necessitates the consideration of an alternative hypothesis. The occurrence there of a Niagaran fauna requires the shifting of Weller's hypothetical western boundary of the Silurian sea at least a thousand miles to the westward in the northern third of the continent. It gives much weight to the northwestern route as the probable path followed by Silurian faunas in traversing the area between Europe and America. Between the Silurian faunas of northern Russia and northeastern Alaska there intervene the nearly continuous land masses of Siberia and western Alaska. That the present shallow marine conditions of the continuous continental shelf were represented by somewhat similar conditions across northeastern Asia during the Silurian is suggested by the presence of Ordovician strata in western Alaska.

In this connection the known distribution of the peculiar brachiopod *Streptis greyi* deserves consideration. It occurs in England, the island of Gotland, Bohemia, Alaska and Arkansas, while it is entirely unknown east of the Mississippi River and in northeastern America. This peculiarly developed species forms an important connecting link between the faunas of Arkansas, Alaska and Europe, and its apparent absence from the eastern third of America points toward a northwestern, rather than a northern or northeastern, connection between the Silurian faunas of Europe and America. When the Siberian faunas have been studied it is very probable that Silurian faunas will be found in northern Asia connecting those of Alaska with the Silurian fauna of northeastern Russia.

U. S. Geological Survey, Washington, D. C.

ART. XVII.—*A Method for the Volumetric Estimation of Titanium*; by H. D. NEWTON.

[Contributions from the Kent Chemical Laboratory of Yale Univ.—clxix.]

ABOUT forty years ago, F. Pisani\* stated that titanous acid could be estimated by reduction with zinc in hydrochloric acid solution, the action being hastened by gentle heat, and, after the reduction was complete, pouring off the undissolved zinc, washing and titrating with potassium permanganate. Pisani, while stating that the above procedure gave excellent results, gave no test analyses. Marignac† applied Pisani's method, shortly after its publication, to the estimation of titanous acid in the presence of niobic acid. Marignac's procedure differed slightly, however, from Pisani's, in that the titanous acid was reduced out of contact with the air, by means of a long bar of zinc extending well up into the neck of the flask, the zinc being removed after the reduction was completed and the solution titrated directly in the flask. The test analyses given are good, though the results are low, especially when large quantities of titanous acid are used.

Somewhat later, Wells and Mitchell‡ modified Pisani's method, as improved by Marignac, by using sulphuric acid solutions and protecting the solution from oxidation during cooling and titration by means of a stream of carbon dioxide. The experimental results are still below the theory, the greater portion of the error being attributed by the authors to the oxidizing action of the air, which gained access to the liquid in spite of the precautions taken.

The work to be described is a result of an attempt to eliminate the oxidizing action of the air by reducing and cooling under an atmosphere of hydrogen, and converting the equivalent of titanium sesquioxide to ferrous sulphate by introducing an excess of ferric salt. A cold solution of a ferrous salt, as is well known, is very slowly acted upon by atmospheric oxygen.§

The reaction between the salts of titanium and iron takes place according to the following equation:

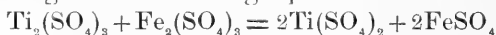

For this work, the titanium solutions were made by treating recrystallized potassium titanofluoride with concentrated sulphuric acid, evaporating the mixture to the fuming point of the acid, and diluting to a known volume. The resulting solutions were standardized by the basic acetate method,|| slightly modified in the present case, owing to the absence of any iron in the solutions used.

\* Compt. Rend. lix, 298.

† Zeitschr. Anal. Chem., vii, 112.

‡ Jour. A. C. S. xvii, 878.

§ Peters &amp; Moody, this Journal, xii, 367.

|| Gooch, Amer. Chem. Jour., vii, 283.

Measured portions of these solutions were drawn into a flask of about 100<sup>cm</sup><sup>3</sup> capacity, a definite amount of zinc having a known iron content was added, the solution finally made up to such volume as to contain about ten per cent of concentrated sulphuric acid, this strength of acid being sufficient to hold the titanic acid in solution and yet be without oxidizing action on the reduced oxide. A rubber cork, through which passed a delivery tube and small separating funnel, was inserted into the mouth of the flask. Gentle heat was applied, while an atmosphere of hydrogen was constantly kept above the liquid until all the zinc was dissolved and the solution cooled, a process which generally took about an hour. An excess of ferric sulphate was passed through the separating funnel and followed at once by cold, freshly distilled water until the flask was filled to the neck. The contents of the flask were then poured into a liter flask containing more cooled distilled water and the whole immediately titrated with tenth-normal potassium permanganate.

In the following table are given results obtained by the foregoing procedure. In table No. II are recorded similar experiments in which larger amounts of titanic acid were taken.

TABLE I.

Titanium sulphate cm <sup>3</sup>	KMnO <sub>4</sub> cm <sup>3</sup>	TiO <sub>2</sub> taken gram.	TiO <sub>2</sub> found gram.	Error gram.
30 c.c. ----	6.50	0.0520	0.0523	+0.0003
30 ----	6.52	0.0520	0.0524	+0.0004
30 ----	6.45	0.0520	0.0519	-0.0001
30 ----	6.50	0.0520	0.0523	+0.0003
30 ----	6.48	0.0520	0.0521	+0.0001
30 ----	6.42	0.0520	0.0518	-0.0002
30 ----	6.50	0.0520	0.0523	+0.0003

TABLE II.

Titanium sulphate cm <sup>3</sup>	KMnO <sub>4</sub> cm <sup>3</sup>	TiO <sub>2</sub> taken gram.	TiO <sub>2</sub> found gram.	Error gram.
25 c.c. ----	19.95	.1596	.1599	+0.0003
25 ----	19.93	.1596	.1598	+0.0002
25 ----	19.95	.1596	.1599	+0.0003
25 ----	19.90	.1596	.1595	-0.0001
25 ----	19.95	.1596	.1599	+0.0003
25 ----	19.95	.1596	.1599	+0.0003
25 ----	19.90	.1596	.1595	-0.0001
25 ----	19.85	.1596	.1591	-0.0005
25 ----	19.95	.1596	.1599	+0.0003
25 ----	19.88	.1596	.1594	-0.0002
25 ----	19.95	.1596	.1599	+0.0003
25 ----	19.95	.1596	.1599	+0.0003

These experiments show that it is possible to reduce titanous acid by means of zinc in a small flask and to determine the titanium with success, by reducing in an atmosphere of hydrogen, adding an excess of ferric sulphate, and titrating the resulting, and equivalent, ferrous salt with potassium permanganate. The factor for metallic iron divided by 0.689 gives the factor for titanium dioxide.

In conclusion, I wish to thank Prof. F. A. Gooch for advice and assistance given during the progress of this work.



ART. XVIII.—*Isopyrum biternatum* Torr. et Gr.; an anatomical study; by THEO. HOLM. (With three figures in text, drawn from nature by the author.)

It would be interesting to know the internal structure of all the species of *Isopyrum*, since it appears as if the genus is not a very natural one, judging from the external characters. As understood by Maximowicz\* and Franchet,† *Isopyrum* comprises not only all the perennial species with nectaries in the flower, but also the annual *Leptopyrum* Rehb., and those without nectaries, upon which Rafinesque based his genus *Enemion*;‡ this same disposition we find in the works of De Candolle, Bentham and Hooker. In the so-called *Leptopyrum fumarioides* (L.) Rehb. the stem-leaves are almost verticillate, the nectaries are provided with a scale, the ovaries number about twenty, and are erect, besides that the plant is an annual; for this reason Prantl§ has kept *Leptopyrum* as a genus separate from *Isopyrum*. In the so-called *Enemion* there is one species, Gray's *Isopyrum stipitatum*, in which the ovaries are very distinctly stipitate as in *Coptis*, thus differing from all the other members of the genus. However the foliage and the habitus in general of *I. stipitatum* agrees better with *Isopyrum* than with the evergreen *Coptis*. In regard to the carpels we find only two and horizontally spreading in *I. nipponicum* Franch., or divaricate in *I. dicarpon* Miq., *I. stoloniferum* Maxim., *I. trachyspermum* Maxim., and *I. Fauriei* Franch.; in the other species the carpels are mostly erect or very slightly spreading, and never stipitate to such an extent as in *I. stipitatum*. Several, and by no means unimportant, distinctions are furthermore to be observed in the structure of the nectaries, as described by Maximowicz, for instance in *I. cæspitosum* Boiss. et Hoh., *I. dicarpon* Miq., and *I. fumarioides* L., as mentioned above. In connection with these characters may be pointed out the very peculiar rhizomes possessed by some of these species. Only one annual species is known; all the others are perennial and herbaceous. In *I. biternatum* Torr. et Gr. the rhizome is very slender and stoloniferous; the roots are of two kinds, slender in their entire length or moniliform; in *I. occidentale* Hook. et Arn. the roots are very numerous and fascicled, more or less tuberos, but not moniliform;

\* Diagnoses plantarum novarum asiaticarum, V. (Mélanges biol., vol. xi. St. Petersburg, 1883, p. 623).

† *Isopyrum* et *Coptis*; leur distribution géographique (Journ. de Botanique, vol. xi. Paris, 1897, p. 154).

‡ Description d'un nouveau genre de plantes, *Enemion*, et remarques botaniques (Journ. de phys., de chim, vol. xci. Paris, 1820, p. 70).

§ Die natürlichen Pflanzenfamilien. Leipzig, 1888, p. 57.

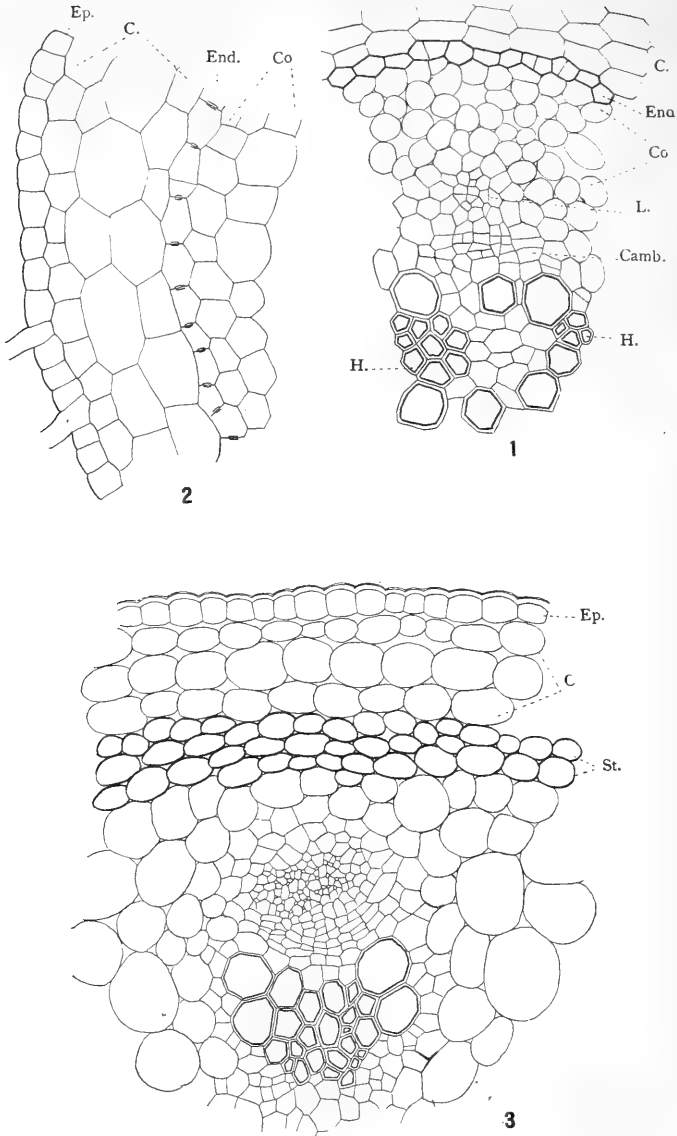

they are densely crowded and very thick in *I. stipitatum* Gr.; in *I. Fauriei* Franch. and *I. trachyspermum* Maxim. the rhizome is slender, but very short, and the roots are almost capillary. Very characteristic is the rhizome of *I. adoxoides* D.C.; in young specimens the root consists merely of a short

tuberous portion with long and slender, filiform apex, but in older plants a vertical and very thick subterranean stem develops from the crown of the root, bearing numerous basal leaves and flowering stems. The caespitose *I. microphyllum* Royle possesses a long and stout subterranean stem with exceedingly short internodes and covered with rigid fibers from the withered leaves; in *I. stoloniferum* Maxim. the rhizome is very thin and stoloniferous with capillary roots, while in the European *I. thalictroides* L. the roots are very slightly tuberous at the base. Finally the inflorescence is somewhat different, and as stated by Maximowicz the seeds exhibit a very distinct structure in several of the species. A study of a more copious material, and especially of the Asiatic species, would, no doubt, add many points in regard to the external structure in general, that of the rhizomes for instance. There is thus in *Isopyrum* as understood by recent authors, Maximowicz and Franchet, some certain variation noticeable in the structure of the floral and vegetative organs, which seems to point toward generic distinctions, and it would be very interesting indeed to know whether this variation is accompanied by divergencies in the internal structure. If the anatomical study of these species should reveal facts of the same importance as those known from the external structure, there is no doubt that the genus would need a thorough revision, and evidently have to be divided; *Leptopyrum* and *Enemion* might, perhaps, prove to be tenable, not speaking of the remarkable *I. stipitatum*. The seedling of *I. thalictroides* has been described by Winkler;\* the cotyledons are hypogeic, and remain enclosed within the seed. There is a distinct hypocotyl, which increases in thickness, and the primary root is strong and ramified; secondary roots become developed from the axils of the cotyledons. The first leaf succeeding the cotyledons is membranaceous and sheath-like, while the second shows the normal form with three green leaflets. A seedling of *I. biternatum* has been figured by MacDougal;† it shows a long primary root, and the cotyledons are free and provided with long petioles. The two first leaves, succeeding the cotyledons, have only rudimentary blades, while in the third leaf three small leaflets are developed. The seedling of *I. biternatum* as figured by MacDougal is, thus, very different from that of *I. thalictroides*. Unfortunately MacDougal does not describe the seedling, and the figure does not seem to have been carefully executed.

But so far the internal structure has only been considered

\* Die Keimpflanze des *Isopyrum thalictroides* L. (Flora, 1884, p. 195, with plate III). See also Irmisch: Beiträge zur Naturgeschichte des *Melittis Melissophyllum* (Bot. Zeitung, 1858, p. 233).

† Minnesota Bot. studies, 1896, p. 501.

and studied from a very few species. Marié\* has presented some notes on *I. thalictroides* dealing with the vegetative organs, and MacDougal (l. c.) has studied the physiology of the root tubers in our American *I. biternatum*. As a small contribution to the knowledge of the internal structure of *I. biternatum* the writer has thought, that the following treatise might be of some interest and assistance to future investigation of the genus. We do not believe, however, that this anatomical characterization of an *Enemion* would prove sufficient for maintaining the genus of Rafinesque, but we wish to demonstrate that some distinction exists, which may possibly be strengthened further, when some investigator succeeds in obtaining serviceable material of the other species. In *Isopyrum biternatum* the structure of the vegetative organs is as follows:

#### *The roots.*

As it has been mentioned above, the secondary roots are either slender in their entire length or moniliform; in the latter the swellings occur in various places without any regularity. The primitive structure may be observed in the capillary, lateral roots, in which no increase in thickness takes place. These roots are very hairy, and possess a distinct, thin-walled exodermis; the cortex consists only of two strata; a thin-walled endodermis and pericambium surround two rays of vessels, which extend to the center of the stele; alternating with two strands of leptome. In the very long and slender secondary roots, we find the same tissues, and of the same weak structure, but the primary cortex is a little broader, consisting of about four layers. Secondary formations have commenced resulting in the development of a broad secondary cortex (Co in fig. 1), and in the development of secondary vessels on the inner face of the primary leptome. Otherwise the structure of the stele corresponds with that of the lateral roots, there being only two rays of primary hadrome, which do not, however, extend to the center since this is occupied by a small cylinder of thin-walled, conjunctive tissue. This same structure occurs, furthermore, in the slender portions of the moniliform roots, and our figure 2 shows the peripheral tissues from epidermis to the secondary cortex incl. In the swollen portions of these same roots, the structure is of course somewhat modified, but the modification depends merely upon a more advanced increase in width of the secondary cortex. All the other tissues are unchanged, and even the stele shows yet, and very plainly so, the primitive diarch structure with two addi-

\*Recherches sur la structure des Renonculacées (Ann. d. sc., ser. 6, vol. xx, Paris, 1885, p. 105).

tional rays of secondary vessels, two groups of secondary leptome, and a small thinwalled pith.

Characteristic of the root-system of *I. biternatum* is thus the occurrence of slender and moniliform roots, in which the increase in thickness is due to the strong development of a secondary cortex, and in which the secondary formations within the stele consist only in two additional rays of hadrome and two strands of leptome, but with no extension of the central parenchyma, the pith.

In the Californian *I. stipitatum*, which is, also, a member of the section *Euemion*, the roots are very different, and we have examined some specimens, although they were not in any very good condition for this purpose, having been pressed and dried. The root-system of this plant consists of a dense ball of tuberous secondary roots like those of *Anemonella*,\* but they are much more numerous. A transverse section of a tuberous root of *I. stipitatum* shows the following structure: Epidermis is very hairy, and covers directly a cortical parenchyma of about four layers, the cells of which are moderately thickwalled; then follows a thinwalled endodermis of very small cells. The larger portion of the section is occupied by a homogeneous, thinwalled parenchyma of secondary cortex and a broad, central pith. There are five minute strands of primordial hadrome, which alternate with five much larger collateral mestome-strands, all separated from each other by several layers of parenchyma. These mestome-strands are arranged in two concentric bands, but the distance from the center of the stele to the primordial groups of hadrome is only very slightly shorter than that to the secondary strands; thus it often appears as if the mestome-bundles, the primary and the secondary, are located in one single band. If we examine the filiform apex of these same roots, we observe the same structure, but with the secondary cortex and the pith much less developed; the filiform lateral roots, on the other hand, show a diarch structure with no signs of secondary formations.

#### *The rhizome.*

The rhizome of *I. biternatum* is very slender, and the structure is rather weak. The cells of epidermis are very small and thinwalled; the cortex consists only of six layers, which are more or less collapsed. There is no endodermis, but a sheath of five strata of collenchyma surrounds the stele; in some specimens we observed two or three strands of typical stereome located in the collenchyma; thus the peri-

\*The author: *Anemonella thalictroides* (L.) Spach. (This Journal, vol. xxiv, September, 1907, p. 243.)

cycle contains actually two types of mechanical tissue. Five collateral mestome-strands traverse the stele; they contain many vessels and cambium, beside leptome, and they are separated from each other by several layers of thinwalled parenchyma, which shows the same structure as the central pith, being very thinwalled. The cambium is not confined to the mestome-bundles, but occurs, also, between these as interfascicular.

*The stem above ground.*

The stem is cylindrical, glabrous and hollow. The cuticle is thin and perfectly smooth, and epidermis (Ep. in fig. 3) is somewhat thickwalled. No hypodermal collenchyma is developed, and the cortex consists only of three thinwalled strata, bordering directly on the pericycle, which consists of about three layers of thinwalled stereome (St. in fig. 3). Inside the pericycle is a broad cylinder of thinwalled parenchyma with seven collateral mestome-strands arranged in a single circular band; they contain very small-celled leptome, some strata of cambium, and a V-shaped group of wide vessels. It deserves notice that the leptome does not border on the pericycle, but is separated from this by layers of thinwalled parenchyma, as may be seen from the figure (3).

*The leaf.*

The long petiole is cylindrical, glabrous, and hollow. It has a thin, smooth cuticle, and epidermis is slightly thickwalled. The cortical parenchyma consists of about six layers of thinwalled cells with chlorophyll, but there is no mechanical tissue, neither collenchyma or stereome, and no endodermis. There are six collateral mestome-strands, four large, and two small ones, arranged in a circular band, surrounding a thinwalled, partly hollow pith. This same structure we find, furthermore, in the shorter petioles of the stem-leaves, in that part of the petiole which is generally called "the characteristic," just below the blade. In the petioles of the leaflets the outline is hemicylindric, and there are only two large and two small mestome-bundles, but otherwise the structure is identical. The small leaf-blades have a thin, smooth cuticle above the thinwalled epidermis, of which the lateral cell-walls are undulate; the lumen of the epidermis cells is about the same on both faces of the blade. The stomata are surrounded by four to five ordinary epidermis cells; they are level with epidermis, and the air-chamber is shallow but wide. The structure is bifacial, not only in regard to the distribution of the stomata, which are confined to the dorsal face, but also in regard to the chlorenchyma, which is here differentiated into

a ventral palisade tissue of a single layer, and a broader pneumatic tissue beneath this. The veins are surrounded by colorless parenchyma sheaths, and the larger of these have a small support of hypodermal collenchyma; the midrib differs from the others by being embedded in a large, colorless water-storage-tissue. If we compare now the structure of our American species, *I. biternatum* of the section *Enemion*, with the European *I. thalictroides*, which is an *Euisopyrum*, we notice the differences as follow. According to Marié (l. c.) the roots of *I. thalictroides* are only slightly tuberous near the base with small development of the secondary cortex. In *I. fumaroides* of the section *Leptopyrum*, examined by the same author, the primary root is developed as a tap-root, in which the secondary leptome forms a continuous zone around the broad cylinder of hadromatic rays with strata of parenchyma, while the secondary cortex represents a rather small tissue. We have thus in *Leptopyrum* the common type of an annual primary root, developed as a tap-root, while in *Enemion* the primary root becomes replaced by secondary, which are either slender, or moniliform (*I. biternatum*), or simply tuberous (*I. stipitatum*); in *Euisopyrum*, the secondary roots are very long and only slightly tuberous near the base.

In regard to the rhizomes of *I. biternatum* and *I. thalictroides* the structure is identical. But the stem above ground shows some points in which these species differ from each other. Marié (l. c.) observed in *I. thalictroides* an endodermis and a pericycle of two zones, an outer very heavily sclerified, and an inner more thinwalled. We remember that in *I. biternatum* no endodermis was observed, and that the pericycle was composed of only three layers of thinwalled stereome. But otherwise the structure of the stele shows no difference of importance. It is, thus, merely in regard to the relative development of the mechanical tissue in the pericycle that these two species differ from each other, so far as concerns the stem structure. While in *I. thalictroides* the structure of the petiole is identical with that of the stem, we notice in *I. biternatum* that the petiole lacks the mechanical support of stereome and collenchyma. In the leaf-blades of *I. thalictroides* Marié observed a large-celled epidermis with the outer walls convex on the dorsal face, and an almost homogeneous chlorenchyma, since the palisade tissue is barely differentiated; the leaf structure of this species is, thus, quite different from that of our *I. biternatum*, as described above.

The anatomical structure of these two species of *Isopyrum*, representing *Euisopyrum* and *Enemion*, does not indicate that these plants might belong to two distinct genera. The external structure, however, is very different, if we consider the

flowers and the rhizomes, especially the roots. To decide the question whether *Enemion* and *Leptopyrum* deserve generic rank would require a thorough revision of all the species, giving due attention to the structure of the rhizomes, which is yet but imperfectly known, and very difficult to study from herbarium material alone. Very remarkable are the Asiatic species with two divaricate carpels, and we should not wonder if a future investigator might refer these to a section of their own, and distinct from *Euisopyrum*. The Californian *I. stipitatum*, as indicated already by the specific name, ought not to be placed side by side with the species of true *Enemion*.

*Isopyrum* is altogether a very interesting little genus, not only from a morphological point of view, but also, if we consider the geographical distribution, so excellently outlined by Franchet (l. c.). We see from his paper that the section *Enemion* is the only one represented on this continent; that *Euisopyrum* is confined to Europe and Asia, and that *Leptopyrum*, which is monotypic, is only known from central and oriental Asia; moreover that one member of the section *Enemion* occurs in Asia, *I. Raddeanum* Maxim (China and Japan). The geographical center of the genus is no doubt to be sought in Eastern Asia, where in accordance with Franchet all the three sections are represented, and where *Euisopyrum* is especially abundant.

Brookland, D. C., Oct. 1907.

#### EXPLANATION OF FIGURES.

FIGS. 1 and 2.—Roots of *Isopyrum biternatum*. FIG. 1. Transverse section of a slender, secondary root; C=cortex; End.=endodermis; Co=secondary cortex; L=leptome; Camb.=cambium; H=hadrome. FIG. 2.—Transverse section of the slender portion of a moniliform secondary root; Ep.=epidermis; the other letters as above. FIG. 3. Transverse section of a flowering stem; St.=the stereomatic pericycle; the other letters as above.  $\times 320$ .



ART. XIX.—*Phosphorescence Produced by the Canal Rays*;  
by JOHN TROWBRIDGE.\*

IN most cases the phosphorescence caused by the canal rays is similar in color to that produced by the cathode rays. When, however, the canal rays fall upon lithium chloride there seems to be a marked difference. Professor J. J. Thomson, in his treatise on conduction of electricity through gases, describes a form of tube in which a layer of lithium chloride can be bombarded alternately by both kinds of rays, and he states that when the layer is struck by the canal rays it shines with a bright red light and the lines of the lithium spectrum are very bright; when, however, the direction of the discharge is reversed so that the layer is struck by the cathode rays, its color changes from bright red to steely blue, giving only a faint continuous spectrum but not the lithium lines. The layer steadily becomes black in hydrogen.

I have succeeded in producing the red phosphorescence by the cathode rays, thus annihilating the distinction in this case between the two kinds of rays. The method adopted seems to have a general application in the study of phosphorescence and is as follows;

The vacuum tube was of cylindrical form; the cathode was a concave aluminium mirror, the anode a circular iron electrode with a circular orifice at its center. A glass tube was inserted in this orifice and was welded to the walls of a tubular appendix, shutting out all rays except those which passed through the orifice. This cylindrical appendix 3<sup>cm</sup> to 8<sup>cm</sup> long was closed at the end by a ground glass stopper with a flat end; on this end could be sifted the layer of lithium chloride which was held by a suitable medium; a solenoid was slipped over the tube, the latter forming the core of the solenoid; the longitudinal magnetic

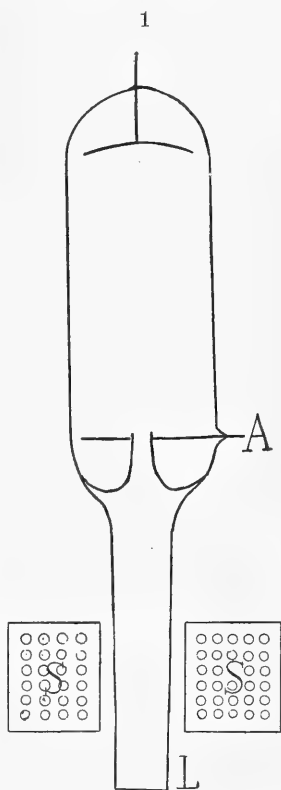

\* University Press, Cambridge, 1906, p. 642.

line of the solenoid thus passed through the core. Fig. 1 shows the arrangement; *A* represents the circular iron terminal with its central orifice perforated by a glass tube; *S* the solenoid; *L* the stopper with the layer of lithium chloride at its end.

When the solenoid is excited the cathode rays can be brought to a sharp focus on the layer at *L*, and the apparatus can be called in popular language a magnetic lens. A very intense cathode beam can be made to converge at *L* by suitably adjusting the solenoid. The rays seek the weakest part of the magnetic field. Immediately on striking the layer of lithium chloride the red phosphorescence appears at the center of the focus, and is surrounded by the blue phosphorescence; either the red or the blue can be produced at pleasure.

It seems, therefore, that if *n* is the number of cathode particles, *m* their mass, *v* their velocity; and *n'* the number of positive particles, *m'* their mass, *v'* their velocity, that the equation

$$nmv^2 = n'm'v'^2$$

holds on the unit of area; and that the distinction in this case between the color produced by the cathode rays and the canal rays disappear. The production of the two colors is a question of energy on the unit of area.

I have examined the phosphorescence of the other metals of the same group as lithium. Cæsium gives a very bright blue color for both the cathode and the canal rays and the blue lines of the spectrum appear with the application of the cathode beam. Rubidium gives both a red and blue color; the red, however, is much less bright than in the case of lithium chloride. All of these salts are quickly decomposed. Calcium tungstate recovers from fatigue very quickly and is not decomposed appreciably even after long exposures. Its use for X-ray screens is, therefore, substantiated by these experiments.

Jefferson Physical Laboratory, Harvard University.

ART. XX.—*The Application of a Longitudinal Magnetic Field to X-ray Tubes*; by JOHN TROWBRIDGE.

IN an article on the Magnetic Field and Electric Discharges in the Proceedings of the American Academy (vol. xli, No. 28) I stated that the application of a longitudinal magnetic field at the anode might form a useful method of concentrating the cathode rays. Since this article was written I have studied the subject more carefully and have devised a safe and practical method, which is analogous to that I have described in the article on the phosphorescence of the canal rays, published in the present number of this Journal (p. 141).

The form of tube is shown in fig. 1: *A* is an iron disc anode with a perforation at its middle; *S* is a solenoid which can be adjusted along an appendix to the X-ray bulb; *F* is the usual focus plane of polished platinum. Opposite this focal plane the glass is blown thin to permit the egress of the X-rays. The cathode beam is brought to a focus at *F* by adjustment of the longitudinal field of the solenoid. The dimensions of the apparatus are as follows:

Diameter of the spherical bulb, 10<sup>cm</sup>; distance between the concave aluminium cathode and the iron disc anode, 6<sup>cm</sup>; length of the cylindrical appendix containing the focal plane, 10<sup>cm</sup>; internal diameter of the cylindrical appendix approximately 3<sup>cm</sup>. The outer diameter of the solenoid was 10<sup>cm</sup>, the internal diameter 3<sup>cm</sup>, length 4<sup>cm</sup>. There were 10 layers of No. 12 wire Brown and Sharpe gauge. The solenoid was excited by two or five storage cells. A narrower appendix and a smaller bulb opposite the focal plane would give a stronger field with less current.

When the cathode stream is made to converge by the solenoid on the focal plane *F*, the intensity of the X-rays is increased in a marked manner. Judging the intensity by the distance at which equal intensity is obtained with and without the magnetic field, I have more than doubled the intensity of the X-rays by the application of the field. The method has the advantage

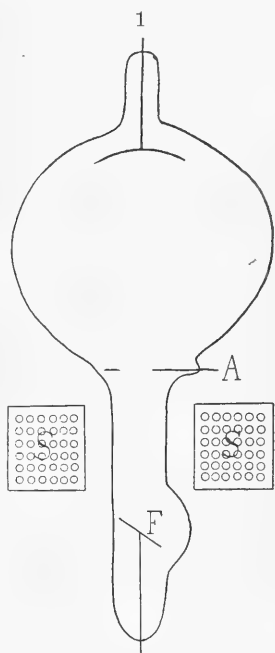

of producing the X-rays from a sharp focus and should, therefore, give better definition.

It may be urged that the amount of energy employed in exciting the magnetic field could, with equal advantage, be added to that which excites the tube; but this would result in possible strain or danger to the tube and would not result in bringing the stream to a sharp focus. The large bulb need not be blown thin and, therefore, the danger of perforation can be greatly lessened; moreover, the application of the magnetic field serves as a rectifier, and when a Leyden jar is used it allows only the oscillation from the cathode to reach the focal plane.

Jefferson Physical Laboratory, Harvard University.

## SCIENTIFIC INTELLIGENCE.

## I. CHEMISTRY AND PHYSICS.

1. *Condensation of Water Vapor in the Presence of Radium Emanation.*—MADAME CURIE has found that when a gas under atmospheric pressure contains radium emanation, the "induced radio-activity" in suspension in the gas acts like a heavy body, as it tends to fall downward. She has shown that this falling is diminished or even prevented if the gas is perfectly dry, and has come to the conclusion that the presence of water vapor favors the formation of agglomerations having as nuclei the particles of the "induced radio-activity," and capable of attaining a size sufficient for acquiring an appreciable velocity in falling. Following up this conclusion, she has found that it is possible to observe a fog in moist air containing radium emanation when it is illuminated by the light of an electric arc. The phenomenon was found to take place when the air contained much less moisture than was sufficient for its saturation, and dry air containing vapor of petroleum ether gave a similar cloud. When two platinum electrodes in an experimental vessel were subjected to a difference of potential of several hundred volts, the mist was rapidly dispersed by the electric field and disappeared entirely. Upon disconnecting the electric field the mist gradually formed again, being distinctly visible after 5 minutes, and fully reformed after 15 minutes. This behavior corresponds to that of radium A, the first product of "induced radio-activity."—*Comptes Rendus*, cxlv, 1145.

H. L. W.

2. *Gaseous Nitrogen Trioxide.*—The compound  $N_2O_3$  has been prepared in a pure state as a green liquid, but upon allowing this liquid to evaporate, almost complete dissociation took place into nitrogen peroxide and nitric oxide. Since it had been shown by one of them that traces of moisture were necessary for the dissociation of the vapors of ammonium chloride, mercurous chloride, and other substances, H. B. BAKER and M. BAKER have investigated the behavior of nitrous anhydride in this respect, and find that when it is perfectly dried by means of  $P_2O_5$  it is capable of existing as a gas at ordinary temperatures, but as the density determinations gave variable results, usually considerably higher than the calculated density, it appears that the gas contains a polymer of  $N_2O_3$ . The slightest trace of moisture causes practically complete decomposition of the substance when it evaporates. The authors determined the molecular weight of the liquid  $N_2O_3$  by the freezing point method, using perfectly dry benzene, and found no evidence of polymerization in the liquid at  $4^\circ$ . This liquid has a specific gravity of about 1.11; its color is green at ordinary temperature, but when cooled to  $-2^\circ$ , or below, it

becomes deep indigo-blue ; it shows no signs of freezing at  $-81^{\circ}$ , but in liquid air it forms very deep blue crystals.—*Jour. Chem. Soc.*, xci, 1862, Nov. 1907. H. L. W.

3. *Atomic Weight of Tellurium*.—Much work has been done in recent years upon tellurium on account of the fact that its atomic weight, being higher than that of iodine, does not properly place it in Mendeléeff's periodic system. All attempts to find a suspected impurity in the element which would account for this high atomic weight have been fruitless. BAKER and BENNETT have recently given an account of some thirteen years of work upon this problem, and their extensive investigations confirm the conclusion that the atomic weight of tellurium is 127.60, and that many methods of fractionation give no indication of the presence of an unknown element. They have made the further new observation that highly purified tellurium does not burn in perfectly dry oxygen.—*Jour. Chem. Soc.*, xci, 1849, Nov. 1907.

4. *A New Element, Lutecium*.—By means of a long series of fractional recrystallizations of the nitrate of Marignac's ytterbium, using nitric acid of density 1.3 as a solvent, G. URBAIN has succeeded in separating the material into two distinct substances, one of which gives a characteristic spark spectrum. This new element he calls lutecium, Lu, from an ancient name for Paris, and he finds that its atomic weight is not much greater than 174. The other element present he calls neo-ytterbium, Ny, in order that it may not be confused with Marignac's ytterbium. Its atomic weight cannot differ much from 170. Two spectrum bands obtained by Lecoq de Boisbaudran's method are probably characteristic of neo-ytterbium, while a third band appears to belong to lutecium.—*Comptes Rendus*, cxiv, 759. H. L. W.

5. *The Association of Helium and Thorium*.—STRUTT believes that he has found a case where Boltwood's opinion that helium in radio-active minerals may be always attributed to the action of the uranium-radium series of transformations is untenable. He has examined a mineral from Ivitgut, Greenland, similar in some respects to fluor spar, but containing rare earths, and liberating  $27^{\circ}\text{C}$  of helium per kilogram when heated. He finds that this mineral contains no more radium than is present in average rocks, while on the other hand it gives an abundant thorium emanation. He believes, therefore, that the helium has been produced in connection with thorium.—*Chem. News*, xciv, 259.

H. L. W.

6. *Organic Chemistry for Advanced Students* ; by JULIUS B. COHEN. 8vo, pp. 632. London, 1907, Edward Arnold ; New York, Longmans, Green & Co.—This book contains a series of essays upon important topics of organic chemistry. They have been prepared from notes of lectures delivered to senior students, and are intended only for those who have completed an elementary course of organic chemistry. The subject is presented somewhat in the manner in which it has naturally developed. The fourteen chapters of the book have the following titles:

Historical Introduction, Isomerism and Stereoisomerism, Stereochemistry of Unsaturated and Cyclic Compounds, Stereochemistry of Nitrogen, Isomeric Change, Steric Hindrance, Condensation, The Carbohydrates, Fermentation and Enzyme Action, The Purine Group, The Proteins, The Benzene Theory, The Terpenes and Camphors, The Alkaloids. The book is undoubtedly a very useful addition to our text-book literature.

H. L. W.

7. *Radio-activity of Lead and Other Metals*.—Prof. J. C. McLENNAN, of the University of Toronto, finds that the high activity of lead is due to the presence of impurities, and not to a high intrinsic radiation from the metal. The differences in the conductivity of air confined in vessels of different metals are due to differences in the secondary radiation from these metals. Approximately 9 ions per c.c. per second are generated in free air by the penetrating radiation from the earth.—*Phil. Mag.*, Dec. 1907, pp. 760-779.

J. T.

8. *Production and Origin of Radium*.—Prof. E. RUTHERFORD concludes that in the ordinary actinium preparations there exists a new substance which is slowly transformed into radium. This direct parent of radium can be chemically separated both from actinium and radium. Observations have not determined yet whether this direct parent of radium has any genetic connection with actinium or not.—*Phil. Mag.*, Dec. 1907, pp. 733-749.

J. T.

9. *Radium Emanation in the Atmosphere near the Earth's Surface*.—In 1906 Professor Rutherford found that charcoal prepared from coca nuts entirely absorbed the radio-active emanations, provided they were passed slowly through the charcoal. Professor A. S. EVE, of Montreal, has adopted this method and finds that the emanation in the atmosphere is absorbed by this kind of charcoal; and that its magnitude is  $80 \times 10^{-12}$  expressed in terms of the amount of radium required to maintain the supply per cubic meter constant.—*Phil. Mag.*, Dec. 1907, pp. 724-733.

J. T.

10. *Anomalies in the Behavior of Dielectrics*.—A long paper, with abundant references to previous workers, has been published by EGON RITTER V. SCHWEIDLER. He finds that Maxwell's theory of non-homogenous structure of the dielectric leads to qualitative correct consequences, but is not available on account of mathematical difficulties for quantitative work. It seems that there is no theory at present which comprises all the anomalies observed.—*Ann. der Phys.*, No. 14, 1907, pp. 711-770.

J. T.

11. *Effect of Pressure upon Arc Spectra*.—In a paper by W. GEOFFREY DUFFIELD, communicated to the Royal Society by Prof. A. Schuster, July 4, 1907, the author shows that in the case of iron all lines become broader. The broadening may be symmetrical or unsymmetrical; in the latter case the broadening is greater on the red side. With increase of pressure the displacement is toward the red side of the spectrum. The displacement is real and is not due to unsymmetrical broadening. I have shown—

High Electromotive Force, *Memoirs American Academy*, vol. xiii, No. v.—that the strong lines of all metals broaden under great pressure toward the red.

J. T.

12. *Modification of the First Linear Spectrum of Emission of Mercury*.—Prof. ENRICO CASTELLI has observed this modification in observing the mercury spectrum produced by the vapor of mercury contained in a Uriol lamp. One set of photographs of the spectral lines was made when this lamp was new—the other set when it had been working for a hundred hours, during intervals. The lines corresponding to less refrangible monochromatic rays gradually became more intense and produced on the orthochromatic plates a greater and greater effect; while the contrary occurred with the more refrangible lines. It occurs to one in reading this article that the change in the material of the lamp—glass or quartz—might account for the phenomenon.—*Phil. Mag.*, Dec. 1907, pp. 784–785.

J. T.

13. *A Gas Generated from Aluminum Electrodes*.—R. v. HIRSCH and F. SODDY, starting with the formula  $P^2V = \text{constant}$ , P being the gas pressure and V the discharge potential, which they believe to hold for pure gases submitted to electrical discharges, think they have discovered a new gas which indicates that it is not a mixture but a pure gas, and that its molecular weight is 4 or some multiple. The authors are inclined to believe that the supposititious new gas may be a modification of hydrogen as ozone is of oxygen, capable of withstanding the discharge of an influence machine, but decomposed by the discharge of a coil. They admit that the quality of aluminum employed is of great importance. Too great purity of the British aluminum they think may serve to explain some of the difficulties besetting the X-ray bulb manufacturers in England.—*Phil. Mag.*, Dec. 1907, pp. 779–784.

J. T.

14. *Two New Worlds*. I, The Infra-world. II, The Supra-world; by E. E. FOURNIER D'ALBE. vii + 157 pp. 1907. (Longmans, Green & Co.)—The author of this work has previously published an excellent popular exposition of the electron theory. In the book before us he has used our present knowledge of the electron (imperfect, slight, and recently acquired as that knowledge is) as the basis of an astonishing mass of speculation as to the constitution of the universe—or rather of an infinite series of universes of different orders of size, of whose existence he gives “proofs.” The basis of his speculations is a simple one: the diameter of the earth is about  $10^{22}$  times the diameter of an electron; the earth's period about the sun is about  $10^{22}$  times the average period of an electron in the vibrations which give rise to light waves; the author is thus led to consider an “infra-world” in which “space and time are reduced in the same proportion.” The number,  $10^{22}$  “is nothing less than the ratio of the scales of successive universes.” The theory of physical dimensions plays a great part in defining the physical



conditions in the "infra-world." By the time page 28 is reached, the author has got so far along his way that he can say: "But if the main thesis of this essay is true, and *the infra-world is a habitable universe not essentially different from our own*, then there is no valid argument either in physiology or psychology, to show the impossibility of our having been inhabitants of the infra-world previous to our birth into this world. . . . . The facts of embryology are far from being accounted for and the phenomena of ontogenetic development are so obscure that a reasonable hypothesis like the above can only tend towards their elucidation."

Analogy leads the author in the second part of his book to consider the supra-world in which the earth is but an electron, the solar system an atom, and the whole visible galaxy is perhaps an amoeba. In Chapter 3 of part II, the existence of this supra-world is "proved." On page 134, it is stated in italics that: "*Our galactic system is in all probability a supra-organism.*" It is reassuring to find (p. 137) that: "Possibly our galaxy has no voluntary motion. Its life may be more vegetative than animal;" but a little later (p. 139) the author considers Kapteyn's theory of two systems of stars, and tentatively suggests that "it may be an act of a great Birth—a mingling of two germ-cells to form a more self-determining being."

The author has a boundless faith in the future triumphs of man over nature and looks forward to the time when man "will control the sun with a switch like an electric lamp." It may seem unkind, but it will probably be wholesome, to point out that our progress in these directions in the past, and our hopes for the future, depend upon our avoidance of such uses of the reason and the imagination as are exemplified in this book. On the whole we are compelled to think that the book does not fulfill the purpose expressed in its motto, which is: "For the Glory of God and the Honour of Ireland."

H. A. B.

## II. GEOLOGY.

1. *United States Geological Survey, Twenty-eighth Annual Report, 1906-1907, of the Director, GEORGE OTIS SMITH.* Pp. 80, with one plate.—This report contains a statement of the work done by the various divisions of the Survey during the past fiscal year. The most noteworthy event of the year was the resignation of the former Director, Dr. Charles D. Walcott, in order to accept the position of Secretary of the Smithsonian Institution, and the appointment of Dr. George Otis Smith as the new Director.

The organization of the Survey has been modified within the year by the creation of a technologic branch, by changes in the divisions constituting the topographic branch, and by the sub-

stitution of the name water-resources branch for hydrographic branch.

The technologic branch includes the division of fuels and the division of structural materials. These changes merely organize into a recognized branch of the Survey, the work which has been carried on for several years past in investigating the properties of the structural materials, the chemical composition and adaptabilities of the fuels, present waste, and methods for preventing smoke and waste.

The changes in the topographic branch have been to create five divisions instead of two and the appointment of three of the most experienced topographers as inspectors of topographic work. The publication branch has also been reorganized to some extent and desirable changes instituted in the business methods of the Survey.

The changes noted are a continuation of the progress instituted years ago by Walcott, by which better organization has kept pace with the great growth of the Survey, tending to promote efficient and uniformly high-grade work. The Survey has also appreciated the needs of the public in obtaining information concerning the national resources and how best to use and conserve them. With strange shortsightedness, however, Congress reduced the appropriation of the water-resources branch by 25 per cent, making it necessary to break the continuity of many stream measurements.

The plan of operations for the year involved an expenditure of \$1,758,620; this amount is practically the same as for the previous year, \$213,700 of it being allotted to geology. Of this, 25 per cent was devoted to areal and stratigraphic geology, 39 per cent to economic geology, 25 per cent to investigations in paleontologic, stratigraphic, glacial, and physiographic geology, and 11 per cent to supervision and administration; \$14,000 was also allotted to paleontology. The disbursements for topographic surveys during the past year were \$327,400, and the new areas surveyed in 1906-7 amounted to 32,448 sq. miles. The total area surveyed in the United States up to the present time is 1,025,065 square miles, or about 33 per cent. J. B.

2. *Publications of the United States Geological Survey.*—Recent publications of the United States Survey are noted in the following list (continued from vol. xxiv, p. 376).

FOLIOS—No. 151. Roan Mountain Folio. Tennessee—North Carolina; by ARTHUR KEITH. Pp. 11, with 4 colored maps, 2 illustrations and 3 figures.

No. 152. Patuxent Folio. Maryland—District of Columbia; by GEORGE B. SHATTUCK, BENJAMIN LE ROY MILLER and ARTHUR BIBBINS. Pp. 12, with 3 colored maps and 2 figures.

No. 153. Ouray Folio, Colorado; by WHITMAN CROSS, ERNEST HOWE, and J. D. IRVING. Geography and General Geology of the Quadrangle; by WHITMAN CROSS and ERNEST HOWE. Pp. 20, with 2 colored maps and 10 figures.

BULLETINS.—No. 277. Mineral Resources of Kenai Peninsula, Alaska. Gold Fields of the Turnagain Arm Region; by FRED H. MOFFIT. Coal Fields of the Kachemak Bay Region; by RALPH W. STONE. Pp. 80, with 18 plates and 5 figures.

No. 309. The Santa Clara Valley, Puente Hills and Los Angeles Oil Districts, Southern California; by GEORGE H. ELDRIDGE and RALPH ARNOLD. Pp. x, 266, with 41 plates and 17 figures.

No. 313. The Granites of Maine; by T. NELSON DALE, with an introduction by GEORGE O. SMITH. Pp. 202, with 14 plates and 39 figures.

No. 316. Contributions to Economic Geology. 1906. Part II.—Coal, Lignite, and Peat. MARIUS R. CAMPBELL, Geologist in charge. Pp. 543, with 33 plates and 6 figures.

No. 321. Geology and Oil Resources of the Summerland District, Santa Barbara County, California; by RALPH ARNOLD. Pp. 93, with 17 plates and 3 figures.

No. 322. Geology and Oil Resources of the Santa Maria Oil District, Santa Barbara County, California; by RALPH ARNOLD and ROBERT ANDERSON. Pp. 161, with 26 plates.

No. 323. Experimental Work conducted in the Chemical Laboratory of the United States Fuel-Testing Plant at St. Louis, Mo., January 1, 1905, to July 31, 1906; by N. W. LORD. Pp. 49.

No. 324. The San Francisco Earthquake and Fire of April 18, 1906, and their Effects on Structures and Structural Materials. Reports by GROVE K. GILBERT, RICHARD L. HUMPHREY, JOHN S. SEWELL, and FRANK SOULÉ, with Preface by JOSEPH A. HOLMES. Pp. vi, 170, with 57 plates and 2 figures.

WATER SUPPLY AND IRRIGATION PAPERS.—No. 198. Water Resources of the Kennebec River Basin, Maine; by H. K. BARROWS, with a section on the Quality of Kennebec River Water, by GEORGE C. WHIPPLE. Pp. v, 235, with 7 plates, 17 figures.

No. 202. Surface Water Supply of Hudson, Passaic, Raritan, and Delaware River Drainages, 1906. H. K. BARROWS and N. C. GROVER, District Hydrographers. Pp. iv, 77, with 2 plates and 2 figures.

No. 205. Surface Water Supply of Ohio and Lower Eastern Mississippi River Drainages, 1906. M. R. HALL, N. C. GROVER, and A. H. HORTON, District Hydrographers. Pp. 123, with 3 plates and 2 figures.

No. 207. Surface Water Supply of Upper Mississippi River and Hudson Bay Drainages, 1906. A. H. HORTON and ROBERT FOLLANSBEE, District Hydrographers. Pp. v, 94, with 4 plates and 2 figures.

No. 209. Surface Water Supply of Lower Western Mississippi River Drainage 1906. R. I. MEEKER and J. M. GILES, District Hydrographers. Pp. iv, 79, with 2 plates and 2 figures.

No. 210. Surface Water Supply of Western Gulf of Mexico and Rio Grande Drainages 1906. T. U. TAYLOR and W. A. LAMB, District Hydrographers. Pp. 114, with 2 plates and 2 figures.

No. 216. Geology and Water Resources of the Republican River Valley and Adjacent Areas, Nebraska ; by G. E. CONDRA. Pp. 71, with 13 plates and 3 figures.

3. *A Report on the Cretaceous Paleontology of New Jersey* ; by STUART WELLER. Geol. Surv. of New Jersey, vol. iv of Paleontology Series, 1907, one vol. text, 871 pp., vol. of pls., 111.— In these valuable volumes there is brought together all that is known in regard to the Upper Cretaceous invertebrate faunas of New Jersey. About 600 species are described and illustrated, of which 95 are new.

The Upper Cretaceous formations are 13 in number and their faunal content is discussed in detail on pages 27-175. The lowest horizon is the estuarine Raritan, followed by 9 marine zones to and including the Tinton, all of which are embraced under the new term *Ripleyian* (corresponding to the European Senonian and especially that of Aachen in Germany). The three highest members are embraced under the new term *Jerseyian* (European Maestrichtian or lower Danian). The older general terms, Matawan, Monmouth and Rancocas, are abandoned because but two major paleontologic divisions can be recognized, to which none of these names is applicable.

The author states that in the Ripleyian of New Jersey there are "a considerable number of species [that] have an extra-territorial distribution, and by far the larger number of these species which occur outside of New Jersey are known from the upper Cretaceous formations of the Gulf-border region, in the Ripley and associated formations of Alabama, Mississippi, Texas, etc. The community of species between this southern region and New Jersey is so marked that no doubt can be entertained as to the essential time-equivalent of the formations and faunas of the two regions, and because of the typical development of the faunas in the Ripley formation this series may be designated by the name Ripleyian." . . . . . The Ripleyian fauna as seen in New Jersey is a complex assemblage of organisms with two or more distinct facies, which were doubtless associated with different environmental conditions, such as depth of water, character of the sea bottom, etc. . . . Two distinct [alternating] facies of the fauna have here been distinctly recognized, one of which, the *Cucullæa* fauna, . . . is characteristic of the more glauconitic beds. . . . The second faunal facies, characterized by *Lucina cretacea* or its associates, occurs in the clays and sandy clays." "In tracing their relationships with other Cretaceous faunas in North America, it is found that they have a close analogue in the faunas of the Montana group of the West and Northwest."

The following Fox Hills species have been identified in these New Jersey faunas: *Micrabacia americana*, *Cuspidaria ventricosa*, *Cymella undata*, *Pteria petrosa*. Many others of the New Jersey species are clearly allied very closely to Fox Hills forms. The relationship with the Montana is stated to be "far closer than would be suggested by a mere comparison of the

species here considered as identical, and future studies will surely show many more identical species as well as many which are closely allied. These relationships are so close, in fact, that the name Montanan might perhaps be extended to embrace the faunas and their including sediments."

The fauna of the three youngest Cretaceous formations, numbering about 150 species, has its typical development in New Jersey. "Its most conspicuous faunule is the one characterized by *Terebratula harlani*, but south of Maryland this fauna has not been recognized . . . This higher fauna may therefore be designated as the Jerseyian." Its chief elements are Foraminifera (46 species), Brachiopoda (5), Bryozoa (54, described by Ulrich and Bassler), Echinoids (15), and no ammonites. "These beds or their equivalents seem to be absent in the Gulf-border region south of Maryland, in fact, no faunas related to the Jerseyian fauna being recognized elsewhere in North America."

"A comparison of the extensive bryozoan fauna of the Vincetown limesand with similar bryozoan faunas of typical Maestricht beds shows a remarkably close relationship. The genera are largely the same and many of the species also are either identical or closely allied in the two faunas." c. s.

4. *Die Gastropoden des Karnischen Unterdevon*; von Dr. ALBRECHT SPITZ. Beitr. z. Pal. u. Geol. Osterreich-Ungarns, xx. 1907, pp. 115-190, pls. xi-xvi.—This careful and detailed work describes the Lower Devonian gastropods of the central Carnic Alps. There are 112 species, of which 59 are new. Recent generic work on Paleozoic gastropods has progressed so rapidly that but few Americans appreciate the many new names now in use. In this work there are defined but two new genera, *Zonidiscus* and *Cunearia* (a six-sided *Conularia*), but the number of genera and subgenera introduced are thirty-four.

In the Carnic Alps overlying the higher marine Silurian (probably equivalent to the Bohemian E2), a series of black and light-colored limestones occurs that, in physical character and faunal content, are closely correlated with the Lower Devonian of Bohemia, usually referred to as F1 and F2. For many years there has been a discussion as to whether the black limestone, F1, is a distinct horizon or is a facial equivalent of the light-colored and often highly crystalline reef limestone, F2. The problem seemingly cannot be adjusted in Bohemia, as there is no known superposition of these limestones. In the Carnic Alps, however, the two types of limestone are superposed, and here bear, as in Bohemia, their very distinctive faunas. In the black limestone there are 40 species of gastropods and of these 25 pass into the white limestones. The former are characterized by vast quantities of *Hercynella* (4 species) and euomphaloids and by the complete absence of capulids (25 species), as *Strophystulus*, *Platyceras* and *Orthonychia*. In the white limestones there are 97 species, of which 72 are restricted. While but few identical forms occur (9) between Bohemia and the Carnic Alps, yet

their general development indicates direct equivalence and water intercommunication.

In the Carnic Alps, however, the author shows that the black limestones are differently interbedded with the white limestones and, further, that at one end of the region the sections are mainly black, while on the other they are mainly white with intermediate horizons of black limestones. In other words, in the Carnic Alps the faunas that characterize the Bohemian limestone horizons, F1 and F2, are here also restricted to the same kind of limestone; but these specific assemblages are due to the physical character of the sediments and do not represent distinct time horizons. This is a very important observation and seemingly adjusts the difficulties in the age interpretation of the Bohemian etages F1 and F2.

As is well known, the Lower Devonian has a decided Silurian impress and this fact is again brought out in this study. Of the 112 species 24 are closely related to Silurian forms found in Gotland, and 28 with those in etage E2 of Bohemia. In other words, the Lower Devonian life of southern Europe is a direct outgrowth of the Silurian faunas of the Atlantic area. The American Helderbergian is also derived from this area, but belongs to a distinct province. Of American species in the Carnic Alps there are: *Phanerotrema labrosa*, *Loxonema robustum*?, *Strophostylus expansus*, *S. ventricosus*?, and *Orthonychia undata*?  
c. s.

5. *Geologic Map of the Rochester and Ontario Beach Quadrangles*; by C. A. HARTNAGEL. Bull. 114, N. Y. State Mus., pp. 35, 1907, and map in pocket.—In this bulletin the various Silurian deposits outcropping about Rochester, N. Y., are described and mapped. The section extends from the Medina red shale well up into the Salina. The Clinton formation is here divided into Sodus shale (24 feet), Furnaceville iron ore (14 inches), Wolcott limestone (14 feet), Williamson shale (24 feet) and the Irondequoit limestone.  
c. s.

6. *Scapolite Rocks of America*; by J. E. SPURE (Communicated).—In an article in this Journal published in October, 1900 (vol. x, pp. 310, 311), I described rocks from the Yentna river as containing scapolite. Within the last few months Mr. F. L. Ransome has called my attention to his observation that the mineral in these rocks which was described as scapolite is not scapolite, but quartz. On investigation I have found that this latter determination is correct. In the same article I have described another occurrence of scapolite rocks from the Kuskokwim river and have lately tried to find the material which I described, and so far without success. For the reasons given above, however, I am at present skeptical as to the value of this latter determination also.

7. *Mammalian Migrations between Europe and North America*.—Attention is called to the fact that in an article by Dr. W. D. MATTHEW upon the above subject in the January

number (pp. 68-70) several serious errors of composition were allowed to pass uncorrected: In the tenth line of the first paragraph "Upper Eocene" should read "Upper Miocene"; in the eighteenth line of the same paragraph "North America" should read "North Africa." Further, the middle line in the table on p. 70 should read

Upper Eocene,                      No. America || Asia  $\leftarrow$   $\rightarrow$  Europe; Asia  $\leftarrow$   $\rightarrow$  Africa

8. *The Geological Structure of the North-west Highlands of Scotland*; by B. N. PEACH and JOHN HORNE, with petrological chapters by J. J. H. Teall, edited by Sir Archibald Geikie. Mem. Geol. Surv. Great Britain, Glasgow, 1907. 668 pp., 66 figures and 39 plates in text; 13 petrological plates and a geological map (1:253,440) at end of volume.—Although Gunn, Clough and Hinxman are named on the elaborate title page, which is much abbreviated in the above citation, this fine volume will be universally known as the work of the two senior authors, who for twenty years past have been associated in the laborious task of working out in detail the extraordinary structures of the north-west Highlands of Scotland. The chief headings are: Lewisian Gneiss, Torridonian, Cambrian, Post-Cambrian Movements, and Eastern Schists: it is under the fourth of these headings that the extraordinary overthrusts of the region are described. In contrast to the extreme disturbance of the zone of dislocation, it is remarkable to see, a little farther west, the undisturbed and unaltered Torridonian resting on buried hills of Lewisian gneiss in perfectly normal unconformity. The volume is finely illustrated with photo-plates.

W. M. D.

9. *Schmidt's Geological Sections of the Alps*.—American geologists who are interested in modern interpretations of Alpine structure will find a valuable series of colored sections in several pamphlets by Prof. C. Schmidt of Basel, as follows: *Bild und Bau der Schweizeralpen*, which appeared as a supplement to Vol. XLII of the Swiss Alpine Club, 1907 (Finckh, Basel, 5 francs) containing, besides a beautifully illustrated text, a small geological map and a remarkable group of profiles illustrating the extreme extension given to the modern idea of overthrust folds. *Führer zu den Exkursionen der deutschen geologischen Gesellschaft im südlichen Schwarzwald, im Jura und in den Alpen, August, 1907*, by Schmidt, Buxtorf and Preiswerk (Schweizerbart, Stuttgart, 5 marks), contains a number of more detailed sections, as well as the group of general sections. *Ueber die Geologie des Simplongebietes und die Tektonik der Schweizeralpen* (Ecol. geol. Helv., IX), gives a number of detailed sections and a general geological map of the Alps between St. Gotthard and Mont Blanc. *Tektonische Demonstrationenbilder* (to be had of the author, 1 franc), gives some of the same Alpine sections and several additional sections for the Vosges and the Schwarzwald.

W. M. D.

10. *Südafrika, Eine Landes-, Volks- und Wirthschaftskunde*; by Prof. Dr. SIEGFRIED PASSARGE. Leipzig (Quelle and Meyer),

1908 (received late in 1907).—Passarge, known for his thorough explorations of the Kalahari region of South Africa as reported in a large volume entitled *Die Kalahari* (Berlin, 1904), has now, while acting as professor of geography in the University of Breslau, prepared a more popular account of the region of his travels, from which one may obtain a comprehensive understanding of its geology, land forms and climate, flora, fauna, natives and European colonists. The book is of special value to the scientific geographer—as distinguished from the narrating traveller—in that it places constantly in the foreground the dependence of various phenomena on the nature of the land. W. M. D.

11. *The Production of Gold and Silver in 1906*; by W. LINDGREN and others. Pp. 265.—This is one of the chapters from the Mineral Resources of the United States for 1906, published by the Geological Survey, which are issued in advance of the completed volume, the appearance of which is now promised within a few weeks. It is shown that the production of gold in the United States has increased from \$36,000,000 in 1880 to upwards of \$94,000,000 in 1906. Between 1880 and 1894, the amount produced varied but a few million dollars; in 1895, however, it jumped up to \$46,000,000, and since then the progress has been almost uninterruptedly upward. In regard to silver, the production during the same period and also the price per ounce have varied widely, the total value varying from less than \$30,000,000 (in 1902 and 1903) to upwards of \$57,000,000 (in 1890 and 1891). The amount for 1906 is a little in excess of \$38,000,000, while in 1880 it was nearly \$35,000,000.

Another chapter from the same volume, by David T. Day, is devoted to the production of platinum; it states that the amount produced in the United States has risen from 100 troy ounces in 1880 to 1439 ounces in 1906, the latter valued at \$45,189. During the past year or two, as is generally known, the market price has varied widely, the minimum given for 1907 being \$26 and the maximum \$41 per ounce.

12. *Origin of Meteor Crater (Coon Butte) Arizona*; by H. L. FAIRCHILD. Bull. Geol. Soc. America, vol. xviii, pp. 493–504.—The interesting phenomena presented by the remarkable crater-like pit in Arizona, with which is associated the occurrence of the Canyon Diablo meteorites, are discussed again in this paper. The conclusion reached is summarized as follows: “All the phenomena thus far found in the long and careful exploration of the crater, the distribution of the wreckage both inside and outside, and the composition and structure of the materials, seem to be fully and satisfactorily explained on the theory of impact by a celestial bolide of high velocity, and do not fit any other theory.”

The author urges the propriety of calling the crater *Meteor Crater*, instead of Coon Mountain, or Coon Butte,—names which have formerly been employed. A series of plates give excellent views of the crater as seen from within and without.



13. *On Granite and Gneiss, their Origin, Relations and Occurrence in the Pre-cambrian Complex of Fenno-Scandia*; by J. J. SEDERHOLM (Bull. Com. Geol. de Finlande, No. 23, pp. 110, pls. 8, map and figs. Helsingfors, 1907.)—The author shows in this paper that the rocks of the Fenno-Scandian shield are divisible into definite groups. Some of these are clearly elastic rocks and agree in character in a general way with the Algonkian of North America; in other cases, however, where these rocks have been invaded and injected with granites, they are held to have the characters of the Archean of North America as that term is now used. The explanation of the origin of the gneissose rocks is regarded as necessary to solve the riddle of the Archean, not only because the gneisses form so important a part of the Archean complex of the region, but because the granitization is the process which has done most to obliterate the structures of the Archean rocks and their stratigraphical relations to each other. The Finnish gneisses are not dynamically metamorphosed granites but non-homogeneous distinctly veined rocks. The body of the work is devoted to the detailed study and recording of the facts observed on the splendid exposures along a portion of the southern coast of Finland, and from these observations the author draws some important conclusions. Thus he observes gradual passages between granites and mica schists in which no line of demarcation can be drawn. He believes that the strongly contorted structure characteristic of most Finnish gneisses is not a secondary phenomenon in a true sense but that it originated when the rock was in a melting condition. He regards the foliation of the granites, when not of dynamic metamorphic origin, as formed by the incomplete melting and recrystallization of schistose rocks.

The author holds that in some regions he has found that the basement complexes of the typical Archean sedimentary formations have been preserved though much altered. But in the coast region the phenomena of refusion or resolution have occurred so extensively that it must be assumed that the whole area has been in a melting condition when it was once sunk to so great a depth that it approached the magma ocean or tectosphere of the earth. His ideas concerning the interior of the earth are based on the views of Arrhenius. The magmas under pressure make their way upward through the weakest parts of the crust, dissolving them in large measure. It is assumed that this process of regional resolution does not alter the composition of the magma as a whole because it assimilates almost *all* of the material resulting from the destruction of magmatic rocks, whose composition is thus restored. Granitic rocks predominate in the basal complexes which the magma penetrates on its upward way and the sheet of sediments is too thin in comparison to have any serious effect in changing the composition of the great magma masses.

Following Hutton, the author imagines the process of the destruction and gradual renewal of the solid part of the earth's crust as one of circulation. The granitic magma, once solidified and in part decomposed, undergoes again, when brought into the deeper parts of the earth, a resurrection. Regional metamorphism is caused by a weaker form of the plutonic forces which at greater depths manifest themselves in regional resolution, to which latter the general name of *anatexis* is given. L. V. P.

### III. ZOOLOGY.

1. *Recent Madreporaria of the Hawaiian Islands and Laysan*; by T. WAYLAND VAUGHAN. Bulletin 59, U. S. National Museum, 4to, pp. ix + 222 + index, 96 plates, 1907.—This is another admirable work on the corals, illustrated by excellent half-tone reproductions of photographs, which serve admirably to show the details of coral structures. This work is practically an exhaustive one for the reef corals of the regions treated. It also contains all the deep-sea corals hitherto dredged in the adjacent ocean. Many pages are devoted to tables of the local and general distribution, both geographical and bathymetrical, and other matters of general interest. The present work records 129 species and varieties, many of them new. Previously only about 38 species were recorded. A. E. V.

2. *Madreporaires d'Amboine*; by M. BEDOT. Voyage de MM. M. Bedot et C. Pictet dans l'Archipel Malais. Geneva, 8vo, pp. 143-292, plates 5-50 (double size), 1907.—This is a richly illustrated work on the reef corals of Amboina. The 46 plates are double octavo size. They are finely executed reproductions of excellent photographs, many of them enlarged. Amboina has a rich coral fauna, and many of the species illustrated are widely distributed in the Indo-Pacific faunæ. This work is therefore of great utility in the study of the corals of the entire region. Numerous new species are described. A. E. V.

3. *An Account of the Crustacea of Norway*; by G. O. SARS. Vol. V, Copepoda, Harpactoidea; Parts xix, xx, 1907; 4to, pl. 145 to 160.—This is a continuation of the great work on Norwegian Crustacea upon which Professor Sars has been engaged for several years, parts of which have hitherto been noticed in this Journal, from time to time. The plates, as usual, are autographic, drawn by the author. A. E. V.

4. *North American Parasitic Copepods belonging to the family Caligidae*; by CHAS. B. WILSON. Parts 3 and 4, Pandarinae and Cercopinae. Proc. U. S. Nat. Mus., vol. xxxiii, pp. 323-490, plates xvii-xliii, 1907.—This is a valuable contribution to our knowledge of a group of Crustacea that has hitherto been too much neglected in America. It includes general accounts of the larval development and habits. It represents a large amount of

good work, but indicates much more yet to be done, in the same lines.

A. E. V.

5. *Echinoidea of the Danish Ingolf Expedition*; by TH. MORTENSEN. Vol. IV, 2. Part II. 4to, 20 pages, 19 plates, 27 cuts.—This elaborate work contains detailed descriptions and figures of a large number of deep-sea species, with elaborate details of the pedicellariæ, spicules, etc., together with chapters on the distribution and a very useful general list of the Echinoidea of the Atlantic, with their geographical and bathymetrical distribution. In the Introduction the author discusses still further the unfortunate controversy and misunderstanding between himself and Mr. A. Agassiz in regard to the nomenclature and classification of the Echini.

A. E. V.

6. *Bermuda in Periodical Literature, with occasional reference to Other Works. A Bibliography*; by GEORGE WATSON COLE. Pp. 275, with portrait of the author and 8 fac-simile reproductions of the title-pages of ancient works on Bermuda, 1907. Published by the author, Riverside, Conn.—This is a reprint (with additions) of a series of articles on this subject published during several years past in the Bulletin of Bibliography. It contains the titles of 1382 works. A large part of the articles noticed are on scientific subjects, especially zoölogy, botany, and geology. The author has in most cases given a synopsis of the contents of such papers, often with complete lists of species recorded for the first time, together with other matters of importance. In the case of historical and descriptive works, extracts of notable or important passages are also given. The work is an exceedingly useful one for any one interested in the Bermudas. For the student of its flora or fauna it is indispensable. Many titles which were received too late for insertion in their regular places are included in the supplements, and, as a matter of course, a few were overlooked, but it is remarkably complete.

A. E. V.

7. *Notes on the Parasites of Bermuda Fishes*; by EDWIN B. LINTON. Proc. U. S. Nat. Mus. xxxiii, No. 1560, pp. 85-126, 15 plates, 1907.—This includes the results of the studies made by Professor Linton, while at the Bermuda Biological Station in the summer of 1903. In addition to the large number of species described, many of which are new, the author gives a list, of considerable length, of the fishes examined and the parasites found in them. Also notes on the food contents. This is a pioneer work on the internal fish-parasites of that locality, few if any having been recorded previously.

A. E. V.

8. *North Carolina Geologic and Economic Survey. Volume II. The Fishes of North Carolina*; by HUGH M. SMITH. Pp xi, 453, with 21 plates and 188 figures. Raleigh (E. M. Uzzell & Co. 1907).—The state of North Carolina is naturally divided into three sections, each peculiar in the character of its waters and hence more or less so in its fish fauna. These include the coastal plain, the Piedmont plateau, and the Appalachian mountain region.

This varied character of the waters, taken into account with the number of prominent rivers, results in an unusually large number of species. The subject has been investigated by many authors, so that the list here given may be regarded as very nearly complete. The volume gives for each species the technical name and original describer, the popular names and a concise description; then follows a general account as to distribution, habits, economic value, and so on. The volume is liberally illustrated, both by text-figures and by excellent full-page plates, many of the latter showing the species in their natural colors.

9. *Wiedersheim's Comparative Anatomy of Vertebrates*; adapted from the German by W. N. PARKER. Third Edition, pp. vi, 576; with 372 figures. London, 1907 (Macmillan & Co.).—For a quarter of a century the German editions of this work have served as standard books of reference throughout the world. The two preceding English editions have been used extensively in advanced courses in vertebrate anatomy in the principal universities of all English-speaking countries. The present book, based on the sixth German edition, has been almost entirely re-written by Professor Parker and such additional matter and illustrations added as were necessary to include the results of the most recent investigations in the field of vertebrate zoology. The more important original publications on the subject are arranged in a classified bibliography containing more than two thousand titles.

As a standard text-book for advanced students, and a reference handbook for teachers and students in elementary courses, this work stands preëminent. It is, however, to be regretted that so excellent a book is marred by a large number of typographical errors.

W. R. C.

10. *Final Natural History Essays*; by GRAHAM RENSHAW. Pp. 225. London and Manchester, 1907 (Sherratt & Hughes).—This book consists of a series of essays on some of those species of mammals which are of peculiar interest to the general reader either because of their singular habits and instincts or their near approach to extinction. The subject is treated from the standpoint both of the zoologist and the historian, and a multitude of interesting facts about the animals selected are presented in a popular and entertaining manner.

W. R. C.

#### IV. MISCELLANEOUS SCIENTIFIC INTELLIGENCE.

1. *Report of the Secretary of the Smithsonian Institution for the Year ending June 30, 1907*. Pp. 95. Washington, 1907.—The report of the Secretary of the Smithsonian Institution recently published is of special interest since it is the first which has been issued by Dr. Walcott. The Institution is fortunate in that its new head has not only a thorough command of the various branches of science concerned, but also has unusual executive

ability long shown in his effective administration of the Geological Survey ; under him we may look forward to a development of the Smithsonian to a still higher degree of efficiency. It is to be hoped that the duties of the office will not be so arduous as to interfere with his desire to follow in the footsteps of his predecessors in carrying forward research work in his own department of geology and paleontology.

In discussing the special problems in connection with the Institution, attention is called by the Secretary to the fact that while its activities are most varied, and call for a large expenditure each year, its specific endowment is somewhat less than \$1,000,000, one-quarter of which belongs to the Hodgkins research fund established in 1891. The Institution has been liberally treated by Congress, receiving \$1,000,000 for the year ending June 30th, 1907, and \$1,750,000 for the current year including the amount called for by the new Museum building. Notwithstanding this support from the Government, however, there are many lines of work in which the Institution is interested, which lie outside of those which the Government can properly be asked to support. In order that it should accomplish, therefore, the fullest amount of usefulness, a large increase of its endowment fund is called for.

The Institution has distributed through the year nearly 33,000 volumes and separates of its various publications. Of the Annual Report 10,000 copies are printed, most of which go to public libraries, and thus bring within the reach of many readers the permanent results of the year's progress in science. In addition to the above, a plan has been initiated of distributing abstracts of the publications of the Institution and also special articles on the investigations in progress, which have been distributed and widely used by the daily newspapers.

The present report gives a concise statement of the various special subjects which have been under investigation, including those supported by the income of the Hodgkins fund ; also an account of the various other functions of the Institution, all of which must be carefully read before its full activity can be appreciated. In regard to the progress on the new building for the National Museum, it is stated that there is every reason to expect that the work will be completed and the building ready for occupancy by the beginning of 1909. It is proposed to devote it to the scientific and historical collections, while the present Museum building, which has been extensively repaired, will be employed for the development of the department of arts and industries. Further, the upper exhibition hall of the Smithsonian building proper is to be used for the fine arts collection, and the lower hall for a library, containing also certain exposition series. The department of international exchanges has now so fully developed that the number of packages annually handled is about 200,000, weighing over 200 tons. In this way correspondence is carried on with over 58,000 establishments and individuals, 46,500 of which are outside of the United States.

It is interesting to note that Mr. C. G. Abbot, for a number of years in charge of the Astrophysical Observatory established under Professor Langley, has now been made director. The work of the Observatory, carried on during the year both on Mt. Wilson and at Washington, has continued the former investigations of the intensity of the solar radiation and its relation to the earth's temperature. The results accomplished are briefly summarized as follows: "The investigations have resulted in apparently definitely fixing the approximate average value of the 'solar constant' at 2.1 calories per square centimeter per minute, and in showing decisively that there is a marked fluctuation about this mean value, sufficient in magnitude to influence very perceptibly the climate, at least of inland regions, upon the earth." The second volume of the *Annals*, now in press, includes an account of the work of the Observatory from 1900 to 1907.

2. *Report on the Progress and Condition of the U. S. National Museum for the Year ending June 30, 1907.* Pp. 118. Washington, 1907.—The account of the work accomplished by the National Museum for the past year, given briefly in the Report of the Secretary of the Smithsonian Institution as noted above, is here presented in detail by Dr. Rathbun. The progress toward completion of the new building is fully described, as also the work on the collections, in a number of lines of research and in various explorations. The volume closes with a list of accessions for the year and also of papers published under the auspices of the Museum.

3. *Carnegie Institution of Washington. Year Book No. 6, 1907.* Pp. vii, 230, with 11 plates. Washington, January, 1908. (Published by the Institution.)—This report gives an interesting account of the work of the Carnegie Institution for the year ending October 31, 1907. As noted by President Woodward, the Institution has developed very rapidly since its foundation in 1902, so that all its resources are now called for to meet present demands. The income expended during the past six years reaches the large sum of \$2,683,000; of this \$1,202,300 has been devoted to the support of large projects, nearly \$700,000 has gone for minor and special projects and research associates and assistants, \$140,600 for publication, \$234,000 for administration, and the remainder for investments and for the administration building. The allotment for the past year amounts to \$520,000 for large grants, while \$64,000 was assigned for minor grants, \$25,400 for research associates and assistants, \$16,600 for publication and \$10,870 for administration. The fact is noted that the amount devoted to work in the physical sciences, including biology, preponderates largely; but this course finds justification in the relative prominence of this line of investigation at the present time. The larger projects, to which the greater part of the year's income is devoted, are the same as those enumerated in the notice of Year Book No. 5, published a year since (see vol. xxiii, p. 156). It is to be noted, however, that

considerable sums have been devoted to the new Geophysical Laboratory, the Laboratory for Studies in Nutrition, and the Solar Observatory.

The Geophysical Laboratory, of which Dr. A. L. Day is Director, was completed in June, 1907, at a cost of \$100,000 for the site and building, and \$50,000 for its equipment. The building is located near the Bureau of Standards in Washington and has been very carefully planned for the special kinds of research for which it is intended. It presents some novel features: for example, in its treatment of the problem of temperature it is so arranged that investigators can carry on the work uninterruptedly, without excessive discomfort, through the hot summer; this end is accomplished by an insulating layer of hollow terra cotta about the exterior brick wall of the building. Special provisions have also been adopted to prevent the disturbance due to the heavy machinery belonging to the building. The Nutrition Laboratory has been established in Boston, near the Harvard Medical School, and also in the neighborhood of existing and contemplated hospitals, so that the conditions will be as favorable as possible for researches in the physics, chemistry, and pathology of nutrition. The cost for the building will be about \$100,000; it is to be commenced on February 1, and its completion is promised at an early date. The Solar Observatory, at Mt. Wilson, has progressed favorably, notwithstanding the difficulties of the problems involved, and unfavorable local conditions due to weather and labor. The erection of the 60-inch reflecting telescope will be completed in the coming spring.

In addition to the report of the Director, this volume contains also interesting summaries of the results accomplished on the various larger projects, prepared by the several gentlemen in charge, and also abstracts of the work done in connection with the numerous minor lines of investigation.

The following list gives the titles of the publications of the Institution received during the last few months (continued from vol. xxiv, p. 382):

No. 43. Heliographic Positions of Sun-Spots Observed at Hamilton College from 1860 to 1870; by C. H. F. PETERS. Edited for Publication by EDWIN B. FROST. Pp. xiii, 189, 4to.

No. 55. Revision of the Pelycosauria of North America; by E. B. CASE. Pp. 176 with 35 plates and 74 figures, 4to. (See p. 84.)

No. 54 (Volume 2). Research in China. In three volumes and Atlas. Volume Two. Systematic Geology; by BAILEY WILLIS. Pp. v, 133, 4to.

No. 63. The Electrical Conductivity of Aqueous Solutions. A Report presented by ARTHUR A. NOYES upon a Series of Experimental Investigations executed by A. A. NOYES and others. Pp. vi, 352, with 145 tables and 20 figures.

No. 67. The Fauna of Mayfield's Cave; by ARTHUR M. BANTA. Pp. 114 with 13 figures.

No. 77. The Influence of Inanition on Metabolism; by FRANCIS G. BENEDICT. Pp. v, 542, with 258 tables.

No. 78. Synopsis of Linear Associative Algebra: A Report on Its Natural Development and Results Reached up to the Present Time; by JAMES B. SHAW. Pp. 145.

No. 85. Index of Economic Material in Documents of the States of the United States. Vermont, 1789-1904. Pp. 71. Maine, 1820-1904. Pp. 95. Prepared for the Department of Economics and Sociology of the Carnegie Institution of Washington, by ADELAIDE R. HASSE.

No. 91. Guide to the Materials for the History of the United States in Spanish Archives (Simancas, the Archivo Historico Nacional, and Seville); by WILLIAM R. SHEPHERD. Pp. 107.

Contributions from the Solar Observatory, Mt. Wilson, California. No. 20. Spectroscopic Observations of the Rotation of the Sun; by WALTER S. ADAMS. Pp. 22. Reprinted from the ASTROPHYSICAL JOURNAL, vol. xxvi, November, 1907.

No. 79. Researches in the Performance of the Screw Propeller; by W. F. DURAND. Pp. 61, with 85 figures and 4 tables.

No. 80. Conductivity and Viscosity in Mixed Solvents. A Study of the Conductivity and Viscosity of Solutions of Certain Electrolytes in Water, Methyl Alcohol, Ethyl Alcohol, and Acetone; and in Binary Mixtures of these Solvents; by HARRY C. JONES, and others. Pp. v, 235.

No. 81. Mutations, Variations, and Relationships of the Oenotheras; by D. T. MACDOUGAL, A. M. VAIL, and G. H. SHULL. Pp. 82, with 22 plates.

No. 83. Guide to the Materials for American History in Cuban Archives; by LUIS M. PEREZ. Pp. ix, 142.

4. *The Carnegie Foundation for the Advancement of Teaching. Second Annual Report of the President, HENRY S. PRITCHETT, and Treasurer, THOMAS MORRISON CARNEGIE.* Pp. 124.—The Second Annual Report of the Carnegie Foundation covers the period from July 1st, 1906, to September 30th, 1907; it having been arranged that the fiscal year shall in future begin on October 1st. All those who are concerned with college and university work in this country will be interested in this detailed report, showing what the Foundation has accomplished thus far and what are its plans for the future. There are at present 55 institutions upon the accepted list, and grants have thus far been made to 166 persons involving an annual cost of \$234,660. On October 1st, 148 persons were receiving allowances, 133 of these being professors and officers, and 15 widows of professors. The total expenditure was \$202,145, \$124,990 going to accepted institutions and \$77,155 being paid to individuals outside of them. This last item indicates the wise liberality with which the funds are being administered. The total fund with accumulations now amounts to a little over \$10,700,000, and the income for the fifteen months covered by the report was \$644,000, of which only \$199,000 was expended, leaving an additional accumulated sum of \$445,000.



Dr. Pritchett discusses in detail the policy that has been adopted in dealing with institutions, and with individual teachers not falling directly under the provisions of the gift. One reading these pages sees at once the careful thought which this part of the work has received, which is especially necessary in view of the surplus income now available.

In addition to the information given in regard to the special work of the Foundation, a series of chapters also contain discussions of a number of problems concerning the higher education in this country; these will be read with profit by all who are connected with the work of advanced teaching. Some of the topics discussed are: The place of the college in American education, the evolution of the American type of university, the distinction between college and university, and the relation in both of efficiency to cost. The fact that there are more than 950 institutions in the United States and Canada which claim to be either colleges or universities, and that out of 500 of these 330 have incomes of less than \$50,000, gives point to the suggestions made; as also the additional fact that the cost of educating a student at one of our larger institutions involves an expenditure of \$420 per student.

5. *Bulletin of the Mount Weather Observatory.* WILLIAM J. HUMPHREYS, Director; WILLIAM R. BLAIR, Assistant Director. Prepared under the direction of WILLIS L. MOORE, Chief of Weather Bureau. Pp. 63, with 9 plates, 3 figures, and 6 charts. Washington (U. S. Weather Bureau), 1908.—The Mount Weather Observatory is situated in Virginia, 20 miles from Harper's Ferry, and at an altitude of 1725 feet on the top of the Blue Ridge Mountains. The bulletin now inaugurated is planned to appear quarterly and will contain accounts of the meteorological researches conducted at the observatory named by the Weather Bureau. The first number is largely devoted to methods and apparatus used in obtaining by kite flights the observations of the upper air, which have proved to be of such value in weather forecasting. It argues well for the further development of the weather service, which has accomplished such good work since it started in 1870, that systematic and well directed work in the various lines of scientific research connected with weather forecasting should be carried on.

6. *Publications of the Allegheny Observatory of the Western University of Pennsylvania.* Volume I, No. 1. On the Distortion of Photographic Films; by FRANK SCHLESINGER. Pp. 6. Published from the Magee Fund.—This discussion of a subject of much importance in astronomical work has recently appeared.

7. *Les Prix Nobel en 1905.* Stockholm 1907 (Imprimerie Royale. P. A. Nostedt & Söner).—This is another volume of the series (see vol. xxiv, 508) relating to the Nobel Prizes. It gives biographical notices and portraits of the recipients for 1905, namely, in science, Philipp Lenard, Adolf von Baeyer, and Robert Koch, also representations of the medals and diplomas. The lectures delivered by these gentlemen at Stockholm close the volume.

It is interesting to note in this connection that Professor A. A. Michelson, of the University of Chicago, has recently been awarded the Nobel prize in Physics for 1907. The same gentleman has received the award of the Copley medal of the Royal Society of London.

The other recipients of the Nobel prizes in science are Prof. Buchner of Berlin in chemistry and Dr. Laveran of Paris in medicine.

8. *The Elements of Mechanics*; by W. S. FRANKLIN and BARRY MACNUTT. Pp. 283. New York, 1907 (The Macmillan Company).—The authors have succeeded in making a dry subject for the most part genuinely interesting reading. This is achieved by a pleasing style and the choice of very up-to-date illustrations, such as unbalanced torque in a fan blower, the use of the gyroscope to prevent rolling in a ship, etc. The chapter on Physical Arithmetic is especially good, and there is an abundance of fresh and well graded exercises for numerical calculation. Perhaps too little attention is paid to rigid proof of formulæ, and some topics are treated rather cursorily.

An introductory chapter, which might well be omitted, abounds in passages hardly less surprising than the following :—

“The Laws of Motion! You, my young friend, must have in some measure my own youthful view, which, to tell the truth, I have never wholly lost.” . . . . “The Method of Science! That, my young friend, is where constraint and exactness lie.” . . . . “The change of thought . . . . which must take place before you can enter into practical life may best be expressed by the life history of a remarkable little animal, the “axoloti” . . . . etc., etc.

W. B.

#### OBITUARY.

##### PROFESSOR CHARLES A. YOUNG, LL.D.

On January 3, 1908, there occurred an eclipse of the sun, and on the same day the life of Professor Young, the eminent student of solar physics and observer of many eclipses, came to its close. Coming so soon after the death of Professor Asaph Hall, the vacancy thus left in the ranks of the older astronomers of America will be widely felt and not easily filled.

Charles Augustus Young was born at Hanover, N. H., on December 15, 1834, the son of Ira Young, Professor of Natural Philosophy and Astronomy at Dartmouth, and grandson of Ebenezer Adams, an earlier occupant of the same chair. His early education was at home, and he graduated from Dartmouth College in 1853, at the age of only nineteen, but at the head of his class. From 1853 to 1856 he taught in the Classical department of Phillips Andover Academy, pursuing also a course of theological study during the last year. From 1856 to 1865 he was Professor of Mathematics, Natural Philosophy and Astronomy in Western Reserve College, Hudson, Ohio; and in 1865 returned to follow his father and grandfather as Professor of

Natural Philosophy and Astronomy at Dartmouth, to which position was attached the directorship of the Shattuck Observatory. From here he was called in 1877 to become Professor of Astronomy at Princeton, where he had connected with his dwelling a good working observatory equipped with a nine-inch equatorial, four-inch transit, pair of fine clocks with chronographs, etc.; he was also director of the Halsted Observatory, where in 1882 the 23-inch equatorial was installed. Here he remained till 1905, when from failing health he resigned his active duties and was made Professor Emeritus, returning to spend the closing years of his life at his old home in Hanover.

As might be expected from his training and his parentage, he early showed a decided aptitude for astronomical observation, and gave himself to that science, to which his life was devoted and in which his well-deserved fame was won. He devised a form of automatic spectroscope which has been in very general use, and during his life made many new and important observations on the solar spectrum and prominences. He also verified experimentally the fact that the Fraunhofer lines are slightly shifted in one direction or the other, according as the source of light is moving toward or from the earth, and by this method was able to calculate the velocity of the sun's rotation.

He took part in several astronomical expeditions of importance, observing nearly all the solar eclipses that have occurred during his active life. On August 7, 1869, while at Dartmouth, he had charge of the spectroscopic observations of the party to observe the eclipse at Burlington, Ia., and at that time first saw the "1474" line which characterizes the coronal spectrum (see this Journal (2), *xlviii*, p. 288). On December 22, 1870, as a member of the U. S. Coast Survey party under Professor Winlock, which observed the solar eclipse at Jerez, Spain, he for the first time observed the reversal of the Fraunhofer lines of the solar spectrum (this Journal (3), *i*, 156), an observation for which in 1891 he received the Janssen medal from the French Academy of Sciences. In the summer of 1872 he made spectroscopic observations at Sherman, Wy., in connection with the U. S. Coast Survey party, taking advantage of the high altitude (8300 feet), and published lists of the lines reversed in the chromosphere (this Journal (3), *iv*, 358)). In 1874 he was with the Watson expedition to observe the transit of Venus at Peking, China, whose results were valuable, in spite of clouds. On July 29, 1878, the year after he went to Princeton, he had charge of the Princeton expedition to observe the eclipse at Denver, Col., (*ibid.*, *xv*, 279). In 1882 he made observations of the transit of Venus at Princeton, using the 23-inch refractor then recently installed in the Halsted Observatory (*ibid.*, *xxv*, 321), and in 1887 took a party to Russia to observe the eclipse of that year at Ržev, 150 miles from Moscow, but was baffled by stormy weather. Finally, May 28, 1900, he led a Princeton party to observe the eclipse at Wadesboro, N. C., which was perhaps his last active scientific work.

In all these years of scientific observational activity, with the pressure of University duties ever upon him, and in later years with impaired health, he yet found time to publish many articles in periodicals both scientific and popular, delivered popular lectures at the Peabody Institute, Baltimore, and Lowell Institute, Boston, and educational courses for successive years at Mount Holyoke College, Williams College, St. Paul's School and elsewhere. He wrote several books. "The Sun," a volume in the International Science Series, 1882; "General Astronomy for Colleges and Scientific Schools," 1889; "Elements of Astronomy," 1890; "Lessons in Astronomy," 1891; and "Manual of Astronomy," 1902.

Such a life of scientific achievement did not go without public recognition. He received the degree of Ph.D. from Pennsylvania 1870 and Hamilton 1871, and that of LL.D. from Wesleyan 1876, Columbia 1887, Western Reserve 1893, Dartmouth 1903 and Princeton 1905. He was a member of the National Academy of Sciences, and a Foreign Associate of the Royal Astronomical Society of England; member Astron. and Phys. Soc., vice pres. 1902; fellow A. A. A. S., vice pres. 1876, pres. 1883; Assoc. fellow Amer. Acad. Arts and Sci., Boston; Honorary member of N. Y. Acad. Sci., Philadelphia Philos. Soc., Brit. Assoc., Cambridge Philos. Soc., Manchester Lit. & Philos. Soc., Astron. Gesell., Soc. Ital. di Spettroscop., and President of the Board of Visitors of U. S. Naval Observatory 1901-2.

Before closing this brief notice of Prof. Young's life, some mention of his personal character as a friend and a Christian must not be omitted. During the twenty-eight years of his life at Princeton the writer was associated with him in the University work and can testify to his estimable qualities as a Christian man of science, never losing sight of the God behind the Nature which he loved and studied. The resolutions of the University Faculty well say: "His transparent honesty, his unaffected modesty, his insight into principle, and his achievement in discovery united to give his career not only distinction but also grace and beauty, and his qualities as a man won for him our love as well as our admiration," while the students' paper speaks of his "lovable, manly Christian character." So all who knew him mourn his loss, while recognizing the beauty of his life.

C. G. R.

PIERRE JULES CAESAR JANSSEN, the eminent French astronomer and director of the Observatory at Meudon, died on December 23 at the age of eighty-three years. His scientific labors extended into various fields; he was one of the first to use the spectroscope in the study of the sun and accomplished important results at the transit of Venus in 1874, and at a number of solar eclipses, particularly those of 1868, 1870, and 1883; even in 1905, when a man of eighty, he was an active observer.

Dr. PETER TOWNSEND AUSTIN, at one time Professor of Chemistry in Rutgers College, later a consulting chemist, died on December 30 at the age of fifty-four years.

# Relief Map of the United States

We have just prepared a new relief map of the United States, 48 x 32 inches in size, made of a special composition which is hard and durable, and at the same time light. The map is described in detail in circular No. 77, which will be sent on request. Price, \$16.00.

---

WARD'S NATURAL SCIENCE ESTABLISHMENT,

76-104 College Ave., ROCHESTER, N. Y.

---

---

## WARD'S NATURAL SCIENCE ESTABLISHMENT

**A Supply-House for Scientific Material.**

Founded 1862.

Incorporated 1890.

### DEPARTMENTS:

*Geology*, including Phenomenal and Physiographic.

*Mineralogy*, including also Rocks, Meteorites, etc.

*Palaeontology*.      *Archaeology* and *Ethnology*.

*Invertebrates*, including Biology, Conchology, etc.

*Zoology*, including Osteology and Taxidermy.

*Human Anatomy*, including Craniology, Odontology, etc.

Models, Plaster Casts and Wall-Charts in all departments.

---

Circulars in any department free on request; address

Ward's Natural Science Establishment,

76-104 College Ave., Rochester, New York, U. S. A.

## CONTENTS.

	Page
ART. IX.—Historic Fossil Cycads ; by G. R. WIELAND.....	93
X.—Accelerated Cone Growth in Pinus ; by G. R. WIELAND	102
XI.—Ainsworth Meteorite ; by E. E. HOWELL .....	105
XII.—High Level Terraces in Southeastern Ohio ; by G. D. HUBBARD .....	108
XIII.—Triassic Reptile, Hallopus Victor, Marsh ; by F. R. VON HUENE and R. S. LULL .....	113
XIV.—Species of Grapsoid Crustacean ; by A. E. VERRILL	119
XV.—Tourmaline of Crown Point, N. Y. ; by WM. P. BLAKE	123
XVI.—Silurian Fauna in Western America ; by E. M. KINDLE	125
XVII.—Method for the Volumetric Estimation of Titanium ; by H. D. NEWTON .....	130
XVIII.—Isopyrum biternatum Torr. et Gr. ; by T. HOLM ..	133
XIX.—Phosphorescence Produced by the Canal Rays ; by J. TROWBRIDGE .....	141
XX.—Application of a Longitudinal Magnetic Field to X-ray Tubes ; by J. TROWBRIDGE .....	143

### SCIENTIFIC INTELLIGENCE.

- Chemistry and Physics*—Condensation of Water Vapor in the Presence of Radium Emanation, MME. CURIE : Gaseous Nitrogen Trioxide, BAKER and BAKER, 145.—Atomic Weight of Tellurium, BAKER and BENNETT : New Element, Lutecium, G. URBAIN : Association of Helium and Thorium, STRUTT : Organic Chemistry for Advanced Students, J. B. COHEN, 146.—Radio-activity of Lead and Other Metals, J. C. McLENNAN : Production and Origin of Radium, E. RUTHERFORD : Radium Emanation in the Atmosphere near the Earth's Surface, A. S. EVE : Anomalies in the Behavior of Dielectrics, E. R. v. SCHWEIDLER : Effect of Pressure upon Arc Spectra, W. G. DUFFIELD, 147.—Modification of the First Linear Spectrum of Mercury, E. CASTELLI : Gas from Aluminum Electrodes, R. v. HIRSCH and F. SODDY : Two New Worlds, E. E. FOURNIER D'ALBE, 148.
- Geology*—United States Geological Survey, G. O. SMITH, 149, 150.—Report on the Cretaceous Paleontology of New Jersey, 152.—Die Gastropoden des Karnischen Unterdevon, A. SPITZ, 153.—Geologic Map of the Rochester and Ontario Beach Quadrangles, C. A. HARTNAGEL : Scapolite Rocks, J. E. SPURR : Geological Structure of the Highlands of Scotland, PEACH and HORNE : Geological Sections of the Alps : Südafrika, S. PASSARGE, 155.—Production of Gold and Silver in 1906, LINDGREN : Origin of Meteor Crater, Arizona, H. L. FAIRCHILD, 156.—Granite and Gneiss, J. J. SEDERHOLM, 157.
- Zoology*—Madreporaria of the Hawaiian Islands and Laysan, T. W. VAUGHAN : Madreporaires d'Amboine, M. BEDOT : Crustacea of Norway, G. O. SARS : North American Parasitic Copepods, C. B. WILSON, 158.—Echinoidea of the Danish Ingolf Expedition, T. MORTENSEN : Bermuda in Periodical Literature, G. W. COLE : Parasites of Bermuda Fishes, E. B. LINTON : Fishes of North Carolina, H. M. SMITH, 159.—Comparative Anatomy of Vertebrates, W. N. PARKER : Natural History Essays, G. RENSHAW, 160.
- Miscellaneous Scientific Intelligence*—Report of the Secretary of the Smithsonian Institution, 160.—Report of the U. S. National Museum : Carnegie Institution of Washington ; Year Book No. 6, 162.—Carnegie Foundation for the Advancement of Teaching, 164.—Bulletin of the Mount Weather Observatory : Publications of the Allegheny Observatory : Les Prix Nobel, 165.—Mechanics, W. S. FRANKLIN and B. MACNUTT, 166.
- Obituary*—C. A. YOUNG, 166.—P. J. C. JANSSEN : P. T. AUSTIN, 168.

VOL. XXV.

MARCH, 1908.

Established by BENJAMIN SILLIMAN in 1818.

THE  
AMERICAN  
JOURNAL OF SCIENCE.

EDITOR: EDWARD S. DANA.

ASSOCIATE EDITORS

PROFESSORS GEORGE L. GOODALE, JOHN TROWBRIDGE,  
W. G. FARLOW AND WM. M. DAVIS, OF CAMBRIDGE,

PROFESSORS ADDISON E. VERRILL, HORACE L. WELLS,  
L. V. PIRSSON AND H. E. GREGORY, OF NEW HAVEN,

PROFESSOR GEORGE F. BARKER, OF PHILADELPHIA,  
PROFESSOR HENRY S. WILLIAMS, OF ITHACA,  
PROFESSOR JOSEPH S. AMES, OF BALTIMORE,  
MR. J. S. DILLER, OF WASHINGTON.

FOURTH SERIES

VOL. XXV—[WHOLE NUMBER, CLXXV.]

No. 147—MARCH, 1908.

NEW HAVEN, CONNECTICUT.

1908

THE TUTTLE, MOREHOUSE & TAYLOR CO., PRINTERS, 123 TEMPLE STREET.

# REMARKABLE CONSIGNMENT OF Rare and Choice Minerals.

We would again call your attention to this remarkable consignment, which has created a stir among the more advanced collectors. Descriptive lists are now ready for mailing, so if you are interested, send for one of them. We give below a brief list of the most remarkable of them:—

Fine lot of Diamond crystals, from East India, in shades of pink, yellow, purple, and light green, \$3 to \$5 each; Euclase, Capão do Lane, Brazil, one \$75 (white), \$55 (blue) and \$45 (blue); Emeralds, in matrix, Bogota, Columbia, S. A., \$35 to \$250; Takovaya, Ural, \$2 to \$15; Aquamarine, Nertschinsk, Ural, loose crystals and matrix, 50c. to \$15; Alexandrite, Takovaya, Ural, matrix specimens and loose xls, \$3 to \$25; Diopase, Kirghes Steppes, \$15 to \$22.50; Crocoite, with Vanquelinite, Ural, also Tasmania, \$5 to \$10; Topaz, Schneckenstein, matrix specimens, 75c. to \$7.50; Blue and white Topaz, Romana, Cal., \$8 to \$10; Tourmalines, Mesa Grande and Pala, Cal., matrix specimens and loose crystals, \$1 to \$150; Chrysoprase, Silesia, and Pala, Cal., polished, \$2 to \$4; Hyacinth in basalt, Siebengebirge; in lava, Niedermendig, \$2 to \$2.50; Pyropes in serpentine, Zoebnitz, 50c. to 75c.; Essonite, Ala, Piedmont, \$1.75 to \$2.50; Garnet, Bodö, Norway, loose crystals, 25c. to 75c.; Cyanite and Staurolite, Mt. Campione, \$2 to \$2.50; Herderite, on quartz, Poland, \$1 to \$15; Zeophyllite, new mineral, Radzein, Bohemia, \$1 to \$5; Benitoite in matrix, San Benito Co., Cal., \$5 to \$7.50; Polybasite, xls, Durango, Mexico, \$4 to \$6; Hausmannite, new locality, Cumberland, 50c. to \$3; Zinkenite, Nevada, \$1.50 to \$3; Copalite on Coal, new mineral, Castle Gate, Utah, \$1.50 to \$2; Torbernite, Tincroft, \$5 to \$10; Semseyite, on Galena, Felsöbanya, \$2.50 to \$10; Chalcophyllite, Redruth, Cornwall, \$8 to \$10; Crystal Gold, in leaves, Vöröspatak, \$15 to \$25; and in the matrix, from Siebenburgen, \$15; Sylvanite, Nagyag, \$5 to \$7.50; Crystal Silver, Calumet, Michigan, 75c. to \$20; Libethenite, Libethen, \$2.50 to \$5. We still have a fine lot of Hungarian and English Minerals.

## Ore Collection of 220 Specimens.

We have just secured a collection of rich ores, all hand size, and all fine examples, from American Mines. They will be sold singly or as a whole.

## Another Old Collection.

We have secured still another collection of what have come to be known as old collections, that is collections that are rich in examples, from exhausted localities. Particulars on application.

## Cut Gems.

We have every known gem and semi-precious stones.

## Scientific Rubies.

We have a fine lot of these fine gems, from Paris, from 1/2 to 4 k.

Send for lists of our Brooklyn and other collections.

**A. H. PETEREIT,**  
81—83 Fulton Street, New York City.



T H E

# AMERICAN JOURNAL OF SCIENCE

[FOURTH SERIES.]

ART. XXI.—*The Evolution of the Elephant\**; by RICHARD S. LULL.

CONTENTS :

- Part I. General discussion.
- Part II. Evolutionary sequence.
- Part III. Migrations of the Proboscidea.

## PART I.

THE modern word elephant, which may be used comprehensively to include all of the proboscideans, comes from the Greek *ἐλέφας* (*ἐλεφαντ*), a word first used in the literature by Herodotus, the father of history. The origin of the word is somewhat a matter of doubt, certain authorities deriving it from the Hebrew *eleph*, an ox; others from the Hebrew *ibāh*, Sanskrit *ibhas*, an elephant, comparing this with the Latin *ebur*, meaning ivory. Another Sanskrit word is *hastin*, elephant, from *hasta*, a hand or trunk. Thus the ancients emphasized the three characteristics of the proboscideans, size, the tusks, and the trunk, which are the most striking features of the most remarkable of beasts.

The proboscideans may be defined as large, trunk-bearing mammals, with pillar-like limbs, short neck and huge head, often with protruding ivory tusks, the modified upper and, in earlier, extinct types, the lower incisor teeth. The proboscideans constitute a sub-order of the great group of ungulates or hoofed mammals, yet have their nearest living allies in creatures strangely remote in size, form and environment from the lordly elephant, for the paleontologist, in his ardent search for family trees other than his own, often discloses some seemingly paradoxical relationships which completely upset the older ideas of classification. Explorations have recently brought to light evidence to show that the sea-living Sirenia, whose American representative is the Florida manatee, can claim close relationship with the elephants, though nothing

\* An earlier paper in the same series, on the Evolution of the Horse Family, was published in the number for March, 1907.

could be more unlike than the proboscideans and the fish-like Sirenia with broad swimming tail, front limbs reduced to flippers, and no hind limbs at all. On the other hand, anatomists had already recognized certain similarities of structure between the elephants and the *Hyracoidea*, the Hyraces, or conies, furry, rabbit-like animals not more than 18 inches in length, short ears, tailless, and with hoof-like nails instead of the claws one would be led to expect from their general

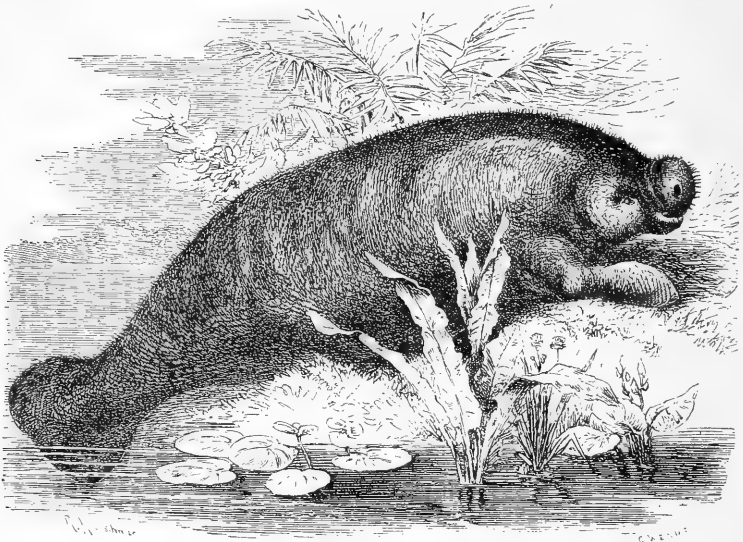

FIG. 1. The Manatee, *Manatus australis*; after Brehm.

appearance. They are confined to Africa with the exception of the Syrian conies, which the Book of Proverbs tells us "are but a feeble folk, yet make their houses in the rocks." Recent exploration in Egypt has revealed the presence of a hyrax much larger than the modern representatives of the order, and proclaiming by its structure a much closer approximation with the early elephants whose bones are found entombed in the same deposits.

Elephants show a curious intermingling of primitive and specialized characters, for in spite of the remarkable development of teeth, tusks, and trunk, many of the other bodily features would serve to place them among the most archaic of the ungulates.

The primitive features of the elephants, briefly enumerated, are as follows: simplicity of stomach, liver, and lungs and the

rather low type of brain. The limbs combine the archaic features of five toes in front and rear and a serial arrangement of wrist and ankle bones with the admirable adaptation of the entire limb to the support of the huge body. The limbs are further primitive in the retention of both bones of the lower leg and arm, for in most other ungulates one of these in each

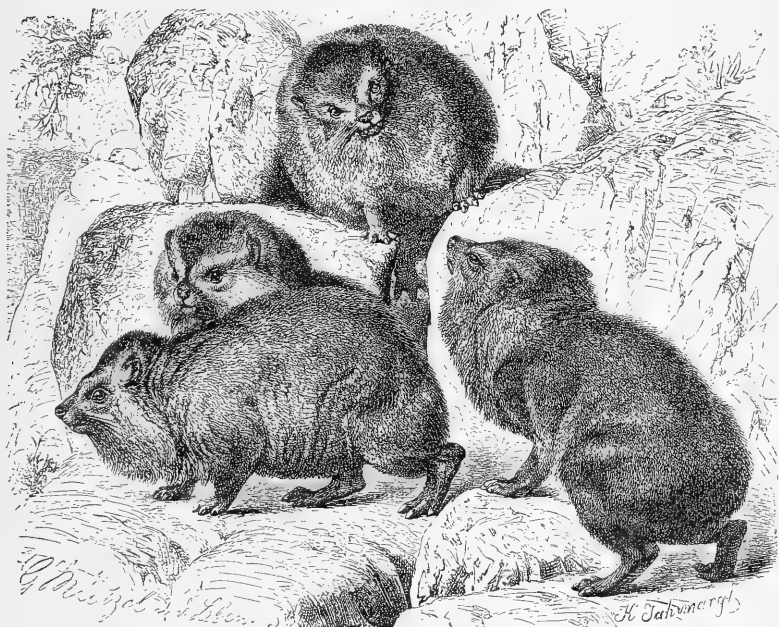

FIG. 2.—Conies, *Hyrax abyssinicus*; after Brehm.

member becomes greatly reduced, being, for part of the length at least, often entirely absent.

The special adaptations are, as in the horses, primarily for food-getting and locomotion, although incidentally the elephants have developed admirable weapons for defense, which, together with the great size and thick skin, render them almost impregnable to their enemies of the brute creation.

#### *Adaptations of the Limbs and Feet.*

The development of the pillar-like limb of the elephant has been shown to be merely a device to support the enormous bodily weight and was independently acquired in other groups of land animals of huge size. In most quadrupeds, however,

the knee and elbow are permanently bent, the upper limb-bones being of the shape of an elongated S. Increasing weight necessitates a straightening of the limb in order that the weight may be transmitted through a vertical shaft. This is more far-reaching than one would suppose, as it implies also a straightening of the bones themselves and a shifting of the articular facets from an oblique to a right angle with reference to the long axis of the bone. The foot has changed its posture

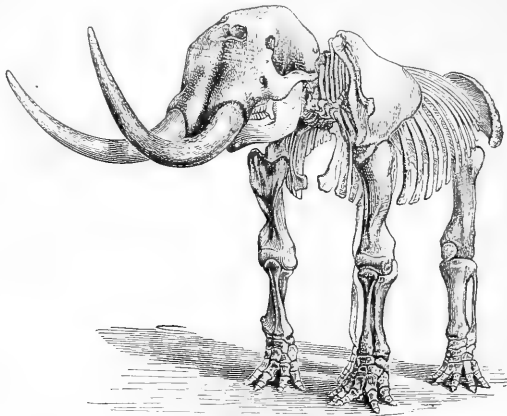

FIG. 3. American Mastodon ; after Owen.

from the primitive plantigrade position, for the heel and wrist bones are elevated above the ground and a thick pad of gristle has developed beneath them in each foot, forming a cushion to receive a share of the weight. The toes are not separate but are imbedded in the common mass of the cylindrical foot, the hoofs being represented by nails around its forward margin. These may be fewer in number than the toes.

#### *Adaptations of the Skull and Teeth.*

Owing to the shortness of the neck and the height of the head from the ground, the proboscis or trunk, which is merely an elongation of the combined nose and upper lip, becomes a most necessary device for securing food and water. This organ is composed of a great number of muscles and so combined and controlled as to give not only enormous strength but the utmost delicacy of movement. The trunk terminates in one (Indian) or two (African elephant) finger-like projections, with which a pin can be picked up from the ground while the entire organ has sufficient strength to uproot a tree.

The development of the trunk has been accompanied by a marked change in the character and form of the skull, which is merely a mechanical adaptation to provide the leverage necessary to wield so weighty an organ. This has been brought about by a shortening of the skull accompanied by a corresponding increase in height. The result is that the base of the trunk has been brought much nearer the fulcrum at the neck, thus shortening the weight arm of the lever, while the increasing height not only lengthens the power arm but gives more surface for the attachment of muscles and the great elastic *ligamentum nuchæ* which aids in supporting the head.

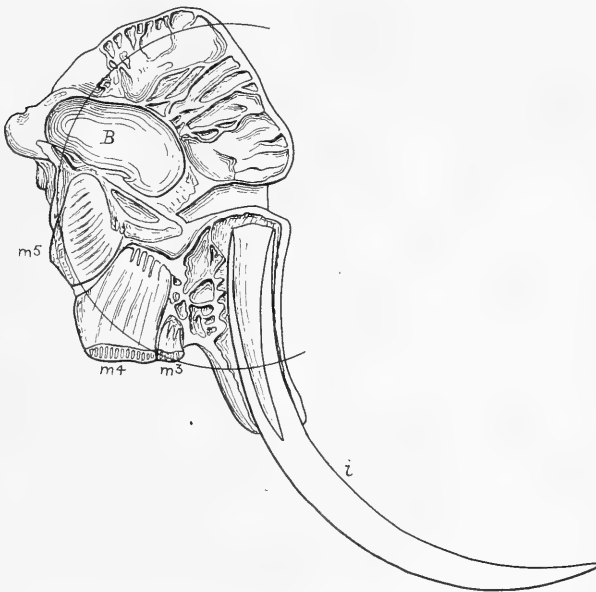

FIG. 4. Sectioned skull of Indian elephant ; after Owen.

This change in the form of the skull, while it gives to the physiognomy of the animal that dignified, intellectual look, does not imply a similar development of the brain, for the brain case has increased but little, the great size of the skull being largely due to the development of air cells in the cranial bones so that the actual thickness of the roof of the skull is greater than the height of the brain chamber itself, a feature well shown in fig. 4.

#### *The Teeth.*

It is generally true among mammals that the normal number of teeth in the adult is forty-four, eleven in each half of

each jaw. This number is rarely exceeded, but often because of specialization a reduction in numbers occurs until, as in the ant-bears, the limit of a totally toothless condition may be reached. The elephants, owing to the great increase in the size of the individual grinders and the loss of all but two upper incisors in the forward part of the mouth, have the total number of teeth reduced *apparently* to six, as but one fully formed grinder is in use in each half of each jaw at any one time.

Actually, however, the number of teeth is greater than this, owing to the peculiar manner of tooth succession in which, instead of having the adult teeth replace those of the milk set vertically, the succession is from behind forward. The tooth forms in the rear of each jaw and moves forward through the arc of a circle (see fig. 4.), gradually replacing the preceding tooth as it wears away through use, until the final remnant is crowded from the jaw and the new tooth is in full service. Bearing this in mind, it is evident that the full tooth series is not confined to those present at any one time, but should include not only teeth which have gone before, but, in a young animal, those yet to come. Sir Richard Owen gives the total dentition of the modern elephant as follows:—incisors  $\frac{2-2}{0-0}$ , molars  $\frac{6-6}{6-6}=28$ , which being interpreted means that there are in each half of the upper jaw two tusks, the first milk tusk being succeeded by the permanent one, while in the lower jaw there are none. There are all told six grinders in each half of each jaw, the first appearing at the age of two weeks and being shed at the age of two years. The second is shed at the age of six, the third at nine, the fourth from twenty to twenty-five, the fifth at sixty, while the sixth lasts for the remainder of the creature's life, up to the age of a hundred to a hundred and twenty years.

The structure of a single tooth finds no exact parallel among other mammals, as it consists of a series of vertically placed transverse plates, each composed of a flattened mass of dentine or ivory surrounded by a layer of enamel. The plates are in turn bound together into a solid mass by a third material known as cement. When the upper surface of the tooth becomes worn through use, the hard enamel appears as a series of narrow transverse ridges between which lie the dentine and cement in alternate spaces, as two enamel ridges with the enclosed dentine are derived from each plate. In order to keep the teeth in proper condition a certain amount of harsh, siliceous grasses or woody material is necessary, otherwise the teeth become as smooth as polished marble and, as the rate of growth is nicely adjusted to normal wear, the elephant suffers

greatly when given improper food. The number of plates in the largest teeth varies from ten or eleven in the African elephant to twenty-seven in the Indian. The hairy mammoth had the most numerous and finest plates of all, representing in this respect the culmination of evolution.

The tusks are merely modified incisor teeth of the upper jaw which continue to grow throughout life. They are com-

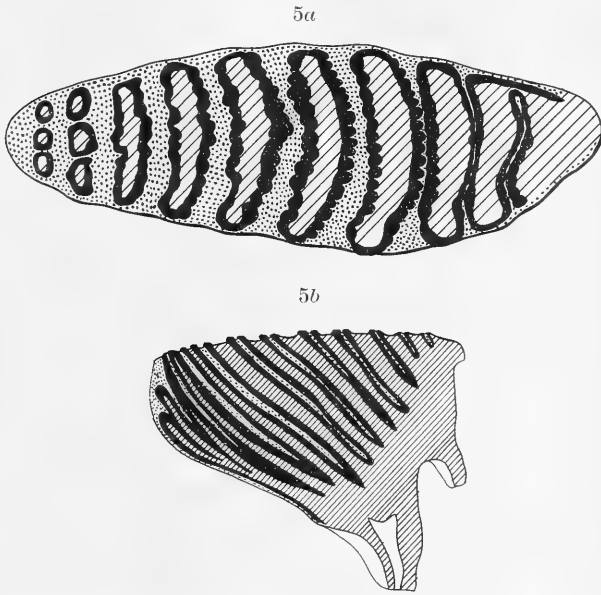

FIG. 5. Crown view and section of a molar tooth, original.

posed entirely of dentine or ivory of a superlative quality, the enamel being reduced to a small patch at the tip which soon becomes worn away. The tusks have various uses, but their primitive purpose is for digging. The African elephant is so industrious a digger that the right tusk is always the shorter, as it has to bear the brunt of the work. Tusks are so small as to be apparently absent in the female Indian elephant and often in the male, while they are present in both sexes in the African species. In size they are always much smaller in the Indian form, as seventy-six pounds is the maximum weight for a single tusk, while the greatest recorded size of those of the African elephant is 10 feet  $\frac{3}{4}$  inches in length by 23 inches in circumference at the base, with a weight of 224 pounds for the right tusk, while the left measured 10 feet  $3\frac{1}{2}$  inches in

length by  $24\frac{1}{2}$  inches in circumference and weighed 239 pounds, a total of 463 pounds for the pair!

#### *Mentality.*

In spite of its archaic type the brain is large and the surface is highly convoluted, the weight being on the average  $8\frac{1}{2}$  pounds; more than double that of man. The intelligence of the elephant has been exaggerated by some writers and greatly minimized by others. Sir Henry Baker, a British explorer, and the German naturalist Schillings, give us the most unbiased view of the mentality of the elephant. Elephants possess a remarkable memory of injuries, real or fancied; of misfortunes; and of the time and place of the ripening of favorite fruits. They also learn to perform complex labors, as the carrying and piling of logs in the teak yards in India without other directions than the initial order. They are said to be weather-wise and to be able to foretell rain some days in advance. Elephants are obedient and docile, notably those of India, but the males especially are subject to periods of nervous excitement, apparently of a sexual nature, known as "must," when they become very dangerous and sometimes destroy the keepers in their paroxysms of rage. Ultimately all male elephants become surly and intractable; in the wild state such are known as rogues and live apart from their kind until they die. A fine specimen of the Indian elephant known as "Chunee" was brought to England in 1810. He was very tractable and continued to grow until 1820, when the first paroxysm occurred, in which he attempted to kill his keeper. Similar paroxysms occurred with increasing force until 1826, when the violence of the animal necessitated its slaughter. With "Chunee" this condition occurred very early in life, as the animal was not fully adult at the time of its death. The famous "Jumbo," an African elephant, was sold from the London Zoölogical gardens because he was no longer trustworthy, from the same cause. He was not, however, a confirmed rogue, even when he died three and a half years later. Jumbo was about seventy-five years old at the time of his death.

There is a possible parallelism between human mental development and that of the elephant. One of the most potent factors in the evolution of man's mind is his ability to handle various objects and thus bring them before the face for examination. This is also found in the elephant, although to a less extent, and undoubtedly has aided materially in its mental development as well.

Elephants are rightly accused of timidity and cowardice, though, when brought to bay, rage may simulate courage,



making a charging tusker a most formidable foe. In common with most forest and jungle dwellers, elephants, while relatively dull of sight, are keen of scent and hearing, in fact marvelously so, for, as Schillings tells us, they either have an acuteness of some known sense far beyond our comprehension or possibly some other sense unknown to us. The sentinels of the herd stand with uplifted trunk, which emphasizes the value of the sense of smell.

Elephants rarely breed in captivity, almost all of the tamed individuals having been born wild; hence artificial selective breeding which has given rise to such valuable results in the betterment of domestic animals is unavailable for the improvement of the race.

The rate of increase is extremely slow, for Darwin tells us that they begin to bear young at thirty years and continue to do so until ninety, during which time six single young are produced on the average. But, to illustrate the necessity of a check upon increase among animals, Darwin says that even at this slow rate the offspring of a single pair would in 500 years amount to fifteen millions, provided they all lived to maturity!

#### *Evidences of Evolution.*

The evidences of evolution are threefold: structure, as shown by comparative anatomy, ontogeny or individual development, and phylogeny or racial history. The last paleontology makes known to us. We may, by comparing the structure of a given form with that of other animals, gain an insight into the probable course of modifications which it has undergone in the development of its distinctive features and often a hint at least as to its ancestry and relationship, as in the case already mentioned of the Hyracoidea and elephants. Again, the small hind-limb and hip bones buried deep within the body of the whales and the hip bones alone in the case of the manatee (*Sirenia*) having no possible function, are indubitable evidence for descent in each case from some land-dwelling quadrupedal type. This has been corroborated in the last instance by the recent finding, in the Eocene of the Egyptian Fayûm, of *Sirenia* with hind limbs.

#### *Ontogeny.*

Embryology shows us the curious parallelism which exists between the individual's history and that of the race, that of the individual being in most cases a more or less abridged summary of that of its ancestors.

I have spoken of the shortening and corresponding increase in height of the elephant's skull to provide the leverage

necessary in wielding the huge trunk. The development of this feature is beautifully shown in individual growth, for the new-born elephant has a relatively long, low skull the walls of which are slightly thickened so that the brain chamber fills the skull completely as in most other mammals. During the

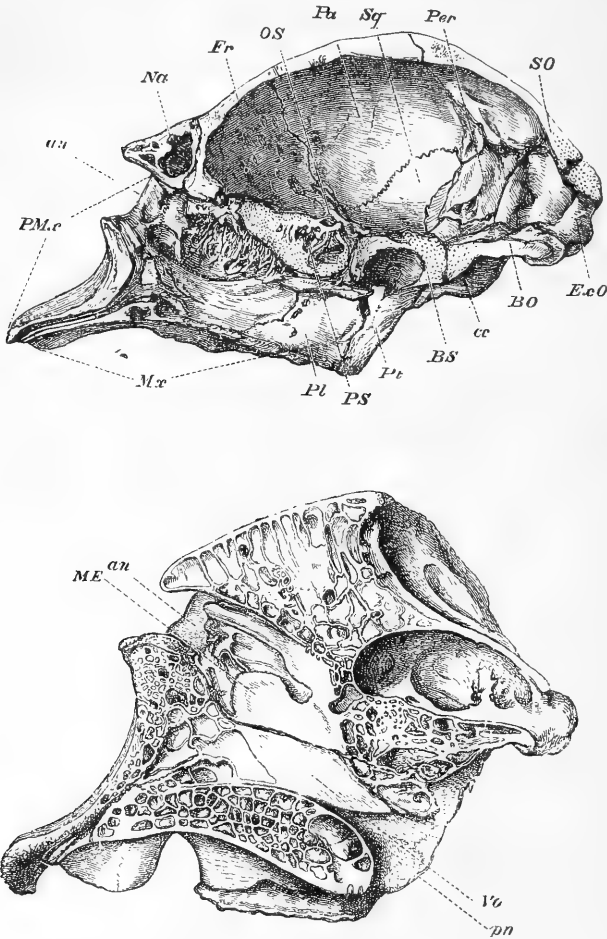

FIG. 6. Section of skull young ( $\times \frac{1}{4}$ ), and old ( $\times \frac{1}{12}$ ): from Flower's Osteology.

course of growth, however, the skull walls thicken greatly through the development of the air cells, while the brain cavity increases comparatively little, just as one would predict from the structure of the adult skull.

Of the prenatal life of the elephant, covering a period of twenty months, we know very little, but it is reasonable to suppose that embryology would give us much more light upon the development of elephantine features. New-born young are elephant-like in every particular with the exception of the skull.

#### *Paleontology.*

The great proof of the evolution of a race of animals is the finding in the ancient rocks more and more primitive forms as one recedes in time, until the most archaic type is reached. By the study of such a series of fossils not only may the evolutionary changes be learned, but former geographical distributions, the original home and the various migrations of the race. While this matter is treated much more fully in the second and third parts of this paper, a brief summary of the racial history may be given as follows :

The earliest known proboscidians were discovered in the Egyptian Fayûm, in beds of middle Eocene age. Their remains are also found in the Upper Eocene of the Fayûm, but the Oligocene elephants are as yet undiscovered. During the early Miocene the first migration occurred into Europe and thence to the region of India and even as far as North America, both of which were reached by the Middle Miocene. The Pliocene saw the elephants in their millenium, having reached the widest dispersal and the maximum in numbers of species. During Pleistocene times the Proboscidia covered all of the great land masses except Australia, but were diminishing in numbers, and toward the close of the Pleistocene the period of decadence began, resulting in the extinction of all but the Indian and African elephants of to-day.

#### *Summary of the Evolution.*

The physical changes undergone by the race are also clearly shown, as the paleontological series is very complete. These changes may thus be summarized: Increase in size and in the development of pillar-like limbs to support the enormous weight. Increase in size and complexity of the teeth and their consequent diminution in numbers and the development of the peculiar method of tooth succession. The loss of the canines and of all of the incisor teeth except the second pair in the upper and lower jaws and the development of these as tusks. The gradual elongation of the symphysis or union of the lower jaws to strengthen and support the lower tusks while digging, culminating in *Tetrabelodon angustidens*. The apparently sudden shortening of this symphysis following the loss of the lower tusks and the compensating increase in size and the change in curvature of those of the upper jaw.

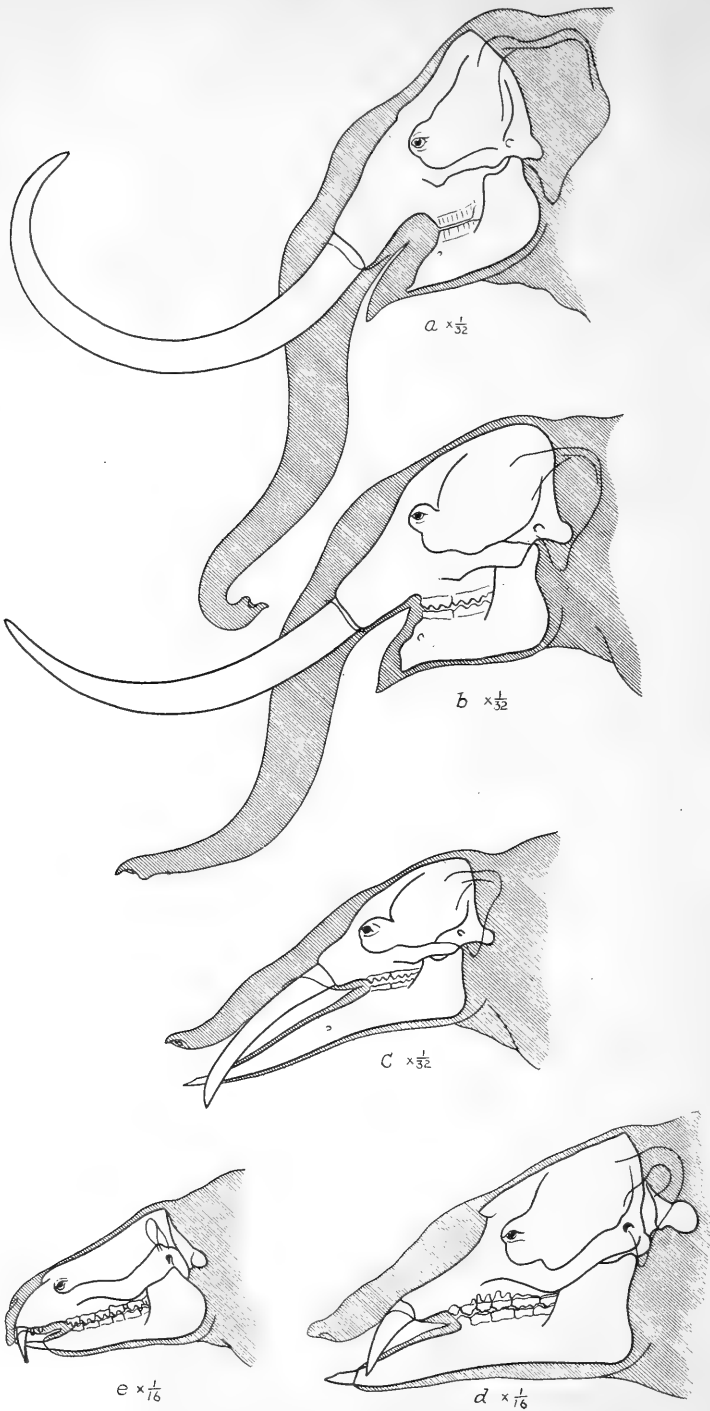

FIG. 7. Evolutionary changes of Proboscidea.

The increase in bulk and height, together with the shortening of the neck necessitated by the increasing weight of the head with its great battery of tusks, necessitated the development of a prehensile upper lip which gradually evolved into a proboscis for food-gathering. The elongation of the lower jaw implies a similar elongation of this proboscis in order that the latter may reach beyond the tusks. The trunk did not, however, reach maximum utility until the shortening jaw, removing the support from beneath, left it pendant as in the living elephant.

The change in the form of the skull developed *pari passu* with the growth of the tusks and trunk, as it is merely a mechanical adaptation to give greater leverage in the wielding these organs. It may readily be seen that these changes curiously interact upon one another; the result of the evolution of its parts being the development of a most marvelous whole.

#### *Elephants Contemporary with Man.*

Aside from the species of elephant now living, at least three extinct types were coeval with mankind, one distinctively American, the mastodon, *Mammot americanum*, one confined to Europe and southern Asia, *Elephas antiquus*, while the third, the hairy mammoth, *Elephas primigenius*, was common to both and to northern Asia as well. Of these the mammoth is without exception the best known of all prehistoric animals, for not only have its bones and teeth been found in immense numbers, but, in several instances, frozen carcasses have been discovered nearly or quite intact, the hair, hide, and even the viscera and muscles wonderfully preserved. In many instances these were irrevocably lost or were devoured by the dogs and wolves or by the natives themselves; two specimens have been preserved however and are now in the St. Petersburg zoölogical museum.

Of these one was found in the Lena Delta in Siberia in 1799 and secured in 1806. The skeleton with patches of hide adhering to the head and feet may still be seen, but the flesh of the animal was devoured by wolves and bears after being preserved in Nature's cold storage warehouse for thousands of years (see fig. 26). In 1901 another specimen was found at Beresovka, Siberia, 800 miles west of Behring strait and 60 miles within the arctic circle. It is supposed that this creature slipped into a crevasse in the ice which may have been covered by vegetation as in the Malaspina glacier of Alaska. That the poor brute died a violent death is certain from the fracture of the hip and one foreleg, and the presence of unswallowed grass between the teeth and upon the tongue. A great mass of clotted blood in the chest tells how suddenly the Reaper over-



FIG. 8. Mammoth of 1901 *in situ*; after Herz.

took it, the creature having burst a blood vessel in its frantic efforts to extricate itself. Much of the hair had been destroyed when the animal was dug out of the cliff, but the collector, M. O. F. Herz, has preserved a very accurate record of texture and color of the hair on different parts of the body. This consists of a wooly undercoat, yellowish-brown in color, and an outer bristly coat, varying from fawn to dark brown and black. The hair on the chin and breast must have been at least half a yard in length and it was also long on the shoulders; that of the back, however, was not preserved.

This interesting relic is mounted in the St. Petersburg museum, the skin in the attitude in which it was found, while the skeleton is in walking posture beside it.

Immense quantities of fossil ivory have been exported from Siberia, there having been sold in the London market as many as 1,635 mammoth tusks in a single year, averaging 150 pounds in weight; of these but 14 per cent were of the best quality, 17 per cent inferior, while more than half were useless commercially. The total number of mammoths represented by the output of fossil ivory since the conquest of Siberia is not far from 40,000, not, of course, a single herd, but the accumulations of thousands of years. The oyster trawlers from the single village of Happisburg dredged from the Dogger Banks off the coast of Norfolk, England, 2,000 molar teeth, besides tusks and other mammoth remains, between the years 1820 and 1833. This indicates not only the great profusion of the mammoths of the Pleistocene, but the existence of comparatively recent land connection between England and the continent.

Direct evidences of the association of man and the mammoth are plentiful in Europe but strangely enough absolutely wanting in North America, although we have every reason to believe that such an association existed in the New World as well as in the Old. In Europe not only have the bones of man and the mammoth been found intermingled in a way that implied strict contemporaneity, but still more striking evidence is shown in the works of prehistoric artists. The fidelity with which the mammoth is drawn indicates that the artist must have seen the animal alive.

One of the most notable of these relics is an engraving of a charging mammoth drawn upon a fragment of mammoth tusk found in a cave dwelling at La Madeline in southern France. In the Grotte des Combarelles (Dordogne), France, there are in addition to some forty drawings of the horse at least fourteen of the mammoth. These are mural paintings or engravings, the former being executed in a black pigment and some kind of a red ochre, while the latter are scratched or deeply incised, sometimes embellished with a dark coloring



FIG. 9. Mammoth of 1901 mounted in the St. Petersburg museum; after Herz.



matter (oxide of manganese). It is especially interesting to note that the people of that day were not only sufficiently advanced to have artists of a very high order, but that they also had begun to domesticate the horse, if one may judge from the indications of harness on some of the equine figures. The horse is a most potent factor in the civilization of mankind.

In the caverns of Fond de Gaume in southern France there are at least eighty pictures, largely those of reindeer but including two of the mammoth. The actual association of man and the mammoth in America has not been proven. In Afton, Oklahoma, is a sulphur spring from which have been brought

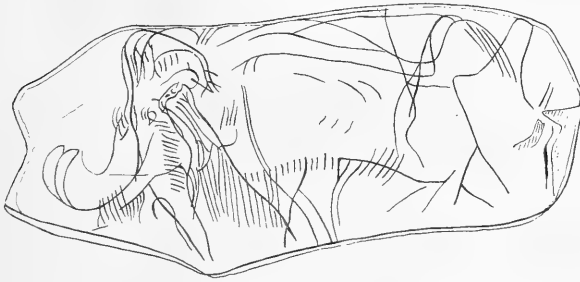

FIG. 10. Charging Mammoth ; after Lubbock.

to light remains of the mammoth (*Elephas primigenius*) and mastodon (*Mammot americanum*) and numerous other animal remains, such as the bison and prehistoric horses. In the spring there were also found numerous implements of flint, mainly arrowheads. This naturally was first interpreted as an instance of actual association of mankind and the elephants, but careful investigation proved that the elephant remains far antedated the human relics, and that the latter were votive offerings cast into the spring by recent Indians as a sacrifice to the spirit occupant, the bones being venerated as those of their ancestors (Holmes). Another instance, not of the association of the mammoth with mankind, but of the mastodon, is probably authentic. This was in Attica, New York, and is reported by Professor J. M. Clarke. Four feet below the surface of the ground in a black muck he found the bones of the mastodon, and twelve inches below this, in undisturbed clay, pieces of pottery and thirty fragments of charcoal (Wright). The remains of the mastodons and mammoths are very abundant in places, the Oklahoma spring already mentioned producing 100 mastodon and 20 mammoth teeth, while the famous Big Bone Lick in Kentucky has produced the remains of an equal number of fossil mastodons and elephants.

Indian tradition points but vaguely to the proboscideans, and one cannot be sure that they are the creatures referred to, yet it would be strange if such keen observers of nature as the American aborigines should not have some tales of the mammoth and mastodon if their forefathers had seen them alive. One tradition of the Shawnee Indians seems to allude to the mastodon, especially as its teeth led the earlier observers to suppose that it was a devourer of flesh. Albert Koch, in a small pamphlet on the Missouri (mastodon) discovered by

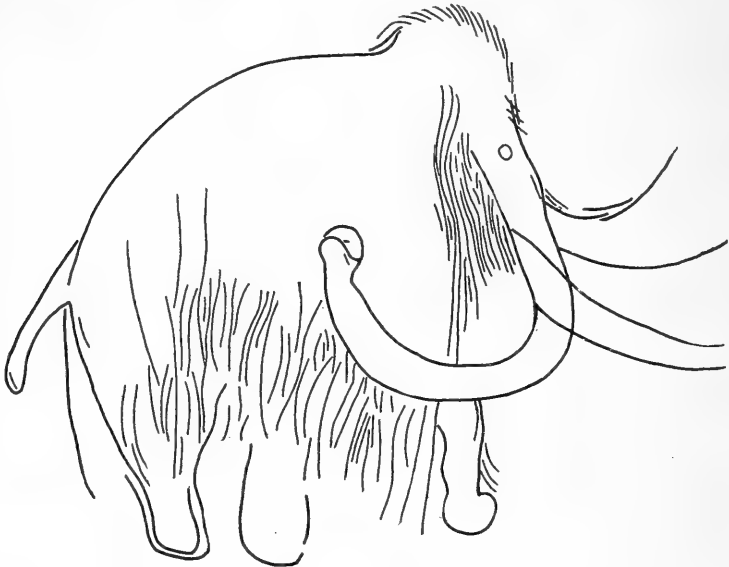

FIG. 11. Painting of Mammoth on wall at Combarelles; after MacCurdy.

him in Osage county, Missouri, and published in 1843, gives the tradition as follows:

“Ten thousand moons ago, when nothing but gloomy forests covered this land of the sleeping sun,—long before the pale man, with thunder and fire at his command, rushed on the wings of the wind to ruin this garden of nature,—a race of animals were in being, huge as the frowning precipice, cruel as the bloody panther, swift as the descending eagle, and terrible as the angel of night. The pine crushed beneath their feet and the lakes shrunk when they slaked their thirst; the forceful javelin in vain was hurled, and the barbed arrows fell harmlessly from their sides. Forests were laid waste at a meal and villages inhabited by man were destroyed in a moment.

The cry of universal distress reached even to the regions of peace in the West; when the good spirit intervened to save the unhappy; his forked lightnings gleamed all around, while the loudest thunder rocked the globe; the bolts of heaven were hurled on the cruel destroyers alone, and the mountains echoed with the bellows of death; all were killed except one male, the fiercest of the race, and him even the artillery of the skies assailed in vain; he mounts the bluest summit that shades the sources of the Monongahela, and roaring aloud, bids defiance to every vengeance; the red lightning that scorched the lofty fir, and rived the knotty oak, glanced only on this enraged monster, till at length, maddened with fury, he leaps over the waves of the West, and there reigns an uncontrolled monarch in the wilderness, in spite of Omnipotence."

## PART II.

*The Early Proboscidians.**Mœritherium.*

The earliest known genus of proboscidians is *Mœritherium*, a small, tapir-like form, from the Middle Eocene Qasr-el-Sagha

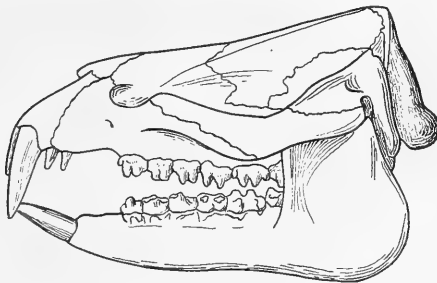

FIG. 12. *Mœritherium* skull; after Andrews ( $\times \frac{1}{7}$ ).

beds of the Fayûm in Egypt. This creature was probably a dweller in swamps, living upon the succulent, semi-aquatic herbage of that time. It has little that suggests the elephants of later days and, were it not for transitional forms, would hardly be recognized as a proboscidian at all. However, one can see the beginnings of distinctively elephantine features. The hinder part of the cranium is already beginning to develop the air cells or diploë, the nostril opening and nasal bones are commencing to recede, indicating the presence of a prehensile upper lip, and the reduction of the teeth has begun, the second pair of incisors in each jaw being already developed as tusks. Those of the upper jaw were dagger-like, and

downwardly projecting, while the lower ones were directed forward, their combined upper surface forming a continuation of the spout-like union or symphysis of the jaws. The molar

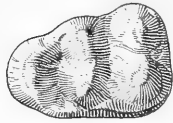

FIG. 13. Tooth of Mærittherium ( $\times \frac{1}{2}$ ).

teeth, 24 in number, bore on the crown four low tubercles partially united into two transverse crests. The neck was of sufficient length to enable the animal readily to reach the ground, though the prehensile lip must have been used for food-gathering. Our knowledge of the creature's bodily form is imperfect, as a complete skeleton has not been found. *Mærittherium* measured about  $3\frac{1}{2}$  feet

in height, and existed up into the Upper Eocene as a contemporary of *Palæomastodon*, doubtless owing to a continuation of those favorable conditions under which it lived.

#### *Palæomastodon.*

*Palæomastodon* of the Upper Eocene was more elephant-like than its predecessor, *Mærittherium*, and of larger size, while its limbs were much like those of more modern types. The skull has increased materially in height, with a consider-

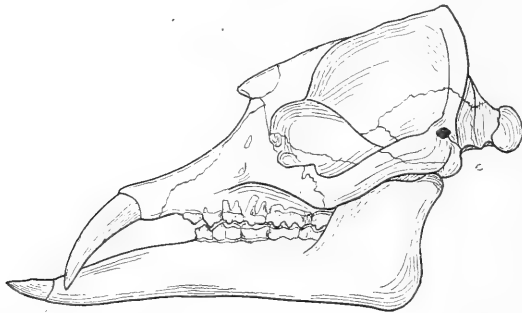

FIG. 14. Skull of *Palæomastodon* ( $\times \frac{1}{2}$ ); after Andrews.

able development of air cells in the bones. The small nasals with the nasal openings had receded so that they lay just in front of the orbits, much as in the tapir of to-day. This would imply the development of a short extensile proboscis, essentially like that of the modern elephant except for size. The upper and lower canines and incisors have entirely disappeared except the second pair of incisors in each jaw, which have become well-developed tusks. Those of the upper jaw are large, downwardly curved, and with a band of enamel on the outer face. The lower jaw has elongated considerably, especially at

the symphysis, and the lower tusks point directly forward as in *Mærittherium*. The proboscis possibly did not extend beyond the lower tusks while at rest, though it could probably be extended beyond them. The premolar teeth have two while the molars have three transverse crests composed of distinct tubercles and the cingulum of the hindermost tooth shows a strong tendency to form yet another crest. There were twenty-six teeth altogether. The neck is still fairly long, though the hinder neck vertebræ are beginning to shorten.

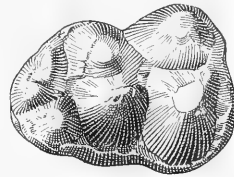

FIG. 15. Tooth of *Palæomastodon* ( $\times \frac{1}{2}$ ).

*Palæomastodon* is confined to the Upper Eocene, and has thus far been found only in the Fayûm region.

The Yale collection includes full-sized restorations of the skulls of *Mærittherium* and *Palæomastodon* as well as casts of the type specimens, gifts of the British Museum of Natural History.

#### *Classification of the Later Proboscidea.*

We know as yet no Oligocene proboscideans, the next forms being found in the lower Miocene of northern Africa and Europe, so that a considerable break occurs in the continuity of our series. It is evident that the line was still African in distribution, for apparently the exodus from Egypt did not occur before Miocene times.

The mastodons have been divided in two ways, one depending upon the number of ridges borne upon the grinders, while the other classification is based upon the number and character of the tusks. The latter seems the more logical from a developmental viewpoint. The first of these genera is *Tetrabelodon*, with four, enamel-banded tusks. The second is *Dibelodon*, having but two tusks which still retain the band of enamel. The last genus is *Mammut*, with enameless upper tusks in the adult, though one or two may also be present in the adolescent lower jaw. The latter are sometimes retained throughout life.

#### *Tetrabelodon.*

The third recorded stage in the evolution of the elephants is represented by the Miocene *Tetrabelodon angustidens*, of which a splendid specimen from Gers, France, is preserved in the museum of the Jardin des Plantes at Paris. It was an animal of considerable size, nearly as large as the Indian elephant, but differing markedly from the latter in the peculiar character of the lower jaw, which was enormously long at the symphysis and contained a pair of relatively short tusks. This form represents the culmination of the jaw elongation, for in its successors the symphysis is rapidly shortened and the infe-

rior tusks finally disappear. The upper tusks in *Tetrabelodon* were longer than those of the lower jaw but did not extend much beyond the latter. The tusks had an enamel band upon the outer and lower face and were slightly curved downward. The nasal orifice had receded farther to the rear, indicating a still greater development of the trunk than in *Palaeomastodon*.

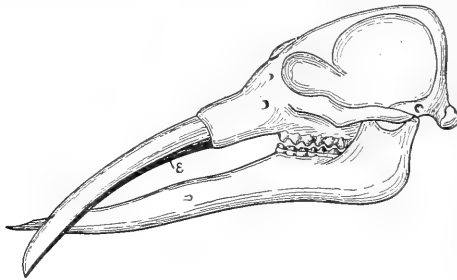

FIG. 16. Skull of *Tetrabelodon angustidens*.

The proboscis, still supported from beneath by the rigid lower jaws, could only be raised and moved from side to side. The neck is now quite short, so much so that were it not for the



FIG. 17. Tooth of *Tetrabelodon angustidens* ( $\times \frac{1}{4}$ ).

adult grinders at a time can be contained in each half of the jaws.

*Tetrabelodon* was a widely spread, migratory form, for we find species referable to this genus not only in Europe but in Africa, Asia, and in North America. In Eurasia it gave rise to *Mammut* through the loss of the lower tusks and the enamel band, while in America there arose *Dibelodon*, which retained the enamel band and which was the first proboscidian to reach South America after the formation of the Central American land connection either late in the Miocene or in the early Pliocene.

The Yale Museum contains fine specimens of teeth and tusks of *Tetrabelodon angustidens* from France as well as similar remains of *Tetrabelodon poavus*, *T. campesta*, *T. productus*, and *T. serridens*. In the Yale Museum is also pre-

served part of the holotype of *Tetrabelodon shepardi* Leidy from California, of which the remainder is in the museum of Amherst College.

*Dibelodon.*

The genus *Dibelodon* is known principally from the jaws, teeth and tusks, though two splended skulls of *D. andium* are preserved in the Museo Nacional in Buenos Aires. The upper

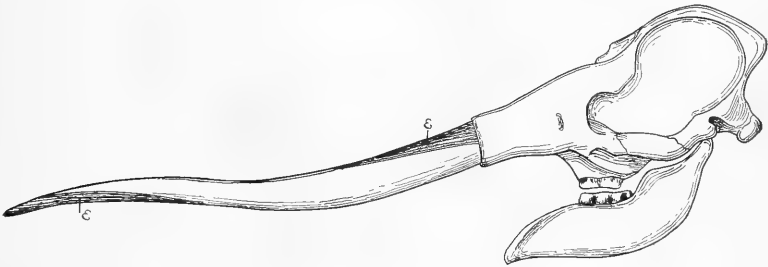

FIG. 18. Skull of *Dibelodon andium*.

tusks are well developed, displaying an elongated spiral form, with a well developed enamel band, but the lower jaw is quite short though the symphysis is longer and more trough-like than in the genera *Mammot* and *Elephas*. The lower tusks have entirely disappeared and with the shortening of the jaw the trunk must have become pendant as in the modern elephants.

The genus *Dibelodon* contains several species, among which are *Dibelodon humboldii* (Cuvier), *D. mirificium* (Leidy), *D. præcursor* (Cope), and *D. andium* (Cuvier). Of these *Dibelodon humboldii* and *D. andium* ranged into South America and were in fact almost the only proboscidiens to cross into the southern hemisphere of the New World. Some of these animals lived in the high Andes at an elevation of 12,350 feet above the level of the sea, at a time when the region had a greater rainfall than now and therefore a richer vegetation.

The Yale collection contains teeth and portions of the tusks of *Dibelodon mirificus* and *D. obscurum* as well as of *D. humboldii*. One *D. -obscurum* specimen is part of that figured by Leidy, the remainder being in the Amherst College Museum. There are also preserved at Yale a femur and an axis probably referable to *Dibelodon andium*, from the Pliocene Bone Bed of Quito valley, South America, found at an altitude of 10,000 feet.

*Mammut.*

This genus reaches its culmination in the American mastodon, a creature of great bulk, though about the height of the Indian elephant. It was, however, much more robust, a feature especially noticeable in the immense breadth of the pelvis and the massiveness of the limb bones. The feet were more spreading than in the true elephants, which, together with the character of the teeth, and the conditions under which the remains are found, points to different habits of life from those of the mammoth, the mastodons being more distinctively forest-dwelling types. The skull differs from that of the true elephants in its lower, more primitive contour, for while there is a large development of air cells in the cranial walls the brain cavity is relatively larger. The tusks are well-

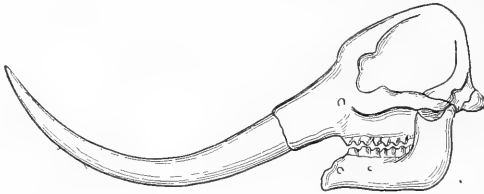

FIG. 19. Skull of the American Mastodon.

developed, powerful weapons, not so sharply curved as in the elephants, though in this respect individuals vary. The tusks are very heavy at the base and taper rapidly, curving inward at the tips. In the lower jaw the tusks are vestigial, being apparently present only in the male. Usually they are soon shed and the sockets may entirely disappear as in the Otis-

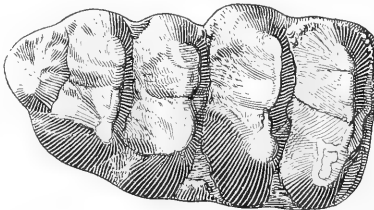

FIG. 20. Tooth of Mastodon ( $\times \frac{1}{4}$ ).

ville mastodon at Yale, whereas the Warren mastodon now in the American Museum, a fully adult animal, retained the left lower tusk, which is about eleven inches in length. The socket of the right tusk is also still distinct. A cast of the symphysis of the lower jaw of a young animal containing one tusk is exhibited at Yale.



The grinding teeth were of large size, two in each half of either jaw, as in the *Tetrabelodon*, but the crests are simpler with but few accessory cusps. The crown of the tooth is covered with thick enamel, which in turn is overlain by a thin layer of cement before it cuts the gum. This is soon removed by wear. These teeth are admirably adapted for crushing succulent herbage such as leaves and tender twigs and shoots, but not for grinding the siliceous grasses which form a necessary part of the food of the true elephants. "Broken pieces of branches varying from slender twigs to boughs half an inch long" have been found within the ribs of a mastodon together with "more finely divided vegetable matter, like comminuted twigs to the amount of four to six bushels." "Twigs of the existing conifer *Thuja occidentalis* were identified in the stomach of the New Jersey mastodon, while that of Newburgh, N. Y., contained the boughs of some conifer, spruce or fir, also other not coniferous, decomposed wood. A newspaper account of the finding of the great Otisville mastodon, now preserved at Yale, says that the region of the stomach contained "fresh-looking, very large leaves, of odd form, and blades of strange grass of extreme length and one inch to three inches in width."

The Yale collection contains numerous specimens of the American mastodon, including the nearly complete skeleton from Otisville, N. Y., soon to be mounted, another fairly complete skeleton of a younger individual from Urbana, Ohio, and many jaws and teeth. There are also specimens of the apparently ancestral *M. borsoni* from England.

#### *True Elephants.*

In order to trace the evolution of the true elephants we must go back once more to the Upper Miocene of southern India to the form known as *Mammot latidens*. This creature gave rise to a species variously known as *Mastodon elephantoides* or *Stegodon clifti*, for its transitional character is such that authorities differ as to whether it is a mastodon or an elephant.

#### *Stegodon.*

In *Stegodon* the molar teeth have more numerous ridges than in the true mastodons and the name *Stegodon* is given because of the roof-like character of these ridges, the summits of which are subdivided into five or six small, rounded prominences. There is a thin layer of cement over the enamel in an unworn tooth but no great accumulation in the intervening valleys as in the elephants. These teeth show how slight the transition is, however, merely a filling of

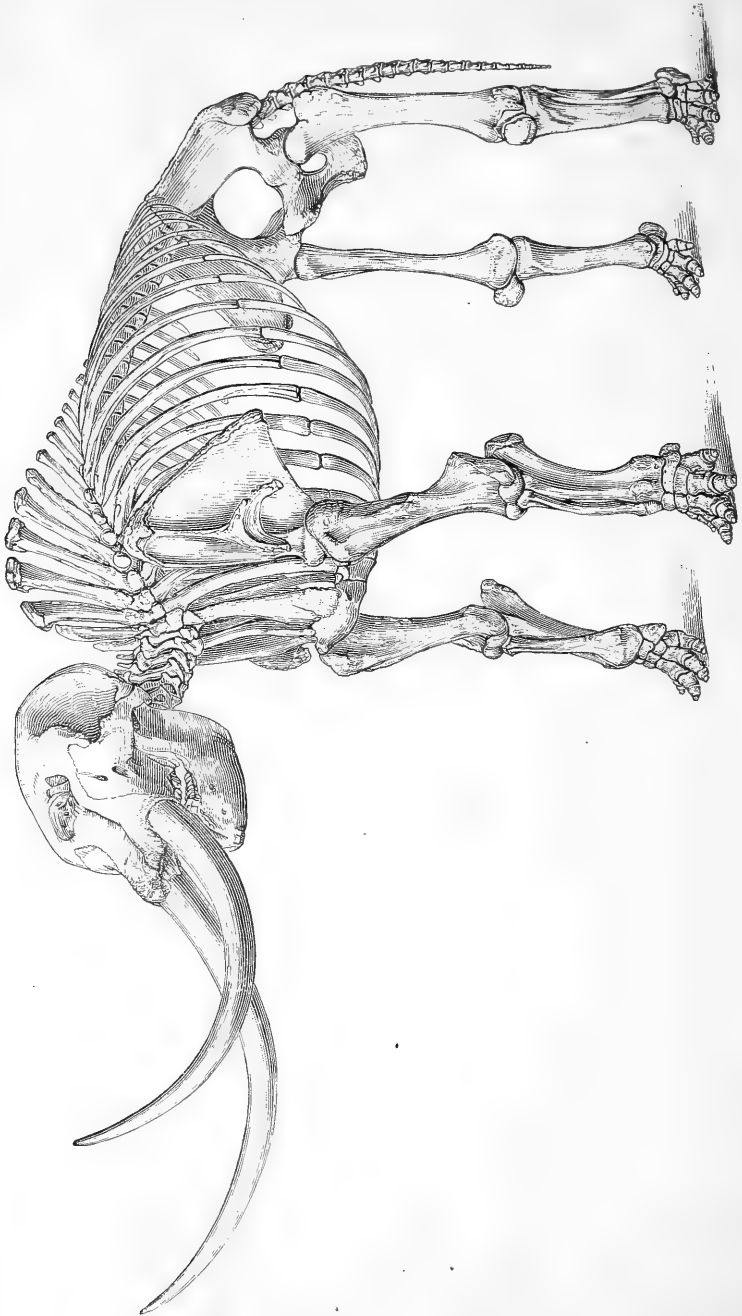

FIG. 21. Marsh's Restoration of Mastodon.

cement to bind the crests together and the elephant tooth is formed.

*Stegodon* embraces at least three species, the home of which was central and southern India, though two of them ranged east as far as Japan, then united to the Asiatic continent. *Stegodon insignis* lived into Pliocene times. Of the transitional forms, the Yale Museum contains casts of the type specimens of *Mammot latidens* and *Stegodon clifti*. True elephants, derived from the Stegodonts, existed in India, their remains being found in the Siwalik hills.

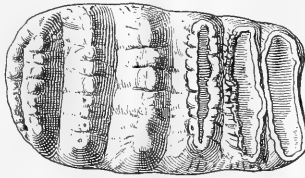

FIG. 22. *Stegodon* tooth ( $\times \frac{1}{2}$ ).

During Pliocene times there existed in Europe two immense elephants known as *Elephas meridionalis* and *E. antiquus*, each of which lingered on into the cooling climate of the Pleistocene. The former, while ranging as far north as England, was more southerly in general distribution and of a size which has probably never been exceeded except possibly by *Elephas imperator* of North America. A mounted specimen of *Elephas meridionalis* in the Natural History Museum of the Jardin des Plantes at Paris, France, measures thirteen feet and one inch at the shoulder and probably exceeded this in the flesh. The tusks are massive but do not reach the extreme of development of the later mammoths, while the teeth have rather coarse lamellæ.

*Elephas antiquus* stands midway in character between the African and Indian elephants of to-day. The tusks were nearly straight and the creature was also of great size. It is first found in the Lower Pleistocene (Forest Beds) of Norfolk, England. In the Thames valley deposits it was contemporaneous with early man and, for a while, with *Elephas primigenius*, the hairy mammoth. *E. antiquus* was essentially an animal of warm climate, giving way to the mammoth when the arctic conditions of the glacial period arose.

*Elephas antiquus* is represented at Yale by a fine cast of the skull, jaws, a tusk and other bones from the Belgium Royal Museum, while of the early elephants of India there are three casts of skulls recently presented by the British Museum of Natural History.

In North America, during the cooling to cold climatic condi-

tions of Pleistocene time, there were three species of *Elephas* of which the most primitive in point of tooth structure was the great imperial elephant, *E. imperator*, a migrant from the Eurasian continent. This species appeared in the Lower Pleistocene (Equus or Sheridan beds) and, while it ranged from Ohio to California, was more southern in distribution, ranging as far as Mexico and possibly into French Guiana. In this species the grinding teeth were of enormous size with very coarse lamellæ and the outer covering of cement was extremely thick.

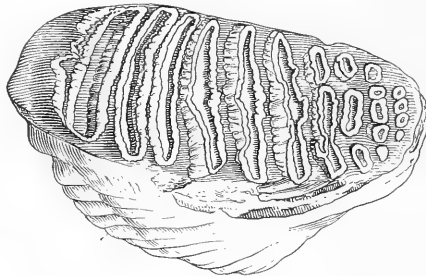

FIG. 23. Tooth of *E. imperator* ( $\times \frac{1}{4}$ ).

*Elephas imperator* was of great size,  $13\frac{1}{2}$  feet in height at the shoulder, and the huge, spiral tusks measured thirteen feet along the curve by 22 inches in circumference. One tusk in the city of Mexico is said to be sixteen feet in length! The collection at Yale contains one molar tooth of *Elephas imperator* from Mexico, one from Ohio, and the right ramus of the lower jaw containing a single molar from Alameda county, California. An upper molar of this same individual is in the

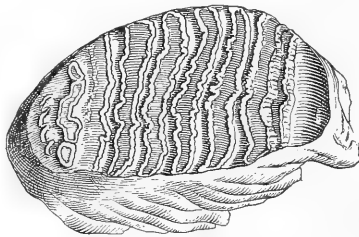

FIG. 24. Tooth of *E. columbi* ( $\times \frac{1}{4}$ ).

Amherst College museum, while a portion of the tusk is in that of Wabash College.

*Elephas columbi*, the Columbian mammoth, is thought by some authorities to be but a variety of *E. primigenius*, the teeth being transitional in the character of the lamellæ between

the latter and *E. imperator*. In fact, they greatly resemble those of the modern Indian elephant. *E. columbi* was early and middle Pleistocene in distribution, more southern in range than *E. primigenius*, though the two inhabited a broad frontier belt along the northern United States. *E. columbi* reaches the maximum of evolution in the shortening and heightening of the skull. The tusks in a mounted specimen in the American Museum of Natural History are so huge that their tips actually curve backward and cross each other. They have completely lost their original digging function and their use as weapons must have been much impaired. They seem to represent an instance of a certain acquired momentum of evolution carrying them past the stage of greatest usefulness to become an actual detriment to their owner. This may have been an important factor for extinction. Specimens at Yale referable to *E. columbi* consist of several molars from Idaho, Florida, California, and Mexico.

*Elephas primigenius.*

The mammoth was not among the largest of elephants, being but little in excess of *Elephas indicus* in height, but with

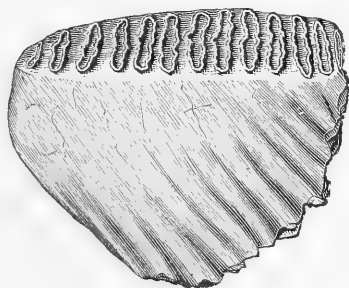

FIG. 25. Tooth of *E. primigenius* ( $\times \frac{1}{4}$ ); after Marsh.

relatively huge tusks exceeding, in some instances, a length of over eleven feet measured along the outer curve. The teeth have the most numerous and finest lamellæ, and in this respect, as well as in the development of hair, this creature shows the greatest degree of specialization as compared with the tusks and skull in the Columbian species. It is curious to note, however, that in three ways one can trace the increasing fineness in the lamellæ of the molars corresponding to the three modes of distribution,—latitude, altitude, and time,—for the more ancient individuals, living the farthest south and nearest the sea-level, have teeth very much like those of *E. columbi*. The increasing fineness of lamellæ is correlated with increasing cold and a consequent change in the character of food plants, as the last of the

mammoths fed upon harsh grasses and the needles and cones of the fir and other conifers, mingled with moss. The hairy coat, another adaptation to extreme cold, was of three sorts, an inner coat of reddish wool, next a longer, fawn-colored coat outside of which were long, black bristles, especially on certain parts of the body, as the neck, back, and chest. It is interesting to note that in the Indian elephant, the nearest living ally of the mammoth, there is, at birth, a complete coat of rather long hair which is shed in a few weeks except that in the mountain region of the Malay peninsula elephants are reported to be persistently hairy. This points to an ancestral hairy condition atavistically developed in later types when necessitated by cold. A similar development is seen in the Manchurian tiger, in form and markings precisely like its tropical cousin, the sleek Bengal tiger, but with a long, thick fur which defies the cold of a climate as severe as that of New England.

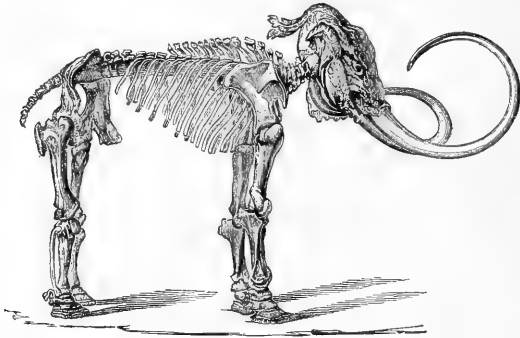

FIG. 26. St. Petersburg Mammoth of 1806.

The hairy mammoth was circumpolar in distribution, ranging from Europe across the north of Asia as far as 70° north latitude to the eastern part of the United States, its southern limit overlapping the northern range of *Elephas columbi*.

Of *Elephas primigenius* the museum at Yale contains several important specimens: Molar teeth from Minnesota and Washington state. A fine jaw from Nebraska with teeth nearly as coarsely ridged as those of *Elephas columbi*. Molars from England and Siberia, tusks from Alaska, hair from an Alaskan ice cliff and a piece of hide from the Siberian mammoth brought to St. Petersburg, Russia, in 1806.

#### *Modern Elephants.*

The African elephants are the more primitive in the character of the teeth with their broad lozenge-shaped lamellæ, unless, as has recently been suggested, they are in this respect degenerate. The African forms included by some authorities under

the genus *Loxodonta* have recently been divided into four species. They are distinguished from their cousins of India by the contour of the head, the greater size of the ears, greater development of the tusks, and the presence of two figure-like processes at the tip of the proboscis instead of but one. African elephants reach a greater size than do those of India, attaining a height of twelve to thirteen feet at the shoulders and a weight of over seven tons.

The Indian elephant includes but one species, *E. indicus*, of which there are, however, several well-marked castes or breeds, varying greatly in commercial value. In size the Indian elephant rarely reaches eleven feet, averaging about nine for the males. The high, convex forehead gives the Indian elephant a somewhat nobler, more intellectual cast of countenance than its African cousin, but this character is due solely to the greater development of the air cells in the skull.

#### *Dinotherium.*

In the Miocene of Europe, though ranging up into the Pliocene of Asia, is a curious aberrant type, evidently a probosci-

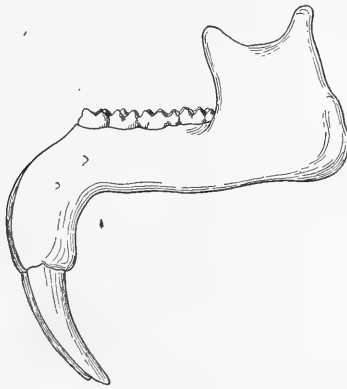

FIG. 27. Jaw of *Dinotherium*; after Kaup.

dian though formerly classed with the Sirenia. This form is *Dinotherium* and must have been derived from some very early genus, certainly not later than *Palæomastodon*. The teeth differ from those of the elephants in their greater number and in their mode of succession, being more like those of other mammals. The grinding teeth are extremely simple, the premolars having three while the molars have but two cross crests with open, uncemented valleys. Tusks are apparently confined to the lower jaw, no trace of upper tusks having been

seen in the only known skull, now unfortunately lost. Those of the lower jaw were large and, together with the elongated symphysis, bent abruptly downward, the tips being actually recurved. The skeleton, so far as known, indicates a huge elephant-like body and limbs and the impression is that the creature must have been semi-aquatic, frequenting the beds of streams and living upon the succulent herbage which it rooted up by means of its tusks. The contour of the skull is ill known, so that, with the exception of the lower jaw, restorations of the head are largely conjectural. *Dinotherium* died out in the Pliocene, leaving no descendants.

### PART III.

#### *Migrations of the Proboscidea.*

In studying the dispersal of a group of terrestrial vertebrates one has to consider not alone the probability of land bridges over which the wandering hordes might pass, but, on the other hand, the existence of barriers to migration other than the absence of these bridges.

The possible barriers are climatic, topographic, and vegetative. Of these the climatic has been given weight, but in the case of the proboscidians the direct action of temperature is relatively unimportant, though the presence of moisture is a prime necessity.

The African elephant formerly ranged from Cape of Good Hope into Spain, while *Elephas primigenius* enjoyed an even greater range in latitude and consequent temperature. The African species has a vertical distribution from sea level to a height of 13,000 feet in the Kilimanjaro region, which also gives a great range of climatic variation. Aridity, however, is a most efficient barrier, not only from its effect upon the food supply, but because water is a prime necessity to elephantine comfort. The Sahara to-day marks the northernmost limit of the African species, the former distribution to the north being by way of the Nile valley or possibly to the westward of the great desert.

Mountain ranges on the whole do not impede elephant migration, except of course such mighty uplifts as the Himalayas. The height to which the elephant wanders in the Kilimanjaro has already been mentioned, while Hannibal took a number of African elephants across the Little St. Bernard pass, which has an altitude of 7,176 feet, in his invasion of Italy in 218 B. C. The Pyrenees, however, seem to have prevented the numerous elephants of France from invading the adjacent Spanish peninsula, as the few species of fossil



elephants found therein seem almost without exception to have entered from Africa by way of Gibraltar. The great ranges of mountains in the new world may have influenced somewhat the trend of migration, but were crossed by the proboscidi-ans at will.

Vegetation does constitute a most effective barrier, especially in the case of the tropical jungle of central America. During the Pliocene, as we shall see, after the land bridge was established, intercommunication between the two Americas was very free. In the Pleistocene, however, this migration of large quadrupeds gradually ceased, so that in spite of the great abundance of mammoths and mastodons in North America none attained a foothold south of the Mexican plateau. To-day the jungle is absolutely impenetrable for all of the larger mammals except such as may be at least partially arboreal in habits.

The migrations were forced, not voluntary, for it would appear that the mighty elevations of Asia beginning in late Miocene times and the consequent alternations of moist and arid climates, with a strong tendency toward the latter, has caused these great animals to disperse themselves from the rising high lands of central Asia into the more stable low lands. In these forced wanderings the land bridge between Asia and Alaska was again and again discovered and crossed by the migrating hordes.

The first appearance of the proboscidi-ans is in the Middle Eocene beds of the Egyptian Fayûm district. There we find in *Mæritherium*, the most primitive type, the forerunner of the race. Of the extent of the geographical range of *Mæri-therium* and of its successor, *Palæomastodon*, we know nothing further than that they have only been found within the Fayûm.

During the Oligocene the proboscidi-ans seemingly remained in Africa, though of this we have no record. Early Miocene deposits of Mogara, which lies northwest of the Fayûm some five days' journey, about 75 miles, give us the remains of *Tetrabelodon angustidens*, the next known type in the evolutionary series. From Tunis again this species is reported, being what Professor Deperét calls the ancestral (ascending mutation) race of *T. angustidens*, *pigmæus*. This race is also reported from the sands of Orleans and from the Burdigalienne of Agles (Aglie, Italy). Thus it seems as though *Tetrabelodon angustidens*, the form with the maximum development of symphysis, were the one to make the exodus from Africa, not as the children of Israel did, by way of the northeast, but by the land bridge connecting Tunis with Sicily and the latter with Italy, and thence, by way of Greece to Europe and Asia.

*Mammut americanum* phylum.

(See Chart 1.)

*Tetrabelodon angustidens* did not go unaccompanied, for another type, *Tetrabelodon turicensis* (= *tapiroides*), found in the Lower Miocene of Algeria, must have travelled into Europe by the same route and about the same time. In *T. turicensis* the grinders are simple in character as though it had already begun to differ in its feeding habits from its contemporary, in which the teeth are comparatively complex. *Tetrabelodon turicensis* spread during the Miocene over France, Germany, Austria-Hungary, Russia and as far as southeastern Siberia. The successor of *Tetrabelodon turicensis* was *Mammut borsoni*, covering much the same geographical area as its forebear, being found as far as England to the north and Russia, along the northern coast of the Black sea, to the east. Geologically it ranges from Lower to Upper Pliocene. *M. borsoni* merges into *Mammut americanum*, the great American mastodon which outlived the mammoth in the New World. Some teeth found in southeastern Russia have been referred to the American type by Mme. Pavlow, who was perfectly familiar with *M. borsoni*. However that may be, the migration of this race was without doubt across Siberia, the Behring isthmus and into the New World from the northwest. The American mastodon's remains have been found from Alaska to California, east to Prince Edward's Island and from Hudson Bay to Florida on the east coast, while Le Conte reports a specimen from Tambla, Honduras, about 15° north latitude, the nearest recorded approach to South America.

*Tetrabelodon*—*Dibelodon* phylum.*Tetrabelodon*—*Elephas* phylum.

(See Chart 2.)

Reverting once more to *Tetrabelodon angustidens*, we find in it the possible ancestor of all of the later proboscidians, with the exception of the very aberrant *Dinotheres* and the American mastodon phylum. *Tetrabelodon angustidens* was a great migrant covering most of Europe with the exception of Spain and England. Its descendants diverged along several lines of specialization as along varied lines of travel, at least one representative reaching North America in the Middle Miocene (Deep River beds), possibly before (Virgin Valley of Oregon (Merriam)). The earliest North American form, *Tetrabelodon productus*, resembled its European prototype very closely and



CHART 1. Miocene-Pleistocene. Mammut americanum Phylum.

+ Tetrabelodon turicensis. ● Mammut americanum.

▲ Mammut borsoni.

gave rise to a remarkable group of four-tusked mastodons which ranged from Nebraska to Florida. From some of the later species arose the *Dibelodon* race with upper, enamel banded tusks, but lacking those of the lower jaw. This genus is reported from the Pliocene (Blanco) of Texas and Mexico and ranges as far south as Buenos Aires in the southern hemisphere. Two South American species are known to us, one, *D. andium*, following the chain of the Andes as far south as Chili. This type is often found at great altitudes, a specimen from the Quito valley in Ecuador, now in the Yale collection, having been found 10,000 feet above the level of the sea.

*Dibelodon humboldti* was a dweller on the plains, being found in the pampas formation near Buenos Aires, while Darwin records it along the banks of the Parana river in Argentine, and Wallace reports the same species among other remains in a limestone cavern near the headwaters of the San Francisco river in southern Brazil. *D. humboldti*, like *D. andium*, has its origin in the Texas Pliocene, the line of migrations nearly paralleling, the one along the tropical plains, the other along the Andine plateau as far south as northern Chili. With the exception of a lone specimen of *Elephas* reported from French Guiana and the mastodon of Honduras, *Dibelodon* is the only proboscidian of the Neotropical realm. The migration of these great forms occurred in the late Pliocene, and for some reason, evidently climatic and vegetative, the route has been closed ever since. Otherwise it is reasonable to suppose that the elephants and mastodons of the Pleistocene would have spread into South America as well.

In Europe *Tetrabelodon angustidens* had successors in *T. longirostris* and *arvernensis*, the latter ranging over western Europe into England. It did not, however, cross the Pyrenees into Spain. *T. longirostris* and a late mutation of *T. angustidens*, *palæindicus*, made the long journey to the Orient, transferring the evolution from Europe to India. The path of this migration is as yet unknown, as little or no paleontological exploration has been made in the region lying between Armenia on the west across Persia, Afghanistan, and Beluchistan to the Indus river. This oriental migration must have occurred during the Upper Miocene and was followed by a relatively rapid evolution involving a number of species of mastodons and elephants. *Tetrabelodon longirostris* seems to have given rise to *Mammut*\* *cautleyi* with a shortened lower jaw, thence through *M. latidens* to *Stegodon clifti*, the transitional form between the mastodons and the elephants. *S. clifti* was followed

\* These Indian forms agree probably with the American mastodon in having but one pair of enamelless tusks. They may represent the *Mammut* stage but in an entirely different phylum, hence should not bear the same generic name.



CHART 2. Miocene-Pliocene. Tetrabelodon-Elephas Phylum (part). Tetrabelodon-Dibelodon Phylum.

- F Fayûm.
- Old World Tetrabelodon.
- New World Tetrabelodon.
- + Old World Mammut (leading to Stegodon).
- ▲ New World Dibelodon.

in succession by *Stegodon bombifrons* and *S. insignis* and finally by the genus *Elephas* itself. *Elephas* proved to be a great migrant, although the stegodont species had spread from their original homes in the sub-Himalayan region eastward through Burma, China, and Japan and perhaps as far as Java. *Elephas* later travelled in two directions, westward back to Europe and Africa, and eastward, thousands of miles, into the United States.

Evidence seems to point to an interesting parallelism in evolution between the American elephants and those of Europe, though they were undoubtedly derived from a common ancestry.

### *The True Elephants.*

(See Chart 3.)

Disregarding for the present the hairy mammoth, *E. primigenius*, two notable types are found in Europe during Pliocene and Pleistocene times. Of these the more ancient is *Elephas meridionalis*, probably derived from *Stegodon insignis* of India and undoubtedly the migratory species over the Persia-Asia Minor route which the remote ancestors travelled in their journey to the East.

*Elephas meridionalis* ranges from the Red Crag (Upper Pliocene) to the Lower Pleistocene Forest Beds and from England on the north to Algeria on the south, though never gaining a permanent foothold in Africa. *E. meridionalis* is succeeded by *E. antiquus*, a great form with straight tusks, whose geological range is from the Forest Beds to the Upper Pleistocene. *E. antiquus* is found in England, central Europe, as far east as the region lying north of the Black sea. In a southerly direction one can trace the course of migration through Italy, Malta, Sicily, north Africa, and across the present strait of Gibraltar to southern Spain, where specimens have been found at Europa Point and at Seville. Evidently the Pyrenees proved too great a barrier for a direct migration into Spain, though the invasion was accomplished through this circuitous route. In the islands of Sicily and Malta are found relics of this southern march of *E. antiquus*, not only remains of the normal species, but of its curiously dwarfed descendants, *Elephas mnaidriensis*, *E. melitensis* and *E. falconeri*, the last only three feet high. These types developed through degeneracy after the migration had passed and the line of communication was cut off, leaving Sicily and Malta as small islands. The limited area, scanty food and general hard conditions were responsible for the dwarfing, precisely as the Shetland ponies have lost the original stature of *Equus caballus*. In the Mal-

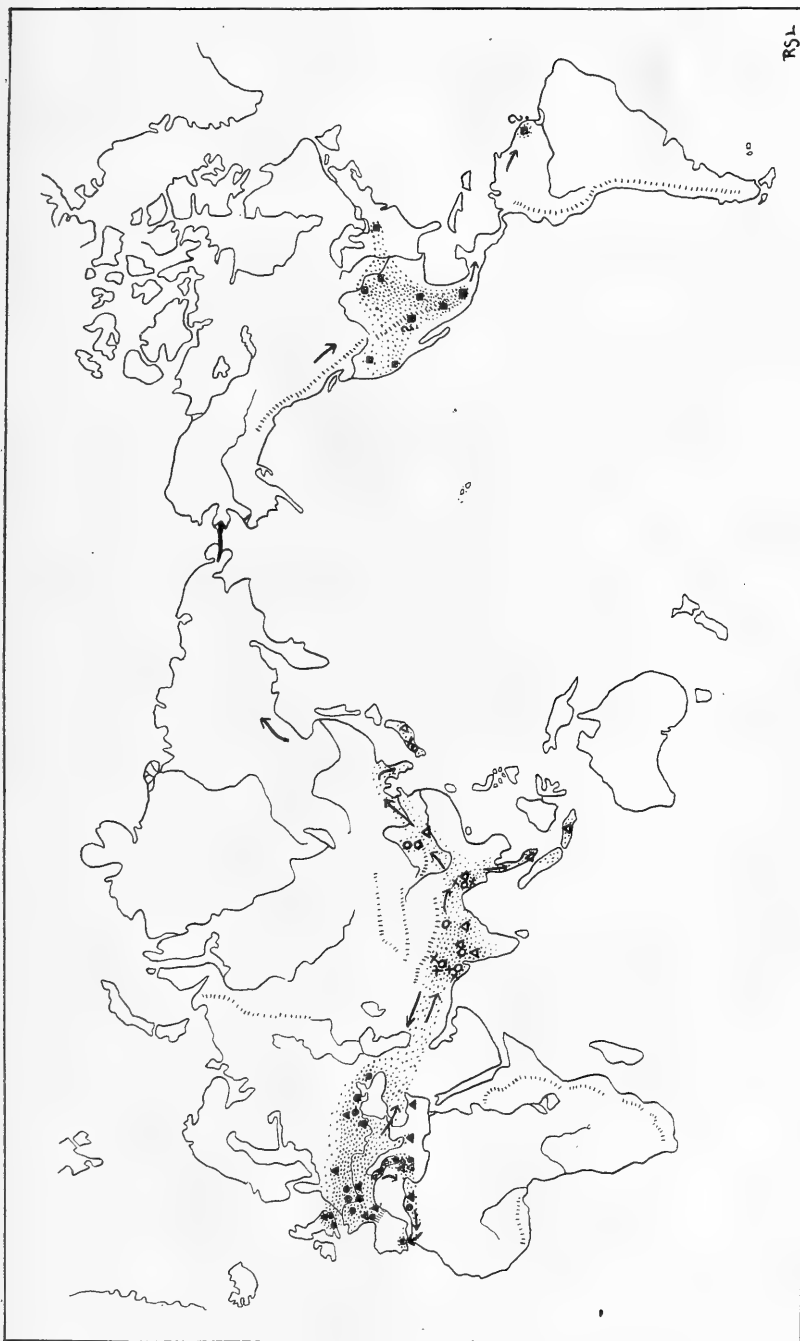

CHART 3. Pliocene-Pleistocene. Stegodon—Elephas Phylum.

- × *Stegodon clifti*.
- + *Elephas planifrons*.
- o *Stegodon insignis*.
- *Elephas meridionalis*.
- ▲ *Elephas antiquus*.
- △ *Elephas nomadicus*.
- *Elephas imperator*.

tese elephants the diminution in size brings the animal *below* the stature of the ancestral *Mæriitherium*, though in no other way is it an atavistic type. Dwarf forms are also found in Crete and Cyprus.

An early form of *Elephas antiquus* evidently gave rise to the modern African elephant through the type known as *Elephas priscus*, included by some authorities in *E. antiquus* itself. The development of teeth of *E. africanus* with relatively few lozenge-shaped ridges seems to be a matter of degeneracy which casts some doubt upon the value of the subgenus *Loxodonta*. *Elephas africanus* deployed over the whole of Africa with the exception of the Sahara desert. It also crossed to Gibraltar and spread over most of the Spanish peninsula. It has since been extirpated, however, in all of the region north of the Sahara. The living Indian elephant exhibits similarity of structure with the *E. antiquus*, a form known as *Elephas armeniacus*, found in Asia Minor, being annectent type. *Elephas indicus* may have come from *Elephas insignis* through the Lower Pleistocene *E. hysudricus*, and probably represents a purely local evolution, not a migratory form.

A most perplexing question arises with reference to the origin of the great North American elephants, *Elephas imperator*, *E. columbi* and finally *E. primigenius* itself. Emphasis has been placed on the similarity existing between the American and European elephants, though I know of no expression of opinion as to the actual relationship of the forms in question. In tooth characters *Elephas columbi* is certainly suggestive of its European contemporary *E. antiquus*, while *E. imperator* somewhat resembles *E. meridionalis*. The tusks which are so important from the developmental standpoint have apparently been ignored, for the American types have huge spiral tusks, while those of *Elephas antiquus* are nearly straight, and in *E. meridionalis* they show by no means the development of *E. imperator*. It is the writer's opinion that the American forms may prove to be a distinct evolution, having been derived from some such form as *Elephas planifrons*, found in India from the Pliocene of the Siwalik hills to the Pleistocene of Narbada valley. We have no record of the migration of *E. planifrons*, but its progenitors and contemporaries ranged, in some cases, as far as China and Japan by way of Burma. This being an accustomed route, *E. planifrons* or a successor might well have ventured beyond China to the northeast through Siberia, across the Behring isthmus and thence southward as far as Mexico, giving rise to the American form *Elephas imperator*, which is first reported from the Equus or Sheridan beds (Lower Pleistocene). The known range of the





CHART 4. Pleistocene-Recent. *Elephas columbi-primigenius* Group.

- *Elephas primigenius*.
- Dotted area, distribution of Mammoth.
- + *Elephas columbi*.
- //// *Elephas indicus*, present distribution.
- |||| *Elephas africanus*, present distribution.

latter is from Nebraska to southern Mexico along the 100° meridian, although specimens in the Yale collection were found as far east as Ohio and west to the California coast. We have the authority of Lartet for the finding of a tooth of *Elephas* in the Lower Pleistocene in Cayenne, French Guiana. From the description of the "thick ridge plates" this specimen is evidently that of *E. imperator*, probably a stray to the southward before the conditions which later prohibited proboscidean migration into South America arose. It is the only recorded instance of a true elephant known to me south of the Mexican plateau. The geographical range of *E. columbi* embraced the whole southern part of the United States and the highlands of Mexico, including the area covered by *E. imperator*, with the exception of the South American locality.

*Elephas primigenius* phylum.

(See Chart 4.)

*Elephas primigenius* has been generally conceded to be of Asiatic origin and a near relative of *E. indicus*. The character of the teeth and the presence of hair in the young *E. indicus* are certainly suggestive of relationship. The teeth are also similar to those of *E. columbi* and may represent a further development of the latter type as readily as of *E. indicus* or *E. antiquus*. The presence of hair is an atavistic character developed in *E. primigenius* to meet climatic conditions, and we are by no means sure that *E. columbi* was naked, as this is simply argued from its geographical distribution. The tusks of *E. primigenius*, however, are generally the immense spirally coiled structures of *E. columbi* and *E. imperator*, though short-tusked specimens do occur, presumably young individuals. In *E. indicus* the tusks are greatly reduced, being absent in the female, often in the male, and are evidently degenerate.

*Elephas columbi* molars grade into those of *E. primigenius*, and there is preserved in the Yale museum a fine jaw, the characters of which are clearly those of *E. primigenius*, while the teeth are those of *E. columbi*. In fact, *E. columbi* is often regarded merely as a southern variety of the Siberian mammoth. It seems, however, as though the reverse of this statement might be true, looking upon *E. primigenius*, which is the more specialized form, as the latest mutation of the *imperator-columbi* phylum, originating in North America and becoming circumpolar in its distribution, invading Siberia from the American northwest. One tooth has been found on Long Island in the eastern part of Hudson bay, transitional in character between the mammoth and *Elephas columbi*. Lucas

supposes that this tooth may have been carried thither with a carcass or a portion of a carcass by the water or ice. This may be true, but upon such slender evidence as this we have sometimes based a route of migration which subsequent discoveries have proven true. It may in this instance imply that the migration was not wholly by way of the Behring route and that the hairy mammoth was indeed a circumpolar form.

Thus it will be seen that these majestic creatures were great wanderers, ranging in the course of time over nearly the entire world. Few mammals have been such world-wide travellers as the elephants, as their record has been exceeded only by mankind, the horses, dogs and cats, the rhinoceroses and camels pressing close behind. It would seem that in each instance the perfection of the race was in a large measure due to the development of the migratory instinct.

## EXPLANATION OF FIGURES.

- FIG. 1. The manatee, *Manatus australis*; after Brehm.  
 FIG. 2. Conies, *Hyrax abyssinicus*; after Brehm.  
 FIG. 3. Skeleton of the American mastodon; after Owen.  
 FIG. 4. Skull of Indian elephant sectioned longitudinally, showing the great development of air cells and the relatively small brain cavity; after Owen.  
 B, Cavity of brain; *i*, incisor (tusk); *m*, 3, 4, 5, molars 3, 4 and 5.  
 FIG. 5. *a*, Crown view, and *b*, longitudinal section of the molar tooth of an Indian elephant, schematic. Black, enamel; dotted portion, cement; cross-lined, dentine or ivory. Original.  
 FIG. 6. Section of skull of a very young and of a full-grown African elephant, showing the change of contour during growth due to the development of air cells or diploë. From Flower's Osteology, 1/4 and 1/12 natural size, respectively.  
 FIG. 7. Evolution of the Proboscidea. Original. Based upon restorations modeled by R. S. Lull.  
*a*, *Elephas columbi*; *b*, *Mammuth americanum*; *c*, *Tetrabelodon angustidens*; *d*, Palæomastodon; *e*, Mœritherium. Figs. *a*, *b* and *c* are 1/32, figs. *d* and *e* 1/16 natural size.  
 FIG. 8. Mammoth found frozen in the ice near Beresovka, Siberia, as it lay in the cliff, after Herz.  
 FIG. 9. The mammoth of Beresovka mounted in the St. Petersburg Zoölogical Museum; after Herz.  
 FIG. 10. Charging mammoth drawn on mammoth ivory by prehistoric man, after Lubbock.  
 FIG. 11. Prehistoric engraving of a mammoth, Cavern of Les Combarelles, Dordogne, France. 1/6, from MacCurdy; after Capitan and Breuil.  
 FIG. 12. Skull of Mœritherium; after Andrews. About 1/7 natural size.  
 FIG. 13. Last upper molar of Mœritherium. Drawn from a cast, No. 11663, Yale Museum, 1/2 natural size. Original.  
 FIG. 14. Skull of Palæomastodon; after Andrews. About 1/12 natural size.  
 FIG. 15. Last upper molar of Palæomastodon. Drawn from a cast, No. 11660, Yale Museum, 1/2 natural size. Original.  
 FIG. 16. Skull of *Tetrabelodon angustidens*. Original.

- FIG. 17. Last upper molar, tooth of *Tetrabelodon angustidens*. Catalogue No. 11732 Yale Museum, 1/4 natural size. Original.
- FIG. 18. Skull of *Dibelodon andium*, modified from Burmeister.
- FIG. 19. Skull of *Mammut americanum*. Original.
- FIG. 20. Last upper molar tooth of *Mammut americanum*. Catalogue No. 10681 Yale Museum, 1/4 natural size. Original.
- FIG. 21. Restoration of the American mastodon, *Mammut americanum*, after Marsh, 1/32 natural size. The animal stands too high at the shoulders and the tusks are reversed, as they should curve inward at the tip. Catalogue No. 12600 Yale Museum.
- FIG. 22. Molar tooth of *Stegodon clifti*. From a cast, No. 10759, Yale Museum, 1/4 natural size. Original.
- FIG. 23. Molar tooth of *Elephas imperator*. Catalogue No. 11677, Yale Museum, 1/4 natural size. Original.
- FIG. 24. Molar tooth of *Elephas columbi*. Catalogue No. 11683, 1/4 natural size. Original.
- FIG. 25. Molar tooth of the mammoth *Elephas primigenius*; after Marsh.
- FIG. 26. Mammoth found in the Lena Delta, Siberia, in 1799, as mounted in the St. Petersburg Zoölogical Museum. Portions of the hide still adhere to the head and feet; after Marsh.
- FIG. 27. Jaw of *Dinotherium*, showing the downwardly directed lower tusks; after Kaup.

ART. XXII.—*On the Original Type of the Manganese Ore Deposits of the Queluz District, Minas Geraes, Brazil;*  
by ORVILLE A. DERBY.

IN a paper published in the July number for 1901 of this Journal, the commercial manganese ore that in recent years has been quite extensively shipped from the Queluz (Lafayette) district, in the state of Minas Geraes, was attributed to the alteration and leaching of an original silicate rock for which the name Queluzite was proposed.

Of the various types of this rock described in that paper, the only one that almost completely preserved its original elements consisted almost exclusively of manganese garnet (spessartite) with a slight admixture of another silicate element, usually much altered, that was referred doubtfully to the amphibole group. Another consisted of spessartite with a large admixture of quartz which was presumed to be secondary, replacing some mineral, or minerals, that had entirely disappeared; while a third presented minute isolated grains of spessartite distributed through a groundmass of hard steely manganese oxide that had the appearance of a primary constituent.

Since the writing of that paper, one of the mines there mentioned, that of Piquery, has been stripped of nearly all of the secondarily enriched material, and has been abandoned after furnishing about 250,000 tons of merchantable ore. A recent hurried visit to this mine revealed some interesting and unexpected features, which seem worthy of a preliminary notice pending a more detailed investigation, which it is hoped can soon be made.

The bottom of the mine shows exposed in a perfectly sound condition a large surface of the original rock from which the merchantable ore was derived. This consists mainly of a black, fine-grained, highly jointed and somewhat flaggy rock with the aspect of a limestone, with broad bands and patches of a more massive (less jointed), yellowish gray (where unstained by secondary manganese oxide) rock with the aspect of a quartzite. The latter is in part the garnet rock described in the above-cited paper from an isolated mass preserved in the midst of the merchantable ore, and which is now seen to constitute segregated masses and layers which, as regards the entire body of manganese-bearing rock, are of secondary importance, instead of being, as supposed, the predominant type of that body. This is constituted by the limestone-like rock which on treatment with cold weak acid gives a brisk

effervescence with a very abundant separation of gelatinous silica, leaving an insoluble residue of graphite and a heavy whitish sand, consisting almost exclusively of spessartite with a slight admixture of minute black granules. The solution shows a large amount of manganese with a comparatively small proportion of lime and magnesia.

The specimen of the quartzite-like type obtained from the bottom of the mine, or rather quarry, also gives a certain amount of effervescence and separation of gelatinous silica and thus differs from the almost pure spessartite rock previously reported, in which, however, the former existence of other elements was deduced from the existence of secondary quartz and asbestiform amphibole. In places this type shows a considerable admixture of rose-colored rhodonite concentrated in streaks and patches so as to present the appearance of an accidental rather than an essential element of the rock. Rhodonite without the characteristic rose color was also found in one specimen as a predominant element, with a slight admixture of spessartite, but without the readily soluble carbonate and silicate element.

Specimens of the dark-colored rock selected with reference to a presumed higher and lower percentage of the carbonate element were submitted to Dr. Eugene Hussak, who has kindly communicated a preliminary note on their chemical and mineral composition in advance of a paper on the rocks and minerals of the manganese deposits that he has in preparation. The results of a partial analysis are given below under I and II, to which are added, under III, those given in the above-cited paper for the type composed almost exclusively of spessartite.

	I	II	III
CO <sub>2</sub> .....	22.62	4.59	----
SiO <sub>2</sub> .....	11.80	27.67	38.47
MnO.....	47.52	57.48	27.90
Al <sub>2</sub> O <sub>3</sub> .....	) 7.50	1.41	21.07
Fe <sub>2</sub> O <sub>3</sub> .....		2.48	7.38
CaO.....	3.76	1.82	4.70
MgO.....	6.27	4.60	----

Strong traces of titanium, cobalt and zinc were found in Nos. I. and II, which also carry a very perceptible amount of graphite, of which minute traces were also found in No. III.

Dr. Hussak reports that the microscopic examination shows the rocks to be composed of a carbonate (rhodochrosite?), an olivine-like silicate (tephroite) and spessartite, the latter being in small amount and extremely minute grains in No. II and in greater amount and larger grains in No. I. Some sections

also show a small amount of rhodonite. A considerable amount of the iron, not separately determined in No. I, is in the form of pyrites, which is tolerably abundant in this rock. The titanium is in part in opaque black grains (ilmenite), in part in transparent red grains with the appearance of rutile, but from which on isolation, I obtained strong characteristic reactions for both titanium and manganese, from which, as in the former paper, the mineral is presumed to be pyrophanite.

At Piquery it is very evident that the merchantable ore, consisting almost exclusively of manganese oxide (psilomelane?), is due to the superficial alteration of this rock, involving the subtraction of the carbonic acid and of a large proportion of the silica, alumina, iron, lime and magnesia. Moreover, it is evident that this alteration has proceeded from above downward, or in other words, that it is simply atmospheric weathering. So far as observed the ore at this place has lost all trace of the platy (joint) structure of the original rock and, except in the rejected block of low grade ore, all recognizable traces of the original constituents.

From the neighboring mines of São Gonçalo and Morro da Mina a type of ore was described that is characterized by a light-colored earthy aspect, platy structure and spongy texture due to innumerable minute rounded cavities. This passes in the upper levels to the ordinary black, massive type of ore (psilomelane?) in which all these characteristics are lost, and, in one of the lower levels of the Morro da Mina, to a hard black, lustrous type which under the microscope shows minute isolated grains of spessartite in a groundmass of manganese oxide. This groundmass was presumed to be an original constituent, and comparable with a specimen of magnetite from a neighboring district in which spessartite occurs in a similar groundmass of iron oxide. The recent observations at Piquery, however, suggest the much more plausible hypothesis that this groundmass is a residue of manganese oxide due to the alteration and leaching of original carbonate and silicate (tephroite) elements like those of the rock at Piquery. The alteration of the latter with retention of the spessartite and of the platy structure is readily conceivable, and this would give precisely the type of low-grade siliceous (from the presence of unaltered spessartite) ore that characterizes the lowest level reached at Morro da Mina.

Further investigation, which it is hoped can soon be made, will doubtless clear up this and other knotty points in the question of the genesis of this type of manganese ore deposits, which, when of large extent and of commercial value, seem to be due to the alteration of an original rock with predominant carbonate of manganese and tephroite rather than of spes-

sartite and rhodonite as hitherto supposed. Numerous localities in the Queluz and other districts in Brazil have been prospected, in which at a comparatively slight depth the commercial ore ran into an almost pure spessartite rock, and this fact suggests the hypothesis that for the alteration to proceed far enough to produce extensive deposits of merchantable ore, the presence of large proportions of the less resistant carbonate and of tephroite is necessary. So far as can be seen at Piquery, rhodonite is an element of subordinate importance, though it may be suspected to have been present in greater force in the original type of the low grade ore characterized by secondary quartz.

Rio de Janeiro, Dec. 24th, 1907.



ART. XXIII.—*A Possible Overflow Channel of Pounded Waters Antedating the Recession of Wisconsin Ice*; by FRANK CARNEY.

*Introduction.*

WHEN the ice-cap extended into Pennsylvania south of the "Lake region" in central New York, the Susquehanna through its tributaries carried off the augmented drainage. Following this maximum reach of the ice came a period of decline marked by successive retreats and halts. In withdrawing from the Alleghany plateau area the front of the ice became grossly serrate, the pattern of the longitudinal valleys of the outer slope of the plateau. Each valley held a lake which grew deeper and broader as the ice-barrier receded. The Susquehanna was still the ultimate drainage-line of ice-front waters. Each lake retained an outlet southward till the ice uncovered some new point northward lower than the altitude of this overflow channel; then the lake coalesced with the water-body in a neighboring valley, still reaching the Susquehanna, but by a less direct route. In time the glacier revealed altitudes so low that the impounded waters were no longer carried to the Atlantic by the former course, but went first to the west, overflowing ultimately by the Chicago outlet, and later eastward via the Mohawk.

It is apparent that when the ice had retreated along a particular divide between two adjacent north-sloping valleys far enough to allow the water-body having the higher level to flow into the other, the line of flowage was at first either a channel with ice for one wall, in which position the overflow stream might intrench itself provided the ice kept a constant front; or a sag in the divide, a location that the overflow would maintain until the ice had withdrawn from a level lower than the bed of the stream. Successive stages of coalescing ice-front lakes would thus develop channels transverse to the intervalley divides.

*Local Ice-Front Lakes.*

The two unreported channels that occasion this paper mark stages of an ice-front lake or lakes in Keuka valley; an impounded lake occupying Seneca valley constituted the local base-level of these channels.

*Résumé.\**—The first ponded body (Hammondsport Lake)†

\* See this Journal, vol. vii, 1899. Professor H. L. Fairchild's map, Plate vi, in his paper, "Glacial Lakes Newberry, Warren, and Dana in Central New York," pp. 249-263, will aid in following this brief description.

For a bibliography on the history of the high level ice-front lakes see footnote to p. 325, vol. xxiii, 1907, of the Journal.

† H. L. Fairchild, loc. cit., p. 253.

in Keuka valley overflowed by way of Bath, the altitude of the channel being 1125 feet; in Cayuga\* valley, which bifurcates south of Ithaca, the Danby stage, the lake of the western arm, had an overflow at 1040 feet, but this stage later coalesced with the ponded body in Six Mile Creek, and thereafter the White Church channel—975 feet—became the spillway of the resultant Lake Ithaca; in Seneca valley the Horseheads channel (900 feet) carried the overflow of Watkins Lake.† In time the ponded drainage of these three valleys united, forming glacial Lake Newberry.‡ Lake Ithaca was diverted to the west as soon as the ice discovered a level on its shore lower than 975 feet, the White Church overflow; such a level was revealed at Ovid.§ Lake Hammondsport, before coalescing with Watkins Lake, had an intermediate level via Wayne about 10 feet lower than the Bath outlet.||

#### *New Channels.¶*

Fairchild, in discussing the genesis of Lake Newberry, says concerning the coalescence of Hammondsport Lake: "the locality of its overflow was probably near Second Milo, four miles south of Penn Yan."\*\*\* In this area two channels have been studied; their position is indicated in fig. 1.

*Channel No. 1* (fig. 2).—The topographic map suggests that this outlet, nearly four miles southwest of Penn Yan, is rock bound; the stream has incised the Hatch shales and flags,†† developing a channel about 50 feet deep and 90 rods long. The discontinuity of rock northward indicates that a salient has been cut across. The altitude of the entrance of the channel is approximately 1080 feet; the fall of the bed is not over 30 feet. The walls of this channel have a gentle slope, suggesting either rapid or long-continued subaerial weathering; the bed is aggraded. Extending eastward, the course of the outlet appears to have passed near the house of A. C. Ansley, on whose farm the channel is located; but there is no conclusive evidence of the further course taken by the stream.

*Channel No. 2.*—This is three miles southeast of Penn Yan. It heads on the property of John Armstrong, east of the intersection of the highways, in an area containing a conspicuous number of large boulders. The entrance to this

\* H. L. Fairchild, Bull. Geol. Soc. Am., vol. vi, pp. 369-371, 1895.

† Ibid., p. 365.

‡ H. L. Fairchild, this Journal, vol. vii, p. 255, 1899.

§ Ibid.

¶ H. L. Fairchild, Bull. Geol. Soc. Am., vol. x, p. 40, 1899.

¶¶ The Penn Yan and Ovid sheets of the U. S. Geol. Surv. may be of use in following this discussion.

\*\*\* This Journal, vol. vii, p. 255, 1899.

†† N. Y. State Mus., Bulletin 101, p. 47, 1906.

overflow channel is about 40 rods wide; the drift has been swept away by the stream which terraced the kame-like moraine on the



FIG. 1. From the Penn Yan (N. Y.) Quadrangle. Shows northern end of the divide between Seneca and Keuka valleys. Location of two unreported spillways of glacial waters is indicated by parallel black lines; the row of small circles near No. 1 represents glacial moraine.

farm of W. L. Spooner, forming its northern wall, at the same time cutting a bench in the rock of the southern wall; crossing the highway, it continues eastward through the property of Samuel McElvee. The development attained by this outlet does not indicate a very long stage of the lake at this level, approximately 1010 feet.

*Base-level of channels.*—Lake Newberry overflowed at Horseheads; since the outlet is heavily aggraded, it is possible that this lake at one time rose above the 900-foot contour, but later removed some of the glacial outwash; the level of its deltas,



FIG. 2. Looking eastward through Channel No. 1.

however, preclude much allowance for cutting down of the overflow channel. This altitude, then, was the intermediate base-level of the streams that led the ponded water of Keuka valley into Seneca valley. The intakes of the channels represent the water levels of the former valley; this level minus the gradient of the outlet streams should be the altitude of Lake Newberry, or 900 feet.

*Correction for differential movement.*—The whole Great Lakes region in post-Wisconsin time has been subject to a deformation which has either depressed the areas in the west and south, or upraised those in the east and north, or, by a combination of these movements, has produced the same result. The amount of this deformation in the Finger Lake area has been computed at 2.7 feet per mile.\* The channels we

\* R. S. Tarr, *Journal of Geology*, vol. xii, pp. 79-80, 1904; data communicated to Professor Tarr by Dr. G. K. Gilbert.

are considering are approximately 30 miles north of Horseheads. Consequently a correction of about 80 feet must be applied; this makes the intake of channel No. 2 930 feet, an altitude that includes a stream gradient of thirty feet; the measurement made in the field was about 40 feet for the slope of this overflow stream, but there is opportunity for some misapprehension through post-glacial erosion. The corrected reading for the intake of channel No. 1 is 1000 feet.

*Correlation of Channels.*

*No. 2.*—The north wall of this channel consists apparently of submarginal ice deposits; kame material characterizes the drift for a mile northward. No evidence of a waterway between this outlet and the Newberry level has been found. Obviously this channel represents the last position of the ice-front preceding the retreat that brought about the coalescence of the ponded bodies in Seneca and Keuka valleys.

*No. 1.*—This channel, if associated with Lake Newberry, must have dropped 100 feet in a distance of about two and one-half miles; this estimate is based on the altitude of rock to the east near Plum Point Creek after making the correction for landwarping. The presence of moraine extending southeastward from the vicinity of the channel is suggested by the topographic map; the trend of this moraine indicates the tapering outline of the ice-lobe in Seneca valley. The northern portion of the outlier produced by the cutting of this channel through the salient of rock is covered by drift which marks the vertex of the reëntrant angle between the lobes that occupied these adjacent valleys; the lobe in Keuka valley, however, was much the shorter, judging from the trend of the lateral moraine developed along the ice-front which appears to have had an east-west direction as far as Second Milo. With this relation of ice-lobes and valley walls it is probable that the outlet stream skirted the ice-margin, or the drift deposits accumulating along this margin, taking the course indicated by the headwater segment of Plum Point Creek. Under this hypothesis, during the early stage, as the stream turned more to the south it apparently was crowded by the ice, and in consequence produced the cliff-like slope one and one-half miles directly west of Himrod. A slight withdrawal of the ice would allow the stream to broaden; no evidence of an incised channel east of the initial cut, or of terracing against the drift, was found.

This outlet stream even in its short course should have acquired a considerable load since it had a sharp gradient and was flowing along accumulating moraine. Its point of debouchure into Lake Newberry would be marked by a delta; at Himrod is a conspicuous delta; this delta, however, can not be connected with the stream in question, because when the

ice abutted the rock salient at channel No. 1, thus holding the Keuka valley lake up to the level of the channel, the lobe of ice in Seneca valley extended south many miles, covering the site of the Himrod delta, which was not built till the ice-lobe had retreated several miles north. In case this stream did mark its union with Lake Newberry by a delta, we would look for it southwest of Himrod.

That this overflow channel correlates with the Newberry level is supported (1) by the position of drift on the north slope of the outlier immediately north, showing that ice was present and hindered the passage of water by a lower contour; (2) by the distribution of moraine laterally from this position evincing a continuous ice-front; (3) the evidence of at least some stream work in the direction of Lake Newberry; (4) the certainty that when the ice in its retreat had reached this point, discovering a lower level, 1000 feet, than the Wayne outlet, 1100 feet (both levels corrected for differential movement), Hammondsport Lake would be diverted into Seneca valley.

But other facts must be considered before deciding that a pro-Wisconsin (recessional) ponded lake was connected with the genesis of channel No. 1: (1) The walls of this channel have a more aged appearance in slope and the consequent covering of vegetation than have unquestionable post-Wisconsin channels of this vicinity cut in the same formation. (2) There is glacial drift in the bed of the channel; it is evidently modified so far as may be judged in the absence of sections. (3) The proportions of this channel imply a time factor that should be represented by erosional work in the path the stream must have taken. While the altitude of the channel in reference to the Newberry level is not contradictory to their being associated, nevertheless it seems improbable that a stream having a gradient of approximately 100 feet in less than three miles, and having performed so much degradation work at the outlet of the lake which it drained, should not have developed a channel elsewhere in its course. If such a channel exists, it is buried; if buried, it was not genetically related to Lake Newberry.

#### *An Alternate Hypothesis.*

As the Wisconsin ice-sheet moved into and over the Alleghany plateau, its front was fringed by lakes, the ponded north-flowing streams. These lakes, save the very earliest, overflowed southward, probably doing some erosional work on their outlets. Tarr, however, concludes, after having studied a wide area, that "ice-born stream-erosion," particularly that of marginal lakes, was very slight.\* The ice later passed over

\*Bull. Geol. Soc. Am., vol. xvi, pp. 239-240, 1905.

and abraded these outlets; still later during the recession stage, it is probable that aggradation immediately from the ice or by extra-morainic waters filled up the spillways to some extent. A similar play of factors operated during each preceding ice-invasion. With the weight given at present by glacialists to the ice-erosion factor, it is probable that these outlets or cols were appreciably lowered by even one advance of the ice. It has been convincingly established that ice-erosion was effective in the trough of Seneca valley.\*

All evidence, then, points to the conclusion that ice-front waters of earlier invasions, as well as the pro-Wisconsin lakes, flowed southward over cols or outlets at higher levels than did the ponded bodies marginal to the receding Wisconsin ice. The alternative hypothesis for channel No. 1 is that it was associated in genesis with a lake held to a higher level than that of Lake Newberry; the divide somewhere between Horseheads and Watkins has since been lowered.

The list of channels in New York State† made by waters of the waning Wisconsin ice is long; further detailed study will reveal many more. An equal number of channel-ways must have been necessitated in the advance of the Wisconsin ice-sheet, and in both the advance and retreat of earlier ice-sheets, provided the glacier moved as far over the area and then retreated as deliberately as did the ice of the last invasion, and provided further that glaciation produces but slight changes in topographic relationships, a proposition on which there is agreement.‡ Such channels are short, being transverse to divides. Conditions in later glaciation favored their obliteration possibly by ice-erosion, more probably by drift-burial. It is conceivable that neither factor may have operated in every case; also that the retreating Wisconsin ice may have halted in positions favorable to the resurrection of filled or partially buried channels. Obviously channel No. 1 was used as a spillway for the last high level lake of its altitude in Keuka valley; but at the present we find no satisfactory explanation for the objections raised against its being associated genetically with a lake held in front of the receding Wisconsin ice. We believe that this channel suggests a pre-Wisconsin ice-invasion of central New York.§

Department of Geology, Denison University, December, 1907.

\* *Ibid.*, Journal of Geology, vol. xiv, p. 19, 1906.

† H. L. Fairchild, Bull. Geol. Soc. Am., vol. x, pp. 60-61, 1899; *ibid.*, N. Y. State Mus., 20th Report of the State Geologist, pp. r119-r125, 1900; *ibid.* N. Y. State Mus., 21st Report of the State Geologist, pp. r33-r35, 1901; *ibid.*, N. Y. State Mus., 22d Report of the State Geologist, pp. r25-r30, 1902; *ibid.*, N. Y. State Mus., Bulletin 106, pp. 15-33, 1907; J. B. Woodworth, N. Y. State Mus., Bulletin 83, pp. 16-24, 1905.

‡ R. S. Tarr, The Physical Geography of New York State, pp. 104-5, 1902. Chamberlin and Salisbury, Geology, vol. i, p. 275, 1904.

§ Somewhat analogous evidence of multiple glaciation in New York was presented in vol. xxiii, pp. 325-335, 1907, of this Journal.

ART. XXIV.—*The Axial Colors of the Steam Jet and of Coronas*; by C. BARUS.

1. THESE colors overlie the source of light when looked at through a long column of wet air in which uniform cloud particles are suspended. It makes no difference whether the source is a point simply, or a disk, say, four inches in diameter; it appears uniformly colored, as if seen through colored glass, so long as the cloud lasts. The order of colors beginning with particles of extreme smallness is the same as that of Newton's interferences, seen by transmitted light. In case of the steam jet, however, on passing the transition from crimson to violet in the first order, the field becomes opaque while the steady flow of the jet usually breaks down and becomes turbulent. In the case of coronas I have thus far failed to reach this transition, the medium showing mere fogs of uncertain character.

To produce the actual colors vividly, and especially the tints of the second and third orders for relatively large particles, the columns of fog must be long and very uniform. The steam jet soon fails in this respect, but a drum one to two meters long used as a fog chamber shows saturated colors surrounded by coronas. In the case of hydrocarbon vapors, the columns may be shorter, because the particles throughout are larger for like numbers per cubic centimeter, than is the case with water vapor.

2. In my earlier work\* I was inclined to regard these colors as interferences superimposed on the coronas, regarding the small field of refraction possible with small particles, as in keeping with the long columns needed for observation. The explanation at best is purely tentative. Later in my work when the size of particles was estimated from data given by successive exhaustions,† it appeared that the size of the fog particles were of an order about ten times larger than would be needed to produce interferences of the same kind. The interference hypothesis was therefore abandoned. In my more recent results, the diameter of fog particles,  $d$ , and the ratio in question is somewhat reduced, but remains of the same order. Thus if  $n$  be the number of fog particles per cubic centimeter,  $D$  the thickness of an air plate giving like interference colors, the following results may be selected at random.

\* Phil. Mag. (5), xxxv. p. 315, 1893, Bull. U. S. Weather Bureau, No. 12, 1895.

† Phil. Mag. (6), iv, p. 26, 1902, Smith's contrib. No. 1373, 1903; No. 1651, 1905.



Axial color	Disc color	$d$ cm	$n^{-\frac{2}{3}}$ cm	$d/D$
$b$	(fog)	(.00015)	.008	8.8
$y$	$bg$	22	.011	7.7
$p$	$gy$	25	13	6.1
$v$	$y$	27	14	6.4
$b$	$ro$	29	15	6.5

From this it appears that the strong axial blues of the first order must belong to particles even larger than .0001<sup>cm</sup> in diameter, and that all particles are more than six times larger than would be demanded for interferences.

3. Recently I have considered the case of a lamellar grating, in which diffractions are obtained from a uniform succession of alternately different thicknesses of clear glass. Experiments with such gratings were originally made by Quincke and there is a full theoretical treatment by Verdet. The behavior of this grating differs from that of the usual kind in the occurrence of an additional factor

$$\cos^2(\pi d(n-1) + \pi a \sin \delta)/\lambda$$

where  $n$  is the index of refraction,  $d$  the difference in thickness between thin strips of width  $a$  and of thick strips of width  $b$ ,  $\delta$  the angle of diffraction. Hence for axial color,  $\delta=0$ , minima occur at  $(n-1)d=(2m+1)\lambda/2$ , whereas for Newton interferences the minima occur for a thickness of  $D$  in case of transmitted light, where  $2\mu D=(2m+1)\lambda/2$ ; whence

$$d/D = \frac{2n}{n-1} .$$

In case of water  $n=1.33$ , or  $d/D=8.0$ . This result holding for a grating of transparent strips, is so near the above datum  $d/D>6$  for a medium of transparent particles (for which there is no theory), that it seems reasonable to conclude, that the actual colors are referable to the same type of phenomenon in both cases. The need of observations through long columns in case of fog particles suspended in air is additionally confirmative, since the contribution of color due to one particle must be exceedingly small.

4. One might be tempted to explain the disk colors in the same way, for in case of deviation  $\delta$  from the axial ray

$$D/d=(n-1)/2n + a \sin \delta/2dn.$$

But here there are several insuperable difficulties, which refer the disk color to a different origin. In the first place, they are much more intense than the axial colors and are seen distinctly through very small thicknesses of fog; disk colors are apparently abruptly complementary to the axial colors and

there is certainly no continuous transition; finally there is no incident light of the requisite obliquity.

The appearance is therefore as if, corresponding to the interferences by transmission, there were complementary interferences by reflection toward the source of light. This phenomenon could then be reversed in direction at any fog particle in its path, and thus turned again toward the observer. But apart from the complementary nature of disk and axial color, no other evidence bears on this explanation. Moreover, any such theory must account for the intensity of disk colors in general, and in particular for the vividness of the greens.

5. In a long chamber and intense illumination, the axial colors may be extended over a considerable area and intensified by strong illumination. It is not improbable that they will then be serviceable for spectroscopic investigation, in which case the mean wave length of the interference bands may serve for their identification. They would then offer a means of further investigating the fog phenomenon at a degree of fineness beyond which the coronas cease to be available. Experiments of this kind are in progress.

Brown University, Providence, R. I.

ART. XXV.—*Descriptions of Tertiary Insects*; by T. D. A. COCKERELL.

PART II. [Continued from p. 52.]

(3) *A Belostomatid (Hemiptera) from Colorado.*

THE occurrence of Belostomatid bugs in the Tertiary rocks of Europe has been known ever since 1837, when Germar described *Belostoma goldfussi* from the vicinity of Bonn, in Rhenish Prussia. *Belostoma speciosum* Heer, from Ceningen, is one of the largest and finest fossil insects from that famous locality. So far as the paleontological evidence went, one might have supposed that the Belostomatids, now so characteristic of America, were in Tertiary times confined to the Old



FIG. 1.—*Zaitha vulcanica*,  $\times 2$ .

World. That this was not really the case is shown by the discovery of a small species in the Florissant Miocene.

*Zaitha vulcanica* sp. nov.

Length of body  $10^{\text{mm}}$ , not counting the thick caudal valves, which are about  $2^{\text{mm}}$  long; breadth in middle a little over  $5^{\text{mm}}$ ; shape normal; anterior femora  $4^{\text{mm}}$  long, thick, but not swollen in the middle, the anterior edge practically straight (distinctly convex in the living *Z. fluminea*), the anterior side with a distinct groove; anterior tibia + tarsus about  $3^{\text{mm}}$  long, curved as in *Z. fluminea*; hind femora distinctly incrassated in the middle; hind tibia + tarsus about  $6^{\text{mm}}$ , thus shorter proportionally than in *Z. fluminea*. General appearance quite *Nepa-*

like, but the structure is that of *Zaitha*. The apical angle of the corium appears to have been broader than in *Z. fluminea*, but the whole dorsal region is very indistinctly preserved. Florissant Station 14 (*W. P. Cockerell*, 1907).

(4) *A Tipulid Fly from the Green River Shales.*

The genus *Dicranomyia* Stephens is represented in the living fauna of North America by 35 described species. In the fossil state, numerous species occur in Prussian amber,

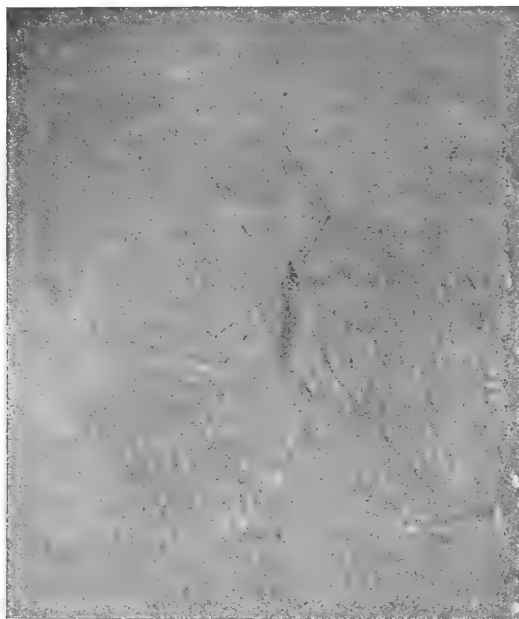

FIG. 2.—*Dicranomyia rhodolitha*,  $\times 2$ .

according to Loew. Scudder has described eight species from the Tertiary rocks of the Rocky Mountains; five being from Florissant and three from the Lower White River, at the boundary between Utah and Colorado. A new species is added from Wyoming.

*Dicranomyia rhodolitha* sp. nov.

Male. Length 7<sup>mm</sup>; length of thorax 2<sup>mm</sup>, its width 1 $\frac{1}{8}$ <sup>mm</sup>; genitalia essentially as in *D. stigmosa* Scudder. Eyes separated by an interval of about 135  $\mu$ .

Legs long and slender; anterior femur  $4\frac{3}{8}$ , tibia  $5\frac{1}{2}$ , tarsus  $6\frac{1}{4}^{\text{mm}}$ ; middle femur  $5\frac{1}{2}$ , tibia  $6^{\text{mm}}$ ; hind femur 6, tibia  $6\frac{2}{5}^{\text{mm}}$ .

Wings  $7^{\text{mm}}$  long: a small dark spot on costa  $2\frac{3}{8}^{\text{mm}}$  from base; another  $4^{\text{mm}}$  from base; stigmal spot large, as in *D. stigmosa*. Venation not well preserved, but the subcosta (mediastinal of Loew) and the four apical veins are all quite normal.

Allied to *D. stigmosa* Scudder, but distinguished by the details of the measurements, and especially by the two costal spots.

Red shale of Green River, Wyoming, in Yale University Museum. Collector unknown. One specimen, with reverse.

(5) *A Pompilid Wasp from Florissant.*

In all, four fossil Pompilidæ have been described, three from Florissant, and one from Eningen. One or two others, not named, are said to occur in Baltic amber. The Florissant species have been referred to *Hemipogonius* (2) and *Ceropalites* (1); an additional species, now described, belongs to *Agenia*.



FIG. 3.—*Agenia saxigena*,  $\times 2$ .

*Agenia saxigena* sp. nov.

Length about  $11\frac{1}{2}^{\text{mm}}$ ; rather stout, width of abdomen about  $3\frac{1}{2}^{\text{mm}}$ ; anterior wing  $9\frac{3}{8}^{\text{mm}}$  long; body and femora black, tibiae and tarsi ferruginous; wings faintly dusky, with a dark cloud in the marginal cell and below, and another in lower basal part of first discoidal and below; venation ferruginous; antennæ more or less curled apically; legs not at all spinose; stigma fairly large; marginal cell lanceolate, ending in a point

on costa; *first discoidal cell of the same length as first submarginal*, viz. 2890  $\mu$ ; cubitus of hind wings originating about 34  $\mu$  beyond transversomedial. The following measurements are in  $\mu$ :

Greatest width of marginal cell .....	595
First submarginal on marginal .....	255
Second " " " " .....	714
Third " " " " .....	1020
Marginal from end of third transverso-cubital to apex .....	680
Basal nervure on first submarginal .....	340
" " " " discoidal .....	595
" " from transversomedial (basad of it) .....	680
Length of transversomedial .....	340
Lower side of first submarginal .....	2346
First transverso-cubital nervure .....	646
Second submarginal on first discoidal .....	255
" " " third " .....	612
Third " " " " .....	561
Lower side of third submarginal beyond third discoidal .....	1105

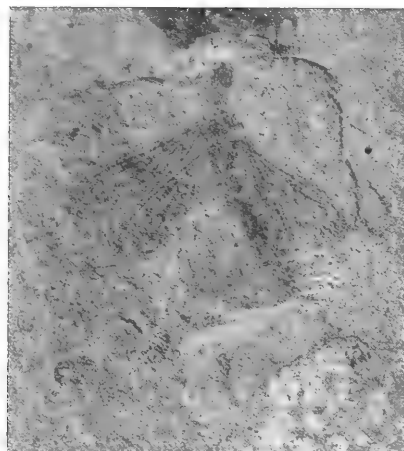

FIG. 4.—*Embia florissantensis*,  $\times 2$ .

According to Fox's\* table the Pompilini (to which *Agenia* belongs) should have the first discoidal cell definitely longer than the first submarginal, but in some of the living forms the difference is trifling. *A. saxigena* is from Florissant, Station 14 (W. P. Cockerell, 1907).

\*Proc. Phila. Acad., 1894, p. 295.

(6) *The Second Tertiary Embiid.*

Pietet in 1854 described *Embia antiqua* from Baltic amber, and this has remained the single fossil representative of the family; *E. westwoodi* Hagen, from copal, being properly of the recent period

An insect occurring at Florissant, having a strong general resemblance to a Termite, proves upon careful examination to disagree in important particulars with all Termitidæ, and to agree well with the Embiidæ, to which it must be referred. It has even the peculiar streaked appearance of the wings, so characteristic of this family.

*Embia florissantensis* sp. nov.

Length  $12\frac{1}{2}$ mm; head about 2mm; prothorax about  $1\frac{2}{3}$ ; anterior wing 11mm long and  $3\frac{3}{4}$  broad; posterior wing just over 9mm long, but as broad as the anterior; shape of wings normal, with the usual longitudinal bands of color, giving rather the appearance of a flower-petal with colored veins. The head is narrow-oblong, considerably narrower than in *E. (Oligotoma) michaeli*, McLachlan; prothorax unusually elongated, shorter, but not very much smaller than the head; the distinct venation consists of two parallel veins, barely separated, running along the upper part of the wing for about three-quarters its length, nearly parallel with the costa, but gradually nearing it apically, and apparently fusing at their ends; and of an oblique vein in the anal region. According to the interpretation of Melander\* the parallel veins represent the subcosta; and the oblique vein the cubitus, with its lowermost branch. The color bands, regarded as representing veins, show the media + radius, giving off two large branches above, essentially as in *E. urichi* Saussure (this Trinidad species is presumably named after Mr. Urich, the well-known naturalist of that island; hence there is no reason for perpetuating the erroneous form "*uhrichi*"), except that the branches are given off much sooner, the first about  $4\frac{2}{3}$ mm from base of wing, the second a little more than 4mm from apex. The two lower color-bands, representing the third media and first cubitus, are also well represented. These particulars are derived from the anterior wing, but the hind wing is similar.

*Hab.*—Florissant, Station 14 (*W. P. Cockerell*, 1907). Also two from Station 13 (*S. A. Rohwer*, 1907, *W. P. Cockerell*, 1906). Melander, in giving an account of the discovery of *E. texana*, remarks that *Sapindus* and *Eysenhardtia* grew profusely in the locality where it was found. It is of interest to

\* Biol. Bull., 1903.

note that *Sapindus* was abundant at Florissant and *Eysenhardtia* also grew there.\*

(7) *A Mayfly from Florissant.*

Seven Ephemerids have been described from Baltic amber, and one from Ceningen. In America, Scudder has described five nymphs and one adult from Florissant. I have examined the type of the latter (*E. exsucca*) in the Museum of Comparative Zoology. A much larger form is here described; like the other, it unfortunately does not show the characters necessary for precise generic reference.



FIG. 5.—*Ephemera howarthi*,  $\times 2$ .

*Ephemera* (s. lat.) *howarthi* sp. nov.

Length of body, excluding caudal setæ,  $15^{\text{mm}}$ ; thorax about  $5^{\text{mm}}$ ; three slender caudal setæ; head transversely oval, about  $2^{\text{mm}}$  broad, eyes about  $\frac{1}{3}^{\text{mm}}$  distant on vertex; length of anterior wing  $13^{\text{mm}}$ , costa very slightly arched, subcostal vein close to costa; outer margin about  $9^{\text{mm}}$  long, distinctly convex.

Another specimen (from Sta. 13 B) is larger (anterior wing about  $14^{\text{mm}}$ ), but evidently the same species.

Florissant, Station 14 (*T. D. A. Cockerell*); also Sta. 13 B (*Geo. N. Rohrer*, 1907). I have named this species after Mr. Howarth, of Florissant, who is known even in Europe as a skillful creator of new genera and species of mayflies, of wondrous form and color, used by fishermen to lure the speckled trout.

\* *Eysenhardtia* (or *Viborquia*) *nigrostipellata* Ckll. ined. was collected at Florissant by the Princeton expedition, and is now in the British Museum. The leaflets have the blade about  $5\frac{1}{2}^{\text{mm}}$  long and  $2\frac{2}{3}$  broad, and are almost exactly as in *E. orthocarpa* (Gray) Watson. The little black pointed stipels are like those of *E. spinosa* Engelm.



ART. XXVI.—*The Reduction of Vanadic Acid by Zinc and Magnesium*; by F. A. GOOCH and GRAHAM EDGAR.

[Contributions from the Kent Chemical Laboratory of Yale Univ.—clxx.]

A METHOD recently proposed by B. Glasmann\* for the estimation of vanadic acid and molybdic acid in association with one another, depends upon the dissimilarity in the action of zinc and magnesium upon the former and the similarity in the action of these metals upon the latter in the presence of hydrochloric acid. The method consists essentially in treating for an hour to an hour and a half, in a flask closed with a Bunsen valve, each of two aliquot portions of the solution containing a vanadate and a molybdate, the one with zinc and hydrochloric acid under gentle heating and the other with magnesium and hydrochloric acid, opening the flasks to the air, pouring the contents of each flask into a 500<sup>cm</sup><sup>3</sup> porcelain dish containing a solution of 10 gms. of manganese sulphate in 300<sup>cm</sup><sup>3</sup> of air-free boiling hot water, and titrating with potassium permanganate while stirring actively. The amount of permanganate taken in titrating the contents of the first flask is used presumably in oxidizing the molybdenum from the condition of Mo<sub>2</sub>O<sub>3</sub> to that of MoO<sub>3</sub> and the vanadium from the condition of V<sub>2</sub>O<sub>2</sub> to that of V<sub>2</sub>O<sub>5</sub>: the amount of permanganate used in titrating the contents of the second flask shows presumably oxidation corresponding to a change of Mo<sub>2</sub>O<sub>3</sub> to MoO<sub>3</sub> and to a change of V<sub>2</sub>O<sub>2</sub> to V<sub>2</sub>O<sub>5</sub>. The difference between the amounts of permanganate used in the two titrations should presumably indicate the oxidation of V<sub>2</sub>O<sub>2</sub> to V<sub>2</sub>O<sub>5</sub> and so by calculation give the amount of V<sub>2</sub>O<sub>5</sub> originally present in the solution. The amount of V<sub>2</sub>O<sub>5</sub> having been determined, the amount of MoO<sub>3</sub> originally present is easily calculated from the amount of permanganate used in either titration.

It is plain that the value of the method depends largely upon the definiteness with which vanadic acid may be reduced to the condition of V<sub>2</sub>O<sub>3</sub> by magnesium and left in the condition of V<sub>2</sub>O<sub>2</sub> when the solution is treated with zinc and subsequently exposed to the air.

Concerning the reduction of vanadic acid by magnesium in the presence of hydrochloric acid, Glasmann gives the data and results of three experiments.† Of these two are in fair agreement with the hypothesis; but, unfortunately, the record of the third experiment is affected by an error of about 10 per cent, either typographical or of calculation. It is likewise

\* Ber. Dtsch. chem. Ges. xxxviii, 600.

† Titrations Tabelle, II, loc. cit.

interesting to note, though the conditions are different, that in Roscoe's study of the behavior of vanadic acid in the presence of magnesium and sulphuric acid,\* to which Glasmann refers, the variation in the degree of reduction is likewise considerable, amounting to more than 2 per cent.

As to the reduction of vanadic acid by zinc, Roscoe's results show a degree of reduction approaching that of  $V_2O_5$ , but with variations of as much as 3 per cent; and it is well known that the oxidation of solutions thus reduced proceeds rapidly and ultimately results in the condition represented by  $V_2O_4$ .† Whether reductions may be kept regular and the action of air made so small as not to vitiate the analytical results of Glasmann's method during the short exposure, are matters for experimental determination. According to Glasmann's results in these experiments, the interference would seem to be inappreciable, but here again the calculated results are not in complete accord with the printed data.‡

It has seemed desirable, therefore, to consider further the accuracy which may be expected under the conditions of analysis in the reduction of vanadic acid by magnesium and by zinc.

#### *Reduction by Magnesium.*

Portions of a solution of sodium vanadate, standardized by the very accurate method of Holverscheit,§ were reduced by magnesium in the presence of hydrochloric acid or sulphuric acid.

In each of the experiments of Table I, A, the reduction was made, in a funnel-trapped flask, by magnesium in the presence of hydrochloric acid added gradually to properly moderate the action. After the magnesium had been used up, the contents of the flask were added to 800<sup>cm</sup><sup>3</sup> of boiled water containing 1 grm. of manganese sulphate and 2<sup>cm</sup><sup>3</sup> of sulphuric acid, and titration was made with nearly N/10 potassium permanganate. The conditions of the experiment were essentially those of Glasmann's method in respect to reagents and time of action.

In the experiments of Table I, B, the treatment was modified so that the action might be slower and long continued, with a view to bringing about better contact of the vanadium solution with the magnesium cushioned by evolved hydrogen. The reduction was made in a stoppered flask connected with a hydrogen generator, arranged for the maintenance of an atmosphere of hydrogen during the period of reduction, and

\* Ann. Chem. Suppl. vi, 77 (1868).

† Roscoe, loc. cit.; Gooch and Gilbert, this Journal, xv, 390.

‡ Titrations Tabelle, I, loc. cit.

§ Inaug. Diss. Berlin, 1890.

fitted with a separatory funnel through which dilute sulphuric acid was added from time to time in small portions as required during the prolonged action, never evolving hydrogen violently enough to float the magnesium.

The experiments of Table I, C, were made to test the effect of using magnesium in the form of a heavy amalgam. About two grams of magnesium were dissolved, with heating, in an excess of mercury and the resulting liquid amalgam was used as the reducing agent, in the flask containing vanadic acid and sulphuric acid. At the end of the action, which took place without the application of heat and was over in about ten minutes, the distinctly violet solution was decanted, filtered from the mercury with careful washing, and titrated with potassium permanganate. Special tests in blank having shown that, for the amount of amalgam used, mercury goes into solu-

TABLE I.

Time	Magnesium met. grm.	KMnO <sub>4</sub> $\frac{N}{10} \times 1.052$ cm <sup>3</sup>	V <sub>2</sub> O <sub>5</sub> taken as NaVO <sub>3</sub> grm.	V <sub>2</sub> O <sub>5</sub> calc. from oxidation of V <sub>2</sub> O <sub>3</sub> grm.	Error in terms of V <sub>2</sub> O <sub>5</sub> grm.	V <sub>2</sub> O <sub>2</sub> reduced to	
						V <sub>2</sub> O <sub>3</sub> grm.	V <sub>2</sub> O <sub>2</sub> grm.
A							
Reduced by Magnesium and Hydrochloric Acid.							
1 hr.	4.0	26.05	0.1144	0.1249	+0.0105	0.0934	0.0210
1 hr.	4.0	26.2	0.1144	0.1257	+0.0113	0.0918	0.0226
1½ hr.	4.0	27.1	0.1144	0.1300	+0.0156	0.0834	0.0312
1½ hr.	4.0	28.3	0.1144	0.1357	+0.0213	0.0718	0.0426
B							
Reduced by Magnesium and Sulphuric Acid							
8 hrs.	4.0	24.1	0.1144	0.1156	+0.0012	0.1120	0.0024
8 "	4.0	23.8	0.1144	0.1142	-0.0002	----	----
8 "	4.0	25.2	0.1144	0.1208	+0.0064	0.1015	0.0129
8 "	4.0	25.4	0.1144	0.1218	+0.0074	0.0996	0.0148
16 "	8.0	26.5	0.1144	0.1271	+0.0127	0.0890	0.0254
16 "	8.0	26.1	0.1144	0.1252	+0.0108	0.0928	0.0216
20 "	12.0	26.8	0.1144	0.1285	+0.0141	0.0861	0.0283
C							
Reduced by Magnesium-Amalgam and Sulphuric Acid							
Calculated from V <sub>2</sub> O <sub>2</sub>							
10 min.	2.0	32.1	0.1144	0.1027	-0.0117	0.0353	0.0791
10 "	2.0	33.4	0.1144	0.1068	-0.0076	0.0228	0.0916
10 "	2.0	34.1	0.1144	0.1090	-0.0054	0.0161	0.0983
10 "	2.0	32.4	0.1144	0.1034	-0.0110	0.0329	0.0815
10 "	2.0	33.1	0.1144	0.1054	-0.0090	0.0269	0.0875
10 "	2.0	33.6	0.1144	0.1075	-0.0069	0.0208	0.0936

tion and acts upon the permanganate sufficiently to use up about  $0.7\text{cm}^3$  of that reagent, a deduction of that amount from the total amount used was made for such action in each experiment, before calculating the degree to which the vanadic acid had been reduced.

From these results it is plain that the degree in which vanadic acid may be reduced by magnesium in the presence of hydrochloric acid or sulphuric acid is irregular and dependent upon conditions not easily controlled. With magnesium amalgam the reduction proceeds most readily and approximates more or less to the condition of  $\text{V}_2\text{O}_3$ .

It is obvious that under none of the conditions which we have tried is the reduction by magnesium sufficiently definite to be applied in a good analytical process.

In Table II are given the results of the reduction of vanadic

TABLE II.					
Exp't	KMnO <sub>4</sub> cm <sub>3</sub>	V <sub>2</sub> O <sub>5</sub>	V <sub>2</sub> O <sub>5</sub>	Error	Remarks
		taken as NaVO <sub>3</sub> gram.	calculated from oxidation of V <sub>2</sub> O <sub>2</sub> gram.	in terms of V <sub>2</sub> O <sub>5</sub> gram.	
A.					
Reduced in flask with Zinc and Hydrochloric Acid					
	N/10 × 1.095				
1.	35.0	0.1235	0.1166	-0.0069	} Poured out into dish titrated in presence of MnSO <sub>4</sub>
2.	35.85	0.1235	0.1194	-0.0041	
3.	34.9	0.1235	0.1163	-0.0072	
B.					
Reduced in flask with Zinc and Sulphuric Acid					
	N/10 × 1.0956				
4.	36.3	0.1235	0.1203	-0.0032	} Titrated in the reduction flask.
5.	36.4	0.1235	0.1209	-0.0026	
6.	36.2	0.1235	0.1213	-0.0022	
7.	36.05	0.1235	0.1206	-0.0029	
8.	36.1	0.1235	0.1201	-0.0034	} Poured into dish for titration Exposed in dish 20 minutes
9.	35.68	0.1235	0.1188	-0.0047	
10.	34.8	0.1235	0.1159	-0.0076	
C.					
Reduced by column of Amalgamated Zinc					
	N/10 × 1.052				
1.	42.4	0.1381	0.1356	-0.0025	} Titrated in the receiver exposed to the air
2.	42.7	0.1381	0.1366	-0.0015	
3.	42.2	0.1381	0.1350	-0.0031	
4.	42.5	0.1381	0.1359	-0.0022	

acid by zinc. The details of experiments made in the reduction flask with zinc and hydrochloric acid are given in A; the record of experiments also made in the reduction flask with zinc and sulphuric acid is given in B; and C contains the data of experiments made with the Jones reductor,\* in which a column of amalgamated zinc 40<sup>cm</sup> long and 2<sup>cm</sup> in diameter was used. In all these experiments the titration was effected directly in air by nearly N/10 potassium permanganate. The  $V_2O_5$  is calculated upon the hypothesis that the reduction goes to the condition of  $V_2O_2$ .

From the results of Table II it is evident that in no case does the condition of oxidation of the product of the reduction of vanadic acid by zinc and hydrochloric acid in the flask, by zinc and sulphuric acid in the flask, or by amalgamated zinc in the reductor, correspond exactly to  $V_2O_2$  when titration is made in air. A series of experiments was made, therefore, in which care was taken to protect the reduced solution from the action of air until the highest degree of oxidation is past and registered, by an adaptation of a method used by Randall† for the accurate titration of molybdic acid similarly reduced by the column of amalgamated zinc.‡ According to this procedure, the receiver attached to the zinc column was charged with a solution of ferric alum, gentle suction was applied to the receiver, and in succession were passed through the column of amalgamated zinc, hot water (100<sup>cm<sup>3</sup></sup>), 2.5 per cent sulphuric acid (100<sup>cm<sup>3</sup></sup>), the solution of vanadic acid in 2.5 per cent sulphuric acid (125<sup>cm<sup>3</sup></sup>), and finally hot water (200<sup>cm<sup>3</sup></sup>). To the receiver was added syrupy phosphoric acid (4<sup>cm<sup>3</sup></sup>), to decolorize the solution, and the titration was made in the hot solution in the usual manner with potassium permanganate. Table III contains the results of these experiments, corrected for the action of the zinc column upon the reagents without the vanadic acid.

The results of Table III show plainly that the action of the column of amalgamated zinc carries the reduction easily and rapidly to the condition of  $V_2O_2$ , and that by anticipating the oxidizing action of the air by means of a ferric salt in the receiver the solution is made less sensitive to the action of the air, while the highest degree of reduction is registered by the ferrous salt formed. A comparison of these results with those of Table II shows unmistakably that a solution containing vanadium in the condition of  $V_2O_2$  cannot be exposed to air, even momentarily, without undergoing oxidation.

\* "The Chemical Analysis of Iron," Blair, 6th ed., 225.

† This Journal, xxiv, 313.

‡ We are indebted to Professor Henry Fay for the information that this mode of treating reduced molybdic oxide was first worked out many years ago by Dr. C. B. Dudley, though never published.

TABLE III.

Ferric alum 10 % sol.	Phosphoric acid syrup	KMnO <sub>4</sub> $\frac{N}{10} \times 1.052$	V <sub>2</sub> O <sub>5</sub> taken as NaVO <sub>3</sub>	V <sub>2</sub> O <sub>5</sub> calculated from oxidation from V <sub>2</sub> O <sub>2</sub>	Error in terms of V <sub>2</sub> O <sub>5</sub>
cm <sup>3</sup>	cm <sup>3</sup>	cm <sup>3</sup>	gram.	gram.	gram.
25	5	43.10	0.1381	0.1378	-0.0003
25	5	43.20	0.1381	0.1381	0.0000
25	5	43.30	0.1381	0.1384	+0.0003
25	5	43.28	0.1381	0.1384	+0.0003
25	5	43.32	0.1381	0.1385	+0.0004
15	3	21.60	0.0691	0.0690	-0.0001
15	3	21.62	0.0691	0.0691	0.0000
15	3	21.80	0.0691	0.0696	+0.0005
40	8	64.90	0.2072	0.2075	+0.0003

Finally, it is evident that the assumptions upon which Glas-  
mann's method for the determination of vanadic and molybdic  
acids is based—viz., that the condition of vanadium in a solu-  
tion reduced by magnesium is definitely that of V<sub>2</sub>O<sub>3</sub> and that  
the condition of vanadium in a solution reduced by zinc and  
exposed subsequently to the air is definitely that of V<sub>2</sub>O<sub>2</sub>—are  
unwarranted.

ART. XXVII.—Ancient Finger Lakes in Ohio,\* by GEO. D. HUBBARD.

DURING the last two summers, while gathering data for a preliminary report on the physiography of the state, the author has found, in several localities of eastern Ohio, evidence of valley glaciers. It is undertaken in this paper to describe some of the long, narrow lakes that were associated with the withdrawal of these valley dependencies of the Wisconsin ice sheet

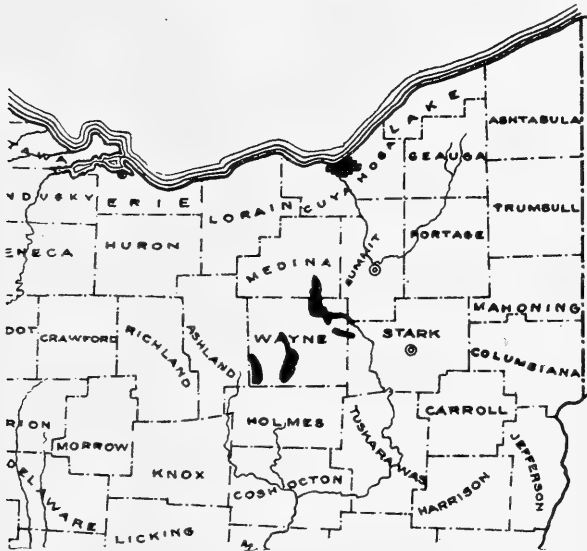

FIG. 1. Northeastern Ohio. Lake beds of four finger lakes (in black).

from several of the rock valleys of northeastern Ohio. As in New York state, only the hilly region has been favorable to the development of such lakes; and also as in New York, the hilly part contains several rather interesting finger lake basins. But differing from those in the eastern state, our Ohio finger lakes have usually not persisted to the present, nor were they quite so genetically inter-related.

The following statement is a preliminary report on the lake beds, a report of progress, stating some results of a rapid investigation of the Ohio finger lakes. It presents positive evidence of the occurrence of four such lake beds. If our topographic

\*By permission of the State Geologist of Ohio. This paper was read in a different form November 30, 1907 before the Ohio State Academy of Sciences.

map were finished it would probably be possible to give a better account of the lakes studied and also to locate others; for they are represented, in almost every instance, by hill-surrounded, lake-bottom plains,—features easily detected on a good topographic map.

The accompanying map of a part of the state (fig. 1) shows in black the approximate location of four of these long, narrow lakes. Concerning some of them much of detail can be given, but of others, in the preliminary survey now being executed, little more than the proof of their existence has been learned. This is a problem that will yield very interesting results, when it is possible to go into a further, more exhaustive study.

The north and largest of this group of finger lakes extends along the valley of Chippewa river from near Medina on the north, southward past Seville and Creston, then eastward almost to Canal Fulton, in the northwest corner of Stark county. Chippewa and Luna lakes and a pond near Doylestown station are remnants of this lake. Formerly it must have attained a length of twenty miles, and at Creston a width of about four miles. In its east and west portion past Rittman, it was probably less than a mile wide. A rather definite beach of sand was found at several points east and south of Chippewa lake but 25–40 feet above its present level; and also on both sides of Rittman. Fine clays and sandy clays floor almost the entire valley as outlined: but in patches between Chippewa lake and the Medina county line south, and also in large areas around Creston, the soil is black and carbonaceous, suitable for the growing of onion sets and celery.

South of Chippewa lake are two loops of waterlaid, and much subdued, moraine, bearing clays over their summits; and at two or three other points near Doylestown, moraine across the valley is not quite obliterated. Massive morainic loops cross the valley at Canal Fulton and at a dozen places southward to Massillon, beyond which is much outwash gravel and sand. This series of morainic loops formed the plug at the south end of the valley; the rock walls held in the lake at the sides, and the ice at the north. As the ice withdrew it occasionally halted and several minor halts are marked by the moraines noted in the valley; and then, while standing a longer time with its front just south of the site of Medina, large moraines were built there which prevented the waters ever finding an outlet northward, in consequence of which the drainage is southeastward down the Chippewa to the Tuscarawas river.

South of this lake bed near Orrville, and eastward to North Lawrence, is another one, which was mentioned by Read, in



1878.\* He recognized it as the bed of a short-lived glacial lake. It was probably eight miles long with a maximum width of about one mile. Weak shore lines and a level, lake-clay floor with some peaty material and marl beds are the evidence upon which this one is based. At present the plain lies 50 feet above the last one described, and from one end drains down into it; while from the other end drainage goes down through a narrow postglacial gorge in drift to the Tuscarawas at Massillon.

The third lake of the group lay in the level-floored valley, west and south of Wooster. The sides of the valley are of drift-covered rock, the floor at present of black muck, and poorly drained. To the south near Shreve, the valley is closed with a complex of moraine, looping across the valley and now cut through by Killbuck creek but not deeply enough to thoroughly drain the lake bottom. About four miles south of Wooster, two fine terminal moraines come down the east valley wall and extend out half way or more across the valley, convex southward. They are both buried knee-deep in sediments. A hill about three miles south of Wooster composed of drift must have been an island in the lake; and several small swells a mile or so nearer Wooster consisting of drift and gravel, and overlain with fine sand and clay, represent the summits of another morainic loop which the lake waters completely submerged.

The lake was one half to one mile wide at Wooster and northward; but southward it widened to nearly two miles. Other evidence of the presence of a lake in this valley was found at several critical points. In the eastern part of Wooster is a large terrace of stratified gravel and sand at approximately the 940 foot level. The sand was seen where an excavation for a building was made in 1907, northwest of the Pennsylvania R. R. station; and the gravel could be seen in the railroad cut, and in several minor excavations east and south of the station. This level area is a delta at the mouth of Spring Run, built when the lake stood at the level of its summit. Some two miles northwest of Wooster, at the mouth of Clear creek, is a smaller, similar deposit. Its surface is at almost exactly the same level. It consists of gravel overlying moraine, and along its west side, back a third of a mile, bed rock appears in a steepened slope. Manifestly moraine was formed against the ice and south of the rock point, and subsequently, when beneath the lake, the moraine was covered with the sediments washed down by Clear creek. Along the west side of the valley from two to five miles south of Wooster,

\* Geol. Surv. of Ohio, vol. iii, p. 529.

just at the crest of the bluff, and 940–960 feet above sea level, occur sand and gravel, usually in small quantities but specially marked where the little runs descend. These are taken to be ancient shore lines. This lake basin, like the first, has its outlet to the south and hence may have disappeared before the glacier did. It certainly would only persist until the outlet could be cut through the retaining moraine.

The soil survey\* working in the Wooster area recognized the clay and silt deposits in this valley, also in the first one de-

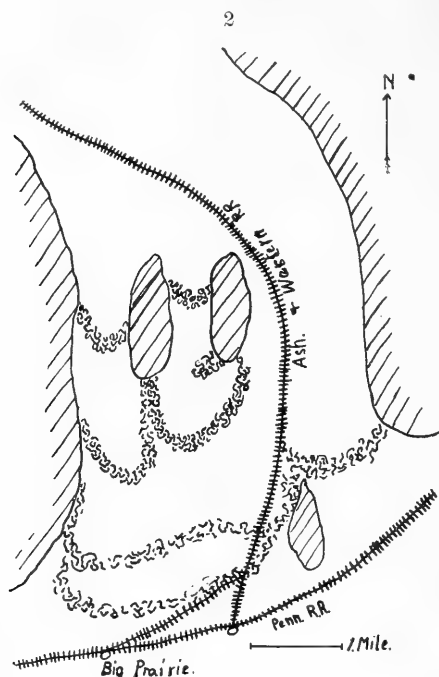

scribed, and found rather extensive peat deposits in places on these lake bottoms. Ancient lakes are located by that survey where peat occurs but apparently are not recognized where the clays and silts are laid.

The bed of the fourth finger lake has been called the Lakeville plain. It may be entered at its south end about a mile northeast of Big Prairie station in southwestern Wayne county, where it has been effectually closed by the building of big morainic loops. Rock walls shut in the sides of the basin, and

\* Bureau of Soils, Field Operations 1904. Wooster Map and text, pp. 548–562.

ice probably closed it at the north. The floor is now of stratified clay and fine sand with a heavy muck layer over most of it. At several points in the valley are inconspicuous areas of water-laid or worked-over moraine, and along the margins may be found, at several points, well defined beach sand. These shore lines are at a level (U. S. G. S.) of 765 feet at Blachleyville and Funk, and the lake bottom is 20 feet lower, but descending very gently northwestward.

The plain representing the lake bottom varies in width from one-quarter to one and one-half miles in the southern part, but widens in the north to about two miles. This plain delivers its drainage northward, hence persisted until the ice melted away. Its northern end has not been seen, but the plain was followed five miles and undoubtedly continues northwestward, possibly connecting with one or both of the "water plains" of Read\* in northwestern Ashland county.

It is probable that other finger lakes equally well marked may yet be found where the glacier invaded the hilly part of Ohio.

Ohio State University.

\* *Geology of Ohio*, vol. iii, pp. 519-521.

ART. XXVIII.—*Stephanite Crystals from Arizpe, Sonora, Mexico*; by W. E. FORD.

RECENTLY two remarkable specimens of stephanite were sent by Mr. J. W. Miller to Prof. L. D. Huntton of the Mining Department of the Sheffield Scientific School and were kindly given to the writer by the latter for investigation. They were found at the J. Pedrazzini mine at Arizpe, Sonora, Mexico, in a narrow but rich silver vein in which the stephanite occurs

1

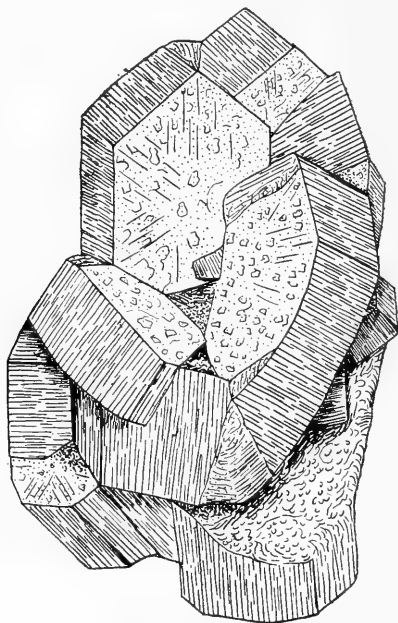

associated with polybasite, argentite, the ruby silvers and the native metal.

The stephanite crystals are of two types; the first showing crystals of simple form but of extraordinary size; the second type being of small but highly modified crystals which were found on the back of the specimens and projecting into the cavities. The two widely divergent types of crystals represent undoubtedly two different periods of formation. The large type of crystals is somewhat diagrammatically represented in figure 1, which was sketched from the smaller of the two specimens and is reproduced nearly in its natural size. The crystals have the form of short thick hexagonal prisms, being pre-

sumably formed by a combination of the basal plane  $c(001)$  with the prism,  $m(110)$ , and the pinacoid,  $b(010)$ .

Occasionally on the basal plane radial striation lines were observed which suggested that the crystal form might be in part at least due to twinning. The crystals average between two and three centimeters across the base, and in one or two cases as much as four centimeters, while the height of the crystals is quite uniformly one and one-half centimeters. The prism faces are invariably vertically striated and frequently show a strong tendency to round into each other, making it

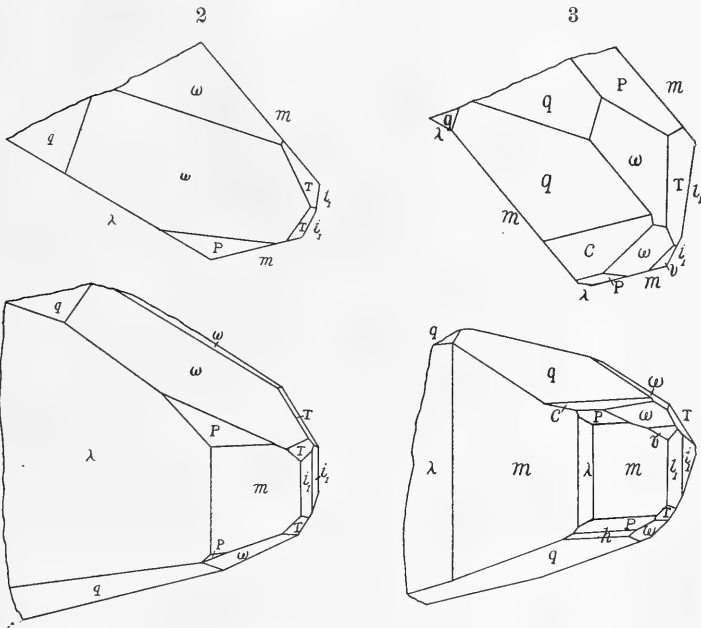

impossible to obtain even approximate measurements of their angles. The basal planes are rough and etched, showing small irregular angular pits, the unetched surfaces however being smooth and with a good luster. In general no other faces beside the base and those in the prism zone were to be observed, but in one or two instances small truncations were seen on the edges between but in such positions as not to admit of measurements.

The smaller type of crystals were more interesting crystallographically. Their faces were brilliant and in most cases gave on the goniometer angular readings with almost theoretical values. In all twelve different forms were identified,

which are shown on the stereographic projection, figure 6, and were as follows:  $b(010)$ ,  $c(001)$ ,  $i_1(190)$ ,  $\lambda(310)$ ,  $m(110)$ ,  $d(021)$ ,  $q(114)$ ,  $h(112)$ ,  $P(111)$ ,  $\omega(134)$ ,  $v(132)$ ,  $T(142)$ . All of these are well known and common forms and are included in the lists given by Dana and Goldschmidt, with the exception of  $i_1(190)$ . This prism is listed by Hintze and was observed on crystals from Příbram, by Nejdí.\* This form on the crystals from Arizpe was observed five times and although it occurred in each case as small faces four of the reflections obtained from them were good. The average of the four measurements  $b \wedge i_1 = 10^\circ 6'$ ; calculated =  $10^\circ 1'$ .

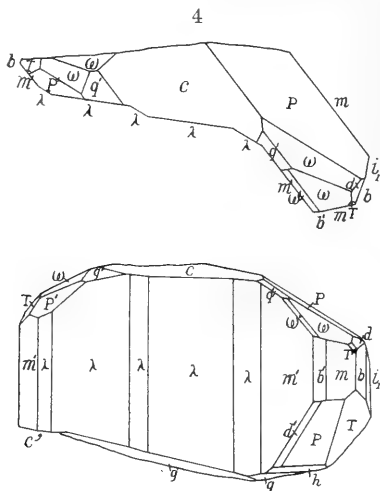

The habit of the simple crystals of this type is represented in top view and clinographic projection in figures 2 and 3. The prism zones are well developed and distinct, some of the faces, either  $m$  or  $\lambda$ , being commonly large and prominent, giving to the crystals their peculiar habit of being elongated in a diagonal direction. The pyramid faces are smaller, very irregularly developed and frequently show repeated oscillation from one to the other. In figure 3 such a characteristic oscillation is shown where the base  $c$  caps the pyramids  $P$  and  $\omega$  and then gives place again to the pyramid  $q$ .

Among this type of crystals twinning according to the usual stephanite law, in which  $m$  becomes the twinning plane, was observed in several cases. The stereographic projection, figure 6, shows the observed forms in normal and one twinned

\*Zeitschr. f. Kryst. u. Min., xxix, 408.

position. The twinning is usually quite irregular and frequently repeated. Figure 4 shows such a twin, the faces in twin position being indicated by a prime (') mark. At the

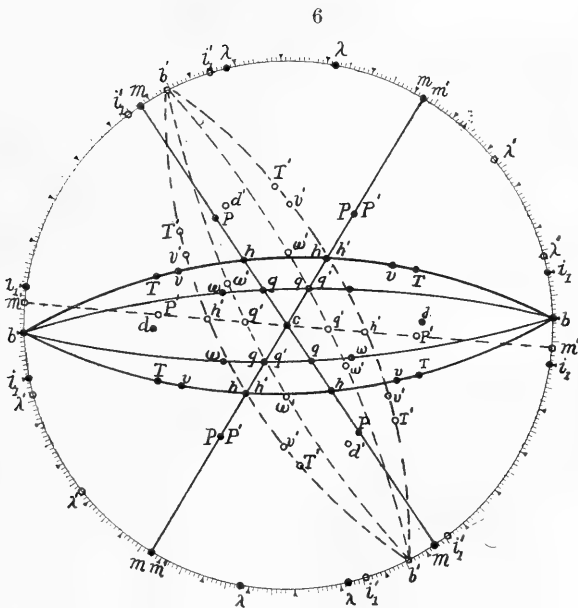
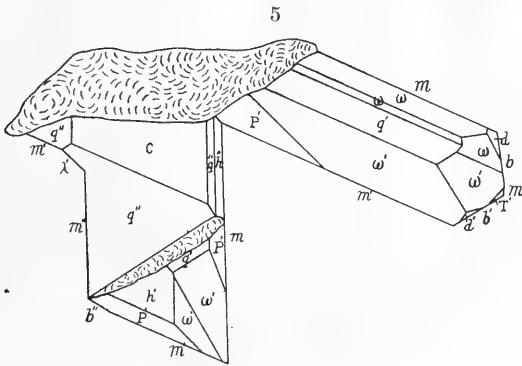

• Normal position                      ○ Twin position

extreme right hand of the figure the faces were taken as in normal position; then came a series of small faces,  $q'$ ,  $\omega'$ ,  $m'$ ,  $b'$  and  $d'$  in twin position. Next followed a series of  $\lambda$  faces in

normal position, oscillating with each other, then three more faces again in twin position,  $q'$ ,  $P'$  and  $m'$ , and finally a few others in normal position again. Figure 5 shows the top view of another twin which showed two projecting arms twinned to each other, each arm in turn being itself a twin. On the right hand and upper side of the right hand arm the faces were taken as in normal position, those on the lower and left hand side being in twin position ( $'$ ); on the upper left hand arm the faces are in twin position to ( $'$ ) and are marked with a double prime ( $''$ ), while on the lower side of this arm the position reverts to that of the faces on the lower side of the right hand arm ( $'$ ). The crystals of this second type averaged between three and six millimeters for their greatest dimension.

A chemical analysis was made of the mineral, the results of which agree closely with the theoretical composition of stephanite. Tests were made for other elements likely to be present but with only negative results. The method of analysis was simple: the finely powdered mineral was digested for some hours with aqua regia, the insoluble  $\text{AgCl}$  filtered off, dissolved in ammonium hydroxide and the undissolved mineral, of which there was always, at least, a small amount, collected on a weighed filter and its weight deducted from the amount taken. The silver was precipitated as  $\text{AgCl}$  by acidifying the ammoniacal solution with nitric acid. After the nitric acid in the original solution had been destroyed by repeated evaporation with hydrochloric acid, the antimony was precipitated by  $\text{H}_2\text{S}$ , collected on a weighed filter tube, ignited in an atmosphere of carbon dioxide and weighed as  $\text{Sb}_2\text{S}_3$ , following the method described by Bradley.\* The sulphur was determined both by fusion with sodium carbonate and potassium nitrate, and after treating the mineral with strong nitric acid. The results of the analysis are as follows:

	I.	II.	Av.	Theory for $5\text{Ag}_2\text{S.Sb}_2\text{S}_3$
S .....	16.23	16.44	16.33	16.23
Sb .....	15.43	15.18	15.30	15.25
Ag .....	68.29	68.42	68.36	68.47
			99.99	100.00

The Mineralogical Laboratory is indebted to Mr. Miller for his kindness in sending these specimens to the School, and to Prof. Huntoon for placing them at its disposal.

Mineralogical Laboratory of the  
Sheffield Scientific School of Yale University,  
New Haven, Conn., Feb. 1908.

\* This Journal, xxi, 453, 1906.



ART. XXIX.—*The Use of the Filtering Crucible in Electrolytic Analysis*; by F. A. GOOCH and F. B. BEYER.

[Contributions from the Kent Chemical Laboratory of Yale Univ.—clxxi.]

THE rapidity with which a metal or oxide may be thrown upon the electrode and thereafter handled successfully in the ordinary processes of electrolytic analysis depends upon keeping to conditions under which deposits are compact and adherent. It is for the purpose of getting adherent deposits that in modern rapid processes use is made of rotating electrodes,\* of apparatus so arranged that gases evolved or introduced shall stir the liquid,† and of the agitating action of a magnetic field.‡

The use of these methods is, however, limited to those cases in which attainable conditions and the nature of the processes are such that the deposits may be handled and washed without loss of material from the electrode. Plainly, the range of conditions and processes may be very much extended if means can be found for handling easily and safely electrolytic deposits more or less loose. The chief purpose of the device to be described, in which the perforated filtering crucible, of platinum or of porcelain, is adapted to the use of an electrolytic cell, is to handle such deposits.

*First Process.*

Figure 1 shows a convenient form of apparatus for use in electrolytic analysis. The crucible (A), fitted in the usual manner with an asbestos felt (*a*), serves as an electrode (*e*) the surface of which is very much increased by a layer of pieces of platinum foil (*b*) within the crucible and in contact with its walls. The joint between cap and crucible is made water-tight by a thin rubber band (F). The capacity of the cell is made conveniently ample by attaching to the crucible, by means of a close-fitting, thin rubber hand (E), a glass chamber (C) easily made from a wide, short test-tube. The second electrode (*f*) is introduced from above through the glass

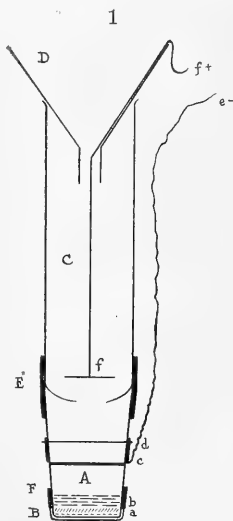

\* V. Klobukow, *Jour. prakt. Chem. (N. F.)*, xxxiii, 473. Gooch and Medway, *this Journal*, xv, 320. Exuer, *Jour. Amer. Chem. Soc.*, xxv, 876.

† Levoir, *Zeitschr. Anal. Chem.* xxviii, 63. Richards, *Jour. Amer. Chem. Soc.*, xxvi, 530.

‡ Frary, *Zeitschr. Elektrochem* xiii, 308. *Jour. Amer. Chem. Soc.*, xxix, 1592.

funnel (D), which serves to prevent spattering of the liquid during the electrolysis, and hangs within the glass chamber. The cell, held by a clamp, may be kept cool during action by immersing it in water contained in a cooler, as indicated in figure 2.

Electrical connection is made with the crucible by means of a platinum triangle (*c*) bent as shown and held tightly against the outer wall of the crucible by a rubber band (*d*). Figure 2 shows, on the left, the apparatus adjusted for work.

In using the apparatus, the crucible fitted with asbestos and

2

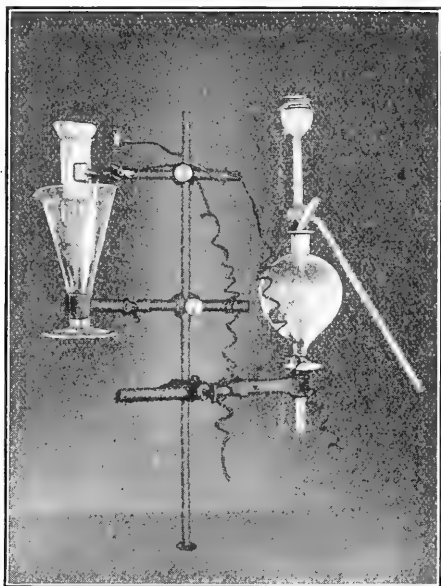

containing clippings of platinum foil, is capped, ignited and weighed. The glass chamber with the wide rubber band folded back against itself is set upon the crucible and the band is snapped into place. The other adjustments are made in the manner shown. The electrolyte is introduced and the current turned on. After the expiration of time enough to complete the electrolysis, the cooler is lowered and arrangements are made to draw off the liquid in the cell. If the process is such that no harm can follow the stopping of the current before removing the liquid, the upper electrode and funnel are washed and removed, the cap and band are slipped off, and the apparatus is set in the holder of the filtering flask as for an ordinary

filtration. The liquid is drawn through the felt to the flask, the chamber washed down, and removed from the crucible, and the deposit is well washed. The crucible and contents are dried and weighed, the increase over the original weight being, of course, the weight of the deposit.

In Table I are given the details of experiments made to test this form and use of the apparatus. Copper sulphate strongly acidulated with sulphuric acid was the electrolyte. Deposition was completed in the times given and the ferrocyanide test applied to the whole filtrate showed the absence of copper in every case. The apparatus and deposit were washed first with water and finally with alcohol. It was noticed that though the filtrate contained no copper, the washings did sometimes contain a bare trace. When the filtrate was allowed to stand after treatment with potassium ferrocyanide it turned blue rapidly, and this action, which indicated probably the presence of hydrogen dioxide or of persulphuric acid produced in the electrolysis of the sulphuric acid, is suggestive that the liquid should be drawn from the deposit as quickly as may be after the current is cut off. In experiments (1) and (2) no special care was taken in this respect, and in these experiments the results are a trifle higher than those of experiments (3) to (7), in which the manipulation was quickly made.

TABLE I.

First Process: Electrolysis with filtration after interruption of the current.

CuSO <sub>4</sub> .5H <sub>2</sub> O taken grm.	Vol. of liquid cm <sup>3</sup> .	H <sub>2</sub> SO <sub>4</sub> (1:1) cm <sup>3</sup> .	Current amp. volt.	Time min.	Theory for copper grm.	Copper found grm.	Error grm.
(1) 0.0538	50	5	$\left\{ \begin{array}{l} 2 \\ 4 \end{array} \right\}$	$\left\{ \begin{array}{l} 5 \\ 7 \\ 40 \end{array} \right\}$	0.1283	0.1290*	+0.0007
(2) 0.0510	50	5	$\left\{ \begin{array}{l} 2 \\ 4 \end{array} \right\}$	$\left\{ \begin{array}{l} 5 \\ 7 \\ 40 \end{array} \right\}$	0.1276	0.1282*	+0.0006
(3) 0.5009	50	5	$\left\{ \begin{array}{l} 2 \\ 4 \end{array} \right\}$	$\left\{ \begin{array}{l} 5 \\ 7 \\ 40 \end{array} \right\}$	0.1276	0.1279*	+0.0003
(4) 0.5005	50	5	$\left\{ \begin{array}{l} 2 \\ 4 \end{array} \right\}$	$\left\{ \begin{array}{l} 5 \\ 7 \\ 40 \end{array} \right\}$	0.1275	0.1277*	+0.0002
(5) 0.5047	50	5	$\left\{ \begin{array}{l} 2 \\ 4 \end{array} \right\}$	$\left\{ \begin{array}{l} 5 \\ 7 \\ 40 \end{array} \right\}$	0.1285	0.1286*	+0.0001
(6) 0.5039	50	5	$\left\{ \begin{array}{l} 2 \\ 4 \end{array} \right\}$	$\left\{ \begin{array}{l} 5 \\ 7 \\ 40 \end{array} \right\}$	0.1283	0.1285*	+0.0002
(7) 0.5030	50	5	$\left\{ \begin{array}{l} 2 \\ 4 \end{array} \right\}$	$\left\{ \begin{array}{l} 5 \\ 7 \\ 40 \end{array} \right\}$	0.1281	0.1282†	+0.0001

\* No copper in filtrate or in washings.

† Trace of copper in washings.

Obviously this process of electrolytic analysis is fairly rapid, easily executed, and accurate; but the desirability of quickly removing the liquid from the deposit after stopping the current is evident.

### *Second Process.*

In Table II are given results obtained as in the preceding process excepting the single point that the liquid was drawn off while the current was still running. In these experiments the filtration was effected by removing the cooler, taking off the cap and band from the crucible, and quickly swinging into place the filtration apparatus shown at the right in figure 2. The liquid was then drawn through the crucible and replaced by wash water until the current ceased to flow because there was no electrolyte to carry it. The apparatus was washed with water and finally with alcohol, and the crucible and contents were dried for periods of ten minutes at 100°–110°, to constant weight.

TABLE II.

Second Process: Electrolysis and filtration without interruption of the current.

CuSO <sub>4</sub> .5H <sub>2</sub> O taken gram.	Vol. of liquid cm <sup>3</sup> .	H <sub>2</sub> SO <sub>4</sub> (1:1) cm <sup>3</sup> .	Current amp. volt.	Time min.	Theory for copper gram.	Copper found gram.	Error gram.
(1) 0.5030	50	5	$\left\{ \begin{array}{l} 2 \\ 4 \end{array} \right\}$	$\left\{ \begin{array}{l} 5 \\ 7 \\ 30 \end{array} \right\}$	0.1281	0.1278†	–0.0003
(2) 0.5008	50	5	$\left\{ \begin{array}{l} 2 \\ 4 \end{array} \right\}$	$\left\{ \begin{array}{l} 5 \\ 7 \\ 40 \end{array} \right\}$	0.1275	0.1275‡	0.0000
(3) 0.5024	50	5	$\left\{ \begin{array}{l} 2 \\ 4 \end{array} \right\}$	$\left\{ \begin{array}{l} 5 \\ 7 \\ 40 \end{array} \right\}$	0.1280	0.1277†	–0.0003
(4) 0.5014	50	5	$\left\{ \begin{array}{l} 2 \\ 4 \end{array} \right\}$	$\left\{ \begin{array}{l} 5 \\ 7 \\ 40 \end{array} \right\}$	0.1277	0.1276*	–0.0001
(5) 0.5018	50	5	$\left\{ \begin{array}{l} 2 \\ 4 \end{array} \right\}$	$\left\{ \begin{array}{l} 5 \\ 7 \\ 40 \end{array} \right\}$	0.1278	0.1278*	0.0000

\* No copper in filtrate or in washings.

† Trace of copper in filtrate.

‡ Trace of copper in washings.

These results are plainly excellent.

### *Third Process.*

When a deposit is so loosely adherent as to be moved by the liquid it may be compacted upon the filtering felt by keeping the liquid in process of filtration and constant motion through the cell to the receiver. The adjustment of apparatus for this purpose is shown in figure 3. Here the electrolytic cell rests in the crucible holder fitted to a separating funnel used as a receiver and connected into the vacuum

pump. A stop-cock in the tube of the crucible holder is convenient but not necessary.

The manner of using the apparatus is simple. First, the weighed crucible, fitted in the usual manner with an asbestos felt and containing the platinum clippings, is adjusted to the glass chamber. The cell is pressed into the platinum triangle

3

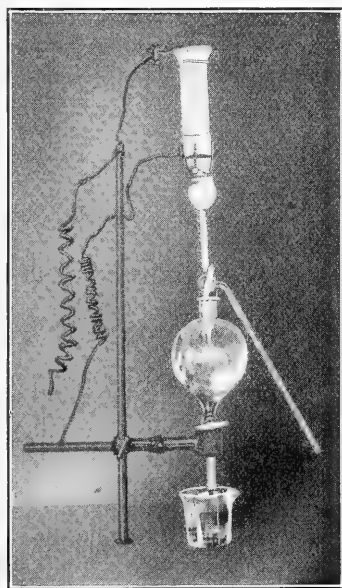

and set into the holder. The funnel which carries the wire electrode is put in place. The cell is charged with the electrolyte and the current is turned on. The electrolysis begins and, under regulated action of the vacuum pump, the liquid is drawn through to the receiver at a convenient rate. Usually, before the upper electrode is uncovered the stop-cock is closed, the suction pump disconnected, and the liquid drawn off from the receiver and returned to the electrolytic cell. The pump is again connected, the stop-cock is opened and filtration begins again.

Should the deposit be noticeably loose, it may be compacted by allowing the cell to drain complete under the action of the suction pump. The electrolyte is thus kept in circulation, and loose particles of the deposit are held upon the filtering layer. From time to time, the process of emptying the receiver and filling the cell is repeated. When the electrolysis is complete, as shown by proper testing of the filtrate, the liquid is drawn

through the crucible and replaced by water from above until the current no longer flows. The electrodes are disconnected, the extension chamber easily slipped off, and the washing of the crucible and its contents continued sufficiently, with care, should the deposit be spongy, to give time enough in the washing to properly soak out absorbed material. The crucible and contents are dried, ignited, and weighed as usual. This method of manipulation was also put to the test in the electrolysis of copper sulphate. Experimental details are given in Table III. The results show that there is no difficulty in getting accurate results while maintaining continuous filtration during the process, and that the time needed to complete the action is somewhat shortened when the liquid is kept in circulation by filtering.

#### *Fourth Process.*

Another form of apparatus, in which a porcelain filtering platinum filter crucible, is shown in figure 4. In this apparatus, it is necessary to make the connection from above

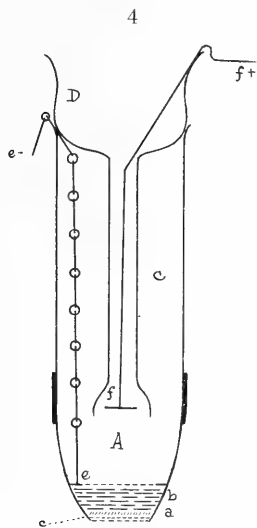

with the electrode inside the crucible, and this is accomplished by a linked platinum wire, as shown. In putting together and using this apparatus, a finely perforated disc of platinum foil (*c*) is laid upon the more coarsely perforated bottom of the porcelain crucible (*A*). Upon this disc, the asbestos felt (*a*) is deposited in the usual manner. Platinum clippings (*b*) form a layer of suitable thickness above the asbestos, and upon this layer, and in contact with it, is placed another perforated disc of platinum foil to which is attached a twisted wire (*e*) so linked that it may be folded within the crucible. This apparatus is ignited and weighed, and to it is adjusted, as shown, a chamber to hold the electrolyte. The other electrode (*f*),

enclosed within a funnel (*D*) made from a thistle tube, is introduced in the manner indicated. This apparatus is adapted only to use in the method of continuous filtration, and it is used exactly as in the Third Process. Experimental details are given in Table IV.

By either of the processes described, reasonably rapid and accurate electrolytic determinations may be made without the use of rotating motors or special stirring apparatus, and without

TABLE III.

Third Process: Electrolysis and continuous filtration.

CuSO <sub>4</sub> ·5H <sub>2</sub> O taken gram.	Vol. of liquid cm <sup>3</sup> .	H <sub>2</sub> SO <sub>4</sub> (1:1) cm <sup>3</sup> .	Current amp.	Time min.	Theory for copper gram.	Copper found gram.	Error gram.
(1) 0·5013	50	5	{ 2 } { 4 }	{ 5 } { 7 } { 20 }	0·1277	0·1280†	+0·0003
(2) 0·5003	50	5	{ 2 } { 4 }	{ 5 } { 7 } { 20 }	0·1274	0·1276‡	+0·0002
(3) 0·5015	50	5	{ 2 } { 4 }	{ 5 } { 7 } { 20 }	0·1277	0·1279*	+0·0002
(4) 0·5001	50	5	{ 2 } { 4 }	{ 5 } { 7 } { 20 }	0·1274	0·1274*	0·0000
(5) 0·5041	50	5	{ 2 } { 4 }	{ 5 } { 7 } { 20 }	0·1284	0·1285‡	+0·0001

\* No copper in filtrate or washings. † Trace of copper in filtrate.  
‡ Trace of copper in washings.

TABLE IV.

Fourth Process: Electrolysis and continuous filtration, with the use of the porcelain crucible.

CuSO <sub>4</sub> ·5H <sub>2</sub> O taken gram.	Vol. of liquid cm <sup>3</sup> .	H <sub>2</sub> SO <sub>4</sub> (1:1) cm <sup>3</sup> .	Current amp.	Time min.	Theory for copper gram.	Copper found gram.	Error gram.
(1) 0·5025	50	5	{ 2 } { 3 } { 4 }	{ 6 } { 8 } { 10 } { 10 }	0·1280	0·1277†	-0·0003
(2) 0·5009	50	5	{ 2 } { 3 } { 4 }	{ 6 } { 8 } { 10 } { 15 }	0·1276	0·1279*	+0·0003
(3) 0·5025	50	6	{ 2 } { 4 }	{ 6 } { 10 } { 25 }	0·1280	0·1278*	-0·0002
(4) 0·5011	50	5	{ 2 } { 4 }	{ 6 } { 10 } { 25 }	0·1276	0·1273†	-0·0003
(5) 0·5013	50	5	{ 2 } { 4 }	{ 6 } { 10 } { 25 }	0·1277	0·1276†	-0·0001

\* No copper in filtrate or in washings. † Trace of copper in filtrate.  
‡ Trace of copper in washings.

large and expensive apparatus of platinum. The use of the filtering crucible as a part of the electrolytic cell makes possible the utilization of operations and conditions in which the deposit may lack the degree of adhesiveness necessary in ordinary electrolytic processes; and it is hoped, therefore, that the device may extend the range of electrolytic analysis.

It is obvious, of course, that in the First Process and in the Second Process a single suction apparatus may serve to make filtrations for many cells, so that several electrolytic operations, started successively, may be carried on simultaneously without loss of time to the analyst.

## SCIENTIFIC INTELLIGENCE.

## I. CHEMISTRY AND PHYSICS.

1. *Phosphorescent Elements*.—Several years ago Sir W. Crookes, from a study of the spectra of the phosphorescent light emitted by various fractions of rare earth sulphates under the influence of cathodic rays, assumed the existence of several new element and "meta-elements" in the gadolinium group, designating them as  $G\beta$ ,  $G\zeta$ ,  $G\alpha$ , ionium, and incognitum. G. URBAIN has now made an examination of the spectra produced by fractions of earths between gadolinium and terbium, and has found all the bands described by Crookes, but he fails to agree with the latter investigator in regard to the presence of new elements in the mixtures. There is no indication of them in other kinds of spectra. The terbium plays the rôle of an active phosphorescent substance in the gadolinium sulphate, and slight changes of composition, such as occur between one fraction and the succeeding one, may cause the complete disappearance of certain bands. It was shown by mixing pure gadolinium sulphate with pure terbium sulphate in varying proportions, that a mixture containing one per cent of the terbium salt gave many bands, while preparations containing less than 0.5 per cent or more than 10 per cent of it were very slightly phosphorescent. Variations in the mixture showed different effects upon different bands.—*Comptes Rendus*, cxlv, 1335.

H. L. W.

2. *Metallic Vacuum Vessels for Liquid Air*.—In a lecture delivered at the Royal Institution, SIR JAMES DEWAR has described a metallic vacuum vessel which will be of use in industrial cryogenic operations, and for the storage and safe transit of liquid air. The metallic vessels resemble the ordinary glass silvered vessels and are from 2 to 10 liters capacity. The envelopes may be made of brass, copper, nickel, or tinned iron, with necks made of a bad conducting alloy. The vacuum between the walls of these vessels is maintained by enclosing some charcoal in a small globular space made in the bottom of the inner vessel. The necks may be covered with silvered glass vacuum cylinders which act as stoppers and at the same time utilize the cold of the slowly evaporating liquid. The efficiency of the best metallic flasks is equal to that of the chemically silvered glass vacuum flasks now generally used in low temperature investigations.—*Chem. News*, xlvii, 7.

H. L. W.

3. *Manganese and the Periodic Law*.—The classification of manganese with the halogens in the periodic system of the elements is doubtless somewhat unsatisfactory, so that REYNOLDS has recently advocated the transference of this element into the eighth group in company with iron, nickel and cobalt. He argues that the present arrangement is based on the facts that unless Mn were



placed in the seventh group, there would be only one column of elements in it, and that  $\text{KMnO}_4$  happens to have a similar formula to  $\text{KClO}_4$  and to share with it the property of being an oxidizing agent. He calls attention to the fact that the argon group, whose position is on the other side of group VIII, has only one column. He brings forward the similarity of manganese to iron, nickel and cobalt in the formation of sulphates, double sulphates, etc., and to iron and cobalt in the formation of alums, metalocyanides and metallicyanides. He shows the relations of manganese to ruthenium and osmium in the formation of metalocyanides and the salts  $\text{K}_2\text{MnO}_4$ ,  $\text{KMnO}_4$ ,  $\text{K}_2\text{RuO}_4$ ,  $\text{KRuO}_4$  and  $\text{KOsO}_4$ . The arrangement advocated is shown in the following table :

VI		VII	VIII	O	I	
S		Cl		Ar	K	
	Cr		Mn Fe Ni Co			Cu
Se		Br		Kr	Rb	
	Mo		Ru Rh Pd —			Ag
Te		I		Xe	Cs	
	W		Os Ir Pt —			Au

—*Chem. News*, xcvi, 260.

H. L. W.

4. *Higher Oxides of Manganese*.—MEYER and RÖTGER have investigated the well known changes of the oxides  $\text{MnO}_2$ ,  $\text{Mn}_2\text{O}_3$  and  $\text{Mn}_3\text{O}_4$  upon ignition in air and oxygen, and have determined the exact temperatures, heretofore unknown, at which the transformations take place. It appears that the changes from higher to lower oxides take place at sharply defined temperatures, which vary according to the presence of air or oxygen :

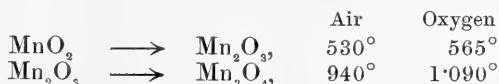

Upon cooling  $\text{Mn}_3\text{O}_4$  in contact with oxygen, it is converted into  $\text{Mn}_2\text{O}_3$ , but this change does not take place upon cooling in contact with atmospheric air. In the analytical determination of manganese as  $\text{Mn}_3\text{O}_4$  this state of oxidation can be attained with precision if the ignition is continued long enough above 940°, and if the product is cooled in the air.—*Zeitschr. anorgan. Chem.*, lvii, 104.

H. L. W.

5. *White Phosphorus*.—It has been observed by LLEWELLYN that when yellow phosphorus is distilled in a current of ammonia gas a white form of phosphorus is obtained. Upon exposure to the air or warming with water it is gradually converted to the ordinary yellow modification. The author considers this method more convenient than the method of distilling in purified hydrogen which has been described by Remsen and Keiser.—*Chem. News*, xcvi, 296.

H. L. W.

6. *The Radiometer for Measurement of Low Pressures.*—Prof. J. DEWAR finds that this instrument is available for the measurement of extremely low pressures. It is well known that the McLeod gauge is not very reliable for measurements below one-thousandth of a millimeter. Professor Dewar, by the use of his well-known methods of the use of charcoal combined with liquid air, found that the radiometer indicated pressures as low as  $\frac{1}{50,000,000}$  of an atmosphere.—*Proc. Roy. Soc. (A)*, lxxix, pp. 529-532, 1907. J. T.

7. *Existence of Positive Electrons in the Sodium Atom.*—Prof. R. W. WOOD finds two types of magnetic rotation in the channelled spectrum of sodium vapor, and believes that these two types indicate the presence of positive and negative electrons in the atom.—*Phil. Mag.*, Feb., 1908, pp. 274-279. J. T.

8. *Magnetic Effect of Cathode Rays.*—It is well known that a magnet easily deflects a stream of cathode rays. This effect is explained by the fact that the rapid movement of charged particles constitute an electric current. EUGEN KLUPATHY shows that the converse is true, that the stream of cathode rays can produce a magnetic effect.—*Ann. der Physik*, No. 1, 1908, pp. 31-47. J. T.

9. *Practical Physics*; by W. S. FRANKLIN, C. M. CRAWFORD and BARRY MACNUTT. Vol. I. Precise Measurements. Measurements in Mechanics and Heat. Pp. vi+172. Vol. II. Elementary and Advanced Measurements in Electricity and Magnetism. Pp. vi+160. Vol. III. Photometry, Experiments in Light and Sound. Pp. vii+80. New York, 1908. (The Macmillan Co.)—This laboratory manual for students in colleges and technical schools contains a well-chosen list of instructive and interesting experiments; the descriptions of apparatus and the directions for carrying out the experiments are clear and practical. The suggestions as to the calculation and presentation of results and the estimation of errors are also to be commended. H. A. B.

10. *Praktische Photometrie*; by EMIL LIEBENTHAL. 8vo, 445 pp., 201 figures. Braunschweig, 1907 (F. Vieweg u. Sohn).—This book owes its excellence to the fact that its writer has had many years experience in photometric investigations conducted in the laboratory of the Physikalisch-Technische Reichsanstalt at Charlottenburg. The author has treated all phases of the subject in great detail and has endeavored to express the ideas in language comprehensible to the non-scientific, practical reader and yet, at the same time, rigorous enough to satisfy the requirements of the student of pure science. Numerical examples are given throughout to illustrate the use of the principles and formulæ previously discussed. The special subject of spectrophotometry has only seventeen pages devoted to it because the author does not consider that it properly comes under the title of "Practical Photometry." The wealth of late, accurate, numerical data contained in the text and appended tables will undoubtedly make the book very useful for reference. H. S. U.

11. *The Principles of Physics*; by ALFRED P. GAGE, revised by ARTHUR W. GOODSPEED. Pp. 547. New York and Boston, 1907 (Ginn & Co.).—In the present publication the edition of 1895 has been brought down to date while it also presents several other points of advantage over the older text. For example, it contains eighty-seven pages less than its predecessor and “this has been effected by omitting some sections which, in the experience of the reviser as a teacher, have been found of little value to students of an elementary course.” The illustrations also are wisely made a less prominent part of the work. H. S. W.

12. *A Text-book in Physics for Secondary Schools*; by WILLIAM N. MUMPER. Pp. 411. New York, 1907. (American Book Co.)—The author has correctly characterized the volume in the following words: “This book has been prepared in the belief that there is a demand for a *text-book* ‘pure and simple’; a book that does not attempt to do the work of either the teacher or the laboratory, one which aims to present only those phases of the secondary school course in physics which the pupil should acquire from the study of a book.”

The text seems to be very well balanced, and to be the product of the kind of pedagogic insight that can alone come from long experience in teaching. The illustrations constitute a distinctive and pleasing feature of the book. The subjects chosen for illustration, and the brief explanations directly associated with the figures, are also unusually apt. In short, a discussion of the facts which are graphically represented by the collection of illustrations, taken as a whole, would constitute an adequate and satisfactory course in secondary school physics. The author has wisely preferred the use of *waves* and *wave fronts* to *rays*, in the sections on light. The book unquestionably merits the consideration of all progressive teachers of the elementary phase of physics. H. S. U.

13. *Laboratory Exercises in Elementary Physics*; H. NEWMAN. Book I. Measurement, Gravity, Mechanical Powers. Pp. 25. Boston, and New York, 1907. (Ginn & Company.)—This publication is simply a paper-covered note book designed for use in the laboratory. It gives a brief description of each of the twenty well-chosen exercises, illustrated by a good sketch of the associated apparatus; this is followed by a blank form in which are to be entered the experimental results of the student. H. S. U.

## II. GEOLOGY AND MINERALOGY.

1. *Earthquakes, An Introduction to Seismic Geology*; by WILLIAM HERBERT HOBBS. 310 pp., 24 pls., and 112 illustrations. New York, 1907 (D. Appleton and Company).—The theory of earthquakes was rescued from myths by Robert Mallet in 1857, but the belief in explosions inside of a focal cavity was firmly fixed in his mind. In 1872 Professor Suess demonstrated

the fact that successive earthquakes occurred repeatedly along a line marking the position of a fault. The latest epoch in seismology was inaugurated in 1894, when the possibility of recording distant earthquakes was made known. Since that date the British Association and the Vienna Academy of Sciences, the Japanese Earthquake Investigation Committee, and, finally, the Committee on Seismology for the American Association, have taken up the work and have carried it so far as to show that the chief cause of earthquakes is faulting and that the ultimate cause is only approximately known. Statistical study has shown that earthquakes are distributed along Tertiary mountain systems, in zones bordering the coasts, in regions of active vulcanism, and in the most mobile portions of the earth's crust. Professor Hobbs discusses the nature of earthquake fissures and earthquake shocks, and contributes important new material regarding the derangement of surface waters and ground waters, including the origin and behavior of certain cold and thermal springs and, in this same connection, discusses the origin of sand dikes and the peculiar sandstone "pipes" of Wales and other districts. Full descriptions are given of the following earthquakes: Lisbon, 1755, Calabria, 1783, the Mino-Owari, 1891, Iceland, 1896, Assam, 1897, Kingston, 1907. The chief earthquakes in the United States, namely, the New Madrid, 1811, Owens Valley, 1872, Charleston, 1886, Sonora, 1887, Yakutat Bay, 1899, San Francisco, 1906, are discussed somewhat fully.

The particular contribution of Professor Hobbs to seismology is the location of earth "lineaments" by topographic methods and the connection of earthquakes with these supposed "lineaments." The line of reasoning followed here departs widely from the safe ground of theory based on fact. In some cases fault lines appear to be located by Professor Hobbs not as the result of field evidence, but because earthquakes have occurred in certain localities, which places may be connected by straight lines. This leads to the assumption that faults exist and are responsible for the topography in regions where other explanations are as acceptable. For instance, East Haddam, Conn., is given first rank in seismicity for the entire eastern United States and is said to be "located" where the fall line intersects the gorge of the lower Connecticut, itself a strongly marked lineament." The objections to these statements are, first, that the fall line, as physiographers understand it, does not extend through East Haddam, and, secondly, there is no proof that the lower Connecticut follows a fall line. If the location of other earth "lineaments" rest on no better geologic data than is shown by this instance, the conclusion of Professor Hobbs must be considered speculative.

Aside from its theoretical portions this book is a valuable general discussion of earthquakes, and students will be particularly thankful for the chapters discussing the methods of study of earthquakes in the field and the efficiency of different types of

seismographs. The references to seismological literature will be found very helpful to those who wish to follow up the subject.

H. E. G.

2. *Glaciers of the Canadian Rockies and Selkirks*; by WILLIAM HITTELL SCHERZER, Ph.D. Smithsonian Contributions to Knowledge, No. 1692, part of volume xxxiv. Pp. xii+135, pls. xlii. Washington, D. C., 1907.—As stated in the opening pages, Dr. Scherzer has brought together in the present memoir the results of an expedition undertaken, under the auspices of the Smithsonian Institution, among the glaciers of the Canadian Rockies and Selkirks in 1904. The author's observations began, however, in 1902, and continued each year until and including 1905.

The general objects of the research were to render available a description of some of the most accessible glaciers upon the American continent, to investigate to what extent the known glacial features of other portions of the world are reproduced in these American representatives, and to ascertain what additional light a study of similar features here might shed upon glacier formation and upon some of the unsettled problems of Pleistocene geology.

The five glaciers selected for study are representative ones, easy of access, among the many which exist in this region. These detailed quantitative investigations serve an immediately valuable purpose in promoting knowledge of this region of magnificent mountains and glaciers, but perhaps its greatest value will be as a standard of quantitative comparison for studying future changes in North American glaciation.

The volume shows the results of thorough study and is finely and profusely illustrated. It is unfortunate, however, that in this, as in certain other Smithsonian reports, there is no general map of the region. This is to be regretted, since most readers who handle the volume will not have such a map at hand, and difficulty will be experienced in holding in mind the geographic relations of the various localities.

J. B.

3. *Traité de Géologie: I. Les Phénomènes géologiques*; par EMILE HAUG. Pp. 546, photographic pls. 71, figs. and maps 195. Paris 1907 (Librairie Armand Colin).—The aim of this volume is to meet the demand for a work on geology which shall be intermediate in character between the elementary manuals and the works of reference written especially for professional geologists. The work will comprise two parts of equal importance; the first part, on geological phenomena, forms by itself a rounded treatise. The volume is well illustrated, largely from European localities, and contains at the end of each chapter a list of the more important works dealing with the subject. Such a volume should be of great value to all American geologists, since it gives in an attractive form illustrations of geologic significance from unfamiliar localities and presents prevailing French views of geologic problems. The discussions on continental fragmen-

tation and Haug's views on the geosynclines and continental areas will be new to many. The succeeding portions of the work will be awaited with interest.

J. B.

4. *La Science Séismologique. Les Tremblements de Terre* par le COMTE DE MONTESSUS DE BALLORE, Directeur du Service séismologique de la République du Chili, avec une préface par M. Ed. Suess. Pp. vii + 579, maps and figs. 222. Paris 1907 (Librairie Armand Colin).—This is a work of still wider scope than the recent volume by the same author upon *la Géographie séismologique*. The introduction consists of two chapters. The first upon the present standing and tendencies of the science and its two divisions,—the study of the nature of earthquake waves, a branch of physics; and the study of their causes and effects, a branch of observational geology. The second introductory chapter is on the history of seismology and indicates the extreme recency of the science as a subject of exact study and its present increasingly great importance.

The body of the work is divided into three portions, the first being devoted to macroseisms, or perceptible earthquakes, the second to microseisms and to instrumental or theoretic seismology, the third to megaseisms, or destructive earthquakes, followed by a discussion of means designed to minimize the disastrous results.

As is to be expected from this author, the work is one of great value and completeness and will not fail to interest all students of seismology.

J. B.

5. *The Lower Paleozoic Fossils of the Northern Shan States, Burma*; by F. R. COWPER REED, Mem. Geol. Surv. India, Pal. Indica, New Series, ii, Mem. 3, 1906, pp. 154, pls. 8.—As yet little is known of the older Paleozoic rocks of Asia, and it is therefore very gratifying to find so much that is new in a recent paper published by the Survey of India.

*Ordovician* (Naungkangyi formation). From twenty localities 48 species have been obtained; of these, 28 are specifically named and 19 are restricted to Burma. The following are the more important forms from a stratigraphic standpoint. Of the Bohemian genus, *Aristocystis*, there is a new species; of the widely distributed European *Heliocrinus* 3 (new), and of *Echinoencrinus* 2 are compared with north European forms. The genus *Caryocrinus* is said to be present in 3 new species, but these seem to the reviewer to be nearer *Hemicosmites* in having but three pairs of closely set brachioles, while the Silurian genus has 13-14 in five widely separated bases. The Baltic *Protocrinus* is represented by a new form and *Cyclorinus* by a form near *C. spasski* Eichwald.

Of brachiopods, there are *Rafinesquina imbrex* Pander, *R. subdeltoidea* (a new form closely related to American Trenton *R. deltoidea*). *Orthis subcrateroides* (a new *Rafinesquina* near *R. minnesotaensis* but larger), *Leptaena ledetensis* (new, near *L. charlottae* W. & S., of the Black river), *Plectambonites quinque-*

*costata* McCoy (near *P. gibbosus* W. & S., of the Trenton), *Orthis chaungzonensis* O. and *irravadica* (both new Plectorthis related to *P. triplicatella*), Clitambonites of the Baltic *C. squamata* group, *Porambonites intercedens* Pander (Baltic). Of trilobites the genera represented are Remopleurides, Encrinurus, Calymene, and Amphion (=Pliomera). These species are said to be from "one set of beds" which the author is not disposed to correlate definitely. To the reviewer, they seem to agree fairly well with the Baltic formations marked C by Schmidt (Echinospaerit, Kuckurs and Itfer zones), and though less clearly, but still with considerable evidence, with the American interior Galena and Trenton formations.

Recently Weller has added other Baltic types, as Hemiproites, Asaphus (5 species), and Megalaspis, collected by Willis and Blackwelder from the Kinsinling limestone, province Ssich'uan, China. The age, he states, is "approximately equivalent to the fauna of the Trenton limestone of North America." In Shantung Ormoceras and Gonioceras occur according to Crick. This evidence points clearly to an intimate relationship between these Asiatic faunas and those of the Baltic region. On the other hand, it is also clear that the interior American Mohawkian faunas are of the Pacific realm, but with a development that readily separates them into a distinct province. In further support of this view is the discovery by Ulrich and Bassler of Echinospaerites and Cycloerinus in Virginia.

*Silurian* (Namhsim sandstone).—The more characteristic of the 38 species described are *Mimulus aunglokensis* (new), *Orthis rustica*, *Bilobites biloba* (exceedingly common), *Platystrophia biforata*, *Atrypareticularis*, *Spirifer sulcatus*, *Nucleospira pisum*, *Encrinurus konghsaensis* (new, near *E. punctatus*), *Calymene blumenbachi*, and *Dalmanites longicaudatus orientalis* (new). This fauna is regarded "as homotaxially equivalent" with the Wenlock.

*Silurian* (Nyaungbaw formation).—These beds yield fragments of a Scyphocrinus, *Camarocrinus asiaticus* (near *C. ulrichi* of Oklahoma), and a small Orthoceras. The crinoid material has the development of the Silurian etage E2 of Bohemia. La Touche "is inclined to put the Nyaungbaw beds at the top of the Ordovician," but with this correlation the reviewer does not agree (he is aware that Fritsch has recently described *Camarocrinus quartzitarum* from the middle Ordovician of Bohemia). The paleontologic evidence clearly places this formation in close association with the Zebingyi beds.

*Lower Devonian* (Zebingyi formation).—Among the 23 species the more important are *Monograptus dubius* Suess, *M. cf. riccartonensis* Lapworth, *Atrypina sub-globularis* (fig. 31 seemingly the young of *Atrypa reticularis*, 32, 33 represent a large *Atrypina*, but the specific name is a misnomer, as no known species is globular or even biconvex), *Tentaculites elegans* (in Bohemia F1—H1 = Lower Devonian), *Styliolina cf. laevis*, *Dalmanites*

*swinhoei* (new, this large species is said to be closely related to the Lower Devonian *D. rugosus*); *Phacops shanensis* (new, a large form).

This formation lies unconformably above the Ordovician Naungkangyi beds (the Namhsim sandstones are not present in the same area with the Zebingyi beds). Reed clearly recognizes the Hercynian aspect of the fauna, and the "lithological and stratigraphical type of development," but is perplexed over the presence of Silurian graptolites, probably because they have been determined for him by a specialist, Miss Elles. The evidence of the other fossils, however, is so convincing that the Zebingyi formation must be referred to the Lower Devonian, and is directly comparable with the Bohemian black limestone fauna (F1) of the Konieprussian. C. S.

6. *A Summary of the Geology of India*; by ERNEST W. VREDENBURG. 67 pp., Calcutta, 1907. (Printed by Thacker, Spink & Co.) This booklet gives a short but clear account of the main geological events throughout the Indian Empire. It should be in the hands of all teachers of general geology. It can be had of Geo. E. Stechert & Co., New York City, for eighty cents. C. S.

7. *Die Fossilen Insecten*; von ANTON HANDLIERSCH.—The seventh and eighth Lieferungen of this monograph, published by W. Engelmann, Leipzig, have been received. The former has the remainder of the annotated catalogue, with bibliography of Tertiary insects, on pages 961–1092. The Quaternary insects are similarly treated, but only a portion appear in this part, on pages 1093–1120, the remainder embracing pages 1121–1140 of the eighth part. The latter part (pp. 1141–1280) also contains several important chapters of comprehensive and general character. Another part will probably conclude this handbook. C. S.

8. *Evolution of Mammalian Molar Teeth to and from the Triangular Type*; by HENRY FAIRFIELD OSBORN, Sc.D., LL.D., D.Sc. Edited by W. K. GREGORY, M.A. Pp. vi, 250. New York, 1907 (The Macmillan Company).—This admirable volume consists of a series of reprints of the various articles which the author has written upon the mammalian molar teeth, together with new chapters on the ordinal types of molars, the evolution of the premolars, and a judicial discussion of the theories concerning the development of the molar teeth,—those of the author and of others who oppose his views. Aside from its main purpose, the book is of great value to the student as a text-book of mammalian odontology, being accurate in description and rich in illustrations. A very full bibliography completes the volume. R. S. L.

9. *Mineral Resources of the United States, Calendar Year 1906*. Pp. 1307. Washington, 1907. U. S. Geological Survey, GEORGE OTIS SMITH, Director.—The annual volume on the mineral production in the United States, announced in the last number (p. 156), has now been distributed. This volume is the



twenty-third report which has been issued by the Survey during the past twenty-seven years, and the entire series gives a most interesting and valuable presentation of the development of our mineral wealth. It may not be generally appreciated that since 1880 the mineral output of the country has increased more than five times, the value rising from \$365,000,000 to \$1,900,000,000. The amount of labor which has fallen upon this division of the Survey in keeping up the records of this progress can easily be imagined. The division of Mining and Mineral Resources, which has been a definite part of the Survey for some years, has now been placed in charge of Mr. E. W. Parker; Dr. David T. Day, who has done such excellent work for it in the past, will devote himself to the reports on petroleum and natural gas. The separate chapters which make up this volume of 1300 pages have already been distributed to the public in advance of the appearance of the completed volume.

10. *Handbuch der Mineralogie*; von DR. CARL HINTZE. Erster Band; Elfte Lieferung. Pp. 1601-1760. Leipzig, 1907 (Verlag von Veit & Comp.).—This is the twenty-third part of Hintze's Mineralogy, begun in 1889; it embraces the oxides from rutile to corundum. Mineralogists will congratulate themselves and also the author that the progress of this monumental work, if not rapid, is still continued uninterruptedly, so that its completion may be looked for at no distant date.

11. *The Meteor Crater of Canyon Diablo, Arizona; its History, Origin and associated Meteoric Irons*; by GEORGE P. MERRILL. Smithsonian Miscellaneous Collections, Quarterly Issue, vol. 1, pp. 461-498, plates lxi, lxxv. Washington, Jan. 27, 1908.—The general interest in the remarkable crater-like depression near Canyon Diablo, in Coconino County, Arizona, which has been repeatedly described since it was first brought to notice by A. E. Foote in 1891,\* will be much stimulated by the present thorough study of the subject by Dr. Merrill, the field investigations for which were conducted under the auspices of the Smithsonian Institution. The present communication is admirably exhaustive in character, covering all the features of the crater within and without, giving the results of the borings carried on by Messrs. Barringer and Tilghman, and also an account of the iron and the peculiar iron shale and shale balls which accompany it. The last part, it may be added, forms the subject of an earlier article by Merrill and Tassin in vol. 1, part 2, pp. 203-215 of the same publication. The whole is fully illustrated, particularly by numerous excellent reproductions from photographs; the contour map of the crater is of especial interest. The author weighs judiciously the two theories which have been offered to explain the existence of the crater, and decides in favor of its meteoric origin.† The fact that the borings thus far made tend to show that no very large mass of iron lies buried in the crater

\* See this Journal (3), xlii, 413, 1891.

† See also Fairchild, noticed in the February number, p. 156.

is not fatal to the theory, if it is true, as assumed probable, that the impact of the meteoric mass was followed by the volatilization of a large part of it with the outrush of a great volume of vapor.

12. *The Foyer Collection of Meteorites.*—A recent publication of the American Museum of Natural History (Guide Leaflet, No. 26) contains an interesting account by Dr. E. O. Hovey of the remarkable series of large meteorites on exhibition in the entrance hall of the Museum. This includes the Ahnighito meteorite brought by Captain Peary from Cape York, Greenland, weighing upwards of 36.5 tons, also the two other Peary irons known among the Eskimos as “the Woman” of 3 tons weight and “the Dog” (1100 lbs.). Another of the specimens is the unique Willamette iron, weighing 15.6 tons, with its extraordinary basin-like depressions produced by oxidation. The collection also includes a large example of the Canyon Diablo irons (1087 lbs.), a composite specimen of the Brenham meteorite half siderite and half siderolite, and several large aërolites, that from Selma weighing 306 lbs.

### III. MISCELLANEOUS SCIENTIFIC INTELLIGENCE.

1. *Introduction to Higher Algebra*; by MAXIME BÔCHER: prepared for publication with the cōoperation of E. P. R. DUVAL. Pp. xi, 321. New York, 1907. (The Macmillan Company.)—There is no field of mathematics in which the need of a clear and thorough exposition has been more seriously felt than in the topics of Algebra that Professor Bôcher has included in his book. There are already an abundance of excellent works in French, German and English, that treat in detail the classical theory of equations, invariants, finite groups, the theory of separation and approximation of the roots of algebraic equations, and Professor Bôcher makes no attempt to add to the list. He has, in fact, very little to say on any of these subjects. His object is rather to give a thorough introduction to the theory of linear equations and quadratic forms with particular reference to the problem of reduction to normal form and classification.

The book is of especial interest to students of analytical geometry who now have, for the first time, a convenient, clear and adequate treatise from which to derive the necessary algebraic background for their more advanced work.

After a short chapter on the fundamental properties of polynomials, the subjects of determinants and matrices are taken up, with their application to linear equations and transformations. The treatment of matrices shows the influence of Frobenius rather than that of Cayley, and is directed, as is the original work of Frobenius, toward the problem of reducing families of bilinear and quadratic forms to a normal form. The subject of invariants is illuminated rather than exhausted, a brief chapter being devoted to the geometrical interpretation of the invariant and covariant properties of equations. No details are attempted

and the symbolic notation and Aronholdt's operator are not even mentioned. A short chapter later in the book considers some of the simplest rational invariants.

It is a pleasure to find Sylvester's dialytic method of elimination developed in a careful manner. There is no doubt that this is the simplest and the most effective method to determine the existence of common roots of equations, but apart from the treatment in Mansion's *Théorie des Déterminants*, one does not find the method given the place in the treatises that it deserves.

The most suggestive and important chapters of the book are the last three, in which the theory of elementary divisors is for the first time made completely accessible to students of geometry. The fundamental memoirs of Weierstrass, Kronecker and Frobenius are not adapted for a rapid acquisition of the theory and the book of Muth on *Elementarteiler* can scarcely be called a successful exposition. The only other development of the subject is found in a little tract of Bromwich which is hardly adequate algebraically. Professor Bôcher's treatment contains all the virtues that the other writers lack. His development follows that of Frobenius though his reduction of a matrix to a normal form in which the elementary divisors are displayed is that of Kronecker. Not enough special cases are included to obscure for a moment the aim of the discussion, which is appropriately closed by an actual enumeration of all classes of collineations and families of quadratic forms.

An important feature of the book is the large number of exercises, the solution of which will ensure a thorough comprehension of the subject. The students of algebra and higher geometry are to be congratulated on the appearance of a work, that to such a marked degree clarifies and simplifies what has hitherto been one of the most difficult subjects in which to obtain a satisfactory perspective.

H. E. HAWKES.

2. *Observations simultanées de la Surface de Jupiter*; réunis par M. Jean Mascart. Pp. 70. Paris, Société Astronomique de France.—At the suggestion of M. Jean Mascart of the Paris Observatory, and with the sanction of Flammarion, thirty-six observers residing in Eastern Europe, England and Northern Africa undertook to make a telescopic study of the planet Jupiter during the month of January 1906, subject to certain rules of procedure drawn up by Mascart—those of prime importance being that the observations should be taken simultaneously and that each observer should record his results as soon as possible and according to a prescribed form.

The days were from Jan 2 to 20 and the time, 8 P. M. Paris. 172 observations were obtained, each accompanied by a drawing,—the least number on any night being 5, the greatest 17 and the average 9.

The report forms a pamphlet of 70 pages with plates showing separately for each night all the drawings made on that night. The results are analyzed by Mascart for each night—separately, with a résumé of all the nights, which is the essentially valuable

part of the pamphlet. From it the reader may draw for himself a safe conclusion as to how far in the long run observers of the same telescopic object may be expected to differ from each other.

The question suggested to the mind of most readers will be, whether it would be possible to apply such a system to the study of Mars for the purpose of verifying the results claimed by Mr. Percival Lowell, and if it were possible whether it would be worth the trouble.

W. B.

3. *L'Heure à Paris*.—The above is the title of a pamphlet by JEAN MASCART, Adjunct Astronomer at the Observatory of Paris, published in 1907 by Gauthiers-Villars, of the Bureau of Longitudes of the same observatory. It is a description of the system for distribution of accurate time from the above observatory to the clocks of Paris, preceded by a rather exhaustive historical sketch of the whole problem of the measurement of time. The principal facts in the development of the subject are introduced and described in chronological order,—the gnomon, transit instrument, astrolabe, quadrant and other astronomical instruments, the clepsydra, sundial, clocks, watches and chronometers, and the successive stages of improvements in each of these time-keepers, the different customs among nations as to when the day begins and how it was divided, the difficulties of keeping time by the real sun and the introduction of mean time in its place, and finally the adoption of the mean time of a nation's capital for that of the entire country, which, except in France, has given way to the system of Standard Time.

The author refrains from going into the reasons for France not complying with the general custom, but concludes his disquisition with an elaborate description of the equipment for determining time at the Paris Observatory, giving particular attention to the delicate synchronizing apparatus attached to their clocks and the system of distributing time to the various clocks of the city by electricity. He recounts the many difficulties encountered and finally makes an appeal for a reorganization of the system and extending it so as to cover not only Paris, but the whole of France.

The author's general discussion of the problem of time contains many interesting facts well brought together in their proper relation.

F. L. C.

4. *Globus-karte. Weltkarte in Teilkarten in einheitlichem Flächenmassstabe mit einer-statistischen Tabelle der selbständigen Staaten und der deutschen Kolonien*; von F. SIPMAN. Berlin, 1907 (Verlag von Dietrich Reimer).—This quarto pamphlet contains a chart of the world on a scale of 1200 miles to the inch, cut into six segments, each segment extending from the north to the south pole, and embracing sixty degrees of latitude. The segments are in contact at the equator, and all parallels of latitude and the central meridians of each segment form a true scale, differing in this respect from a Mercator's projection. Statistical tables of the various governments are included.

J. B.

# Relief Map of the United States

We have just prepared a new relief map of the United States, 48 x 32 inches in size, made of a special composition which is hard and durable, and at the same time light. The map is described in detail in circular No. 77, which will be sent on request. Price, \$16.00.

---

WARD'S NATURAL SCIENCE ESTABLISHMENT,

76-104 College Ave., ROCHESTER, N. Y.

---

---

## WARD'S NATURAL SCIENCE ESTABLISHMENT

**A Supply-House for Scientific Material.**

Founded 1862.

Incorporated 1890.

### DEPARTMENTS:

*Geology*, including Phenomenal and Physiographic.

*Mineralogy*, including also Rocks, Meteorites, etc.

*Palaeontology.*      *Archaeology* and *Ethnology*.

*Invertebrates*, including Biology, Conchology, etc.

*Zoology*, including Osteology and Taxidermy.

*Human Anatomy*, including Craniology, Odontology, etc.

Models, Plaster Casts and Wall-Charts in all departments.

---

Circulars in any department free on request; address

Ward's Natural Science Establishment,

76-104 College Ave., Rochester, New York, U. S. A.

## CONTENTS.

	Page
ART. XXI.—Evolution of the Elephant; by R. S. LULL . . . .	169
XXII.—Manganese Ore Deposits of Brazil; by O. A. DERBY	213
XXIII.—Possible Overflow Channel of Poned Waters Antedating the Recession of Wisconsin Ice; by F. CARNEY	217
XXIV.—Axial Colors of the Steam Jet and of C. . . . . C. BARUS . . . . .	224
XXV.—Descriptions of Tertiary Insects, II; by T. D. A. COCKERELL . . . . .	227
XXVI.—Reduction of Vanadic Acid by Zinc and Magnesium; by F. A. GOOCH and G. EDGAR . . . . .	233
XXVII.—Ancient Finger Lakes in Ohio; by G. D. HUBBARD	239
XXVIII.—Stephanite Crystals from Arizpe, Sonora, Mexico; by W. E. FORD . . . . .	244
XXIX.—Use of the Filtering Crucible in Electrolytic Analysis; by F. A. GOOCH and F. B. BEYER . . . . .	249

### SCIENTIFIC INTELLIGENCE.

*Chemistry and Physics*—Phosphorescent Elements, G. URBAIN: Metallic Vacuum Vessels for Liquid Air, J. DEWAR: Manganese and the Periodic Law, REYNOLDS, 256.—Higher Oxides of Manganese, MEYER and RÖTTERS: White Phosphorus, LLEWELLYN, 257.—Radiometer for Measurement of Low Pressures, J. DEWAR: Existence of Positive Electrons in the Sodium Atom, R. W. WOOD: Magnetic Effect of Cathode Rays, E. KLUPATHY: Practical Physics, W. S. FRANKLIN, C. M. CRAWFORD and B. MACNUTT: Praktische Photometrie, E. LIEBENTHAL, 258.—Principles of Physics, A. P. GAGE: Text-book in Physics for Secondary Schools, W. N. MUMPER: Laboratory Exercises in Elementary Physics, H. NEWMAN, 259.

*Geology and Mineralogy*—Earthquakes, an Introduction to Seismic Geology, W. H. HOBBS, 259.—Glaciers of the Canadian Rockies and Selkirks, W. H. SCHERZER: Traité de Géologie, E. HAUG, 261.—La Science Séismologique. Les Tremblements de Terre, M. de BALLORE: Lower Paleozoic Fossils of the Northern Shan States, Burma, F. R. COWPER REED, 262.—Summary of the Geology of India, E. W. VREDENBURG: Die Fossilen Insecten, A. HANDLIRSCH: Evolution of Mammalian Molar Teeth to and from the Triangular Type, H. F. OSBORN: Mineral Resources of the United States, Calendar Year 1906, 264.—Handbuch der Mineralogie, C. HINTZE: Meteor Crater of Canyon Diablo, Arizona, G. P. MERRILL, 265.—Foyer Collection of Meteorites, 266.

*Miscellaneous Scientific Intelligence*—Introduction to Higher Algebra, M. BÔCHER, 266.—Observations simultanées de la Surface de Jupiter, 267.—L'Heure à Paris, JEAN MASCART: Globus-karte, F. SIPMAN, 268.

Established by BENJAMIN SILLIMAN in 1818.

THE  
AMERICAN  
JOURNAL OF SCIENCE.

EDITOR: EDWARD S. DANA.

ASSOCIATE EDITORS

PROFESSORS GEORGE L. GOODALE, JOHN TROWBRIDGE,  
W. G. FARLOW AND WM. M. DAVIS, OF CAMBRIDGE,

PROFESSORS ADDISON E. VERRILL, HORACE L. WELLS,  
L. V. PIRSSON AND H. E. GREGORY, OF NEW HAVEN,

PROFESSOR GEORGE F. BARKER, OF PHILADELPHIA,

PROFESSOR HENRY S. WILLIAMS, OF ITHACA,

PROFESSOR JOSEPH S. AMES, OF BALTIMORE,

MR. J. S. DILLER, OF WASHINGTON.

FOURTH SERIES

VOL. XXV—[WHOLE NUMBER, CLXXV.]

No. 148—APRIL, 1908.

NEW HAVEN, CONNECTICUT.

1908

THE TUTTLE, MOREHOUSE & TAYLOR CO., PRINTERS, 123 TEMPLE STREET.

# New Arrivals of Rare and Choice Minerals and a Few Remarkable Cut Gems.

Gold, crystallized, three large beautiful specimens in milky quartz, from Bonanza mine, Trinity Co., California; weight 25 oz., 21 oz., and 14 $\frac{1}{4}$  oz., \$1250, \$750, \$500. Also smaller specimens from \$5 to \$15, from different localities. Kunzites, Pala, Cal., about 200 crystals good color, some are doubly terminated, prices from \$1 to \$10. Tourmaline, fine lot from Mesa Grande, Cal., loose xls and matrix, different colors, from \$2 to \$150. One doubly terminated crystal 5 in. long, 1 in. diam. of 4 different colors, pink, red, purple and green, a perfect gem, costs \$275. Silver, beautifully xld. from Batopilas, Mexico, \$5 to \$10, also a number of nicely crystallized specimens from Houghton Co., Calumet, Mich., from \$1 to \$10. Herderites, fine lot from Auburn, Maine, loose xls and in the matrix, from 25c. to \$20; a remarkable terminated crystal in the matrix, about 1 in. long,  $\frac{3}{8}$  in. diam. almost clear; matrix 2 $\frac{3}{4}$   $\times$  1 $\frac{1}{2}$  inches, price \$20. Apatites, deep lilac, Auburn, Maine, loose xls and in the matrix, from \$1 to \$20. Euclase crystals, Capio do lane, Brazil, prices \$5, \$45 and \$55. Emeralds, in matrix, from Bogota and Ural Mts., from \$5 to \$35. Topaz crystals, Mino, Japan, 25c. to \$5 each. Cassiterite crystals, a new find from Mino, Japan, 75c. to \$2.50. Crocoite, with Vauquelinite, from Berjosow and Beresowsk, Ural, also Tasmania, \$5 to \$10. Aquamarine, xls, Colo. and Siberia, 50c. to \$25. Alexandrite, matrix specimens from Ural, from \$20 to \$25, loose crystals from \$3 to \$5 each. Anatase, Binnenthal, fine xls in the matrix, attached to Eisenrose, \$8 to \$10. Zeophyllite, Radzein, new mineral, from \$1 to \$3. Chryso-prase, Silesia, \$2.50 to \$4. Topaz, Schneckenstein, 25c. to \$3. Quartz groups, Isere, France, \$1.75 to \$3.50.

## ENGLISH MINERALS.

Chalcophyllite, Cornwall, \$8 to \$10; Torbernite, Cumberland, \$5 to \$10. Fluorites, Calcites, Barites, Specular-iron, Hausmanites, all from Cumberland, varying in price from 50c. to \$2.

## HUNGARIAN MINERALS.

Barites, Calcites, Tetrahedrites, Fluorites, Amethysts, Plumosites, Pyrites, Sphalerites, Stibnite, Quartz, Cinnabar, Rhodochrosite, Realgar, Bournonite, Cerussite, Galenite, Marcasite, Galena, Chalcopyrite; we have these specimens from 50c. to \$5 each; Semseyite on Galena, Felsöbanya, Hungary, \$2.50 to \$5.

## CUT GEMS.

Alexandrite, Russia, fine color, 10 $\frac{3}{4}$ ,  $\frac{1}{3}$  k., price \$150; Pink Beryl, Pala, Cal., 21 $\frac{1}{8}$  k. of rich color, price \$60; one at 21 $\frac{1}{8}$  k., price \$50; Tourmaline cats-eye, Calif., 18 k., price \$25; another one from Calif., 7 $\frac{1}{4}$  k., at \$15; another from Brazil, 7 $\frac{1}{4}$  k., price \$35; Pink Tourmaline, Cal., 12 $\frac{3}{8}$  k., price \$50; remarkably rich color. (2) Yellow Topaz, Brazil, 27 $\frac{1}{4}$  k., price \$15 each; Siberian Amethyst, 41 $\frac{1}{2}$  k., price \$25; another 19 k., price \$15; another 12 k., price \$10; polished Thomsonites, from \$3 to \$5, each; Chlorastolites, from \$1 to \$3. Also a full line of every known cut gem, of course smaller. I have in stock a fine lot of reconstructed Rubies. Further particulars cheerfully furnished on application.

**A. H. PETEREIT,**

81—83 Fulton Street, New York City.



THE

# AMERICAN JOURNAL OF SCIENCE

[FOURTH SERIES.]



ART. XXX.—*On the Radio-activity of Uranium Minerals*;  
by BERTRAM B. BOLTWOOD.

[Contributions from the Sloane Physical Laboratory of Yale University.]

A COMPARISON of the radio-activity of uranium minerals with the radio-activity of freshly prepared uranium compounds and metallic uranium was first made by Madame Curie\* and is of interest chiefly because it was one of the first steps which led to the discovery of polonium and radium. Further, and much more elaborate, experiments of a similar character have been carried out by McCoy, who has published a number of important papers on the subject. In McCoy's first paper† it is stated that the uranium minerals (free from thorium) have an activity which is 5.7 times as great as that of the uranium which is contained in them. In a subsequent paper the value of the ratio was found to be 4.15,‡ and in a recently published paper§ the value is given as 4.54. These differences in the value for the ratio are due to the introduction of certain modifications in the methods of analysis, measurement and calculation which were employed.

A knowledge of the exact value of this ratio is highly desirable and its determination is by no means a simple matter. It is also equally important that we should know what part of the total activity of a uranium mineral is due to each of the separate radio-elements or products which are contained in it. It was particularly with a view to obtaining light on the latter question, namely, the relative proportion of the total activity of uranium minerals due to each separate active constituent,

\* S. Curie, C. R., cxxvi, 1101, 1898.

† Ber. d. chem. Ges., xxxvii, 2641, 1904.

‡ Phil. Mag., xi, 176, 1906.

§ McCoy and Ross, Jour. Am. Chem. Soc., xxvii, 1698, 1907.

that the experiments to be described in this paper were undertaken.

The problem was first brought to my attention in April, 1905, by Professor Rutherford, who suggested that an attempt be made to determine the relative activity due to actinium and its known products in a uranium mineral. At his suggestion certain experiments were undertaken with the object of measuring the rise with the time in the activity of a uranium mineral from which the radium emanation and its immediate products (radium A, radium B and radium C) had been completely removed, and also of determining the relative activities of the radium and actinium emanations which were evolved by a solution containing a known amount of a uranium mineral.

In the former experiments a fraction of a gram of a pure uraninite was dissolved in dilute nitric acid and the solution was boiled to expel the radium emanation. The solution was heated for a further period of several hours, and was finally transferred to a shallow dish and evaporated to dryness. The radium emanation and the products of rapid change formed from it (RaA, RaB and RaC) having been completely removed in this manner, the dish with the residue was placed in an electroscope and the activity measured. The rise in the activity with the time due to the accumulation of fresh quantities of emanation and active products was then observed and the final maximum activity attained at the end of about thirty days was ultimately determined. Results were obtained which indicated that the activity of the residue free from radium emanation, radium A, B and C, was from 0.55 to 0.62 that of the residue when the maximum amounts of emanation and products were present. From these data and from other data on the relative activity of uranium minerals and the uranium contained in them, it was possible to calculate roughly the activity of the radium and known radium products as compared with the activity of the other active substances (including the actinium products) present in the mineral. The relative activity of the actinium products as calculated in this manner was found to be so low that it appeared highly improbable that actinium was an intermediate product in the main line of descent in the uranium-radium disintegration series.\* This matter had been discussed in some detail by Rutherford.†

In the experiments in which it was attempted to measure the actinium emanation evolved by a solution of the mineral, it was found that the amount of the emanation given out by a

\* Rutherford and Boltwood, this Journal, xx, 56, 1905.

† Radioactive Transformations, p. 177.

solution\* containing as much as ten grams of a pure, soluble uraninite was too small to be measured or even to be detected with certainty. This result could be explained neither by the fact that the life of the actinium emanation was too short (3.9 seconds) nor on the assumption that the amount produced was too small, since certain dry preparations obtained from smaller quantities of the mineral and introduced in place of the solution gave out amounts of actinium emanation which could be readily measured. It appeared to be due rather to a very marked retention of the emanation by the solution, the real cause of which has not yet been discovered. It was evident, however, that no reliable data as to the relative amounts of radium and actinium present could be obtained by this method.

Considerable time was spent in testing the method depending on the measurement of the rise of the activity of the residues obtained from the solutions of the mineral, and the conclusion was finally reached that this was capable at best of giving but very rough approximations for the values of the relative activities. Efforts were then made to devise experiments by which more direct and accurate values could be obtained.

The important discovery by Bragg and Kleeman† that radium and its immediate products (radium emanation, radium A and radium C) emitted  $\alpha$  particles with different ranges and velocities, did not seem to justify the earlier assumption made by Rutherford‡ that each change which gave rise to  $\alpha$  rays supplied about an equal fraction of the total activity, and made a further experimental investigation of this matter very desirable. This was undertaken and the results obtained have been already published.§ It was found that the relative activities of the different products were approximately proportional to the ranges of the  $\alpha$  particles emitted by each product.

It soon became apparent that the uranium minerals (namely, the primary uraninites) which were most suitable in all other respects to the purposes of the investigation, contained small proportions of thorium. The primary activity of thorium was still in question and the statements made by Hofmann, Zerban, Baskerville and others suggested that thorium might not be a radio-active element. It therefore became necessary to investigate this matter also before any definite conclusions could be drawn from the activities of the minerals. The careful examination of a considerable number of minerals contain-

\* A strong current of air was drawn through the solution into a small electroscope.

† *Phil. Mag.*, x, 318, 1905.

‡ *Radio-activity*, 1st edition, p. 308.

§ Boltwood, *this Journal*, xxi, 409, 1906.

ing varying proportions of thorium and uranium demonstrated that the specific activity of the thorium and its products in a mineral is constant\* and furnished reliable data by which the activity of a uranium mineral could be so corrected as to eliminate that fraction of the total activity which was due to the thorium contained in it. The conclusions with regard to thorium were independently confirmed by Dadourian,† by McCoy and Ross‡ and by Eve.§

The experiments described in this paper were begun over two and one half years ago and have been steadily continued throughout the intervening period. Various improvements and modifications have suggested themselves from time to time and much of the work has been frequently repeated in order to insure greater accuracy and reliability. The results are even now by no means so satisfactory as could be desired and the repetition of some of the work would undoubtedly lead to more trustworthy values. It is believed, however, that the values as found are sufficiently accurate to permit certain important deductions and conclusions to be drawn from them.

It is of interest to note that the methods which were employed in several cases depended on the quantitative chemical separation of a number of the radio-elements from the complex mixture of active substances present in the mineral. Information as to the exact chemical behavior of the radio-elements other than uranium and thorium which can be found in the literature is extremely meager and, as will be pointed out later, is frequently untrustworthy. It has therefore been necessary not only to work out the methods of separation which were used, but to demonstrate that the separations were more or less complete by confirmatory evidence of a purely physical character.

#### *The Radio-active Measurements.*

The measurements of the radio-activity of the different minerals and preparations were made in an electroscope, a plan of which in vertical cross-section is shown in fig. 1. The ionization chamber was 14<sup>cm</sup> in height, 19<sup>cm</sup> in diameter at the middle and 15<sup>cm</sup> in diameter at the top and bottom. It was made from two tin pans loosely fastened together by a single copper rivet which permitted the lower pan to be swung to one side for the introduction of the preparation to be measured. The preparations were placed on the bottom of the lower pan and the two sections of the ionization chamber were firmly

\* Boltwood, this Journal, xxi, 415, 1906.

† This Journal, xxi, 427, 1906.

‡ Ibid., xxi, 433, 1906.

§ Ibid., xxii, 477, 1906.

held together by a spring clamp after the lower half had been swung back into position. The charged electrode was a circular aluminium plate 7.5<sup>cm</sup> in diameter and was 9.5<sup>cm</sup> from the bottom of the chamber. The vertical brass rod holding the electrode passed through a sealing-wax plug in the top of the chamber and carried on its top a brass plate and gold-leaf five centimeters in length and eight millimeters in width. The insulating sealing-wax plug was surrounded by a brass

1

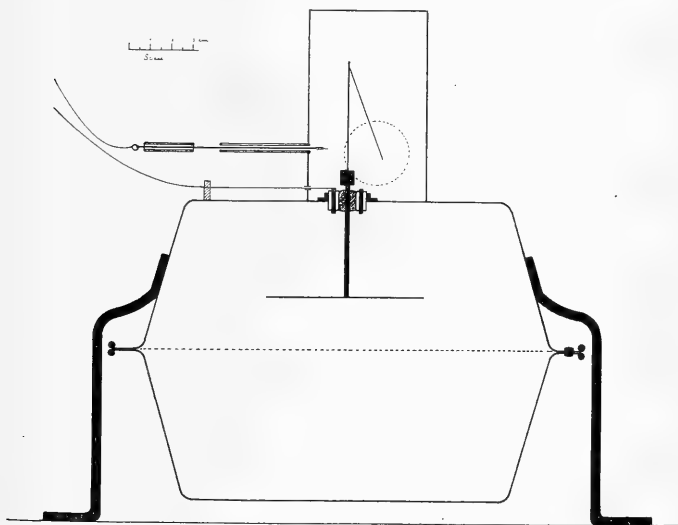

guard-ring which was kept permanently attached to the charging battery, consisting of 190 small storage cells. The gold-leaf was protected by a metal case with small mica-covered windows. The insulated electrode could be charged at will by touching the back of the plate carrying the gold-leaf with a fine wire inserted through a short glass tube in the side of the metal case. The guard ring and charging wire were connected through a water resistance with the negative terminal of the charging battery. The positive pole of the battery and the case of the electroscopes were connected to earth. The movement of the gold-leaf was observed through a microscope rigidly mounted in front of the electroscopes. The type of microscope used has already been described\* and the practice was always followed of noting the time required for the passage of the

\* This Journal, xviii, 99, 1904.

gold-leaf over a certain definite portion (8.0 divisions) of the scale in the eye-piece. The natural air-leak of the electroscopes was low and averaged about 0.04 division per minute. The maximum and minimum noted in the course of over two years were 0.058 and 0.029 div., respectively. The air-leak was always higher in winter, when the windows of the laboratory were closed, than in summer, when the windows were open. With proper precautions the natural leak could be kept constant within a few per cent for days at a time. In every series of measurements the sensitiveness of the electroscopes was determined by measurements of the leak produced by a certain standard film of uranium oxide. This film was attached to a plate of aluminium in a manner which will be described later. This standard film was carefully preserved during the entire course of the investigation. When the electroscopes and reading microscope were undisturbed the sensitiveness of the electroscopes remained quite constant for long periods, but during the time occupied by the experiments it was necessary on one occasion to completely dismount and re-assemble the entire apparatus. On several other occasions a slight readjustment of the microscope was made. These alterations produced slight changes in the constants of the instrument, which could be readily determined by the measurements of the standard film mentioned above. By means of these readings obtained with the standard film the different measurements can all be calculated in terms of a single standard. The results of earlier measurements as given in this paper have thus been reduced to the terms of the present sensitiveness of the instrument.

*Preparation of the Films.*—The method followed in preparing the minerals and solid preparations for the radio-active measurements has been described in an earlier paper.\* The material to be tested was ground to an impalpable powder in an agate mortar with freshly distilled chloroform. At the end of the grinding operation the mixture of solid and chloroform consisted of a thin paste. A small amount of this paste was removed on the point of a small camel's-hair brush,† a little fresh chloroform was dropped on the brush, and the material was quickly and quite evenly spread over the surface of a sheet of aluminium 7.5<sup>cm</sup> wide, 9<sup>cm</sup> long and 0.1<sup>mm</sup> in thickness. The aluminium sheets weighed about 2 grams, and the weight of the film of solid remaining after the chloroform had evaporated could be determined with considerable accuracy. The material adhered quite firmly to the surface of the plate and showed

\* The Radio-activity of Thorium Minerals and Salts, this Journal, xxi, 418, 1906.

† The brushes before use were carefully cleaned with chloroform in order to remove any soluble substances contained in them.

no tendency to fall off even when the plate was completely inverted.

In measurements of a similar character to those here described McCoy\* has used films of such appreciable thickness that a correction had to be made for the absorption of the radiations in the material itself. By using very thin films the absorption becomes inappreciable and the activity is directly proportional to the weight of the material present. This relation is indicated in the following table (Table I) giving the results of the measurements of a series of films prepared from an oxide of uranium containing 82.1 per cent of uranium:

TABLE I.

Film No.	Weight of oxide grams	Activity : Divisions per minute	Activity Weight
1	0.0324	3.16	98
2	0.0131	1.36	104
3	0.0087	0.885	102
4	0.0088	0.889	101
5	0.00435	0.446	102

In the case of the uranium minerals the absorption with increasing thickness of the film is more apparent, as is indicated in the following table (Table II):

TABLE II.

Film No.	Weight grams	Activity : Divisions per minute	Activity Weight
1	0.0364	13.76	378
2	0.0250	9.56	382
3	0.0229	9.11	397
4	0.0049	2.07	422

The results given in Table II are shown graphically in fig. 2, in which the ordinates are proportional to the activity and the abscissæ to the weights. The dotted straight line is drawn through the first point and the origin and indicates the locus of the points if no absorption took place. It is evident that for films weighing about 5 milligrams (and approximately 60<sup>cm</sup> in area) the absorption of the radiations in the material of the film is very slight. The films of minerals used in these experiments weighed in no case more than 11 milligrams and no corrections were therefore made in the activities for any absorption of the radiations in the films themselves.

*Determination of the Uranium in the Minerals.*

An accurate determination of the proportion of uranium contained in the minerals was highly essential as it was desired to express the activity of all the other substances in terms of

\* Jour. Am. Chem. Soc., xxvii, 391, 1905.

the activity of uranium taken as a standard. In my earlier work\* I had found that very satisfactory results could be obtained when the uranium was separated and weighed as the phosphate, but in the present instance it was considered preferable to weigh the separated uranium in the form of uranoso-uramic oxide ( $U_3O_8$ ) and to employ as a standard of radio-activity a specimen of the same oxide prepared in an identical manner from a very pure sample of uranium nitrate.

The method used for separating the uranium from the minerals was a slight modification of the method described by

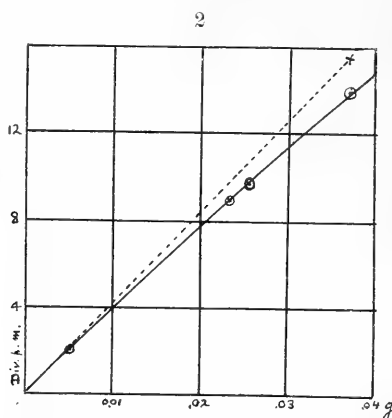

Hillebrand.† One gram of the finely powdered mineral was decomposed with dilute nitric acid and the solution was evaporated to dryness. The residue was moistened with a little dilute nitric acid, digested with a few cubic centimeters of water and the resulting solution was filtered to remove insoluble matter. After further dilution the solution was treated with an excess of hydrogen sulphide and the precipitate of sulphides was filtered off.‡ The filtrate was then evaporated to dryness and the residue was heated for some time at  $110^\circ$  to insure complete drying. The dry residue was thoroughly extracted with pure, dry ether which removed nearly all of the uranium salt present. The material insoluble in ether was dissolved in dilute nitric acid, and to this solution an excess of

\* *Phil. Mag.*, ix, 603, 1905.

† *Bulletin U. S. Geological Survey*, No. 78, p. 46, 1891.

‡ It was found that when the precipitation was conducted in a very dilute nitric acid solution the precipitate could be filtered off and completely washed without the slightest difficulty. When a dilute hydrochloric acid solution was used the precipitated sulphides could not be satisfactorily removed as they ran through the finest filter paper with great readiness.



oxalic acid was added and the mixture was allowed to stand for 24 hours. The rare earths present together with a little calcium were precipitated as oxalates. The filtrate from the oxalates was evaporated to dryness and cautiously heated to destroy the oxalic acid present. The residue remaining was dissolved in a small amount of dilute nitric acid and this solution was poured into a cold solution of about 1 gram of ammonium carbonate in 20<sup>cc</sup> of water. To this mixture a little hydrogen sulphide was added. It was then heated to boiling, allowed to cool and filtered. The filtrate was boiled to remove the ammonium carbonate present, made slightly acid with nitric acid, and added to the residue obtained by the evaporation of the ether solution. The uranium solution was then transferred to a standard volumetric flask and diluted to exactly 100<sup>cc</sup>. Separate portions of this solution 10<sup>cc</sup> in volume were measured out with a standard pipette. The uranium was determined in these portions in the following manner:—The solution was diluted to about 50<sup>cc</sup>, and 10<sup>cc</sup> of a freshly prepared solution of pure yellow ammonium sulphide was added.\* The mixture was heated nearly to boiling for an hour, and the separated uranous oxide was filtered off and washed with hot water. After drying, the filter paper and precipitate were ignited in a porcelain crucible, at first gently in the air and finally at the highest heat of the blast-lamp in an atmosphere of oxygen. After determining the weight of the uranoso-uranic oxide obtained in this manner it was in many cases converted into the uranous oxide by a similar, intense ignition in an atmosphere of hydrogen,† and the weight of the uranium when in the form of the lower oxide determined. Very good agreement was shown by the results obtained in this manner.

*Determination of the Thorium.*—The determination of the thorium in the minerals was made by separating the thorium from the precipitate of rare earths thrown down by oxalic acid in the solution of the residue remaining after extracting the dry nitrates with ether. The oxalates were converted into oxides, the oxides dissolved by fusion with sodium bisulphate and subsequent treatment with water, and the thorium removed by making use of the solubility of thorium oxalate in an excess of ammonium oxalate.‡ In some cases the determination of the thorium was also carried out by other standard

\* Remelé, *Zeitschr. f. anal. Chem.*, iv, 379, 1865.

† In the various works on analytical chemistry which I have consulted sufficient emphasis is not placed on the importance of highly heating both the uranoso-uranic and the uranous oxide. A very high temperature is essential in order to insure the complete conversion of either form of the oxide into the other.

‡ This Journal, xxi, 416, 1906.

methods, and the results of all determinations were in good agreement.

*Preparation of the Uranium Standard.*

The uranoso-uranic oxide used as a standard of the uranium activity was made from some very pure uranium nitrate which was a portion of that prepared some years ago for experiments on the growth of radium in uranium compounds.\* A fraction of a gram of this nitrate was dissolved in 50<sup>cc</sup> of water, an excess of a solution of pure, yellow ammonium sulphide was added, and the mixture was digested for an hour at the temperature of boiling water. The uranous oxide formed was filtered off and ignited over the blast-lamp in oxygen. After the weight of the uranoso-uranic oxide had been determined it was again ignited, this time in hydrogen, and converted into the uranous oxide. After weighing the uranous oxide this was again converted into uranoso-uranic oxide and again weighed. The weight of the  $U_3O_8$  in both cases was the same and was in perfect agreement with the weight obtained for the uranous oxide. It was therefore assumed that the uranoso-uranic oxide finally obtained was pure and this material was used in preparing the standard. Two films of this material on aluminium sheets were made. The following table (Table III) gives the data obtained from their measurement.

TABLE III.

Film No.	Weight $U_3O_8$ g.	Activity div. per min.	$\frac{\text{Activity}}{\text{Weight}}$	Activity per g. Uranium
50	0.0061	0.641	105	124 div. per min.
51	0.0063	0.663	105	124 " " "

In calculating the activity of one gram of uranium it was assumed that the oxide ( $U_3O_8$ ) contained 84.8 per cent of uranium.

At the beginning of the investigation some uranium oxide supposed at that time to be pure  $U_3O_8$  was prepared by igniting pure uranium oxalate first in air and then in oxygen at the highest temperature attainable with an ordinary Bunsen burner. This was the oxide used in the preparation of the films included in Table I. A duplicate sample of this oxide was preserved and when examined later it was found to contain only 82.1 per cent of uranium. Film No. 3 of this series was the film used throughout the investigation for determining the sensitiveness of the electroscope.

*The Activity of the Minerals.*

In attempting to reach any definite conclusions from data derived from the measurement of the activity of a uranium

\* This Journal, xx, 239, 1905.

mineral one important point must be taken into consideration. This is the spontaneous loss of radium emanation from the powdered material, to which attention was first called by the writer.\* It will be shown later that the activity due to the radium emanation and its immediate disintegration products is a considerable factor in the total activity of the mineral. In order to obtain a true measure of the activity of a mineral a determination must be made of the emanating power of the mineral in the form used in the film, and if the proportion of emanation lost is appreciable a correction must be made in the activity as measured.†

The proportion of the total emanation lost by the powdered minerals was determined in the manner previously described,‡ and the material used was the finely powdered mineral left after the evaporation of the chloroform with which it had been mixed in the operation of grinding. The necessity of any very appreciable correction for the emanation lost was avoided in at least one instance, by the use of a specimen of a very dense and pure uraninite (the Branchville material), in which the emanation lost by the powder was only 1.4 per cent of the total amount present. The data from which the correction for the emanation lost was calculated will be given later (p. 283).

The correction to be applied for the thorium contained in the mineral was determined in the following manner. A film was prepared from a specimen of thorite containing 52.0 per cent of thorium oxide and 0.37 per cent of uranium. The weight of mineral in the film was 0.00955 gram and its activity was 0.704 divisions per minute. This was equivalent to 73.7 div. per min. per gram of mineral. The activity due to the uranium would be equal to 2.2 div. per gram of mineral ( $576 \times 0.0037$ ). One gram of mineral contained 0.520 gram of thorium oxide, and the activity per gram of thorium oxide was therefore  $71.5 \div 0.52 = 137$  divisions per minute in the electroscope.§

The following minerals were used in the experiments:—

No. 1. Uraninite from Branchville, Conn. This specimen was a portion of some very fine material which was most kindly presented to me by the late Professor S. L. Penfield, Curator of the Brush collection. It consisted of small, imperfect crystals

\* Phil. Mag., ix, 603, 1905.

† This point was neglected by McCoy in his earlier experiments, but the method of determining and applying the correction was called to his attention by the writer. The correction has been applied in the paper which he recently published (Jour. Am. Chem. Soc., December, 1907).

‡ Phil. Mag., ix, 603, 1905.

§ This is equivalent to 156 div. per min. per gram of thorium. The activity of one gram of uranium was 124 div. per min. The ratio of these numbers is 1.26; viz., the specific activity of thorium containing equilibrium amounts of products is 1.26 times that of uranium. The value found by McCoy and Ross for this ratio is 1.27 (Jour. Am. Chem. Soc., xxix, 1709, 1907).

in a feldspar matrix from which they could be readily separated. The large specimen was crushed and about three grams of the pure uraninite was picked out. This was divided into two portions consisting of larger and smaller fragments respectively. Examined with a lens, the portion consisting of smaller fragments appeared to carry a slight admixture of the matrix. The appearance of all of the material indicated the complete absence of secondary alteration. The smaller fragments were taken for the preparation of this sample, which was found to contain 0.50 per cent of silica and matter insoluble in dilute nitric acid.

No. 2. This was prepared from the larger fragments mentioned above. It was found to contain 0.34 per cent of silica and matter insoluble in dilute nitric acid.

No. 3. Uraninite from Spruce Pine, N. C. This was a portion of a lot of about 50 grams of very pure material obtained from the centers of a number of good-sized lumps which had been externally altered into gummite and uranophane. The material selected showed only the slightest traces of secondary alteration and was found to contain only 0.03 per cent of material other than silica which was insoluble in dilute nitric acid. The silica present was equal to 0.14 per cent.

No. 4. Material similar to No. 3, but containing a slightly greater proportion of secondary alteration products. It contained 0.37 per cent of silica and 0.04 per cent of insoluble matter other than silica.

No. 5. Uraninite from Joachimsthal. Carefully selected material of fair purity, but containing small amounts of sulphides.

No. 6. Uraninite from Saxony. An inferior variety containing various impurities.

No. 7. Uraninite from Colorado. This material was very kindly sent to me by Professor McCoy, who stated that it was similar to the No. 1 Pitchblende from Colorado described in his paper in the Philosophical Magazine for January, 1906.

No. 8. Carnotite from Colorado. This was also obtained from Professor McCoy and was a sample of the No. 5 Carnotite mentioned in his paper. Both this specimen and No. 7 above were tested in the powdered form in which they were received.

No. 9. Carnotite from Colorado. Obtained through the kindness of Mr. William Zowe of Uranium, Colorado. It gave a residue insoluble in nitric acid amounting to 16.7 per cent of the total.

No. 10. Thorianite, Sabaragamuwa Province, Ceylon. A portion of some very fine material kindly supplied by Mr. H. S. Miner of the Welsbach Company.

The result of the measurements made with these minerals are given in Table IV.

TABLE IV.

No.	Mineral	Uranium Per cent	Thorium oxide Per cent	Weight of flin	Activity of flin Div. per min.	Activity per gram due to ThO <sub>2</sub>	Activity due to uranium	Activity due to uranium	Ratio of activity per gram uranium to act. of powdered mineral 1 g. U	Proportion of total emanation lost by 14-1	Corrected emanation lost for uranium
1.	Uraninite, Branchville, Conn.	77.2	6.0	0.060 g.	2.73	4.55	8	447	579	1.4%	0.03
2.	Uraninite, Branchville, Conn.	77.7	6.1	0.0111 "	5.03	4.54	8	446	574	2.2	0.05
3.	Uraninite, Spruce Pine, N. C.	78.5	1.9	0.0056 "	2.41	4.29	3	426	543	14.1	0.29
4.	Uraninite, Spruce Pine, N. C.	75.8	1.9	0.0049 "	2.07	4.22	3	419	551	14.0	0.29
5.	Uraninite, Joachimsthal	66.7	0.0	0.0047 "	1.76	3.76	0	376	564	6.2	0.13
6.	Uraninite, * Saxony	46.0	0.0	0.0057 "	1.49	2.61	0	261	568	3.0	0.06
7.	Uraninite, * Colorado	56.9	0.0	0.0040 "	1.22	3.05	0	305	536	13.3	0.28
8.	Carnotite, * Colo.	49.0	0.0	0.0055 "	1.21	2.20	0	220	449	33.6	0.70
9.	Carnotite, * Colo.	43.1	0.0	0.0066 "	1.50	2.27	0	227	527	12.0	0.25
10.	Thorianite, Ceylon	12.5	78.8	0.0061 "	1.11	182	109	73	584	4.70	0.02

\* In specimens Nos. 6, 7, 8 and 9 the proportion of uranium contained in the minerals was not determined by direct analysis, but was calculated from the relative amounts of radium emanation from these and from the analyzed specimens.

The low values obtained for the activities of the carnotite specimens are not difficult to explain. This mineral is extremely porous and in its natural (unpowdered) state loses a considerable proportion of its radium emanation. It occurs, moreover, in an extremely permeable sandstone, is obtained from shallow excavations, and is subject to the action of percolating surface waters. It is therefore unsuited for the purposes of an accurate determination.

The average value of the ratios obtained from the first four specimens is 4.69, a number differing by less than 4 per cent from the value of the same ratio as determined by McCoy and Ross. The results may be taken as indicating that the activity of a uranium mineral containing its equilibrium amount of emanation is about 4.7 times the activity of the uranium which is present in the mineral.\*

*Relative Activity of Radium and Uranium in Minerals.*

A solution was prepared by dissolving a few milligrams of recrystallized radium-barium chloride in 250<sup>cc</sup> of distilled water containing a little free hydrochloric acid.† The emanation produced by a portion of this solution was compared with the emanation produced by a standard solution of radium bromide.‡ The amount of the radium in one cubic centimeter of the chloride solution was thus found to be  $8.5 \times 10^{-10}$  gram. By a comparison of the emanation formed in 10<sup>cc</sup> of this solution with the emanation produced in known amounts of the analyzed uraninites (Nos. 1, 2, 3, 4 and 5, Table IV) it was determined that the radium in 10<sup>cc</sup> of the chloride solution was equal in amount to that associated with 0.0250 gram of uranium in the minerals.

Portions of this solution 10<sup>cc</sup> in volume were evaporated to dryness in shallow glass dishes under conditions which insured the complete removal of radium emanation and its immediate active products. The activity of the residue remaining in the form of a very thin film was then determined in the electro-scope.

The following values were obtained for the activities :

1.396, 1.373, 1.437, 1.341 ; average 1.386 div. per min.

The activity of 0.0250 g. of pure uranium was equal to  $124 \times 0.25 = 3.10$  div. per min.

$$\frac{1.386}{3.10} = 0.447$$

namely, the activity of the radium itself in the minerals was 0.447 that of the uranium present.

Because of the variation shown in the separate results above given, and particularly because of a slight uncertainty as to the effect of the sides§ and non-conducting material of the glass

\* In a communication published in *Nature* for January 3, 1907, the value 5.3 was given for this ratio. This high and incorrect value was obtained under the erroneous assumption that the substance obtained by moderately heating the oxide of uranium in oxygen was pure  $U_3O_8$ .

† For further details concerning the preparation of this solution see this *Journal*, xxi, 410, 1906.

‡ Rutherford and Boltwood, this *Journal*, xxii, 2, 1906.

§ 9<sup>mm</sup> in height.

dishes, a further experiment was made in which 10<sup>cc</sup> of the radium solution were evaporated to dryness in a shallow platinum tray 5<sup>cm</sup> square with edges having a height of only 1<sup>mm</sup>. The activity of the film obtained (the film extended to, but did not touch the edges) was 1.401 div. per min. This gave the value of the ratio as 0.451.

It has been shown\* that for the electroscope used in these experiments, the activity of radium containing equilibrium amounts of the emanation and the products radium A, radium B and radium C, is about 5.64 times the activity of the radium itself. Taking the activity of the radium in the minerals as 0.45 of that of the uranium present, the activity of the radium and its immediate products is found to be  $5.64 \times 0.45 = 2.54$  times the activity of the uranium present. The activity of the equilibrium amounts of the products radium emanation, radium A, radium B and radium C is therefore equal to  $4.64 \times 0.45 = 2.09$  times the activity of the uranium. This is the factor used in Table IV in correcting the activity of each mineral for the radium emanation lost by the powdered material.

An attempt was made to determine the activity of the products A, B and C by direct experiment. The radium emanation from exactly 0.200 gram of uraninite No. 4 (Table IV) was collected and introduced into an air-tight, glass vessel having a capacity of about 250<sup>cc</sup>. One end of the vessel consisted of a copper plate 8<sup>cm</sup> in diameter, and 5.5<sup>cm</sup> from this and near the opposite side was a spiral of copper wire. The copper plate was attached to the negative pole of a battery giving a potential of 400 volts and the wire spiral was connected with the positive terminal. At the end of about four hours the copper plate was removed and quickly placed in the electroscope. Its activity was followed for the course of about sixty minutes. As was to be expected, it was found that the amount of active deposit collected by the plate varied with the character of the field, and was greatest when the inner side of the glass vessel was entirely covered with a conducting coating to within about one millimeter of the copper plate and the coating was connected with the positive terminal.

The data obtained from the decay curve for the active deposit were used for calculating the maximum value for the activity of radium A and radium C by means of the equations given by Rutherford.†

The data furnished by measurements of the most active deposit are shown graphically in figure 3. The ordinates are

\* This Journal, xxi, 409, 1906.

† Radio-activity, 2d edition, p. 334. The values taken for the constants were:  $\lambda_1$  (radium A) = 0.231 (min.)<sup>-1</sup>;  $\lambda_2$  (radium B) = 0.0266 (min.)<sup>-1</sup>;  $\lambda_3$  (radium C) = 0.0365 (min.)<sup>-1</sup>. Bronson, Phil. Mag., xi, 73, 1906.

proportional to the activity in divisions per minute and the abscissas are taken as the time in minutes from the instant at which the plate was removed from contact with the emanation. The initial activity for radium C (plus radium B) given by the equations is about 10 div. per min., and for radium A+radium B+radium C about 15.7 div. per minute. The initial activity of radium A was therefore about 5.7 div. per min. An interesting relation is shown by these numbers if considered in con-

3

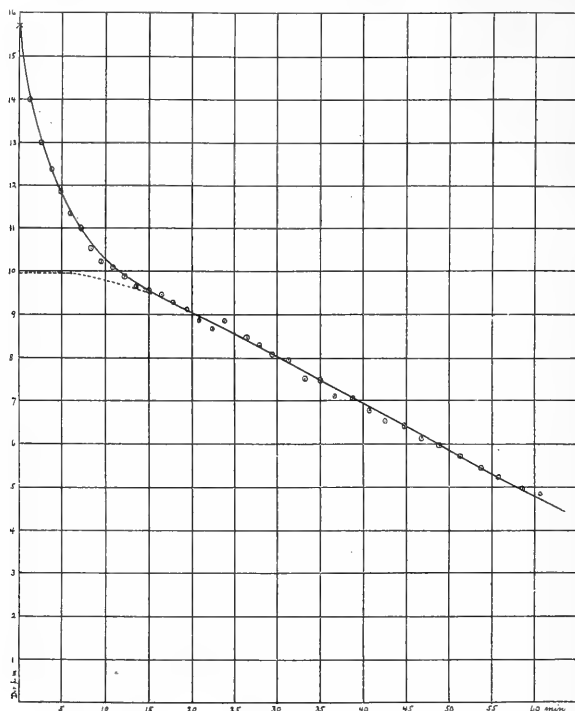

nection with the ranges in air of the  $\alpha$  particles emitted by these products. If it is assumed that the ionization produced by the easily absorbed  $\beta$  radiation from radium B is about 5 per cent of the ionization produced by the  $\alpha$  particles from radium C,\* the activity of radium C alone is found to be 9.5 div. per min. The ratio of the activities of equilibrium amounts of radium A and C as determined in this manner is

\* The results obtained by H. W. Schmidt (*Annal. d. Phys.*, xxi, 609, 1906) and Bronson (*loc. cit.*) afford some basis for this assumption.



the same as the ratio of ranges of the  $\alpha$  particles emitted by these substances, namely,

$$5.7 : 9.5 = 4.23 : 7.06.$$

This is an important confirmation of the suggestion made in an earlier paper\* that the ionization produced by an  $\alpha$  particle is proportional to its range.†

The value found for the activity of radium A and C in the active deposit on the copper plate is only about 60 per cent of the activity to be expected. It is probable that under more favorable conditions the entire equilibrium amount of these products could be obtained.

The results obtained indicate that if the activity of the uranium in a mineral be taken as unity, the activities of radium and its immediate products are approximately the following:

Radium	=	0.45,
Emanation	=	0.62,
Radium A	=	0.54,
Radium B	=	0.04?
Radium C	=	0.91,
(Uranium	=	1.00).

#### *Activity of Polonium (Ra F).*

About four years ago I carried out some experiments on the separation of the polonium from known amounts of certain uranium minerals. About 10 grams each of uraninite and gummite were taken, the former containing 75 per cent and the latter 63 per cent of uranium. The minerals were dissolved in dilute hydrochloric acid, the solutions evaporated to dryness to remove silica, and the filtrate from the silica, after the addition of a little bismuth nitrate, was treated with an excess of hydrogen sulphide. The sulphides were decomposed with nitric acid, the lead was removed as sulphate, and the bismuth and other substances were precipitated with ammonia.

\* Boltwood, this Journal, xxi, 414, 1906.

† Professor Bumstead has pointed out to me that this assumption is in no way contradictory to the evidence furnished by the ionization curves obtained by the Bragg method. A typical Bragg curve for radium C has been given by McClung (Phil. Mag., xi, 135, 1906). On the assumption that the ionization is proportional to the range, the total ionization is considered as proportional to the area of the rectangle measured by the range and the ionization per centimeter for the first centimeter or so of the range. In the Bragg curves the ionization is proportional to the area included within the curve, and the range is taken as the point where the first, upper, well-defined break occurs in the curve. It will be found that the area of that portion of the rectangle which lies without the curve is approximately equal to the area included by the curve which lies without the rectangle. This equality will hold for  $\alpha$  particles having a range of 3<sup>cm</sup> or more; when the range of the  $\alpha$  particle is less than about three centimeters the proportionality between range and ionization will be less exact.

After the small precipitate was filtered off and washed, it was dissolved in a small volume of very dilute hydrochloric acid. A button of metallic bismuth was suspended over the solution so that its under side just dipped below the surface of the liquid. The solutions were allowed to stand for about ten days, when the bismuth buttons were removed and their activities compared in an electroscope. The activities found were quite closely proportional to the amounts of uranium in the minerals taken.\* The residues obtained when the solutions were evaporated to dryness were found to be almost completely inactive.

Rutherford† has shown that polonium is a direct disintegration product of radium. As a consequence of this it is to be expected that minerals will contain amounts of polonium in proportion to the amounts of uranium and radium present. If the mineral in its natural state loses an appreciable amount of its radium emanation, the amounts of polonium present will be correspondingly reduced.

As the relative activities of the radium and the polonium in a mineral are of some importance, the following experiments were carried out to determine this relation:—

First Series.—Early experiments. In these experiments the polonium was separated from 0.100 gram of uraninite (containing 75.8 per cent of uranium) by the operations already described. Instead, however, of allowing the bismuth buttons to remain in contact with the solutions for a longer period of 10 days or so, the buttons were attached to a short, vertical rod connected with a motor, and were rotated in the solutions for periods of from one to three hours, or longer. The buttons were then removed, washed, dried and their activity determined in the electroscope. The activity of the polonium obtained in this manner was compared with the activity of the uranium present in the mineral taken, with the following results:—

No. 1,  $0.33 \times U$ ; No. 2,  $0.37 \times U$ ; No. 3,  $0.44 \times U$ .

The periods that the buttons were treated were about one, two and four hours respectively.

Second Series.—Later experiments. The addition of even small amounts of bismuth to the mineral solution previous to the separation of the sulphides introduced certain difficulties later, the most serious of which was the necessity of having considerable free hydrochloric acid present in the final solution in order to prevent the precipitation of the bismuth as a basic salt. When the basic salt was formed it carried with it a large proportion of the polonium. The addition of the bismuth salt was therefore omitted, and an attempt was made to separate

\* *Eng. and Min. Jour.*, lxxvii, 756, 1904.

† *Phil. Mag.*, viii, 636, 1904; *ibid.*, x, 290, 1905.

the polonium from a quantity of 1 gram of a uraninite, containing 78.5 per cent of uranium, the process followed being otherwise identical with that already outlined. The precipitate of hydroxides obtained was very small, and was readily dissolved in a couple of drops of dilute hydrochloric acid. This solution was diluted to exactly 50<sup>cc</sup> and quantities of this, 10<sup>cc</sup> in volume, were taken for separate treatment with metallic bismuth. In the first experiment the button was rotated in the solution for 3½ hours; in the second the button previously used was run for 4 hours, when a fresh button was put in and run for one hour longer. The polonium on the second button was only about 2.5 per cent of that obtained on the first. In the third experiment, which was made on the day following, a button was run in this solution for 7 hours and a fresh button was then put in and run for one hour longer. The amount of polonium removed on the second button was an inappreciable fraction of that deposited on the first.

The activities of the total polonium obtained in the separate experiments, expressed in terms of the activity of the uranium in the original mineral, were 0.38, 0.34 and 0.22, respectively. It was found, from these and from other experiments, that the polonium was gradually precipitated from very dilute hydrochloric acid solutions on standing, even when the amount of bismuth salts in the solution was inappreciable.

Third Series.—Final experiments. One gram of uraninite (78.5 per cent uranium) was used for these experiments and about 10 milligrams of bismuth nitrate was added to the solution of the mineral in nitric acid before the sulphides were precipitated with hydrogen sulphide. The separation of the polonium was conducted as before. The final hydrochloric acid solution contained 5<sup>cc</sup> of concentrated HCl and had a volume of 100<sup>cc</sup>. Portions of this solution 10<sup>cc</sup> in volume were introduced into a glass cylinder closed at the bottom by a copper plate. The plate was about 2 inches square and was held tightly to the cylinder by clamps; the joint between cylinder and plate was made tight by a washer of thin sheet rubber. The solution in the cell was diluted to about 30<sup>cc</sup> and was stirred by a small glass stirrer driven by a motor. In the first experiment, conducted with the freshly prepared solution, after a run of 3½ hours, the activity of the copper plate was 4.27 div. per minute. A fresh copper plate treated with the same solution for two hours longer had an activity of 0.10 div. per minute. The total was therefore 4.37 div. per minute per 0.1 gram of mineral, equivalent to 43.7 div. per gram. The amount of uranium in 1 gram of the mineral was 0.785 gram and the activity of the polonium obtained per gram of uranium was therefore  $\frac{43.7}{.785} = 55.7$  div. per minute. The activity of

one gram of uranium being 124 div. per minute, the relative activity of the polonium was  $\frac{55.7}{124} = 0.45 \times U$ .

A second similar experiment made shortly after the first one was completed gave  $0.41 \times U$  for the relative activity of the polonium. A third experiment made with  $10^{\text{cc}}$  of the same solution after it had stood for 2 days gave the value  $0.32 \times U$  for the activity of the polonium, indicating that in this solution also the polonium was slowly separating out in an insoluble form.

The precipitate of lead sulphate removed in preparing the polonium solution was dissolved by warming with some dilute hydrochloric acid to which a few crystals of potassium chlorate had been added,\* a little sulphuric acid was then added and the solution was heated until white fumes appeared. The solution obtained by treating the residue of lead sulphate with a drop or two of dilute hydrochloric acid and a little water, was placed in the cell and stirred in contact with a copper plate for about an hour. The activity of the polonium obtained on the plate was equal to 0.80 div. per min. Correcting the activity of the polonium obtained in the first experiment by this amount gives the value of its relative activity as  $0.46 \times U$ . It would appear that but little of the polonium remains with the lead when the latter is removed as the sulphate.

Attempts were also made to separate the polonium on a platinum plate from a nitric acid solution by electrolysis. The acid solutions tried were of various strengths but the results were very unsatisfactory, the chief difficulty lying in the fact that a greater proportion of the polonium was deposited on the anode than on the cathode. It was also found that in general the chemical separation of the polonium was incomplete when some bismuth salt was not added to the solution of the mineral before the sulphides were precipitated.

The activity of the polonium separated in the three series of experiments varied with the conditions, and the maximum value obtained was  $0.46 \times U$ . The value to be expected from the theory is somewhat greater than this, namely, about  $0.49 \times U$ , when the relative ranges of the  $\alpha$  particles from radium ( $3.5^{\text{cm}}$ ) and polonium ( $3.8^{\text{cm}}$ ) are taken into consideration and the activity of the radium is assumed to be  $0.45 \times U$ . That the experimental results should come out somewhat low (about 6 per cent) is not surprising in view of the difficulties attending the separation of so minute an amount of matter.†

\* Considerable quantities of lead sulphate can be decomposed by this treatment.

† The weight of polonium in one gram of the uraninite is probably of the order of  $5 \times 10^{-11}$  gram.

That the active substance separated on the copper plates and bismuth buttons was wholly polonium was demonstrated by measurements of its rate of decay, which corresponded closely to that of polonium (Rutherford, *Radioactive Transformations*, p. 127).

*Activity of Ionium.*

A preliminary notice of the occurrence in uranium minerals of a new radio-active element showing a chemical behavior similar to that of thorium has already been published.\* Details concerning the chemical and radio-active properties of this interesting substance will be given in a later paper,† where it will be shown that ionium emits  $\alpha$  particles having a range of approximately  $2.8^{\text{cm}}$  in air and is the immediate substance from which radium is produced. For the present it will be assumed merely that the ionium is separated with the thorium in a mineral, an assumption which is supported by the experiments of Hahn,‡ who has observed its presence in the purified thorium salts prepared by technical methods.

Experiment 1. One gram of uraninite (No. 4, Table IV) was decomposed by heating with dilute nitric acid and the solution was evaporated to dryness. The residue was treated with a few drops of nitric acid and hot water, and the insoluble matter was filtered off. The sulphides were precipitated with hydrogen sulphide and removed. After the removal of the excess of hydrogen sulphide exactly 0.2 gram of thorium nitrate was added to the solution. This nitrate had been prepared shortly before by a method which insured its freedom from mesothorium,§ and the proportion of thorium oxide in the salt had been accurately determined. The solution was heated to boiling, an excess of oxalic acid was added, and the mixture was allowed to stand for 24 hours. The precipitated oxalates were filtered off, and ignited. The oxides were fused with sodium bisulphate and the melt dissolved in water. The precipitation with oxalic acid was repeated, the oxalates were converted into oxides by intense ignition over the blast-lamp, and the weight of the oxides was accurately determined. A portion (90 per cent) of the oxides was removed, again converted into the soluble sulphate, and the rare earths were precipitated as hydroxides with ammonia. The hydroxides, after thorough washing with hot water, were dissolved in hydrochloric acid and the solution was evaporated to dryness. A few drops of dilute hydrochloric acid were added to the residue of

\* Boltwood, this Journal, xxiv, 370, 1907; *Nature*, lxxvi, pp. 544, 589, 1907.

† This Journal, May, 1908.

‡ *Ber. d. chem. Ges.*, xxx, 3304, 1907; *ibid.*, xxx, 4415, 1907.

§ Boltwood, this Journal, xxiv, 93, 1907.

chlorides, which was then treated with water. The solution was filtered to remove traces of silica. The filtrate, diluted to a volume of about 100<sup>cc</sup>, was heated to boiling, an excess of sodium thiosulphate was added, and the mixture was boiled until the free sulphurous acid was completely removed. The precipitate, containing free sulphur, was filtered off and treated with dilute hydrochloric acid. The solution was filtered and the precipitation with sodium thiosulphate was repeated. The second precipitate was ignited at a high heat in a platinum crucible over the blast-lamp. The thorium oxide obtained in this manner weighed 0.0878 gram. A film containing 0.0123 gram of this oxide was prepared.

The activity of the film when first prepared was 4.53 div. per minute. The activity rose for about 30 days and then fell very slowly.\* At the end of 110 days the activity of the film was 4.75 div. per minute. This was equal to 37.7 div. per min. per gram of the mineral taken. The correction for the activity of the thorium and thorium products present was now calculated and was found to be equal to 5.7 div. per min. for the total activity.† The activity of the ionium from the mineral was therefore equal to 32.0 div. per minute. Dividing this by the activity of the uranium in one gram of mineral ( $0.758 \times 124$ ) gives the value  $0.34 \times U$  for the relative activity of the ionium.

Experiment 2. One gram of Branchville uraninite (No. 2, Table IV) was taken for this experiment. The material was treated in the same manner as was the North Carolina uraninite in Experiment 1 and the film of thorium oxide finally prepared showed the same proportionate variations in its activity. The activity of the film at the end of 110 days was equal to 3.88 div. per min. This corresponded to 41.7 div. per min. for the activity of the total oxide and the correction for the thorium products present was 10.6 div. per min. The activity of the ionium from one gram of the mineral was therefore 31.1 div. per minute. When this is divided by the activity of the uranium ( $0.777 \times 124$ ), the value 0.32 is found for the ratio of the activity of the ionium to that of the uranium with which it is associated.

Experiment 3. In this experiment one gram of North Carolina uraninite (No. 3, Table IV) was taken. After the

\* The initial rise was due to the formation of thorium X and its products, which had been removed by the chemical treatment. The subsequent fall was due to the decay of the radiothorium present.

† To determine this correction a film of thorium oxide was prepared from the nitrate added to the mineral solution. This film was measured in the electroscope at the end of the 110 day period. The activity of the thorium in the mineral was calculated directly from the rates of decay of radiothorium and mesothorium.

removal of the insoluble matter and the sulphides precipitated by hydrogen sulphide, the solution was evaporated to dryness. The residue of nitrates was heated for some time at  $110^{\circ}$  to remove all excess moisture and was then extracted with ether. The oxalates precipitated from a dilute nitric acid solution of the residue remaining after treatment with ether (as described under the heading "Determination of Uranium," page 276), were converted into the oxides and dissolved as sulphates after fusion with sodium bisulphate. From the solution obtained, the rare earths were precipitated as hydroxides by ammonia and the thorium was separated by treatment with sodium thiosulphate, twice repeated. The final precipitate was dissolved in dilute hydrochloric acid, the sulphur present was filtered off, and the thorium was precipitated as hydroxide by ammonia. The thorium hydroxide was finally ignited strongly to form the oxide, and from this oxide a film weighing 0.00735 gram was prepared. The activity of this film was 13.0 div. per min. at the start; it rose slightly at first and then fell slowly like the others; and at the end of 128 days amounted to 12.8 div. per minute. This was equivalent to 33.3 div. per gram of mineral and the amount to be deducted for the thorium present was 2.2 div. The activity of the ionium was therefore 31.1 div. per minute and its relative activity was 0.32 as compared with the activity of the uranium present.

Experiment 4. One gram of the same mineral used in Experiment 3 was taken and the chemical treatment to which it was submitted was identical, except that the thorium was not separated from the other rare earths by precipitation with sodium thiosulphate. Instead, the combined hydroxides precipitated by ammonia were directly ignited to form the oxides and a film was prepared from this material. The activity of this film rose steadily from the start, and at the end of 129 days had increased by 64 per cent of its initial value. It will be shown later that the rise was due to the presence of actinium in the oxides and that the activity due to the actinium in the freshly prepared oxide was practically equal to zero. The initial activity of the film, corrected for the thorium products present (radiothorium only), was therefore due only to ionium and was equivalent to an activity of 34.3 div. per minute for the ionium in the mineral taken. This gives a value of  $0.35 \times U$  for the relative activity of the ionium in the mineral.

The values for the relative activity of the ionium obtained in these four experiments were therefore 0.34, 0.32, 0.32 and  $0.35 \times U$ .

#### *Activity of Actinium.*

The most difficult problem encountered in the course of this investigation was the separation of the actinium from the min-

erals. The difficulty was due chiefly to the fact that most of the chemical properties attributed to this element by Debiere\* are not possessed by it, but are characteristic for two quite different substances, namely, thorium and ionium.

The fact that actinium is precipitated with the rare earths was noted by Giesel,† and its further property of not being precipitated with thorium by sodium thiosulphate has been observed by Marekwald‡ and by Giesel.§ In the experiments which will next be described advantage was taken of these properties, and the actinium was precipitated from the solutions of the rare earths after the removal of the thorium.

Experiment 1. The filtrates obtained after removing the thorium and ionium precipitated by sodium thiosulphate as described under "Activity of Ionium," "Experiment 3," were combined and concentrated by evaporation. An excess of hydrochloric acid was added and, after boiling to decompose the sodium thiosulphate present, the separated sulphur was removed by filtration. The solution was still further concentrated, and finally in a volume of about 50°c the rare earths were precipitated as hydroxides by ammonia. The hydroxides were filtered off and intensely ignited to form the oxides. From the oxides, having a total weight of 0.0068 g., a film weighing 0.0037 g. was prepared. The activity of the film when freshly prepared was less than 0.10 div. per min. The activity rose slowly and at the end of 128 days reached a value of 7.55 div. per min. This corresponded to 13.9 div. per minute for the total oxide. Dividing this by the activity of the uranium in the gram of mineral taken gives  $0.14 \times U$  for the relative activity of the actinium separated. That the active substance was certainly actinium was demonstrated by the rate of rise of the activity, which is shown in figure 4. In this diagram the ordinates represent the activity and the abscissas the time in days. The maximum activity is taken as 100. The crosses give the activities as measured and the curve is the recovery curve for actinium from which all active products have been removed.|| The slight irregularity at the start was probably due to the presence of small amounts of products in the fresh oxide.

Experiment 2. In this experiment the filtrates obtained in Exp. 1, "Ionium," were treated as described in Experiment 1 of this series (Actinium). The ignited oxides of the rare earths were made into a film weighing 0.0065 gram. The activity of the film at the start was 0.45 div. per min., and the activity

\* C. R., cxxix, 593, 1899; *ibid.*, cxxx, 206, 1900.

† Ber. d. chem. Ges., xxxv, 3608, 1902.

‡ Ber. d. chem. Ges., xxxviii, 2264, 1905.

§ Ber. d. chem. Ges., xl, 3011, 1907.

|| Hahn, *Phil. Mag.*, xiii, 165, 1907.



rose at a rate corresponding to the growth of products in actinium. At the end of 110 days the activity of the film was 4.05 div. per minute, which corresponded to 14.1 div. per minute for the equilibrium value of the actinium separated with the total oxides. The relative activity of the actinium products obtained in this case was therefore  $0.15 \times U$ .

Experiment 3. The amount of actinium in the mineral was calculated from the rise in the activity of the film described under "Experiment 4, Ionium." The activity of this film at the end of 129 days was corrected for the activity of the thorium products present. The initial activity (corrected for thorium products) had been equivalent to  $0.34 \times U$ ; the final activity (similarly corrected) was equal to  $0.58 \times U$ . The difference, amounting to  $0.24 \times U$ , could be attributed to the actinium (and products) in the mineral.

Experiment 4. A portion of the oxides of the rare earths separated as oxalates in "Experiment 1, Ionium," was made into a film about six months later. Another small portion of

4

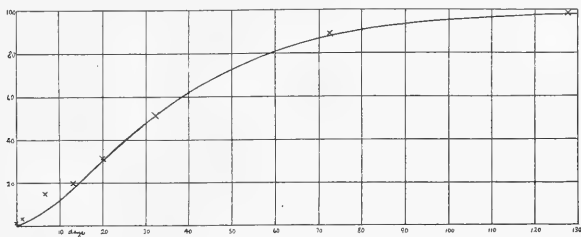

the oxides was tested by the emanation method and found to be free from appreciable quantities of radium. The activity of the film corresponded to an activity of  $0.71 \times U$  for the total material separated, after a correction had been made for the activity of the thorium products. It is regretted that the activity of this film was not followed from the time when it was first prepared, although a strict interpretation of any variations which might have been noticed would have been difficult owing to uncertainty as to the products contained in it. Assuming that the final activity was due to actinium and ionium only, and deducting the maximum value of  $0.35 \times U$  found previously for the ionium, gives a maximum value of  $0.36 \times U$  for the relative activity of the actinium products in a mineral.

I am inclined for various reasons to believe that this is more nearly the correct value. It has been observed by both Hahn\* and Levin† that the precipitation of actinium by ammonia is

\* Phil. Mag., xiii, 165, 1907.

† Phys. Zeit., viii, 129, 1907.

very uncertain and often incomplete. In the course of some further experiments, which will be described in a later paper, where larger quantities of minerals were used, the data obtained on the chemical behavior of actinium indicated that the quantitative separation of this radio-element and its subsequent complete recovery are matters of considerable difficulty. The investigations of other experimenters have been directed chiefly toward determining its qualitative characteristics, so that the information to be found in the literature is of but little assistance.

*Other Experiments.*

*Activity of Heated Minerals.*—That a greater or less proportion of the radium emanation contained in minerals can be expelled by heating has been observed by Strutt.\* About one gram of the uraninite No. 4 (Table IV) in the form of fine powder was placed in a porcelain crucible, which was enclosed in a covered platinum crucible and heated to bright redness for about ten minutes over a Bunsen burner. The loss in weight of the mineral was determined (3.21 per cent) and a film was prepared from the heated material. About three hours after heating, the activity of this film was measured and at the same time the proportion of the total amount of radium emanation present was determined in a duplicate sample of the ignited mineral. It was found that the ignited mineral contained 46 per cent of its equilibrium amount of radium emanation. After correcting for the activity of the thorium products present, the activity of the uranium and its products† in the film was found to be equal to 3.51 times the activity of the uranium only.

A few days later (3 days 19 hours after the first measurement) the activity of the mineral in the film was again measured, and the activity of the uranium and its products was found to have risen to  $4.08 \times U$ . When a further period of 26 days from the start had elapsed the corresponding activity was  $4.75 \times U$ . Four months later the activity was  $4.72 \times U$ , and the same value was found when the film was measured about 17 months from the time of heating. It was found that after it had been heated, the mineral retained over 99 per cent of the total radium emanation subsequently formed.

It is apparent that the final activity reached by the ignited mineral was the same as that found for a natural mineral containing equilibrium amounts of all the products. This indicates that the amount of polonium expelled by the heating was inappreciable and allows the activity ( $3.51 \times U$ ) found for the freshly ignited material to be taken as a measure of the activity

\* Proc. Roy. Soc., lxxiii, 191, 1904.

† By "uranium and its products" is meant the uranium and all other active substances except thorium products contained in the mineral.

of uranium and its products less 54 per cent of the equilibrium amount of radium emanation, radium A, radium B and radium C. The difference between the initial and final activities, namely,  $4.72$  less  $3.51$ , equals  $1.21 \times U$ ; and this value can be considered as equivalent to 54 per cent of emanation and products. This corresponds to a value of  $2.24 \times U$  for the relative activity of the total amounts of radium emanation, A, B and C, a number which is in good agreement with the value  $2.09 \times U$  found by the more direct method (p. 283).

The indications that none of the polonium was volatilized in heating the mineral as described were somewhat unexpected, as this active product is quite readily driven off by similarly heating more concentrated preparations. A further quantity of the mineral was therefore heated in a porcelain crucible over the blast-lamp. The activity of the ignited material was only about 2.0 times the activity of the uranium present. After about thirty days the activity of the uranium and the uranium products was equal to about  $3.8 \times U$ , and this value increased during a further period of about 12 months to  $3.95 \times U$ . It is probable, therefore, that at the higher temperature a large part of the polonium as well as portions of the other more permanent products were removed. In the case of another portion of the mineral heated to an equally high temperature in an atmosphere of pure oxygen the activity of uranium and its products was reduced to  $3.17 \times U$  and the corresponding value four months later was  $4.41 \times U$ .

It was noted in general that the emanating power of a mineral was greatly reduced by heating. A sample of carnotite which lost 12 per cent of its radium emanation in the natural state lost only 1.4 per cent after it had been heated to a very low red heat.

*Activity of Old Radium.*—Rutherford has shown that polonium is a disintegration product of radium. As he has pointed out,\* it is to be expected that old preparations of radium will contain appreciable amounts of polonium, the actual amount depending on the age of the radium salt and the rates of disintegration of the products. The standard solution of radium bromide prepared by Rutherford, Eve and Boltwood† was made from pure radium which is now at least four years old. A portion ( $10^{\text{cc}}$ ) of this solution containing  $1.57 \times 10^{-5}$  gram of radium was recently evaporated to dryness in a shallow platinum tray and the activity of the radium free from emanation and immediate products was determined in the electroscope. The activity of the uranium with which  $1.57 \times 10^{-5}$  gram of radium would be in radio-active equilibrium was then calculated. It was found that the activity of

\* Phil. Mag., x, 290, 1905.

† This Journal, xxii, pp. 1 to 7, 1906.

the radium deposit from the standard solution was approximately 0.52 of the activity of the uranium with which it would be associated in a mineral. This is about  $0.07 \times U$  higher than the value obtained with a freshly prepared radium salt (p. 282). If the amount of polonium to be expected in the old radium salt is calculated from the half-value period (12 years) of radium D as recently determined by Meyer and Schweidler\* and the half-value period of radium F (polonium) generally accepted (143 days), it is found that about 17 per cent of the equilibrium amount of polonium would be formed in a period of four years. The relative activity of seventeen per cent of polonium would be  $0.48 \times 0.17$ , namely,  $0.08 \times U$ , and this number is in good agreement with the value found above.

*Emanating Power of Radium Sulphate.*—It was noted in the course of certain experiments that the emanating power of radium sulphate in the form of a thin film was not a negligibly small quantity. From a film containing about  $10^{-9}$  gram of pure radium sulphate per square centimeter the loss of radium emanation was nearly 10 per cent of the total. The radium salt had been dried by heating to a low red heat.

#### *Relative Amounts of Radium and Uranium in Minerals.*

The value for the amount of radium in equilibrium with one gram of uranium in a mineral given in the paper by Rutherford and Boltwood† is somewhat in error because of the incorrect assumption as to the proportion of uranium in the mineral used.‡ Instead of 68.2 per cent of uranium the mineral actually contained 75.8 per cent of uranium. The amount of radium associated with one gram of uranium in a mineral is therefore about  $3.4 \times 10^{-7}$  gram, instead of  $3.8 \times 10^{-7}$  gram.

#### *Relative Activity of Radium and Uranium.*

The relative activity of the radium present in a uranium mineral has been shown to be 0.45 times the activity of the uranium with which it is associated. The amount of radium associated with one gram of uranium in the same mineral has been found to be  $3.4 \times 10^{-7}$  gram. One gram of uranium will therefore have the same activity as  $7.5 \times 10^{-7}$  gram of radium, and one gram of radium (free from all products) will have the same activity as 1,300,000 grams of uranium. One gram of radium containing its equilibrium amount of the products radium emanation, radium A, radium B, and radium C will have about the same activity as  $7.3 \times 10^6$  grams of

\*Phys. Zeit., viii, 457, 1907.

†This Journal, xxii, 1, 1906.

‡The error arose from the difficulty encountered in obtaining a pure uranoso-uranic oxide. Page 282.

uranium. The activity of one gram of pure, anhydrous radium bromide (58 per cent Ra) over 30 days old and retaining all of its emanation will therefore be the same as that of about 4,200,000 grams of pure uranium. These values are based on the assumption that the radium bromide used by Rutherford and Barnes,\* for determining the heating effect of radium, was pure, since this material was used in the preparation of the standard solution.

Dealers and manufacturers of radium bromide are in the habit of using as a measure of the activity of the pure salt the expression "1,800,000  $\times$  Uranium." I have never found a definite statement as to the exact meaning of this expression or the manner in which the activity is determined. I have observed,† however, that thin films obtained by the evaporation of dilute solutions of radium bromide may retain less than fifty per cent of the emanation formed within them, so that the number "1,800,000  $\times$  Uranium" may express with a rough degree of approximation the activity of pure radium bromide measured under similar conditions.

*Summary of Results.*

The values for the relative activities of the uranium and the various products contained in a uranium mineral which are indicated in the preceding experiments can be expressed as follows, the activity of the uranium being taken as unity :

Element	Activity
Uranium .....	1.00
Ionium .....	0.34
Radium .....	0.45
Radium emanation .....	0.62
Radium A .....	0.54
Radium B .....	0.04 (?)
Radium C .....	0.91
Radium F (polonium) .....	0.46
Actinium products .....	0.28
Total activity .....	4.64 $\times$ Uranium.

If the value to be theoretically expected for the relative activity, namely,  $0.49 \times U$ , be taken for radium F, and also the maximum values found for the activity of ionium ( $0.35 \times U$ ) and the actinium products ( $0.36 \times U$ ), the sum of the separate activities is equal to  $4.76 \times U$ . These numbers are in good agreement with the corresponding value of  $4.69 \times U$  found from the direct measurement of the uranium minerals. The numerical value of these different quantities will show more or

\* Phil. Mag., viii, 202, 1904.

† This Journal, xxi, 414, 1906.

less marked variations when the relative activities are measured in an ionization chamber of different size and dimensions from that of the electroscope used in these experiments. In a smaller ionization chamber the relative activity of the products emitting  $\alpha$  particles of longer ranges will be less, while in a larger chamber the ionizing effects due to the various  $\beta$  radiations will be proportionately greater. Without special definition, therefore, the numbers as derived above can not be considered as approximating to definite constants.

The values found indicate that the activity of the uranium is about 2.22 times that of the radium with which it is in radio-active equilibrium. It seems very certain that the range of the  $\alpha$  particles from uranium is not greater than the range of the  $\alpha$  particles from radium itself,\* and the number found is, therefore, not the one which would be expected on the basis of the simple disintegration theory, in which it is assumed that the same number of  $\alpha$  particles is emitted per second by equilibrium amounts of successive products. It is possible, however, that two distinct  $\alpha$  ray changes may exist in ordinary uranium, although the assumption of two such products does not entirely obviate the difficulty. The problem is evidently too complicated to permit of any simple explanation of the relations for the present.

In so far as these experiments throw any light on the question of a genetic relation between actinium and uranium, I think that the constancy of the activity of the different minerals and the fact that quite appreciable amounts of actinium can be separated from all of them† make it necessary to assume that the amounts of actinium in a mineral are proportional to the quantity of uranium present. It is therefore extremely probable that actinium is a disintegration product of uranium, although its position in the uranium-radium series is still to be determined.

New Haven, Conn.,  
February 14, 1908.

\* Bragg, *Phil. Mag.*, xi, 754, 1906. McCoy and Ross, *Jour. Am. Chem. Soc.*, xxix, 1698, 1907.

† I have had no difficulty in demonstrating the presence of actinium in carnotite.

ART. XXXI.—*On the Heating Effects produced by Röntgen Rays in Lead and Zinc*; by H. A. BUMSTEAD.

[Contributions from the Sloane Physical Laboratory of Yale University.]

IN an earlier number of this Journal\* the writer described a series of experiments from which it appeared that when Röntgen rays were equally absorbed in lead and in zinc, approximately twice as much heat was generated in the lead as in the zinc. These experiments were carried out in the Cavendish Laboratory of the University of Cambridge and the further prosecution of the investigation was interrupted by the writer's return to America. An unusual pressure of other duties prevented the resumption of the work until last summer and autumn, when a considerable series of observations was made with such variation of the conditions as might be expected to reveal certain possible errors in the original experiments. It soon became apparent that errors had been present, and that the difference in the quantities of heat generated in the two metals was much less than had appeared from the earlier experiments. The source of the original mistake was inherent in the apparatus used (a special form of radiometer), and although it could be diminished it was not easy to eliminate it altogether. There still remained an uncertainty of from 5 to 10 per cent as to the equality of the heat in the two metals. I had accordingly planned, before publishing this correction, to attempt to bring the result within narrower limits, by substituting for the radiometer a thermopile, with which the principal source of difficulty could be easily avoided. In the meanwhile, however, a paper by E. Angerer has appeared,† in which a series of very careful experiments of this kind are recorded. Angerer's results leave no doubt, I think, that the heating effects in lead and zinc are equal to within a few per cent; the total effect is so small and the experimental difficulties are so considerable, that it does not seem practicable at present to seek for a possible small difference within these limits. Certain facts in connection with the emission of electrons by metals make it not improbable that there may be some liberation of atomic energy when ultra-violet light, or Röntgen rays, fall on a heavy metal. Such considerations have been advanced by Lenard,‡ by W. Wien,§ and by J. J. Thomson;|| and they are in a measure supported by the recent work of Bestelmeyer,¶ Cooksey,\*\* and Innes.††

\* Vol. xxi, p. 1, 1906.

† Ann. der Phys., xxiv, p. 370, 1907.

‡ Ibid., viii, p. 169, 1902.

§ Ibid., xviii, p. 991, 1905.

¶ Conduction of Electricity through Gases, p. 319.

|| Ann. der Physik., xxii, p. 429, 1907.

\*\* This Journal, xxiv, p. 285, 1907.

†† Proc. Roy. Soc., A. lxxix, p. 442, 1907.

But so little is as yet known about the mechanism of this emission of electrons, that it is by no means certain that the facts observed by these investigators necessarily involve the liberation of atomic energy. And in any event, the results of Angerer indicate that this energy, if it is set free, forms only a small part of the total produced by the absorption of Röntgen rays.

The source of my own erroneous results was found in the greater rate of loss of heat by the zinc, for a given temperature above its surroundings, than by the lead. In the original experiments small strips of the two metals (of different thickness so as to produce equal absorption of the rays) were held by an ebonite support so that each strip was opposite one vane of a radiometer made of thin aluminium foil and suspended by a quartz fiber. The whole was enclosed in a heavy metal case from which the air could be exhausted to the point of maximum radiometric sensitiveness. An aluminium window, with a movable lead screen outside, permitted either or both of the strips to be subjected to the action of Röntgen rays; and through a glass window the deflections of the radiometer could be read by telescope and scale. The position of the strips could be reversed and the balance of the two vanes tested by a device which is described in the former paper. The repulsion of one of the vanes was of course primarily dependent on the temperature of the surface of the strip to which it was exposed; to make the radiometer deflections a measure of the quantities of heat developed in the metals, it was necessary that the rate at which the two metals lost heat, per degree excess of temperature above their surroundings, should be the same. If then the steady state was observed when the heat lost was equal to the heat generated, the rise in temperature of either strip would be proportional to the heat developed in it. I sought to realize this condition by covering both metals with thin aluminium foil which was stuck to the metal by a very thin layer of wax. It was recognized that, if any considerable part of the total heat were lost over the supports to which the ends of the strips were attached, the zinc would be at a disadvantage in comparison with the lead owing to its greater conductivity and thickness. This possibility appeared to be excluded (as well as any sensible difference in the emissivity of the surfaces) by a control experiment in which the strips were heated by exposure to the light of an incandescent lamp, instead of Röntgen rays. The deflections of the radiometer were almost exactly equal in this case, and the whole behavior was such as to indicate that the conditions specified above were fulfilled; the question was discussed in the previous paper and the experiments with light were taken as excluding the possibility of the result being due



to the more rapid loss of heat by the zinc. My recent experiments, however, force me to the conclusion that the zinc did lose heat more rapidly (for a given temperature) mainly over the supports, and that, in the control experiments, this was accidentally compensated by a greater absorption of the incident light by the zinc, possibly owing to a thinner layer of wax between it and its covering of aluminium foil. The experiments with light were made at the very end of my stay in Cambridge and could not be repeated on account of lack of time; if they had been repeated under slightly varied conditions the error would doubtless have been discovered. The agreement between the two metals, however, was so good, and the improbability of two unrelated large errors which exactly compensated each other was so great, that I was led to put more confidence in this result than it deserved.

When the experiments were again taken up, however, I did consider the possibility that the emissivity of a surface and its absorption of light might vary together—thus destroying the force of the control experiment. It was not likely that the emissive power of a surface for low temperature radiations would be proportional to its absorption of the high temperature radiation from an incandescent filament, but I nevertheless made some experiments to test the matter. For this purpose two lead strips were used, one of which was left with its original dull surface and the other covered with aluminium foil. Röntgen rays and light were both used; the rays gave deflections agreeing to about 5 per cent; with light on the other hand, the dull lead strip gave four times the deflection of the other. It thus appeared (as was expected) that the rate at which heat was lost varied very little with the state of the surface, while the absorption of light varied greatly. Thus there appeared to be no reason for distrusting the control experiment.

A series of experiments was next made, by means of an electroscope, on the amount of secondary radiation from lead and zinc, in order to test the possibility that a considerable fraction of the energy in the case of the zinc might escape in this form. It appeared from these that the total intensity of the secondary rays escaping from both surfaces of the zinc strip (as measured by the ionization produced) was less than 1/15 of the primary rays absorbed.

The energy measurements were again taken up and a change was made in the method which would render it independent of the rate of loss of heat from the metals. The strips of lead and zinc were held at the ends by massive brass clamps, connected to binding screws outside the case by means of rods insulated from the case. In this way a known current of electricity could be sent through either strip; the resistances of the

strips were measured, and thus a known quantity of energy could be developed in either strip and the corresponding deflection of the radiometer obtained. The loss of heat through the electrodes was so rapid, however (especially in the case of the zinc), that measurable deflection could not be got with the Röntgen rays. I accordingly substituted for each strip a five-barred grid, carefully cut from the same materials, each bar being one millimeter wide; one electrode-clamp held the beginning of the first bar, the other the end of the fifth bar, so that the current passed through the five bars in series. This served the purpose although the deflection produced by the rays falling on the zinc were still too small for very accurate measurement. The resistance of the zinc grid was  $6.5 \times 10^{-5}$  ohms and of the lead  $64 \times 10^{-5}$  ohms; currents of 10 to 12 milliamperes were used in the lead and from 35 to 50 milliamperes in the zinc. The deflections produced by either grid were found to be proportional to the quantity of heat developed in it, but the sensitiveness of the two grids was very different. Thus in one experiment, which may serve as an example of many which were made, the energy necessary to produce a deflection of  $1^{\text{cm}}$  was: with the zinc grid, 26.8 ergs per second; with the lead grid, 7.82 ergs per second. When the Röntgen rays fell upon the zinc, the deflection of the radiometer was  $2.6^{\text{cm}}$ ; when on the lead,  $10.8^{\text{cm}}$ . These measurements give 70 ergs per second in the zinc and 84 ergs per second in the lead; the ratio of the two is 1.2. This is a much smaller difference than was obtained in the Cambridge experiments; and, what is more significant, any errors (due, for example, to a gain of heat by both strips from other portions of the apparatus struck by the rays, or to imperfect screening of one strip) would favor the lead on account of its greater sensitiveness. So that the difference would be less than 20 per cent, rather than more.

A more careful consideration of the conditions of the original experiments showed that it was not impossible that the result obtained was due to escape of heat by conduction through the ebonite disc which supported the strips, the aluminium leaf which covered the disc (to prevent electrical effects), and the copper wires by which the strips were earthed. The lead strips had also, between them and the disc, pieces of cardboard to bring their front surface into the same plane with those of the thicker zinc strips. I accordingly repeated the experiments with the following modifications: the cardboard was left out and the zinc strips sunk into recesses cut in the disc; the aluminium foil was scraped away from the vicinity of the ends of the strips; and the strips were earthed by manganin wires  $0.05^{\text{mm}}$  in diameter and  $3^{\text{cm}}$  long; also the strips were covered

with aluminium paint, instead of foil, to make the coefficient of absorption for light less uncertain.

Two series of observations with this arrangement were made (one with Röntgen rays, the other with light), during which the balance of the radiometer vanes was tested, the position of the metals reversed and various corrections applied as detailed in the former paper. The ratio of the lead effect to the zinc effect was :

With Röntgen rays .....	1.47 ± .04
With light .....	1.43 ± .06

These results show that the heating effects of Röntgen rays in the two metals are equal, with an uncertainty of between 5 and 10 per cent.

Some time before the above results were obtained, two experiments of another kind were made with the view of testing certain aspects of the hypothesis that Röntgen rays caused atomic disintegration. The first was an attempt to find out whether any rays similar to *a*-rays existed among the secondary radiations given off when a heavy metal is exposed to Röntgen rays. An iron tube was provided with an aluminium window at the side, through which a beam of Röntgen rays could be sent; this beam fell upon a lead plate at an angle of 45°. To the upper end of the tube, 3<sup>cm</sup> above the center of the lead plate, was cemented a glass plate, the inner side of which was coated with powdered zinblend. The tube was exhausted to 0.1<sup>mm</sup> and the zinblend screen examined by means of a lens in the ordinary manner, while the rays fell on the lead plate. No scintillations were seen; the sensitiveness of the eye was tested by alternate observations of another, similar screen placed above a weak radium preparation which gave a few scattered scintillations; this was placed near the Röntgen tube and observed while the tube was excited. A large Müller water-cooled tube was used (20<sup>cm</sup> in diameter) and a heavy discharge sent through it; the focus was only 28<sup>cm</sup> from the lead plate, so that the latter was exposed to very intense rays. The air between the lead and the screen would have formed, at atmospheric pressure, a layer only 0.004<sup>mm</sup> thick.

I also tried to find out whether Röntgen rays had an accelerating effect upon the disintegration of a radio-active substance. The active deposit of thorium was used in preference to one of the more permanent radio-active substances. An aluminium plate, one side of which had been exposed to thorium emanation for some hours, was placed over a hole in the wall of an electroscope with the exposed side inward. A number of measurements of the activity were made and then the plate

(without being removed) was exposed for ten minutes to strong Röntgen rays from the large bulb with its focus 20<sup>cm</sup> from the plate. The ionization was then measured again several times. The following is an example of the results obtained :

Activity before exposure	---	7.56	±	.056
Activity after exposure	-----	7.54	±	.076

Repetition of the experiment gave similar results.

#### *Conclusions.*

1. The result previously obtained by the writer, that the heat generated in lead by Röntgen rays was twice that in zinc is not confirmed by further experiments, which show that the quantities of heat are equal, with an uncertainty of from 5 to 10 per cent. The source of the error was imperfect heat-insulation of the metals; this escaped the control experiment on account of a difference in the coefficients of absorption of the surfaces for light, which, by an unfortunate accident, was just sufficient to compensate the other inequality.

2. No rays capable of producing scintillations on a zinc-blende screen are present among the secondary radiations from lead when exposed to Röntgen rays.

3. The disintegration of the active deposit from thorium emanation is not hastened by exposure to Röntgen rays.

New Haven, Conn., Dec. 6, 1907.

ART. XXXII.—*A Review of the Minerals Tungstite and Meymacite*; by T. L. WALKER, University of Toronto.

EARLY in the last century Silliman\* described a mineral rich in tungstic acid from Huntington, Connecticut, and although no analysis had been made of this mineral it was agreed to regard it as anhydrous tungstic acid,  $WO_3$ . Many years later Nordenskiöld described the crystal form of artificially prepared anhydrous tungstic acid, and this description has been incorporated in the general description of Silliman's mineral. Finally in 1874 Carnot studied and described an occurrence of a massive mineral greenish to yellowish in color, very impure from the presence of foreign substances and, concluding that it was hydrated tungstic acid of the formula  $WO_3 \cdot 2H_2O$ , named it Meymacite and regarded it as a distinct species. The uncertainty as to the proportion of water in the case of Carnot's analyses is shown by the fact that in his three analyses the water percentage varied from 6.85 to 12.93. Meymacite has usually been regarded as a variety of tungstite. Recently, while examining some specimens from British Columbia, the writer had occasion to review the relationship of these minerals. Material from the vicinity of Salmo occurring in small masses in gold quartz veins, and at times containing small particles of native gold, appeared on examination with the blow-pipe to agree fairly well with the standard description of tungstite. This was followed by a detailed examination, which leads to the conclusion that it is at once the same as the material of Silliman and of Carnot and that the chemical composition is  $WO_3 \cdot H_2O$ . In the following description the main characteristics of the British Columbia mineral are recorded.

*General Description.*—The material here considered reached the Mineralogical Museum of the University of Toronto through the kindness of Mr. R. B. Thomson, lecturer in botany in the University of Toronto. Later, on visiting British Columbia in 1907, more specimens were obtained, but as the vein from which the specimens came was not being worked at the time of my visit no considerable quantity was obtainable. The specimens are made up of a heavy golden-yellow mineral streaked and netted with dark strings exhibiting a structure common to serpentines. In the centers of the yellow areas small druses of minute crystals may be observed on examination with the microscope. Quartz, wolframite, scheelite and specks of native gold make up a considerable portion of the whole. The grain is too fine to make it possible to secure a sample of pure yellow material for analysis. The yellow min-

\* This Journal (1), iv, pp. 52 and 187.

eral apparently results from the alteration of wolframite. Having determined by the aid of the pycnometer the specific gravity of the aggregate as a whole and later of the part insoluble in ammonia and knowing the relative proportions of the soluble and insoluble constituents, it is simple to calculate the specific gravity of the yellow soluble constituent. In this way the density has been found to be 5.517, hardness 2.5, luster resinous, pearly on the one perfect cleavage. In thin section the mineral is seen to be golden yellow, in transmitted light, but not perceptibly pleochroic. The index of refraction is less than that of Canada balsam since the mineral in thin section is smooth-surfaced. Examined between crossed nicols the polarization colors are brilliant, indicating fairly low double refraction. As the mineral is very cleavable in one direction numerous cleavage plates are torn loose in the mounting, and these being oriented so that their cleavage plane is that of the mount, give in convergent light biaxial interference figures.

Although there are numerous druses lined with tiny crystals none of them was large enough for study on the goniometer. All that we know of the crystallography of this mineral depends upon two observations: the mineral possesses one perfect cleavage and these cleavage plates exhibit biaxial interference figures. Since in this case the acute bisectrix is at right angles to the cleavage we may conclude that the mineral may be rhombic and the cleavage pinacoidal, or it may be monoclinic with the cleavage parallel to the plane of symmetry. Later it may be possible to secure crystals large enough to settle this question definitely.

*Chemical characters.*—Since both tungstite and meymacite are said to be soluble in ammonia and sodic hydroxide, the powdered mineral was treated with warm caustic soda, and the residue washed and dried at 110° was found to make up only 13.52 per cent of the whole. In this way it was possible to consider (from a chemical point of view) the specimens as made up of two parts—one soluble in alkali corresponding to tungstite or meymacite, and an insoluble portion made up, according to physical and chemical examination, of wolframite, limonite and scheelite.

The result of a complete analysis was as follows:

WO <sub>3</sub> .....	86.20%
CaO .....	.54
FeO* .....	1.21
Fe <sub>2</sub> O <sub>3</sub> .....	4.14
H <sub>2</sub> O .....	7.72
<hr/>	
Total .....	99.81%

\* The condition of the iron was not determined—that portion necessary to form wolframite with the balance of the tungstic acid has here been expressed as FeO.

On analysis of that portion soluble in ammonia it was found to yield 80.08 per cent  $\text{WO}_3$ , the balance not accounted for by the insoluble dried at  $110^\circ \text{C}$ . being apparently water. This amount agrees very closely with the difference between the percentage of water contained in the powder sample as a whole and that contained by the insoluble portion. As scheelite, wolframite and limonite appear to make up the insoluble part of the sample, we may indicate the approximate mineralogical composition of our aggregate as follows:

	$\text{WO}_3 \cdot \text{H}_2\text{O}$	$\text{FeO} \cdot \text{WO}_3$	$\text{CaO} \cdot \text{WO}_3$	$2\text{Fe}_2\text{O}_3 \cdot 3\text{H}_2\text{O}$	Excess
$\text{WO}_3$ ----	86.20%	80.08	3.88	2.24	---
$\text{CaO}$ ----	.54	----	----	.54	---
$\text{FeO}$ ----	1.21	----	1.21	..	----
$\text{Fe}_2\text{O}_3$ ----	4.14	----	----	..	4.14
$\text{H}_2\text{O}$ ----	7.72	6.21	----	..	.69
	86.29%	5.09%	2.78%	5.83%	
	Tungstite	Wolframite	Scheelite	Limonite	

The material soluble in alkali is therefore hydrated tungstic acid,  $\text{WO}_3 \cdot \text{H}_2\text{O}$ . Since the mineral of Silliman has never been analyzed and that of Carnot was so impure that nearly half of the constituents found had to be rejected in calculating his formula  $\text{WO}_3 \cdot 2\text{H}_2\text{O}$ , it seems very probable that all three of these occurrences have really the same chemical composition.

This mineral is probably widely distributed as indicated by the following extract from the "Economic Resources of the Northern Black Hills."\* The reference is to the formation of secondary products by the alteration of wolframite.

"Despite the decomposed and gouge-like character of the country rock, alteration has not generally taken place to any noticeable degree. Where the ore has been long exposed to atmospheric conditions, however, a mineral of gold-yellow color, in glistening druses of extremely minute crystals, very often coats the surface. This has been considered by Forsyth as suggestive of tungstite or tungsten trioxide, but none of that collected by the writer gave satisfactory results to tests for tungsten and its true character has not yet been determined."

Some of the gold quartz mines in Southern British Columbia in the vicinity of Salmo have, according to report, produced considerable amounts of this mineral, but as nobody suspected the presence of any valuable substance other than the gold, it does not appear to have been utilized.

\*Irving, Emmons and Jagger, U. S. Geol. Survey. Professional Papers No. 26, p. 166.

*Conclusion.*—In British Columbia and possibly in the Black Hills, S. D., a yellow crystalline mineral occurs having the formula  $\text{WO}_3 \cdot \text{H}_2\text{O}$ . This appears to be the substance which under various conditions has been called tungstite and meymacite. It occurs along with gold and other tungsten minerals and may be of industrial importance. The author suggests that the name tungstite be used for this well established hydrated oxide since the supposed anhydrous material had never been analyzed.

Mineralogical Laboratory,  
University of Toronto, January, 1908.



ART. XXXIII.—*Descriptions of Tertiary Insects*; by  
T. D. A. COCKERELL.

PART III. [Continued from p. 232.]

(8) *Fossil Diptera of the Family Nemestrinidæ.*

THE Nemestrinidæ constitute a small but exceedingly interesting family of brachycerous Diptera; called by Comstock the tangle-veined flies. (The spelling Nemestrinidæ, in Comstock's Manual, is a mistake.) Among the Brachycera they appear to have certain primitive characters: palpi (always?) 3-jointed; antennæ with a jointed terminal appendage; wings with comparatively simple and direct veins. The last statement seems at variance with that of Sharp, who says, "the wing nervuration is perhaps the most complex found in the Diptera, there being numerous cells at the tip, almost after the fashion of Neuroptera." The apical reticulation of the wings, such as is described in the South African *Megistorhynchus*, does not occur in the fossil species examined by me, and may be supposed to be secondary to the venation proper, though perhaps suggestive of an ancestral character. Comparison is suggested with the Blepharoceridæ.

That the Nemestrinids are actually of great antiquity is shown by the remarkable fossil *Prohirmoneura jurassica* Handlirsch.\* This insect was found in the Jurassic rocks of Bavaria, and if Handlirsch's interpretation of the venation is correct, it seems to suggest that Comstock's nomenclature of the veins in modern forms may need amendment. It is with hesitation that I base an argument on this little-known fossil; but in any event the discussion may serve to illuminate the readily visible characters of the later remains from the Miocene.

The figure of *Prohirmoneura* exhibits the following characters:

(1) A strong subcostal vein, extending nearly to the end of the wing, where it bends upwards and joins the costa.

(2) A radius, arising from the subcosta very near its base, running nearly parallel with it, but ending near the tip of the wing, not curving upwards at its apex.

(3) A radial sector, or second radius, parallel with and close to the radius, and not confluent with it basally,—but this last character may be considered doubtful.

(4) A media, branching in the apical field, and connected with the radial sector by two cross-veins, the first directed obliquely inwards, the other in the reverse direction.

(5) A cubitus, arising from the media not far from the base, and branching near the middle of the wing, the branches run-

\* Die Fossilen Insekten, Part IV, 1906, p. 633, pl. li, figs. 11, 12.

ning parallel. Two cross-veins extend from the media to the hind margin, crossing the cubitus; the first crossing at its point of forking, the second (which is continuous with the second radio-medial cross-vein) far beyond.

(6) Two simple anal veins, the cubital cell open.

(7) A very large alula.

This arrangement, which is not very different from that of various modern Nemestrinids, strongly suggests that the apparent cross-veins are really such, and are not to be interpreted

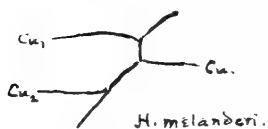
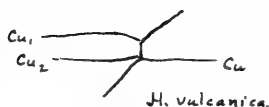
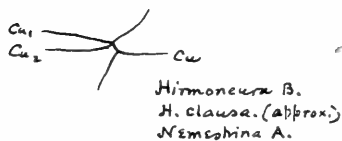

Branching of the cubitus.

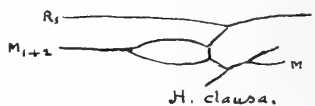
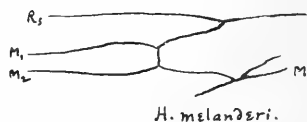
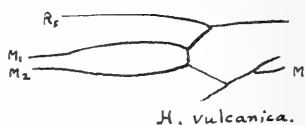
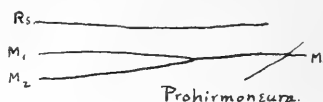

Branching of the media.

as longitudinal veins deflected out of their course; with the exception of the cross-vein seen in modern species at the branching of the media, which is deflected  $M$ , whereas the oblique vein reaching it from  $R_s$ , and looking like a branch of the latter, is nothing but a cross-vein, which is either absent or obliterated in *Prohirmonsura*. The cubital cell is thought of as extending nearly or quite to the apex of the wing, and being twice broken by cross-veins (not branches of the cubitus), so that there are three posterior cubital cells, and two between the forks of the cubitus.

The Nemestrinids are divided into two groups,—those with, and those without, an elongate proboscis. *Palembolus florigerus* Scudder, described many years ago, from the Florissant shales, belongs to the first group: the two fossils now before me belong to the second. It is not possible that either of the latter represents *Palembolus* with the proboscis broken off or concealed, as the venation does not by any means accord with Scudder's description. I saw the type of *Palembolus* in the Museum of Comparative Zoology last summer, but, as I now much regret, I made no detailed examination of it.

The new fossils are:—

(1) *Hirmonœura melanderi* n. sp. Miocene shales of Florissant, Colorado, Station 14 (*W. P. Cockerell*, 1907). Length about  $15\frac{1}{2}$ mm, with the apical segments of the abdomen extended, so that the chitinous rings are separated; body black, wings hyaline, slightly dusky; width of head  $3\frac{3}{4}$ mm; of thorax 5mm; of abdomen about middle  $4\frac{1}{3}$ mm; length of wing 10mm. Named after Prof. A. L. Melander. Holotype in Yale University.

(2) *Hirmonœura vulcanica* n. sp. Miocene shales of Florissant (*Mrs. Charlotte Hill*). In Yale University Museum. Smaller and more slender; length about 12mm; head and thorax at least mainly black; abdomen dark brown (probably reddish in life), the hind margins of the segments having broad entire light bands, about one-third the width of the segments and extending more or less forwards at the extreme sides; a fine dark line borders the extreme hind margins; width of head and thorax each about 3mm; of abdomen about middle 4mm; wings hyaline, very faintly dusky, 11mm long. The wings are much longer in proportion to the insect than in *H. melanderi*. Holotype in Yale University Museum.

*Palembolus florigerus* is 19mm long, with wings 12mm; proboscis  $12\frac{1}{3}$ mm. In describing the venation I compare the fossils with three living species:—

(3) *Hirmonœura clausa* Osten Sacken. Texas. This is the species figured in Comstock's Manual, p. 460, as *Rynchocephalus sackeni*. I am indebted to Professor A. L. Melander for the correction.

(4) *Hirmonœura* B. A new species from Texas, of which I have the drawing of the wing, very kindly furnished by Prof. Melander.

(5) *Nemestrina* A. An undescribed species from Turkestan, of which a figure has been kindly sent by Prof. Melander. The Nemestrinids are to-day comparatively numerous in Turkestan and the adjacent regions, although so rare in North America.

The wing-characters may be best understood if taken one by one:—

(1) *Costal cross-vein* is barely beyond upper insertion of first radio-medial cross-vein in *Hirmonœura* B. and *H. melan-*

*deri*; a little more basad in *Nemestrina* A., and distinctly more apicad in *Hirmononeura clausa*.

(2) *Subcosta* similar in all the species of *Hirmononeura*, but ending somewhat further from the apex in *H. vulcanica* (nearly 3<sup>mm</sup> from tip of wing) and *H. clausa*; ending still further from apex in *Nemestrina* A.

(3) *Radius* (R) is practically the same in all. In *H. vulcanica* it and the subcosta are very thick veins, contrasting with the other longitudinal veins, all of which are slender.

(4) *Radial sector*, or R<sub>2+3</sub>. Practically the same in all. In *H. vulcanica* it rises rapidly at the cross-vein, as shown in the figure.

(5) *Radial cell*. In all very long; the cross-nervure, which in many Diptera is very short, having become greatly elongated, and also very oblique, so that it forms more than half of the upper side of the cell. In *Nemestrina* A. and *Hirmononeura* B., as also in *Prohirmononeura*, the cell terminates at the point of origin of the second mediocubital cross-nervure; but in *H. melanderi* it falls a little short of this, and in *H. vulcanica* and *clausa* the distance is considerable. This is shown in the accompanying figures, where the little fork on the right side of the diagram is the end of the radial cell.

(6) *Third radio-medial cross-nervure*. This nervure is absent or not preserved in *Prohirmononeura*. In *H. melanderi* it is very long, and looks like a branch of the radial sector. In the others it is oblique but much shorter, as is shown in the figures (the nervure connecting R<sub>5</sub> with M).

(7) *Media*. In *Prohirmononeura* it simply forks; in *Nemestrina* A. it forks, but the branches are bulged outwards at the base; in *Hirmononeura* B. the upper branch has been deflected basally by the cross-nervure, so that there is a small false cross-nervure at the bifurcation; in the other species the false cross-nervure is large, as the figures show. In *H. clausa* the branches of the media meet again, enclosing a cell.

(8) *Cubitus*. The branching differs in its relation to the first cross-vein, as the figures clearly indicate, a verbal description being unnecessary. It is remarkable that in this, as well as in some features of the media, the recent species, especially *Hirmononeura* B. and *Nemestrina* A., are nearer to the *Prohirmononeura* condition than are the Florissant fossils. The apical cell between the branches of the cubitus is open in all except *H. clausa*.

(9) *Cubital cell* is just closed in *H. clausa*; in the others, narrowly open. According to my interpretation, the vein bounding it apically is a cross-nervure, and not a branch of the cubitus. If this is correct, the vein which Comstock and Needham call Cu<sub>2</sub> in *Leptis*, *Dixa*, etc., is apparently this same cross-nervure, and their M<sub>3</sub> and Cu<sub>1</sub> are Cu<sub>1</sub> and Cu<sub>2</sub>.

University of Colorado, Boulder, Colo., November 11, 1907.

ART. XXXIV.—A *New Devonian Brachiopod Retaining the Original Color Markings*; by DARLING K. GREGER.

THE preservation of the original color markings among fossil brachiopods has been noticed by a number of European writers; Professor E. Deslongchamps mentions obscure markings in Jurassic forms, especially in *Acanthothyris spinosa*, which species, he thinks, in life assumed a bright red color.

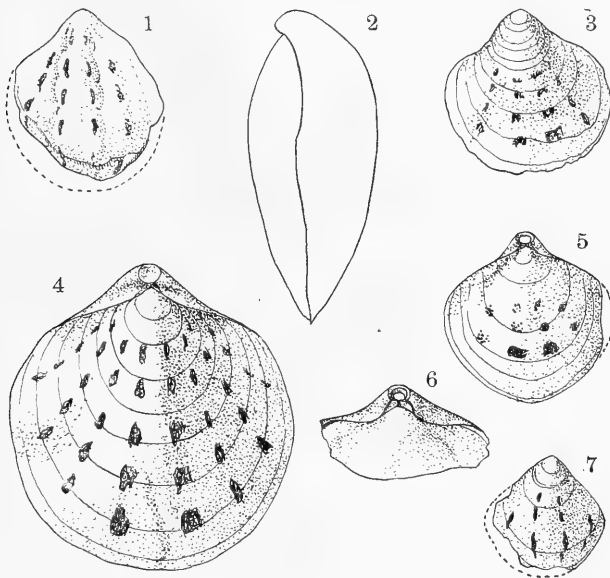

EXPLANATION OF FIGURES.

- Fig. 1. A small pedicle valve retaining color markings.  
 Fig. 2. Profile of an adult individual.  
 Fig. 3. A small pedicle valve retaining color markings,  $\times 2$ .  
 Fig. 4. Brachial view of a perfect specimen.  
 Fig. 5. Brachial view of a small specimen slightly restored.  
 Fig. 6. Posterior view of a fragment showing deltidial plates and foramen.  
 Fig. 7. A small pedicle valve retaining color markings.

Dr. Thomas Davidson in his *British Fossil Brachiopoda* figures specimens of *Dielasma hastata* and *Terebratulula biplicata* with radiating bands or stripes of color, which in his opinion were, in life, red and resembling the rayed variety of *Laqueus rubellus*. Professor Kayser records the retention of color markings in a Devonian rhyntonelloid, this being the only other recorded Devonian occurrence.

*Cranæna morsii* sp. nov. Shell large for the genus, sub-circular, valves nearly equally and uniformly convex. Marginal line along the lateral and anterior juncture of the valves, forming a sharp, thin edge. No defined fold or sinus. Surface covered with very faint, even concentric lines of growth; otherwise the surface is smooth. Shell structure abundantly punctate, the punctae very minute and arranged as in the related *Cranæna iowensis* (Calvin).

Brachial valve similar in degree of convexity to the opposite valve, slightly ridged from beak to near the center. Beak obtuse and but slightly incurved.

Pedicle valve regularly convex, most prominent near the center, sloping gently to the front and sides. Beak elevated, slightly incurved and truncated by a circular foramen. Deltidial plates conspicuous. A slight auriculation in the postero-lateral region gives a shouldered appearance to some individuals, but it is not a constant character.

Brachial valve similar in degree of convexity to the opposite valve, slightly ridged from beak to near the center. Beak obtuse and but slightly incurved.

Measurements: The average of a number of mature individuals give the following: Length, 42 millimeters; breadth, 40 millimeters; thickness, 17 millimeters.

Found near the base of the Snyder Creek shale associated with *Atrypa reticularis*, *Spirifer amarus*, *Schizophoria macfarlani*, *Strophonella crassa*, *Stropheodonta inflexa*, *Stropheodonta kemperi*, *Schuchertella pandora*, and *Productella marquessi*. With the exception of *Atrypa reticularis*, *Spirifer amarus* and *Productella marquessi*, the species here listed appear to be confined to the first twenty inches of dark shale resting directly upon the Callaway Limestone.

Locality: Snyder Creek, six miles south of Fulton, Callaway County, Missouri. Our shell differs from *Cranæna iowensis*, its near congener, in being a constantly larger and more circular species. The retention of the original color markings—some individuals retaining them in a most perfect condition—gives to the species a special interest.

It is with keen pleasure that we dedicate this interesting brachiopod to Professor Edward S. Morse of Salem, Mass., a student of the Brachiopoda, who with acute perception and artistic hand has added so much to our knowledge of the embryology and development of the Class.

ART. XXXV.—*Method of Hibernation and Vegetative Reproduction in North American Species of Stellaria*; by THEO. HOLM. (With six figures in text, drawn from nature by the author.)

ALTHOUGH the *Caryophyllaceæ*, and especially the *Alsineæ*, exhibit such a remarkably wide geographical distribution throughout the northern hemisphere, being able to thrive in the most northerly points\* and at the highest elevations† at which flowering plants are known to exist, they are, nevertheless, rather poor in biological types.

Neither the aerial nor the subterranean organs have become modified to any great extent that might lead us to suspect the extraordinary vitality possessed by some of these species. The habit is strikingly uniform; the diagram of the flower, the structure of the inflorescence, the foliage, and the ramification of the shoot is almost identical, or at least very little modified in a number of these plants. In the perennial *Sileneæ*, for instance, the frequent structure of the shoot with its compact rosette of leaves and persisting primary root shows very little variation among the arctic, the alpine, and lowland representatives; among the *Alsineæ* we observe in some genera exactly the same morphological structure as in the *Sileneæ*, while in others there is a marked tendency to spread by producing creeping rhizomes so as to enable the individual to take rapid and wide possession of the soil. In the genus *Stellaria*, for instance, there are some perennial species, in which the shoot demonstrates certain characteristic modifications so far as concerns "hibernation and vegetative reproduction," and these we intend to illustrate by a few examples, inasmuch as the literature does not give but a very scant information about the biology of these plants. The diagnoses of the species as given in the Synoptical Flora‡ are undoubtedly very exact, and may be sufficient for the determination, but mostly the floral organs have been considered; we believe, however, that the vegetative organs in several cases might be of some importance also, not only as a means of distinguishing the species, but also for the sake of giving a more complete demonstration of the particular habit of some of these plants.

\* *Cerastium alpinum* L. has been collected at 82° 50', *Stellaria longipes* Goldie and *Alsine verna* Bartl. at 82° 27', and *Alsine Groenlandica* (Retz.) Fenzl at 81° 42' N. L.

† *Arenaria Stracheyi* Hook. grows at an elevation of 19,200 ft. in Tibet; *Cerastium trigynum* Vill., *Stellaria subumbellata* Edgew., and *Sagina procumbens* L. are reported from the Himalayas at an elevation of 16,000 to 17,000 ft.

‡ Fasc. II, p. 208, 1895-97.





So far as concerns the perennial North American species of *Stellaria* s. s. (not including *Malachium* and *Cherleria*) the primary root is only of short duration, but becomes replaced by secondary roots developing from the basal nodes of the aerial stem or from the rhizome. Very characteristic of several of these species is the ability of the stems above ground to remain active for more than one season, beside that some of these are, moreover, provided with true rhizomes; in one species we find the shoots to be differentiated as floral and vegetative, the former being merely annual, while the latter may persist for about two seasons. Finally in another species we notice a highly developed rhizome with fleshy, swollen internodes, resembling long tubers. We might thus distinguish between these types so far as concerns the vegetative reproduction, viz:

A, without rhizome, but with persisting aerial stolons.

B, with rhizome, and with persisting aerial stems.

C, with rhizome, but without persisting aerial stems.

Of these the first type is represented by *Stellaria pubera* Michx. and may be described as follows:

*Stellaria pubera* Michx.

The plant is generally in full bloom in April or in the earlier part of May; the floral shoots are quite numerous, spreading, and leafy to the top. The inflorescence is a regular, very rich-flowered cyme. About the middle of May, or even earlier, while the plant is still blooming, a few vegetative shoots commence to develop (V in fig. 1). The leaves of these shoots are always larger than those of the floral, but otherwise in regard to pubescence and outline the foliage is the same.\* It is now interesting to see, that while the floral shoots die down to the ground as soon as the fruits have matured, the vegetative shoots not only remain active, but they continue their growth for several months with the leaves fresh and green. Sometimes a few-flowered inflorescence develops at the apex of these shoots, but it seems to be the most frequent case that they stay as purely vegetative. Although these flowers become developed much later than the others (those of the normal, floral shoots), they are, nevertheless, perfect, and of the same size or even larger than the earlier ones. If we examine the plant in the month of August or early in September, we find the vegetative shoots still alive, but closely appressed to the

\* As stated in the Synoptical Flora, p. 236, "the stems are pubescent in lines" mostly so, but not always; in the vicinity of Washington, D. C., it is not uncommon to find individuals as the one figured (fig. 1) in which the pubescence is not in lines but equally distributed all over the stems and branches of the inflorescence.

ground; then the leaves begin to wither, and nothing will be seen of the plant until next spring. We have, thus, in *Stellaria pubera* two kinds of shoots: floral and vegetative, of which the latter remain active for a much longer period than the floral, and of which the function is to give rise to new individuals. This may be readily observed during the spring, by lifting the plant carefully.

As shown in our figure 1, the specimen shows a long, horizontal, leafless branch, which consists of several stretched internodes, and with a pair of flowering stems (F) developed at each node, in the axils of the leaves, which have now faded away. This long, horizontal branch represents a vegetative shoot (V\*) in its second year, and when the axillary shoots (F) have reached maturity and developed roots, the old internodes die off, and a series of independent individuals is produced. These vegetative shoots being above ground, and no subterranean stolons being developed, our plant may be well characterized as being perennial, but without a rhizome. However, the base of the floral shoot does not die off with the aerial portions, but stays alive and produces axillary buds, which, later on, develop into aerial stems; such perennial stem-bases are called pseudo-rhizomes. It is thus characteristic of this species of *Stellaria*, that some of the aerial shoots remain vegetative: that they become horizontal, and develop new, axillary shoots, which soon become separated from the mother-plant as independent individuals. These vegetative shoots thus become developed as stolons above ground. We find this same method of reproduction in *Phlox divaricata* L. with the only exception that the stolons persist here for several years and continue their growth, developing axillary shoots without becoming separated from the mother-plant. In *Phlox reptans* Michx., on the other hand, the stolons become terminated by an inflorescence preceded by a rosette of leaves in the same manner as in *Antennaria*. But in regard to the *Caryophyllaceæ* we have only observed this type of reproduction in *Stellaria pubera*.

In the second type we have plants which persist by means of hibernating buds above ground and by subterranean stolons; as an example of this method of reproduction may be mentioned:

*Stellaria longipes* Goldie.

Common on the arctic shores, and not infrequent in the alpine region of the Rocky Mountains,\* this little herb shows a remarkable power to withstand the severity of the winter; it has been described by Kjellman in his interesting paper on

\* Collected by the writer on several peaks in Colorado at an elevation of 12,000 to 12,500 feet.

the life of the polar-plants.\* In this species the rhizome consists of long stolons with small scale-like leaves, and stretched internodes. The aerial shoots are ascending, and the leaves are more or less crowded on account of the shortness of the internodes. When the winter commences the leaves are still attached to the shoots, but in a withered condition; the stems, on the other hand, remain alive and persist throughout the winter. At the beginning of the spring small buds become visible in the axils of the withered leaves, which soon develop into small leafy shoots. These shoots frequently remain vegetative for one or two years until they become terminated by an inflorescence. We have, thus, in this species of *Stellaria* a very interesting example of herbaceous aerial stems, which winter over, and produce axillary buds, the function of which is to develop assimilating leaves, new axillary buds, and finally to produce flowers and fruits. This method of reproduction we observed, also, in the alpine plant, but in this the axillary shoots frequently reach the flowering stage already in the first year of their growth.

Several other species of *Stellaria* exhibit this type of vegetative reproduction, for instance: *S. longifolia* Muehl, *S. humifusa* Rottb., *S. Holostea* L.,† and *S. crassifolia* Ehrh. But in *S. borealis* Big. (specimens from Hudson Bay, and St. Paul island in Behring Sea), and in *S. crispa* Cham. et Schl. (from Annette island, Alaska) we observed only the subterranean stolons; thus it appears as if the aerial stems of these two species do not persist throughout the winter.

As representing this type may, furthermore, be mentioned

*Stellaria umbellata* Turcz.

This species we collected in Colorado on the summit of the mountains (above 14,000 ft.), where it grows among boulders, associated with *Claytonia megarhiza*, *Trifolium manum*, *Saxifraga cernua*, *S. flagellaris*, *S. nivalis*, *Poa Lettermannii*, etc.; it occurs, also, at lower elevations, for instance in the Spruce-zone on Mt. Massive (10,500 ft.).—In the alpine plant the aerial shoots (fig. 2) are very short with crowded leaves and a small, terminal inflorescence, mostly three-flowered; the stems persist throughout the winter, and minute buds become formed in the axils of the withered leaves as in *S. longipes*. There is a very distinct rhizome, consisting of several stolons, in which the internodes are very short, and mostly shorter than the

\* Ur Polarväxternas liv (in A. E. Nordenskiöld's Studier och Forsknningar, Stockholm, p. 513, 1884).

† An interesting account of the hibernation of this species has been given by O. G. Petersen (Bot. Tidsskr., ser. 2, vol. 4, Kjøbenhavn, 1874-76, p. 30), who has, also, described the development of cork as it occurs in *Caryophyllaceæ*, and the structure of the pericycle (ibidem, p. 187, 1888).

small, fleshy, scale-like leaves (fig. 3). In specimens from lower altitudes the stems are taller, and the inflorescence is an amply ramified cyme, beside that the stolons are much longer with the internodes stretched, almost to the same extent as in the species described above.

The internal structure of the alpine plant is quite characteristic; the green leaves have a larger number of stomata on the ventral face than on the dorsal, and these are surrounded by four or five ordinary epidermis-cells; they are level with epidermis, and the air-chamber is wide, but shallow. In most of the other *Caryophyllaceae* the stomata are surrounded by two subsidiary cells, which are arranged vertical on the stoma.\* The chlorenchyma consists of a typical palisade-tissue of one or two layers, and an open pneumatic tissue below this. There is a small, thinwalled water-storage tissue on the leptome-side of the midvein, but in regard to the mechanical tissues we find only a very few, thinwalled stereome-cells on the dorsal face of the midvein, but inside the parenchyma-sheath. The leaves of the stolons have, of course, no stomata, and the chlorenchyma represents a homogeneous tissue of roundish cells filled with starch, and very compact; the veins are, also, here surrounded by thinwalled parenchyma-sheaths, and lack mechanical support.

The aerial stem has a thickwalled epidermis with prominent, longitudinal ridges on the outer cell-wall, covered by a thick, smooth cuticle; the cortex is quite compact, and a thinwalled endodermis surrounds a pericycle of slightly thickwalled stereome. The stele consists of an almost continuous zone of leptome and hadrome, with a central pith of moderately thickwalled cells. A corresponding structure is to be observed in the subterranean axes, the stolons, but the pericycle is here very thinwalled, and the stele is composed of four separate mestome-strands and a broad, central pith.

This peculiar method of hibernation is thus characteristic of species that occur under very extreme climatologic conditions: in the far north, and on the summit of high mountains. We now pass to describe the third type of vegetative reproduction, in which a strongly developed rhizome occurs, and in which the aerial stems are strictly annual. This type is represented by

*Stellaria Jamesii* Torr.

This species is an inhabitant of the wooded belts of the Rocky Mountains in Colorado. The slender stem is terminated by a large, leafy cyme, and the lower stem-leaves subtend short, vegetative branches, which do not winter over; the aerial stems,

\* Compare Solereder: Systematische Anatomie der Dicotyledonen. Stuttgart, p. 122, 1899.

thus, die down to the ground at the end of the first season. As mentioned above, this species possesses a rhizome which shows a much higher development than that of other American representatives of the genus. Our figures 4-6 illustrate the external structure of the rhizome. It is horizontally creeping; the internodes are partly swollen and tuberous; they root freely, especially at the nodes. The leaves of the rhizome are opposite, scale-like, and membranaceous; they support buds, of which those that are located near the apex of the rhizome develop into aerial, floral shoots; the others stay dormant. It is a structure which is very common, and characteristic of many, very different genera, but it seems to be very rare within the *Alsineæ*, and perhaps within the *Caryophyllaceæ* in general. If we examine the internal structure, we notice the same structural peculiarities which we are used to find in rhizomes that store nutritive matters. In the slender portions of the internodes the epidermis is thinwalled, and no hypoderm is developed; the cortical parenchyma consists of about five layers, and does not contain starch; a few layers of very thinwalled cork, which has originated from the innermost stratum of the cortex, surround a pericycle of a closed sheath of mostly six layers of moderately thickened collenchymatic tissue; but there is no endodermis. We find in the stele five separate, collateral mestome-strands, which contain cambium. There is no interfascicular cambium; thus the mestome-strands are located in the periphery of a broad central parenchyma, which contains druids of calcium oxalate, and large deposits of starch, the starch-grains being of equal size, and quite large.

A corresponding structure is to be observed in the swollen portion of the internodes, with the exception of the pith being much broader, and the mestome-strands, the secondary, having a much longer radius, when viewed in cross-sections. The structure of the primordial mestome is as described above, but the secondary hadrome appears here as a long and very narrow line of vessels in each strand; the pith is hollow in the center. The secondary formations are, thus, limited to the stele, and the nutritive matters are deposited in the pith, but not in the cortex.

In bringing these facts together it is readily to be seen, that our species of *Stellaria* are not so very uniformly developed in regard to the means by which the hibernation and vegetative reproduction is effected. The three biological types which we have suggested are well marked, and might, with some benefit, be included in the specific diagnoses. But otherwise the morphological structure is very uniform in this genus, and we might at the same time take the opportunity to make a correction in regard to the inflorescence, as described in the Synop-

tical Flora (l. c., p. 233-236). The inflorescence is constantly terminal in *Stellaria* as in all the other members of the family, but it happens, sometimes, that the flowers become overtopped by the excessive growth of an axillary, vegetative shoot. This is, for instance, the case with *S. longifolia*, which is said to have a "lateral cyme." In *S. crispa* the flowers are not "solitary, axillary," but terminal. However the ramification of this species is quite singular, and it may look as if the flowers were axillary, but only apparently so. The shoots are very long, and leafy to the top; not infrequently the single flower is placed next to a long shoot with many pairs of leaves, and also bearing a single flower, accompanied by a long vegetative shoot. The flower is terminal, however, but instead of occupying the center in a cyme, it is single, since only one lateral shoot becomes developed from the uppermost pair of opposite leaves, and this shoot being frequently vegetative in its entire length. It is far from seldom, however, to find specimens which show the normal structure in a perfectly typical manner. Among the specimens which Mr. Kearney collected in Alaska and kindly placed at our disposal, there are some in which the shoots are terminated by a single flower, and in which no axillary, vegetative branch has been produced; in others the terminal flower is located between two very short branches, each of which is again terminated by a flower.

Brookland, D. C., December, 1907.

#### EXPLANATION OF FIGURES.

FIG. 1. *Stellaria pubera* Michx. showing a vegetative shoot (V) in its first year of growth, and another (V\*) in its second year; the shoots marked F are floral; one half natural size.

FIG. 2. A complete specimen of *S. umbellata* Turcz. from an elevation of 14,200 feet (Colorado); stolons with scale-like leaves are developed from the subterranean stem-portion; natural size.

FIG. 3. Two stolons of the same species; 2 × natural size.

FIGS. 4, 5, 6. Tuberos rhizomes of *S. Jamesii* Torr.; one half natural size.

ART. XXXVI.—*Two New Boron Minerals of Contact-Metamorphic Origin*; by A. KNOPF and W. T. SCHALLER.

THE material upon which the following paper is based was gathered by one of the writers (Knopf) during the summer of 1907 while engaged in an investigation of the Alaskan tin deposits for the U. S. Geological Survey. The chemical and crystallographical work was performed in the laboratory of the Survey by Waldemar T. Schaller.

The Alaskan tin deposits of known economic importance are limited to the extreme western part of the Seward Peninsula, about 100 miles northwest of the city of Nome. They are genetically associated with granitic intrusives which have invaded limestones of Paleozoic age. Along the margins of the granitic bosses an intense pneumatolytic contact-metamorphism has frequently been produced and a considerable variety of minerals developed. The largest granite boss of the region is that of Brooks Mountain, and the most energetic contact action is displayed along its periphery. The granite has a coarse porphyritic habit, and consists of phenocrysts of orthoclase an inch in diameter, and of smoky quartz, half an inch in size, embedded in a coarse to fine-grained granular matrix of feldspar, quartz and biotite. Along the margin of this intrusive body, the granite is often strongly tourmalinized. No tin deposits are known to be associated with this particular granite, but a few miles to the south of it they occur in connection with a smaller intrusive.

On the northwest flank of Brooks Mountain a prospect cut has been opened on a showing of contact metamorphic minerals occurring in marmorized limestone 10 feet from the granite contact. Examination of this deposit showed that an unknown mineral, which subsequent investigation has shown to be a new boron mineral, was present in considerable abundance. We propose for it the name *hulsite*, in honor of Mr. Alfred Hulse Brooks, geologist in charge of the Division of Alaskan Mineral Resources. In the hand specimen brown-green vesuvianite, magnetite, hulsite and rarely brown garnet occur scattered through a matrix of coarse white calc-spar. Occasionally some fluorite is visible. The characteristic forms of vesuvianite are  $a \{100\}$ ,  $m \{110\}$ ,  $f \{120\}$ ,  $c \{001\}$ ,  $p \{111\}$ ,  $t \{331\}$ . Less prominent,  $h \{130\}$ ,  $\delta \{113\}$ ,  $v \{112\}$ ,  $b \{221\}$  and others. Treated with fluorite mixture, it gives a distinct boron flame, and is therefore regarded as probably belonging to

the variety wiluite. The magnetite shows  $o \{111\}$ ,  $m \{311\}$  large with  $a \{100\}$ ,  $d \{110\}$  small. The hulsite is quite abundant and is sometimes intergrown with magnetite and vesuvianite. Its characteristic features are its strong submetallic luster, black color, good prismatic cleavage, and tendency toward a tabular development. Its surface weathering is entirely similar to that of magnetite, and on casual inspection the hulsite may easily be confounded with that mineral. The tabular individuals of hulsite vary in thickness from a fraction of a millimeter to over a centimeter in the maximum noted. Under the microscope few additional features appear. A small amount of diopside is found to be associated with the other minerals already enumerated. The hulsite is completely opaque and appears black in reflected light. The thin sections show that magnetite is often intimately intergrown with the hulsite, from which it is distinguished by its bright metallic reflection.

The other mineral, for which we propose the name *paigeite*, in honor of Mr. Sidney Paige of the Geological Survey, was found at two localities, at Brooks Mountain in loose blocks, and at Ear Mountain, 40 miles to the northeast, *in situ*. It is a lustrous coal-black mineral of foliated appearance. The material from Brooks Mountain was subjected to chemical analysis. A thin section of the matrix shows vesuvianite, calcite, hedenbergite, a small amount of biotite, and arsenopyrite in sporadic grains. Paigeite is abundant, and is often in capillary or trichite-like forms transfixing the various other associated minerals. It is opaque, and appears black in reflected light. Other contact-metamorphosed limestones, from the near vicinity from which the paigeite rock was collected, show the following combination of minerals: chondrodite, spinel, magnetite, and calcite; a fibrous green boron mineral resembling ludwigite, and galena; highly ferriferous sphalerite, galena, pyrrhotite, diopside, calcic plagioclase, fluorite and calcite.

At Ear Mountain a granite intrusion has produced an extensive development of contact-metamorphosed limestones, largely consisting of lime-silicate hornfels. Some of these are flecked with paigeite and chalcopyrite. Under the microscope this variety of hornfels is seen to consist of a confused intergrowth of calcite, zonally banded tourmaline, pleochroic in tones of blue and brown, vesuvianite, fluorite and zoisite, with accessory phlogopite, chalcopyrite, and magnetite. Paigeite fibers and matted aggregates are embedded in the various constituent minerals, especially in the tourmaline and calcite. With the paigeite-bearing hornfels is associated a tourmaline-scapo-



lite-pyroxene hornfels, which reacts chemically for chlorine. It is clear from the paragenesis of paigeite that it represents a fixation product of magmatic emissions rich in fluorine (and chlorine), boron, and iron.

#### *Hulsite.*

Hulsite always occurs crystallized; either as small crystals about 1<sup>mm</sup> diameter, or as large tabular masses, extending several centimeters and showing the prismatic cleavage well developed. The crystals, while often complete, are always uneven, and the faces dull and rough, so that no measurements could be obtained from any of the natural faces. Inspection with a hand lens shows that these crystals are often rectangular in shape, and as hulsite is provisionally considered orthorhombic these rectangular prisms consist of three pinacoids. Sometimes the crystals are bounded by the prism faces, and the basal pinacoid, though it is not always possible to decide whether the prisms are natural crystal faces or those due to cleavage. Often one pair of prism faces becomes much larger than the other pair. The cleavage parallel to the prism is good and measurements of three such cleavage angles gave the values:

$$m \wedge m''' = 57^\circ 44', 57^\circ 38', 57^\circ 33'. \text{ Average value, } 57^\circ 38'.$$

Therefore assuming that hulsite is orthorhombic, the crystallographic elements become

$$a : b : c = .5501 : 1 : ?.$$

Forms  $a \{100\}$ ,  $b \{010\}$ ,  $c \{001\}$ ,  $m \{110\}$ .

The crystals are often twinned, one individual being turned about 120° to the other, the two basal pinacoids remaining in the same plane. The crystals are also often grouped in parallel position, especially when the individual crystals are elongated parallel to a prism face. The following photomicrograph shows the characteristic appearance of hulsite crystals when grouped together (fig. 1).

The color of the mineral is black, and when free from enclosed magnetite has a greenish, brownish and sometimes a reddish tinge. Many of the smaller crystals are covered with a brownish coating, probably limonitic in character. Streak black, luster submetallic, but on the pure mineral inclining more to vitreous-like hornblende. Hardness about 3. Density 4.28. Cleavage good, prismatic  $m\{110\}$ . Readily soluble in HCl and HF, less so in other acids. Gives off water in a closed tube and before the blowpipe fuses quietly to a dull black slag and colors the flame slightly green. Gives a

persistent green color to the flame when heated with potassium bisulphate and fluorite.

The samples of hulsite first submitted for chemical investigation were apparently homogeneous. They were, however, strongly magnetic, and though it was suspected that they consisted of a mixture of a non-magnetic borate with magnetite, various tests that were made failed to show the presence of the latter mineral. The very finest powder suspended in water was completely attracted by a magnet and numerous chemical tests failed to lead to a separation of the magnetite from the borate. After the analytical work on these samples had been finished, some specimens of hulsite, collected in pre-



Fig. 1. Hulsite (opaque mineral) intergrown with vesuvianite and calcite. Magnified 12 diameters.

vious years, were found, which when tested were non-magnetic. These specimens showed that the earlier ones contained admixed magnetite, and a careful examination of all of the samples on hand showed the very frequent presence of magnetite in varying amounts included in the hulsite. Analyses of the non-magnetic and magnetite free hulsite serve to establish its formula, and on the basis of these analyses the data obtained on the first samples become intelligible, the samples analyzed being about  $1/5$  magnetite. While there were a number of specimens of hulsite which were not magnetic and therefore free from magnetite, several of them had become more or less altered to a limonitic substance. Only half a gram of pure material, unaltered and non-magnetic, could be obtained. This was divided into three portions of about  $1/6$  gram each for the following analyses, the size of the grains being  $\langle 60 \rangle$  100 mesh:

Analyses of Hulsite.				
	1	2	3	Average.
FeO .....	33·27	----	----	33·27
MgO .....	----	10·17	----	10·17
Fe <sub>2</sub> O <sub>3</sub> .....	----	----	----	17·83
Total iron as Fe <sub>2</sub> O <sub>3</sub> ..	54·40	54·20	----	----
H <sub>2</sub> O .....	----	----	1·24	1·81 (calc.)
B <sub>2</sub> O <sub>3</sub> .....	----	----	----	27·42 (calc.)
Insol. ....	----	10·00	----	10·00
				100·00

	Ratio	Av. Anal.		
FeO .....	462	}	7·00	7
MgO .....	·254			
Fe <sub>2</sub> O <sub>3</sub> .....	·108		1·05	1
H <sub>2</sub> O .....	·101		·98	1
B <sub>2</sub> O <sub>3</sub> .....	·392		3·83	4

The formula for hulsite then becomes 7(Fe,Mg)O·Fe<sub>2</sub>O<sub>3</sub>·H<sub>2</sub>O·4B<sub>2</sub>O<sub>3</sub>.

The values given for B<sub>2</sub>O<sub>3</sub> and water are calculated from the figures obtained from the magnetite-hulsite mixture as given beyond. The direct water determination, 1·24 per cent, is of no exact value on account of the small quantity of water weighed, being in this case only 2·3<sup>mg</sup>, so that more reliance is placed on the figures obtained from the hulsite-magnetite mixture, from which the value 1·81 per cent is calculated. As above stated, the determinations on this sample were made on powder of <60> 100 mesh. Considerably more material of the magnetite-hulsite mixture was available for chemical analysis and the following results were obtained, about 1/4 gram substance being used for a determination:

Analyses of Magnetite-Hulsite.						
	1	2	3	4	5	Average.
FeO .....	34·48	34·35	----	----	----	34·44
MgO .....	8·60	8·83	8·36	8·12	----	8·48
Fe <sub>2</sub> O <sub>3</sub> .....	----	----	----	----	----	27·64
Total iron as Fe <sub>2</sub> O <sub>3</sub> ..	66·24	67·08	65·70	65·42	65·32	----
H <sub>2</sub> O .....	1·63	1·68	----	----	----	1·66
B <sub>2</sub> O <sub>3</sub> .....	25·27	----	----	----	----	25·27
Insol. ....	2·25	1·97	2·24	2·48	----	2·24
						99·73

The total iron determinations given were all made volumetrically, as the gravimetric determinations gave very varied

results, due to the retention of boric acid. It seems as if the presence of so much iron had a very great tendency to retain some of the boric acid, for the lowest gravimetric determinations of iron were several per cent higher than the volumetric ones, even though the solutions of iron chloride were repeatedly evaporated with methyl alcohol. The ferrous iron was determined by a modification of Pratt's method, which has been shown (Hillebrand) to give reliable values.\* The water was determined by heating the mineral (size  $<20> 60$  mesh) in a glass tube and weighing the water directly in a portion of that tube (Penfield's method). The boric acid was determined by fusing the mineral with sodium carbonate, leaching with water, refusing the residue, acidifying the solution with nitric acid, distilling with methyl alcohol, collecting in ammonia, and finally weighing boric acid as calcium borate.

The ratios obtained from the average analysis are shown below, the proportion of magnetite present being obtained as presently to be described.

\* Bull. 305, U. S. Geol. Survey, p. 138. Both of the two new borates here described dissolve readily in hydrofluoric acid, so that no difficulty was had in rapidly making the ferrous iron determinations. The powder was always coarser than 100 mesh and for the paigeite coarser than 60 mesh, so that very little, if any, oxidation of the ferrous iron resulted from the grinding. That such oxidation occurs, sometimes to a large extent, has recently been shown by Mauzelius (Sveriges Geol. Undersökning, Yearbook I, 1907, No. 3. See Chem. Abstracts, 1907, 2861, for an abstract of the article). For the paigeite samples the oxidation caused by grinding is considerable, the value for ferrous iron falling from 44.48 per cent (on  $<20> 60$  mesh) to 39 per cent on the finely ground material. The direct determination of total water was similarly made on coarse material, so that the amount of hygroscopic water in the sample was a minimum. What increase in the water (given off at  $110^\circ$ ) is caused by grinding these borates is not known, but the following results made on ludwigite from Hungary (a mineral of analogous composition) show that a very considerable amount of water is taken on by the mineral during grinding. Direct duplicate determinations of water at  $110^\circ$  on powder of  $<10> 20$  mesh gave:

(1) 0.09 per cent.                      (2) 0.12 per cent.

On same powder finely ground:

(1) 0.50 per cent.                      (2) 0.52 per cent.

Therefore a total water determination on a mineral such as these borates must, to be of any value, be made on coarse material such as was used for hulsite and paigeite. It is therefore believed that the water content given for these minerals is an essential part of their composition and is not to be taken as hygroscopic or accessory water. However, the question is still an undecided one as to just what rôle the water plays and it may be that future work will show that the water content of these two minerals is extraneous and does not actually belong to the minerals themselves. See a paper soon to be published by Dr. Hillebrand for a discussion of the effect of grinding on the water content, as well as on the oxidation of ferrous iron. To Dr. Hillebrand the writer is under obligation for calling his attention to these points, which served to explain the very varying results first obtained on paigeite for ferrous iron. Data showing the oxidation of ferrous iron for these borates as well as for other minerals will be given in a later paper.

Ratios	Hulsite	Magnetite	Hulsite	Magnetite					
FeO ----- 479	} = 392	87	} 4.56	} 7.02	1.01				
MgO ----- 212						212	2.46		
Fe <sub>2</sub> O <sub>3</sub> ----- 173						86	+ 87	1.00	+ 1.01
H <sub>2</sub> O ----- 092						92		1.07	
B <sub>2</sub> O <sub>3</sub> ----- 361						361		4.19	

The proportion of magnetite present is calculated as follows: The analysis of the magnetite-free hulsite shows that the ratio of Fe<sub>2</sub>O<sub>3</sub>:RO is 1:7. Therefore from the ratios of Fe<sub>2</sub>O<sub>3</sub> and RO in the average analysis of the magnetite-hulsite mixture there must be deducted such an amount (*x*) of both Fe<sub>2</sub>O<sub>3</sub> and RO (in the proportion 1:1 to form magnetite) that the resulting ratio shall be 1:7.  $\frac{\text{Fe}_2\text{O}_3}{\text{RO}} = \frac{173}{691}$  in the mixture of mag-

netite and hulsite. Then  $\frac{173-x}{691-x} = \frac{1}{7}$ ; solving, *x* = 87. Subtracting 87 from both 173 Fe<sub>2</sub>O<sub>3</sub> and 691 RO, the resulting ratio becomes 86:604 or 1:7. This mixture of minerals then becomes one part of hulsite (7RO.Fe<sub>2</sub>O<sub>3</sub>.H<sub>2</sub>O.4B<sub>2</sub>O<sub>3</sub>) with one of magnetite (FeO.Fe<sub>2</sub>O<sub>3</sub>). That all the magnesia belongs to the hulsite is shown by the analysis of the magnetite-free mineral, which gives as the ratio of FeO:MgO = 453:249, while that in the above analysis is 453:244, or practically the same. The composition of the sample analyzed is then found by calculation to be as follows, the formula for hulsite being taken as 9FeO.5MgO.2Fe<sub>2</sub>O<sub>3</sub>.2H<sub>2</sub>O.8B<sub>2</sub>O<sub>3</sub>.

(Insoluble)	Vesuvianite	2.24
	Hulsite	77.40
	Magnetite	20.36
		100.00

The density of this mixture is 4.438. Taking the density of vesuvianite as 3.40 and that of magnetite as 5.17, the density of hulsite is found by calculation to be 4.28.

The ferrous iron and magnesia are doubtless not present in any definite ratio, but vary reciprocally, so that hulsite may be considered as a mixture of a ferrous with a magnesian borate. The ratio of 9FeO:5MgO just given is therefore only an approximate one. Ferrous iron and magnesia are doubtless isomorphous in hulsite as well as in paigeite, and similarly in the related borate ludwigite.\* Any discussion as to the structural formula of hulsite would be very premature, as our knowledge of such minerals is very scanty. The formula

\* An analysis of ludwigite from Montana shows this particularly well, this mineral containing very little ferrous iron while that from Hungary contains about 15 per cent.

$7\text{RO}\cdot\text{Fe}_2\text{O}_3\cdot\text{H}_2\text{O}\cdot 4\text{B}_2\text{O}_3$  does not lead to any simple constitutional formula.

*Paigeite.*

The specimens of paigeite from Brooks Mt. show a coal-black lustrous mineral of a laminated appearance. No distinct crystals were seen, but the entire mass has a crystalline appearance and in thin sections is seen to be composed of innumerable hair-like needles, often forming radiating groups. The characteristic appearance of paigeite is shown in the photomicrograph (fig. 2). The mineral apparently possesses an imperfect

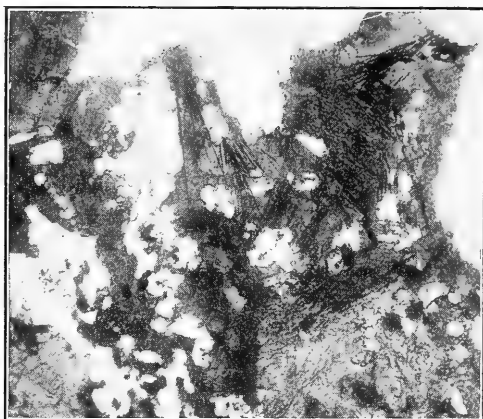

Fig. 2. Paigeite fibers embedded in tourmaline. Colorless mineral is fluorite. Magnified 60 diameters.

cleavage, is soft, hardness about 3, with a density of 4.71. The color is coal-black, streak the same, and the luster very shining. It is readily soluble in HCl and HF and in its pyrognostic properties resembles hulsite.

Analyses of paigeite from Brooks Mt. gave the following results:

Analyses of Paigeite.					
	1	2	3	4	Av. Anal.
FeO .....	43.91	44.30	45.82	43.87	44.48
MgO .....	1.70	1.22	1.39	----	1.44
Fe <sub>2</sub> O <sub>3</sub> .....	----	----	----	----	16.72
Total iron as Fe <sub>2</sub> O <sub>3</sub>	66.26	65.95	66.22	----	
H <sub>2</sub> O .....	2.03	----	----	----	2.03
B <sub>2</sub> O <sub>3</sub> .....	20.89	----	----	----	20.89
Insol .....	14.25	14.46	14.35	----	14.35
					99.91

		Ratios
FeO .....	·618	} 6·00
MgO .....	·036	
Fe <sub>2</sub> O <sub>3</sub> .....	·105	·97
H <sub>2</sub> O .....	·113	1·04
B <sub>2</sub> O <sub>3</sub> .....	·298	2·74

These ratios lead to the formula  $6(\text{Fe}, \text{Mg})\text{O} \cdot \text{Fe}_2\text{O}_3 \cdot \text{H}_2\text{O} \cdot 3\text{B}_2\text{O}_3$ .

The methods of procedure were similar to those described for hulsite. The reason for the single high value for ferrous iron (45·82 per cent) is not known, but as the other three values agree well, the average of all four is taken rather than to give preference to the single higher value, which may be due to error in the manipulation. (See footnote on page 328 for reference to the ferrous iron and water determinations.) The value here given for FeO includes that of the vesuvianite present, but it is probably so small that it may be neglected. While this mineral has not yet been analyzed, the ferrous iron in the 14 per cent vesuvianite present is doubtless less than .3 per cent. The effect of the arsenopyrite was probably *nil*, as the mineral particles were so large that the arsenopyrite remained undissolved in the hydrofluoric acid solution. Of the insoluble material about 1·20 per cent was arsenopyrite, the remainder being vesuvianite. The boric acid determination is probably too low.

The density of the sample analyzed was determined as 4·544. By calculation the density of pure paigeite is found to be 4·71, the sample analyzed consisting of the minerals in the proportion shown below:

Vesuvianite,	density	3·40 =	13·75
Arsenopyrite	“	6·0 =	1·20
Paigeite	“	4·71 =	85·05
			100·00

While these two minerals are very similar in composition, there is sufficient difference between them to preclude their being referred to the same species. The mode of occurrence, the hulsite in stout crystals, the paigeite in long hair-like needles, and the general appearance of these two minerals render it very easy to distinguish them on sight. The only borates known of analogous composition to these new minerals are ludwigite, pinakiolite and warwickite, of which only the first is similar in composition, this being  $4(\text{Fe}, \text{Mg})\text{O} \cdot \text{Fe}_2\text{O}_3 \cdot \text{B}_2\text{O}_3$ .

ART. XXXVII.—*The Determination of Vanadic and Molybdic Acids in the Presence of One Another*; by GRAHAM EDGAR.

[Contributions from the Kent Chemical Laboratory of Yale Univ.—clxxii.]

A METHOD has been recently proposed by Glasmann\* for the estimation of vanadic and molybdic acids in the presence of one another, based on the different reducing action of zinc and magnesium upon the hydrochloric acid solution of these acids. In a previous paper from this laboratory† it has been shown that the action of magnesium is irregular and not adapted to an accurate quantitative method. Vanadic acid, however, is reduced to the state of dioxide by a column of amalgamated zinc and may be estimated by titration with potassium permanganate, if the receiver be charged with a solution of ferric alum to anticipate the oxidizing action of the air.‡ That molybdic acid is under the same conditions reduced to the state of  $\text{Mo}_2\text{O}_3$  has been shown by Dudley§ and, independently by Randall.¶ The ease with which vanadic acid is reduced to the state of tetroxide by sulphur dioxide and the difficulty, as has been found, with which this reagent attacks molybdic acid under proper conditions of acidity and concentration, suggest its use in one of two processes of differential action for the determination of these acids. To determine the conditions under which molybdic acid is unaffected by sulphur dioxide, a series of experiments was made in which solutions of molybdic acid of varying concentrations, acidified with varying amounts of sulphuric acid, were heated to boiling and treated with a current of sulphur dioxide for varying lengths of time. The excess of sulphur dioxide was then removed by boiling the solution, a current of carbon dioxide being meanwhile passed into it, and the degree of reduction was determined by titration with nearly N/10 potassium permanganate. The solution of molybdic acid was standardized by the method of Randall¶ and by evaporating a portion to dryness and igniting at low red heat. The results of the experiments are given in Table I.

The results show that if the concentration be not greater than 0.2 grm. of  $\text{MoO}_3$  in  $50\text{cm}^3$  of solution, and the acidity not less than  $1\text{cm}^3$  of sulphuric acid (sp. gr. 1.84) in the same volume, the molybdic acid is not reduced, and that if the acidity be increased to  $5\text{cm}^3$  of sulphuric acid, reduction does not occur at even a concentration of 0.4 grm. in  $25\text{cm}^3$ .

\* Ber. Dtsch. chem. Gesellsch., xxxviii, 600.

† Gooch and Edgar, this Journal, xxv, 233.

‡ Gooch and Edgar, loc. cit.

§ Unpublished, but privately communicated by Professor Henry Fay.

¶ This Journal, xxiv, Oct. 1907.

¶¶ Loc. cit.



TABLE I.

Volume of solution cm <sup>3</sup> .	MoO <sub>3</sub> grm.	H <sub>2</sub> SO <sub>4</sub> sp. gr. 1.84 cm <sup>3</sup> .	Time of treatment with SO <sub>2</sub>	KMnO <sub>4</sub> N 10 × 1.004 cm <sup>3</sup> .	Color of solution
25.0	0.200	faintly acid	10 min.	0.15	light blue
35.0	0.200	0.5 <sup>cm<sup>3</sup></sup>	10 "	0.05	faint blue
50.0	0.200	1.0 <sup>cm<sup>3</sup></sup>	10 "	0.0	colorless
75.0	0.200	2.0 <sup>cm<sup>3</sup></sup>	10 "	0.0	"
50.0	0.200	2.0 <sup>cm<sup>3</sup></sup>	30 "	0.0	"
25.0	0.200	5.0 <sup>cm<sup>3</sup></sup>	10 "	0.0	"
25.0	0.400	5.0 <sup>cm<sup>3</sup></sup>	10 "	0.0	"
50.0	0.400	5.0 <sup>cm<sup>3</sup></sup>	10 "	0.0	"
50.0	0.400	10.0 <sup>cm<sup>3</sup></sup>	10 "	0.0	"
50.0	0.400	15.0 <sup>cm<sup>3</sup></sup>	10 "	0.0	"

A series of experiments was than made in which solutions containing vanadic and molybdic acids were diluted to 75<sup>cm<sup>3</sup></sup>, acidified with 2 to 3<sup>cm<sup>3</sup></sup> of strong sulphuric acid, heated to boiling and subjected to a current of sulphur dioxide for a few minutes until the clear blue color indicated the complete reduction of the vanadic acid to the state of tetroxide. The boiling was continued for some time, a current of carbon dioxide being passed into the liquid until the last traces of sulphur dioxide had been removed. Titration was then effected by nearly N/10 potassium permanganate and the vanadic acid was calculated from the equation,



The solution, preceded by 100<sup>cm<sup>3</sup></sup> hot water, and 125<sup>cm<sup>3</sup></sup> of dilute (2½ per cent) sulphuric acid, and followed by 100<sup>cm<sup>3</sup></sup> dilute sulphuric acid and 200<sup>cm<sup>3</sup></sup> of hot water, was passed slowly through a column of amalgamated zinc in a Jones reductor,\* the receiver containing a solution of ferric alum. The hot solution was then titrated with nearly N/10 potassium permanganate, a little phosphoric acid being added to decolorize the ferric salt.

Since the reduction of vanadic acid is in this case to the condition of dioxide, V<sub>2</sub>O<sub>2</sub>, if the number of centimeters of permanganate used in the titration of the tetroxide be multiplied by three and the product subtracted from the total number of centimeters of permanganate used in the final titration, the result is the number of centimeters used in oxidizing Mo<sub>2</sub>O<sub>3</sub> to MoO<sub>3</sub>, from which the amount of molybdic acid present may be easily calculated. The results, given in Table II, show that molybdic acid and vanadic acid may be accurately estimated in the presence of one another by two processes of reduction and oxidation, the reduction being made first by sulphur dioxide and last by amalgamated zinc.

\* The Chemical Analysis of Iron, Blair, page 225.

TABLE II.

Ferric alum 10% cm <sup>3</sup> .	Phosphoric acid syrup cm <sup>3</sup> .	KMnO <sub>4</sub> $\frac{N}{10} \times 1.052$ cm <sup>3</sup> .	KMnO <sub>4</sub> $\frac{N}{10} \times 1.052$ cm <sup>3</sup> .	V <sub>2</sub> O <sub>5</sub> taken as NaVO <sub>3</sub> gm.	MoO <sub>3</sub> taken as (NH <sub>4</sub> ) <sub>2</sub> MoO <sub>4</sub> gm.	V <sub>2</sub> O <sub>5</sub> found grm.	MoO <sub>3</sub> found grm.	Error on V <sub>2</sub> O <sub>5</sub> grm.	Error on MoO <sub>3</sub> grm.
50	8	11.95	74.15	0.1144	0.1930	0.1146	0.1934	+ .0002	+ .0004
50	8	11.95	74.00	0.1144	0.1930	0.1146	0.1926	+ .0002	- .0004
50	8	11.94	74.20	0.1144	0.1930	0.1145	0.1936	+ .0001	+ .0006
25	4	5.97	37.10	0.0572	0.0965	0.0572	0.0965	.0000	.0000
25	4	5.97	37.05	0.0572	0.0965	0.0572	0.0962	+ .0000	- .0003
25	4	5.98	37.12	0.0572	0.0965	0.0573	0.0963	+ .0001	- .0002
35	6	11.95	55.0	0.1144	0.0965	0.1146	0.0967	+ .0002	+ .0002
35	6	11.95	55.0	0.1144	0.0965	0.1146	0.0967	+ .0002	+ .0002
35	6	11.96	54.86	0.1144	0.0965	0.1147	0.0958	+ .0003	- .0007
65	10	17.92	92.0	0.1716	0.1930	0.1719	0.1931	+ .0003	+ .0001
65	10	17.94	92.05	0.1716	0.1930	0.1720	0.1931	+ .0004	+ .0001
65	10	17.92	92.02	0.1716	0.1930	0.1719	0.1932	+ .0003	+ .0002

In conclusion the author desires to thank Prof. F. A. Gooch for many kind and helpful suggestions and criticisms during the progress of the work.

ART. XXXVIII.—*On the Constituents of Atmospheric Radio-activity*; by H. M. DADOURIAN.

[Contributions from the Physical Laboratory of  
The Sheffield Scientific School of Yale University.]

1. THE study of the atmospheric radio-activity may be said to have had its origin in an interesting discovery made by Elster and Geitel\* in the spring of 1901. They found that if a negatively charged conductor be exposed to the open air for a short time, it temporarily exhibits the properties of radio-active bodies. They showed further in a series of investigations† that this activity is due to a substance in the solid state, which is attracted towards and deposited upon the charged body under the action of the electric field. The active deposit was isolated by dissolving it in acid solutions and evaporating the solution to dryness; the residue was found to possess the general properties of the rapidly disintegrating radio-active products.

A number of investigators,‡ working under different experimental conditions and in widely separated localities, conducted experiments similar to those of Elster and Geitel, and obtained similar results. Rutherford and Allan,§ who made a study of the rate of decay of the active-deposit, found that its activity fell off exponentially to half value in about 45 minutes. This is not close enough to the half-value periods of radium and thorium emanations to justify one to ascribe the atmospheric radio-activity to the presence in the atmosphere of either of these emanations alone. Therefore they arrived at the following conclusion: "From the differences observed for the penetrating power and the rate of decay we can conclude that the excited radiation from air cannot be ascribed to the presence of any known radio-active substance in the atmosphere."§

Later it was shown by Elster and Geitel|| that the decay curves of active-deposits obtained from the air and from radium emanations agreed fairly well. But the observations on the decay were not carried beyond two hours after the removal of the potential difference from the negatively charged body. Thus the agreement was confined to within a rather small region of the activity and time-diagram. Furthermore the agreement was not as close as would be expected from the precision of the experimental data, if the active-deposits obtained from the air were due to radium emanation. Soon after the appearance of

\* Elster and Geitel, *Phys. Zeitschr.*, ii, 590, 1901.

† Elster and Geitel, *ibid.*, iii, 305, 1902, iv, 522.

‡ Rutherford and Allan, *Phil. Mag.*, iv, 352, 1902; Gockel, *Phys. Zeitschr.*, v, 591, 1904; J. J. Thomson, *Phil. Mag.*, iv, 352, 1902; Himstedt, *Phys. Zeitschr.*, iv, 482, 1903.

§ *Loc. cit.*, 712.

|| Elster and Geitel, *Phys. Zeitschr.*, v, 11, 1904.

the above paper by Elster and Geitel, Allan\* published a paper in which he came to this conclusion: "The difference of the rates of decay of excited activity obtained under different conditions seems to point to the fact that the radio-activity of the atmosphere is of a very complex nature."

Bumstead† was the first to show the true nature of the atmospheric activity and to account for the agreements as well as disagreements among the rates of decay of the active-deposits obtained from the air, from radium emanation and from thorium emanation. Like other investigators of atmospheric activity he exposed to the air a negatively charged wire and observed the rate of decay of its activity, after the electric field was removed from the wire. But instead of confining his observations to the first few hours of the process of disintegration, he continued them beyond the time necessary for the complete disintegration of the rapidly changing radium products. Then he observed that there remained a slowly decaying activity, which proved to have a half-value period equal to that of the active-deposit of thorium emanation. For exposures of three hours duration the activity of the slowly decaying product was found to be from three to five one-hundredths of the total initial activity, while for an exposure of twelve hours it was 15 one-hundredths. When the activity of this product was subtracted from the total activity at any instant, the rate of decay of the residual activity was found to agree very closely with that of an active-deposit obtained from radium emanation. He therefore concluded that atmospheric activity was due to the presence of radium and thorium emanations in the air.

The presence in the ground air of radium emanation was demonstrated by several observers‡ long before the discovery of the exact nature of the atmospheric radio-activity. These investigators found that there was a close agreement between the decay curves of radium emanation and of the "radio-active gas" obtained from the ground. Later it was shown by the writer§ that the radio-activity of the ground air was due to the presence of not only radium emanation but also thorium emanation. It was found that the close agreement between the rates of decay of the radio-active gas and of radium emanation was due not to the absence of thorium emanation in the ground, but to its decay during the short time taken in transferring the radio-active gas from the ground into the

\* Allan, *Phil. Mag.*, vii, 140, 1904.

† Bumstead, *this Journal*, xviii, 1, 1904.

‡ Elster and Geitel, *Phys. Zeitschr.*, iii, 574, 1902, and v, 11, 1904; Ebert and Ewers, *Phys. Zeitschr.*, iv, 162, 1902; Gockel, *Phys. Zeitschr.*, iv, 604, 1903; Bumstead and Wheeler, *this Journal*, xvii, p. 97, 1904.

§ Dadourian, *this Journal*, xix, 16, 1905.

testing vessel. On account of the rapid decay of thorium emanation it is very difficult to detect its presence in the ground air by direct observation on the rate of decay of the activity of the radio-active gas. This difficulty was avoided by measuring the rate of decay of the active-deposit obtained from underground air.

A cavity 50<sup>cm</sup> in diameter and 200<sup>cm</sup> deep was dug in the earth near the Physical Laboratory. A negatively charged wire wound around a cylindrical frame was suspended in the cavity. The top of the cavity was sealed and the air was removed by means of a filter pump in order to keep the wire in contact with fresh ground air. After exposures of three hours duration the wire was taken out and the rate of decay of its activity observed. About 5 per cent of the total initial activity was found to be due to the disintegration products of thorium emanation, the balance being due to those of radium emanation.

It should be observed that unless account is taken of the time of exposures Bumstead's results do not give a measure of the relative amounts of radium and thorium emanations present in the open air in New Haven, nor do the results obtained by the writer measure the relative amounts of these emanations present in the underground air. The activity of a body which is negatively charged in the open or underground air is due to at least six disintegration products of radium and thorium, e. g., Ra A, Ra B, Ra C, Th A, Th B, and Th C. Each of these accumulates and decays at a perfectly definite rate, which is characteristic of that particular substance. So that the amounts of these disintegration products present on the negatively charged body at any instant of the time of exposure are not, in general, proportional to the amounts of the corresponding products present in a unit volume of the air.

Suppose  $P$  to represent the number of particles of any one of these radio-active products present on the charged wire at any instant of the time of exposure. Then the observed rate of decay is represented by the exponential law

$$P = P'e^{-\lambda t}$$

where  $P'$  is the number of particles at the time  $t=0$ , and  $\lambda$  is the constant of disintegration. Now if  $p$  represents the number of particles which are transformed per sec., then

$$\begin{aligned} p &= \int_t^{t+1} dP \\ &= -\lambda P \end{aligned}$$

In other words, the number of particles which are transformed is proportional to the number of particles present. Therefore

$$\lambda P dt$$

particles are transformed in the differential time  $dt$ . If the air be in radio-active equilibrium the number of particles which are deposited on the wire per second will be constant. Denoting this number by  $q$ , we obtain

$$dP = -\lambda P dt + q dt$$

for the net change in the number of particles during the time  $dt$ .

Integrating and remembering the fact that  $P=0$  for  $t=0$ , we get

$$P = \frac{q}{\lambda} \left( 1 - e^{-\lambda t} \right)$$

The right-hand member approaches the value  $\frac{q}{\lambda}$  asymptotically as the time increases indefinitely. Denoting this final value by  $P_0$ ,

$$P = P_0 \left( 1 - e^{-\lambda t} \right)$$

If the disintegration product under consideration is not a rayless one, the ionization it produces is proportional to the number of its particles, hence

$$I = I_0 \left( 1 - e^{-\lambda t} \right)$$

where  $I$ =value of ionization at any instant of the exposure, and  $I_0$ =the value it would have attained if the exposure were continued for an indefinite length of time. Theoretically an infinitely long exposure is necessary for any of the disintegration products on the wire to reach equilibrium value. But only a comparatively short exposure is necessary for the ionization due to any of the products to approach within one one-hundredth of the equilibrium value. The last column of the following table gives the time of exposure necessary for the ionizations produced by the six disintegration products of radium and thorium to attain 0.99 of their equilibrium values. It takes over three days for thorium A to reach within one one-hundredth of its equilibrium amount. Therefore it is necessary to continue the exposure for at least three days in order to make the amounts of the six disintegration products present on the wire proportional to the amounts of the corresponding products present in a unit volume of the air.

	Range of <i>a</i> -particle	Half-value period	$\lambda$	Exposures necessary to make $I=99I_0$
Radium Em	4.33 <sup>cm</sup>	3.8 days	$2.11 \times 10^{-6} \text{ sec}^{-1}$	25.3 days
“ A	4.83	3 min.	$3.85 \times 10^{-3} \text{ “}$	0.33 hrs.
“ B	(no <i>a</i> -rays)	26 “	$4.44 \times 10^{-4} \text{ “}$	2.9 “
“ C	7.06 <sup>cm</sup>	19 “	$6.08 \times 10^{-4} \text{ “}$	2.1 “
Thorium Em	5.55	54 sec.	$1.28 \times 10^{-2} \text{ “}$	6.1 “
“ A	(rayless)	11 hrs.	$1.75 \times 10^{-5} \text{ “}$	73.1 “
“ B	5.0	1 hr.	$1.93 \times 10^{-4} \text{ “}$	6.6 “
“ C	8.6	few sec.*	—	—

2. *Open air*.—A copper wire  $\frac{1}{4}$ mm in diameter and about 100 meters in length was strung between two buildings of the Scientific School, at a height of about seven meters from the ground. The wire was insulated and connected to the negative electrode of a Wimshurst machine, the positive pole of which was earthed. A spark gap of 2mm was maintained between the electrodes of the machine. After exposures of four days the potential difference was removed from the wire and the latter was placed in a testing vessel. The ionization was measured by means of a Dolezalek electrometer connected to the testing vessel. The initial total activity was over one hundred times as large as that produced by the spontaneous ionization in the apparatus.

From 20 to 30 one-hundredths of the initial total ionization was found to be due to the thorium products and the balance due to radium products. In other words, the initial ionization produced by the thorium products was from 25 to 40 one-hundredths of that due to radium products. This is much less than that observed by Blanc† in Rome. He found that of the initial total activity of a wire, which was exposed to the open air in Rome for three days, from 50 to 70 per cent was due to the thorium products. Both his observations and those of the writer are based on arbitrary units of ionization, therefore no conclusion can be drawn as to the relative amounts of radium and thorium emanations present in a unit volume of the atmosphere at Rome and at New Haven. But it is certain that the ratio of thorium emanation to radium emanation is greater in the Roman than in the New Haven atmosphere.

3. We can make use of the above results to find the ratio of the amount of the thorium emanation to the radium emanation present in a unit volume of the air at New Haven. But in order to do this it is necessary to find a relation between the amount of emanation per unit volume and the activity of a wire exposed to the emanation.

\* Hahn, Phil. Mag., xi, 793, 1906.

† Blanc, Phil. Mag., xiii, 378, 1907.

Suppose

$N$	=	number of atoms of radium emanation in 1 <sup>cc</sup> of air		
$N_1$	=	"	"	A
$N_2$	=	"	"	B
$N_3$	=	"	"	C
$N_1'$	=	"	thorium emanation	
$N_2'$	=	"	"	A
$N_3'$	=	"	"	B
$N_4'$	=	"	"	C

$n$  and  $n'$  = number of atoms of radium and thorium emanation which are transformed per second in 1<sup>cc</sup> of the air.

$\lambda, \lambda_1, \lambda_2, \lambda_3, \lambda', \lambda'_1, \lambda'_2,$  and  $\lambda'_3,$  = the disintegration constants of radium emanation, Ra A, Ra B, Ra C; thorium emanation, Th A, Th B, and Th C respectively.

We will assume that each particle of any one of a group of disintegration products gives rise to a particle of the next product of the group. Then if this group is in radio-active equilibrium the number of the particles which are transformed per second is the same for all the members of the group. Since the air is supposed to be in radio-active equilibrium,

$$n = \lambda N = \lambda_1 N_1 = \lambda_2 N_2 = \lambda_3 N_3 \quad (1)$$

holds for the radium group, and

$$n' = \lambda' N' = \lambda'_1 N'_1 = \lambda'_2 N'_2 = \lambda'_3 N'_3 \quad (2)$$

for the thorium group.

The number of atoms of any of the disintegration products present on the negatively charged wire is proportional to the number of particles of the same product present in 1<sup>cc</sup> of the air, provided the wire has reached the state of radio-active equilibrium with the surrounding air. Therefore if we denote the number of particles on the wire of any one of the six products by  $M$ , with the proper subscript and prime according to the above notation, we can write

$$\frac{M_1}{N_1} = \frac{M_2}{N_2} = \frac{M_3}{N_3} \quad (3)$$

$$\frac{M'_1}{N'_1} = \frac{M'_2}{N'_2} = \frac{M'_3}{N'_3} \quad (4)$$

or  $N_1 = K M_1, N_2 = K M_2, N_3 = K M_3$   
 $N'_1 = K' M'_1, N'_2 = K' M'_2, N'_3 = K' M'_3$

Therefore substituting in equations (1) and (2)

$$n = \lambda N = K \lambda_1 M_1 = K \lambda_2 M_2 = K \lambda_3 M_3 \quad (5)$$

$$n' = \lambda' N' = K' \lambda'_1 M'_1 = K' \lambda'_2 M'_2 = K' \lambda'_3 M'_3 \quad (6)$$



So far as the writer is aware no evidence has been put forward to show that the positively charged particles of the active-deposit of radium are attracted toward the negatively charged wire with either greater or less force than those experienced by the particles of the active-deposit of thorium. Hence we will assume the force experienced in an electric field by the particles of both groups to be the same. This amounts to setting  $K = K'$

$$n = \lambda N = K \lambda_1 M_1 = K \lambda_2 M_2 = K \lambda_3 M_3 \quad (7)$$

$$n' = \lambda' N' = K \lambda'_1 M'_1 = K \lambda'_2 M'_2 = K \lambda'_3 M'_3 \quad (8)$$

Now let us consider the activity of the wire shortly after the removal of the potential difference from it. The amount of Ra A becomes negligible after the first few minutes of the process of disintegration. Therefore its direct contribution to the activity of the wire may be neglected. Since Ra B is rayless, we may assume the component of the activity which is due to the radium group to be proportional to the number of Ra C particles present. Supposing the ionizing power of an  $\alpha$ -particle to be proportional to its range, we can write

$$I = k R_3 M_3 \quad (9)$$

where  $R_3$  is the range and  $M_3$  the number of the  $\alpha$ -particles of Ra C.  $k$  is the number of ions produced by an  $\alpha$ -particle while moving through a distance of  $1\text{cm}$ .

The component of the ionization produced by the thorium group is due to Th B and Th C; Th A does not emit  $\alpha$ -particles, therefore its effect may be neglected. On account of the absence of any evidence to the contrary, we will assume that the  $\alpha$ -particles of the thorium group produce the same number of ions as those of the radium group in traversing a distance of one centimeter. Then we may write for the component of the ionization of the wire which is due to the thorium group,

$$I' = k(R'_2 M'_2 + R'_3 M'_3) \quad (10)$$

where  $k$  is the same constant as that in the last equation.  $R'_2$  and  $R'_3$  are the ranges and  $M'_2$  and  $M'_3$  the numbers of the  $\alpha$ -particles of Th B and Th C respectively. Dividing equation (10) by equation (9)

$$\frac{I'}{I} = \frac{R'_2 M'_2 + R'_3 M'_3}{R_3 M_3} \quad (11)$$

substituting for  $M_2, M'_2$  and  $M'_3$  expressions obtained from equation (7) and (8) and simplifying

$$\frac{I'}{I} = \frac{N' \lambda' \lambda_3 (\lambda'_3 R'_2 + \lambda'_2 R'_3)}{N \lambda \lambda'_2 \lambda'_3 R_3} \quad (12)$$

$$\therefore \frac{N'}{N} = \frac{I'}{I} \frac{\lambda \lambda'_2 \lambda'_3 R_3}{\lambda' \lambda_3 (\lambda'_3 R'_2 + \lambda'_2 R'_3)} \quad (13)$$

The rate of decay of Th C has not yet been measured accurately, so far as the writer is aware. But it is stated that its half-value period is only a few seconds.\* If that is the case  $\lambda'_3$  is large compared with  $\lambda'_2$ , therefore we can simplify the right-hand number of equation (13)

$$\frac{N'}{N} = \frac{I'}{I} \frac{\lambda \lambda'_2 R_3}{\lambda \lambda'_3 R'_2} \quad (14)$$

Substituting the values of the constants from the table on p. 339 we obtain

$$\frac{N'}{N} = 7.37 \times 10^{-6} \frac{I'}{I} \quad (15)$$

Taking 0.25 and 0.40 as the limiting values of  $\frac{I'}{I}$  for the air at New Haven, we find the amount of radium emanation to be, in round numbers, from 30,000 to 50,000 times as great as the amount of thorium emanation. Substituting the limiting values of  $\frac{I'}{I}$  obtained from data given by Blanc,† the equation (15) gives from 20,000 to 30,000 for the ratio of the amount of radium emanation to that of thorium emanation present in the atmosphere at Rome.

New Haven, Conn., February, 1908.

\* Hahn, loc. cit.

† Loc. cit.

ART. XXXIX.—*The Estimation of Iron by Potassium Permanganate after Reduction with Titanous Sulphate*; by H. D. NEWTON.

[Contributions from the Kent Chemical Laboratory of Yale Univ.—clxxiii.]

KNECHT\* was the first to point out and recommend the use of titanium sesquioxide and its salts in volumetric operations where a rapid and powerful reducing agent is required. Somewhat later the same author in collaboration with E. Hibbert† published a method for the direct titration of ferric chloride by a standard solution of titanous chloride, using potassium sulphocyanate as an indicator, the reaction between the two salts taking place according to the following equation :



According to these authors, the above method yields excellent results, and rapidly. The only precautions necessary are that the solution of titanous chloride, being naturally very sensitive to the action of atmospheric oxygen, must, after being boiled in presence of marble to expel occluded oxygen, be kept under a constant pressure of hydrogen. It has been found, however, that even with such precautions the standard of the solution gradually changes, and must be checked from time to time against known amounts of ferric iron.

The present investigation was undertaken for the purpose of adapting the well known and accurate method of titration with standard potassium permanganate to the determination of ferrous salts, after reduction has been effected by a titanous salt according to the excellent and rapid method of Knecht.

It has been shown in a former paper‡ that bismuth oxide completely oxidizes titanous sulphate while having no appreciative effect on salts of ferrous iron. So the plan of this work has been to reduce the iron by titanous sulphate, oxidize the excess of titanous sulphate by bismuth oxide, and titrate the remaining ferrous salt by permanganate.

A solution of titanous sulphate of convenient strength was made up by mixing twenty grams of commercial titanous acid, in two portions, with three times its own weight of a mixture of sodium and potassium carbonates and fusing in a platinum crucible until all the titanous acid was converted into the soluble alkali titanates. The melt obtained in this manner, after being finely ground, placed in a platinum dish and treated with hot concentrated sulphuric acid (which soon effected solution) was

\* Ber. Dtsch. Gesellsch., xxxvi, 166-169.

† Ibid., xi, 3819.

‡ This Journal, vol. xxiii, p. 365.

cooled, diluted a little, and filtered. To these concentrated solutions of titanium sulphate, zinc was added until reduction was complete, and while there was some zinc left in the flask the solution was quickly filtered through a platinum cone into about two liters of freshly distilled water contained in a small reservoir, the latter being set up and connected with burette and hydrogen generator as described by Knecht and Hibbert.\*

A test solution of ferric sulphate was prepared by treating ferrous ammonium sulphate with oxalic acid, drying and igniting the resulting ferrous oxalate, dissolving the ferric oxide thus formed with concentrated hydrochloric acid, and converting the ferric chloride to sulphate by digesting with concentrated sulphuric acid. After diluting and filtering, the solution was made up to known volume and standardized by drawing from a burette into 50<sup>cm</sup><sup>3</sup> flasks several portions, reducing each by a definite amount of zinc of known iron content, cooling, pouring into a liter of cold distilled water and immediately titrating with tenth normal potassium permanganate.

In the following table are recorded results obtained by effecting the reduction of carefully measured amounts of the ferric sulphate solution by addition of an excess of titanous sulphate in the cold, destroying this excess by treating with a little bismuth oxide, filtering from the excess of bismuth oxide and reduced bismuth into about a liter of cool distilled water and titrating with permanganate.

$\text{Fe}_2(\text{SO}_4)_3$ cm <sup>3</sup>	$\text{KMnO}_4$ cm <sup>3</sup>	Taken $\text{Fe}_2\text{O}_3$ gram.	Found $\text{Fe}_2\text{O}_3$ gram.	Error gram.
20	13.46	0.1063	0.1064	+0.0001
20	13.42	0.1063	0.1060	-0.0003
20	13.44	0.1063	0.1062	-0.0001
20	13.44	0.1063	0.1062	-0.0001
20	13.41	0.1063	0.1060	-0.0003
30	20.18	0.1594	0.1594	0.0000
30	20.20	0.1594	0.1596	+0.0002
30	20.20	0.1594	0.1596	+0.0002
30	20.22	0.1594	0.1598	+0.0004
30	20.19	9.1594	0.1595	+0.0001
40	26.92	0.2127	0.2127	0.0000
40	26.90	0.2127	9.2125	-0.0002
40	26.90	0.2127	0.2125	-0.0002
40	26.93	0.2127	0.2128	+0.0001
40	26.90	0.2127	0.2125	-0.0002

In later experiments it was found that the bismuth oxide failed to oxidize the sesquioxide of titanium when there was

\* Loc. cit.

an appreciable amount of hydrochloric acid present in solution. Therefore it is advisable if the original solution is made with hydrochloric acid, to evaporate to dryness and convert the chloride to sulphate by use of concentrated sulphuric acid. Upon addition of the sulphuric acid a white pasty mass of basic ferric sulphate is formed which rapidly goes into solution on diluting with water and warming. As titanous sulphate prepared in the above manner always contains some iron, it is necessary to make a correction for this, by treating with bismuth oxide an amount of the solution equal to that used, filtering and running in potassium permanganate to color. This correction should not amount to more than  $0.1\text{ cm}^3$  when working with  $0.3$  grm. of ferric oxide.

If these simple precautions be taken, ferric iron may be determined with rapidity and exactness by reduction with titanous sulphate, and subsequent titration with potassium permanganate.

## SCIENTIFIC INTELLIGENCE.

## I. CHEMISTRY AND PHYSICS.

1. *Lithium in Radio-active Minerals.*—Experiments by Ramsay having led him to the conclusion that copper in solution is converted into lithium by the action of radium, it is of interest to know whether or not lithium is present in uranium minerals which contain copper. McCoy has found that samples of pitchblende from Colorado and Bohemia contain copper and give distinct tests for lithium, while a sample of gummite from North Carolina showed the presence of lithium without showing any copper. McCoy states that the latter case is no argument against Ramsay's theory, because copper originally present may have all disappeared. Indeed, it would appear to the reviewer that a transformation rapid enough to be detected by laboratory tests would be very likely to be completed in any of these minerals. —*Nature*, lxxvii, 79.

MLLE. GLEDITSCH has now made some quantitative determinations of copper and lithium in several minerals, I. pitchblende from Joachimsthal, II. pitchblende from Colorado, III. carnotite, IV. chalcocite from Cornwall, V. autunite, VI. thorite, with the following results :

	Cu, per cent.	Li, per cent.	Activity compared with uranium
I	1.2	0.00017	1.5
II	0.15	0.00034	1.75
III	0.15	0.030	0.52
IV	6.54	0.00011	2.0
V	0.	0.00083	1.48
VI	trace	0.0033	0.59

The author is doubtful in some cases whether the lithium, which was determined spectroscopically, came from the gangue or from the mineral. It is her opinion that the results do not show that Ramsay's theory is wrong, although they may not be in its favor.—*Comptes Rendus*, cxlvi, 331. H. L. W.

2. *Radium in the Earth.*—There has been much interest and discussion in regard to radium as the source of the earth's internal heat. For instance, Rutherford calculated from certain data that the temperature gradient at the surface would be about accounted for by the presence of radium. STRUTT has more recently reached some novel and interesting conclusions in regard to this matter. From an examination of a large number of rocks he finds that there is very much more radium in all of them than would be needed to maintain the earth's internal heat if the earth were constituted of rock throughout. From this he concludes

that the interior of the earth does not contain radium, and that in all probability its composition is quite different in other respects also from that of the surface materials. His data from the quantity of radium in the rocks point to a thickness of at most forty-five miles for the earth's rocky crust. Calculation on these premises, assuming that the conductivity of rock is not much affected by change of temperature, indicates that the bottom of the crust, forty-five miles down, would have a temperature of 1500°C. The inside nucleus, heated by this crust of radium-containing material, must be at this uniform temperature throughout.—*Chem. News*, xciv, 125. H. L. W.

3. *Ionium*.—MARCKWALD and KEETMAN state that they have observed that several uranium minerals contain a constituent which is obviously identical with Boltwood's ionium. It follows thorium in the usual chemical processes, and they have been unable to separate it from that element. They explain why a substance of such high emanation power has hitherto escaped discovery by stating that only residues of the Joachimsthal uranium manufacture have been treated on the large scale for the separation of radio-active substances. It appears that these residues are comparatively poor in ionium, as most of this substance probably goes into solution with the uranium during the process. The authors report the surprising circumstance that the mineral autunite, which is a calcium-uranium phosphate occurring in beautiful crystals, was found to be free from lead when 10 g. of it were investigated. This result, which will be further examined, is of importance because lead is supposed to be the end product of the radio-active transformation of uranium.—*Berichte*, xli, 49. H. L. W.

4. *Natural Occurrence of Sodium Fluoride*.—LACROIX has found crystallized sodium fluoride as a constituent of an eruptive rock, nephelite-syenite, from the Islands of Los, off the coast of Guinea. The mineral, which has been named *villiaumite*, occurs in small grains of a carmine color, and the author believes it to be an essential constituent of the rock and not of secondary origin. Being soluble in water it is found only in fresh specimens of the rock. Upon treating a kilo of the rock with boiling water 3.5 g. of soluble salts were obtained, consisting chiefly of sodium fluoride, but containing a little sodium chloride, and small quantities of other impurities. The mineral is softer than calcite, has a specific gravity of 2.79 and is characterized not only by its color and solubility, but by being isometric in crystallization, and having an index of refraction of 1.328 in sodium light, which is less than that of water or of any other known mineral.—*Comptes Rendus*, cxlvi, 213. H. L. W.

5. *Mechanical Effect of Temperature on a Gold Leaf Electrometer in a Vacuum*.—J. BOTTOMLEY describes such an effect. The approach of heated bodies to the exhausted vessel containing the gold leaves caused a movement of these even when the vessel was enclosed in a cage to prevent electrical effects. The leaves

repelled each other by the presence of heated bodies and were attracted together by cold bodies. Interposing absorption media gave no clue to the cause of the effect.—*Proc. Roy. Soc. (A)*, lxxix, pp. 285-295, 1907. J. T.

6. *Effect of a Magnetic Field on Ionized Air in Movement.*—M. A. BLANC finds that a current of air having a velocity of 6<sup>m</sup> per second passing through a magnetic field of 4000 Gauss units is diverted by a force which is equivalent to that exercised by an electric difference of potential equal to 0.024 volts. He finds that the velocity of the negative ions is greater than that of the positive ions in the ratio of 1 to 1.6.—*Comptes Rendus*, cxliv, pp. 739-741, 1907. J. T.

7. *Mechanical Working of Canal Rays.*—A. A. CAMPBELL SWINTON has constructed tubes similar to those employed by Crookes to show the mechanical effects of the cathode rays. The type employed was that of movable vanes. The author believes that the effect observed was a true mechanical effect of the positive rays and not a radiometer effect.—*Proc. Roy. Soc.*, lxxix, pp. 391-395, 1907. J. T.

8. *Velocity of Sound in Fluids.*—It has often been suggested that Kundt's dust figures afford an interesting method of studying the velocity of sound in various media. KARL DÖRSING has elaborated the method, using many interesting modifications of Kundt's method. The powder employed was pulverized pumice stone which was carefully dried in a furnace. It was found that the velocity in water increased with rising temperature; in other fluids diminished under a similar condition. The ratio of specific heats of ether at constant volume and pressure was  $c_p/c_v = 1.376$ .—*Ann. der Physik*, No. 2, 1908, pp. 227-251. J. T.

9. *On Factors serving to Determine the Direction of Sound.*—In an interesting and apparently exhaustive study of this subject Mr. T. J. BOWKLER concludes "that in noting the direction of a fog horn at sea the observer should be well away from any reflecting surface of any kind. (In one experiment an umbrella held to one side of the head at a distance of two feet displaced the sound image 20°.) It adds to accuracy in fixing the direction to have a flat board slung on the shoulders vertical and parallel to the axis of the ears. This increases the intensity in front and shuts off sound from the rear. I think it would also be better to have two short blasts of three seconds each, every half minute at sea, rather than a long blast every minute. Fog horns should be placed well above any reflecting surface, but it might add to their carrying power if a large disk or sounding board were placed horizontally directly over them."—*Phil. Mag.*, March, 1908, pp. 318-332. J. T.



## II. GEOLOGY.

1. *Research in China*. Vol. I, Pt. I (April, 1907, 4°, pp. xiv, 353), *Descriptive Topography and Geology*, by BAILEY WILLIS, ELIOT BLACKWELDER, and R. H. SARGENT; Vol. II (July, 1907, pp. 133), *Systematic Geology*, by BAILEY WILLIS. Published by the Carnegie Institution of Washington (vol. I, pt. II reviewed in December number of this Journal).—In 1902 a geological expedition was sent to China by the Carnegie Institution; this was in accordance with a plan first suggested by Charles D. Walcott, the special object in view being the investigation of the pre-Cambrian and Cambrian formations. The expedition was in charge of Mr. Bailey Willis and he was assisted by Mr. Eliot Blackwelder and Mr. R. Harvey Sargent. The party was in the field from October, 1903, to June, 1904, during which time they made a geological traverse of about 2,000 miles through northeastern, northwestern, and central China. The results of their work are given in these handsomely illustrated and well printed volumes. They will take place beside the other three-volume work, the classic "China," by Von Richthofen. The reviewer regrets that the lack of space prevents more than a brief notice of some of the more important results presented in this monumental work.

The widely distributed yellow earth deposit forming the Great Plain of eastern China is discussed in Chapter x of vol. i. Willis concludes as follows: "In central and eastern Asia, in consequence of a change from moist to arid climate, a deep layer of decayed rocks was denuded of vegetation and exposed to effects of winds and occasional rains. The disintegrated material was transported and sorted, both by wind and water; wind being the more effective agent during the dry seasons and on wide plains; waters doing a larger work during rainy seasons and in river valleys. Sorted and transported repeatedly and alternately by winds and waters, the material came to consist in great part of fine dust, the loess, which both agents could carry in largest amount; but this was always mingled, as it is now, with some coarser sand and gravel introduced by flood waters. Beyond desert basins, the path along which the Huang-t'u was distributed was chiefly down the valleys of a previous physiographic epoch, as it is now down the valleys of the present far more mountainous surface. It was deposited on flood-plains and in lake basins. The lighter portions of it were blown out onto mountain slopes and gathered beneath wind eddies or in sheltered hollows. In course of distribution it became thoroughly decomposed and oxidized; and where it accumulated and was exposed to subaerial conditions it acquired vertical cleavage, a secondary characteristic due to gravity and movement of ground waters, and became charged with salts brought in by such waters. The processes of transport-

tation and accumulation are in progress now and are believed to have been similar in past ages" (pp. 184, 185).

One of the most striking results was the discovery in the gorge of the Yang-tsi of a glacial tillite 120 feet thick, underlying the massive, cliff, marine limestone of Cambrian age. "It is a greenish gritty clay-rock of hackly fracture, in which lie irregular stones of various sizes and kinds with their long axes at random angles with the horizontal. . . . The stones range in size from sand-grains to blocks 50 to 75 centimeters in length, and there is no suggestion of the assortment of the individual sizes. Coarse and fine particles lie indiscriminately mingled and chaotic in their arrangement. The forms of the majority of the stones are subangular, i. e., angles are present, but are smooth and rounded. . . . the scratched stones found in numbers firmly fixed in the green tillite, in such a condition as to show that they had never been disturbed nor subjected to surface abrasion since they were imbedded there in early Paleozoic time."

In northern Shansi the Tai-shan basal complex of Archean time consists of varied gneisses and younger intrusions (volume ii). Above an unconformity follow two great systems of Proterozoic time. The lower Wu-t'ai system, several thousand feet in thickness, has three series of formations, each separated by an unconformity. Basally the system begins with heterogeneous quartzose and clayey rocks, that are more argillaceous in the middle series, and finally calcareous above. It is the material of a complete erosion cycle and in time may equal the duration of the Paleozoic. Finally, the Wu-t'ai system was folded and intruded before the time of the next system, the Hu-to. The latter is of late Proterozoic time, consisting of unmetamorphosed sedimentaries, chiefly of slates with thin bands of dolomite, and siliceous limestone of not less than 3500 feet thickness, followed by about 3,000 feet of massive limestone with much chert in sheets. Then follows a very long erosion interval during which time Asia was reduced to a featureless continent.

Over a fairly flat land with red soils there followed in north-eastern China the very widely spread Sinian system of Von Richthofen, beginning apparently late in lower Cambrian time and continuing without break into the lower Ordovician. Basally, there is a red and brown shale not unlike that of Permian and Triassic time with thin layers of limestone, together having a thickness of from 350 to 850 feet. Then follows an interbedded series of limestone and shale having a thickness of from 900 to 1,000 feet, abounding in upper and middle Cambrian fossils. Above is a series, chiefly dolomitic limestones, at least 2750 feet thick, eroded at the top (caverns with iron ore) to an unknown extent. But few fossils have been secured near the top of these dolomites, and these indicate lower Ordovician time. In the middle Yang-tzi Province, however, Blackwelder found above the dolomites a soft green calcareous shale 200 feet thick, with many fossils, described by Weller. These clearly indicate middle Ordo-

vician of the Baltic region, a fauna that also greatly influenced the make-up of the Mohawkian assemblage of the Mississippi valley, migrating here by way of the Pacific ocean.

The Sint'an formation (upper Ordovician to and including lower Carboniferous), 2,000 feet thick, represents chiefly Silurian time but no fossils were collected by the Willis party, the correlation being made on the work of Kayser in Richthofen's China. The Devonian has a calcareous, marly and bituminous character and is of no great thickness. The Sint'an is said to be without unconformities. During this time China was in a stable condition without very high lands and devoid of great movements.

Upon the older Paleozoic follows conformably the upper Carboniferous; to these formations six pages only are devoted. As in eastern America, so in China there are two, apparently contemporaneous, widely differing series of deposits. The one of north-eastern China is essentially of a continental nature, sandstones and shales with numerous coal beds, and thin zones of marine bituminous limestones. The other is a single limestone formation in places more than 4,000 feet thick. During the late Carboniferous movements are again in progress, during which time the Kuen-lung system of folds developed. The extensive mediterranean, Tethys of Suess, is now in full development, depositing in Asia the complete sequence of Permian and Triassic marine formations. In northern Asia and Siberia is the continent Angara with its fluvial deposits, while to the south is the greater land Gondwana with its *Glossopteris* flora. In all of central Shantung there was volcanic activity, beginning during the latest Paleozoic and continuing well into the Mesozoic. It is also during this interval that the various parts of Asia were still separated by the Himalayan strait. Mountains then developed "which are structurally still the controlling features of Asia. The foundations of the ranges are now raised to the summits of the Tien'-shan, Kuen-lung, and Ts'in-ling-shan, and the substance of their masses constitutes the Triassic and Jurassic sediment of Asia. By Cretaceous time the continent was again low."

"Nor are Cretaceous strata of any kind known in the vast area of Asia north of Tibet, east of the Urals, and south of northern Siberia. No other fact than this, perhaps, more sharply challenges the hypothesis that the present mountain ranges and basins of central Asia date from a pre-Cretaceous time. Highlands without waste and waste without deposit in these interior basins are inconceivable; . . . in the latest Jurassic, Lower Cretaceous, and Upper Cretaceous of northern India we have the sedimentary record of the reduction, peneplanation, and partial submergence of the continent, which in preceding Mesozoic time had attained very prominent relief" (pp. 95-96).

The principal continental upwarp of central Asia "appears to fall chiefly within the Quaternary, but may extend back into the Pliocene." "It is the time of one of the most remarkable diastrophic movements of which we have knowledge."

The volume closes with Chapter viii, "Continental Structure of Asia" (pp. 115-133), a chapter full of valuable suggestion even though one of hypothesis. "The analysis of Asia into continental elements, the interpretation of successive geographic conditions, the attempt to explain the arrangement of the "leitlinien," and the statement of a source of tangential thrust are contributions to theory. They are, so far as I can now judge, consistent with the known facts, but they must stand or fall quantitatively and qualitatively by the test of the great host of facts which are yet to be gathered in the wonderful continent" (p. 133). c. s.

2. *Patuxent Folio, No. 152, Maryland-District of Columbia*; by GEORGE BURBANK SHATTUCK, BENJAMIN LE ROY MILLER, and ARTHUR BIBBINS. 12 pages text, 3 page plates, 1 page geological section. U. S. Geol. Surv., 1907.—This quadrangle, of a quarter of a square degree in area, has been surveyed in coöperation with the Maryland Geological Survey and fuller discussions of the Maryland portion are to be found in a number of the reports of that state. The region lies mostly on the Atlantic Coastal Plain, its northeastern quarter embracing a small portion of the Piedmont Plateau, here not more than two hundred feet above the sea.

The geologic formations consist of a few outcrops of Archean granite-gneiss, showing through the Cretaceous of the northwest, and of Tertiary and Quaternary deposits of the coastal plain,—these later deposits being mapped as eight formations. This indicates the increased degree of refinement which in recent years has marked the study of the coastal plain deposits.

J. B.

3. *Ouray Folio, No. 153, Colorado. Geography and General Geology*; by WHITMAN CROSS and ERNEST HOWE. *Economic Geology* by J. D. IRVING and WHITMAN CROSS. 20 pages text and geologic section, 3 pages maps, 1 page illustrations. U. S. Geol. Surv., 1907.—This folio contains the geologic maps and descriptions of a sixteenth of a square degree in the neighborhood of Ouray, Colorado. The folio is of value and interest not only because of the great mineral wealth of the region, but because of the rugged character of the San Juan Mountains within which it is situated, and the great number of sedimentary and igneous formations.

The elevation ranges from 6800 feet in the northwest corner of the quadrangle to 14,020 feet near the southeast corner. The dominant features in the geology are the San Juan tuffs, forming the body of the mountains, and the Mancos (Cretaceous) shale of the northwestern quarter. Many other formations are exposed, however, which range in age from Algonkian to Recent.

The page of illustrations which has been added to many of these western folios is an extremely desirable feature, supplementing the reading matter in giving a vivid conception of the district. A feature of the economic portion is the presentation

of the evidence showing the relation of ore deposition in the fissures to the wall rock. J. B.

4. *Some Characteristics of the Glacial Period in non-glaciated Regions*; by ELLSWORTH HUNTINGTON. Bull. Geol. Soc. America, vol. xviii, pp. 351-388, pls. 31-39, 1907.—In this paper the author calls attention to the fact that the glacial period was characterized by glaciation over a relatively small portion of the earth's surface, and that minor changes of this character might occur without actually reaching glacial conditions. Glaciation has represented rather local and extreme effects, but the climatic changes which resulted in glaciation affected all parts of the earth and left their stratigraphic records in the form of fluvial and lacustral deposits. The phase of glaciation has almost monopolized scientific attention, however, and the other changes have not received the study which their broad distribution warrants, due to the striking evidences of glacial action and the fact that geology has taken its rise in that part of the world which suffered the most extreme glaciation in recent times.

The paper is important in calling attention to the fluvial and lacustral phenomena of the recent glacial period in the basins of central Asia and in showing that these are as definite in their nature as the glacial and interglacial deposits on the two sides of the North Atlantic Ocean. The record is, further, likely to be more complete, since the maximum glacial advance destroys nearly all of the previous deposits and the resulting record is one in which the oldest evidence belongs to the farthest ice advance.

The author points out also the rhythmic nature of the Pleistocene climatic changes and as terms of wider application than *glacial* and *interglacial* suggests from the analogy of poetic rhythm the words *arsis* and *thesis*. A *glacial* period is thus a *strophic* period, consisting of *arsial* and *thesial* stages. J. B.

5. *Origin and Significance of the Mauch Chunk Shale*; by JOSEPH BARRELL. Bull. Geol. Soc. America, vol. xviii, pp. 449-476, pls. 49-52, 1907.—The first half of this paper gives the results of field observations upon the Mauch Chunk formation, accompanied by half-tone reproductions from photographs. The mineralogical and structural features and the nature of the plant fossils are described in detail. In the second half are discussed the conditions under which such structures and plant remains are buried at the present time. From this it is concluded that while a marine phase occurs in south-central Pennsylvania, that in the northeastern portion of the state the formation consists dominantly of fluvial beds accumulated under a semi-arid climate.

6. *Water Resources of the East St. Louis District*; by ISAIAH BOWMAN, assisted by CHESTER ALBERT REEDS. Bulletin No. 5, Illinois State Geological Survey, 1907. Pp. x + 128, pls. 4, figs. 11.—This report opens with an interesting discussion of the economic features which have determined the flood-plain of the Mississippi at East St. Louis as a manufacturing site. The marginal upland shows combinations of normal topography with

sink holes and underground drainage, giving rise to "karst topography." A chapter on the geologic structure further lays the basis for considering the subject of the surface and underground waters. These are taken up in detail and their origin, quality, and use discussed. Thus much matter of geologic interest is found in the report.

J. B.

7. *Geological Survey of Michigan*.—The following publications, parts of the Report for 1906, have recently been issued :

Eighth Annual Report of the State Geologist, ALFRED C. LANE, for the year 1906. Pp. 578–601.

The Surface Geology of Portions of Menominee, Dickinson, and Iron Counties, Michigan; by ISRAEL C. RUSSELL. Pp. 91, with 12 plates and one figure.—This gives a description of the topography of the region named and also the various phases in the glaciation; the latter has more than a local interest.

Peat. Essays on its Origin, Uses and Distribution in Michigan; by CHARLES A. DAVIS. Pp. 95–395, with plates xiii–xxxi, and figures 2–20.—This series of papers is characterized by the State Geologist as "the fruit of a happy marriage of botany and geology." There is much that is important both from a scientific and an economical standpoint.

A Geological Section from Bessemer down Black River; by W. C. GORDON, assisted by ALFRED C. LANE, State Geologist. Pp. 405–507, plates 32–35, and figures 21–26.

Crataegus in Southern Michigan; by C. S. SARGENT. Pp. 515–570.

8. *Geological Survey of Wisconsin*, E. A. BIRGE, Director.—The following Bulletins have appeared recently :

No. XVII. Scientific Series No. 5. The Abandoned Shore-Lines of Eastern Wisconsin; by JAMES W. GOLDTHWAIT. Pp. ix, 134, with 37 plates and 37 figures.—This is a valuable contribution to the glacial and post-glacial history of the Great Lakes, especially as regards the extinct lakes Nipissing and Algonquin. The observations are based upon a large number of accurate measurements made with the wye level.

No. XVIII. Economic Series No. 11. Rural Highways of Wisconsin; by WILLIAM O. HOTCHKISS. Pp. x, 136, with 16 plates and 2 figures.

9. *Earthquakes, An Introduction to Seismic Geology*; by WILLIAM HERBERT HOBBS.—In a review of this book in the March number, (vol. xxv, p. 259) occurred the following typographic error: on page 260, eighth line from the bottom, "fall line" should have read "fault line."

### III. PALEOBOTANY.

1. *The Flowering Plants of the Mesozoic Age*; by DUKINFIELD H. SCOTT. President's Address, Journal of the Royal Microscopical Society, London, 1907, pp. 129–141, with plates vi–ix.—In this admirable presentation Dr. Scott says, "There is no longer any presumption that the simplest forms among

the flowers of the Angiosperms are likely to be the most primitive. . . . The tendency of the older morphologists to regard such flowers as reductions from a more perfect type appears fully justified by the discovery of the elaboration of floral structure attained by the Mesozoic Cycadophyta before the advent of the Angiosperms themselves." These "remarkable organs," it is held, "fully merit the name of 'flower' in the same sense in which we apply it in everyday language to the flowers of our gardens and fields." And Dr. Scott adds, "I am inclined myself to believe that the comparison holds good from a morphological point of view also."

G. R. W.

2. *Beiträge zur Morphogenie der Sporophyllé und des Trochophylls in Beziehung zur Phylogenie der Kormophyten*; von Dr. HANS HALLIER. Jahrb. d. Hamburgischen Wiss. Anst., xix, 1901 (3. Beiheft: Arb. der Bot. Inst.), [Hamburg, 1902], 110 pp. and 1 pl.—While on a recent visit at the home of Dr. D. H. Scott, I was asked if I had seen this contribution of Hallier, and replied that I was wholly unacquainted with his work. From this explanation, it may be understood that it has been with a deep interest that I have since read the above paper, certainly one of the most brilliant contributions to a natural classification of plants yet made. Strikingly clear is the statement of the relationship of *Anomozamites* to the Magnoliaceæ, written as Hallier has himself since explained without knowledge of my earlier contribution of June, 1901, on the Microsporangiata Fructification of *Cycadeoidea*, in which I definitely compared the bisexual flower-bud of that genus with *Liriodendron*.

With the evidence I had then at first hand of the true type of fructification in the Cycadeoideæ, and of the innumerable variations which such an obviously plastic form of flower would be capable of undergoing, it was impossible to escape the conviction that a reasonable method of descent for the Angiosperms was at least established. And, *à fortiori*, from the series of steps involved in the course of its own evolution, this new type of fructification indicated at once that the Magnoliaceæ rather than any other group, such, for instance, as the Amentaceæ, must be the most primitive of the Angiosperms; though plainly enough the flowers of *Williamsonia* and *Cycadeoidea* were already too far specialized to permit these genera or the immediate family to which they belong to stand in any general ancestral Angiosperm line. Later, in my American Fossil Cycads, I contented myself with a simple insistence on the value of the earlier statement, which I believe I was the first to make.

That Hallier with his splendid knowledge of existing forms, but with less paleontologic evidence before him, should have independently reached such entirely similar conclusions, demonstrates the completeness of the chain of facts, both botanic and paleobotanic, proving indubitably the derivation of the Angiosperms from forms closely related to *Anomozamites*. For equally with Hallier we regard this genus as the most significant cycad-

deoid yet discovered, though destined sooner or later to yield this position to some still simpler type with multiovulate carpophylls and spirally inserted microsporophylls. G. R. W.

3. *Pteridosperms and Angiosperms*; by F. W. OLIVER. *New Phytologist*, vol. v, No. 10, Dec. 31, 1906, pp. 232-242.—To give an adequate summation of this lecture would be to quote it entire. In speaking of the general morphologic significance of the flowers of *Cycadeoidea*, Professor Oliver says:

“The great interest to many, and among them myself, will be the significance of this hermaphrodite flower from an angiospermous point of view. Does it tend to bring Angiosperms into the fern-Pteridosperm-Cycad line? The flower is admittedly a gymnosperm in that pollination is direct, but one’s faith in the old shibboleths has in these days received many shocks. As a feature of taxonomic importance, secondary thickening has lost all its former significance. The possession of seeds, again, is readily admitted to be no mark of affinity. Is it possible that Angiospermy and Gymnospermy as differential criteria will have to go too?”

“Whatever else one may think of this flower, it cannot be regarded as that of a quite typical Angiosperm, although Wieland has compared it appropriately enough with the flower of a Magnoliaceous plant.

“Its great interest and value seem to be that whilst just missing the Angiosperm it shows how close the cycad line could come to realizing it. It is indeed the key to the Angiosperms; when that is recognized the rest is easy.” G. R. W.

4. *On the Origin of Angiosperms*; by E. A. NEWELL ARBER. *Linn. Society’s Journ., Botany*, vol. xxxviii, July, 1907, pp. 29-80, with four text-figures.—This is decidedly the most interesting paleobotanic contribution of the past year. Nor will space permit an adequate critique. The examination of evidence, and the development of the “strobilar theory” by Arber leads to conclusions not remote from those advanced by Hallier in the contribution just noted, as well as to a virtual concurrence in our own interpretation of the significance of the “amphisporangiate” flowers of the *Cycadeoideæ*.

It is held by Arber that the most generally accepted theory that simple angiospermous flowers are better regarded as primitive than as reduced forms, is inadequate; and, in accordance with his view of a strobilar derivation he would restrict the use of the word flower, which for the existent Angiosperms is limited as a *Eu-anthostrobilus*, derived of course from the *Pro-anthostrobilus* of Mesozoic ancestors, and exemplified morphologically by the flower-bud of *Cycadeoidea*. It follows, moreover, that the Angiosperm families exhibiting the greatest assemblage of primitive features are primarily the Magnoliaceæ and then the Ranunculaceæ, Nympheaceæ, and Calycanthaceæ, amongst Dicotyls,—and the Alismaceæ, Butomaceæ, and Palmaceæ amongst Monocotyls, which latter must also be derivatives from an ancestry with hermaphrodite flowers and well developed perianth.



Saporta, as will be remembered, established the Proangiospermeæ as a primitive quasi-gymnospermous group containing the ancestors of the Monocotyls and Dicotyls, and including the Cycadeoideæ. But Arber, while stating that the Cycadeoideæ are near the Angiosperm line, in actuality relegates this family to a far remoter position, inasmuch as he not only removes it from the Proangiospermeæ, but fails to include it in an early Mesozoic complex of primitive Angiosperm ancestors which he endeavors to establish as the Hemiangiospermeæ. For our part, we find difficulty in following here. We still believe the Cycadeoideæ to be a much varied group of *cycads*, and furthermore have come to regard them as occupying a position on the very borders of just such an ancestral complex as Saporta defined, standing so to speak on the threshold of the Mesozoic and ushering in the early Angiosperms. It appears to us, moreover, that Arber's own conception of a "Hemiangiosperm" would on last analysis find a place as comfortably near the cycadeoid line as the latter is near the Cycadaceæ. For it is to be remembered, too, that to be adequate a classification must be sufficiently elastic to admit some overlapping as knowledge of separate phylæ is extended. We therefore prefer the more explicit statement of Hallier on this point, and we much like the latter's characterization of the conifers as the real "half-angiosperms," or "Halb-Angiospermen." Whatever difference of opinion there is here, however, is quantitative rather than qualitative, and all paleobotanists at least must feel greatly indebted for the originality and suggestiveness with which Arber has essayed the discussion of the most comprehensive and difficult of all botanic questions.

G. R. W.

5. *Les Végétaux Fossiles et leur Enchainements*; par M. RENÉ ZEILLER. Extrait de la Revue du Mois, Paris, 10 février, 1907, t. iii, pp. 129-149.—This is one of the most luminous of the considerable number of general reviews of the recent great progress in paleobotany which have appeared in the past year. One of the concluding paragraphs is as follows:—

"Quant aux Angiospermes, Monocotylédones et Dicotylédones, le problème est plus obscur encore, . . . Il nous est impossible de discerner, dans les flores antérieures, aucun type qui puisse être considéré avec tant soit peu de vraisemblance comme leur ayant donné naissance, et tant que nous n'aurons pas recueilli de nouveaux documents, de la rencontre desquels il ne faut jamais désespérer, nous demeurons dans une complète ignorance des origines de cet immense groupe de plantes."

This view of one of the most eminent and accomplished of all the authorities on fossil plants, is of course not unmindful of recent great progress in our knowledge of gymnosperms as understood better by no one than Zeiller himself. Rather does it resolve itself into a conservative insistence that valid clues to the origin of a group must come from within the group itself; for the last analysis can only be based on continuous series. Can it be, we ask, that the paleontologic day is still in its earliest hours, and

that before its work is done, there will have been witnessed relatively as great overturnings of beliefs, classifications and systems as, for instance, Astronomy has already seen? G. R. W.

6. *Études sur les Végétaux Fossiles du Trieu de Leval (Hainaut)*; par PIERRE MARTY. Mem Musée Roy. d'Hist. Nat. de Belgique, T. V., Bruxelles, 1907, 52 pp. and 9 pls.—The chief botanic feature of this upper Cretaceous florule is the fine series of *Dryophyllum* specimens, and the nearest comparison amongst existing floræ is found in tropical American regions.

G. R. W.

7. *The Plant remains in the Scottish Peat Mosses. Part III. The Scottish Highlands and the Shetland Islands*; by FRANCIS J. LEWIS. Tran. Roy. Soc. of Edinburgh, Vol. xlv, Part 1 (No. 2), Nov. 1907, pp. 33-70, with four plates.—In this admirably clear exposition it is shown that all the Scottish peat mosses show (1) a definite basal arctic bed in the south of Scotland and the Shetland Islands, succeeded by (2) the lower forests of birch, hazel and alder, containing temperate plants, which are followed by (3) a second arctic plant bed overlain in all except the Hebrides, Cape Wrath and the Shetlands, by (4) an upper forest covered by several feet of peat-bog plants. The two arctic beds descend to within 150 feet of sea-level, whilst the lowest forest rises to 1500, and the upper to 3500 feet, the present lower level of arctic-alpine vegetation in Britain being taken as 2000 feet.

G. R. W.

8. *The Structure and Origin of the Cycadaceæ*; by W. C. WORSDELL. Annals of Botany, vol. xx, No. lxxviii, April, 1906, pp. 129-159.—In this clear and important résumé of evidence mainly derived from vascular anatomy, essentially the same conclusions of pteridosperm origin of the Cycads result, as appear from the more detailed study of fructification in the Cycadeoideæ. Though of course the facts afforded by a study of stem structures are so far rather more connected than those yielded by the study of fructification, for which latter category of examination there is less available comparative material.

Mr. Worsdell devotes considerable space to a careful explanation of his view that the solid type of monostele (*Heterangium*) does not, according to Dr. Scott's supposition, give origin to the lax monostele of *Lyginodendron*, composed of from 5 to 8 or 9 collateral bundles, but that on the contrary both these forms are derived from a Medullosan polystele by non-development of the pith side of the circular series of steles. Certainly the recent and decidedly suggestive discovery by Matte of a Medullosan stage in the seedling axis of *Encephalartos Barteri* appears to tell in favor of Worsdell's view. Nevertheless, we are inclined to regard both his and Dr. Scott's idea as morphologically feasible methods, both of which have doubtless been followed in the evolution of stem structures in the series leading from pteridosperms into cycadophytes. This is but another example of the present hopefully rapid accumulation of evidence for modes of plant evolution.

9. *Études sur la Flora Fossile de l'Argonne (Albien-Céno-manien)*; par P. FLICHE. Extrait du Bull. de la Soc. des Sci. de Nancy; Nancy, 1896, 196 pp. and 17 pls.—This contribution has been hitherto overlooked by American reviewers, although of very considerable interest; inasmuch as in it are described, in addition to various other gymnosperms, three new species of more or less perfectly conserved Cycadeoidean trunks, and two of related ovulate cones referred to the new genus *Amphibennettites*. The trunks are named *Cycadeoidea Argonnensis*, *C. semiglobosa*, and *C. Colleti*, the latter being a curiously flattened out armor only of a large trunk mainly composed of oxide of iron, with much remaining carbonaceous material. These specimens are all from the Albian, and therefore represent quite the youngest typical Cycadeoidean florule so far reported. The seeds of the cone *Amphibennettites Renaulti* are fully 1 centimeter in length by 5 millimeters in diameter and the largest known in the Cycadeoideæ. This is a mature size, embryo outlines being present. Finely conserved ramental scales of one specimen figured suggest that although very brittle these cycads might reveal considerable microscopic structure if subjected to some infiltration process permitting subsequent sectioning; perhaps they could be studied from smoothed, or smoothed and etched surfaces, by means of Nathorst's collodium method. G. R. W.

10. *Paleobotanische Mitteilungen 1 und 2*; von A. G. NATHORST. Kungl. Svensk. Vetenskapsakad. Hand., Band 42, No. 5; Stockholm, 1907, 20 pp. and 3 plates.—(1) *Pseudocycas eine neue Cycadophytengattung aus den Cenomanen Kreideablagerungen Grönlands*.—A recent closer examination of certain Cycas-like fronds collected by Professor Nathorst himself at Atanekerdluk in 1883 showed that instead of a single midrib, there were two with the stomata entirely limited to the nether intervening space. After finding this condition in three of the supposed *Cycas* species, a portion of the epidermis of the well-known *Cycas Steenstrupi* of the Copenhagen Museum was secured and found to be in all likelihood a similar fourth species of the wholly new genus thus clearly indicated, *Pseudocycas*. The reviewer has seen all the original preparations, as well as *Pseudocycas (Cycas) Steenstrupi* (Heer) Nathorst, and found there was no doubt of the presence of the double midrib on that specimen.—As to the accuracy of Heer's figure showing an accompanying cycas-like megasporophyll we can only say it is not impossible that such a structure was present, but think a long hairy scale-leaf may be the true explanation. The view that the peculiar distribution of the stomata in *Pseudocycas*, also observed in two Greenland conifers, was likely due to the light and moisture conditions of the unidiurnal arctic year has much in its favor. (2) *Die Kutikula der Blätter von Dictyozamites Johnstrupi Nath.*—The structure and distribution inferiorly of the stomata between the netted veins, with absence of stomata on the superior surfaces, is decidedly fern-like.—Every contribution to a knowledge of *Dictyozamites* is of the highest intrinsic interest and value. G. R. W.

11. *Ueber Trias und Jurapflanzen von der Insel Kotelny*; von A. G. NATHORST. Resultats Scientifique de l'expédition Polaire Russe en 1900-1903, sous la direction du Baron E. Toll, section C: Géologie et Paléontologie, Livr. 2, Mem. de l'Acad. Imp. des Sci. de St. Petersburg, VIII Série, cl. Phys.-Math., vol. xxi, No. 2; St. Pétersbourg, 1907, 12 pp. and 2 pls.—The present Mesozoic flora, while not extensive, is of considerable interest, since the New Siberian Islands, of which Kotelny is one, have hitherto yielded only Tertiary plants.

G. R. W.

12. *On Triassic Species of the Genera Zamites and Pterophyllum: Types of Fronds Belonging to the Cycadophyta*; by E. A. NEWELL ARBER. Trans. Linn. Soc. of London, 2d ser., Botany, Vol. VII, part 7; London, Nov., 1907, pp. 109-127, pls. 17-19.—In this paper it is shown that the form genus *Zamites* includes various fronds of very large size with Monocotyledon-like leaves sometimes quite 50 centimeters in length, though in nearly all cases found detached. It is thus clear that various of the earlier Mesozoic imprints described as *Yuccites*, *Cordaites*, *Bambusium*, etc., are really cycadophytes and not in themselves evidence of early Monocotyls, Proangiospermeæ, or persistent Cordaitalean forms.

G. R. W.

13. *Végétaux Fossiles de Normandie. IV.—Bois Divers (Ire Série)*; par OCTAVE LIGNIER. Mem. Soc. Linn. de Norm. T. xxii; Caen, 1907, pp. 237-333, with pls. xvii-xxiii.—Both from the extent of the subject matter and the care with which it is elaborated and figured, the present memoir must rank as one of the most important and satisfactory treatises which have ever appeared on fossil woods. A half dozen genera of coniferous and dicotyledonous woods are here studied at length. Additional testimony for the great abundance of *Araucarioxylon* in the Jurassic and Wealden is adduced; and the very interesting determination is made that in *Cormaraucarioxylon* the woody structure is that of the Cordaitales, thus virtually verifying the view of Zeiller that such Jurassic imprints as *Yuccites* and *Eolirion*, and even the middle Cretaceous *Krannera*, do include persistent Cordaitalean forms.

G. R. W.

14. *Om några Ginkgoväxter från Kolgrufvorna vid Stabarp i Skåne*; af A. G. NATHORST. Lunds Univ. Årsskrift. N. F. Afdeln 2, Band 2, Nr. 8 (Kongl. Fysiog. Sällskapets Hand. N. F., Band 17, Nr. 8), 15 pp. and 2 pls.—Figures complete leaves of several species of *Czekanowskia* and of the related ornate Ginkgoalean form *Baiera spectabilis*, showing excellent preservation of epidermis, stomata, and guard cells of the Ginkgo type. We note the interesting likeness between the leaves of *Czekanowskia rigida* and the similarly much dichotomized pinnules of the but recently discovered *Cycas Micholitzii* Dyer of Annam.

G. R. W.

15. *The Taxoidea: a Phylogenetic Study*; by AGNES ROBERTSON. New Phytologist, Vol. VI, Nos. 3 and 4, March and April, 1907, pp. 92-102 and one pl.—In this interesting paper it

is held that *Taxus* more closely recalls *Cordaites* than any other known plant, there being reason to suppose both are descended from the same primitive stock, and that *Cordaianthus* thus gives some idea of one of the stages passed through by the female flower of *Taxoideæ* in the course of its evolution towards the reduced and specialized forms of the present day. G. R. W.

#### IV. NATURAL HISTORY.

1. *The Cahow: Discovery in Bermuda of fossil bones and feathers supposed to belong to the extinct bird called "Cahow" by the early settlers.*—In a letter just received from Mr. Louis Mowbray, who is now in charge of the new Marine Biological Station and Aquarium at Bermuda, he tells of his recent very important and interesting discovery of remains of the mysterious cahow, which the writer, in several former articles,\* has considered an extinct bird, unknown to zoölogists, while others have tried to identify it with the shearwater (*Puffinus obscurus* or *Auduboni*), which still breeds at Bermuda in small numbers.

The following is an extract from Mr. Mowbray's letter:—I have found the bones of the Cahow, together with feathers answering identically the description of "russet color and white" [the colors mentioned by the writers of 1612–20]. The bird is closely related to the petrels. The beak is sharp, hooked. The cnemial process of the tarsus is well developed; more so than in *Puffinus obscurus*, of which I have also taken several pairs. The bones found certainly do not belong to the shearwaters. I have found the beak and bones of the shearwater in the same locality and they can easily be separated, one from the other. I found the bones in a cave, some of them buried three inches deep in the calcite of the floor, which will testify as to their age. The feathers are imbedded from  $\frac{1}{16}$  to  $\frac{1}{8}$  of an inch under the surface of a large stalactite. By holding the stalactite to the light one can see five or six feathers imbedded, with the shafts of the feathers all pointing one way downward.

The cave is a new one, found only a few months ago. I had the pleasure of exploring it thoroughly and found many skeletons. When the different bones are selected, I think almost the whole skeleton can be made up. Measuring the stained portion of the snow-white calcite floor, around the bones, I should say that the bird was about twelve to fourteen inches long, not more. I hope the finding of these remains may interest you. . . .

\* The Story of the Cahow, the mysterious extinct bird of the Bermudas. Popular Science Monthly, ix, pp. 23–30, 1901; and Zoölogy of Bermuda, vol. I. The Cahow of the Bermudas, an extinct bird. Annals and Mag. Nat. Hist., ix, pp. 26–31, 1902.

The Bermuda Islands, vol. i, ed. 2, p. 249, Supplement, p. 573, 1907.

For the adverse view, H. B. Tristram, Ann. and Mag. Nat. Hist., ix, Jan. 1902.

The Aquarium is proving a great success. The Biological Station is getting into fine shape. (Signed) LOUIS L. MOWBRAY.  
Hamilton, Berm., March 15, 1908.

This remarkable discovery ought to settle the status of the cahow, when the bones have been carefully studied by an expert osteologist. The fact that the bird discovered is distinct from the shearwater, found with it, is of itself an important point. The colors of the cahow seems to have been similar to those of the exceedingly rare, if not extinct, "Scaled Petrel."

A. E. VERRILL.

2. *Principles of Breeding: A Treatise on Thremmatology*, or the Principles and Practices Involved in the Economic Improvement of Domesticated Animals and Plants; by E. DAVENPORT; with appendix by H. L. RIETZ. Pp. 13 + 727. New York and Boston, 1907 (Ginn & Company).—The practical breeding of plants and animals has long been influenced by so large a degree of prejudice and tradition that the modern advances in biological knowledge has left the subject far in the rear. Breeding as it is being conducted by the professional investigator has clearly demonstrated the rapid changes and improvements that can be accomplished by the application of the theories resulting from recent discoveries in biological science. The breeding of animals and plants on the farm, however, is still largely in the same condition as in the last century, when tradition, prejudice, and the element of chance were important factors.

The author aims to make a clear distinction between the established facts and the traditional theories of the subject, and at the same time to indicate lines of research which will be most likely to result in further advances in the improvement of breeds. Believing that the successful breeder of the future will be a book-keeper and a statistician, a considerable amount of mathematics has been introduced in the later chapters, and in order to make the subject intelligible to all readers the principal mathematical problems involved are elucidated in an appendix.

The work will undoubtedly succeed in decreasing to some extent the wide gap which has hitherto separated the professional investigator from the practical breeder of plants and animals, and while it is designed particularly to meet the needs of the student in agriculture and the practical breeder, it will prove of equal value to the professional biologist.

W. R. C.

3. *Mechanismus und Vitalismus in der Biologie des neunzehnten Jahrhunderts: ein geschichtlicher Versuch*; von Dr. KARL BRAEUNIG. Pp. 111. Leipzig, 1907 (Wilhelm Engelmann).—This work is not so much a new discussion of the worn-out argument as to whether the vital processes are dominated by mechanical—that is, physico-chemical—forces or by some special kind of force commonly termed "vital force" which is peculiar to living bodies, as it is to show the historical course of events which in the middle of the nineteenth century led to the overthrow of the vitalistic doctrine and the almost universal adoption of the

mechanical conception of the forces of life, and the beginning of a return during the last few years to the older theory, which now passes under the name of "neovitalism." W. R. C.

4. *Plant Anatomy from the Standpoint of the Development and Functions of the Tissues, and Handbook of Micro-Technic*; by WILLIAM CHASE STEVENS, Professor of Botany in the University of Kansas. Pp. xii + 349, with 136 text-figures. Philadelphia, 1907 (P. Blakiston's Son & Co.).—Professor Stevens's text-book is restricted to the anatomy of the Spermatophytes and consists, as the title implies, of two distinct and independent portions. The first is of more general interest and gives a clear account of the development, structure and arrangement of the various tissues found in stem, leaf and root. Throughout the discussion the functions of the tissues involved are continually kept in mind, and the striking relationships which exist between structure and function are emphasized. Even the more complex topics, such as the differentiation of the stem-tissues from the primordial meristem and the secondary growth in thickness through cambial activity, are fully and adequately treated. The figures are mostly original and include a number of generalized diagrams which ought to be of much assistance to the teacher. The second portion of the book describes the preparation and staining of sections, the use of the microscope, the various reagents and processes used in botanical investigation, the microchemistry of plant products, and the methods employed in the detection of adulterants in foods and drugs. A. W. E.

5. *Der Lichtgenuss der Pflanzen: Photometrische und Physiologische Untersuchungen mit besonderer Rücksichtnahme auf Lebensweise, geographischer Verbreitung und Kultur der Pflanzen*; by J. WIESNER, Director of the Institute for Plant Physiology at the University of Vienna. Pp. viii + 322, with 25 text-figures. Leipzig, 1907 (W. Engelmann).—Light has long been recognized as an indispensable factor in certain of the vital phenomena of plants, as, for example, in the important function of photosynthesis and in the heliotropic growth-curvatures. With respect to these individual processes the intensity, color and other qualities of light have been carefully investigated. The relationship of the plant as a whole to the intensity of light, however, was a subject which had received but little attention until Professor Wiesner undertook the studies which have resulted in the present work. For this peculiar relationship he employs the term "Lichtgenuss", for which there is no exact English equivalent. It signifies the ratio between the intensity of light which the plant receives and the intensity of the entire daylight. After a discussion of the methods employed in the determination of the intensity of light, the author calls attention to the various component parts of ordinary daylight, distinguishing especially between direct sunlight and diffuse or scattered light. He describes the variations in light intensity to which plants are exposed at different hours of the day, at different seasons of the year and

in different regions on the earth's surface, and shows how they react more or less definitely to such variations. At the close of the volume he discusses the significance of light measurements in horticulture, agriculture and forestry.

A. W. E.

6. *Chemie der Höheren Pilze: eine Monographie*; von Dr. JULIUS ZELLNER. Pp. iv + 257. Leipzig, 1907 (Wilhelm Engelmann).—This volume is a compilation of the entire literature on the chemistry of the higher fungi up to September, 1907, and should appeal strongly to those interested in fungi chemistry. The subject matter is condensed and yet the more important desirable details have been given. Beginning with a consideration of the mineral constituents of the fungi, the more important chapters are as follows: fats, lecithins, alcohols, acids, amino acids, urea and purine bodies, bases, carbohydrates, coloring matters, terpenes, proteins, ferments, toxins and the food value of fungi. Numerous tables are also presented dealing with the quantitative aspects of the subject.

F. P. UNDERHILL.

#### V. MISCELLANEOUS SCIENTIFIC INTELLIGENCE.

1. *Library of Congress. Report of the Librarian of Congress and Report of the Superintendent of the Library Building and Grounds, for the fiscal year ending June 30, 1907.* Pp. 167. Washington, 1907.—The Library of Congress, under the able management of Mr. Herbert Putnam, has become so prominent a leader to the other libraries of the country in matters of administrative detail, large and small, that this report will be read with interest by all those concerned in such work. As of more immediate interest to the general public in the report is to be noted the account of the library of Mr. G. V. Yudin, of Krasnoiarsk, Siberia, recently acquired. This comprises upwards of 80,000 volumes relating to Russia and Siberia, all but about 12,000 in the Russian language. This is much the most complete collection of works on Russian history, literature, and institutions in the country, surpassing the J. Sumner Smith collection at Yale of 12,000 volumes, which has previously held the first rank. The Yudin library was obtained for a sum hardly more than one-third of what the owner had expended in its accumulation, extended over a period of thirty years, the owner having desired to do this great service to the American people. The Library has also, through the efforts of Dr. Asakawa, recently acquired some 9,000 works relating to Japan.

2. *The Metric and British Systems of Weights, Measures and Coinage*; by F. MOLLWO PERKIN. Pp. 83, with 17 diagrams. London and New York, 1907 (Whittaker & Co.).—This is a brief account of the metric system in its relation particularly to English units; it is presented in a form suitable for the elementary student. Its scope is widened by the addition of chapters on specific gravity, temperature, measurements, and the use of the balance.



# Relief Map of the United States

We have just prepared a new relief map of the United States, 48 x 32 inches in size, made of a special composition which is hard and durable, and at the same time light. The map is described in detail in circular No. 77, which will be sent on request. Price, \$16.00.

---

WARD'S NATURAL SCIENCE ESTABLISHMENT,

76-104 College Ave., ROCHESTER, N. Y.

---

---

## WARD'S NATURAL SCIENCE ESTABLISHMENT

**A Supply-House for Scientific Material.**

Founded 1862.

Incorporated 1890.

### DEPARTMENTS:

*Geology*, including Phenomenal and Physiographic.

*Mineralogy*, including also Rocks, Meteorites, etc.

*Palaeontology*.      *Archaeology* and *Ethnology*.

*Invertebrates*, including Biology, Conchology, etc.

*Zoology*, including Osteology and Taxidermy.

*Human Anatomy*, including Craniology, Odontology, etc.

Models, Plaster Casts and Wall-Charts in all departments.

---

Circulars in any department free on request; address

Ward's Natural Science Establishment,

76-104 College Ave., Rochester, New York, U. S. A.

## CONTENTS.

	Page
ART. XXX.—Radio-activity of Uranium Minerals; by B. B. BOLTWOOD .....	269
XXXI.—Heating Effects produced by Röntgen Rays in Lead and Zinc; by H. A. BUMSTEAD .....	299
XXXII.—Review of the Minerals Tungstite and Meymacite; by T. L. WALKER .....	305
XXXIII.—Descriptions of Tertiary Insects; by T. D. A. COCKERELL .....	309
XXXIV.—New Devonian Brachiopod Retaining the Original Color Markings; by D. K. GREGER .....	313
XXXV.—Method of Hibernation and Vegetative Reproduction in North American Species of <i>Stellaria</i> ; by T. HOLM .....	315
XXXVI.—Two New Boron Minerals of Contact-Metamorphic Origin; by A. KNOPF and W. T. SCHALLER .....	323
XXXVII.—Determination of Vanadic and Molybdic Acids in the Presence of One Another; by G. EDGAR .....	332
XXXVIII.—Constituents of Atmospheric Radio-activity; by H. M. DADOURIAN .....	335
XXXIX.—Estimation of Iron by Potassium Permanganate after Reduction with Titanous Sulphate; by H. D. NEWTON .....	343

### SCIENTIFIC INTELLIGENCE.

- Chemistry and Physics*—Lithium in Radio-active Minerals, MCCOY: Radium in the Earth, STRUTT, 346.—Iodine, MARCKWALD and KEETMAN: Sodium Fluoride, LACROIX: Effect of Temperature on a Gold Leaf Electrometer, BOTTOMLEY, 347.—Effect of a Magnetic Field on Ionized Air, BLANC: Mechanical Working of Canal Rays, CAMPBELL SWINTON: Velocity of Sound in Fluids, DÖRSING: Direction of Sound, BOWKLER, 348.
- Geology*—Research in China, WILLIS, BLACKWELDER, and SARGENT, 349.—Patuxent Folio, SHATTUCK, MILLER, and BIBBINS: Ouray Folio, Colorado, CROSS, HOWE and IRVING, 352.—Characteristics of the Glacial Period in non-glaciated Regions, E. HUNTINGTON: Mauch Chunk Shale, J. BARRELL: Water Resources of the East St. Louis District, BOWMAN and REEDS, 353.—Geol. Survey of Michigan: Geol. Survey of Wisconsin: Earthquakes, HOBBS, 354.
- Paleobotany*—Mesozoic Flowering Plants, SCOTT, 354.—Morphogenie der Sporophylle, etc., HALLIER, 355.—Pteridosperms and Angiosperms, OLIVER: Origin of Angiosperms, ARBER, 356.—Végétaux Fossiles, etc., RENÉ ZEILLER, 357.—Végétaux Fossiles du Trias de Leval, MARTY: Plant remains in Scottish Peat Mosses, LEWIS: Cycadaceæ, WORSDELL, 358.—Flora Fossile de l'Argonne, FLICHE: Paleobotanische Mittheilungen, NATHORST, 359.—Trias and Jurapflanzen von Kotelny, NATHORST: Zamites and Pterophyllum: Cycadophyta: Végétaux Fossiles de Normandie, LIGNIER: Ginkgo-växter, NATHORST: Taxoideæ, ROBERTSON, 360.
- Natural History*—The Cahow in Bermuda, 361.—Principles of Breeding, DAVENPORT: Mechanismus und Vitalismus in der Biologie, 362.—Plant Anatomy, STEVENS: Lichtgenuss der Pflanzen, WIESNER, 363.—Chemie der Höheren Pilze, ZELLNER, 364.
- Miscellaneous Scientific Intelligence*—Library of Congress: Metric and British Systems of Weights, Measures and Coinage, F. M. PERKIN, 364.

---

Established by BENJAMIN SILLIMAN in 1818.

THE  
AMERICAN  
JOURNAL OF SCIENCE.

EDITOR: EDWARD S. DANA.

ASSOCIATE EDITORS

PROFESSORS GEORGE L. GOODALE, JOHN TROWBRIDGE,  
W. G. FARLOW AND WM. M. DAVIS, OF CAMBRIDGE,

PROFESSORS ADDISON E. VERRILL, HORACE L. WELLS,  
L. V. PIRSSON AND H. E. GREGORY, OF NEW HAVEN,

PROFESSOR GEORGE F. BARKER, OF PHILADELPHIA,  
PROFESSOR HENRY S. WILLIAMS, OF ITHACA,  
PROFESSOR JOSEPH S. AMES, OF BALTIMORE,  
MR. J. S. DILLER, OF WASHINGTON.

---

FOURTH SERIES

VOL. XXV—[WHOLE NUMBER, CLXXV.]

NO. 149—MAY, 1908.

WITH PLATES I-III.

---

NEW HAVEN, CONNECTICUT.

1908

---

THE TUTTLE, MOREHOUSE & TAYLOR CO., PRINTERS, 123 TEMPLE STREET.

# AN EXTENSIVE COLLECTION

We take pleasure in announcing that we have secured an extensive private collection of minerals, Geological specimens and ores. This is one of the largest, most varied and finest collections yet secured; it numbers several thousand specimens and contains many fine large groups suitable for Museums. The collection is so large it is impossible to list it, but we will say that it contains almost all known species. If it is impossible to call we will be pleased to send them on approval; send list of what you desire and we will send you a fine lot to select from.

In addition to the above we secured a collection of choice polished specimens, a few of which are as follows:—Agates, very picturesque and with sharp lines; fine slabs of Moss Agates with delicate tracings of moss; large variety of Jaspers; Serpentine; Carnelian Agates; Heliotrope; Lapiz-lazuli; picturesque Marbles, one 11 inches long, 9 inches and 4½ inches; Tiger-eye; Sunstone; Rose Garnet Slab, 6 x 6 inches, ½ inch thick; Mexican Onyx, slabs from Mexico and other fine onyx slabs and various marble slabs.

## ENGLISH MINERALS.

Fluorite, Calcite, Barite, Specular-iron, Hausmannite, Tetrahedrite, Hematite, Bournonite, Pearl-spar, Pyrites, Iridescent, 50c to \$2.50.

## HUNGARIAN MINERALS.

Barites, Calcite, Tetrahedrite, Fluorite, Amethyst, Plumosite, Pyrite, Sphalerite, Stibnite, Quartz, Cinnabar, Rhodochrosite, Realgar, Bournonite, Cerussite, Galenite, Marcasite, Chalcopyrite, Greenockite; we have these from 50c. to \$5 each; Semseyite on Galena, a rare mineral from Felső-banya, Hungary, from \$2.50 to \$5 each.

## RARE MINERALS.

Neptunite, San Benito Co., Cal., \$7.50 to \$10; Herderite, Auburn, Me., loose xls, from 50c to \$250; in matrix from 75c to \$20; Terlinguaite, Terlingua, Texas, \$5 to \$8; Calomel, Terlingua, Texas, \$5 to \$10; Montroydite, Terlingua, Texas, \$3 to \$7.50; Autunite and Volborthite, Richardson, Utah, 50c to \$1.50; Hydromagnesite, Livermore, Calif., \$1 to \$2.50; Torbernite, Redruth, Cornwall, England, \$5 to \$10; Cassiterite Crystals, from Mino, Japan, from 25c to 75c; Cassiterite, large twin crystal, Tasmania, 1¼ inch diameter, price \$15; Crocoite with Vauquelinite, Ural and Tasmania, \$5 to \$10; Euclase Crystals, Capio do Lane, Brazil, \$5, \$45, \$55; Emeralds; in matrix, Bogota, S. A., \$5 to \$35; Apatite, Auburn, Me., deep lilac color, \$2.50 to \$15; Kunzites, xls, Pala, Cal., \$1 to \$10; Tourmaline, fine lot, different colors, Mesa Grande, Cal., loose xls and in the matrix, from \$2 to \$150.

## CUT GEMS.

We have all the known gems, and semi-precious stones, also scientific rubies. Further particulars cheerfully furnished.

**A. H. PETEREIT,**

81—83 Fulton Street, New York City.

T H E

# AMERICAN JOURNAL OF SCIENCE

[ F O U R T H S E R I E S . ]

ART. XL.—*On Ionium, a New Radio-active Element*; by  
BERTRAM B. BOLTWOOD.

[Contributions from the Sloane Physical Laboratory of Yale University.]

IN a preliminary paper published about five months ago\* it was stated that a highly radio-active substance, which differed in general properties from any of the known radio-elements, could be separated by certain chemical operations from uranium minerals. In the present paper it will be shown that the earlier conclusions were correct, and that there occurs in uranium minerals a previously unidentified radio-element having distinctive physical and chemical properties.

### *Introduction.*

The discovery of a new radio-element, "actinium," was announced by Debierne in two papers which appeared in the *Comptes rendus de l'Académie des sciences* for October, 1899, and April, 1900†. In these papers, which were characterized by the lack of precise experimental details and the absence of explicit statements, the chemical properties of actinium were described as very similar to those of thorium, from which it had not been found possible to separate it completely. The following reactions‡ were given as characteristic for the new substance:

(1) Precipitation in hot solutions, slightly acidified with hydrochloric acid, by an excess of sodium thiosulphate. The active matter is contained almost entirely in the precipitate.

\* Boltwood, this Journal, xxiv, 370, 1907; Nature, lxxvi, 544, 589, 1907.

† Vol. cxxix, p. 593; vol. cxxx, p. 906.

‡ It will be noted that the first three reactions given are characteristic for thorium.

(2) Action of hydrofluoric acid on the freshly precipitated hydrates held in suspension in water. The portion dissolved is only slightly active. By this method titanium may be separated.

(3) Precipitation of neutral nitrate solutions by hydrogen peroxide. The precipitate carries down the active body.

(4) Precipitation of insoluble sulphates. If barium sulphate, for example, is precipitated in the solution containing the active body, the active material is carried down by the barium. The thorium and actinium are freed from barium by converting the sulphate into chloride and precipitating with ammonia.

About two years later, in 1902, Giesel published an account\* of a highly radio-active substance which he had obtained from pitchblende. He stated that this body was separated with the cerium earths, and could be ultimately removed with the lanthanum. A very characteristic emanation was evolved by Giesel's more concentrated preparations and he at first used the term "emanating substance" to distinguish the active material. The emanating substance was not separated with the thorium, and its chemical deportment was so different from that of the latter element that in Giesel's opinion the "emanating substance" and Debierne's actinium could not be identical. In a later paper† the name "emanium" was applied to the "emanating substance."

Giesel's claims for emanium were answered by Debierne in a paper published in 1904,‡ stating that his "actinium" preparations emitted an emanation similar to that noted by Giesel from "emanium" and asserting that the active material contained in them could not therefore be different. To this Giesel replied by calling attention to differences in the observed rates of decay of the active deposits from "emanium" and "actinium," and stating,§ moreover, that "Debierne no longer uses the thorium of the pitchblende for obtaining the new preparations, but uses instead, as I do, the cerium earths in which the activity is concentrated, as Debierne acknowledges." Further data on the chemical behavior of "emanium" were given in a later paper by Giesel.||

Certain experiments described by Marekwald¶ were believed by him to indicate that "actinium" and "emanium" were not identical, but stood in a genetic relationship to one another. A different and correct interpretation of Marekwald's results

\* Ber. d. chem. Ges., xxxv, 3608, 1902; *ibid.*, xxxvi, 342, 1903.

† Ber. d. chem. Ges., xxxvii, 1696, 1904.

‡ Comptes r., cxxxix, 14, 588, 1904.

§ Ber. d. chem. Ges., xxxvii, 3963, 1904.

|| Ber. d. chem. Ges., xxxviii, 775, 1905.

¶ Ber. d. chem. Ges., xxxviii, 2264, 1905.

was, however, given later by Hahn,\* who showed that they were due to the existence of a product which Hahn named "radio-actinium." It is interesting to note, in passing, that Marekwald states that the thorium precipitated from a solution of rare earths containing "emanium" was at first highly active but had lost its activity some months later.

The question of the similarity of actinium and emanium is discussed by Debierne in the *Physikalische Zeitschrift* of January 1, 1906. This paper adds little to the information contained in earlier publications, but the following quotation† is of interest:

"Ich muss hinzufügen, dass ich mich bei allen meinen Versuchen darauf beschränkt habe, nur Präparate zu verwenden, die nach einer gewissen Zeit eine konstante Aktivität behielten. Von diesen Präparate enthielten einige erhebliche Beträge an Thorium. . . . Der Name Aktinium muss für die neue Substanz vorbehalten bleiben, die die Anfangsursache der Radioaktivitätserscheinungen ist. Was die Gieselsche Substanz anbelangt, so habe ich schon gezeigt, dass sie mit Aktinium identisch ist, und diese Identität wird jetzt allgemein zugegeben.

"Ich will nochmals daran erinnern, das in meiner ersten Mitteilung über Aktinium (C. r., April, 1900) die fällung mit seltenen Erden als eine der Eigenschaften der neuen Substanz angegeben ist: . . . [doch] habe ich hinzugefügt, 'dass man jedoch nicht versichern könne, ob die aktive Substanz das Thorium bei allen seinen Reaktionen begleiten würde'."

The identity of the emanations evolved by preparations of actinium and emanium has been demonstrated by a number of experimenters. Our knowledge of the physical and chemical properties of the actinium products is due chiefly to the researches of Hahn‡ and Levine.§

In the papers published by Hofmann and Zerban|| much stress was laid on the differences in activity shown by thorium preparations which had been obtained from certain minerals containing various proportions of uranium. Not only were marked differences noted in many instances, but the subsequent behavior of certain of these preparations was quite irregular, some of the preparations losing and others gaining in activity. In some cases what was believed to be an entirely inactive thorium salt was obtained,¶ and the authors reached the conclusion that the specific activity of thorium was dependent solely on the amount of uranium with which it was associ-

\* Ber. d. chem. Ges., xxxix, 1605, 1906; Phil. Mag., xiii, 165, 1907.

† Phys. Zeitschr., vii, p. 16.

‡ Loc. cit.

§ Phys. Zeitschr., vii, 513, 812, 1906; *ibid.*, viii, 129, 1907.

|| Ber. d. chem. Ges., xxxv, 531, 1902; *ibid.*, xxxvi, 3092, 1903.

¶ Also Hofmann and Strauss, Ber. d. chem. Ges., xxxiii, 3126, 1900.

ated, a conclusion which was not justified, as was shown later by the work of Dadourian, McCoy, Eve, and Boltwood.

These excerpts from the literature have been given because they have an interesting bearing on the experiments, which will now be described.

#### *Early Experiments.*

In the spring of 1899, Mr. Clifford Langley, one of my students in the Sheffield Scientific School, with which I was at that time connected, undertook to repeat under my direction the interesting experiments of M. and Mme. Curie on the separation from pitchblende of the active substances polonium and radium. The work was carried out with about thirty grams of pitchblende, and the products separated were tested for radio-activity in a sheet metal box containing an insulated electrode connected with a quadrant electrometer. Precipitates containing polonium and radium were obtained without difficulty, but on applying the radio-active test to the material from which these substances had been separated we found that the activity of this was apparently greater than was to be expected for the uranium only. After the removal of the uranium by treatment with ammonium sulphide and ammonium carbonate, a small residue remained which proved to be highly active. From a hydrochloric acid solution of this residue the active material was not removed by further treatment with hydrogen sulphide and was not precipitated when the solution was treated with sulphuric acid. On adding an excess of ammonia, a precipitate consisting chiefly of ferric hydroxide was formed. The total active substance present was separated with this precipitate.

The main conclusion reached from these experiments was stated as follows in a thesis presented by Mr. Langley as a candidate for honors in chemistry in June, 1899: "This investigation shows the possibility of the presence of another active element not precipitated by hydrogen sulphide or by sulphuric acid, but which is precipitated by ammonium sulphide and ammonium hydroxide, thus differing from polonium and radium."

Owing to various causes the work was not continued further, until after the announcement by Debierne, in the following October, of the discovery of a new radio-active element which was separated with the iron group and which had chemical properties similar to those of thorium. I then found that the active substance which we had obtained was almost completely precipitated from a dilute hydrochloric acid solution on the addition of an excess of oxalic acid. Further experiments



were not practicable because of the very limited amount of material available, but over three years later the substance was again tested and found to have apparently lost none of its original activity. The material was again obtained in hydrochloric acid solution and the active substance was found to be precipitated by treatment with an excess of sodium thiosulphate. This close agreement with the properties of "actinium" given in Debierne's papers appeared to remove all doubt as to the identity of the active substance.

In the winter of 1903-1904 I made a rather systematic investigation of the constituents of a number of radio-active minerals, in the course of which I frequently observed that the rare earths freshly separated from certain primary uraninites, and other similar minerals containing uranium and thorium, always had associated with them a highly radio-active substance. It was further noted that when a solution of the chlorides of the earths was treated with an excess of sodium thiosulphate, the active substance was almost entirely precipitated with the thorium. The material remaining in the filtrate was essentially inactive when first prepared, but gained in activity slowly, until at the end of several months it was nearly as active as the thorium precipitate from which it had been separated. The activity of the thorium preparation remained nearly constant during the same period. It was also found that if a little thorium salt were added to the solution of a mineral initially free from thorium (for example, carnotite) and the thorium afterwards separated in the usual manner, an active substance was obtained with the thorium which appeared to be identical with that obtained in the other cases. If, instead of a thorium salt, a solution of rare earths from cerite was added to the solution of the uranium mineral and these earths were again separated, a highly active body was found to have been removed with them.

It was at first supposed that these results could be explained on the assumption that the active material which was found to accompany the thorium was Debierne's "actinium," while that which accompanied the other rare earths was Giesel's "emanium," a supposition which was somewhat supported by the fact that the production of a short-lived emanation could be detected in the earths in all cases and in the thorium only occasionally. But even this hypothesis did not appear to be defensible in the face of Debierne's emphatic assertions as to the identity of "emanium" and "actinium."

A number of unsuccessful attempts were then made to effect a separation of the thorium from the more strongly active substance which was associated with it. The thorium was repeatedly precipitated in dilute hydrochloric acid solution by

an excess of sodium thiosulphate, was precipitated in solutions of the neutral nitrate with hydrogen peroxide, and the hydroxide suspended in water was treated with hydrofluoric acid. The material obtained after this series of operations was to all appearances and chemical tests pure thorium hydroxide, but it still possessed a high activity out of all proportion to the actual amount of thorium present. The possibility of the presence of a new and previously unidentified radio-active substance naturally suggested itself, but in the absence of more convincing evidence the agreement with the chemical behavior of "actinium" as given by Debierne appeared to offer an insurmountable objection to such a conclusion. The numerous radio-active changes which had already been shown to exist in the actinium series were suggestive of the possibility of further complicated relations of a similar nature. The problem was therefore temporarily abandoned. In a paper on the radio-activity of thorium minerals and salts,\* in discussing the results obtained by Hofmann and Zerban, it was stated that:—"This element (actinium) invariably accompanies the thorium, and in the thorium separated from minerals containing much uranium and little thorium the activity due to the actinium may be much greater than the activity due to the thorium present."

#### *Later Experiments.*

The definite and constant proportion which has been shown† to exist between the quantities of uranium and radium in minerals could be satisfactorily explained only by the assumption that radium was a disintegration product of uranium. On the other hand, attempts to observe the growth of radium in solutions of purified uranium salts had given results‡ which demonstrated that radium was not directly formed from uranium at anything like the rate which was to be expected from the value for the life of radium as calculated by Rutherford. The discrepancy could be accounted for if an intermediate, slowly changing product intervened between uranium and radium, but the existence of such a product had not yet been established. In the search for this product my attention was again directed to the active substances separated with the rare earths from uranium minerals, as the anomalies already mentioned had been observed in these preparations, and as, moreover, my earlier experiments had shown that practically all of the permanent activity, other than that due to uranium, radium and polonium, was associated with this material.

\* This Journal, xxi, 424, 1906.

† Boltwood, Phil. Mag., ix, 603, 1905.

‡ This Journal, xx, 239, 1905.

Sometime before this Rutherford had published\* a brief account of an experiment in which he had attempted, without success, to detect the growth of radium in a solution of Giesel's "emanating substance," and had stated that measurements extending over a period of three months indicated that if radium was produced at all, it was produced at a very small fraction of the theoretical rate.

In spite of the unpromising outlook, the following experiment was undertaken with the object of further investigating the existing relations. A kilogram of rather low grade carnotite ore was treated for some time with hot, dilute hydrochloric acid and the considerable residue of insoluble matter remaining was removed by filtration. The solution was then treated with hydrogen sulphide and the precipitated sulphides filtered off. The filtrate was heated to boiling, and about two grams of thorium nitrate (from monazite), followed by a large excess of oxalic acid, were added. The mixture was allowed to stand for several days, when the precipitated oxalates were removed, converted into nitrates, and the precipitation with oxalic acid was repeated. The second precipitate, consisting almost wholly of thorium oxalate, was ignited to form the oxide, the oxide was treated with sulphuric acid to obtain the sulphate, and the sulphate in dilute solution was treated with an excess of ammonium hydroxide. The hydroxide was filtered off, washed thoroughly with hot water, dissolved in dilute hydrochloric acid and again precipitated with ammonia. After washing with water, the second precipitate of hydroxides was dissolved in a small volume of hydrochloric acid and the solution† was sealed up in a glass bulb. About two months later the gases in the bulb were removed by boiling the solution and the activity of the radium emanation present was determined in an air-tight electroscope. The bulb was then sealed up for a further period of 193 days, when the gases were again collected and tested. The amount of radium emanation found in the second case was nearly twice as great as that found in the first. It was evident that the amount of radium contained in the solution had increased during the interval between the tests and that the particular substance from which radium was derived had been separated with the thorium. In view of the results of my earlier experiments on the activity of the thorium treated in this manner, I was led to assume that the active substance associated with the thorium was actinium, or at all events the "actinium" described by Debierne in his early papers. The results obtained on the growth of radium were published in the form of a prelimi-

\* Phil. Trans. Roy. Soc. Lond., cciv, 218, 1904.

† This solution is referred to in the following pages as "solution 1."

nary paper\* and other experiments were immediately begun with the object of more carefully investigating the entire matter.

On learning of the outcome of my experiments, Professor Rutherford then made some further tests of the preparation of Giesel's "emanating substance" which he had earlier examined, and obtained positive evidence of the growth of radium in this material.† This tended to strengthen rather than otherwise the presumption that actinium was the intermediate product between uranium and radium, although there appeared to be certain theoretical objections to such a conclusion.‡

On continuing his experiments still further, Rutherford was able to effect a partial separation of the emanating substance proper from the radium-forming material by treatment of the solution with ammonia and hydrogen sulphide. He therefore concluded that ordinary commercial preparations of actinium contained a new substance which was slowly transformed into radium, was chemically quite distinct from actinium and radium, and was capable of complete separation from them.§ He was unable, however, to decide whether the new substance emitted ionizing radiations or was rayless. He also obtained results which indicated that the production of radium in solutions of the parent was approximately constant for a period of over 240 days from the time of its preparation.||

In the continuation of my own experiments I prepared the following materials:

Solution 2. Another kilogram of the carnotite ore, similar to that used in preparing the first solution, was similarly treated with dilute hydrochloric acid and the insoluble material was separated. This insoluble matter after drying in the air had a weight of about 800 grams and consisted largely of silica. The silica was completely removed by treatment with hydrofluoric and sulphuric acids, and the residue of sulphates remaining was almost entirely soluble in water. The solution of the sulphates was treated with an excess of ammonia and the precipitate of hydroxides was removed and carefully washed with water. The hydroxides were dissolved in dilute hydrochloric acid, the solution was treated with hydrogen sulphide and the precipitated sulphides were filtered off. To the filtrate about one gram of thorium nitrate was first added and then an excess of oxalic acid. The precipitated oxalates were filtered off about two days later. A further quantity of about

\* Nature, Nov. 15, 1906; this Journal, xxii, 537, 1906.

† Nature, lxxv, 270, 1907.

‡ Rutherford, Radioactivity, p. 177.

§ Nature, lxxvi, 126, 1907.

|| Phil. Mag., xiv, 733, 1907.

one gram of thorium nitrate was added to the filtrate and a second precipitation of thorium oxalate was made in the solution. The solution obtained by heating the mineral with hydrochloric acid was worked up by the same series of chemical operations as that used in the preparation of the first solution (p. 371). After the precipitate of thorium oxalate had been removed more thorium nitrate was added and a second precipitation of the oxalate was made in the same solution. The object of the second addition of the thorium salt was to insure the removal of any of the new substance which had escaped the first treatment. The four oxalate precipitates were combined, were converted into chlorides and were again treated with oxalic acid. The final oxalate was converted into the chloride, was twice precipitated as the hydroxide to remove the radium as completely as possible, and was finally obtained as the chloride, in which form it was sealed up in a glass bulb and the growth of radium observed. About thirty per cent more radium was produced in this solution in a given time than was produced in the first solution in the same period.

**Solution 3.** This solution was prepared from a quantity of Joachimsthal pitchblende weighing 200 grams. The chemical operations were essentially the same as those carried out in the preparation of solution 2, except that the mineral was first decomposed with dilute nitric acid. A considerable residue remained after treating the insoluble material with hydrofluoric and sulphuric acids. This residue was obtained in solution by a series of operations, including fusion with sodium carbonate, and this solution was separately treated with thorium. The entire thorium material ultimately recovered was freed from radium as completely as possible by repeated precipitation with ammonia, and the growth of radium was measured in this solution in the usual manner.

**Solution 4.** This was prepared from about 100 grams of secondary uranium minerals, consisting chiefly of gummite and uranophane. No thorium was introduced into the solution of this material, which contained naturally about one per cent of thorium oxide and about two per cent of other rare earths, but instead there was added a solution of about two grams of oxides of rare earths obtained from a specimen of cerite. This cerite had been found to be wholly free from thorium, uranium or other active substances. The rare earths were then separated in the usual manner, by precipitation as oxalates. The oxalates were converted into chlorides and the thorium was removed in the customary manner by treatment with sodium thiosulphate. The precipitate obtained was digested with hot, dilute hydrochloric acid, the sulphur was filtered off and the treatment with sodium thiosulphate was

repeated. The final precipitate was dissolved in hydrochloric acid and the solution was examined for the growth of radium. In 140 days the amount of radium was seven times as great as the amount present at the start.

Solution 4*b*. The rare earths left after the separation of the thorium used for the preparation of solution 4 were recovered by treating the filtrates with an excess of ammonia. They were reprecipitated four times as hydroxides in order to remove radium and, as a solution of the chlorides, were sealed up in a glass bulb. The amount of radium formed in this solution in a period of over 140 days was too small to be detected and could not have been as much as one one-hundredth of the amount formed in solution 4 in the same interval.

Solution 4*c*. The solution from which the thorium and other rare earths used in 4 and 4*b* had been separated was evaporated to dryness and the residue was heated to destroy the oxalic acid present. The residue was dissolved in dilute hydrochloric acid and a solution of about two grams of rare earths from cerite was added. The earths were then separated as before, and, after removal of the radium, were obtained in hydrochloric acid solution. No evidence of the growth of radium in this solution could be obtained. It was apparent that the substance from which the radium was formed had been completely separated with the thorium.

*Activity of the Substances in Solutions.* After the solutions had been preserved for some time, during which observations of the growth of radium were carried out, the solutions were removed from the bulbs, diluted to a known volume and a definite fraction removed. In this fraction the material present was precipitated as hydroxide with ammonia, and the hydroxide was strongly ignited to form the oxide. From the oxides thus obtained thin films weighing a few milligrams were prepared\* and the activities of the films were determined in an electroscope. The activities of the films were measured at frequent intervals over a period of about 130 days. The activity of the material from solutions 1, 2, 3 and 4 showed a slight initial rise corresponding to the formation of thorium X in the thorium present, but the final maximum attained was only about two per cent greater than the activity at the start. From the known weights of the films, which had been accurately determined, the total activity of the substances present in each of the solutions could be calculated. On comparing these calculated activities with the amounts of radium produced in the different solutions in equal periods, it was found that these two quantities were closely related to one another.

\* The films were prepared by the method already described; this *Journal*, xxv, 274, 1908.

After correcting the activities for the amounts of thorium and thorium products present, it was found that the amount of radium produced in each solution was quite closely proportional to the activity of the other material present. From these results it appeared highly probable that the substance from which radium was produced was an element emitting an *a* radiation. To further test the properties of the active substance the following experiments were performed. Some thorium had been separated from a quantity of uraninite about six months before and had been carefully purified by the well known method of dissolving the oxalate in an excess of ammonium oxalate. The oxalate had been later ignited at a low heat to form the oxide. The activity of this oxide was high and it contained an amount of the new body having an activity about equal to that of five grams of pure uranium. The oxide, weighing 0.4 gram, was placed in a glass tube between plugs of cotton wool, and a strong current of air was drawn through the tube and into a sensitive electroscope. The only emanation which could be detected was that due to thorium.

The greater part of solution 3, described above, was then taken, diluted to a volume of about 800<sup>cc</sup> and, after heating to boiling, an excess of ammonia was added. The hydroxides were filtered off and the residue obtained on evaporating the filtrate to dryness was examined. The activity of this residue was slight and appeared to be due entirely to thorium X. The hydroxides were dissolved in an excess of hydrochloric acid and a small quantity of sodium thiosulphate was added. The solution was boiled and the separated sulphur was filtered off. It was ignited and the activity of the very slight residue was tested and found to be one one-thousandth of that of the total active material in the solution. Some sulphuric acid followed by barium chloride was added to the solution and the precipitate of barium sulphate which formed was removed. The activity of this was tested and was found to be less than the activity of the residue left from the sulphur. It was evident that the active substance in the solution was not actinium, for if it had been the treatment with ammonia would have separated actinium X\*, and the treatment with sodium thiosulphate and barium sulphate would have separated radio-actinium.†

A more active preparation of the new substance was then obtained in the following manner: To the solution procured by treating about one kilogram of carnotite ore with dilute hydrochloric acid there was added a few milligrams of thorium

\* Giesel, Ber. d. chem. Ges., xxxviii, 775, 1905; Godlewski, Phil. Mag., x, 35, 1905.

† Hahn, Phil. Mag., xiii, 165, 1907.

nitrate and about five grams of the chlorides of inactive rare earths from cerite. The rare earths were precipitated as oxalates, after the removal of the hydrogen sulphide group, and the thorium was separated from the other rare earths (and the actinium) by repeated precipitation with sodium thio-sulphate. In this way a few milligrams of a substance, consisting chiefly of thorium oxide and having an activity at least 1000 times that of an equal weight of uranium oxide, were obtained. The radiations emitted by this material in the form of a thin film were examined in the electroscope and were compared with that emitted by a preparation of polonium on bismuth having an approximately equal activity. It was found that the new body gave out an  $\alpha$  radiation which was much more readily absorbed by air and aluminium than the  $\alpha$  radiation from polonium. The presence of a  $\beta$  radiation, producing over ten per cent of the total ionization, was also noted. The first measurements were thought to indicate a high absorption, but on comparing the results with those obtained by Levin\* for uranium X, it was found that the coefficient of absorption for the  $\beta$  rays was the same in both cases.† That this  $\beta$  radiation was due to uranium X was also evident from the fact that it fell off exponentially with the time at a rate corresponding to half-value in about 22 days.

An attempt was then made to determine the range of the  $\alpha$  particles in air by the scintillation method, and although the difficulties were increased by the presence of a small proportion of  $\alpha$  particles of longer range emitted by the thorium products in the material, it was easily ascertained that range in air of the  $\alpha$  particles from the new substance was certainly less than three centimeters. No other radio-active element emitting rays of so short a range had been previously identified. From this and from the data obtained in the other experiments it was evident that the material in hand contained a new radio-active element and the name "ionium" was suggested for this substance.

#### *Separation of Ionium.*

As a result of further experiments it was found that highly active preparations of ionium free from appreciable amounts of other radio-active substances could be obtained in the following manner: A quantity of carnotite‡ was treated with hydrochloric

\* Phys. Zeit., viii, 585, 1907.

† Levin's measurements give the value  $17.0(\text{cm})^{-1}$  for the coefficient of absorption for thicknesses of aluminium between 0.0136 and 0.180 cm. For the same thicknesses I obtained the same value for the coefficient of absorption of the  $\beta$  rays from my preparation.

‡ The carnotite used in these and the earlier experiments was kindly sent to me by Mr. William Zowe of Uranium, Colo. I have recently obtained some very excellent material of the same sort from Mr. B. J. Manning of Paradox, Colo.



acid and several grams of rare earths from cerite in the form of chlorides were added to the solution. The earths were then separated by the method already described. The material precipitated from a solution of the earths by treatment with sodium thiosulphate was further purified by repeated precipitation with the same reagent, and the material finally obtained weighed only a little over one milligram. This material had an activity several thousand times greater than that of an equal weight of pure uranium. It contained when first prepared very appreciable amounts of uranium X, but this substance disintegrated with the time until now at the end of about five months its presence can scarcely be detected. Only a relatively small proportion of the total ionium present is obtained by this process.

*Range of the  $\alpha$  Particles from Ionium.*

Dr. L. P. Wheeler of the Sheffield Scientific School and Mr. T. S. Taylor of this Laboratory have both been so kind as to measure for me the range in air of the  $\alpha$  particles emitted by ionium. They each used a somewhat modified form of the Bragg apparatus and the measurements were conducted on a small quantity of a very active preparation. Their results, obtained independently, were in excellent agreement and gave a range for the  $\alpha$  particles of 2.8 centimeters in air (at 760<sup>mm</sup> pressure).

*Other Radiations from Ionium.*

The question as to whether ionium emits also a  $\beta$  and a  $\gamma$  radiation is still an open one, as the preparations which I have are not strong enough or old enough to make it possible as yet to reach a definite conclusion. The indications, however, are in favor of the view that ionium emits  $\beta$  rays which are more readily stopped by matter than the  $\beta$  rays from uranium X.

*Relative Activity of Ionium in Minerals.*

The results obtained on the determination of the relative activity of the amount of ionium in radio-active equilibrium with uranium and radium in a mineral have already been given in an earlier paper.\* It was found that the activity of the ionium is about 0.34 and that the activity of the radium is about 0.45; the activity of the uranium with which they are associated being taken as unity. The ratio of the activity of the ionium to the activity of the radium is therefore approximately  $\frac{0.34}{0.45} =$

\* This Journal, xxv, 291, 1908.

0.76, a value which is in good agreement with the ratio of the ranges of the  $\alpha$  particles  $\left(\frac{2.8}{3.5} = 0.80\right)$  emitted by the two substances.

#### *Life of Ionium.*

Some idea of the probable life of ionium, or, in other words, of the time which would have to elapse before one-half of a given quantity of this element would completely disintegrate into other forms of matter, can be gained from the results of experiments on the production of radium by ionium and on the growths of radium in pure uranium compounds. I have found, for example, that the rate of production of radium in a solution of ionium is constant, within the limits of experimental error, for a period of over 500 days, although a change of the rate by as little as five per cent could probably have been noted with certainty. This would indicate that the half-value period, or time required for half of a given quantity of ionium to be transformed into radium, is at least 25 years. I have also found that the amount of radium formed in a solution containing 48 grams of purified uranium in a period of over two and one-half years is probably less than  $10^{-11}$  gram, and from this result it would appear that the life of ionium is at least as long as that of radium, provided that no other product having a slow rate of change occurs between uranium X and ionium. If the life of ionium is of the same order of magnitude as that of radium, then the amounts of the two substances contained in uranium minerals should be approximately equal. If this is the case, then it ought to be possible ultimately to obtain preparations of pure ionium, just as it has been found possible to obtain pure radium salts. By a comparison of the activity of a known amount of pure ionium with the activity of a definite quantity of pure uranium oxide it would be a simple matter to determine the relative amounts of these elements contained in a mineral.

#### *Ionium in Pitchblende Residues*

Through the kindness of Professor Rutherford and the Royal Society of London it has been possible for the writer to examine a small quantity of material which had been separated from the pitchblende residues presented to the Royal Society by the Austrian Government. The material was in the form of a crude hydroxide containing polonium, actinium, radium, lead, zinc, and a large number of other elements, and weighed, in the form of a wet paste, about 180 grams. It was treated with hot dilute hydrochloric acid, the silica was

removed and the substances precipitated by hydrogen sulphide were separated. The filtrate from the sulphides was treated with an excess of oxalic acid, the oxalates were further purified, and treated, as chlorides, with an excess of sodium thio-sulphate. After repeated precipitation with thiosulphate a few milligrams of material which was free from actinium and actinium products was finally obtained. This material contained ionium having an activity about equal to that of a half gram of pure uranium. The almost complete absence of thorium in this product was quite unexpected, and it is not impossible that the thorium and ionium may have been undesignedly separated in the early treatment of the residue. It is not unlikely, moreover, that the greater proportion of the thorium and ionium present in the original mineral is not retained in the insoluble residue but is removed with the crude uranium salts which are separated in the technical process of manufacture.

#### *Production of Ionium by Uranium.*

If ionium is produced directly from uranium X it ought to be possible under suitable conditions to determine this fact by direct experiment. With this object in view I have made some preliminary experiments, using a portion of my carefully recrystallized uranium nitrate\* prepared nearly four years ago. By certain chemical operations, it was found possible to separate a small quantity of material free from uranium and emitting an  $\alpha$  radiation. The final, permanent activity of this substance was slight, but was of about the magnitude to be expected for the activity of ionium if this had been formed directly from the uranium. Further experiments on larger quantities of uranium salts are now in progress and it is hoped that the question of the production of ionium by uranium can ultimately be decided with a satisfactory degree of certainty.

#### *Chemical Properties of Ionium.*

The chemical properties of pure ionium can not be definitely determined until it has been possible to examine weighable amounts of this element. But from the data which has been already obtained it would appear probable that it belongs to the group of elements commonly known as the rare earths and forms salts which are in general isomorphous with those of thorium. The separation of ionium from thorium presents indeed a difficult problem, and I have been unable to discover any indications that even a partial separation can be effected by the use of such characteristic reactions as the precipitation

\* This Journal, xx, 239, 1905.

of the thorium by hydrogen peroxide, sodium thiosulphate, meta-nitro-benzoic acid or fumaric acid. From its position with respect to radium it can be safely assumed that the atomic weight of ionium is probably not far from 230, and the atomic weight of thorium, 232.5, would bring these two elements into close proximity in the periodic table.

By observations of the growth of radium in purified salts of thorium obtained from monazite by commercial methods, Hahn\* has demonstrated that ionium is also contained in these compounds.

#### *General Discussion of Results.*

It appears highly probable from the data now available that, in the earlier experiments of Debierne, the material which he described under the name of "actinium" consisted in reality of a mixture of ionium with the element first definitely identified and described by Giesel under the name of "emanium." Debierne's statement, quoted in the introduction, that he had used in his experiments only preparations which had retained a constant activity for a certain time, while not very explicit, would at least appear to exclude the possibility that the incorrect chemical properties which he attributed to what is now known as actinium can be explained by any other assumption. That Giesel's preparations of the "emanating substance" have in one case, at least, contained appreciable amounts of ionium, is evident from the results obtained by Rutherford on the growth of radium in a specimen of this material.

The anomalous behavior of the thorium separated from uranium minerals by Hofmann and Zerban can also be explained without difficulty. In those cases where a permanent high activity was shown by the thorium it was probably due to a relatively high proportion of ionium in the preparation. When the freshly separated thorium contained radio-actinium, the activity at first rose and later fell with the time; when actinium itself was present the activity rose only. It is probable that the radio-active measurements were not sufficiently sensitive to detect the activity of thorium and its products when not accompanied by other active substances, so that when thorium was separated from minerals containing but a small proportion of uranium it was erroneously assumed to be inactive.

The existence of ionium also has a bearing on the conclusion reached by Hahn† that thorium itself on disintegrating emits an  $\alpha$  radiation. Hahn has published as yet no quantitative data in regard to this matter, but measurements which I have

\* Ber. d. chem. Ges., xl, 4415, 1907.

† Ibid., xl, 3304, 1907.

carried out by a method similar to that which he has described would appear to indicate that the activity which can be attributed to thorium, from monazite, when free from all thorium disintegration products can not be greater than about seven per cent of the activity of the same thorium when equilibrium amounts of its disintegration products are present. This is so nearly of the same order of magnitude as the relative activity of the ionium undoubtedly associated with the thorium, that there would appear to be some question as to the correctness of Hahn's conclusions.

The results which I have obtained on the rate of growth of radium in solutions of ionium, indicating that the half-value period of radium is about 2000 years, will be given in a later paper.

*Summary.*

It has been found that uranium minerals contain a new radio-active element, to which the name "ionium" has been given. The chemical behavior of ionium is similar to that of thorium, from which it can not be separated by the usual reactions characteristic for thorium.

Ionium emits an  $\alpha$  radiation having a range of about  $2.8^{\text{cm}}$  in air, and probably also a  $\beta$  radiation. Results obtained on the growth of radium in solutions of ionium indicate that it is the immediate substance from which radium is formed. It is therefore undoubtedly a disintegration product of uranium intermediate between uranium X and radium. The relative activity of radium and ionium in minerals is in agreement with this assumption.

New Haven, Conn.,  
February 28, 1908.

ART. XLI.—A *Mid-Cretaceous Species of Torreya*; by  
EDWARD W. BERRY.

DURING a geological reconnaissance undertaken in the summer  
of 1907 under the auspices of the North Carolina Geological



FIG. 1. Type specimens of *Turion carolinianum*.  
FIG. 2. Single leaf showing stomatal bands,  $\times 3$ .

Survey\* a fossil plant locality of mid-Cretaceous age was discovered on Rockfish creek, about a mile east of Hope Mills, in Cumberland county, N. C. Among the specimens found† were several representing a new species of the genus *Torreya*, or *Tumion*, as the nomenclatorial experts now insist it must be termed.‡ They are of interest since they present some features in addition to the general resemblance of external form in support of the identification. These are especially welcome, since it has frequently been shown that similarities in form between the Mesozoic and modern Conifers cannot be relied upon as indices of relationship with any degree of certainty. The species may be characterized as follows:

*Tumion carolinianum* sp. nov.

Leaves flat, somewhat rigid, linear-lanceolate, gradually tapering to a slender point from the broad, but slightly contracted, decurrent base, 25-30<sup>mm</sup> long and up to 3<sup>mm</sup> in greatest width, averaging somewhat more than 2<sup>mm</sup>, arranged in a rather close spiral and apparently not distichous in habit. Mid-vein absent, but in strong transmitted light a darker, i. e., more opaque, central band gradually dying out and presumably of vascular tissue is seen in the basal third of the leaf; this is not a surficial feature, however, since both the dorsal and ventral surfaces are unmarked centrally. In strong transmitted light the two stomatal bands characteristic of the modern species are fairly well shown after the leaves have been appropriately treated to reduce their opacity. These bands are narrow and their inner margin is just about  $\frac{1}{2}$  of the distance across the leaf, i. e., they are slightly nearer the margin than the median axis; they are confined to the ventral surface and die out apically, becoming well marked proximally, and are made out with difficulty in the upper half of the leaf. The stomata are confined to the surface of these bands and are without orderly arrangement, usually not more than four in a transverse direction. These stomata are of medium size and strictly comparable with those of the existing American *Tumions*, with which comparisons have been made; the guard cells are slender and their orientation with respect to the leaf axis is indefinite with apparently a prevailing tendency in the material examined to a position at right angles instead of one parallel with this axis, as is the case in the living material seen.

This restriction of the transpiratory surface in *Tumion* and other *Taxeæ* to two narrow ventral bands with the stomata more or less confined to the basal half of the leaf and more or less protected in this Cretaceous species by the arrangement of the leaves in rather dense spirals, might be taken to indicate

\* Coöperating with the United States Geological Survey.

† Additional collections were made at this locality later in the summer by Dr. L. W. Stephenson of the Federal Survey.

‡ *Torreya* was used at least three times as a generic name in three different families before 1838, the date when Arnott proposed it for these plants.

a decided xerophytic habitat, but this does not accord with the evidence of the associated flora, and the most reasonable conclusion seems to be that this feature is rather to be correlated with stem structure, i. e., to primitive water-conducting tissues; or as an inheritance from still older and more primitive plants in which the vascular structure was still simpler. In fact it seems quite probable that in dealing with modern plants, one standard of values will have to be adopted for

3

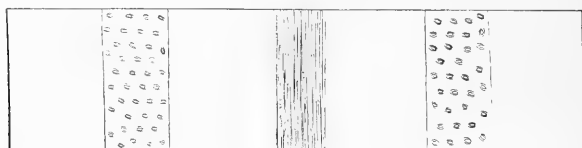

Part of ventral surface of leaf showing stomata,  $\times 30$ .

Angiosperms and another for Gymnosperms, since the latter combine a usually marked xerophytic leaf-structure with habitats not essentially xerophytic; or as recently suggested by Moss,\* comparisons between mesophytic deciduous vegetation or herbaceous plants dying down in the Fall, which amounts to the same thing, and evergreen Gymnosperms, should be on a basis covering the whole year, when it will be seen that the latter are not xerophytes in the proper sense of the term. When the present distribution of the species of *Tumion* is considered,† it must be evident that the genus is not strictly a member of the existing flora, but a relic of a prehistoric one in which it was a far more abundant and widespread element, and it seems quite probable that many centuries will not elapse before it becomes entirely absent in the living flora. The almost extinct *T. taxifolium* making its last stand on the narrow ridges that extend out into the Apalachicola river swamps, separated by over 3000 miles from *T. californicum* of the mountains of California,‡ and this in turn separated by the breadth of the Pacific from the two species restricted to the mountains of China and Japan,§ all point to the same conclusion. When we turn to the geological record we find it so meager and incomplete that it does not, as yet, possess

\* New Phytologist, vol. vi, pp. 183-185, 1907.

† This peculiar distribution was dwelt upon by Prof. Asa Gray in his presidential address before the American Association for the Advancement of Science at Dubuque, Iowa, in 1872.

‡ Mendocino county to the Santa Cruz mountains along the Coast Range and somewhat more abundantly at middle altitudes on the western slopes of the Sierra Nevadas.

§ *T. nucifera* of the mountains of Nippon and Sikok and *T. grandis* of the mountains of northern China.



much value except that it shows the existence of species of *Torreya* and of forms resembling the allied genus *Cephalotaxus* in sediments of older Cretaceous age, Fontaine having described two species from the Potomac group of Virginia, while Heer described two species from the nearly homotaxial Kome beds of the west coast of Greenland. To mention a few later records, a species has been described from Colorado and doubtfully referred to the Dakota group (mid-Cretaceous), an upper Cretaceous form is recorded from Protection Island, a supposed Senonian species from Alaska, an Eocene form from Greenland, a species of unknown age from Northwest Territory, and Saporta and Marion have described a form from the French Pliocene which they were unable to separate from the existing *T. nucifera*, calling it *var. pliocenica*. Finally it may be suggested that some of the impressions of coniferous twigs which have been identified as referable to *Sequoia* may more properly be considered as related to *Tumion*. It might be added that the writer is simply quoting the record in the foregoing cases and in no way vouches for the identifications of the various authors.

The genus *Tumion* with *Taxus* and *Cephalotaxus* constitute the subfamily *Taxeæ* of the family *Taxaceæ*, the other subfamily being the *Podocarpeæ*. The latest treatment of the *Taxaceæ*, that by Pilger in 1903 (*Engler's Pflanzenreich*), erects a third subfamily, the *Phyllocladoideæ*, and subdivides the old *Taxeæ* into the *Cephalotaxeæ* and the *Taxeæ*, but the wisdom of this grouping is not especially obvious.

The relative antiquity and consequent relation of the *Taxaceæ* to the *Abietæ* is a much mooted question. The older view that the *Taxaceæ* were a simpler and more primitive type, the view of Strasburger, Coulter, Worsdell, etc., has been questioned of late years by Jeffrey, Thomas, Lawson, etc., who regard them as more specialized and argue that the *Abietæ* are to be regarded as the more primitive group. Robertson in a recent paper\* has ably summarized the arguments for both sides, her own studies pointing to the correctness of the older view. It would seem that this was a question to be ultimately decided by the evidence of the fossils themselves rather than by the presence or absence of a megaspore membrane, ventral canal cell, or prothallial nuclei in the pollen. Confining our attention to the genus *Tumion* it may be noted that the pollen-sacs are usually four in number, a case of reduction from the still more numerous pollen-sacs of *Taxus* as Coulter and Land have shown, a feature which should surely be regarded as relatively primitive. Again, the vascular anatomy

\* *New Phytologist*, vol. vi, pp. 92-102, 1907.

of the large erect seeds is regarded by Oliver\* as distinctly ancient and peculiar among recent plants. Omitting arguments drawn from the unspecialized secondary phloëm, reduced archegonia, two cotyledones, etc., which may be susceptible of more than one explanation, it may be added that the present geographical distribution of *Tumion* indicates considerable antiquity. Add to this the evidence of its existence in the oldest Cretaceous along with forms which are seemingly close to *Cephalotaxus*, i. e., *Cephalotaxopsis*, and it would seem that there are strong grounds for the belief that the *Taxeæ* are, at least, a very old stock, even if we are not quite prepared, as yet, to follow them back to the Paleozoic Cordaitales.

Johns Hopkins University, Baltimore, Md.

\* *Annals of Botany*, vol. xvii, p. 451, 1903.

ART. XLII.—*The Cranial Musculature and the Origin of the Frill in the Ceratopsian Dinosaurs*; by RICHARD S. LULL. (With Plates I to III.)

DOLLO (1884) in his fifth note on the Dinosaurians of Bernissart has discussed the muscles of mastication of certain dinosaurs in comparison with those of a rodent, a crocodile, and a chameleon. This work has suggested to the writer a further study of the musculature of the skull, especially in the Ceratopsia, with a view of gaining an insight, if possible, into the origin of the peculiar defensive cranial armor of this remarkable group.

These studies are based more particularly on the type skulls of *Triceratops serratus* and *T. prorsus* Marsh which are preserved in the Peabody Museum at Yale, supplemented by an admirable palate, referred to the former species, in the American Museum of Natural History. The chief basis for comparative study has been the modern chameleon, which, as the author will show, exhibits some very remarkable points of convergence in structure toward the Ceratopsia.

#### PART I. *Musculature.*

##### *Muscles of mastication.*

The Iguanodont dinosaurs differed from all other reptiles in their method of feeding in that they were herbivores which *masticated* their food, thus requiring a development of muscles, especially the temporal, rare among reptiles. Chameleons, though insectivorous, and having the tongue for prehension, use the teeth, not for holding, but for chewing the firm-bodied Orthoptera and Lepidoptera which constitute their food. There is thus an analogy between the chameleons and the Iguanodontia in contrast to the carnivorous dinosaurs which, like the crocodiles, used the jaws for holding and tearing the prey rather than for mastication. The chameleons have enormous temporals, while in the crocodiles, as Dollo (1884) has shown, the temporals are relatively small and the pterygoid muscles, which in chameleons are feeble, are correspondingly large. In other words, the temporals are the larger in masticating forms; the pterygoids where the jaw function is largely one of resistance and, correlated with the development of the temporals, there is a corresponding development of the coronoid process of the jaw. In *Triceratops*, and other Ceratopsia, the jaw is powerful, articulated to a rigid suspensorium consisting of the quadrate, quadrato-jugal and the strong overlying jugal. The two dentaries meet in symphysis and their union is further strengthened by the massive predentary bone

which bore the lower beak. The teeth form an admirable chopping mechanism, shearing vertically past those of the upper jaw. The worn face of the entire tooth series, however, is not a perfect plane but is slightly twisted, being somewhat oblique at the posterior and becoming vertical at the anterior end of the row. The worn faces of the individual teeth exhibit in some instances tiny oblique striæ passing upward and backward across the enamel in those of the lower jaw. These would seem to indicate the direction of wear. The articulation of the jaw is such as to permit some freedom of

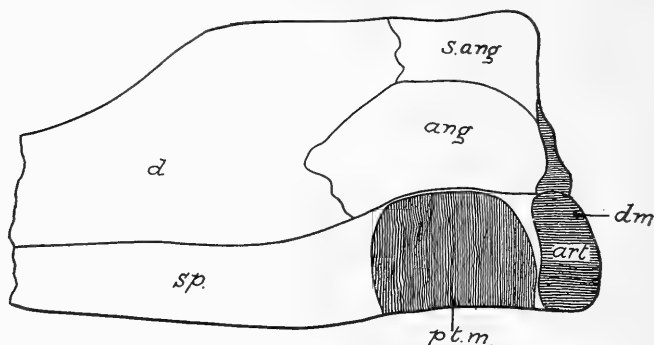

FIG. 1. Under side, rear, of lower jaw of Triceratops.

motion, and, judging from these facts, it would seem as though the jaw movement was in the main vertical, with a slight lateral motion either to the right or left at the beginning of the upward movement. When the final closure is reached the jaws would, however, be in perfect alignment, enabling the upper and lower beaks to form a perfect, turtle-like shear. There may have been a slight movement to the rear, which would account for the oblique striæ on the teeth; a forward movement would of course be out of the question on closure, as it would cause the wedge-shaped mechanism to bind.

Muscle insertions are indicated on the jaw, first on the rear margin of the very high coronoid process for the temporal muscle; on the inner lower margin of the splenial and dentary for the pterygoid muscles and on the lower face of the articular, angular, and splenial for the digastric or *depressor mandibuli* (fig. 1). A passage on either side leads upward and backward within the bones of the cheek, above the quadrate and exoccipital, and finally opens upon the upper surface of the frill through the *supratemporal fossa*. These are evidently the tracts wherein lay the temporal muscles, having

their origin on the dorsal surface of the parietals, one on each side of the median ridge of the frill and passing directly downward and forward to be inserted into the posterior margin of the coronoid process (Plate I). The direction of pull is met by that of the quadrate, whose oblique position is such as to withstand the strain to the best advantage. The high coronoid gives a long power arm which, though at an angle of  $90^{\circ}$  with the axis of the jaw, affords admirable leverage for the masticatory movements. The pterygoid muscles, both external and internal, must have been present; their direction of pull was more nearly vertical, and, while not strongly developed, they undoubtedly seconded the temporal muscle to a certain extent and guarded against dislocation.

A masseter muscle may also have been present having its insertion along the coronoid process just outside of that of the temporal and arising from the forward margin of the jugal bone.

The jaw was opened by means of the *depressor mandibulæ*, having its origin on the posterior and inner face of the quadrate, possibly to a certain extent on its outer face, as well as upon that of the quadratojugal. This was a rather broad, sheet-like muscle of moderate thickness and was inserted, as indicated above, into the lower aspect of the articular, angular, and splenial, possibly to a slight extent on the surangular. Cheek muscles must have existed, originating on the outer side of the maxillary and the posterior portion of the premaxillary as indicated by a sudden inward compression of the lower portion of these bones along a line running obliquely downward and forward from the jugal to the lower margin of the premaxillary bone. The insertion of this muscle lies along the forward margin of the coronoid and sweeps forward along the outer surface of the jaw, finally rising again to the end at the upper termination of the dentary-predentary suture. This broad sheet of muscle, probably equivalent to the buccinator, was subsidiary to mastication, as its chief function was to retain the food in the mouth. The extent of this muscle limits the backward extent of the gape of the mouth, as the writer (Lull, 1905) has shown in previous papers.

#### *Muscles of the Neck.*

The occipital condyle is hemispherical and fits into a correspondingly deep depression in the atlas. The extent of the two articular surfaces is so nearly equal that a very slight movement of the cervicals causes one facet to go past the limits of the other, as verified by actual experiment. This would seem to imply a very limited range of movement at this point, the hemispherical condyle being an ancestral feature retained

in order to allow a rotary motion of the skull, as the usual mechanism for permitting this movement, the articulation between the atlas and axis, by means of an odontoid process, is wanting, the first four cervicals being immovably coössified. The chief movement of the head seems to have been accomplished by the bending of the neck as a whole. The normal posture of the head was depressed, the muzzle coming rather near the ground. The proof of this lies in the fact that the condyle is borne on a stalk or peduncle which is bent downward at an angle with the longitudinal axis of the skull. If the cervical vertebræ are not in line with the axis of the condyle, it not only produces what engineers call an "invert joint", an extremely weak structure mechanically, but the articular facets no longer coincide. Plate II serves to illustrate this matter.

The ring-like atlas bears no transverse or other processes, which, together with the fact that movement of the anterior cervicals is so limited, makes it probable that some of the muscles which are ordinarily inserted into the atlas have been transferred to the occipital region of the skull. The rear of the skull and the inferior surface of the frill exhibit a number of well-developed muscle depressions which may be interpreted as follows:

The basioccipital shows, on either side of the median line beneath, a deep depression, the insertion of the *rectus capitis anticus longus* (*rl*) muscle, which has its origin on the ventral aspect of the cervical vertebræ from the axis backward (Plate II). This doubtless served to depress the skull and was a muscle of moderate power. Smaller depressions, also in the basioccipital, lying without the first mentioned, seem to have been the insertions of the *rectus capitis anticus brevis* (*rb*), the origin of which was on either side of the axis. This was also a depressor muscle of the skull as well as one which swayed it from side to side but was relatively feeble, being in all probability passively resistant rather than active in its function. On either side of the foramen magnum may be found small depressions evidently for the insertion of the *rectus capitis posticus minor* (*rmi*), which in the turtle arise from the neural arch and diapophyses of the atlas. In *Triceratops* the point of origin was probably shifted backward to the axis.

Above, the supraoccipitals show large depressions into which were inserted the *rectus capitis posticus major* (*rma*) muscles, which arose from the neural spine of the axis. These were muscles of considerable volume and aided in raising, or rather in supporting the head. Thus there seem to have been, as in the turtle, four pairs of muscles running from the anterior cervicals

to the occipital bones, of which the dorsal and ventral ones were powerful, the lateral ones relatively feeble.

Just above the foramen magnum in the supraoccipital bone lie two deep depressions separated by a thin lamina of bone. These are continuous with a median groove on the ventral surface of the parietal extending backward about two-thirds of the distance toward the margin of the frill. Along the center of this groove lies a slight ridge running backward for about half its distance, the precise extent being variable. This ridge is continuous with the lamina which divides the depressions in the supraoccipital. In the two specimens of *Triceratops serratus* the parietal groove fades out toward the rear, while in *T. prorsus* it ends abruptly and is quite deep at the posterior end. Just beneath this groove when the cervicals are *in situ* lie the neural spines of the second, third, and fourth vertebræ, which are depressed backward so as to lie nearly parallel with the under surface of the frill. There can be no question that we have here the insertion on the skull of the *complexus major* muscles, which arose from the cervical spines and expanded upward and forward in a pair of relatively thin sheets as in the chameleon. These muscles were of prime importance, not alone in fulfilling the function of the *ligamentum nuchæ* of the mammal, but also from a developmental standpoint, as will ultimately be shown. They served to maintain the poise of the skull and were probably, as in recent reptiles, continuations of the *longissimi dorsi* which run the length of the back. At the extremities of the exoccipitals and upon the adjacent ventral surfaces of the squamosal bones are large, depressed muscle areas which were confluent. These, if taken collectively, were the insertions of the largest muscle masses of the neck, those which, lying as they did in the wake of the supra-orbital horns, bore the brunt of the strain, in wielding these powerful weapons (*vide infra*, p. 395). It is somewhat difficult to homologize these muscles with accuracy but they must have included the *complexus minor*, the anterior prolongation of the *latissimus dorsi*, the insertion of which is normally in the exoccipital. The under surface of the frill shows other somewhat variable depressions, notably in the parietal bone near the squamosal suture. These are well out toward the periphery of the frill (Plate III). I am not sure of their identity, but it is reasonable to suppose that the whole neck of the creature must have been enormously muscular, covering the entire lower surface of the frill except for its free margin, the extent of which is a specific variation).

From the frequency with which one observes injuries, perforations and fractures, upon the ceratopsian skull, I cannot believe that the powerful armament of the horns was for mere

passive defense. Many of the injuries are such that none other than a Ceratopsian could have inflicted them, and this, together with the fine mechanical development of the great muscles, especially those in the wake of the supraorbital horns, shows that, in spite of apparent unwieldiness, *Triceratops* was an aggressive fighter when thoroughly aroused. In the type skull of *Diceratops hatcheri* Lull (1905) in the United States National Museum, the so-called foramina through the anterior part of the squamosal bones almost entirely obliterate the insertion of the *complexus minor* muscle of the left side, and partially obliterate that on the right. Enough, however, remains to indicate that the muscle depressions were precisely as in *Triceratops*. This strengthens the conviction which the writer has always had, that these perforations are entirely pathologic; moreover, the wounds must in large measure have disabled the animal and may ultimately have caused its death, though it lingered on long enough for the broken margins of the bone to heal, a matter of a few weeks.

#### PART II. *Origin of the Crest.*

The crest, which is so characteristic of the Ceratopsia, has its parallel in the so-called casque of the chameleon skull. The

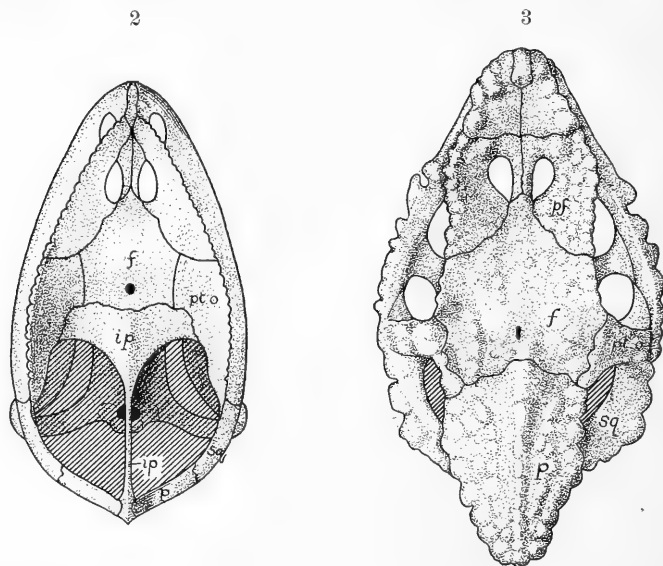

FIG. 2. *Chameleo vulgaris*; adapted from Parker.

FIG. 3. *Chameleo pumilis*; " " "

latter, however, while variably developed in different species of chameleons, never reaches the extreme degree of perfection which was attained by *Triceratops*.



In the chameleon the casque generally contains five bony elements: a median interparietal, two lateral squamosals, and, connecting these in the rear, a pair of slender parietal bars (fig. 2). These structures enclose two lateral supratemporal fossæ generally of large extent, though in some species, as *Chameleo pumilis* (fig. 3), much reduced owing to the great development of the parietal elements of the crest. (Parker 1881, p. 97.) In the *Triceratops* the crest contains the same elements except that the parietal region is composed of but one bone, no trace of sutures having been found as yet. Here the supratemporal fossæ are relatively small and do not lead directly through the crest or frill but downward and forward

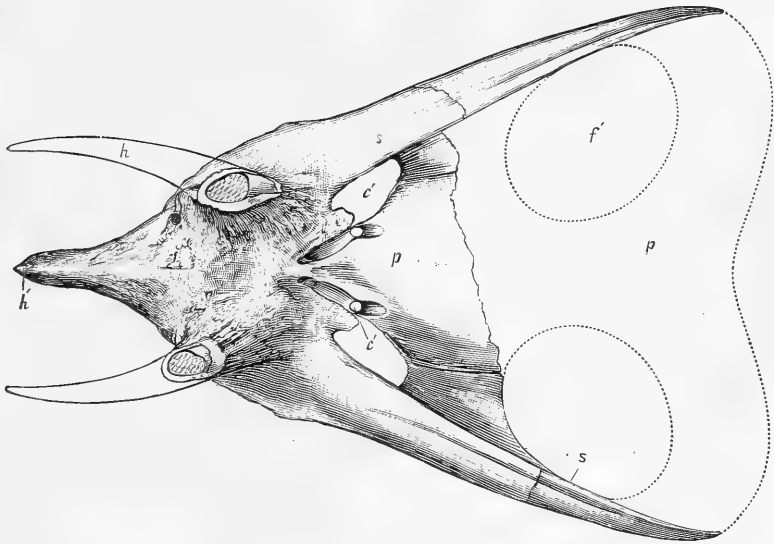

FIG. 4. *Torosaurus latus*; skull, top view.

beneath the postfrontal bones and above the exoccipitals and jugals into the spacious cavities within the false roof of the skull (*vide infra*, p. 395), fig. 6.

In the Judith River genera, *Ceratops*, *Monoclonius*, and *Centrosaurus*, and in *Torosaurus* of the Ceratops beds, the crest is perforated by a pair of relatively immense parietal fenestræ, absent in *Triceratops* and its near relative *Dicera-*  
*tops*. These fenestræ seem at first sight to be the equivalents of the supratemporal fossæ of the chameleon, as their relationship with the bony elements of the frill is practically the same. This I believe to be partially true: the fenestræ in the Cera-

töpsia representing the space between the median and lateral elements of the parietal region which has been constricted off from the present supratemporal fossæ by a union of the parietal elements at their anterior end. Evidence in favor of this view is seen in the type specimen of *Torosaurus latus* Marsh, here figured (fig. 4), in which a distinct suture may be seen on either side leading from the parietal fenestra forward to the supratemporal fossa and representing the line of final closure of the bony bridge separating the two openings. *Torosaurus gladius* Marsh has a faint indication of the same suture, thus exhibiting a greater degree of specialization than its ally. *Centrosaurus apertus* Lambe from the Judith river beds also has indications of the same suture (fig. 5), while in the specimen of *Monoclonius crassus* Cope from the same horizon the suture probably existed if indeed the closure was complete.

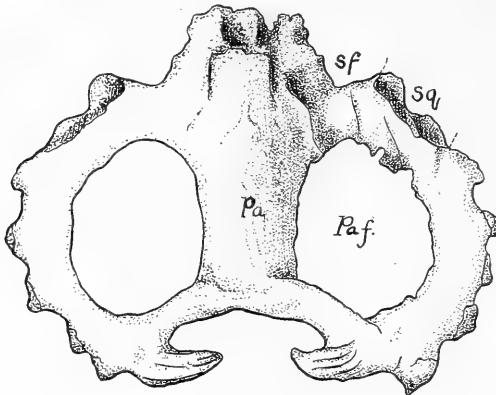

FIG. 5. *Centrosaurus apertus* Lambe ; modified from Lambe.

The bone is fractured at this region, unfortunately in the only known specimen, so that this question cannot be decided. In *Ceratops canadensis* Lambe, also from the Judith river, the squamosal is relatively much larger than in most of its contemporaries and the lateral element of the parietal, the only part preserved, is a slender bar of bone which did not unite with the median element forward (fig. 7). It is probable, however, that the shutting off of the fenestra from the supratemporal fossa was effected by the widening of the anterior portion of the median parietal element to meet the squamosal. In *Triceratops* the final closure of the parietal fenestræ is effected by a continuous growth of bone over the entire parietal region of the frill (fig. 6). This bone is, however, extremely thin in what would be the anterior

part of the fenestra if it were present and which probably represents the point of final closure of that aperture.\*

There is a very precise analogy between the crest of a chameleon and that of the Ceratopsia, as it is primarily, in each instance, merely a backward extension of the parietal segment of the skull to obtain a greater area for the origin of the temporal muscles. This backward extension of the median region especially gave greater area for the *complexus major* muscles, which could then extend from their old insertion on the supraoccipital backward along the interior surface of the median parietal bar (interparietal), giving greatly increased leverage in wielding the head.

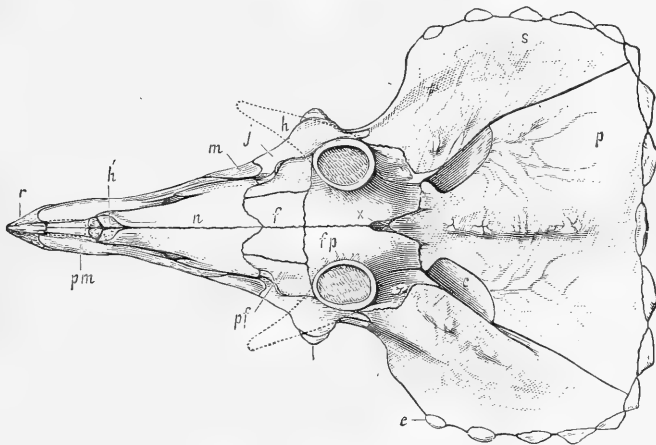

FIG. 6. *Triceratops serratus*.

There seems to be an interesting correlation between the development of the squamosal elements of the frill and that of the paired horns. The broadening squamosals evidently increased in size to allow for the extension of the great lateral muscles of the neck from their original insertion on the exoccipitals (*vide supra*, p. 391). This not only provides for larger and more powerful muscles, but also gives greater leverage in wielding the supraorbital horns. *Centrosaurus apertus* Lambe (1904) (fig. 5) had a straight, powerful nasal horn, evidently its chief weapon, and extremely small squamosals, as shown by the very short parieto-squamosal suture, the major part of the crest being composed of the parietal elements. In the Judith

\* *Triceratops* and *Torosaurus* it must be remembered, while contemporaneous, are not directly related, but represent parallel races derived independently from Judith river ancestry. In *Torosaurus* the parietal fenestrae were persistent. (Lull, 1908, p. 101.)

River *Ceratops canadensis* Lambe (1904) in which the supra-orbital horns are powerful, backwardly curved weapons, the squamosals are large, as shown in figure 7. The squamosals are important elements of the frill in all of the later genera, in which the nasal horn is retrogressive and the supraorbitals all important.

Though primarily to provide muscular insertion and leverage, the protective function of the frill was gradually assumed. First along the spine, then along the area of the great veins and arteries of the neck and finally as a complete armor for



FIG. 7. *Ceratops (Monoclonius) canadensis* Lambe ; after Lambe.

the entire neck. In *Torosaurus* this final condition was never reached even though the offensive armament was fully equal to that of *Triceratops*, while in the last mentioned type the ideal frill was attained with its flaring margin armed with epoccipital bones, giving it a serrated edge which may have aided in aggressive warfare. (Compare figs. 4 and 6.)

All Iguanodont skulls which the author has seen exhibit a rudimentary crest, with its primary function of attachment for the temporal muscles ; but only in the Ceratopsia has the backward extension for wielding the head and finally for protection of the neck been attained among dinosaurs. (Figs. 8, 9.)

### PART III. *Convergencies.*

The distinctively Ceratopsian features are mimicked in a most remarkable manner by other reptiles, notably the turtles and chameleons.

With the turtles the features in common are the upper and lower beak and the curious false roofing of the skull above the brain case, so that both the turtles and Ceratopsia give the

impression of a mental capacity far beyond the actual size of the brain. In each case the large, seemingly massive skull is composed of extensive plates of bone bridging over cavernous spaces within, giving great superficial extent for mechanical needs with comparatively little expenditure of osseous material.

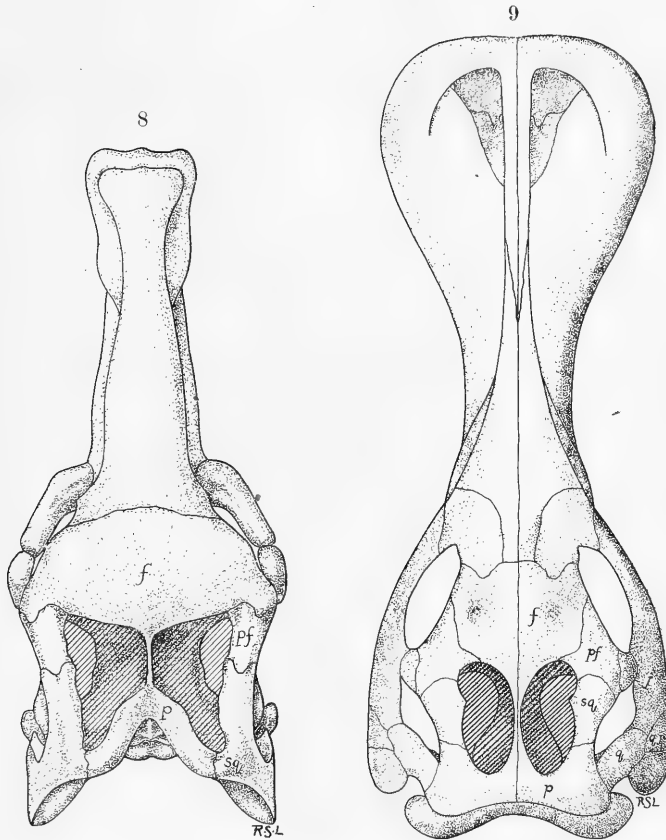

FIG. 8. *Iguanodon bernissartensis*; adapted from Dollo.  
FIG. 9. *Trachodon mirabilis*; after Cope.

*Meiolania*, a chelonian from the Pleistocene of Lord Howes Island and Queensland, has even developed horns, at first sight extremely suggestive of those of the Ceratopsia though situated too far back over the occiput for a precise homology.

The most interesting instances of convergence are with the chameleons, the likeness of whose casque to the Ceratopsian crest has been emphasized. The Dwarf chameleon *C. pumilis*

(fig. 3) has perhaps the most *Triceratops*-like crest, but the culmination is seen in the male of the little *Chameleo owenii* from Cameroon (fig. 10), as it not only has a fairly perfect frill but three horns as well, one upon the nose and a pair above the eyes precisely as in *Triceratops*. There is, however, this distinction; the horns in the chameleon are entirely epidermal, having no bony horn cores, and are confined to the male, whereas a hornless *Triceratops* has never been found. In

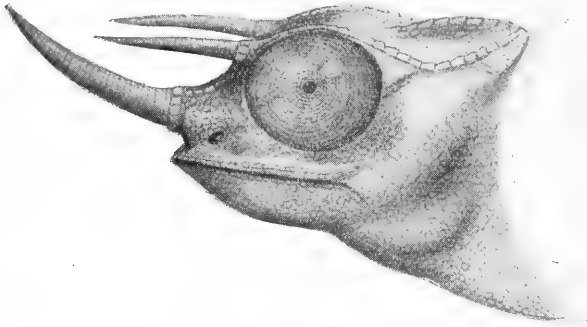
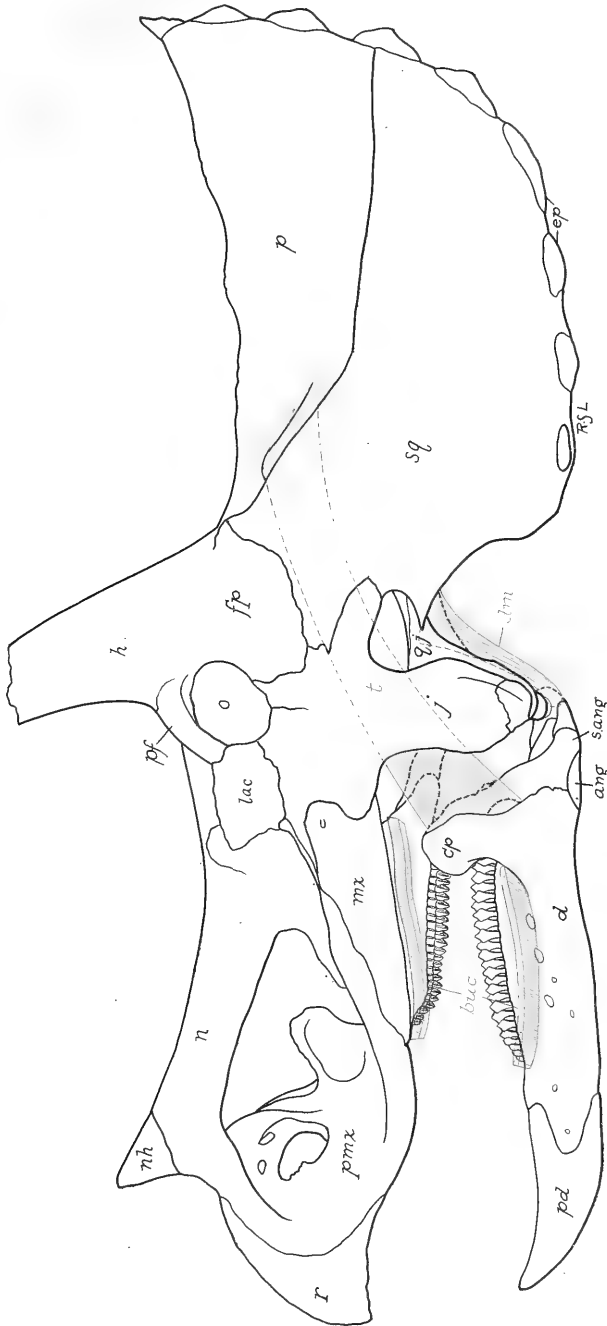

FIG. 10. *Chameleo owenii*; adapted from Metcalf.

Chameleon they seem to be the result of sexual selection and are certainly not for aggressive warfare in a creature which moves with the utmost caution, while in *Triceratops* the presence of efficient weapons in both sexes was an imperative factor in the struggle for existence.

#### *Bibliography.*

1884. Dollo, L.: Cinquième note sur les Dinosauriens de Bernissart. Extrait du Bulletin du Musée Royale d'hist. nat. de Belgique, T. iii, pp. 136-146, pl. vi.
1904. Lambe, L. M.: On the squamoso-parietal crest of the horned Dinosaurs *Centrosaurus apertus* and *Monoclonius canadensis* from the Cretaceous of Alberta. Trans. Roy. Soc. Canada (2), vol. x, sect. iv.
1905. Lull, R. S.: Restoration of the horned Dinosaur *Diceratops*; this Journal (4), vol. xx, p. 420.
1908. Lull, R. S.: The Ceratopsia, Monograph xlix, U. S. Geol. Surv., part ii (only).
1896. Marsh, O. C.: Dinosaurs of North America, 16th Ann. Rept. U. S. Geol. Surv., part i.
1870. Mivart, St.G.: On the Mythology of *Chameleon parsoni*. Proc. Zool. Soc. London, 1870, pp. 850-890.
1881. Parker, W. K.: On the Structure of the Skull in the Chameleons. Trans. Zool. Soc., vol. xi, part iii, No. 4, pp. 77-105, pls. xv-xix.



Skull of *Triceratops serratus* Marsh., with jaw muscles.





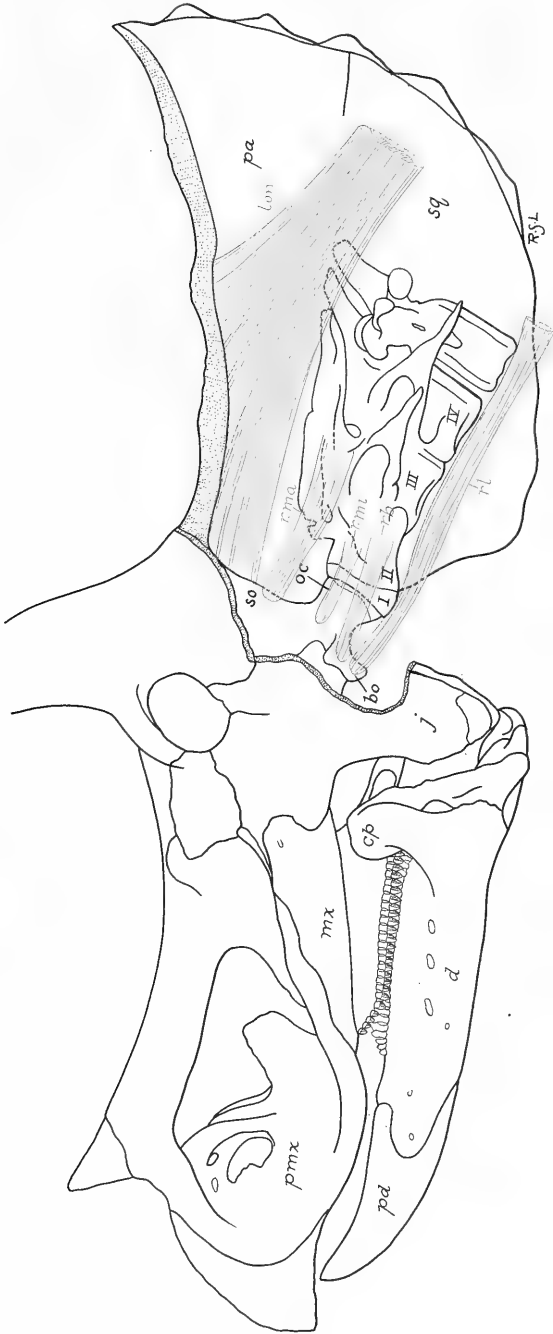

Skull of *Triceratops serratus* Marsh, with neck muscles.



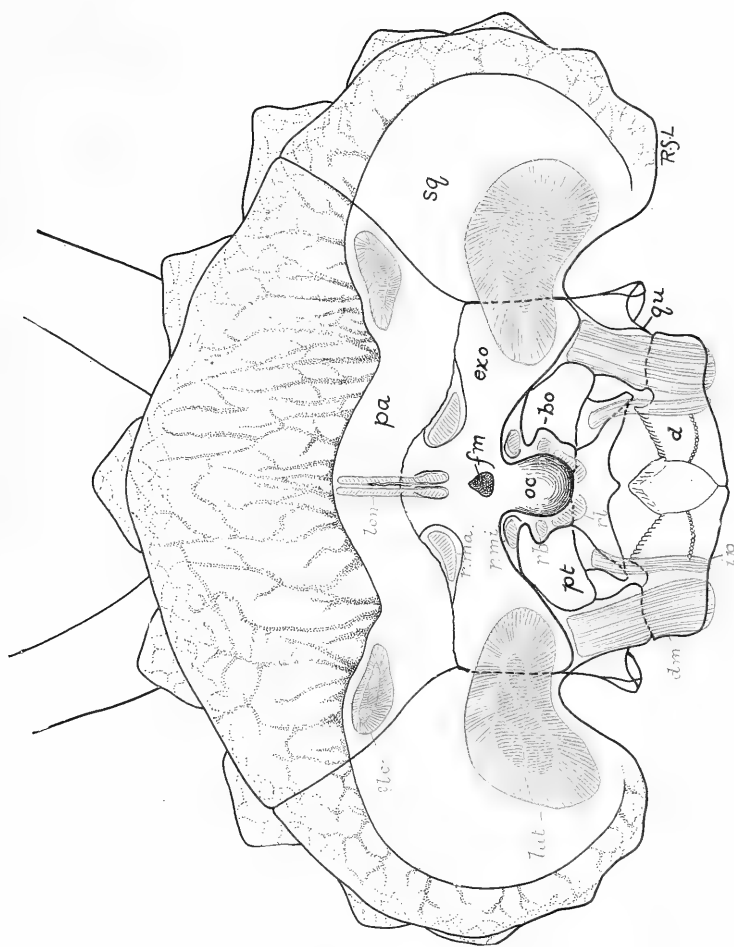

Skull of *Triceratops serratus* Marsh, rear view and muscles.



## EXPLANATION OF PLATES AND FIGURES.

PLATE I. Skull of *Triceratops serratus* Marsh, with jaw muscles (1/8).

PLATE II. Skull of *Triceratops serratus* Marsh, with neck muscles (1/8).

PLATE III. Skull of *Triceratops serratus* Marsh, rear view, with muscles (1/8). (Blood vessel impressions indicate the free margin of the frill.)

Bones: *ang*, angular; *bo*, basioccipital; *cp*, coronoid process; *d*, dentary; *ep*, epoccipital; *exo*, exoccipital; *fm*, foramen magnum; *fp*, postfrontal; *h*, supraorbital horn; *j*, jugal; *lac*, lachrymal; *m*, maxillary; *n*, nasal horn; *o*, orbit; *oc*, occipital condyle; *p*, *pa*, parietal; *pd*, predentary; *pf*, prefrontal; *pmx*, premaxillary; *qj*, quadratojugal; *qu*, quadrate; *r*, rostral; *sang*, surangular; *sg*, squamosal; I, atlas; II, axis; III and IV, 3d and 4th cervical vertebræ.

Muscles: *buc*, buccinator; *dm*, depressor mandibuli; *ip*, pterygoideus; *lat*, complexus minor (latissimus dorsi); *lc*, levator claviculæ; *lon*, complexus major (longissimus dorsi); *rb*, rectus anticus brevis; *rl*, r.a.longus; *rma*, rectus posticus major; *rmi*, r.p. minor; *t*, temporalis.

FIG. 1. Under side, rear, of lower jaw of *Triceratops serratus*.

FIG. 2. *Chameleo vulgaris*, adapted from Parker.

FIG. 3. *Chameleo pumilis*, adapted from Parker.

FIG. 4. *Torosaurus latus*, skull, top view, after Marsh.

FIG. 5. *Centrosaurus apertus*, frill top view, modified from Lambe.

FIG. 6. *Triceratops serratus*, skull, top view, after Marsh.

FIG. 7. *Ceratops canadensis*, portion of skull, side view, after Lambe.

FIG. 8. *Iguanodon bernissartensis*, skull, top view, adapted from Dollo.

FIG. 9. *Trachodon mirabilis*, skull, top view, after Cope.

FIG. 10. *Chameleo owenii*, adapted from Metcalf.

*c*, *sf*, supratemporal fossa; *f*, *paf*, parietal fenestra; shaded area, supratemporal fossa.

ART. XLIII.—*Desiccation Conglomerates in the Coal-measures Limestone of Ohio*;\* by JESSE E. HYDE.

THE occurrence of conglomeritic layers of limestone of greater or less thickness in the midst of a limestone formation is not uncommonly noted. They consist of fragments of limestone ranging in size from small shot to great bowlders several feet in diameter which may be either rounded or angular. In some instances the source of the pebbles has clearly been a regularly bedded limestone lying conformably immediately below the conglomerate, in others the beds which have furnished the material lie somewhat lower with the intervention of other strata. In many cases the conglomerate can not be supposed to represent a period of elevation, erosion and subsidence of any importance, that is, a true geological hiatus. In typical cases in mind they occur within the formation, there being no notable lithic or faunal differences between the underlying and overlying parts. They may occur singly and at widely separated intervals or in considerable numbers and only a few feet apart and may range in thickness from a fraction of an inch to several feet.

Dr. C. D. Walcott has described a number of examples of such conglomerates in rocks of Cambrian and Ordovician age and has applied to this type of deposit the name *intra-formational conglomerate*. According to his definition of the term, "an intra-formational conglomerate is one formed within a geological formation of material derived from and deposited within that formation."† In all of his examples where the thickness is mentioned the conglomerate is from two to ten feet or even more in thickness, and contains beside the smaller fragments many large ones or "bowlders," the sizes of which are not always stated but which in many cases range from two to six feet in diameter. Their origin is puzzling to say the least and Dr. Walcott's explanation is the only one that has been proposed, so far as is known to the writer.

"The presence of the conglomerates above the limestone beds, from some portion of which they were derived, leads me to believe that the sea bed was raised in ridges or domes above the sea-level, and thus subjected to the action of the seashore ice, if present, and the aerial agents of erosion. From the fact that the limestones upon which the conglomerates rest rarely, if ever, show traces of erosion where the conglomerates come into contact with them, the inference is drawn that the debris

\* Published by permission of Dr. J. A. Bownocker, State Geologist of Ohio.

† Bull. Geol. Soc. Am., vol. v, pp. 191-198. The same paper without modification and with a slight addition was reprinted in Bulletin 134 of the United States Geological Survey, pp. 34-40.

worn from the ridges was deposited in the intervening depressions beneath the sea.”\* The presence of occasional large boulders in the bedded strata either above or below the conglomerate bed is explained by dropping from floating ice.

For all the various types of conglomerate which can be included under the term intra-formational conglomerate, it is very probable that a number of different explanations are necessary. The thin brecciated layers only a few inches in thickness composed of relatively small fragments of limestone have certainly, in some instances, been formed in a manner at least different in detail from that outlined above. Walcott, from observations made on the shore of Rhode Island, suggests a method by which the formation of such breccias may take place. A thin crust of fine sand and mud which had had sufficient time to dry and harden after ebb tide, was broken up by the following flood into small angular flattened fragments which were heaped up in places several inches deep and in one case covered by sand. He suggests that if this should occur on a sinking shore line conglomerate layers like those often seen in sedimentary rocks would result.†

The purpose of the present paper is the consideration of one of these possible types, which, although apparently not of common occurrence is, nevertheless, distinct enough to be worthy of notice. It is possible that close observation may show it to be of more common occurrence than has been suspected. While in a general way formed in a manner quite similar to that suggested by Walcott as outlined in the last paragraph, it is peculiar in its details. The method of formation is briefly this: Extensive areas of lime mud may be exposed to the atmosphere either by elevation above a body of water due to land movement or by the evaporation of an enclosed body of water in which such muds exist. On drying, the surface of these lime-mud flats would become cracked and hardened, and if exposed a sufficient length of time the cakes thus formed might become hard enough to withstand more or less working over by waves on resubmergence. If it should then be covered by succeeding lime muds, the layer would constitute a true intra-formational conglomerate. A stratum so formed will probably be of no great thickness unless fragments from a considerable area should be washed into a limited one.

There are a number of conglomerates in the so-called “fresh-water” limestones of the Ohio Coal-measures which seem to have had this origin, but in only one instance is it so well shown that a detailed description is possible. In order to present this one example clearly, a brief summary of the little that is known of this type of formation is given. If further investigation

\* Bull. Geol. Soc. Am., vol. v, p. 197. Bull. 134 U. S. G. S., p. 39.

† Bull. U. S. G. S., No. 134, p. 40.

should show this to be a distinct type of conglomerate of sufficient importance to warrant its being placed in a class by itself, the name *desiccation conglomerate* will be a suitable one.

The Ames limestone lying near the middle of the Monongahela formation and from 150 to 200 feet below the Pittsburg coal is the highest of the marine formations in the Pennsylvanian series or Coal-measures of Ohio. Below it there are numerous limestones and chert beds or in some instances shale zones which carry marine faunas, but all of them are thin, although they may occur persistently over wide areas. The same is true of the Ames, which occurs at almost all points in the state where it is due, either on the outcrop or under cover, and is seldom more than three feet thick. Aside from these thin beds and the coal seams, this portion of the Coal-measures series is made up almost entirely of sandstones and argillaceous or sandy shales. The limestones constitute only a small fraction of the total thickness and are mostly of marine origin, the method of deposition of a few being unknown.

Above the Ames limestone another type of deposit makes its appearance for the first time as an important constituent of the series, the "fresh-water" limestones. In the interval between the Ames and the Pittsburg coal, shales and sandstones like those lying below the former occur throughout the state, but there also occurs here and there a thin stratum of limestone from a few inches to one or two feet thick and often traceable over several square miles with little or no variation. The horizon may be represented by a single bed or by two or three thin layers, in which case the separate layers occur as such with greater or less persistency. In general, these limestones become more numerous in passing upward, until in some cases the 25 or 30 feet or more of strata immediately below the Pittsburg coal consist of an almost solid bed of limestone. There is great variation in the succession, however, for within a few miles of such a section the Pittsburg seam may be underlain by 40 or 50 feet of massive coarse sandstone.

The Meigs Creek Coal horizon occurs with little variation about 90 or 100 feet above the Pittsburg seam and it is in this interval that the limestones are most conspicuous. In some sections, notably those of Belmont county, with the exception of one to three thin coal beds, the occasional occurrence of a sandstone several feet thick and minor beds of argillaceous shale, the section is practically composed of these limestones and calcareous shales, but in the southern part of the state along the line of outcrop they are replaced by a massive sandstone. In some sections on the extreme western outcrop, the limestones disappear to a noticeable extent and are replaced by shales. Up to 50 feet or more above the Meigs Creek Coal, the limestones are usually the predominant feature of the section, but



above this they are of less importance and occur as scattered beds in a mass of shale which in the southern part of the state is also largely replaced by sandstones.

It is difficult to characterize in a few words so variable a series as this, but the above remarks will serve to show the general method of occurrence of the limestones, which lie in extensive basins and accumulated to a thickness of 100 or 150 feet or more. During the period of deposition it is quite evident that there were numerous interruptions of the process of sedimentation, as is shown by the presence of from two to five coal seams varying from one to six feet in thickness, and sandstones locally as much as 25 or 50 feet thick, as well as occasional beds of argillaceous shale.

The lithological and chemical character of the limestone varies widely. They are usually magnesian and have a high percentage of silica and sometimes of clayey material. They vary from hard ringing layers which resist the weather well to limestones which weather up into small sharp conchoidal fragments on exposure of a few weeks. All gradations occur between limestone and moderately soft calcareous shale. The limestones are amorphous and blue to gray or brownish in color. Individual layers in places maintain their characteristics over considerable areas, but again they may change rapidly over distances of a mile or two. Contrary to the prevalent idea, these limestones are quite fossiliferous, and it is seldom that a search of a few moments is not rewarded by many small individuals. The fauna is limited to probably not more than four or five species, all minute, the most abundant being small ostracod carapaces which cover some of the bedding planes, notably on mud-cracked surfaces, by the hundreds. *Spirorbis anthracosia* Whitf. is numerous. In certain layers, especially near the top of the limestones at a horizon not far below the Waynesburg coal, small gastropods are very abundant, among them a form either identical with or very similar to *Anthracopupa ohioensis* Whitf. Mud-cracked surfaces are not uncommonly seen on loose slabs in stream beds or cuttings, and are doubtless much more abundant than can be gathered from a study of the cliff-like exposures, which are usually the only ones available. Layers of conglomerate, consisting of fragments of limestone cemented in a limestone matrix, occur throughout the series. Their thickness may vary from a fraction of an inch to two or three feet. The fragments are usually small, from the size of a pea or less up to an inch or two in diameter and rarely four or six inches in diameter. These layers differ in their nature, many being undoubtedly formed in the manner just described, but others which are thicker have the appearance of a true breccia in which the angular fragments have been cemented in a matrix of argillaceous limestone, the fragments being larger and bearing no apparent

relation to the blocks produced by cracking of a mud surface. The latter type is not yet explained.

The origin of these limestones is an open question, but it is probable that they were formed in restricted basins which may have had an extent of many miles. The numerous mud-cracked surfaces and abrupt lithological changes show that the area was subject either to rapid oscillation and consequent successive flooding and drainage, if they be considered of marine origin, or to periods of desiccation if they be considered as lake deposits. There is not a single species suggesting an undoubtedly marine fauna (unless *Spirorbis* be so considered) and the beds were probably deposited in fresh or brackish lakes. The fresh marl lakes occurring throughout much of the drift-covered area of North America suggest a method of formation which, however, possibly differed considerably in details. In these lakes deposits of calcium carbonate are forming at present as a result of precipitation of lime by aquatic plants, principally *Chara*. These beds in places are known to be at least 30 to 45 feet or even more in thickness and may consist of quite pure lime or they may be quite highly magnesian with considerable clay and vegetable matter. During the summer months the water of some of the lakes evaporates so far as to leave great flats of almost pure lime mud exposed to the atmosphere and these in drying become cracked.\* Unfor-

\* Geol. Surv. Michigan, vol. viii, pt. iii, pp. 41-96. 25th Ann. Rept. Dept. Geol. and Nat. Resources, Indiana. On plate 6, fig. a, opp. p. 41, a photograph is given showing such a mud-cracked surface.

Since this paper was completed Mr. George H. Ashley has offered the same suggestion for the origin of most of the limestones of the Appalachian coal fields, including many of those lying below the Ames limestone. ("Were the Appalachian and Eastern Interior Coal Fields Ever Connected?" Economic Geology, vol. ii, pp. 659-666.) He says in part: "It is a singular fact that in the Appalachian basin the majority of the limestones underlie the nearest of the associated coals, as note the Vanport, the Johnstown cement, Upper and Lower Freeport, Pittsburg and other limestones, all of which closely underlie the corresponding coals," and "it may almost be termed a habit of the limestones to carry an overlying bed of iron ore" (p. 664).

In explanation of this succession the following is proposed: "The limestones of the Appalachian field I ascribe largely to the action of plants and bacteria, their accumulation being in bogs or enclosed waters by secretion of lime from the water, as is being done to-day in the lakes and marshes of northern Indiana, Ohio and southern Michigan. The iron ores were accumulated under similar conditions by the same or associated bacteria in the same way that bog ores are accumulating to-day in the localities named and in many parts of the world. These accumulations were followed by the growth of a peaty deposit that later became coal" (p. 665).

It is not evident how far Mr. Ashley intends to apply this explanation. In Ohio, contrary to his statement, the four best known limestones of the lower Coal-measures, the Lower and Upper Mercer, Putnam Hill, and Ferriferous or Vanport limestone, directly or almost directly overlie the nearest coal, and each carries a more or less persistent iron ore. The same is true of the Cambridge limestone horizon in Muskingum county, Ohio, except that the iron ore is not present. The association of coal, limestone and iron ore is just as intimate as in the examples which he cites although the order of superposition is different, but the limestones are unquestionably of marine origin and will not fall under his explanation.

tunately nothing has been recorded to show how hard such a lime surface may become when exposed to the sun for some time, but Professor Alexander Agassiz notes that on the Florida coral islands the interval of time between two tides is sufficient for the formation of a thin film of hard, ringing limestone on the surface of fine coral sands.\*

The best example of a conglomerate formed by the breaking up of a sun-cracked lime-mud surface was seen near Bellaire, Belmont county, Ohio. The exact point is in a clay pit on the south side of McMahan's creek about one and one-half miles above the point where it empties into the Ohio river at Bellaire. Here an argillaceous shale lying above the Pittsburg coal is mixed with a sandy shale lying below it and used for making brick, but the combination contains so much lime that constant care is necessary to insure success. Following is the section exposed in the pit from above downward:

9. Limestone in several beds with thin shales between, some of the beds one foot thick .....	8 ft. +
8. Gray argillaceous shales with many limestone nodules .....	5 to 5 1/2 ft.
7. Dark gray and black shales .....	1 ft. 8 in.
6. Roof coal of Pittsburg seam .....	2 ft. 10 in.
5. Soft gray argillaceous shale .....	2 in. to 1 ft. 2 in.
4. Coal, Pittsburg seam .....	5 ft. 1 in.
3. Dark gray argillaceous shales with considerable carbonaceous matter .....	2 ft. 4 in.
2. Gray amorphous limestone, bottom very irregular and thickness abruptly variable as a result of the uneven surface on which it rests; top horizontal and unaffected by the irregular lower contact. At the top of this bed occurs the conglomerate to be especially described, 1 ft. to 1 1/2 ft.	
1. Sandy micaceous shales, inclined at a sharp angle to the overlying bed and separated from it by an erosion plane. Such local unconformities occasionally occur in the Coal-measures and are not yet understood .....	about 15 ft.

In getting out the sandy shales for brick-making, the large blocks of overlying limestone, number 2 of the section, are thrown aside and after short exposure all the dark shale adhering to the upper surface weathers off, exposing the conglomerate layer in excellent shape. The conglomeritic portion is only one half to one inch in thickness and is preserved on the surface of these blocks exactly as it existed at the time it was covered by the shale. Throughout the entire opening, covering perhaps three or four acres, it maintains its character and

\* "Three Cruises of the Blake," vol. i, p. 87.

thickness persistently. It is composed almost entirely of pebbles of limestone varying in size from that of very coarse sand grains to four and one half-inches in diameter, the largest seen. The bulk of the layer is made up of fragments from one-fourth inch to one inch in diameter, with considerable amounts of much finer material scattered between. Each pebble is so cemented to the upper surface of the limestone layer that about half of it stands out in relief, the lower half being buried in a matrix consisting principally of small limestone fragments which might be termed very coarse sand. During deposition the dark shale overlying filled not only all the interstices between the projecting pebbles but settled down into the smaller spaces

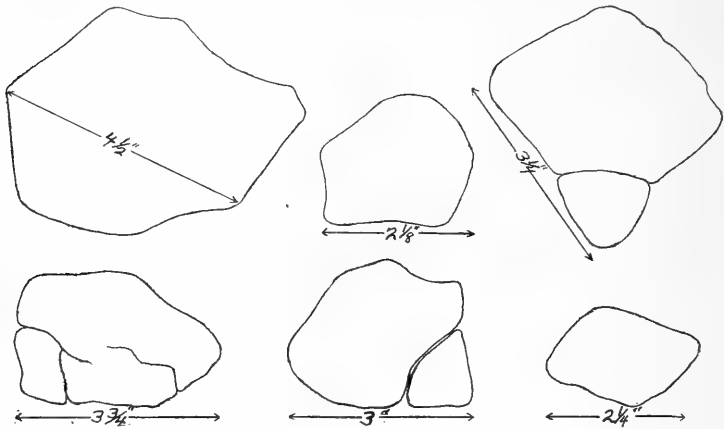

between sand grains. When the blocks are removed and exposed to the weather this shale is quickly washed out, all trace of it being removed in time, and the conglomeritic surface is left exposed exactly as it was when first covered up. It has every appearance of a land surface strewn with a thin layer of limestone pebbles and coarse sand, such as one might see to-day under suitable conditions, and so fresh is it that it is difficult to believe that one is looking at a land surface which was covered during Paleozoic time.

Although the great majority are less than one inch, pebbles up to two inches or more in diameter are not uncommon. Those more than one inch in diameter are all flat and usually about three-eighths of an inch thick, although at one point the thickness of a number reaches an inch. The outlines of the large pebbles are quite irregular but in general are definitely polygonal with numerous concave sides as shown in the outline figures. These pebbles all lie flat in the stratum. The edges, although sometimes noticeably angular, are usually more or

less rounded and subangular. Those less than an inch in greatest diameter are usually less angular and do not show their flat character so strikingly if at all. The larger blocks are exactly of the type that would be formed on a mud-cracked surface and the concave surfaces would not be found in a beach or stream-rolled pebble except in fragments plucked from thinly bedded strata which had not been worn to any extent. Furthermore, at one point an area one and one-half feet long by one foot wide was seen in which all the fragments remain in the relative positions in which they were formed by the cracking. These fragments are three-fourths of an inch to an inch in thickness and one to two and one-half inches across. The edges are fairly sharp and the cracks are filled with many much smaller fragments. Occasionally, two little-worn pebbles are seen entirely surrounded by broken fragments but still holding their original positions with relation to each other. Examples of these are shown in the outline sketches, which were all made from a surface which otherwise showed no trace of mud-cracking. The limestone composing all the pebbles is indistinguishable from that of the underlying bed.

The matrix in which the pebbles rest consists almost entirely of small limestone fragments which, as just stated, might better be termed a very coarse sand, throughout which are numerous small fragments of teeth and bones of fish, many ostracod carapaces and shells of *Spirorbis anthracosia* Whitf. Angular quartz sand grains are common although constituting only a small percentage of the whole, the largest being from .5 to .7 millimeters in diameter. A single rounded weathered fragment of coal was also found on the surface.\* The matrix is usually about one-fourth or one-half an inch thick, but under some of the pebbles it may thin away to a mere trace. It rests on the underlying compact amorphous limestone without any gradation into it although the two are so closely bound together that they do not split apart.

The surface of many of the pebbles, especially of the smaller ones, appears to be extensively weathered; this is notably so when they are so turned as to expose a side which cuts across the planes of sedimentation. The fine laminae, not readily noticeable on a fresh fracture, have caused unequal weathering

\*This piece is of more than passing interest. It is only two and three-tenths millimeters in diameter, is rounded and has the lustreless black etched surface of a piece of coal which has been rolled along a stream bed. The fracture is bright and smooth like that of fresh coal and the hardness is that of coal. The bed from which it was derived must have passed through all the stages of coal formation and must have been in the condition shown in the fragment before it was eroded, for it is inconceivable that the piece could have been formed in position where found. This would mean that some coals at least had progressed in their formation to this stage before the deposition of the Pittsburg coal.

along horizontal lines and as a result some of the pebbles look quite old. This seems to be due to the probable fact that at the time of formation the dried mud in the pebbles, while hard enough to withstand considerable rolling, was still soft enough to yield readily to the agents of weathering and erosion if exposed for a moderate period of time. The surface of the matrix after consolidation appears to have been exposed to the atmosphere for a short period, as quartz grains and small shells are often found standing in relief.

The succession of events in the formation of the bed appears to have been about as follows: A body of water, probably of no considerable depth, existed, in which lime muds had accumulated to a slight thickness. On evaporation all ostracods and Spirorbis shells would be laid down on the surface of the mud. Such a layer of shells is sometimes seen on well-preserved mud-cracked surfaces in these limestones and a few such shells are found on the surface of some of the blocks in this layer but never to any extent, as they were probably subsequently rubbed off. After the complete evaporation and cracking of the lime surface, it is necessary to suppose that there was a submergence in order to account for the movement, breaking and rolling of the pieces and the formation of the matrix of small fragments and shells in which the pebbles all rest. The presence in the matrix of a considerable amount of quartz sand which is absent from the limestone of the pebbles and the underlying bed is best accounted for in this way, the size and angularity of the grains being contrary to the idea of wind-blown sand. Whether the animal remains in the matrix were rubbed off the pebbles (they are numerous both in the pebbles and in the underlying limestone) or whether they lived in the water which caused the breaking up, is not known. This point is mentioned because they do not occur in the overlying dark shale. Following the breaking up of the sun-cracked blocks, there must have been another period in which the surface was dry and during which it hardened into the form now seen. Proof of this is seen in the weathered surface of the matrix with its quartz grains and ostracod shells in relief and in the perfectly sharp line of contact between the conglomerate and the overlying shale, which can only be accounted for on the assumption that the former was completely formed and hardened as now seen before the submergence which brought the deposition of the shale.

If, after the conglomerate was completely formed, the deposition of limestone had been resumed instead of a soft shale, the result would have been a typical intraformational conglomerate of a thinner type, in which the structure would probably have been so obscured that a detailed study would have been impossible or only possible with a great amount of labor.

ART. XLIV.—*The Behavior of Nuclei of Pure Water*; by  
C. BARUS.

1. FOR very small fog particles suspended in dust-free air saturated with water vapor and left without interference, the dissipation by evaporation is enormously more important than that by subsidence. In my fog chambers the transition occurs for the number of nuclei per cubic centimeter,  $n = 200,000$ , or the diameter of fog particles,  $d = .0003^{\text{cm}}$ , when about one half evaporate and one half subside.

Fog particles precipitated on solutional nuclei (phosphorus) evaporate to persistent water nuclei without other loss than is attributable to subsidence and in a small degree to time losses (diffusion). There is no loss by complete evaporation.

Fog particles precipitated on the nuclei of water vapor in dust-free air evaporate under the same circumstances and by contrast, almost without residue, the yield of water nuclei (after allowing for subsidence and in the absence of all interference) being but .004 of the number of fog particles when  $d = .00016^{\text{cm}}$ , increasing to .036 when  $d = .00032^{\text{cm}}$ . These fog particles vanish into the wet air from which they were precipitated and the experiment may be repeated indefinitely. Relatively more water nuclei persist as the fog particles evaporated are larger.

The persistence of water nuclei obtained in the last case from the nuclei of water vapor is much increased by *accelerating* the evaporation of the fog as soon as formed. Such forced evaporation is produced by the rise of temperature, due to the compression accompanying the influx of dust-free air after the exhaustion which precipitated the fog. This result cannot be associated with losses due to subsidence.

When the rate of evaporation is increased by compression, moreover, the number of water nuclei (derived from the reasonably rapid evaporation of fog particles precipitated on vapor nuclei and persisting within five minutes after the evaporation) may be as large as 5 per cent to over 20 per cent, depending upon the size ( $d = 19 \times 10^{-5}$  to  $d = 32 \times 10^{-5}$  cm. respectively) of the fog particles evaporated. Again relatively more water nuclei persist when the fog particles evaporated are larger, within limits given. By keeping the influx cock for dust-free air slightly open, on sudden exhaustion, 10 per cent of the fog particles evaporated may be represented by persistent water nuclei, even when  $d = 19 \times 10^{-5}$  cm. or  $n = 10^6$ . If it were safe\* to make use of more rapid evaporations this

\* Naturally the efficiency of the filter must be tested in connection with each experiment and this efficiency must be perfect.

limit could unquestionably be much increased. Thus on the rapid evaporation of fog particles by the influx of dust-free air from a large independent reservoir into the fog chamber, about 18 per cent of the fog particles were converted into residual water nuclei when  $n = 10^6$ , and actually 48 per cent when  $n = 10^8$ . All such values or lower limits, because the loss of fog particles at the walls of the vessel and by coalescence is not included; but tests under most rapid evaporation possible showed that a limit had been practically reached.

2. The loss of nuclei by decay (diffusion) in the lapse of time (say 6 per cent per minute within the given interval of observation) and the effect of changes in the drop of pressure on sudden exhaustion, have no causal bearing on the production of water nuclei by rapid evaporation. They merely modify the number. Similarly the effect of subsidence is secondary. Hence the cause of the production of persistent water nuclei in rigorously dust-free air must be associated with the speed of evaporation or with the motion of the fog particles during evaporation. It is a curious fact that whereas the relatively enormous fog particle of pure water evaporates at once beyond the range of visibility, this process stops in case of certain of the invisible particles (about .5 to 50 per cent of the total number) as the evaporation is more rapid in the manner specified. The remaining fog particles evaporate completely.

3. J. J. Thomson, Langevin and Bloch, and others\* have referred the persistence of pure water nuclei of about  $10^{-6}$  cm. in diameter, to the minimum of surface tension discovered by Reinold and Rucker† for thicknesses of films of about the same value. Since all fog particles are so much larger than this order of values, it is difficult to see why, under quiet evaporation without any interference, they do not all terminate in water nuclei, allowance being made for subsidence. Yet under these circumstances the yield of water nuclei is *least*, being usually within one per cent. Whatever losses may be due to coalescence should be increased when the rate of evaporation is increased, because there is more motion of the air relatively to the fog particles. Again precisely the reverse occurs, inasmuch as an increased rate of evaporation enormously increases the yield of water nuclei.

Moreover, the residual water nuclei may, on rapid evaporation, exceed the order of  $10^{-6}$  cm. in diameter, two or three times; or on slow evaporation they may fall below  $5 \times 10^{-7}$  cm.

\* Reinold and Rucker, Proc. Roy. Soc., vol. xl, p. 441, 1886.

† J. J. Thomson, Conduction of Electricity through Gases, p. 152, 1903; C. T. R. Wilson, Trans. St. Louis Electrical Congress, vol. i, p. 374-8, 1904.



and yet persist for half an hour or more. Under any circumstances they are graded. They appear to diminish in size with extreme slowness in the lapse of time, so that an appropriate interval of waiting will yield any size.

4. Since the fog particles in question are absolutely pure water (water condensed on water vapor), it is tempting to suggest electrical charge as the cause of the observed persistence, such charge being acquired either by friction during the motion of particles undergoing rapid evaporation (influx of air), or by the mere act of evaporation. The latter, like the minimum of surface tension, would require the same persistence of all fog particles under conditions of quiet evaporation. As has frequently been shown, this is not the case. A frictional mechanism, suggested in view of the occurrence of convection during the period of evaporation and influx of air, if in action, would account for the discrimination between fog particles as to survival. Thus drops of larger size are stirred about for a longer time before completed evaporation and they are therefore more favorably circumstanced to persist, as they have been found to do; water nuclei should not be of the same size and they are not; etc. But all my experiments have failed to detect the amount of charge commensurate with the persistence of nuclei. An effective charge would have to be latent.

If the radius of residual water nuclei be taken as  $10^{-6}$  cm., the charge needed would be roughly  $e = 6.3 \times 10^{-8}$  electrostatic units per particle, and its potential would be about 18 volts. If about two hundred thousand of these droplets or residual water nuclei are present per cubic centimeter (as were found above), the charge would be about 4 coulombs for a cube each side of which is 100 meters. Finally the electric contents of my fog chamber should be about 30 electrostatic units of quantity and ought thus, in spite of the moisture present, to be easily determinable. The experiments showed only about  $.50 \times 10^{-6}$  electrostatic units per cubic centimeter, less than the contents ( $.88 \times 10^{-6}$ ) in the room air without at the time; that is, the average charge per nucleus was about  $5 \times 10^{-12}$  electrostatic units, or less than 1 electron. Hence the electrical hypothesis must be abandoned. It would in any case be improbable for the charge to show so small a coefficient of decay as do the water nuclei.

5. Under the circumstances it seems permissible to suggest an hypothesis of a statistical character; namely, that the molecule of liquid water is composite, consisting of virtually more volatile and less volatile constituents. Such a view is quite compatible with the composite molecule observed in water vapor, where millions of nuclei may be captured long before

the molecule proper is reached, the evidences of which are now beyond question. In case of fog particles, when the evaporation is reduced to extreme slowness, we may conceive that all groups of molecules evaporate together at about the same rate, and that therefore the residue, i. e. the persistent water nuclei, are present in least amount. On the other hand, when the evaporation is forced, or accelerated by the heat due to compression, the more volatile constituents of the fog particles evaporate faster than the less volatile, and there is a correspondingly greater residue of persistent water nuclei, because of this concentration of the less volatile molecular aggregates of water in each fog particle. It follows also that relatively more persistent nuclei are obtained by the evaporation of large fog particles than by the evaporation of small particles, because a greater relative number of these droplets would contain a sufficient number of the less volatile groups to persist; i. e., the opportunities for concentrating the less volatile aggregates are enhanced. Finally it should never be possible to replace all fog particles by the water nuclei derived from them. All of these deductions are in keeping with the experimental evidence as pointed out.

ART. XLV.—*The Relations between the Meteorological Elements of the United States and the Solar Radiation* ;\*  
by FRANK H. BIGELOW.

IN attempting to trace out any synchronous relations which may exist between variable sources of energy in the sun and their corresponding effects in the atmosphere of the earth, there are three considerations which must be carefully complied with, or else the existing relations will be entirely smothered. (1) The complete homogeneous series of all data must be provided, eliminating local conditions at the station and employing a uniform system of reductions. (2) The summation of the residuals must not be made strictly periodic at the earth unless the solar action is also strictly periodic. As this is not the case at the sun, the synchronism at the earth must be traced through only roughly periodic variations. The 33-year period, the 11-year period and the 3-year period are known to have wide variations in length and amplitude, but the solar intervals should be compared with the terrestrial intervals as they occur, without forcing a uniform period upon them. (3) The temperatures of the United States are more the product of heat which is transported in the general circulation than of direct solar radiation, so that the main features of the circulation must be admitted to be the connecting link between the periods. Thus, an increase in solar radiation will increase the heat energy and temperatures of the tropics, but this will be followed by a decrease in the temperatures of the middle latitudes, because the return currents from the polar zones transport an excess of cold air towards the tropics, over the temperate zones; which is to compensate for the increase of warm air transported in the upper levels towards the polar zones. All the complex circulation observed in the earth's atmosphere stands between the solar radiation and the temperature effects in any latitude. Especially does this become an important feature in the United States, where the influences of the circulation are vigorously registered in the prevailing powerful cyclonic action. The question whether there are variations in the observed solar phenomena, numbers of the prominences, faculae and sun-spots, which are synchronous with the observed magnetic and meteorological elements on the earth, is one simply of statistical comparison and analysis. The other question of the cause of such synchronism, if it exists, the mode of transferring the variable energy of the sun's output to the earth, may properly

\* Read before the Philosophical Society of Washington, Feb. 1, 1908.

be taken up at a later time after the facts are known. In 1889\* I concluded that the variation of the solar radiation is responsible for the annual variations in the terrestrial magnetic field, because the magnetic disturbing vectors follow the sun in its changes in declination. In 1894† evidence of the effect of the solar variation upon the magnetic field of Europe, and upon the temperatures of the United States, together with the action of the same upon the position of the storm tracks and the velocity of the movement of cyclones in the United States, was added. In 1904‡ the comparison was extended to the temperatures and pressures of the entire earth's atmosphere, with the general result that the temperatures respond directly to the solar variation in the tropics, but inversely in the temperate zones; while the pressures correspond directly in the eastern hemisphere, but inversely in the western hemisphere. It thus became apparent that the circulation of the atmosphere has to do with the prevailing annual temperatures quite as much as the direct radiation of the sun. To separate these two terms is a task of great difficulty, and it is the purpose of this paper to record one step in that direction.

The variations in the annual values of the temperature, vapor tension and barometric pressure are in fact comparatively small quantities, and the question whether they are to be ascribed to the influence of the solar variations can only be determined by using data of several kinds reduced to strictly homogeneous series. There are several causes for the fact that the meteorological observations of the United States, as originally made, are not sufficiently free from accidental errors to permit of this refined use, and advantage was taken of the necessity of providing for the Weather Bureau some new normals of temperature, vapor pressure and barometric pressure, to make the series from 1873 to the present time as homogeneous as possible. In the report of the Chief of the Weather Bureau, 1900-1901, the results for the barometric pressure were published, the succeeding annual volumes containing the supplementary data. In 1908, the temperatures and vapor pressures reduced to homogeneous systems are to be published, and this completes the re-reductions for the United States for one-third of a century. Evidently these data are very valuable for the study of the solar-terrestrial problems. There are about 100 stations available in the United States for these

\*The Causes of the Variation of the Magnetic Needle, this Journal, Sept. 1891.

†Inversions of temperatures in the 26-68 day solar magnetic period, *ibid.*, Dec. 1894.

‡Synchronism of the variation of the solar prominences with the terrestrial barometric pressures and the temperatures, *Monthly Weather Review*, Nov. 1903.

studies, and the record is made homogeneous for the years since 1873. For the purposes of this paper there have been employed 50 stations, separated into 10 groups of 5 stations each, covering the United States as fairly as possible, as follows:

1. *Missouri Valley.* St. Paul, St. Louis, Keokuk, Davenport, La Crosse.
2. *Lake Region.* Marquette, Milwaukee, Chicago, Alpena, Detroit.
3. *Middle States.* Pittsburg, Lynchburg, Buffalo, Oswego, Washington.
4. *North Atlantic.* Philadelphia, New York, New Haven, Boston, Portland.
5. *South Atlantic.* Montgomery, Knoxville, Jacksonville, Augusta, Wilmington.
6. *West Gulf.* Shreveport, Galveston, Memphis, Vicksburg, New Orleans.
7. *North Plateau.* Denver, North Platte, Bismarck, Yankton, Omaha.
8. *South Plateau.* Yuma, El Paso, Santa Fe, San Antonio, Palestine.
9. *North Pacific.* Portland, Roseburg, Red Bluff, Winnemucca, Spokane.
10. *South Pacific.* San Francisco, Los Angeles, San Diego, Yuma, Sacramento.

For the purposes of exhibit, these 10 groups have been united into three groups, I (9, 10) Pacific States, II (6, 7, 8) Plateau and West Gulf States, III (1, 2, 3, 4, 5) Central and Eastern States, and this is justified by comparing the curves together, as well as by their geographical characteristics. It should be remembered that each station is independent of every other, so far as the making of the observations is concerned, and therefore whatever harmony is found to exist among the residuals for any of the 10 sections cannot be due to local peculiarities. In order to exhibit the kind of agreement that has been found, the residuals of temperature, vapor pressure and barometric pressure for the group No. 1, Missouri Valley, are collected in Table I. It shows that there is generally a fair agreement in the signs of the residuals for the same year in each of the three elements. In some years the magnitude of the residuals is large, in others it is small, and in still others the residuals are scattering, in which case there was no pronounced external force determining the prevailing circulation to move aside from the normal in a given direction. The means of the groups of five stations each have been carried forward, and combined, as stated, into three groups, and

TABLE I.—*The Annual Variations of the Temperature, Vapor Pressure and Barometric Pressure in the Lake Region.*

Year.	Temperature, °F.						Vapor Pressure, inch of mercury.						Barometric Pressure, inch of mercury.							
	Mar.		Chic.		Alp.		Mar.		Chic.		Alp.		Mar.		Chic.		Alp.		Means.	
	Mil.	Det.	Mil.	Chic.	Mil.	Alp.	Mil.	Det.	Mil.	Chic.	Mil.	Alp.	Mil.	Det.	Mil.	Chic.	Mil.	Alp.	Det.	Means.
1873	-2.0	-1.2	-1.1	-1.9	-1.7	-1.6	-0.07	-0.05	-0.15	-0.18	-0.11	-0.18	-0.11	-0.11	-0.25	-0.12	+0.04	-0.31	-0.16	
74	0.0	+0.8	+2.1	+0.3	+0.4	+0.6	+0.03	+0.14	+0.12	+0.11	+0.06	+0.11	+0.06	+0.02	+0.55	+0.30	+0.44	+0.27	+0.28	
75	-4.1	-4.4	-2.9	-4.1	-3.8	-3.9	-0.24	-0.36	-0.21	-0.32	-0.28	-0.32	-0.28	-0.28	+0.11	+0.21	+0.12	+0.13	+0.09	
76	-0.4	-1.2	+0.7	+0.7	+0.7	+0.5	+0.09	+0.03	+0.12	+0.06	+0.02	+0.06	+0.02	+0.02	+0.57	+0.24	+0.26	+0.20	+0.25	
77	+3.3	+0.8	+2.0	+1.8	+1.1	+1.8	+0.11	+0.07	+0.26	+0.09	+0.00	+0.07	+0.00	+0.11	+0.16	+0.04	+0.19	+0.04	+0.08	
78	+5.3	+3.4	+3.2	+3.5	+1.7	+3.4	+0.38	+0.41	+0.24	+0.20	+0.11	+0.27	+0.11	+0.27	-0.33	-0.55	-0.64	-0.56	-0.55	
79	+1.5	+1.1	+1.6	+0.2	0.0	+0.8	+0.10	+0.09	+0.01	-0.08	+0.01	-0.08	+0.01	+0.03	+0.11	+0.18	+0.17	+0.18	+0.15	
1880	+0.8	+1.6	+2.3	+0.7	+0.7	+1.2	+0.03	+0.14	+0.16	+0.16	+0.02	+0.10	+0.16	+0.09	-0.09	-0.06	+0.01	+0.05	+0.13	
81	-0.2	+1.3	+1.1	+0.5	+3.3	+1.2	+0.08	+0.19	+0.18	+0.02	+0.31	+0.16	+0.31	+0.16	+0.17	+0.07	+0.15	+0.07	+0.08	
82	+1.1	+2.1	+1.3	+1.1	+3.3	+1.8	+0.07	+0.17	+0.19	+0.02	+0.25	+0.14	+0.25	+0.14	+0.28	+0.09	+0.03	+0.20	+0.16	
83	-3.0	-1.7	-2.0	-2.8	-0.2	+1.9	-0.25	-0.18	-0.32	-0.29	-0.02	-0.19	-0.02	-0.19	+0.11	+0.17	+0.25	+0.06	+0.15	
84	-2.1	-1.2	-0.1	-1.1	+1.8	-0.5	-0.08	+0.01	-0.02	-0.12	+0.07	-0.12	+0.07	-0.03	+0.14	+0.01	-0.02	+0.15	+0.02	
85	-2.9	-3.7	-1.8	-3.7	-1.0	-2.6	-0.22	-0.15	-0.02	-0.13	+0.08	-0.13	+0.08	-0.04	0.00	-0.26	-0.25	-0.47	-0.26	
86	-0.6	-4.4	+0.7	-1.0	+1.0	+1.3	-0.16	-0.08	+0.21	+0.04	+0.30	+0.04	+0.30	+0.06	+0.11	-0.01	-0.02	+0.05	+0.01	
87	-1.4	-0.5	-0.6	-0.9	+0.5	+0.6	-0.03	-0.06	-0.14	-0.05	-0.04	-0.05	-0.04	-0.05	+0.17	+0.07	+0.06	+0.08	+0.04	
88	-3.1	-2.1	-1.7	-1.9	-2.2	-2.2	-0.19	-0.20	-0.30	-0.16	-0.28	-0.16	-0.28	-0.23	+0.39	+0.20	+0.31	+0.26	+0.30	
89	+0.5	+0.6	-0.1	+0.6	-0.4	+0.2	+0.07	-0.04	-0.10	0.00	-0.14	0.00	-0.14	-0.04	+0.16	+0.03	+0.07	+0.02	+0.04	
1890	+0.2	+0.9	+0.3	+0.5	+0.1	+0.4	-0.06	-0.06	-0.06	+0.02	-0.04	+0.02	-0.04	-0.04	+0.04	+0.12	+0.15	+0.05	+0.08	
91	+1.6	+1.3	-0.1	+1.5	+0.2	+1.2	+0.01	-0.10	-0.30	+0.10	+0.03	+0.10	+0.03	+0.06	-0.11	+0.11	+0.10	+0.17	+0.15	
92	0.0	-0.9	-1.7	0.0	-0.8	-0.7	+0.04	-0.04	-0.08	+0.11	+0.02	+0.11	+0.02	+0.01	+0.02	+0.22	+0.12	+0.25	+0.11	
93	-1.6	-1.4	-2.0	-0.7	-1.4	-1.4	-0.07	-0.24	-0.15	+0.10	-0.15	+0.10	-0.15	+0.10	-0.61	-0.27	-0.36	+0.31	+0.33	
94	+1.9	+2.1	+1.3	+1.9	+1.0	+1.6	+0.07	+0.15	-0.14	-0.17	+0.07	-0.14	+0.07	+0.04	-0.22	-0.08	-0.06	+0.06	-0.10	
95	-0.2	-0.5	-1.0	-0.3	-1.5	-0.7	-0.03	-0.23	-0.34	-0.12	-0.29	-0.12	-0.29	-0.20	-0.27	+0.01	-0.06	+0.18	-0.09	
96	+1.1	+1.5	+1.3	+1.2	+0.2	+1.1	+0.04	+0.16	-0.04	+0.06	+0.10	+0.06	+0.10	+0.06	+0.11	+0.18	+0.10	+0.11	+0.09	
97	+0.7	+1.3	+0.3	+1.4	-0.1	+0.7	+0.15	+0.01	-0.02	+0.14	-0.04	+0.14	-0.04	+0.05	-0.04	+0.23	+0.14	+0.12	+0.11	
98	+1.7	+1.7	+0.6	+2.4	+1.4	+1.6	+0.16	+0.12	-0.11	+0.23	+0.12	+0.15	+0.12	+0.15	-0.31	+0.03	-0.02	-0.08	-0.04	
99	-0.3	+1.0	+0.3	+0.3	+0.1	+0.3	+0.15	-0.01	+0.25	+0.13	-0.06	+0.09	-0.06	+0.09	-0.17	+0.19	+0.15	+0.07	+0.08	
1900	+2.1	+1.9	+0.4	+2.1	+0.9	+1.5	+0.34	+0.13	+0.36	+0.21	+0.23	+0.25	+0.23	+0.25	-0.01	+0.19	+0.10	+0.04	+0.04	
01	+0.9	+0.7	-0.7	+0.7	-0.7	+0.8	-0.12	+0.13	-0.10	+0.10	-0.03	+0.07	-0.03	+0.07	+0.04	+0.06	-0.03	-0.11	-0.27	
02	+1.7	+1.0	+0.1	+1.1	0.0	+0.2	+0.17	+0.03	+0.11	-0.03	+0.04	+0.01	+0.04	+0.01	+0.14	+0.01	-0.08	-0.20	-0.07	
03	+0.5	-0.1	-1.1	+0.7	-0.6	-0.1	-0.19	+0.10	-0.14	+0.05	+0.04	-0.03	+0.04	-0.03	+0.07	+0.20	+0.16	+0.02	+0.07	
04	-1.9	-1.3	-2.3	-2.1	-2.6	-2.0	-0.26	-0.10	-0.26	-0.12	-0.22	-0.19	-0.22	-0.19	+0.32	+0.32	+0.25	+0.18	+0.22	
05	-0.5	0.0	-0.5	-0.1	-0.7	-0.4	-0.13	-0.04	+0.04	+0.06	+0.03	-0.06	+0.03	-0.01	-0.11	-0.28	-0.19	+0.06	+0.04	

TABLE II.—*Monthly and Annual Frequency numbers of the Solar Prominences.*

Year	Jan.	Feb.	Mch.	Apr.	May	June	July	Aug.	Sept.	Oct.	Nov.	Dec.	P	M	P-M
1872	220	230	227	187	254	274	335	330	193	146	140	109	2645	1800	+845
1873	183	190	161	201	180	193	250	154	191	112	98	140	2053	1700	+353
1874	132	138	136	102	115	107	115	123	171	90	107	79	1415	1569	-154
1875	67	68	64	66	57	52	128	132	65	71	55	31	856	1188	-332
1876	32	51	38	49	47	51	107	136	111	94	80	80	876	865	+11
1877	40	75	59	37	55	95	54	115	82	42	31	57	742	695	+47
1878	19	57	32	49	21	29	69	71	50	30	1	10	438	791	-353
1879	17	6	23	13	37	64	57	66	80	100	58	40	561	1015	-454
1880	13	71	145	54	81	146	260	137	137	120	77	97	1338	1332	+6
1881	45	80	88	109	210	177	299	284	187	121	258	140	1998	1604	+394
1882	229	242	184	146	183	269	288	249	169	137	139	92	2327	2063	+264
1883	95	137	97	133	183	122	219	167	133	233	135	142	1796	2352	-456
1884	139	186	317	212	237	237	364	399	233	269	152	111	2856	2170	+686
1885	104	197	146	111	226	351	328	221	177	104	126	193	2284	2280	+4
1886	116	98	126	82	162	174	233	162	149	68	138	77	1585	2098	-513
1887	115	134	137	129	127	257	268	231	161	69	141	108	1877	1671	+206
1888	198	107	197	266	181	117	154	222	144	158	73	70	1887	1352	+535
1889	76	84	140	49	19	20	62	99	75	29	47	24	724	1402	-678
1890	25	27	29	38	31	63	60	82	68	175	36	51	685	1521	-836
1891	60	170	110	138	98	108	256	210	220	217	98	151	1836	1592	+244
1892	83	95	122	158	207	330	323	298	305	186	216	151	2472	1740	+732
1893	145	214	272	324	143	161	167	267	185	138	70	155	2241	1931	+310
1894	87	141	159	104	114	178	157	167	116	78	104	62	1467	1806	-339
1895	28	69	127	131	141	181	257	246	178	93	114	75	1640	1534	+106
1896	134	155	71	77	103	125	143	105	106	102	55	35	1211	1230	-19
1897	60	69	109	85	84	119	81	113	143	101	95	54	1113	1037	+76
1898	53	42	31	60	26	77	64	78	121	86	27	56	721	817	-96
1899	45	38	40	45	18	51	52	44	76	42	28	19	498	604	-106
1900	40	13	20	32	48	36	68	56	96	60	20	54	543	398	+145
1901	5	8	9	2	15	26	28	33	7	2	3	7	145	295	-150
1902	7	3	6	4	17	12	11	13	6	1	1	2	83	305	-222
1903	4	13	9	21	15	17	35	33	13	16	18	10	204	300	-96
1904	21	12	50	35	53	55	79	115	29	35	22	44	550	800	-250
1905	22	37	65	24	45	53	55	96	59	18	38	7	519	1194	-675
Daily	6.2	6.6	6.7	6.6	5.9	6.2	6.3	6.1	6.4	6.7	6.1	5.9	6.3		
Days	13	15	16	15	18	21	26	26	20	15	14	13	212		

they are found in Tables IV, V, VI, under the columns marked T (temperature), V (vapor pressure), B (barometric pressure) respectively.

*The solar prominences and the European magnetic horizontal force.*

In order to procure other elements due to solar action with which to compare the meteorological variations, the annual numbers of the solar prominences and the annual amplitudes of the European magnetic field have been selected. The number of the prominences, as recorded in the reports of the Italian observers, Osservatorio del Collegio Romano, and Catania, were counted out month by month, and the numbers are given in Table II. The annual sums are taken. The lowest line of

TABLE III.—*The Amplitude of the Horizontal Magnetic Force without regard to sign.*

Year	Jan.	Feb.	Mch.	Apr.	May	June	July	Aug.	Sept.	Oct.	Nov.	Dec.	I	M	H-M
1872	186	217	235	220	260	208	228	265	192	275	252	174	2712	2038	+ 679
1873	206	145	186	178	146	157	105	141	94	152	140	153	1803	2054	-251
1874	146	262	195	250	149	160	162	146	124	203	137	128	2062	1894	+168
1875	110	195	168	142	133	142	106	94	139	126	111	103	1569	1630	- 61
1876	119	128	154	93	105	75	82	98	106	75	127	161	1323	1681	-358
1877	125	84	100	85	142	128	153	145	89	98	144	102	1395	1715	-320
1878	178	157	168	161	170	241	151	140	154	144	227	167	2058	1948	+110
1879	241	129	138	123	189	224	183	173	194	220	177	242	2233	2256	- 23
1880	188	169	195	138	297	176	166	380	268	305	225	213	2730	2729	+ 1
1881	250	371	198	212	161	239	265	181	303	189	252	245	2866	2946	- 80
1882	206	193	252	458	242	350	148	311	244	359	577	317	3757	3144	+613
1883	197	297	245	323	215	231	255	242	353	241	331	216	3146	3193	- 47
1884	259	250	263	266	248	283	257	289	273	234	319	282	3223	3204	+ 19
1885	330	227	251	200	383	246	214	199	256	207	229	240	2973	2920	+ 53
1886	275	158	308	272	242	187	220	205	315	304	263	171	2920	2779	+142
1887	182	159	183	184	172	154	202	244	255	171	234	196	2336	2569	-233
1888	228	155	258	228	244	183	170	179	182	220	219	176	2432	2298	+144
1889	152	119	165	164	153	149	188	152	245	222	305	158	2172	2320	- 48
1890	129	125	137	101	99	134	149	139	143	179	157	127	1619	2473	-854
1891	155	185	195	219	291	142	208	181	330	186	212	227	2531	2613	- 82
1892	250	286	387	374	378	324	358	282	224	230	257	249	3599	2795	+804
1893	170	320	266	184	242	263	267	342	249	283	299	259	3144	2993	+151
1894	186	361	324	237	217	187	286	318	283	156	310	215	3080	3073	+ 7
1895	180	198	175	217	251	178	187	243	232	303	249	198	2611	2806	-195
1896	255	189	232	192	323	280	218	203	259	221	292	266	2930	2650	+280
1897	261	179	195	215	221	218	206	129	129	138	119	254	2264	2441	-177
1898	198	212	249	229	185	206	130	145	246	240	154	172	2366	2236	+130
1899	162	196	223	235	201	169	159	136	146	112	159	134	2032	1925	+107
1900	115	107	235	175	193	95	93	132	80	133	113	118	1589	1765	-176
1901	107	139	160	83	103	112	111	96	122	100	90	151	1374	1717	-348
1902	117	79	109	145	169	112	112	94	83	163	177	103	1464	1853	-389
1903	82	98	117	197	94	96	132	162	124	321	454	249	2126	1896	+230
1904	191	130	93	169	172	207	148	119	125	153	181	99	1787	2000	-213
1905	139	216	271	159	107	164	151	205	198	118	290	176	2194	2180	+ 14
Means	185	189	207	201	203	189	184	191	199	199	229	189			

the table shows the average number of days on which observations were made, 13 in the midwinter and 26 in the midsummer, while the line above shows the average number of prominences seen on the edge of the sun's disk per day in each month. It will be noted that there is a small semi-annual period in these day-numbers, which will be considered in a later section of this paper.

It was found the most simple, and approximately sufficient, method to use the variations of the horizontal magnetic force in the European field, though strictly the total disturbing vector for the entire hemisphere should be carefully computed. Practically, the horizontal force at from three or four stations, Pawlowsk, Pola, Paris, Greenwich, were plotted on diagram paper month by month, and mean lines were drawn to elimi-



TABLE IV.—*Annual Variations of the Temperature.*

Year.	Pacific.			Rocky Slope.			Central-Eastern.		
	T.	M.	T.-M.	T.	M.	T.-M.	T.	M.	T.-M.
1873	----	----	----	-0.9	-0.4	-0.5	-1.2	-1.2	0.0
74	----	----	----	+0.8	-0.6	+1.4	+0.3	-0.9	+1.2
75	----	----	----	-1.7	-0.5	-1.2	-2.7	-0.5	-2.2
76	----	----	----	-0.9	0.0	-0.9	-0.3	+0.2	-0.5
77	----	----	----	+0.3	+0.2	+0.1	+1.3	+0.3	+1.1
78	+0.8	+0.2	+0.6	+1.0	+0.3	+0.6	+2.3	+1.0	+1.3
79	+0.4	0.0	+0.4	+1.6	+0.5	+1.0	+0.7	+1.4	-0.7
1880	-1.8	-0.4	-1.4	-0.3	+0.7	-1.0	+1.2	+1.3	-0.1
81	-0.3	-0.7	+0.4	+0.2	+0.5	-0.3	+1.3	+0.7	+0.6
82	-1.1	-0.9	-0.2	+1.1	+0.1	+1.0	+1.1	+0.6	+0.5
83	-0.5	-0.2	-0.3	-0.2	0.0	-0.2	-0.7	-0.1	-0.7
84	-0.9	0.0	-0.9	-0.6	-0.2	-0.3	+0.1	-0.5	+0.6
85	+1.8	+0.2	+1.6	-0.8	-0.4	-0.4	-2.0	-0.8	-1.2
86	+0.2	+0.5	-0.3	-0.8	-0.4	-0.4	-1.2	-0.9	-0.3
87	+0.4	+1.0	-0.6	+0.4	-0.3	+0.7	-0.1	-0.9	+0.8
88	+1.2	+0.6	+0.6	-0.5	+0.1	-0.6	-1.5	-0.4	-1.1
89	+1.2	+0.6	+0.6	+0.2	+0.1	+0.1	+0.3	0.0	+0.6
1890	-0.2	+0.4	-0.6	+1.0	-0.1	+1.1	+0.7	-0.1	+0.8
91	+0.2	-0.1	+0.3	-0.7	-0.1	-0.6	+0.6	0.0	+0.6
92	-0.2	-0.6	+0.4	-0.7	0.0	-0.7	-0.6	+0.2	-0.8
93	-1.6	-0.6	-1.0	-0.1	-0.4	+0.3	-1.1	-0.1	-1.0
94	-1.1	-0.6	-0.5	+0.6	-0.1	+0.7	+1.3	-0.1	+1.4
95	-0.6	-0.6	0.0	-1.3	+0.1	-1.4	-0.7	+0.1	-0.8
96	+0.4	-0.3	+0.7	+0.8	+0.1	+0.7	+0.6	+0.5	+0.1
97	0.0	-0.2	+0.2	+0.4	-0.1	+0.5	+0.5	+0.3	+0.2
98	-0.2	+0.2	-0.4	-0.1	+0.4	-0.5	+1.0	+0.7	+0.3
99	-0.4	+0.1	-0.5	-0.4	+0.3	-0.7	+0.2	+0.6	-0.4
1900	+1.0	0.0	+1.0	+1.1	+0.3	+0.8	+1.3	+0.5	+0.8
01	+0.3	0.0	+0.3	+0.6	+0.2	+0.4	-0.3	+0.2	-0.5
02	-0.5	+0.2	-0.7	+0.5	+0.3	+0.2	+0.3	-0.1	+0.4
03	-0.5	0.0	-0.5	-0.9	-0.1	-0.8	-0.3	-0.6	+0.3
04	+0.8	+0.1	+0.7	+0.1	-0.3	+0.4	-1.9	-0.8	-1.1
05	+0.2	+0.2	0.0	-0.6	-0.3	-0.3	-0.6	-0.7	+0.1

nate the zero-point correction, as well as that for the slope of the curves due to the change in the mean value of the horizontal force during the month. Then, the amplitudes or departures of the minor crests from the mean line were scaled off from day to day, and their sum taken out for the month, the average sum for the stations employed being entered in Table III. The magnetic field varies in its intensity, and these amplitude numbers are a relative measure of the intensity itself, whatever may be the physical cause of the same. These relative numbers may, perhaps, be improved by closer computations covering more stations, but they are sufficient for our present purpose, which is to exhibit the evidence of solar and terrestrial synchronism, by using easily accessible data. It may be observed that the monthly means for the interval 1872-1905 possess the same semi-annual period as the solar promi-

TABLE V.—*Annual Variations of the Vapor Pressure.*

Year.	Pacific.			Rocky Slope.			Central-Eastern.		
	V.	M.	V.-M.	V.	M.	V.-M.	V.	M.	V.-M.
1873	-.004	000	-.004	-.002	-.002	000	-.012	-.010	-.002
74	+ .006	+ .003	+ .003	+ .006	+ .003	+ .003	+ .002	-.006	+ .008
75	+ .015	+ .010	+ .005	-.007	+ .003	-.010	-.019	-.004	-.015
76	+ .010	+ .012	-.002	+ .012	+ .009	+ .003	-.001	+ .002	-.003
77	+ .020	+ .012	+ .008	+ .007	+ .011	-.004	+ .008	+ .002	+ .006
78	+ .010	+ .006	+ .004	+ .029	+ .016	+ .012	+ .019	+ .007	+ .012
79	+ .006	+ .006	000	+ .015	+ .020	-.005	+ .001	+ .012	-.011
1880	-.016	+ .002	-.018	+ .020	+ .023	-.003	+ .010	+ .014	-.003
81	+ .008	+ .002	+ .006	+ .030	+ .020	+ .010	+ .021	+ .009	+ .012
82	000	+ .006	-.006	+ .022	+ .022	000	+ .015	+ .012	+ .003
83	+ .012	+ .020	-.008	+ .012	+ .020	-.007	-.001	+ .010	-.011
84	+ .023	+ .024	-.001	+ .023	+ .016	+ .007	+ .015	+ .007	+ .008
85	+ .056	+ .027	+ .029	+ .011	+ .014	-.003	-.002	+ .003	-.005
86	+ .028	+ .029	-.001	+ .012	+ .013	-.001	+ .008	+ .001	+ .007
87	+ .016	+ .024	-.008	+ .013	+ .008	+ .005	-.004	-.002	-.002
88	+ .018	+ .010	+ .008	+ .006	+ .007	-.001	-.014	-.002	-.012
89	+ .004	+ .004	000	000	+ .001	-.002	-.001	-.005	+ .004
1890	-.014	-.001	-.013	+ .004	-.004	+ .008	-.001	-.006	+ .005
91	-.004	-.008	+ .004	-.016	-.011	-.005	-.006	-.006	000
92	-.012	-.012	000	-.016	-.015	-.001	-.006	-.005	000
93	-.017	-.014	-.003	-.025	-.020	-.005	-.013	-.008	-.005
94	-.014	-.014	000	-.023	-.018	-.005	-.001	-.006	+ .005
95	-.022	-.014	-.008	-.022	-.016	-.006	-.016	-.005	-.011
96	-.007	-.016	+ .009	-.001	-.013	+ .012	+ .006	000	+ .006
97	-.012	-.016	+ .004	-.009	-.011	+ .002	-.002	+ .001	-.003
98	-.022	-.012	-.010	-.009	-.006	-.003	+ .013	+ .007	+ .006
99	-.014	-.012	-.002	-.015	-.008	-.007	+ .002	+ .005	-.003
1900	-.004	-.011	+ .007	+ .005	-.008	+ .012	+ .015	+ .004	+ .011
01	-.006	-.009	+ .003	-.013	-.010	-.003	-.006	000	-.006
02	-.007	-.006	-.001	-.004	-.010	+ .006	-.003	-.004	+ .001
03	-.012	-.008	-.004	-.020	-.009	-.012	-.007	-.007	000
04	-.002	-.008	+ .006	-.016	-.007	-.009	-.019	-.009	-.010
05	-.012	-.004	-.008	+ .008	-.005	+ .012	000	-.007	+ .007

nences, as can be seen by comparing the lowest lines of Table III with lowest line but one in Table IV.

*Separation of the annual numbers into two groups, (1) the long-period variations as in 11 years, and (2) the short-period variations as in 3 years.*

In order to exhibit the annual and secular variations of these data, the annual numbers have been separated into two groups, by the following simple process: Since the short period is evidently of 3 years duration, and the long period of 11 years, as can be seen by an inspection, the means of successive groups of five years, as 1873–1877 inclusive, 1874–1878, 1875–1879 . . . . . were taken out, and these are entered in the column M, against the middle year of the group in every case, as 1873–1877 against 1875, 1874–1878 against 1876, 1875–1879 against

TABLE VI.—*Annual Variations of the Barometric Pressure.*

Year	Pacific			Rocky Slope			Central-Eastern		
	B	M	B-M	B	M	B-M	B	M	B-M
1873	----	----	----	+·005	+·012	-·007	--·010	+·010	-·020
74	----	----	----	+·011	+·010	+·001	+·038	+·006	+·032
75	----	----	----	+·006	+·006	000	+·004	+·006	-·002
76	----	----	----	+·008	-·004	+·012	-·003	-·003	000
77	----	----	----	000	-·006	+·006	+·003	-·007	+·010
78	-·027	-·006	-·021	-·043	-·007	-·035	-·055	-·006	-·049
79	+·001	-·004	+·005	-·004	-·012	+·009	+·015	-·006	+·021
1880	+·023	-·001	+·023	-·006	-·014	+·008	+·013	-·004	+·016
81	-·003	+·007	-·010	-·013	-·001	-·012	-·006	+·011	-·018
82	+·004	+·001	+·003	-·002	-·001	-·001	+·013	+·008	+·005
83	+·014	-·007	+·021	+·017	000	+·018	+·020	-·001	+·021
84	-·032	-·008	-·024	-·002	+·002	-·005	-·004	-·001	-·002
85	-·020	-·009	-·011	000	+·002	-·002	-·028	-·004	-·024
86	-·006	-·015	+·009	-·001	000	-·001	-·006	-·006	-·001
87	-·002	-·012	+·010	-·004	+·002	-·006	-·001	-·006	+·004
88	-·018	-·004	-·014	+·005	+·005	000	+·012	+·002	+·010
89	-·011	-·002	-·009	+·012	+·005	+·007	-·003	+·006	-·009
1890	+·016	000	+·016	+·015	+·008	+·007	+·011	+·007	+·004
91	+·004	+·006	-·002	000	+·004	-·004	+·010	000	+·010
92	+·007	+·010	-·003	+·008	+·004	+·003	+·007	000	+·006
93	+·012	+·009	+·003	-·013	+·003	-·017	-·025	-·003	-·023
94	+·014	+·008	+·006	+·013	+·005	+·008	+·004	-·003	+·006
95	+·008	+·008	000	+·008	+·004	+·004	-·008	-·003	-·005
96	-·002	+·005	-·007	+·011	+·007	+·004	+·009	+·001	+·008
97	+·007	+·002	+·005	+·004	+·004	000	+·004	000	+·004
98	+·001	000	+·001	-·003	+·002	-·005	-·007	+·001	-·008
99	-·002	+·001	-·003	-·001	000	-·001	+·002	-·007	+·009
1900	-·006	-·004	-·002	-·001	-·004	+·003	-·006	-·013	+·007
01	+·006	-·002	+·008	+·002	000	+·002	-·028	-·012	-·016
02	-·018	-·001	-·017	-·017	+·004	-·022	-·028	-·012	-·016
03	+·012	-·002	+·014	+·016	+·007	+·008	-·002	-·008	+·006
04	+·002	-·006	+·008	+·019	+·005	+·014	+·012	-·005	+·017
05	-·013	-·004	-·009	+·015	+·009	+·006	+·004	+·008	-·004

1877. Finally the third column in the summaries, P-M, H-M, T-M, V-M, B-M were made by subtraction, and this gives the short period, which is required to be superposed upon the long period to produce the original curve representing the observed annual values of the several elements.

These data of the long and short periods are transferred to fig. 1 for the Pacific States, to fig. 2 for the Plateau and West Gulf States, and to fig. 3 for the Central and Eastern States, and their mutual relations can there be readily studied. The arguments are marked in every case, and need not be further explained.

*Synchronism of the solar prominences and the European magnetic field with the temperatures, vapor pressures and barometric pressures of the United States in the 11-year and the 3-year periods.*

1. An inspection of these curves indicates that there is a clear synchronism between the numbers of the prominences and the terrestrial magnetic field in both the long and the short periods, showing that if the prominences stand as representatives of the solar activity, the intensity of the radiation, electromagnetic or magnetic, varies with it in such a way as to modify the strength of the earth's magnetic field from year to year. It should be noted that there is a tendency for the short-period curve to lag somewhat, possibly several months, behind the solar curve. This suggests very interesting speculations between the time of formation of the solar impulses generating the prominences, and those producing the radiation. Do the great heat and radiation waves pass from the interior to the surface of the sun in such a way that the prominences first feel the impulse in the solar circulation that produces them, and afterwards does the main flood of radiant energy follow from the interior of the sun? It becomes a problem in circulation and convection of heat on the sun, just as in the earth's atmosphere the maximum of heat and the minimum of cold lag about 40 days behind the position of the sun causing them. It has been pointed out, furthermore, that the temperature variations recorded in these tables are a product of circulation in the temperate zones rather than of direct radiation, as might hastily be assumed.

2. A comparison of the curves on fig. 1, fig. 2, fig. 3 indicates that the *synchronism is better defined in the Pacific States than it is east of the Mountains*, and that while the long period tends to break down, the short period persists with considerable precision. This accords with the statement made on page 125, Bulletin No. 21, Solar and Terrestrial Magnetism: "The occurrence of four subordinate crests in the 11-year period suggests strongly that a 2.75 year period is superposed upon the long sweep of that periodic curve. Apparently this is more at the basis of the seasonal variations of the weather conditions of the United States than anything else, so that in long-range forecasting this period must be very carefully considered." If the ten sections of the United States be plotted separately, it is shown that the amplitude of the temperature, vapor pressure and barometric pressure curves *increases from south to north. It is weakest on the Southern Rocky Mountain plateau, and strongest in the Lake Region.*

3. The phenomenon of inversion is very clearly exhibited, and it is fundamental in all these reseaches. *In the long-period*

1

*Synchronism in the Pacific States.*

Solar Prominences, Magnetic Field, Temperature, Vapor Pressure and Barometric Pressure.

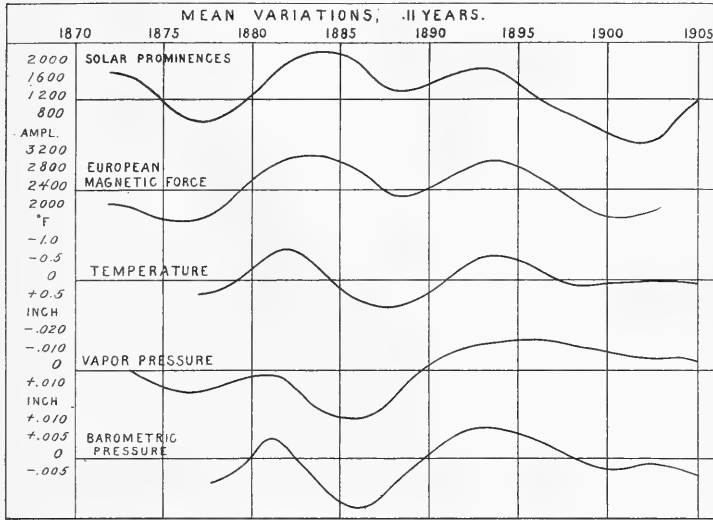

SHORT PERIOD VARIATIONS, 3 YEARS.

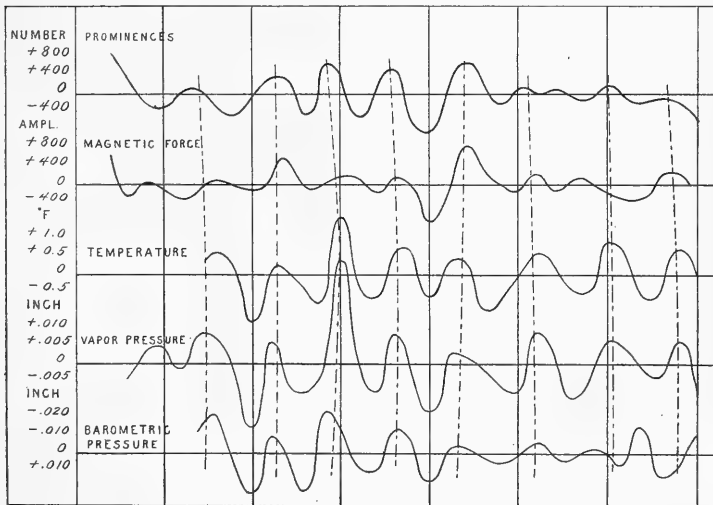

*curves an increase in the prominence and the magnetic force numbers is always accompanied by a decrease in the temperature*

and the vapor pressure, but an increase in the barometric pressure. In the short-period curves the reverse of this is true in the Pacific States, but the same rule holds good on the Rocky Mountain plateau and eastward to the Atlantic Coast. An increase of solar energy, as registered by the number of prominences and the strength of the magnetic field, is attended by *direct* synchronism of the temperature and its dependent vapor pressure, but *inverse* or barometric pressure, in the Pacific States. An increase of the solar output of radiation is accompanied by a decrease in the temperature and vapor pressure, but increase of the barometric pressure, to the east of the Rocky Mountains. We already have shown\* that the *direct synchronism* between the prominences and the temperature prevails throughout the tropics, while the synchronism is generally reversed in the temperate zones. The direct increase of solar radiation is attended by diminution of temperature in the greater part of the United States. Meteorologists are familiar with the fact that the temperatures of the Pacific States generally are the reverse of those in the central and eastern districts, in the sense that the monthly residuals usually have opposite signs, as can be seen on numerous monthly maps representing these conditions for the years 1873-1905.

It therefore is evident that this phenomenon of inversion is to be explained only by the facts of *circulation* of the atmosphere. Since the high-pressure belt, separating the westward drift of the tropics from the eastward drift of the temperate zone, crosses the United States from Florida to Northern California or Oregon, it follows that the Pacific States are practically to be considered as a part of the tropical system, so far as circulation is concerned. This is characterized by freedom from cyclonic circulation, and by a quiescent state of the atmosphere. On the other hand, east of the Rocky Mountains the atmosphere is continually filled with cyclones and high-pressure areas which advance down the slope and move eastward. This is the result of well-known meteorological configurations, which are determined by the relations of the general circulation to the ocean and land areas. When the solar radiation is stronger than the normal, it increases the tropical circulation, with its currents directed poleward in the upper and lower strata, and this is counterbalanced by return cold polar currents, which flow persistently over the United States eastward of the mountains. This therefore conforms to our observations of the temperature, vapor pressure and barometric pressure. *The temperature observed in the temperate zones*

\*Studies on the circulation of the atmospheres of the Sun and of the Earth, Monthly Weather Review, November, 1903.

*North Plateau, South Plateau, West Gulf States.*

Solar Prominences, Magnetic Field, Temperature, Vapor Pressure, Barometric Pressure.

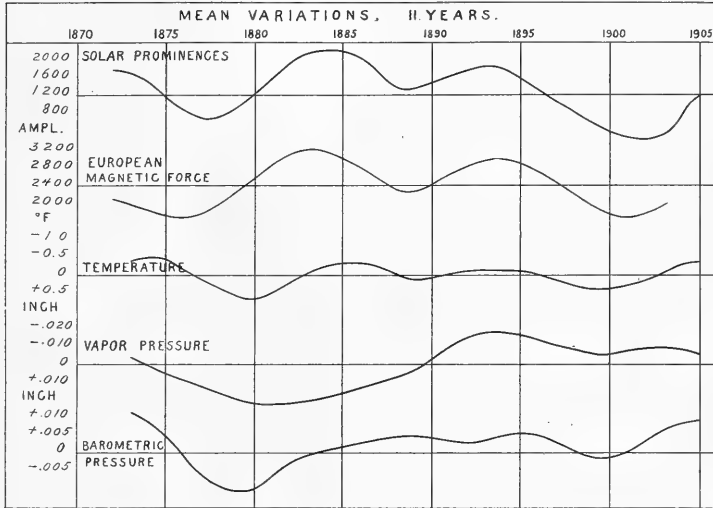

SHORT PERIOD VARIATIONS, 3 YEARS.

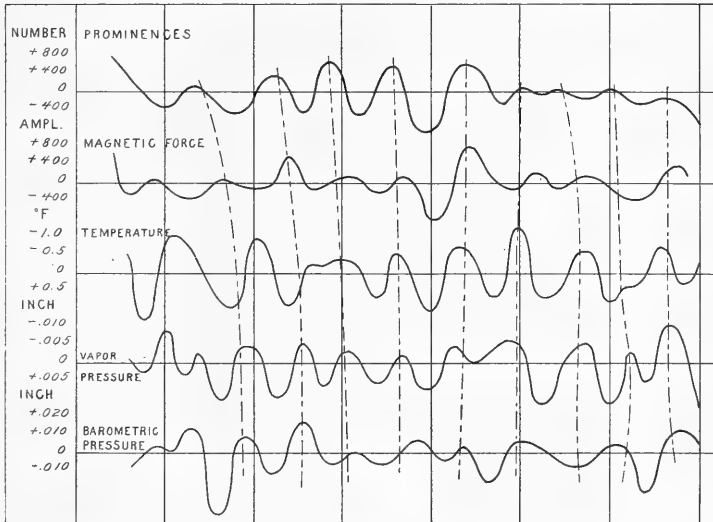

as a yearly amount is the product of the transportation of heat in horizontal currents, rather than of direct heating by radiation. The comparisons of the sun's heat, observed with

the pyrliometer, and the simultaneous temperature at the surface of the earth in the temperate zones, must be treated with the utmost caution, and the entire effect of the temperature due to the currents of the atmosphere, prevailing in a given region, must be fully eliminated before the function of equivalent solar heat energy can be known. *It is this necessity of separating the effects of circulation from those of radiation which constitutes the unusual difficulty attaching to this research,* and which has made it necessary to secure very accurate data from the observations before a beginning could be made upon the real analysis of the problem.

4. It is seen that the amount of the annual variation of the temperature is about one degree Fahrenheit on either side of the normal in the long period, and another degree in the short period, making two degrees amplitude or four degrees range, per day for the year. Multiplying this amplitude by 365, we have 730° F. or 405° C. as the accumulated temperature between the extreme years. These numbers can be compared with the numbers of the solar prominences and the magnetic field as given in our tables, which are the annual sums. The range of the vapor pressure is about 0.040 inch of mercury in the long-range period and 0.020 inch in the short-range period. That of the barometric pressure is 0.015 inch for the long period and 0.040 for the short period. Some preliminary studies show that the variations in certain seasons, as the winter or the summer, may be very large in restricted areas, such as the Lake Region, and it will be our next endeavor to carry this analysis one step further in the direction of the periodic variations of the seasons. As stated, the complexity of the function is very great on account of the circulation, but there is good ground for pursuing the research.

5. In my studies on the magnetic field it was found that a periodic action takes place, having 26.68 days duration, and that a certain type curve emerged from the variations within that period. On attempting to match this curve with the temperatures and pressures of the United States, and other data, it was found that the phenomenon of inversion appeared persistently. A very brief account of this research was summarized in Bulletin No. 21, U. S. Weather Bureau, and on Table 21 the number of the direct and the inverse types found by trials for the magnetic field, the temperatures and the pressures, were recorded. Taking the magnetic field, 1841-1894, we found for the ephemeris the curve given in fig. 4 reproduced from Chart 19 of that Bulletin. It is quite probable that a better conformity can be secured by executing more exact computations. For the prominences the *intensity*



*Lake Region, Central, Atlantic and East Gulf States.*

Solar Prominences, Magnetic Field, Temperature, Vapor Pressure, Barometric Pressure.

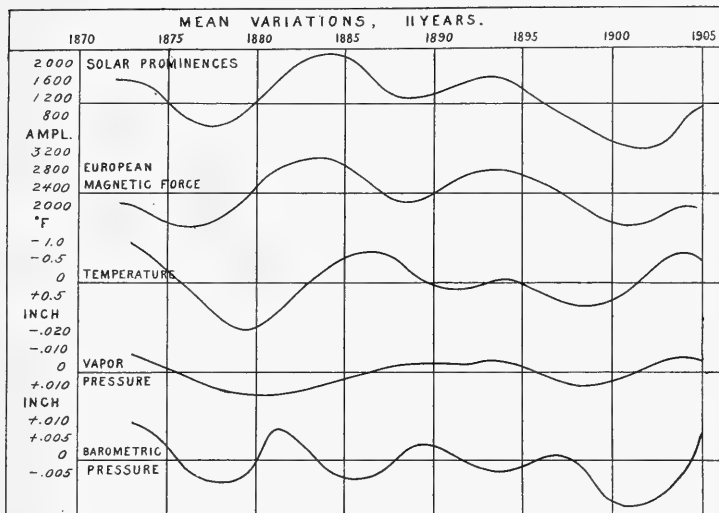

SHORT PERIOD VARIATIONS, 3 YEARS.

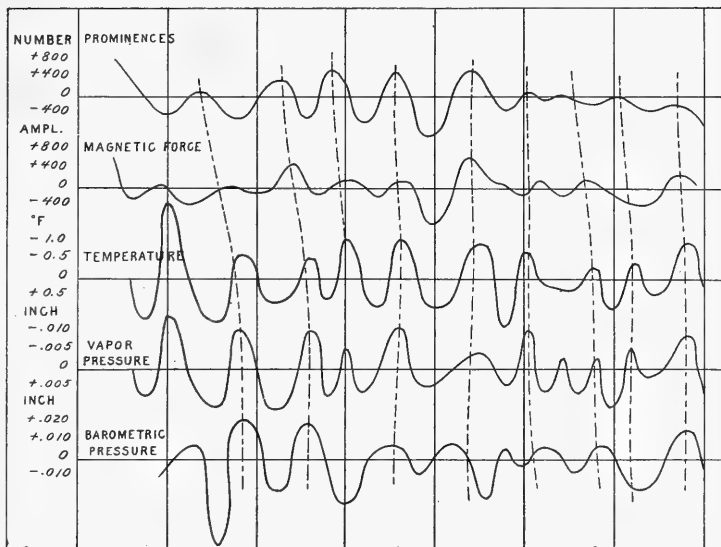

of the eruptions, as well as the number of them, and the number of those appearing over the *entire visible disk* every day of the year, as well as on the edge, should be recorded.

The variations of the magnetic field should embrace several stations in each hemisphere, and combine the horizontal component with those of the declination and the vertical force. The comparison of the direct and the inverse forms of the adopted 26.68 day curve, which apparently lies underneath the complex phenomena of circulation in the earth's atmosphere, should be carefully followed out in different regions, in order to discover the least disturbed place for observatory work. The relation of this central or heart action to the other members of the atmospheric system can then be studied out.

6. The many problems that I have not mentioned, but which are implied in this series of relations, are most fascinating. Not the least of these is the possibility of developing a system of long-range seasonal forecasting. When the crests on the curves reach a certain amplitude, it is easy to foresee their course for a couple of years. The fact that the terrestrial curves tend to lag somewhat behind the solar curves make this a point of value. Since the prominences on the sun develop in middle latitudes a year sooner than they do near the equator or near the poles, there is a chance here to anticipate the impulse at the earth that moves the atmospheric circulation. Our next study will be on the monthly and seasonal variations, as distinguished from the annual variations treated in this paper. It is important to secure homogeneous data of the sun's prominences, the earth's magnetic field and the temperatures, in places of quiet circulation, such as in So. California, to serve as the basis for other corollary researches. It has been assumed in this paper that the frequency of the prominences and the amplitudes of the magnetic field are practically proportional to the intensity of the invisible solar radiation. There are no better elements available at present, and until a continuous homogeneous series of observations with the bolometer or the pyrheliometer are secured, extending over many years, it will not be possible to bring this problem to a conclusion. There will doubtless be a difference of opinion as to the final interpretation of such data, because the smallness of the residuals and the overpowering influence of the circulation in effacing the evidences of synchronism, introduce an element of uncertainty. It must be shown to what extent the maxima of the invisible radiation coincide with the maxima of the prominences. Again, it is evident that the apparent synchronism on the Pacific Coast is partly destroyed through reversal and the turmoil of the cyclones and anticyclones in the lower strata of the atmosphere. It may properly be inferred that the stations for making observations on radiation should be located in the midst of the high pressure belt in about latitude  $33^{\circ}$ - $35^{\circ}$ , where the circu-

[Semi-annual period in the solar prominences, the magnetic force, and the direct type of the normal curve of the 26·68 day period.]

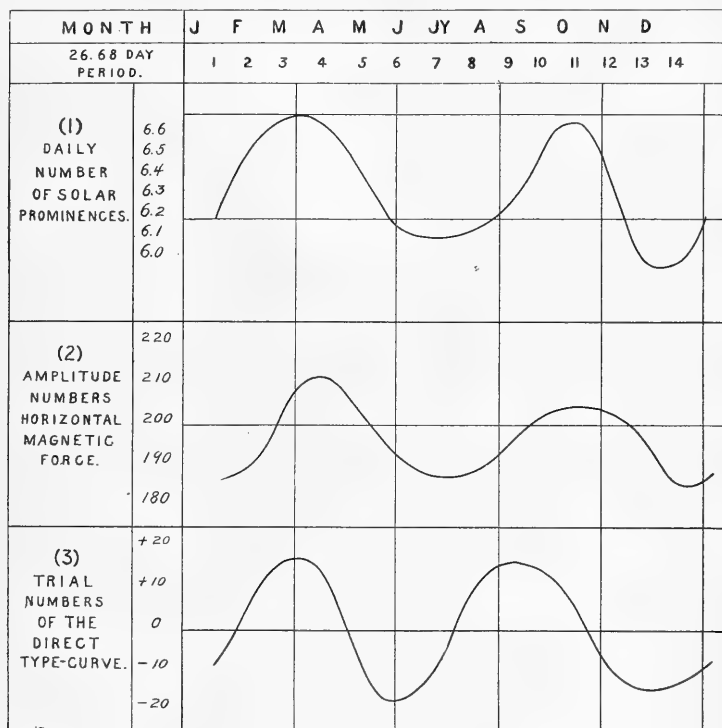

(1) Daily number of solar prominences. Table 2, 1872-1905.

(2) Amplitude number of the European magnetic horizontal force. Table 3, 1872-1905.

(3) Trial numbers of the direct type-curve in the 26·68 day period. Bulletin No. 21, page 102.

It is probable that this synchronism in these three semi-annual periods depends upon the aspect of the earth to the sun in its orbit, the maximum effects occurring at the time of the equinoxes. More prominences can be seen at that time, because the sun's disk shows the two hemispheres more evenly; the magnetic force is more disturbed; the direct type is at a maximum in the successive 26·68 day periods. The physical explanation of these effects is probably this, that the solar radiation is more favorable for influencing the earth's magnetic field, through the process of ionization which produces electric currents. The evidence is that these are most vigorous in the strata of the atmosphere near the earth's surface. It is also found that the warm and cold masses of air move over the Missouri valley in such a procession that the order reverses in the same semi-annual period, when referred to the typical 26·68 day periodic curve.

lation is at a minimum. It should be placed in a dry climate free from fog and clouds, where the region is shielded from strong diurnal winds. Similar stations to the north and south of the equator, in the eastern and the western hemispheres, to supplement each other, and to fill in gaps in the record occurring in any station, are urgently recommended. It is my belief that this subject will in the future assume large proportions, because it is the only way at all promising in which to lay the foundations for a system of seasonal forecasting. The Weather Bureau has now adjusted its records to the required standard of observation and computation for about 100 stations, and the future records will continue automatically to unroll the hidden story of the sun's influence upon the earth's weather and climatic conditions.

ART. XLVI.—*On the Lower Paleozoic Stratigraphy of Southwestern Illinois*; by T. E. SAVAGE, University of Illinois.

[Contributions from the Paleontological Laboratory of Yale University.]

THE following paper is a preliminary statement concerning the pre-Mississippian formations that occur in the southwest portion of Illinois. A monograph on the stratigraphy and paleontology of these terranes in the above mentioned area is being prepared by the writer for presentation as a thesis for the degree of Doctor of Philosophy at Yale University.

The field work on which the report is based was done during the summer of 1907, under the auspices of the Illinois Geological Survey; while the paleontological study was made at the Peabody Museum under the direction of Professor Charles Schuchert. The writer wishes at this time to acknowledge his indebtedness to the Director of the Illinois Geological Survey for assigning him to this very interesting piece of work, and to Professor Schuchert for his invaluable assistance in the study and interpretation of the faunas and the data that were collected.

The pre-Mississippian beds in this portion of the state underlie the surficial materials over an area 150 square miles in extent. They appear in the southwest corner of Jackson county, at the Back Bone and Bake Oven ridge; at the south end of Walker ridge; and at Bald Rock, and southward on the east side of the Big Muddy river. In Union and Alexander counties they extend from the flood plain of the Mississippi river eastward to the general line passing within about one mile west of the towns of Alto Pass, Mountain Glen, Jonesboro, and Mill Creek to a point nearly two and one-half miles southeast of Elco, whence the line separating the Devonian from the younger formations trends toward the southwest past the Diswood postoffice, to near the middle of section 28, Township 15 South, Range 2 West. Eastward they are bordered by Mississippian beds, while along the southern edge sands and clays of Tertiary age lie upon the flanks of these older formations. Occasional patches of Tertiary gravels occur within the region under discussion.

This small area is exceedingly interesting geologically because of the fact that some of the formations here represented do not appear further north anywhere in the Mississippi valley. The successive beds were deposited in a basin of the Interior or Mississippian sea which, during a great part of the time, was more or less separated from that in which the older strata in other portions of the state were laid down. Owing to its prox-

imity to Ozarkia this basin was subjected to vertical movements and therefore to variable conditions of sedimentation, very different from those that prevailed during the same time over the more northern areas.

#### Ordovician.

*Galena-Trenton*.—A thickness of 68 to 80 feet of this formation is exposed in Alexander county. It appears at two points adjacent to the Mississippi river where the waters of that stream have cut across low arches which bring the Galena limestone above the level of the water. One of these exposures is a short distance below Thebes, where a thickness of about 68 feet of limestone may be studied. The second fold crosses the river about two miles north of Thebes, just west of the village of Gale, where these limestones may again be seen on Little Rock Island.

The Galena formation is here a light colored, crystalline, non-magnesian limestone, in layers from a few inches to four feet in thickness, which are imperfectly exposed in the upper part. The lowest layers contain in abundance *Receptaculites oweni*, *Hebertella* near *occidentalis*, *Parastrophia hemiplicata*, *Platystrophia biforata*, *Rafinesquina alternata*, *Rhynchotrema inæquivalve*, *Strophomena emaciata*, *Triplecia* n. sp., and the trilobites *Bronteus lunatus*, *Bumastus trentonensis*, *Illænus americanus*, *Isotelus maximus* and *Platymetopus cucullus*. Eighteen feet above low water *Crania trentonensis*, *Cyrtolites ornatus*, *Plectorthis plicatella* and *Remopleurites striatulus* are associated with most of the above mentioned forms. In the middle and upper parts the white color is in places mottled with pink, and the fossils become much less abundant. *Receptaculites oweni* is still common, while *Crania trentonensis*, *Hebertella* near *occidentalis*, *Platystrophia biforata*, *Rafinesquina alternata*, *Rhynchotrema inæquivalve* and *Triplecia* n. sp., persist in diminished numbers. This facies of the Galena resembles, in its fossils and lithology, the Kimmswick limestone of Ulrich, also described by Weller from Jersey and Calhoun counties.\* The basin in which it was deposited may have been somewhat separated from that which received the sediments of the more northern dolomite phase of the Galena.

*Richmond-Maquoketa*.—The beds provisionally referred to the Richmond have an aggregate thickness of 91 feet. This formation succeeded that of the Galena after a long land interval. All of the Utica and Lorraine deposits are wanting, and, seemingly, much of the Richmond is also absent. The formation in southwest Illinois consists of two members, 2a

\* Weller, Illinois State Geological Survey, Bull. No. 4, p. 222.

and 2*b* of the general section described at the end of this article. The lower one (2*a*) is a sandstone or sandy shale—"Thebes sandstone and shale"—which is exposed along the flanks of the Thebes and Gale anticlines, and in the intervening trough. The materials are reddish-brown where weathered, and blue where not changed by the atmosphere. The lower part is a sandstone, thick bedded and in regular layers, which are well exposed at the east end of the railroad bridge at Thebes. In the upper half the layers are thinner and, where much weathered, appear decidedly argillaceous. This more shaly horizon is well exposed in the river bank three-fourths of a mile south of Gale. *Lingula* cf. *covingtonensis* occurs sparingly throughout the sandy shale of this member.

The upper member is a bed of fossiliferous, bluish shale (2*b* of the section). It is exposed in the bank of the river, and in a cut along the Illinois Central railway about three-fourths of a mile south of Gale, where it overlies the "Thebes sandstone and shale" member. The bed has a thickness of 18 feet, and contains *Cyclocystoides* n. sp., *Phylloporina* near *granistriata*, *Dalmanella testudinaria*, *Plectambonites sericea*, *Rhynchotrema inæquivalve?*, *Strophomena sulcata?*, *Zygospira recurvirostra*, *Conradella* near *fimbriata*, and species of *Isotelus* resembling *I. susæ* and *I. platycephalus*. The lithologic and faunal change from the Thebes sandstone member to this blue shale is abrupt, which may indicate a break between the two beds. The fauna reminds one much of the Black River formation, but as it occurs in, or immediately above, the Maquoketa series, and its life assemblage is not at all that of the overlying Cape Girardeau limestone, it seemed best to group it with the Thebes sandstone.

Neither of these members contain *Rhynchotrema capax*, the widely distributed guide fossil to the Richmond. Indeed, none of their fossils which have yet been determined are decisive markers, but the lithology and position of the beds, and their relation to known formations to the north and south, leads to their provisional reference to the Richmond until the complete study of the fauna and the wider study of their field relations shall determine definitely their stratigraphical position.

The above shales and sandstone do not extend so far north as does the underlying limestone. The sea in which they were deposited probably washed the shores of the Ozarkian land area a few miles to the west, which, during late Richmond time, was the source of the sediments that make up these terrigenous beds.

#### Middle Silurian.

*Alexandrian.*—The beds referred to this formation are exposed in Alexander county to a thickness of 44 feet. They

include the Cape Girardeau limestone and the overlying beds containing *Dalmanites danae* and *Whitfieldella billingsana*. The Cape Girardeau limestone is well exposed about two miles south of Thebes, in the bank of the river and along the streams in that immediate vicinity. It is also seen in a cut along the Illinois Central railroad, and in the river's bank, one and one-half miles north of Thebes. In the former locality this limestone is nearly 40 feet thick, and consists of black, fine-grained, brittle limestone, in thin layers which are often separated by narrow partings of dark, calcareous shale. This zone has a rich fauna which appears abruptly at this horizon. Among the forms are several species of crinoids, *Dalmanella* near *elegantula*, *Homæospira* n. sp., *Leptaena rhomboidalis*, *Rafinesquina mesacosta*, *Rhynchotretra* n. sp., *Schuchertella missouriensis*, *Zygospira* n. sp., *Cornulites tenuistriata*, *C. incurvus*, *Platystoma* near *niagarensis*, *Strophostylus* sp., *Acidaspis halli*, *Calymene* sp., *Cyphaspis girardeauensis* and *Encrinurus* sp.

At the exposure north of Thebes the Cape Girardeau limestone rests directly upon the fossiliferous blue shale (2b of section). This member is succeeded by a bed of dark gray limestone, oolitic in the upper part, which contains *Favosites* sp., *Stromatopora* sp., *Atrypa rugosa*, *Clorinda* n. sp., *Homæospira* n. sp., cf. *Hindella umbonata*, *Leptaena rhomboidalis*, *Platystrophia biforata*, *Rafinesquina mesacosta*, *Rhynchotretra* n. sp., *Schuchertella subplanus* (probably a coarse form of *S. missouriensis*), *Strophomena* sp., *Whitfieldella billingsana*, *Dalmanites danae*, *Dalmanites* sp., and *Lichas breviceps clintonensis*.

There are here no diagnostic fossils of the Richmond. The genera *Favosites*, *Stromatopora*, *Atrypa*, *Whitfieldella*, *Homæospira*, *Schuchertella* and *Clorinda* do not occur in American Ordovician strata, while *Atrypa rugosa* and *Lichas breviceps clintonensis* are indicative of the Silurian. On the other hand, the fauna is not directly related to that of the Clinton, from which formation it is separated by a marked erosional unconformity. Schuchert\* cites a fauna from Edge-wood, in eastern Missouri, collected by Ulrich, which corresponds closely with the above. Since there seems to be no direct time equivalent of these beds in the Ordovician or in the Silurian as generally defined, the horizons 3a to 3c are classed as Middle Silurian strata that more or less completely bridge the lost interval between the Cincinnati and the Clinton. For these beds the time term Alexandrian is proposed, from Alexander county, Illinois, where they are well exposed; the term to have the same rank as Cincinnati, which it immediately follows.

\* Jour. Geol., vol. xiv, pp. 728, 729, 1906.



*Silurian.*

*Clinton.*—The limestone of this formation has here a maximum thickness of 75 feet. One-half mile southeast of Gale it immediately overlies the "Thebes sandstone and shale"; the shale member (2*b* of section) and all of the Alexandrian beds having been cut out by erosion prior to the deposition of the Clinton. One and one-half miles north of Thebes the Clinton limestone rests on the *Whitfieldella billingsana* member (3*c* of section), while two miles south of Thebes it immediately overlies the Cape Girardeau limestone (3*a* of section). The upper part of the Clinton (4*c*) consists of heavy bedded, pink or mottled limestone, 23 feet thick, which contains many small, immature brachiopods, besides *Plectambonites transversalis*, *Rafinesquina mesacosta*, *Spirifer* near *sulcata*, *Illenus* sp., and a few new species of *Orthoceras*. Below this pink limestone lie 6 feet of thin-bedded, dark gray limestone with narrow bands of chert (4*b* of section). The limestone layers contain *Favosites favosus*, *Halysites catenulatus*, *Stromatopora* sp., *Atrypa rugosa*, *Orthis* cf.  *davidsoni*, *Orthis flabellites*, *Plectambonites transversalis*, and var. *elegantula*, *Stricklandinia triplexiana* and *Triplecia ortonii*. The above fauna corresponds with that of the Interior or Western Clinton, as described by Foerste from the region of Dayton, Ohio.

The lower portion of this formation (4*a*) is well exposed in the vicinity of Gale, and two miles further north, along Sexton Creek in the N.W.  $\frac{1}{4}$  sect. 27, T. 14 S., R. 3 W., where it consists of 46 feet of thin-bedded, gray limestone, the layers of which are separated by narrow chert bands.

The thickness of the Clinton is variable. It does not exceed 29 feet in the exposure south of Thebes, while near Gale and along Sexton creek and in the river bluff two miles east of McClure the aggregate thickness is 75 feet. Where the formation is thinnest it is the lower and not the upper layers that are absent.

*Devonian.*

*Helderbergian.*—The rocks of Helderbergian age in Illinois correspond with the New Scotland formation of New York. They succeed the Clinton after an exceedingly long land interval, represented by all of the Silurian after the Clinton, and the Coeymans of the Lower Devonian. In New Scotland time the Interior or Mississippian sea was much more restricted than during the Clinton. According to an unpublished paleogeographic map of the time, by Schuchert, this sea extended as an embayment from the Gulf region as far north as Jackson county, Illinois. It spread west to Indian Territory and east as far as southeast Tennessee. It was separated by a land barrier from the Atlantic embayment (Cumberland basin) which

occupied parts of New York, Maryland, and northeastern Tennessee; and it is probable that the Kankakee barrier, as defined by Schuchert, prevented its spreading far to the north and northwest.

The New Scotland formation in Union and Jackson counties has an aggregate thickness of more than 160 feet. The lower portion, for a thickness of 100 feet, consists of shaly limestone with interbedded bands of chert. This phase is exposed in the lower part of Bald Rock, four miles southeast of Grand Tower, on the Big Muddy river. It appears in the east bluff of the Mississippi river for some distance south from this point. It makes up Tower Rock, in the Mississippi river channel, west of Grand Tower; and it is exposed in the quarry, and in the cut made by the Frisco Railroad company a short distance south and west of this rock. At the latter point were collected *Streptelasma recta*, *Dalmanella subcarinata*, *Leptaena rhomboidalis*, *Leptænisca adnascens*, *Meristella lævis*, *Spirifer cyclopterus*, *S. perlamellosus*, *Stropheodonta punctulifera*, *Hausmannia* sp., and *Phacops logani* var.

The upper 58 feet of the New Scotland formation is composed of light gray, heavy bedded, coarsely crystalline limestone. This facies is exposed in the south end of the Back Bone ridge where a fault brings it above the level of the floodplain. It forms the upper part of Bald Rock, where another fault has raised it to the level of the adjacent Chester limestone, of Mississippian age. It occurs in the east bank of Clear creek, in sections 23 and 24, T. 11 S., R. 3 W. The beds furnished *Aspidocrinus scutellaformis*, *Anoplotheca concava*, *Eatonia singularis*, *Leptænisca concava*, *Megalanteris condoni*, *Meristella arcuata*? *Oriskania sinuata* n. var., *Spirifer concinnus*, *S. cyclopterus*, *S. macropleura*, *S. perlamellosus*, *Stropheodonta beckii*, *S. varistriata*, and variety *arata*, *Strophonella punctulifera*, *Uncinulus nobilis*? and *U. nucleolata*.

*Oriskanian*.—*Clear Creek cherts*, *Camden cherts*.—The Clear Creek formation consists of light grey to yellowish colored cherts that are usually in thin layers, but which in the lower part are sometimes three to five feet in thickness. At some points the cherts are thoroughly leached and decomposed, and occur as a fine white powder that can be dug with a shovel, and is utilized for commercial purposes.

This formation rests, with erosional unconformity, upon the New Scotland beds at the south end of the Back Bone ridge. It corresponds in age to the Camden cherts of western Tennessee. The beds represent deposits of the Upper Oriskany time, as is indicated by the interwedging of the upper chert layers with those of the basal portion of the succeeding Onondaga (see 6a to 6e of section). The chert formation has a thickness,

in Illinois, of about 237 feet. Fossils are somewhat rare in the lower portion, but in the middle, and especially in the upper, portion there is a rich fauna including *Michelinia*, n. sp., *Ambocalia* cf. *umbonata*, *Amphigenia curta*, *Anoplia nucleata*, *Anoplotheca flabellites*, *A. fimbriata*, *Centronella glansfagea*, *Chonostrophia reversa*, *Cyrtina hamiltonensis*, *Eatonia peculiaris*, *E.* cf. *whitfieldi*, *Eodevonaria melonica*, *Leptostrophia perplana*, *Megalanteris condoni*, *Oriskania sinuata* n. var., *Pholidops terminalis*, *Rhipidomella musculosa*, *Spirifer worthenanus*, *S. duodenarius*, *S. macrothyris*, *S. hemicyclus*, *S. tribulis*, *S.* cf. *murchisoni*, *Schuchertella pandora*, *Acidaspis tuberculata*, *Odontocephalus arenarius* and *Phacops cristata*.

These Upper Oriskany beds were deposited near the north end of the Mississippian embayment, which at this time was even more contracted than during the Helderbergian. The basin was remote from, and not connected with, the New York-Maryland province. It covered western Kentucky and Tennessee, and lapped over the southeast corner of Missouri and the east side of Arkansas, spreading an arm across northern Alabama.

*Onondaga*.—The sedimentation of the Upper Oriskany time continued without a break into the Onondaga or Corniferous. The latter period was initiated by disturbances to the westward, in Ozarkia, which increased mechanical sedimentation in the Illinois area. These resulted for a time in the deposition, along the eastern shore of Ozarkia, of layers of sand containing Onondaga fossils alternating with the return of the Oriskanian limestone conditions. Eventually sand deposition prevailed and there was spread over the basin the basal sandstone of the Onondaga formation (7a of section), containing *Michelinia stylopora*, *Aulacophyllum* sp., *Amphigenia curta*, *Centronella glansfagea*, *Meristella* near *lentiformis*, *Rhipidomella musculosa*, *Spirifer duodenarius*, *S. macrothyris*, *Conocardium cuneus* and *Odontocephalus arenarius*.

Early in the Onondaga time an elevation in the southern portion of Union and in Alexander county put a stop to further deposition in these regions, while farther north, in Jackson county, sedimentation was uninterrupted.

At the cut through the Back Bone and at the Bake Oven, a short distance north of Grand Tower, there is exposed a continuous section of the Onondaga formation showing a thickness of 115 feet. The beds consist largely of light colored, regularly bedded, more or less crystalline limestone, which becomes arenaceous in the lower part. Fossils are abundant throughout the section.

The upper layers are marked by *Chonetes konickianus*, *Leptæna rhomboidalis*, *Pentamerella arata*, *P. papilionensis*,

*Meristella rostrata*, *Rhynchonella gainesi*, *Spirifer acuminatus*, *S. grieri*, *S. macra*, *Stropheodonta patersoni*, *Conocardium trigonale* and *Onychodus sigmoides*. In the lower part *Nucleocrinus verneuili*, *Cosciniium cribriformis*, *Centronella glansfagea*, *Leptena rhomboidalis*, *Meristella barrisi*, *Pentamerella arata*, *Spirifer acuminatus*, *S. duodenarius*, *S. macrothyris*, *Stropheodonta patersoni*, *Dalmanites calypso*, *Odontocephalus ægeria* and *Onychodus sigmoides* are common.

During the Onondaga and the succeeding Hamilton time the warm waters from the Gulf region, with their successive faunas, spread towards the northeast across Illinois and Indiana, passing around the north end of the Cincinnati axis, and mingled with those of the eastern embayment in western New York. Such water connections permitted continued migrations within this sea, and accounts for the close correspondence between the various Middle Devonian faunas of southwestern Illinois and those of western Ontario and New York.

*Hamilton.*—Throughout Hamilton time the Kankakee barrier, or peninsula, extending from Ozarkia towards the north-east across Illinois, was largely effective in preventing the waters of the Interior or Mississippian sea from uniting with those of the Northwestern or Dakotan basin towards the northwest. As a result of this separation the deposits and the faunas of Hamilton time, in Illinois, belong to two distinct provinces. The phase of the Hamilton in the vicinity of Rock Island, and in Jersey and Calhoun counties, belongs to the Northwestern or Dakotan province; while that of southwest Illinois belongs to the New York province.

The New York faunal phase of the Hamilton is well developed in the south part of Union county, in the north half of sect. 34, T. 13 S., R. 2 W.; and further north in the N.E.  $\frac{1}{4}$  of sect. 34, T. 11 S., R. 2 W. The formation is also represented in the upper beds near the north end of Back Bone ridge, in Jackson county.

At the first mentioned exposure there is at the base of the Hamilton 28 feet of yellowish-blue shale, which contains *Leiorhynchus limitare*. Both the character of the sediment and the fossils remind decidedly of the Marcellus shale of New York. This shale rests unconformably (erosional) upon the basal sandstone member (7a) of the Onondaga. It is succeeded by a few feet of limestone which, in places, is much leached and very fossiliferous; *Athyris spiriferoides*, *Delthyris sculptilis*, *Rhipidomella penelope*, *Spirifer granulatus* and *Stropheodonta concava* being very common. At points further north the lower beds of the Hamilton consist of dark colored, impure limestone which succeeds the Onondaga without any apparent break. The characteristic fossils of these layers are *Microcyclus discus*, *Athyris vittata*, *Eunella atten-*

*uata*, *Spirifer fornacula*, *Conocardium cuneus* and *Onychodus sigmoides*.

The middle portion of the Hamilton limestone is dark colored and evenly bedded, and contains *Ambocælia umbonata*, *Chonetes yandellanus*, *C. pusillus*, *Cranæna romingeri*, *Parazyga hirsuta*, *Pholidops oblata*, and *Spirifer pennatus*. Above this horizon occurs about 25 feet of yellowish-brown, impure siliceous limestone with few fossils. Near the top of the formation come in a few feet of hard, gray limestone containing *Chonetes coronatus*, *Rhipidomella vanuxemi*, *Spirifer audaculus*, *S. pennatus*, *Tropidoleptus carinatus* and *Vitulina pustulosa*.

*Upper Devonian*.—During Upper Devonian time the Mississippian sea continued to expand, spreading the materials of this formation more widely than the preceding. In the N.E.  $\frac{1}{4}$  of section 34, T. 11 S., R. 2 W., the lower deposits of the Upper Devonian are conformable upon the Hamilton. There is here exposed a thickness of 33 feet of yellowish-brown (black where unweathered), siliceous shale or shaly limestone, cherty near the top, and marked by *Leiorhynchus globuliformis*, *L. mesacostalis*, *Reticularia lævis* and *Spirifer pennatus*. At other points the upper cherty phase is succeeded by 50 or more feet of greenish to black, almost barren shales. These siliceous and dark colored shales are probably the equivalent of the "calico rock," a mottled and leached, siliceous shale, present further south in Union and Alexander counties. They doubtless correspond with the Chattanooga Black Shale, Ohio Black Shale, New Albany Black Shale, and the Lower Portage beds of other states.

*Conclusion*.—The present studies have shown that the pre-Mississippian beds have a much wider distribution in southwestern Illinois than was formerly supposed. They have distinguished the presence of a bed of blue, fossiliferous shale (2*b* of section) containing the Cyclocystoides and Phylloporina fauna, immediately overlying the Thebes sandstone and shale horizon. They have demonstrated the presence, in this region, of Silurian beds corresponding with the Clinton formation in Ohio. They have shown that the massive crystalline limestone underlying the Clear Creek cherts, in Jackson and Union counties, belongs to the New Scotland formation of the Helderbergian. They have demonstrated the Upper Oriskany age of the Clear Creek cherts. They have disclosed the absence of the greater portion of the Onondaga formation in the southern portion of Union and in Alexander county; and they have shown that the Hamilton formation, in Union county, continues upward without a break into the Lower Portage beds of the Upper Devonian.

The general relations of the formations discussed above may be shown in a composite section as follows:

## Generalized section of the pre-Mississippian strata in southwestern Illinois.

System	Correlations.	Location of sections	Descriptions of horizons
Devonian	Upper Devonian New Albany Black Shale = Chattanooga Black Shale = Ohio Black Shale = Lower Portage, 86 feet.	N. E. 1/4 sec. 34, T. 11 S., R. 2 W. and S. E. 1/4 sec. 1, T. 13 S., R. 2 W.	10c. Greenish-blue shale, fossils almost none..... 29 ft. 10b. Black shale with few fossils, but carrying numerous very small balls of iron pyrite from 1/8 to 1/2 inch in diameter..... 21 ft. 10a. Brown to black, siliceous shale or shaly limestone with <i>Leiorhynchus globuliformis</i> and <i>Reticularia levis</i> ..... 36 1/2 ft.
	Late Middle Devonian Hamilton, 70 feet.	N. E. 1/4 sect. 34, T. 11 S., R. 2 W., Union co. Sect. at Back Bone near Grand Tower	9c. Light gray, siliceous limestone, in part oolitic, characterized by <i>Chonetes coronatus</i> , <i>Cranæna romingeri</i> , <i>Spirifer pennatus</i> , <i>S. audaculus</i> , <i>Tropidoleptus carinatus</i> and <i>Vitulina pustulosa</i> ..... 7 ft. 9b. Yellowish-brown siliceous or shaly limestone with few fossils..... 25 ft. 9a. In the north are dark colored, fine-grained limestones with <i>Microcyclus discus</i> , <i>Chonetes yandellanus</i> , <i>Eunella attenuata</i> , <i>Parazyga hirsuta</i> , <i>Spirifer fornacula</i> and <i>S. pennatus</i> . In the south are gray or leached limestones with <i>Athyris spiriferoides</i> , <i>Delthyris sculptilis</i> , <i>Spirifer granulatus</i> , <i>Rhipidomella penelope</i> ... 38 ft.
	Marcellus, 28 feet	N. 1/2 sect. 34, T. 13 S., R. 2 W. Union county	8a. Rather soft shale weathering to a yellowish-brown color, with <i>Leiorhynchus limitare</i> ..... 28 ft.  This horizon is not present at the north, in Jackson county.
Early Middle Devonian	Onondaga, 156-2/3 feet	Back Bone, Jackson county	The Onondaga is well developed in Jackson county, where it passes without a break into the Hamilton. In the southern part of Union county there is a break, and the Onondaga is represented only by the basal sandstone (7a of section). 7i. Heavy layers of very hard, gray, coarsely crystalline limestone, containing corals, <i>Chonetes konickianus</i> , <i>Pholidostrophia iowensis</i> , <i>Productella spinulicosta</i> , and <i>Stropheodonta concava</i> . <i>Strophalosia truncata</i> is abundant in the lower half, while <i>Productella spinulicosta</i> is common in the upper part..... 26 ft. 7h. Layer of dark colored limestone largely composed of <i>Chonetes konickianus</i> var..... 3 5/6 ft.

System	Correlations	Location of sections	Descriptions of horizons
Devonian	Early Middle Devonian	Onondaga, 156-2/3 feet	7g. Thin-bedded, hard, gray limestone, layers 2-10 inches thick. Fossils rare; <i>Chonetes konickianus</i> var. present in the upper part and <i>C. pusillus</i> and <i>Stropheodonta concava</i> in the lower ..... 15 ft.
			7f. Hard, gray, impure limestone with few fossils... 21 ft.
Devonian	Early Middle Devonian	Onondaga, 156-2/3 feet	7e. Dark gray, impure limestone with thin chert bands near the top. Fossils numerous, <i>Nucleocrinus verneuili</i> , <i>Rhynchonella gainesi</i> , <i>Meristella barrisi</i> , <i>Spirifer acuminatus</i> , <i>Stropheodonta patersoni</i> , etc. .... 8 1/3ft.
			7d. Dark gray, impure, fine-grained limestone. <i>Chonetes mucronatus</i> abundant in a zone near the middle. Other fossils are <i>Rhipidomella vanuxemi</i> , <i>Spirifer grieri</i> , <i>Stropheodonta patersoni</i> , <i>S. perplana</i> , and <i>Phacops cristata</i> ..... 11 ft.
			7c. Heavy layers of light gray, subcrystalline limestone. Fossils abundant. <i>Coscinium cribriformis</i> , <i>Centronella glansfagea</i> , <i>Spirifer duodenarius</i> , <i>S. macrothyris</i> and <i>Odontocephalus aegeria</i> present throughout ..... 38 ft.
			7b. Alternating layers of light gray, arenaceous, subcrystalline limestone and coarse-grained sandstone, containing <i>Centronella glansfagea</i> , <i>Meristella</i> near <i>lentiformis</i> , <i>Rhipidomella musculososa</i> , <i>Spirifer duodenarius</i> and <i>S. macrothyris</i> ..... 15 1/2ft.
			7a. Bed of more or less iron-stained sandstone, in places soft and friable, at other points cemented by a deposit of iron or silica, containing <i>Michelinia stylopora</i> , <i>Aulacophyllum</i> sp., <i>Centronella glansfagea</i> , <i>Spirifer duodenarius</i> , <i>S. macrothyris</i> and <i>Odontocephalus arenarius</i> ... 18 ft.
Oriskanian	Upper Oriskany—Clear Creek Chert, Camden Chert, 237 feet	Schaffer's branch, 2 miles west of Jonesboro. N. W. 1/4 sec. 26, T. 12 S., R. 2 W. Union county	6e. Bed of light gray chert in layers 3-9 inches thick. <i>Amphigenia curta</i> , <i>Chonostrophia reversa</i> , <i>Eodevonaria melonica</i> , <i>Schuchertella pandora</i> and <i>Spirifer worthenanus</i> abundant ..... 5 1/2 ft.
			6d. Reddish-brown, friable sandstone with <i>Michelinia stylopora</i> , <i>Zaphrentis</i> sp., <i>Amphigenia curta</i> and <i>Spirifer duodenarius</i> ..... 2 5/6 ft.
			6c. Layers of light chert, 4-8 inches thick. <i>Anoplia nucleata</i> , <i>Chonostrophia reversa</i> , <i>Eodevonaria melonica</i> , <i>Schuchertella pandora</i> and <i>Spirifer worthenanus</i> ..... 1 1/2 ft.
			6b. Reddish-brown, friable sandstone ..... 2 ft.

System	Correlations	Location of sections	Descriptions of horizons
Devonian	Oriskanian	Upper Oriskany—Clear Creek Chert, Camden Chert, 237 feet	6a. Bed of light colored chert layers, in places alternating with impure siliceous limestone, and at other points composed wholly of chert bands. Fossils most abundant in the upper part. <i>Amphigenia curta</i> , <i>Anoplotheca flabel-lites</i> , <i>Eatonia peculiaris</i> , <i>Eodeconaria melon-ica</i> , <i>Chonostrophia reversa</i> , <i>Schuchertella pandora</i> , <i>Spirifer worthenanus</i> , and <i>S. hemi-cyclus</i> common in the upper part..... 225 ft. In the southern part of Union county the lower chert layers are massive and contain but few fossils. In the pit worked by the M. and O. railroad, 1 1/2 miles north of Tamms, in Alexander county, may be seen an exposure of more than 100 feet in which few fossils were found.
		N. W. 1/4 sec. 10, T. 12 S., R. 2 W., Union co. N. E. 1/4 sec. 12, T. 12 S., R. 3 W., Union co. N. E. 1/4 sec. 36, T. 14 S., R. 2 W., Alexander co.	
Devonian	Helderbergian	New Scotland, about 158 feet	5b. Heavy bedded, light colored, coarsely crystalline limestone with <i>Eatonia singularis</i> , <i>Spirifer macropleura</i> , <i>S. perlamellosus</i> , <i>Stropheodonta beekii</i> and <i>Strophonella punctulifera</i> ..... about 58 ft.
		Grand Tower, South end of Back Rock, and Frisco, Bone, Grand Tower, railroad cut a few Jackson co. and Bald Rock S. E. 1/4 sec. 23, T. 11 S. R. 3 W., Jackson co. in Mo.	
Upper Silurian or Silurian	Niagaran	Clinton—Dayton, Ohio Clinton, Interior or Western Clinton, 75 ft.	5a. Bed of impure, shaly limestone with bands and nodules of chert in the upper portion. <i>Dal-manella subcarinata</i> , <i>Meristella levis</i> , <i>Spirifer cyclopterus</i> , <i>S. perlamellosus</i> and <i>Strophonella punctulifera</i> ..... about 100 ft. The horizon of 5a appears to belong immediately below 5b. It is doubtless present at Bald Rock and in the river bluff further south, but the fossils were not found at the latter points.
		2 miles N. E. of Gale, N. W. 1/4 sec. 27, T. 14 S., R. 3 W. and 1/4 mile S. and S. E. of Gale, Alexander county	
Upper Silurian or Silurian	Niagaran	Clinton—Dayton, Ohio Clinton, Interior or Western Clinton, 75 ft.	A short break in sedimentation.
		2 miles N. E. of Gale, N. W. 1/4 sec. 27, T. 14 S., R. 3 W. and 1/4 mile S. and S. E. of Gale, Alexander county	
Upper Silurian or Silurian	Niagaran	Clinton—Dayton, Ohio Clinton, Interior or Western Clinton, 75 ft.	A long break in sedimentation.
		2 miles N. E. of Gale, N. W. 1/4 sec. 27, T. 14 S., R. 3 W. and 1/4 mile S. and S. E. of Gale, Alexander county	
Upper Silurian or Silurian	Niagaran	Clinton—Dayton, Ohio Clinton, Interior or Western Clinton, 75 ft.	4c. Pink, mottled limestone in layers 10-45 inches thick, containing many small, immature brachiopods, with which occur <i>Plectambonites transversalis</i> , <i>Rafinesquina mesacosta</i> and <i>Spirifer</i> near <i>sulcata</i> ..... 23 ft.
		2 miles N. E. of Gale, N. W. 1/4 sec. 27, T. 14 S., R. 3 W. and 1/4 mile S. and S. E. of Gale, Alexander county	
Upper Silurian or Silurian	Niagaran	Clinton—Dayton, Ohio Clinton, Interior or Western Clinton, 75 ft.	4b. Layers of gray to drab colored limestone, 2-6 inches thick, alternating with thin bands of chert, and characterized by such typical Clinton fossils as <i>Stricklandinia triplesiana</i> , and <i>Triplecia ortonii</i> ..... 6 ft.
		2 miles N. E. of Gale, N. W. 1/4 sec. 27, T. 14 S., R. 3 W. and 1/4 mile S. and S. E. of Gale, Alexander county	
Upper Silurian or Silurian	Niagaran	Clinton—Dayton, Ohio Clinton, Interior or Western Clinton, 75 ft.	4a. Bed of tough, gray limestone in layers 3-8 inches thick, which are imperfectly separated by 2- to 4-inch partings of chert. Fossils rare.... 0-46 ft. 4a is wanting at some points in this area.
		2 miles N. E. of Gale, N. W. 1/4 sec. 27, T. 14 S., R. 3 W. and 1/4 mile S. and S. E. of Gale, Alexander county	



System	Correlations	Location of sections	Descriptions of horizons
Middle Silurian	Alexandrian	Cape Girardeau Limestone, about 44 feet	A short break in deposition.
			<p>3c. Coarse-grained, somewhat oolitic limestone, in layers 12-18 inches thick. <i>Atrypa rugosa</i>, <i>Rhynchotrema</i> sp., <i>Schuchertella subplanus</i>, <i>Whitfieldella billingsana</i> and <i>Lichas breviceps clintonensis</i> are common..... 3 1/2 ft.</p> <p>3b. Fine-grained, dark colored shaly limestone, in layers 4-10 inches thick, characterized by <i>Rafinesquina mesacosta</i>, <i>Schuchertella subplanus</i> and <i>Dalmanites danae</i>..... 2 1/2 ft.</p> <p>3a. Cape Girardeau limestone: Fine-grained, black, brittle limestone, layers 1-4 inches thick, separated from each other by thin lenses or partings of calcareous shale on the surface of which are exposed Crinoids, <i>Rafinesquina mesacosta</i>, <i>Rhynchotrema</i> sp., <i>Schuchertella missouriensis</i> and <i>Cornulites tenuistriata</i>, etc. 33-38 ft.</p>
Lower Silurian or Ordovician	Cincinnati	Richmond-Maquoketa, 91 ft.	A probable short break in sedimentation.
			<p>2b. Bed of grayish-blue shale in which 1-inch bands of more resistant calcareous shale occur 4-6 inches apart, bearing <i>Rhynchotrema inaequivalve</i>?, <i>Strophomena sulcata</i>, <i>Zygospira recurvirostra</i>, <i>Conradella</i> sp., and <i>Isotelus</i> sp. 18 ft.</p> <p>2a. Thebes sandstone and shale: Bluish to brown, shaly sandstone. In the lower part a sandstone in layers 1/2 - 2 1/2 feet thick; the upper portion thinner bedded with a larger admixture of shale. <i>Lingula</i> cf. <i>covingtonensis</i> the only fossil found..... 73 ft.</p>
Lower Silurian or Ordovician	Mohawkian	Galena-Trenton, 68-80 ft.	A long break in deposition.
			<p>1a. Light gray, coarsely crystalline limestone, in regular layers 3-48 inches thick, the upper part characterized by the fossils <i>Receptaculites oweni</i>, <i>Herbertella</i> near <i>occidentalis</i>, <i>Platystrophia biforata</i>, <i>Plectorthis plicatella</i>, <i>Cyrtolites ornatus</i> and <i>Platymetopus cucullus</i>, while the lower is marked by <i>Receptaculites oweni</i>, <i>Rhynchotrema inaequivalve</i>, <i>Parastrophia hemiplicata</i> and <i>Triplecia</i> n. sp. .... 68-80 ft.</p>

ART. XLVII.—*The Separation of Magnesium from the Alkalies by Alcoholic Ammonium Carbonate*: by F. A. GOOCH and ERNEST A. EDDY.

[Contributions from the Kent Chemical Laboratory of Yale Univ.—clxxiv.]

NEARLY fifty years ago Schaffgotsch\* brought out the ammonium carbonate method for the separation of magnesium from the alkalies. According to this process, the very concentrated solution of the sulphates, nitrates or chlorides of magnesium, sodium, and potassium, is treated with a concentrated solution of ammonium carbonate. The voluminous precipitate which first falls is acted upon by an excess of the precipitant, sometimes dissolving completely, and crystalline ammonium magnesium,  $MgCO_3 \cdot (NH_4)_2CO_3 \cdot 4H_2O$ , is soon formed. After standing twenty-four hours the precipitate is filtered off, washed with the concentrated ammoniacal solution of ammonium carbonate, dried and strongly ignited. In the absence of salts of potassium, the residue is weighed at once as magnesium oxide, and from the filtrate sodium salts are recovered by evaporation. When a salt of potassium is originally present, with or without a salt of sodium, the ignited magnesium oxide is to be washed out and again ignited before weighing, and the washings are to be added to the filtrate containing the greater part of the alkalies.

When Schaffgotsch published this method† it was customary to deal in analysis with larger amounts of material than at present and the requirements as to results were not so exacting. In eight complete determinations, upon which Schaffgotsch rested, weights of salts taken ranged between 1.75 grm. and 3.69 grm., and the magnesium oxide taken approximated 0.6 grm.; while the weight of magnesium oxide found varied from 0.0007 grm. to 0.0082 grm., with an average error amounting to 0.6 per cent.

Though these results do not meet the modern requirements of a good analytical method, the process has been recently recommended and applied in rock analysis by Wuelfing,‡ and mentioned by Hillebrand.§ It has seemed to us desirable, therefore, that the method should be again submitted to careful testing, and to that end the following work was undertaken.

\* Ann. Phys., civ., 482, 1858.

† A similar method was published by H. Weber, Jahresb. Chem., 1858, p. 606.

‡ Ber. Dtsch. Gesellsch., xxxii, 2214, 1899.

§ U. S. Geol. Sur. Bulletin, 305, 149.

*Experimental.*

Schaffgotsch's reagent was prepared by dissolving 230 gm. of ammonium carbonate in 180<sup>cm<sup>3</sup></sup> of ammonium hydroxide, diluting the solution to one liter and filtering.

A solution of magnesium chloride was prepared by the following process. Presumably pure magnesium oxide, 20 gm., was treated with nitric acid not quite sufficient in amount to act upon all the oxide. The solution thus obtained was diluted somewhat, and boiled and filtered to remove traces of the elements of the iron group. From this filtrate the greater part of the magnesium was precipitated by concentrated ammonium carbonate, thrown upon a filter, washed, and nearly dissolved in nitric acid. The solution, containing some undissolved magnesium carbonate, was first boiled and filtered to remove traces of the elements of the calcium group, and then treated again with ammonium carbonate to precipitate magnesium carbonate. The insoluble magnesium carbonate was washed and dissolved in the least possible amount of hydrochloric acid; and the solution was suitably diluted, and standardized by heating definite portions in a large platinum crucible with sulphuric acid, evaporating, removing the excess of sulphuric acid by careful heating over a radiator and bringing to constant weight the residue of magnesium sulphate. With the Schaffgotsch reagent and the standard solution of pure magnesium chloride the following experiments were made.

In Table I are given results of experiments made to test the solubility of the ammonium magnesium carbonate in an excess of the precipitant of full strength or half strength. Definite portions of the standard solution of magnesium chloride were evaporated in a beaker of 250<sup>cm<sup>3</sup></sup> capacity nearly to dryness, and the precipitant was added in the amount indicated. The mixture, stirred vigorously until the flocky precipitate had disappeared and the crystalline double carbonate had begun to form, was allowed to stand at least twenty-four hours. The precipitate, filtered off on asbestos in a perforated crucible, the filtrate being used to effect the transfer without addition of other liquid, was dried, ignited, and weighed as magnesium oxide. The filtrate was treated with microcosmic salt, and, after standing over night, was again filtered on asbestos in a weighed perforated crucible, and the precipitate was washed with water faintly ammoniacal, dried, ignited and weighed. The increase in weight of the crucible was taken as magnesium pyrophosphate from which the magnesium oxide was calculated. In the experiments of A, Schaffgotsch's reagent of full strength was used as the precipitant. In B the same reagent was used of half strength.

TABLE I.

MgO taken as MgCl <sub>2</sub> grms.	MgO weighed grm.	Error MgO grm.	MgO found as Mg <sub>2</sub> P <sub>2</sub> O <sub>7</sub> in filtrate grm.	Volume of precipitant cm <sup>3</sup> .	Volume of reagent used in washing cm <sup>3</sup> .
A.					
0.0029	0.0000	-0.0029	0.0024	100	--
0.0289	0.0286	-0.0003	0.0007	10	--
0.1444	0.1430	-0.0014	0.0006	50	--
0.1444	0.1427	-0.0017	0.0009	50	50
B.					
0.0034	0.0000	-0.0034	0.0033	100	--
0.0342	0.0342	-0.0000	0.0002	10	--
0.1708	0.1694	-0.0014	0.0012	50	--
0.1708	0.1696	-0.0012	0.0012	50	--
0.1708	0.1698	-0.0010	0.0020	50	25
0.1708	0.1683	-0.0025	0.0024	100	10
0.1708	0.1670	-0.0038	0.0043	200	10

These experiments show plainly that ammonium magnesium carbonate is noticeably soluble in Schaffgotsch's solution of full strength, and rather more so in the same reagent of half strength. So, it is evident that an exact separation of magnesium from the alkalies, in solutions of reasonable volume, cannot be made without some modification of the method. The effect of adding to the mixture certain proportions of alcohol was therefore tried, and, after some preliminary attempts, a series of experiments was performed for which the precipitant used was made by saturating with ammonium carbonate a mixture of 180<sup>cm</sup><sup>3</sup> of ammonium hydroxide, 800<sup>cm</sup><sup>3</sup> of water, and 900<sup>cm</sup><sup>3</sup> of absolute alcohol, and filtering, after some hours, from the undissolved ammonium carbonate. In the experiments of Table II (A), portions of the standard solution of magnesium chloride were evaporated nearly to dryness and to the residue was added a definite amount of the alcoholic solution of ammonium carbonate. The precipitates, after stirring and standing over night, were filtered upon asbestos in the perforated platinum crucible, washed with the precipitant, dried, ignited strongly, and weighed. The filtrates were examined as before for dissolved magnesium by the phosphate method. In the experiments of Table II (B) an equal volume of alcohol was added to the solution of magnesium chloride taken and to this mixture was added, as a precipitant, a volume of the saturated alcoholic solution of ammonium carbonate equal to that of the magnesium chloride. The precipitate was filtered, washed, dried, ignited, and weighed as in the former experiments. The filtrate was examined as before for magnesium.

TABLE II.

MgO taken as MgCl <sub>2</sub> grm.	MgO weighed grm.	Error in MgO grm.	MgO found as Mg <sub>2</sub> P <sub>2</sub> O <sub>7</sub> grm.	Original vol. cm <sup>3</sup>	Vol. of alcohol added cm <sup>3</sup>	Vol. of precipitant. cm <sup>3</sup>	Vol. of solution used in washing cm <sup>3</sup>
A							
0.1444	0.1446	+0.0002	0.0001	--	--	50	--
0.1444	0.1449	+0.0005	0.0000	--	--	100	--
0.1444	0.1445	+0.0001	0.0000	--	--	100	50
0.1444	0.1445	+0.0001	0.0000	--	--	100	50
B							
0.1444	0.1443	-0.0001	0.0000	50	50	50	--
0.1444	0.1440	-0.0004	0.0002	50	50	50	--

From the results of section A of this table, it appears that the precipitation of the magnesium brought about in 100<sup>cm</sup><sup>3</sup> of a saturated ammoniacal ammonium carbonate solution containing 50 per cent of alcohol is complete. From the result of section B it appears that the precipitation produced in 150<sup>cm</sup><sup>3</sup> of a one-third saturated solution of ammonium carbonate containing 50 per cent of alcohol is reasonably complete.

Table III shows the details of certain experiments in which the separation of magnesium from the alkalis was attempted by the precipitation processes of Table II. In the experiments of A the precipitation was brought about by treating the solution of magnesium chloride and the alkali chlorides, concentrated in the highest degree, with the saturated ammoniacal ammonium carbonate solution containing 50 per cent of alcohol. In the experiments of B, an equal volume of absolute alcohol was added to the water solution containing magnesium chloride and the alkali chlorides, and to this mixture was added the saturated ammoniacal ammonium carbonate solution containing 50 per cent of alcohol. In the experiments of C the precipitate was made as in the experiments of B, but, after pouring off the supernatant liquid through the asbestos felt of a weighed perforated platinum crucible, was dissolved in the beaker by warming with the least possible amount of hydrochloric acid. The solution was diluted with water to 50<sup>cm</sup><sup>3</sup> and treated as in the first precipitation. The second precipitate was collected upon the asbestos felt through which the supernatant liquid had been filtered after the first precipitation, ignited, and weighed. The filtrates were tested for dissolved magnesium as in former experiments. In experiments in which the filtration was made after twenty minutes it was found advisable to hurry the crystallization by stirring the mixture for not less than five minutes after adding the precipitant.

TABLE III.

MgO taken gram.	NaCl taken gram.	KCl taken gram.	NH <sub>4</sub> Cl taken gram.	MgO weighed gram.	Error MgO gram.	MgO found as Mg <sub>3</sub> P <sub>2</sub> O <sub>7</sub> gram.	Volume of water solution—cm <sup>3</sup>	Volume of alcohol added—cm <sup>3</sup>	Volume of precipitant—cm <sup>3</sup>	Volume of solution used in washing—cm <sup>3</sup>	Time of standing.
0.1444	--	0.1	--	0.1455	+0.0011	0.0000	1-2	---	100	50	over night
0.1444	0.1	--	--	0.1446	+0.0002	0.0000	1-2	---	100	50	
B											
0.1444	--	0.1	--	0.1445	+0.0001	0.0001	50	50	50	50	20 min.
0.1444	--	0.1	--	0.1444	0.0000	0.0001	50	50	50	50	20 "
0.1444	0.1	--	--	0.1445	+0.0001	0.0002	50	50	50	50	20 "
0.1444	0.1	--	--	0.1449	+0.0005	0.0001	50	50	50	50	20 "
0.1444	0.2	--	--	0.1449	+0.0005	0.0002	50	50	50	50	20 "
0.1444	--	0.2	--	0.1461	+0.0017	0.0000	50	50	50	50	20 "
0.1444	--	--	3.0	0.1444	0.0000	0.0001	50	50	50	50	20 "
0.1444	--	--	3.0	0.1447	+0.0003	0.0002	50	50	50	50	20 "
C											
0.1444	0.2	--	--	0.1446	+0.0002	0.0002	50	50	50	50	20 min.
0.1444	--	0.2	--	0.1442	-0.0002	0.0002	50	50	50	50	20 "

The results of each method of treatment are plainly very good, but it is more convenient to add alcohol to a water solution than to evaporate a solution and then treat the residue. Reprecipitation is shown to be advisable when large amounts of the alkalis are present. For amounts comparable to those which we have handled, the procedure is very rapid and simple. The solution containing the salts of magnesium and the alkalis is brought to a volume of about 50<sup>cm</sup><sup>3</sup> and an equal amount of absolute alcohol is added, precipitation is made by addition of 50<sup>cm</sup><sup>3</sup> of the saturated ammoniacal ammonium carbonate solution containing 50 per cent alcohol, and the mixture is allowed to stand twenty minutes with stirring for five minutes. If the amount of alkali salt originally present is small, the precipitate may be collected on asbestos in a perforated crucible, washed with the precipitant, dried, ignited, and weighed as magnesium oxide. When the amount of alkali salt originally present is large, the precipitate may be freed from traces of the alkali salt by pouring off the supernatant liquid through the prepared asbestos filter, dissolving the precipitate, and precipitating ammonium magnesium carbonate as at first. This second precipitate, collected upon the filter originally used, leaves upon ignition practically pure magnesium oxide.

## SCIENTIFIC INTELLIGENCE

## I. CHEMISTRY AND PHYSICS.

1. *Determination of Small Amounts of Iron in Copper Alloys.*—A colorimetric method for this purpose has been worked out by A. W. GREGORY by making use of the well-known color imparted to solutions of ferric salts by salicylic acid. Two tenths of a gram of alloy are dissolved in a minimum quantity of strong nitric acid. If a precipitate is formed, due to tin or antimony, the liquid is diluted slightly and filtered. Lead if present must be removed as sulphate. To the solution 20° of a concentrated solution of sodium acetate are added and 10° of a 10 per cent. solution of salicylic acid in glacial acetic acid. A 3 per cent solution of potassium cyanide is now added gradually until the green color of the solution has disappeared and the precipitate of copper cyanide has dissolved. The liquid, which is red if iron is present, is made up to a definite volume, and a measured portion, depending upon the strength of the color, is transferred to a Nessler comparison tube. The color is then matched in another Nessler tube by adding a standard solution of ferric chloride to the same amounts of sodium acetate and salicylic acid solutions. By this method it is possible to detect as little as .00002 g. of iron in the presence of .2 g. of copper. The test cannot be employed in the presence of considerable amounts of bismuth. Test analyses gave very accurate results with quantities of iron up to .2 per cent.—*Jour. Chem. Soc.*, xciii, 93.

H. L. W.

2. *The Action of Carbonates upon Tetrathionates.*—A. GUTMANN, having previously shown that dilute caustic alkalies convert a tetrathionate into thiosulphate and sulphite, as, for example,



has observed the peculiar circumstance that carbonates and ammonia do not act in the same way upon a tetrathionate, but produce thiosulphate and sulphate as follows :



Similar results were obtained with potassium carbonate, lithium carbonate, and ammonia. The reactions take place upon boiling, and they were shown to be sharply quantitative. A peculiar result was obtained when carbonates of calcium, strontium and barium were allowed to act upon a tetrathionate, for in these cases it appears that a new isomer of ordinary thiosulphates is formed, for it does not react like the latter when boiled with potassium cyanide. It was found further that sodium tetrathionate when boiled alone with water gives the reaction



although it had been previously supposed that a trithionate was thus produced.—*Berichte*, xli, 300. H. L. W.

3. *Percarbonates*.—WOLFFENSTEIN and PELTNER have found that by acting upon barium dioxide in excess with carbon dioxide in the presence of water at a low temperature an unstable compound,  $\text{BaCO}_4$  is formed,



which they regard as barium percarbonate. Very little hydrogen peroxide is produced until the carbon dioxide is in excess, but then it is rapidly produced, apparently according to the equation

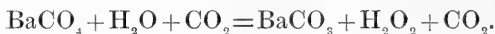

The same authors believe that they have shown the existence of a series of sodium percarbonates, two of which are new, as follows :

- Carbonate of sodium dioxide,  $\text{Na}_2\text{CO}_4$ .
- Bicarbonate of sodium dioxide,  $\text{Na}_2\text{C}_2\text{O}_6$ .
- Carbonate of sodium trioxide,  $\text{Na}_2\text{CO}_6$ .
- Bicarbonate of sodium trioxide,  $\text{NaHCO}_4$ .

—*Berichte*, xli, 280.

H. L. W.

4. *Practical Methods for the Iron and Steel Works Chemist*, by J. K. HEES, 8vo, pp. 60. Easton, Pa., 1908. (The Chemical Publishing Co.)—The object of this book is to give the best methods for the commercial analysis of iron and steel works materials. With few exceptions only one method is given for each determination, the methods chosen being those employed in the laboratory of an important steel works. The directions are concise and clear, all unnecessary matter being excluded, and the book will be useful both to chemists of steel works and to students who wish to fit themselves for this field of work. H. L. W.

5. *Laboratory Exercises in Physical Chemistry*, by FREDERICK H. GETMAN. Second edition. 12mo, pp. 285. New York, 1908. (John Wiley & Sons.)—Only a brief notice is needed to announce the appearance of a new edition of this useful book. A chapter on thermostats has been inserted, and the chapters treating of electromotive force, solubility and chemical dynamics have been enlarged, while other minor improvements have been made in the new edition. H. L. W.

6. *Quantitative Chemical Analyses*, by ALBERT F. GILMAN. 24mo, pp. 88. Easton, Pa., 1908. (The Chemical Publishing Co.)—This little book contains laboratory directions, questions for the student, and blank forms for recording results in connection with a course in quantitative determinations. These exercises for practice appear to deal exclusively with determinations of constituents of pure compounds, no attention being paid to the important subject of the separation of metals, etc., from each other. H. L. W.

7. *Flame Spectra obtained by Electrical Means*.—G. A. HEMS-ALIECH and C. DE WATTEVILLE lead the vapor produced by an



arc lamp—provided with various forms of carbon—into a Bunsen flame. If iron vapor is led into this flame, its spectrum is seen together with a strong continuous background: the latter disappears if the vapor is filtered through glass wool before reaching the flame.—*Comptes Rendus*, cxlv, Dec. 16, 1907, pp. 1266-1268.

J. T.

8. *Electric Furnace Reactions under High Pressure*.—R. S. HUTTON and J. E. PETAVEL describe their experiments and give preliminary results. Electromotive forces of 25,000 volts and pressures of 200 atmospheres were employed. A concentrated and compressed atmosphere of CO has little effect upon the formation of calcium carbide. Under high pressures the production of carborundum becomes very difficult, which confirms the view that it is formed by the interaction of silica vapor with highly heated carbon.—*Roy. Soc. Phil. Trans.*, Ser. A 207, Jan. 17, 1908, pp. 421-462.

J. T.

9. *The Positive Column in Oxygen*.—REV. P. J. KIRBY has investigated the electric force in the positive column when a steady electric charge passes through oxygen at low pressures between two plane-parallel electrodes placed in a straight glass tube. He finds that the force presents exceptional features in the case of oxygen—being much smaller than in other common gases—and instead of diminishing continually with the pressure, reaches a minimum of about  $2 \cdot 0^{\text{mm}}$  pressure, and there is a sharp discontinuity at a pressure of  $\cdot 8^{\text{mm}}$ . The method employed did not involve the use of an exploring wire. The author attributes the discontinuity to the presence of ozone.—*Phil. Mag.*, April, 1908, pp. 559-568.

J. T.

10. *Quadrant Electrometers*.—H. SCHULZE discusses the error or disturbances which arise from contact difference of potential in the use of very sensitive electrometers, and suggests precautions in their use.—*Zeitschrift Instrumentenkunde*, March, 1908, pp. 61-69.

J. T.

11. *The Reception of Electric Waves in Wireless Telegraphy*.—In a discussion upon the amount of energy received by the antennæ employed in wireless telegraphy, REINHOLD-RÜDENBERG confirms the result of R. A. Fessenden that long waves are more efficient than short waves for overcoming great distances. He proves that in general the amount of energy received increases with the square of the wave length, and shows how very small the amount of energy is which is received, and how fallacious is the hope that any large or rational amount can ever be transmitted by electric waves through the ether.—*Ann. der Physik*, No. 3, 1908, pp. 446-466.

J. T.

12. *Velocity of Sound*.—By means of resonators, M. Thiesen has determined this velocity in air at  $0^{\circ}$  C. and finds it  $3 \cdot 3192 \times 10^{10} \pm 5^{\text{cm}}$ /sec.—*Ann. der Physik*, No. 3, 1908, pp. 506-520.

J. T.

13. *Diffraction of X rays*.—Hayn and Wind claimed to have shown the diffraction of these rays and their results are quoted in various treatises; notably in Prof. J. J. Thomson's work on

Conduction in Gases. B. WALTER and R. POHL have repeated the experiments of Hayn and Wind and do not substantiate them, and find that the wave lengths  $0.012$  and  $0.27\mu\mu$  found by these experimenters, if such wave lengths exist, must lie far under  $0.1\mu\mu$ .—*Ann. der Physik*, No. 4, 1908, pp. 715-724. J. T.

14. *Electrolitic Rectification of Niobium*.—G. SCHULZE under this head discusses the rectification of alternating currents by various metals, and concludes that the rectification behavior of niobium is similar to that of tantalum, and it appears that scandium, lanthanum, yttrium, ytterbium, show rectification quantities.—*Ann. der Physik*, No. 8, 1908, pp. 775-782. J. T.

15. *A Manual of Practical Physics*; by E. S. FERRY and A. T. JONES, Vol. I, pp. xi, 273; London and New York, 1908. (Longmans, Green & Co.)—This volume contains a well-arranged and fairly extensive series of experiments upon fundamental measurements, the properties of matter, and heat. In the list of experiments chosen, it does not differ greatly from other laboratory manuals; but the theory underlying each measurement is given in considerable detail, and the sources of error are carefully considered, so that the work is really of a more advanced character than some others which apparently cover the same ground. Two other volumes upon Sound and Light and upon Electrical Measurements are in preparation. H. A. B.

16. *La Telegraphie sans Fil*; par I. VAN DAM. Deuxième édition. Pp. xiii, 239. Paris et Liège, 1908 (Ch. Béranger).—The first three chapters of this work deal with the elementary theory of the production and propagation of electrical waves with special reference to their application in wireless telegraphy. Succeeding chapters give descriptions of the numerous forms of receivers which are in use, of methods of syntonization, of special apparatus for measurement and of the arrangements of apparatus which are characteristic of the various "systems" now in use. Short chapters are included upon undamped waves such as are given by the Poulsen arc, and upon the attempts which have been made to give a determinate direction to the waves. The final chapter gives an account of the legal regulation of wireless telegraphy in various countries and of the international convention of 1906. As a whole the book is interesting and well arranged; so far as the reviewer can judge it appears to be up to date and should prove a useful compendium of the present state of the art of wireless telegraphy. H. A. B.

## II. GEOLOGY.

1. *Shepard on the Underground Waters of Missouri*; by A. C. LANE (communicated).—The U. S. Geological Survey has recently issued a Water Supply paper\* which attracted my attention, since I had recently cited a St. Louis water as an example of buried seawater.†

\* Water Supply and Irrigation Paper No. 195, Underground Waters of Missouri, their geology and utilization, by Edward M. Shepard.

† Science, August 8, 1907, p. 135.

It interested me to see how far this larger collection of analyses compiled by a competent hand would warrant my reference. This took a little study, since the index to the paper does not group the analyses under any one head. It has seemed to me,

1

84	25	67	0
82	14	48	60
52	89	05	90
51	76	90	90
59	55	90	00
77	23	55	66
54	20	57	11
51	11	57	12
53	10	94	53
190	10	94	53
61	68	91	32
68	00	77	32
26	19	92	55
59	46	76	33
48	46	76	33
47	46	76	33
40	69	77	33
66	44	90	44
76	66	49	44
11	99	19	19
11	63	15	19
11	87	19	19
11	70	14	12
12	17	12	33
11	77	33	33
11	88	57	88
16	55	70	00
14	44	55	55
16	55	55	33
77	55	55	33
73	55	21	10
16	55	49	00
13	88	44	00
13	44	99	55
13	33	33	88
19	88	33	16
18	17	27	66
13	77	26	00
14	44	24	00
14	60	22	55
13	33	21	02
13	33	18	22
14	41	17	55
14	41	16	90
14	60	15	00
17	88	11	20
18	66	11	33
83	83	3	9

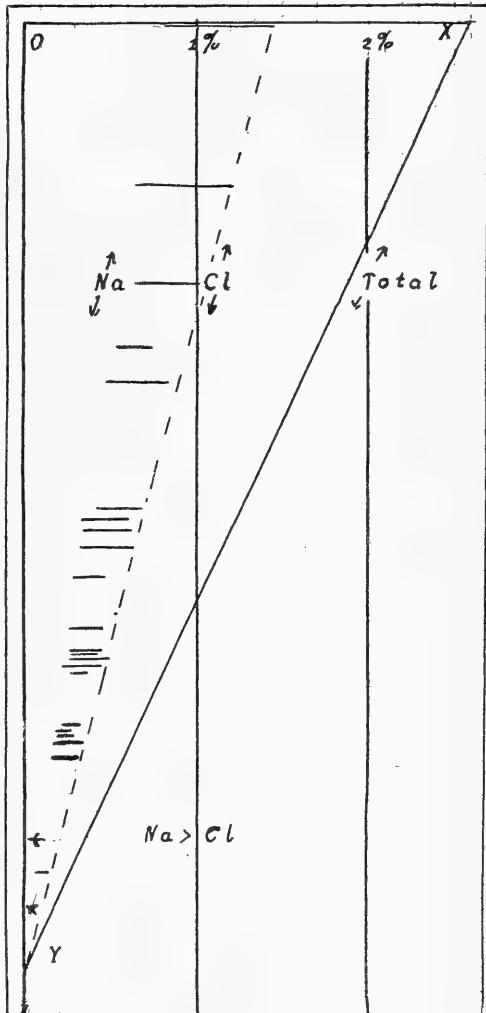

therefore, that my compilation of the analyses in order of concentration might be worth record.

The geological column of Missouri shows a distinct transition from that typical of the east to that of the west, the Grand Canyon

type, in that the whole interval from the Cambrian (or rather the Saint Peter) sandstone to the Carboniferous is not very thick. Thus very many of the deeper Missouri wells may draw both from the Calciferous and the Lower part of the Pennsylvanian. The Calciferous or St. Peter is, says Shepard, the most important water bearer, and is classed as Cambro-Ordovician.

This relatively thin column between the St. Peter and the Coal-measures is in part due to one or more unconformities. These imply that Missouri was out of water during long periods of the Paleozoic. We also find that there are considerable local disturbances, so that, for instance, the beds from which the deep St. Louis wells draw their water come to the surface within a few miles. Thus both during Paleozoic times and more recently considerable circulation may have taken place. Missouri, then, is not a very good state from which to draw safe conclusions as to buried waters. Nevertheless Shepard also notes indications of "fossil brines."

I have arranged the analyses in order according to the total solids. The strongest water given has a little over two per cent solids. I have then (fig. 1) drawn a line from an abscissa X corresponding to this concentration down to an arbitrary ordinate. Opposite points on this line corresponding to the strengths of the various waters I have drawn lines connecting an abscissa corresponding to the chlorine with one corresponding to the sodium for the same analysis. If the waters were dilutions of one water, or simply compounds of two waters, straight lines could be drawn through the ends of these lines.

With the chlorine this is nearly but not absolutely true, leading one to infer that there is one strong water, strong in solids and also strong in chlorine, and that the waters with which it has been diluted have relatively almost insignificant amounts of chlorine.

With the sodium this is not so much so. The ratio of sodium to chlorine is quite variable, sometimes more and sometimes less than in salt. In the sodium there are at least three types of water that must be assumed,—a saline one with over 2.5 per cent solids, a fresh one practically pure, and an alkali water such as is characteristic of the far west and is best represented by the Haver well, p. 69, strong in sodic sulphate or carbonate. Other fairly weak wells show the same predominance of sodium.

These arid land waters are factors which I have hitherto neglected. If the stronger analyses were derived by solution of salt from a weaker buried ocean water containing the calcium chloride, we might expect the chlorine to form a larger proportion of the total solids in the weaker brines. Of this there is little or no sign.

On the whole, therefore, the Missouri analyses, if compatible with the theory of the chemical evolution of the ocean at all, would indicate a greater degree of concentration in the Paleozoic than the figures in my address of last July, and hence much

greater time previous, and a relatively much earlier determination of the composition and concentration of the "organic medium."

There has also just appeared a bulletin of the Illinois Geological Survey on the waters of the East St. Louis district,\* which should be studied at the same time. The Mascoutah well seems to be especially of interest. Unfortunately there are a number of slips by which contradictory statements as to the character of the water at different depths are made, but it seems likely that there are two main flows as usual, one from the Carboniferous and one from the Calciferous, differing greatly in sodium. In chlorine and total solids it agrees with the strongest of the Missouri water.

2. *The Falls of the Niagara,—their Evolution and varying Relations to the Great Lakes; Characteristics of the Power, and the Effects of its Diversion*; by JOSEPH WILLIAM WINTHROP SPENCER. Pp. xxxi, 470, with 58 plates and 30 figures, frontispiece and map. Geological Survey of Canada, Ottawa, 1907.—During the years 1905–1906 special surveys were made to determine disputed points regarding the origin and history of certain features of the Niagara falls region. The results of these surveys, taken in connection with work previously done by Spencer, Taylor, Gilbert and others, give a fairly complete account of the physiography of the Niagara river. New soundings have been made for the entire gorge, which have determined its shape much more accurately than heretofore. The soundings directly underneath the Canadian falls, where an unexpected depth of 192 feet was found, and also in the Whirlpool rapids, were executed with great skill.

A detailed study of the form of the gorge in connection with the structure of the rock forming its sides and bed has led to recalculations of the rate of recession. The mean rate for the Canadian falls from 1842 to 1905 is 4.2 feet annually; for the American falls about .6 of a foot annually. The rate is slower now than previously and the future retreat will be still slower, owing to the fact that the river is now receding up the bank of an ancient river depression.

The chapters dealing with the development of the Great Lakes, their shifting outlets due to uncovered channels and earth tilting, contain material that has previously been presented, but for the first time a definite pre-Glacial outlet for Lake Erie has been discovered and the existence of a buried valley extending from the falls southwestward toward the Welland river has been proven by well borings. A study of the rainfall, fluctuation of level, amount of discharge, etc., of Lake Erie is discussed in detail, and the conclusion reached that there has been practically no tilting of the lake beds during the past fifty years.

\* Bulletin No. 5, Illinois Geological Survey by I. Bowman and C. A. Reeds (this Journal, April, 1908, p. 393). The Mascoutah well is mentioned pp. 24, 57, 64, 76, 78, 93, 94, 117.

Dr. Spencer calls attention to the changes that are sure to occur in the character of the falls and the river as the result of power plants established at Niagara. If the concessions already granted are completely developed, the waters of the lakes will decrease materially and the American falls will entirely disappear. The level of Lake Erie has dropped eight inches already as the result of the development of about one-fourth of the franchise power.

The detailed studies outlined above enable the author to reach the following conclusions regarding the age of the falls: "The time required for the recession of the double falls to Wilson point (in addition to the 3,200 years mentioned) is found to have been 31,600 years, and 700 years more to the head of Foster flats, the whole distance being nearly three miles. This was the length of the gorge excavated during the Erie Epoch. From now onward the recession was very rapid, modified at times, but in all requiring only about 3,500 years, so that the age of Niagara falls may be placed at about 39,000. Slight variations on one side or the other are probable, but under the conditions, all of which are now apparently known, the error in calculations will not exceed ten per cent." (p. 11.)

The book is admirably illustrated and contains valuable historical matter.

H. E. G.

3. *Michigan State Geological Survey*. ALFRED C. LANE, State Geologist. Peat; essays on its Origin, Uses and Distribution in Michigan; by CHARLES A. DAVIS. Pp. 105-361, 19 pls., and 19 figs. Lansing, 1907.—This book, issued as part of the Michigan Geological Survey report for 1906 (see this Journal, vol. xxv, p. 354), is deserving of wide recognition. It constitutes practically the only available source of information on a question which is much misunderstood. While the book is designed to apply particularly to the peat deposits of Michigan, the discussion is so general as to be practically a treatise on the whole subject. Part I deals with the origin of peat, Part II with the peat bogs of northern Michigan, Part III with the economics of peat.

The discussion of peat origin necessarily involves a considerable treatise on ecology, a subject with which Professor Davis is evidently much at home. The character of the peat-forming plants and the conditions under which they thrive are explained in detail. The discussion of the origin of peat bogs will interest all geologists, for Professor Davis finds that, contrary to the almost universally accepted idea, sphagnum moss is not an important factor in bog formation. "... peat is chiefly formed by plants which grow below or very near the water level, aquatic plants in connection with sedges, and other grass-like plants; *Sphagnum* does not appear until late in the history of the formation, if at all, and develops only shallow, superficial layers of peat and usually grows best in association with certain shrubs, which may become prominent before the *Sphagnum* appears, and which may also reduce its effectiveness in peat-forming by developing dense

shade" (p. 170). The reviewer wishes to say that this conclusion is entirely in accord with the recent studies made of nearly one hundred bogs in Connecticut, in which the rôle played by peat has been heretofore misinterpreted.

The chapter on the method of formation of bogs and their distribution contains much that is of interest to physiographers.

The commercial value of peat, method of preparing it for the market, etc., is discussed in considerable detail. H. E. G.

4. *Illinois State Geological Survey*, H. FOSTER BAIN, Director. Bulletin No. 6. The Geological Map of Illinois (Second edition) ; by STUART WELLER. Pp. 32, with map. Urbana, 1907.—The activity of the Illinois Survey is well shown by the fact that a second edition of the geological map has been issued within a year (see this *Journal*, vol. xxii, p. 543, 1906). Considerable new information is given on the revised map, and in the accompanying bulletin Dr. Weller discusses the formations in the light of recent field work. The outline of the Carboniferous has been entirely revised. H. E. G.

5. *North Dakota Geological Survey. Fourth Biennial Report*. A. G. LEONARD, State Geologist. Pp. 312, 37 pls., 1 map. Bismarck, 1906.—The present report is a volume on the clays and clay industry of the state and should serve to increase the esteem with which the Survey is held by the people of North Dakota. The subdivisions of the subject, as treated, are: clay and its properties with special reference to North Dakota, stratigraphy of North Dakota clays, economic geology of clays, uses and value of clay products, and methods of brick manufacture. H. E. G.

6. *Sur la Fixation des Coquilles de Quelques Strophomenacea* ; by N. YAKOVLEV. Bull. Comité Géol., St. Petersburg, xxvi, 1907, pp. 181–201, pls. 3, 4.—From the short French résumé one learns that *Meekella* may be cemented to foreign objects by the ventral beak and grow in clusters with three to four individuals lying over one another—the cardinal area of one adjusted over the back of the ventral valve of another individual. When the shells are not cemented the cardinal areas are low and symmetrical, the valves flattened and the plications regularly developed. In the cemented forms the ventral area is much drawn out and more or less twisted to one side, while the plications are irregularly developed and even obsolete on the lateral parts of the valves. The calcareous cement, the author thinks, is extended through umbonal pores—a probable misunderstanding of the punctate nature of the *Strophomenacea*.

The author also states that in *Strophalosia* and *Aulosteges* individuals may or may not be cemented by the ventral beak. In these genera the reviewer has seen individuals cemented by the spines, so that the absence of a ventral cicatrix is not final evidence of a lack of cementation.

Finally the author states that different species of *Strophalosia* have developed different species of *Aulosteges*, just as different

species of *Productus* have given rise to different forms of *Strophalosa*. If this is all true, our definitions of these subdivisions needs emendation, and the reviewer regrets that he is not able to follow the discussion in the Russian text. C. S.

7. *The Data of Geochemistry*; by FRANK WIGGLESWORTH CLARKE. Pp. 716. Bull. 330, U. S. G. S.—The critical works of Bischof and Roth are well known to all geologists and contain what is most essential to the discussion of Chemical Geology down to the time of their publication. Years, however, have passed since the more recent of these appeared, and the material which many workers have added to this department of geology is extensive and varied. Furthermore, recent investigations have attacked many new problems, or approached old ones from new points of view. Important service to science has, therefore, been done by Prof. Clarke in bringing together in this volume a digest of this recent literature belonging to the special department which is called by the author, *Geochemistry*. The work, however, is not simply a compilation, although on this side its completeness and the abundant references to the original literature would make it most useful; it is also a critical summary of the whole subject, containing many suggestions from the author himself. After an introductory chapter devoted to the relations of the chemical elements and their distribution, the principal topics treated of are: the atmosphere; the water of lakes, rivers, and oceans, with the saline residues which have accumulated in certain regions; volcanic gases and the molten magma; rock-forming minerals; igneous and metamorphic rocks, and metallic ores.

### III. MISCELLANEOUS SCIENTIFIC INTELLIGENCE.

1. *National Academy of Sciences*.—The annual spring meeting of the National Academy was held in Washington on April 21-23; upwards of forty members were in attendance. The following are the officers: President, Ira Remsen; Vice President, Chas. D. Walcott; Home Secretary, Arnold Hague; Treasurer, S. F. Emmons.

The following new members were elected: Edwin Brant Frost, Yerkes Observatory; William E. Story, Clark University; Ernest F. Nichols, Columbia University; William F. Hillebrand, U. S. Geological Survey; William B. Clark, Johns Hopkins University; Whitman Cross, U. S. Geological Survey; Edwin Grant Conklin, Princeton University; Theobald Smith, Harvard Medical School; Simon Flexner, Rockefeller Institute for Medical Research.

The following foreign associates were also elected: S. A. Arrhenius, Stockholm; Charles Barrois, Lille; Joseph Larmor, Cambridge; Ivan Petrovic Pavlov, St. Petersburg; Hugo Ritter von Seeliger, Munich.

The next meeting of the Academy will be held on November 17 next at Johns Hopkins University, in Baltimore, Md.



The following is a list of the papers presented at the meeting :

- W. M. DAVIS : A proposed International Atlas of land forms.  
 W. B. SCOTT : The geological age of the Santa Cruz beds of Patagonia with restorations of Santa Cruz mammals.  
 E. L. MARK : The biological station for research at Agar's Island, Bermuda.  
 E. B. WILSON : The cytological basis of heredity and the determination of sex.  
 W. G. MACCALLUM and C. VOEGTLIN : On the functions of the parathyroid glands in their relation to calcium metabolism and to tetany.  
 T. C. CHAMBERLIN : Supplementary atmospheres.  
 BAILEY WILLIS : Great tangential movements of the earth's crust.  
 L. A. BAUER : Some results of the magnetic survey of the United States.  
 E. T. ALLEN : The metasilicates of lime and magnesia—an application of physical chemistry to minerals.  
 W. P. WHITE : The exact measurement of quantities of heat, up to 1500° Centigrade.  
 E. L. MARK and MARTIN COPELAND : Spermatogenesis in the bee and in the wasp.  
 J. MCK. CATTELL : Perceptions, ideas, and hallucinations.  
 F. R. MOULTON : Application of periodic solutions of the problem of three bodies to the motion of the Moon.  
 A. AGASSIZ : The elevated reefs of Mombasa and adjacent coast. The pelagic fauna of Victoria Nyanza.  
 C. G. ABBOT : Recent work of the Smithsonian Astrophysical Observatory.  
 E. W. WASHBURN : The hydration of ions in solution.  
 LEWIS BOSS : Radiant of the star-group in Taurus.  
 W. K. BROOKS : Biographical memoir of Alpheus Hyatt.  
 G. W. HILL : Biographical memoir of Asaph Hall.

The members of the Academy attended, on Wednesday evening, the Hamilton lecture delivered by Prof. George E. Hale on the subject "Some Recent Advances in our Knowledge of the Sun." In the afternoon of the same day a visit was made to the recently completely Geophysical Laboratory of the Carnegie Institution, under the Directorship of Dr. Arthur L. Day.

2. *Report of the Superintendent of the Coast and Geodetic Survey*, O. A. TITTMANN, showing the *Progress of the Work from July 1, 1906, to June 30, 1907*. Pp. 565, with seven appendixes, numerous plates and 9 maps in pocket. 1907.—The work of the Coast Survey for the period covered by this volume has been in many respects novel, since it included the investigation of the effect of the San Francisco earthquake of April, 1906, on the region in the vicinity of the great fault which extends for a distance of 200 miles, from Point Arena to Monterey. The subject is discussed in detail in Appendix III and some of the conclusions noted are as follows ; First, with reference to an earthquake of 1868, about 1000 square miles of the earth's crust in the region immediately north of San Francisco were permanently displaced to the northward about 5.2 feet, the whole area probably moving as a bulk without distortion. During the great earthquake of April, 1906, points on opposite sides of the fault moved in opposite directions, those to the eastward southerly, and those to the westward in a northerly direction, the displace-

ments being approximately parallel to the fault and diminishing as the distance from it increased. On the western side the displacements were about twice as large as at corresponding points on the east. A critical examination was made of the small area one and one-quarter miles north of the Golden Gate, and it was decided that no general change of elevation of sufficient magnitude to be detected had occurred.

In addition to the regular work of the Survey the results given in Appendix V, by R. L. FARIS, of magnetic observations, may be mentioned; and also the fifth and closing part of a Manual of the Tides, by R. A. HARRIS, the earlier parts of which were published in 1894, 1897, 1900 and 1904. In regard to the magnetic work it is to be noted that five observatories have been in continuous operation during the year, namely at Cheltenham, Md., Baldwin, Kans.; Sitka, Alaska; near Honolulu. H. I. and on Vieques Is., Porto Rico.

3. *Harvard College Observatory*, EDWARD C. PICKERING, Director.—Recent publications from the Harvard Observatory are included in the following list (continued from vol. xxiv, p. 509):

ANNALS.—Vol. XLIX, Part I. Peruvian Meteorology; by SOLON I. BAILEY. Observations made at the Arequipa Station 1892–1895. Pp. 103, plate i.

Vol. LIX, No. 1. Standard Tests of Photographic Plates; by EDWARD S. KING. Pp. 32, with 16 tables and 1 plate.

Vol. LX, No. VI. Nebulæ Discovered at the Harvard College Observatory. Pp. 194, with 8 tables. No. VII. Double Stars south of  $-30^\circ$ , and of magnitude 6.3 to 7.0. Pp. 195–198, with 1 table. No. VIII. A Catalogue of Bright Clusters and Nebulæ; by SOLON I. BAILEY. Pp. 199–229, with 5 plates.

CIRCULARS.—No. 131. Group of Red Stars near Nova Velouin.

No. 132. Stars having Peculiar Spectra: 15 New Variable Stars. Pp. 3.

No. 133. 15 New Variable Stars in Harvard Maps, Nos. 15, 18, and 27. Pp. 2, with 2 tables.

No. 134. 16 New Variable Stars in Harvard Map, Nos. 37 and 46. Pp. 4, with 2 tables.

No. 135. 25 New Variable Stars in Harvard Map, Nos. 24, 36, and 42. Pp. 3, with 2 tables.

4. *Publications of the Allegheny Observatory of the Western University of Pennsylvania*. Volume I, No. 2.—The subject discussed is “A simple method for reducing spectograms;” by FRANK SCHLESINGER. Pp. 9–16, with 2 tables.

5. *Darwin Celebration at Cambridge*.—It is announced that arrangements are now being made by the University of Cambridge to celebrate on June 22–24, 1909, the hundredth anniversary of the birth of Charles Darwin, and the fiftieth anniversary of the publication of the “Origin of Species.” It is proposed to invite representatives of universities and other learned bodies, together with distinguished individuals, to visit the university on this occasion. A program of the celebration will be issued in the near future.

# Relief Map of the United States

We have just prepared a new relief map of the United States, 48 x 32 inches in size, made of a special composition which is hard and durable, and at the same time light. The map is described in detail in circular No. 77, which will be sent on request. Price, \$16.00.

---

WARD'S NATURAL SCIENCE ESTABLISHMENT,

76-104 College Ave., ROCHESTER, N. Y.

---

---

## WARD'S NATURAL SCIENCE ESTABLISHMENT

**A Supply-House for Scientific Material.**

Founded 1862.

Incorporated 1890.

### DEPARTMENTS:

*Geology*, including Phenomenal and Physiographic.

*Mineralogy*, including also Rocks, Meteorites, etc.

*Palaeontology*.      *Archaeology* and *Ethnology*.

*Invertebrates*, including Biology, Conchology, etc.

*Zoology*, including Osteology and Taxidermy.

*Human Anatomy*, including Craniology, Odontology, etc.

Models, Plaster Casts and Wall-Charts in all departments.

---

Circulars in any department free on request; address

Ward's Natural Science Establishment,

76-104 College Ave., Rochester, New York, U. S. A.

## CONTENTS.

	Page
ART. XL.—Ionium, a New Radio-active Element ; by B. B. BOLTWOOD .....	365
XLI.—Mid-Cretaceous Species of Torreyia ; by E. W. BERRY	382
XLII.—Cranial Musculature and the Origin of the Frill in the Ceratopsian Dinosaurs ; by R. S. LULL. (With Plates I-III.) .....	387
XLIII.—Desiccation Conglomerates in the Coal-measures Limestone of Ohio ; by J. E. HYDE .....	400
XLIV.—Behavior of Nuclei of Pure Water ; by C. BARUS.	409
XLV.—Relations between the Meteorological Elements of the United States and the Solar Radiation ; by F. H. BIGELOW .....	413
XLVI.—Lower Paleozoic Stratigraphy of Southwestern Illinois ; by T. E. SAVAGE .....	431
XLVII.—Separation of Magnesium from the Alkalies by Alcoholic Ammonium Carbonate ; by F. A. GOOCH and E. A. EDDY .....	444

### SCIENTIFIC INTELLIGENCE.

*Chemistry and Physics*—Determination of Small Amounts of Iron in Copper Alloys, A. W. GREGORY : Action of Carbonates upon Tetrathionates, A. GUTMANN, 449.—Percarbonates, WOLFFENSTEIN and PELTNER : Practical Methods for the Iron and Steel Works Chemist, J. K. HEES : Laboratory Exercises in Physical Chemistry, F. H. GETMAN : Quantitative Chemical Analyses, A. F. GILMAN : Flame Spectra obtained by Electrical Means, G. A. HEMSALECH and C. DE WATEVILLE, 450.—Electric Furnace Reactions under High Pressure, R. S. HUTTON and J. E. PETAVEL : Positive Column in Oxygen, P. J. KIRBY : Quadrant Electrometers, H. SCHULZE : Reception of Electric Waves in Wireless Telegraphy, REINHOLD-RÜDENBERG : Velocity of Sound, M. THIESEN : Diffraction of X-rays, B. WALTER and R. POHL, 451.—Electrolytic Rectification of Niobium, G. SCHULZE : A Manual of Practical Physics, E. S. FERRY and A. T. JONES : La Telegraphie sans Fil, I. VAN DAM, 452.

*Geology*—Shepard on the Underground Waters of Missouri, C. A. DAVIS, 452.—Falls of the Niagara, J. W. W. SPENCER, 455.—Michigan State Geological Survey, A. C. LANE, 456.—Illinois State Geological Map, STUART WELER : North Dakota Geological Survey, A. G. LEONARD : Sur la Fixation des Coquilles de quelques Strophomenacea, N. YAKOVLEW, 457.—The Data of Geochemistry, F. W. CLARKE, 458.

*Miscellaneous Scientific Intelligence*—National Academy of Sciences, 458.—Report of the Superintendent of the Coast and Geodetic Survey, O. A. TITTMANN, 459.—Harvard College Observatory, E. C. PICKERING : Publications of the Allegheny Observatory of the Western University of Pennsylvania, F. SCHLESINGER : Darwin Celebration at Cambridge, 460.

---

Established by BENJAMIN SILLIMAN in 1818.

THE  
AMERICAN  
JOURNAL OF SCIENCE.

EDITOR: EDWARD S. DANA.

ASSOCIATE EDITORS

PROFESSORS GEORGE L. GOODALE, JOHN TROWBRIDGE,  
W. G. FARLOW AND WM. M. DAVIS, OF CAMBRIDGE,

PROFESSORS ADDISON E. VERRILL, HORACE L. WELLS,  
L. V. PIRSSON AND H. E. GREGORY, OF NEW HAVEN,

PROFESSOR GEORGE F. BARKER, OF PHILADELPHIA,

PROFESSOR HENRY S. WILLIAMS, OF ITHACA,

PROFESSOR JOSEPH S. AMES, OF BALTIMORE,

MR. J. S. DILLER, OF WASHINGTON.

---

FOURTH SERIES

VOL. XXV—[WHOLE NUMBER, CLXXV.]

No. 150—JUNE, 1908.

---

NEW HAVEN, CONNECTICUT.

1908

---

THE TUTTLE, MOREHOUSE & TAYLOR CO., PRINTERS, 123 TEMPLE STREET.

# IMPORTANT NOTICE.

We recently secured a fine collection of specimens of rocks about 248 in number, from all parts of the world, some polished on all sides; average size  $4 \times 3\frac{1}{2}$  inches; a black walnut block  $4\frac{1}{4} \times 3\frac{3}{4}$  inches, goes with each specimen; the block is beveled, with label attached, and the specimen and label are numbered. We will sell this collection at a low figure, with list of localities. This collection was originally labelled and arranged by Ward and Howell, of Rochester, New York.

## Latest Arrivals of Rare and Choice Minerals and Remarkable Cut Gems.

Will name a few as follows:—Petzite, Offenbanya; Stephanite, Hoelritsch; Helvite xls. Kapnik; Greenockite, Dognacska, Schneeberg, Vaskö; Proustite & Pyrargyrite, Nagybanya, Felsöbanya; Sylvanite, Colorado; Hessite, Botes; Semseyite, Felsöbanya; Enargite, cryst., Montana, Hungary; Polybasite, Hungary; Uranite, Schlaggenwald; Miargyrite & Pyrargyrite, Felsöbanya; Zircon, Nidlermendig; Sphaerosiderite, Felsöbanya; Realgar, Felsöbanya; Tourmaline, Fichtelgebirge; Stibnite & Heteromorphite, Felsöbanya; Chalcedony, blue crystals, Trestia; Orpiment, Felsöbanya; Himbeerspath, Kapnik; Tetrahedrite, Kapnik; Orthoclase, Karlsbad; xld. Gold in qtz.; Cinnabar, Opal, precious, Kapnik; Albite & Natrolite, Aussig.

These minerals have not yet arrived, but are in the Custom House, and we have taken this list from the invoice, so cannot give prices. They will be on sale June 1st.

## Other Remarkable Minerals.

Neptunite, San Benito Co., Cal., \$7.50 to \$10; Herderite, Auburn, loose xls, from 50c to \$2; matrix, 75c to \$20; Terlinguaite, \$5 to \$8; Calomel, \$5 to \$10; Montroydite, \$3 to \$7.50; Cassiterite, xls, Japan, 25c to 75c; Cassiterite, Tasmania,  $1\frac{3}{4}$  in. diam., \$10 to \$15; Crocoite, Tasmania, \$5 to \$10; Euclase xls, Brazil, \$5-\$45-\$55; Emerald, Bogota, \$5 to \$35; Apatite, Auburn, deep lilac color, \$2.50 to \$15; Kunzite, Pala, \$1 to \$10; Tourmaline, Mesa Grande, different colors, loose xls and matrix, 50c to \$275. Precious Opal, Queensland, very picturesque piece, the center precious opal, bottom blue and top red, price \$40.

## Remarkable Cut Gems from Russia and other Countries.

Green Garnets, Aquamarines, Amethysts, Zircon, Topaz, Spinel, Sapphires, star-sapphires, star-rubies, pink beryls, tourmaline cats-eye, tourmalines, opals, reconstructed sapphires and rubies, and other semi-precious stones.

Please send name and address for our mailing list.

**A. H. PETEREIT,**

81—83 Fulton Street, New York City.

T H E

# AMERICAN JOURNAL OF SCIENCE

[ F O U R T H S E R I E S . ]

ART. XLVIII.—*A Determination of the Molecular Weight of Radium Emanation by the Comparison of its Rate of Diffusion with that of Mercury Vapor*; by P. B. PERKINS.

[Contributions from the Sloane Physical Laboratory of Yale University.]

ON account of the very small quantity of radium emanation which has hitherto been available for experimental purposes, a direct determination of its density has not been possible. Several investigators have, therefore, attempted to determine the density by comparing the rate of diffusion of the emanation with that of a known gas or vapor and applying Graham's Law, according to which the molecular weights of two gases should be inversely proportional to the squares of their coefficients of diffusion. Such experiments have led to widely different results and the values obtained have been difficult to reconcile with the value which would be expected on the disintegration theory of radio-activity. This investigation was undertaken to clear up, if possible, these discrepancies.

### *History.*

Shortly after the discovery of the emanation, an approximate estimate of its molecular weight was made by Rutherford and Miss Brooks,\* by determining its rate of interdiffusion in air contained in a long metal cylinder. Values were obtained for the interdiffusion constant intermediate between those for carbon dioxide and ether, the molecular weights of which are 44 and 74 respectively. They, therefore, concluded that very probably the molecular weight of the emanation was between 40 and 100.

Results obtained by Curie and Darnet†, who measured the interdiffusion constant for emanation passing through capillary

\*Transact. of the Roy. Soc. of Canada, 2d series, 1901-2.

†Comptes Rendus, cxxxvi, p. 1314, 1903.

tubes into the air, gave about the same value for the molecular weight of the emanation as the estimate made by Rutherford and Miss Brooks.

In 1904, Bunstead and Wheeler\* compared the rate of diffusion of the emanation through a porous plate with that of carbon dioxide. Their results showed that, providing Graham's Law applies, the molecular weight of the emanation was about 4.1 times that of carbon dioxide or near 180.

Makower† compared the rates of diffusion of hydrogen, oxygen, carbon dioxide and sulphur dioxide with that of the emanation and, for different plugs of different materials, got results for the molecular weight ranging from 85.5 to 97.

#### *Reasons for using Mercury Vapor.*

Rutherford and Soddy‡ have shown that the radio-active emanations are incapable of chemical combination. From this resemblance to the inert gases, it is highly probable that the emanations are monatomic gases. It would also appear from the position of radium emanation in the radio-active series that its molecular weight is probably near 225. Graham's Law has been shown to hold very well for gases of similar molecular structure which did not differ greatly in molecular weights; but to break down entirely when applied to the diffusion of gases or vapors of complex molecular structure and widely different molecular weights. If the emanation is monatomic and has a molecular weight near 225, Graham's Law cannot be expected to hold when its rate of diffusion is compared with that of any gas or vapor which has been used in any previous investigation.

In order to satisfy both the conditions required for application of Graham's Law, mercury vapor was chosen for a series of comparisons. This is monatomic and has a molecular weight of 200. Since it is necessary to work at quite high temperatures to obtain large enough amounts for accurate weighing, most of my work was done near 250° C. and 275° C.

#### *Apparatus.*

*Electric furnace.*—For maintaining the required temperature, an electric furnace was constructed in the following way:

A copper tube, 45<sup>cm</sup> long and of about 5.5<sup>cm</sup> outside diameter, was coated with a mixture of talc and water glass as recommended by Nernst. On this insulating base, about 110

\* This Journal, xvii, Feb. 1904.

† Phil. Mag., ix, p. 56, 1905.

‡ Phil. Mag., Nov. 1902.



turns of German silver resistance wire, of less than 5<sup>mm</sup> diameter, were wound. After filling the spaces between the wires by another coating of talc and water glass, this was followed by a coat of rope asbestos 2<sup>cm</sup> thick; finally by an outside coating of asbestos packing 1.5<sup>cm</sup> in thickness. Ends for the furnace were cut from thick asbestos board.

Temperature was registered by a mercury thermometer. The city current of 110 volts gave about 4.5 amperes through the furnace and heated it to 250°C. in 20 min. After heating, by aid of the city current, to within a few degrees of the temperature required, the furnace was connected with the storage battery, a sufficient number of cells being used to maintain the temperature needed. An adjustable resistance of 14 ohms in circuit was used to keep the temperature constant. After equilibrium had been established, which usually took nearly an hour, it was found that the temperature did not vary more than 0.5° per hour.

*Diffusion apparatus.*—The diffusion apparatus must be designed so as to minimize temperature changes and viscosity effects. The diffusion chamber must be air-tight except at

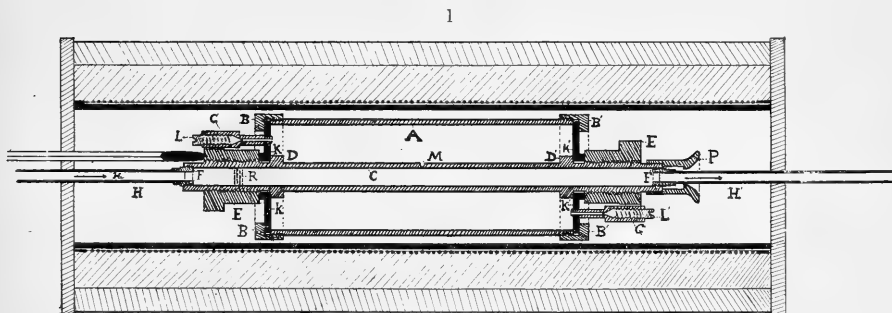

the plug, which should be as symmetrically placed as possible with regard to the diffusion chamber. It is necessary to insure diffusion through the plug in only one direction and to use some suitable means for collecting and condensing the diffused vapor.

Preliminary experiments were made with an apparatus constructed in glass including several stopcocks. This proved to be impracticable owing to my inability to find a good lubricant at these temperatures.

The accompanying figure (fig. 1) is a section of the furnace containing the diffusion apparatus as it was finally constructed in iron. C is a piece of iron tubing about 30<sup>cm</sup> long and of 2<sup>cm</sup> outside diameter on which collars with perfectly true edges

were shrunk at D and D'. For outside jacket, A, a piece of tubing of nearly 5<sup>cm</sup> outside diameter was squared off to exactly the same length as the distance between the shoulders D and D'. Iron plates, K and K', with accurately ground surfaces were made to bear at D and D' on the outside tube and the ends of the outside jacket, thus forming a diffusion chamber. Collars B and B', threaded and shouldered inside, pulled the plates against the ends of the outside jacket; while collars E and E', threaded on the inner tube, served a similar purpose at D and D'. In order to bring down the size of the ends of the inner tube, iron plugs, F and F', were threaded into them. These were reamed out and ground to fit thin-walled iron tubes 1<sup>cm</sup> in diameter. One of these tubes communicated with a hydrogen generator, while two others were alternately inserted in F for collecting and condensing the diffused vapor. The hydrogen generator was used for maintaining a slow current through C to continually remove the diffused vapor from the plug.

Some early experiments showed that when mercury was heated in air, red oxide of mercury began to appear at 275° C. and probably at a slightly lower temperature; in addition, small quantities of iron scale were formed. By performing the experiments in an atmosphere of hydrogen, all oxidation effects were eliminated. Before entering the diffusion apparatus, the hydrogen was bubbled through bottles of copper sulphate to remove hydrogen sulphide and then passed through a calcium chloride drying tube.

For the purpose of introducing mercury or emanation into the diffusion chamber, small holes were bored through the collars D and D' and still smaller holes through the plates about midway between the outer and inner tubes. Into these holes in the plates were threaded small iron caps G and G', closed by iron plugs L and L' with conical tips. These iron plugs had slotted heads and could be screwed into place, then set in with a wrench.

Some previous experiments with asbestos fiber showed it to be especially adapted for use as porous plugs. When a mixture of fine asbestos fiber and water was run through fine holes under pressure, very uniform and porous plugs were formed of any desired thickness, which seemed to suffer very little change in porosity over wide ranges of temperature.

To serve as a base for porous plugs of this kind, 40 small cup-shaped holes were bored through the middle of the inner tube C as follows: Small borings were made with a drill of nearly 3<sup>mm</sup> diameter reaching almost through to the inside of the tube. Through the remaining 0.2<sup>mm</sup>, holes were bored 1<sup>mm</sup> in diameter. Before the plugs were formed, all the different parts

of the apparatus were carefully cleaned with gasoline and boiled in a strong solution of potassium hydroxide. A series of iron screens was also fitted into the end of C nearer the generator in order to make the current as uniform as possible through the inner tube. As the different parts were assembled, all the bearing surfaces were given a thin coat of water glass, which was also run inside around each end of the diffusion chamber. After heating in the furnace at about 110° C. for several hours, to set the water glass, no appreciable leak through the outer jacket occurred in twelve hours. That no time should be lost in pushing the collecting tubes into position, a guiding tube P with a smoothly ground flaring end was fitted over the end of C and worked very satisfactorily.

The only change necessary in the diffusion apparatus, when working with the emanation, was to replace the iron plugs L and L' by small brass tubes threaded into the iron caps and reaching outside the furnace, where their ends were left large enough to be closed off with rubber tubing and pinchcocks. The holes through these tubes were made so small that their volume was negligible when compared with that of the diffusion chamber.

*Electroscope.*—For work with the emanation an electroscope provided with a guard ring was constructed, connected with a perfectly air-tight ionization chamber, made from a mercury flask of nearly 3 liters capacity. The guard ring and gold leaf were charged to a negative potential of 320 volts by a storage battery. The motion of the gold leaf was observed by a microscope provided with a scale of 100 equal parts. The time required for the leaf to move from 20 to 80 on the scale was chosen as a satisfactory means of finding the leak in divisions per minute. A minute irregularity in the leaf, near the scale, greatly assisted in making the readings.

*Constant pressure apparatus.*—In order to collect the diffused emanation under constant pressure, a simple device was used which could be readily adjusted. A hole was made in the side, near the bottom, of a common acid bottle of about 3 liters capacity. This served as collecting vessel and was connected, by means of rubber tubing, with an inverted balance bottle from which the bottom had been removed. Enough distilled water was introduced to fill the collecting bottle and leave a small amount in the balance bottle. By lowering the latter as gas entered the top of the collecting bottle, the two surfaces could be kept at practically the same level and atmospheric pressure maintained on the collected gas.

*Methods of Determining the Diffusion Constant for Mercury.*

Two methods are available for finding the diffusion constant for mercury vapor.

*Methods Employed: Method 1.*—Introduce into the diffusion chamber a quantity of mercury large enough to give a constant supply of vapor as diffusion proceeds and weigh the amount diffusing in a known time, when the diffusion constant is given by the following relation :

$$M_t = kM_0t = k\rho Vt$$

$M_t$  = Amt. of vapor diffusing in time  $t$ .  
 $k$  = Diffusion constant.  
 $M_0$  = Amt. of vapor in diffusion chamber.  
 $\rho$  = Density at the temp. used.  
 $V$  = Vol. of diffusion chamber.

The use of this method of finding the diffusion constant requires an accurate determination of the density.

*Method 2.*—Place a very small amount of mercury in the diffusion chamber and find as before the amounts diffusing in a known time. As diffusion proceeds, a condition is finally reached where vapor alone remains in the diffusion chamber, after which the amounts diffusing in a given time fall off very rapidly according to the following exponential law, which also holds for the emanation :

$$M = M_0e^{-kt}$$

$M_0$  = Amt. of vapor present in the diffusion chamber at the beginning of collection.  
 $M$  = Amt. present at the end “ “  
 $k$  = Diff. const.  $t$  = Time “ “

A very simple relation holds between amounts of vapor or emanation collected during successive, equal intervals of time,  $t$ .

Let  $M_I$  = amount of 1st collection.  
 “  $M_{II}$  = “ “ 2d “  
 “  $M_0$  = “ in the diffusion chamber at beginning of first collection.

$$\text{Then } M_I = M_0(1 - e^{-kt}).$$

$$\text{Also } M_{II} = M_0e^{-kt}(1 - e^{-kt}).$$

$$\text{Therefore } \frac{M_I}{M_{II}} = e^{kt}.$$

As from 5 to 8 sec. were required to withdraw one collecting tube and push the other into position, 20 min. periods were chosen for collection so as to introduce an error considerably less than 1 per cent.

*Method used for Measuring Relative Amounts of Diffused Emanation.*—In order to keep the conditions for diffusion similar to those for mercury vapor, it is essential that diffusion of the emanation should take place in an atmosphere of hydrogen. If the amounts of emanation diffusing through the porous plug are to be measured directly, this must necessarily

be done by having the electroscope filled with hydrogen. This would be inconvenient and involve considerable liability to error due to differences in ionizing power produced by the presence of any small amount of air. A statement made by Rutherford and Soddy\* seemed, however, to give an easy solution of the difficulty. They say:

“If either emanation is conveyed by a slow stream of hydrogen, oxygen or air through a metal spiral immersed in liquid air, no trace of emanation escapes in the issuing gas.”

Provided this were true, after diffusion the emanation could be condensed by means of liquid air, the hydrogen replaced by air and, as soon as room temperature was reached, the emanation mixed with air could be introduced into the electroscope. In order to test this statement, a long spiral of copper tubing was made just large enough to fit inside a Dewar bulb filled with liquid air. A very slow current of air mixed with emanation was passed through the spiral, when it was found that enough emanation remained uncondensed to give a decided leak in an electroscope placed at the issuing end, thus forbidding the adoption of such a method.

A series of experiments showed that very good results were given for the relative amounts of diffused emanation by measuring the amount of the active deposit (Radium C) induced on the negative electrode. Using this method of measurement, the order of experiment was as follows:

Measure the natural leak of the electroscope while bringing the furnace into equilibrium at the required temperature. Introduce into the diffusion chamber, by displacement, emanation boiled from 4 grs. of carnotite dissolved in hydrochloric acid, the containing flask having been previously filled with hydrogen. This is an amount of emanation equivalent to that in equilibrium with  $9.2 \times 10^{-8}$  grs. of radium. Let diffusion take place for 10 min. into the open air, so as to allow a sufficient time for the emanation to get well mixed with the hydrogen in the diffusion chamber. Collect the first sample for 20 min. in one bottle; then transfer, by means of a “T” tube and pinchcocks, into the other bottle for a second period of 20 min. Exhaust the electroscope and introduce sample 1, leaving sample 2 under a negative pressure so that any leak will be into the collecting bottle rather than out into the air. After 3 hrs., draw a rapid current of air through the electroscope by means of a water pump to displace the emanation, and make a series of measurements of the ionization produced by the active deposit. Introduce sample 2 and after 3 hrs. measure the activity of the active deposit as before. Correct the values obtained for sample 2 for the decay of the emanation for the time which has elapsed between the introduction of sample 1

\* *Phil. Mag.*, May, 1903.

and sample 2. Plot leak in div. per min. as ordinates and time of decay of the active deposit as abscissae, time to begin at the moment the water pump is turned on. The ratios of the two ordinates at any given time after the first few minutes are proportional to the relative amounts of emanation in sample 1 and sample 2.

In order that any slight changes in the porosity of the plug might be eliminated, experiments with the emanation were alternated with those for mercury vapor, using the two methods already described. Diffusion under constant supply (method 1) furnished a ready means of revealing any systematic change in porosity.

#### *Results.*

The earlier trials made under constant supply gave about 1.2 grs. of mercury diffusing per hour, showing that diffusion probably took place about as rapidly as the vapor was formed. In order, therefore, to materially lessen the amount diffusing, the inner tube C was removed and all but one of the original porous plugs were closed with a drop of water glass. About one sixth as much diffusion took place through this one plug as through the forty originally made.

The position of this plug with respect to the mercury supply made no difference in the amount of vapor diffusing per min., showing the density of the vapor in the diffusion chamber to be pretty uniform.

The following tables give the results in full of diffusion with the emanation for Jan. 23, at 250° C.; and the observed values for  $k$  only, for experiments made on succeeding days:

Time after pump began	Leak of Sample 1 in div. per min.	Leak of Sample 2 corrected for 4 hrs. decay	$k$
15 min.	36.5	18.6	.0336
20 "	34.5	17.8	.0331
25 "	32.4	16.8	.0328
30 "	30.4	15.6	.0333
35 "	28.7	14.4	.0344
40 "	26.5	13.3	.0344

Jan. 24, at 250° C.		Jan. 25, at 250° C.		Jan. 27, at 250° C.	
Time after pump began in min.	$k$	Time after pump began in min.	$k$	Time after pump began in min.	$k$
15	.0337	15	.0346	15	.0334
20	.0339	20	.0353	20	.0334
25	.0340	25	.0349	25	.0334
30	.0339	30	.0348	30	.0329
35	.0335	35	.0346	35	.0321
40	.0337	40	.0346	40	.0324
45	.0339	45	.0344	45	.0329
				50	.0329

Jan. 31, at 275° C.		Feb. 1, at 275° C.	
Time after pump began in min.	<i>k</i>	Time after pump began in min.	<i>k</i>
15	·0379	15	·0387
20	·0372	20	·0389
25	·0368	25	·0378
30	·0368	30	·0378
35	·0366	35	·0382
40	·0371	40	·0380
45	·0366	45	·0378

Feb. 11, at 250° C.		Feb. 12, at 250° C.	
Time after pump began in min.	<i>k</i>	Time after pump began in min.	<i>k</i>
15	·0349	15	·0344
20	·0344	20	·0347
25	·0342	25	·0344
30	·0342	30	·0347
35	·0342	35	·0347
40	·0337	40	·0344
45	·0339	45	·0347

The decay curves plotted from the results of the above experiments are indistinguishable from those obtained for the active deposit from radium.

The following tables give the times of collection in min. and the amounts diffusing per min. in grs. when a constant supply of mercury vapor from about 300 grs. of mercury was kept in the diffusion chamber:

Feb. 3, at 250° C.		Feb. 4, at 250° C.		Feb. 6, at 250° C.	
Time	Amts. diffusing in grs. per min.	Time	Amts. diffusing in grs. per min.	Time	Amts. diffusing in grs. per min.
45	·00450	26	·00447	60	·00456
46	·00452	50	·00449	40	·00454
67	·00445	40	·00446	102	·00451
64	·00446			30	·00445
31	·00450				

Feb. 5, at 250° C.	
Time	Amts. diffusing in grs. per min.
50	·00468

Feb. 6, at 250° C.		At 275° C.		
Time	Amts. diffusing in grs. per min.	Date	Time	Amts. diffusing in grs. per min.
55	·00468	Feb. 4	36	·01028
50	·00444	"	30	·01003
50	·00451	Feb. 5	26	·01021
60	·00459	Feb. 6	60	·00981

As the ground ends of the collecting tubes were heated, in a Bunsen flame, to about the temperature of the furnace each time before insertion, very slight changes took place in the

weights of the empty tubes, which were, therefore, weighed after each collection.

*Approximation for k at Constant Supply.*

Since no experimental data were available on the density of mercury vapor, an attempt was made to find approximate values, at the temperature at which diffusion took place by means of the gas laws.

Using standard thermometers, the corrected temperatures were found to be 252.8° C. and 278.2° C. Vapor pressures for mercury vapor have been determined with a good deal of accuracy at these temperatures. Person\* found the latent heat for mercury vapor at 350° C. to be 62. By using

the equation:  $L = (V_2 - V_1) T \frac{dP}{dT}$ , where L is the latent

heat,  $(V_2 - V_1)$  the difference in vol. of 1 gr. of mercury after and before vaporization, P the vapor pressure and T the absolute temp., and extrapolating by means of Boyle's Law to 252.8° C. and 278.2° C., the values for the density came out .000550 grs. / ccm. and .000988 grs. / ccm. respectively. The volume of the diffusion chamber was 237 ccm. Making these substitutions in the formula for constant supply given on p. 5, the diffusion constant at 252.8° C. was .0346; and, at 278.2° C., .0431. Applying Graham's Law, this gave for the molecular weight of the emanation 208 and 262 respectively, with a mean of 235, showing that in all probability the molecular weight of the emanation was a little greater than that for mercury vapor. The very discordant results for the two temperatures showed that the method was not available because of the uncertainty in the value of the density. Therefore, the other method, using unsaturated vapor, was tried.

Results obtained at 250° C. with a small supply of mercury (less than 1 gr.) in the diffusion chamber, showed that diffusion began under saturation conditions. For 20 min. periods of collection, since the rate of diffusion was slightly in excess of that of supply, the amounts diffusing showed a slow gradient until a point was reached where a sudden drop took place, showing that vapor alone remained in the diffusion chamber. This result is well illustrated by the following curve (fig. 2) plotted from data obtained from the first experiment made under these conditions. Amounts diffusing during 20 min. collections are plotted as ordinates and 20 min. periods of time as abscissae:

\* Pogg. Annal., vol. lxx, 310, 386, 1847.



The exponential character which the curve assumes after the 14th collection will be noted. That the curve is exponential, after vapor alone remains in the diffusion chamber, is well shown in the following tables, which contain the results of an experiment in full, made at 250° C. with about 0.4 grs. of mercury in the diffusion chamber; and the results for  $k$ ,

2

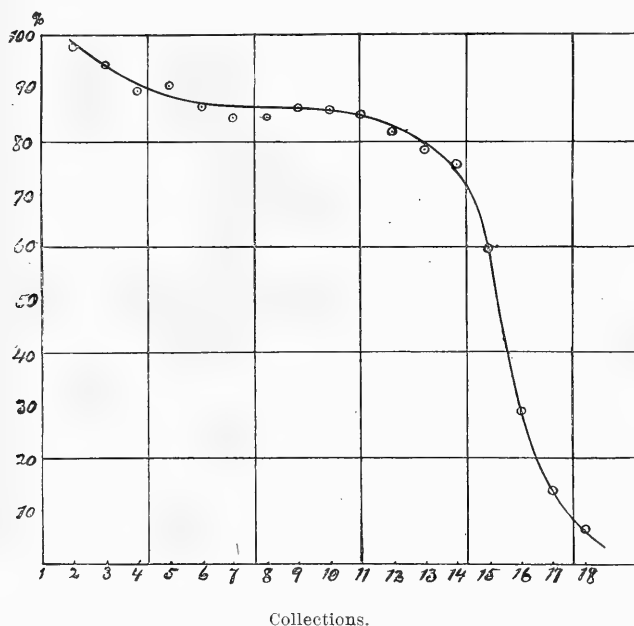

calculated from the data given by similar experiments at 250° C.; also at 275° C., using 0.7 grs. :

Time of collection in min.	Wt. after collection in grs.	Wt. of tubes empty in grs.	Amt. of Hg diffusing	Calculation for $k$
20	44.9167	44.8390	.0777	
20	47.3115	47.2366	.0749	
20	44.9109	44.8393	.0716	
20	47.3074	47.2381	.0693	
20	44.8938	44.8393	.0545	$\frac{.0545}{.0262} = e^{20k}$
20	47.2629	47.2367	.0262	$\therefore k = .0366$
20	44.8519	44.8393	.0126	$\frac{.0262}{.0126} = e^{20k}$
				$\therefore k = .0366$

Feb. 13, at 250° C.			Feb. 14, at 250° C.		
Time	Amt. of Hg diffusing	Calculation for $k$	Time	Amt. of Hg diffusing	Calculation for $k$
20	·0650		20	·0817	
20	·0489	$\frac{·0489}{·0231} = e$ $20k$	20	·0531	$\frac{·0531}{·0251} = e$ $20k$
20	·0231	$\therefore k = ·0374$	20	·0251	$\therefore k = ·0374$
20	·0110	$\frac{·0231}{·0110} = e$ $20k$	20	·0120	$\frac{·0251}{·0120} = e$ $20k$
		$\therefore k = ·0371$			$\therefore k = ·0369$
Feb. 15, A. M., 250° C.			Feb. 15, P. M., 275° C.		
Time	Amt. of Hg diffusing	Calculation for $k$	Time	Amt. of Hg diffusing	Calculation for $k$
20	·0658		20	·1440	
21	·0548	$\frac{·0548}{·0249} = e$ $21k$	20	·0682	$\frac{·0682}{·0296} = e$ $20k$
21	·0249	$\therefore k = ·0375$			$\therefore k = ·0416$
21	·0112	$\frac{·0249}{·0112} = e$ $21k$	20	·0296	$\frac{·0296}{·0131} = e$ $20k$
		$\therefore k = ·0379$			$\therefore k = ·0408$
Feb. 17, A. M., 275° C.			Feb. 17, P. M., 275° C.		
Time	Amt. of Hg diffusing	Calculation for $k$	Time	Amt. of Hg diffusing	Calculation for $k$
20	·1414		20	·1233	
20	·0700	$\frac{·0700}{·0306} = e$ $20k$	22	·0589	$\frac{·0589}{·0246} = e$ $22k$
		$\therefore k = ·0414$			$\therefore k = ·0397$
20	·0306	$\frac{·0306}{·0138} = e$ $20k$	22	·0246	
20	·0138	$\therefore k = ·0399$			

*Résumé.*

Following is a brief review of the data in the order obtained :

- (1) Four experiments at 250° C. with emanation.  $k = ·0338 \pm ·00025$ .
- (2) Two experiments at 275° C. with emanation.  $k = ·0376 \pm ·00040$ .
- (3) A series at 250° C. with a constant supply of mercury vapor in the diffusion chamber. Average amount per min. =  $·00450 \pm ·000012$ .
- (4) One experiment at 250° C. with mercury vapor by Method II.  $k = ·0366$ .
- (5) Two experiments at 250° C. with emanation.  $k = ·0344 \pm ·00026$ .
- (6) Three experiments at 250° C. with mercury by Method II.  $k = ·0374 \pm ·00009$ .

- (7) Three similar experiments with mercury at 275° C.  $k = .0407 \pm .00032$ .
- (8) A series for mercury vapor at 250° C. under constant supply. Average amount diffusing per min. =  $.00456 \pm .000031$ .

Series (8) was used to test the constancy of the porous plug by comparison with (3).

*Final Calculations for the Molecular Weight of the Emanation.*—A slight increase in the porosity of the plug appears to have taken place as the experiments proceeded. By taking the mean of the different sets of determinations for a certain diffusion constant, any small error due to change in porosity should be approximately eliminated.

$$\begin{array}{l} \text{Average } (k) \text{ at } 250^\circ \text{ C. for emanation} = .0341. \\ \text{" } (k) \text{ " " " mercury vapor} = .0370. \end{array}$$

Applying Graham's Law, the molecular weight of the emanation equals

$$200 \frac{.0370^2}{.0341^2} = 235.$$

$$\begin{array}{l} \text{Average } (k) \text{ at } 275^\circ \text{ C. for emanation} = .0376. \\ \text{" } (k) \text{ " " " mercury vapor} = .0407. \end{array}$$

$$\text{Molecular weight of the emanation} = 200 \frac{.0407^2}{.0376^2} = 234.$$

*Conclusion.*—These experiments leave little doubt that the molecular weight of radium emanation is greater than that of mercury vapor (200). Although the actual value obtained (235) is larger than the atomic weight of radium (226.5), yet the uncertainties of the diffusion method render it likely that this is due to experimental errors. It is, however, evident that the emanation has an atomic weight in the immediate neighborhood of radium—a result to be expected, on the disintegration theory, but which previous diffusion experiments had not confirmed.

It is with pleasure that I acknowledge my indebtedness to Prof. H. A. Bumstead for suggesting the investigation and for valuable advice during its progress; also to Prof. B. B. Boltwood for kind assistance throughout the entire work.

ART. XLIX.—*Paleozoic Formations in Trans-Pecos Texas*;  
by G. B. RICHARDSON.\*

THE presence of Paleozoic rocks in trans-Pecos Texas has been known since the middle of the last century, when fossils were collected by the surveying parties engaged in exploring routes for a Pacific railway and in establishing the boundary between the United States and Mexico.† In 1874 W. P. Jenney‡ measured a section of the rocks in the Franklin Mountains, north of El Paso, and called attention to the long Paleozoic sequence there exposed, which in 1896 was also examined by C. D. Walcott. W. H. von Streeruwitz and E. T. Dumble made a number of references to the Paleozoic rocks

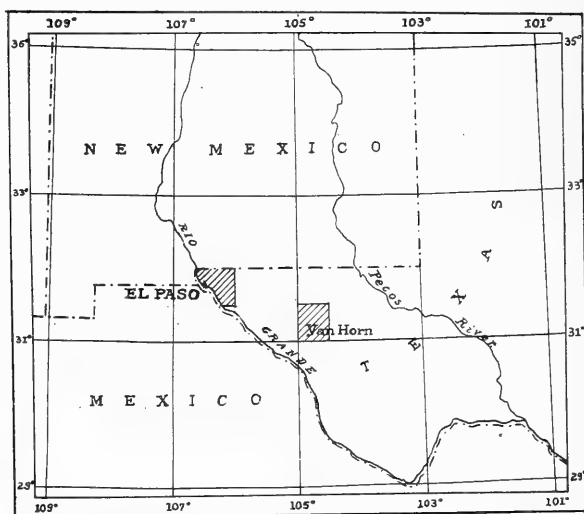

in the vicinity of Van Horn, in the reports of the Geological Survey of Texas, 1890-93, but that organization was discontinued before correlations and maps were published.

An important result of the early surveys was the determination by the Shumard brothers§ of the presence of a Permian

\* Published by permission of the Director of the U. S. Geological Survey.

† Explorations and surveys for a railroad route from the Mississippi River to the Pacific Ocean, vol. ii, Washington, 1855. Report of the United States and Mexican Boundary Survey, by Wm. H. Emory, vol. i, part 2, Washington, 1857.

‡ This Journal (3), vii, p. 25, 1874.

§ Transactions St. Louis Academy of Science, vols. i and ii, 1860, 1868.

fauna in the Guadalupe Mountains, near the Texas-New Mexico boundary about 60 miles west of Pecos River. R. S. Tarr disagreed with this conclusion,\* but G. H. Girty in 1901 confirmed the early work,† and he has described the unique fauna in an elaborate report which is now in press.‡ And in 1904, J. A. Udden reported the presence of Carboniferous rocks in the Chinati Mountains in Presidio County.§

The present writer in 1903 made a reconnaissance of that portion of trans-Pecos Texas in which the greater part of the Paleozoic rocks are exposed,|| and later, in connection with the survey of the El Paso and Van Horn quadrangles, had an opportunity to map the formations in detail and to collect fossils. These have been examined by Messrs. C. D. Walcott, E. O. Ulrich and G. H. Girty, and the writer is particularly indebted to Dr. Girty, who accompanied him in the field both in the El Paso and Van Horn regions.

The formations which are the subject of this paper outcrop in the Franklin and Hueco Mountains in the El Paso quadrangle, and in the Sierra Diablo, Delaware Mountains and associated groups of hills in the Van Horn quadrangle. These two quadrangles, which have recently been mapped by the U. S. Geological Survey, are situated about 60 miles apart and they include practically all of the known occurrences of lower Paleozoic rocks in trans-Pecos Texas. The following table summarizes the Paleozoic formations in the El Paso and Van Horn quadrangles:

#### CAMBRIAN.

##### *Bliss Sandstone.*

The main occurrence of the Bliss sandstone is along the eastern slopes of the Franklin Mountains, but the considerable faulting to which the range has been subjected causes its distribution to be very irregular. The Bliss is a massive, fine-textured, brownish sandstone that varies from a few feet to slightly more than 300 feet in thickness. The lower beds are indurated and are practically quartzites and at the base of the formation the strata are coarser textured, locally are conglomeritic and contain pebbles of the underlying rocks. The sandstone is composed of small grains of quartz imbedded in a matrix of sericite and kaolin. In places the Bliss sandstone

\* Reconnaissance of the Guadalupe Mountains, Bull. No. 3, Geol. Survey of Texas, 1892

† This Journal (4), xiv, p. 363.

‡ The Guadalupian fauna, U. S. Geol. Sur., Prof. Paper No. 58.

§ The Geology of the Shafter Silver Mine District, Bull. No. 8, University of Texas Mineral Survey, 1904.

|| Report of a reconnaissance in trans-Pecos Texas north of the Texas and Pacific Railway, Bull. No. 9, University of Texas Mineral Survey, 1904.

*Table of Paleozoic formations in the El Paso and Van Horn Quadrangles, Texas.*

El Paso quadrangle	Thick-ness	Sys-tem	Series	Thick-ness	Van Horn quadrangle
Absent		Carboniferous	Permian ?	500 +	Capitan limestone
Absent			(Guadalupian)	2000 +	Delaware Mountain formation
Hueco limestone	3000		Pennsylvanian	2500 +	Hueco limestone
Absent			Mississippian		Absent
Absent		Devonian			Absent
Fusselman limestone	1000	Silurian	(Niagara)		Absent
Montoya limestone	250	Ordovician	Upper and Middle Ordovician	250	Montoya limestone
El Paso limestone	1000		Lower Ordovician	750	El Paso limestone
Bliss sandstone	0 to 300	Cambrian	Saratogan or Acadian	0 to 700	Van Horn sandstone

is in contact with granite of post-Carboniferous age and elsewhere it rests on rhyolite porphyry, of which it contains rounded pebbles in the basal beds. In the central part of the Franklin Mountains the sandstone thins out and locally disappears, and the overlying limestone, containing a basal conglomerate, lies directly on the rhyolite porphyry.

Annelid borings both perpendicular and parallel to the bedding occur abundantly in the Bliss sandstone. Other fossils are rare, but in places in the lower strata some brachiopod shells have been found. Of these Mr. Walcott has identified *Lingulepis acuminata*, *Obolus matinalis* (?) and fragments of *Lingullela* which determine the Cambrian age of the rocks and indicate that either the upper or middle division of the system is here represented.

#### *Van Horn Sandstone.*

The Van Horn is a medium to coarse-textured cross-bedded sandstone that is banded with thin lenses of conglomerate. The formation is of a prevailing brick-red color in its lower part, which becomes paler towards the top, where the color fades away and the sandstone is white. The conglomerate lenses vary from a few inches to about a foot in thickness and are irregularly distributed throughout the formation. At the base the pebbles are composed of fragments of the underlying rocks and consist of quartz schist, fine-textured red sandstone, cherty limestone, porphyry and quartz, while the conglomerate in the upper part of the formation consists chiefly of well rounded quartz pebbles. The sandstone likewise varies in composition; its lower part being composed of quartz and decomposed feldspar grains while the upper portion is prevailingly quartzose. The formation varies from a few feet to 700 feet in thickness and averages about 400 feet.

The Van Horn sandstone unconformably overlies highly tilted metamorphosed rocks and is overlain in places by the El Paso limestone (Ordovician), and elsewhere by the Hueco limestone (Carboniferous). The upper part of the formation contains numerous annelid borings and fucoid-like remains, but no characteristic fossils have been found in the sandstone and its age therefore is undetermined.

The presence of sandstone at the base of the Paleozoic section in southwestern United States has been noted wherever observations have been made, and it is suggested that the Bliss and Van Horn sandstones are the probable equivalent of the Tonto sandstone of the Grand Canyon, the Bolsa quartzite of Bisbee, the Coronado quartzite of Clifton, the Reagan sandstone of Oklahoma and the Cambrian sandstone of the Central Texas Paleozoic area.

#### ORDOVICIAN.

##### *El Paso Limestone.*

The El Paso limestone outcrops in the Franklin and Hueco Mountains in the El Paso quadrangle and in Beach and Baylor Mountains in the Van Horn quadrangle. The formation is

typically a massive gray magnesian limestone which contains the same fauna in both regions. In the El Paso area the formation is about 1000 feet thick, the lower 100 feet of which is characteristically arenaceous and weathers brownish. A distinctive feature of the middle portion of the formation is the presence of thin connected nodules of brown chert arranged in irregular streaks parallel to the bedding. This limestone lies apparently conformably on the Bliss sandstone, but, as already stated, in the central part of the Franklin Mountains the Bliss sandstone is locally absent and the El Paso limestone rests directly on pre-Cambrian (?) rocks with a basal conglomerate varying up to 20 feet thick composed of rounded pebbles of rhyolite porphyry in a calcareous matrix. In the Van Horn quadrangle the El Paso limestone does not contain the cherty layers that are characteristic of the middle parts of the formation in the Franklin Mountains, and 50 feet above the base of the formation a thin bed of white sandstone is present. In this region there are indications of an unconformity at the base of the limestone marked by a slight undulatory contact between the El Paso and Van Horn formations.

Mr. Ulrich reports that the fossils obtained from the El Paso limestone in both the El Paso and Van Horn quadrangles represent essentially the same Beekmantown fauna. Most of the species are undescribed, but all are of unmistakable types. The more characteristic forms are the following:

*Calathium*, sp. nov. (coral-like sponge), *Maclurea* ? sp. nov. The small horn-like opercula are very common. The shell itself is of the type of *M. oceana* Billings. Solid siphuncles of endoceratoid cephalopod, evidently a close ally of *Camero-ceras brainardi*. Besides these there are a number of less easily recognized small gastropods.

#### *Montoya Limestone.*

The Montoya limestone also has been recognized by its stratigraphic position and fossils in both of the quadrangles. This limestone contains two distinct Ordovician faunas, the Richmond and Galena, and on paleontologic grounds it is desirable to separate the two, but the small thickness of the formation, only about 250 feet, and the scale of the maps will not admit of it.

Fossils characteristic of the Galena occur in the lower part of the Montoya limestone, the zone being commonly marked in the El Paso quadrangle by massive dark-colored limestone containing little or no chert. The upper part of the limestone is prevailingly gray, but some of the beds are almost white



while others are dark, and the two parts of the formation can not always be distinguished lithologically. The zone which carries the most abundant Richmond fossils in places is seamed with conspicuous bands of chert a few inches in thickness. In the Van Horn quadrangle the base of the Montoya limestone is commonly marked by the presence of thin-bedded earthy yellow and reddish limestone, but otherwise in both quadrangles the contact is apparently conformable. Like the El Paso limestone, the Montoya is characteristically magnesian. Mr. Ulrich has identified the following fossils from the Montoya limestone:

*Fossils from the Galena beds.*

<i>Receptaculites oweni.</i>	<i>Hormotoma major.</i>
<i>Maclurina manitobensis.</i>	<i>Ormoceras</i> sp. undet.
<i>Maclurina acuminata.</i>	

*Fossils from the Richmond beds.*

<i>Streptelasma rusticum.</i>	<i>Dinorthis proavita.</i>
<i>Hemiphragma imperfectum.</i>	<i>Platistrophia acutilerata.</i>
<i>Monotryprella quadrata.</i>	<i>Rhynchotrema capax.</i>
<i>Strophomena flexuosa.</i>	<i>Orthis whitfieldi.</i>
<i>Leptaena unicostata.</i>	<i>Parastrophia divergens.</i>
<i>Dinorthis subquadrata.</i>	

In southwestern United States outside of the areas here considered few Ordovician rocks are known. The system apparently is not represented by sediments in either the Grand Canyon or Bisbee districts. The Longfellow formation in the Clifton quadrangle, Arizona, probably should be correlated with the El Paso limestone as well as a part of the Ordovician limestone in the central Texas region. Recently several small areas of Ordovician rocks have been reported in central New Mexico by Gordon and Graton.\* Mr. Ulrich reports that the Beekmantown fauna of the El Paso limestone is of the type prevailing in the Wichita Mountains, Oklahoma, in the upper 1,000 feet or so of the Arbuckle limestone; and that the Galena and Richmond fauna of trans-Pecos, Texas, are similar to those in the Mississippi valley, Oklahoma, the Black Hills, the Big Horn Mountains, and elsewhere.

SILURIAN.

*Fusselman Limestone.*

The Silurian system in trans-Pecos Texas is represented only in the El Paso region, where the Fusselman limestone outcrops in the Franklin and Hueco Mountains. This is a massive

\* This Journal (4), xxi, p. 190, 1906.

whitish magnesian limestone approximately 1000 feet thick. It overlies the Montoya limestone apparently conformably, although in one locality fragments of the underlying limestone included in the Fusselman is evidence of an unconformity. Throughout the greater part of the formation fossils are scarce, but at a few horizons they are very abundant. The commonest form is a species of radially plicated pentameroid shell which, with *Amplexus* and *Favosites*, determined by Mr. Ulrich, proves that the upper Niagaran stage of the Silurian is here represented. Gordon and Graton\* have recently found Silurian fossils in the Silver City region and at Lake Valley, New Mexico; and Taff's Hunton formation in Oklahoma† also contains a Silurian fauna. But with these exceptions the Fusselman limestone is the only known occurrence of rocks of Silurian age in southwestern United States.‡

#### CARBONIFEROUS.

##### *Hueco Limestone.*

Neither the Devonian nor the Lower Carboniferous, so far as known, is represented by sediments in trans-Pecos Texas, and the Silurian, where present, is overlain by the Upper Carboniferous. The Hueco limestone outcrops in an area of several hundred square miles in trans-Pecos Texas. It underlies the Diablo Plateau, a large area between the El Paso and Van Horn quadrangles, and outcrops in the Sierra Diablo, Finlay, Hueco and Franklin Mountains. The Hueco is a rather homogeneous gray limestone, generally massive, though in places it is thin-bedded. It is comparatively free from chert and differs from the limestones of Silurian and Ordovician age in that it contains little or no magnesia. Although the limestone is prevailing gray, there are local variations in color from light gray to almost black.

In the Franklin and Hueco Mountains the Hueco limestone immediately overlies the Fusselman limestone apparently conformably in spite of the fact of the great hiatus indicated by their ages. But in the Van Horn region a well developed basal conglomerate averaging approximately one hundred feet in thickness and composed of pebbles of all of the pre-Carboniferous formations is present at the base of the limestone, which rests with marked irregularity on the underlying formation. The Hueco limestone generally is overlain by Pleistocene debris, but in a few areas, notably in the Finlay Mountains, and also eight miles northwest of Van Horn, it is directly overlain by Cretaceous strata. The total thickness of

\* Quoted above.

† Tishomingo Folio, U. S. Geological Survey, 1903.

‡ Kindle, E. M., this Journal (4), xxv, pp. 125-129, 1908.

the Hueco limestone has not yet been determined, but it is more than 3000 feet.

The Hueco limestone carries an abundant fauna of Pennsylvanian age, of which the following, identified by G. H. Girty, is a partial list. According to Dr. Girty, this fauna with some modifications is similar to that found over much of the Cordilleran region, and the Hueco limestone is tentatively correlated with the Aubrey formation and the Weber quartzite.\*

*List of fossils from the Hueco limestone.*

- Fusulina*, several sp.  
*Archæocidaris* cf. *A. biangulata* Shum.  
*Azophyllum* sp.  
*Fistulipora* sp.  
*Septopora* sp.  
*Schizophoria* sp.  
*Enteleles* cf. *E. hemiplicatus* Hall.  
*Orthotetes* sp.  
*Productus* cf. *P. inflatus* Tsch., non McChesney.  
*Productus* cf. *pustulatus* Keys.  
*Productus* cf. *P. longus* Tsch., non Meek, and *P. porrectus*

Kut.

- Productus*, cf. *P. irginae* Stuck.  
*Productus*, several sp. type of *P. semireticulatus* Martin.  
*Marginifera*, cf. *M. wabashensis* Nor. and Pratt.  
*Spirifer*, cf. *S. marcoui* Waagen.  
*Spirifer*, cf. *S. cameratus* Morton.  
*Squamularia* (?) sp.  
*Spiriferina* cf. *S. cristata* Schlot.  
*Seminula*, cf. *S. subtilita* Hall.  
*Hustedia*, cf. *H. Mormoni* Marcou.  
*Camarophoria* cf. *C. mutabilis* Tsch.  
*Pugnax*, cf. *P. utah* Marcou.  
*Dielasma*, cf. *D. truncatum* Waagen.  
*Myalina* sp.  
*Naticopsis* sp.  
*Euomphalus* sp. (large.)  
*Omphalotrochus obtusispira* Shumard.  
*Bellerophon* sp.  
*Patellostium*, cf. *P. Montfortainum* Nor. and Pratt.  
*Phillipsia* sp.

GUADALUPIAN.

In the Van Horn quadrangle and north of it the bolson plain known as Salt Flat, which is occupied by an unknown depth of unconsolidated Quaternary deposits, lies between the Sierra Diablo on the west and the Guadalupe-Delaware Mountains on the east and completely conceals the relations of

\* Proceedings Washington Academy of Sciences, vol. vii, p. 14, 1905.

the rocks in the two mountains. As has been stated, the Sierra Diablo is made up of the Hueco limestone, the stratigraphic top of which has not been observed. And the Guadalupe-Delaware Mountains are composed of Paleozoic strata, younger than the Pennsylvanian, which contain a fauna not elsewhere known in North America, that Girty has named Guadalupian. This fauna, which has Permian affiliations, is described by Dr. Girty in a paper now in press, and it is intended here only to outline the stratigraphy of these rocks, which complete the long Paleozoic sequence of trans-Pecos Texas.

*Delaware Mountain Formation.*

The Delaware Mountain formation includes a varying mass of sandstone and limestone having a maximum thickness of at least 2300 feet, but the base of the formation is not exposed in Texas and has not been determined. In the northern part of the Guadalupe-Delaware Mountain uplift, the formation is prevailingly sandy and contains only thin beds and lenses of limestone. Southward the sandstone decreases and the limestone increases in amount until, in the southern part of the main Delaware Mountains, the formation consists of gray limestone with only subordinate beds and lenses of sandstone. The sandstone is a massive to thin-bedded buff to brownish quartzose rock and the limestone likewise is both thick and thin-bedded, of a prevailing gray color, and contains little chert. The following fossils, determined by Dr. Girty, are characteristic of the Delaware Mountain formation :

*List of fossils from the Delaware Mountain formation.*

<i>Fusulina elongata.</i>	<i>Astartella nasuto.</i>
<i>Productus Guadalupensis.</i>	<i>Pleurophorous Delawarenensis.</i>
<i>Productus Meekanus.</i>	<i>Pleurotomaria englyphia.</i>
<i>Productus Walcottianus.</i>	<i>Pleurotomaria arenaria.</i>
<i>Richthofenia Permiana.</i>	<i>Warthia Americana.</i>
<i>Myoconcha costulata</i> var.	<i>Gastrioceras serratum.</i>

*Capitan Limestone.*

In the Guadalupe Mountains, 60 miles north of Van Horn, about 2200 feet of the Delaware Mountain formation is conformably overlain, in a magnificently exposed section, by 1800 feet of limestone named the Capitan limestone. The name is taken from El Capitan Peak, which, having an elevation of 8690 feet,\* is the highest point in Texas. The Capitan is a light colored, usually white limestone which, although possessing minor variations, is homogeneous in general appearance. Bedding planes in many places are not appa-

\* Recently determined by Arthur Stiles.

rent and the rock is characteristically massive. Chemically it is of variable composition, some analyses showing the presence of considerable magnesium while others indicate its almost complete absence. Besides its main occurrence in the Guadalupe Mountains the Capitan limestone was determined in 1907 to be present in the southern end of the Delaware Mountains, where it has been faulted down and adjoins the limestone of the Delaware Mountain formation. R. S. Tarr reports, in the paper cited above, the presence of 1000 feet or more of sandstone lying above the Capitan formation, but these rocks have not been studied, so that neither the base nor the top of the strata bearing the Guadalupian fauna has yet been determined. It is expected that these relations can be determined in the northward continuation of the formations in the Sacramento Mountains of New Mexico. The following is a short list of fossils typical of the Capitan limestone determined by Dr. Girty:

*List of fossils from the Capitan limestone.*

<i>Fusulina elongata</i>	<i>Squamularia Guadalupensis</i>
<i>Orthotetes Guadalupensis</i>	<i>Spiriferina pyramidalis</i>
<i>Chonetes Hillanus</i>	<i>Composita emarginata</i>
<i>Productus latidorsatus</i>	<i>Pugnax Swallowiana</i>
<i>Productus pinniformis</i>	<i>Dielasma spatulatum</i>
<i>Richthofenia Permiana</i>	<i>Heterelasma Shumardianum</i>
<i>Spirifer Mexicanus</i>	<i>Leptodus Guadalupensis</i>

*Résumé.*

In both the El Paso and Van Horn quadrangles the basal Paleozoic strata are sandstones which lie unconformably on pre-Cambrian rocks. These conditions are in accord with observations elsewhere in southwestern United States, where part of late Cambrian time was characterized by the deposition of coarse arenaceous sediments in a sea which was advancing on an old land surface. The succeeding record is of subsidence, interrupted by probable emergences, and of the accumulation in Ordovician, Silurian, and Upper Carboniferous time of a great mass of limestone exceeding 5000 feet in thickness. The presence in this limestone of five distinct faunas representing the Beekmantown, Galena, Richmond, Niagara, and Pennsylvanian stages, and the absence of the intervening faunas which are present in the complete Paleozoic section, imply a number of unconformities to account for the hiatuses, yet these are not lithologically well marked and their exact stratigraphic positions generally are unrecognizable. It is especially noteworthy that in the Franklin Mountains Upper Carboniferous

(Hueco) limestone lies with apparent conformity on Silurian (Fusselman) limestone. The absence of the intermediate series between the Cambrian and Pennsylvanian in the two quadrangles points to several uplifts which in general did not appreciably deform the rocks, and apparently the emergences were so slight that there is little record of erosion. But in the Van Horn region there is abundant evidence of profound pre-Pennsylvanian erosion, for the Hueco limestone with a well-developed basal conglomerate rests indifferently on all of the underlying formations. The deposition of the sandstone members of the Guadalupian series indicates changed conditions during late Paleozoic time in contrast to those prevailing during the accumulation of the great mass of limestone in the earlier periods, but the extent and relationships of these Permian? strata have not yet been determined.

The close of the Paleozoic era in the trans-Pecos Texas region apparently was accompanied by general uplift, but there is little record of immediately succeeding events. Early Mesozoic rocks are known in only a few areas, such as the marine Jurassic beds in the Malone Mountains,\* 65 miles southeast of El Paso. East of the Van Horn quadrangle the Delaware Mountain formation is unconformably overlain by several hundred feet of gypsum of undetermined age. There is abundant evidence of considerable post-Carboniferous, pre-Cretaceous erosion in this region and in several places the Hueco limestone is immediately overlain by Lower Cretaceous strata.

U. S. Geological Survey, Washington, D. C.

\* Bulletin No. 266, U. S. Geological Survey, 1905.

ART. I.—*A Rectification Effect in a Vacuum Tube*; by HENRY A. PERKINS.

THE effect to be described in this article was accidentally discovered by the writer during some experiments on the electrodeless discharge. It was noticed, in the first place, that a tube exhausted to about  $\frac{1}{2}$  mm pressure showed ionization when acted on by an alternating electrostatic field of low frequency and comparatively low potential, 550 volts and above. Moreover a direct current was sent through a galvanometer connected to two terminals sealed into the ends of the tube.

The alternating field was supplied from one end of a transformer capable of giving 2000 volts, and the other end was

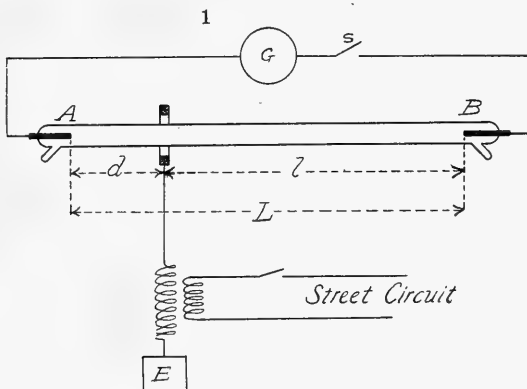

grounded. The free end was connected to a ring surrounding, but not touching, the tube, and was adjustable to various positions along the tube. The tube itself was about 20 cm long between the inside ends of the electrodes, and about 2 cm outside diameter. It was exhausted from a point near one end, thus leaving the main body of the tube a smooth cylinder, and in order to secure as much symmetry as possible, a dummy tube was blown in the other end as shown in the diagram. The galvanometer used was a Thompson type of instrument having a resistance of 5800 ohms, and, as adjusted, 1 cm deflection on the scale was equivalent to  $5 \times 10^{-8}$  amperes. The connections are shown in fig. 1.

As soon as the main transformer circuit was closed, the ionization became evident by a faint glow in the tube, and on closing S, by a deflection of the galvanometer. This deflec-

tion was too small to be observed, however, when the potential of the ring was less than 550 volts, or when the ring was so situated that the glow did not reach to both electrodes. If the ring was moved in successive readings from A to B, a curve of deflections was obtained of the general character of fig. 2. This current was practically zero at A and B, but on moving toward the center it increased very rapidly beyond 5 cm from the ends, went through a maximum, then decreased very rapidly and reversed sign when the ring was at the

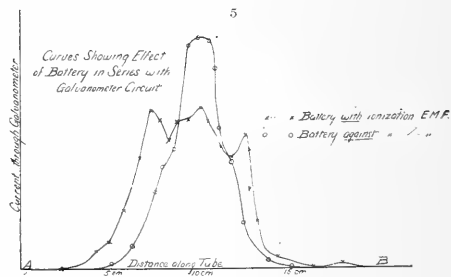
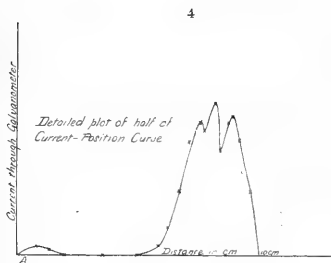
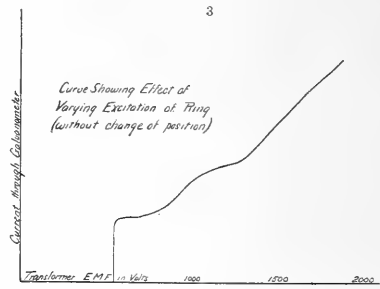
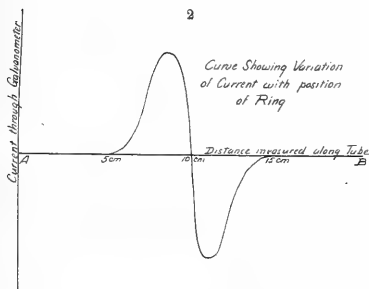

center and went through a similarly situated maximum on the other side, the two halves of the curve being substantially alike.

The readings between the two maxima were very unsteady, but the maxima themselves and points outside them as steady as could be expected with the somewhat variable nature of the commercial E. M. F. The actual currents indicated by the maxima varied greatly with the exciting E. M. F., but currents of the order  $5 \times 10^{-7}$  were readily obtained and, with a short thick tube, still larger ones.

Fig. 3 gives a rough idea of the effect on the current of varying the exciting field, at the maximum points. It shows a sudden appearance of the phenomenon when the pressure exceeds a certain minimum value, and after that a less rapid but fairly steady rate of increase.



A careful study of the critical points of the curve shows certain indentations in the maxima that persisted in quite an unaccountable manner, and were nearly similar in the two maxima; also curious humps in the curve near the electrodes, where a very small current could be produced. Fig. 4 gives half of the curve exhibiting these effects. A further series of readings was taken with a storage battery interposed in the galvanometer circuit. A few volts only were needed to reverse the current when the coil was near the center, and a large current in the opposite direction was readily produced; but 100 volts or more were needed at points near ends. The current produced by a given battery E. M. F. while the exciting ring was moved from A to B is given in fig. 5. It will be noticed that at the center larger values were obtained when the two pressures in the tube were opposed, than when they acted together; also that the ionization was more available for carrying a current when the ring was near the center.

In order to study the potential differences between A and B for different settings of the ring, an electrostatic voltmeter of the Kelvin multicellular type was used, and fig. 6 (p. 490) shows how the voltage varied. This bears out the indications of the battery effect mentioned above, where the pressure needed to reverse the current was a maximum at the ends. It will be seen that the voltmeter indicated the largest values when the ring was near the terminals, although the limited range of the instrument prohibited a complete set of readings. It was also most significant to note that the time required for the "needles" to come to rest varied with the magnitude of the deviation. The small values near the center were reached in a fraction of a second; while for the large readings near the ends it required several minutes to fully charge the voltmeter to the indicated potential. This again bears out the evidence of the other curves that indicate a maximum current effect when the ring is near the center of the tube.

Any theory accounting for this phenomenon must explain the following facts:

(1) A direct current caused by an alternating electrostatic field.

(2) The positive pole of the tube is always the one nearest the exciting ring.

(3) The maximum currents are obtained at points near by, and on either side of the center.

(4) The terminal voltage of the tube varies oppositely from the current; it is minimum when the current is maximum.

No attempt will be made to account for the indentations already referred to, and other minor effects; they may be due to minute disturbances, the shape of the tube, terminals, etc., and so will be ignored.

In the following discussion it will be necessary to make some assumption as to the nature of the field produced by the ring. If it were not for the terminals and galvanometer circuit, we might say that beyond a short distance from the ring the intensity varied inversely as the square of the distance, but the terminals, particularly when grounded, seriously affect the distribution, and a uniform gradient between ring and terminal probably more nearly represents the actual conditions; at any rate the truth lies somewhere between the two, and we shall make the latter assumption as being the simpler one; moreover, working out the equation on the other basis does not alter the curves obtained very seriously. A second assumption will be that most of the ionization occurs very near the ring; this would be the case if the intensity varied inversely as the square of the distance, and unless the gradient is very constant, it will probably be so anyway. When a very long tube was tried the glow was confined to a comparatively narrow region near the ring, and was most intense just under it.

Let  $2m^*$  = the number of ions produced per second by the ring.

“  $T$  = half period of alternating field.

“  $l$  and  $d$  = lengths of two segments of tube as shown in fig. 1.

“  $r$  = ratio of velocities of ions.

“  $V$  = effective value of potential of ring.

“  $v$  = velocity of + ions with unit potential gradient.

Assume that the  $2m$  ions produced in a second divide between the two segments directly as the gradient of the segments.

Then  $\frac{2md}{l+d}$  will travel toward B.

And  $\frac{2ml}{l+d}$  will travel toward A.

Also  $\frac{vV}{l}$  will be the velocity of ions moving toward B

And  $\frac{vV}{d}$  “ “ “ “ “ “ “ A

during the first, or positive, half cycle; hence the number of + ions reaching B in this half cycle

$$= \frac{2md}{l+d} \left( T - \frac{l}{vV} \right) = \frac{2md}{l+d} \left( T - \frac{l^2}{vV} \right).$$

- But there will be a certain number of recombinations, during their journey, with negative ions that were repelled during

\* It should be noted that  $m$  is a function of  $V$ , although no attempt is made at this point to evaluate it.

the previous half cycle, failed to give up their charges, and are returning under the electrostatic attraction of the ring.

To account for their effect

Let  $n$  = number of ions in the tube per cm. length

Then  $K_n^2$  = number of recombinations per second per cm. length

“  $TKn^2$  = total number during half period

But  $n$ , in long segment, =  $\frac{2md}{l+d} \div \text{velocity} = \frac{2md}{l+d} \times \frac{l}{vV}$

∴ total number of recombinations in the time  $T$  =

$$\frac{TK4m^2l^2d^2}{v^2V^2(l+d)^2} = K_1l^2d^2 \text{ where } K_1 = \frac{4TKm^2}{v^2V^2(l+d)^2}$$

and the number uncombined at the end B

$$= K_3(1-K_1l^2d^2)(T-K_2l^2)d \tag{1}$$

$$\text{where } K_2 = \frac{1}{Vv} \text{ and } K_3 = \frac{2m}{l+d}$$

Similarly the total number arriving at A during the same time is

$$= K_3(1-K_1l^2d^2)(T-K_2d^2)l \tag{2}$$

And the negative ions arriving at B during the second half cycle are

$$= K_3 \left(1 - K_1 \frac{l^2d^2}{r^2}\right) \left(T - \frac{K_2l^2}{r}\right) d \tag{3}$$

And the negative ions arriving at A are

$$= K_3 \left(1 - K_1 \frac{l^2d^2}{r^2}\right) \left(T - \frac{K_2d^2}{r}\right) l \tag{4}$$

The sum of (2)+(3) - {(1)+(4)} gives us the number of outstanding + ions at A at the end of a complete cycle. This is equal to

$$N = \frac{K_3}{r^3} \{ld(l-d)[K_2r^2(r-1) - TK_1ldr(r^2-1) - K_1K_2l^2d^2(r^3-1)]\}$$

But  $K_1$  is necessarily small with the short period used, so in order to obtain an approximate form of the theoretical curve, we may drop all terms multiplied by  $K_1$ , and substituting for  $K_2$  and  $K_3$  we have

$$N = \frac{2m}{Vv(l+d)} \frac{(r-1)}{r} \{ld(l-d)\}$$

This curve is plotted in fig. 7, assuming  $l+d=20$  and letting the constant part of the expression equal unity. The result satisfactorily accounts for the two maxima, the polarity

of the tube, and the zero at the center. To still further explain the form of the experimental curve we have to consider that the value of  $N$  obtained is proportional simply to the balance of + charges left at  $A$  at the end of one cycle, but we have taken no account of the conductivity of the tube itself which it is necessary to consider if we are investigating the current through the galvanometer. We must then introduce a factor that takes account of the variation of the tube's conductivity, or rather *convectivity*. Now it is clear that such a factor

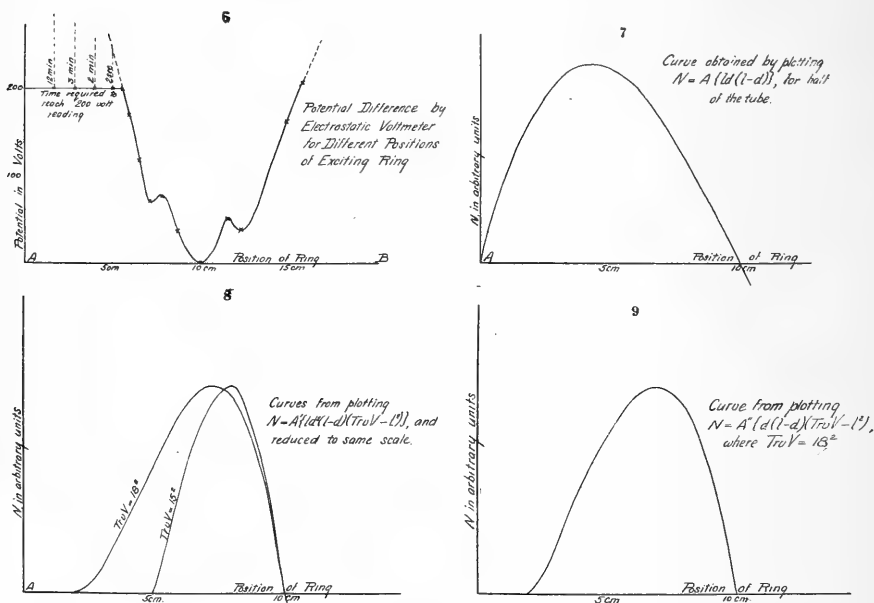

depends on the longer segment, and will be zero for all cases when no ions are able to reach  $B$  during the time  $T$ . It is further limited to that portion of the cycle in which the ions are traveling in the right direction to conduct the current indicated above. This is supplied by (3) only. Then, if instead of regarding all  $2m$  ions as available, we multiply  $N$  by the factor that determines the proportion of  $2m$  reaching  $B$  during the second half cycle, we shall account for the limited conductivity of the tube. Consider, as before,  $K_1$  as quite

small, then (3) reduces to  $\frac{2m}{l+d} \left( T - \frac{K_2 l^2}{r} \right) d$  and substituting this for  $2m$  in the main equation we have

$$N = \frac{2m}{V^2 v^2 (l+d)^2} \frac{(r-1)}{r^2} \{ld^2(l-d)\} (TrvV - l^2)$$

In this new factor  $(TrvV - l^2)$ , we must regard all negative values as zero; for when  $l^2 > TrvV$  it shows that no ions can reach B at all, hence no current can flow. Moreover,  $l$  is supposed always to be the larger segment, it can thus vary only between

$L$  and  $\frac{L}{2}$ , where  $L$  is the tube's length. Thus the current

will begin to flow when  $TrvV = l^2$ , and a plot of the equation between  $N$  and  $l$ , assuming  $TrvV = 18^2$  and  $l+d = L = 20$ , in fig. 8 exhibits all the essential features of the experimental curve. Letting  $TrvV = 15^2$  gives an even closer similarity, as is shown on the same diagram. The effect of assuming a

distribution unaffected by the ends (i. e.,  $\frac{Q}{x^2}$ ) is to make the slopes more abrupt than those shown.

One more possible effect ought to be considered; the possibility of a variation in the total ionization for different positions of the ring. For instance, the number produced on either side of the ring might depend on the gradient on that side. Let  $n$  = the number of ions produced per second, per unit gradient. Then  $\frac{nV}{l}$  will be produced on the side toward

B and  $\frac{nV}{d}$  on the side toward A (assuming as before that nearly all the ionization occurs very near the ring). Then total ionization =  $n \frac{V(l+d)}{ld} = 2m$ . Substituting this in the last equation, we have

$$N = \frac{n(r-1)}{Vv^2(l+d)r^2} \{d(l-d) (TrvV - l^2)\}$$

which yields the curve shown in fig. 9, which does not differ very materially from that in fig. 8.

The variation of potential as exhibited by the electrostatic voltmeter is easily explained by considering the potentials, due to the ring, at A and B. When the galvanometer circuit is to open the ends will not affect the field so much, and we may assume  $P_a = \frac{Q}{d}$  and  $P_b = \frac{Q}{l}$  when

$Q$  is the charge on the ring. Then  $P_a - P_b = P.D. = Q \frac{(l-d)}{ld}$ .

This gives a curve very similar to the one obtained, although

it reaches  $\infty$  at A and B, which follows of course from assuming  $P_a = \frac{Q}{d}$ .

The foregoing attempt to explain the phenomena seems to account fairly well for the form of the curves obtained, as well as the chief effect of rectification. The few quantitative measurements so far made are not discordant with the theory, and further experiments are now in progress involving changing the frequency, the pressure in the tube, the form of the terminals, etc.; all of which should give interesting data on the various ionic properties involved.

Jarvis Laboratory, Trinity College, Hartford, Ct.,  
March, 1908.

ART. LI.—*On the Life of Radium*; by BERTRAM B. BOLTWOOD.

[Contributions from the Sloane Physical Laboratory of Yale University.]

THE theory proposed by Rutherford and Soddy to explain the behavior of radio-active substances assumes that the phenomena of radio-activity are accompanied by the disintegration of the atoms of the radio-elements and the production of atoms of other elements having distinctive physical and chemical properties. On the basis of this theory it is necessary to conclude that in any salt of radium a certain proportion of the total number of radium atoms present are constantly being transformed into atoms of other substances.

A number of estimates of the approximate order of magnitude of the change occurring in radium have been made by Rutherford. From the heating effect observed in radium salts he at first calculated that the half-value period of radium, *i.e.*, the time required for exactly half of a given quantity of radium to disintegrate into other substances, was about 800 years,\* but very shortly afterward he decided upon 1500 years† as a more probable value.

Later, he was able to determine‡ the quantity of positive electricity communicated to an insulated conductor by the  $\alpha$  particles from a known weight of radium bromide in the form of a thin film and in this way obtained further data on which a calculation of the life of radium could be based. Thus, for example, when the film contained  $0.484^{mg}$  of radium bromide, the current due to the charge carried by the  $\alpha$  particles was found to be  $9.8 \times 10^{-13}$  ampere. This corresponded to  $2.03 \times 10^{-9}$  ampere per gram of radium bromide and, since at most not more than half of the  $\alpha$  particles escaped (the rest being absorbed in the plate supporting the film), the total charge carried per second by the  $\alpha$  particles from one gram of radium bromide was equal to  $4.07 \times 10^{-9}$  ampere. Assuming that the charge carried by each  $\alpha$  particle was the same as the charge on an ion, *viz.*,  $1.13 \times 10^{-19}$  coulomb, the total number of  $\alpha$  particles emitted per second by one gram of radium bromide was given as  $3.6 \times 10^{10}$ . Taking the composition of the radium salt used to be  $RaBr_2$ , containing 58 per cent of pure radium, it followed that the total number of  $\alpha$  particles expelled per second from one gram of radium was  $6.2 \times 10^{10}$ . This number was for radium itself, that is for radium free from other products (Em, Ra A, etc.). If it is

\* Bakerian Lecture, Phil. Trans. Roy. Soc., cciv, 169, 1904.

† Radio-activity, 1st edition, p. 333, 1904.

‡ Phil. Mag., x, 193, 1905.

assumed that an atom of radium on disintegrating to form an atom of emanation emits a single  $\alpha$  particle, then the number of  $\alpha$  particles expelled per second from a gram of radium is a measure of the number of atoms undergoing transformation in the same period. It can be shown that the number of atoms in one gram of radium is approximately equal to  $3.6 \times 10^{21}$ . The number of atoms disintegrating per second is, from the number of  $\alpha$  particles emitted, equal to  $6.2 \times 10^{10}$ . The fraction of the whole number present undergoing transformation per second is accordingly  $1.72 \times 10^{-11}$ , or  $5.4 \times 10^{-4}$  per year. It follows from this that the half-value period of radium is about 1300 years.

Not long after making the above estimate Rutherford experimentally determined the velocity and the ratio of the charge to the mass of the  $\alpha$  particles from the radium products, and found the value of  $\frac{e}{m}$  to be approximately  $5.1 \times 10^8$ . Since the value of  $\frac{e}{m}$  for the hydrogen ion in the electrolysis of water is nearly  $10^4$ , he concluded that of the three possibilities, viz., that the  $\alpha$  particle is (1) a molecule of hydrogen carrying the ionic charge of hydrogen, (2) a helium atom carrying twice the ionic charge of hydrogen, or (3) one-half of the helium atom carrying a single ionic charge; the most probable was the second. He has pointed\* out that if this assumption is applied in the calculation of the number of  $\alpha$  particles emitted per second by one gram of radium, the value obtained is one-half of that calculated above, namely  $3.1 \times 10^{10}$ . This would give the half-value period of radium as 2600 years instead of 1300 years.

The experimental data on the velocity and the value of  $\frac{e}{m}$  for the  $\alpha$  particles have also been used by Rutherford in obtaining an estimate of the number of  $\alpha$  particles from the heating effect of radium bromide. It has been found that the heat emitted by pure radium bromide is equivalent to about 100 gram calories per hour per gram of radium containing equilibrium amounts of its immediate products. This is mechanically equivalent to  $1.16 \times 10^6$  ergs per second. Taking the energy of the  $\alpha$  particle from radium itself as nineteen one-hundredths of the total energy due to the four  $\alpha$  ray changes (Ra, Em, Ra A and Ra C), the heating effect which can be attributed to radium alone is  $2.24 \times 10^5$  ergs per second per gram. This is on the assumption that the energy emitted as heat is due to the kinetic energy of the expelled  $\alpha$  particles. Since the energy of an  $\alpha$  particle from radium itself is

\* Phil. Mag., xii, 348, 1906.



$2.41 \times 10^{14}e$ , when the value of  $e$  is expressed in electromagnetic units, the number of  $\alpha$  particles expelled per second by one gram of pure radium free from products is equal to  $\frac{29.9}{10^{10}}e$ .

Now assuming that the disintegration of the radium atom is accompanied by the expulsion either of (1) a single  $\alpha$  particle having a mass equal to that of a helium atom and bearing twice the charge of a hydrogen ion, or of (2) two  $\alpha$  particles of a mass equal to half that of a helium atom with a single ionic charge, the number of atoms in one gram of radium disintegrating per second is given as  $4.1 \times 10^{10}$  per second, or  $12.7 \times 10^{17}$  per year. Taking the total number of atoms in one gram of radium as  $3.6 \times 10^{21}$ , the fraction disintegrating per year is equal to  $3.5 \times 10^{-4}$  and the half-value period is approximately 2000 years. The latter is about 77 per cent of the maximum estimate on the basis of the measurement of the charge carried by the  $\alpha$  particles.

Owing to the relative uncertainty as to the exact values of many of the quantities used in the above calculations, it is not to be expected that the results obtained by the different methods will at best give more than the approximate order of the rate of the change taking place in radium.

The amount of emanation produced by one gram of radium is also a measure of the rate of disintegration of radium. The results obtained by Ramsay and Soddy from measurements of the volume of the emanation produced by known amounts of radium salts were in fair agreement with the quantities to be expected from the rate of change indicated by Rutherford's early calculations.\* Quite recently, however, Cameron and Ramsay have published† an account of the results of some similar experiments which they interpret as indicating that the rate of change of radium is much more rapid than has been generally supposed, and on the basis of these results they have calculated that the fraction of radium disintegrating per day is  $1.162 \times 10^{-5}$ , which corresponds to only 163 years for the half-value period.

#### *Theory of Present Experiments.*

It follows from the disintegration theory, that in any system of radio-active substances, consisting of a parent element A and a series of successive disintegrating products, B, C, etc., when the relative amounts of products have reached their highest possible value and a state of radio-active equilibrium has been attained in the system, the number of atoms of the parent substance disintegrating in unit time is exactly equal to

\* Radio-activity, 2d edition, p. 458, 1905.

† Jour. Chem. Soc., xci, 1266, 1907.

the number of atoms of each successive product disintegrating in the same period. If the number of atoms of the substances A, B, and C is equal to P, Q, and R, respectively, and  $\lambda_1$ ,  $\lambda_2$ , and  $\lambda_3$  are the respective constants of change or fractions of the total amounts of each substance which undergo change each second, then the relation existing under equilibrium conditions is expressed by

$$\lambda_1 P = \lambda_2 Q = \lambda_3 R$$

and the amount of the first product B which disintegrates per second to form the second product C is exactly equal to the amount of B which is produced per second by the disintegration of the parent substance A. This follows from the very assumption of a state of equilibrium, for if the amount of B which disintegrated per second was greater or less than the amount formed in the same interval, the relative proportion of B as compared to A would diminish or increase accordingly, which is contrary to the fundamental assumption.

If, therefore, it is desired to find the rate of change  $\lambda_2$  for the product B, and for any reason a direct determination of this is impracticable, it is possible to obtain a knowledge of its value by comparing the amount of B formed in a given interval from a known amount (P) of A with the amount of B in radio-active equilibrium with P. Thus  $\lambda_2 = \frac{\lambda_1 P}{Q}$ , where  $\lambda_1 P$  is the amount of B formed per second by P atoms of the parent A.

Now in the case of radium, owing to its rarity and its slow rate of change, it is not at present possible by direct measurements conducted with radium compounds to accurately determine the rate at which disintegration is taking place. The primary uranium minerals, however, represent systems which are certainly of sufficient age for a state of radio-active equilibrium to have been reached by the different products. If, therefore, the parent substance from which the radium is formed can be separated from such a mineral, and the amount of radium produced by this parent can be determined and compared directly with the amount of radium with which it was associated in the mineral, it is possible to obtain a more accurate knowledge of the constant of change of the radium than can be obtained by other methods.

The constant proportion which has been found to exist between the quantities of uranium and radium in different minerals is very conclusive evidence in support of the assumption that radium is a disintegration product of uranium, but attempts made to detect the growth of radium in compounds of pure uranium indicated that if radium was produced at

all it was produced at a very small fraction of the rate which was to be expected from other considerations. It was possible, however, that the transformation of uranium X into radium was not a direct one, and that the atoms of uranium X disintegrated to form atoms of an unknown intermediate product with a slow rate of change from which radium was ultimately produced.

The indications were all in favor of the presumption that this intermediate product, if it existed, had so slow a rate of change that, for purposes of determining the rate of production (and disintegration) of radium, it offered all the advantages of a true parent. In a search for this possible intermediate product I finally found\* that there could be separated from uranium minerals a substance from which radium was unquestionably produced at a readily measurable rate. This substance was separated with thorium, with which it remained very persistently, exhibiting a chemical behavior almost identical with that given by Debierne as characteristic for actinium. It was, therefore, at first supposed that the radium-forming substance was actinium, although the necessity of further investigation before reaching a definite conclusion was fully appreciated. Further experiments were therefore undertaken from the results of which it was established that the radium-producing substance was a new radio-active element, to which the name "ionium" was given.† In the mean time Rutherford had found‡ that, although radium was produced in a commercial preparation of actinium which he had examined, the substance from which the radium was formed could be partially separated from the actinium and could not therefore be identical with it.

#### *Experimental Part.*

The experiments which will be described in this paper were undertaken with the object of determining the rate of disintegration of radium. The operations consisted in the separation of the ionium from definite quantities of certain uranium minerals and the comparison of the amounts of radium produced by the separated ionium in known periods with the amounts of radium originally associated with it.

The radium present in the minerals used was ascertained by comparing the activity of the maximum or equilibrium amount of radium emanation evolved from a small, average sample of

\* This Journal, xxii, 537, 1906.

† This Journal, xxiv, 370, 1907.

‡ Nature, lxxv, 270, 1907; *ibid.*, lxxvi, 126, 1907; *Phil. Mag.*, xiv, 733, 1907.

the powdered material, with the activity of the emanation from a solution containing a known amount of radium.

The solutions of ionium were sealed up in glass bulbs and the radium emanation present was determined from time to time by boiling off the gases in each bulb and measuring the activity of these gases in an electroscope. The radium emanation obtained in this manner is a measure of the amount of radium present in the solution at any time, but for short periods of accumulation is not directly proportional to the actual amount of radium contained in the solution.\*

If a freshly prepared solution of ionium free from radium is sealed up and radium is produced at a constant rate, then at the end of  $t$  days the amount of emanation present in the solution is proportional to

$$qt - \frac{q}{\lambda} (1 - e^{-\lambda t})$$

when  $q$  is the amount of radium produced per day expressed in terms of its equilibrium amount of emanation and  $\lambda$  is the constant of change for the emanation, the day being taken as the unit of time. The ratio of the amount of emanation in the solution at the end of  $t$  days, to the amount of emanation in equilibrium with the total quantity of radium then present would be equal to

$$\frac{qt - \frac{q}{\lambda} (1 - e^{-\lambda t})}{qt}$$

or

$$1 - \frac{1}{\lambda t} (1 - e^{-\lambda t}).$$

Thus at the end of four days, for example, taking  $\lambda$  as 0.178, the value of the ratio would be

$$1 - \frac{1}{.712} (1 - .49) = 0.286,$$

viz., the amount of emanation present would be 0.286 the amount in equilibrium with the radium in the solution.

If a quantity of radium  $q_0$  is present in the ionium at the start, then the proportion of its equilibrium amount of emanation which will accumulate in the solution in the time  $t$  will be equal to  $q_0(1 - e^{-\lambda t})$ . The total amount of emanation at the time  $t$  will then be equal to

$$q_0 (1 - e^{-\lambda t}) + qt \left[ 1 - \frac{1}{\lambda t} (1 - e^{-\lambda t}) \right].$$

\* The general mathematical considerations which apply in this case have been discussed and developed by Rutherford. *Phil. Mag.*, xiv, 733, 1907.

This is the form of the expression used in calculating the results of the experiments. Two curves with the time in days taken as the abscissas, one for the values of  $1 - e^{-\lambda t}$  and the other for the values of  $1 - \frac{1}{\lambda t}(1 - e^{-\lambda t})$ , were plotted on squared paper and afforded a convenient means for quickly obtaining the values of these quantities for different periods of time.

If, after testing a solution, a second test was made less than 30 days later, the value obtained for the amount of emanation in the second case was increased by an amount equal to  $Ie^{-\lambda t_2}$ , where  $I$  was the activity of the emanation found in the first test and  $t_2$  was the interval between the times of testing.

The method followed in calculating the results of the experiments will be illustrated by the following example: A solution of ionium (Solution 3) was prepared and was sealed up, after thorough boiling to remove all emanation. Five days and twenty-two hours later the gases were boiled out and tested in the electroscope. The leak due to radium emanation was found to be equal to 0.094 divisions per minute. Eighteen days later (23.9 days from the start) the gases were again removed and the activity of the emanation then obtained was equal to 0.613 div. per min. in the electroscope. The value found in the first test was 0.094, and  $0.094 \times e^{-18\lambda}$  is 0.004; this quantity was therefore added to 0.613, giving 0.617 div. per min. for the activity of the emanation at the second time of testing. The equations then had the form

$$\text{(For 5.9 days)} \quad 0.65q_0 + 2.25q = 0.094$$

$$\text{(For 23.9 days)} \quad 0.986q_0 + 18.36q = 0.617$$

and from these equations the values  $q = 0.0317$  and  $q_0 = 0.034$  were obtained. The sensitiveness of the electroscope was such that a leak of 1.00 div. per min. corresponded to the equilibrium amount of emanation from  $1.05 \times 10^{-9}$  gram of radium. The amount of radium produced per day was therefore  $0.0333 \times 10^{-9}$  gram and the amount present in the solution at the start was  $0.0357 \times 10^{-9}$  gram.

#### *Ionium Solution 1.*

The preparation of this solution has already been described in a previous paper.\* The mineral used consisted of about one kilogram of a crude carnotite ore containing approximately nine per cent of uranium and a total quantity of radium equal to about  $3.1 \times 10^{-5}$  gram.†

\* This Journal, xxv, 371, 1908.

† This is the solution mentioned in an earlier paper, this Journal, xxii, 537, 1906, where the content of uranium in the mineral taken and the amount of radium produced in the first 193 days are incorrectly given.

This solution was tested for the growth of radium for a total period of 539 days from the time of its first preparation. The results obtained are given in the following table (Table I).

The first column gives the number of each test, the number 1 signifying first test, 2 second test, etc.; the second column gives the time in days which elapsed from the time that the solution was first prepared and sealed up to the time that any given test was made; the third column gives the amount of radium emanation obtained in each test expressed in terms of the weight of radium with which it would be in equilibrium; the fourth column gives the amount of radium produced per day during the different periods as calculated in the manner already explained.

TABLE I.  
*Growth of Radium in Solution 1.*

I	II	III	IV
1	69 days	$5.58 \times 10^{-9}$ g.	
2	263 "	9.22 " "	$0.0187 \times 10^{-9}$ gram.
3	376 "	11.38 " "	0.0192 " "
4	539 "	14.43 " "	0.0188 " "

The amount of radium produced per day calculated from the results of the first and the last test only was  $0.0188 \times 10^{-9}$  gram, and the amount of radium present in the solution at the start calculated from this number and the result of the first test was  $4.40 \times 10^{-9}$  gram. The amount of radium produced in this solution in one year would therefore be approximately  $6.9 \times 10^{-9}$  gram. Assuming that all of the ionium in the original mineral was contained in this solution, the constant of change ( $\lambda$ ) for radium is given by  $\frac{6.9 \times 10^{-9}}{3.1 \times 10^{-5}} = 2.2 \times 10^{-4}$ , and the half-value period indicated is about 3100 years.

#### *Ionium Solution 2.*

The preparation of this solution has also been described in a previous paper.\* It was prepared from a kilogram of carnotite containing  $3.1 \times 10^{-5}$  gram of radium. The chemical treatment to which the mineral was subjected was more elaborate than in the first instance and was designed to effect, if possible, a more complete separation of the ionium. The data obtained from the measurements conducted on this solution are given in Table II, in which the arrangement is similar to that in Table I.

\*This Journal, xxv, 372, 1908.

TABLE II.  
*Growth of Radium in Solution 2.*

Test No.	Time from start days	Radium emanation found in terms of Ra	Radium growth per day
1	9	$0.636 \times 10^{-9}$ g.	
2	32	1.31 " " "	$0.0252 \times 10^{-9}$ g.
3	196	5.35 " " "	0.0246 " " "

The average growth calculated from (1) and (3) was equivalent to  $0.0247 \times 10^{-9}$  g. radium per day and the amount of radium present at the start was  $0.65 \times 10^{-9}$  gram. The amount of radium produced per year would be  $9.01 \times 10^{-9}$  g., giving a value for  $\lambda$  equal to  $2.9 \times 10^{-4}$  and a half-value period of 2400 years.

*Ionium Solution 3.*

The ionium contained in this solution was separated from 200 grams of Joachimsthal uraninite by the chemical operations described in a former paper.\* The mineral taken contained  $2.13 \times 10^{-7}$  gram of radium per gram, or a total of  $4.26 \times 10^{-5}$  gram of radium. The data obtained on the growth of radium in this solution are given in Table III.

TABLE III.  
*Growth of Radium in Solution 3.*

Test No.	Time from start in days	Ra Em found expressed in terms of Ra	Growth radium per day
1	5.9	$0.0987 \times 10^{-9}$ g.	
2	23.9	0.648 " " "	$0.0333 \times 10^{-9}$ g.
3	46	1.397 " " "	0.0339 " " "
4	209	6.97 " " "	0.0342 " " "

The average amount of radium produced per day calculated from the results of the first and last tests only, was  $0.0341 \times 10^{-9}$  g., and the amount of radium in the solution at the start was only  $0.0346 \times 10^{-9}$  gram. The amount of radium produced per year in this solution would be  $12.45 \times 10^{-9}$  gram, giving a value of  $2.92 \times 10^{-4}$  for  $\lambda$  and indicating a half-value period of about 2400 years for radium.

*Ionium Solution 4.*

This solution was prepared from about 100 grams of secondary uranium minerals, chiefly gummite and uranophane, by the chemical operations which have been already described in the earlier paper.† During the later stages of the chemical

\* This Journal, xxv, 373, 1908.

† This Journal, xxv, 373, 1908.

treatment a considerable portion (about half) of the solution of ionium was lost through an accident. The amount of radium in the original mineral is therefore of no significance, but the growth of radium in this solution is shown in Table IV.

TABLE IV.  
*Growth of Radium in Solution 4.*

Test No.	Time from start in days	Ra Em found expressed in terms of Ra	Growth of radium per day
1	6	$0.150 \times 10^{-9}$ g.	$0.00875 \times 10^{-9}$ g.
2	140	$1.37 \times 10^{-9}$ g.	

The amount of radium present at the start was  $0.20 \times 10^{-9}$  g., and the amount of radium produced per year would be  $3.19 \times 10^{-9}$  gram.

*Ionium Solution 5.*

The separation of the ionium from the relatively impure materials used in preparing the first four solutions involved very considerable difficulties. The minerals themselves were not entirely soluble in any one reagent and various insoluble residues were obtained from time to time which further added to the complications. It was therefore doubtful in the end whether a complete separation of the ionium had been effected. In order to avoid these difficulties a solution of ionium was prepared from a specimen of very pure uraninite from North Carolina. The material used consisted of exactly 40 grams of the mineral which was essentially free from traces of secondary alteration products. It was heated with an excess of dilute nitric acid and the solution was evaporated to dryness. The residue was moistened with a few drops of dilute nitric acid, was treated with hot water and the solution was filtered. The insoluble material removed in this manner weighed only 0.0663 gram after ignition, corresponding to 0.17 per cent of the material taken. It consisted chiefly of silica equivalent to 0.14 per cent of the mineral and only 0.03 per cent of other substances. Its activity was not greater than that of about one milligram of uranium.

The filtrate from this residue was first treated with an excess of hydrogen sulphide and the sulphides of lead, etc., removed. The excess of hydrogen sulphide was expelled from the solution, which was then heated to boiling and a solution of 10 grams of oxalic acid added. An immediate precipitation of oxalates occurred and the solution was allowed to stand for three hours until cold. The precipitated oxalates were filtered off. The filtrate was evaporated to dryness and ignited to destroy the oxalic acid. The residue was dissolved in nitric



acid, the solution evaporated to dryness and the residue of nitrates was treated with pure, dry ether to remove the uranium nitrate. That portion of the residue undissolved by the ether was treated with dilute hydrochloric acid, and to the resulting solution about 5 grams of oxalic acid were added. An immediate precipitate of oxalates formed, but the mixture was allowed to stand over night before filtering. The oxalates were then removed, were added to the oxalates obtained by the first precipitation with oxalic acid, and the whole was ignited gently to form the oxides. The oxides were treated with hydrochloric acid to form the chlorides, and the chlorides were thrice precipitated with ammonia to form the hydroxides. The final precipitate of hydroxides was dissolved in dilute hydrochloric acid and the solution was tested for the growth of radium. The results obtained with this solution are given in Table V.

TABLE V.  
*Growth of Radium in Solution 5.*

Test No.	Time from start in days	Ra Em found expressed in terms of Ra	Growth of radium per day
1	8.7	$0.097 \times 10^{-9}$ g.	$0.0110 \times 10^{-9}$
2	21.7	$0.240 \times 10^{-9}$ g.	$0.0101 \times 10^{-9}$
3	147.0	$1.51 \times 10^{-9}$ g.	

The average production of radium per day, calculated from the results of tests 1 and 3 only, was  $0.0102 \times 10^{-9}$  gram and the amount of radium in the solution at the start was  $0.067 \times 10^{-9}$  gram. The amount of radium produced per year would therefore be  $3.72 \times 10^{-9}$  gram. The amount of radium contained in the 40 grams of mineral (78.5 per cent U) taken was  $1.07 \times 10^{-6}$  gram. The fraction ( $\lambda$ ) of the radium changing per year was therefore  $3.48 \times 10^{-4}$ , which gives 1990 years for the half-value period of radium.

#### *Activity of Ionium in Solutions.*

The activity of the substances present in solutions 1, 2, 3 and 4 was determined in the manner which has been already described.\* Now it has been elsewhere shown† that the activity of the ionium in radio-active equilibrium with uranium is about 0.35 the activity of the uranium with which it is associated in a mineral. From the activity of an ionium preparation it is therefore possible to determine the weight of uranium with which this quantity of ionium would be in radio-active equilibrium. Since the amount of radium in equilibrium with one gram of uranium is known,‡ it is also possible to

\* This Journal, xxv, 374, 1908.

† Ibid., xxv, 291, 1908.

‡ Ibid., xxv, 296, 1908.

calculate the amount of radium in equilibrium with the ionium contained in a preparation of this element. Thus, for example, the total activity of the substances contained in solution 1 was found to be equivalent to 2591 divisions per minute in the electroscope. The activity of the thorium products present was calculated to be equal to 30 divisions per minute, which leaves 2561 divisions per minute for the activity of the ionium. Now the sensitiveness of the electroscope was such that one gram of pure uranium had an activity of 124 divisions per minute. The activity of the ionium in equilibrium with one gram of uranium would therefore be  $124 \times 0.35 = 43$  divisions per minute. From this it follows that the ionium contained in solution 1 was the amount in radio-active equilibrium with 59.6 grams of uranium. The amount of radium in equilibrium with one gram of uranium is  $3.4 \times 10^{-7}$  gram, and the amount of radium in equilibrium with the ionium contained in solution 1 would therefore be  $2.02 \times 10^{-5}$  gram.

The amount of radium in equilibrium with the ionium present in each of the first four solutions has been calculated in this manner and the results are shown in Table VI. The activities taken for the total material in the different solutions are calculated from the activities of the specimen films prepared from these solutions and are expressed in terms of divisions per minute in the electroscope. At the time that these values were obtained the films were about four months old and had attained an essentially constant activity.\* Column I gives the total activity of the substances contained in the solution; column II the activity due to the thorium products present; column III the activity of the ionium; column IV the calculated amount of uranium (in grams) with which the ionium would be in radio-active equilibrium; column V the calculated amount of radium (in  $\text{gram} \times 10^{-5}$ ) in equilibrium with the ionium; column VI the observed growth of radium per year in terms of  $\text{gram} \times 10^{-9}$ ; column VII the fraction of the radium undergoing change per year as given by the ratio of the amount of radium produced to the amount in equilibrium with the ionium.

TABLE VI

Sol. No.	I	II	III	IV	V	VI	VII
1	2591	30	2561	59.6	2.02	6.90	$3.41 \times 10^{-4}$
2	3485	84	3401	79.1	2.69	9.01	$3.35 \times 10^{-4}$
3	4495	90	4405	102.4	3.48	12.45	$3.57 \times 10^{-4}$
4	1268	68	1200	28.0	0.95	3.19	$3.35 \times 10^{-4}$

\*The activity of these films will probably fall slowly with the time owing to the decay of the radiothorium contained in them.

The average value for  $\lambda$  is  $3.42 \times 10^{-4}$ , which is in good agreement with the value  $3.48 \times 10^{-4}$  obtained directly from the growth of radium in solution 5.

Giesel has published\* an account of some experiments with a strong preparation of actinium in the course of which he obtained results suggesting the existence of a very slowly changing type of emanation, and has intimated that the production of this new emanation would account for the results which I had previously obtained and believed to indicate the growth of radium in actinium compounds. It is therefore desirable to state that in the course of the experiments described in this paper I have been unable to obtain any evidence of the existence of an emanation in any way resembling that described by Giesel. The emanation produced in the solutions of ionium was in all respects identical with the radium emanation, showing the characteristic rate of decay and producing the readily identified radium active deposit.

An interesting insight into the effectiveness of the method used by Rutherford for separating the radium parent from actinium can be gained from the data given in his later paper.† He states that the actinium preparation used had an activity about 250 times that of uranium, and on page 747‡ the total constant activity of 0.32 gram of this material is given as 12900. This would correspond to an activity of about 160 per gram of uranium. Now it can be readily shown that the radium produced per year by a quantity of ionium having an activity equal to that of one gram of uranium is about  $3.3 \times 10^{-10}$  gram. From this it follows that in the crude actinium preparation which Rutherford used about one-tenth of the total activity was due to the ionium present. It can be similarly shown that in his "Actinium I" and "Actinium II" the activity due to the ionium was about 0.12 of the total in the case of the former and about 0.18 of the total in the case of the latter. By the chemical operations which he describes the relative proportion of ionium to actinium was approximately doubled in his more concentrated preparation but was still considerably below that in which these elements occur in the uranium minerals.§

#### *Discussion of Results.*

The results obtained in the different experiments indicate that the growth of radium in the solutions of ionium was constant within the limits of experimental error throughout the periods during which the solutions were under examination.

\* Ber. d. chem. Ges., xl, 3011, 1907.

† Phil. Mag., xiv, 733, 1907.

§ Boltwood, this Journal, xxv, 269, 1908.

‡ *Loc. cit.*

This would appear to justify the conclusion that the rate of change of ionium is relatively slow and that it is the immediate substance from which radium is formed.

It is obvious that the significance of the value found in these experiments for the rate of disintegration of radium depends chiefly on the matter of the complete separation of the ionium. That the separation of the ionium was essentially complete in the preparation of Solution 5 appears highly probable, as it has been found\* that by similar, and even more complicated chemical operations, the amount of ionium to be expected from the disintegration theory can be separated from a pure uranium mineral. The method which has been used has also the further advantage that the result obtained is wholly independent of any standard of radium salt or of any hypothesis or assumption other than the fundamental theory of disintegration and the conclusion that the emanation is a measure of the radium present. Except for convenience there is no advantage in expressing the results of the separate measurements in terms of the standard radium solution. They could just as well be expressed in terms of divisions per minute in the electroscope.†

It is therefore very significant that the rate of disintegration of radium as determined in this direct manner should agree so closely with the rate which has been predicted by Rutherford from distinctly complex theoretical considerations, and this agreement is a further corroboration of Rutherford's extraordinary ability in such matters. It affords me much pleasure to acknowledge my indebtedness to Professor Rutherford for his constant interest and encouragement during the course of this investigation.

#### *Summary.*

Results obtained on the growth of radium in preparations of ionium separated from uranium minerals indicate that the disintegration constant of radium has a value of approximately  $3.48 \times 10^{-4}$  (year)<sup>-1</sup>.

The half-value period of radium is therefore about 2000 years.

New Haven, Conn., March 24, 1908.

\* This Journal, xxv, 269, 1908.

† The rate of change of uranium, calculated from the rate of change of radium and the amount of radium associated in a mineral with one gram of uranium, is given as  $1.16 \times 10^{-10}$  (year)<sup>-1</sup>. This is equivalent to a half-value period of  $6 \times 10^9$  years for uranium. These values are of course dependent on the purity of the radium standard.

ART. LIII.—*A New Occurrence of Proustite and Argentite*,\*  
by FRANK R. VAN HORN.

IN 1902, the Mine Developing Company of Cleveland, Ohio, was operating a property known as the California or Bell Mine on Glacier Mountain about 3 miles from Montezuma, Summit County, Colorado. The ore occurs in a fissure vein in granitic gneiss and consists chiefly of argentiferous galena, sometimes with considerable sphalerite mixed irregularly through it. The vein sometimes shows a simple structure made by the irregular mixture of galena and sphalerite; at other times it is banded symmetrically, while in a few other instances a brecciated appearance was observed.

*The Proustite.*

In September, 1902, the paying portion of the vein widened to about 21 inches, and assumed a distinctly banded structure, with galena and sphalerite in coarsely crystalline masses irregularly mixed on each wall; this was followed by siderite, also symmetrical, while the center consisted of massive proustite mixed with finally divided quartz which at times was more or less drusy. The proustite-quartz aggregate was generally about 2 inches wide, but in one case became 14 inches in thickness. This aggregate had an average of specific gravity of 4.17 as compared with 5.60 for pure proustite. This ore was followed along the strike for a distance of 30 feet with an upward slope of about 20 feet, when it disappeared. Mr. J. C. Sharp, Case '03, made two analyses of carefully chosen proustite, which gave the following average:

	Found	Theoretical Ag <sub>3</sub> AsS <sub>3</sub>
Ag -----	67.60	65.5
As -----	13.85	15.1
Sb -----	.93	
S -----	17.40	19.4
	<hr/>	<hr/>
	99.78	100.0

The analysis shows a slight admixture of the pyrrargyrite molecule (Ag<sub>3</sub>SbS<sub>3</sub>), also that the sulphur is too low, which is probably due to analytical errors. The silver is probably too high for the same reason, but might be due to native silver although none was observed on the specimen analyzed.

\* A full description of this occurrence with assays of ores was contained in a paper read before the Geological Society of America at the Albuquerque meeting, December 30, 1907. This article will be published in volume xix of the Bulletin of the Society.

*The Argentite.*

For a very short distance in the symmetrically banded vein above described, proustite was replaced by argentite which in two instances was reduced to wire silver. The argentite seam was from 2 to 3 inches in width and generally of a massive and finally granular appearance; in some cases, however, the mineral became quite coarsely granular; in all specimens the argentite was sectile and malleable but like the proustite was mixed more or less with minutely divided quartz. The average specific gravity of three specimens was 6.55, compared with 7.28 for pure argentite. The average of two analyses made by Mr. R. B. Dennis, Case '07, is as follows:

Ag .....	83.57
S .....	12.66
Insoluble .....	3.62
	<hr/>
	99.85

The insoluble matter conforms in general to the lower specific gravity (6.55) and probably consisted of quartz. The analysis was recalculated with the following result:

	Found	Theoretical Ag <sub>2</sub> S
Ag .....	86.71	87.1
S .....	13.13	12.9
	<hr/>	<hr/>
	99.84	100.0

As far as the writer could learn, the proustite and argentite have never been found previously in this locality, and the occurrence of both minerals in such massive form and large amounts is also considered a matter of interest. Several fine vein sections were presented by The Mine Developing Company to the geological department of Case School of Applied Science, and are on exhibition in the Museum.

Geological-Mineralogical Laboratory  
Case School of Applied Science,  
Cleveland, Ohio, April, 1908.

ART. LIII.—*On the Occurrence of Gedrite in Canada*; by  
N. NORTON EVANS and J. AUSTEN BANCROFT.

IN the year 1836 Thomson\* reported the discovery of anthophyllite at Perth, Ontario, but although the authors have not been able to gain access to Thomson's original paper, both Hintze and Rammelsberg refer to the occurrence of anthophyllite at this locality as doubtful. Furthermore, the mineral is not mentioned in the "Annotated List of Minerals Occurring in Canada" compiled by G. C. Hoffmann.† It seems, therefore, very doubtful whether the mineral has hitherto been found in Canada. So far as can be ascertained furthermore, the mineral has never been found in place in the United States, although it was found in bowlders of dunite at Bakersville, North Carolina, by the late Professor S. L. Penfield. The aluminous variety of this species known as gedrite has, however, been recently found by Dr. Frank D. Adams occurring abundantly in amphibolite on Lot 11 of Range IX of the Township of Harcourt, Haliburton County, Ontario. The discovery was made in the course of the geological survey of a large area on the margin of the Laurentian Protaxis to the north of Lake Ontario, which has recently been completed by Adams and Barlow for the Geological Survey of Canada.

The occurrence of amphibolite in question belongs to the Grenville series, which is very extensively exposed and is of great thickness in this region, consisting chiefly of limestone with, however, a considerable amount of associated amphibolite. Towards the southern margin of the Protaxis the Grenville series has an almost continuous development, but on going north it is invaded by great bathyliths of gneissic granite which rise through it and induce in it extreme metamorphism. Still farther north the granite appears in increasing abundance, the Grenville series being represented by long curved belts and irregular patches distributed through the invading rock. One of these belts, consisting of impure limestone, crosses the north end of Elephant Lake in the Township of Harcourt, being about seven miles in length and half a mile wide, and completely surrounded by the granite referred to above, whose foliation coincides with the direction of the strike of the limestone.

About a mile and a half from the northern extremity of this limestone belt, in the direct line of the strike and of the foliation of the enclosing granite, there appears a narrow belt of

\*Records Gen. Sc. Edinb., iii, 336, 1836.

†Ann. Rept. Geological Survey of Canada, 1888-89, pp. 1-67 T.

amphibolite which stretches for about two miles along the north shore of Fishtail Lake. This mass of amphibolite is traversed in all directions by pegmatite veins.

The amphibolite is a dark basic variety, consisting largely of anthophyllite and garnet associated with cordierite and subordinate amounts of quartz, biotite, iron ore and rutile. The anthophyllite is very abundant, occurring in groups or sheaves of long narrow individuals, often curved and without proper crystallographic terminations. Under the microscope the anthophyllite is seen to contain a few little inclusions of black iron ore and of biotite. The mineral has a bright luster and possesses that delicate clove-brown color which caused Schumacher, who first described this mineral, to give to it the name anthophyllite.

The mineral has a perfect cleavage parallel to the prism (110) and also to the brachypinacoid (010). Two cleavage fragments were selected and measured on a reflecting goniometer. The average of four measurements gave the cleavage angle as  $54^{\circ} 41'$ . In thin sections the mineral shows the lozenge-shaped cleavage traces characteristic of the hornblendes, and in sections in the prismatic zone always presents a parallel extinction. The mineral is negative and the pleochroism is as follows:

X = pale yellow; Y = brownish yellow; Z = dove color or gray. The absorption is  $Z > Y > X$ .

The cordierite occurs in colorless allotriomorphic individuals which are slightly turbid when contrasted with the quartz which they otherwise resemble. The mineral is biaxial and displays itself no pleochroism, but shows in a striking manner the little pleochroic halos so commonly found in this mineral when it occurs as a constituent of metamorphic rocks. These halos, which are quite numerous, change from deep yellow to colorless as the section is rotated, each halo having in its center a minute, colorless, rounded crystal with high index of refraction and high double refraction. The cordierite also shows in places the twin lamellae frequently observed in this species and is occasionally somewhat altered, especially along the cleavage lines, into the cryptocrystalline aggregate of some micaceous mineral. It also occasionally contains the little bundles of minute sillimanite crystals which occur so characteristically as inclusions in cordierite.

This is, so far as can be ascertained, the first occurrence of cordierite which has been described from Canada.

In order to obtain material for analysis a hand specimen of the amphibolite was crushed sufficiently fine to pass through a sieve of 70 meshes to the inch. To free the powdered material



from the finest dust, it was then placed on a sieve of 100 meshes to the inch, and that portion which passed through the latter sieve was discarded. The material was then submitted to the action of a Wetherill Magnetic Separator provided with two pair of magnets, the first of which were placed one quarter of an inch apart while the second set were  $5/16$ ths of an inch apart. It was found that .8 amperes removed the magnetite and a little ilmenite, while with a current of 3 amperes the rest of the ilmenite, the rutile, some garnet and some anthophyllite were withdrawn. The current was then raised to 15 amperes, which removed the remainder of the anthophyllite and the garnet with most of the biotite, the tailings consisting of cordierite, quartz and a little biotite. In order to complete the separation recourse was had to heavy solutions. By means of Klein's solution the garnet was removed. Iodide of methylene was then employed, which when diluted with a few drops of benzol was of such a specific gravity that the biotite floated while the anthophyllite sank. This latter, however, was seen, when examined under the microscope, to still contain a few composite grains of feldspar or garnet with a little black iron ore. The powder was accordingly placed under a lens of low power and the foreign material removed by means of a fine needle. Perfectly pure anthophyllite was thus secured.

In the analysis which was made by N. Norton Evans all the determinations were made in duplicate with the exception of those of water and the alkalis. The mean of the analysis of the air-dried powder is given below. An analysis of the original gedrite from the valley of Héas by Pisani is presented for purposes of comparison.

	Township of Harcourt, Ont. (Evans)		Valley of Héas, near Gèdres. (Pisani)	
		Ratio		
SiO <sub>2</sub> .....	44.32	.734	.....	43.58
Al <sub>2</sub> O <sub>3</sub> .....	16.04	.156	.....	17.07
Fe <sub>2</sub> O <sub>3</sub> .....	2.80	.017		
FeO .....	16.88	.235	.....	15.96
MnO .....	0.09	.001		
CaO .....	0.77	.013	.....	0.75
MgO .....	15.95	.395	.....	18.30
H <sub>2</sub> O .....	1.31	.073	.....	3.92
K <sub>2</sub> O and Na <sub>2</sub> O	1.86	.024		
	100.02			99.58

The ratio of RO:SiO<sub>2</sub> is .741: .734, or very nearly 1:1; and the ratio of R<sub>2</sub>O<sub>3</sub>:SiO<sub>2</sub> is .173: .734, or almost 1:4.

This gives a formula corresponding to that suggested by Ram-melsberg, namely,  $4\text{RSiO}_3 + \text{Al}_2\text{O}_3$  where  $\text{R} = \text{Mg, Fe, H}_2$ .

From this analysis, as well as from its negative character, it will be seen that the mineral belongs to the aluminous variety of anthophyllite known as Gedrite, this being, as above mentioned, as far as can be ascertained, the first occurrence of this variety reported from North America. The close similarity in composition of the mineral from Harcourt and the original gedrite from the valley of Héas near Gèdres (Hautes-Pyrénées) will be noted.

Geological Laboratory,  
McGill University, Montreal.

ART. LIV.—*The Iodometric Determination of Arsenic and Antimony Associated with Copper*; by F. H. HEATH.

[Contributions from the Kent Chemical Laboratory of Yale Univ.—clxxv.]

It has been said that the iodometric process for the determination of copper can be used without error in the presence of arsenic and antimony provided that the latter elements are in the higher condition of oxidation. A. H. Low\* makes this statement and gives careful directions for the complete oxidation of the arsenic and antimony. There appears, however, to be no record of any attempt to determine arsenic and antimony iodometrically after the separation of copper from a mixture containing the three elements.

It has been thought worth the while, therefore, to attempt the determination of arsenic and antimony in the filtrate from cuprous iodide after titration of the free iodine by means of sodium thiosulphate, and filtration. To this end, the attempt has been made to reduce the arsenic and antimony by boiling with potassium iodide and sulphuric acid according to the method of Gooch and Gruener† and determining these elements by reoxidation with a standard solution of iodine. The reactions involved in these processes may be expressed by the general symbols,



and



The trials of the method were made with tartar emetic and potassium arseniate. The tartar emetic was dissolved in water and the antimony oxidized to the higher condition by means of standard iodine solution in presence of sodium or potassium bicarbonate. The amount of iodine required was taken as a measure of the amount of antimony used. The solution of antimony thus obtained, or the solution of arsenic taken in the higher condition of oxidation, was acidified and a known volume of a standard solution of copper nitrate was added. The copper was determined iodometrically with precautions previously recommended by Gooch and Heath.‡

A special precaution to be observed is the choice of the acid used during the determination of copper. Mineral acids must not be present on account of their tendency to bring about reduction of the arsenic and antimony by action of the excess of potassium iodide used in throwing out the copper. Such action causes high results on copper and low results on arsenic and antimony. A mixture of acetic acid and potassium iodide

\*Jour. Amer. Chem. Soc., xxiv, p. 1083.

†This Journal, xlii, Sept., 1891.

‡Ibid., xxiv, 65, 1907.

reduces the higher salts slowly. Tartaric acid is somewhat irregular in action and tends to cause an interfering precipitation of acid potassium tartrate. The action of citric acid is more favorable. The amount of iodine set free by the combined action of citric acid and potassium iodide upon an arsenic compound in the higher condition of oxidation is appreciable if the solution is allowed to stand, while in the case of an antimonious salt the action is not nearly so rapid.

A few determinations were carried out to test the action of citric acid quantitatively. Portions of tartar emetic were oxidized to the higher condition by iodine in presence of sodium bicarbonate, the solution was then acidified with citric acid, weighed amounts of citric acid and potassium iodide were added, and the solution was allowed to stand for a definite time to find whether there was any reduction. When the solution was acidified, after the oxidation with iodine solution, a little iodine was set free and this was bleached with a drop of sodium thio-sulphate before continuing the experiment. For the test with arsenic a standardized solution of potassium arseniate was used. The results of these experiments are shown in Table I.

TABLE I.

*Effects of Citric Acid and Potassium Iodide in reducing Arsenic and Antimonious Salts.*

Sb taken gram.	As taken as KH <sub>2</sub> AsO <sub>4</sub> gram.	Citric acid used gram.	KI used gram.	Vol. of sol. cm <sup>3</sup> .	Time of standing min.	I found gram. no color with starch " " trace
·1209	----	3	4	60	10	no color with starch
·0797	----	3	2	50	20	"
·1057	----	3	3	60	20	"
					→ 60	trace
----	----	----	----	----	----	----
	·1238	2	3	50	10	·0009
	·1238	2	4	60	10	·0012
	·1238	3	3	50	10	·0019
	·1238	3	5	75	10	·0017
----	----	----	----	----	----	----
·1211	·1238	3	5	100	10	·0010
·1211	·1238	3	5	100	10	·0017

From these results it appears that in the iodometric determination of copper associated with arsenic there must be no delay in titrating the iodine even when the free acid is citric acid; otherwise, some reduction of the arsenic acid and liberation of iodine may take place, thus affecting the result of the copper determination. Antimonious acid is not reduced appreciably, in a reasonable time, under similar conditions.

In the course of preliminary work the fact developed that tetrathionic acid, which results from titration of free iodine by sodium thiosulphate in the copper determination, makes trouble in the subsequent operation. For, when the solution is boiled, after addition of sulphuric acid, the tetrathionic acid decomposes to give hydrogen sulphide and free sulphur, and sulphides of antimony and arsenic may be precipitated. Various means were tried to oxidize the tetrathionic acid and its decomposition products before reducing the arsenic and antimony. Solid iodine and potassium nitrite were tried for this purpose but not very successfully. Bromine water and, better, liquid bromine were used with success.

It was found that if liquid bromine was added to the cold solution in sufficient quantity to decompose all the excess of potassium iodide present, and the solution then boiled, there was very little subsequent trouble on account of tetrathionic acid. To decompose the remainder of the potassium iodide used in the precipitation of the copper about one cubic centimeter of bromine was added. If, after boiling for a short time, the solution did not become clear it was cooled, a little more bromine added, and the boiling repeated to ensure complete oxidation and to expel excess of bromine. It is well to concentrate the solution somewhat at this point so as to remove most of the bromine; otherwise, when potassium iodide is added to bring about reduction of the arsenic or antimonious salt so much of it may be decomposed by the bromine that the reducing action may not be complete. Some free iodine remains in the solution after the reduction process and there was found to be some difficulty in bleaching it with exactness in the hot solution. If the solution was cooled starch indicator could be used. Accordingly in the cooled solution the free iodine, in presence of starch indicator, was bleached by adding an excess of dilute sulphurous acid. The solution was then diluted to 100<sup>cm</sup><sup>3</sup> or more and iodine solution added to a faint color. This pale blue color was then just bleached by careful addition of dilute sulphurous acid from a pipette. The solution was neutralized by use of sodium or potassium bicarbonate and the arsenic or antimony determined by titration with standard iodine solution in the usual way. Following are tables showing results obtained by this method.

The procedure for the determination of copper and arsenic or of copper and antimony may be outlined as follows:—To the solution containing the copper and also the arsenic or antimony in the higher condition of oxidation, add 1 grm. to 2 grm. of citric acid. To precipitate amounts of copper not exceeding .3 grm. in a volume of 50<sup>cm</sup><sup>3</sup> add 3 grm. of potassium iodide; in a volume of 100<sup>cm</sup><sup>3</sup> add 5 grm. of potassium iodide. Titrate

TABLE II.—*Copper and Arsenic.*

KI used grm.	Vol. at end of pptn. cm. <sup>3</sup>	Cu taken grm.	Cu found grm.	Error in Cu grm.	Liquid bromine used cm. <sup>3</sup>	KI used grm.	As taken grm.	As found grm.	Error in As grm.
3	50	·0700	·0700	±·0000	1·0	2	·1238	·1231	—·0007
3	50	·0700	·0693	—·0007	1·0	2	-----	·1231	—·0007
3	50	·0875	·0869	—·0006	1·0	2	-----	·1239	+·0001
4	50	·0700	·0698	—·0002	0·6 0·4	1	-----	·1235	—·0003
4	45	·0700	·0703	+·0003	1·0	2	-----	·1247	+·0009
4	50	·0700	·0700	±·0000	1·0	2	-----	·1235	—·0003
5	70	·1400	·1407	+·0007	1·0 .5	2	-----	·1233	+·0005
5	50	·0910	·0907	—·0003	1·0 .5	2	-----	·1239	+·0001
4	50	·0700	·0703	+·0003	1·0	2	-----	·1237	—·0001
4	50	·0875	·0879	+·0004	1·0	2	-----	·1234	—·0004
5	65	·1400	·1410	+·0010	1·0	3	-----	·1239	+·0001
3	30	·0875	·0860	—·0015	.8	2	·0495	·0493	—·0002

TABLE III.—Copper and Antimony.

KI used gram.	Vol. at end ppm. cm <sub>3</sub>	Cu taken gram.	Cu found gram.	Error in Cu gram.	Liquid bromine used cm <sub>3</sub>	KI used gram.	Sb taken gram.	Sb found gram.	Error in Sb gram.
4	85	.0700	.0703	+ .0003	1.0 .5	2	.1417	.1421	+ .0004
4	80	.0700	.0701	+ .0001	1.0 .5	2	.1727	.1725	— .0002
4	80	.0875	.0869	— .0006	1.0 .5	2	.1286	.1289	+ .0003
5	80	.0735	.0739	+ .0004	1.0 .5	2	.1641	.1645	+ .0004
5	90	.1050	.1050	± .0000	1.0 .5	2	.1378	.1372	— .0006
4	75	.0875	.0874	— .0001	1.0 .5	2	.1329	.1326	— .0003
6	115	.0700	.0707	+ .0007	1.3 .5	2	.2474	.2477	+ .0003
8	120	.1575	.1571	— .0004	1.5 .5	2	.1419	.1413	— .0006

TABLE IV.  
*Copper, Arsenic, and Antimony.*

Vol. at end of pptn.	Cu taken	Cu found	Error in Cu	As taken as $\text{KH}_2\text{AsO}_4$	Cm <sup>3</sup> of I re-quired by theo-ry to oxidize As	I used to oxid-ize Sb	Sb taken as found by I used	Br used	KI used in reduc-tion	Cm <sup>3</sup> of I re-quired by theory to oxid-ize As and Sb	I used to oxid-ize As and Sb	Error in terms of I*
gm.	gm.	gm.	gm.	gm.	cm <sup>3</sup>	cm <sup>3</sup>	gm.	cm <sup>3</sup>	gm.	cm <sup>3</sup>	cm <sup>3</sup>	gm.
--	--	--	--	·1238	32·54	17·87	·1088	1·0	2	50·41	50·06	—·0043
--	--	--	--	·0495	13·01	13·46	·0820	1·0	2	26·47	26·46	—·0001
--	--	--	--	·1238	32·54	15·40	·0938	0·5	2	47·94	47·70	—·0030
--	--	--	--	·0990	27·21	18·12	·1054	1·0	2	45·33	44·90	—·0053
5	·0700	·0718	+·0018	·0495	13·01	17·15	·1044	1·0	2	30·16	30·00	—·0020
5	·0700	·0710	+·0010	·0990	27·21	21·86	·1272	1·0	2	49·07	49·00	—·0009
† 5	·1222	·1223	+·0001	·0990	27·21	29·68	·1727	1·5	2	56·89	56·23	—·0081
9	·0875	·0868	—·0007	·0990	27·21	20·20	·1176	2·0	3	47·41	46·90	—·0063
6	·1050	·1067	+·0017	·0990	27·21	15·55	·0905	1·3	2	42·76	42·64	—·0015
† 7	·1613	·1611	—·0002	·0990	27·21	18·92	·1101	1·5	2	46·13	45·90	—·0028

\* Wt. of iodine  $\times 0.50$  = error calculated entirely on Sb.  
 " "  $\times 0.30$  = " " " " " As.

† Separate portions of Cu were weighed out.



the free iodine with sodium thiosulphate solution. The reactions involved in the copper determination are

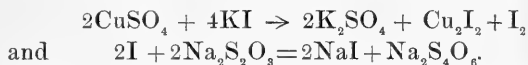

Filter off the cuprous iodide on asbestos. To the filtrate add 1<sup>cm</sup><sup>3</sup> of liquid bromine and boil the solution in an Erlenmeyer flask, using a trap to prevent loss by spattering. If, after boiling for a short time and allowing the large amount of free iodine to volatilize, the solution does not become clear, cool it, add a little more bromine (0.5<sup>cm</sup><sup>3</sup>) and boil again. When the solution has become clear, concentrate it somewhat (to about 60<sup>cm</sup><sup>3</sup>) to expel excess of bromine. Dilute to about 100<sup>cm</sup><sup>3</sup>, add 2 gm. of potassium iodide and boil to a volume of 50<sup>cm</sup><sup>3</sup>. Cool the solution, bleach the free iodine by adding sulphurous acid, using starch as indicator. Dilute to 100<sup>cm</sup><sup>3</sup>, add iodine solution to color and just bleach by careful addition of dilute sulphurous acid from a pipette. Neutralize the solution with sodium or potassium bicarbonate and titrate the arsenic or antimony with standard iodine solution in the usual way.

From the results obtained it seems possible by this method to separate and determine copper and arsenic, or copper and antimony, with errors of only a few tenths of a milligram. It is also possible to determine the sum of arsenic and antimony present with a fair degree of accuracy, and to separate and determine copper when associated with both arsenic and antimony. In the latter case the sum of the arsenic and antimony may also be determined, but the values here obtained for copper tend to come a little too high and those for arsenic and antimony a little too low.

In conclusion, the author wishes to express his appreciation of the kind assistance and many suggestions given by Professor F. A. Gooch during the course of these investigations.

## SCIENTIFIC INTELLIGENCE.

## I. CHEMISTRY AND PHYSICS.

1. *Crystallized Chlorophyl*.—An important contribution to our knowledge of the green substance of plants has been made by WILLSTÄTTER and BENZ. Following up the observation of Borodin, made in 1881, that when microscopic sections of green leaves of various plants are moistened with alcohol and allowed to dry slowly upon the object-glass, peculiar green crystals are often obtained, they have succeeded in preparing such crystals on a large scale, apparently in a very pure condition, and have recrystallized and analyzed them. This is the first time that an actual chlorophyl has been studied analytically, for it has been shown that the preparations of Hoppe-Seyler and Gautier were products of the decomposition of chlorophyl by acids. The analyses showed some variations in the different preparations in their contents of carbon and nitrogen, but the surprising fact was shown that chlorophyl is a magnesium compound and leaves a residue of pure magnesium oxide upon being burnt. Two analyses are as follows :

	Crude product	Recrystallized preparation
Carbon .....	66.41	65.83
Hydrogen .....	6.27	6.15
Nitrogen .....	7.46	8.24
Magnesium .....	3.40	3.40
Oxygen .....	16.46	16.20

The composition corresponds best to the formula  $C_{38}H_{42}O_7N_4Mg$ . The crystals are usually 0.1 to 0.2<sup>mm</sup> in diameter, sharply defined, and usually of hexagonal or triangular outline. They are bluish-green in color; in transmitted light only very thin scales show a green color, and generally they are opaque. They are characterized by a strong metallic luster, especially in sunlight, where they show wonderful reflections.—*Liebig's Ann.*, cccxviii, 267.

H. L. W.

2. *Mercury Peroxide*.—When metallic mercury is covered with a ten per cent solution of hydrogen peroxide, and the liquid is neutralized by the addition of a few drops of dilute sodium acetate solution, an intermittent evolution of oxygen takes place, in the form of regular pulsations. Previous to each period of oxygen evolution there is formed upon the surface of the mercury a yellow or brown film, which is decomposed again as long as the catalysis continues. VON ANTROPOFF has attempted without success to isolate the substance of which this film is composed. He was able to increase its stability by lowering the temperature and using 30 per cent hydrogen peroxide, but he was unable to

obtain it in a pure condition. He observed, however, the formation of a red compound under certain conditions, and found that this compound could be prepared by the action of hydrogen peroxide upon pure red mercuric oxide. This product has the appearance of red phosphorus and has a composition corresponding to the formula  $\text{HgO}_2$ . Its preparation is difficult, since diluted hydrogen peroxide reduces it, and therefore it cannot be washed, but the hydrogen peroxide can be removed by evaporation in a desiccator at a low temperature. It is extremely unstable, and even when covered with liquid it gives small local explosions when stirred with a glass rod. The dry substance explodes violently when slightly heated, or by concussion or friction. The author considers the compound to be a mercuric derivative of hydrogen peroxide, and upon theoretical grounds he supposes that the film formed upon metallic mercury may be the corresponding mercurous derivative,  $\text{Hg}_2\text{O}_2$ .—*Jour. prakt. Chem.*, lxx, 273.

H. L. W.

3. *A Supposed New Element in Thorianite*.—In connection with the working up of 5 cwt. of thorianite from Ceylon belonging to Sir William Ramsay, C. DE B. EVANS has observed some colorations that could not be accounted for in the examination of the tin group of metals. What was evidently a brown sulphide was eventually isolated with arsenious sulphide, which it resembles in being insoluble in hydrochloric acid and readily soluble in ammonium carbonate solution. Like arsenious sulphide it dissolves in nitric acid, but the concentrated syrupy liquid has a strong golden-brown color, and leaves on evaporation at  $120^\circ$  a brown hygroscopic oxide. This is reduced by hydrogen at  $250\text{--}300^\circ$  to a black oxide, and then at a higher temperature to a dark grey, non-volatile metal which melts at a bright red heat. After many months of work only about 0.05g. of the brown oxide was collected from about one-third of the mixed sulphides, and this was not free from arsenic. This corresponds to less than one gram per ton of thorianite. It is probable that this small amount of substance would not have been detected at all, had it not been for the fact that the sulphide dissolves in water, which is colored brown by a very small quantity. This solubility greatly increases the difficulty of separation. Attempts to determine the equivalent of the metal indicate a considerably higher equivalent than that of arsenic. A preliminary spectroscopic examination revealed no new lines. Incidentally in this investigation more knowledge was gained of the composition of thorianite, and it can be stated positively that this mineral contains arsenic, mercury, bismuth, molybdenum and selenium.—*Jour. Chem. Soc.*, xciii, 666.

H. L. W.

4. *Stereochemistry*, by A. W. STEWART, 12mo, pp. 583. London, 1907 (Longmans, Green & Company).—The author of this book has not attempted to give a complete treatment of every branch of the subject of stereochemistry, since it was found impracticable to mention, in a book of reasonable size, all the

work on the subject which has been carried out within the last twenty years. He has made a selection, therefore, of the cases which throw light upon the general lines along which stereochemical research has advanced. The book is a valuable contribution to chemical literature, and its references and index are excellent features.

T. B. J.

5. *Condensation of Water Vapor in the Presence of Radium Emanation.*—Mme. CURIE has shown that radium particles have the power of condensing water vapor. A cloud is formed and made visible by an arc light. The formation of the cloud occurs far below the saturation pressure. The phenomenon differs from the effect produced in the condensation of water vapor by ions. The condensation disappears under the effect of an electric field, and disappears after the field is removed.—*C. R.*, cxlv, pp. 1145-1147, 1907.

J. T.

6. *Anode Rays.*—E. GEHRCKE and O. REICHENHEIM filled the anode with various salts which were raised to a high temperature and formed a family of positive rays, which conveyed particles of the salts to a suitably placed screen. In order to increase the brilliancy of the effects it was necessary to mix the salts with some inert substance, pulverized graphite, for instance. The color of the fluorescence produced was always identical with that of the canal rays. The anode rays emerge perpendicularly to the surface of the anode. They were directed by a magnetic field in a direction opposite to that taken by the negative rays. They also showed the Doppler effect. Proceeding to calculation, they obtained the value of  $v = 1.4 \cdot 10^7$  cm/sec for the fastest rays and  $v = 1 \cdot 10^7$  cm/sec for the rays of mean velocity. From the

anode fall of potential the value  $\frac{\epsilon}{m_e} = 0.45 \cdot 10^8$  was obtained for sodium vapor; comparing this with the value  $\frac{\epsilon}{m} = 9.5 \cdot 10^8$  for

hydrogen, the authors obtain 21 for the atomic weight of sodium. In a similar manner atomic weights of other substances were obtained.—*Ann. der Physik*, No. 5, 1908, pp. 861-884.

J. T.

7. *Handbuch der Spectroscopie*; by H. KAYSER. Vol. IV, pp. xix + 1248. Leipzig, 1908 (S. Hirzel).—In order to place the fourth volume of Kayser's treatise in proper perspective it seems desirable to call attention both to the author's original plan and to the chief characteristics of the preceding volumes. As stated in the preface to the first volume (which appeared in 1900\*), it was Kayser's intention to fill a very important gap in the literature of spectroscopy by writing and compiling a reference book which should possess the greatest possible completeness and also present a critical recapitulation of the views and opinions held with regard to disputed questions.

Conformably to this plan the first volume dealt with the history of the subject and also contained a detailed description of all

\* See this Journal, vol. x (1900), p. 464; xiv (1902), p. 460; and xx (1905), p. 69.

the important forms of spectroscopic apparatus supplemented by the theory and practical applications of the latter. This volume, as well as each of the succeeding volumes, closed with a detailed index arranged with reference to authors and to subjects separately.

The second volume (1902) took up the following subjects: Emission and absorption from the standpoint of Kirchhoff's law; radiation of solids; radiation of gases; spectra of compounds and multiple spectra; the influence of pressure, of temperature and of the form of electrical discharge upon spectra; the appearance of spectra; Doppler's principle; laws of spectra; and the Zeeman effect with related phenomena. This second volume has proved to be of inestimable value to spectroscopists, and it has been the exciting cause of a great deal of subsequent important investigation.

The author's original intention of devoting the third volume to the discussion of the phenomena of absorption and of such allied matters as fluorescence, phosphorescence, and surface colors had to be modified because of the enormous volume of work done upon these subjects. Consequently the third volume (1905) was limited to a description of the apparatus and methods for the study of absorption and to a detailed account of the absorption of such organic and inorganic materials as are not derived, directly at least, from the vegetable and animal kingdoms. The volume in question closes with a complete list of all known absorption spectra which pertain to the classes of substances just indicated. If any one of the four volumes is less important than the others, then it seems to be the third.

On the contrary, the fourth volume is of fundamental importance not only to the spectroscopist but also to the theoretical physicist, to the botanist, to the zoölogist, and to the student of medicine. That this is true may be seen from an inspection of the following synopsis of the contents of the last published volume:

The first chapter is devoted to a detailed account of the natural coloring matters produced by plants. More specifically, the five sections of this chapter deal respectively with green coloring matters and their derivatives; with yellow and other pigments of leaves and flowers; with certain coloring matters which do not fall under the preceding heads; with the colored constituents of fungi, bacilli, and lichens; and with the coloring matters of algæ. The second chapter deals with the coloring matters of blood, of normal and pathological urine, and of bile. Animal pigments are exhaustively treated in the third chapter.

The subject matter of each of the preceding chapters is presented in a thoroughly systematic manner. First, the historical development of each field of investigation is unfolded, then the facts and appertaining opinions are discussed, and, finally, complete lists of bibliographical references are followed by alphabetical synopses of the characteristic absorption spectra of the substances concerned. Kayser expresses doubt as to the relevancy

of the contents of these three chapters to a treatise on spectroscopy, but we think that his final decision to include these subjects in his book was a happy conclusion since there is no other published list which approaches the present one either in completeness or in scientific critique.

The fourth chapter practically exhausts the subject of dispersion, both from the theoretical and from the experimental points of view. It comes from the pen of Pflüger, who is a recognized authority on the questions involved. This chapter is also unique in completeness and elegance of presentation. It will be as welcome to the theoretical physicist as to the specialist in spectroscopy. The fifth and sixth chapters were written, in the order named, by Kayser and by Konen, and they are devoted respectively to phosphorescence and fluorescence. No other accounts of these subjects are at all comparable with the exposition of these two chapters. In this sense, the last two chapters are as new as the preceding ones.

The four volumes, thus far published, constitute a masterpiece of scientific literature. The fourth volume ranks with the second in promise of stimulating interest in research in its special fields. Other volumes are to follow until the whole subject of spectroscopy will have been critically discussed and its literature brought down to the dates of publication of the several volumes.

H. S. U.

8. *Refrigeration: an Elementary Text-book*; by J. WEMYSS ANDERSON. Pp. ix+242. New York and London, 1908 (Longmans, Green & Co.).—The first seventy-eight pages of this book are devoted to an introduction to the theory of heat and the thermal properties of gases, liquids and vapors. The simplest element of thermodynamics are given, Carnot's engine is described, and the doctrine of the efficiency of refrigerators is based upon its reversed action. The remainder of the work describes a number of forms of refrigeratory machinery and deals with various practical problems which arise in connection with them. Ice-making, and the design and insulation of cold-stores are considered, and much useful information is given in the form of tables.

H. A. B.

9. *Introduction to Metallography*; by PAUL GOERENS. Translated by FRED IBBOTSON. Pp. x, 214. New York and London, 1908 (Longmans, Green & Co.).—The first of the four parts into which this work is divided deals with allotropy and the experimental determination of transformation points by the method of curves of cooling. The more important forms of pyrometers are described (including recording instruments) and brief directions are given for their use. The second part begins with an admirably simple and interesting introduction to those parts of the theory of solutions which have recently been applied with so much success to the study of alloys. Gibbs's phase-rule is explained and its applications by Roozeboom and others. Curves are given for a large number of binary and ternary alloys, their

properties are discussed and references given to the original investigations. The third part deals with the microscopy of metals; directions are given for grinding, polishing and etching the sections, the construction and use of the Martens and Le Chatelier microscopes are described, and several pages are devoted to the technique of photography. In the fourth part the special metallography of the iron-carbon alloys is considered. As a whole, the book seems to be admirably adapted to serve as an introduction to this comparatively new subject whose technical importance is already widely recognized.

H. A. B.

10. *Lehrbuch der theoretischen Elektrochemie auf thermodynamischer Grundlage*; by J. J. VAN LAAR. Pp. xii + 307. Leipzig, 1907 (Wilhelm Engelmann), Amsterdam (S. L. van Looy).—Although this is not the first book on electrochemistry to give a systematic treatment of the subject from the standpoint of the theory of the thermodynamic potential, it is in many respects the most satisfactory one that has yet appeared. By omitting all description of experimental processes, and by judicious limitation of the amount of numerical data employed for purposes of illustration, the author has been able, within the compass of 300 pages of large print, to cover a fairly wide field with more than the usual thoroughness. The book is up to date both in spirit and in subject matter, and the style clear and direct. As would naturally be expected in a treatise of this sort, the thermodynamic potential is used to the complete exclusion of the osmotic pressure in the derivation of the formulas for the electromotive force of galvanic cells.

Among the noteworthy features of the volume are the critical summary of the most trustworthy values for the velocities of the commoner ions (p. 31), the comprehensive review of work on conductivity in non-aqueous solvents (chap. iv), and the clear and satisfactory discussion of oxidation cells and gas cells (chap. ix) and of the relation between potential and surface tension of mercury electrodes (chap. xii).

The work is hardly suitable for the use of beginners as an elementary text-book, but will recommend itself to those of wider experience, as it contains much that is interesting and suggestive.

R. V. N.

11. *Comparative Electro-Physiology*; by JAGADIS CHUNDER BOSE. Pp. xliii, 760 with 406 figures. London, 1907 (Longmans, Green & Company).—This is a somewhat unique attempt to point out a continuity between the most complex living and the simplest inorganic matter—to interpret all responsive phenomena on a uniform basis. “In this demonstration of continuity it has been found that the dividing frontiers between physics, physiology, and psychology have disappeared.” “All the responsive phenomena of the animal are thus found to be foreshadowed in the plant, and this to such a degree that in the common script of the response record the one is indistinguishable from the other . . . Both alike are responsive, and similarly responsive, to

AM. JOUR. SCI.—FOURTH SERIES, VOL. XXV, No. 150.—JUNE, 1908.

all the diverse forms of stimulus that impinge upon them.” “A single molecular derangement may thus find manifestations as change of form, alteration of electrical condition, and subjective sensory variation.”

The author has covered a large range of experimental observations to show that those properties (physiological responses), generally regarded as distinguishing living matter, are capable of analysis into physico-chemical processes. Some of the illustrations, as for example the electromotive response of many plants or the responses of metals to diverse influences, are well recognized. Where the author attempts, however, to remove the distinction commonly assumed to exist between sensitive and non-sensitive parts by a demonstration of responsive movements, he enters a distinctly controversial field. Thus it is somewhat startling to find the distinction between motile and non-motile tissues completely rejected and replaced by records of the contractile response of animal nerves, analogous to those of muscle. Plant tissues are similarly conceived to be capable of universal mechanical response. New experimental methods are described for the study of such anomalous experiences. A critique of this effort to find “an underlying unity in apparent diversity” must be left to others.

L. B. M.

## II. GEOLOGY.

1. *New Zealand Geological Survey*, J. M. BELL, Director. Bulletin No. 4 (New Series). *The Geology of the Coromandel Subdivision, Hauraki, Auckland*; by COLIN FRASER assisted by JAMES HENRY ADAMS. Pp. 148, 32 plates, 11 maps, and 2 sections. Wellington, 1907.—The geological formations of the Coromandel district consist of two series of pre-Triassic rocks, the first,—Tokatea Hill,—made of argillites, grauwackes and interstratified basic and acidic lavas; the second,—Moehau,—of thin-bedded argillites without volcanic rocks. The Manaia Hill series, consisting of conglomerates, argillites, etc., has been assigned to the Jurassic period. The three series mentioned constitute a folded complex on which rest conglomerates, sandstones, and coal-bearing shales, followed by marls and limestones constituting the Torehine series, presumably of lower Eocene age. During Tertiary times lavas of different types were extruded. Detailed descriptions of the rocks of these different formations are given, accompanied by micro-photographs and analyses.

A chapter is devoted to the physical geography of the district and considerable information given regarding the fauna, flora, conditions of settlement, etc.

Mineral veins are treated in a separate chapter, in which is included an account of the history of mining in the region.

The abundant illustrations are fully up to the high standard of the previous bulletins.

H. E. G.



2. *Geological Survey of Western Australia*. A. GIBB MAITLAND, Government Geologist.—The following bulletins have recently been issued by this organization :

Bulletin No. 27. Palaeontological Contributions to the Geology of Western Australia ; by R. ETHERIDGE, F. CHAPMAN, and W. HOWCHIN.

Bulletin No. 28. The Geology and Mineral Resources of Lawlers, Sir Samuel, and Darlot (East Murchison Goldfield), Mount Ida (North Coolgardie Goldfield), and a portion of the Mount Margaret Goldfield ; by CHAS. G. GIBSON, Assistant Geologist ; 68 pp., with 3 maps and 5 mining plans. Perth, 1907.—The rocks in the district including these mines are granites and greenstones, the former intrusive in the latter. Quartz veins of still later origin cut both rocks. The bulletin is chiefly concerned with detailed descriptions of the occurrence of the ores and of the mining operations.

Bulletin No. 30. The Distribution and Occurrence of the Baser Metals in Western Australia ; by EDWARD S. SIMPSON and CHAS. G. GIBSON. 117 pp., with map. Perth, 1907.—The method of exploitation and the history of mining of copper, tin, lead, zinc, iron, manganese, tantalite, aluminium, antimony, bismuth, cobalt, tungsten, and molybdenum are discussed in detail. The iron deposits of Western Australia are "probably some of the largest in the world" but have remained undeveloped owing to their location and the absence of coal.

The bulletins issued by the Survey of Western Australia are necessarily of economic nature, and although the ore deposits are described in great detail the publications do not serve to explain the geology of the region as a whole. This defect has been remedied in part by the admirable address of A. Gibb Maitland, Government Geologist, on the Recent Advances in the Knowledge of the Geology of Western Australia. This address is accompanied by a geological map. H. E. G.

3. *Geological Survey of Canada*, A. P. Low, Director.—The following publications have recently been received :

Section of Mines. Annual Report on the Mineral Industries of Canada for 1905. Pp. 174. Also Summary Report for 1907. Pp. 123.

Report on the Cascade Coal Basin, Alberta ; by D. B. DOWLING. Pp. 37 with Appendix. Eight maps in separate pockets.

Report on the Geology and Natural Resources of the Area Included in the Northwest Quarter-sheet, Number 122 of the Ontario and Quebec Series, comprising portions of the Counties of Pontiac, Carleton and Renfrew ; by R. W. ELLS. Pp. 71.

The Barytes Deposits of Lake Ainslie and North Cheticamp, N. S., with Notes on the Production, Manufacture and Uses of Barytes in Canada ; by HENRY S. POOLE. Pp. 43.

Moose Mountain District of Southern Alberta ; by D. D. CAIRNES. Pp. 55, 3 plates and map.

Report of the Section of Chemistry and Mineralogy ; by G. Chr. HOFFMANN. Pp. 71.

Also eleven Geological Maps.

4. *The Ankylosauridæ. A new Family of Armored Dinosaurs from the Upper Cretaceous*; by BARNUM BROWN. Bulletin American Museum Natural History, vol. xxiv, art. xii, pp. 187-201.—In this bulletin Mr. Brown describes one of the most unique of dinosaurs, found by a party from the American Museum in the Hell Creek beds of Montana in 1906. The striking features of this reptile, Ankylosaurus, are its sculptured, plated skull, large, flat or low-ridged body plates, some of which are united as a shield, short-spined vertebræ with parapophyses never arising above the centra, and posterior ribs co-ossified to the vertebræ. This genus Brown includes under the Stegosauria, but erects for it a new family because of its departure from the more typical members of that group. Mr. Brown has restored the animal after Stegosaurus, modifying the skeleton in accordance with the known elements. His result is strikingly glyptodon-like, Ankylosaurus representing a remarkable case of convergence towards that mammalian group.

R. S. L.

5. *A Revision of the American Eocene Horses*; by WALTER GRANGER. Bulletin American Museum of Natural History, vol. xxiv, pp. 221-264.—This valuable paper forms one of a series of several, preliminary to a forthcoming treatise on the Equidæ by Professor H. F. Osborn. The Hyracotheres or Eocene horses have been recorded from the Wasatch upward, with the exception of the Washakie basin of southern Wyoming, predominating over all other forms in the Wasatch of the Big Horn basin. Twenty-six species, embracing some ten different genera, have been described, but Mr. Granger reduces the latter to three,—*Epibippus* Marsh, from the Uinta; *Orohippus* Marsh, from the Bridger, and *Eohippus* Marsh, ranging through the Wasatch, Wind River, and, possibly, the Huerfano. In referring these genera to their European equivalents, Granger expresses some doubt, but the closest approach is apparently that of the *Eohippus* to *Hyracotherium* in the lower Eocene, and of *Epibippus* to *Lophiotherium* in the upper Eocene. In his final summary of species, Mr. Granger enumerates twenty-three, of which five are new; the sub-genus *Aminippus* being proposed to include the more advanced species of *Orohippus* from the upper Bridger.

R. S. L.

6. *Ideas on the Origin of Flight*; by DR. BARON FRANCIS NOPCSA. Proc. Zoölogical Society of London, 1907, pp. 223-236.—Baron Nopcsa sharply differentiates flying by means of a patagium from flight by means of feathers, as the former requires numerous firm, radial supports to render the soft membrane effective, while for the quills but one line of attachment is needed. Bats and Pterosaurs exhibit an analogous direction of evolution, as shown by the development of the patagium with all that this implies, and have risen in similar manner from leaping, quadrupedal arboreal forms. "Birds," Nopcsa thinks, "originated from bipedal, long-tailed cursorial reptiles which during running oared along in the air by flapping their free anterior extremities." He

further states that a bipedal animal never could or did develop a patagium without giving up bipedalism. This makes it somewhat difficult to account for the pre- and post-patagia of modern birds, which are usually looked upon as vestigial organs. One important conclusion is that the birds and pterodactyls are unrelated, the similarities which they exhibit being merely the result of convergence, while the dinosaurs and birds show many striking similarities which indicate parallel adaptations in forms having a common ancestry.

R. S. L.

7. *Traité de Géologie I, Les Phénomènes géologiques*; par EMILE HAUG. Pp. 538, 8°, 195 figs. and 71 pls. Colin, Paris 1907.—This large work is a general treatise on geology, of the type of those of Suess and Neumayr; the volume corresponds in a general way with the first one of Chamberlin and Salisbury, being devoted to geological processes; it thus gives a general presentation of the subject of dynamical geology. It has the descriptive character of Neumayr's volumes rather than the philosophical nature of the American work just mentioned. In so far as the theoretical treatment of subjects is involved, the author naturally reflects the views of the French school. It is well and clearly written, the material has been selected with judgment, the author exercises an admirable restraint and poise in his presentation of a topic, so that, the balance between descriptive matter and theory being justly held, it is an excellent work for the reader who desires a general knowledge of the subject. In this respect the work recalls the text-book of Geikie. A valuable feature is a short bibliography appended to the discussion of each important topic, giving the chief works relating to it. The cuts and diagrams are well selected, and the half-tone plates are reproductions of remarkably good photographs, which show, as a rule, very clearly the phenomena which they are intended to depict. One of the greatest advances, if not the greatest, that has been made during the past five years or so in geological text-book making, is in the quality of pictorial illustration, and in this respect the work is up to the recent standard. While intended as a work of reference, and for reading by advanced students in France, the volume is one that commends itself to every geologist, and should be in every geological library.

L. V. P.

8. *Key for the Determination of the Rock-forming Minerals in Thin Sections*; by A. JOHANNSEN. Pp. 542, 8°, 1 col. pl. New York, 1908 (Wiley & Sons).—Perhaps no more striking evidence could be given of the extent to which the study of rocks in thin sections has become a science in itself, than the appearance of this large volume entirely devoted to technical methods for determining rock minerals by optical methods. While not a text-book, the first part, comprising some forty odd pages, is given to a brief explanation of the phenomena of polarized light, the optical properties of crystals, and the methods for their observation and determination. In a second part of about the same

extent, the individual properties, especially the optical ones, of the various important and accessory rock minerals are compactly described. The main body of the work which follows consists of tables arranged according to a definite plan, optical characters being used, somewhat in the way in which the properties of plants are classified in botanies, for the determination of the species. Under the heading of each mineral in the table its important crystallographic and optical properties are given, and tests of various kinds are suggested for its discrimination from others, with which it might be confused. Although the book is printed and bound in the ordinary manner, an arrangement for cutting the edges is indicated, which, if followed, will facilitate the use of the tables.

A large amount of time and labor has evidently been expended in the preparation of this volume and great care used in collecting and tabulating the large number of details it contains. For all those who are seriously engaged in the study of rock sections it will prove of great service. In the few weeks that have elapsed since its publication the writer has found it an efficient aid in the petrographical laboratory, especially with more advanced students. It is well printed and durably bound, and is a credit to both author and publisher.

L. V. P.

### III. MISCELLANEOUS SCIENTIFIC INTELLIGENCE.

1. *A Monograph of the British Annelids. Vol. 2, Part 1. Polychæta: Nephthydidæ to Syllidæ*; by WILLIAM CARMICHAEL MCINTOSH. Pp. viii, 232, quarto, with 22 plates of which 8 are colored; London 1908. (The Ray Society.)—All students of marine zoology will welcome the appearance of this new volume continuing the series of beautiful monographs by the well-known authority on British Annelids. The first part of this work dealt with the Nemerteans, and appeared about 35 years ago. It is hardly necessary to state that the present book exhibits the same thorough study of the species which has characterized the other portions of the work. Whenever sufficient material could be obtained, each species has been subjected to detailed anatomical examination, and such structures as are of importance to the systematist illustrated by well-executed drawings. The habits of the species and such embryological data as are available have been given in each case, and finally, the extensive synonymy of the species will be appreciated by every worker in the group.

The author retains the older system of classification and includes in this part the families *Nephthydidæ*, *Phyllodocidæ*, *Hesionidæ*, and *Syllidæ*, which are represented in British waters by 30 genera and a much larger number of species. A discussion of the evidence as to the relationships and systematic position of the families is promised for the final part of the work.

Seven of the colored plates represent most admirably the beautiful coloring of many of the species, while one plate shows the coloring of the larval stages.

It is a matter of great satisfaction to learn that the next part, similar to this in size and in number of plates, is already prepared for publication.

W. R. C.

2. *Selectionsprinzip und Probleme der Artbildung*; Ein Handbuch des Darwinismus; von Dr. LUDWIG PLATE. Third edition; pp. viii, 493. Leipzig 1908 (Wilhelm Engelmann).—In many points this new edition differs widely from the second revision of the work, and contains upwards of twice the amount of matter. This extensive enlargement was necessary in order to allow a more detailed discussion of such phases of evolution as have recently been subject to controversy among biologists and to incorporate the discoveries of the past few years. During this time the mutation theory of DeVries has gained wide acceptance among both botanists and zoologists. In this new theory, however, the author sees little more than a rehabilitation of Darwin's earlier hypotheses.

This book gives unreserved support to Darwin's principle of natural selection, and discusses at length the more important objections which have been urged against it.

Deserving of special attention is the newly written chapter on the question as to the inheritance of characters acquired by the body during the life of the individual, for the author still maintains that such an inheritance occurs, and presents evidence from recent observations which may seem to support this view. The author attempts to explain the possibility of such an inheritance as due to a process of "somatic induction," by which external influences of sufficient strength may affect the germ plasma, while the continued effect of such influence may be cumulative through a number of generations until it finally becomes manifest externally. At a time when Weismann's hypothesis is so widely accepted by biologists, such a support of the Lamarckian doctrine is of much interest. The book as a whole is an able discussion of the recent discoveries and hypotheses relating to heredity, evolution, and allied topics.

W. R. C.

3. *Annals of the Astrophysical Observatory of the Smithsonian Institution*; by C. G. ABBOT, Director, and F. E. FOWLE, Jr., Aid, vol. ii, 245, with 44 tables, and 29 plates. Washington, 1908.—This second volume, published by the Astrophysical Observatory (see vol. xi, 473, 1901), is a notable contribution to the subject of solar radiation, and an honor alike to the present Director, and to Prof. Langley who founded the Observatory. It contains the results of observations carried on between the years 1900 and 1906, in part at Washington and in part at Mount Wilson, California. These observations embrace chiefly measurements of the solar radiation, and, having a high degree of accuracy and being carried out on a consistent system, permit of important conclusions in regard to the general subject. Briefly

stated, they show a considerable variation in the radiation from the sun from time to time, sufficient to produce a very appreciable effect upon the temperature of the earth. The probable mean value of the solar constant obtained is estimated in round numbers at 2.1 calories per square centimeter per minute; otherwise expressed, this implies an intensity of solar radiation which would melt an ice shell over the earth's surface 35 meters (114 feet) in thickness annually. Substantially similar results are obtained for observations at sea level, and at altitudes of 1800 (Mt. Wilson) and of 3500 meters (Mt. Whitney). The variations of the solar radiation, as observed at Mount Wilson, are comprised between 1.93 and 2.14 calories, and at Washington 1.89 to 2.22. The variation of intensity of about  $3\frac{1}{2}$  per cent between August and October, due to change in the distance of the sun, is distinctly noted in the Mount Wilson observations, which indicate that the larger changes noted are in fact solar, and not atmospheric or accidental. In consequence of the interference of clouds and water vapor, it is shown that the earth can radiate only slightly into space, the temperature being kept nearly constant, chiefly by the layer of water vapor at a height of 4000 to 5000 meters. This layer is estimated as being  $10^{\circ}$  or more below  $0^{\circ}$  C. It is shown to be probable that the changes in solar radiation produce not infrequently marked changes in temperature over the continents, and such changes could be predicted if accurate measurements of the solar radiation were continued at a few well-selected situations. It is further indicated by comparative measurements of the center and the edge of the solar disk, that observed changes in total radiation accompany a variation in the transparency of the solar envelope and perhaps are caused by it. Numerous other points are brought out in detail through the body of the work, which also gives the observations in full and the methods and instruments by which they have been obtained.

4. *Bulletin of the Mount Weather Observatory*; prepared under the direction of WILLIS L. MOORE, Chief U. S. Weather Bureau. Vol. i, pt. 2, pp. 65-133, charts vii-ix.—Among the papers contained in this second number of the Bulletin of the Mount Weather Observatory may be mentioned one by W. R. Blair, on the change of phase in electrical waves on passing through thin plates and the refractive index of water for such waves; also by the same author, on upper air temperature in October, November and December, obtained by kite flights at a mean altitude of 2342 meters, and a maximum of 7044 meters. The results are shown graphically on three charts which are highly interesting. Still another article by H. H. Kimball discusses observations with the pyrbeliometer and polarimeter.

5. *Field Columbian Museum*.—Recent publications are the following:

Annual Report of the Director, Dr. Frederick J. V. Skiff, to the Board of Trustees for 1907. Pp. 109-212, plates xviii-xxxii. Geological Series, Vol. II, Table of Contents and Index.

Publication No. 122. Geol. Series, Vol. III, No. 6. Meteorite Studies II; by O. C. FARRINGTON. Pp. iii, 129, with plates xxix-xliii.—Interesting observations, with numerous illustrations, are given in regard to a number of meteorites, particularly the following: Bath Furnace, Chupaderos, Modoc, Lampa, Saline.

No. 123. Geol. Series, Vol. II, No. 10. New Crinoids from the Chicago Area; by ARTHUR W. SLOCOM. Pp. 273-306, with plates lxxxii-lxxxvii, and Index for Vol. II.

No. 124. Zoölogical Series, Vol. VII, No. 5. Notes on Fresh-Water Fishes from Mexico and Central America; by SETH EUGENE MEEK. Pp. 133-157.

No. 126. Botanical Series, Vol. II, No. 6. New or Noteworthy Spermatophytes from Mexico, Central America, and the West Indies; by JESSE M. GREENMAN. Pp. 247-286.

6. *The Museum of the Brooklyn Institute of Arts and Sciences*.—The following publications have recently appeared:

Science Bulletin, Vol. I, No. 11. Notes on the Electrical Phenomena of the Vesuvian Eruption, April, 1906. Notes on the Eruption of Stromboli; April, May, June, 1907. By FRANK A. PERRET. Pp. 307-323, with 9 figures.

Vol. I, No. 12. List of the Longicorn Coleoptera collected on the Museum Expeditions to Brownsville, Texas, and the Huachuca Mts., Arizona, with Descriptions of New Genera and Species and Notes on known Species; by CHARLES SCHAEFFER. Pp. 325-352. No. 13. On a Second Small Collection of Birds from the Island of Trinidad; by GEORGE K. CHERRIE.

7. *University of California Publications in American Archaeology and Ethnology*.—The University of California has recently issued the following papers in the department of American Ethnology:

Vol. VI, No. 1. The Ethno-Geography of the Pomo and neighboring Indians; by S. A. BARRETT. Pp. 332, with 2 maps.—This memoir is an exhaustive discussion of the distribution and dialects of the Pomo Indians and of the tribes most nearly associated with them.

Vol. VI, Nos. 2 and 3. The Geography and Dialects of the Miwok Indians; by S. A. BARRETT. Pp. 333-368.—On the Evidences of the Occupation of Certain Regions by the Miwok Indians; by A. L. KROEBER. Pp. 369-380.

Vol. VII, No. 2. Recent Investigations Bearing on the Question of the Occurrence of Neocene Man in the Auriferous Gravels of the Sierra Nevada; by WM. J. SINCLAIR. Pp. 107-131.—The conclusion reached in this paper by Mr. Sinclair is an important one, namely, that the evidence as to the occurrence of human remains in the auriferous gravels is insufficient to establish the fact.

8. *Medico-Physical Works of John Mayow (1674). Being a Translation of "Tractatus Quinque Medico-Physici."* Pp. xxiii, 331. Edinburgh (The Alembic Club); Chicago, 1908 (The University of Chicago Press.) Alembic Reprints, No. 17.—

This little volume contains a republication in English of the writings of an author, Dr. John Mayow, who, although he died in 1679 at the early age of 36, made most important contributions to the subjects of Chemistry and Physiology. These had been long forgotten, when Dr. Thomas Beddoes in 1790 brought them to notice in his *Analyses of Mayow's Chemical Theories*. The five treatises which constitute the *Opera omnia* of Mayow are now presented entire, and this book hence has a peculiar value to all interested in the history of Chemistry.

9. *Graphic Algebra*; by ARTHUR SCHULTZE, Ph.D., New York University (The Macmillan Co.).—This volume follows the author's larger works on elementary algebra and advanced algebra, and presents in very clear form the process of drawing the graph of a function of one variable; from this are deduced the most practically convenient methods of solving quadratic, cubic and biquadratic equations by means of a standard curve combined with straight lines and circles. With the exception of two these methods are original with the author, who first published them in a paper read before the American Mathematical Society in 1905. The book leaves little to be desired in the way of economy and efficiency, its aim being to replace computation by measurement in solutions where a high degree of accuracy is unnecessary. W. B.

10. *Ostwald's Klassiker der Exakten Wissenschaften*. Leipzig, 1907 (Wilhelm Engelmann).—The following are the latest additions to this important series:

No. 160. Untersuchungen über die Galvanische Leitfähigkeit der Elektrolyte, von Svante Arrhenius. Übersetzt von ANNA HAMBURGER und herausgegeben von OTTO SACKUR. Pp. 153, mit 6 Figuren im Text.

No. 161. Abhandlungen von Christian Doppler. Herausgegeben von H. A. LORENTZ. Pp. 194, mit 36 Figuren im Text.

11. *Decapod Crustacea of the Bermudas, Part I. Brachyura and Anomura*; by ADDISON E. VERRILL. Trans. Conn. Acad. Science, vol. xiii, pp. 299-474, plates ix-xxviii, Jan.-May, 1908.—This report includes a review of all the known species and subspecies (78) with accounts of their distribution and habits, and full descriptions of many species. Nearly all the species are illustrated by half-tones from photographs. There are included 16 additions to the Bermuda fauna, and 9 are described as new species or subspecies. One, which is made the type of a new genus and species, *Troglocarcinus corallicola*, of the family Hapalocarcinidæ, forms dens or houses under the surface of living corals (*Mussa* and *Mæandra*). For this group of peculiar small crabs, all of which are parasitic in corals, the new superfamily, Hapalocarcinidea, is proposed. This article includes a pretty full bibliography and index to scientific names.



# INDEX TO VOLUME XXV.\*

## A

- Academy**, National, meeting at Washington, 458.  
**Air**, liquid, vacuum vessels for, Dewar, 256.  
**d'Albe**, Two New Worlds, 148.  
**Algebra**, Higher, Böcher, 266.  
 — Graphic, Schultze, 534.  
**Allegheny Observatory**, 165, 460.  
**Alpen**, die, im Eiszeitalter, Penck and Brückner, 84.  
**Alps**, Schmidt's sections, 155.  
**Anderson, J. W.**, Refrigeration, 524.  
**Anode rays**, Gehrcke and Reichenheim, 522.  
**Arc spectra**, Duffield, 147.  
**Archæology**, American, Univ. of California publications, 533.  
**Arizona**, Meteor Crater, Fairchild, 156; Merrill, 265.  
**Arrhenius, S.**, Immuno-Chemistry, 81.  
**Artbildung**, Probleme der, Plate, 531.  
**Astrophysical Observatory** 162, 431.

## B

- de Ballore**, Seismology, 262.  
**Bancroft, J. A.**, gedrite in Canada, 509.  
**Barrell, J.**, Mauch Chunk shale, 353.  
**Barus, C.**, axial colors of steam jet and coronas, 224; behavior of nuclei of pure water, 409.  
**Bermuda**, Bibliography, Cole, 159; Cahow from, 361; fishes, parasites of, Linton, 159; decapod crustacea, Verrill, 534.  
**Berry, E. W.**, mid-Cretaceous species of *Torreya*, 382.  
**Beyer, F. B.**, filtering crucible in electrolytic analysis, 249.  
**Bigelow, F. H.**, meteorological elements and solar radiation of the United States, 413.  
**Biology of the Nineteenth Century**, Braeunig, 362.  
**Blackwelder, E.**, Research in China, 349.  
**Blake, W. P.**, tourmaline of Crown Point, N. Y., 123.

- Blodgett, M. E.**, stratigraphy of Mt. Taylor region, N. M., 53.  
**Boltwood, B. B.**, radio-activity of uranium minerals, 269; ionium, 365; life of radium, 493.  
**Bose, J. C.**, Electro-Physiology, 525.

## BOTANICAL WORKS.

- Pflanzen, der Lichtgenuss der, Wiesner, 363.  
 Pilze, Chemie der höheren, Zellner, 364.  
 Plant Anatomy, Stevens, 363.  
 Technical Products, Microscopy, Hanausek and Winton, 87.

## BOTANY, PALEOBOTANY.

- Angiosperms, origin, Arber, 356.  
 Chlorophyll, crystallized, Willstätter and Benz, 520.  
 Cycadaceæ, structure, Worsdell, 358.  
 Flora fossile de l'Argonne, Fliche, 359.  
 Gingko-like forms, Nathorst, 360.  
*Isopyrum biternatum*, Holm, 133.  
 Mesozoic age, flowering plants, Scott, 354.  
 Paleobotanische Mitteilungen, Nathorst, 356.  
*Pinus*, cone growth, Wieland, 103.  
 Plant remains in the Scottish peat mosses, Lewis, 358.  
 Pteridosperms and angiosperms, Oliver, 356.  
 Sporophyl, morphogeny, Hallier, 355.  
*Stellaria*, North American species, Holm, 315.  
 Taxoideæ, Robertson, 360.  
*Torreya*, mid-Cretaceous species, Berry, 382.  
 Trias und Jurapflanzen von der Insel Kotelny, Nathorst, 360.  
 Végétaux fossiles, Zeiller, 357; Marty, 358; de Normandie, Lignier, 360.  
 Zamites and pterophyllum, Arber, 360.

\* This Index contains the general heads. BOTANY, CHEMISTRY (incl. chem. physics), GEOLOGY, MINERALS, OBITUARY, ROCKS, ZOOLOGY, and under each the titles of Articles referring thereto are mentioned.

- Brazil**, manganese deposits, Derby, 213.  
**Breeding**, Davenport, 362.  
**Brooklyn Institute**, publications, 533.  
**Brückner, E.**, die Alpen im Eiszeitalter, 84.  
**Bumstead, H. A.**, Röntgen rays in lead and zinc, 299.  
**Burma**, lower Paleozoic fossils, Reed, 262.

## C

- Canada** geol. survey, 527.  
**Canadian glaciers**, Scherzer, 261.  
**Canal rays**, mechanical working, Swinton, 348.  
 — phosphorescence by, Trowbridge, 41.  
**Cape of Good Hope**, geol. map, 83.  
**Carnegie Foundation**, second annual report, 164.  
 — Institution of Washington, publications, 162.  
**Carney, F.**, glacial overflow channels in New York, 217.  
**Cathode rays**, magnetic effect, Klupathy, 258.  
**Chemistry**, History of, Bauer, 81.  
 — Organic, Cohen, 146; Noyes, 80.  
 — Physical, Getman, 450.  
 — Qualitative analysis, Du Parc and Monnier, 80; Quantitative, Gilman, 450.

## CHEMISTRY.

- Actinium, activity, 291.  
 Aluminium electrodes, gas from, Hirsch and Soddy, 148.  
 Ammonium molybdate, hydrolysis, Moody, 76.  
 Arsenic and antimony, determination, Heath, 513.  
 — trisulphide, reduction, Ehrenfeld, 79.  
 Benzoic acid, esterification, Phelps and Osborne, 39.  
 Carbonates, action of, Gutmann, 449.  
 Helium and thorium, Strutt, 146.  
 Ionium, Marckwald and Keetman, 347; activity, 289; Boltwood, 365.  
 Iron, estimation, Newton, 343.  
 — in copper alloys, Gregory, 449.  
 Lithium in radio-active minerals, McCoy, 346.  
 Lutecium, Urbain, 146.  
 Magnesium, separation, Gooch and Eddy, 444.

- Manganese and the periodic law, Reynolds, 256.  
 — higher oxides, Meyer and Rötgers, 257.  
 Mercury peroxide, Von Antropoff, 520.  
 Niobium, Schulze, 452.  
 Nitrogen trioxide, Baker, 145.  
 Percarbonates, Wolfenstein and Peltner, 450.  
 Phosphorescent elements, Urbain, 256.  
 Phosphorus, white, Llewellyn, 257.  
 Polonium, activity, 285.  
 Radium, see **Radium**.  
 Tellurium, atomic weight, Baker and Bennett, 146.  
 Thorianite, new element in, Evans, 521.  
 Titanium, volumetric estimation of, Newton, 130.  
 — trichloride, Knecht and Hibbert, 80.  
 Uranium, 269; see **Radium**.  
 Vanadic acid, reduction, Gooch and Edgar, 235.  
 — and molybdic acid, determination, Edgar, 332.

- China**, Research in, Willis, Blackwelder and Sargent, 349.  
**Clarke, F. W.**, Data of Geochemistry, 458.  
**Coast Survey**, U. S., 459.  
**Cockerell, T. D. A.**, Tertiary insects, 51, 227, 309.  
**Cohen, J. B.**, Organic Chemistry, 146.  
**Cole, G. W.**, Bermuda Bibliography, 159.  
**Colors**, axial, of steam jet and coronas, Barus, 224.  
**Coon Butte**, 156, 256.  
**Crawford, C. M.**, Physics, 258.  
**Cycads**, see **GEOLOGY**.

## D

- Dadourian, H. M.**, atmospheric radio-activity, 335.  
**Darwin**, celebration at Cambridge, 460.  
**Derby, O. A.**, manganese deposits of Brazil, 213.  
**Dielectrics**, anomalies of, Schweidler, 147.

## E

- Earthquakes**, de Ballore, 262; Hobbs, 259, 354.  
**Eddy, E. A.**, separation of magnesium, 444.

**Edgar, G.**, reduction of vanadic acid, 233; vanadic and molybdic acids, 332.  
**Electric furnace reactions**, Hutton and Petavel, 451.  
 — waves in wireless telegraphy, Reinhold-Rüdenberg, 451.  
**Electro-Chemistry**, van Laar, 525.  
**Electrometer**, gold leaf, effect of temperature, Bottomley, 347.  
**Electrometers**, quadrant, Schulze, 451.  
**Electrons**, positive, in the sodium atom, Wood, 258.  
**Electro-Physiology**, Bose, 525.  
**Elephant**, evolution, Lull, 169.  
**Evans, N. N.**, gedrite, 509.

## F

**Ferry, E. S.**, Practical Physics, 452.  
**Field Columbian Museum**, 532.  
**Filtering crucible**, Gooch and Beyer, 249.  
**Flight**, ideas on the origin of, Nopcea, 528.  
**Flora**, see **Botany**.  
**Ford, W. E.**, stephanite crystals from Arizpe, Mexico, 244.  
**Fossils**, see **BOTANY, GEOLOGY**.  
**Franklin, W. S.**, Physics, 258.

## G

**Gage, A. P.**, Physics, 259.  
**Geochemistry**, Data, Clarke, 458.

## GEOLOGICAL REPORTS.

Canada, 455, 527.  
 Illinois, 353; geol. map, 457.  
 Indiana, 31st annual report, 82.  
 Michigan, 354, 456.  
 New Jersey, 1906, 82, 152.  
 New Zealand, 83, 526.  
 North Carolina, 159.  
 North Dakota, 457.  
 United States, 28th annual report, 149; folios, 150, 352; bulletins, 151; mineral resources, 264; water supply papers, 151.  
 Western Australia, 527.  
 West Virginia, 85.  
**Geologie**, *Traité*, Haug, 261, 529.

## GEOLOGY.

Alpen im Eiszeitalter, Penck and Brückner, 84.  
 Alps, Schmidt's sections, 155.  
 Ankylosauridæ, Brown, 528.  
 Brachauchenius, skull of, Williston, 85.

Brachiopod, new Devonian, Greger, 313.  
 Conglomerates, desiccation, in the coal-measures of Ohio, Hyde, 400.  
 Cretaceous of Montana, Hell Creek beds, Brown, 86.  
 — paleontology, New Jersey, Weller, 152.  
 Cycads, historic, Wieland, 93; see **BOTANY**.

Dinosaurs, von Huene, 86.  
 — cranial musculature, Lull, 387.  
 Earthquakes, de Ballore, 262; Hobbs, 259, 354.  
 Elephant, evolution, Lull, 169.  
 Eocene horses, American, Granger, 528.  
 Finger lakes, ancient, in Ohio, Hubbard, 239.  
 Gastropods, Spitz, 153.  
 Glacial overflow channels in New York, Carney, 217.  
 — period in non-glaciated regions, Huntington, 353.  
 Glaciers, Canadian, Scherzer, 261.  
 Hallopus, von Huene and Lull, 113.  
 Hell Creek beds of Upper Cretaceous, Montana, Brown, 86.  
 Insects, Fossil, Handlirsch, 264.  
 — Tertiary, Cockerell, 51, 227, 309.  
 Lower Paleozoic of Illinois, Savage, 431.  
 Mammalian migration, Matthew, 69, 154.  
 — molar teeth, Evolution, H. F. Osborn, 264.  
 Mauch Chunk shale, Barrell, 353.  
 Mt. Taylor region, N. M., Shimer and Blodgett, 53.  
 Ouray folio, Colorado, Cross, Howe, and Irving, 352.  
 Paleozoic formations in Texas, Richardson, 474.  
 — fossils of Burma, Reed, 262.  
 Patuxent folio, Shattuck, Miller and Bibbins, 352.  
 Peat in Michigan, Davis, 456.  
 Pelycosauria, E. C. Case, 84.  
 Silurian fauna, in Western America, Kindle, 125.  
 Strophomenacea, Yakovlew, 457.  
 Terraces in Ohio, Hubbard, 108.  
 Tertiary insects, Cockerell, 51, 227, 309.  
 Triassic reptile Hallopus, von Huene and Lull, 113.  
 See also under **BOTANY**.  
**Getman, F. H.**, Physical Chemistry, 450.

- Gilman, A. F.**, Chemical Analysis, 450.
- Glaciers**, see **GEOLOGY**.
- Globus karte**, Sipman, 268.
- Gooch, F. A.**, reduction of vanadic acid, 233; filtering crucible in electrolytic analysis, 249; separation of magnesium, 444.
- Goodspeed, A. W.**, Physics, 259.
- Greger, D. K.**, new Devonian brachiopod, 313.
- H**
- Hanausek, T. F.**, Microscopy of Technical Products, 87.
- Handlirsch, A.**, die Fossilien Insecten, 264.
- Harvard Observatory**, 460.
- Haug, E.**, Géologie, 261, 529.
- Heath, F. H.**, determination of arsenic and antimony, 513.
- Hintze, C.**, Mineralogie, 265.
- Hobbs, W. H.**, earthquakes, 259, 354.
- Hofmeister, F.**, Beiträge zur chemischen Physiologie, 81.
- Holm, T.**, Isopyrum biternatum, 133; North American species of stellaria, 315.
- Howell, E. E.**, Williamstown, Ky., meteorite, 49; Ainsworth meteorite, 105.
- Hubbard, G. D.**, terraces in south-eastern Ohio, 108; ancient finger lakes in Ohio, 239.
- Huene, F. R. von**, Triassic reptile, Hallopus, 113.
- Huntington, E.**, glacial period in non-glaciated regions, 353.
- Hyde, J. E.**, desiccation conglomerates, 400.
- I**
- Illinois geol. survey**, 457.
- lower Paleozoic stratigraphy, Savage, 431.
- Immuno-Chemistry**, Arrhenius, 81.
- India**, geology, Vredenburg, 264.
- Indiana**, geol. survey, 82.
- Insects**, Tertiary, Cockerell, 51, 227, 309.
- Fossil, Handlirsch, 264.
- Ionium**, new radio-active element, Boltwood, 365; 289, 347.
- Ionized Air**, effect of magnetic field, Blanc, 348.
- J**
- Johannsen, A.**, Key for Rock-forming Minerals, 599.
- Johnson, B. L.**, geology of Iron Mine Hill, R. I., 1.
- Jones, A. T.**, Practical Physics, 452.
- Jupiter**, surface of, 267.
- Jutland**, moraines, Ussing, 84.
- K**
- Kayser, H.**, Spectroscopie, 522.
- Kindle, E. M.**, Silurian fauna in Western America, 125.
- Knopf, A.**, new boron minerals, 323.
- L**
- Lagunari, Ricerche**, 89.
- Lane, A. C.**, Shepard on underground waters of Missouri, 452.
- Library of Congress**, 364.
- Lull, R. S.**, Triassic reptile Hallopus, 113; evolution of the elephant; 169; Ceratopsian Dinosaurs, 387.
- M**
- McIntosh, W. C.**, British Annelids 530.
- MacNutt, B.**, Physics, 258.
- Mammalian migrations**, Matthew, 69, 154.
- Matthew, W. D.**, mammalian migrations, 69, 154.
- Mayow**, Medico-physical Works, 533.
- Mechanics**, Franklin and MacNutt, 166.
- Merrill, G. P.**, meteor crater of Arizona, 265.
- Metallography**, Goerens, 524.
- Meteor crater**, Arizona, origin, Fairchild, 156; Merrill, 265.
- Meteorite, iron**, Ainsworth, Nebraska, Howell, 105; Williamstown, Ky., Howell, 49.
- Meteorites**, Foyer collection of Amer. Museum, New York, 266.
- Meteorological elements of United States**, Bigelow, 413.
- Metric systems**, Perkin, 364.
- Michigan geol. survey**, 354; peat in, Davis, 456.
- Microscopical Technique**, Rawitz, 88.
- Mineral Resources of the United States**, 1906, 264.
- Mineralogie**, Hintze, 265.
- MINERALS.**
- Argentite, Colorado, 507.
- Diamonds in Kimberlite, 87.
- Gedrite, Canada, 509. Gold and silver, production in 1906, 156.
- Hulsite, Alaska, 325. Hyalosiderite, R. I., 19.
- Meymacite, 305. Molybdate, Colorado, 74.
- Paigeite, Alaska, 330. Powellite, Texas, 71; Nevada, 72. Proustite, Colorado, 507.

**MINERALS**—*continued.*

- Stephanite, Mexico, 244.  
 Thorianite, 521. Tourmaline, New York, 123. Tungstite, 305.  
 Uranium, radio-activity, 269.  
 Villiamite, 347.  
**Minerals**, Key for Rock-forming, Johannsen, 599.  
**Mining** Congress, American, 89.  
 Missouri, Shepard on underground waters, Lane, 452.  
**Moody, S. E.**, hydrolysis of ammonium molybdate, 77.  
**Mowbray, L.**, the cahow in Bermuda, 361.  
**Mumper, W. N.**, Physics, 259.

**N**

- Natural History** Essays, Renshaw, 160.  
**New Jersey**, Cretaceous paleontology, Weller, 152.  
 — geol. survey, 82.  
**Newman, H.**, Physics, 259.  
**Newton, H. D.**, volumetric estimation of titanium, 130; estimation of iron by potassium permanganate, 343.  
**New Zealand**, geology of the Coromandel region, 526; of Parapara subdivision, 83.  
**Niagara**, Falls of, Spencer, 455.  
**Nobel** prize in 1905, 165.  
**North Carolina**, fishes, Smith, 159.  
**North Dakota** geol. survey, 457.  
**Noyes, W. A.**, Organic Chemistry, 80.  
**Nuclei** of pure water, behavior, Barus, 409.

**O****OBITUARY.**

- Austin, P. T., 168.  
 Hall, A., 90.  
 Harrington, B. J., 91.  
 Janssen, P. J. C., 168.  
 Kelvin, Lord, 92.  
 Underwood, L. M., 92.  
 Young, C. A., 166.  
**Observatory**, Allegheny, publications, 165, 460.  
 — Astrophysical, publications, 431.  
 — Harvard College, publications, 460.  
 — Mt. Weather, bulletins, 155, 532.  
**Ohio**, ancient finger lakes, Hubbard, 239.  
 — desiccation conglomerates, Hyde, 400.

- Ohio terraces, Hubbard, 108.  
**Osborn, H. F.**, Evolution of Mammalian Molar Teeth, 264.  
**Osborne, R. W.**, esterification of benzoic acid, 39.  
**Ostwald's Klassiker**, 89, 534.  
**Oxygen**, positive column, Kirby, 451.

**P**

- Paleobotany**, see **BOTANY**.  
**Penck, A.**, Alpen im Eiszeitalter, 84.  
**Perkins, H. A.**, rectification effect in a vacuum tube, 485.  
**Perkins, P. B.**, molecular weight of radium emanation, 461.  
**Phelps, I. K. and M. A.**, esterification of benzoic acid, 39.  
**Phosphorescence** by canal rays. Trowbridge, 141.  
**Photometry**, Liebenthal, 258.  
**Physics**, Elementary, Newman, 259.  
 — Practical, Franklin, Crawford and MacNutt, 258; Ferry and Jones, 452.  
 — Principles, Gage and Goodspeed, 259.  
 — Text-book, Mumper, 259.  
**Physiologie**, Beiträge zur chemischen, Hofmeister, 81.  
**Plate L.**, Probleme der Artbildung, 531.

**R**

- Radio-active** minerals, lithium in, McCoy, 346.  
**Radio-activity**, atmospheric, Dadourian, 335.  
 — of lead, McLennan, 147.  
 — of uranium minerals, Boltwood, 269.  
 — see **Radium**.  
**Radiometer** for low pressures, Dewar, 258.  
**Radium** emanation in the atmosphere, Eve, 147; molecular weight of, Perkins, 461; water vapor in, Curie, 145, 522.  
 — in the earth, Strutt, 346.  
 — life of, Boltwood, 493.  
 — origin, Hahn, 79; Rutherford, 147.  
**Refrigeration**, Anderson, 524.  
**Rhode Island**, geology of Iron Mine Hill, Johnson and Warren, 1.  
**Richardson, G. B.**, Paleozoic formations in Trans-Pecos Texas, 474.  
**Rochester** quadrangle, geologic map, Hartnagel, 154.

## ROCKS.

- Cumberlandite, R. I., 2.  
 Granite and gneiss of Finland, Sed-  
 erholm, 157.  
 Scapolite rocks of America, Spurr,  
 154.  
**Röntgen Rays** in lead and zinc,  
 Bumstead, 299.  
 — see **X-RAYS**.

## S

- Sargent, R. H.**, Research in China,  
 349.  
**Savage, T. E.**, lower-Paleozoic strat-  
 igraphy in Illinois, 431.  
**Schaller, W. T.**, powellite and mo-  
 lybdite, 71; new boron minerals,  
 323.  
**Scherzer**, Canadian glaciers, 261.  
**Schmidt's** Alpine sections, 155.  
**Schultze, A.**, Graphic Algebra, 534.  
**Scotland**, geological structure of  
 Highlands, 155.  
**Sederholm, J. J.**, Finland granite and  
 gneiss, 157.  
**Seismology**, de Ballore, 262.  
**Shimer, H. W.**, Stratigraphy of the  
 Mt. Taylor region, N. M., 53.  
**Smithsonian** Institution, report, 160.  
**Sound**, direction, Bowkler, 348.  
 — velocity, 451; in fluids, Dörsing,  
 348.  
**South Africa**, Passarge, 155.  
**Spectra**, flame, Hemsalech and de  
 Watteville, 450.  
**Spectroscopy**, Kayser, 522.  
**Spectrum**, emission, of mercury,  
 Castelli, 148.  
**Spencer, J. W. W.**, Falls of the  
 Niagara, 455.  
**Spurr, J. E.**, scapolite rocks of  
 America, 154.  
**Stereochemistry**, Stewart, 521.  
**Stevens, W. C.**, Plant Anatomy,  
 263.  
**Stewart, A. W.**, Stereochemistry,  
 521.  
**St. Louis** district, water resources,  
 Bowman and Reeds, 353.

## T

- Telegraphie sans fil**, Van Dam, 452.  
**Texas**, Paleozoic formations in, Rich-  
 ardson, 474.  
**Time** distribution in Paris, 268.  
**Trowbridge, J.**, phosphorescence  
 produced by canal rays, 141; use of  
 magnetic field with X-ray tubes,  
 143.

## U

- United States** Coast Survey, 459.  
 — — geol. survey, see **GEOL.**  
**REPORTS**.

## V

- Vacuum-tube**, rectification effect,  
 Perkins, 485.  
**Van Horn, F. R.**, proustite and ar-  
 gentite, 507.  
**Verrill, A. E.**, grapsoid crustacean,  
 119; decapod crustacea, 534.

## W

- Walker, T. L.**, tungstite and mey-  
 macite, 305.  
**Warren, C. H.**, geology of Iron  
 Mine Hill, R. I., 1.  
**Weller, S.**, Cretaceous paleontology  
 of New Jersey, 152.  
**West Australia** geol. survey, 527.  
**West Virginia** geol. survey, 83.  
**Wiedersheim's** Comparative Anat-  
 omy of Vertebrates, Parker, 160.  
**Wieland, G. R.**, historic cycads,  
 93; accelerated cone growth in  
 Pinus, 103; notes on Paleobotany,  
 354.  
**Willis, B.**, Research in China, 349.  
**Wisconsin** geol. survey, 354.  
**Worlds**, Two New, d'Albe, 148.

## X

- X-ray tubes**, in use of magnetic  
 field, Trowbridge, 143.  
 — diffraction, Walter and Pohl, 452.

## Z

## ZOOLOGY.

- Annelids, British, McIntosh, 530.  
 Cahow in Bermuda, Mowbray, 361.  
 Copepods, No. American parasitic,  
 Wilson, 158.  
 Crustacea of Norway, Sars, 158.  
 — decapod, Bermuda, Verrill, 534.  
 Echinoidea of Danish Expedition,  
 Mortensen, 159.  
 Fishes of North Carolina, Smith,  
 159.  
 Grapsoid crustacean, Verrill, 119.  
 Insects, instincts, etc., Fabre, 89.  
 Madreporaria of Amboina, Bedot;  
 158; of the Hawaiian Islands,  
 Vaughan, 158.  
 Parasites of Bermuda fishes, Lin-  
 ton, 159.  
 Vertebrates, Comparative Anatomy,  
 Wiedersheim, Parker, 160.  
 See also **GEOLOGY**.

# Relief Map of the United States

We have just prepared a new relief map of the United States, 48 x 32 inches in size, made of a special composition which is hard and durable, and at the same time light. The map is described in detail in circular No. 77, which will be sent on request. Price, \$16.00.

---

WARD'S NATURAL SCIENCE ESTABLISHMENT,

76-104 College Ave., ROCHESTER, N. Y.

---

---

## WARD'S NATURAL SCIENCE ESTABLISHMENT

**A Supply-House for Scientific Material.**

Founded 1862.

Incorporated 1890.

### DEPARTMENTS:

*Geology*, including Phenomenal and Physiographic.

*Mineralogy*, including also Rocks, Meteorites, etc.

*Palaeontology*.      *Archaeology* and *Ethnology*.

*Invertebrates*, including Biology, Conchology, etc.

*Zoology*, including Osteology and Taxidermy.

*Human Anatomy*, including Craniology, Odontology, etc.

Models, Plaster Casts and Wall-Charts in all departments.

---

Circulars in any department free on request; address

Ward's Natural Science Establishment,

76-104 College Ave., Rochester, New York, U. S. A.

## CONTENTS.

	Page
ART. XLVIII.—Determination of the Molecular Weight of Radium Emanation by the Comparison of its Rate of Diffusion with that of Mercury Vapor ; by P. B. PERKINS .....	461
XLIX.—Paleozoic Formations in Trans-Pecos, Texas ; by G. B. RICHARDSON .....	474
L.—Rectification Effect in a Vacuum Tube ; by H. A. PERKINS .....	485
LI.—Life of Radium ; by B. B. BOLTWOOD .....	493
LII.—New Occurrence of Proustite and Argentite ; by F. R. VAN HORN .....	507
LIII.—Occurrence of Gedrite in Canada ; by N. N. EVANS and J. A. BANCROFT .....	509
LIV.—Iodometric Determination of Arsenic and Antimony Associated with Copper ; by F. H. HEATH .....	513

### SCIENTIFIC INTELLIGENCE.

*Chemistry and Physics*—Crystallized Chlorophyll, WILLSTÄTTER and BENZ : Mercury Peroxide, VON ANTROPOFF, 520.—Supposed New Element in Thorianite, C. DE B. EVANS : Stereochemistry, A. W. STEWART, 521.—Condensation of Water Vapor in the Presence of Radium Emanation, Mme. CURIE : Anode Rays, GEHRCKE and REICHENHEIM : Handbuch der Spectroscopie, H. KAYSER, 522.—Refrigeration, J. W. ANDERSON : Introduction to Metallography, P. GOERENS, 524.—Lehrbuch der theoretischen Elektrochemie auf thermodynamischer Grundlage, J. J. VAN LAAR : Comparative Electro-Physiology, J. C. BOSE, 525.

*Geology*—New Zealand Geological Survey, 526.—Geological Survey of Western Australia : Geological Survey of Canada, 527.—The Ankylosauridæ, B. BROWN : Revision of the American Eocene Horses, W. GRANGER : Ideas on the Origin of Flight, Dr. B. F. NOPCSA, 528.—Traité de Géologie I, Les Phénomènes géologiques, E. HAUG : Key for the Determination of the Rock-forming Minerals in Thin Sections, A. JOHANSEN, 529.

*Miscellaneous Scientific Intelligence*—Monograph of the British Annelids, W. C. MCINTOSH, 530.—Selectionsprinzip und Probleme der Artbildung, Dr. L. PLATE : Annals of the Astrophysical Observatory of the Smithsonian Institution, C. G. ABBOT, 531.—Bulletin of the Mount Weather Observatory, W. L. MOORE : Field Columbian Museum, O. C. FARRINGTON, 532.—Museum of the Brooklyn Institute of Arts and Sciences : University of California Publications in American Archaeology and Ethnology : Medico-Physical Works of John Mayow, 533.—Graphic Algebra, A. SCHULTZE : Ostwald's Klassiker der Exakten Wissenschaften: Decapod Crustacea of the Bermudas, Part 1, A. E. VERRILL, 534.









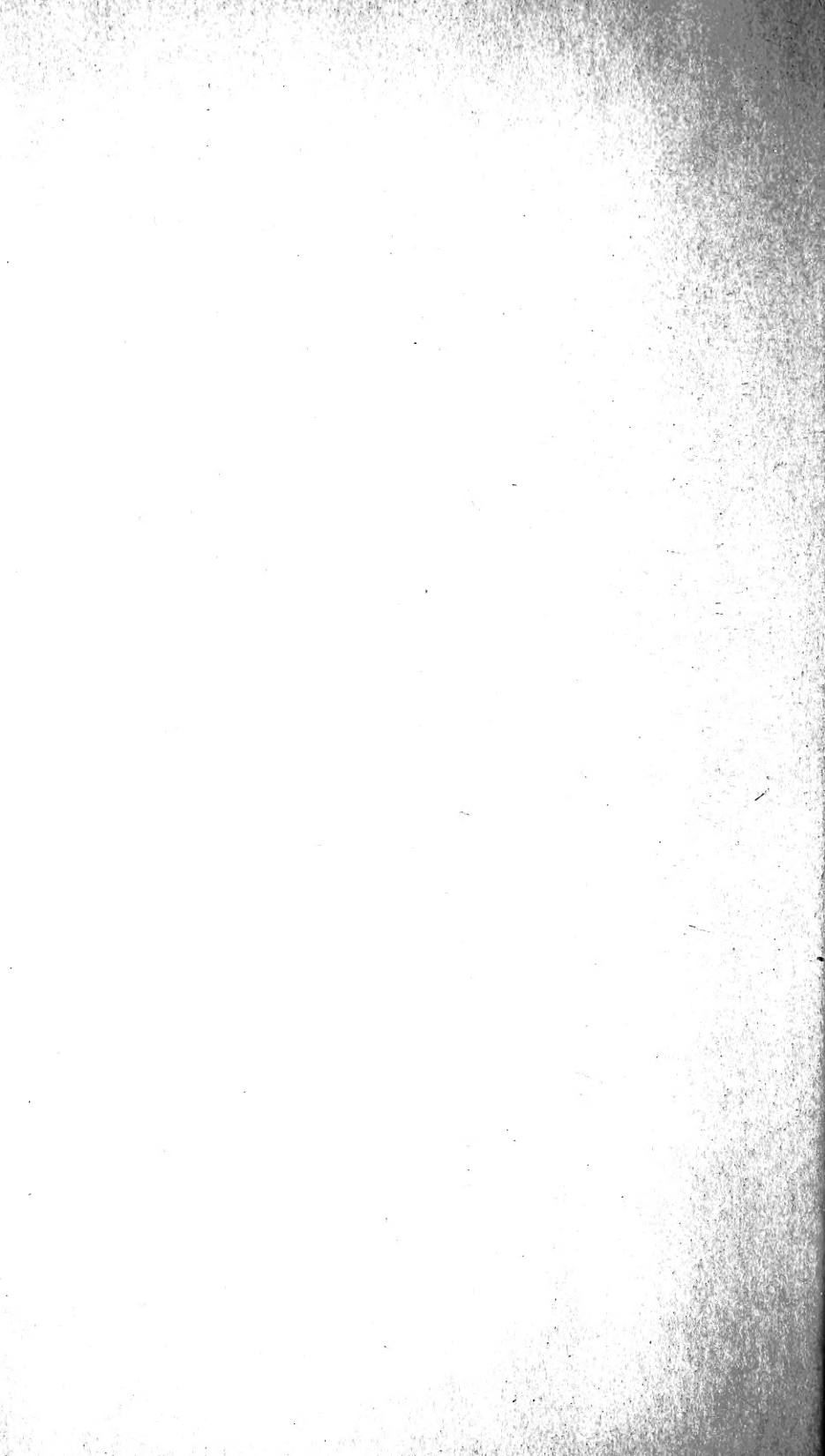



SMITHSONIAN INSTITUTION LIBRARIES



3 9088 01298 5768