



# elektor 48 decoder

Volums 5

Number 4

Elektor Publishers Ltd., Elektor House,  
10 Longport, Canterbury CT1 1PE, Kent, U.K.  
Tel.: Canterbury (0227) 54430. Telex: 965504.  
Office hours: 8.30 - 12.45 and 13.30 - 16.45.

Bank: 1. Midland Bank Ltd., Canterbury, A/C no. 11014587  
Savings code 40-16-11, Giro no. 3154524.  
2. U.S.A. only: Bank of America, c/o World Way  
Postal Center, P.O. Box 80689, Los Angeles,  
CA 90080, A/C no. 12350-04207.  
3. Canada only: The Royal Bank of Canada,  
c/o Lockbox 1969, Postal Station A, Toronto,  
Ontario, M5W 1W9. A/C no. 160-269-7.

Please make all cheques payable to Elektor Publishers Ltd. at the above address.

Elektor is published monthly.  
Number 61/62 (July/August) is a double issue.

SUBSCRIPTIONS: Mrs. S. Barber

Subscription 1979, January to December incl.:

U.K.	U.S.A./Can.	other countries
£ 8.50	surface mail airmail \$ 21.00 \$ 31.00	surface mail airmail £ 8.50 £ 14.00

Subscriptions normally run to December incl. Subscriptions from

May issue:	U.S.A./Can.	other countries
U.K.	surface mail airmail £ 5.50 \$ 14.00 \$ 20.00	surface mail airmail £ 5.50 £ 9.00

Back issues are available at original cover price.  
Change of address: Please allow at least six weeks for change of address. Include your old address, enclosing, if possible, an address label from a recent issue.

ASSISTANT MANAGER: R.G. Knapp

ADVERTISING MANAGER: N.M. Willis

National advertising rates for the English language edition of Elektor and international rates for advertising in the Dutch, French and German issues are available on request.

EDITOR  
W. van der Horst

U.K. EDITORIAL STAFF  
I. Meikiejohn

TECHNICAL EDITORIAL STAFF

A. Nachtmann  
J. Dudleier  
A.C. Paupitt  
K.S.M. Weiraven  
P. de Winter

J. Barendrecht  
G.H.K. Dem  
P. Holmes  
E. Krepmpelauer  
G. Nechbor

Technical telephone query service, Mondays only, 13.30 - 16.45.  
For written queries, letters should be addressed to dept. TD.  
Please enclose a stamped, addressed envelope or a self-addressed envelope plus an IRC.

ART EDITOR: F. v. Rooij

Letters should be addressed to the department concerned:

TD = Technical Queries	ADV = Advertisements
ED = Editorial (articles submitted for publications etc.)	ADM = Administration
SUB = Subscriptions	EPS = Elektor printed circuit board service

The circuits published here for domestic use only. The submission of designs or articles to Elektor implies permission to the publishers to alter and translate the text and design, and to use the contents in other Elektor publications and activities. The publishers cannot guarantee to return any material submitted to them. All drawings, photographs, printed circuit boards and articles published in Elektor are copyright and may not be reproduced or imitated in whole or part without prior written permission of the publishers.

Patent protection may exist in respect of circuits, devices, components etc. described in this magazine.

The publishers do not accept responsibility for failing to identify such patent or other protection.

Dutch edition: Elektuur B.V., Postbus 75, 6190 AB Beek (L), the Netherlands.

German edition: Elektor Verlag GmbH, 5133 Gangel, W-Germany

French edition: Elektor Serl, La Douliue, 59940 Estaires, France.

Distribution in U.K.:

Smythor Press Ltd., 334 Brixton Road, London SW9 7AG.

Distribution in CANADA: Fordon and Gotch (Can.) Ltd., 55 York Street, Toronto, Ontario M5J 1S4.

Copyright © 1979 Elektor publishers Ltd. - Canterbury.

Printed in the U.K.

What is a TUN?  
What is 10 n?  
What is the EPS service?  
What is the TO service?  
What is a missing link?

## Semiconductor types

Very often, a large number of equivalent semiconductor types exist with different type numbers. For this reason, 'abbreviated' type numbers are used in Elektor wherever possible:

• '741' stand for  $\mu$ A741, LM741, MC641, MIC741, RM741, SN72741, etc.  
• 'TUP' or 'TUN' (Transistor, Universal, PNP or NPN respectively) stand for any low frequency silicon transistor that meets the following specifications:

UCEO, max	20V
IC, max	100 mA
h <sub>fe</sub> , min	100
P <sub>tot</sub> , max	100 mW
f <sub>T</sub> , min	100 MHz

Some 'TUN's are: BC107, BC108 and BC109 families; 2N3856A, 2N3859, 2N3860, 2N3904, 2N3947, 2N4124. Some 'TUP's are: BC177 and BC178 families; BC179 family with the possible exception of BC159 and BC179; 2N2412, 2N3251, 2N3906, 2N4126, 2N4291.

• 'DUS' or 'DUG' ( $\mu$ Diode Universal, Silicon or Germanium respectively) stands for any diode that meets the following specifications:

	DUS	DUG
UR, max	25V	20V
IF, max	100mA	35mA
IR, max	1 $\mu$ A	100 $\mu$ A
P <sub>tot</sub> , max	250mW	250mW
CP, max	5pF	10pF

Some 'DUS' are: BA127, BA217, BA218, BA221, BA222, BA317, BA318, BAX13, BAY81, 1N914, 1N4148.

Some 'DUG' are: OA86, OA81, OA85, AA116.

• 'BC107B', 'BC237B', 'BC547B' all refer to the same 'family' of almost identical better-quality silicon transistors. In general, any other member of the same family can be used instead.

## BC107 (-8, -9) families:

BC107 (-8, -9), BC147 (-8, -9), BC207 (-8, -9), BC237 (-8, -9), BC317 (-8, -9), BC347 (-8, -9), BC547 (-8, -9), BC171 (-2, -3), BC182 (-3, -4), BC382 (-3, -4), BC437 (-8, -9), BC414

## BC177 (-8, -9) families:

BC177 (-8, -9), BC157 (-8, -9), BC204 (-5, -6), BC307 (-8, -9), BC320 (-1, -2), BC350 (-1, -2), BC557 (-8, -8), BC251 (-2, -3), BC212 (-3, -4), BC512 (-3, -4), BC251 (-2, -3), BC416.

Resistor and capacitor values  
When giving component values,  
decimal points and large numbers

of zeros are avoided wherever possible. The decimal point is usually replaced by one of the following abbreviations:

p (pico-) = 10<sup>-12</sup>  
n (nano-) = 10<sup>-9</sup>  
 $\mu$  (micro-) = 10<sup>-6</sup>  
m (milli-) = 10<sup>-3</sup>  
k (kilo-) = 10<sup>3</sup>  
M (mega-) = 10<sup>6</sup>  
G (giga-) = 10<sup>9</sup>

A few examples:  
Resistance value 2k7: 2700  $\Omega$ .  
Resistance value 470: 470  $\Omega$ .  
Capacitance value 4p7: 4.7 pF, or 0.000 000 004 7 F...  
Capacitance value 10n: this is the international way of writing 10 000 pF or .01  $\mu$ F, since 1 n is 10<sup>-9</sup> farads or 1000 pF.  
Resistors are  $\frac{1}{2}$  Watt 5% carbon types, unless otherwise specified. The DC working voltage of capacitors (other than electrolytic) is normally assumed to be at least 60 V. As a rule of thumb, a safe value is usually approximately twice the DC supply voltage.

## Test voltages

The DC test voltages shown are measured with a 20 k $\Omega$ /V instrument, unless otherwise specified.

## U, not V

The international letter symbol 'U' for voltage is often used instead of the ambiguous 'V'. 'V' is normally reserved for 'volts'. For instance: U<sub>b</sub> = 10 V, not V<sub>b</sub> = 10 V.

## Mains voltages

No mains (power line) voltages are listed in Elektor circuits. It is assumed that our readers know what voltage is standard in their part of the world! Readers in countries that use 60 Hz should note that Elektor circuits are designed for 60 Hz operation. This will not normally be a problem; however, in cases where the mains frequency is used for synchronisation some modification may be required.

## Technical services to readers

• EPS service. Many Elektor articles include a lay-out for a printed circuit board. Some - but not all - of these boards are available ready-etched and drilled. The 'EPS print service list' in the current issue always gives a complete list of available boards.

• Technical queries. Members of the technical staff are available to answer technical queries (relating to articles published in Elektor) by telephone on Mondays from 14.00 to 16.30. Letters with technical queries should be addressed to: Dept. TD. Please enclose a stamped, self-addressed envelope; readers outside U.K. please enclose an IRC instead of UK stamps.

• Missing link. Any important modifications to, additions to, improvements on or corrections in Elektor circuits are generally listed under the heading 'Missing Link' at the earliest opportunity.



In early TV games, the 'objects' on the screen consisted of little more than two vertical bars ('bats') and a small square ('ball'). Nowadays, complete cowboys, battleships or jet aircraft are more in demand. The  $\mu$ P TV games computer can cater for all tastes, p. 4-06 and p. 4-26



For mobile public address systems, in particular, an amplifier that will produce well over 100 watts while running off a standard car battery can be extremely useful. The Stentor was designed to provide a truly 'stentorian' mouthpiece in this type of application, p. 4-14

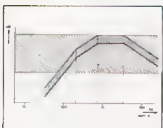

By fully utilising the available output power in a sound installation, it is often possible to produce clearly intelligible speech in even the noisiest of environments. The Assistor uses a two-pronged approach; dynamic compression to boost low-level signals and frequency response tailoring to put all the power into the most important part of the speech spectrum, p. 4-20



A few of the possibilities of the TV games computer are illustrated on this month's cover: racing, cards, and even simple arithmetic.

Photographs courtesy of Philips Gloeilampenfabrieken NV, the Netherlands.

# contents

selektor .....	4-01
$\mu$ P TV games .....	4-06
An introduction to the microprocessor-controlled TV games computer.	
car light reminder (M. Panrose) .....	4-13
An extremely simple circuit that will remind the motorist to switch off his headlights before leaving the car. No components are connected in series with the existing wiring, so that it is easy to install and will not effect the operation of the car electrical system.	
stentor .....	4-14
In Homer's Iliad, Stentor is the name of one of the Greeks at Troy, who it is said had a voice louder than that of 50 men. Stentor thus seemed a suitable name to call an amplifier which, to continue the analogy, provides the power of 50 transistor radios!	
The distinguishing feature of this amplifier is that it is portable (!) since it can be powered from a normal 12 V car battery and is therefore ideally suited for open air P.A. work.	
TAP switch (U. Sussbauer) .....	4-19
This circuit for a touch activated switch uses only 4 1/2 components!	
assistentor .....	4-20
Everyone must at some time have had the maddening experience of standing on a railway platform and straining anxiously to make out what the station announcer has just said — a situation which provides a good example of the problems facing P.A. systems used in environments with high levels of background noise.	
One solution is to employ a dynamic range compressor to boost the amplitude of the softer portions of speech above the threshold level of the background noise, without altering the level of the louder speech passages. When used in conjunction with the 'Stentor' power amplifier the result should be a P.A. system which will make itself heard in even the noisiest of crowds.	
zero pF screen .....	4-23
quiz master .....	4-24
In many quiz games it is important to be able to determine who is the first to reply to a question. To avoid disputes and unseemly family arguments the simplest approach is to use an impartial electronic 'quizmaster'.	
building the TV games computer .....	4-26
The introductory article on page 4-06 describes what the TV games computer looks like and what it can do. Without further ado, this article gives the constructional details.	
market .....	4-35
advertisers index .....	UK 22

Supplement:  
**BASIC (part (2)), an introduction to a simple computer language.**

# SELEKTOR

## Saltng away spare power

Meeting peak demands for electricity means idle machinery at other times. One way to generate more economically is to run the main stations at a more even rate and store their spare, off-peak power in the form of compressed air in underground caverns. It can then be called back to augment the supply at peak hours. Storing some of this energy through heat exchange promises to make such systems even more efficient. In most countries, and certainly in the industrialized world, electricity generating authorities are faced with the same problems: how to supply all the demands of their consumers and how to make the best use of their generating equipment. Every authority also faces the fact that the main demand comes in the working day, when equipment runs flat out to meet the need. The load is only slightly relieved as darkness falls because the domestic consumer then starts to make big demands on the supply. But late at night the demand from all users drops markedly, and the pressure on turbines and generators is at last reduced.

One could be forgiven for thinking that the ease-up is no bad thing. But any machinery that is subject to peaks and troughs in usage becomes more and more susceptible to wear and, subsequently, more likely to break down. The family car never runs better than at cruising speed on a good road, when it consumes less fuel per mile than at any other time. In the power generating field this cruise condition is highly desirable, for it would allow turbines to be run at a steady rate through the 24 hours. Peak demands would have to be met by stored energy, and it is the store problem that prevents the best use of power output potential. The only storage available to electrical authorities is hydrostorage, in which excess output is made to pump water up into a convenient reservoir. Then, when peak-period power is needed, the water is released to run down through channels to drive turbines. But not all countries are blessed with the geological formations that lend themselves to dams and reservoirs, and in some countries water itself may be scarce. So what is the answer? The battery system to store vast amounts of power for domestic and industrial use has yet to be invented; but there is hope from another source, and that is to store the surplus power below ground.

At Huntorf, in West Germany, a unique power storage system is now in use. Though the principle has been discussed for some years, this system employs the first commercial prototype generating unit using compressed air as a storage medium. During the off-peak period the turbines in the power station

drive a compressor unit and compressed air is channelled into nearby salt caverns. Then, when demand reaches its peak, the stored air is released under careful control to drive a turbo-generator, which adds its weight to the station's output; but, unfortunately, the heat generated by the compression process has long since been dissipated. To develop enough expansion to drive the turbine efficiently, fuel has to be added to the air and the mixture ignited.

So, futuristic as it is, the Huntorf system still wastes quite a lot of energy. First, fuel has to be provided for combustion; second, in the compression stage a good deal of heat is lost by being dissipated. Every schoolboy knows that when you operate a bicycle pump it produces heat. The same is true with the Huntorf compressors, and the heat there goes into the salt cavern. There is the danger that it might harm the storage chamber by making the walls become semi-plastic and thereby reduce the available storage space. If the storage were not the ideal salt caverns, with their guaranteed sealing qualities, but rock caverns, or caverns with water all round them, the heat would create even greater problems. It would make 'dry' rock even more dry, giving rise to crumbling and subsequent leaks, and if a seal were provided by placing the compressed air inside an underground water 'bubble', quite clearly the water would soon be driven off by the high temperatures involved. It is this problem that has attracted the attention of Britain's Central Electricity Board. At their Marchwood research station, near Southampton, they have been working for some time on ways to make use of the heat generated in the compression stage of storage. What they propose is that once the turbines are switched to the compression stage, instead of the air being directed straight to the storage cavern it should be passed through heat-retaining units. These would be giant 'silos' containing heat-retaining materials such as dense fireclay pebbles. The air subsequently in store would be cool, so it would not cause the storage chamber to deteriorate. But that is only a relatively small advantage. It is further proposed that when the trapped air is released to drive a power turbine at peak periods, it should pass back through the silos, where it would pick up enough heat to start the turbine without having to add fuel. In effect you would have a turbine that did not burn any fuel at all. Ambitious this may well be, but small-scale tests have shown it to be feasible and many American authorities are looking at the 'no-fuel' method very seriously indeed. In the opinion of all concerned, salt caverns form the best store, not only

because of their sealing qualities but because they can be easily created. All that is needed is to tap a hole into the ground in a known salt area and then pump water into it at high pressure. Unwanted deposits are washed out by a pumping system. Proponents are quite convinced that natural rock caverns could be utilised, too, with perhaps a sealant applied to the rock face. And the idea of storage in a bubble becomes feasible if the compressed air has been cooled.

It is understood that the Huntorf unit reaps back about 70 per cent of the energy expended in storing its output. A figure of 80 to 85 per cent or even more is possible by first removing and then replacing the heat.

Theoretical storage volumes are in figures that stretch the mind, but various authorities in the UK and elsewhere are seriously evaluating this sort of storage. And who knows, perhaps we are witnessing the first steps along the road to the power station gas turbine, as we know it, becoming obsolete.

*Spectrum no. 158*

(451 S)

## Computerised camping

Wigwam International Ltd. of Norwich are using a computer system to keep track of holiday bookings for 220 tents and 37 caravans on seven sites in France, Spain and Italy.

At the end of each day charts of each site with the latest state of bookings and vacancies for the whole summer are produced in a few minutes at 160 characters per second by a Tally 1612 printer.

Since campers may stay one night or ten, vacancies occur in random patterns. Re-arranging bookings to make maximum use of tents and caravans used to be difficult and time-consuming, and producing the up-dated charts by hand was tedious and open to error. Now when a booking is entered the computer searches for a vacancy and, if it finds one, allocates it. Then the printer produces a letter of confirmation to the camper on pre-printed stationery. When the peripheral bookings - on ferries or airlines, for example - are confirmed, the printer runs off the invoice. It is also used to produce statistics and analysis reports.

*Tally Limited, Tally House  
7 Crenyll Road,  
Reading RG1 8NQ,  
England*

(453 S)

# SELEKTOR

## Looking into engines with lasers (Dr. B. W. Dale)

Many people are surprised when they find that research is going on into the way internal combustion engines work. What more needs to be known about an engine that has been around since the last century, is based on a simple principle, and has been the subject of countless engineering studies? Because internal combustion engines can be made to perform quite well without our needing to know precisely what goes on inside the cylinders, there has been little incentive to study in detail the way they work. But several factors have combined recently to create problems for engine designers. Growing awareness of environmental problems has led to pressure for quieter, less polluting engines. Realization that the world's oil resources are being used up has produced two more pressures: engines will be expected to become progressively more efficient in their use of fuel and, more important, the practice of refining motor fuel to suit engines may have to cease. It looks as though we shall have to design our engines to accept, as time goes by, fuels that fall more and more short of ideal, especially if the oil companies are forced, in the end, to synthesize liquid fuel from coal.

Engine designers have a fairly clear idea of the sort of fuel-air mixture that is needed for desirable combustion characteristics. The problem lies in creating suitable mixtures and in transporting them, without deterioration, inside a practical engine. These points can best be illustrated by example. In a fourstroke diesel engine, air is drawn into the cylinder during the induction stroke by a downward motion of the piston. The inlet valve closes and the air is compressed by an upward motion of the piston, becoming very hot in the process. Fuel is injected just before the end of this compression stroke. Combustion starts within about a millisecond, so during this short delay the fuel must become thoroughly mixed

with the air for combustion to be satisfactory.

Rapid mixing is commonly achieved by ensuring that the air in the cylinder is swirling and turbulent at the moment of injection, and by injecting the fuel in such a way that it immediately breaks up into very small droplets. Note, however, that the swirling and turbulent motion must be imparted to the air during the induction stroke, half a cycle before combustion takes place. In practice it is found that, for no apparent reason, some air-inlet ports are very much better than others in achieving the desired result. An understanding of this problem would remove a large element of uncertainty from diesel engine design. The problem is mainly how to measure, and then to try to account for, the way the fuel droplets interact with gas-flows inside engines.

### Complex Problems

In a typical petrol engine the fuel and air are mixed in the carburettor. The fuel-laden air then has to flow past the throttle plate and the bends and junctions in the manifold without depositing the fuel droplets onto the solid surfaces. In the manifold there is the further problem of ensuring that all cylinders receive the same amount and quality of fuel-air mixture, in spite of the fact that cylinders 1 and 4 are further away from the source of the mixture than cylinders 2 and 3. Such problems are often solved by putting weirs or baffles inside the manifold, but these are usually more effective at some engine speeds than others, which means that the manifold functions well only under certain engine conditions. Here, too, the problems are those of understanding gasflows and their interaction with liquid droplets. They are very complex problems, bearing in mind that at a typical engine speed the flow in the manifold changes direction some 100 times a second because of the cyclic demands of the four cylinders. Many ingenious techniques have been developed for studying fuel-air motion inside engines. High-speed photography

has achieved considerable success, but is essentially qualitative. The depth of the volume in which the fuel droplets and other particles are in focus (that is, the depth of field) is not very certain; the technique is also off-line, which means the data does not become available during the experiment. Most other techniques involve inserting probes into the engine cavities; they may be vanes, heated wires, tubes, and so on. None of these give unambiguous results. They clearly interfere with the normal functions of the engine and they have never been used with complete success on a running engine.

Over the last decade, a number of optical techniques have been developed to measure various physical phenomena in engineering. One of the most highly developed is laser anemometry, for measuring fluid flow. There are several ways of constructing a laser anemometer. The most straightforward is the so-called real-fringe system.

### Crossing Beams

Here, we must first consider some of the wave-like properties of light. A light-wave is a propagation through space of a small, rapidly oscillating, electric potential, in the same way that a water-wave is a propagation across a surface of an oscillating depth, or potential, of water. If we represent fluctuations in the electric potential by alternate light and dark shading, laser beams can be depicted as shown in figure 3, which represents the crossing of two laser beams. It is the peculiar and very useful property of laser beams that the wave-fronts are spaced absolutely evenly and are parallel. In the cross-over region of the two beams the total oscillating electric potential is the sum of the components from the two beams, and here a very useful phenomenon occurs. Along the line A-A', for example, one beam always reinforces the effect of the other (in our representation the shading is either particularly heavy or completely absent). Remembering that all the wave-fronts are moving in the direction of propagation at the speed of light, any point along the line A-A' will experience a particularly strong oscillating electric potential, and will therefore be intensely illuminated. But along the lines B-B', or C-C', one laser beam exactly cancels out the effect of the other (in our representation the intensity of shading does not change). The electric potential does not oscillate at any point along lines B-B' or C-C', so the illumination here is zero. It will be seen that the cross-over region of the two beams consists of alternate light and dark 'fringes' parallel to A-A'. In laser anemometry the cross-over region is referred to as the control volume, and typically occupies 0.01 cubic millimetres.

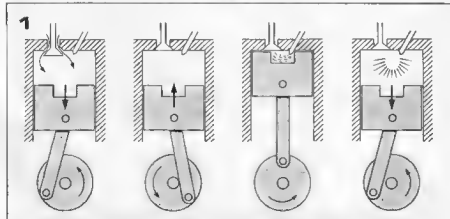

# SELEKTOR

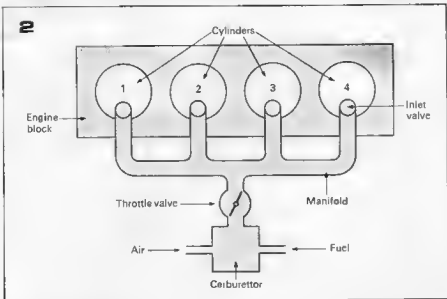

Figure 1. Four stages in the engine cycle of a four stroke diesel engine. During the induction stroke (a) air is drawn past the inlet valve into the cylinder. The inlet valve is closed during the compression stroke (b) and the air is compressed, becoming hot enough to ignite the fuel when it is injected. Injection takes place when the piston reaches 'top dead centre' (c). After about a millisecond, combustion begins, in this case starting in the combustion bowl hollowed out of the piston crown. During the working stroke (d) the piston is forced down by the hot, expanding gases produced by ignition of the fuel.

Figure 2. In the four-cylinder petrol engine, the fuel-air mixture is prepared in the carburettor. Fuel-laden air then has to travel past the throttle valve, which controls the total flow of fuel-air charge, and through the manifold and inlet valves to the cylinder. The inlet valves open one at a time (usually in the order 1, 3, 4, 2) to allow fuel-air mixture to be drawn into the cylinders.

A small liquid droplet or particle of dust happening to pass through the control volume meets the alternately light and dark fringes and, if it is observed from a distance, appears to flash on and off as it passes through the fringe system. If the repetition frequency of the flashes is measured, the rate at which the particle is passing through the control volume can be found. This is the principle of real-fringe laser anemometry. Unless they are specially filtered, all normal fluids contain an abundance of minute particles. If the fluid is flowing the small particles follow the flow very closely, so measuring the movement of the particles is tantamount to measuring the movement of the fluid. The laser anemometer just described, in common with other types of anemometer, suffers from three intrinsic and

serious drawbacks. First, although the rate at which particles move is measured, the direction in which they move is not discovered. Second, the anemometer gives wrong information in cases where the turbulent fluctuations of the flow (which can be thought of as the random movements of tiny eddies of fluid super-imposed on the bulk flow) are about the same size as the average flow. In such instances small pockets of fluid move, momentarily, in a direction opposite to the bulk flow. The anemometer, unable to distinguish between pockets of fluid flowing in opposite directions, treats all pockets as travelling in the same direction and gives an incorrect value for the average flow. Third, the instrument is embarrassed by stagnation regions, such as occur at the centre of vortices, where no particles

Figure 3. Wave-theory representation of two laser beams crossing. Light and shaded bars show the wave-fronts of alternating electric potential. In the cross-over region the two beams reinforce one another along A-A' but cancel out along B-B' and C-C'. The cross-over region therefore consists of a pattern of light and dark fringes parallel to A-A'.

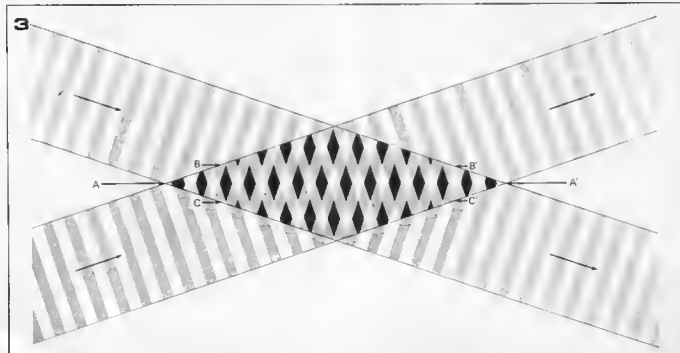

## SELEKTOR

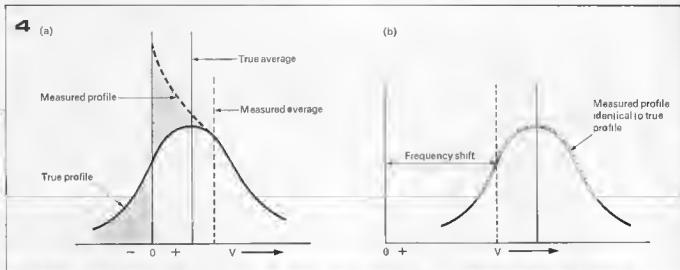

Figure 4. Frequency-shifting gives less anemometry a considerable advantage when dealing with highly turbulent flows. In (a) flow velocities  $V$  are plotted against the fractions of fluid travelling at those velocities. The plot shows some of the fluid to have a negative velocity; that is, it moves against the main flow. An anemometer unable to distinguish between positive and negative velocities would count negative values as positive and give a wrong average value. By shifting the frequency, as in (b), all velocities are made to appear positive and the measured profile is the same as the true one. Bias introduced by this technique is subtracted later to give the true velocities of the fluid.

Figure 5. (a) Optical system for measuring the steady-flow pattern set up when air is forced through a diesel-engine inlet port, past the valve and into a transparent cylinder. A laser beam is split in two and the beams directed to meet at a point. A particle moving through the fringe system formed in the control volume scatters light in a stream of pulses at a rate which is a measure of the particle velocity. The scattered light is collected by a lens and detected by a photo-multiplier, and the pulse rate is worked out by an electronic signal processor. (b) Optical measurement of gas velocity from back-scatter uses the same principle as that for forward scatter.

cross the fringes and no signals are recorded. All three difficulties can be overcome by causing the fringe system itself to move in a direction at right angles to the fringes. Suppose, then, that the fringes are made to move faster than any pockets of fluid that are present. Particles moving in the same direction as the fringes will appear to be moving very slowly, and particles moving in the opposite direction will appear to be moving very fast. If the bias introduced by the fringe motion is then allowed for, the true velocities of the particles can be found. This resolves the ambiguity in the direction of motion, and permits valid measurements to be made in highly turbulent flows.

Stagnant regions are no longer a problem because fringes are swept past the particles; if there are particles, there will be signals. The fringes can be moved within the control volume by making the two incoming laser beams have slightly different optical frequencies, a technique known as frequency-shifting. It can be done either by inserting an electro-optical device, such as a Kerr cell, into the path of one of the beams, or by using a rotating diffraction grating as the device for originally splitting one laser beam into two.

#### Substantial Advantages

The device of shifting the frequency, coupled with an inherent lack of sensitivity to heat released within the

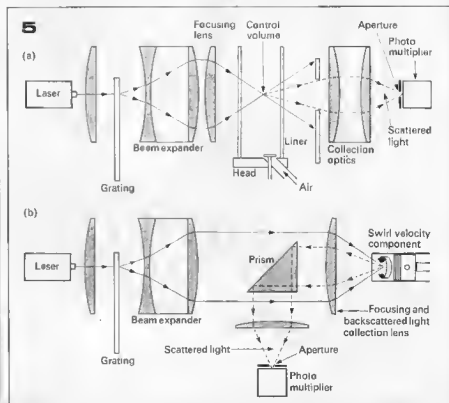

# SELEKTOR

system under study, gives the laser anemometer substantial advantages over other techniques in the study of complex and/or combusting flows. The laser technique interferes to only a very slight extent in the normal working of the system under study, although it does require optical access; inserting windows is often a serious problem. It is sometimes necessary to 'seed' the flow with extra scattering particles to speed up the measurements.

Typical optical arrangements for making laser anemometry measurements are shown in figure 5. Small particles scatter light in all directions, but mostly forward. The easiest way of conducting an experiment is therefore as shown in the first diagram (5a), which shows the measurement of the steady flow-pattern produced when air is forced through a diesel engine inlet port, past the valve and into a transparent cylinder. But such an arrangement is often impracticable in engineering work, for it needs two transparent windows. The so-called back-scatter technique is shown in figure 5b. The scattered light is collected through the same window as is used for the incoming beams. Optical access problems are greatly reduced, but because the light scattered in the backward direction is 1000 times less than that scattered in the forward direction, the measurements themselves are a lot more difficult.

At Harwell, the Research Laboratory of the United Kingdom Atomic Energy Authority, we have had a great deal of experience, over a long time, in applying laser anemometry to the study of gas and liquid flows in difficult environments met with in engineering. Towards the end of 1976 we were given the task of demonstrating that laser anemometry could be applied to the study of internal combustion engines. The work was funded entirely by the UK Department of Industry, and we have been advised and guided by a panel of senior engineers drawn from the UK motor industry. Imperial College, London, has collaborated in several aspects of the work.

So far, our internal combustion engine project has been highly successful. Demonstration experiments have included the measurement of gas flows in the manifold of a motored petrol engine, in the cylinder of a research petrol engine (motoring and running), and in the cylinder of a motored production diesel engine. (By motored, I mean that the engine is turned over at normal working speeds by an electric motor, without combustion in the cylinders.)

#### The problems

The first problem to be considered is that we need to know what is happening

at specific parts of the engine cycle, a substantial but tractable problem for modern electronics. Each particle passing through the control volume produces a train of light pulses, which are collected in a photo-multiplier and converted into a train of electrical pulses. The pulse repetition frequency is measured and the information is fed into an electronic store. Simultaneously, a device attached to the crank-shaft of the engine is made to produce either a stream of timing pulses, or a digital code providing instantaneous identification of the point reached in the engine cycle. The timing information can be handled in several ways. The pulses can be used to direct the signals from the photo-multiplier to any one of a number of separate electronic stores, each corresponding to a different part of the engine cycle, or the timing device can be used to 'label' each signal from the photo-multiplier with a code identifying the point in the engine cycle at which the signal originated.

Many optical techniques of studying engines suffer from the fact that viewing windows become sooted up during running, and tend to collect droplets of fuel, smears of oil, and so on. Laser anemometry manages to surmount the problem of dirty windows because it depends upon measuring the repetition frequency of light signals rather than their intensity.

With modern techniques, repetition frequencies can be determined from very weak signals. The problems of fuel and oil films or droplets on viewing windows, and of stray reflections from internal surfaces, are solved largely by careful focusing of the image of the control volume onto the collection aperture of the photo-multiplier. This ensures that light originating from anywhere other than the control volume is strongly defocused. Light emitted during the combustion process can be removed by optical filtering. Engine vibration is not a problem because the dimensions of the control volume are such that the time particles take to cross it is short compared with the time taken for the engine to move significantly through vibration. The main effect of the vibration is to cause the whole of the control volume to oscillate slightly in relation to the engine. In practice this means that the results obtained are averaged over a volume of several cubic millimetres, which is acceptable.

#### Other Optical Techniques

Air-flows represent only a small part of the picture. Clearly, to understand the fuel-air mixing process, for example, it would be necessary to be able to measure the sizes of fuel droplets and the way they evolve. Although

commercial instruments are available for measuring droplets, they are mostly unsuitable for engine work. We are developing an instrument for measuring, simultaneously, the size and the velocity of fuel droplets, as functions of crank-angle, inside engines. If successful, such an instrument would be able to examine how well fuel droplets of various sizes follow the gas flow, a matter that is fundamentally important.

Knowing how fuel droplets of various sizes move in an engine would provide much of what needs to be known about the mixing of fuel and air; but the picture would still be incomplete, for little would be known about the vaporized fuel. We are hoping to develop laser-Raman scattering to the point where it can be used to discover the concentrations of fuel, oxygen, nitrogen, carbon dioxide, carbon monoxide and so on in the vapours inside engines. The technique, which depends upon the propensity of gas molecules to extract small, discrete amounts of energy from passing beams of light, has been demonstrated successfully upon simple flames, but the application to real engine problems may be several years away.

(Spectrum no. 159.)

(448 S)

#### Booze from STC?

A huge underground reservoir beneath one of Standard Telephones and Cables' factories in South Wales supplies water of such quality that the company is supplying it to blenders of whisky, rum, gin and brandy.

The first tanker load of water has been shipped to Avery's of Bristol where it has been used in the reducing process of 750 cases of malt scotch whisky destined for the United States.

STC's telephone cable factory in Newport, Gwent, uses over 40,000 gallons of water a day in its manufacturing processes. When the 1976 drought threatened production, STC had to look for an alternative water supply. The company found the reservoir under its own factory and the Welsh Water Authority granted STC a licence to abstract up to 18 million gallons of water a year.

Subsequent tests have shown that the natural untreated water is completely free of bacteria. The water is filtered only to prevent any possibility of discolouration from the sandstone through which it passes.

(452 S)



# μP TV games

## Doing battle with chips.

'Chips', in the electronic sense, used to be transistors. Then came the Integrated Circuit, quickly followed by 'MSI ICs' (Medium Scale Integration Integrated Circuits) — quad opamps, for instance. Inevitably, these were followed by 'LSI ICs' (Large Scale Integration): complete alarm clocks, TV games and microprocessors. It's amazing how much circuitry manufacturers can squeeze onto a 'chip' nowadays!

However, microprocessors have posed an unexpected problem. We've got them, but very few amateur electronics enthusiasts seem to know what to do with them! The best approach would appear to be to simply use them as 'complicated integrated circuits', build something interesting around them, and quickly proceed to forget what particular component makes the unit tick. That particular approach is what we have in mind with the circuit described here. Once completed, it is a box with a keyboard and joystick controls; after playing some 'space sounds' off a tape or disc into it, it becomes a sophisticated TV games machine — with full colour, all sorts of 'object shapes', score-on-screen and sound. At a later date, it should also create an irresistible urge to 'program' ones own games. This will prove to be relatively easy: the unit just happens to contain what microprocessor 'freaks' call 'comfortable monitor software'.

The TV games computer contains a microprocessor — μP for short. So be it. There's no reason to be scared of μPs — they don't bite! Furthermore, absolutely no knowledge of microprocessors is required to have fun building and using this unit. At the same time, it offers a unique possibility of getting to grips with μPs at a later date, simply by exploiting its capabilities to the full.

This article is intended as a basic introduction to the unit.\* The descriptions of what it does — and how — are sufficient for those readers who want to build and use it with the TV games programs available via the Elektor Software Service (ESS). A much fuller description, for those who want to develop and program their own games, will be supplied with the p.c. board (and is also available separately — for those who have access to facilities for etching double-sided boards with plated-through holes ...).

For many of our readers, however, we expect that this information will be of little interest at present, so we do not intend to publish it in Elektor. Let's concentrate on what it does.

It's great fun! For some time now, we've had a working prototype set up in our offices and our editorial staff regularly crowd around as two colleagues engage in a heated battle of wits. We've also got a solo game — man against machine — which is basically an extended version of noughts and crosses. It's called 'four in a row'. The 'machine' has proved to be a formidable opponent ... What, exactly, can it do? Well ...

### What it does

The unit is intended for TV games. This means that it must create a (colour) picture on a standard (PAL) TV set, corresponding to some game — man against man or man against machine. The effect — and the fun — can be enhanced by including sound effects. Games can be won or lost, so a 'score' display is also required.

The first requirement for a 'game' display are 'objects' on the screen. In early TV games, these consisted of two vertical bars (bats) and a small square (ball). Nowadays, complete cowboys, battleships or jet aircraft are more in demand. The TV games computer can cater for all tastes.

A single 'object' can consist of up to 80 squares in an 8 x 10 rectangle (see table 2). By filling in the necessary squares, quite detailed objects can be displayed: as an example, in figure 1 a locomotive fills the centre of the screen. The same object can be repeated in different parts of the screen; furthermore, several sizes are available: the little steam engine at the bottom of the screen in figure 1 is a scaled-down version of its big brother in the centre. To be more precise, any object can be displayed in four different sizes: 1:1, 2:1, 4:1 and 8:1.

The shape of the object can be re-programmed quite rapidly, so that the same 'section of memory' can produce several different objects (or object sizes) in the same picture. However, this is a complicated system for microprocessor specialists only; for most users it is more interesting to know that four completely different objects can be 'stored' simultaneously. A battleship, submarine, jet aircraft and 'missile', for instance; or, for a more peaceful game, two footballers, a goal (displayed twice) and a ball.

The colour of the objects can also be determined according to personal taste: a choice of eight colours is available.

Table 1.

#### The TV games computer in a nutshell

- both joystick and keyboard control;
- video output suitable for PAL colour TV receivers (UHF and VHF input);
- sound effects via built-in loudspeaker;
- microprocessor controlled, and therefore programmable for a wide variety of games;
- cassette interface included, for easy loading and storing of programs (e.g. ready-made games supplied through the Elektor Software Service);
- extensive monitor software.

\* The actual constructional details are given in a companion article elsewhere in this issue.

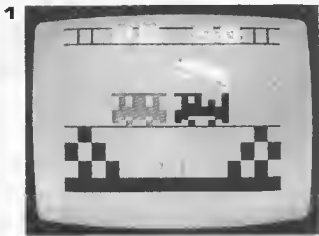

Each of the primary colours (red, green and blue) can be selected independently, so that the various mixtures are also available; for instance, red plus green equals yellow. All in all, red, green, blue, three mixtures (orangy-yellow, greeny-blue and purple), white and black can be produced.

For most games, objects are not enough: a 'background' is also required. This may consist of anything from a partial boundary to a complete cross-hatch pattern. Building up the desired background with the TV games computer is similar, in many ways, to building up an 'object'. Basically, the background consists of 160 squares: 10 rows of 16 squares each. Each square is defined by its upper and left-hand sides: the right-hand side and bottom 'belong' to the adjoining squares. Any of these sides can be displayed, as required; furthermore, by 'widening' the left-hand edge it is possible to fill in the entire square.

This system can be used to create a wide range of different background patterns. A few examples are shown in figure 1: all the squares along the bottom row have been 'filled in' to produce a solid edge. The checker-board pattern in the lower left- and right-hand corners is achieved by filling in alternate squares; the cross-hatch along the top consists of the sides of the corresponding squares only. Various other horizontal and vertical lines, bars and dots are all variations on the same theme.

The colour of the general background 'between the lines' and that of the lines

themselves can both be chosen independently. As before, a choice of eight colours are available. The only restriction is that if the same colour is chosen for both background and 'object', the latter will not be visible!

The final point, as far as the picture is concerned, is the possibility of displaying the score. The TV games computer offers four alternative display modes, each consisting of four digits. These digits can be displayed either at the top or at the bottom of the picture; furthermore, they can be used either as a single four-digit number (e.g. 2650) or as two two-digit numbers (26 50).

In figure 1, the latter option is displayed at the top of the screen.

The colour of the 'score display' is always chosen to contrast with the colour of the background lines.

So much for the picture. However, this by no means exhausts the capabilities of the games computer. As mentioned earlier, sound effects can also be included: the unit contains a 'programmable squarewave generator' that can be used to produce all kinds of squawks and whistles via a small built-in loudspeaker. In most games, the score depends to a large extent on 'hits' and 'misses'. In this unit, collisions between each object and any other object or the background are all detected and stored individually. This information can be used for a variety of different effects, quite apart from up-dating the score. Suitable sound effects can be triggered; an object can be made to change shape, disintegrate, or simply disappear; the back-

Figure 1. This photo illustrates the various display possibilities of the TV games computer.

ground can be altered; and so on. For instance, in a particularly war-like game like a shoot-out between two cowboys, each time one of them is 'hit' he could fall down and then proceed to float slowly up to and off the top of the screen - to the accompaniment of 'heavenly' music!

The facilities discussed so far are the basic 'pieces' out of which a game can be constructed. For an exciting game, the picture and sound must be modified continuously - as the players manipulate their joy-stick controls and/or keyboard. This is where the 'brain in the box' comes in: once the microprocessor has been programmed for a particular game it will set up the necessary objects and background, monitor the signals from the players' controls and detect any 'collisions', and proceed to modify the display, add sound effects and update the score accordingly. The beauty of this system is that merely running a new program from tape into the machine is sufficient to obtain an entirely different game - with the number of possible games being virtually unlimited!

Furthermore, the microprocessor is sufficiently 'intelligent' to be a formidable opponent in solo games (man against machine), provided the rules of the game are not too complicated: the memory in the basic unit is insufficient for games like chess.

Having discussed, in general terms, what the 'games computer' can do, the next step is to find out how. In other words, what makes it tick?

Table 2.

**Pictura composition, basic facilities**

*Four different 'objects', each of which:*

- consists of up to 80 squares in an 8 x 10 rectangle,
- can be located simultaneously at different positions on the screen;
- can be displayed in four different sizes (x1, x2, x4 or x8);
- can be displayed in any of eight different colours.

*A 'background', consisting of:*

- a cross-hatch pattern 10 x 16 squares, any parts of the horizontal and vertical lines can be displayed or suppressed as required, and the squares can be partially or wholly filled-in; eight colours are available;
- a general background 'between the lines', once again with a choice of eight different colours.

*A 'score' display:*

- four digits at the top or bottom of the screen;
- displayed as two two-digit numbers (e.g. 14 92) or as one four-digit number (e.g. 1492).
- displayed in the complementary colour to the lines in the background.

2

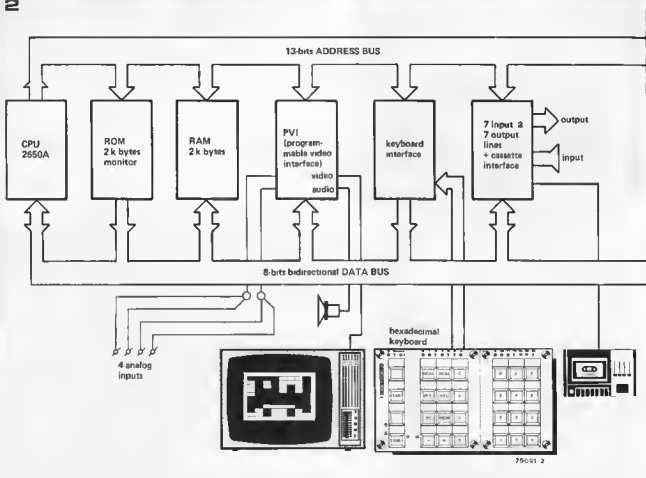

### How it works

At this stage, we only intend to give a very broad outline of the operating principles. Some more detailed explanations will be given later; a truly complete description is outside the scope of this article — it is available separately, as mentioned earlier.

A functional block diagram is shown in figure 2. In the first block, 'CPU' stands for Central Processing Unit. This is the actual microprocessor chip — the 'brain', in other words. It controls all the other units, calling them up as required via the 'address bus'. Although microprocessor specialists seem to take particular delight in describing this type of process in (mistifying) jargon, it is basically a fairly straightforward circuit. Code locks and code switches are fairly well-known, and several circuits have been published over the years.

Imagine, now, that each of the other blocks contains one or more of these code switches. When the correct code appears at the input of one of these switches (i.e. power on the correct lines and no power on the wrong ones), the switch operates and the corresponding part of the block is turned on. Provided each individual circuit in the whole unit is operated by its own code switch with its own unique code, the CPU can turn on any one of them by simply putting the correct code on the address bus.

A 'brain', on its own, is fairly useless. A 'memory' is also required, and two

different memories are actually available in this unit. The first is a 'ROM' (Read Only Memory); it contains all sorts of 'standard reference' information — how to read programs off a tape and how to store them on tape, for instance. The second block of memory is labelled 'RAM', which stands for 'Random Access Memory'. Information can be stored here and recalled as required; its primary use is for storing the program for a particular game, as well as information that changes in the course of each game — such as the scores.

CPU, ROM and RAM could be called the 'internal organs' of the unit. On the outside, there is a TV set, a keyboard, a joystick, a loudspeaker and a tape recorder. In computer language, these are all called 'peripherals'. None of these, of themselves, can be controlled by the CPU — a very unsatisfactory state of affairs. This failing is rectified by adding suitable conversion and switching units between the peripherals and the computer proper. Once again in computer language, this type of 'buffer unit' is called an 'interface'.

Going back now to the block diagram, the remaining sections require little further explanation. The fourth block is labelled 'PVI' (Programmable Video Interface); it is the 'interface' which provides the outputs for the TV set and the loudspeaker. It also takes care of the analog inputs from the joystick controls. The next block, the 'keyboard in-

terface', is exactly what its name implies. Finally, an unnamed block takes care of the remaining in- and outputs — the tape or cassette recorder in particular. The other 7 pairs of in- and output lines from this block can be disregarded for the present.

The text '8-bit bidirectional databus' in the link along the bottom of the blocks is another piece of computer jargon. It signifies that output signals from the various sections can be passed along to other units — the arrows illustrate the possibilities. The CPU, for instance, can receive information from any of the other blocks, or it can itself provide information. By contrast, the ROM and the keyboard can only provide information (on request, when called up via the address bus).

The way in which the various units work together (under central control of the CPU) is best illustrated by an example.

### Painting by numbers

Take the steam engine in figure 1. How do you go about getting it on the screen?

The picture on the screen is determined by information stored in the Programmable Video Interface (PVI). However, this unit will not accept information from the keyboard, or even from the keyboard interface, and so for the purpose of this explanation we will have to

3



Horizontal position of object  
 Horizontal position of duplicate (off screen)  
 Vertical position of object  
 Vertical offset of duplicate (off screen)  
 Size of object  
 Colour of object (red)

binary code	hexa-decimal code	(final) address in PVI	(temporary) address in RAM
11110001	F1	1F00	0A00
01010001	51	1F01	0A01
01010101	55	1F02	0A02
01110101	75	1F03	0A03
01111111	7F	1F04	0A04
11111111	FF	1F05	0A05
11111111	FF	1F06	0A06
11000111	C3	1F07	0A07
10100101	A5	1F08	0A08
00100100	24	1F09	0A09
10000000	80	1F0A	0A0A
11111111	FF	1F0B	0A0B
01001111	4F	1F0C	0A0C
11111111	FF	1F0D	0A0D
11000000	C0	1FC0	0AC0
00100000	20	1FC1	0AC1

78081 3

Figure 2. Functional block diagram of the unit.

Figure 3. Painting by numbers!

resort to a trick: the RAM (the section of memory in which we can store any desired information) will be used as a go-between. First, however, let us see what information the PVI requires.

Without going into too much detail... Obviously, the shape of the 'object' is the first thing to look at. As stated earlier, any object is built up in an 8 x 10 rectangle: 8 horizontal and 10 vertical divisions. At this point, computer jargon becomes useful: it can be used as shorthand. A 'bit' is a single unit of information: voltage present or absent on a particular wire; for digital systems, '1' or '0' respectively. A certain number of bits (the number of bits depending on the system in question) is called a 'byte'.

For the 'games computer' a byte consists of 8 bits; in other words, all information along the data bus is passed in groups of 8 bits, each being 0 or 1.

Each row in the 8 x 10 rectangle for one object consists of 8 squares. Each of these squares corresponds to one 'bit', so a complete row is one 'byte'. Therefore, 10 bytes are required for one object. If we take a closer look at the locomotive (figure 3), the top row consists of four squares, followed by a three-square gap and one final square. The bit corresponding to each filled-in square is '1', so the first byte is 11110001.

This 'binary number' can also be written in shorthand. Reading from right to left, the first bit counts for 1, the second for 2, the third for 4 and the fourth for 8. These four bits, added, can therefore correspond to any number between 0 and 15. So-called hexadecimal numbers also run from 0 to 15: the numbers from 0 to 9 are followed by the first

letters of the alphabet - A is 10, B is 11, and so on. Reading the first byte as two groups of four bits, we can therefore use hexadecimal numbers as shorthand:

1111 = F and 0001 = 1, so the first byte is F1.

Using this system, the complete picture can be described as 'F1, 51, 55, etc.', as shown in figure 3. So far so good: we can now describe any object by means of ten (hexadecimal) numbers. However, these numbers must be stored in a section of the PVI that will be 'addressed' by the CPU when it decides that an object should be displayed. The 'addresses' within the PVI (and anywhere else, for that matter) are also given in hexadecimal numbers. The ten bytes corresponding to the shape of the first object are stored in the PVI at addresses 1F00 through 1F09. The following four addresses (1F0A through 1F0D) are used to store the horizontal and vertical position coordinates of the object and any desired duplicate(s); two further addresses (1F0E and 1F0F) are used as 'scratch-pad memory' (for the moment, they are best forgotten) and the shape of the second object is stored at addresses 1F10 through 1F19. And so on.

The position of the object has been mentioned briefly. This is determined, quite simply, by the distance from the top left-hand corner of the screen to the top left-hand corner of the 8 x 10 rectangle. The picture is divided into 227 horizontal and 252 vertical units; the horizontal and vertical displacement of the object are determined by the numbers stored in bytes 1F0A and 1F0C

respectively (for the first object) - the horizontal coordinate and the vertical offset (with respect to the main object) of a duplicate are stored in bytes 1F0B and 1F0D.

The first two bits in byte 1FC0 determine the size of the first object (the third and fourth bit - from the left - are for the second object, and so on).

'00' is the smallest size, '01' is twice as large, '10' is x 4 and '11' is x 8.

Finally, the colour of the objects is stored in bytes 1FC1 and 1FC2. Reading from right to left, the first three bits determine the presence or absence of each of the primary colours in object 2; the next three bits determine the colour in the first object; the two left-hand bits are unused.

Now, let's cut a long story short. We know what information the PVI needs; let's put it there and see what happens. Utilising the 'monitor software', present in the ROM, the necessary information can be stored in the RAM - after which the CPU can be instructed to transfer this information to the PVI, to produce the required picture on the screen.

The information is typed in via the keyboard, as shown in table 3. Basically, the complete section of memory between addresses 0A00 and 0ACA is first erased, after which the correct information for the desired object is stored in the Random Access Memory (starting at address 0A00). Finally, a brief program is started that causes the CPU to transfer the requisite information from the RAM to the PVI - and the picture appears on the screen.

The explanations given in the table are

Table 3.

This program can be used to produce an 'object' on the screen. It is entered via the keyboard as follows:

keystroke(s)	display on screen	explanation
reset, start	1111	start 'monitor' program
MEM	Ad-	user: 'I want to store a program in memory'. Computer: 'What is the first address?'
0, 9, 0, 0	Ad= 0900	The first address is 0900.
+	0900 xx	Roger. What data? 'xx' is the data already stored here).
0, 5	0900 05	The first 'data byte' is 05.
C; A	0901 CA	The second is CA.
0, 8	0902 06	etcetera.

'Typing errors' are easily corrected: the '-' key can be used to 'step back'. For instance, if the first two data bytes were keyed in as:

0, 5	0900 05	So far, so good.
C; B	0901 CB	Wrong!
-	0900 05	} Back step.
+	0901 CB	
C; A	0901 CA	That's what I meant
0, 6	0902 06	etcetera

The complete program is as follows:

address	data	explanation
0900	05CA	} Load the PVI with the data stored in the RAM under addresses 0A00 through 0ACA.
0902	06CA	
0904	0D4A00	
0907	CD7F00	
090A	FA78	
090C	0C1E88	} Return to the 'monitor' program if the '-' key is operated.
090F	4418	
0911	9970	
0913	1F0000	
0916	0400	
0918	05CA	} Store '00' in all RAM addresses from 0A00 through 0ACA (i.e. erase this section of memory).
091A	06CA	
091C	CD4A00	
091F	FA78	
0921	04EE	
0923	CCAC0C	} Disable 'score' display (by storing 'impossible' numbers - FF - in the score bytes 0AC3 and 0AC5).
0926	CCAC09	
0929	0400	} Make the screen blue (by storing 09 in byte 0AC6).
092B	CCAC0C	
092E	0402	} Determine the size of the object (02 = half-size).
0930	CCAC0C	
0933	1F0000	Go to first section of program (load PVI): start address 0900

Having loaded the program to this point, the PVI can be 'cleaned out' by using the 'erase' program starting at address 0916, as follows

keystroke(s)	display	explanation
PC	PC = 0000	'I wish to run a program ...
0, 9, 1; 6	PC = 0916	... starting at address 0916'.
+	(blue)	The program is running.
-	PC = 0916	Back to the 'monitor' program.

The rest of the program can now be stored, using the same routine as before: 'MEM', followed by the first address (0A00), '+' and then the 'data' (F1, 51, etc.).

address	data	explanation		
0A00	F1	} This data describes the shape of the first object - the steam engine (see figure 3).		
0A01	51			
0A02	55			
0A03	75			
0A04	7F			
0A05	FF			
0A06	FF			
0A07	C3			
0A08	A5			
0A09	24			
0A0A	00	} Horizontal position of object.		
0A0B	FF		} Horizontal position of duplicate(s) (off screen).	
0A0C	4F			} Vertical position of object
0A0D	FF			

This object can now be displayed on the screen, by using the 'load PVI' program starting at address 0900. Keystrokes, as before, PC; 0, 9; 0, 9, +.

After operating the '-' and 'MEM' keys, up to three more objects can be stored (starting at addresses 0A10, 0A20 and 0A40); a background can be added (from address 0A80); the sizes and colours of the objects can be varied (0AC0, 0AC2); background and screen colours can be chosen (address 0AC6) - note that the background will only appear

if the second data 'number' is 8... F); finally, data in address 0AC7 determines the sound. Note that it is possible to step to and fro through the memory without changing data by operating the '+' and '-' keys. If complete chaos results, the 'erase' program can be run - from address 0916. Have fun!

intended as a challenge: by playing around with the shape, colour, position and size information all sorts of other objects can be created. Have fun!

## Background

The background is programmed in much the same way as an object. It was mentioned earlier that the background consists of 160 squares: 10 rows of 16 squares each. Each square is defined by its top and left-hand edges, so that there are 320 edges in all; each of these can be selected independently, by setting a corresponding bit in the PVI to '1'. The 16 edges in one row correspond to 16 bits - two 'bytes', in other words. For one row of squares, two bytes are therefore required for the upper edges and two further bytes for the left-hand sides; the 10 rows thus require 40 bytes in all.

As illustrated in figure 4, the addresses of these bytes run from 1F80 and 1F81 for the first row of 'upper edges' to 1FA6 and 1FA7 for the last row of 'left-hand sides'. As when 'programming' for an object, storing 1111 1111 (= FF) in both the first and second bytes (1F80 and 1F81) causes the whole first row of 'upper edges' to appear on the screen. Similarly, 'FF' and '2A' in the third and fourth byte, respectively, will produce the pattern of left-hand edges shown.

Unlike the situation when displaying objects, the size and position of the background are, of course, fixed. The size of the individual lines can, however, be varied. Starting from the top of the picture, one bit is used to determine whether the first row of 'top edges' appears as full-width lines or whether each 'edge' is shortened to a dot. A second and third bit can similarly widen the upper and lower halves of the left-hand edges to fill the adjoining square. The next row of squares is dealt with in the same way, using three more bits. Finally, two further bits can be used to widen all the lines (top edges and left-hand sides) in the first two rows, to either  $\frac{1}{2}$  or  $\frac{3}{4}$  the width of a square.

To sum it up: 8 bits - one byte - determine the width of all the lines in the first two rows. Four further bytes take care of the other four pairs of rows; the addresses of these five bytes run from 1FA8 to 1FAC.

The various possibilities are shown in figure 4. The information given in hexadecimal numbers to the left of the drawing determines which lines appear; it is stored under the 40 corresponding addresses. To the right of the picture, the addresses and contents of the five 'horizontal extension bytes' are listed.

One final point remains to be discussed, before the background can be conjured up on the screen: the colour. One byte in the PVI takes care of this (address: 1FC6). From right to left, the first three bits determine the presence or absence of the three primary colours in the general background between the lines

4

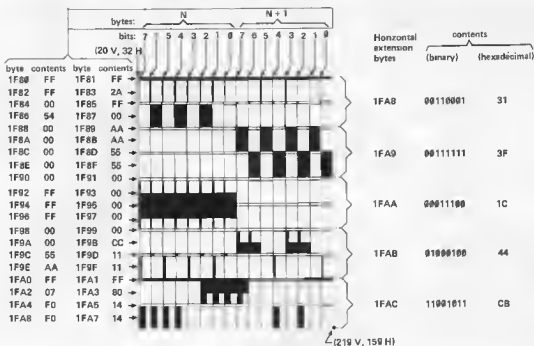

background colour: byte 1FC6, contents: 00101001 = 29 (green lines on blue screen)

79081 4

5

score format and positioning

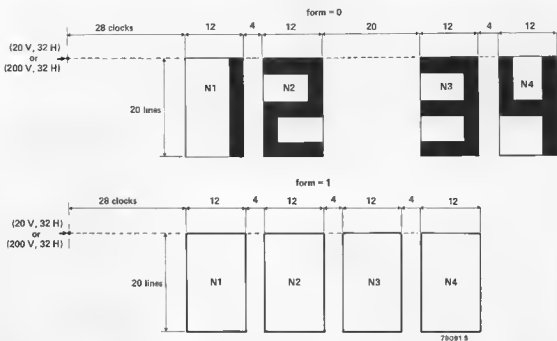

79081 5

Figure 4. The background can be constructed from a wide variety of horizontal and vertical lines, squares and dots.

Figure 5. The score display: two groups of two digits or one group of four.

(‘screen’); the fourth bit turns the background lines on and off (‘background enable’) – note that, unless this bit is 1, no background at all will appear!

The fifth through seventh bits determine the colour of the lines in the background; the last bit is unused.

Using the same principles outlined earlier (table 3, in particular) it is now possible to produce any desired background pattern, by entering the necessary information into the PVI (again using the RAM as go-between).

### What's the score?

Displaying the score on the screen is simplicity itself. As mentioned earlier, the score consists of four digits. The first two are stored in the PVI under address 1FC8 (four bits for each digit); the second pair in byte 1FC9.

The only other points to determine are the position and type of display required. In byte 1FC3, the extreme right-hand bit determines the position: 0 for the top of the screen and 1 for the bot-

tom. The second bit in the same byte determines the score format. As shown in figure 5, a 0 causes the score to be displayed as two two-digit numbers; a single four-digit number is obtained by storing a 1 at this bit.

No other possibilities for position or size are available, and the colour is identical to that of the background lines. In most cases, these limitations do not pose too much of a problem. However, if more flexibility is required, it is of course quite possible to use one or two of the 'objects' to create a score display of any size, shape or colour and in any position!

## Collisions

The score and sound effects will depend to a large extent on collisions. When an object hits the background, this is detected and a bit corresponding to that object is set to 1. For the four objects, the four left-hand bits in byte 1FCA are used for this purpose. Similarly, the six right-hand bits in byte 1FCB are used to signal inter-object collisions.

The CPU can 'read' these two bytes as required, and use the information to update the score, change the direction of travel of an object, add sound effects, and so on.

## Sound effects

The only sound produced is a square-wave. The frequency is determined by an 8-bit number, stored in byte 1FC7 in the PVI. If the number is zero (00), no sound is produced; otherwise, the output frequency is determined by the value stored. To be precise, the frequency equals

$$f_0 = \frac{7874}{n + 1}$$

where  $n$  is the value stored in the 'sound byte'. For instance, if  $n = 01$ , the output frequency will be approximately 4kHz; as higher numbers are stored the frequency decreases, until for the highest value (FF) the output becomes approximately 30Hz.

At a later date, other sound effects can be added if required. Although the games computer itself cannot produce them, it has other outputs that are unused at present. These can be used to trigger external sound effect generators.

## Instructions for use

Having seen, in general terms, what the games computer can do and how it does it, the next step is to get it on the job. Assuming that the complete unit has been built, adjusted and connected up to the TV set as described in the companion article, it is now time to start typing instructions on the keyboard (figure 6).

For the moment, the most important 'procedure' to know is how to transfer programs from an ESS record (or tape) to the memory in the computer. After switching on, the keys 'reset' and 'start' are pressed, whereupon the letters 'IIII' should appear at the lower lefthand corner of the screen. The machine is now ready for programming.

Each program on tape or disc is preceded by a so-called 'file number'. This is a single hexadecimal digit (not 0), and is intended as an aid when looking for one particular program out of several on the same tape. Having operated the reset and start keys, the rest of the procedure is therefore as follows:

- press the 'RCAS' key ('Read Cassette'). The computer will respond by asking for the file number of the program: 'FIL = '.
- type in the desired file number;

- operate the '+' key;
- start the tape at some point before the start of the desired program.

The file number will now appear at the top of the screen ('FIL + 3', for instance) and the machine will start its search for the correct program. If it finds other file numbers first, it will display these on the screen; meanwhile, two dots under the '+' sign will flash rapidly. As soon as the correct file number is located it will proceed to store the following program; this is indicated by the fact that the two dots now flash slowly. When the complete program has been stored, the text 'PC = 0916' (for instance) will appear; the four-digit number is the so-called 'start address' for the program, as specified on the tape. As soon as this text appears, - the '+' key is pressed. This starts the program and, with it, the game!

Should an error occur while the program is being read from the tape, the transfer is stopped and the text 'Ad = 0D00' (for instance) will appear. The number signifies the first 'address' in the group of instructions ('block') where the error occurred. In this case, the tape must be wound back and the whole procedure repeated.

None of the other keys will normally be required until one starts writing programs. At that point, the more extensive information supplied with the p.c. board will be required anyway, and it contains full details on how to use the 'monitor' program. However, to satisfy initial curiosity, we can run through them quickly:

- WCAS, which stands for 'Write Cassette'. This key is used when storing programs on tape. The machine will first want to know the first address in the program (BEG =); then the last address (End =); then the so-

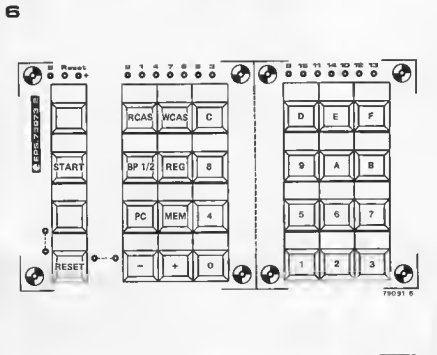

Figure 6. The keyboard.

# car light reminder

- called start address (Sad =); and finally the file number (FIL =).
- BPI/2: this key is used for inserting so-called break points in a program, as an aid to 'debugging' it.
- REG: this is used for checking or altering the contents of seven 8-bit 'registers' and a 16-bit 'status register' in the CPU.
- PC, for 'program counter'. This key can be used for entering the 'start address' of a program; when a program has been copied from tape, this will normally have been taken care of automatically.
- MEM, the 'memory' key. This is used when storing a 'home-brew' program in the memory by means of the keyboard. It was also used in the programming example given earlier (table 3).

So much for the keyboard. For that matter, so much for this introductory article! All that remains is for us to express our hope that everybody will get as much fun out of this 'playful computer' as we have!

## M. Penrose

There are many different designs for alarm circuits which remind the motorist to switch off his lights before leaving the car. The advantage of the circuit presented here is that no extra components have to be connected in series with the existing wiring, so that it will not effect the operation of the car electrical system. Furthermore the circuit is extremely simple, consisting solely of a DC buzzer, a double-pole double-throw switch, and a handful of diodes (depending upon the number of functions to be monitored).

The accompanying circuit diagram shows how the car headlamps, sidelights, fog lamps, and beater rear windscreen can be monitored. Note however that the circuit will not indicate if the above functions are actually working!

With S1 in the position shown in the diagram, the buzzer will be activated the moment the engine is switched off and one of the monitored functions is left on. Switching off the function

concerned also cuts the buzzer.

If one wishes to leave a particular function on, e.g. the parking lights, then S1 should be switched to its alternative position, whereupon the buzzer is disabled until the engine is started again. The alarm can then be re-armed by switching S1 back to its original position.

Normally there is a resistance ( $R_L$ ) in parallel with the ignition system (as a result of the various dashboard indicator lights, fuel gauge etc.) which is sufficiently small to ensure that the buzzer will be activated in the event of the contact breaker coming to rest in the open position when the car is stopped. If, however this resistance is too large, a 100...200  $\Omega$  resistor (2W) can be connected in parallel with  $R_L$ . It may be preferable to use a small lamp - roughly 0.1 W/12V - since due to its positive temperature coefficient, the more power it dissipates, the greater its resistance becomes.

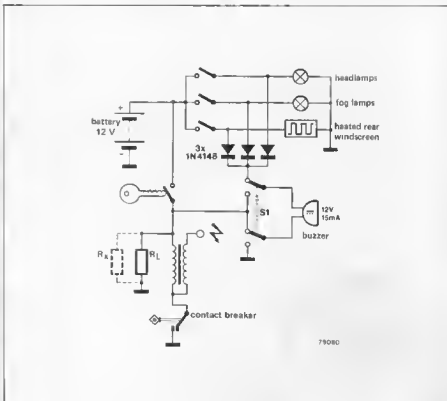
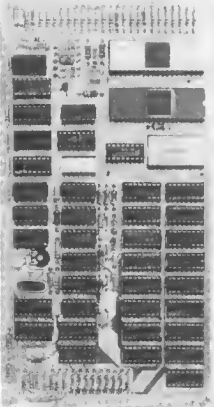



# stantor

In Homer's Iliad, Stentor is the name of one of the Greeks at Troy, who it is said had a voice louder than that of 50 men. Stentor thus seemed a suitable name to call the amplifier described here, which to continue the analogy, provides the power of 50 transistor radios! The distinguishing feature of this amplifier is that it is portable (!) since it can be powered from a normal 12 V car battery and is therefore ideally suited for open-air P.A. work.

There are a number of situations in which high output power amplifiers are required, but where connection to a mains outlet is either difficult or downright impossible. One need only think of e.g. political meetings and demonstrations, fêtes, school sports days, processions etc. The Stentor has therefore been designed specifically to meet the requirements of 'bags of Watts' and portability. Excluding the use of a mains supply results in some degradation of amplifier output. However the aspects of the amplifier's performance which are worst affected, namely an increase in harmonic distortion, are of secondary importance in the type of application for which the Stentor is intended (harmonic distortion is obviously less significant than, e.g. crossover distortion or clipping). Starting with a car battery as the source of supply voltage, what kind of output

power can be achieved using conventional amplifier output stages? If one takes the example of a conventional output stage the power delivered into the load can be calculated with the following simple equation. Assuming that we neglect the voltage losses in the output transistors, resistors and capacitor — and bearing in mind that the calculation is only valid for a sine wave input, the theoretical maximum output power  $P$  is given by:  $P = \frac{U^2}{8 \cdot R_L}$ , where  $U$  = supply voltage  
 $R_L$  = loudspeaker impedance.

Thus in the case of a 12 V supply and a 4  $\Omega$  loudspeaker the output power would equal 4.5 W. Naturally this is a ridiculously small figure for a public address system. However, there is another type of output stage which is commonly used in power amplifiers, and that is the *bridge* configuration.

1

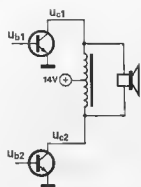
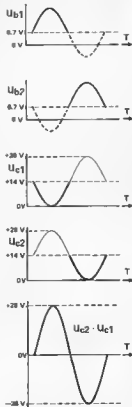

In a bridge amplifier, two output stages are used, and the input signal is applied in antiphase to each of their inputs. The loudspeaker is connected between the two outputs. The result of employing this configuration is that the amplitude of the output signal is doubled, and the power delivered into the load (i.e. the loudspeaker) is quadrupled. Thus assuming our 12 V supply and 4  $\Omega$  loudspeaker, an output power of 18 W is theoretically possible.

There still remains one further trick which we can use, and that is to connect a transformer in parallel with the loudspeaker. The transformer should, as far as possible, have two identical windings, and is connected as a centre-

tapped choke (e.g. a mains transformer with two identical secondaries, the primary not being used). The centre tap is connected to the positive supply rail. The change in the current drawn by one transistor from the supply line via the centre tap induces a voltage in the other winding which can be as large as the supply voltage. Thus, per half period of the waveform, a signal whose amplitude is twice the supply voltage can appear across the loudspeaker, so that the peak to peak amplitude of the loudspeaker voltage can be as much as four times the supply voltage (see figure 1). The power delivered into the loudspeaker is therefore not 18 W, but 72 W (for a 4  $\Omega$  load), and always

Figure 1. This figure illustrates the voltage-doubling effect of coupling the output stage to a transformer.

Figure 2. Block diagram of the Stentor.

Figure 3. Complete circuit diagram of the Stentor. LEDs D2 and D3 set the base bias voltages of T1 and T2, and should light up only very faintly or not at all. The same is true of D1, which is used to set the quiescent current level of the output stages. The adjustment procedure for the quiescent current is quite straightforward: an ammeter is connected in series with the supply line (make sure that the wiper of P2 is initially turned fully clockwise and that of P3 fully anticlockwise - i.e. both wipers are at supply common). P2 is now adjusted until a quiescent current of 0.5 A is obtained. P3 is then adjusted until the meter reads 1 A.

2

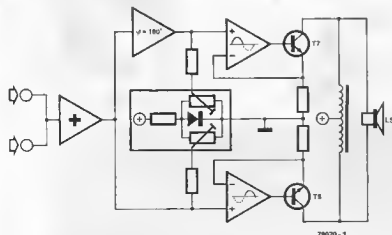

3

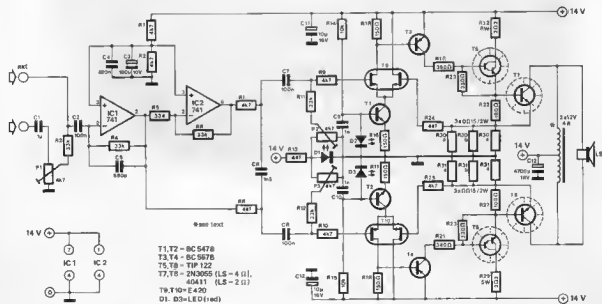

4

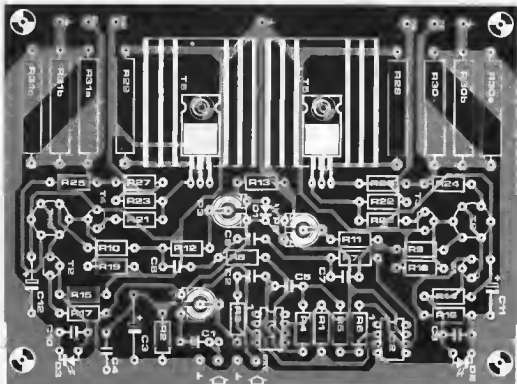
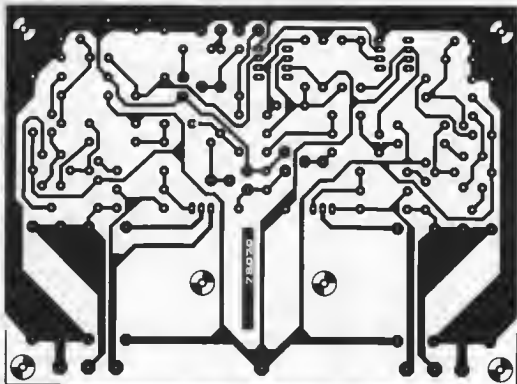

## parts list:

## Resistors:

R1, R2, R7, R8, R9, R10, R13  
 R24, R25 = 4k7  
 R3, R4, R5, R6, R11, R12 = 33 k  
 R14, R15 = 10 k  
 R16, R17, R18, R19 = 150  $\Omega$   
 R20, R21 = 390  $\Omega$   
 R22, R23 = 330  $\Omega$   
 R26, R27 = 100  $\Omega$   
 R28, R29 = 2 $\Omega$ /5 W  
 R30a ... R30c, R31a ... R31c  
 = 0.15  $\Omega$ /2 W  
 P1, P2, P3 = 4k7 preset potentiometers

## Semiconductors:

T1, T2 = BC 547B, BC 107B or equ.  
 T3, T4 = BC 557B, BC 177B or equ.  
 T5, T6 = TIP 122  
 T7, T8 = 2N3055 (LS = 4  $\Omega$ ),  
 40411 (LS = 2  $\Omega$ )  
 T9, T10 = E 420 (double FET)  
 A1, A2 = IC1, IC2 = 741  
 C1, C2, C3 = 400V 100

## Miscellaneous:

Transformer 2 x 12 V/4 A  
 (LS = 4  $\Omega$ ), 2 x 12 V/8 A  
 (LS = 2  $\Omega$ )  
 LS = loudspeaker 4  $\Omega$ /75 W or  
 2  $\Omega$ /150 W (2 x 4  $\Omega$ /75 W)  
 heat sink (approx. 250 cm<sup>2</sup>,  
 approx 5 cm fins)  
 2 x 400V 100V 100

## Capacitors:

C1 = 1  $\mu$  (not electrolytic)  
 C2, C7, C8 = 100 n  
 C3 = 100  $\mu$ /10 V  
 C4 = 820 n  
 C5 = 680 p  
 C6 = 1n5  
 C9, C10 = 1 n  
 C11, C12 = 10  $\mu$ /16 V  
 C13 = 220k 40V 100



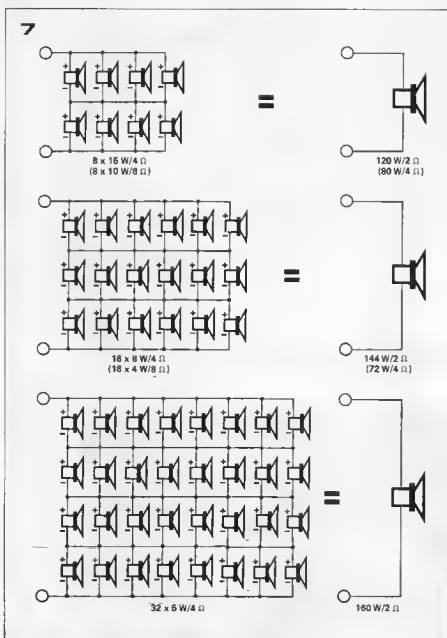
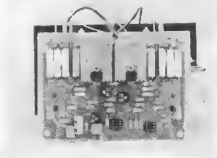

Figure 7. One method of wiring multiple speaker arrangements. Care should be taken to ensure that all speakers are in phase (see text).



provide a DC voltage of 1.4 V. By means of P2 and P3 a portion of this voltage can be used to bias the output stages such that a small quiescent current will flow even in the absence of an input signal. This has the effect of reducing cross-over distortion.

### Construction

Track pattern and component layout of the printed circuit board for the Stentor are shown in figure 4. Construction of the circuit should not present any special problems, however the value of certain components will depend upon the impedance of the loudspeaker being used. Thus with a 2 Ω loudspeaker the 2N3055's (T7/T8) should be replaced by the slightly more expensive 40411. The transformer must be able to supply at least 4 A in the case of a 4 Ω loudspeaker, and 8 A into a 2 Ω speaker.

*It is extremely important that the terminals of the transformer primary are well insulated as the turns ratio between primary and secondaries causes dangerously high voltages to be induced on the primary.*

A wiring diagram for the Stentor is shown in figure 6.

### Loudspeakers

As was emphasised at the start of the article, the Stentor cannot lay claim to hi-fidelity performance. The total distortion of the amplifier is in the region of 10%, although for the most part this is harmonic distortion which has very little effect upon the intelligibility of the spoken word.

Having described how the Stentor manages to pump large numbers of Watts into a loudspeaker, it is worth spending just a little time examining what type of loudspeakers should be used. Note the word loudspeakers, for it would be a waste of time and money trying to use a single speaker to handle the output power of the Stentor. A less expensive and more efficient approach is to connect a number of smaller speakers in series/parallel configurations, as shown in figure 7. Most loudspeaker manufacturers market a small diameter speaker costing under £5 and with a power rating of anything between 5 to 15 W. By mounting the speakers close together on a panel, or above one another in a column, a further improvement in efficiency can be obtained due to reinforcement effects.

Care should of course be taken to ensure that all the speakers are connected in phase. This can be checked by briefly touching a battery across the terminals of the loudspeaker combination. The speaker cones can be seen (and felt) to move in or out and the movement should be in the same direction for all of them. If one is found to be incorrect the connections to its terminals should be reversed. **M**

# TAP switch

U. Sussbauer

The advantage of this circuit for a touch activated switch is that it requires only one set of contacts and uses only two inverters, two resistors and a pair of capacitors. The circuit functions as follows: At switch on, the input of N1 is low, since C1 is discharged. Since the input of N1 is low, the input of N2 must be high and the output of N2 low, which of course holds the input of N1 low — thus the circuit is latched in a stable state.

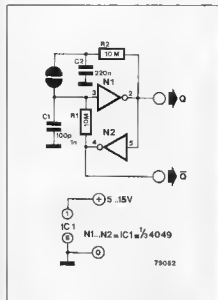

In the meantime capacitor C2 charges up, via R2, to logic '1'. If the touch contacts are now bridged, the logic '1' on C2 is applied to the input of N1 (C2 > C1), taking the output low (and the output of N2 high). The state of the Q and Q-bar outputs is thus inverted.

Bridging the contacts again causes C1 to discharge into C2 so that the outputs revert back to their original state. If the contacts are bridged for longer than the time constant  $R2 \cdot C2$ , then the outputs will change state again. If the contacts are permanently bridged, the circuit will in fact oscillate at a frequency determined by the above time constant.

With the component values shown, the contacts should not be bridged for longer than approx. 1 second. This can be extended by increasing the value of C2.

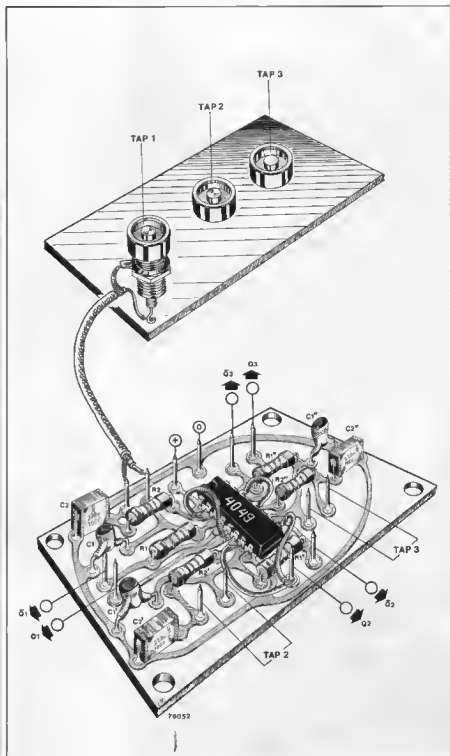

# assistantor

Everyone must at some time have had the maddening experience of standing on a railway platform and straining anxiously to make out what the station announcer has just said — a situation which provides a good example of the problems facing P.A. systems used in environments with high levels of background noise.

One solution is to employ a dynamic range compressor to boost the amplitude of the softer portions of speech above the threshold level of the background noise, without altering the level of the louder speech passages. When used in conjunction with the 'Stentor' power amplifier the result should be a P.A. system which will make itself heard in even the noisiest of crowds.

Environments with considerable background noise (open-air gatherings, factories etc.) present a particular problem to P.A. systems. The signal level of speech varies considerably, so that whilst the louder portions may be readily audible, the quieter passages will be swamped. Unfortunately, simply turning up the volume of the P.A. system is not an answer, since increasing the signal level to the point where the softest portion of speech is above the threshold level of the background noise means that the louder passages will be deafening (and more than likely distorted by the amplifier clipping).

The dynamic range of speech (i.e. the difference between the loudest shout and the quietest whisper) is around 35 dB. However it is fact that this can be reduced to approximately 5 dB without adversely affecting the intelligibility of the speech. Thus it is possible to amplify the low level speech signals above the threshold of the background noise, whilst leaving the high level signals more or less untouched (see figure 1). This process is known as dynamic compression and is the function of the circuit described here. Since it can be used in conjunction with the Stentor power amplifier contained elsewhere in this issue, the circuit has been dubbed the 'Assistantor'.

However the Assistantor is not just a dynamic range compressor, it utilises another interesting feature of human speech to further reduce the volume required to render a speech signal intelligible. Most of the power in a speech signal is concentrated in the lower frequencies. However these frequencies are of little importance for the intelligibility of the signal. For example, passing a speech signal through a 6 dB per octave highpass filter with a cut-off frequency of 1 kHz would reduce the power of the signal by 77%. However the intelligibility of the signal remains virtually unaffected (92% of the original).

The Assistantor imposes the frequency response of figure 2 upon the speech signal. In addition to rolling off the low

frequency signal components, a small amount of treble cut is also applied. This has the effect of preventing sibilant hiss in the speech signal.

## Dynamic range compression

The basic principle of a compressor is of controlled attenuation. The input signal is fed to the attenuator and then to an amplifier, the output of which is rectified, smoothed, and used to control the attenuator. Thus as the input signal increases, so will the control voltage applied to the attenuator and hence the degree of attenuation will be relative to the input-signal level. The result is that the overall gain of the circuit becomes smaller as the input signal level increases. The rectifier output is smoothed in order to give a control voltage which will follow the envelope of the signal waveform.

A number of different non-linear devices could be used to control the attenuator, e.g. FETs, voltage dependent or light dependent resistors, etc. However a simple and effective approach is to employ silicon or germanium diodes. As can be seen from figure 3, the dynamic resistance of a diode decreases as the current through the diode increases. This fact was utilised in the design of the Assistantor as shown in the block diagram of figure 4.

The input signal voltage dropped across the diode attenuator is determined by the size of the control current  $I_c$ . However this control current is itself derived from the output of the attenuator (which thus functions as a current-controlled resistor). As the input voltage falls, so does the control current through the diode, with the result that the dynamic resistance of the diode increases and more of the signal voltage is dropped across it. Thus more of the input signal is amplified and appears at the output of the circuit.

The dynamic range of the input signal is reduced from around 35 dB to approximately 6 dB, i.e. the quietest passages of speech are amplified by roughly

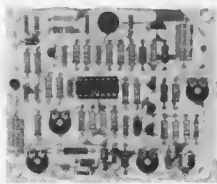

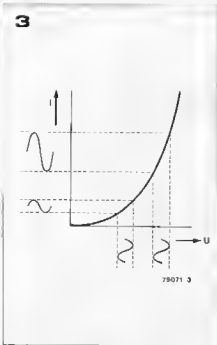
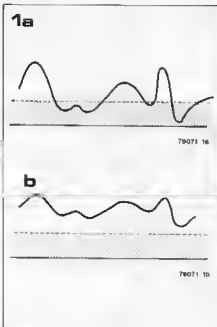

Figure 1a. In an environment with a high level of background noise the quieter portions of the speech signal are swamped.

Figure 1b. By compressing the dynamic range of the speech signal, the quieter passages are lifted above the threshold of the background noise, without affecting the amplitude of the louder passages.

Figure 2. By rolling off the low frequency response of the speech signal it is possible to drastically reduce the power of the signal without impairing intelligibility.

Figure 3. A dynamic compressor can be obtained by exploiting the non-linear transfer characteristic of a diode.

Figure 4. Block diagram of the Assistantor.

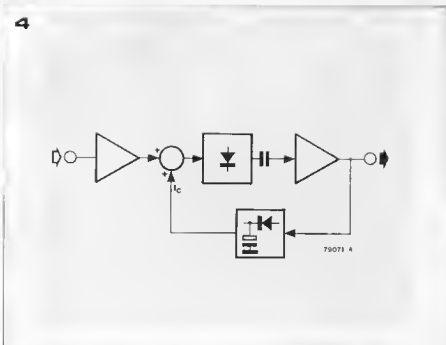
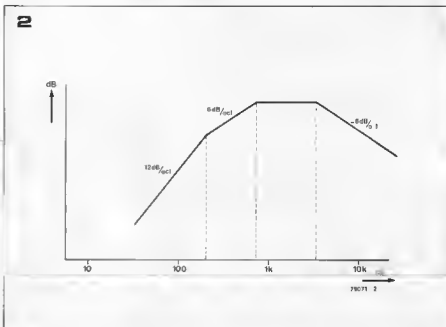

30 dB, without the louder passages being affected.

**Circuit diagram**

The circuit diagram of the Assistantor is shown in figure 5. As is apparent, not one, but four diodes, arranged in a bridge network, are used to form the current controlled attenuator. The reason why four diodes are employed is that the control current also causes a voltage drop across the diode, which is superimposed upon the signal voltage. Variations in this control voltage can give rise to spurious 'clicks'. With the arrangement shown in the circuit diagram the signal is applied differentially, and is amplified by a differential amplifier at the output of the attenuator. The voltage produced by the control current, however, appears in common mode at the amplifier inputs and is rejected.

To ensure that the operation of the attenuator is as symmetrical as possible and to optimise control signal rejection, the diodes should ideally be matched pairs. The best solution is to use a monolithic bridge rectifier, of the type employed in power supply circuits. Before the input signal is fed to the diode attenuator, it is amplified by T1 and A1. Several RC networks around A1 ensure that the circuit has the frequency response shown in figure 2. The gain of this stage can be varied by means of P1.

A2 functions as an inverting amplifier so that antiphase versions of the amplified input signal are fed to the controlled attenuator. A similar configuration is present at the output of the attenuator: A3 amplifies the compressed signal, whilst A4 is again connected as a phase inverter. Antiphase versions of the compressed signal are therefore available,



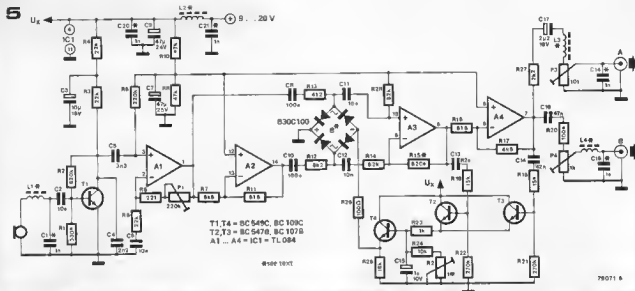

6

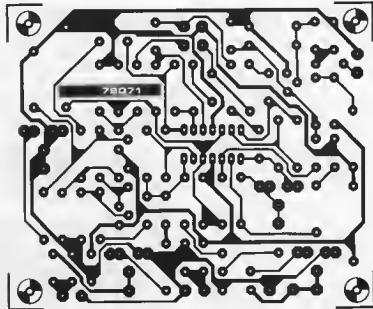
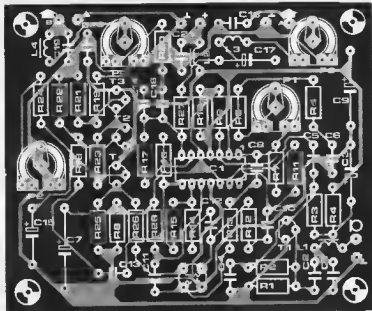

## Parts list

## Resistors:

- R1 = 330 k  
 R2 = 820 k  
 R3 ... R6 = 22 k  
 R7, R11, R16, R17 = 5k $\Omega$   
 R8, R10 = 47 k  
 R9 = 220 k  
 R12, R13 = 8k $\Omega$   
 R14, R28 = 82 k  
 R15 = 820 k (see text)  
 R18, R19 = 15 k  
 R20 = 100 k  
 R21, R22 = 270 k  
 R23 = 1 k  
 R24 = 10 k  
 R25 = 18 k  
 R26 = 100  $\Omega$   
 R27 = 2k $\Omega$   
 P1 = preset potentiometer, 220 k  
 P2 = preset potentiometer, 1 M  
 P3 = preset potentiometer, 10 k  
 P4 = preset potentiometer, 1 k

## Capacitors:

- C1, C18 ... C21 = 1 n (see text)  
 C2, C6, C11, C12 = 10 n  
 C3 = 10  $\mu$ /16 V  
 C4 = 2n2  
 C5 = 3n3  
 C7, C9 = 47  $\mu$ /25 V  
 C8, C10 = 100 n  
 C13, C14 = 82 n  
 C15 = 1  $\mu$ /10 V  
 C16 = 47 n  
 C17 = 2 $\mu$ 2/16 V

## Semiconductors:

- T1, T4 = BC 549C, BC 109C or equ.  
 T2, T3 = 547B, BC 107B or equ.  
 IC1 = TL 084  
 B1 = bridge rectifier, B30C100  
 (see text)

## Miscellaneous:

- L1 ... L4 = ferrite bead (see text)

Figure 5. Complete circuit diagram. The controlled attenuator is formed by a diode bridge network. The output signal is amplified differentially in order to reject the common mode control voltage.

Figure 6. Track pattern and component layout of the printed circuit board for the Assistantor (EPS 79071). A number of precautions are necessary to reduce r.f. pick-up - see text.

Figure 7. In a number of applications it is useful to provide the Assistantor with a by-pass switch. This can be connected as shown.

Figure 8. The transfer characteristic of the Assistantor with P1 set for maximum sensitivity. As can be seen, full dynamic compression occurs at an input voltage of only 1 mV.

permitting full-wave rectification via T2 and T3. The output of these transistors is used to charge C15, the smoothing capacitor. The voltage on this capacitor determines the control current at the emitter of T4. The discharge time of this capacitor, and hence the decay time constant of the compressor, can be varied by means of P2.

The Assistantor has two outputs. Output A provides a signal level suitable for use with power amplifiers such as the Stentor, whilst output B provides a low level signal. The amplitude of both output signals can be adjusted by means of potentiometers P3 and P4 respectively. Since the circuit has a considerable gain (up to approximately 86 dB), it is susceptible to r.f. pick-up. For this reason the input, outputs and supply line are decoupled with the aid of ferrite beads L1...L4 and a sprinkling of 1 n capacitors. This precautionary measure is particularly important if the circuit is to be used in the vicinity of an r.f. receiver or transmitter.

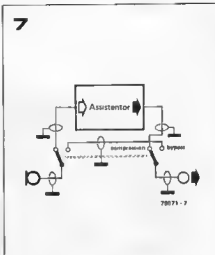

### Construction and use

The printed circuit board for the Assistantor is shown in figure 6. The ferrite beads L1...L4 are printed as coils on the component overlay. The desired self-inductance can be obtained by making a wire link using insulated wire and winding the link through the ferrite bead three or four times.

Any type of bridge rectifier will suffice for B1. However it is best not to use versions with too high a current rating, i.e. a 100 mA type should be preferred to one of several amps. In the circuit diagram and parts list the B30C100 is mentioned, however this is a nominal value, which only serves as a rough guideline.

The sensitivity of the circuit can be adjusted by means of preset P1. If the range provided by this potentiometer proves insufficient, then the value of R15 can be altered. Increasing the value of this resistor increases the sensitivity (and also the level of both output signals).

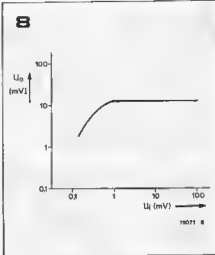

The Assistantor is not restricted to use with the Stentor or other power amplifiers of that nature. The provision of a low level output means that it can be employed with dictaphones, intercoms, office- or school loudspeaker systems, or in amateur radio installations to achieve the maximum modulation depth without overmodulating, and thus obtain maximum range. Figure 7 shows how the Assistantor can be provided with a switch, in order to allow the circuit to be switched in and out of operation. This facility is indispensable if using the Assistantor in conjunction with an amateur radio transmitter.

Finally, figure 8 shows the transfer characteristic of the Assistantor with P1 set for maximum sensitivity. The voltage level at output B is given for various values of the input voltage. As can be seen full-scale compression occurs at as low an input voltage as 1 mV.

Lit.:

Selektor, *Elektor* May 1978, p. 5-02.

## zero pF screen



In a large number of applications it is necessary to screen signal leads from external interference (mains hum, r.f. pick-up etc.). Unfortunately, between the signal-carrying conductors and the screening metal sheath there is inevitably a certain capacitance. The longer the leads the greater this capacitance will be.

It is possible that the capacitance of cables can adversely affect their high frequency transfer characteristic, one example being the influence that the screened lead between pick-up and preamp has on the frequency response of a moving coil cartridge. Although the capacitance cannot be eliminated,

fortunately there is a way to overcome its effect. If we ensure that the load on the capacitance remains constant (e.g. is always zero) or at any rate does not depend upon the AC signal voltage, then the disadvantage of screening can be removed.

How is this done? The screen is connected to the signal conductor via a voltage follower, the output impedance of which is considerably lower than the impedance of the cable. The connection can be made at either end of the signal lead (the other end of the screen is left floating). The result is that the screen no longer has any capacitance effect, since the signal lead and screen are both

carrying the same AC voltage. The cable remains effectively screened, however, since the opamp has an extremely low output impedance.

If the screen was also used as an earth return, then an alternative means of realising the earth lead must be sought. There are several possibilities: one can use an extra conductor inside, or an extra screen outside the neutralised screen, or both. In the latter case the screen is connected to case earth both at the 'transmitter' and 'receiver' end, and thus no longer functions as a return lead.



3

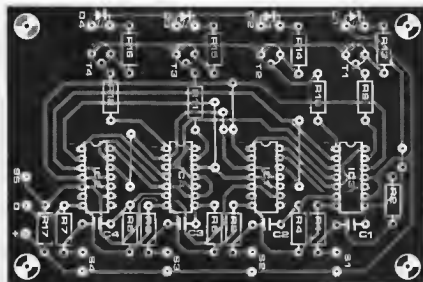
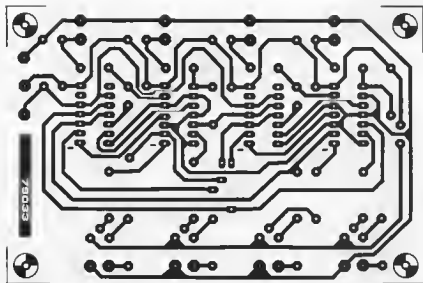

## Parts list

## Resistors:

R1 ... R8, R17 = 2k2  
 R9 ... R12 = 22 k  
 R13 ... R16 = 330  $\Omega$

## Capacitors:

C1 ... C4 = 4n7

## Semiconductors:

FF1 ... FF4 = 4013  
 N1, N2 = 4012  
 T1 ... T4 = TUN  
 D1 ... D4 = LED

## Miscellaneous:

S1 ... S5 = pushbutton switch

The diagram of a suitable circuit is shown in figure 1. The arrangement shown is for 4 players, however the design can be extended for any number of competitors. The operation of the circuit is extremely simple.

Each of the modules shown in figure 1 consists of a flip-flop which is set by means of a pushbutton switch. The Q output of each of the flip-flops is connected via a NAND gate to the reset input of each of the other flip-flops. As soon as one flip-flop is set, the remaining flip-flops will therefore be inhibited, since their reset inputs are held high. The Q output of the flip-flop which has been set goes high, turning on the associated transistor and lighting a LED, thus providing a visual indication of which pushbutton was pressed first. The circuit is reset for the next round by pressing S5.

The RC network at the input of each module is simply a pulse former which prevents undefined logic states occurring in the event of both the set and reset inputs of the flip-flop being high at the same time.

It is a simple matter to extend the circuit to accommodate more than four competitors. For each additional person an extra flip-flop circuit is needed and the number of inputs to the NAND gates must be increased accordingly.

The printed circuit board was designed to use a CD 4068 which is an 8-input NAND gate. However, it may be more convenient to use a 4-input NAND (MC 14012, CD 4012) and a simple method of extending the number of inputs is shown in figure 2. This configuration is equivalent to a 6-input NAND, excluding the reset input, and would therefore be suitable for seven competitors. It must be remembered that any unused inputs should be connected to the positive supply rail.

Construction of the circuit should not present any problems. If desired, the pushbutton switches can be connected to the board via long lengths of wire. The relatively low impedance of the pulse former networks ensure that hum and other types of inductive interference are sufficiently suppressed. If need be, the resistor values of these networks can be reduced to 1 k. **M**

# building the TV-games computer

Elsewhere in this issue, an introductory article about the TV games computer describes what the finished unit looks like and what it can do. In this article, our main interest is how to build the unit. After a brief description of the circuit, we will concentrate on the constructional details and calibration procedure.

One glance at the main circuit diagram is probably sufficient to scare off all but the hardest electronics enthusiasts. However, the block diagram is not nearly as bad (figure 1) and, once it has been understood, it will serve as a guide through the main circuit.

As explained in the introductory article, the 'brain' of the TV games computer is the microprocessor chip, or 'CPU'. By passing 'switching signals' along the 'address bus' (13 wires), it can operate all other sections of the unit as required. Information is passed from one unit to another along the 'data bus' (8 wires); finally, several special-purpose control signals are connected direct from the CPU to the unit(s) involved.

Without a memory, a brain is fairly helpless. Three distinct types of memory are available in this unit: The Read Only Memory (ROM), containing the pre-programmed 'monitor software'; the Random Access Memory (RAM), that is used for storing the actual 'game' program; and, finally, a cassette or tape recorder for long-term storage of as many different 'game' programs as may be desired. The type of memory that is to be used at any particular moment is selected (under CPU control) by the 'address decoder'; the exact part of that memory from which data is to be retrieved (or in which it must be stored) is selected by the CPU itself, via the address bus.

Since most tape and cassette recorders are designed for audio work, using them to store digital signals requires some careful signal handling. The digital output from the computer to the tape must be AC-coupled and filtered to remove the extreme high-frequency components; the input from the tape to the computer must be boosted in level and 'cleaned up' to produce a recognisable digital signal. These operations are performed by the section labelled 'cassette interface' in figure 1.

The sections described so far are common to virtually any computer system. 'Intelligence' — the CPU — and 'memory'. It may be noted, in passing, that precisely this part of the system is shown on the left-hand page of the main circuit diagram. However, the TV games computer has still to be connected to the 'player' controls (joy-sticks and keyboard), the TV set and a loud-

speaker.

First, the controls. The joy-sticks, being potentiometers, are basically analog devices. To adapt them to the otherwise digital system, some kind of analog-to-digital conversion is required: a 'joy-stick interface', which is actually part of the PVI. However, to save space only one 'interface' is actually available and so only one joy-stick can be dealt with at a time. For this reason, a 'joy-stick selector' is included, to switch to and fro between the two controls. This unit is, of course, under CPU control (via a separate connection); it is also connected to the 'keyboard interface'. The latter unit feeds the data from the keyboard onto the data bus — again under CPU control (via the address bus). So much for the inputs. The outputs — to TV and loudspeaker — are rather more complicated. Happily, most of the work is done by a single IC: the PVI, or Programmable Video Interface. This unit is comparable to a 'slave' micro-computer: under CPU control it stores and supplies data as required; it detects certain situations (e.g. inter-object collisions); based on the data stored, it 'creates' the corresponding picture and sound signals. In fact, the 'sound' in particular is simplicity itself. A single buffer stage, connected to the corresponding PVI output, can drive a small loudspeaker.

To create the 'picture' the PVI must enlist the aid of a few ancillary circuits. A crystal-controlled oscillator produces the basic timing signals. These are fed, through frequency dividers, to another useful IC: the 'Universal Sync Generator' (USG). This unit takes care of all the sync signals required for a modern colour TV set, and produces some additional synchronising signals for other parts of the circuit almost as a by-product.

One set of outputs from the USG is fed to the PVI, to tell it what part of the picture is actually being 'written' at any particular moment. Based in part on this information, the PVI produces a group of output signals that determine what colour must be displayed at that point in the picture, in order to reproduce the required display of objects, background and score. These outputs are fed, via a 'gating' circuit controlled by the USG, to the final section: the

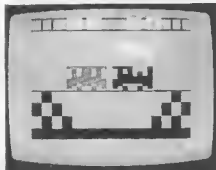

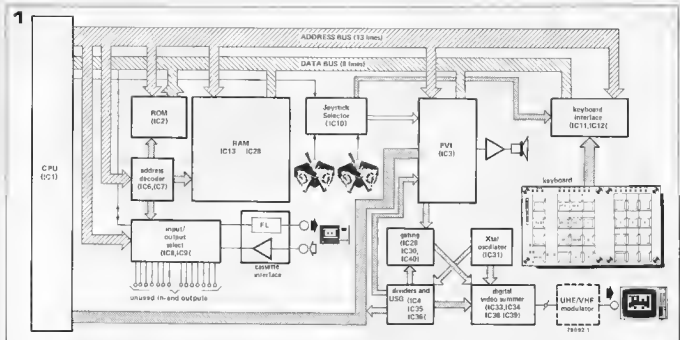

'digital video summer'. This unit does exactly what its name implies: it sums the outputs from the crystal oscillator, the USG and the PVI to produce the total video output. 'Summing', in this case, should be taken in the broadest possible sense: it includes frequency division, gating and level matching. Having a video output is all very well, but most TV sets only have UHF or VHF inputs. This problem is quickly solved, by adding a UHF/VHF modulator.

### The circuit

Having discussed the block diagram, we can now risk a quick look at the main circuit diagram (figure 2). However, there is little point in going into great detail. The main point to note is that the layout corresponds, by and large, to that of the block diagram: the various sections are drawn in the same relative positions.

The CPU (IC1) is at the left; the address and data busses run along the top. The address decoder for the memory and input/output selectors (IC6 and IC7), the ROM (IC2) and the RAM (IC13... IC28) require little explanation. The only point to watch is that 2112's used in the RAM must be 450 ns versions (or faster). The input- and output selectors (IC8 and IC9, respectively) offer eight 'serial' inputs and eight outputs. However, only one of each is used in the basic unit; the other seven in- and outputs are available for other external devices if required. The 'output filter' in the cassette interface consists of three resistors and two capacitors; the 'input buffer' uses an opamp to boost the signal to TTL level.

So much for the first half of the circuit! This 'thumbnail' description should suffice to give a general idea of 'what does what'. A fuller and more detailed explanation is given in the supplementary information supplied with the

printed circuit board.

The second half of the circuit is rather more complicated at first sight (well, even at second and third sight...). However, it is not too difficult to locate a few important sections, by referring to the block diagram. The 'heart' of this part of the circuit is the PVI (IC3); as mentioned earlier, it is almost a 'slave' microcomputer in its own right. The fact that it operates in close collaboration with the CPU is readily apparent: it is the only subsection that is connected directly to virtually all the address and data lines.

The PVI is flanked (quite literally, in the circuit) by the joystick selector (IC10), the 'loudspeaker interface' (TI) and the keyboard with its interface (IC11 and IC12). None of these merit any detailed discussion at this point. The keyboard (or keyboards, depending on how you look at it - them?) will be explained later, from the user's point of view.

Now for the remainder of the circuit. To be honest, this type of circuit should either be described in detail or not at all... However, we will attempt to give a very rough outline, without Qs, Qs, logic ones and zeroes.

Immediately below the PVI, a crystal oscillator (IC31) is used to generate the main timing signals. One of these goes down and around, passes through a divider stage consisting of IC32, IC35 and IC36, and finishes up as the 'clock' input signal for IC4, the 'USG'. This 'Universal Sync Generator' is more important than its relative size in the circuit might lead one to expect: it produces the complicated synchronising signals required for a modem (PAL) colour TV set. Furthermore, it produces reference signals that are used by both the PVI and the CPU; finally, it 'gates' the video outputs from the PVI (i.e. turns them on and off, as required) via an intriguing selection of NANDs,

inverters and EXORs (IC29, IC30 and IC40).

What remains in the circuit was all lumped together in the block diagram as 'Digital video summer'. This section (consisting of IC33, IC34, IC38, IC39 and assorted NANDs and inverters) combines signals from the crystal oscillator, the gating network at the PVI outputs and the USG to produce the final video output. The correct relative levels of the various signals are determined by the resistor network in the 'summer' (R54... R62).

The complete circuit shown in figure 2 is contained on a single printed circuit board. More on this later. However, two further units are required: a power supply and (in most cases) a UHF/VHF modulator.

### Power supply

Any stabilised supply, capable of delivering 5V at 2A, is suitable. A simple circuit is shown in figure 3. Although this configuration may seem rather peculiar, especially where T1 and T2 are concerned, the principle is quite straightforward. If the load current increases, the integrated voltage regulator (IC1) will attempt to supply this current itself. However, in so doing it will increase the voltage drop across R2, thereby turning on T2 - which then proceeds to deliver the bulk of the current. In the event of a short circuit occurring, T1 limits the current through T2 to a safe value and internal protection circuits maintain the dissipation in the IC within its limits.

A suitable printed circuit board is shown in figure 4.

### UHF/VHF modulator

Or rather: 'VHF/UHF TV-modulator, see Elektor 42, October 1978'. Why design a new one if an existing circuit is good enough?

The circuit is shown in figure 5, and the

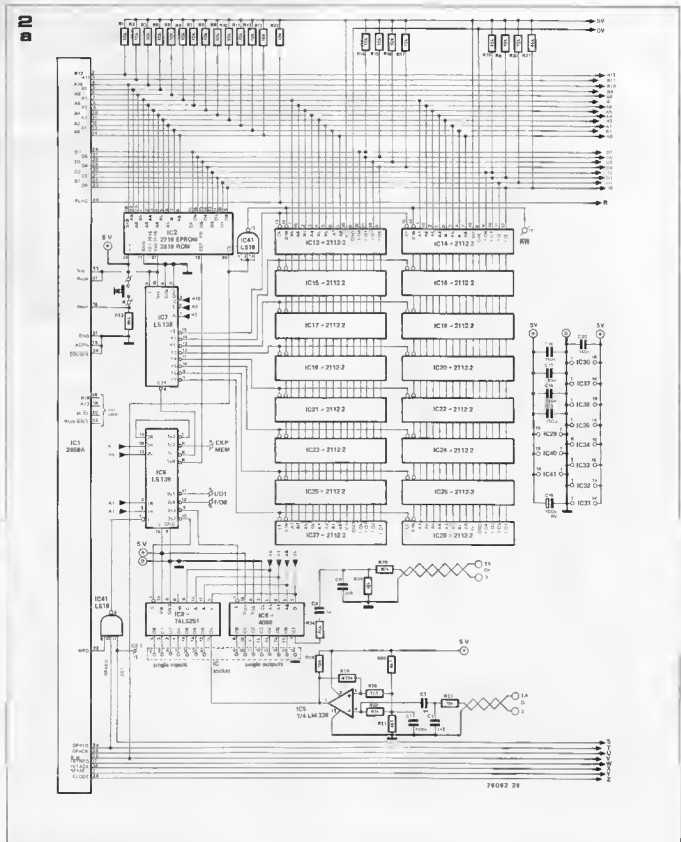

printed circuit board in figure 6. Repeating the circuit description would be rather a waste of space, so we can quickly proceed to the

#### Construction details.

The TV games computer is built up from four basic units: the main circuit, keyboard (figure 9), power supply and UHF/VHF modulator. The wiring between these units (and various external

Figure 2. Complete diagram of the main circuit.

odds and ends: joy-sticks, loudspeaker) is shown in figure 7.

The p.c. board for the main circuit (figure 8) requires some comment. It is a double-sided p.c.b. with plated-through holes. A prime example of modern technology with, regrettably, the associated 'teething problems'. Technology has not yet reached the point where plated-through holes are 100% reliable (at a reasonable price,

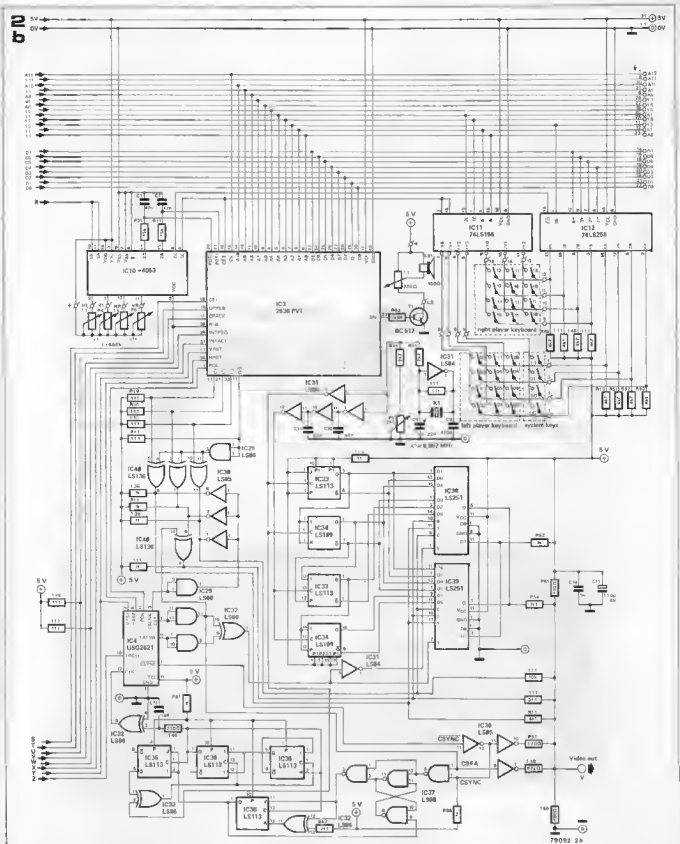

that is) and, as an interim solution, manufacturers often simply mount all components on the board and reject any circuits that don't work. This is rather unsatisfactory for the home constructor, and he is more inclined to 'trouble-shoot'. For complicated circuits like the TV games computer, this can be extremely time-consuming. For this reason, it is advisable to check the board *before* mounting the com-

ponents. A first, visual, check is possible by holding the board up to the light and looking through the holes: the plating should be clearly visible. To make assurance doubly sure, each hole can be tested individually with a multimeter: with one probe on each side of the board, the resistance should be zero.

When mounting the components, it is strongly advised to use a suitable

miniature soldering iron and first-class IC sockets. In a unit like this, tracing dud contacts afterwards can be a harrowing experience.

The main board has a large number of in- and output connections, most of which however remain unused in the basic tv games computer. The connections between main board and keyboard (see figure 7) are clearly numbered on both boards. Note that the two wire



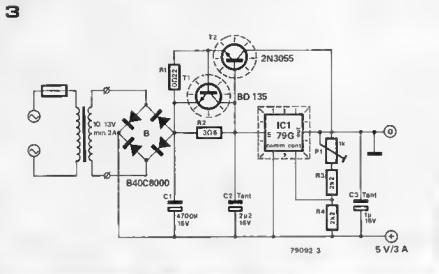

## Parts list for power supply.

## Resistors:

R1 = 0.22  $\Omega$ /3 Watt  
 R2 = 3.9  $\Omega$   
 R3, R4 = 2k $\Omega$   
 P1 = 1k

## Capacitors:

C1 = 4700  $\mu$ F/16 V  
 C2, C3 = 2 $\mu$ F/16 V (Tant.)

## Semiconductors:

T1 = BD 135, BD 137, BD 139  
 T2 = 2N3055  
 IC1 =  $\mu$ A 79G  
 B1 = B40C5000

## Sundries:

Tr1 = main transformer,  
 10 V/2A secondary

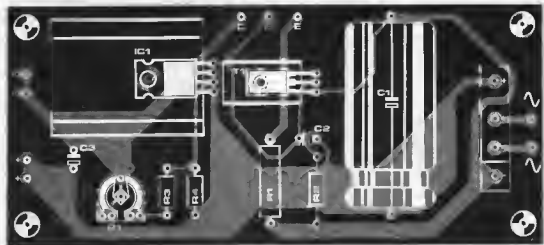
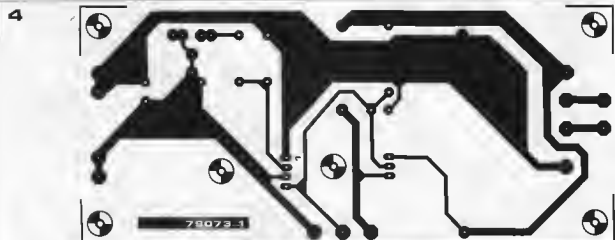

Figure 3. A suitable 5V power supply.

Figure 4. Printed circuit board and component layout for the power supply (EPS 79073-1).

Figure 5. The UHF/VHF modulator, originally described in *Elektron* October 1978. Note that IC1 is not required in this application.

Figure 6. Printed circuit board and component layout for the UHF/VHF modulator (EPS 9967).

links shown as dotted lines on the keyboard p.c.b. should not be mounted in this case.

The key numbers shown on the component layout for the keyboard correspond to the actual addresses of the keys. However, for normal use the indications shown in figure 10 are preferable, since they correspond to normal use in the monitor program. If the keyboard was only to be used in this application, it would have been more logical to run all the keys together into one 7 x 4 block; however, the keyboard will often be used as two separate small

keyboards for two players. For this reason, the suggested layout is designed for easy 'cutting along the dotted line'. The only constructional comment regarding the power supply is that *all due care should be taken!* If, due to a fault occurring at a later date, the supply voltage suddenly jumps to way over 5V, several expensive ICs may die a sudden death. For the same reason, the supply voltage must be adjusted to 5V *before* connecting it to the rest of the unit. A drop of lacquer on the potentiometer will not only keep it from sliding off position, it will also

serve as warning not to touch it at a later date.

The UHF/VHF modulator must be adequately screened. Of course, Modulators should always be mounted in metal boxes. This unit can be powered from the main +5V supply, so the regulator (IC1) can be omitted and the holes in the board for its two outer pins can be bridged with a wire link.

### Calibration procedure

With everything neatly built and all interconnections made, and after a final visual check of the wiring, it is now time to switch on. Note that, as stated earlier, the power supply must already be tested and adjusted to 5V.

The calibration procedure is simplicity itself. In fact, the modulator contains exactly the same number of adjust-

ment points as the rest of the circuit - two, to be precise!

### UHF/VHF modulator

Set P1 to its mid-position and tune the TV set to one of the harmonics of the carrier. When the carrier is picked up, the snow-storm effect on the screen of the TV set will disappear.

Turn P2 up to maximum. This completes the initial adjustment. Some 'touching up' will be dealt with later.

### Main circuit

Operate the reset and start keys. After correct adjustment, this should cause a blue screen to appear with four yellow letters at the lower left-hand corner.

The only adjustment points in the main circuit are P1 and C9 in the crystal

oscillator. These can be 'calibrated' by looking at the picture:

- if P1 is incorrectly adjusted, the oscillator will not run at all, in which case no picture will appear. The simplest adjustment procedure is to turn P1 a little bit further than necessary to obtain a picture.
- C9 determines the oscillator frequency, and incorrect adjustment will lead to poor colour or even no colour at all.

### Final touches

Having obtained a picture, it becomes a simple matter to adjust for maximum picture quality:

The TV set is tuned to the sideband that gives the best picture; if tuned to the wrong sideband the picture will tend to appear negative.

If the picture lacks vertical synchronis-

5

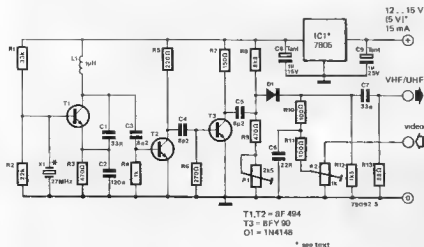

### Parts list for UHF/VHF modulator

#### Resistors:

- R1 = 33 k
- R2 = 22 k
- R3, R9 = 470  $\Omega$
- R4 = 1 k
- R5 = 220  $\Omega$
- R6 = 270  $\Omega$
- R7 = 150  $\Omega$
- R8 = 6k8
- R10, R11 = 100  $\Omega$
- R12 = 1k5
- R13 = 68  $\Omega$
- P1 = 2k5 (2k2) preset potentiometer
- P2 = 1 k preset potentiometer

#### Capacitors:

- C1, C7 = 33 p
- C2 = 120 p
- C3, C4, C5 = 8p2
- C6 = 22 p
- C8, C9 = 1  $\mu$ /16 V tantalum

#### Semiconductors:

- T1, T2 - BF 194, BF 195, BF 254, BF 255, BF 494, BF 495
- T3 - BF Y 90
- D1 = 1N4148
- IC1 = not required (see text)

#### Miscellaneous:

- L1 = 1  $\mu$ H
- X1 = crystal, 27 MHz approximately.

6

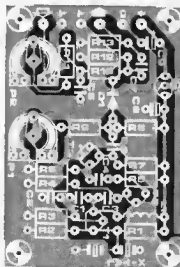
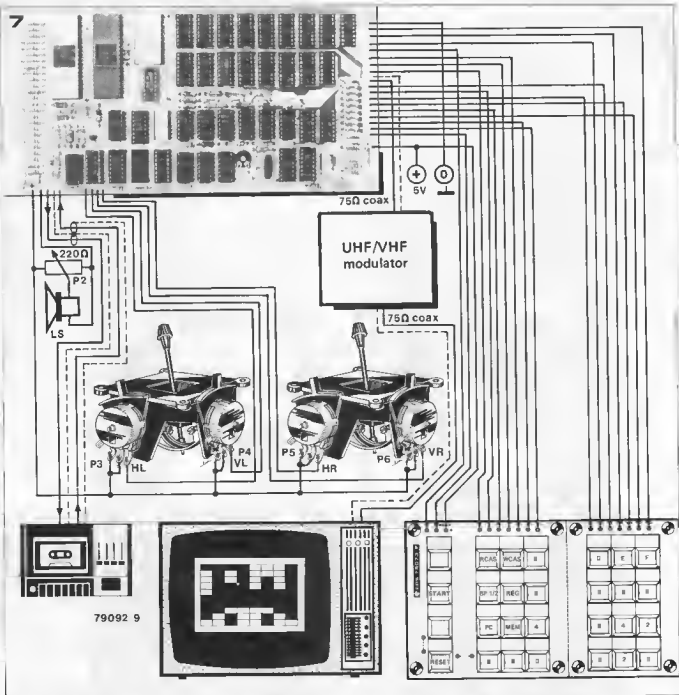

Figure 7. Interconnection between the various units.

Figure 8. Printed circuit board end component layout for the main circuit (EPS 79073). The board is double-sided with plated-through holes. Note that it is reproduced here at 70% of actual size.



## Parts list for main board

## Semiconductors:

IC1 = 2850A (Signetics)  
 IC2 = 2616 (Signetics)  
 IC3 = 2636 (Signetics)  
 IC4 = 2621 (Signetics)  
 IC5 = LM339 (National Semiconductor)  
 IC6 = 74LS139  
 IC7 = 74LS138  
 IC8, IC38, IC39 = 74LS251  
 IC9 = CD 4099  
 IC10 = CD 4053  
 IC11 = 74LS156  
 IC12 = 74LS268  
 IC13 ... IC28 = MM2112-4  
 (450 ns access time)  
 IC29 = 74LS08  
 IC30 = 74LS05  
 IC31 = 74LS04  
 IC32 = 74LS86  
 IC33, IC35, IC36 = 74LS113  
 IC34 = 74LS109

IC37 = 74LS00  
 IC40 = 74LS136  
 IC41 = 74LS10  
 T1 = BC517

## Resistors:

R1 ... R21, R26, R33, R35, R55 = 10 k  
 R22, R23, R26, R27, R30, R31, R39 ... R42  
 R46 ... R53, R57 = 4k7  
 R24, R71 = 15 k  
 R28 = 470 k  
 R29, R44, R45, R56, R67 = 2k2  
 R32, R34, R70 = 47 k  
 R36, R37, R38, R62, R64, R65, R66, R69  
 = 1 k  
 R43 = 33 k  
 R54 = 1k5  
 R58, R59 = 820 Ω  
 R60 = 680 Ω  
 R61 = 470 Ω  
 R63 = 100 k  
 R68 = 220 Ω

P1 = 2k2 preset potentiometer  
 P2 = 220 Ω potentiometer

## Capacitors:

C1, C15, C16, C17, C18, C20 = 150 n MKH  
 C2, C4, C14 = 1 n  
 C3 = 3n3  
 C5 = 3n9  
 C6, C7 = 47 n  
 C8 = 470 p  
 C9 = 0 ... 22 p trimmer  
 C10, C11 = 68 p (cer.)  
 C12 = 56 p (cer.)  
 C13 = 220 μ/6 V  
 C19 = 100 μ/6 V

## Sundries:

Xtal: 8.867 MHz  
 Loudspeaker: 100 Ω/500 mW  
 2 Joysticks (P3 ... P6): potentiometer  
 values 680 k.  
 28 'digitast' switches (for the keyboard).

B

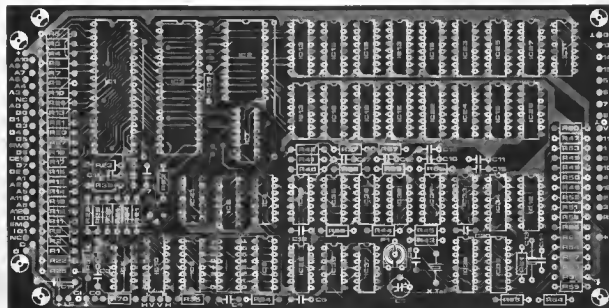
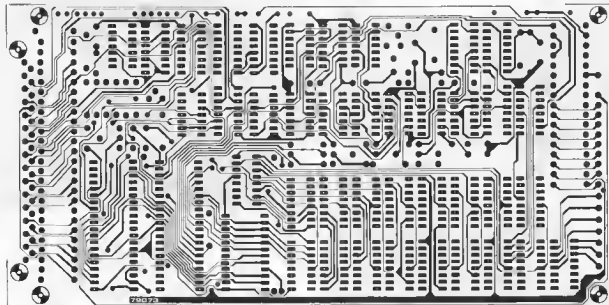
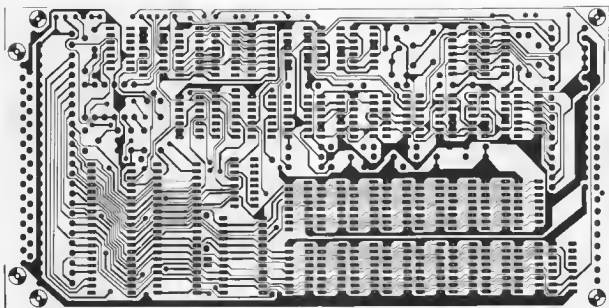

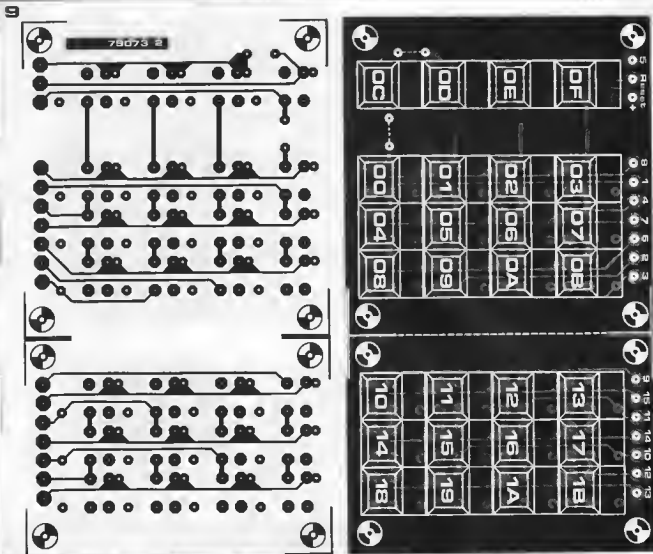

Figure 9. Printed circuit board and component layout for the keyboard (EPS 79073-2). Note that the wire links (shown dotted) should be omitted.

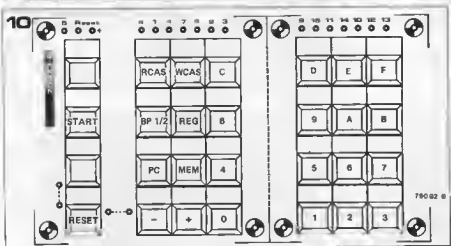

Figure 10. Suggested texts for the key tops.

ation (i.e. rolls), or if some local broadcast transmitter interferes with the picture, P1 can be readjusted slightly and the TV set retuned accordingly.

P2 on the modulator board can be used to adjust the contrast.

C9 on the main board influences the colour above all else. Both C9 and P1 should be adjusted for optimum picture quality.

#### Final notes

The cassette interface should prove

suitable in most cases. However, for the odd recorder the output signal level may be too high or too low, in which case the value of R70 can be altered accordingly. In some cases (excuse the pun) problems may also occur if the cassette recorder is placed too close to the TV set. The solution is, of course, simple: move the recorder further away.

The components used in the circuit are admittedly anything but standard. In particular, the ROM with the correct

program was custom-designed (by Philips) for this application. However, initial contacts with several major component suppliers have shown that there is considerable interest in supplying complete kits, which will include the factory-programmed ROM.

# MARKET

## Spectrum analyzer with 10 Hz resolution to 22 GHz

Using microprocessor control, the Model 8566A Spectrum Analyzer from Hewlett-Packard gives the user the ability to more accurately resolve closely spaced signals over a wider range of amplitudes than previously possible. Using the Hz resolution bandwidth, the analyzer's sensitivity is  $-137$  dBm to 1 GHz,  $-134$  dBm to 5.8 GHz,  $-15$  dBm at 22 GHz.

This high sensitivity includes the presence of built-in pre-selection from 2 to 22 GHz. Related attributes are 80 dB dynamic range and full frequency range amplitude of  $\pm 2.2$  dB. This performance permits direct measurement on microwave signals of line-related sidebands that are 50 dB down. In addition, frequency accuracy virtually that of the internal frequency reference error ( $1 \times 10^{-6}$  per day) can be achieved. This performance is complemented by features that make the 8566A extremely easy to operate, and easy to set up for automatic operation with HP-IB (IEEE-488).

The power and convenience of the 8566A's microcomputer-based controls and CRT readout simplify and speed up in so many ways that previously-impractical analyses now become routine. The fact that harmonic mixing is employed to extend frequency coverage to 22 GHz has been made transparent to the operator. Functions, such as center or start/stop frequencies, frequency span, and amplitude level may be keyboard-set, varied with 'analog' knob (actually a rotary pulse-generator), or incrementally keystepped. Other operating parameters such as resolution bandwidth, sweep time, video filter and rf attenuation are automatically coupled to the entered data for proper signal display.

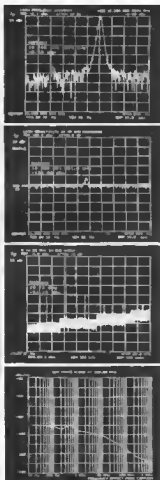

However these parameters can also be manually entered at different values depending upon the application. A tunable marker in the 8566A makes basic measurements more accurately and more easily by directly measuring a signal, or by speeding the process of magnifying the portion of the spectrum to be analyzed. With the marker set to the signal peak, signal amplitude and frequency are numerically displayed on the CRT. A second marker makes relative measurements instantly available, with numerical display of the difference in amplitude

and frequency between the two markers. This is useful for modulation and distortion measurements.

Hewlett-Packard Ltd.,  
King Street Lane,  
Winnersh, Wokingham,  
Berkshire RG11 5AR, England.

(1096 M)

## Electronic baseball

An electronic baseball game which simulates all the functions of the real game in a self-contained, battery-operated unit has been introduced by Micro Electronics Ltd. The microprocessor-controlled game, which uses light-emitting-diode displays to simulate the movements of players and ball and to keep score, allows players to use their own offensive and defensive skills and strategy to influence the result.

In operation, a player chooses the desired speed of pitch (slow, normal or fast) and then presses the 'pitch' button, which starts a scoreboard display cycling through all possible events at the desired speed. When the 'bat' button is pressed, the cycling of events stops, and a crowd cheer (for a 'hit') or a buzz (for an 'out') is heard.

In addition, players can introduce offensive or defensive options in the form of 'pinch hitters' or 'relief pitchers', respectively. The control circuitry is designed so

that the three pinch hitters have a higher 'batting average' (400 against 270 for the normal team players), and the two relief pitchers, although more 'powerful' to start with, are designed to 'tired' to the original pitcher's effectiveness after five batters. There are several ways in which players can use their skill: the pitcher has three choices of speeds, giving him the opportunity to analyse the batter to see whether he hits fast or slow balls, and the batter can time his pressing of the 'bat' button (with practice) to obtain more and better hits.

An alphanumeric display scoreboard provides a continual display of home and visitor score, number of relief pitchers and pinch hitters remaining, event counter (showing score of present batter), inning counter, 'at bat' indicator (showing which side is in), number of 'outs', and indicators to show when pinch hitters or relief pitchers are introduced.

The game is mounted in a sturdy plastic case with a representation of a baseball diamond, with individual lights showing the location of the base runners. An input is provided for an external 9 V DC supply.

Micro Electronics Limited,  
Consumer Products Division,  
766 Finchley Road,  
London, NW11 7TH England.

(1120 M)

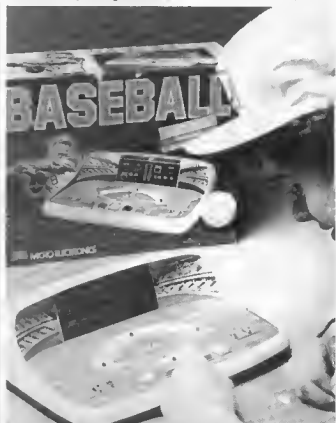

# MARKET

## Automatic Bridge

The Wayne Kerr B605 Automatic Component Bridge is a new microprocessor-based, fully automatic L, C, R, Q and D measuring instrument featuring AUTORANGE and AUTOTRIM with 0.1% accuracy over a wide dynamic range. It will provide fast measurements with guaranteed reliable performance and easy-to-use operational characteristics and yet it is still in the medium price range for laboratory-standard test instruments.



The instrument is compact with simple frontpanel controls. Once an 'unknown' component is connected to the test terminals, the LCD readout performs interactively with the user to guide him/her through a very short and simple procedure to arrive at a correct measurement. The display offers readings with resolution of 0.001 pF on the C-range. Consistency is achieved by using a design requiring only one 'standard' component and all the circuitry is referenced to this single resistor before each measurement sequence. The basic accuracy of the B605 is 0.1% which is guaranteed across the whole impedance range of the bridge and is achieved within the 300 ms taken for a measurement cycle.

The measurement range is broad enough to suit all conceivable component measurements, and there is a choice of three front-panel selectable measurement frequencies; 100 Hz being available for electrolytic capacitors and large inductors; 1 kHz as a general-purpose test frequency; and 10 kHz for low value components such as very small capacitors. The display instructs the user when 'AUTO TRIM' or 'AUTO RANGE' adjustments are required, and clearly states all results in the most practical units. AUTOTRIM is carried out under MPU control, fully automatically. Once the frontpanel control has been pressed, the machine takes four readings on each of the three operating frequencies — stores the results — and then averages them, thus ensuring that residual trim errors do not affect the results. Pressing the AUTORANGE button automatically selects the correct impedance range for the

component being measured. This range is then held even after the component is removed, and thus a batch of similar components can be quickly measured without further range changes.

The B605 terminals are suitable for 2, 3 or 4-terminal measurements, but a small matching adaptor, the JU4, provides for single-handed loading and removal of components with axial, radial or preformed leads. On the top of the JU4, two inline slots give positive connection for parallel wires, and on the front of the unit, spring-loaded jaws (opened by depressing the platform) provide firm connection for axial wired components.

Willmot Breden Electronics Limited,  
Durban Road Bognor Regis West  
Sussex PO22 9RL, England.

(1121 M)

## Transistor and diode tester

It is claimed that the use of multi-meters for the in-circuit testing of transistors and diodes is likely to become outdated with the development of a new tester by Ampmace.



The swamping effect of parallel resistors which has often led to ambiguous readings in the past has been overcome in this tester by the feeding of a sufficiently large, but finely controlled, current into the junction under test.

Audio signals replace the conventional visual indications of the performance of the junction under test, making the tester simple enough for use by unskilled personnel. A steady tone, warbled tone or silence indicate normal junction, short-circuit junction or open circuit junction respectively on diodes and transistors in or out of circuit. This new piece of pocket-sized

equipment with its automatic on/off circuit for long battery life, and built-in protection up to 1,000 V AC or DC, has added versatility in that it may also be used as a continuity tester.

Ampmace Limited,  
Unit 96, Somers Road,  
Rugby, Warwick, England.

(1122 M)

## Verorak cabinet joining kit

Joining together two or more Verorak (R) 19" racks or cabinets of the same size has now been simplified with the introduction of joining kit AB067 from Vero Electronics. The kit is suitable for all 12 types of Verorak currently available and joining time is less than ten minutes with a single spanner being the only tool required. Once joined the racks have an attractive appearance and all round sealing to prevent the ingress of dust or moisture can be achieved with the sealing tape included in the kit.

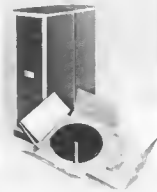

Vero Electronics Ltd.,  
Chandler's Ford Industrial Estate,  
Eastleigh,  
Hampshire, SO5 3ZR, England.

(1127 M)

## Teletext decoder

It is comforting to know that when television 'addicts' become bored with the daily problems experienced by people living in dreary streets and cardboard motels, or when the 'feature' film is dated 1930 (!), an interesting and informative alternative is available from the television media — in the form of news, weather reports, stock-market information etc. presented as magazine-type pages — Teletext. Although becoming less of a rarity, television sets with built-in Teletext decoders are nevertheless rather expensive luxury items.



However, an 'add-on' unit, making the system less costly, has been produced by Radofin Electronics Ltd. This unit can be plugged directly into most domestic television receivers and once set up the decoder will switch instantly from normal programmes to Teletext at the touch of a button. With features such as double-height character facility, black and white and true PAL colour, it meets the latest broadcast specifications by the BBC and IBA. The decoder has remotely controlled push-button page change and is able to receive both CEEFAX and ORACLE transmissions.

Radofin Electronics (U.K.) Ltd.,  
London W6, England.

(1128 M)

## On/off dimmer

The use of micro-electronics in the traditional dimmer switch has resulted in a big jump forward in the concept and design of these popular products.

This dimmer has no moving parts and to dim or raise the light level the user merely places a finger on the stainless steel centreplate. When the finger is taken away the light remains at the existing level. The light can be switched on or off by a rapid touch of the same plate.



The Davi Litetouch also incorporates a simple to replace fuse which provides protection for the electronics while RF interference has been minimised to conform with pending legislation. Available in a choice of two colours (black or white) the dimmer has a pleasant appearance and will fit most U.K. and continental type wall boxes. The forward projection from the wall is only 15 mm.

Davi Marketing Ltd.,  
46a High Street, Stamford,  
Lincolnshire, England.

(1123 M)

# WHO and WHERE

A directory of electronic component suppliers to Elektr readers

IF THERE IS A COMPONENT SHOP IN YOUR AREA NOT LISTED BELOW PLEASE LET US KNOW



## AREA 1

**ACE Meitronics Ltd.**,  
Tootal Street, Wakefield,  
W. Yorks. WF1 5JR.  
Tel: 0924-250375

**A. Marshall (London) Ltd**  
85 West Regent St.,  
Glesgow G2 2DD  
Tel: 041-332-4133

**Aitken Bros. & Co.**  
35 High Bridge,  
Newcastle upon Tyne,  
NE1 1EW  
Tel: 0632-26729

**The Amateur Radio Shop**  
4 Cross Church Street  
Huddersfield, HD1 3PT.  
Tel: 20774

**Bell's Television Services**  
190, Kings Road,  
Herrogate, Yorkshire,  
Tel: (0423) 55885

**Derwent Radio**  
5 Columbus Ravine,  
Scarborough, N. Yorkshire.  
Tel: (0723) 63982

**Electrovelue Ltd.**  
680 Burnage Lane,  
Manchester M19 1NA  
Tel: 061-432-4945

**Gamma Enterprises**  
373 Blackness Road,  
Dundee, DD2 1TL  
Phone Dundee 643061

**Greenbank Electronics**  
94 New Chester Road,  
New Ferry, Wirral,  
Merseyside L62 5AG,  
Tel: 051-645 3391

**Herrogate Electronic Services**,  
25, Regency Parade,  
Harrrogate.

**Shudehill Supply Co. Ltd.**  
53 Shudehill,  
Manchester M4 4AW,  
Tel 061 834 1449

**Tendy**,  
Flottergate,  
Riverhead Centre, Grimsby.  
Tel: 57780

**Spectron Electronics  
Manchester Ltd**

7, Oldfield Road, Salford,  
Greater Manchester  
Tel. 061 834 4583

**M & B Components Ltd**  
86 Bishop Gate Street,  
Leeds 1 LS1 4BB,  
Tel. 0532 35649

**Progressive Radio**,  
93 Dale Street,  
Liverpool 2 Z50  
Tel (051) 2360982

**Electronic Assembly Services**,

Bright Street Works,  
Bury, Lancs. BL9 6AQ

## AREA 2

**Strut Electrical &  
Mechanical Engineering Ltd.**

3c Barley Market Street,  
Tavistock, Devon.  
Tel Tavistock 5439 Telex 45263

**A. Marshall (London) Ltd**

1 Streets Parade,  
Fishponds Rd,  
Bristol BS16 2LX  
Tel 0272 654201  
**Crystal Electronics**  
40 Magdalene Road,  
Torquay,  
Devon.  
Tel: 22699

**G.F. Milward**  
369 Alum Rock Road,  
Birmingham B8 3DR,  
Tel 021-327 2339

**L.F. Hanney**  
77, Lower Bristol Road,  
Bath BA2 3BS, Avon  
Tel: 0225-24811

**The Radio Shop**  
18 Cherry Lane,  
Bristol BS1 3NG,  
Tel: Bristol 421196,  
5 T.O. Code 0272

**Durrant Radio,  
(Component Service)**  
9, St. Marys Street,  
Shrewsbury, Shropshire.  
Tel: 61239

**Swift Electrical**,  
17-19, Harborough Road,  
Northampton, NN2 7AX  
Tel: 0604 712999

**Marco Trading**,  
The Old School, Edgerton,  
Nr. Wem, 5 Shropshire, 5Y4 5RJ.  
Tel: 094872 464/465

**Marcson Electronics**,  
155 High Street,  
Chasetown,  
Walsall, 5 Staffs.  
Tel: (05436) 4632

**Steve's Electronics**,  
15/17 The Balcony,  
Castle Arcade, Cardiff.  
Tel: (0222) 41905

## AREA 3

**A. Marshall (London) Ltd**

40-42 Crickeford Broadway,  
London NW2 3ET  
Tel: 01-452-0161  
325 Edgeware Road,  
London, W 2  
Tel. 01-723-4242

**Ambit International**

25 High Street,  
Brentwood, Essex,  
Tel. (0277) 216029,  
Telex 995194

**Anco Distributors**,

50 Rainford Road,  
Chelmsford, Essex.  
Tel: (0245) 58605

**Arrow Electronics**

Coptford Road,  
Brentwood, Essex,  
Tel: 0277-219435

**Audio Electronics**

301 Edgeware Road,  
London W2 1BN  
Tel: 01 724 3564

**Basic Electronics Ltd**

1B Epsom Road,  
Guildford, Surrey

**B. Bamber Electronics**

5 Stratton Road,  
Littleport, Cambs. CB6 1OE,  
Tel. ELY (0353) 860185

**Baydis Ltd.**,

54, Mortimer Street,  
Herne Bay, Kent.  
Tel: Herne Bay 64586

**BI PAK**,

18 Baldock Street,  
Ware, Herts.  
Tel: (0920) 61593

**Bywood Electronics**

68 Ebbwars Road,  
Hemel Hempstead,  
Herts HP3 9QR  
Tel: 0442-62757

**C. N. Stevenson**

236 High Street,  
Bromley,  
Kent, BR1 1PD  
Tel: 01 464 2951/5/770

**Cavern Electronics**

94 Stratford Road,  
Wolverton, Milton Keynes,  
Tel. Milt. K 314925

**Charles Town**

89 Carrington Street,  
Nottingham,  
Tel. Nottm. 868933 and 55489

**C.P. Developments**

16 Hughenden Road,  
High Wycombe,  
Bucks HP13 5DT  
Tel. 0494 30043

**C.T.S. Ltd**

20 Chetham St.,  
Remgate, Kent CT11 7PP.  
Tel. Thanet 54072

**Custom Electronic**

**Controls**

45, Picardy Road,  
Belvedere, Kent OA1 75OH,  
Tel. Erith 34476

**Dewes Electronics**

121 Onnes Road,  
London SW6,  
Tel 01 381 3975

**Direct Electronics**

627 Romford Road,  
Menor Park,  
London E12 5AD,  
Tel 01 553 1174

**D.P. Hobbs**

11 King Street,  
Luton, Beds  
Tel. (0582) 20907

**Eagle Electronics**

10, Eagle Street,  
Ipswich.  
Suffolk, IP4 1JB,  
Tel: Ipswich 58075.

**Electrovelue Ltd.**

28 St. Judes Road,  
Englefield Green,  
Egham,  
Surrey TW20 0HB  
Tel: Egham 3603

**Eley Electronics**

100/104 Beatrice Road,  
Leicester,  
Tel. Leicester B71522

**Frenk Mozer Ltd**

5 Angel Corner Parade,  
Edmonton, London N18,  
Tel: 01-807 2784

**Frezer-Manning Ltd**

26 Hervey Street,  
Ipswich, IP4 2E5,  
Tel. 50975

**Foreway Services**

19 Old High Street,  
Headington,  
Oxford,  
Tel: 0865 68472.3

**GB Gerland Bros. Ltd**

Chesham House,  
Deptford Broadway,  
London SE8 4QN,  
Tel. 01-692 4412

**Greenway Electronic Components**

(East Grinstead Ltd.,  
62 Myloppe Road,  
Ashurst Wood,  
East Grinstead,  
Sussex,  
Tel: 034 282 3712

**Herrington Colorvision**

9 Queen Street,  
Colchester, Essex,  
Tel. Colchester 47503

**HB Electronics**

22, Newfield Street,  
Kettering Northants,  
Tel. (0536) 83922

**Henry's Radio**

404 Edgeware Road,  
Lodon W2.  
Tel: 01 723 5095

**H.G. Repkin**,

11, Kettering Road,  
Abington Square,  
Northants.

**Hi Fi Cars**,

245 Tottenham Court Rd.,  
London W1



**ILP Electronics Ltd**

Crossland House,  
Nackington,  
Canterbury, Kent,  
Tel: 0227 83218

**J.T. Filmer,**

82 Dartford Road,  
Kant DA1 3ER  
Tel: (03221) 24057

**Kays Electronics,**

195 Sheffield Road,  
Chastelfield,  
Derbyshire  
Tel: (02461) 31696

**Lloyd Electronics**

126, High Street,  
West Wickham, Kent,  
Tel: 01 777 3247

**MTRS**

20 Whita Hart Street,  
Mansfield, Notts.,  
Tel. Mansfield 23107

**Maydele Electronic Services**

2 Wallasay Parade,  
Godstone Road, Whytalafra,  
Surrey CR3 0BL,  
Tel. Upper Warrington 5169

**Mays of Church Gate**

12/14 Church Gate  
Laiicester LE1 4AJ,  
Tel: 58662

**Orchard Electronics**

Orchard House, St. Martins St.  
Wallingford, Oxon OX10 0DE,  
Tel. Wallingford (0491) 35529

**Electronic Centre**

45 Lower Hill Gate,  
Stockport, Cheshire SK11 1JQ,  
Tel: 061 480 9791

**Phonoscopes**

22 High Street  
Sidcup,  
Kent

**RB Electrical & Electronics,**

24 Springfield Park,  
Hollyport,  
Maccanhead,  
Barks  
Tel: 0628 39798

**R.S.M. Television**

38 Carrington Street,  
Nottingham,  
Tel. Nottm. 868933

**S & A Enterprises,**

25, Common View,  
Latchworth, SG6 1BZ,  
Herts. Tel: 01 467 0092

**Noble Electronics,**

26, Lloyd Street,  
Aitringham, Cheshire,  
WA14 2OE  
Tel.: 061 941 4510

**Norman Inskip,**

16 New Road,  
Chatham, Kent  
Tel: (0634) 811119.

**Smiths of Edgware Road**

287-289 Edgware Road,  
London W2 1BE,  
Tel. 01-723 5891

**Swanley Electronics**

P.O. Box 68  
Swanley, Kent,  
Tel. Swanley 64851

**C & L Electronics**

B1 Rosemary Road,  
Nr. Jackson Corner,  
Clacton on sea, Essex,  
Tel: 0255 23266

**S.R. Services**

21b, Park Road, (Intrance  
Queens Road) Chislehurst,  
Kent. Tel: 01 467 0092

**Suttons**

50 Blue Boar Row,  
Salisbury,  
Tel. 27171

**Tandy,**

1 Emmanuel Street,  
Cambridge CB1 1NE  
Tel: (0223) 68155

**Technomatic Ltd.,**

17 Burnley Road,  
London, NW10  
Tel: 01-452 1500  
Telax: 922800

**Telecraft**

53 Werwick Road,  
New Barnet,  
Herts EN5 5EQ  
Tel: 01-440-7033

**Teleredio**

325/7 Foru Street,  
Edmonton,  
London N9 0BE  
Tel. 01 807 3719

**Brian J. Reed,**

161 St. Johns Hill,  
Battans,  
London SW11,  
Tel: 01 223 5016

**OC Trading**

1 St Michaels Terrace,  
Wood Green,  
London N22 4S,  
Tel. 01-889 7593

**Vero Electronics Ltd.**

Retail Dept.,  
Industrial Estate,  
Chandlers Ford,  
Hants SO5 3ZR  
Tel: Chandlers Ford 2956

**Videocraft**

Assets House,  
Elvarton St.,  
London SW1P 2QR  
Tel: 01-828-2731

**Wetford Electronics**

33 3S Cardiff Road,  
Wetford,  
Herts WO1 8DS  
Tel. 0923 37774

**T. Powell,**

306 St. Pauls Road,  
Highbury Corner,  
London N1,  
Tel: 01 226 1489

**Zartronix**

115 Lion Lane,  
Haslemere, Surrey,  
Tel: 0428 5244S

**Rushmoor Electronics**

43, Queens Road,  
Farnborough,  
Hants GU14 6JP  
Tel. Farnborough 515373

**AREA 4****The Electronic Centre**

18 Collage Square East  
Belfast 1  
N Ireland  
Tel. Belfast 27357

**WM. B. Peat & Company Ltd**

25/26 Parnal Street  
Dublin 1, Ireland  
Tel. 749973/4

**WHO and WHERE international****BELGIUM**

Vadelec Electronics  
24-26 Avenue de l'Heliport,  
1000 Brussels.  
Tel: 02 218 26 40  
Telex: 20601

**CANADA****Kitronic**

28236 - 26th Ave.,  
RR 5, Aldergrove,  
British Columbia

**DENMARK****Dansk MINI Radio**

Nr. Farimagsgade,  
S7 59,  
1364 Copenhagen K.

**Aage Nielsen Eftf.**

1, Sortedam Dossingen  
2200 Copenhagen N.

**Hobby Electronics,**

37, Nædergade  
5000 Odense

**Fraderikshave Hobby****Elektronik**

9, Havnegade  
900 Frederikshavn

**Elektroden,**

S. Tordenskjoldsgade  
8200 Århus C.

**IB's Radioservice,**

Hovdrupvej 22,  
9400 Nørresundby

**WK Electronic,**

5, Skolatorvet,  
8600 Silkeborg.

**Kolding Elektronik,**

40, Agrtrupvej 40,  
6000 Kolding

**Ulle Electronic,**

Christiansgade 58,  
9000 Ålborg

**Radiolytternes****Indkøbscentral,**

18, Borgergade,  
1300 Copenhagen K.

**Holte Elektronik,**

Holte Midtpunkt,  
2940 Holte

**Lillie Elektronik,**

89, Søndergade,  
6500 Vejers

**Gettermann Electronic,**

Radhuspassagen,  
7100 Vejle

**EL-Star Hobby,**

143 Finsensvej,  
2000 København F.

**Rotec,**

16, Jernbanegade,  
4800 Nykøbing Falster

**FRANCE****BERIC,**

43 Rue Victor Hugo,  
Melakoff 92, Paris

**PENTASONIC**

5 Rue Maurice Bourdet  
75015 Paris

**Selectronic,**

14, Boulevard Carnot,  
98800 Lilla, France  
Tel: (20) 55.98.98

**INDIA****PRECIOUS ELECTRIC CORPORATION**

3 Chunem Lane,  
Oadasehah Bhadkamkar Marg,  
BOMBAY - 400 007

**INDONESIA****Inel Co.,**

Office: Jl. Naripen 9B,  
Bandung,  
Tel: 59544

**ISRAEL****K.D.M. ELECTRONICS LTD.,**

Tal Aviv,  
21 Tchernihovskiy St.,  
P.O.B. 4770

**ITALY**

Vulpetti Guiseppe,  
i2VTT Via G.Cesare,  
4-22063 Cantu,  
ELCOM

34170 Gorizia,  
Via Angiolina 23

**SOUTH AFRICA****PHILTRON (PTY) LTD.,**

P.O. Box 2749  
Pratoria 0001.

**SWEDEN****COILTRONIC**

Box 5007,  
16305 Spaanga

**KITEL Distribution**

Box 21038  
S-100 31 STOCKHOLM

**TURKEY****ELEKTRONIK DERGI VE KİTAP**

Yayinevi P.K. 1126,  
Karakoy,  
İstanbul;

**NEW ZEALAND****Orbit Electronics,**

181 Hobson St.,  
Auckland 1,  
New Zealand.

# TRANSAM

TRANSAM COMPONENTS LTD., 12 CHAPEL STREET, LONDON, N.W.1. TEL: 402 8137

## The exciting new **TRITON** Personal Computer

**Basic in Rom:** a powerful 2k Tiny basic resident on board, makes Triton unique, easy to use and versatile.  
**Graphics:** 64 Graphic characters as well as full alpha numerics.  
**Single Board:** Holds up to 8k of memory, 4k RAM and 4k ROM, supplied with 3k to use and versatile.  
**Memory Mapping:** 2 mode VDU, I/O or memory mapped for animated graphics.  
**Cassette Interface:** crystal controlled Modern tape I/O with auto start/stop + "named" file search.  
**U.H.F. TV Interface:** On board uhf modulator, plugs into TV aerial socket

COMES COMPLETE with keyboard, case, full power supply, quality through hole plated P.C.B. Full (118 page) instruction manual. A powerful 1k Monitor and 2k Tiny basic in Eprom all I.C. Sockets. All components can be bought separately, so you can start construction on a low budget. Full details of prices and discounts are shown in our new 1979 catalogue.

### EXPANSION BOARDS

**MOTHERBOARD - 8 slot**  
A new 8 slot Triton Motherboard is now available based on Eurobus. It allows easy expansion and has its own meaty power supply.

**8k STATIC RAM**  
Eurocard size (160 x 100mm) 8k Static Ram fully buffered, on board regulation and decoding uses 4k (1k x 4) static rams. Just plugs into Motherboard for memory expansion.

**8k EPROM BOARD**  
Designed to take 8 x 2708 Eproms on the Triton bus. Don't forget our Programming Service



**TRITON KIT** ..... £286  
**MOTHERBOARD KIT** ..... £50  
**8k RAM CARD** ..... £57  
**8k EPROM CARD** ..... T.B.A. end Feb.  
Prices exclude VAT 8%.

118 Page Manual inc. P&P £5.70  
Full details in Catalogue 30p. + SAE.

# Kitronic

AUDID, DIGITAL AND ELECTRONIC  
COMPONENTS LTD.

26236 26TH AVE R R 5 ALDERGRDVE B.C. VOX 1A0 B56-

CANADIAN DISTRIBUTORS to  
specialty shops of:

## ELEKTOR

magazines, binders and P.C.  
boards for elector projects.

WESTERN CANADIAN DISTRIBUTORS OF computer  
PERSONAL COMPUTING, 73 MAGAZINE, R.O.M. magazines:  
INTERFACE AGE, BYTE, KILOBAUD,  
SYBEX BOOKS

THE ONLY WESTERN CANADIAN  
STEREO MAIL ORDER HOUSE

CURRENT and BACK ISSUES  
are available by mail order for  
the above magazines and books.  
Send a self addressed stamped  
envelope for a complete list of  
magazines and books.

Send one dollar for catalog and  
current price lists. Components,  
Kits, speakers, amplifiers, rec-  
eivers etc.

DEALER ENQUIRIES WELCOME

SEND ALL MAIL  
ORDERS TO:

## Kitronic

AUDID, DIGITAL AND ELECTRONIC  
COMPONENTS LTD.

26236 - 26TH AVE., R.R. 5, ALDERGRDVE, B.C. VOX 1A0